



DFS Test Report

Product Name : WIRELESS-A/N 26DBM NETWORK MINI
PCI ADAPTER

Model No. : IWAVEPORT WLM200N5-26

Applicant : Compex Systems Pte Ltd

Address : 135 Joo Seng Road, #08-01 PM Industrial Building
Singapore 368363

Date of Receipt : 2009/01/20

Issued Date : 2009/02/04

Report No. : 091307S-RFUS

Version : V2.0

The test results relate only to the samples tested.

The test report shall not be reproduced except in full without the written approval of QuieTek Corporation.

DFS Test Report

Issued Date : 2009/02/04
Report No. : 091307S-RFUS



Product Name : WIRELESS-A/N 26DBM NETWORK MINI PCI ADAPTER
 Applicant : Compex Systems Pte Ltd
 Address : 135 Joo Seng Road, #08-01 PM Industrial Building
 Singapore 368363
 Manufacturer : Compex Systems Pte Ltd
 Model No. : IWAVEPORT WLM200N5-26
 Trade Name : COMPEX
 Applicable Standard : FCC CFR Title 47 Part 15 Subpart E : 2007
 Test Result : Pass

Test Item	Test Result
Dynamic Frequency Selection (DFS)	<input checked="" type="checkbox"/> Pass <input type="checkbox"/> Fail

Roy Wang

Rita Hsu

(Roy Wang / Manager)

(Rita Hsu / Engineer)

Dynamic Frequency Selection (DFS) Test Result

FCC Part 15.407:

U-NII devices operating in the 5.25-5.35 GHz band and the 5.47-5.725 GHz band shall employ a TPC mechanism. The U-NII device is required to have the capability to operate at least 6 dB below the mean EIRP value of 30 dBm. A TPC mechanism is not required for systems with an E.I.R.P. of less than 500 mW.

U-NII devices operating in the 5.25-5.35 GHz and 5.47-5.725 GHz bands shall employ a DFS radar detection mechanism to detect the presence of radar systems and to avoid co-channel operation with radar systems.

UNII Device Description

The UUT operates in the following band:

1. 5250-5350 MHz
2. 5470-5725 MHz

The UUT is a Client Device that does not have radar detection capability and ad-hoc function. The highest gain antenna assembly utilized with the EUT has a maximum gain of 2 dBi in 5GHz frequency band. The 50-ohm Tx/Rx antenna port is connected to the test system to perform conducted tests. TPC is not required since the maximum EIRP is less than 500mW (27dBm).

The UUT utilizes 802.11a/b/g/n **IP based** architecture. Two nominal channel bandwidths, 20 MHz and 40MHz are implemented.

WLAN traffic is generated by streaming the video file TestFile.mp2 from the Master device to the Slave device in full motion video mode using the media player with the V2.61 Codec package

The master device is a Cisco Aironet 802.11a/g/n Access Point. The DFS software installed in the master device is Cisco IOS Releases 12.3(11) JA.

The UUT is a client device without radar detection, therefore the interference threshold level is not required.

Test Equipment

Dynamic Frequency Selection (DFS) / SR-7

Instrument	Manufacturer	Type No.	Serial No	Cal. Date
Spectrum Analyzer	Rohde & Schwarz	FSP	100561	Jan, 21, 2009
Vector Signal Generator	Rohde & Schwarz	SUM 200A	102168	Jan, 08, 2009

Instrument	Manufacturer	Type No.	Serial No
Splitter/Combiner (Qty: 2)	Mini-Circuits	ZAPD-50W 4.2-6.0 GHz	NN256400424
Splitter/Combiner (Qty: 2)	Mini-Circuits	ZA2PD-63-S+	SN049200828
ATT (Qty: 3)	Mini-Circuits	BW-S3W2 DC-18GHz	0025
Aironet Access Point	Cisco System	AP1252AG	FTX121090DP
Laptop PC	Dell	M65	28G9N1S
RF Cable (Qty: 4)	Schaffner		25494/6

Software	Manufacturer	Function
IOS Releases 12.3(11) JA	Cisco System	DFS Software
R&S K6 Pulse Sequencer	Rohde & Schwarz	Radar Signal Generation Software
Media Player Classic v6.4.8.6	Gabest.org	Multimedia Player

Limit

According to §15.407(h) and FCC 06-96 APPENDIX “COMPLIANCE MEASUREMENT PROCEDURES FOR UNLICENSED NATIONAL INFORMATION INFRASTRUCTURE DEVICES OPERATING IN THE 5250-5350 MHz AND 5470-5725MHz BANDS INCORPORATING DYNAMIC FREQUENCY SELECTION”.

Applicability of DFS requirements prior to use of a channel

Requirement	Operational Mode		
	Master	Client (with radar detection)	Client (without radar detection)
Non-Occupancy Period	Yes	Yes	Yes
DFS Detection Threshold	Yes	Yes	Not Required
Channel Availability Check Time	Yes	Not Required	Not Required
Uniform Spreading	Yes	Not Required	Not Required
U-NII Detection Bandwidth	Yes	Yes	Not Required

Applicability of DFS requirements during normal operation

Requirement	Operational Mode		
	Master	Client (with radar detection)	Client (without radar detection)
DFS Detection Threshold	Yes	Yes	Not Required
Channel Closing Transmission Time	Yes	Yes	Yes
Channel Move Time	Yes	Yes	Yes
U-NII Detection Bandwidth	Yes	Yes	Not required

Interference Threshold value, Master or Client incorporating In-Service Monitoring

Maximum Transmit Power	Value (see note)
≥ 200 milliwatt	-64 dBm
< 200 milliwatt	-62 dBm

Note 1: This is the level at the input of the receiver assuming a 0 dBi receive antenna.
 Note 2: Throughout these test procedures an additional 1 dB has been added to the amplitude of the test transmission waveforms to account for variations in measurement equipment. This will ensure that the test signal is at or above the detection threshold level to trigger a DFS response.

DFS Response requirement values

Parameter	Value
Non-Occupancy Period	30 Minutes
Channel Availability Check Time	60 Seconds
Channel Move Time	10 Seconds
Channel Closing Transmission Time	200 milliseconds + approx. 60 milliseconds over remaining 10 seconds period (See Notes 1 and 2)

Note1: The instant that the Channel Move Time and the Channel Closing Transmission Time begins is as follows:

- For the short pulse radar test signals this instant is the end of the burst.
- For the frequency hopping radar test signal, this instant is the end of the last radar burst generated
- For the long pulse radar test signal this instant is the end of the 12 seconds period defining the radar transmission.

Note 2: The channel closing transmission time is comprised of 200 milliseconds starting at the beginning of the channel move time plus any additional intermittent control signals required facilitating channel changes (an aggregate of approximately 60 milliseconds) during the remainder of the 10 seconds period. The aggregate duration of control signals will not count quiet periods in between transmissions.

Short Pulse Radar Test Waveforms

Radar Type	Pulse Width (μsec)	PRI (μsec)	Pulses	Minimum Percentage of Successful Detection	Minimum Trials
1	1	1428	18	60%	30
2	1-5	150-230	23-29	60%	30
3	6-10	200-500	16-18	60%	30
4	11-20	200-500	12-16	60%	30
Aggregate (radar types 1-4)				80%	120

A minimum of 30 unique waveforms are required for each of the short pulse radar type 2 through 4. For short pulse radar type 1, then same waveform is used a minimum of 30 times. If more than 30 waveforms are used for short pulse radar type 2 through 4, then each additional waveform must also be unique and not repeated from the previous waveforms. The aggregate is the average of the percentage of successful detections of short pulse radar type 1-4.

FCC Radar Types (1 to 4) System Diagram

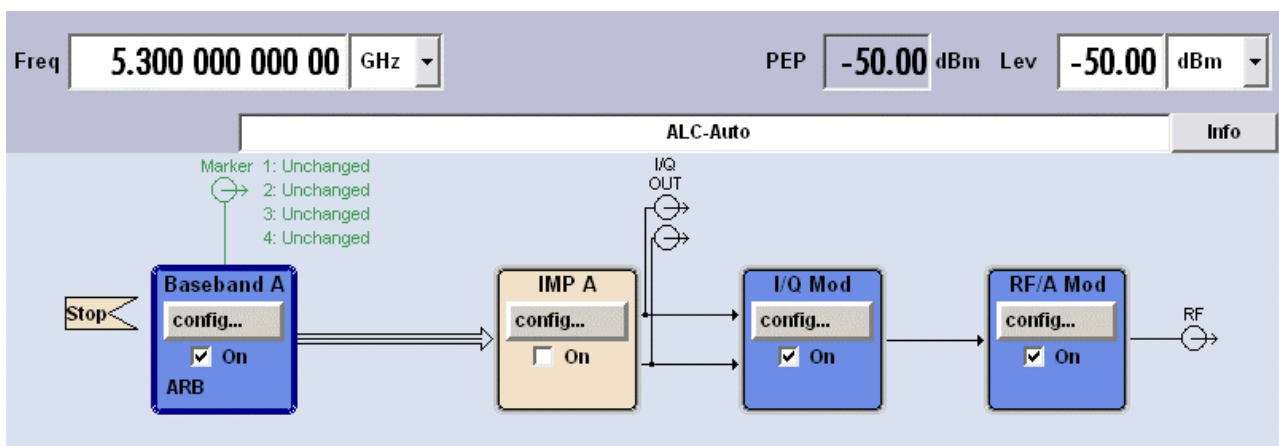

- Used R&S SMU200A (Vector SG with one ARB)
- B11: Base-band Generator with ARB and Digital Modulation
- B13: Base-band Main Module
- B106: Frequency range (100 kHz to 6 GHz)

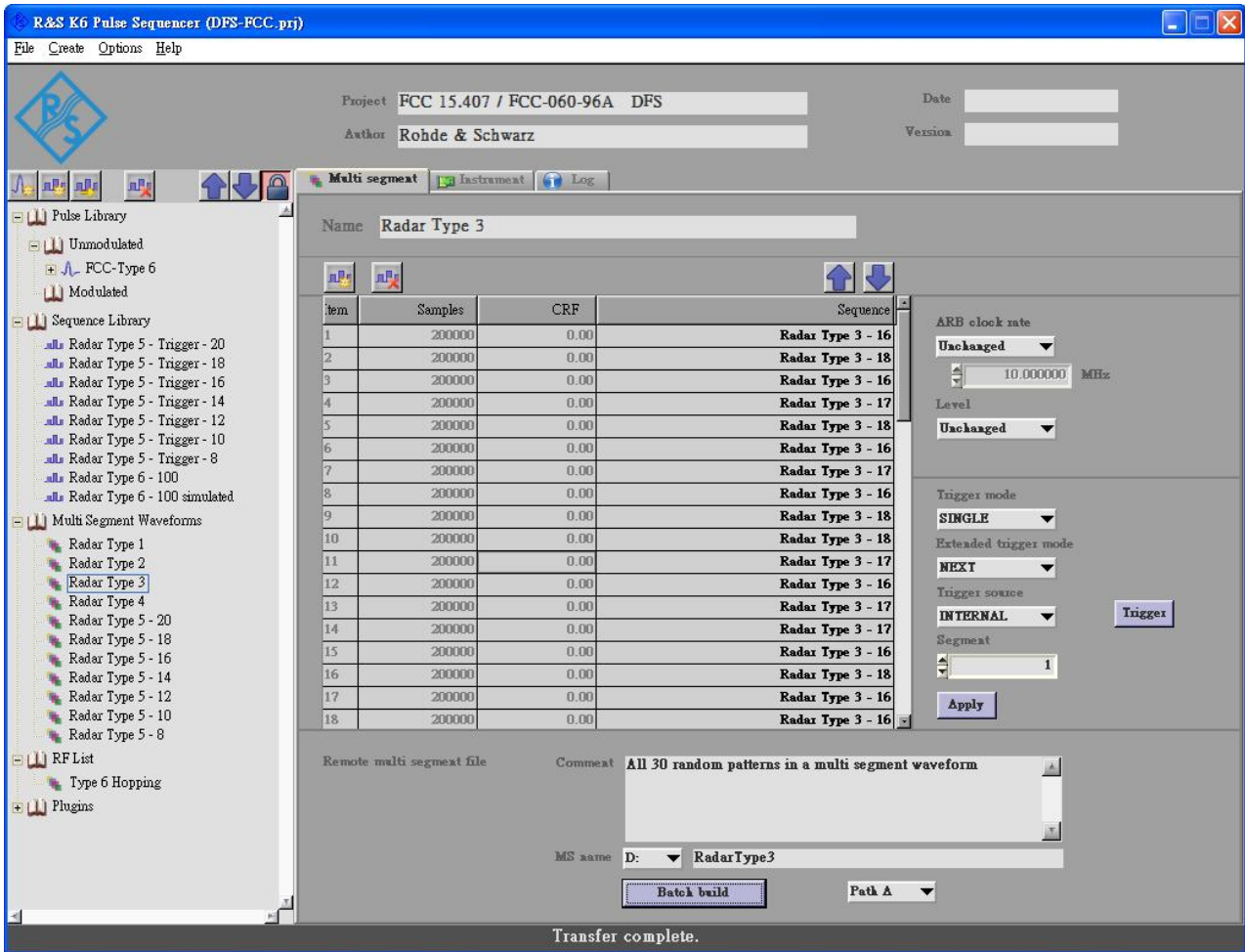

Used R&S K6 Pulse Sequencer Software to select the waveform parameters from the bounds of the signal type, system were random selection using uniform distribution.

Long Pulse Radar Test Signal

Radars Waveform	Bursts	Pulses Per Burst	Pulse Width (μsec)	Chirp Width (MHz)	PRI (μsec)	Minimum Percentage of Successful Detection	Minimum Trials
5	8-20	1-3	50-100	5-20	1000-2000	80%	30

The parameters for this waveform are randomly chosen. Thirty unique waveforms are required for the long pulse radar test signal. If more than 30 waveforms are used for the long pulse radar test signal, then each additional waveform must also be unique and not repeated from the previous waveforms.

FCC Radar Type 5 System Diagram

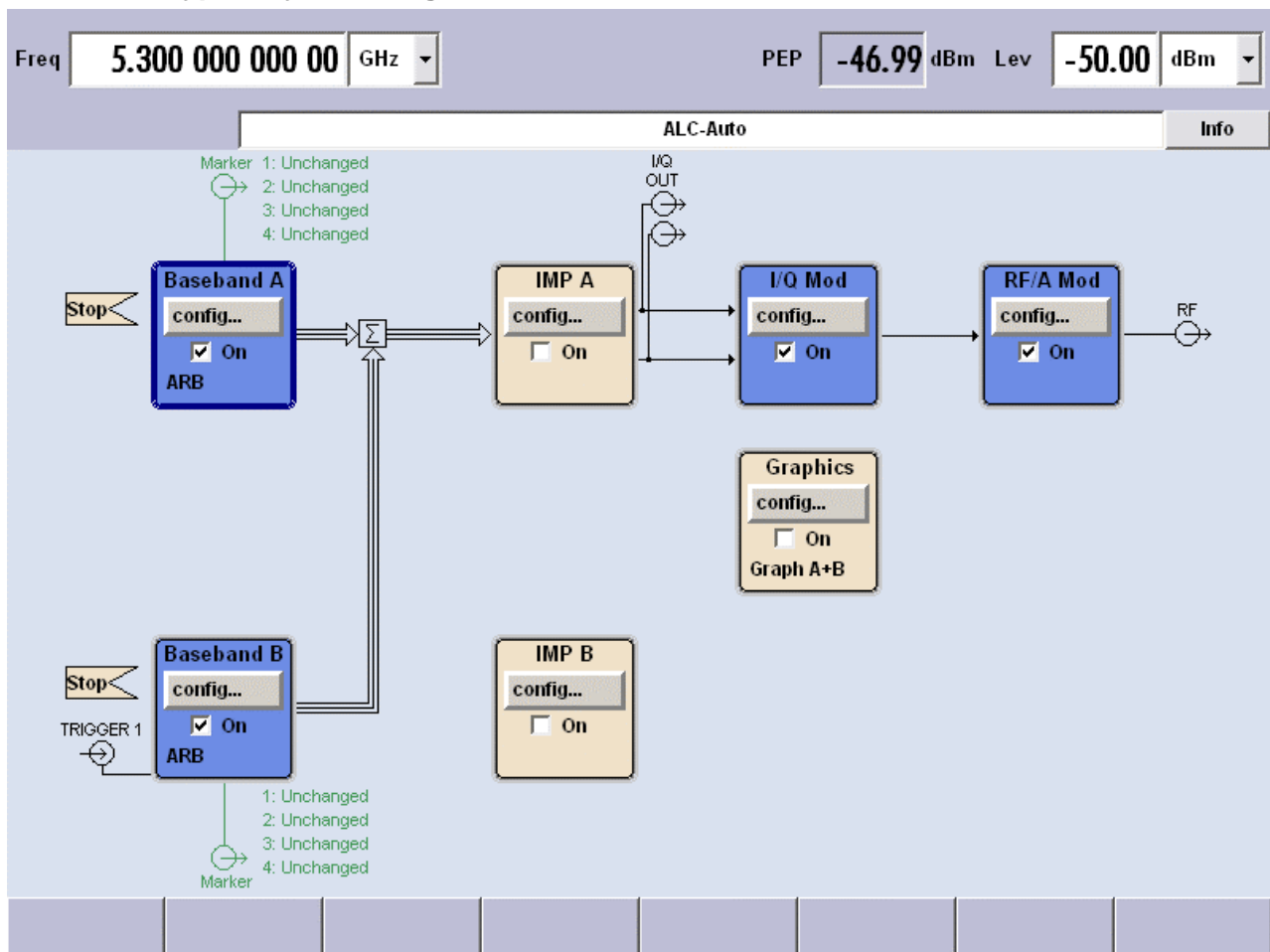

- Used R&S SMU200A (Vector SG with Two ARB)
- 2*B11: Base-band Generator with ARB and Digital Modulation
- 2*B13: Base-band Main Module
- B106: Frequency range (100 kHz to 6 GHz)

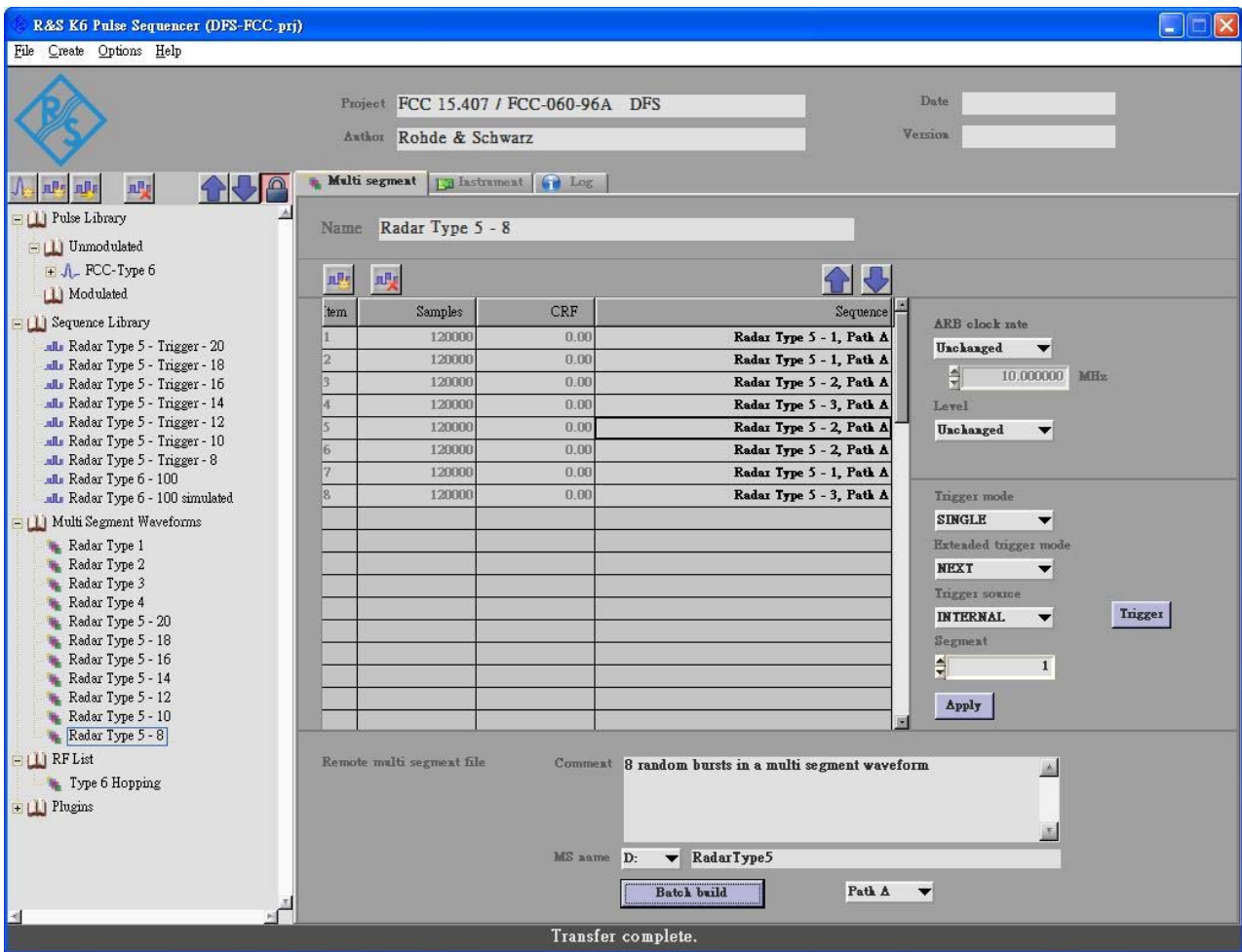

Used R&S K6 Pulse Sequencer Software to select the waveform parameters from the bounds of the signal type, system were random selection using uniform distribution.

Frequency Hopping Radar Test Signal

Radar Waveform	Pulse Width (μsec)	PRI (μsec)	Hopping Sequence Length (msec)	Pulses Per Hop	Hopping Rate (kHz)	Minimum Percentage of Successful Detection	Minimum Trials
6	1	333	300	9	.333	70%	30

For the frequency hopping radar type, the same burst parameters are used for each waveform. The hopping sequence is different for each waveform and a 100-length segment is selected from the hopping sequence.

FCC Radar Types 6 System Diagram

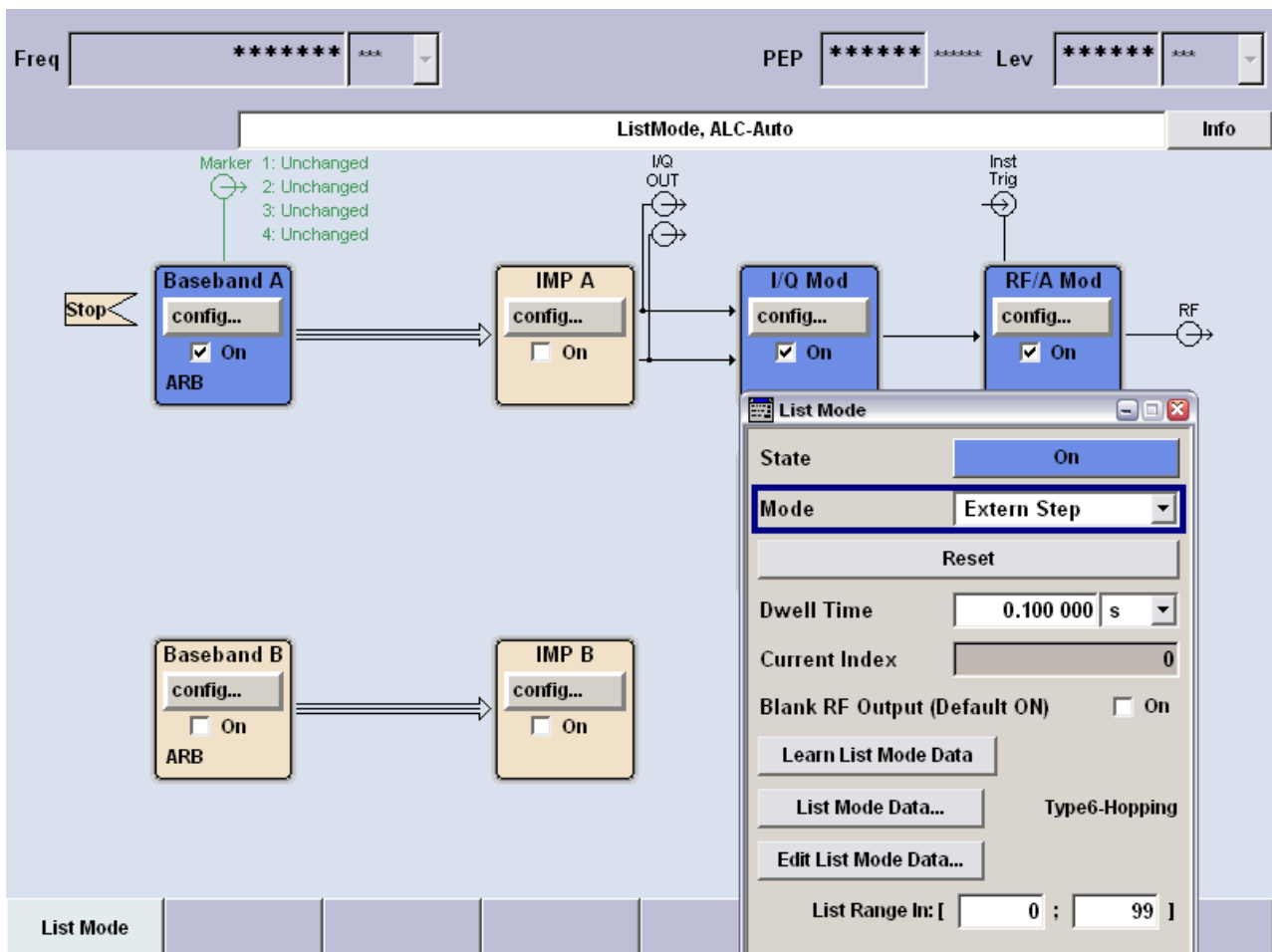

Used R&S SMU200A (Vector SG with one ARB)
 B11: Base-band Generator with ARB and Digital Modulation
 B13: Base-band Main Module
 B106: Frequency range (100 kHz to 6 GHz)

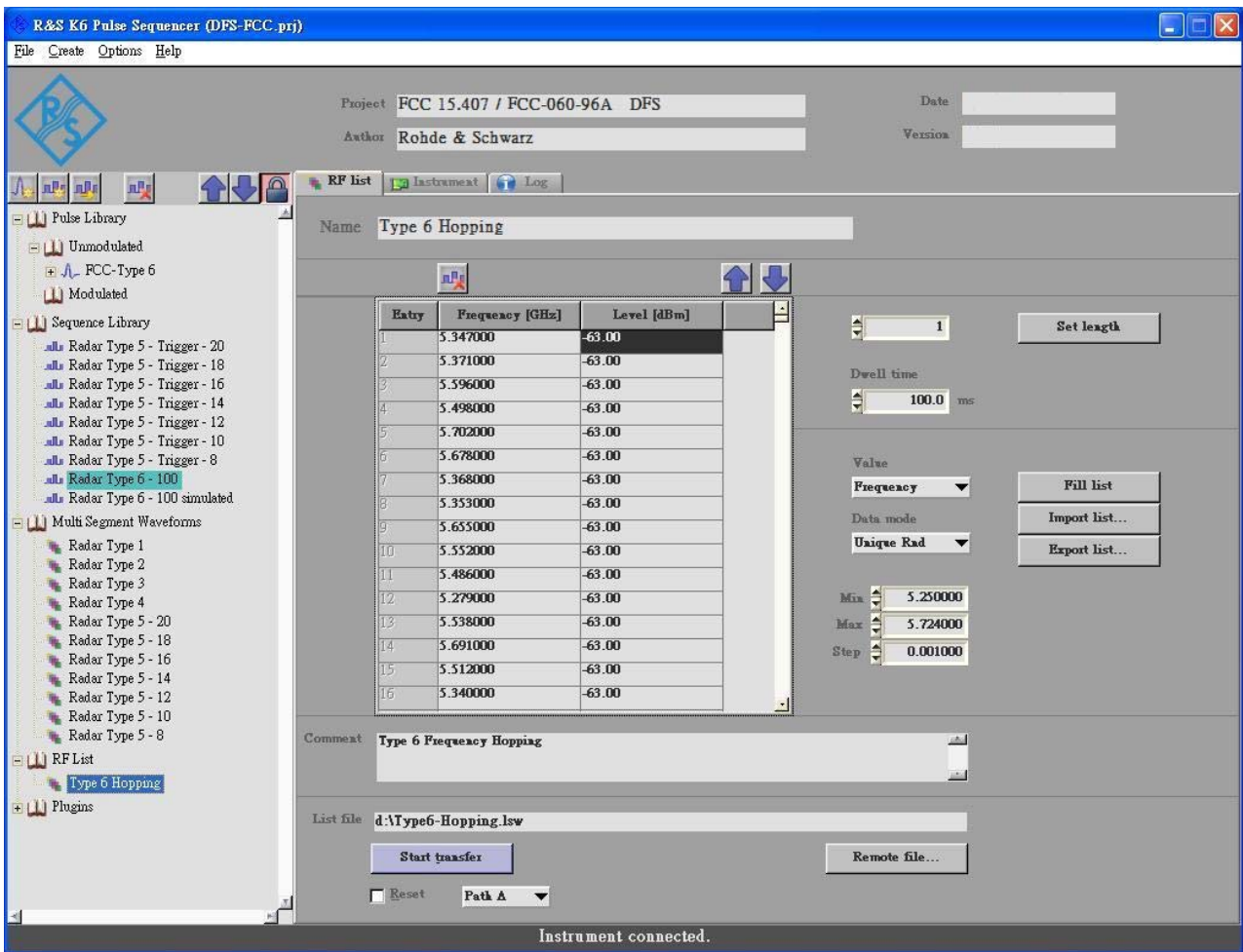

Used R&S Pulse K6 Sequencer Software to select the waveform parameters from the bounds of the signal type, system were random selection using uniform distribution.

Radar Waveform Calibration

The following equipment setup was used to calibrate the conducted radar waveform. A spectrum analyzer was used to establish the test signal level for each radar type. During this process there were replace 50ohm terminal from master and client device and no transmissions by either the master or client device. The spectrum analyzer was switched to the zero span (time domain) at the frequency of the radar waveform generator. Peak detection was utilized. The spectrum analyzer resolution bandwidth (RBW) and video bandwidth (VBW) were set to 1MHz and 3 MHz.

The signal generator amplitude was set so that the power level measured at the spectrum analyzer was -55 dBm due to the interference threshold level is not required.

Conducted Calibration Setup

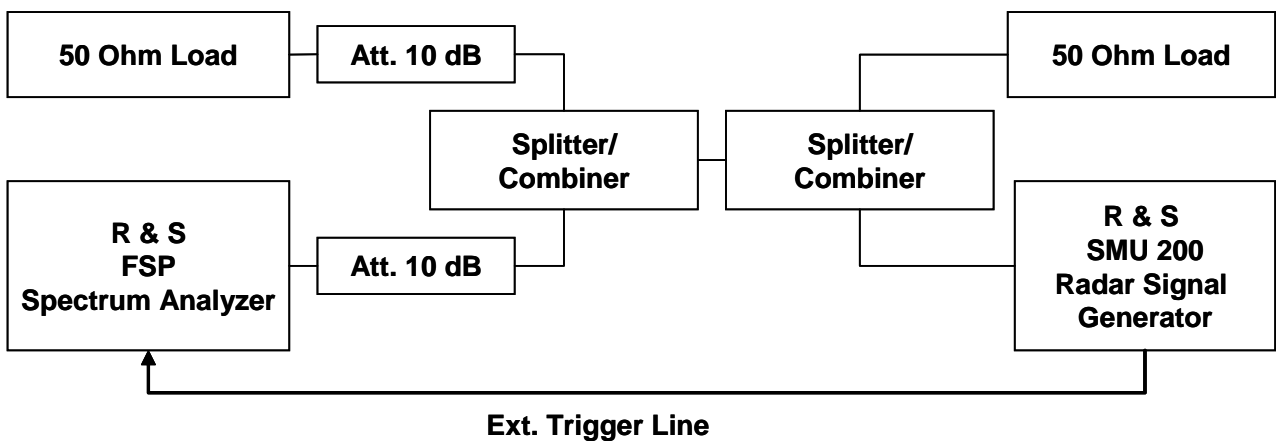

Radar Type 1 Calibration Plot

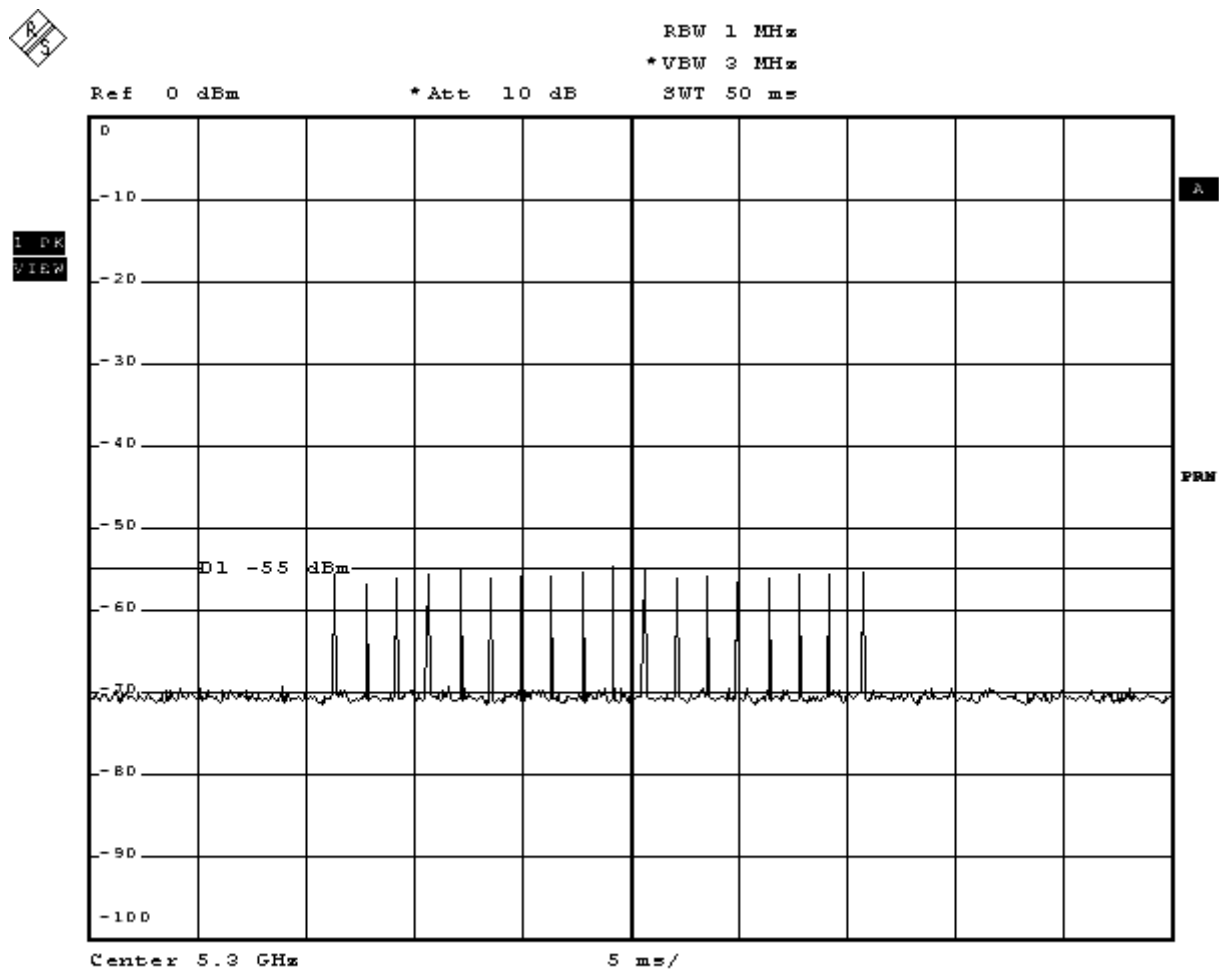

Test Procedure

A spectrum analyzer is used as a monitor to verify that the EUT has vacated the channel within the channel closing transmission time and channel move time after the detection and channel move.

The EUT is a WLAN device operating as client without radar interference detection function. Radar test signals are injected into the master device. This set-up also contains a WLAN device operating in master device. The EUT (client device) is associated with the master device.

Following is the test setup used to generate the radar waveforms and for all DFS tests described herein.

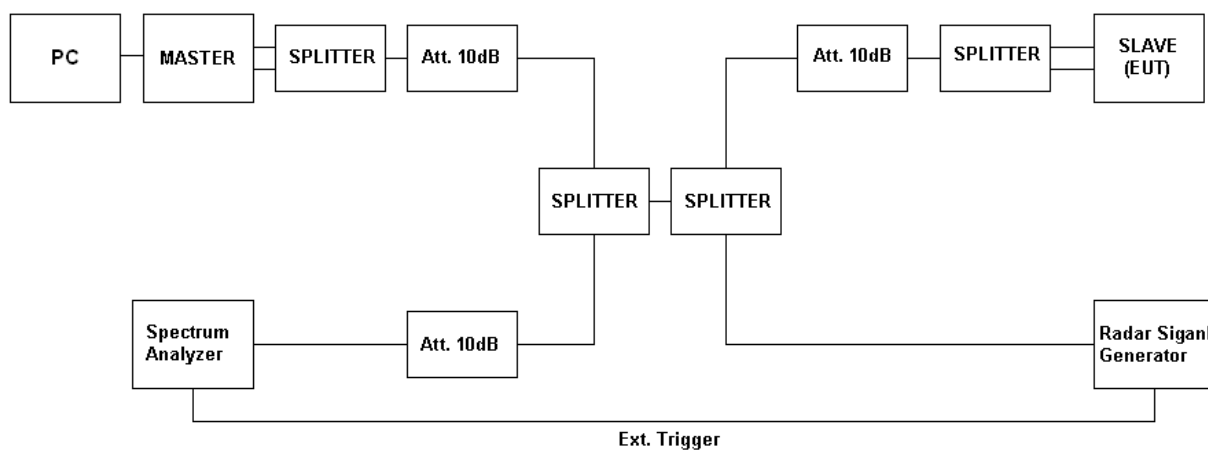

Full DFS Test Set-up Photo

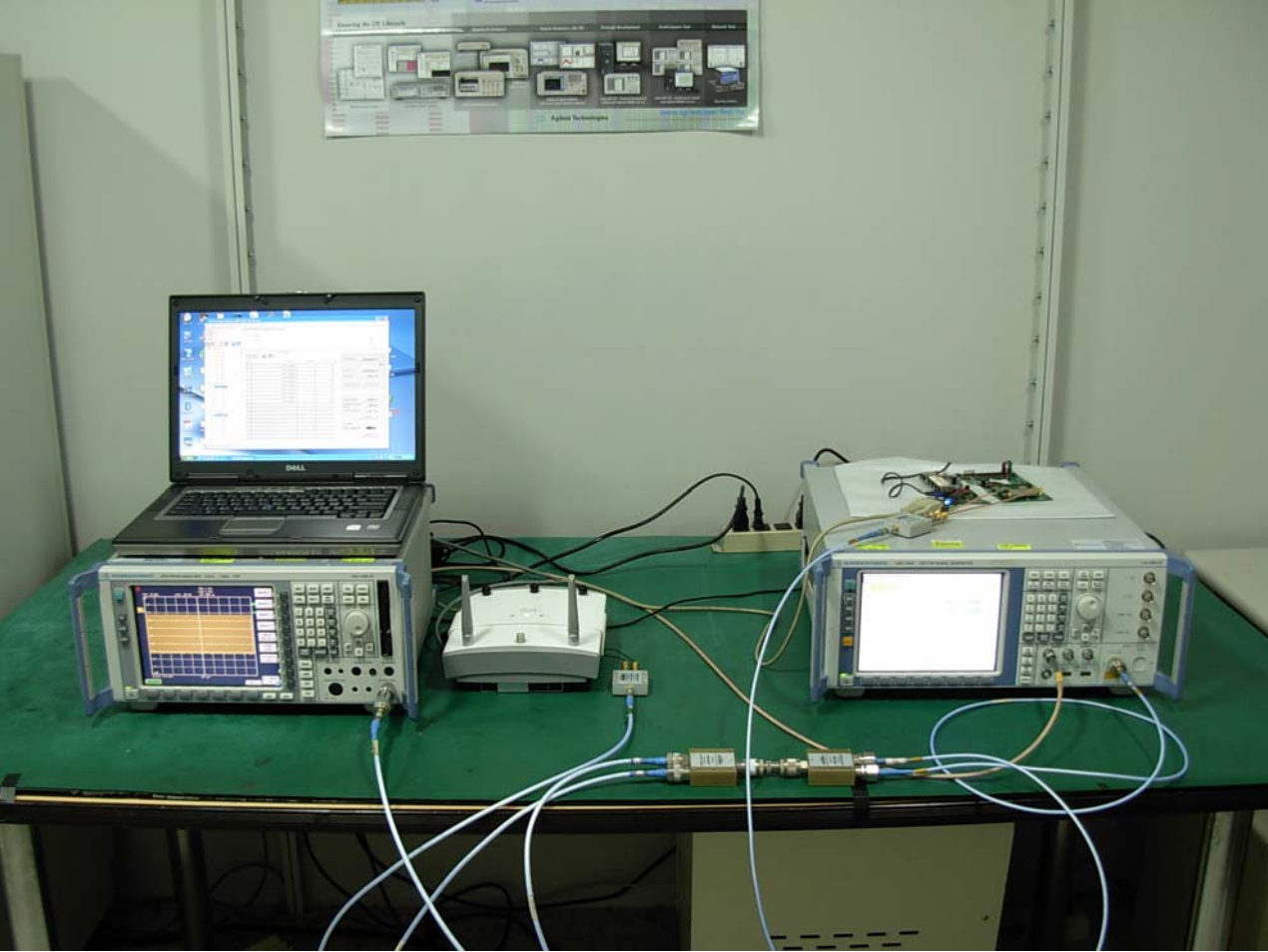

DFS Set-up Photo: Master and Spectrum Analyzer

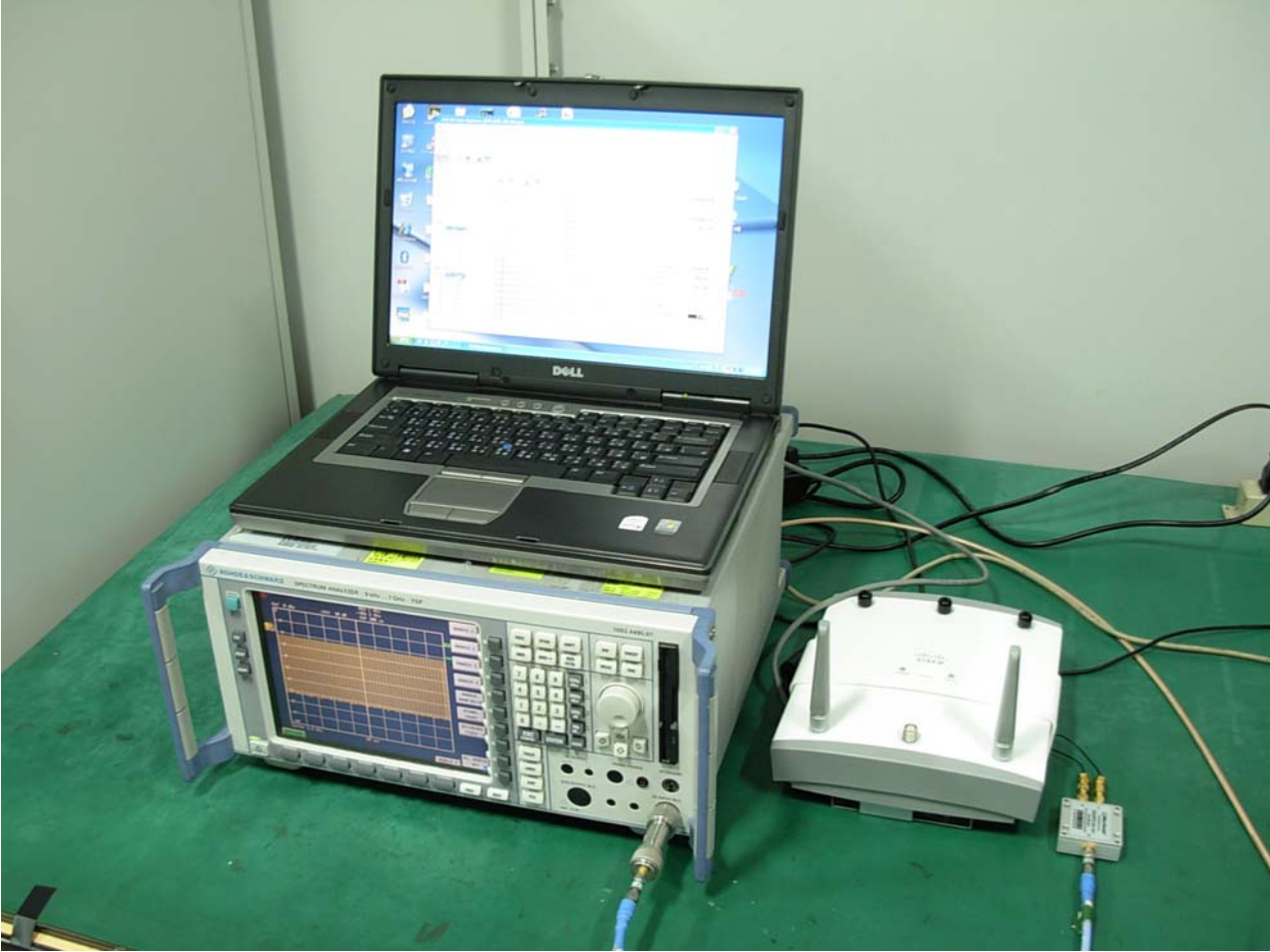

DFS Set-up Photo: Client and Radar Generator

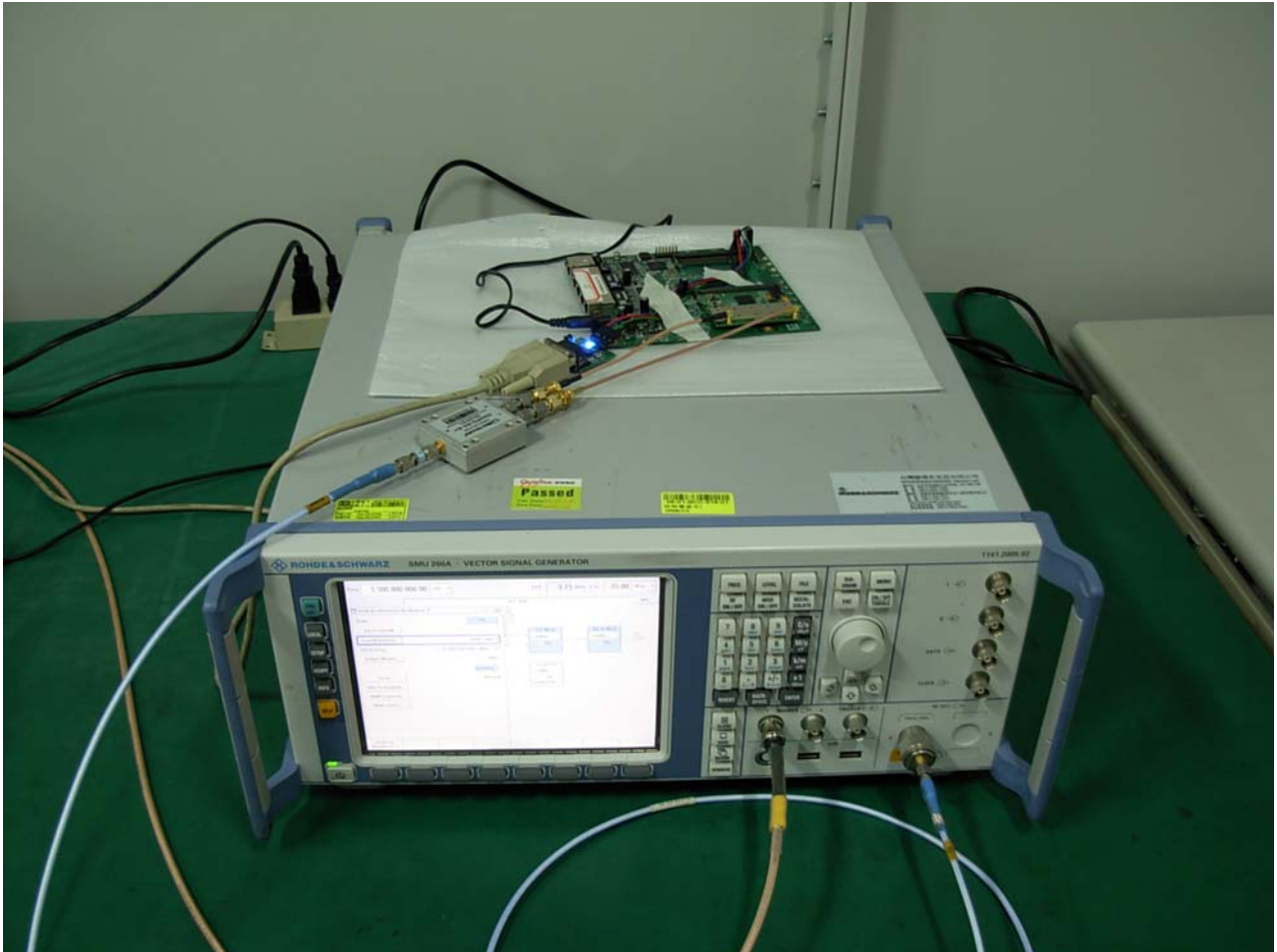

Channel Move Time and Channel Closing Transmission Time

These tests define how the following DFS parameters are verified during In-Service Monitoring; Channel Closing Transmission Time and Channel Move Time.

The steps below define the procedure to determine the above mentioned parameters when a radar burst with a level -55 dBm is generated on the operating channel of the U-NII device.

A U-NII device operating as a Client device will associate with the Master device at 5300MHz, 55000MHz for 20MHz channel bandwidth and 5310MHz, 5510MHz for 40 MHz channel bandwidth.

During the in-service monitoring detection probability and channel moving tests the system was configured with a streaming video file from the master device (sourced by the PC connected to the master device via an Ethernet interface) to the client device. The streamed file was the "FCC" test file and the client device was using Media Player Classic as required by FCC Part 15 Subpart E.

Observe the transmissions of the EUT at the end of the radar burst on the operating channel for duration greater than 10 seconds. Measure and record the transmissions from the spectrum analyzer during the observation time (Channel Move Time). Compare the channel move time and channel closing transmission time results to the limits defined in the DFS Response requirement values table.

20MHz Channel Mode

Channel Move Time for Radar Test Signal 1 at 5300MHz

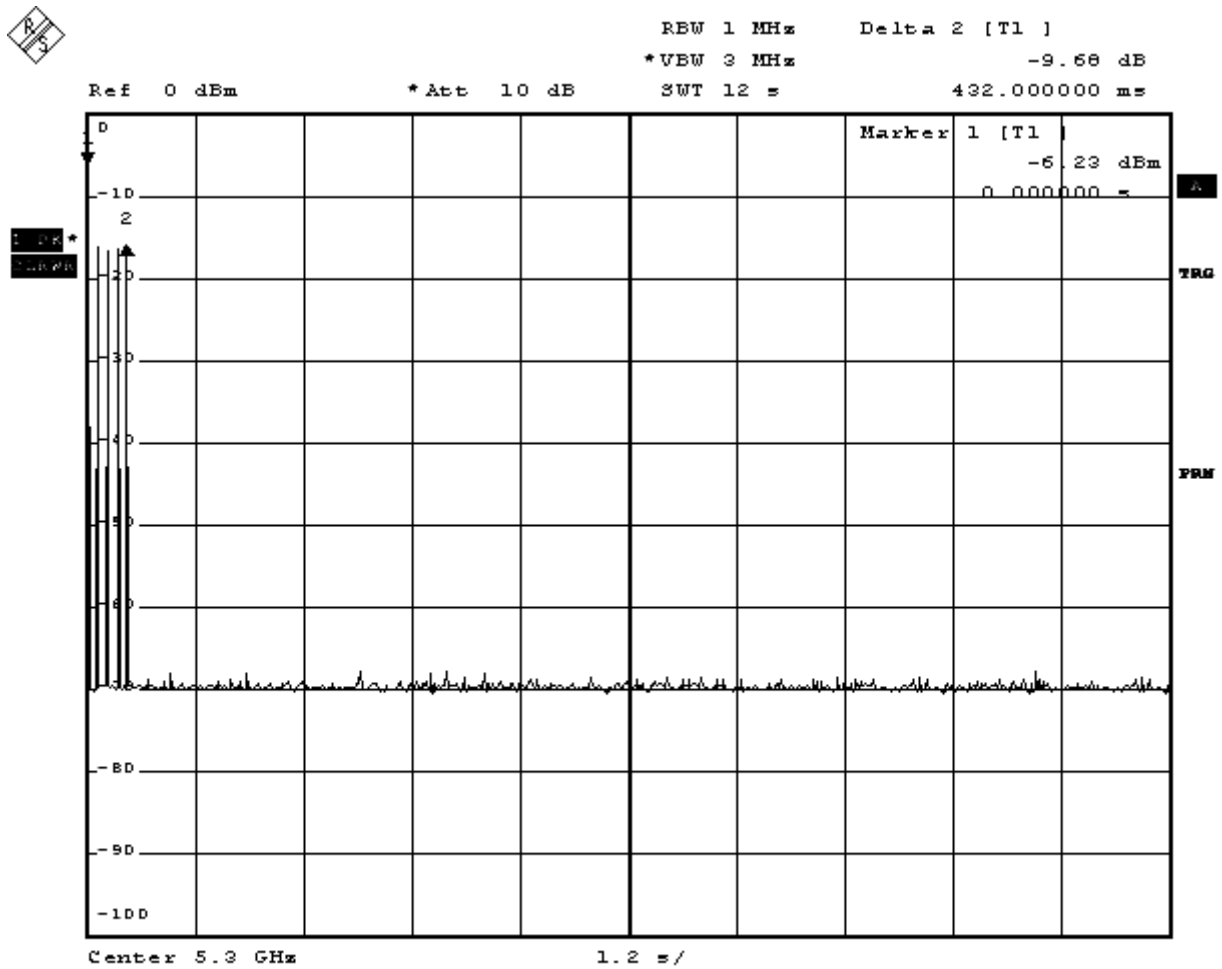

Test Item	Limit	Results
Channel Move Time	10 Seconds	Pass

The results showed that after radar signal injected the channel move time was less than 10 seconds.

20MHz Channel Mode

Channel Closing Transmission Time for Radar Test Signal 1 at 5300 MHz

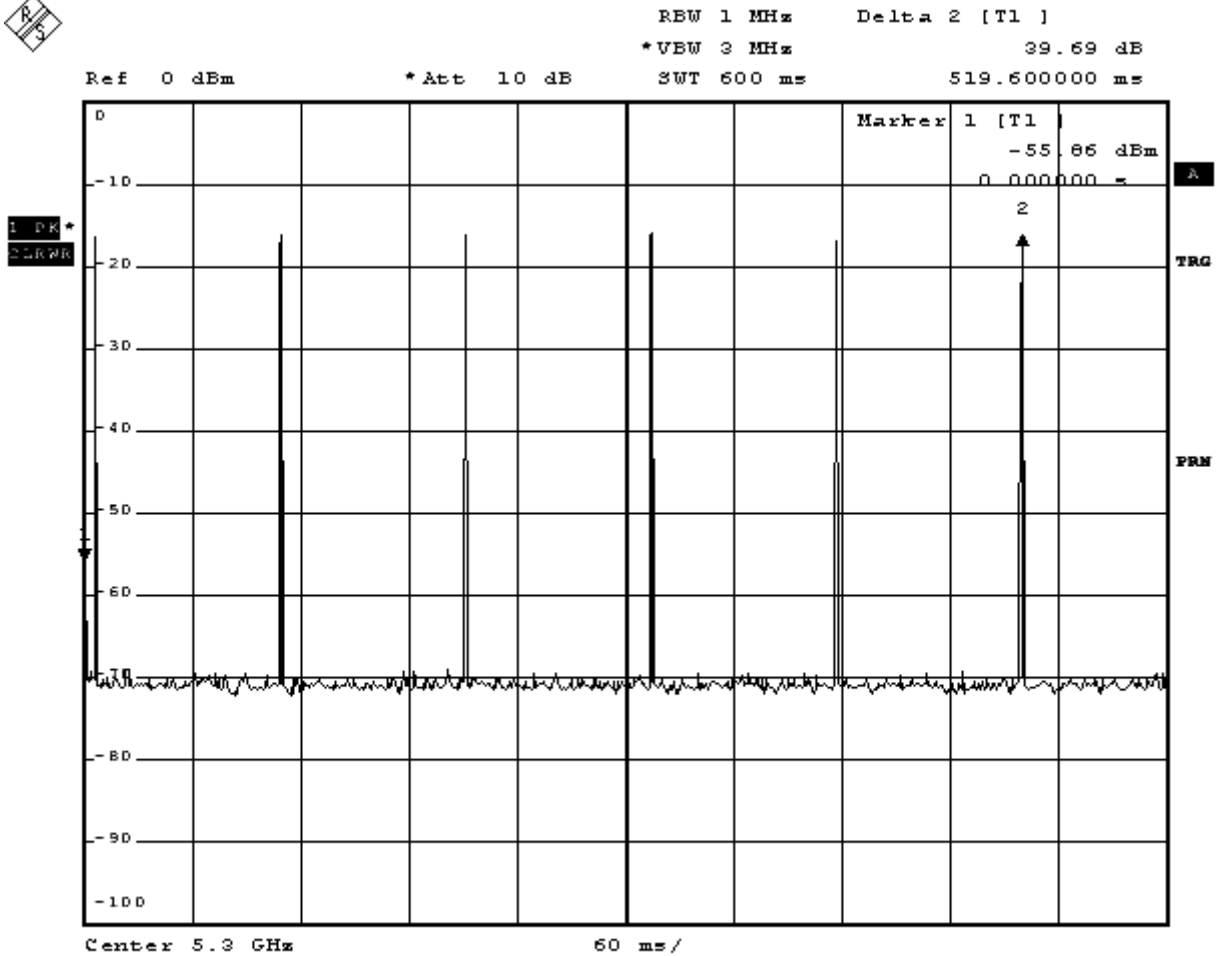

Test Item	Limit	Results
Channel Closing Transmission	200 milliseconds + approx. 60 milliseconds over remaining 10 seconds period	Pass

The results showed that after radar signal injected the channel transmission closing time less than 200 milliseconds and an aggregate of no more than 60 milliseconds.

20MHz Channel Mode

Channel Move Time for Radar Test Signal 5 at 5300MHz

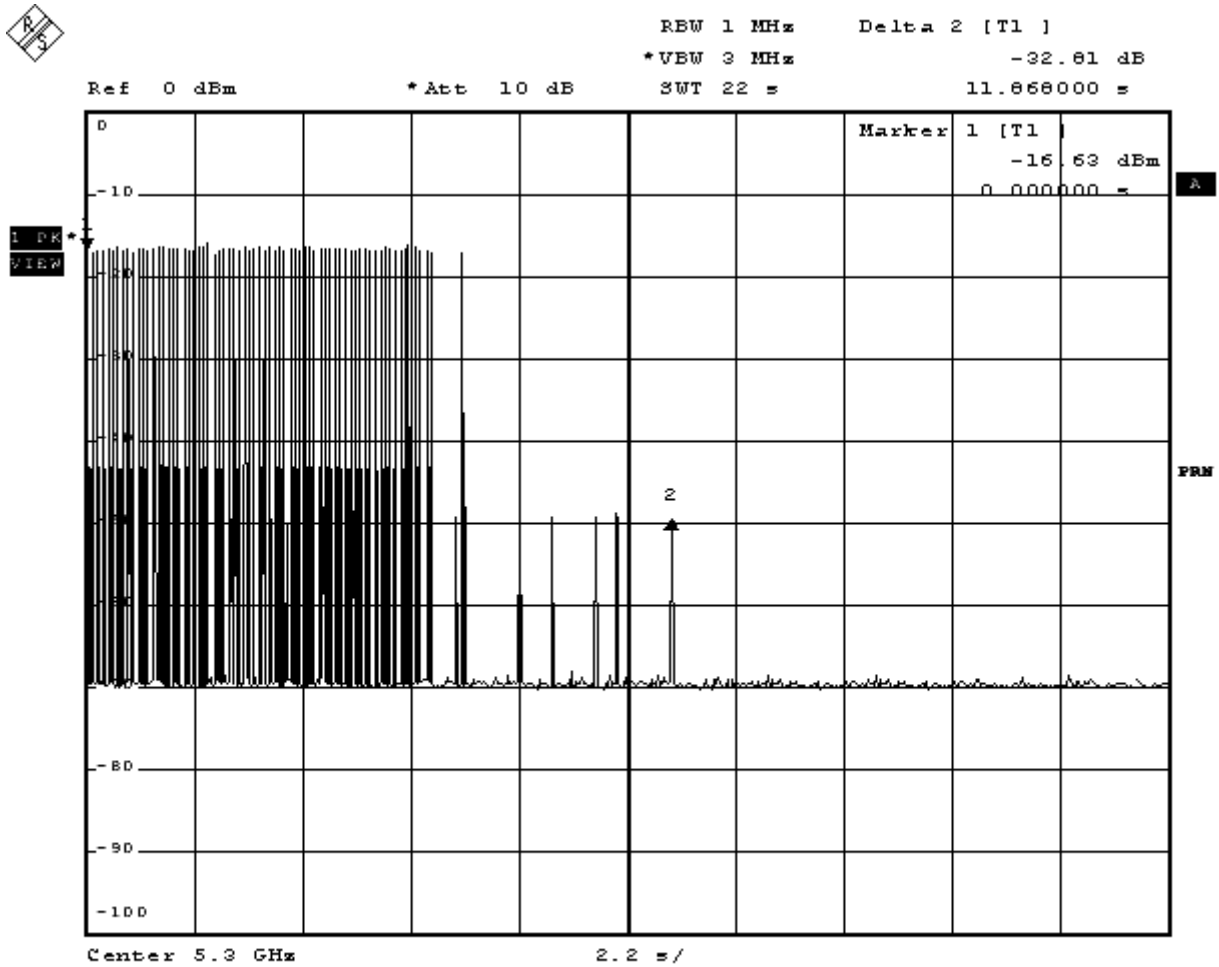

Test Item	Limit	Results
Channel Move Time	10 Seconds	Pass

The results showed that after radar signal injected the channel move time was less than 10 seconds.

20MHz Channel Mode

Channel Closing Transmission Time for Radar Test Signal 5 at 5300 MHz

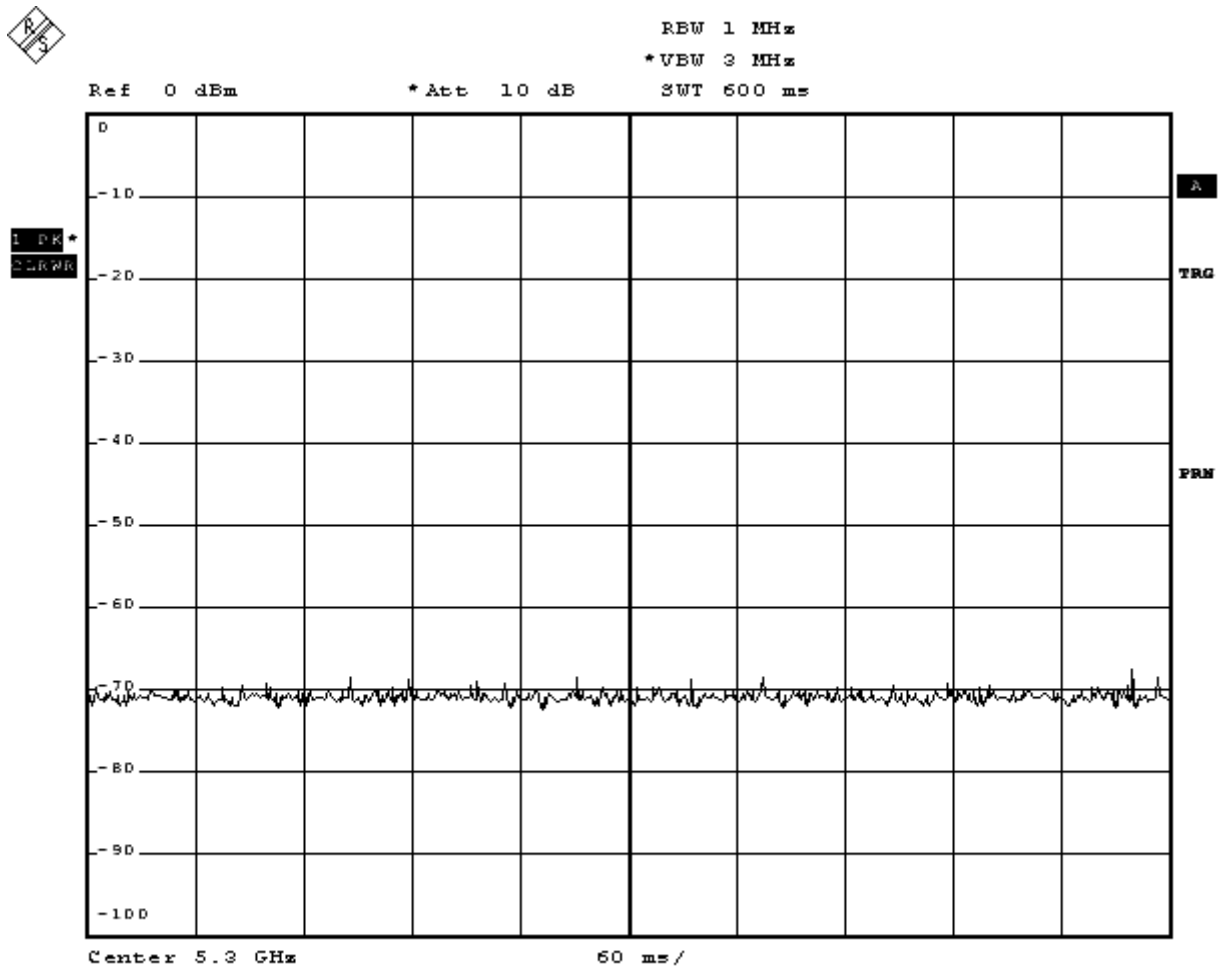

Test Item	Limit	Results
Channel Closing Transmission	200 milliseconds + approx. 60 milliseconds over remaining 10 seconds period	Pass

The results showed that after radar signal injected the channel transmission closing time less than 200 milliseconds and an aggregate of no more than 60 milliseconds.

20MHz Channel Mode

Channel Move Time for Radar Test Signal 6 at 5300MHz

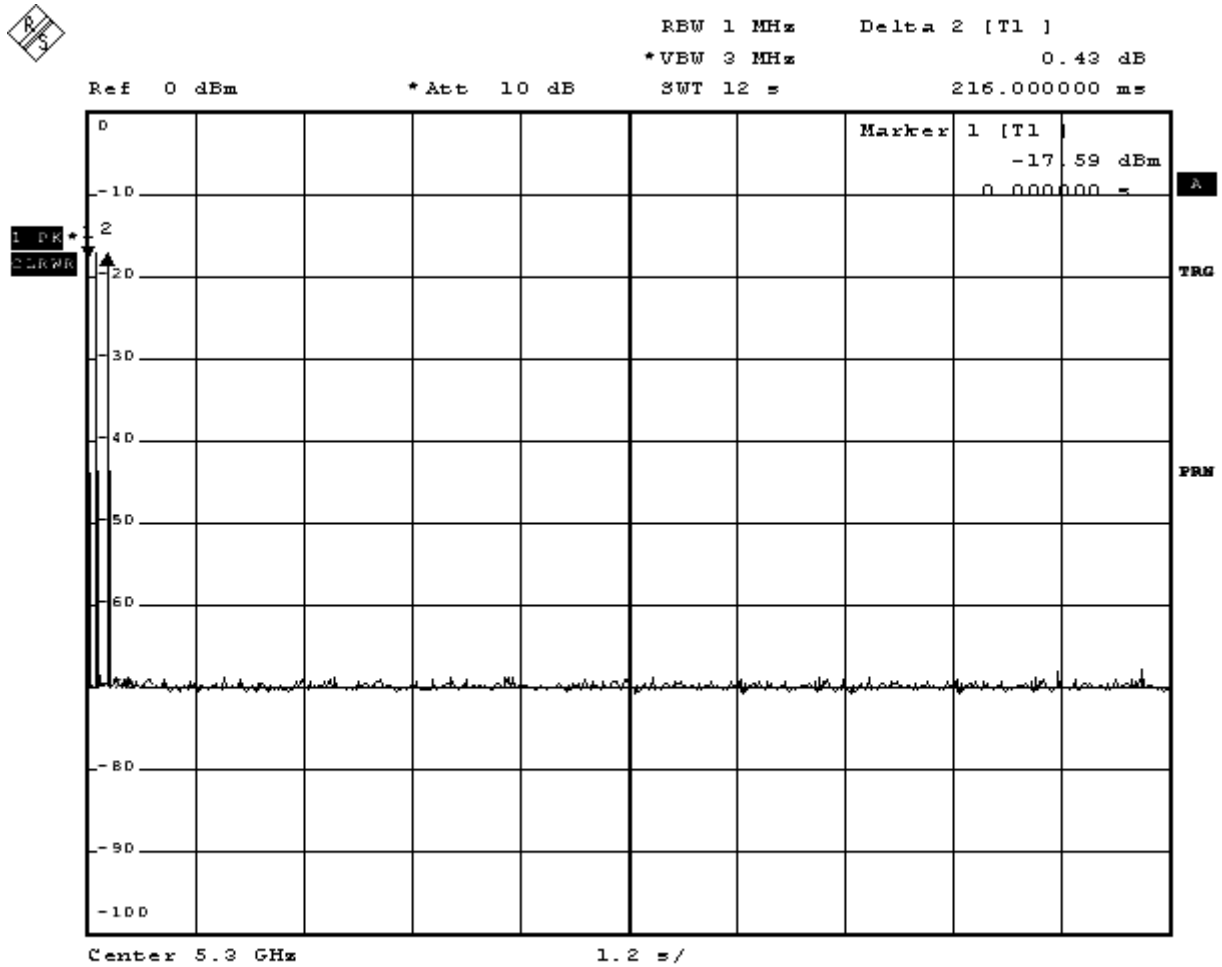

Test Item	Limit	Results
Channel Move Time	10 Seconds	Pass

The results showed that after radar signal injected the channel move time was less than 10 seconds.

20MHz Channel Mode

Channel Closing Transmission Time for Radar Test Signal 6 at 5300 MHz

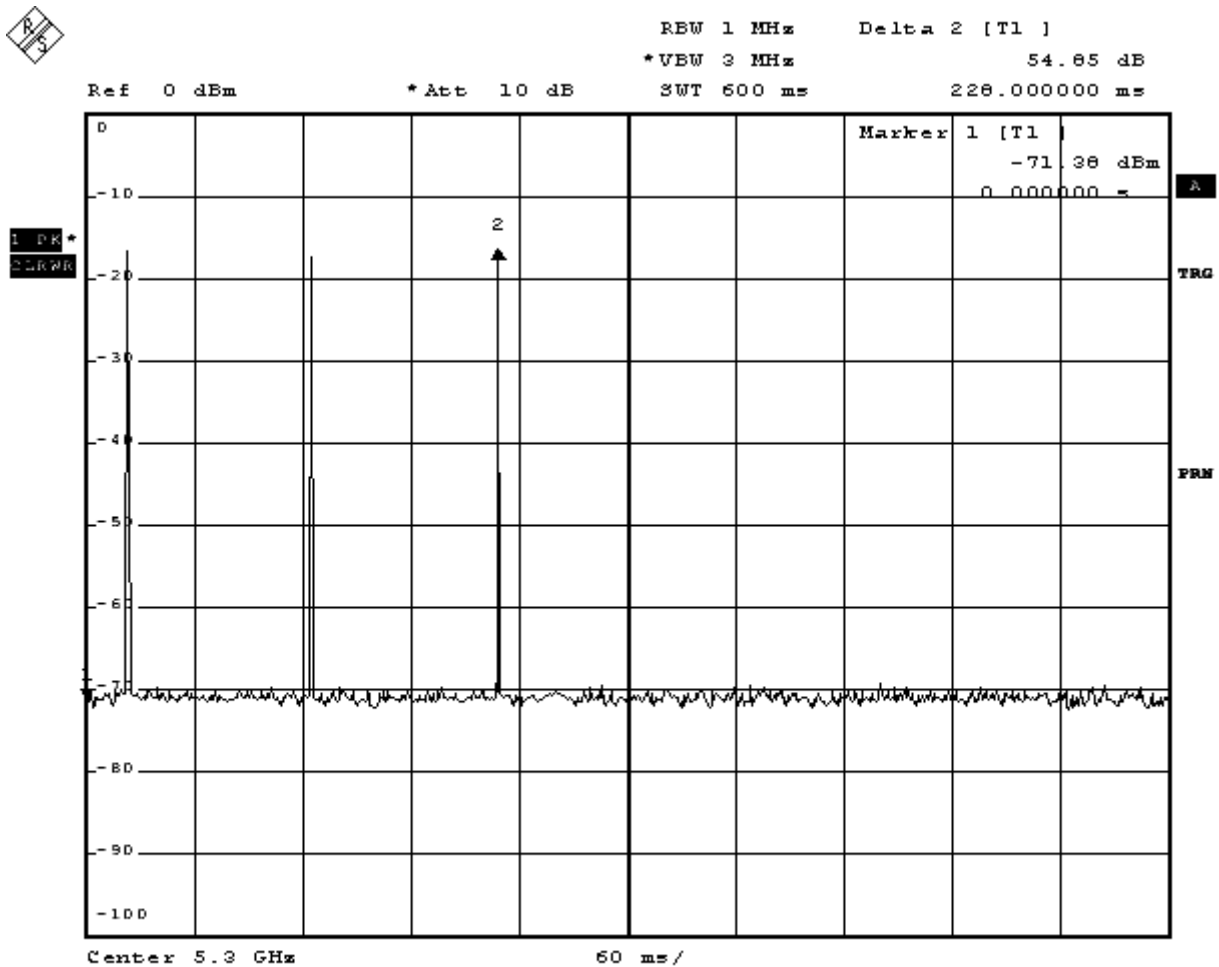

Test Item	Limit	Results
Channel Closing Transmission	200 milliseconds + approx. 60 milliseconds over remaining 10 seconds period	Pass

The results showed that after radar signal injected the channel transmission closing time less than 200 milliseconds and an aggregate of no more than 60 milliseconds.

20MHz Channel Mode

Channel Move Time for Radar Test Signal 1 at 5500MHz

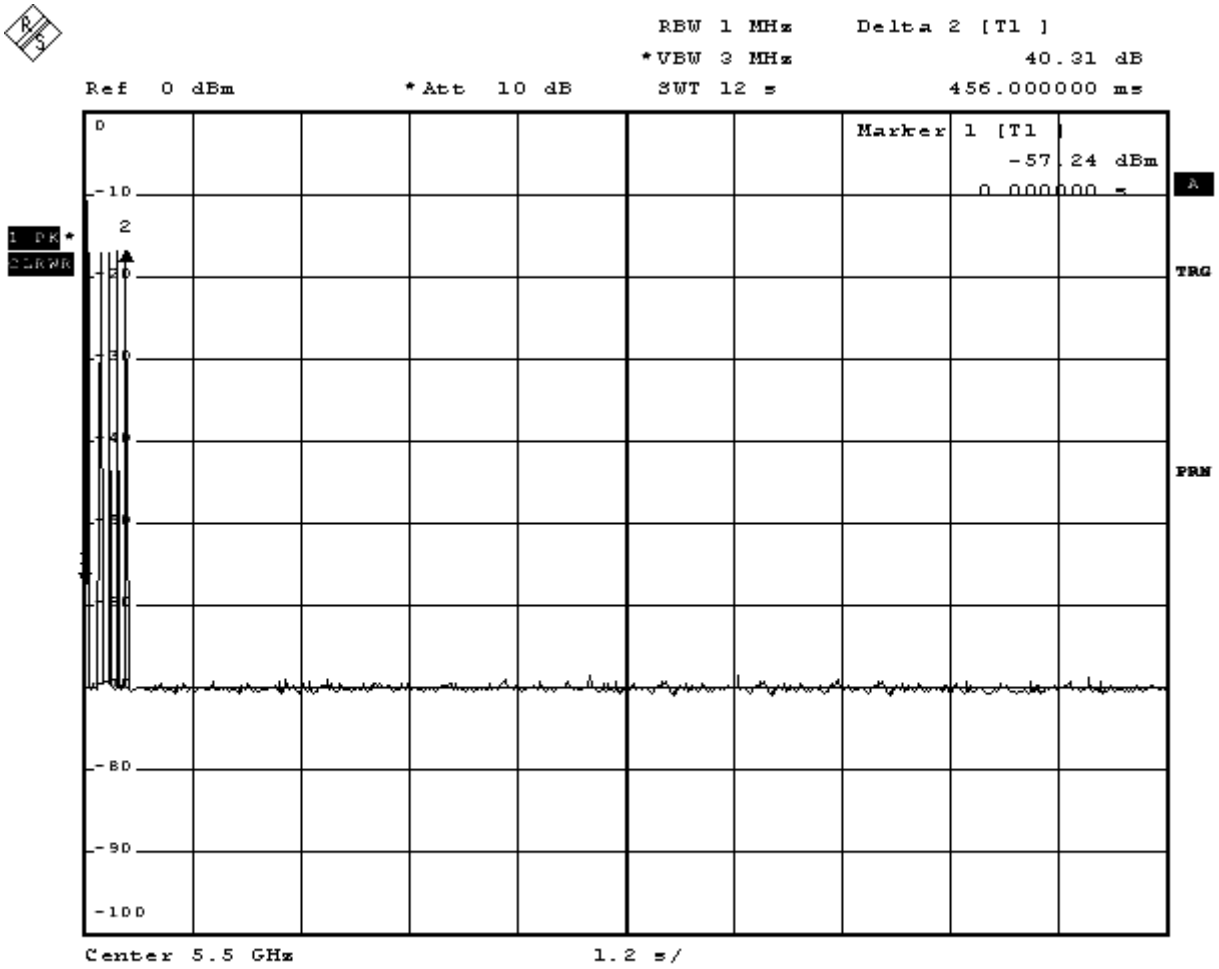

Test Item	Limit	Results
Channel Move Time	10 Seconds	Pass

The results showed that after radar signal injected the channel move time was less than 10 seconds.

20MHz Channel Mode

Channel Closing Transmission Time for Radar Test Signal 1 at 5500 MHz

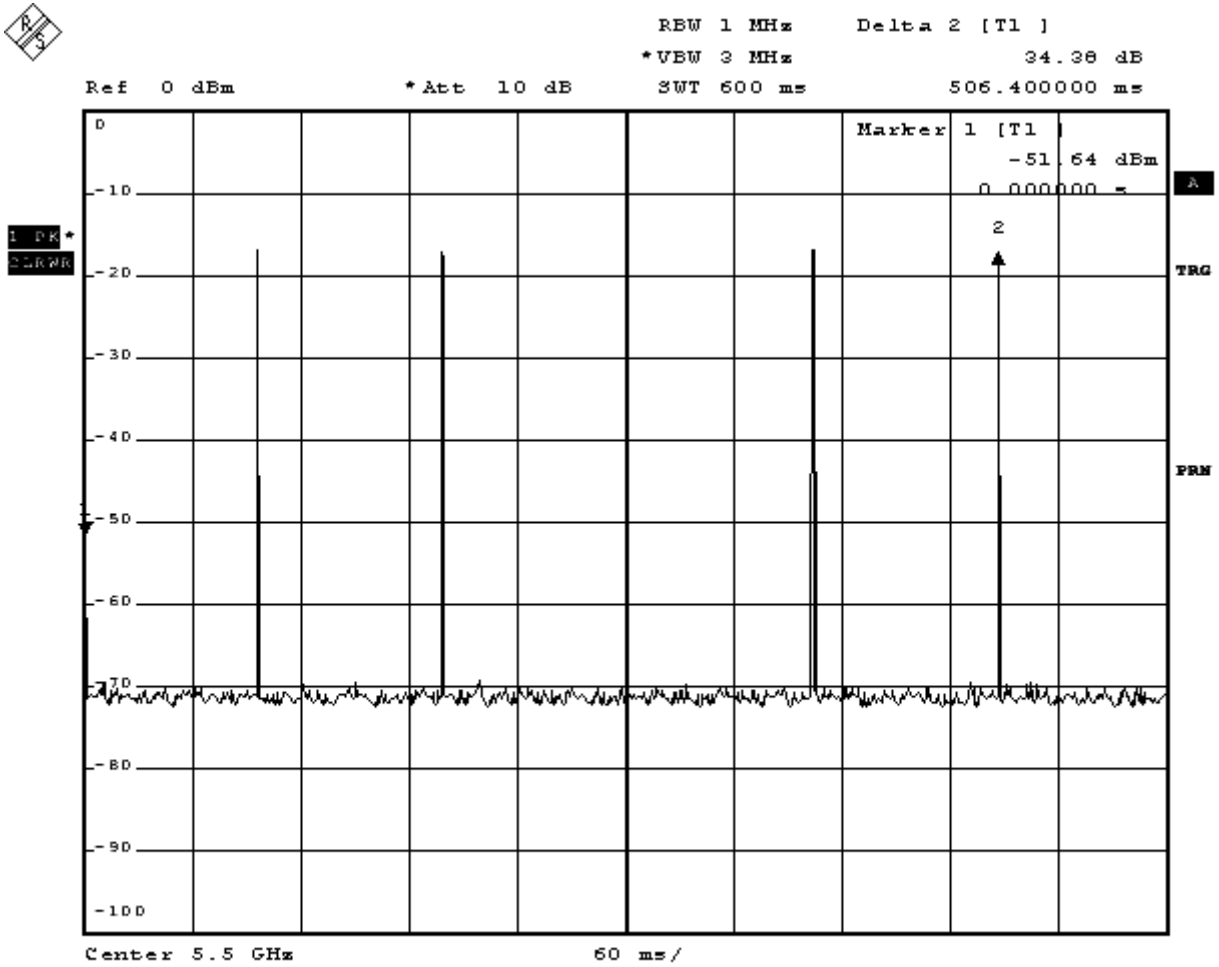

Test Item	Limit	Results
Channel Closing Transmission	200 milliseconds + approx. 60 milliseconds over remaining 10 seconds period	Pass

The results showed that after radar signal injected the channel transmission closing time less than 200 milliseconds and an aggregate of no more than 60 milliseconds.

20MHz Channel Mode

Channel Move Time for Radar Test Signal 5 at 5500MHz

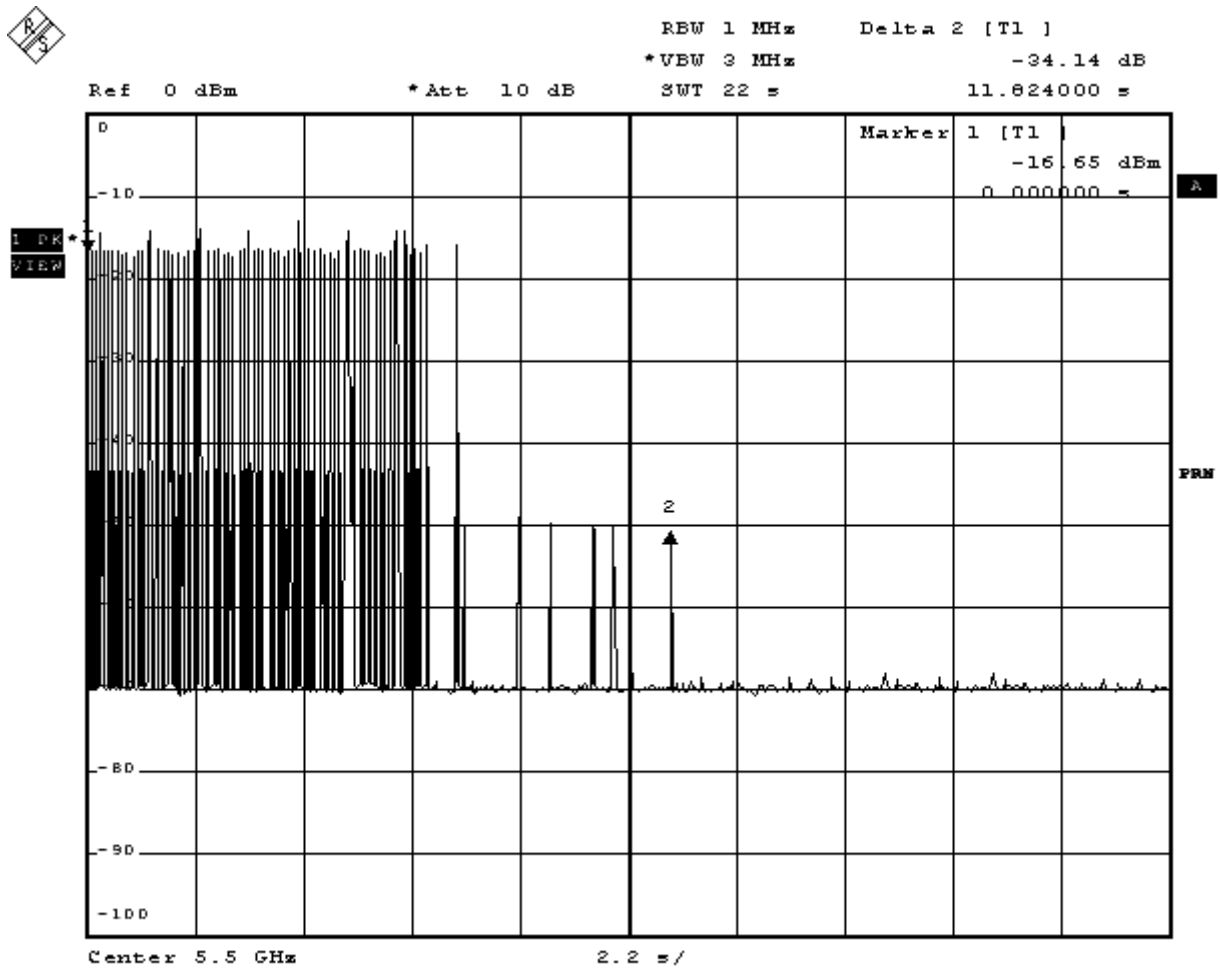

Test Item	Limit	Results
Channel Move Time	10 Seconds	Pass

The results showed that after radar signal injected the channel move time was less than 10 seconds.

20MHz Channel Mode

Channel Closing Transmission Time for Radar Test Signal 5 at 5500 MHz

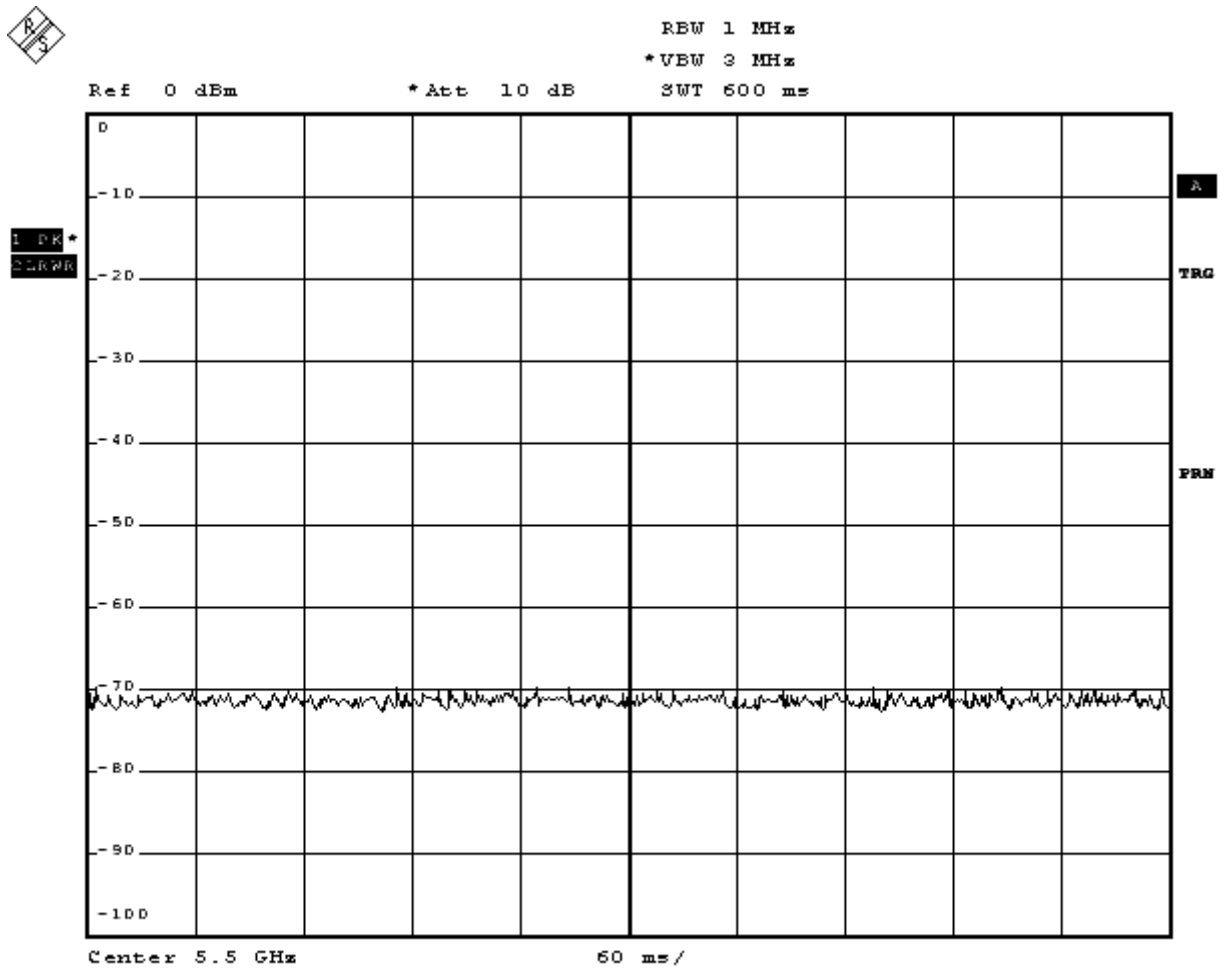

Test Item	Limit	Results
Channel Closing Transmission	200 milliseconds + approx. 60 milliseconds over remaining 10 seconds period	Pass

The results showed that after radar signal injected the channel transmission closing time less than 200 milliseconds and an aggregate of no more than 60 milliseconds.

20MHz Channel Mode

Channel Move Time for Radar Test Signal 6 at 5500MHz

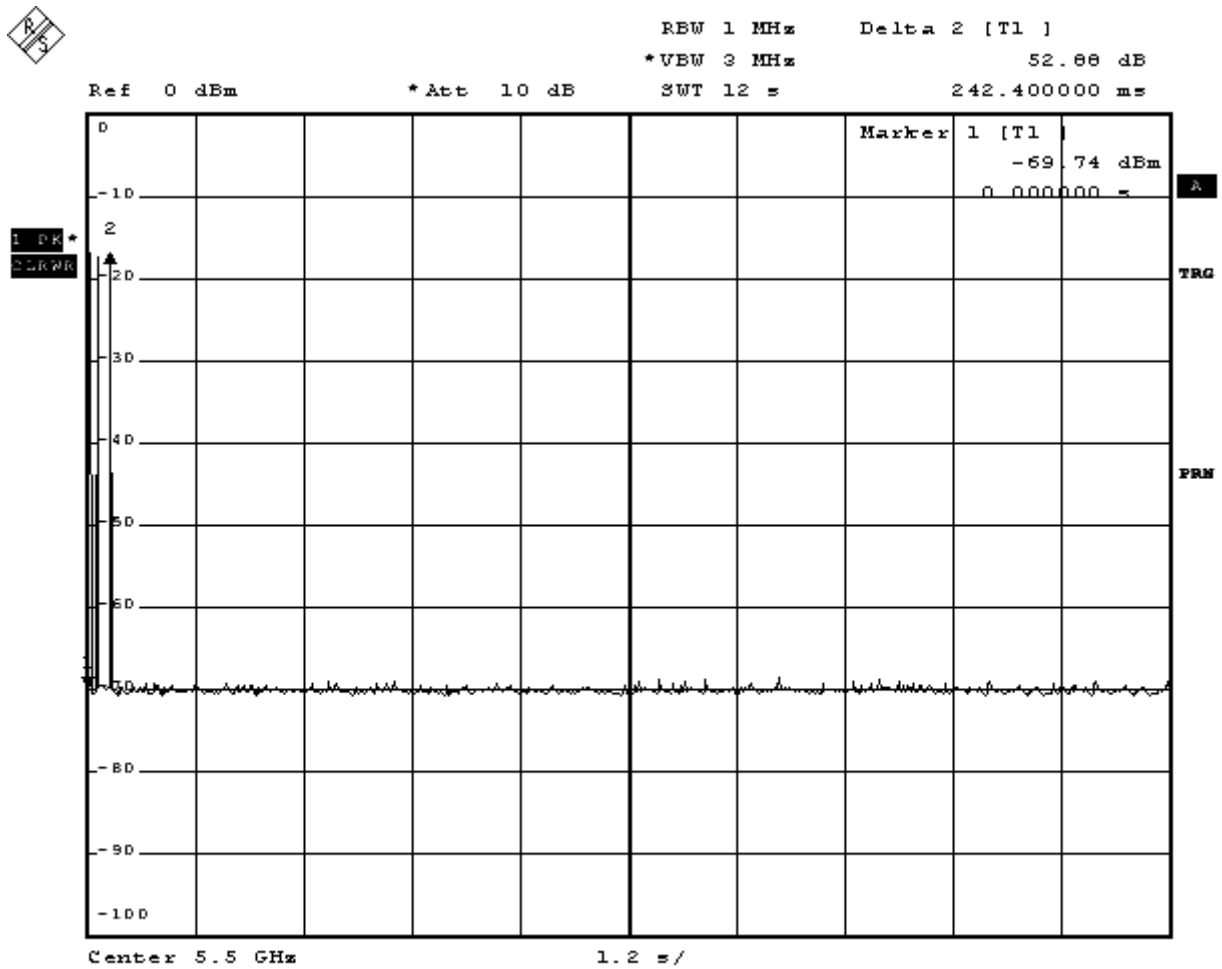

Test Item	Limit	Results
Channel Move Time	10 Seconds	Pass

The results showed that after radar signal injected the channel move time was less than 10 seconds.

20MHz Channel Mode

Channel Closing Transmission Time for Radar Test Signal 6 at 5500 MHz

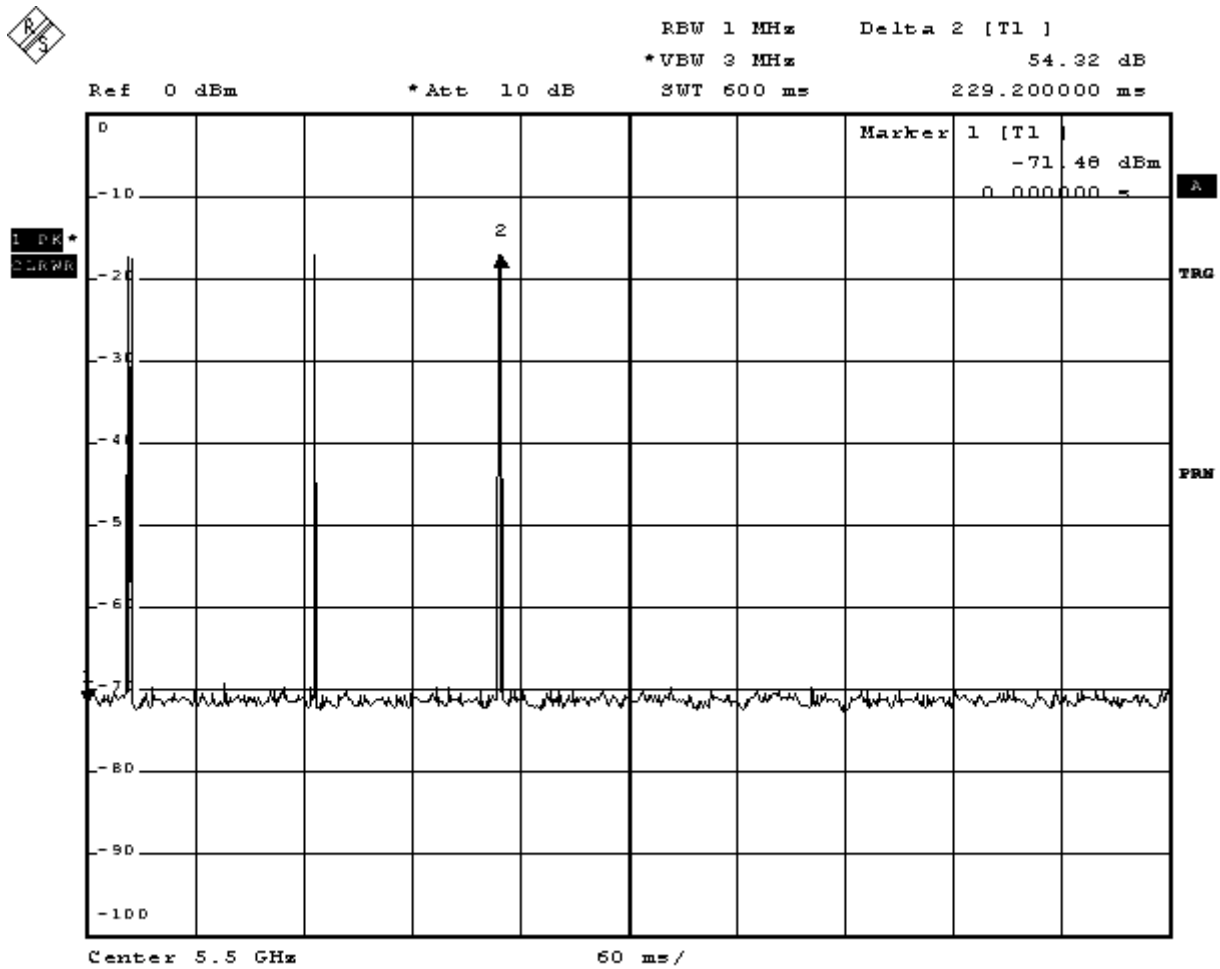

Test Item	Limit	Results
Channel Closing Transmission	200 milliseconds + approx. 60 milliseconds over remaining 10 seconds period	Pass

The results showed that after radar signal injected the channel transmission closing time less than 200 milliseconds and an aggregate of no more than 60 milliseconds.

Draft 802.11n Standard – 40MHz Channel Mode

Channel Move Time for Radar Test Signal 1 at 5310MHz

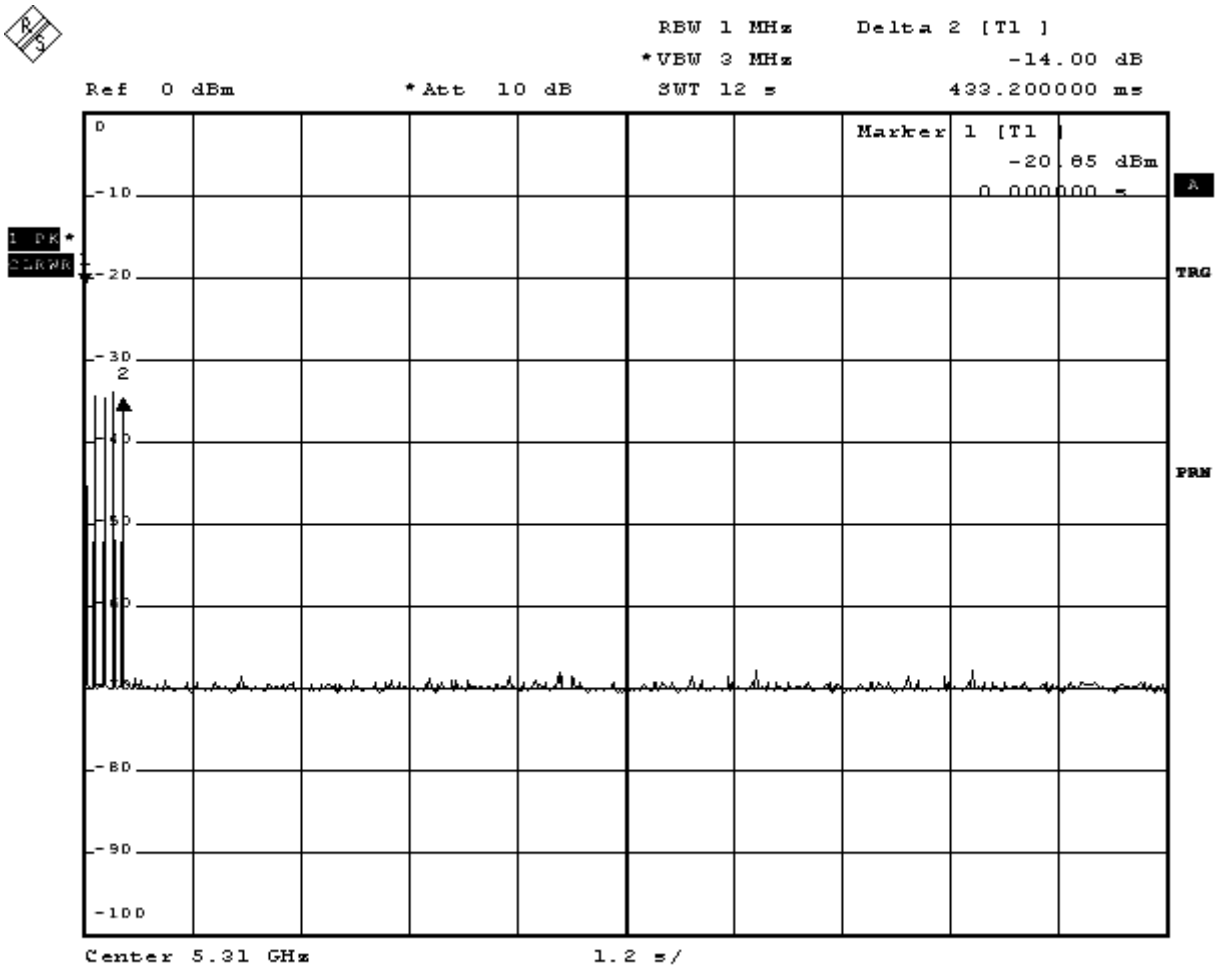

Test Item	Limit	Results
Channel Move Time	10 Seconds	Pass

The results showed that after radar signal injected the channel move time was less than 10 seconds.

Draft 802.11n Standard – 40MHz Channel Mode

Channel Closing Transmission Time for Radar Test Signal 1 at 5310 MHz

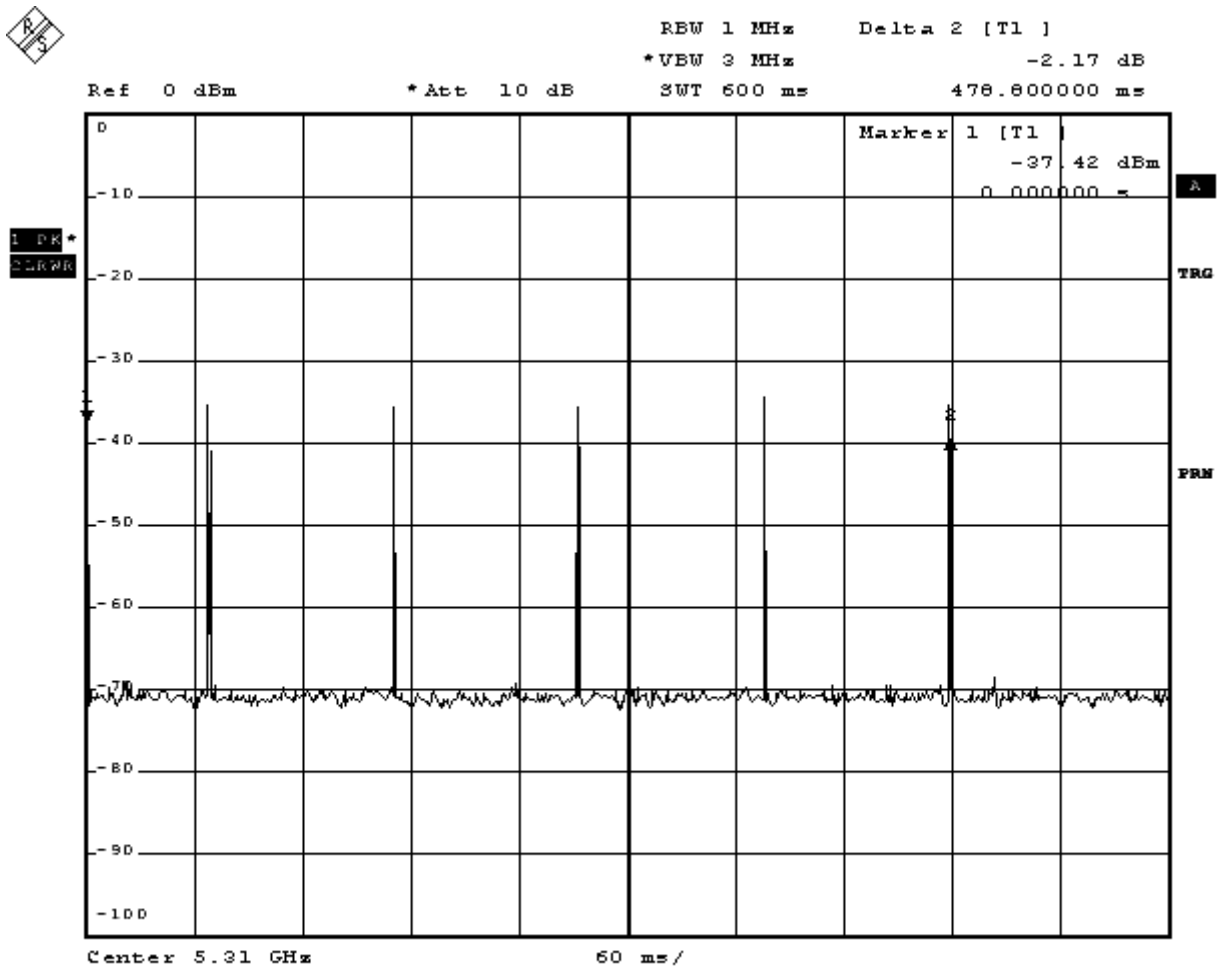

Test Item	Limit	Results
Channel Closing Transmission	200 milliseconds + approx. 60 milliseconds over remaining 10 seconds period	Pass

The results showed that after radar signal injected the channel transmission closing time less than 200 milliseconds and an aggregate of no more than 60 milliseconds.

Draft 802.11n Standard – 40MHz Channel Mode
Channel Move Time for Radar Test Signal 5 at 5310MHz

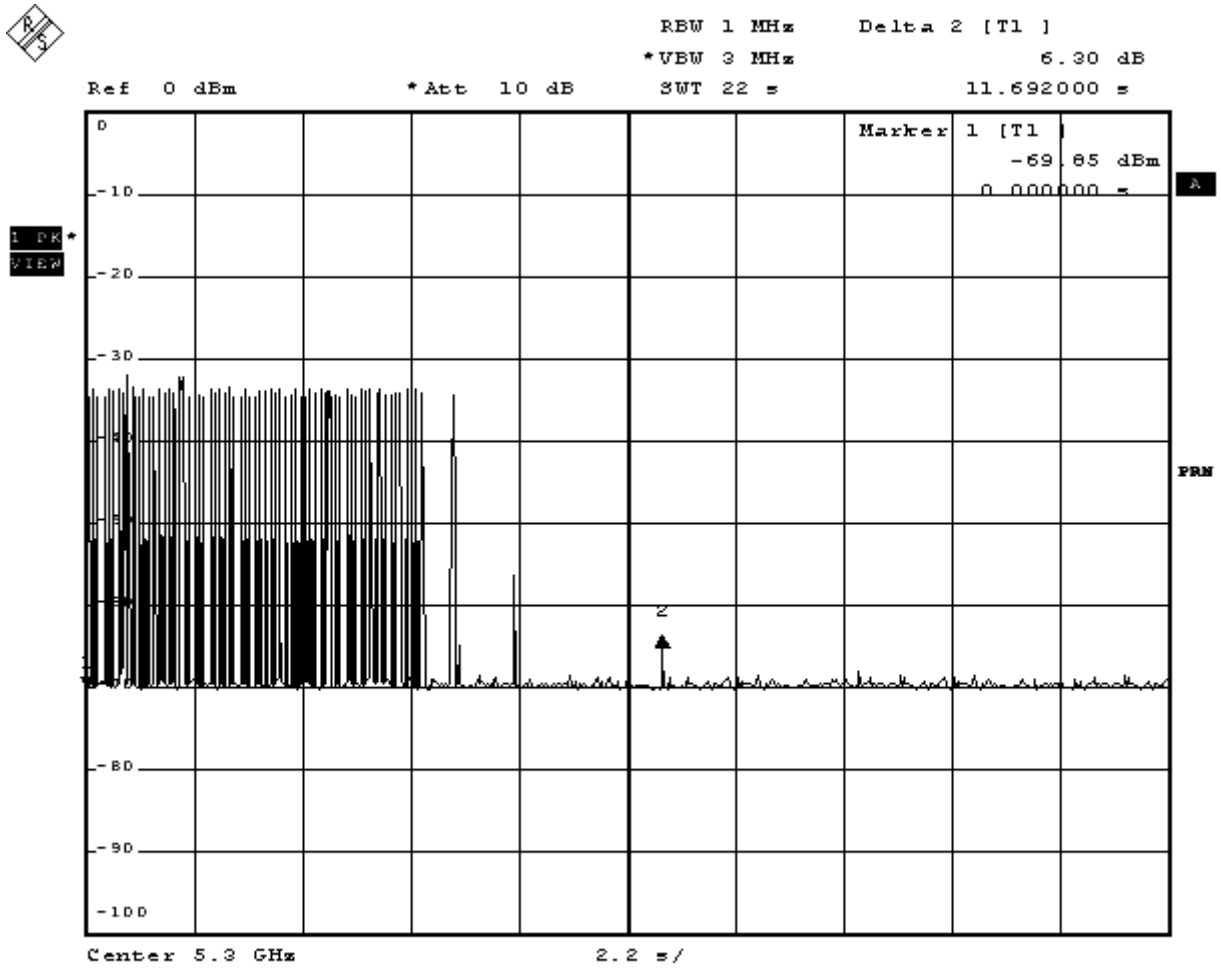

Test Item	Limit	Results
Channel Move Time	10 Seconds	Pass

The results showed that after radar signal injected the channel move time was less than 10 seconds.

Draft 802.11n Standard – 40MHz Channel Mode

Channel Closing Transmission Time for Radar Test Signal 5 at 5310 MHz

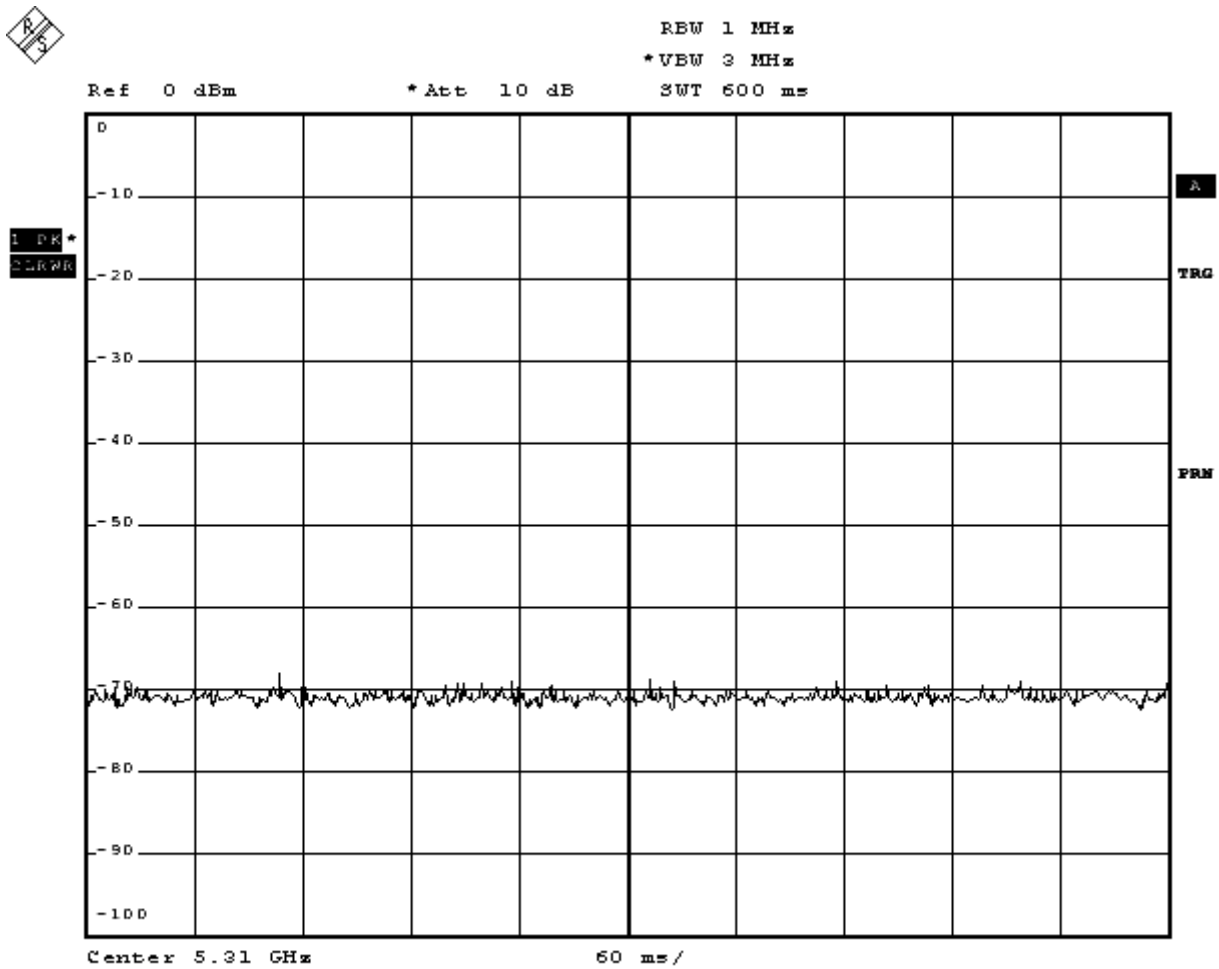

Test Item	Limit	Results
Channel Closing Transmission	200 milliseconds + approx. 60 milliseconds over remaining 10 seconds period	Pass

The results showed that after radar signal injected the channel transmission closing time less than 200 milliseconds and an aggregate of no more than 60 milliseconds.

Draft 802.11n Standard – 40MHz Channel Mode
Channel Move Time for Radar Test Signal 6 at 5310MHz

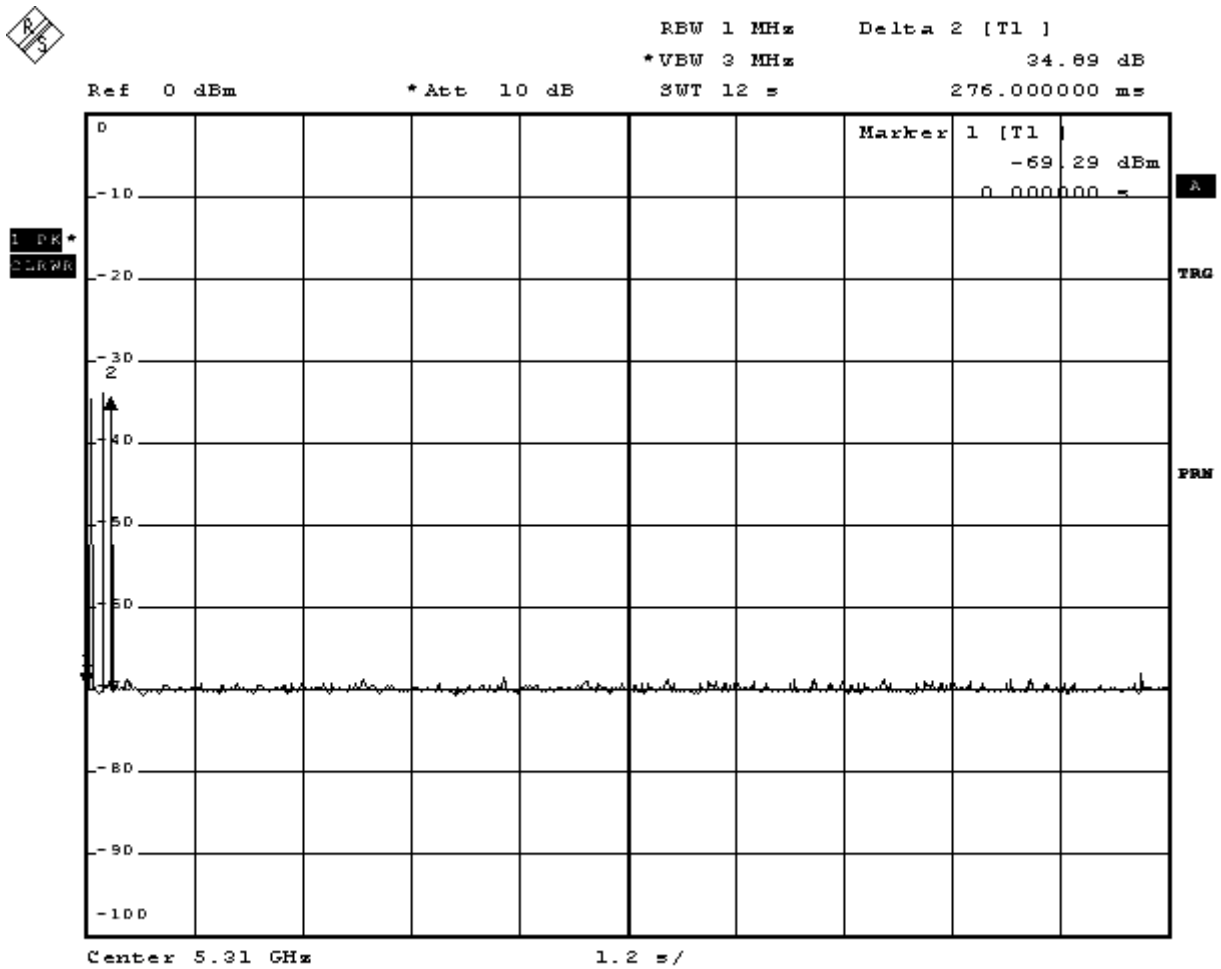

Test Item	Limit	Results
Channel Move Time	10 Seconds	Pass

The results showed that after radar signal injected the channel move time was less than 10 seconds.

Draft 802.11n Standard – 40MHz Channel Mode

Channel Closing Transmission Time for Radar Test Signal 6 at 5310 MHz

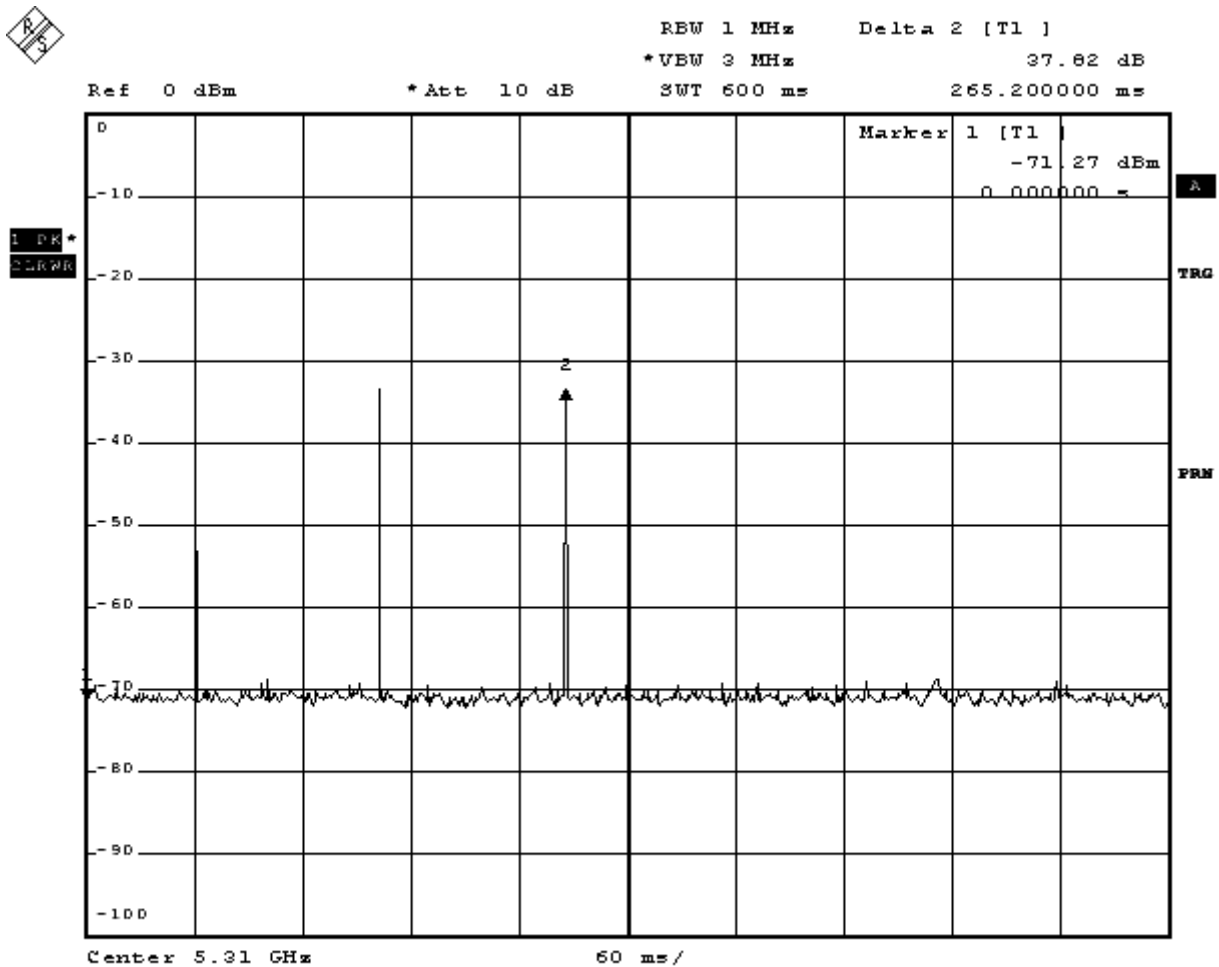

Test Item	Limit	Results
Channel Closing Transmission	200 milliseconds + approx. 60 milliseconds over remaining 10 seconds period	Pass

The results showed that after radar signal injected the channel transmission closing time less than 200 milliseconds and an aggregate of no more than 60 milliseconds.

Draft 802.11n Standard – 40MHz Channel Mode
Channel Move Time for Radar Test Signal 1 at 5510MHz

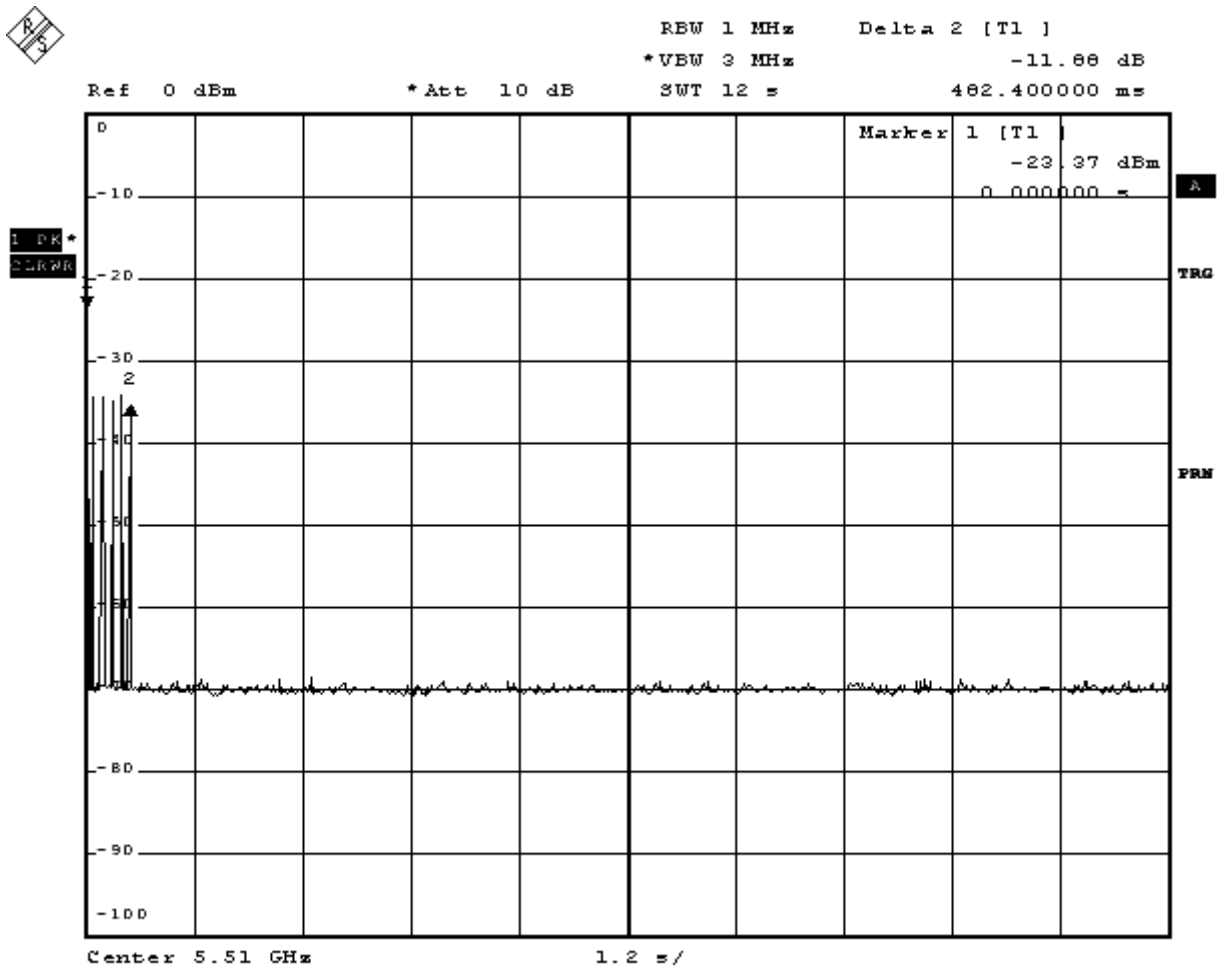

Test Item	Limit	Results
Channel Move Time	10 Seconds	Pass

The results showed that after radar signal injected the channel move time was less than 10 seconds.

Draft 802.11n Standard – 40MHz Channel Mode

Channel Closing Transmission Time for Radar Test Signal 1 at 5510 MHz

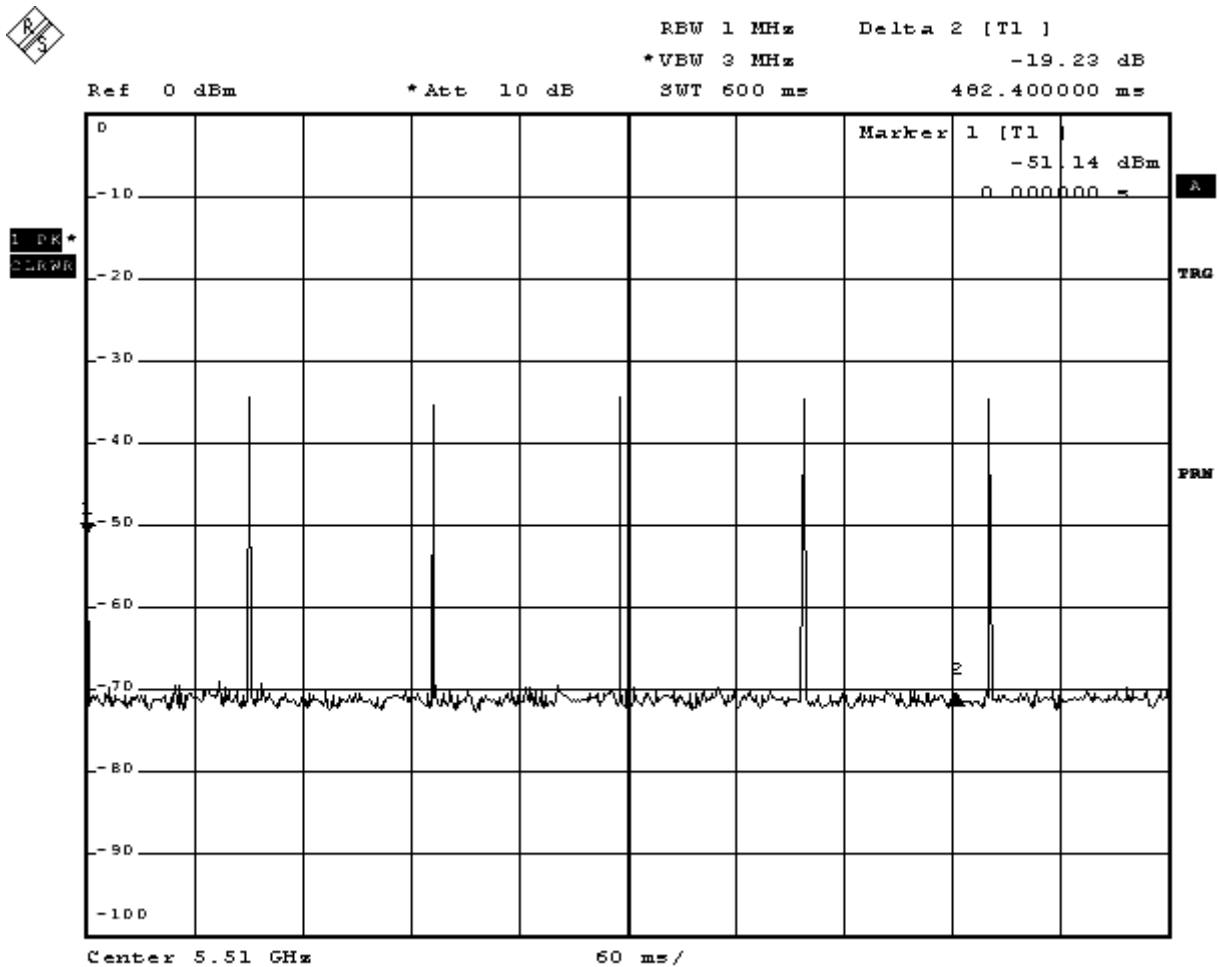

Test Item	Limit	Results
Channel Closing Transmission	200 milliseconds + approx. 60 milliseconds over remaining 10 seconds period	Pass

The results showed that after radar signal injected the channel transmission closing time less than 200 milliseconds and an aggregate of no more than 60 milliseconds.

Draft 802.11n Standard – 40MHz Channel Mode
Channel Move Time for Radar Test Signal 5 at 5510MHz

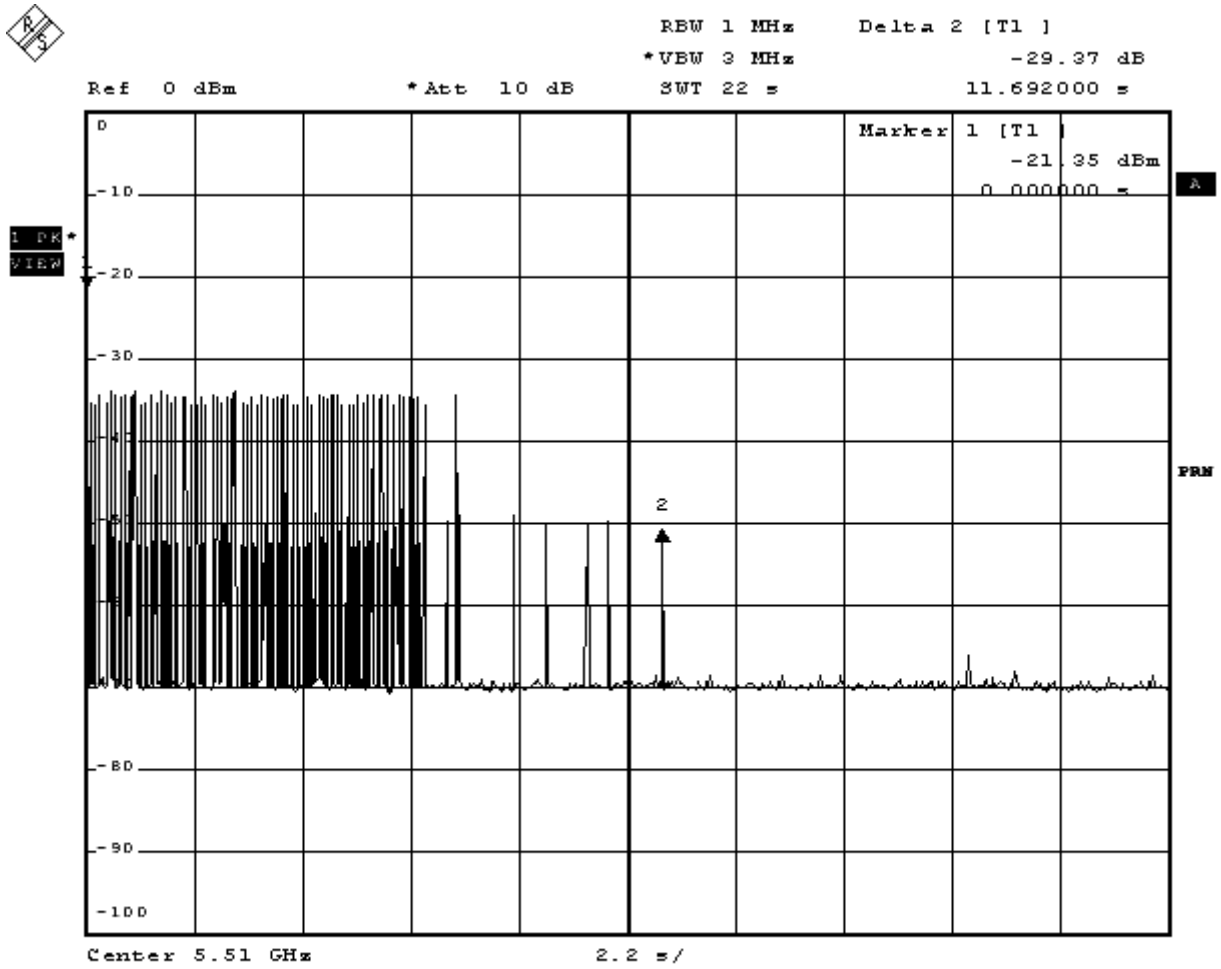

Test Item	Limit	Results
Channel Move Time	10 Seconds	Pass

The results showed that after radar signal injected the channel move time was less than 10 seconds.

Draft 802.11n Standard – 40MHz Channel Mode

Channel Closing Transmission Time for Radar Test Signal 5 at 5510 MHz

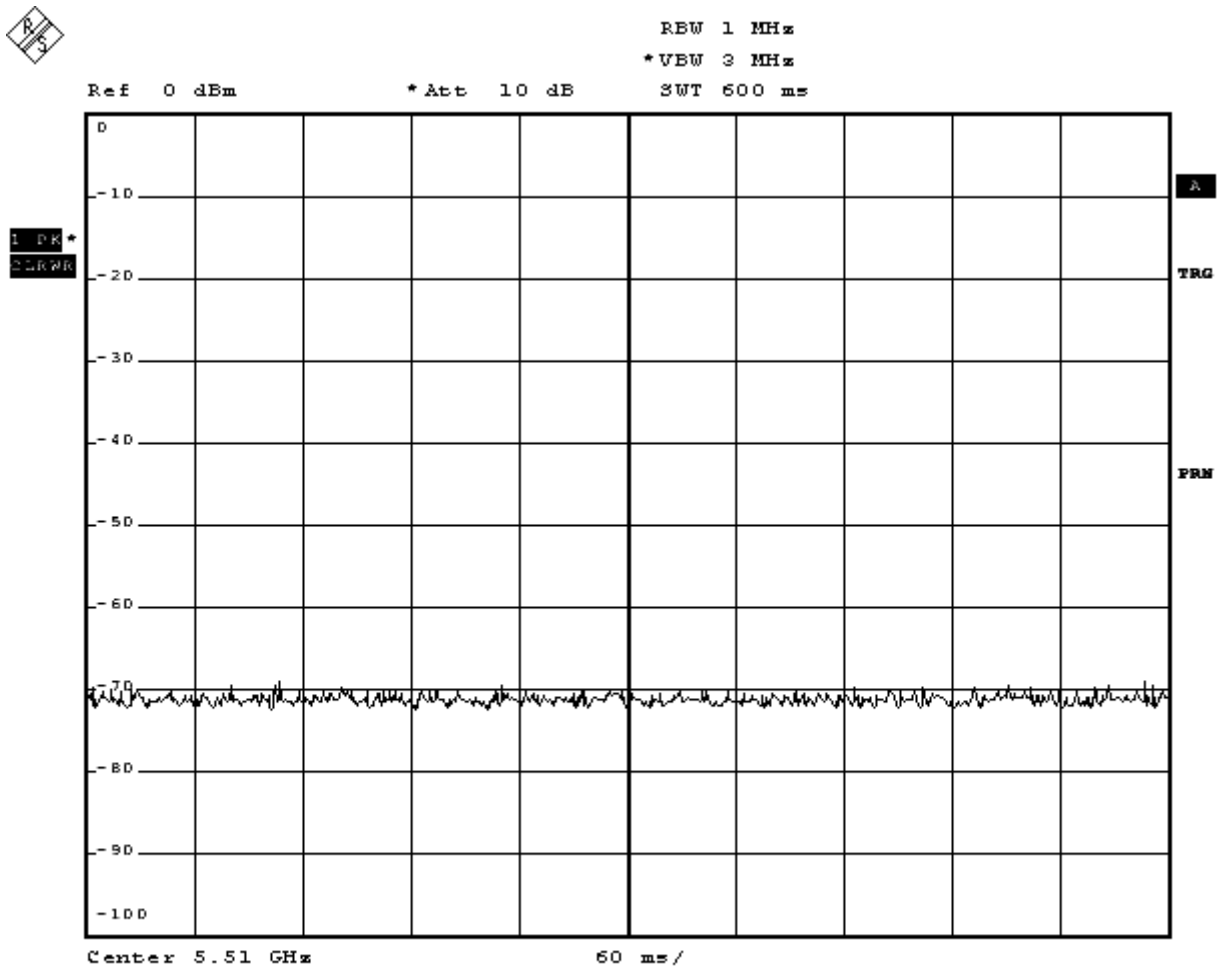

Test Item	Limit	Results
Channel Closing Transmission	200 milliseconds + approx. 60 milliseconds over remaining 10 seconds period	Pass

The results showed that after radar signal injected the channel transmission closing time less than 200 milliseconds and an aggregate of no more than 60 milliseconds.

Draft 802.11n Standard – 40MHz Channel Mode
Channel Move Time for Radar Test Signal 6 at 5510MHz

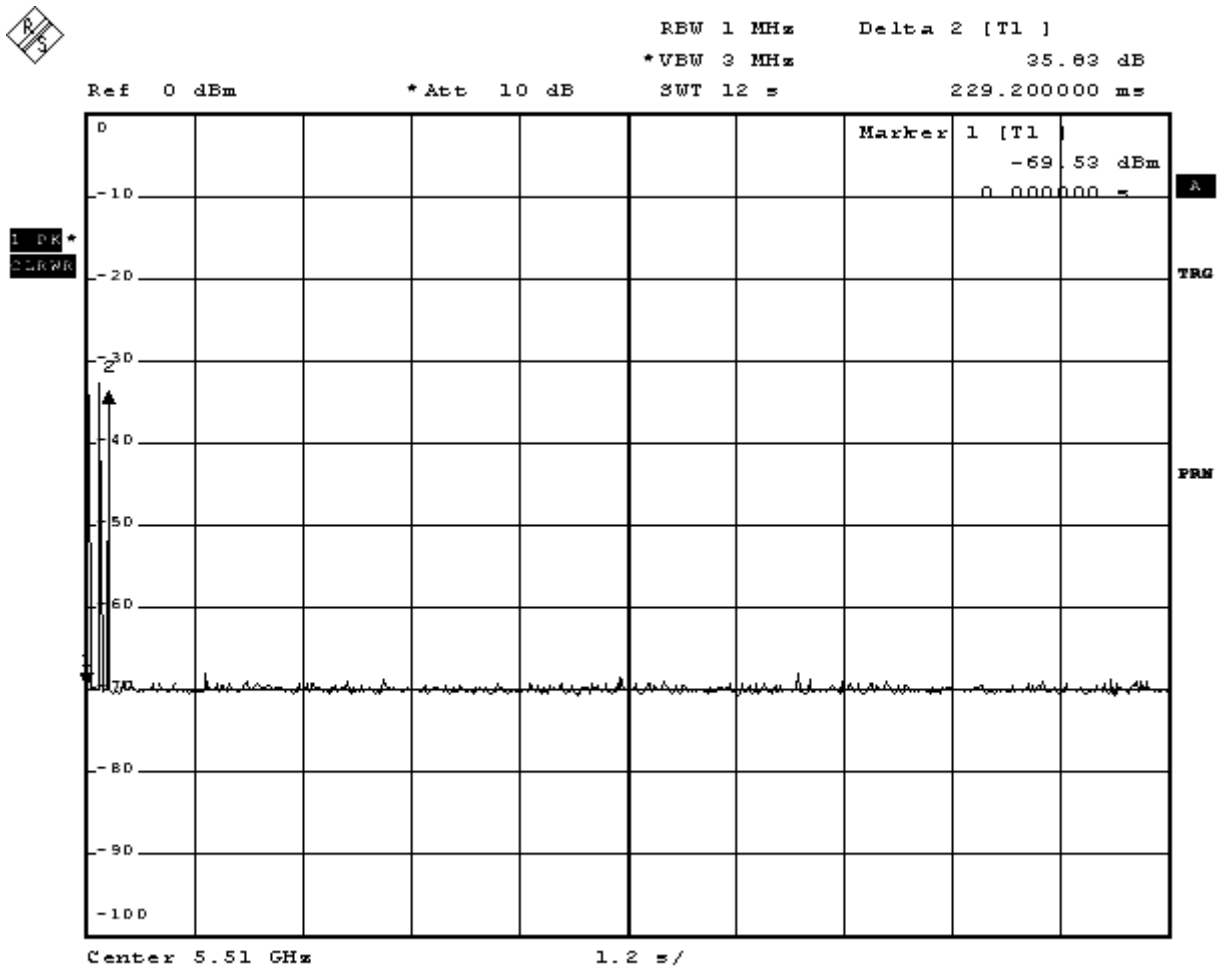

Test Item	Limit	Results
Channel Move Time	10 Seconds	Pass

The results showed that after radar signal injected the channel move time was less than 10 seconds.

Draft 802.11n Standard – 40MHz Channel Mode

Channel Closing Transmission Time for Radar Test Signal 6 at 5510 MHz

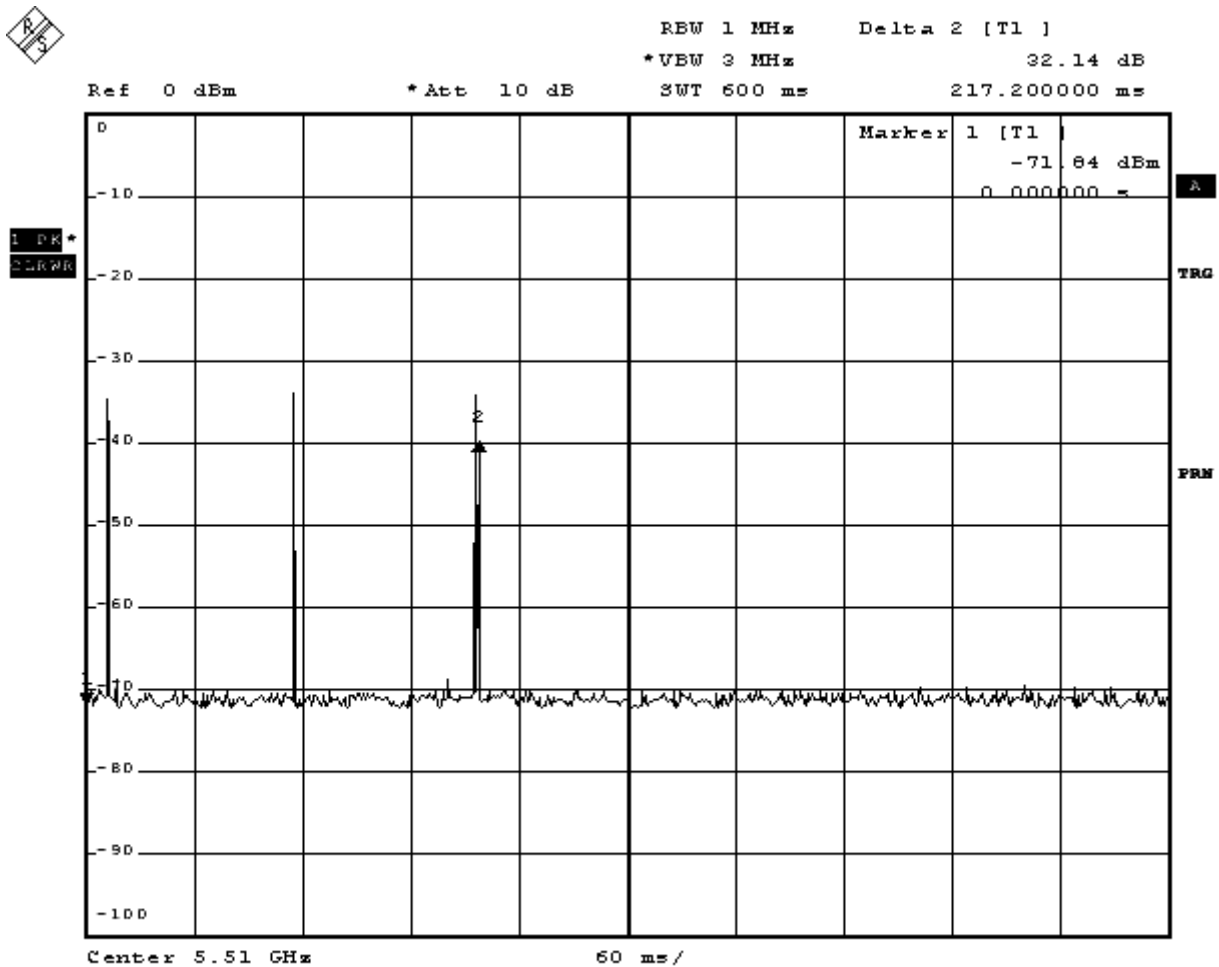

Test Item	Limit	Results
Channel Closing Transmission	200 milliseconds + approx. 60 milliseconds over remaining 10 seconds period	Pass

The results showed that after radar signal injected the channel transmission closing time less than 200 milliseconds and an aggregate of no more than 60 milliseconds.

Non-Occupancy Period

Measure the EUT for more than 30 minutes following the channel close/move time to verify that the UUT does not resume any transmissions on this channel.

20MHz Channel Mode

30 Minute Non-Occupancy Period (using Type 1 Radar) at 5300 MHz

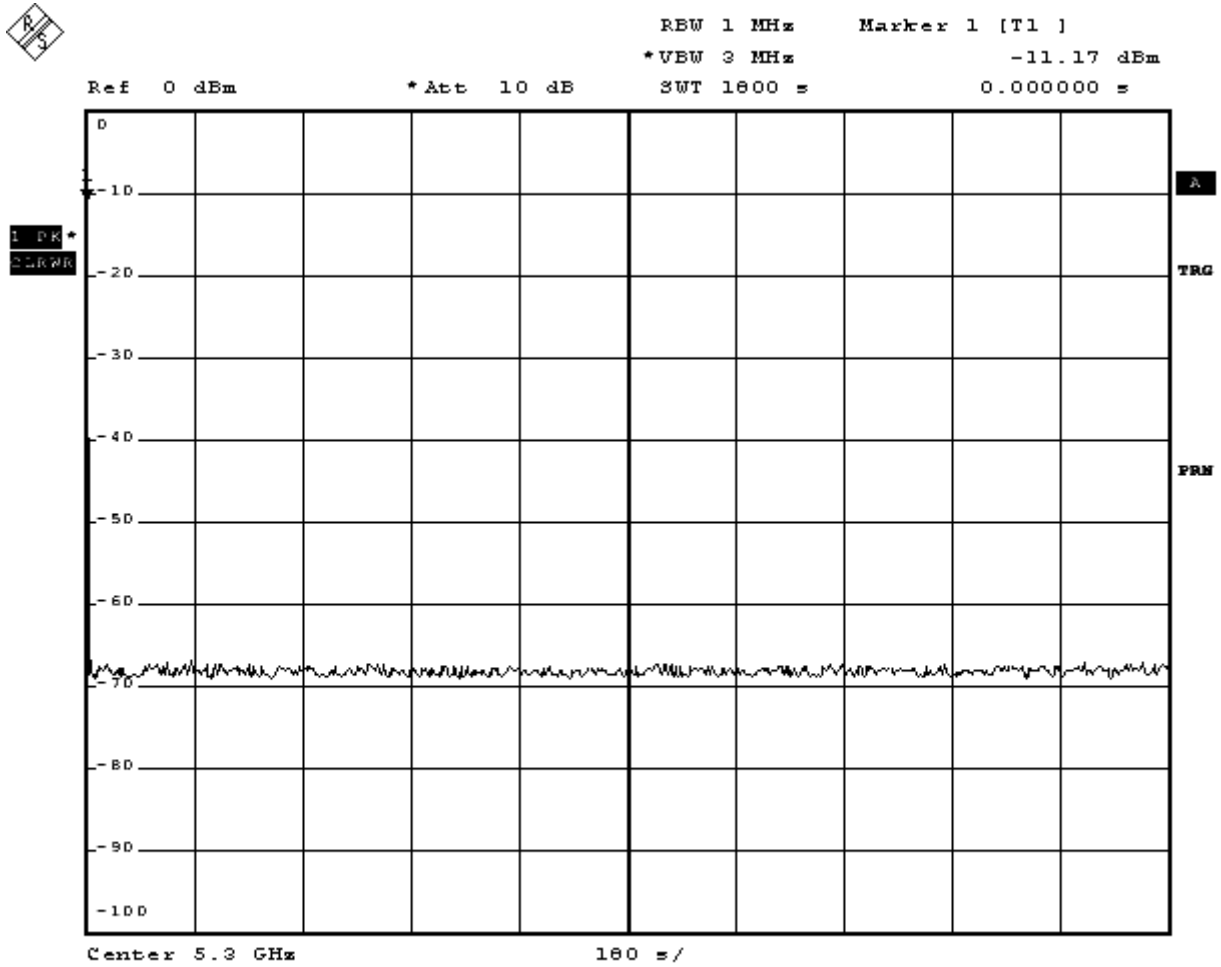

Test Item	Limit	Results
Non-Occupancy Period	30 Minutes	Pass

No EUT transmissions were observed on the test channel during 30 minutes observation time.

20MHz Channel Mode

30 Minute Non-Occupancy Period (using Type 1 Radar) at 5500 MHz

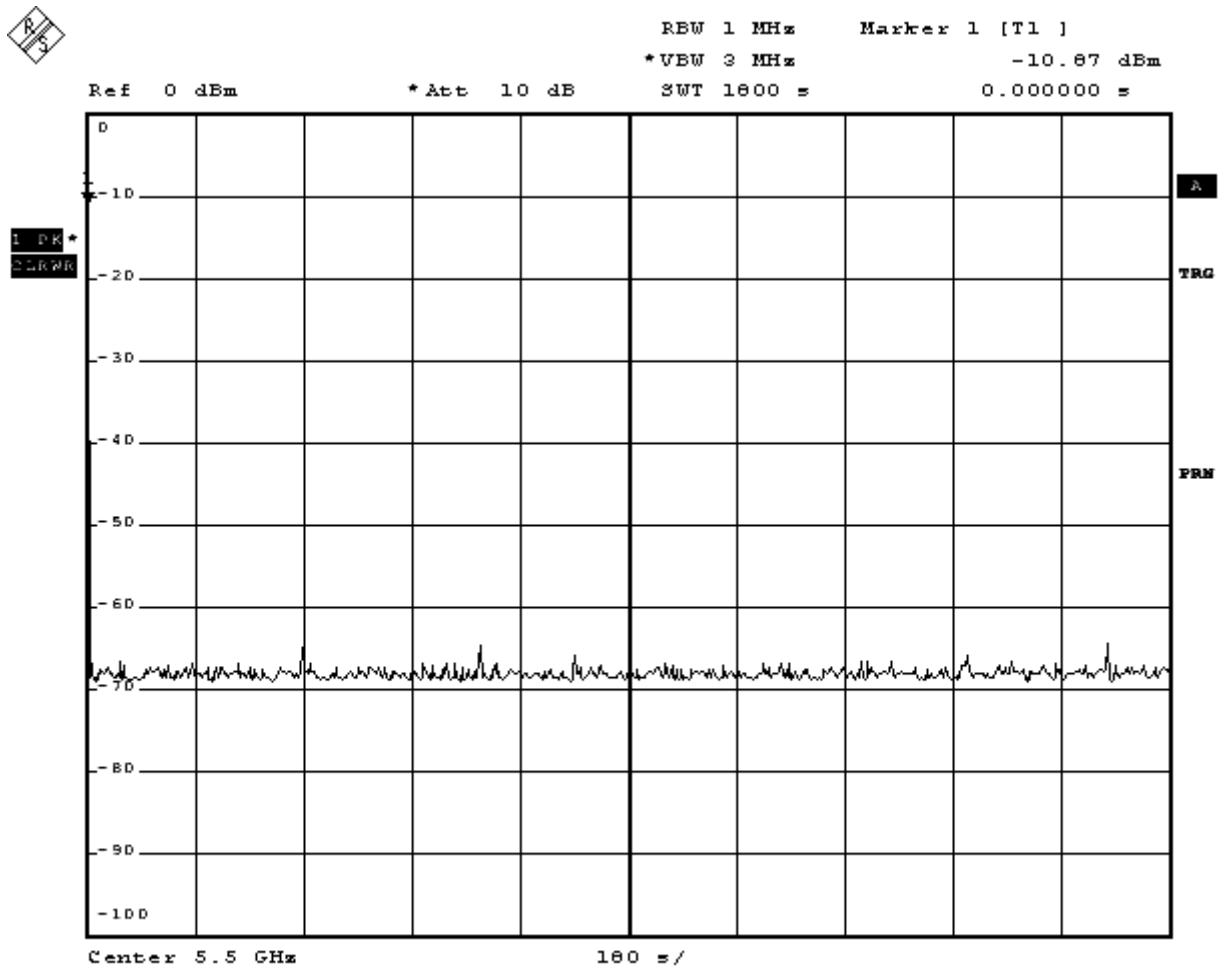

Test Item	Limit	Results
Non-Occupancy Period	30 Minutes	Pass

No EUT transmissions were observed on the test channel during 30 minutes observation time.

**Draft 802.11n Standard – 40MHz Channel Mode
30 Minute Non-Occupancy Period (using Type 1 Radar) at 5310 MHz**

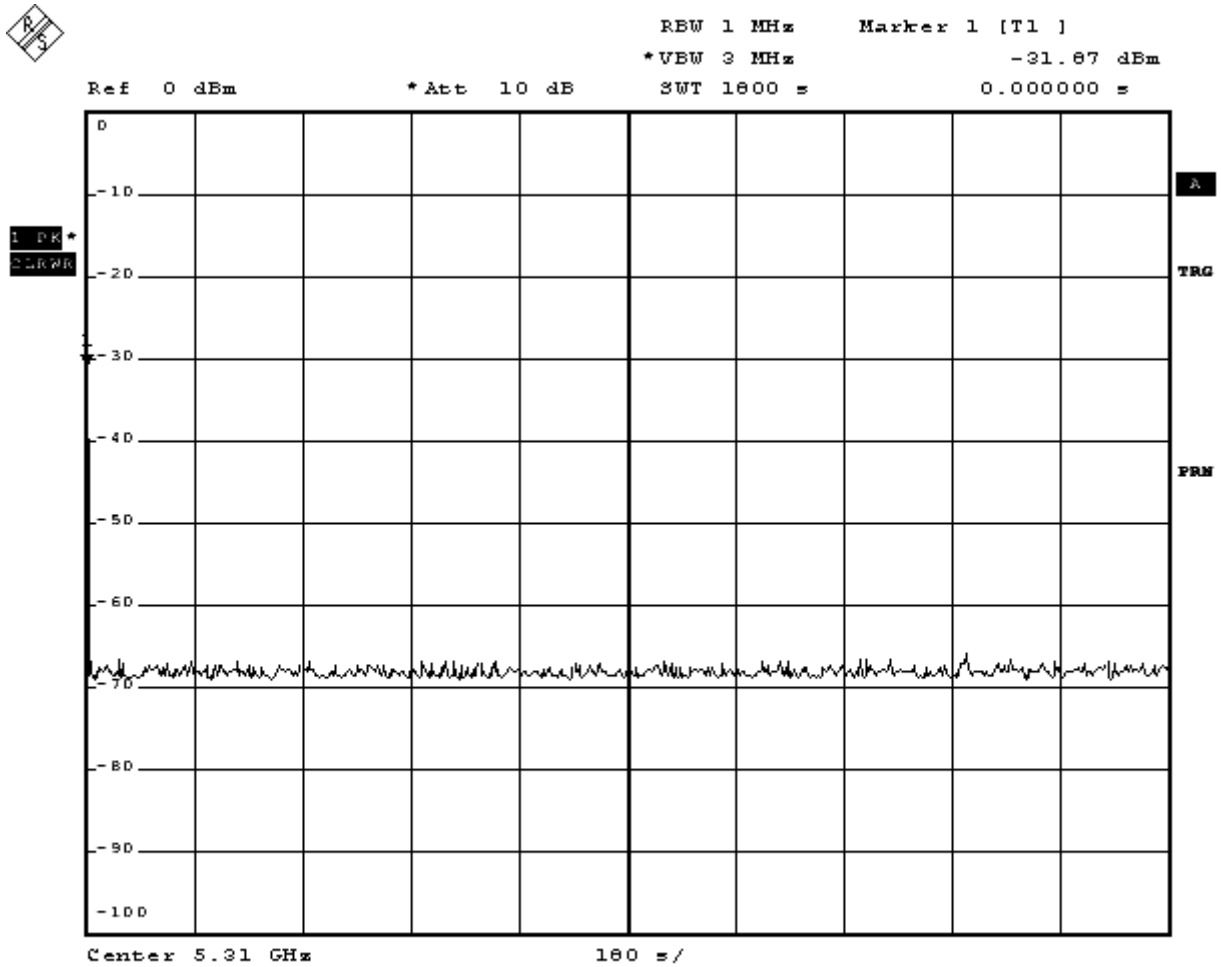

Test Item	Limit	Results
Non-Occupancy Period	30 Minutes	Pass

No EUT transmissions were observed on the test channel during 30 minutes observation time.

**Draft 802.11n Standard – 40MHz Channel Mode
30 Minute Non-Occupancy Period (using Type 1 Radar) at 5510 MHz**

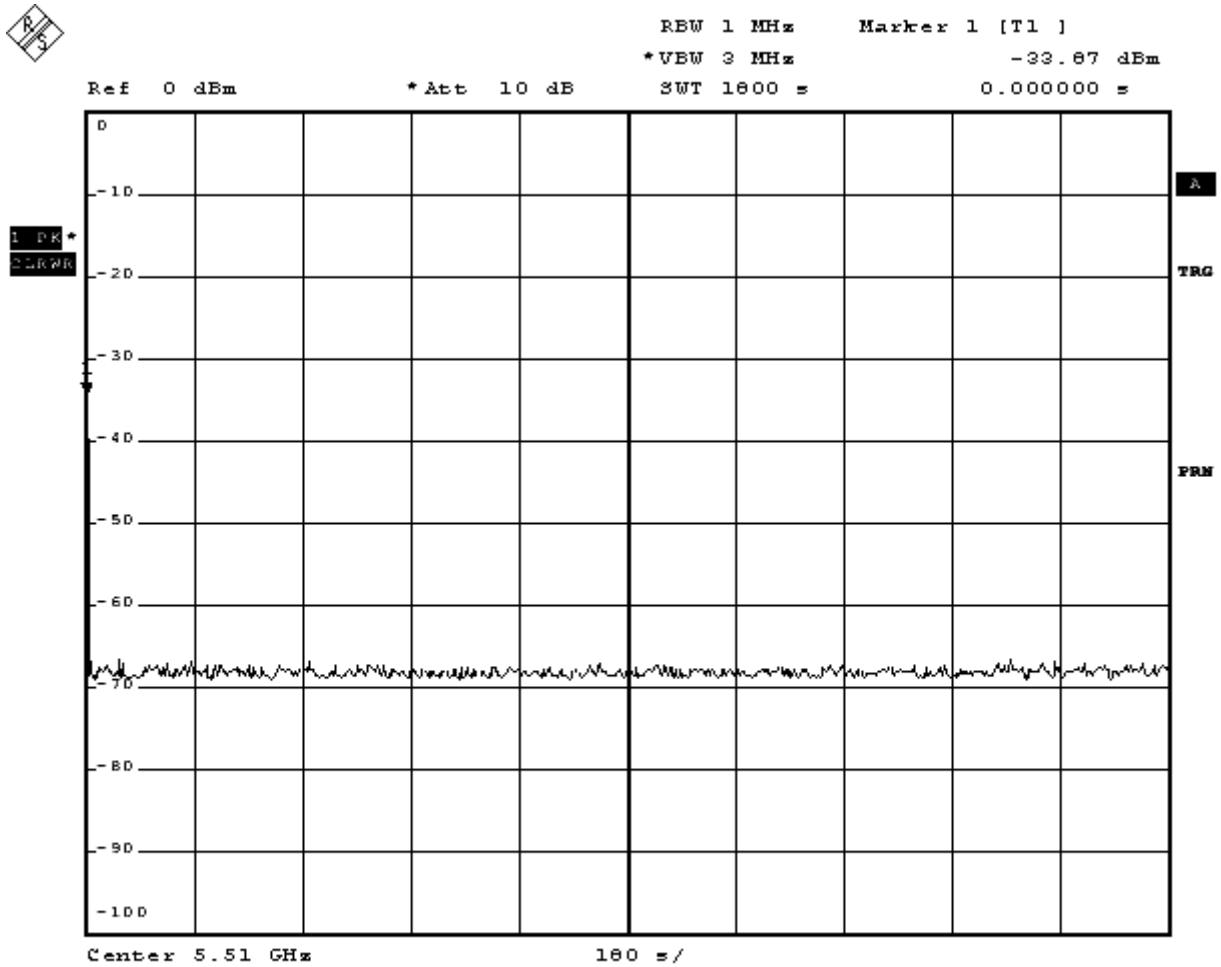

Test Item	Limit	Results
Non-Occupancy Period	30 Minutes	Pass

No EUT transmissions were observed on the test channel during 30 minutes observation time.