



## TABLE OF CONTENTS

Congratulations on the purchase of your new BrakeBuddy®! The BrakeBuddy® was designed and built as an auxiliary braking system to operate in conjunction with the existing braking system in your towed vehicle.

**Use of the BrakeBuddy® in a manner inconsistent with these instructions may result in damage to your vehicle, serious injury or death. You must read and understand these instructions prior to the use of this product.**

If you have any questions after reading these instructions, please call BrakeBuddy® customer service at 1 800-470-2287.

### CONTENTS

Break Away Initial Installation .....	Page 2
Setup .....	Page 4
Alert System .....	Page 6
Operation Instructions .....	Page 7
Removal Instructions .....	Page 8
Troubleshooting .....	Page 9
Warranty .....	Page 10

Remove the BrakeBuddy® and components from the shipping carton. The complete system consists of:

- Main BrakeBuddy® Unit**
- Clevis Assembly**
- Handle and Knob**
- Remote Alert System**
- Break-Away System**

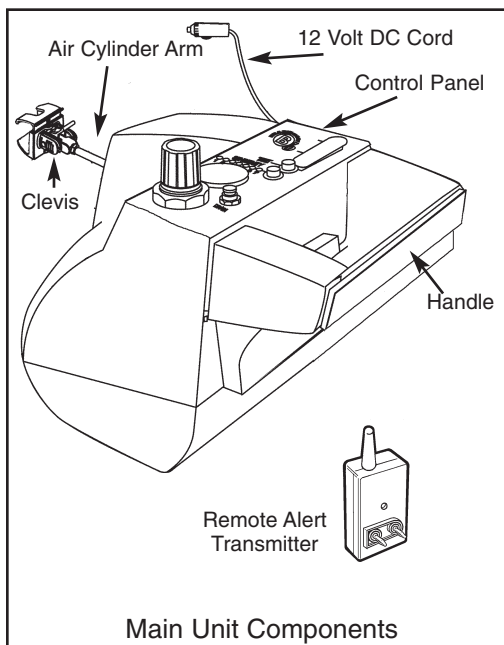

### Break-Away Contents

- (A) 1, 1/16" coiled break-away cable with one large and one small clip on the ends
- (B) 1 junction box with wiring harness
- (C) 1 strap clamp
- (D) 2 hex socket head cap screws
- (E) 2 flat washers
- (F) 2 lock washers
- (G) 2 sheet metal screws
- (H) 2 grommets
- (I) 5 nylon ties
- (J) 1 loose velcro patch

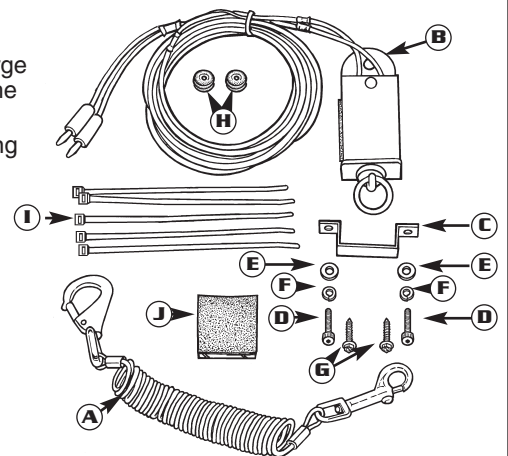



## BREAK-AWAY INSTALLATION

The Break-Away is an important part of the BrakeBuddy system and is required by law in most states. Do not operate your BrakeBuddy without a properly functioning Break-Away.

### Installing Junction Box

1. Find a convenient, sturdy place on the front of your towed vehicle to mount the junction box (B). This should be installed on the driver's side of the vehicle if possible.
2. Clean the mounting surface and attach the velcro patch (J) (Fig. 2).
3. Attach the junction box (B) to the velcro patch (J) so the pin with the ring faces forward and the wiring harness feeds back into the engine compartment.
4. Place the mounting bracket (C) over the junction box (B) and mark the hole locations to be drilled and tapped.

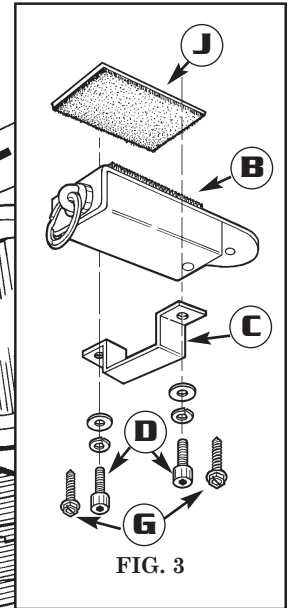
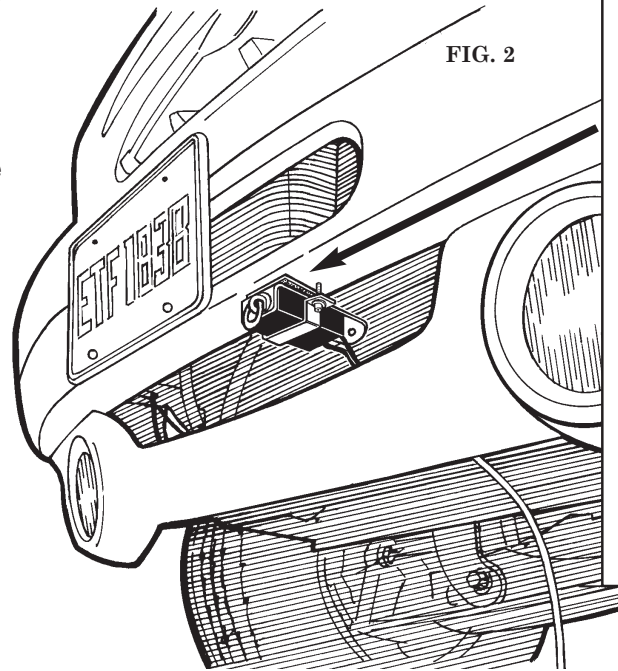

5. Remove bracket (C) and junction box (B). Drill marked holes with a 1/8" metal drill bit.  
**NOTE:** For thin sheet metal or plastic, it may be necessary to reinforce the plastic or thin metal to ensure the bracket will not separate from the vehicle when the break-away pin is pulled. If you are going to drill through thicker metal, use hex socket head cap screws (D). You will need to drill a hole using a #25 drill bit and tap the hole using a 10-24 tap.
6. Replace the junction box (B) and attach the bracket (C) using hex socket head cap screws (D) or sheet metal screws (G) provided (Fig. 3).
7. Locate a place in the firewall that will allow the wiring harness to be fed through into the drivers' side compartment of the towed vehicle. Use of an existing hole would be most convenient.
8. If there is no existing hole, drill a 15/32" diameter hole through the firewall (Fig. 4 / K). Be careful not to drill into any functional components of the vehicle.
9. Starting from the junction box (Fig. 4 / B), route

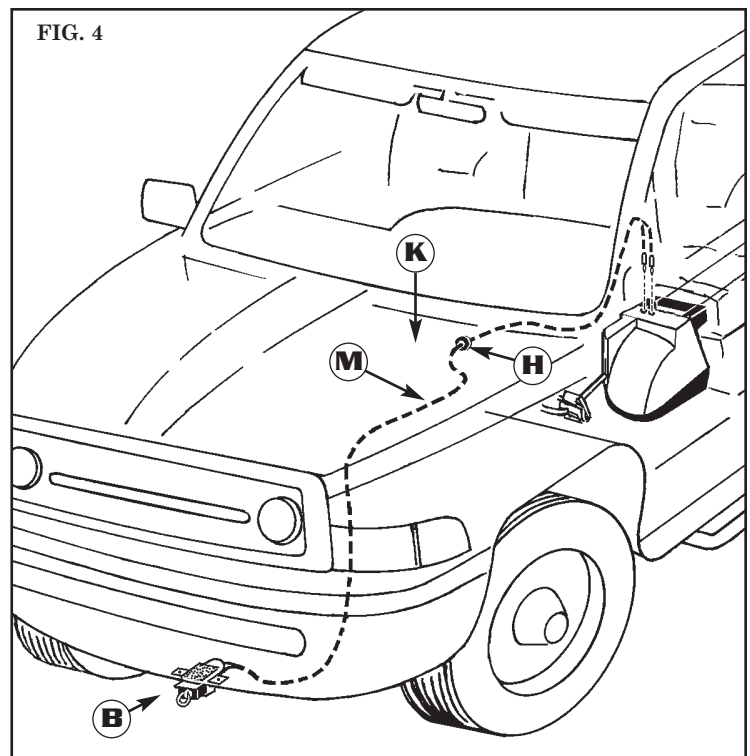



## BREAK-AWAY INSTALLATION

the black electrical wire up to the firewall keeping it away from hot or moving engine components. Secure using the nylon ties (I) provided (Fig. 4 / M).

10. Feed the black wire through the hole in the firewall and into the passenger compartment (Fig. 5).

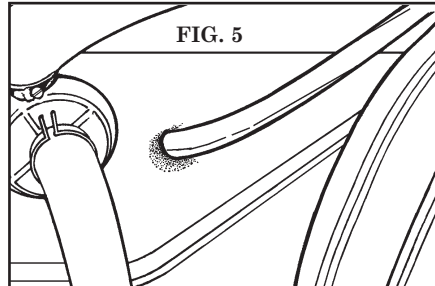

11. Place the split rubber grommet provided (H) over the black electrical wire (Fig. 6) and slide it into the 15/32" hole and fasten it into place (Fig. 7).

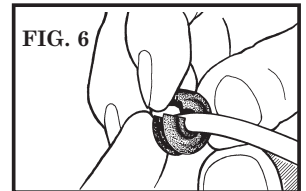

**NOTE:** Failure to properly install the 15/32" rubber grommet may result in harmful fumes entering the vehicle, or damage to the wires.

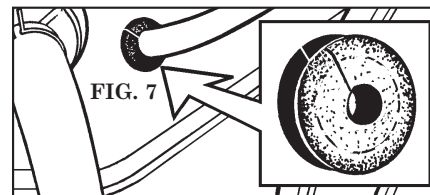

### Using the Break-Away System

After attaching your towed vehicle to your coach and all hook-ups are complete, you will need to attach the break-away cable (A) from the junction box (B) to the motorhome. **On the motorhome end attach to a permanent location. The frame of the vehicle is recommended. DO NOT attach or wrap the cable around the tow bar, hitch or bumper.**

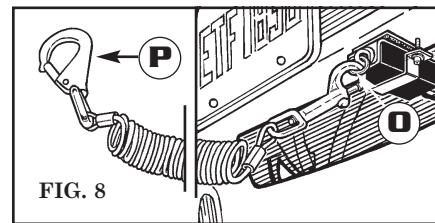

1. Attach the small clip on the cable (A) to the loop on the pull pin of the junction box (Fig. 8 / Q), and then attach the large clip to the motorhome (Fig. 8 / P). The coiled break-away cable fits all applications and needs no adjustment.

2. Setup the BrakeBuddy in your towed vehicle and plug the junction box wire harness into the receptacles on top of the BrakeBuddy (Fig. 9 / Q).



FIG. 9

3. Before the start of every trip, pull the break-away pin to test that the break-away system activates the Brake Buddy.

4. When the use of the towed vehicle is needed, simply unhook the small clip from the loop on the pull pin of the junction box (B). Unplug the junction box wire harness from the BrakeBuddy and coil the wire under the dashboard or under your floor mat (Fig. 10).





## SETUP

1. Press the “Drain” button (A) to ensure there is no air pressure inside the unit (Figure 1).
2. Attach the lock nut and clevis assembly to the air cylinder (Fig. 2).
3. Attach handle assembly to main unit (Fig. 3) with adjustment knob.
4. Adjust the driver’s seat to the far back position (Fig. 3). Place the BrakeBuddy® on the floorboard.
5. With the notched end of the clevis facing up, attach the clevis to the top of the towed vehicle’s brake pedal (Fig. 4). Angle the brake pedal clevis so the upper portion of the clevis grabs the top of the towed vehicle’s brake pedal. Pull down on the lower portion of the clevis to extend the clevis under the bottom of the towed vehicle’s brake pedal. Pull back very firmly on the red tab (B) until it locks into place securely. If attached correctly the clevis should be locked securely around the vehicle’s brake pedal.
6. Move the BrakeBuddy® forward until the Air Cylinder Arm is fully retracted (Fig. 5). Make sure the vehicle’s brake pedal is not being pressed.
7. Adjust the driver’s seat forward until it is less than a quarter inch away from the BrakeBuddy’s® handle or loosely touching the handle (Fig. 6). Again, make sure the vehicle’s brake pedal is not being pressed.
8. Power the BrakeBuddy® by plugging the unit into a 12-volt receptacle in the towed vehicle (Fig. 8). When powered, the air compressor will fill the air tank in under 1 minute. While the air compressor is filling, the red sensitivity lights will descend from 7 to 1. If a 12-volt power supply is not available in the towed position (or the 12-volt power remains off in the ignition off position), a 12-volt Battery Direct Kit is available (part number 39305). At a minimum, a 15-amp 12-volt power supply is required to operate the BrakeBuddy®.
9. When the air compressor is completely filled, the red sensitivity lights will display 1 through 5. This is signaling you to press the Test button five times to (a) make sure the unit is performing and adjusted properly; and (b) to remove the vacuum stored in the towed vehicle’s brake vacuum reservoir, also known as relieving vacuum.

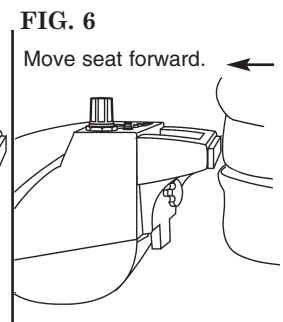
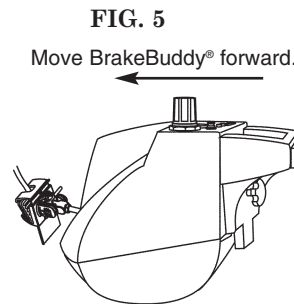
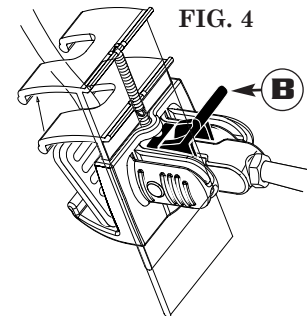
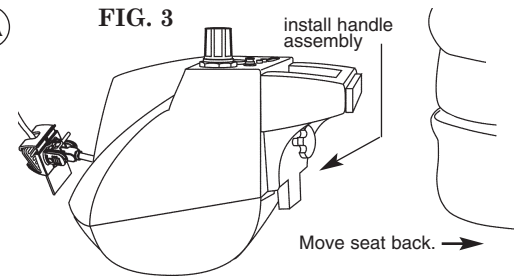
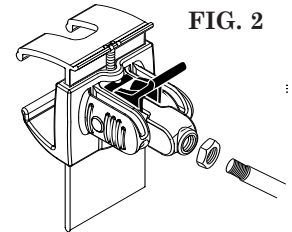
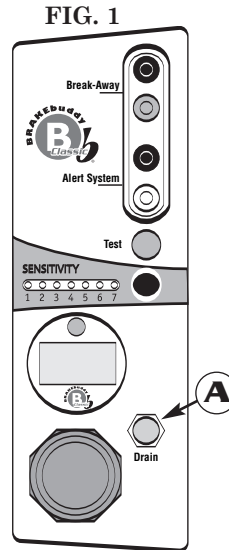



## SETUP

10. Press the Test button on the top BrakeBuddy® panel. The Test button (Fig. 9 / C) will activate the arm one time. Use this time to confirm that the unit is in the correct floor position.

11. If needed adjust the BrakeBuddy® handle (Fig. 8). Loosen the adjustment knob on the back center portion of the BrakeBuddy® and adjust the height of the handle so it contacts the seat at the lowest position possible without sliding under the seat. (NOTE: the lower on the seat, the firmer the support). Tighten the adjustment knob to secure handle. Repeat step 7 until the seat is in the correct position.

12. After pressing the Test button the red sensitivity light will descend from 5 to 4. When the seat is in the correct position press the Test button four more times to completely relieve the brake vacuum. (Make sure the BrakeBuddy® arm is pumping the brake when you activate the Test button.) Each time the test button is pressed the red sensitivity light will decrease by an increment of one.

After pressing the test button five times the sensitivity lights will change to green indicating that the BrakeBuddy® has relieved the vacuum of the towed vehicle's brakes.

**WARNING: For vehicles equipped with electric power assist brakes, call BrakeBuddy® for further instructions 1-800-470-2287. (Electric power assist brakes are common on hybrid vehicles; please call BrakeBuddy® if you have questions).**

**Do not tow your vehicle until the sensitivity lights are green.**

13. If needed, make final seat adjustments. You may continue to press the Test button as many times as needed to confirm that the BrakeBuddy® unit is placed in the correct position.

**IMPORTANT: Look at the brake lights at the rear of the towed vehicle to make sure they are not on. If the brake lights are on, the BrakeBuddy® is too close to the brake pedal.**

If for some reason the BrakeBuddy® does not fit your vehicle properly, please call technical service at 1-800-470-2287.

NOTE: A rubber floor mat under the BrakeBuddy® will not allow the system to function properly and may result in damage. Please be sure a carpet floor mat is being used.

**WARNING: Any time the towed vehicle's engine has been started you must push the Test button 5 times after shutting the towed vehicle's engine off. This removes the vacuum out of the vehicle's brake system. Failure to drain the towed vehicle's brake vacuum will result in excessive tire wear.**

FIG. 7 Plug into 12v accessory receptacle.

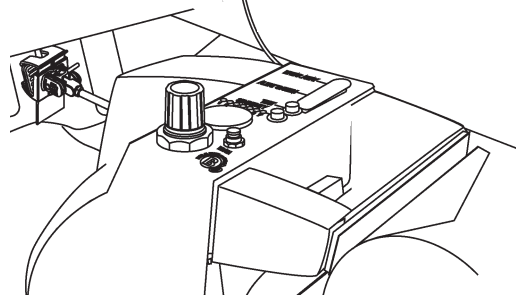

FIG. 8

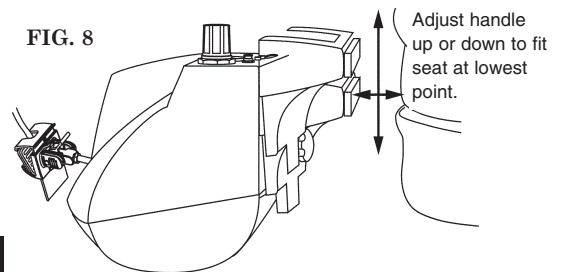
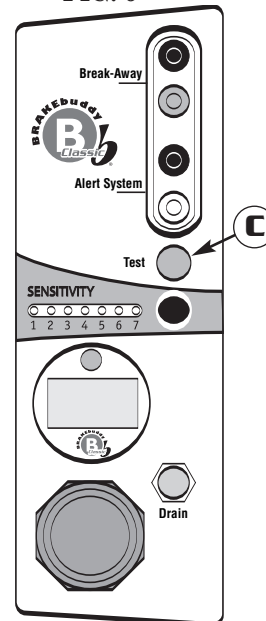

FIG. 9





## ALERT SYSTEM INSTALLATION

The Alert System is a wireless monitor that illuminates on your motorhome's dashboard when the BrakeBuddy is activated telling you that the BrakeBuddy is working properly. This system consists of two parts, the Transmitter and the Receiver.

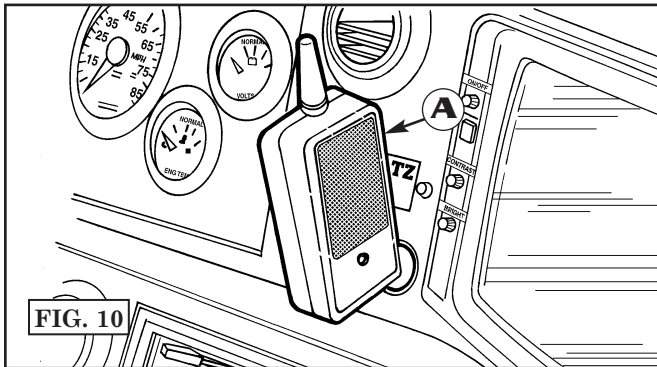

The **Alert System Receiver** (Fig. 10 / **A**) plugs into a 12-volt outlet on the dash of the motorhome. When the BrakeBuddy® is activated in the towed vehicle, the Receiver will illuminate.

The receiver will continually flash red if the towed vehicle's battery drops below 10 volts. Also, the BrakeBuddy® main unit Sensitivity Settings #7, will flash red in a low battery circumstance. At this time you need to stop and restart your towed vehicle to recharge the battery. Remember, always relieve the brake vacuum after shutting the towed vehicle's engine off.

If the towed vehicle breaks away from the motorhome the receiver gives an audible signal and flashes red. The audible will sound until the break-away pin is reinserted.

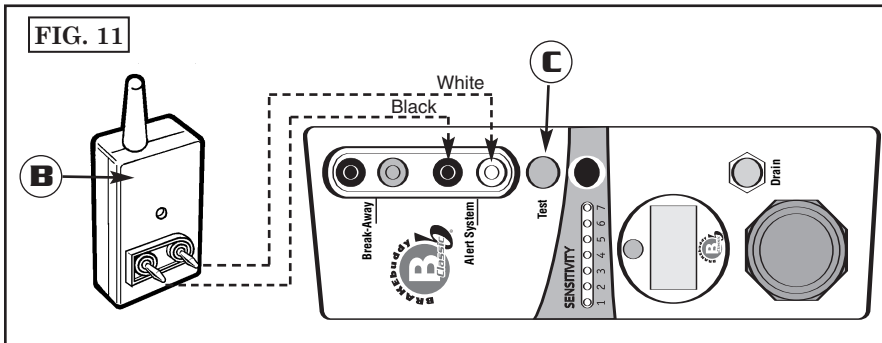

The **Transmitter** (Fig. 11 / **B**) plugs into the top of the BrakeBuddy® and sends a signal to the Receiver when the BrakeBuddy® is activated. Plug the transmitter into the connections on the BrakeBuddy® marked "Alert System" (Fig. 2). The antenna should point toward the motorhome.

### Test Procedure

Perform each time before use.

Before you begin towing, a simple test should be performed to assure your Alert System is operating properly. Have someone push the red test button on the BrakeBuddy® (Fig. 3 / **C**) and hold it for ten seconds while you are in your parked motorhome looking at the Receiver. The Receiver should illuminate for the full ten seconds without blinking. **Do not do this while the motorhome is moving!** The Alert Receiver will illuminate: (1) when the test button is pressed; (2) when the BrakeBuddy activates as a result of forward inertia (i.e., the braking of the motorhome) ; or (3) if the Break-Away pin is pulled.

### NOTE:

In the unlikely circumstance that the receiver is plugged into a 12-volt outlet within 5 feet of the main unit, the Receiver will not confirm braking activity. The BrakeBuddy® Classic will continue to operate the braking function, but the receiver will not glow red to confirm braking.

**NOTE:** An optional transmitter extension cord is available if the signal is not reaching the receiver. Call BrakeBuddy® customer service, 1-800-470-2287.

FCC/ID Notice: This device complies with Part 15 of FCC Rules. Operation is subject to the following two conditions: (1) This device may not cause harmful interference, and (2) this device must accept any interference received, including interference that may cause undesired operation.



## OPERATION INSTRUCTIONS

1. Adjust the air regulator knob to match the weight of your towed vehicle (Figure 12). The braking pressure, or how hard your towed vehicle will brake in tow, is adjusted by the air regulator on top of the BrakeBuddy®. To find the correct pressure setting for your vehicle, please refer to the Vehicle Weight Formula Chart below. To adjust the setting, pull up on the air regulator knob, turn knob until the pressure gauge reads the correct setting specified by the Vehicle Weight Formula Chart, and push the knob down to lock it in place. Press the red button in the Digital Display to choose your preferred mode of weight measurement of kilograms or Psi.

When the BrakeBuddy® engages, the towed vehicle should give a slight and smooth tug on the motorhome. **Note:** Larger motorhomes may not feel a tug when towing smaller vehicles. As mentioned previously, the wireless Alert System also confirms when and how long the BrakeBuddy® is activating.

2. Adjust the Sensitivity Button. The Sensitivity Button on the top of the BrakeBuddy® determines how hard you must apply the brakes in the motorhome before the BrakeBuddy will engage the brakes in your towed vehicle. The sensitivity of the BrakeBuddy® is adjusted by holding down the Sensitivity Button (Figure 10). The more lights that are illuminated, the easier the BrakeBuddy will activate. Each time the BrakeBuddy® is installed, the sensitivity will return to the last setting used on your previous trip.

**NOTE:** Your RV must be moving faster than 15 mph for the BrakeBuddy to engage the brakes in the towed vehicle.

FIG. 12

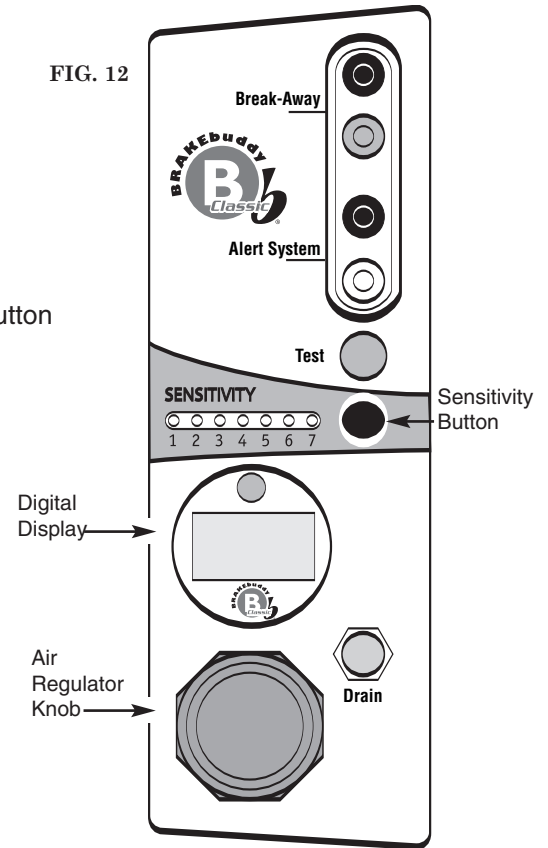

## VEHICLE WEIGHT FORMULA

Settings are made by adjusting the air regulator knob. Lift up and turn the knob clockwise to increase pressure and counter-clockwise to decrease pressure.

Pounds	Kilograms	Psi.	With Tow Dolly
1,500 – 2,000	680 – 907	25	35
2,000 – 2,500	907 – 1,134	35	45
2,500 – 3,000	1,134 – 1,361	40	50
3,000 – 3,500	1,361 – 1,588	45	55
3,500 – 4,000	1,588 – 1,814	50	60
4,000 – 4,500	1,814 – 2,041	55	65
4,500 – 5,000	2,041 – 2,268	65	75
5,000 +	2,268 +	75	85

**NOTE:** 1999 and newer Jeep Grand Cherokees should be set at 55 psi.



**BrakeBuddy®**  
Dedicated to towing safety™

Phone (800) 470-2287  
Brakebuddy.com

---

## REMOVAL INSTRUCTIONS

---

To remove the BrakeBuddy from your towed vehicle, unplug the unit, push the drain button to relieve the air pressure in the system, adjust seat back and remove the BrakeBuddy.

**CAUTION:** *Failure to drain your BrakeBuddy's air system and unplug it from the car's power source before handling may cause damage to your vehicle, serious injury or death.*

### Information to User:

NOTE: This equipment has been tested and found to comply with the limits for a Class B digital device, pursuant to part 15 of the FCC Rules. These limits are designed to provide reasonable protection against harmful interference in a residential installation. FCC Radiation Exposure Statement to comply with FCC RF exposure requirements in section 1.1307, a minimum separation distance of 1.40 cm (0.6 inches) is required between the antenna and all persons. This equipment generates, uses and can radiate radio frequency energy and, if not installed and used in accordance with the instructions, may cause harmful interference to radio communications. However, there is no guarantee that interference will not occur in a particular installation. If this equipment does cause harmful interference to radio or television reception, which can be determined by turning the equipment off and on, the user is encouraged to try to correct the interference by one or more of the following measures:

- Reorient or relocate the receiving antenna.
- Increase the separation between the equipment and receiver.
- Connect the equipment into an outlet on a circuit different from that to which the receiver is connected.
- Consult the dealer or an experienced radio / TV technician for help.

**CAUTION:** Changes or modifications not expressly approved by Hopkins Manufacturing Corporation could void the user's authority to operate the equipment.





---

## TROUBLESHOOTING

---

### TROUBLESHOOTING

- Problem:** The air compressor will not come on after I plug in the BrakeBuddy.  
**Solution:** Check the air gauge for pressure in the tank. If the tank is already pressurized, the compressor is designed to not come on until the tank's pressure is reduced by BrakeBuddy activation. Make sure there is power to the 12-volt receptacle and the fuse for the 12-volt plug is functioning. If both are functioning, the green indicator light on the 12-volt plug will be lit when it is plugged in. To remove the fuse on the BrakeBuddy's power cord, unscrew the finger nut on the end of the plug. Replace fuse with a 15-amp fuse.
- Problem:** The BrakeBuddy will not apply the brakes in the towed vehicle.  
**Solution:** Make sure the air regulator is properly adjusted for the weight of the towed vehicle. Also check the sensitivity setting. Remember, your RV must be moving at least 15 mph for the BrakeBuddy to activate.
- Problem:** The BrakeBuddy applies the brakes too hard in my towed vehicle.  
**Solution:** Push the test button five times before towing to relieve the vacuum in the towed vehicle's brake booster. Or adjust the air regulator knob to reduce the air pressure.
- Problem:** The BrakeBuddy applies the brake as soon as I plug it in.  
**Solution:** Check that the break-away system is properly connected and the pin is plugged into the junction box.
- Problem:** The compressor pumps up and then keeps on pumping slowly.  
**Solution:** There may not be enough current to the BrakeBuddy. You may have a weak battery or you may need a "12-volt Battery Direct Kit" (part number 39305). At a minimum, a 15-amp 12-volt cigarette lighter or auxiliary power plug is required to operate the BrakeBuddy.
- Problem:** I have to apply the brakes in my motorhome very hard for the Brake Buddy to come on.  
**Solution:** Increase the sensitivity of the BrakeBuddy by pressing the sensitivity button.
- Problem:** The BrakeBuddy turns my brake lights on even though I am not applying the brakes in my motorhome.  
**Solution:** The BrakeBuddy may be too close to the brake pedal thereby activating the brake lights. See steps 6 - 12 of the setup instructions.
- Problem:** The compressor will not start.  
**Solution:** BrakeBuddy is designed with an automatic shut-off on the compressor when voltage drops to 9.5 volts.
- Problem:** The seventh sensitivity light is flashing red.  
**Solution:** If your towed vehicle's battery is significantly low the seventh light on the sensitivity setting will warn you by flashing red. The Brakebuddy System will not operate if the towed vehicle's battery is considerably low.
- Problem:** I'm experiencing frequent battery drain on my towed vehicle.  
**Solution:** Battery drain can depend on your braking style and vehicle type. We recommend recharging the car battery once every three days to maintain optimum battery condition. Another solution is to install the Towed Vehicle Battery Maintainer (#39332). This accessory item continuously maintains the towed vehicle's battery charge. Contact your local dealer or BrakeBuddy to order.



**BrakeBuddy®**  
Dedicated to towing safety™

Phone (800) 470-2287  
Brakebuddy.com

---

## WARRANTY

---

Hopkins Manufacturing Corporation thanks you for purchasing BrakeBuddy. A 3-year limited warranty and a 30-day money back guarantee apply to your BrakeBuddy and BrakeBuddy accessories. An additional 2-year extended warranty is also available (part number 39307). Call BrakeBuddy customer service at 1-800-470-2287. We wish you safe and happy travels.

### LIMITED THREE-YEAR WARRANTY

#### WHAT IS COVERED AND FOR HOW LONG?

We are confident our product will perform well and therefore warrant to you, as the original retail purchaser, for a period of three years from the date of original purchase, that your new product will be free of mechanical and electrical defects in material and workmanship.

#### WHAT WILL BRAKEBUDDY DO? HOW DO I GET SERVICE?

During the warranty period, we will **repair or replace** your new product (at our option) without cost to you, which will be your exclusive remedy under this warranty. **Please do not return this product to the place of purchase. Doing so may delay the processing of your claim and our repair of your product.** Return your product postage prepaid, with proof of purchase. Please call BrakeBuddy customer service for shipping instructions.

#### WHAT IS NOT COVERED?

Our warranty for your product will not cover damage resulting from neglect or misuse of the product, use of improper voltage or current, use contrary to operating instructions, or disassembly, repair, or alteration by any person other than an authorized service station. Any implied warranty of merchantability or fitness for a particular purpose of your product is limited to the duration of this written warranty. We shall not be liable for any incidental or consequential damages for breach of any expressed or implied warranty on your product.

#### HOW YOUR STATE'S LAWS MAY APPLY:

Some states do not allow limitations on how long an implied warranty lasts or the exclusion or limitation of incidental or consequential damages, so the above limitation may not apply to you. This warranty gives you specific legal rights, and you may also have other rights, which vary from state to state.