

Ke Mei Ou Laboratory Co., Ltd.

7A, Jiexiangge, JiahuiXincheng, No.3027, Shennan Rd., Futian,
Shenzhen, Guangdong, P.R.China. Zip Code: 518033
Tel: + 86 755 83642690 Fax: + 86 755 83297077
www.kmolab.com

FCC TEST REPORT

Under
FCC 15 Subpart C, Paragraph 15.249: 2004

Prepared For :

Kiss Communications Technology Co., Ltd.

Room 1808, New Century Business Center, No.2-6, Hongde Road, Haizhu District,
Guangzhou, China

FCC ID: TJ7BTK-A22

EUT: Bluetooth Headset

Model: BTK-22

October 30, 2007

Report Type: Original Report

Test Engineer: <u>Jacky Huang</u>
--

Test Date: <u>October 26, 2007</u>

Review By: _____

Apollo Liu / Manager

The test report consists 23 pages in total. It may be duplicated completely for legal use with the allowance of the applicant. It shall not be reproduced except in full, without the written approval of Ke Mei Ou Laboratory Corporation. The test result in the report only applied to the tested sample.

TABLE OF CONTENTS

1. General Information.....	3
1. 1 Notes.....	3
1. 2 Testing Laboratory.....	3
1. 3 Details of Applicant.....	3
1. 4 Application Details.....	3
1. 5 Test Item.....	3
1. 6 Test Standards.....	3
2. Technical Test.....	4
2. 1 Summary of Test Results.....	4
3. EUT Modifications.....	4
4. Conducted Power Line Test.....	5
4. 1 Test Equipment.....	5
4. 2 Test Procedure.....	5
4. 3 Test Setup.....	5
4. 4 Configuration of the EUT.....	6
4. 5 EUT Operating Condition.....	7
4. 6 Conducted Power Line Emission Limits.....	7
4. 7 Conducted Power Line Test Result.....	7
5. Radiated Emission Test.....	8
5. 1 Test Equipment.....	8
5. 2 Test Procedure.....	8
5. 3 Radiated Test Setup.....	8
5. 4 Configuration of the EUT.....	9
5. 5 EUT Operating Condition.....	9
5. 6 Radiated Emission Limit.....	9
5. 7 Radiated Emission Test Result.....	10
6. Band Edge.....	12
6. 1 Test Equipment.....	12
6. 2 Test Procedure.....	12
6. 3 Radiated Test Setup.....	12
6. 4 Configuration of The EUT.....	13
6. 5 EUT Operating Condition.....	13
6. 6 Band Edge FCC 15.249(d) Limit.....	13
6. 7 Band Edge Test Result.....	13
7. Antenna Requirement.....	17
8. Photos of Testing.....	18
8. 1 EUT Test Photographs.....	18
8. 2 EUT Detailed Photographs.....	19
9. FCC ID Label.....	22
10. Test Equipment.....	23

1. General Information

1.1 Notes

The test results of this report relate exclusively to the test item specified in 1.5. The KMO Lab does not assume responsibility for any conclusions and generalizations drawn from the test results with regard to other specimens or samples of the type of the equipment represented by the test item. The test report may only be reproduced or published in full. Reproduction or publication of extracts from the report requires the prior written approval of the KMO Lab.

1.2 Testing Laboratory

SinTek Laboratory Co., Ltd.

No.7, Xinshidai Industrial, Guantian Village, Shiyuan Town, Bao'an District, Shenzhen, Guangdong China..

Tel: +86 755 27608353 Fax: +86 755 27608359

Site on File with the Federal Communications Commission – United States

Registration Number: 963441

1.3 Details of Applicant

Name : Kiss Communications Technology Co., Ltd.
Address : Room 1808, New Century Business Center, No.2-6, Hongde Road, Haizhu District, Guangzhou, China
Contact : N/A
Tel : N/A
Fax : N/A

1.4 Application Details

Date of Receipt of Application : October 8, 2007
Date of Receipt of Test Item : October 26, 2007
Date of Test : October 26-October 29, 2007

1.5 Test Item

Manufacturer : Same Applicant
Address : Same Applicant
Trade Name : N/A
Model No. : BTK-22, BTK-26, BTK-21, BTK-28, BTK-25, BTK-29
Description : Bluetooth Headset

Additional Information

Frequency : 2400-2483.5MHZ
Number of Channels : 79
Power Supply : DC 3.7V (Power by battery)
Operation Distance : N/A
Resolution :

1.6 Test Standards

FCC 15 Subpart C, Paragraph 15.249: 2004
--

Note: All radiated measurements were made in all three orthogonal planes. The values reported are the maximum values.

2. Technical Test

2.1 Summary of Test Results

The EUT has been tested according to the following specifications:

Standard	Test Type	Result	Notes
FCC Part 15, Paragraph 15.203	Antenna Requirement	PASS	Complies
FCC Part 15, Paragraph 15.207	Conducted Test	Not Applicable	Complies
FCC Part 15 Subpart C Paragraph 15.249(a) and 15.249(b) Limit	Field Strength of Fundamental	PASS	Complies
FCC Part 15, Paragraph 15.209	Radiated Test	PASS	Complies
FCC Part 15 Subpart C Paragraph 15.249(d) Limit	Measured Band Edges	PASS	Complies.

3. EUT Modifications

No modification by SinTek Laboratory Co., Ltd

4. Conducted Power Line Test

4.1 Test Equipment

Please refer to Section 10 this report.

4.2 Test Procedure

The EUT and simulators are connected to the main power through a line impedance stabilization network (L.I.S.N.). This provides a 50 ohm/50uH coupling impedance for the measuring equipment. The peripheral devices are also connected to the main power through a LISN that provides a 50ohm/50uH coupling impedance with 50ohm termination.

Both sides of A.C. line are checked for maximum conducted interference. In order to find the maximum emission., the relative positions of equipment and all of the interface cables must be changed according to ANSI C63.4:2003 on conducted measurement. Conducted emissions were invested over the frequency range from 0.15MHz to 30MHz using a receiver bandwidth of 9kHz.

4.3 Test Setup

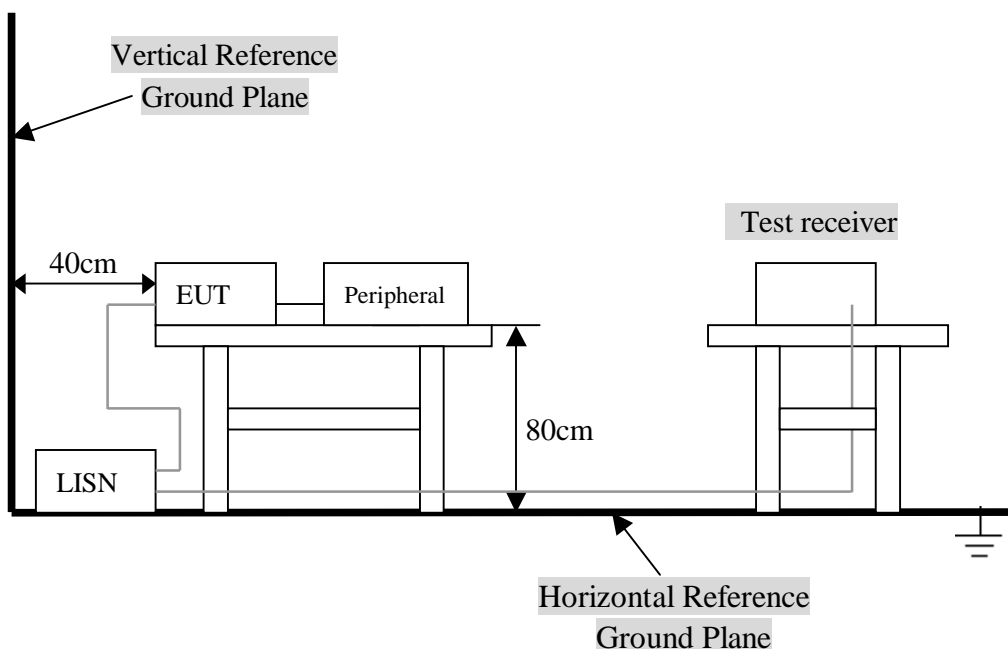

For the actual test configuration, Please refer to the related items – Photos of Testing.

4.4 Configuration of the EUT

The EUT was configured according to ANSI C63.4-2003. EUT was used DC3.7V. The operation frequency is from 2400MHz~2483.5MHz. Enable the signal transmitted from the external antenna from EUT to receiver. All interface ports were connected to the appropriate peripherals. All peripherals and cables are listed below.

Note:

- 1) Below 1GHz, the channel low, middle, high were pre-tested, The channel high, worst case one, was chosen for conducted and radiated emission test.
- 2) Above 1GHz, the channel low, middle, high were tested individually.

A. EUT

Device	Manufacturer	Model #	FCC ID
Bluetooth Headset	Kiss Communications Technology Co., Ltd.	BTK-22	TJ7BTK-A22

B. Internal Devices

Device	Manufacturer	Model #	FCC ID
N/A			

C. Peripherals

Device	Manufacturer	Model # Serial #	FCC ID/ DoC	Cable
Printer	HP	HP930C	DoC	1.5m unshielded power cord 1.2m unshielded data cable.
Modem	GVC	N/A	DoC	1.5m unshielded power cord 1.2m unshielded data cable.
Notebook	DELL	PP10L	DoC	1.5m unshielded power cord
PC	Dell	2400n	DoC	1.5m unshielded power cord

4. 5 EUT Operating Condition

Operating condition is according to ANSI C63.4 - 2003.

- A. Setup the EUT and simulators as shown on follow.
- B. Enable RF signal and confirm EUT active.
- D. Modulate output capacity of EUT up to specification.

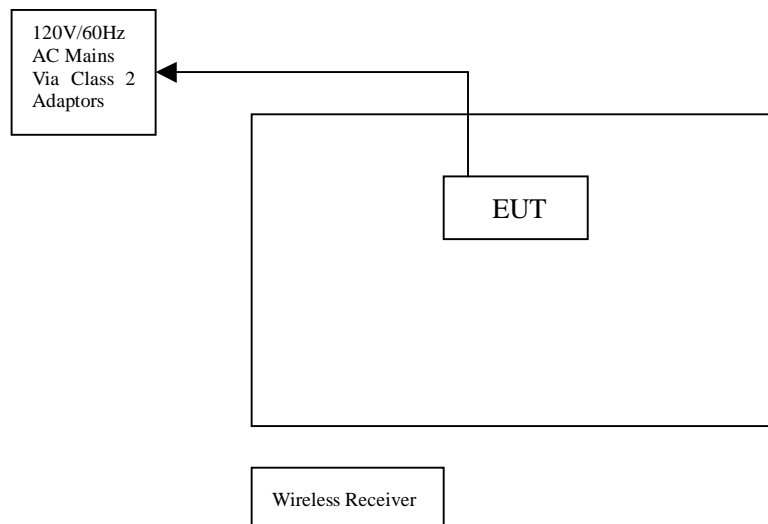

4. 6 Conducted Power Line Emission Limits

FCC Part 15 Paragraph 15.207 (dBuV)		
Frequency Range (MHz)	Class A QP/AV	Class B QP/AV
0.15 – 0.5	79/66	66-56/56-46
0.5 – 5.0	73/60	56/46
5.0 - 30	73/60	60/50

NOTE : In the above table, the tighter limit applies at the band edges.

4. 7 Conducted Power Line Test Result

Owing to the DC operation of EUT, this test item is not performed.

5. Radiated Emission Test

5.1 Test Equipment

Please refer to Section 10 this report.

5.2 Test Procedure

1. The EUT was tested according to ANSI C63.4 - 2003.
2. The EUT, peripherals were put on the turntable which table size is 1m x 1.5 m, table high 0.8 m. All set up is according to ANSI C63.4-2003.
3. The frequency spectrum from 30 MHz to 1 GHz was investigated. All readings from 30 MHz to 1 GHz are quasi-peak values with a resolution bandwidth of 120 KHz. All readings are above 1 GHz , peak values with a resolution bandwidth of 1 MHz . Measurements were made at 3 meters.
4. The antenna high is varied from 1 m to 4 m high to find the maximum emission for each frequency.
5. Maximizing procedure was performed on the six (6) highest emissions to ensure EUT compliance is with all installation combinations. All data was recorded in the peak detection mode. Quasi-peak readings was performed only when an emission was found to be marginal (within -4 dB of specification limit), and are distinguished with a "QP" in the data table.
6. The antenna polarization: Vertical polarization and Horizontal polarization.

5.3 Radiated Test Setup

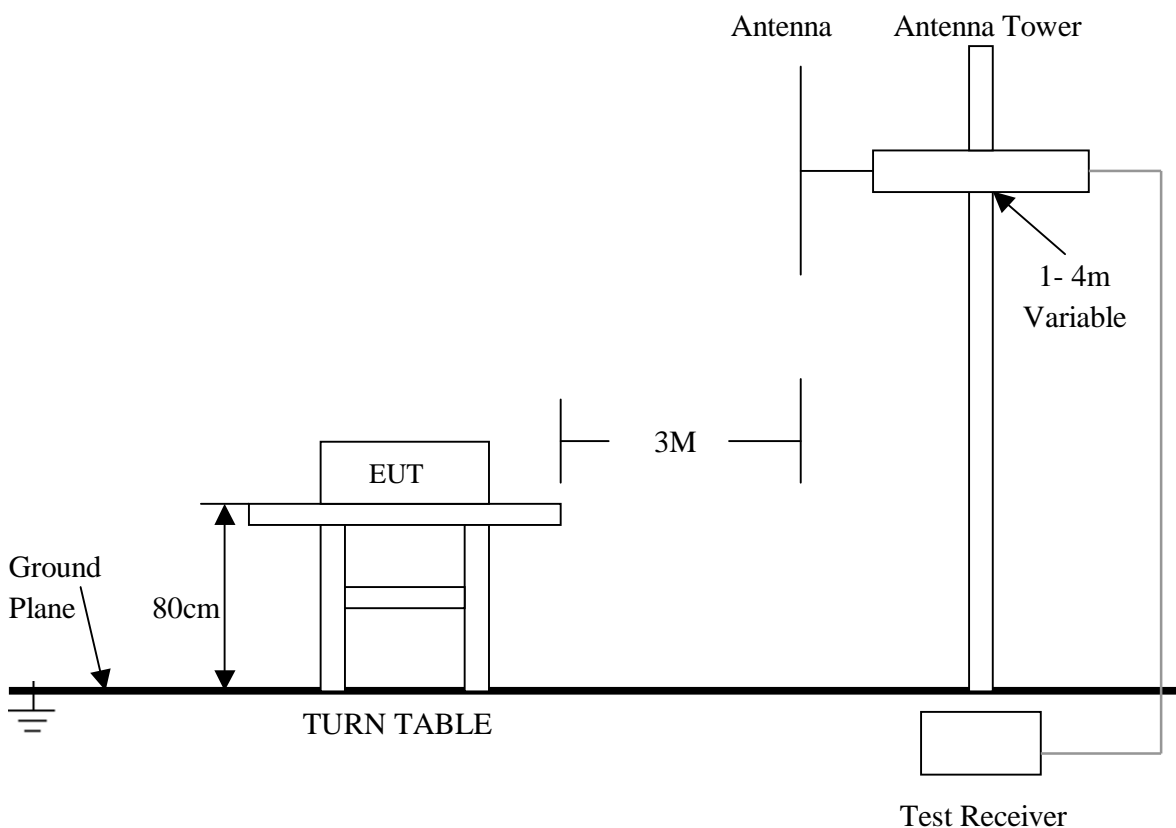

For the actual test configuration, please refer to the related items – Photos of Testing.

5. 4 Configuration of the EUT

Same as section 4.4 of this report

5. 5 EUT Operating Condition

Same as section 4.5 of this report.

5. 6 Radiated Emission Limit

All emission from a digital device, including any network of conductors and apparatus connected thereto, shall not exceed the level of field strength specified below :

A. FCC Part 15 Subpart C Paragraph 15.249(a) Limit

Fundamental Frequency (MHz)	Field Strength of Fundamental (3m)		Field Strength of Harmonics (3m)		
	mV/m	dBuV/m	uV/m	dBuV/m	
902~928	50	94(Average) 114(Peak)	500	54(Average)	74(Peak)
2400~2483.5	50	94(Average) 114(Peak)	500	54(Average)	74(Peak)

- Note:**
- (1) RF Voltage (dBuV) = 20 log RF Voltage (uV)
 - (2) Distance refers to the distance in meters between the measuring instrument antenna and the closed point of any part of the device or system.
 - (3) The emission limit in this paragraph is based on measurement instrumentation employing an average detector. Measurement using instrumentation with a peak detector function, corresponding to 20dB above the maximum permitted average limit.

B. Frequencies in restricted band are complied to limit on Paragraph 15.209.

Frequency (MHz)	Distance (m)	Field Strength (dBuV/m)
30 - 88	3	40.0
88 - 216	3	43.5
216 - 960	3	46.0
ABOVE 960	3	54.0

- Note:**
- (1) RF Voltage (dBuV) = 20 log RF Voltage (uV)
 - (2) In the Above Table, the tighter limit applies at the band edges.
 - (3) Distance refers to the distance in meters between the measuring instrument antenna and the closed point of any part of the device or system.

5. 7 Radiated Emission Test Result

A. Fundamental Radiated Emission Data

Product : Bluetooth Headset Test Mode : CH Low ~ CH High
 Test Item : General Radiated Emission Data Temperature : 25 °C
 Test Voltage : DC 3.7V (Power by battery) Humidity : 56%RH
 Test Result : **PASS**

CH Low

Freq. (GHz)	Emission (dBuV/m)		HORIZ /VERT	Limits (dBuV/m)		Margin (dB)	
	Peak	Average		Peak	Average	Peak	Average
2402.00	77.98	69.83	HORIZ	114.00	94.00	-36.02	-24.17
2402.00	67.44	59.67	VERT	114.00	94.00	-46.56	-34.33

CH Mid

Freq. (GHz)	Emission (dBuV/m)		HORIZ /VERT	Limits (dBuV/m)		Margin (dB)	
	Peak	Average		Peak	Average	Peak	Average
2440.00	76.56	68.23	HORIZ	114.00	94.00	-37.44	-25.77
2440.00	67.14	58.92	VERT	114.00	94.00	-46.86	-35.08

CH High

Freq. (GHz)	Emission (dBuV/m)		HORIZ /VERT	Limits (dBuV/m)		Margin (dB)	
	Peak	Average		Peak	Average	Peak	Average
2480.00	79.22	69.71	HORIZ	114.00	94.00	-34.78	-24.29
2480.00	68.89	61.05	VERT	114.00	94.00	-45.11	-32.95

- Note:**
- (1) All Readings below 1GHz are Quasi-Peak, above are performed with peak and/or average measurements as necessary.
 - (2) Emission Level = Reading Level + Probe Factor + Cable Loss.
 - (3) The average measurement was not performed when the peak measured data under the limit of average detection. If the readings given are average, peak measurement should also be supplied.

B. Harmonics Radiated Emission Data

Product : Bluetooth Headset Test Mode : CH Low~ CH High
 Test Item : Harmonics Radiated Emission Data Temperature : 25 °C
 Test Voltage : DC 3.7V (Power by battery) Humidity : 56%RH
 Test Result : **PASS**

CH Low

Freq. (MHz)	Emission (dBuV/m)	HORIZ / VERT	Limits (dBuV/m)	Margin (dB)
	Peak Detector			
4804.00	48.77	HORZ	74.0 / 54.0	-25.23
4804.00	47.92	VERT	74.0 / 54.0	-26.08
7206.00	47.83	HORZ	74.0 / 54.0	-26.17
7206.00	46.02	VERT	74.0 / 54.0	-27.98
24020.00	49.14	HORZ	74.0 / 54.0	-24.86
24020.00	48.27	VERT	74.0 / 54.0	-25.73

CH Mid

Freq. (MHz)	Emission (dBuV/m)	HORIZ / VERT	Limits (dBuV/m)	Margin (dB)
	Peak Detector			
4880.00	48.01	HORZ	74.0 / 54.0	-25.99
4880.00	47.12	VERT	74.0 / 54.0	-26.88
7320.00	48.23	HORZ	74.0 / 54.0	-25.77
7320.00	46.90	VERT	74.0 / 54.0	-27.10
24400.00	49.67	HORZ	74.0 / 54.0	-24.33
24400.00	48.06	VERT	74.0 / 54.0	-25.94

CH High

Freq. (MHz)	Emission (dBuV/m) Peak Detector	HORIZ / VERT	Limits (dBuV/m) Peak / Average	Margin (dB)
4960.00	48.86	HORZ	74.0 / 54.0	-25.14
4960.00	47.07	VERT	74.0 / 54.0	-26.93
7440.00	47.69	HORZ	74.0 / 54.0	-26.31
7440.00	46.13	VERT	74.0 / 54.0	-27.87
24800.00	49.24	HORZ	74.0 / 54.0	-24.76
24800.00	48.41	VERT	74.0 / 54.0	-25.59

- Note:**
- (1) All Reading Levels below 1GHz are Quasi-Peak, above are peak and average value.
 - (2) Emission Level = Reading Level + Probe Factor + Cable Loss.
 - (3) Receiver setting (Peak Detector) : RBW=1MHz; VBW=1MHz; Span=100MHz
 - (4) Receiver setting (AVG Detector): RBW=1MHz; VBW=30Hz; Span=20MHz
 - (5) The average measurement was not performed when the peak measured data under the limit of average detection. If the readings given are average, peak measurement should also be supplied.

C. General Radiated Emission Data

Product	: Bluetooth Headset	Test Mode	: CH High
Test Item	: General Radiated Emission Data	Temperature	: 25 °C
Test Voltage	: DC 3.7V (Power by battery)	Humidity	: 56%RH
Test Result	: PASS		

Freq. (MHz)	Emission (dBuV/m) QP Detector	HORIZ / VERT	Limits (dBuV/m)	Margin (dB)
43.480	21.40	HORZ	40.0	-18.60
57.240	21.19	VERT	40.0	-18.81
114.680	24.79	HORZ	43.5	-18.71
132.840	26.04	VERT	43.5	-17.46
152.040	28.85	HORZ	43.5	-14.65
225.760	30.08	VERT	46.0	-15.92

- Note:**
- (1) All Readings below 1GHz are Quasi-Peak, above are performed with peak and/or average measurements as necessary.
 - (2) Emission Level = Reading Level + Probe Factor + Cable Loss.

6. Band Edge

6.1 Test Equipment

Please refer to Section 10 this report.

6.2 Test Procedure

1. The EUT was tested according to ANSI C63.4 - 2003.
2. The EUT, peripherals were put on the turntable which table size is 1m x 1.5 m, table high 0.8 m. All set up is according to ANSI C63.4-2003.

6.3 Radiated Test Setup

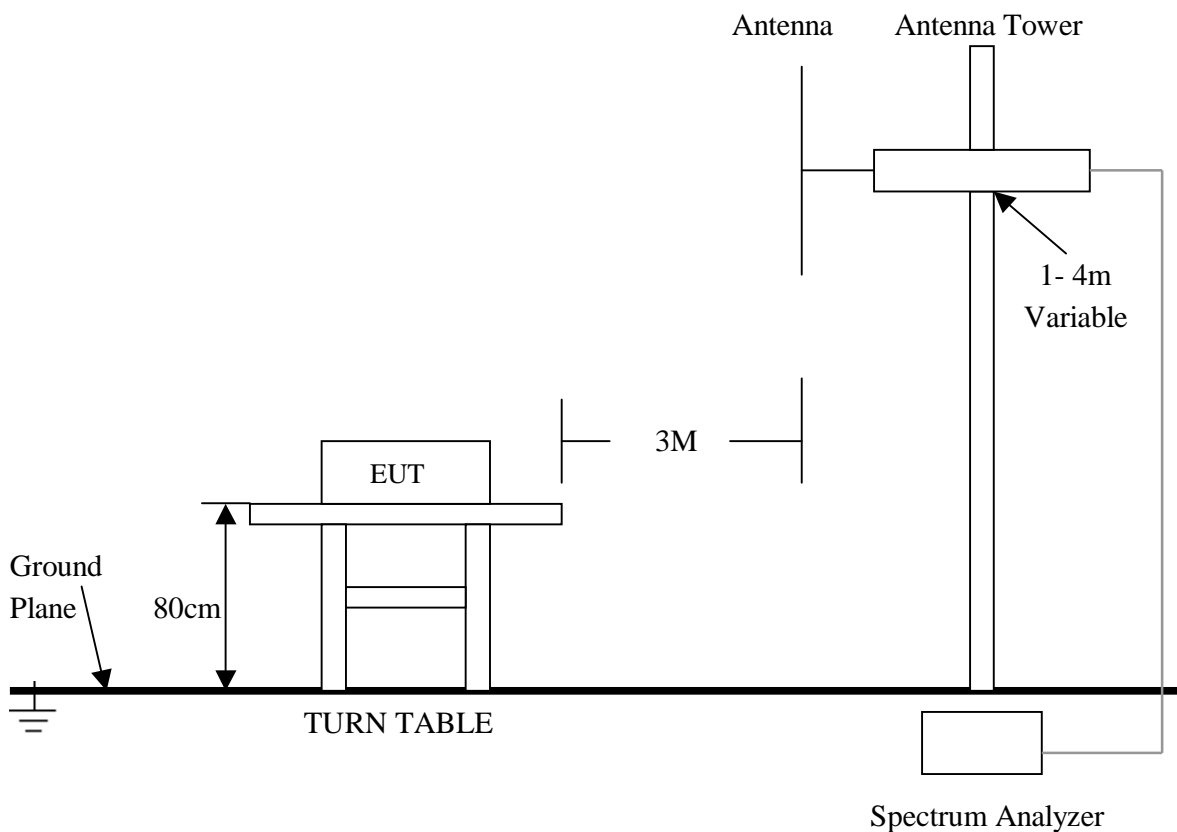

For the actual test configuration , please refer to the related items – Photos of Testing

6. 4 Configuration of The EUT

Same as section 4 . 4 of this report

6. 5 EUT Operating Condition

Same as section 4 . 5 of this report.

6. 6 Band Edge FCC 15.249(d) Limit

In any 100kHz bandwidth outside the frequency band in which the spread spectrum intentional radiator is operating, the radio frequency power that is produced by the intentional radiator shall be at least 50dB below that in the 100kHz bandwidth within the band that contains the highest level of the desired power, based on either an RF conducted or a radiated measurement. Attenuation below the general limits specified in Section 15.209(a) is not required. In addition, radiated emissions which fall in the restricted bands, as defined in Section 15.205(a), must also comply with the radiated emission limits specified in Section 15.209(a) (see Section 15.205(c)).

6. 7 Band Edge Test Result

Product	: Bluetooth Headset	Test Mode	: CH Low ~ CH High
Test Item	: General Radiated Emission Data	Temperature	: 25 °C
Test Voltage	: DC 3.7V (Power by battery)	Humidity	: 56%RH
Test Result	: PASS		

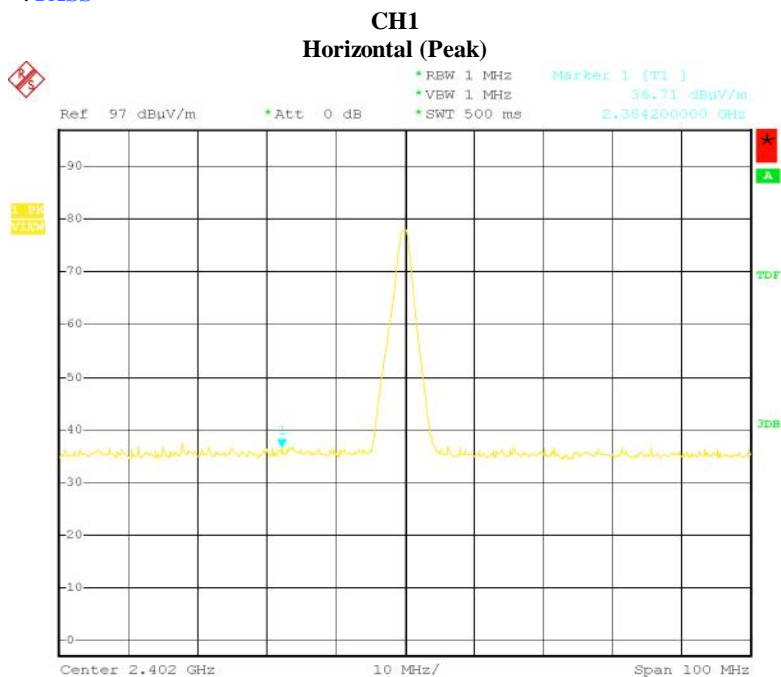

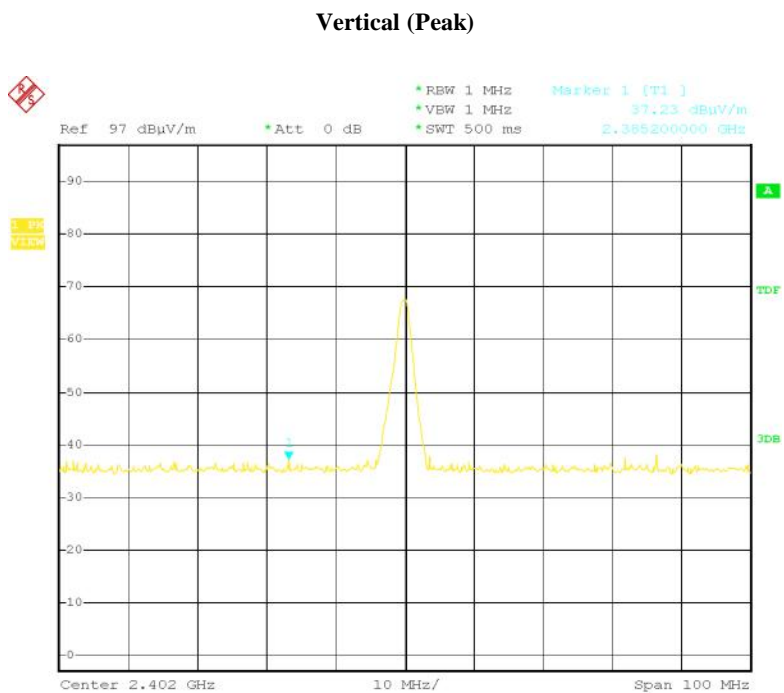
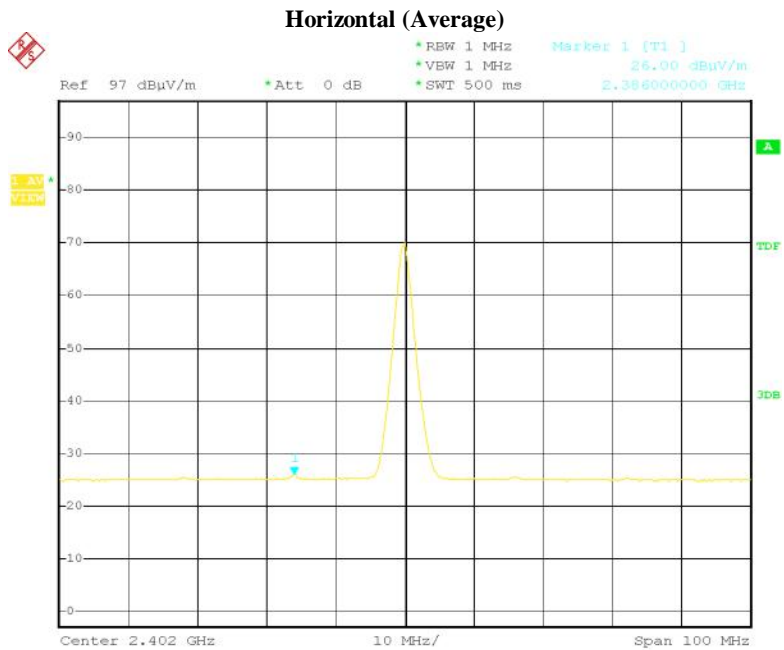

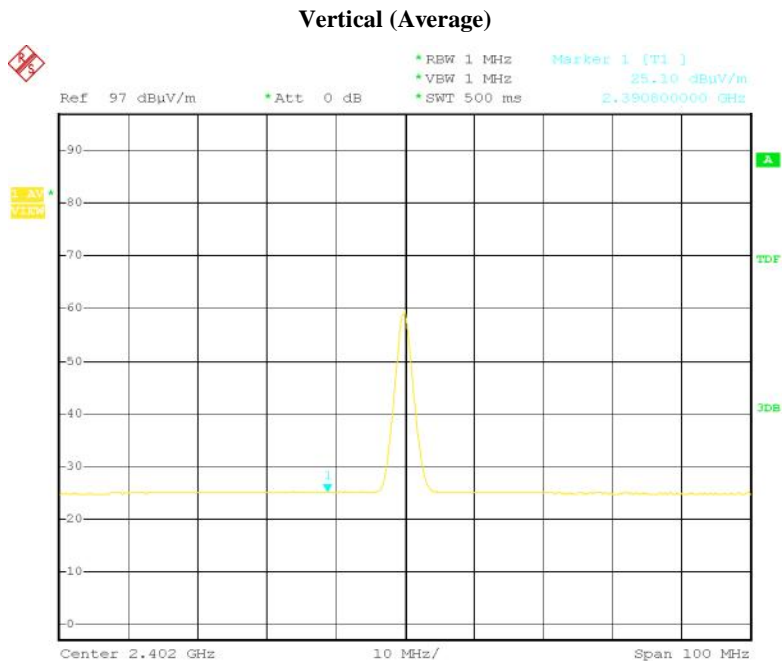

- Note:**
- (1) The field strength of any emissions which appear outside of this band shall not exceed the general radiated emission limits in Section 15.209.
 - (2) The average measurement was not performed when the peak measured data under the limit of average detection.

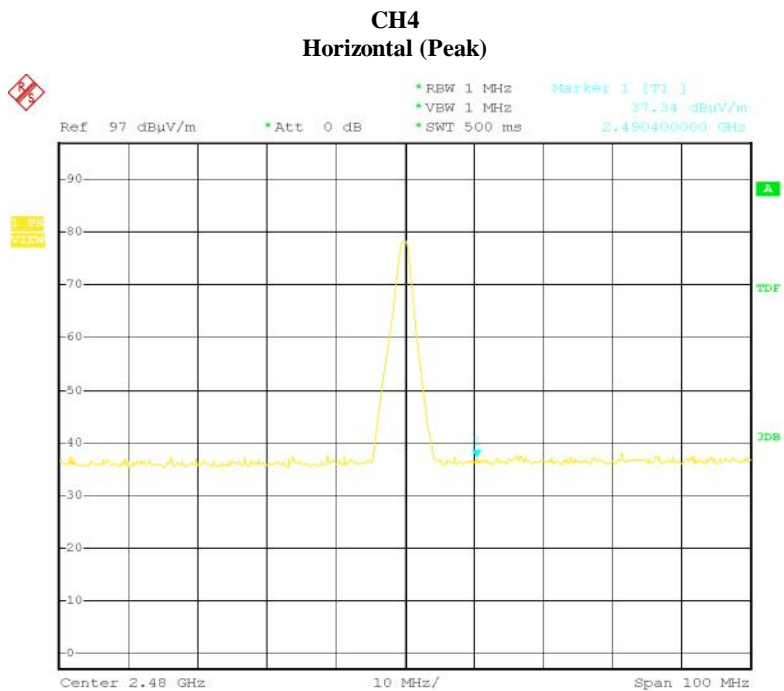

Horizontal (Average)

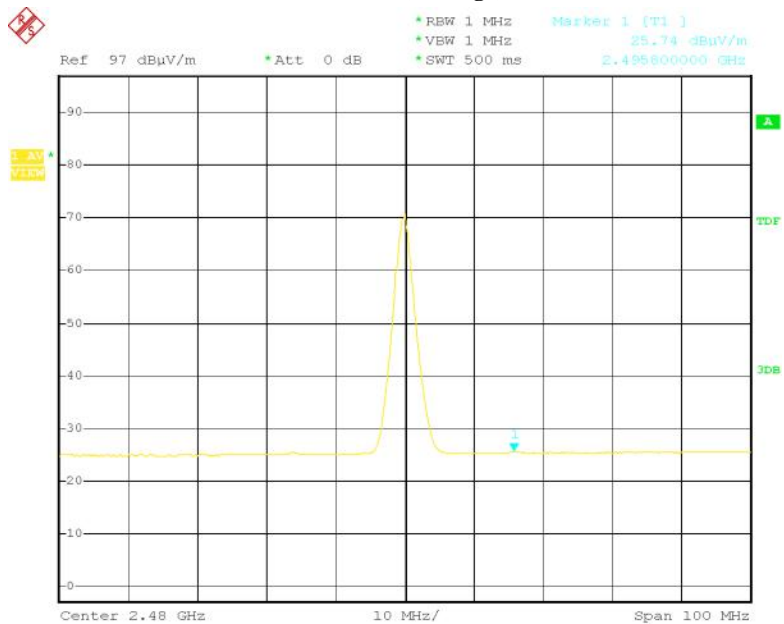

Vertical (Peak)

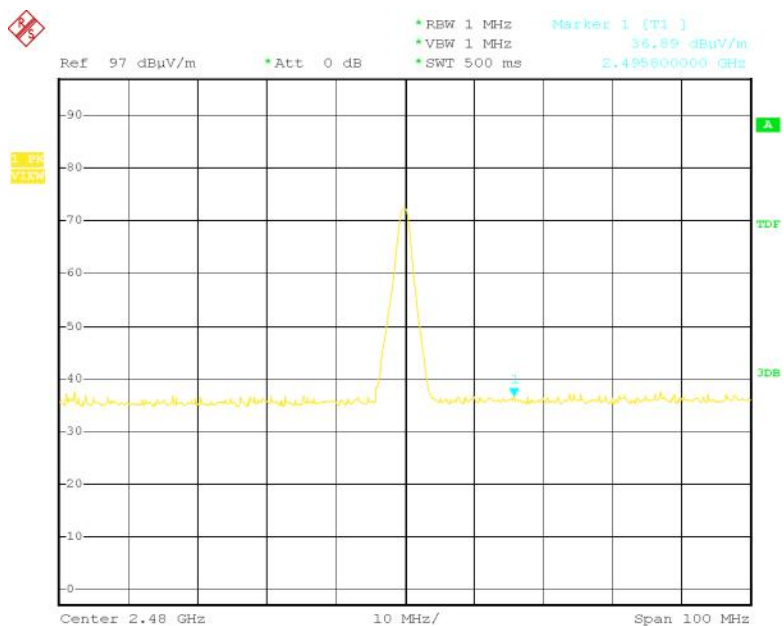

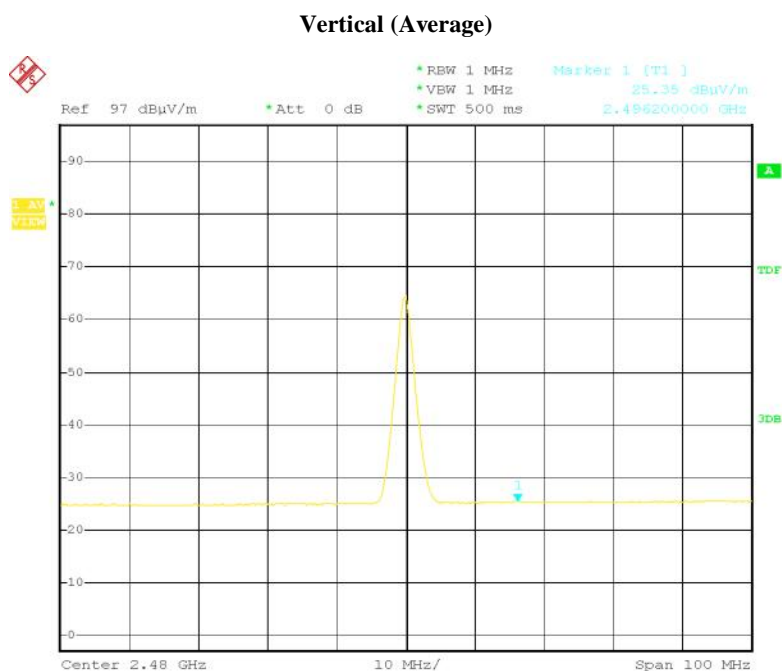

- Note:**
- (1) The field strength of any emissions which appear outside of this band shall not exceed the general radiated emission limits in Section 15.209.
 - (2) The average measurement was not performed when the peak measured data under the limit of average detection.

7. Antenna Requirement

According to Section 15.203, an intentional radiator shall be designed to ensure that no antenna other than that furnished by the responsible party shall be used with the device.

The EUT no antenna connector for printed antenna. Therefore the EUT complies with Section 15.203 of the FCC rules.

8. Photos of Testing

8.1 EUT Test Photographs

Radiated emission test view



8. 2 EUT Detailed Photographs

EUT top view



EUT bottom view



EUT inside whole view

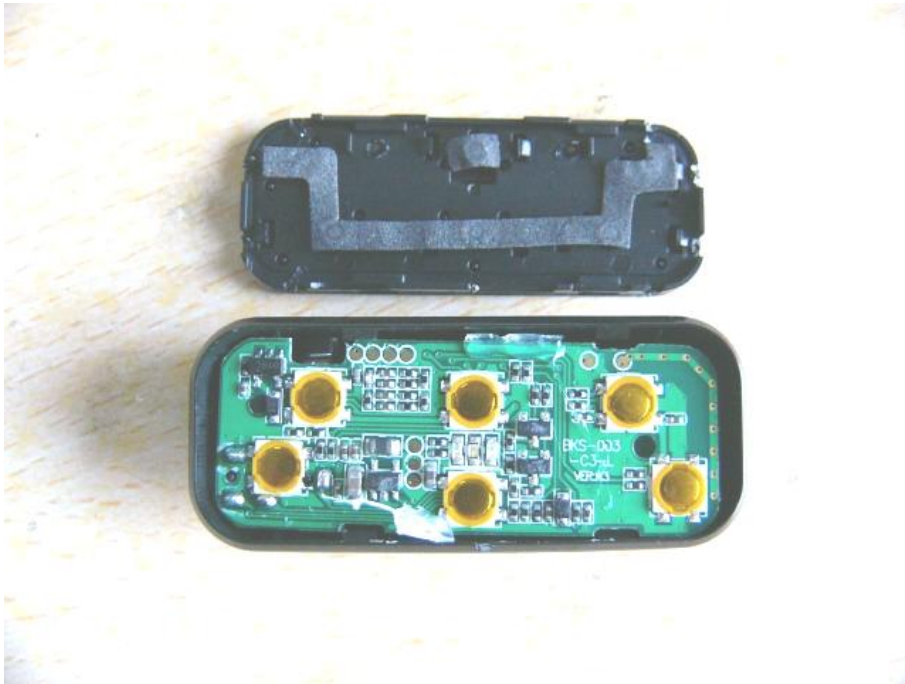

Main board component side



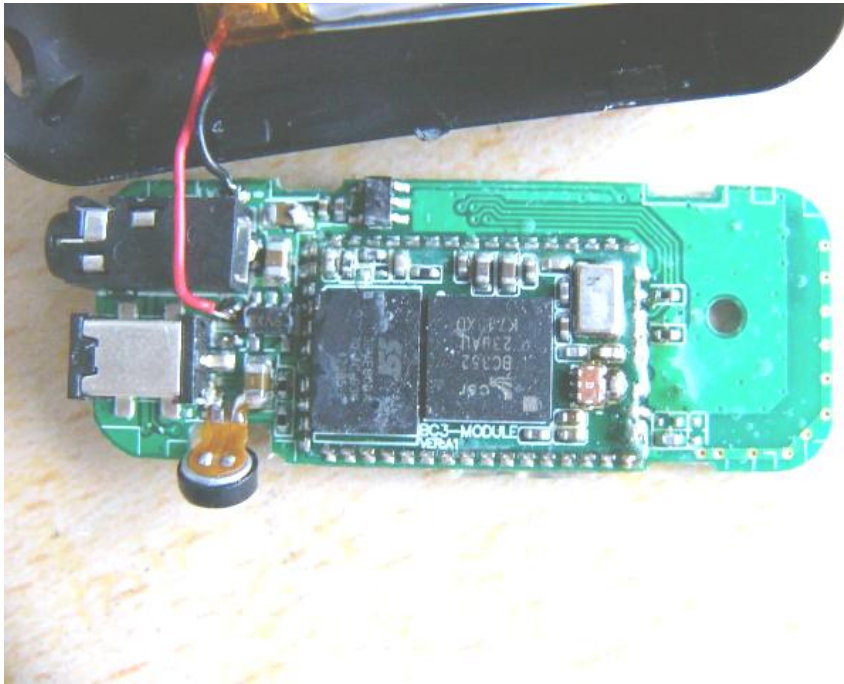

Main board solder side

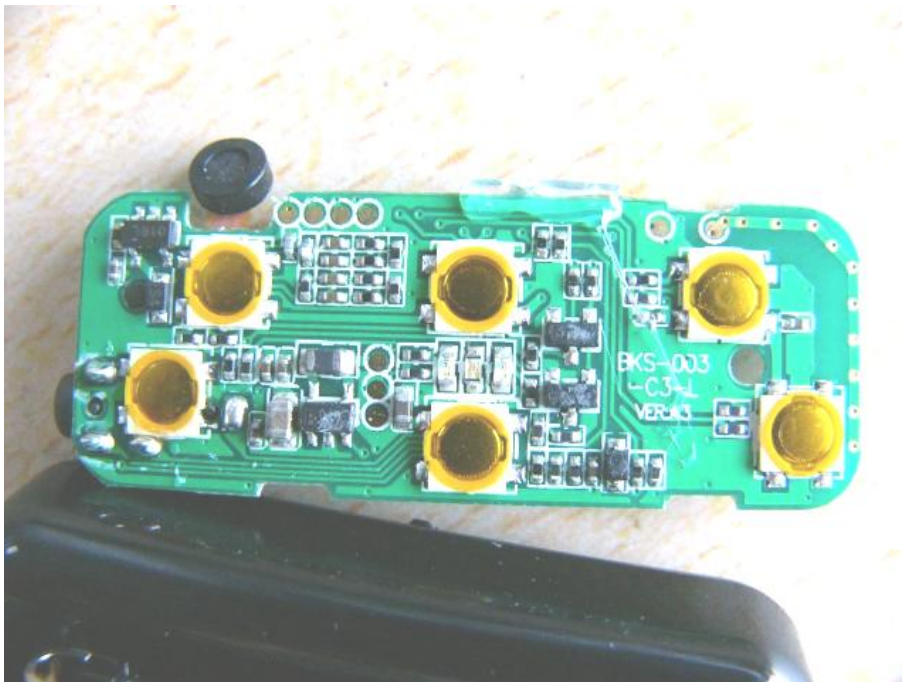

9. FCC ID Label

FCC ID: TJ7BTK-A22

This device complies with Part 15 of the FCC Rules. Operation is subject to the following two conditions: (1) this device may not cause harmful interference, and (2) this device must accept any interference received, including interference that may cause undesired operation.

The Label must not be a stick-on paper label. The Label on these products must be permanently affixed to the product and readily visible at the time of purchase and must last the expected lifetime of the equipment not be readily detachable.

Proposed Label Location on EUT

EUT Bottom View/Proposed FCC ID Label Location



10. Test Equipment

The following test equipments were used during the radiated & conducted emission test:

Equipment/ Facilities	Manufacturer	Model #	Serial No.	Date of Cal.	Due Date
Turntable	SinTek	N/A	N/A	NCR	NCR
Antenna Tower	SinTek	N/A	N/A	NCR	NCR
OATS	SinTek	N/A	N/A	Oct.09, 2007	Oct.09, 2010
EMI Test Receiver	Rohde & Schwarz	ESPI3	100180	Oct.18, 2007	Oct.18, 2008
Spectrum Analyzer	Rohde & Schwarz	FSP40	100273	Sep. 18, 2007	Sep. 18, 2008
Signal Generator	FLUKE	PM5418+Y/C	LO747012	Feb.10, 2007	Feb.10, 2008
Signal Generator	FLUKE	PM5418TX	LO738007	Feb.10, 2007	Feb.10, 2008
Loop Antenna	SCHWARZBECK	FMZB1516	113	Jan. 30, 2007	Jan. 30, 2008
Loop Antenna	Rohde & Schwarz	HFH2-Z2	872096/16	Jan. 30, 2007	Jan. 30, 2008
Trilog-Super Broadband Antenna	SCHWARZBECK	VULB9161	9161-4079	Sep.18, 2007	Sep.18, 2008
Trilog-Super Broadband Antenna	SCHWARZBECK	VULB9161	9161-4080	Sep.18, 2007	Sep.18, 2008
Broad-Band Horn Antenna	SCHWARZBECK	BBHA 9120D	9120D-564	Sep.18, 2007	Sep.18, 2008
Broad-Band Horn Antenna	SCHWARZBECK	BBHA 9120D	9120D-565	Sep.18, 2007	Sep.18, 2008
AMN	Rohde & Schwarz	ESH3-Z5	100196	Oct. 23, 2007	Oct. 23, 2008
AMN	Rohde & Schwarz	ESH3-Z5	100197	Oct. 23, 2007	Oct. 23, 2008
Pulse Limiter	Rohde & Schwarz	ESH3-Z2	N/A	N/A	N/A
Absorbing Clamp	Rohde & Schwarz	MDS-21	N/A	Oct. 29, 2006	Oct. 29, 2007
KMO Shielded Room	KMO	KMO-001	N/A	N/A	N/A
Coaxial Cable with N-Connectors	SCHWARZBECK	AK9515H	95549	Sep.18, 2007	Sep.18, 2008
Power Meter	Rohde & Schwarz	NRVD	100041	Feb.10, 2007	Feb.10, 2008
Radio Communication Test Set	Rohde & Schwarz	CMS 54	846621/024	Feb.10, 2007	Feb.10, 2008
Modulation Analyzer	Hewlett-Packard	8901B	2303A00362	Feb.10, 2007	Feb.10, 2008
Communication Analyzer	Wavetek Stabilock	4032	N/A	Feb. 01, 2007	Feb.01, 2008
Storage Oscilloscope	Tektronix	TDS3052	N/A	Feb. 01, 2007	Feb.01, 2008
Attenuator	Schwarzbeck	20dB	N/A	Feb. 01, 2007	Feb.01, 2008
Attenuator	Rohde & Schwarz	10dB	N/A	Feb. 01, 2007	Feb.01, 2008
SOHO Telephone Switching System	IKE	2000-108C	N/A	Feb.10, 2007	Feb.10, 2008
Temperature Chamber	TABAI	PSL-4GTW	N/A	Feb.10, 2007	Feb.10, 2008