



PHOENIX  
**TESTLAB**

Königswinkel 10  
32825 Blomberg, Germany  
Phone: +49 (0) 52 35 / 95 00-0  
Fax: +49 (0) 52 35 / 95 00-10  
office@phoenix-testlab.de  
www.phoenix-testlab.de

# Test Report

Report Number:

**F172414E4**

Equipment under Test (EUT):

**EasyScan USB**

Applicant:

**Mettler-Toledo GmbH**

Manufacturer:

**Mettler-Toledo GmbH**



Deutsche  
Akkreditierungsstelle  
D-PL-17186-01-01  
D-PL-17186-01-02  
D-PL-17186-01-03



## References

- [1] **ANSI C63.10: 2013** American National Standard of Procedures for Compliance Testing of Unlicensed Wireless Devices
- [2] **FCC CFR 47 Part 15** Radio Frequency Devices
- [3] **RSS-210 Issue 9 (August 2016)** Licence-exempt Radio Apparatus: Category I Equipment
- [4] **RSS-Gen Issue 5 (April 2018)** General Requirements for Compliance of Radio Apparatus

## Test result

The requirements of the tests performed as shown in the overview (chapter 4 of this test report) were fulfilled by the equipment under test.

The complete test results are presented in the following.

Tested and written by:	Thomas KÜHN <small>Name</small>	 <small>Signature</small>	07/05/2018 <small>Date</small>
Authorized reviewer:	Bernd STEINER <small>Name</small>	 <small>Signature</small>	07/05/2018 <small>Date</small>

This test report is only valid in its original form.

Any reproduction of its contents in extracts without written permission of the accredited test laboratory PHOENIX TESTLAB GmbH is prohibited.

The test results herein refer only to the tested sample. PHOENIX TESTLAB GmbH is not responsible for any generalisations or conclusions drawn from these test results concerning further samples. Any modification of the tested samples is prohibited and leads to the invalidity of this test report. Each page necessarily contains the PHOENIX TESTLAB Logo and the TEST REPORT NUMBER.

This test report is valid in hardcopy form as well as in electronic form.

<b>Contents:</b>	<b>Page</b>
1 Identification .....	4
1.1 Applicant .....	4
1.2 Manufacturer .....	4
1.3 Test Laboratory .....	4
1.4 EUT (Equipment under Test).....	5
1.5 Technical data of equipment.....	5
1.6 Ancillary Equipment.....	6
1.7 Dates.....	6
2 Operational states and test setup.....	6
3 Additional information.....	7
4 Overview .....	7
5 Results .....	8
5.1 Conducted emissions on power supply lines (150 kHz to 30 MHz) .....	8
5.1.1 Method of measurement.....	8
5.1.2 Test results (conducted emissions on power supply lines).....	9
5.2 Radiated emissions .....	10
5.2.1 Method of measurement (radiated emissions) .....	10
5.2.2 Results preliminary measurement 9 kHz to 1 GHz.....	17
5.2.3 Result final measurement from 9 kHz to 30 MHz .....	20
5.2.4 Result final measurement from 30 MHz to 1 GHz .....	21
5.3 99 % bandwidth .....	23
5.3.1 Method of measurement .....	23
5.3.2 Test results .....	24
6 Test equipment.....	27
7 Report history .....	28
8 List of annexes .....	28

## 1 Identification

### 1.1 Applicant

Name:	Mettler-Toledo GmbH
Address:	Im Langacher 44, 8606 Greifensee
Country:	Switzerland
Name for contact purposes:	Mr. David KRESS
Phone:	+41 44 944 23 84
eMail address:	David.Kress@mt.com
Applicant represented during the test by the following person:	---

### 1.2 Manufacturer

Name:	Mettler-Toledo GmbH
Address:	Im Langacher 44, 8606 Greifensee
Country:	Switzerland
Name for contact purposes:	Mr. David KRESS
Phone:	+41 44 944 23 84
eMail address:	David.Kress@mt.com
Manufacturer represented during the test by the following person:	---

### 1.3 Test Laboratory

The tests were carried out at:

**PHOENIX TESTLAB GmbH**  
**Königswinkel 10**  
**32825 Blomberg**  
**Germany**

accredited by Deutsche Akkreditierungsstelle GmbH (DAkkS) in compliance with DIN EN ISO/IEC 17025 under Reg. No. D-PL-17186-01-02, FCC Test Firm Accreditation with the registration number 469623, designation number DE0004 and Industry Canada Test site registration SITE# IC3469A-1.

## 1.4 EUT (Equipment under Test)

Test object: *	RFID Reader/Writer
Model name / HVIN: *	EasyScan USB
Serial number: *	None
FCC ID: *	THVEASYSCANUSB
IC: *	22032-EASYSCANUSB
PCB identifier: *	30447756_B, 30407285_C
PMN: *	EasyScan USB
Software version / FVIN: *	30296749_1.0.1.3, 30296750_0.9.1.4
Highest internal frequency: *	27.12 MHz

\*: Declared by the applicant

## 1.5 Technical data of equipment

Operating frequency: *	125 kHz and 13.56 MHz				
Power supply: *	Externally DC by USB port				
Rated output power: *	125 kHz: 5.37 mW 13.56 MHz: 15.83 mW				
Supply voltage: *	$U_{nom} =$	5.0 V <sub>DC</sub>	$U_{min} =$	4.8 V <sub>DC</sub>	$U_{max} =$ 5.2 V <sub>DC</sub>
Type of modulation: *	ASK (125 kHz) / ASK & PPM (13.56 MHz)				
Antenna connector: *	125 kHz: Molex Picoblade 2P 13.56 MHz: Molex Picoblade 3P				
Number of channels: *	125 kHz: 1 13.56 MHz: 1				
Antenna type: *	Integrated: 125 kHz: Wired coil antenna with 0.301 m <sup>2</sup> 13.56 MHz: PCB coil antenna with 0.004 m <sup>2</sup>				
Data rate: *	125 kHz: 5.2 kbit/s 13.56 MHz: 26.48 kbit/s or 106 kbit/s				
Temperature range: *	0 °C to +40 °C				

\*: Declared by the applicant

Ports / Connectors			
Identification	Connector		Length during test
	EUT	Ancillary	
USB	USB Type B Connector	USB type A plug	2.5 m
-	-	-	-
-	-	-	-

## 1.6 Ancillary Equipment

- TAG for 125 kHz: HITAG (provided by the applicant),
- TAGs for 13.56 MHz: ISO15693, ISO14443A and ISO14443B TAG (provided by the applicant),
- Siemens Fujitsu Laptop PC type Lifebook E series Model E780 (provided by the laboratory)

## 1.7 Dates

Date of receipt of test sample:	05/07/2018
Start of test:	06/06/2018
End of test:	06/21/2018

## 2 Operational states and test setup

The EUT is a desktop RFID reader system.

If no otherwise stated, during all measurements a 125 kHz (HITAG) and a 13.56 MHz TAG (ISO15693) was positioned in front of the EUT and the EUT was powered with 5.0 V<sub>DC</sub> either by a fibre optics to USB converter or a Laptop PC.

Except for the bandwidth measurement, there was no measurable difference while using the different 13.56 MHz TAGs (ISO15693, ISO14443A or ISO14443B).

All measurements were carried out with an unmodified sample operating in a test mode. The test mode was entered with the help of a test-software running on a laptop PC, which is connected to EUT via the USB port. With this test mode the TAG data were cyclic read and the TAG was written. The USB connection between the EUT and the laptop PC was set up with the help of two fibre optics to USB converter.

Physical boundaries of the Equipment Under Test

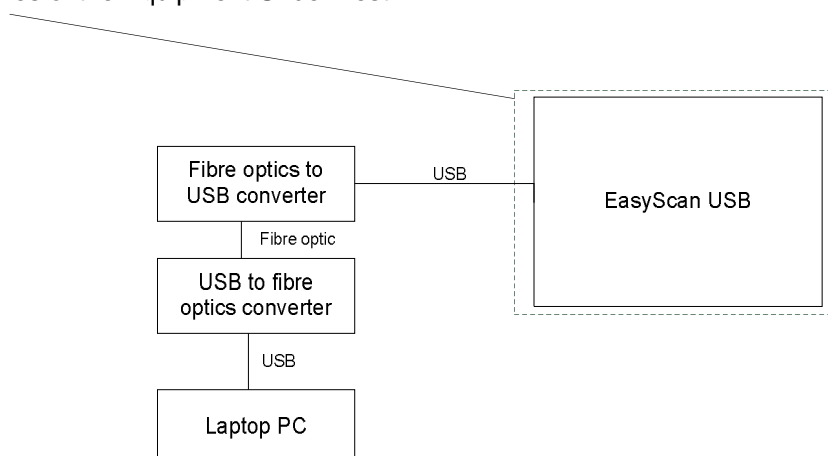

### 3 Additional information

The EUT was not labeled as required by FCC / IC.

### 4 Overview

Application	Frequency range [MHz]	FCC 47 CFR Part 15 section [2]	RSS-Gen [4] and RSS 210 [3]	Status	Refer page
Conducted emissions on supply line	0.15 – 30	15.207	8.8 [4]	Passed	8 et seq.
Radiated emissions	0.009 – 1.000	15.205 15.209	8.9 [4] 4.4 [3]	Passed	10 et seq.
99 % bandwidth	0.125 and 13.56	-	6.7 [4]	-	23 et seq.
Antenna requirement	-	15.203	6.8 [4]	Passed *	-

\*: Integrated antennas only, requirement fulfilled.

## 5 Results

### 5.1 Conducted emissions on power supply lines (150 kHz to 30 MHz)

#### 5.1.1 Method of measurement

This test will be carried out in a shielded chamber. Tabletop devices will set up on a non-conducting support with a size of 1 m by 1.5 m and a height of 80 cm above the ground plane. Floor-standing devices will be placed directly on the ground plane. The setup of the Equipment under test will be in accordance to [1].

The frequency range 150 kHz to 30 MHz will be measured with an EMI Receiver set to MAX Hold mode with peak and average detector and a resolution bandwidth of 9 kHz. A scan will be carried out on the phase (or plus pole in case of DC powered devices) of the AC mains network. If levels detected 10 dB below the appropriate limit, this emission will be measured with the average and quasi-peak detector on all lines.

Frequency range	Resolution bandwidth
150 kHz to 30 MHz	9 kHz

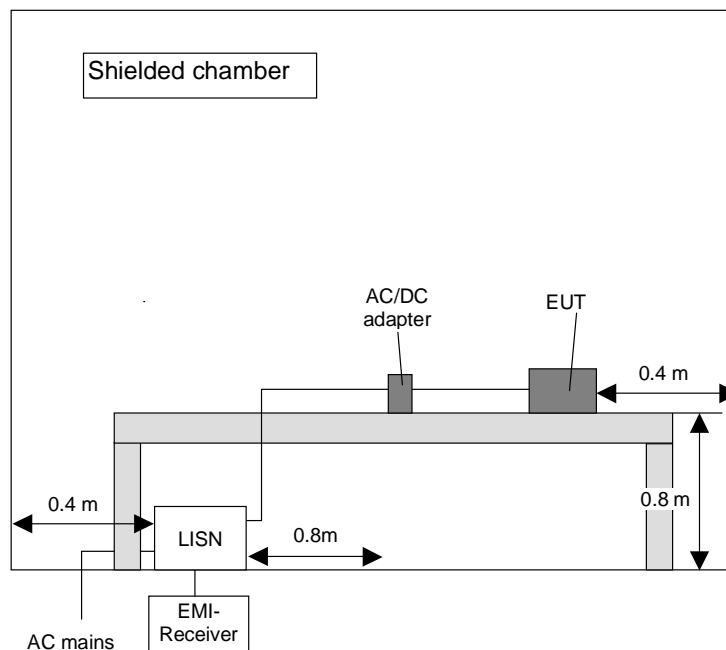



### 5.1.2 Test results (conducted emissions on power supply lines)

Ambient temperature	22 °C	Relative humidity	65 %
---------------------	-------	-------------------	------

Position of EUT: The EUT was set-up on a non-conducting table of a height of 0.8 m.

Cable guide: The cable of the EUT was fixed on the non-conducting table. For further information of the cable guide refer to the pictures in annex A of this test report.

Test record: The test was carried out in TAGs reading and writing mode of the EUT (refer also clause 2 of this test report). All results are shown in the following.

Supply voltage: During this test the EUT was powered with 5 V<sub>AC</sub> by the Laptop PC, which was itself supplied by its dedicated AC/DC adaptor (connected to an AC mains network with 120 V<sub>AC</sub> / 60 Hz).

The curves in the diagram only represent for each frequency point the maximum measured value of all preliminary measurements which were made for each power supply line. The top measured curve represents the peak measurement and the bottom measured curve the average measurement. The quasi-peak measured points are marked by ◆.

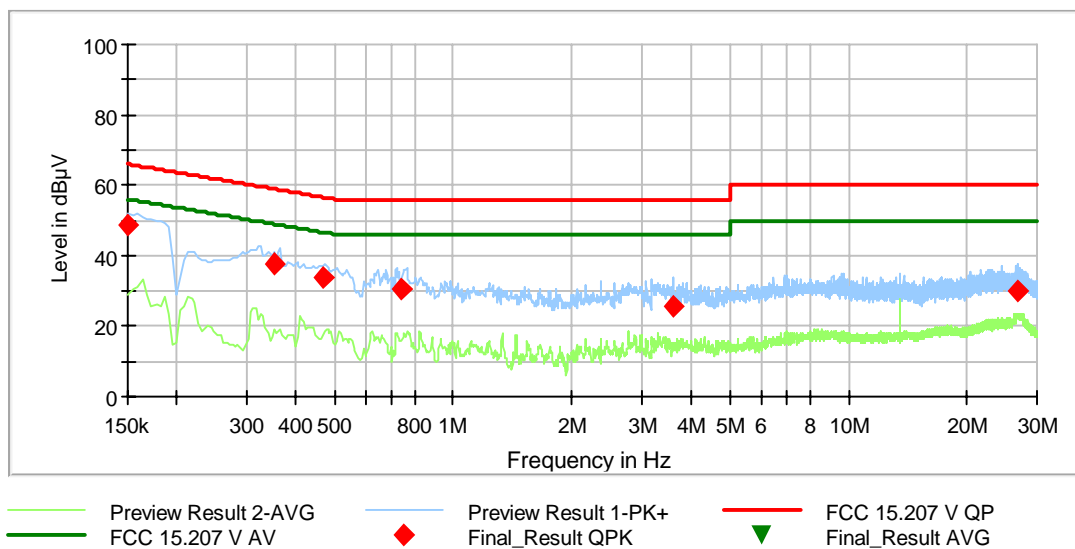

Data record name: 172414\_AC

Remark: The limits of FCC 15.207 are identical to [3]

Frequency (MHz)	QuasiPeak (dBµV)	Average (dBµV)	Limit (dBµV)	Margin (dB)	Meas. Time (ms)	Bandwidth (kHz)	Line	PE	Transducer (dB)
0.150000	48.4	---	66.0	17.6	5000.0	9.000	N	GND	9.8
0.351600	37.9	---	58.9	21.0	5000.0	9.000	L1	GND	9.9
0.467700	34.0	---	56.6	22.6	5000.0	9.000	L1	FLO	9.9
0.741300	30.7	---	56.0	25.3	5000.0	9.000	L1	FLO	9.9
3.596100	25.6	---	56.0	30.4	5000.0	9.000	L1	FLO	10.3
26.808000	30.0	---	60.0	30.0	5000.0	9.000	L1	GND	11.1
Measurement uncertainty			+6.7 dB / -6.0 dB						

Test: Passed

Test equipment used (see clause 6):

1 - 5
-------

## 5.2 Radiated emissions

### 5.2.1 Method of measurement (radiated emissions)

The radiated emission measurement is subdivided into six stages.

- A preliminary measurement carried out in a fully anechoic chamber with a fixed antenna height in the frequency range 9 kHz to 1 GHz.
- A final measurement carried out on an outdoor test site without reflecting ground plane and a fixed antenna height in the frequency range 9 kHz to 30 MHz.
- A preliminary measurement carried out in a fully anechoic chamber with a fixed antenna height in the frequency range 30 MHz to 1 GHz.
- A final measurement carried out on an open area test site with reflecting ground plane and various antenna heights in the frequency range 30 MHz to 1 GHz.
- A preliminary measurement carried out in a fully anechoic chamber with a fixed antenna height in the frequency range 1 GHz to 5 GHz.
- A final measurement carried out in a fully anechoic chamber with a fixed antenna height in the frequency range 1 GHz to 5 GHz.

#### Preliminary measurement (9 kHz to 30 MHz):

In the first stage a preliminary measurement will be performed in a shielded room with a measuring distance of 3 meters. Table-top devices will set up on a non-conducting support with a size of 1 m by 1.5 m and a height of 80 cm. Floor-standing devices will be placed directly on the turntable/ground plane. The set up of the Equipment under test will be in accordance to [1].

The frequency range 9 kHz to 30 MHz will be monitored with a spectrum analyser while the system and its cables will be manipulated to find out the configuration with the maximum emission levels if applicable. The EMI Receiver will be set to MAX Hold mode. The EUT and the measuring antenna will be rotated around their vertical axis to found the maximum emissions.

The resolution bandwidth of the spectrum analyser will be set to the following values:

Frequency range	Resolution bandwidth
9 kHz to 150 kHz	200 Hz
150 kHz to 30 MHz	10 kHz

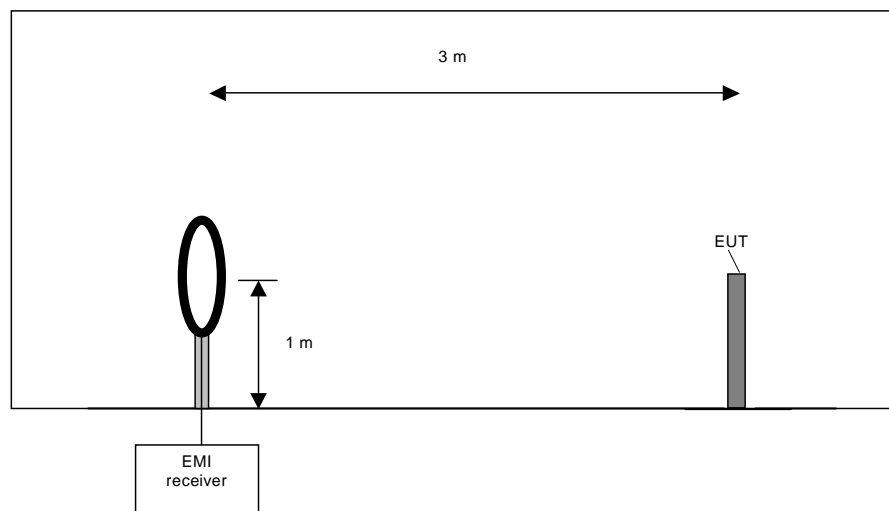

Preliminary measurement procedure:

Prescans were performed in the frequency range 9 kHz to 150 kHz and 150 kHz to 30 MHz.

The following procedure will be used:

- 1) Monitor the frequency range at horizontal polarisation and a EUT azimuth of 0 °.
- 2) Manipulate the system cables within the range to produce the maximum level of emission.
- 3) Rotate the EUT by 360 ° to maximize the detected signals.
- 4) Make a hardcopy of the spectrum.
- 5) Measure the frequencies of highest detected emission with a lower span and resolution bandwidth to increase the accuracy and note the frequency value.
- 6) Repeat steps 1) to 5) with the other orthogonal axes of the EUT (because of EUT is a module and might be used in a handheld equipment application).
- 7) Rotate the measuring antenna and repeat steps 1) to 5).

**Final measurement (9 kHz to 30 MHz):**

In the second stage a final measurement will be performed on an open area test site with no conducting ground plane in a measuring distances of 3 m, 10 m and 30 m. In the case where larger measuring distances are required the results will be extrapolated based on the values measured on the closer distances according to Section 15.31 (f) (2) [2]. The final measurement will be performed with a EMI Receiver set to Quasi Peak detector except for the frequency bands 9 kHz to 90 kHz and 110 kHz to 490 kHz where an average detector will be used according Section 15.209 (d) [2].

On the frequencies, which were detected during the preliminary measurements, the final measurement will be performed while rotating the EUT and the measuring antenna in the range of 0 ° to 360 ° around their vertical axis until the maximum value is found.

The resolution bandwidth of the EMI Receiver will be set to the following values:

Frequency range	Resolution bandwidth
9 kHz to 150 kHz	200 Hz
150 kHz to 30 MHz	9 kHz

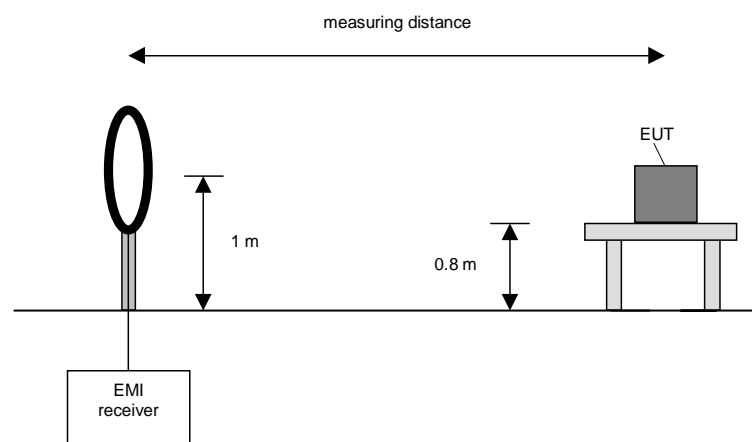

Final measurement procedure:

The following procedure will be used:

- 1) Monitor the frequency range with the measuring antenna at vertical orientation parallel to the EUT at an azimuth of 0 °.
- 2) Rotate the EUT by 360 ° to maximize the detected signals and note the azimuth and orientation.
- 3) Rotate the measuring antenna to find the maximum and note the value.
- 4) Rotate the measuring antenna and repeat steps 1) to 3) until the maximum value is found.
- 5) Repeat steps 1) to 4) with the other orthogonal axes of the EUT (if the EUT is a module and might be used in a handheld equipment application).

**Preliminary measurement (30 MHz to 1 GHz)**

In the first stage a preliminary measurement will be performed in a fully anechoic chamber with a measuring distance of 3 meter. Tabletop devices will set up on a non-conducting support with a size of 1 m by 1.5 m and a height of 80 cm. Floor-standing devices will be placed directly on the turntable/ground plane. The set up of the Equipment under test will be in accordance to [1].

The frequency range 30 MHz to 1 GHz will be measured with an EMI Receiver set to MAX Hold mode and a resolution bandwidth of 120 kHz. The measurement will be performed in horizontal and vertical polarisation of the measuring antenna and while rotating the EUT in its vertical axis in the range of 0 ° to 360 °.

The resolution bandwidth of the EMI Receiver will be set to the following values:

Frequency range	Resolution bandwidth
30 MHz to 1 GHz	100 kHz

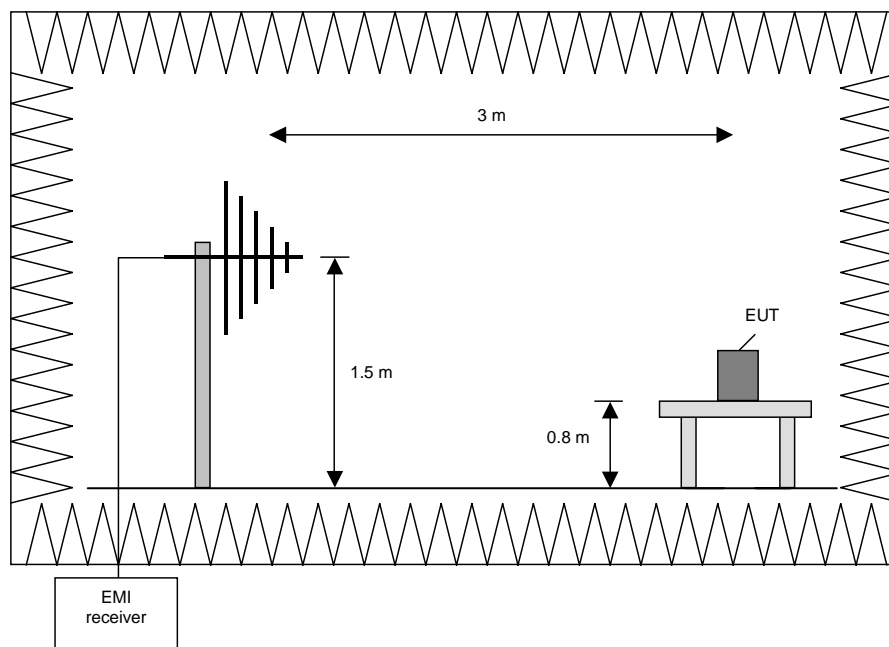

Procedure preliminary measurement:

Prescans were performed in the frequency range 30 MHz to 1 GHz.

The following procedure will be used:

1. Monitor the frequency range at horizontal polarisation and a EUT azimuth of 0 °.
2. Manipulate the system cables within the range to produce the maximum level of emission.
3. Rotate the EUT by 360 ° to maximize the detected signals.
4. Make a hardcopy of the spectrum.
5. Measure the frequency of the detected emissions with a lower span and resolution bandwidth to increase the accuracy and note the frequency value.
6. Repeat 1) to 4) with the other orthogonal axes of the EUT if handheld equipment.
7. Repeat 1) to 5) with the vertical polarisation of the measuring antenna.

**Final measurement (30 MHz to 1 GHz)**

A final measurement on an open area test site will be performed on selected frequencies found in the preliminary measurement. During this test the EUT will be rotated in the range of 0 ° to 360 °, the measuring antenna will be set to horizontal and vertical polarisation and raised and lowered in the range from 1 m to 4 m to find the maximum level of emissions.

The resolution bandwidth of the EMI Receiver will be set to the following values:

Frequency range	Resolution bandwidth
30 MHz to 1 GHz	120 kHz

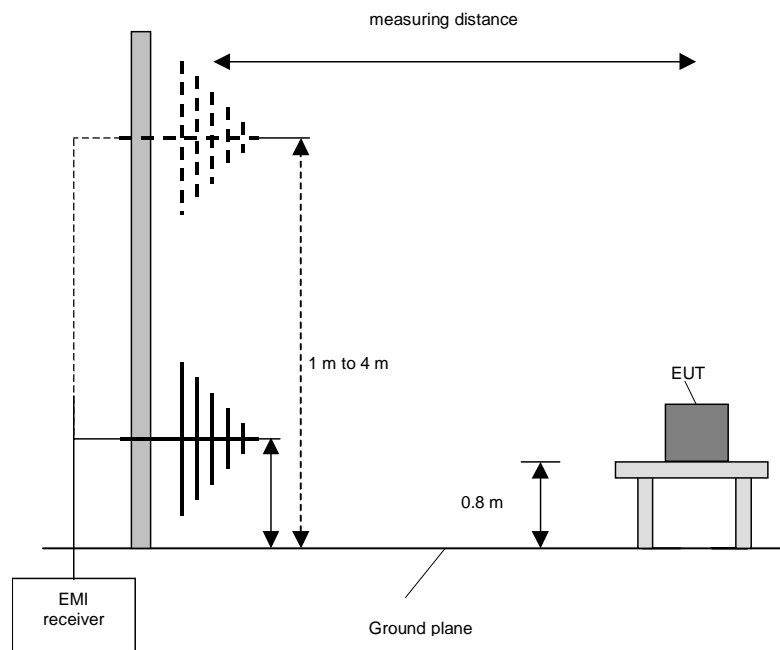

Procedure final measurement:

The following procedure will be used:

- 1) Measure on the selected frequencies at an antenna height of 1 m and a EUT azimuth of 23 °.
- 2) Move the antenna from 1 m to 4 m and note the maximum value at each frequency.
- 3) Rotate the EUT by 45 ° and repeat 2) until an azimuth of 337 ° is reached.
- 4) Repeat 1) to 3) for the other orthogonal antenna polarization.
- 5) Move the antenna and the turntable to the position where the maximum value is detected.
- 6) Measure while moving the antenna slowly +/- 1 m.
- 7) Set the antenna to the position where the maximum value is found.
- 8) Measure while moving the turntable +/- 45 °.
- 9) Set the turntable to the azimuth where the maximum value is found.
- 10) Measure with Final detector (QP and AV) and note the value.
- 11) Repeat 5) to 10) for each frequency.
- 12) Repeat 1) to 11) for each orthogonal axes of the EUT if handheld equipment.

**Preliminary and final measurement (1 GHz to 110 GHz)**

This measurement will be performed in a fully anechoic chamber. Table top devices will set up on a non-conducting turn device on the height of 1.5 m. The set-up of the Equipment under test will be in accordance to [1].

**Preliminary measurement (1 GHz to 40 GHz)**

The frequency range will be divided into different sub ranges depending of the frequency range of the used horn antenna. The spectrum analyser set to MAX Hold mode and a resolution bandwidth of 100 kHz. The measurement will be performed in horizontal and vertical polarisation of the measuring antenna and while rotating the EUT in its vertical axis in the range of 0 ° to 360 °. This measurement is repeated after raising the EUT in 30 ° steps according 6.6.5.4 in [1].

The resolution bandwidth of the EMI Receiver will be set to the following values:

Frequency range	Resolution bandwidth
1 GHz to 4 GHz	1 MHz
4 GHz to 12 GHz	1 MHz
12 GHz to 18 GHz	1 MHz
18 GHz to 26.5 GHz	1 MHz
26.5 GHz to 40 GHz	1 MHz
40 GHz to 60 GHz	1 MHz
50 GHz to 75 GHz	1 MHz
75 GHz to 110 GHz	1 MHz

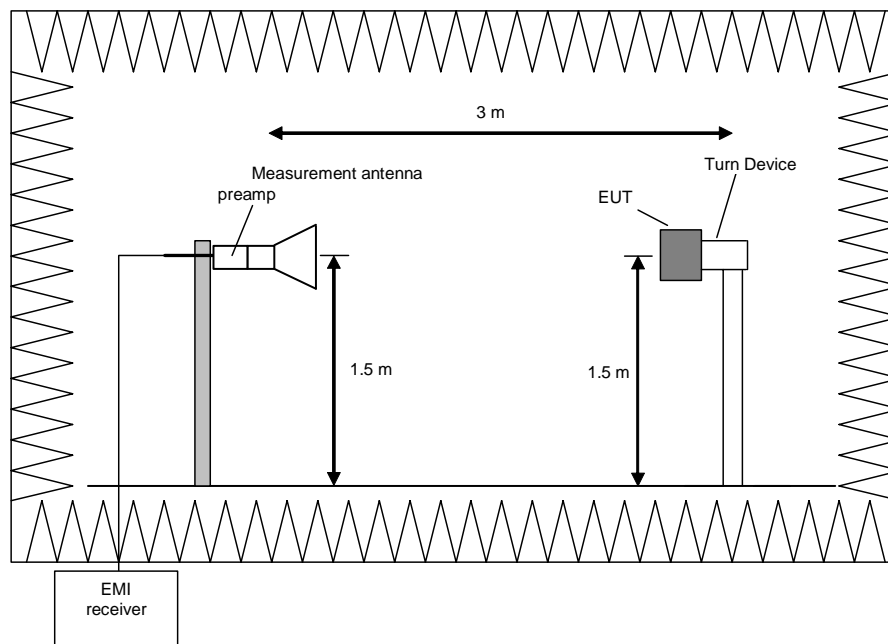

#### Procedure preliminary measurement:

Prescans were performed in the frequency range 1 to 40 GHz.

The following procedure will be used:

1. Monitor the frequency range at horizontal polarisation and a EUT azimuth of 0°.
2. Rotate the EUT by 360° to maximize the detected signals.
3. Repeat 1) to 2) with the vertical polarisation of the measuring antenna.
4. Make a hardcopy of the spectrum.
5. Repeat 1) to 4) with the EUT raised by an angle of 30° (60°, 90°, 120° and 150°) according to 6.6.5.4 in [1].
6. Measure the frequency of the detected emissions with a lower span and resolution bandwidth to increase the accuracy and note the frequency value.
7. The measurement antenna polarisation, with the according EUT position (Turntable and Turn device) which produces the highest emission for each frequency will be used for the final measurement. The six closest values to the applicable limit will be used for the final measurement.

#### Final measurement (1 GHz to 110 GHz)

The frequency range will be divided into different sub ranges depending of the frequency range of the used antenna. The EMI Receiver set to peak and average mode and a resolution bandwidth of 1 MHz. The measurement will be performed by rotating the turntable through 0 to 360° in the worst-case EUT orientation which was obtained during the preliminary measurements.

The resolution bandwidth of the EMI Receiver will be set to the following values:

Frequency range	Resolution bandwidth
1 GHz to 4 GHz	1 MHz
4 GHz to 12 GHz	1 MHz
12 GHz to 18 GHz	1 MHz
18 GHz to 26.5 GHz	1 MHz
26.5 GHz to 40 GHz	1 MHz
40 GHz to 60 GHz	1 MHz
50 GHz to 75 GHz	1 MHz
75 GHz to 110 GHz	1 MHz

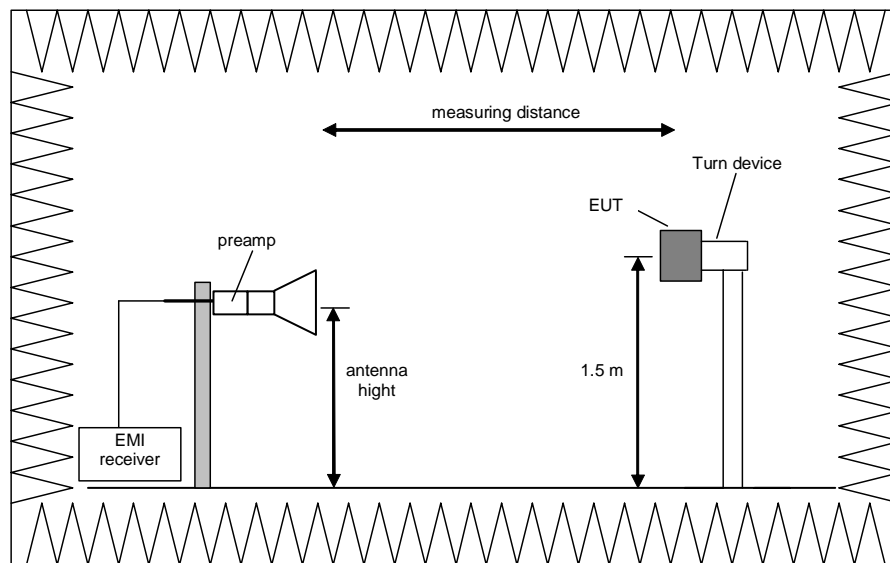

Procedure of measurement:

The measurements were performed in the frequency range 1 GHz to 110 GHz.

The following procedure will be used:

- 1) Set the turntable and the turn device to obtain the worst-case emission for the first frequency identified in the preliminary measurements.
- 2) Set the measurement antenna polarisation to the orientation with the highest emission for the first frequency identified in the preliminary measurements.
- 3) Set the spectrum analyser to EMI mode with peak and average detector activated.
- 4) Rotate the turntable from 0° to 360° to find the EUT angle that produces the highest emissions.
- 5) Note the highest displayed peak and average values
- 6) Repeat the steps 1) to 5) for each frequency detected during the preliminary measurements.



## 5.2.2 Results preliminary measurement 9 kHz to 1 GHz

Ambient temperature	22 °C	Relative humidity	51 %
---------------------	-------	-------------------	------

- Position of EUT: The EUT was set-up on a non-conducting table.
- Cable guide: The cable of the EUT was fixed on the non-conducting table. For further information of the cable guide refer to the pictures in annex A of this test report.
- Test record: The test was carried out in TAGs reading and writing mode of the EUT (refer also clause 2 of this test report). All results are shown in the following.
- Power supply: During this test the EUT was powered with 5 V<sub>DC</sub> by the USB to fibre optics converter, which was itself supplied by its internal battery.
- Frequency range: According to [2] from 9 kHz to 1 GHz.

### 172414\_110.png: Spurious emissions from 9 kHz to 150 kHz

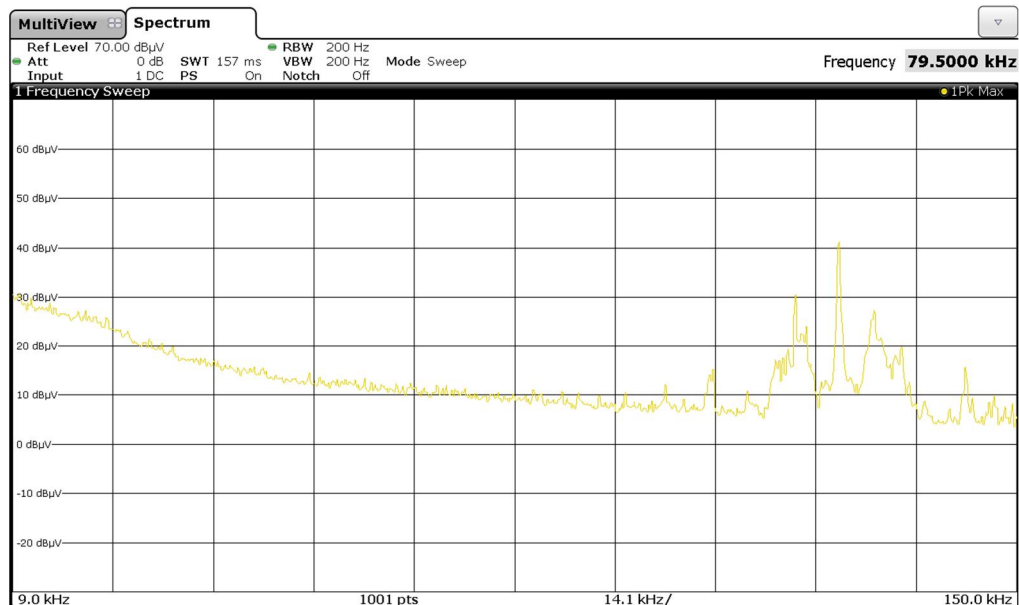

172414\_111.png: Spurious emissions from 150 kHz to 1 MHz

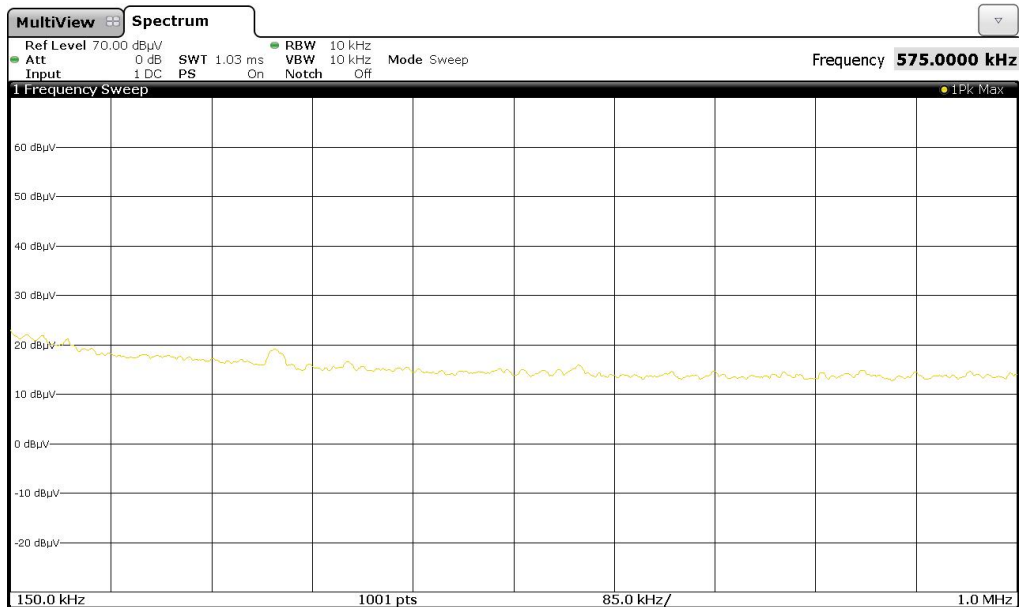

172414\_112.png: Spurious emissions from 1 MHz to 30 MHz



The following emissions were found according to [2] and [3].

106.807 kHz, 118.940 kHz, 125.000 kHz, 131.050 kHz, 143.109 kHz and 13.560 MHz.

These frequencies have to be measured on the outdoor test site. The result is presented in the following.

172414\_113.png: Spurious emissions from 30 MHz to 230 MHz

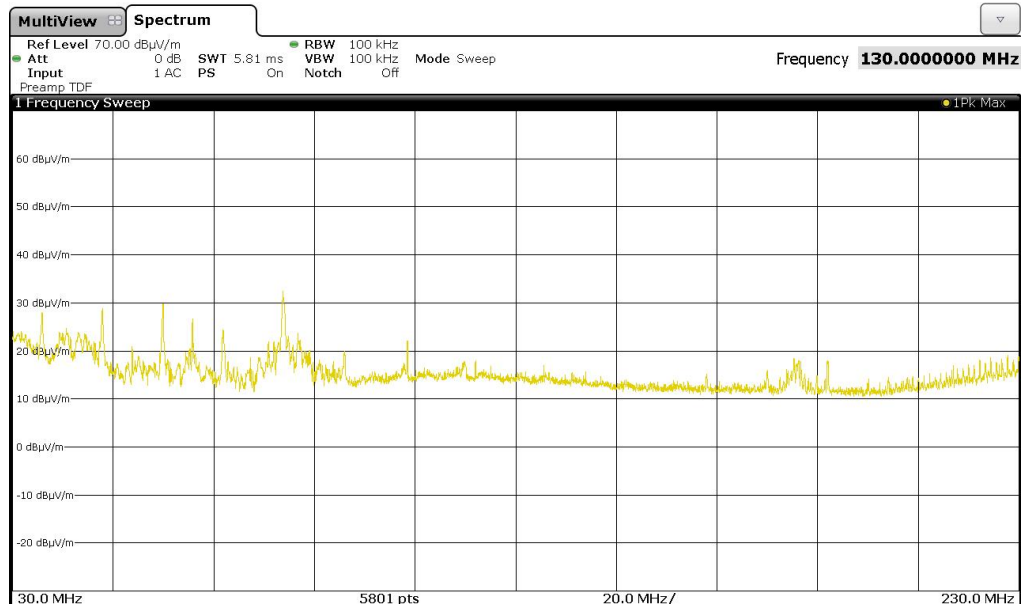

172414\_114.png: Spurious emissions from 230 MHz to 1 GHz

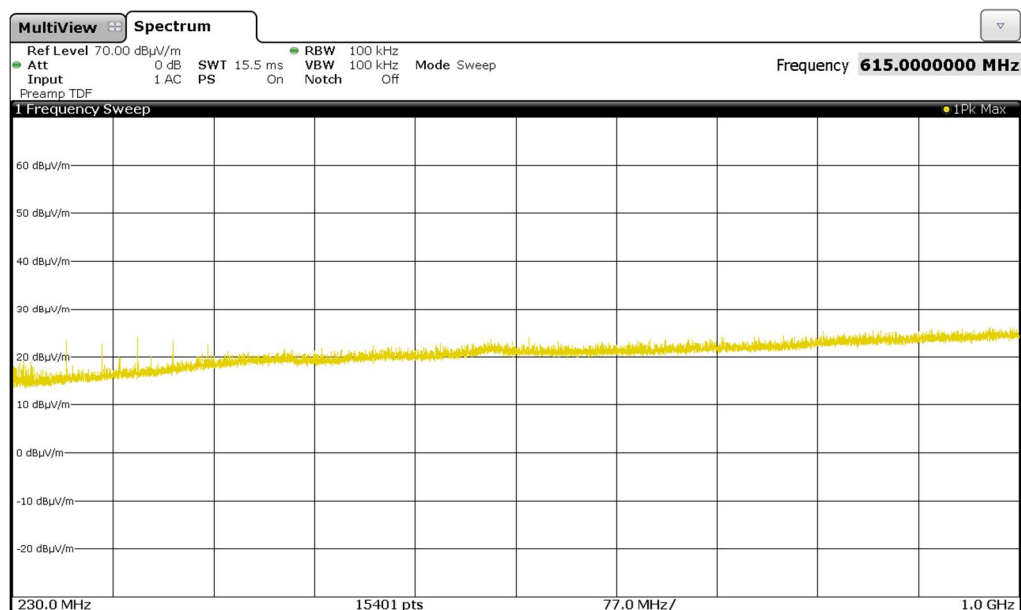

The following frequencies were found emission test outside restricted bands during the preliminary radiated:

- 47.840 MHz, 59.823 MHz, 71.735 MHz, 83.800 MHz, 186.262 MHz, 229.861 MHz, 298.320 MHz and 352.560 MHz

The following frequencies were found inside the restricted bands during the preliminary radiated.

- 108.480 MHz, 271.200 MHz and 325.440 MHz

These frequencies have to be measured on the open area test site. The results were presented in the following.

Test equipment input (see clause 6):

6 - 14

### 5.2.3 Result final measurement from 9 kHz to 30 MHz

Ambient temperature	22 °C	Relative humidity	30 %
---------------------	-------	-------------------	------

Position of EUT: The EUT was set-up on a non-conducting table of a height of 0.8 m. The distance between EUT and antenna was 3 m and 10 m.

Cable guide: The cable of the EUT was fixed on the non-conducting support. For further information of the cable guide refer to the pictures in annex A of this test report.

Test record: The test was carried out in TAGs reading and writing mode of the EUT (refer also clause 2 of this test report). All results are shown in the following.

Power supply: During this test the EUT was powered with 5.0 V<sub>DC</sub> by the Laptop PC which was itself supplied by its internal battery.

Test results: The test results were calculated with the following formula:

$$\text{Result [dB}\mu\text{V/m]} = \text{reading [dB}\mu\text{V]} + \text{antenna factor [dB/m]} + \text{Distance correction dB}$$

Results with measuring distance of 3 m							
Frequency (kHz)	Result (dB $\mu$ V/m)	Limit (dB $\mu$ V/m)	Margin (dB)	Distance correction <sup>2)</sup> (dB)	Readings (dB $\mu$ V)	Detector	Antenna factor <sup>1)</sup> (dB/m)
106.807	-57.9 @ 300 m	27.0	84.9	-80.0	2.1	QP	20.0
118.940	-64.0 @ 300 m	26.1	90.1	-80.0	-4.0	AV	20.0
125.000	-27.6 @ 300 m	25.7	53.3	-80.0	32.4	AV	20.0
131.050	-63.5 @ 300 m	25.3	88.8	-80.0	-3.5	AV	20.0
143.109	-65.0 @ 300 m	24.5	89.5	-80.0	-5.0	AV	20.0
13560	6.4 @ 30 m	29.5	23.0	-40.0	27.3	QP	19.8
Results with measuring distance of 10 m							
Frequency (kHz)	Result (dB $\mu$ V/m)	Limit (dB $\mu$ V/m)	Margin (dB)	Distance correction <sup>2)</sup> (dB)	Readings (dB $\mu$ V)	Detector	Antenna factor <sup>1)</sup> (dB/m)
125.000	-18.9 @ 300 m	25.7	44.6	-60.0	21.1	AV	20.0
13560	13.4 @ 30 m	29.5	16.1	-19.1	12.7	QP	19.8
All other emissions are below the noise floor of the measuring system							
Measurement uncertainty: +2.2 dB / -3.6 dB							

<sup>1)</sup>: Cable loss included

<sup>2)</sup>: Correction Factor according to [2] and [3] extrapolated with a factor of 40 dB/decade according to [2]

Test: Passed

Test equipment used (see clause 6):

14 - 16

### 5.2.4 Result final measurement from 30 MHz to 1 GHz

Ambient temperature	22 °C	Relative humidity	53 %
---------------------	-------	-------------------	------

- Position of EUT:** The EUT was setup on a non-conducting table of a height of 0.8 m. The distance between EUT and antenna was 3 m.
- Test record:** The test was carried out in TAGs reading and writing mode of the EUT (refer also clause 2 of this test report). All results are shown in the following.
- Power supply:** During this test the EUT was powered with 5 VDC by the USB to fibre optics converter, which was itself supplied by its internal battery.
- Test results:** The test results were calculated with the following formula:
- $$\text{Result [dB}\mu\text{V/m]} = \text{reading [dB}\mu\text{V]} + \text{correction factor (cable loss [dB]} + \text{antenna factor [dB/m]} + 6 \text{ dB}$$

The measured points and the limit line in the following diagrams refer to the standard measurement of the emitted interference in compliance with the above-mentioned standard. The measured points marked with an are the ◆ measured results of the standard final measurement on the open area test site.

The results of the standard subsequent measurement on the open area test site are indicated in the table below. The limits as well as the measured results (levels) refer to the above mentioned standard while taking account of the specified requirements for a 3 m measuring distance.

The measurement time with the quasi-peak measuring detector is 5 seconds.

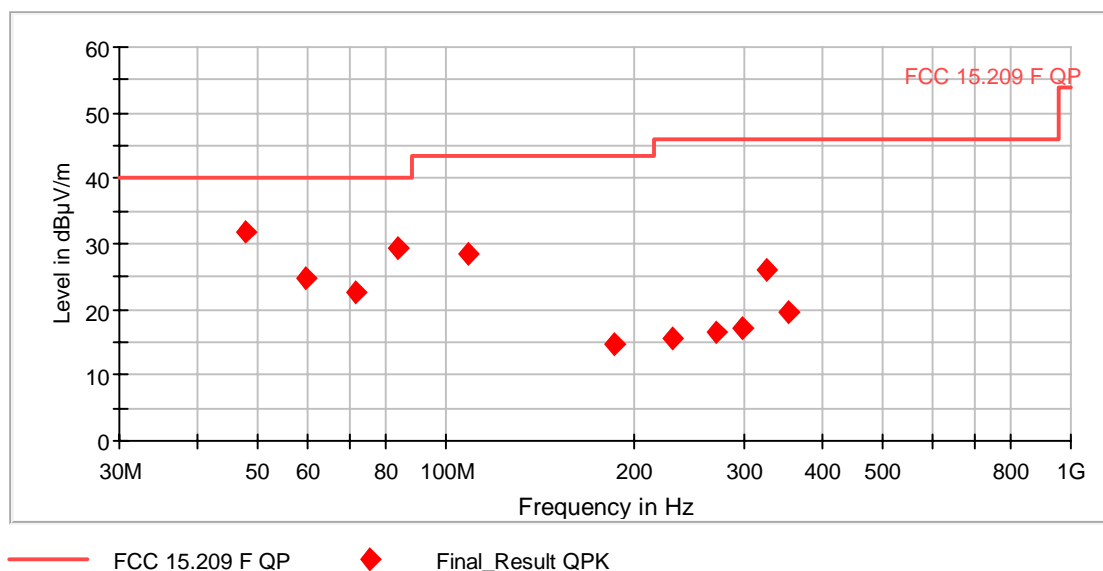

Data record name: 172414\_ff\_NA

**Result measured with the quasi-peak detector:**

Spurious emissions inside restricted bands									
Frequency (MHz)	Result (dB $\mu$ V/m)	Limit (dB $\mu$ V/m)	Margin (dB)	Meas. Time (ms)	Bandwidth (kHz)	Height (cm)	Pol.	Azimuth (deg)	Corr. (dB)
108.480000	28.5	43.5	15.0	1000.0	120.000	185.0	H	271.0	19.9
271.200000	16.6	46.0	29.4	1000.0	120.000	101.0	H	144.0	21.1
325.440000	26.0	46.0	20.0	1000.0	120.000	102.0	H	285.0	22.3
Spurious emissions outside restricted bands									
Frequency (MHz)	Result (dB $\mu$ V/m)	Limit (dB $\mu$ V/m)	Margin (dB)	Meas. Time (ms)	Bandwidth (kHz)	Height (cm)	Pol.	Azimuth (deg)	Corr. (dB)
47.840000	32.0	40.0	8.0	1000.0	120.000	103.0	V	7.0	16.9
59.823000	24.7	40.0	15.3	1000.0	120.000	250.0	V	118.0	13.7
71.735000	22.8	40.0	17.2	1000.0	120.000	157.0	V	130.0	14.3
83.800000	29.4	40.0	10.6	1000.0	120.000	143.0	V	194.0	16.3
186.262000	14.7	43.5	28.8	1000.0	120.000	100.0	V	58.0	17.5
229.861000	15.6	46.0	30.4	1000.0	120.000	232.0	V	8.0	18.6
298.320000	17.0	46.0	29.0	1000.0	120.000	117.0	H	312.0	21.6
352.560000	19.6	46.0	26.4	1000.0	120.000	104.0	H	270.0	23.1
Measurement uncertainty				+2.2 dB / -3.6 dB					

Test: Passed

Test equipment used (see clause 6):

2, 17 - 22

## 5.3 99 % bandwidth

### 5.3.1 Method of measurement

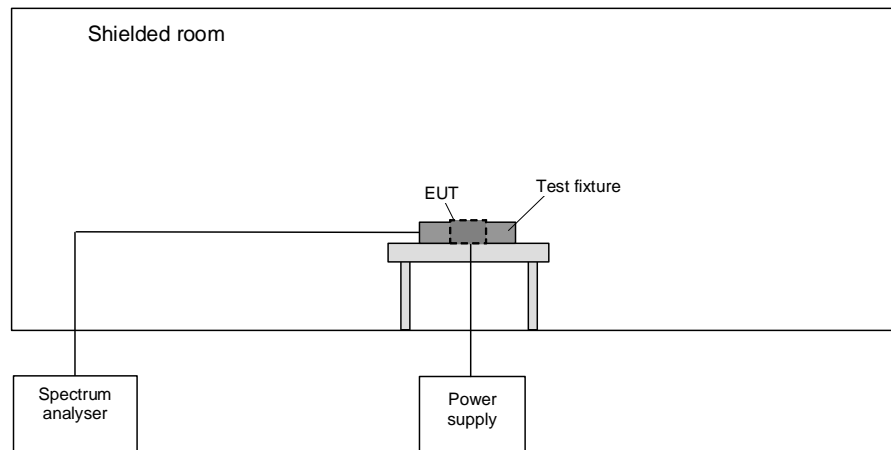

The following procedure will be used for the occupied bandwidth measurement according to [4]:

- The transmitter shall be operated at its maximum carrier power measured under normal test conditions.
- The span of the spectrum analyzer shall be set large enough to capture all products of the modulation process, including the emission skirts, around the carrier frequency, but small enough to avoid having other emissions (e.g. on adjacent channels) within the span.
- The detector of the spectrum analyzer shall be set to "Sample". However, a peak, or peak hold, may be used in place of the sampling detector since this usually produces a wider bandwidth than the actual bandwidth (worst-case measurement). Use of a peak hold (or "Max Hold") may be necessary to determine the occupied / x dB bandwidth if the device is not transmitting continuously.
- The resolution bandwidth (RBW) shall be in the range of 1% to 5% of the actual occupied / x dB bandwidth and the video bandwidth (VBW) shall not be smaller than three times the RBW value. Video averaging is not permitted.

Note: It may be necessary to repeat the measurement a few times until the RBW and VBW are in compliance with the above requirement.

For the 99% emission bandwidth, the trace data points are recovered and directly summed in linear power level terms. The recovered amplitude data points, beginning at the lowest frequency, are placed in a running sum until 0.5% of the total is reached, and that frequency recorded. The process is repeated for the highest frequency data points (starting at the highest frequency, at the right side of the span, and going down in frequency). This frequency is then recorded. The difference between the two recorded frequencies is the occupied bandwidth (or the 99% emission bandwidth).

### 5.3.2 Test results

Ambient temperature:	22 °C	Relative humidity:	62 %
----------------------	-------	--------------------	------

Test record: The test was carried out in TAGs reading and writing mode of the EUT (refer also clause 2 of this test report). All results are shown in the following.

Power supply: During this test the EUT was powered with 5 V<sub>AC</sub> by the Laptop PC, which was itself supplied by its internal battery.

172414\_116.jpeg: 99 % bandwidth at 125 kHz with modulation by HITAG:

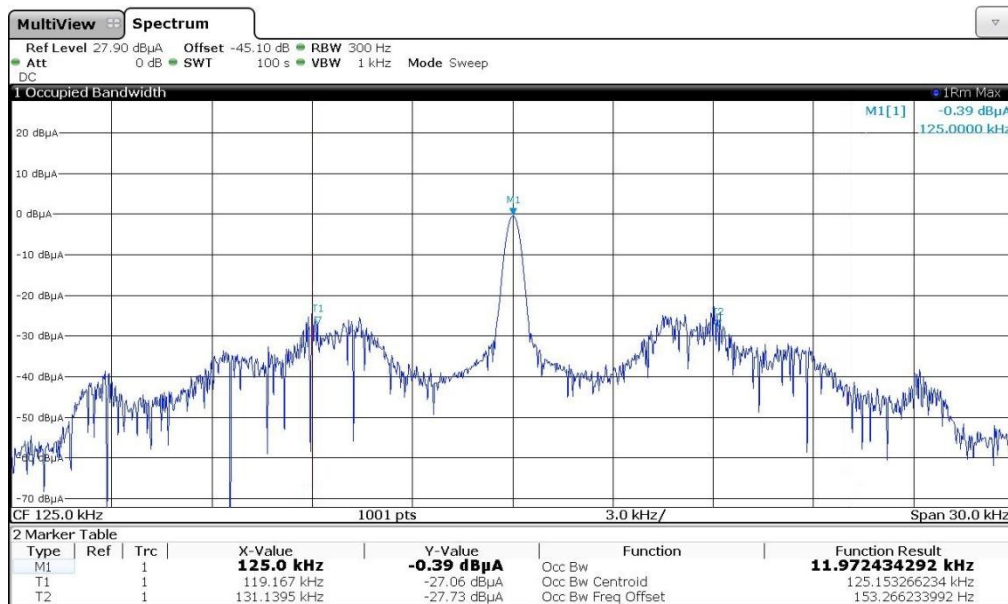

172414\_117.jpeg: 99 % bandwidth at 13.56 MHz with modulation by ISO15693 TAG:

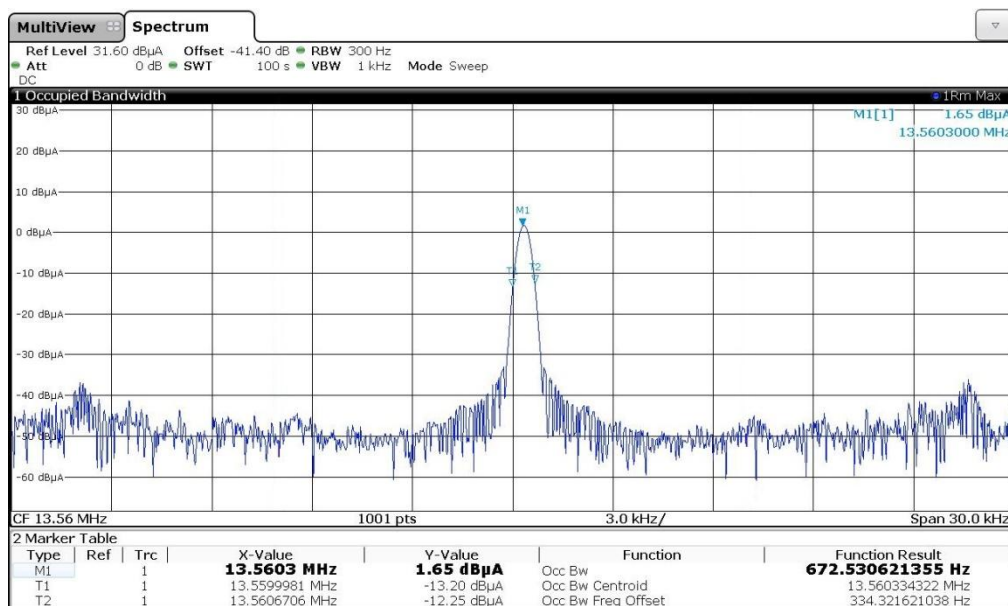



172414\_118.jpeg: 99 % bandwidth at 13.56 MHz with modulation by ISO14443A TAG:

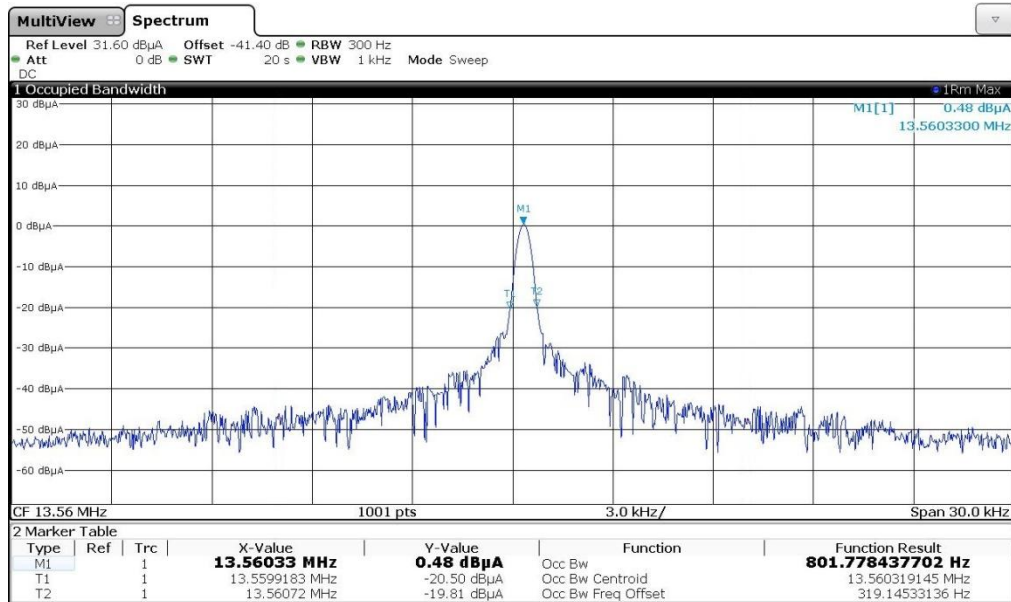

172414\_119.jpeg: 99 % bandwidth at 13.56 MHz with modulation by ISO14443B TAG:

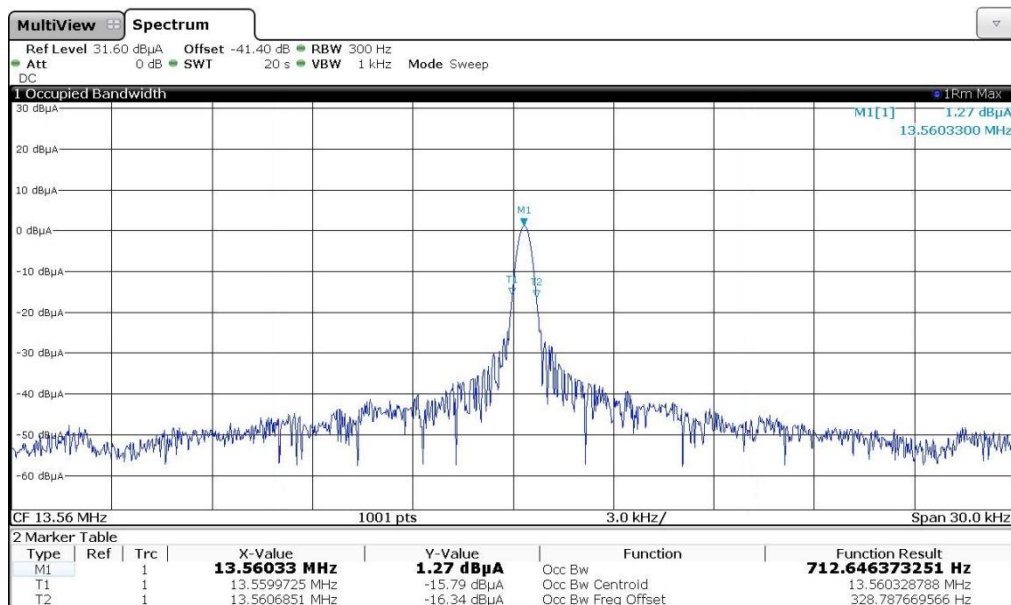

Frequency	Used TAG	F <sub>L</sub>	F <sub>U</sub>	BW (F <sub>U</sub> - F <sub>L</sub> )
125 kHz	HITAG	119.167 kHz	131.1395 kHz	11.9725 kHz
13.56 MHz	ISO15693	13.559998 MHz	13.560671 MHz	672.5 Hz
13.56 MHz	ISO14443A	13.559918 MHz	13.560720 MHz	801.8 Hz
13.56 MHz	ISO14443B	13.559973 MHz	13.560685 MHz	712.6 Hz
Measurement uncertainty			$< 1 \cdot 10^{-7}$	

Test equipment used (see clause 6):

23, 24

## 6 Test equipment

No.	Test equipment	Type	Manufacturer	Serial No.	PM. No.	Cal. Date	Cal Due
1	LISN	NSLK8128	Schwarzbeck	8128161	480138	13.03.2018	03.2020
2	Software	EMC32	Rohde & Schwarz	100061	481022	Calibration not necessary	
3	Shielded chamber M4	B83117-S1-X158	Siemens	190075	480088	Calibration not necessary	
4	EMI Receiver / Spectrum Analyser	ESIB 26	Rohde & Schwarz	100292	481182	28.02.2018	02.2020
5	Transient Filter Limiter	CFL 9206A	Teseq GmbH	38268	481982	14.03.2018	03.2020
6	Antenna mast	AS615P	Deisel	615/310	480187	Calibration not necessary	
7	Turntable	DS420 HE	Deisel	420/620/00	480315	Calibration not necessary	
8	Multiple Control Unit	MCU	Maturo GmbH	MCU/043/971107	480832	Calibration not necessary	
9	Antenna (Bilog)	CBL6112B	Schaffner EMV GmbH (-Chase)	2688	480328	19.06.2017	06.2020
10	RF-cable No.36	Sucoflex 106B	Suhner	0587/6B / Kabel 36	480865	Calibration not necessary	
11	EMI Receiver / Spectrum Analyser	ESW44	Rohde & Schwarz	101635	482467	22.06.2017	06.2019
12	Fully anechoic chamber M20	B83117-E2439-T232	Albatross Projects	103	480303	Calibration not necessary	
13	Antenna support	AS620P	Deisel	620/375	480325	Calibration not necessary	
14	Loop antenna	HFH2-Z2	Rohde & Schwarz	100417	481912	19.12.2017	12.2018
15	Outdoor test site	-	PHOENIX TESTLAB GmbH	-	480293	Calibration not necessary	
16	EMI Receiver / Spectrum Analyser	ESI 40	Rohde & Schwarz	100064/040	480355	27.02.2018	02.2019
17	Open area test site M6	Freifeld M6	Phoenix Contact	-	480085	Calibration not necessary	
18	Antenna mast	MA240-0	Inn-Co GmbH	MA240-0/030/6600603	480086	Calibration not necessary	
19	Turntable	DS412	Deisel	412/316	480087	Calibration not necessary	
20	Controller	HD100	Deisel	100/349	480139	Calibration not necessary	
21	Antenna (Bilog)	CBL6111D	Schaffner Elektrottest GmbH / Teseq GmbH	25761	480894	19.10.2017	10.2020
22	EMI Receiver / Spectrum Analyser	ESR7	Rohde & Schwarz	101939	482558	19.09.2017	09.2019
23	Signal & Spectrum Analyzer	FSW43	Rohde & Schwarz	100586 & 100926	481720	30.5.2018	05.2019
24	Loop antenna	Æ22.5cm	PHOENIX TESTLAB	-	410085	Calibration not necessary	

## 7 Report history

Report Number	Date	Comment
F172414E4	07/05/2018	Document created
-	-	-
-	-	-
-	-	-

## 8 List of annexes

Annex A Test setup photos 7 pages

172414\_26.jpg: EasyScan USB, test set-up shielded chamber  
172414\_6.jpg: EasyScan USB, test set-up fully anechoic chamber  
172414\_7.jpg: EasyScan USB, test set-up fully anechoic chamber  
172414\_8.jpg: EasyScan USB, test set-up fully anechoic chamber  
172414\_9.jpg: EasyScan USB, test set-up fully anechoic chamber  
172414\_16.jpg: EasyScan USB, test set-up open area test site  
172414\_12.jpg: EasyScan USB, test set-up open area test site  
172414\_26.jpg: EasyScan USB, test set-up shielded chamber

Annex B External photographs 3 pages

172414\_a.jpg: EasyScan USB, 3-D-view 1  
172414\_b.jpg: EasyScan USB, 3-D-view 2  
172414\_q.jpg: EasyScan USB, used TAGs

Annex C Internal photographs 10 pages

172414\_q.jpg: EasyScan USB, internal view 1 (housing opened)  
172414\_r.jpg: EasyScan USB, internal view 2 (housing disassembled))  
172414\_k.jpg: EasyScan USB, internal view 4 (antenna fixing inside housing top cover)  
172414\_j.jpg: EasyScan USB, PCB, antennas inside antenna fixing (housing top cover removed)  
172414\_i.jpg: EasyScan USB, internal view 3 (antenna fixing removed)  
172414\_n.jpg: EasyScan USB, PCB, 125 kHz antenna  
172414\_p.jpg: EasyScan USB, 13.56 MHz antenna, top view  
172414\_o.jpg: EasyScan USB, 13.56 MHz antenna, bottom view  
172414\_l.jpg: EasyScan USB, PCB, top view  
172414\_m.jpg: EasyScan USB, PCB, bottom view