



MEASUREMENT REPORT (Class II Change) FCC PART 15.225

FCC ID: TFJUIC680FG
APPLICANT: Uniform Industrial Corp.
Application Type: Certification
Product: Contactless Smart Card Reader Module
Model No.: UIC680FG
Brand Name: 
FCC Classification: (DXX) Part 15 Low Power Communication Device
Transmitter
FCC Rule Part(s): Part 15.225
Test Procedure(s): ANSI C63.10-2013
Received Date: April 21 , 2021
Test Date: May 10 , 2021

Tested By : *Fran Chen*

(Fran Chen)

Reviewed By : *Paddy Chen*

(Paddy Chen)

Approved By : *Chenz Ker*

(Chenz Ker)



Testing Laboratory

3261

The test results only relate to the tested sample.

This equipment has been shown to be capable of compliance with the applicable technical standards as indicated in the measurement report and was tested in accordance with the measurement procedures specified in ANSI C63.10. Test results reported herein relate only to the item(s) tested.

The test report shall not be reproduced except in full without the written approval of MRT Technology (Taiwan) Co., Ltd.

Revision History

Report No.	Version	Description	Issue Date	Note
2104TW5402-U1	1.0	Draft Report	2021-05-13	

CONTENTS

Description	Page
§2.1033 General Information	5
1. INTRODUCTION	6
1.1. Scope.....	6
1.2. MRT Test Location.....	6
2. PRODUCT INFORMATION	7
2.1. Equipment Description.....	7
2.2. Test Mode.....	8
2.3. Test Software.....	8
2.4. Test Configuration.....	8
2.5. EMI Suppression Device(s)/Modifications.....	8
2.6. Labeling Requirements.....	8
3. DESCRIPTION of TEST	9
3.1. Evaluation Procedure.....	9
3.2. AC Line Conducted Emissions.....	9
3.3. Radiated Emissions.....	10
4. ANTENNA REQUIREMENTS	11
5. TEST EQUIPMENT CALIBRATION DATE	12
6. MEASUREMENT UNCERTAINTY	13
7. TEST RESULT	14
7.1. Summary.....	14
7.2. Field Strength of Fundamental Emissions Measurement.....	15
7.2.1. Test Limit.....	15
7.2.2. Test Procedure used.....	15
7.2.3. Test Setup.....	16
7.2.4. Test Result.....	17
7.3. Radiated Spurious Emissions Measurement.....	19
7.3.1. Test Limit.....	19
7.3.2. Test Procedure Used.....	19
7.3.3. Test Setup.....	21
7.3.4. Test Result.....	22
7.4. 20dB Bandwidth Measurement.....	26
7.4.1. Test Limit.....	26
7.4.2. Test Procedure Used.....	26

7.4.3.	Test Setting.....	26
7.4.4.	Test Setup	26
7.4.5.	Test Result.....	27
7.5.	Frequency Stability Measurement	28
7.5.1.	Test Limit	28
7.5.2.	Test Procedure Used	28
7.5.3.	Test Setup	29
7.5.4.	Test Result.....	30
7.6.	AC Conducted Emissions Measurement	31
7.6.1.	Test Limit	31
7.6.2.	Test Setup	31
7.6.3.	Test Result.....	32
8.	CONCLUSION	33

§2.1033 General Information

Applicant	Uniform Industrial Corp.
Applicant Address	2901 Bayview Drive, Fremont, California 94538, United States
Manufacturer	Uniform Industrial Corp.
Manufacturer Address	1F, No.1, Lane 15, Ziqiang St., Tucheng Dist., New Taipei City 236, Taiwan
Test Site	MRT Technology (Taiwan) Co., Ltd
Test Site Address	No. 38, Fuxing Second Rd., Guishan Dist., Taoyuan City 333, Taiwan (R.O.C)
MRT FCC Registration No.	291082
FCC Rule Part(s)	Part 15.225
Test Device Serial No.	#1 <input type="checkbox"/> Production <input checked="" type="checkbox"/> Pre-Production <input type="checkbox"/> Engineering

Test Facility / Accreditations

1. MRT facility is a FCC registered (Reg. No. 291082) test facility with the site description report on file and is designated by the FCC as an Accredited Test Firm.
2. MRT facility is an IC registered (MRT Reg. No. 21723) test laboratory with the site description on file at Industry Canada.
3. MRT Lab is accredited to ISO 17025 by the Taiwan Accreditation Foundation (TAF Cert. No. 3261) in EMC, Telecommunications and Radio testing for FCC (Designation Number: TW3261), Industry Taiwan, EU and TELEC Rules.

1. INTRODUCTION

1.1. Scope

Measurement and determination of electromagnetic emissions (EMC) of radio frequency devices including intentional and/or unintentional radiators for compliance with the technical rules and regulations of the Federal Communications Commission and the Industry Canada Certification and Engineering Bureau.

1.2. MRT Test Location

The map below shows the location of the MRT LABORATORY, its proximity to the Taoyuan City. These measurement tests were conducted at the MRT Technology (Taiwan) Co., Ltd. Facility located at No.38, Fuxing 2nd Rd., Guishan Dist., Taoyuan City 33377, Taiwan (R.O.C).

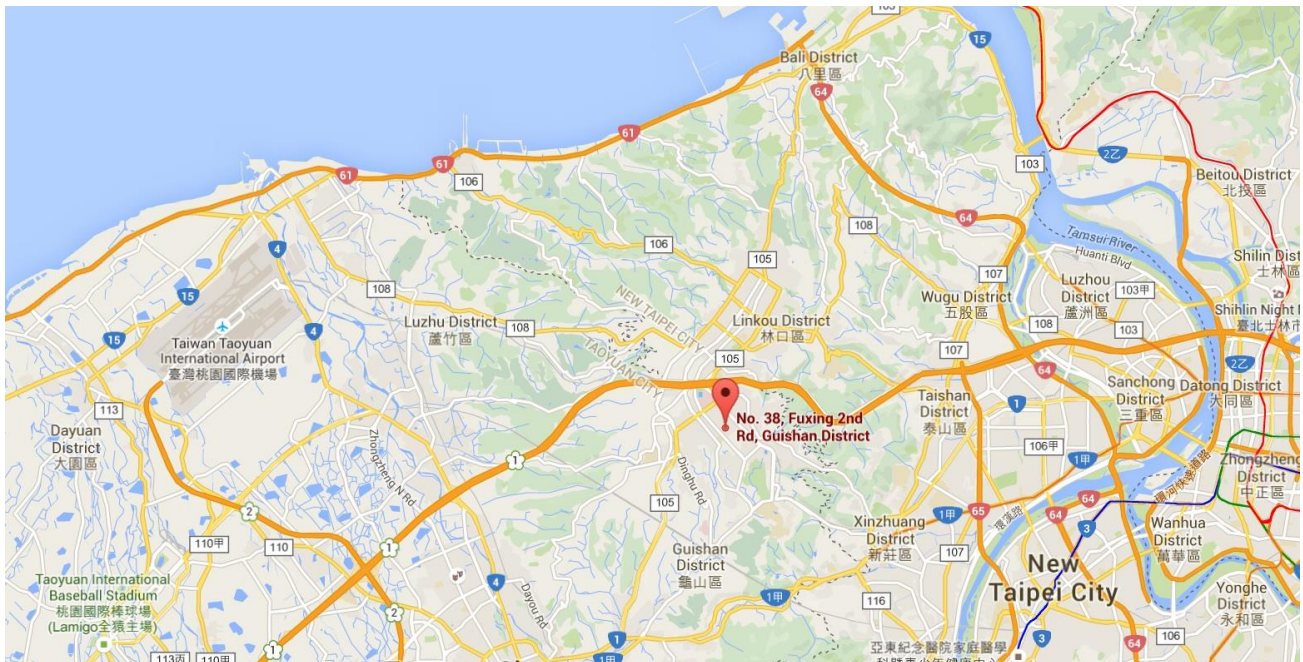

2. PRODUCT INFORMATION

2.1. Equipment Description

Product Name	Contactless Smart Card Reader Module
Brand Name	
Model No.	UIC680FG
NFC Specification	13.56MHz
Modulation	ASK
Antenna Type	PCB Loop Antenna
Accessories	
Power Adapter	Brand: Elementach international Co. Ltd. Model No: A106-2050103U Input: AC 100-240V ~ 50-60Hz 0.2mA Output: DC 5V 1A

Note: This case is change the CPU, so the C2PC (Radiated Spurious Emission) is executed.
 (Original Report Grant Date: 22/2/2017, FCC ID: TFJUIC680FG)

2.2. Test Mode

Test Mode	Mode 1: Transmit by NFC
-----------	-------------------------

2.3. Test Software

N/A.

2.4. Test Configuration

The **Contactless Smart Card Reader Module**, ANSI C63.10-2013 was used to reference the appropriate EUT setup for radiated spurious emissions testing and AC line conducted testing.

2.5. EMI Suppression Device(s)/Modifications

No EMI suppression device(s) were added and/or no modifications were made during testing.

2.6. Labeling Requirements

Per 2.1074 & 15.19; Docket 95-19

The label shall be permanently affixed at a conspicuous location on the device; instruction manual or pamphlet supplied to the user and be readily visible to the purchaser at the time of purchase. However, when the device is so small wherein placement of the label with specified statement is not practical, only the FCC ID must be displayed on the device per Section 15.19(a)(5). Please see attachment for FCC ID label and label location.

3. DESCRIPTION of TEST

3.1. Evaluation Procedure

The measurement procedures described in the American National Standard for Testing Unlicensed Wireless Devices (ANSI C63.10-2013) were used in the measurement of the **Contactless Smart Card Reader Module** .

Deviation from measurement procedure.....None

3.2. AC Line Conducted Emissions

The line-conducted facility is located inside an 9'x4'x3' shielded enclosure. A 1m x 2m wooden table 80cm high is placed 40cm away from the vertical wall and 80cm away from the sidewall of the shielded room. Two 10kHz-30MHz, 50Ω/50uH Line-Impedance Stabilization Networks (LISNs) are bonded to the shielded room floor. Power to the LISNs is filtered by external high-current high-insertion loss power line filters. These filters attenuate ambient signal noise from entering the measurement lines. These filters are also bonded to the shielded enclosure.

The EUT is powered from one LISN and the support equipment is powered from the second LISN. All interconnecting cables more than 1 meter were shortened to a 1 meter length by non-inductive bundling (serpentine fashion) and draped over the back edge of the test table. All cables were at least 40cm above the horizontal reference ground-plane. Power cables for support equipment were routed down to the second LISN while ensuring that that cables were not draped over the second LISN.

Sufficient time for the EUT, support equipment, and test equipment was allowed in order for them to warm up to their normal operating condition. The RF output of the LISN was connected to the receiver and exploratory measurements were made to determine the frequencies producing the maximum emission from the EUT. The receiver was scanned from 150kHz to 30MHz. The detector function was set to peak mode for exploratory measurements while the bandwidth of the analyzer was set to 9kHz. The EUT, support equipment, and interconnecting cables were arranged and manipulated to maximize each emission. Each emission was also maximized by varying: power lines, the mode of operation or data exchange speed, or support equipment which determined the worst-case emission. Once the worst case emissions have been identified, the one EUT cable configuration/arrangement and mode of operation that produced these emissions are used for final measurements on the same test site. The analyzer is set to CISPR quasi-peak and average detectors with a 9kHz resolution bandwidth for final measurements.

An extension cord was used to connect to a single LISN which powered by EUT. The extension cord was calibrated with LISN, the impedance and insertion loss are compliance with the requirements as stated in ANSI C63.10-2013.

Line conducted emissions test results are shown in Section 7.6.

3.3. Radiated Emissions

The radiated test facilities consisted of an indoor 3 meter semi-anechoic chamber used for final measurements and exploratory measurements, when necessary. The measurement area is contained within the semi-anechoic chamber which is shielded from any ambient interference. For measurements above 1GHz absorbers are arranged on the floor between the turn table and the antenna mast in such a way so as to maximize the reduction of reflections. For measurements below 1GHz, the absorbers are removed. A MF Model 210SS turntable is used for radiated measurement. It is a continuously rotatable, remote controlled, metallic turntable and 2 meters (6.56 ft.) in diameter. The turn table is flush with the raised floor of the chamber in order to maintain its function as a ground plane. An 80cm high PVC support structure is placed on top of the turntable.

For all measurements, the spectrum was scanned through all EUT azimuths and from 1 to 4 meter receive antenna height using a broadband antenna from 30MHz up to the upper frequency shown in 15.33(b)(1) depending on the highest frequency generated or used in the device or on which the device operates or tunes. For frequencies above 1GHz, linearly polarized double ridge horn antennas were used. For frequencies below 30MHz, a calibrated loop antenna was used. When exploratory measurements were necessary, they were performed at 1 meter test distance inside the semi-anechoic chamber using broadband antennas, broadband amplifiers, and spectrum analyzers to determine the frequencies and modes producing the maximum emissions. Sufficient time for the EUT, support equipment, and test equipment was allowed in order for them to warm up to their normal operating condition. The test set-up for frequencies below 1GHz was placed on top of the 0.8 meter high, 1 x 1.5 meter table; and test set-up for frequencies 1-40GHz was placed on top of the 1.5 meter high, 1 x 1.5 meter table. The EUT, support equipment, and interconnecting cables were arranged and manipulated to maximize each emission. Appropriate precaution was taken to ensure that all emissions from the EUT were maximized and investigated. The system configuration, clock speed, mode of operation or video resolution, if applicable, turntable azimuth, and receive antenna height was noted for each frequency found.

Final measurements were made in the semi-anechoic chamber using calibrated, linearly polarized broadband and horn antennas. The test setup was configured to the setup that produced the worst case emissions. The spectrum analyzer was set to investigate all frequencies required for testing to compare the highest radiated disturbances with respect to the specified limits. The turntable containing the EUT was rotated through 360 degrees and the height of the receive antenna was varied 1 to 4 meters and stopped at the azimuth and height producing the maximum emission. Each emission was maximized by changing the orientation of the EUT through three orthogonal planes and changing the polarity of the receive antenna, which produced the worst-case emissions.

According to 3dB Beam-Width of horn antenna, the horn antenna should be always directed to the EUT when rising height.

Radiated Emissions test results are shown in Section 7.2 & 7.3 .

4. ANTENNA REQUIREMENTS

Excerpt from §15.203 of the FCC Rules/Regulations:

“An intentional radiator antenna shall be designed to ensure that no antenna other than that furnished by the responsible party can be used with the device. The use of a permanently attached antenna or of an antenna that uses a unique coupling to the intentional radiator shall be considered sufficient to comply with the provisions of this section.”

- The antenna of **Contactless Smart Card Reader Module** is **permanently attached**.
- There are no provisions for connection to an external antenna.

Conclusion:

The **Contactless Smart Card Reader Module** unit complies with the requirement of §15.203.

5. TEST EQUIPMENT CALIBRATION DATE

Conducted Emissions – SR2

Instrument	Manufacturer	Type No.	Asset No.	Cali. Interval	Cali. Due Date
Two-Line V-Network	R&S	ENV216	MRTTWA00019	1 year	2022/3/23
Cable	Rosnol	N1C50-RG400-B 1C50-500CM	MRTTWE00013	1 year	2021/6/21
EMI Test Receiver	R&S	ESR3	MRTTWA00009	1 year	2022/3/24

Radiated Emissions – AC1

Instrument	Manufacturer	Type No.	Asset No.	Cali. Interval	Cali. Due Date
Broadband TRILOG Antenna	SCHWARZBECK	VULB 9162	MRTTWA00001	1 year	2021/10/5
EMI Test Receiver	R&S	ESR3	MRTTWA00009	1 year	2022/3/24
Active Loop Antenna	Schwarzbeck	FMZB 1519B	MRTTWA00002	1 year	2022/5/6
Broadband Horn antenna	SCHWARZBECK	BBHA 9120D	MRTTWA00003	1 year	2022/4/21
Breitband Hornantenna	Schwarzbeck	BBHA 9170	MRTTWA00004	1 year	2022/4/28
Broadband Amplifier	Schwarzbeck	BBV 9721	MRTTWA00006	1 year	2022/4/26
Broadband Preampfier	SCHWARZBECK	BBV 9718	MRTTWA00005	1 year	2022/4/21
Cable	HUBERSUHNER	SF106	MRTTWE00010	1 year	2021/6/16
Cable	Rosnol	K1K50-UP0264- K1K50-4M	MRTTWE00012	1 year	2021/6/21

Conducted Test Equipment – SR2

Instrument	Manufacturer	Type No.	Asset No.	Cali. Interval	Cali. Due Date
EXA Signal Analyzer	KEYSIGHT	N9010A	MRTTWA00012	1 year	2021/10/14
EXA Signal Analyzer	KEYSIGHT	N9010A	MRTTWA00074	1 year	2021/7/14
USB Wideband Power Sensor	KEYSIGHT	U2021XA	MRTTWA00015	1 year	2022/3/24

Test Software

Software	Version	Function
e3	9.160520a	EMI Test Software
EMI	V3	EMI Test Software

6. MEASUREMENT UNCERTAINTY

Where relevant, the following test uncertainty levels have been estimated for tests performed on the EUT as specified in CISPR 16-4-2. This uncertainty represents an expanded uncertainty expressed at approximately the 95% confidence level using a coverage factor of $k = 2$.

Conducted Emission- Power Line
Measuring Uncertainty for a Level of Confidence of 95% ($U=2Uc(y)$): 0.15MHz~30MHz: $\pm 2.53\text{dB}$
Conducted Measurement
Measuring Uncertainty for a Level of Confidence of 95% ($U=2Uc(y)$): 1.3dB
Radiated Spurious Emission
Measuring Uncertainty for a Level of Confidence of 95% ($U=2Uc(y)$): 9kHz~30MHz: $\pm 3.92\text{dB}$ 30MHz~1GHz: $\pm 4.25\text{dB}$ 1GHz~18GHz: $\pm 4.40\text{dB}$ 18GHz~40GHz: $\pm 4.45\text{dB}$

7. TEST RESULT

7.1. Summary

Product Name: Contactless Smart Card Reader Module

FCC Classification: (DXX) Part 15 Low Power Communication Device Transmitter

FCC Part Section(s)	Test Description	Test Limit	Test Condition	Test Result	Reference
15.225 (a)(b)(c)	Field Strength of Fundamental Emissions	FCC 15.225 limits	Radiated	Pass	Section 7.2
15.225(d)	Radiated Spurious Emissions	FCC 15.209 limits		Pass	Section 7.3
2.1049	20dB Bandwidth	N/A	Conducted	N/A	N/A
15.225(e)	Frequency Stability	within $\pm 0.01\%$ of the operating frequency		N/A	N/A
15.207	AC Conducted Emissions 150kHz - 30MHz	FCC 15.207 limits	Line Conducted	N/A	N/A

Notes:

- 1) Determining compliance is based on the test results met the regulation limits or requirements declared by clients, and the test results don't take into account the value of measurement uncertainty.
- 2) All modes of operation and data rates were investigated. For radiated emission test, every axis (X, Y, Z) was also verified. The test results shown in the following sections represent the worst case emissions.
- 3) The analyzer plots shown in this section were all taken with a correction table loaded into the analyzer. The correction table was used to account for the losses of the cables and attenuators used as part of the system to connect the EUT to the analyzer at all frequencies of interest.
- 4) All antenna port conducted emissions testing was performed on a test bench with the antenna port of the EUT connected to the spectrum analyzer through calibrated cables and attenuators.

7.2. Field Strength of Fundamental Emissions Measurement

7.2.1. Test Limit

FCC Part 15.225 Limits				
Frequency (MHz)	Field Strength ($\mu\text{V/m}$) at 30m	Field Strength ($\text{dB}\mu\text{V/m}$) at 30m	Field Strength ($\text{dB}\mu\text{V/m}$) at 10m	Field Strength ($\text{dB}\mu\text{V/m}$) at 3m
1.705 – 13.110	30	29.5	48.58	69.5
13.110 – 13.410	106	40.5	59.98	80.5
13.410 – 13.553	334	50.5	69.58	90.5
13.553 – 13.567	15848	84	103.08	124
13.567 – 13.710	334	50.5	69.58	90.5
13.710 – 14.010	106	40.5	59.98	80.5
14.010 – 30.000	30	29.5	48.58	69.5

7.2.2. Test Procedure used

(A) ANSI C63.10-2013 - Section 11.12.2.3 (quasi-peak measurements)

The specifications for measurements using the CISPR quasi-peak detector can be found in CISPR 16-1-1, As an alternative to CISPR quasi-peak measurement, compliance can be determined for the applicable emission requirements using a peak detector.

(B) ANSI C63.10-2013 - Section 11.12.2.4 (peak power measurements)

1. Analyzer center frequency was set to the frequency of the radiated spurious emission of interest
2. RBW = as specified in Table 1
3. $\text{VBW} \geq 3 \times \text{RBW}$
4. Detector = Peak
5. Trace mode = max hold
6. Sweep = auto couple
7. Allow the trace was allowed to stabilize

Table 1 - RBW as a function of frequency

Frequency	RBW
9 kHz ~ 150 kHz	200 Hz ~ 300 Hz
0.15 MHz ~ 30 MHz	9 kHz ~ 10 kHz

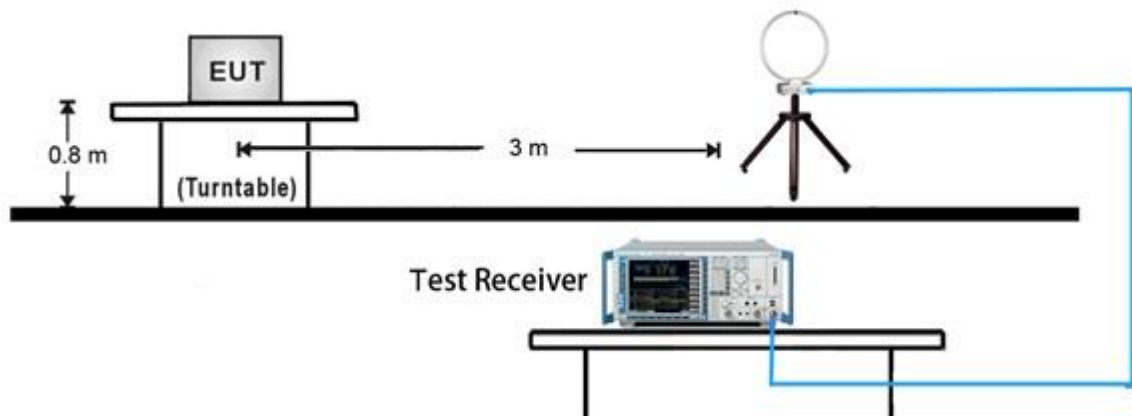
7.2.3. Test Setup
9kHz ~ 30MHz Test Setup:

7.2.4. Test Result

EUT	Contactless Smart Card Reader Module	Date of Test	2021-05-10
Factor	FMZB 1519B	Temp. / Humidity	24°C /71%
Polarity	--	Site / Test Engineer	AC1 / Kaunaz
Test Mode	TX- RFID 13.56MHz	Test Voltage	AC 120V/60Hz

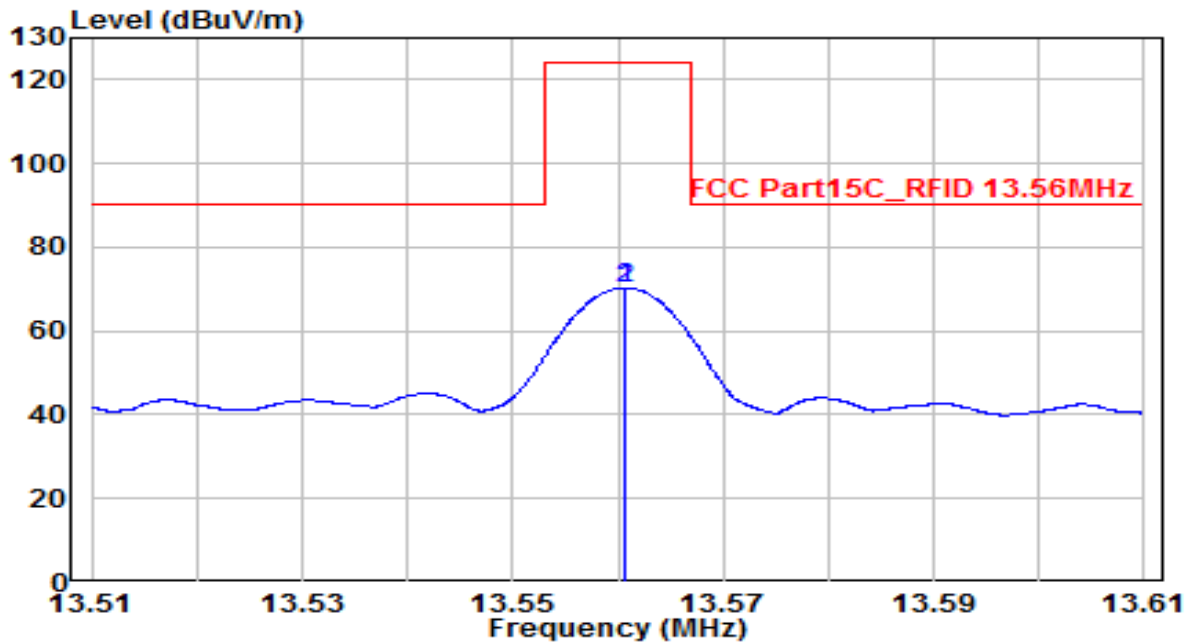

No	Frequency (MHz)	Reading (dBuV)	C.F (dB)	Measurement (dBuV/m)	Margin (dB)	Limit (dBuV/m)	Height (cm)	Angle (deg)	Remark (QP/PK/AV)
1	13.561	49.00	21.06	70.06	-53.94	124.00	100	330	QP
2	* 13.561	49.24	21.06	70.31	-53.69	124.00	100	330	Peak

Note:

1. " *", means this data is the worst emission level.
2. C.F (Correction Factor) = Antenna Factor (dB)+ Cable Loss (dB).
3. Measurement (dBuV/m) = Reading(dBuV) + C.F (Correction Factor).
4. The emission levels of other frequencies are very lower than the limit and not show in test report.

EUT	Contactless Smart Card Reader Module	Date of Test	2021-05-10
Factor	FMZB 1519B	Temp. / Humidity	24°C /71%
Polarity	--	Site / Test Engineer	AC1 / Kaunaz
Test Mode	TX- RFID 13.56MHz	Test Voltage	AC 120V/60Hz

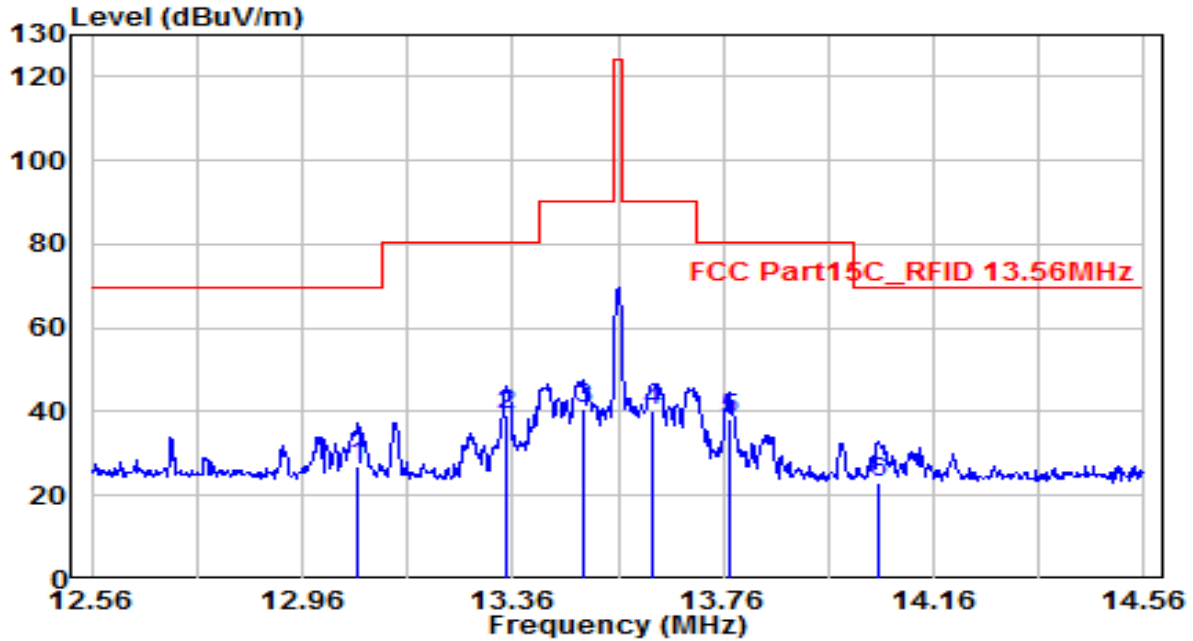

No	Frequency (MHz)	Reading (dBuV)	C.F (dB)	Measurement (dBuV/m)	Margin (dB)	Limit (dBuV/m)	Height (cm)	Angle (deg)	Remark (QP/PK/AV)
1	13.066	6.10	21.03	27.13	-42.41	69.54	100	315	QP
2	* 13.348	18.10	21.05	39.15	-41.35	80.50	100	315	QP
3	13.496	19.80	21.06	40.86	-49.64	90.50	100	315	QP
4	13.628	19.00	21.07	40.07	-50.43	90.50	100	315	QP
5	13.772	17.00	21.08	38.08	-42.42	80.50	100	315	QP
6	14.054	1.80	21.10	22.90	-46.64	69.54	100	315	QP

Note:

- "*", means this data is the worst emission level.
- C.F (Correction Factor) = Antenna Factor (dB)+ Cable Loss (dB).
- Measurement (dBuV/m) = Reading(dBuV) + C.F (Correction Factor).
- The emission levels of other frequencies are very lower than the limit and not show in test report.

7.3. Radiated Spurious Emissions Measurement

7.3.1. Test Limit

All out of band emissions appearing in a restricted band as specified in Section 15.225 of the Title 47 CFR must not exceed the limits shown in Table per Section 15.209.

FCC Part 15 Subpart C Paragraph 15.209		
Frequency [MHz]	Field Strength [V/m]	Measured Distance [Meters]
0.009 - 0.490	2400/F (kHz)	300
0.490 - 1.705	24000/F (kHz)	30
1.705 - 30	30	30
30 - 88	100	3
88 - 216	150	3
216 - 960	200	3
Above 960	500	3

Note : The emission limits shown in the above table are based on measurements employing a CISPR quasi-peak detector except for the frequency bands 9-90 kHz, 110-490 kHz and above 1000 MHz. Radiated emission limits in these three bands are based on measurements employing an average detector.

7.3.2. Test Procedure Used

(A) ANSI C63.10-2013 - Section 11.12.2.3 (quasi-peak measurements)

The specifications for measurements using the CISPR quasi-peak detector can be found in CISPR 16-1-1. As an alternative to CISPR quasi-peak measurement, compliance can be determined for the applicable emission requirements using a peak detector.

(B) ANSI C63.10-2013 - Section 11.12.2.4 (peak power measurements)

1. Analyzer center frequency was set to the frequency of the radiated spurious emission of interest
2. RBW = as specified in Table 1
3. VBW = 3 × RBW
4. Detector = peak
5. Sweep time = auto couple

Table 1 - RBW as a function of frequency

Frequency	RBW
9 kHz ~ 150 kHz	200 Hz ~ 300 Hz
0.15 MHz ~ 30 MHz	9 kHz ~ 10 kHz
30 MHz ~ 1000 MHz	100 kHz ~ 120 kHz
> 1000 MHz	1 MHz

(C) ANSI C63.10-2013 - Section 11.12.2.5 (average power measurements)

1. Analyzer center frequency was set to the frequency of the radiated spurious emission of interest
2. RBW = 1MHz
3. VBW ≥ 1/T
4. Video bandwidth mode or display mode:
 - 1) The instrument shall be set to ensure that video filtering is applied in the power domain. Typically, this requires setting the detector mode to RMS (power averaging) and setting the average-VBW type to power (rms).
 - 2) As an alternative, the instrument may be set to linear detector mode. Ensure that video filtering is applied in linear voltage domain (rather than in a log or dB domain). Some instruments require linear display mode to accomplish this. Others have a setting for average-VBW type, which can be set to “voltage” regardless of the display mode. Detector =

Peak

5. Sweep time = auto
6. Trace mode = max hold
7. Allow max hold to run for at least 50 times (1/duty cycle) traces

7.3.3. Test Setup

9kHz ~ 30MHz Test Setup:

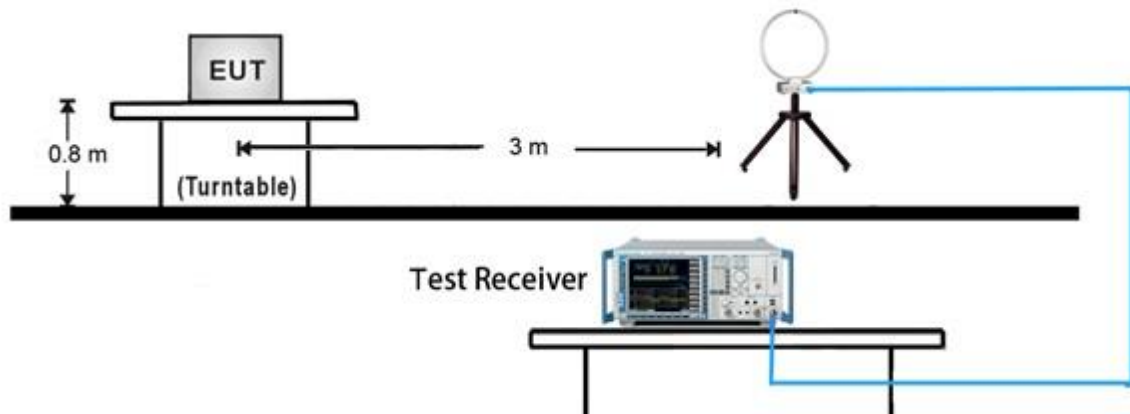

30MHz ~ 1GHz Test Setup:

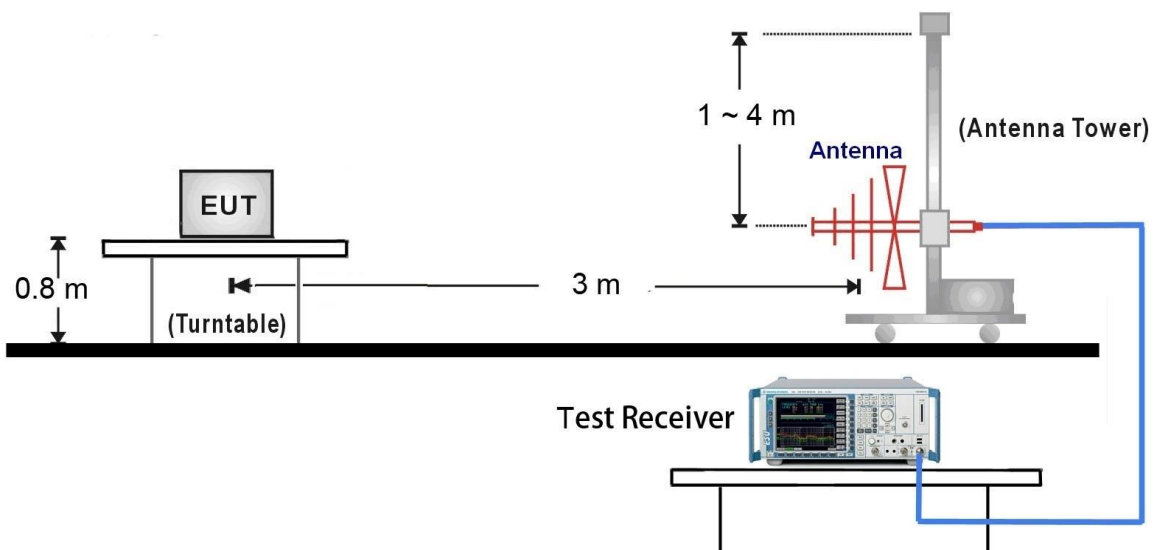

7.3.4. Test Result

EUT	Contactless Smart Card Reader Module	Date of Test	2021-05-10
Factor	FMZB 1519B	Temp. / Humidity	24°C /71%
Polarity	--	Site / Test Engineer	AC1 / Kaunaz
Test Mode	TX-RFID 13.56MHz	Test Voltage	AC 120V/60Hz

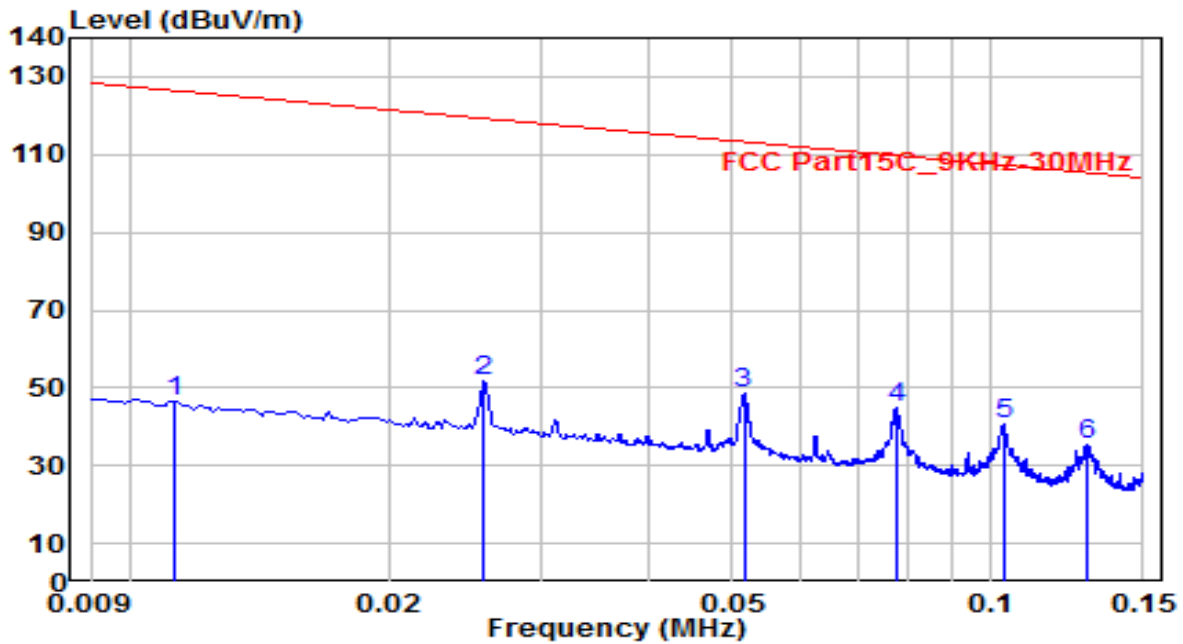

No	Frequency (MHz)	Reading (dBUV)	C.F (dB)	Measurement (dBUV/m)	Margin (dB)	Limit (dBUV/m)	Height (cm)	Angle (deg)	Remark (QP/PK/AV)
1	0.011	27.85	18.77	46.61	-79.95	126.56	100	360	Peak
2	0.026	32.26	19.42	51.68	-67.69	119.37	100	360	Peak
3	* 0.052	29.69	18.89	48.59	-64.76	113.35	100	360	Peak
4	0.078	26.37	18.58	44.95	-64.86	109.81	100	360	Peak
5	0.104	22.16	18.32	40.48	-66.82	107.29	100	360	Peak
6	0.129	16.94	18.35	35.29	-70.07	105.36	100	360	Peak

Note:

1. " *", means this data is the worst emission level.
2. C.F (Correction Factor) = Antenna Factor (dB)+ Cable Loss (dB).
3. Measurement (dBUV/m) = Reading(dBUV) + C.F (Correction Factor).
4. The emission levels of other frequencies are very lower than the limit and not show in test report.

EUT	Contactless Smart Card Reader Module	Date of Test	2021-05-10
Factor	FMZB 1519B	Temp. / Humidity	24°C /71%
Polarity	--	Site / Test Engineer	AC1 / Kaunaz
Test Mode	TX-RFID 13.56MHz	Test Voltage	AC 120V/60Hz

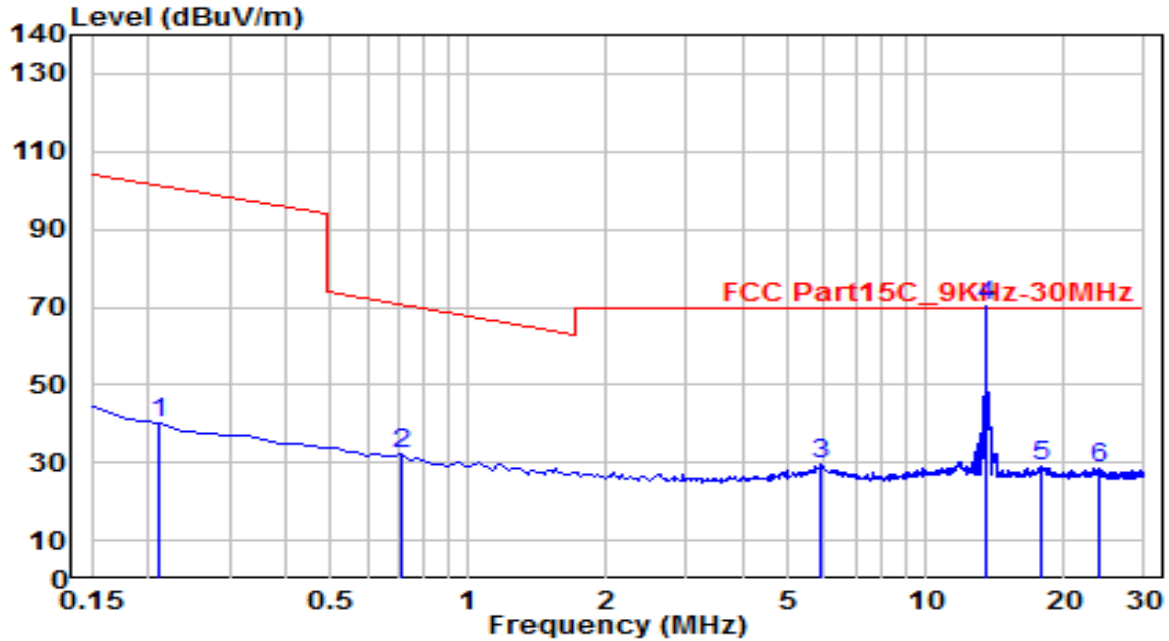

No	Frequency (MHz)	Reading (dBuV)	C.F (dB)	Measurement (dBuV/m)	Margin (dB)	Limit (dBuV/m)	Height (cm)	Angle (deg)	Remark (QP/PK/AV)
1	0.210	21.52	18.48	40.00	-61.17	101.17	100	360	Peak
2	0.717	13.48	18.74	32.22	-38.28	70.50	100	360	Peak
3	5.881	9.68	19.64	29.32	-40.18	69.50	100	360	Peak
4 *	13.553	49.19	21.06	70.25	0.75	69.50	100	360	Peak
5	17.881	7.70	21.36	29.06	-40.44	69.50	100	360	Peak
6	23.761	6.88	21.58	28.46	-41.04	69.50	100	360	Peak

Note:

- " *", means this data is the worst emission level.
- C.F (Correction Factor) = Antenna Factor (dB)+ Cable Loss (dB).
- Measurement (dBuV/m) = Reading(dBuV) + C.F (Correction Factor).
- The emission levels of other frequencies are very lower than the limit and not show in test report.
- This frequency is 13.553MHz RFID operating frequency.

EUT	Contactless Smart Card Reader Module	Date of Test	2021-04-28
Factor	VULB 9162	Temp. / Humidity	25°C /62%
Polarity	Horizontal	Site / Test Engineer	AC1 / Hance
Test Mode	TX-NFC 13.56MHz	Test Voltage	AC 120V/60Hz

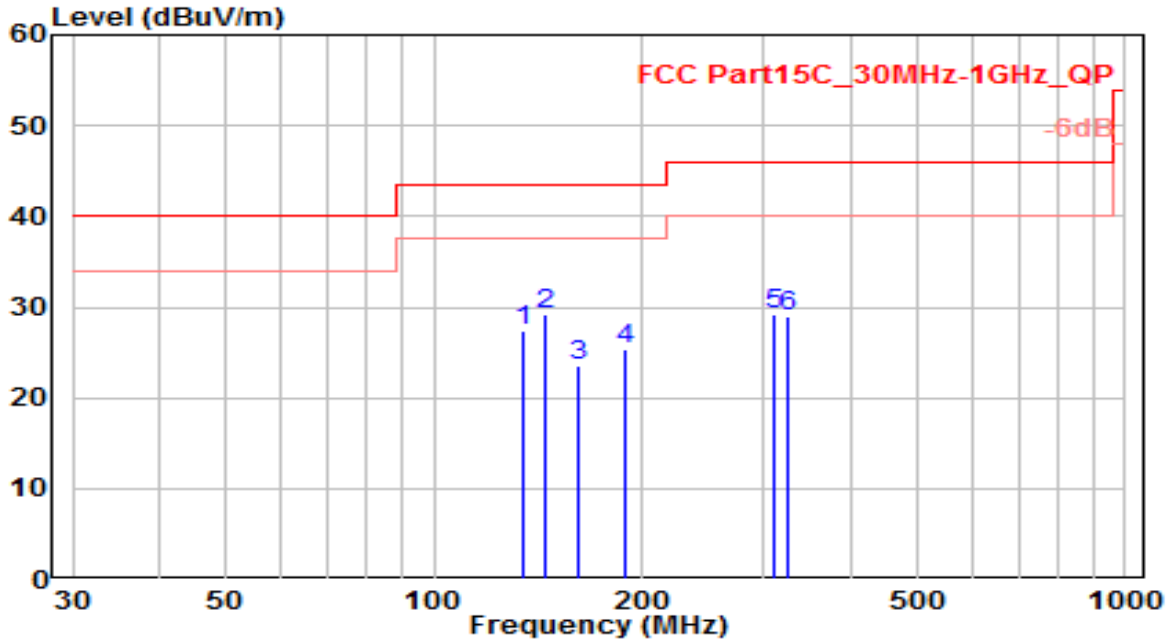

No	Frequency (MHz)	Reading (dBuV)	C.F (dB)	Measurement (dBuV/m)	Margin (dB)	Limit (dBuV/m)	Height (cm)	Angle (deg)	Remark (QP/PK/AV)
1	134.760	11.15	16.16	27.32	-16.18	43.50	100	120	QP
2	* 145.430	13.16	16.00	29.16	-14.34	43.50	100	0	QP
3	161.920	7.24	16.38	23.62	-19.88	43.50	100	140	QP
4	189.080	6.49	18.77	25.26	-18.24	43.50	100	360	QP
5	311.300	7.36	21.89	29.25	-16.75	46.00	100	120	QP
6	324.880	6.60	22.36	28.96	-17.04	46.00	100	0	QP

Note:

- "*", means this data is the worst emission level.
- C.F (Correction Factor) = Antenna Factor (dB)+ Cable Loss (dB).
- Measurement (dBuV/m) = Reading(dBuV) + C.F (Correction Factor).
- The emission levels of other frequencies are very lower than the limit and not show in test report.

EUT	Contactless Smart Card Reader Module	Date of Test	2021-04-28
Factor	VULB 9162	Temp. / Humidity	25°C /62%
Polarity	Vertical	Site / Test Engineer	AC1 / Hance
Test Mode	TX-NFC 13.56MHz	Test Voltage	AC 120V/60Hz

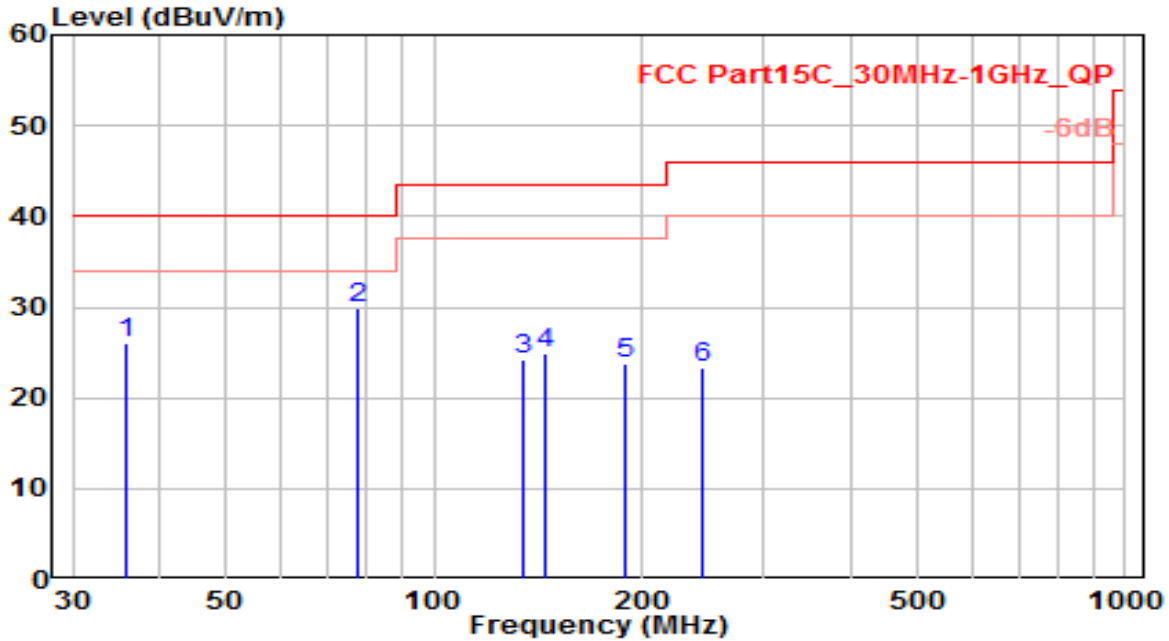

No	Frequency (MHz)	Reading (dBuV)	C.F (dB)	Measurement (dBuV/m)	Margin (dB)	Limit (dBuV/m)	Height (cm)	Angle (deg)	Remark (QP/PK/AV)
1	35.820	6.34	19.61	25.94	-14.06	40.00	100	0	QP
2	* 77.530	14.85	15.00	29.85	-10.15	40.00	100	150	QP
3	134.760	7.96	16.16	24.12	-19.38	43.50	100	360	QP
4	145.430	8.95	16.00	24.95	-18.55	43.50	100	120	QP
5	189.080	4.92	18.77	23.70	-19.80	43.50	110	10	QP
6	244.370	2.94	20.35	23.29	-22.71	46.00	100	20	QP

Note:

1. " *", means this data is the worst emission level.
2. C.F (Correction Factor) = Antenna Factor (dB)+ Cable Loss (dB).
3. Measurement (dBuV/m) = Reading(dBuV) + C.F (Correction Factor).
4. The emission levels of other frequencies are very lower than the limit and not show in test report.

7.4. 20dB Bandwidth Measurement

7.4.1. Test Limit

N/A

7.4.2. Test Procedure Used

KDB 789033 D02v01r01 – Section C.1

7.4.3. Test Setting

1. The analyzers' automatic bandwidth measurement capability was used to perform the 20dB bandwidth measurement. The "X" dB bandwidth parameter was set to $X = 20$. The automatic bandwidth measurement function also has the capability of simultaneously measuring the 99% occupied bandwidth. The bandwidth measurement was not influenced by any intermediated power nulls in the fundamental emission.
2. RBW = approximately 1% ~5% of the emission bandwidth.
3. VBW $\geq 3 \times$ RBW.
4. Detector = Peak.
5. Trace mode = max hold.

7.4.4. Test Setup

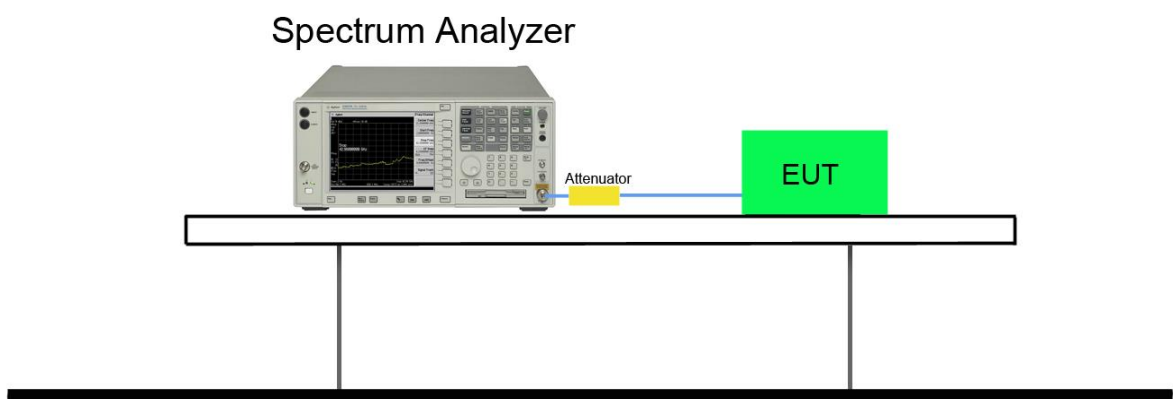

7.4.5. Test Result

Note: Reference Original Report Grant Date: 22/2/2017, FCC ID: TFJUIC680FG.

7.5. Frequency Stability Measurement

7.5.1. Test Limit

Manufactures of U-NII devices are responsible for ensuring frequency stability such that an emission is maintained within the band of operation under all conditions of normal operation as specified in the user's manual.

7.5.2. Test Procedure Used

Frequency Stability Under Temperature Variations:

The equipment under test was connected to an external AC or DC power supply and input rated voltage. RF output was connected to a frequency counter or spectrum analyzer via feed through attenuators. The EUT was placed inside the temperature chamber. Set the spectrum analyzer RBW low enough to obtain the desired frequency resolution and measure EUT 20°C operating frequency as reference frequency. Turn EUT off and set the chamber temperature to highest. After the temperature stabilized for approximately 30 minutes recorded the frequency. Repeat step measure with 10°C decreased per stage until the lowest temperature reached.

Frequency Stability Under Voltage Variations:

Set chamber temperature to 20°C. Use a variable AC power supply / DC power source to power the EUT and set the voltage to rated voltage. Set the spectrum analyzer RBW low enough to obtain the desired frequency resolution and recorded the frequency.

Reduce the input voltage to specify extreme voltage variation ($\pm 15\%$) and endpoint, record the maximum frequency change.

7.5.3. Test Setup

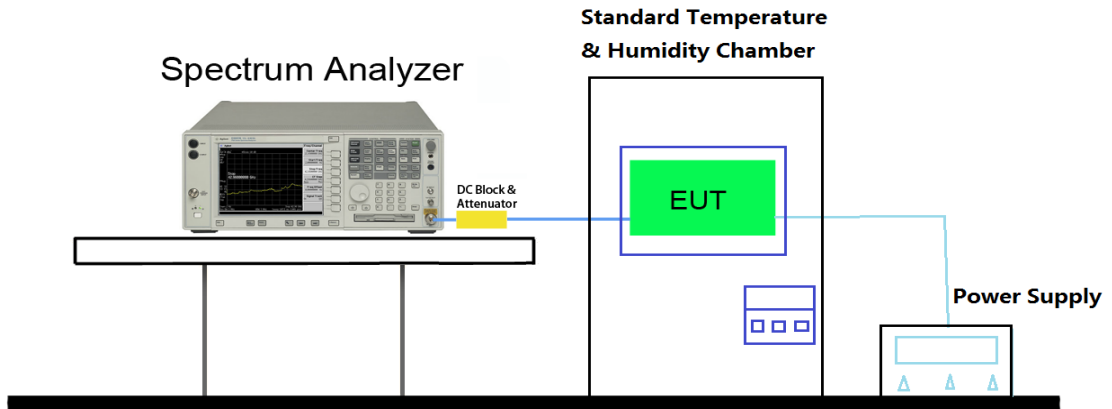

7.5.4. Test Result

Note: Reference Original Report Grant Date: 22/2/2017, FCC ID: TFJUIC680FG.

7.6. AC Conducted Emissions Measurement

7.6.1. Test Limit

FCC Part 15 Subpart C Paragraph 15.207 Limits		
Frequency (MHz)	QP (dBuV)	AV (dBuV)
0.15 - 0.50	66 - 56	56 - 46
0.50 - 5.0	56	46
5.0 - 30	60	50

Note 1: The lower limit shall apply at the transition frequencies.

Note 2: The limit decreases linearly with the logarithm of the frequency in the range 0.15MHz to 0.5MHz.

7.6.2. Test Setup

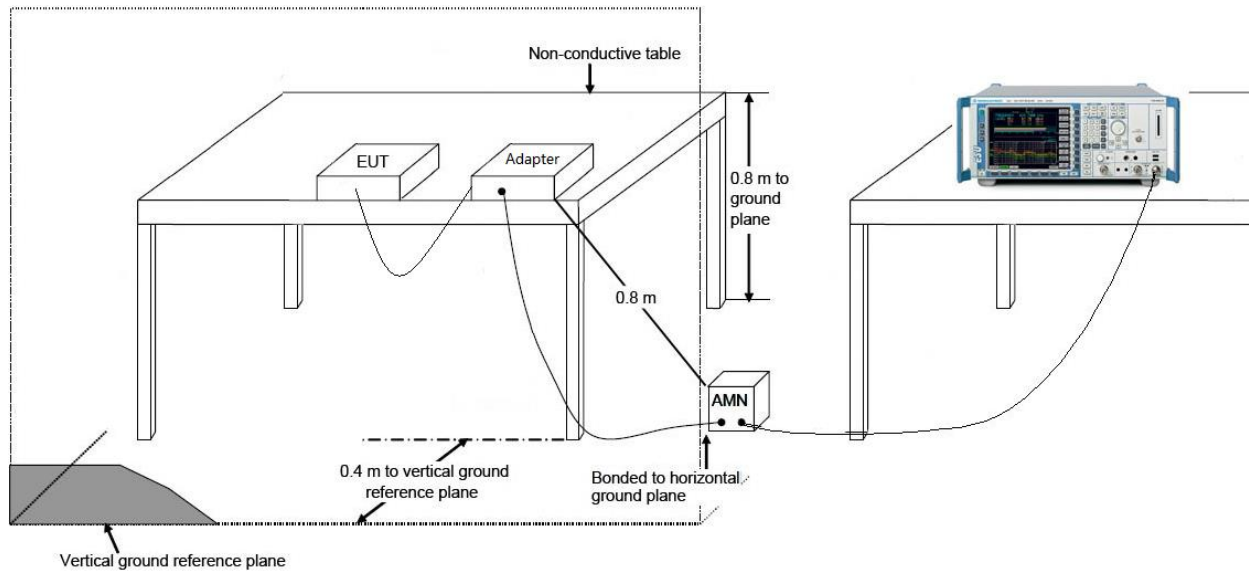

7.6.3. Test Result

Note: Reference Original Report Grant Date: 22/2/2017, FCC ID: TFJUIC680FG.

8. CONCLUSION

The data collected relate only the item(s) tested and show that the **Contactless Smart Card Reader Module** is in compliance with Part 15.225 of the FCC Rules.

————— The End —————