

The background of the top half of the page is a complex geometric pattern of overlapping triangles in various shades of teal and green. The pattern is dense and creates a textured, crystalline effect. A thin pink border is visible on the left and right sides of the page.

TapTap II

Quick Start Guide

Thank you for choosing **Asante**

If you have any questions regarding the product, please feel free to contact
Asante Technical Support:
(408) 435-8388 Ext.511 or send us an email to support@asante.com

Package Contains

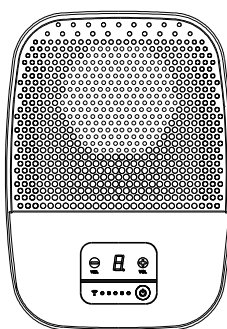

TapTap II device Qty: 1

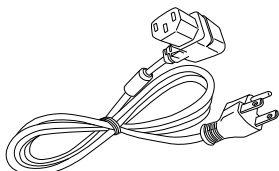

Power cable Qty: 1



Plug cover Qty: 6

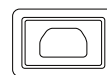

Weatherproof cover
(AC-input) Qty: 1

* Weatherproof cover and plug covers help you protect your TapTap II from dust and/or humidity when not in use. We recommend that you use the AC weatherproof cover to protect your TapTap II from natural conditions such as rain and snow.

Compatibility of Light Strings

TapTap II is compatible with most 110V **LED** light strings with standard AC plug. **Please note that the light strings without existing controller should be used.**

TapTap II Lights and Ports

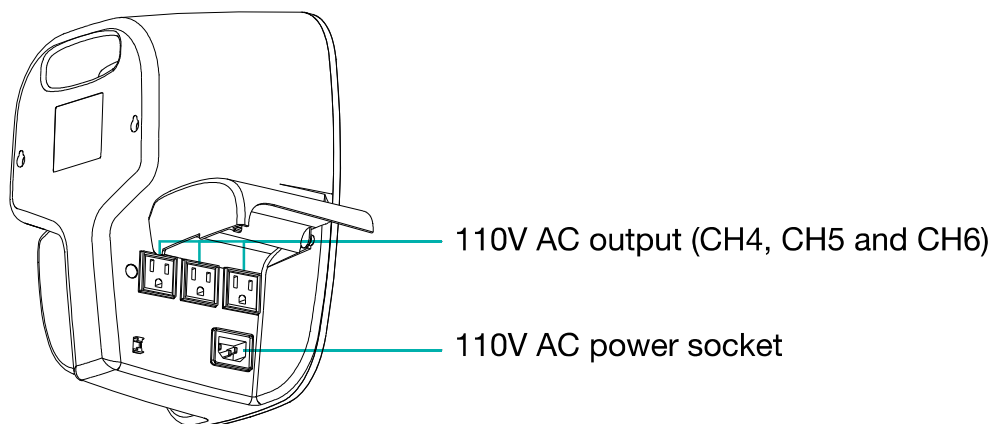
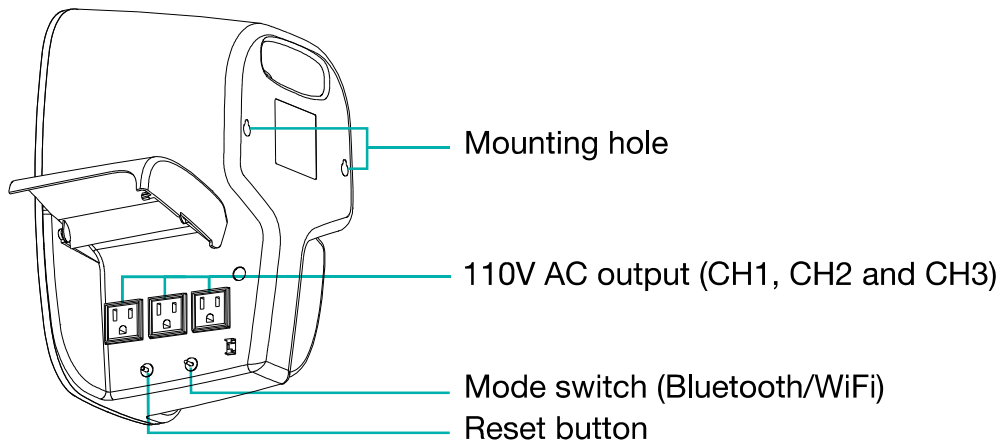
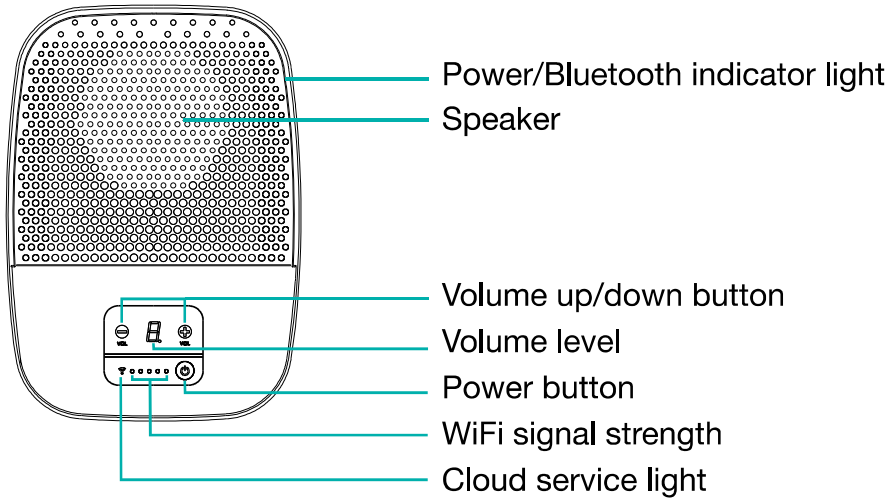



Setup Your TapTap II

STEP 1: Power on your TapTap II

Connect the power cable to your TapTap II device and plug light strings into the outlets.

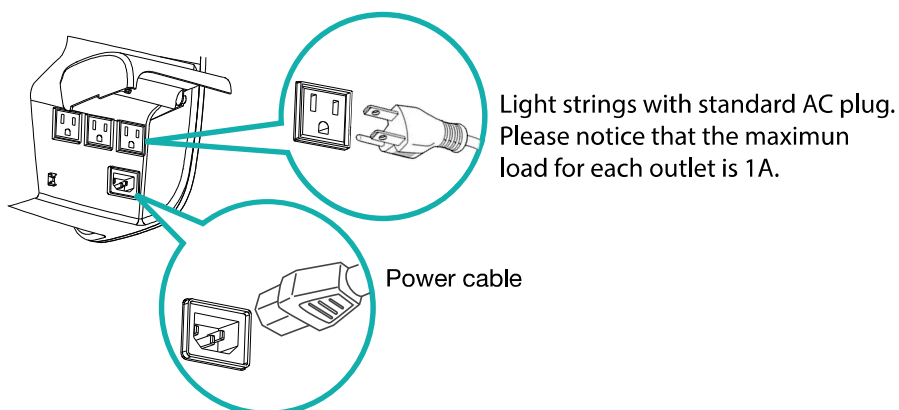

Make sure the mode switch is set to WiFi, then press the power button to power on TapTap II. The cloud service light and WiFi signal lights will start blinking. Wait for couple of seconds until the WiFi signal lights turn to scrolling from blinking and the light strings are on. This indicates that the TapTap II device is completely ready for setup.

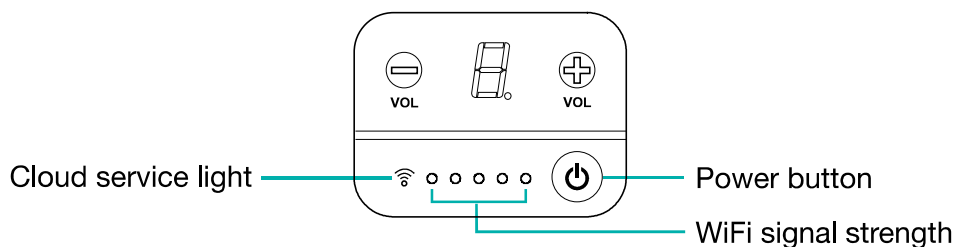

STEP 2: Install TapTap application

Scan the QR code below to download TapTap app or simply search "TapTap light show" in App Store or Google Play.





STEP 3: Connect TapTap II to WiFi router

3-1 Launch the TapTap application on your smart device and create an account for setting up your TapTap II. Click “SETUP NOW” on the screen when the first time logging in.

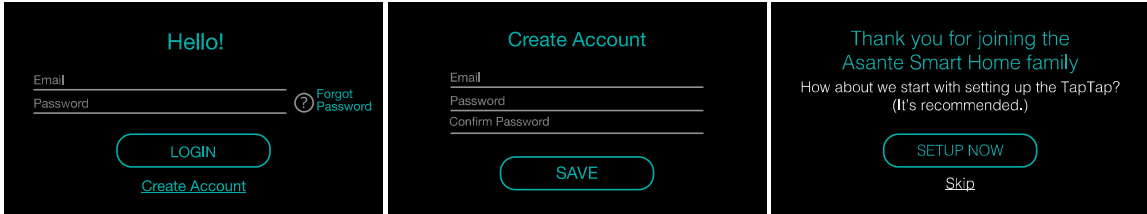

3-2 Follow the setup wizard to set up your TapTap II.

First, leave the TapTap app and go to WiFi settings of your mobile device. Choose to connect to the WiFi network starting with “TapTapII_AP_”.

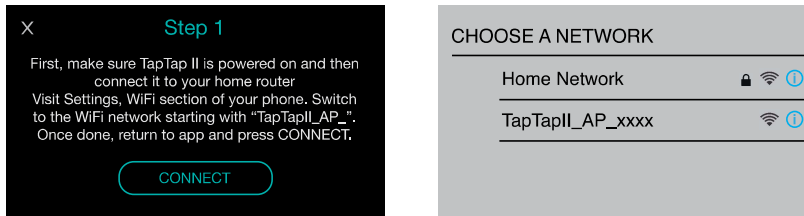

3-3 Return to the TapTap application and click “CONNECT”. Connect back to your home router by selecting your WiFi network. When prompted, enter your WiFi password. Finally, name your TapTap II and click “SAVE”. Your TapTap II has been setup successfully

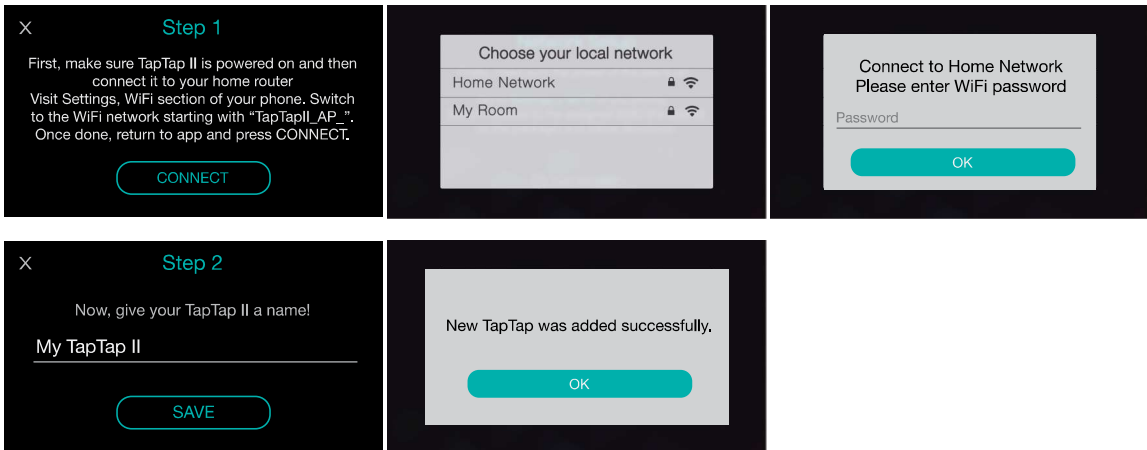

When the setup process has been completed, the LED indicator (WiFi signal strength) is constantly lit and the cloud service light is on. Please note that based on the quality of signal between TapTap II and your personal router, the number of LED lights that are on could vary.

Start Using Your TapTap II

TapTap II works as a musical light show gadget and a Bluetooth speaker. Use the mode switch to select between them.

① Play Musical Light Show

Make sure your TapTap II is set to WiFi mode . Click the menu button at the upper-left corner of the main screen and select “TapTap Management”.



Choose the device you want to use from the list.

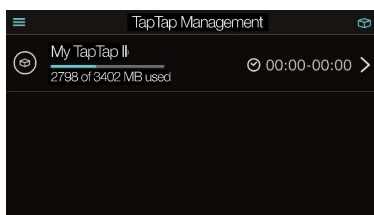

TapTap II comes with 18 preloaded ready-to-play musical light shows.

Select shows you want to play by checking the items and then click the playback icon  to go to playback controls.

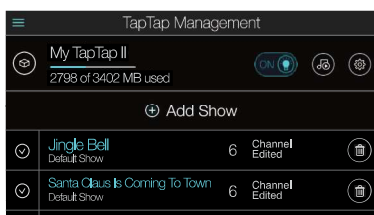

Click the play button “” to start playing the musical light show.



② Play Your Music on TapTap II

To use TapTap II as a Bluetooth speaker, you need to pair it with your smart device first. Switch the mode to Bluetooth . Cloud service light and LED indicator will turn off and light strip will start blinking, which indicates TapTap II is in discoverable mode.

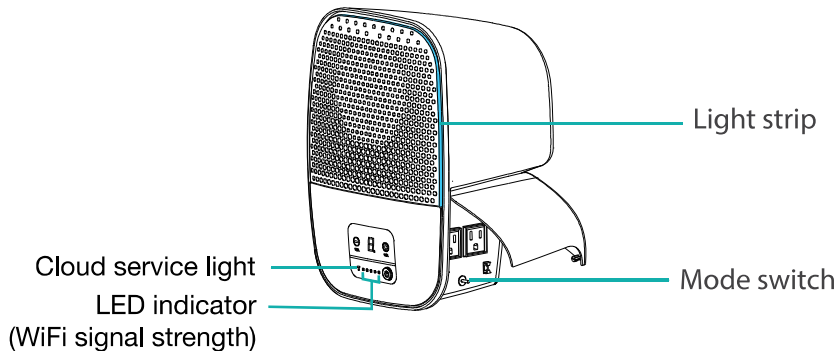

Go to Bluetooth settings of your mobile device and select “TapTapII_BT” from discoverable device list to connect. When the devices are paired, the light strip stops blinking and stays on constantly.

Now you can play music from your mobile device on TapTap II. If you have LED light strings connected to your TapTap II, the lights will flash to the beats of the music.

Set the volume on your mobile device to 80% or higher to ensure the music is fully detected by TapTap II. Use the volume buttons on TapTap II to adjust the volume to your desired level.

* Everytime you power up TapTap II in Bluetooth mode, it will be in discoverable mode for couple of seconds. During this time, “TapTapII_BT” will appear in your smart devices’ discovered Bluetooth list.

* TapTap II will automatically connect to the smart device that it was paired with in the past right after exiting discoverable mode.

In Bluetooth mode, TapTap II automatically creates 3 sets of light channel based on the rhythm of the music, namely Set I: CH 1 & 4, Set II: CH 2 & 5, Set III: CH 3 & 6.

This means that light strings connected to channels 1 and 4 will play and blink exactly the same. So will channels 2 and 5, and lastly, channels 3 and 6.

If you have less than 6 light strings connected to TapTap II, feel free to experiment and try out different combinations to get the best results based on this information.

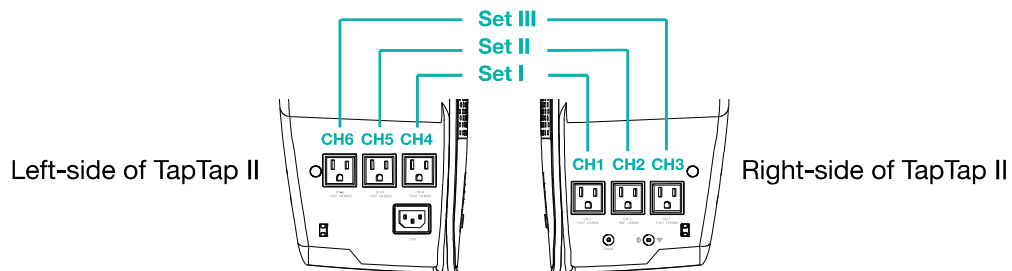

Mounting Your TapTap II

① Wall Mount

Attach two screws to the wall and mount your TapTap II on the screws through the mounting holes at the backside of TapTap II.

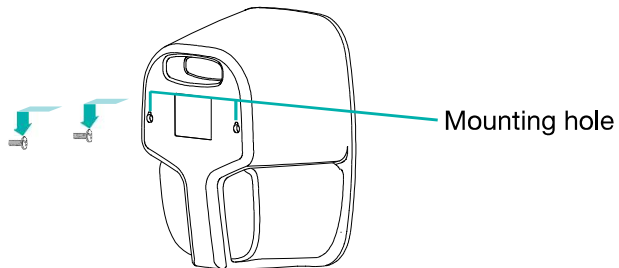

* Please note, TapTap II is a heavy device. Make sure that the screws are properly attached to the wall or studs in order to be able to support the weight of the device.

② Ground Staking

You may also consider TapTap II's optional accessory - ground stake set. It's available at Asante store (<http://store.asante.com/>).

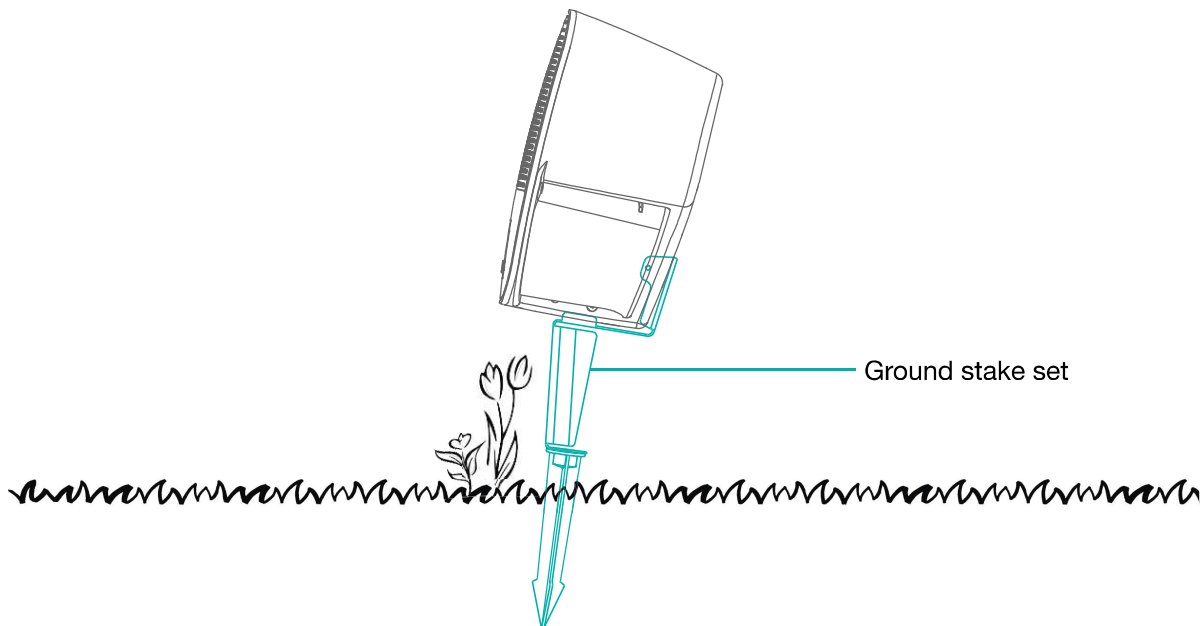

Change WiFi Network

If for any reason you need to reconnect your TapTap II to a wireless network again (different wireless network is being used, router replaced, wireless WiFi password was changed....), please follow the procedure below:

1. Set the mode switch to WiFi and power on your TapTap II. Please wait at least 1 minute for TapTap to complete the boot process.
Press and hold down the reset button for 5 seconds and then release it. You will notice that the cloud service light and LED indicator (WiFi signal lights) will start to blink.

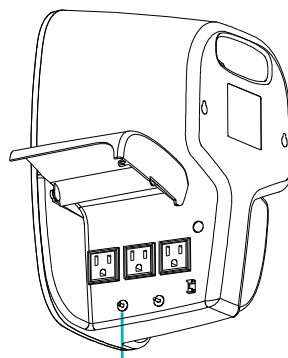

Reset button

When the cloud service light and LED indicator turn to scrolling from blinking, your TapTap II is ready to be setup.

2. Click the menu button on TapTap application and select **Setting**.
Choose **New/Recover TapTap** and follow step 3-2 to 3-3 in page 4 to connect your TapTap II to target WiFi network.

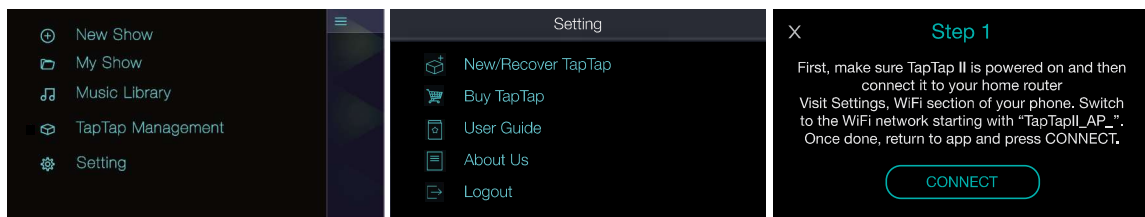

After a factory reset, the Bluetooth mode configuration will also be erased and needs to be configured again.



Licensing of Copyright

We have provided 18 songs with synchronized light show pre-loaded in TapTap II device.
The copyright holders retain all rights and below is the information of copyright of the songs.

All I Want for Christmas Is You

OC/OA: Walter Afanasieff / Mariah Carey
OP: Kobalt Music Copyrights SARL
Control %: 18.75%
SP: Fujipacific Music (S.E. Asia) Ltd.
Admin by Forward Music Publishing Co.,Ltd.
OP: Universal Tunes/Beyondidolization
Control %: 50%
SP: Universal Ms Publ Ltd.
OP: Sony/ATV Tunes LLC/ Tamal Vista Music
Control %: 31.25%
SP: Sony Music Publishing (Pte) Ltd. Taiwan Branch

Blue Christmas

OA/OC: Johnson, Jay W./Hayes, Billy
OP: Universal PolyGram Int. Publishing, Inc.
Control %: 100%
SP: Universal Ms Publ Ltd.

Jingle Bell Rock

OA/OC: Booth, James Poss/Beal, Joseph Carleton
OP: Tro Essex Music Ltd.
Control %: 100%
SP: EMI Music Publishing (S.E.Asia Ltd., Taiwan

Santa Tell Me

OC/OA: Savan Kotecha*/Arian Grande/Ilya Salmanzadeh
OP: MXM Music AB
Control %: 47.5%
SP: Fujipacific Music (S.E. Asia) Ltd.
Admin by Forward Music Publishing Co.,Ltd.
OP: Wolf Cousins/Warner/Chappell Music Scandinavia AB
Control %: 47.5%
SP: Warner/Chappell Music Taiwan Ltd.
OP: Universal Music Corp./Grandarimusic
Control %: 5%
SP: Universal Ms Publ Ltd.

Must Be Santa

OA/OC: Fredricks, Bill / Moore, Hal
OP: Hollis Music
Control %: 100%
SP: EMI Ms.Pub. (S.E.Asia) LTD., Taiwan Branch.

Santa Claus Is Coming to Town

OC/OA: J. Fred Coots / Haven Gillespie
OP: EMI Feist Catalog Inc.
Control %: 100%
SP: Fujipacific Music (S.E. Asia) Ltd.
Admin by Forward Music Publishing Co.,Ltd.

Let It Snow! Let It Snow!

OC/OA: Sammy Cahn / Jule Styne
OP: Cahn Music Company
Control %: 50%
SP: Fujipacific Music (S.E. Asia) Ltd.
Admin by Forward Music Publishing Co.,Ltd.
OP: Producers Music Publ. Co., Inc./ Cahn Music Co.
Control %: 50%
SP: Warner/Chappell music Taiwan Ltd.
Admin by Chappell & Co. Inc.



Silent Night

Public Domain

What a Wonderful World

OC/OA: George David Weiss / Robert Thiele
OP: Abilene Music Inc. / Quartet Music
Control %: 62,5%
SP: Fujipacific Music (S.E. Asia) Ltd.
Admin By Forward Music Publishing Co.,Ltd.
OP: Range Road Music Inc.
Control %: 37,5%
SP: Warner/Chappell Music Taiwan Ltd.

When You Wish Upon a Star

OC/OA: Leigh Harline / Ned Washington
OP: Bourne Co.
Control %: 100%
SP: Fujipacific Music (S.E. Asia) Ltd.
Admin by Forward Music Publishing Co.,Ltd.

* All songs in the TapTap app is provided AS IS for your TapTap II use only. You may not copy, publish, transmit, distribute, perform, sell, create derivative works of, or in any way exploit, any of the content.

* We reserve the right to add, remove, change songs.

Christmas Spirit

Christmas Spirit by Shane Ivers
silvermansound.com
Creative Commons By Attribution 4.0 International License.

Cool Steel Breeze

Cool Steel Breeze by Jason Shaw
audionautix.com
Licensed under Creative Commons By Attribution 3.0 License

Deck the Halls

Deck the Halls by Kevin MacLeod
incompetech.com
Licensed under Creative Commons By Attribution 3.0 License

Jesu, Joy of Man's Desiring

Jesu, joy of man's desiring by Kevin MacLeod
incompetech.com
Licensed under Creative Commons By Attribution 3.0 License

Fine Ding Dong Merrily

Public Domain

Jingle Bells

Jingle Bells by Kevin MacLeod
incompetech.com
Licensed under Creative Commons By Attribution 3.0 License

Play In Christmas Square

Play In Christmas Square by Kenny Sayer
soundcloud.com/kens3
Licensed under Creative Commons By Attribution 3.0 License

We Wish You a Merry Christmas

We Wish you a Merry Christmas by Kevin MacLeod
incompetech.com
Licensed under Creative Commons By Attribution 3.0 License

* Creative Commons:

By Attribution 3.0 and 4.0 License
creativecommons.org/licenses/by/3.0/
creativecommons.org/licenses/by/4.0/

FCC Compliance Class B Digital Device:

This equipment has been tested and found to comply with the limits for a Class B digital device, pursuant to part 15 of the FCC Rules. These limits are designed to provide reasonable protection against harmful interference in a residential installation. This equipment generates, uses and can radiate radio frequency energy and, if not installed and used in accordance with the instructions, may cause harmful interference to radio communications. However, there is no guarantee that interference will not occur in a particular installation. If this equipment does cause harmful interference to radio or television reception, which can be determined by turning the equipment off and on, the user is encouraged to try to correct the interference by one or more of the following measures:

- Reorient or relocate the receiving antenna.
- Increase the separation between the equipment and receiver.
- Connect the equipment into an outlet on a circuit different from that to which the receiver is connected.
- Consult the dealer or an experienced radio/TV technician for help.

CAUTION:

Any changes or modifications not expressly approved by the grantee of this device could void the user's authority to operate the equipment.

RF exposure warning:

This equipment must be installed and operated in accordance with provided instructions and the antenna(s) used for this transmitter must be installed to provide a separation distance of at least 20 cm from all persons and must not be co-located or operating in conjunction with any other antenna or transmitter. End users and installers must be provided with antenna installation instructions and transmitter operating conditions for satisfying RF exposure compliance.



Asante Technical Support

 (408)435-8388 Ext.511

 support@asante.com