

FCC Test Report

for

Payment Reader

Trade Name : Uniform
Model Number : Bezel5
FCC ID : TFJBEZEL5
Report Number : RF-U010-1403-251
Date of Receipt : March 26, 2014
Date of Report : May 7, 2014

Prepared for

Uniform Industrial Corp.

47436 Fremont Blvd., Fremont, CA 94538-6512, USA

Prepared by



Central Research Technology Co.

EMC Test Laboratory

No.11, Lane41, Fushuen St., Jungshan Chiu, Taipei, Taiwan, 104, R.O.C.



NVLAP LAB CODE 200575-0

This report shall not be reproduced, except in full, without the written approval of Central Research Technology Co.. It may be duplicated completely in its entirety for legal use with the permission of the applicant. It should not be used to claim product endorsement by NVLAP, NIST or any U.S. government agency. The test result in the report applies only to the sample tested.

Certification

Equipment under Test : Payment Reader
Model No. : Bezel5
FCC ID : TFJBEZEL5
Manufacturer : Uniform Industrial Corp.
Applicant : Uniform Industrial Corp.
Address : 47436 Fremont Blvd., Fremont, CA 94538-6512, USA
Date of Testing : March 26 ~ April 10, 2014
Applicable Standards : 47 CFR part 15, Subpart C
Deviation : N/A
Condition of Test Sample : Mass Production



We, **Central Research Technology Co.**, hereby certify that one sample of the designated product was tested in our facility during the period mentioned above. The test records, data evaluation and Equipment Under Test (EUT) configurations shown in the present report are true and accurate representation of the measurements of the sample's RF characteristics under the conditions herein specified.

The test results show that the EUT as described in the present report is in compliance with the requirements set forth in the standards mentioned above and apply to the tested sample identified in the present report only. The test report shall not be reproduced, except in its entirety, without the written approval of Central Research Technology Co.

PREPARED BY : Cathy Chen , **DATE** : May 7, 2014
(Cathy Chen/ Technical Manager)
APPROVED BY : J. Y. Shih , **DATE** : May 7, 2014
(Tsun-Yu Shih/General Manager)

Contents

1	General Description	5	
1.1	GENERAL DESCRIPTION OF EUT	5	
1.2	TEST MODE	6	
X AXIS	Y AXIS	Z AXIS	6
1.3	TEST METHODOLOGY	6	
1.4	REQUIREMENT FOR COMPLIANCE.....	7	
1.5	THE SUPPORT UNITS	9	
1.6	LAYOUT OF SETUP	10	
1.7	TEST CAPABILITY	11	
1.8	MEASUREMENT UNCERTAINTY	12	
2	Conducted Emission Measurement	13	
2.1	LIMITS FOR EMISSION MEASUREMENT	13	
2.2	TEST INSTRUMENTS	14	
2.3	TEST PROCEDURES	15	
2.4	TEST CONFIGURATIONS	16	
2.5	TEST DATA.....	17	
3	Field Strength of fundamental.....	21	
3.1	APPLIED STANDARD	21	
3.2	TEST INSTRUMENTS	22	
3.3	MEASUREMENT PROCEDURE.....	23	
3.4	TEST CONFIGURATION	23	
3.5	TEST DATA	24	
4	Radiated Emission	28	
4.1	APPLIED STANDARD	28	
4.2	TEST INSTRUMENTS	29	
4.3	MEASUREMENT PROCEDURE.....	30	
4.4	TEST CONFIGURATION	31	
4.5	TEST DATA	32	
5	Frequency Tolarence	34	
5.1	APPLIED STANDARD	34	
5.2	TEST INSTRUMENTS	35	
5.3	MEASUREMENT PROCEDURE.....	36	
5.4	TEST CONFIGURATION	36	
5.5	TEST DATA	37	

6	20dB Bandwidth	41
6.1	APPLIED STANDARD	41
6.2	TEST INSTRUMENTS	42
6.3	MEASUREMENT PROCEDURE	43
6.4	TEST CONFIGURATION	43
6.5	TEST DATA	44
7	Antenna Requirement	45
7.1	APPLIED STANDARD	45
7.2	ANTENNA TYPE	45
7.3	APPLICABLE RESULT	45

Attachment 1 – Photographs of the Test Configurations

Attachment 2 – External Photographs of EUT

Attachment 3 – Internal Photographs of EUT

1 General Description

1.1 General Description of EUT

Equipment under Test	: Payment Reader
Model No.	: Bezel5
Power in	: 7.5Vdc ~ 45Vdc
Test Voltage	: 120Vac/50Hz to the DC power supply or Adaptor
Manufacturer	: Uniform Industrial Corp.
Channel Numbers	: 1
Frequency Range	: 13.56MHz
Function Modulation	: ASK
Function Description	:

The EUT is used to transmit and receive signal both. Please refer to the user's manual for the details.

1.2 Test Mode

There are six test modes as the specification of manufacturer and which are shown as below.

Test Mode	Communication port	Power in	Position
Mode 1	RS232 port	26Vdc	X axis
Mode 2	USB port		
Mode 3	USB port	7.5Vdc	X axis
Mode 4		45Vdc	
Mode 5	USB port	26Vdc	Y axis
Mode 6			Z axis

According to the preliminary test, It was found that the Mode 2 is the worst. It was taken as the representative condition for test and its data are recorded in the present document.

Test Mode		Test Voltage	Test Item
1	Mode 2	120V/60Hz by power adaptor	Conducted Emission Test
2		26Vdc by DC power source	All tests (excluded Conducted Emission Test)

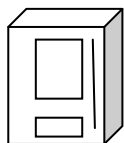

X axis

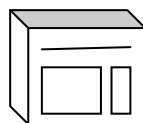

Y axis

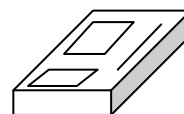

Z axis

1.3 Test Methodology

For this E.U.T., the radiated emissions and conducted emission measurement performed according to the procedures illustrated in ANSI C63.4:2009 and other required were illustrated in separate sections of this test report for detail.

1.4 Requirement for Compliance

(1) Field strength of Fundametal

According to 15.225(a), the field strength of any emissions within the band 13.553 - 13.567 MHz shall not exceed 15,848 microvolts/meter at 30 meters.

(2) Band Edge

According to 15.225(b), Within the bands 13.410-13.553 MHz and 13.567-13.710 MHz, the field strength of any emissions shall not exceed 334 microvolts/meter at 30 meters. According to 15.225(c), Within the bands 13.110-13.410 MHz and 13.710-14.010 MHz the field strength of any emissions shall not exceed 106 microvolts/meter at 30 meters.

(3) Radiation emission

According to 15.225(d), the field strength of any emissions appearing outside of the 13.110-14.010 MHz band shall not exceed the general radiated emission limits in § 15.209.

(4) Frequency tolerance

The frequency tolerance of the carrier signal shall be maintained within +/- 0.01% of the operating frequency over a temperature variation of -20 degrees to +50 degrees C at normal supply voltage, and for a variation in the primary supply voltage from 85% to 115% of the rated supply voltage at a temperature of 20 degrees C. For battery operated equipment, the equipment tests shall be performed using a new battery.

(5) Radiated emission limits, general requirements.

According to 15.209, except as provided elsewhere in this Subpart, the emissions from an intentional radiator shall not exceed the field strength levels specified in the following table:

Frequency (MHz)	Field Strength (uV/m)	Measurement Distance (m)
0.009 - 0.490	2400/F(kHz)	300
0.490 - 1.705	24000/F(kHz)	30
1.705 - 30.0	30	30
30 - 88	100 **	3
88 - 216	150 **	3
216 - 960	200 **	3
Above 960	500	3

** Except as provided in paragraph (g), fundamental emissions from intentional radiators operating under this Section shall not be located in the frequency bands 54-72 MHz, 76-88 MHz, 174-216 MHz or 470-806 MHz. However, operation within these frequency bands is permitted under other sections of this Part, e.g., Sections 15.231 and 15.241.

(6) 20dB Bandwidth

According to 15.215(c) requires the device must be designed to ensure that the 20 dB bandwidth of the emission, or whatever bandwidth may otherwise be specified in the specific rule section under which the equipment operates.

(7) Restricted Band

Frequency (MHz)	Frequency (MHz)	Frequency (MHz)	Frequency (GHz)
0.090 - 0.110	16.42 - 16.423	399.9 - 410	4.5 - 5.15
¹ 0.495 - 0.505	16.69475 - 16.69525	608 - 614	5.35 - 5.46
² 1735 - 2.1905	16.80425 - 16.80475	960 - 1240	7.25 - 7.75
4.125 - 4.128	25.5 - 25.67	1300 - 1427	8.025 - 8.5
4.17725 - 4.17775	37.5 - 38.25	1435 - 1626.5	9.0 - 9.2
4.20725 - 4.20775	73 - 74.6	1645.5 - 1646.5	9.3 - 9.5
6.215 - 6.218	74.8 - 75.2	1660 - 1710	10.6 - 12.7
6.26775 - 6.26825	108 - 121.94	1718.8 - 1722.2	13.25 - 13.4
6.31175 - 6.31225	123 - 138	2200 - 2300	14.47 - 14.5
8.291 - 8.294	149.9 - 150.05	2310 - 2390	15.35 - 16.2
8.362 - 8.366	156.52475 - 156.52525	2483.5 - 2500	17.7 - 21.4
8.37625 - 8.38675	156.7 - 156.9	2690 - 2900	22.01 - 23.12
8.41425 - 8.41475	162.0125 - 167.17	3260 - 3267	23.6 - 24.0
12.29 - 12.293	167.72 - 173.2	3332 - 3339	31.2 - 31.8
12.51975 - 12.52025	240 - 285	3345.8 - 3358	36.43 - 36.5
12.57675 - 12.57725	322 - 335.4	3600 - 4400	(2)
13.36 - 13.41			

¹ Until February 1, 1999, this restricted band shall be 0.490-0.510 MHz.

² Above 38.6

(8) Conduction Emission Requirement

For intentional device, according to §15.207(a) line conduction emission limit is as below table.

Frequency of Emission (MHz)	Conducted Limit (dBuV)	
	Quasi-peak	Average
0.15 – 0.5	66 to 56*	56 to 46*
0.5 - 5	56	46
5 - 30	60	50

* Decreases with the logarithm of the frequency.

1.5 The Support Units

No.	Unit	Model No.	FCC ID	Trade Name	Power Cord	Supported by lab.
1	PC	Elite 8200 MT	DoC	HP	1.8m	✓
2	PS/2 Keyboard	KB-0133	DoC	HP	1.8	✓
3	PS/2 Mouse	MO71KC	N/A	DELL	1.8m	✓
4	LCD Monitor	VA905	DoC	ViewSonic	1.8m	✓
		U2410 ^(Note)	DoC	DELL	1.8m	✓
5	RF ID Card	N/A	N/A	N/A	N/A	
6	Printer	LQ-300+	N/A	EPSON	1.8m	✓
7	Modem	DM-1414	IFAXDM1414	ACEEX	1.8m	✓

Note: The support unit is for Conducted Emission Test.

1.6 Layout of Setup

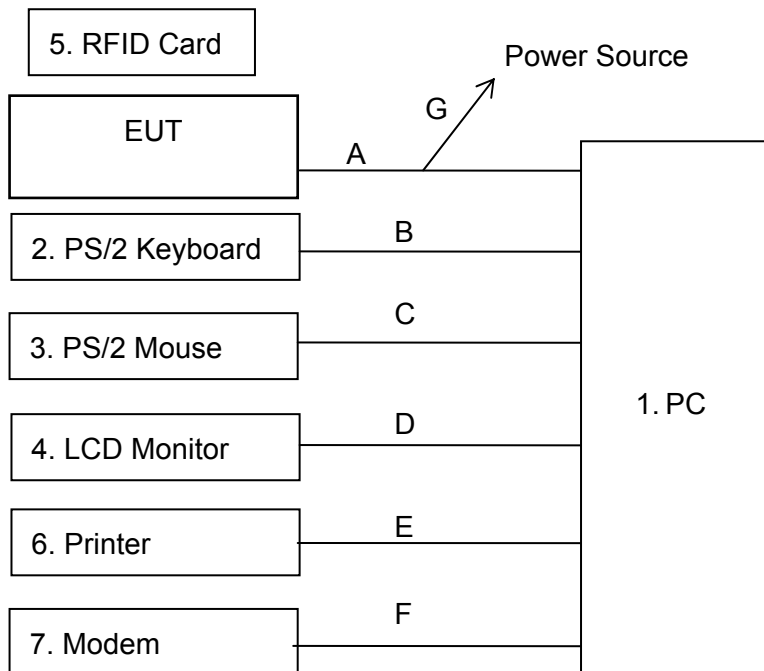

No.	Cable	Length	Shielded	Core	Shielded Backshell	Supported by lab.	Note
A	10pin wildcat to USB Cable	1.35m	✓				
B	PS/2 Keyboard Cable	1.8m	✓			✓	
C	PS/2 Mouse Cable	1.8m	✓			✓	
D	D-SUB Cable	1.8m	✓	✓		✓	
E	USB Cable	1.8m	✓	✓		✓	
F	Series Cable	1.8m	✓			✓	
G	DC power line	1.8m	✓				

1.7 Test Capability

Test Facility

The test facility used for evaluating the conformance of the EUT with each standard in the present report meets what required in CISPR16-1-4, CISPR16-2-3 and ANSI C63.4:2009.

Test Room	Type of Test Room	Descriptions
TR1	10m semi-anechoic chamber (23m×14m×9m)	Complying with the NSA requirements in documents CISPR 22 and ANSI C63.4:2009. For the radiated emission measurement.
TR11	3m semi-anechoic chamber (9m × 6m × 6m)	
TR300	3m fully-anechoic chamber (8m × 5m × 5m)	
TR13	Test site	For the RF conducted emission measurement.
TR5	Shielding Room (8m×5m×4m)	For the conducted emission measurement.

Test Laboratory Competence Information

Central Research Technology Co. has been accredited/registered/authorized by the agencies listed in the following table.

Certificate	Nation	Agency	Code	Mark
Accreditation Certificate	USA	NVLAP	200575-0	ISO/IEC 17025
	R.O.C. (Taiwan)	TAF	0905	ISO/IEC 17025
	R.O.C. (Taiwan)	BSMI	SL2-IN-E-0033, SL2-IS-E-0033, SL2-R1/R2-E-0033, SL2-A1-E-0033 SL2-L1-E-0033	ISO/IEC 17025
Site Filing Document	USA	FCC	474046, TW1053	Test facility list & NSA Data
	Canada	IC	4699A-1,-3	Test facility list & NSA Data
	Japan	VCCI	R-1527,C-1609,T-1441, G-10, C-4400, G-614, T-1334	Test facility list & NSA Data
Authorization Certificate	Germany	TUV	10021687	ISO/IEC 17025
	Norway	Nemko	ELA212	ISO/IEC 17025

The copy of each certificate can be downloaded from our web site: www.crc-lab.com

1.8 Measurement Uncertainty

The assessed measurement uncertainty with a suitable coverage factor K to ensure 95% confidence level for the normal distribution are shown as below, the values are less than U_{cispr} in table 1 of CISPR 16-4-2

Test Item	Measurement Uncertainty
Radiated Emission (30MHz~200MHz)	Horizontal 3.3dB ; Vertical 4.1dB
Radiated Emission (200~1000MHz)	Horizontal 3.8dB ; Vertical 5.1dB

2 Conducted Emission Measurement

Test Data: Pass

2.1 Limits for Emission Measurement

For intentional device, according to §15.207(a) line conduction emission limit is as below table.

Frequency of Emission (MHz)	Conducted Limit (dBuV)	
	Quasi-peak	Average
0.15 – 0.5	66 to 56*	56 to 46*
0.5 - 5	56	46
5 - 30	60	50

* Decreases with the logarithm of the frequency.

Note:

For a device with a permanent antenna operating at or below 30 MHz, the FCC will accept measurements done with a suitable dummy load, in lieu of the permanent antenna under the following conditions: (1) perform the AC line conducted tests with the permanent antenna to determine compliance with the Section 15.207 limits outside the transmitter's fundamental emission band; (2) retest with a dummy load in lieu of the permanent antenna to determine compliance with the Section 15.207 limits within the transmitter's fundamental emission band.

2.2 Test Instruments

Test Site and Equipment	Manufacturer	Model No./ Serial No.	Last Calibration Date	Calibration Due Date
Test Receiver	R&S	ESCS 30/ 836858/021	Jan. 15, 2014	Jan. 15, 2015
LISN	R&S	ESH2-Z5/ 880669/039	March 15, 2014	March 15, 2015
2 nd LISN	R&S	ENV4200/ 833209/010	March 29, 2013	March 29, 2014
50Ω terminator	R&S	N/A/ 001	Aug. 19, 2013	Aug. 19, 2014
RF Switch	N/A	RSU28/ 338965/002	Aug. 19, 2013	Aug. 19, 2014
RF Cable	N/A	N/A/ C0052 ~ 56	Aug. 19, 2013	Aug. 19, 2014
Dummy Load	N/A	50Ω 1/4W Resistance	NCR	NCR
Test Software	Audix	e3/ Ver. 5.2004-2-19k	NCR	NCR
TR5 shielded room	ETS LINDGREN	TR5/ 15353-F	NCR	NCR

Note:

1. The calibrations are traceable to NML/ROC.
2. NCR : No Calibration Required.

Instrument Setting

IF BW	Measurement Time	Detector	Trace	Comment
9kHz	1 second	Quasi-Peak / Average	Maxhold	

Climatic Condition

Ambient Temperature : 26°C; Relative Humidity : 65%

2.3 Test Procedures

- a. The EUT was set up per the test configuration figured in the next section of this chapter to simulate the typical usage per the user's manual.
- b. If the EUT is tabletop equipment, it was placed on a non-conducted table with a height of 0.8 meters above the reference ground plane and 0.4 meters from the conducting wall of the shielded room. Also if the EUT is floor-standing equipment, it was placed on a non-conducted support with a height of 12 millimeters above the reference ground plane.
- c. Connect the EUT's power source to the appropriate power mains through the LISN.
- d. All the other peripherals are connected to the 2nd LISN, if any.
- e. The LISN was placed 0.8 meters from the EUT and at least 0.8 meters from other units and other metal planes.
- f. Measure the conducted emissions on each power line (Neutral Line and Line 1 – Hot side) of the EUT's power source by using the test receiver connected to the coupling RF output port of LISN.
- g. Rapidly scan the signal from 150kHz to 30MHz by using the receiver through the Maximum-Peak detector to determine those frequencies associated with higher emission levels for each measured line.
- h. Then measure the maximum level of conducted disturbance for each frequency found from step g. by using the receiver through the Quasi-Peak and Average detectors per CISPR 16-1.
- i. Record the level for each frequency and compare with the required limit.

2.4 Test Configurations

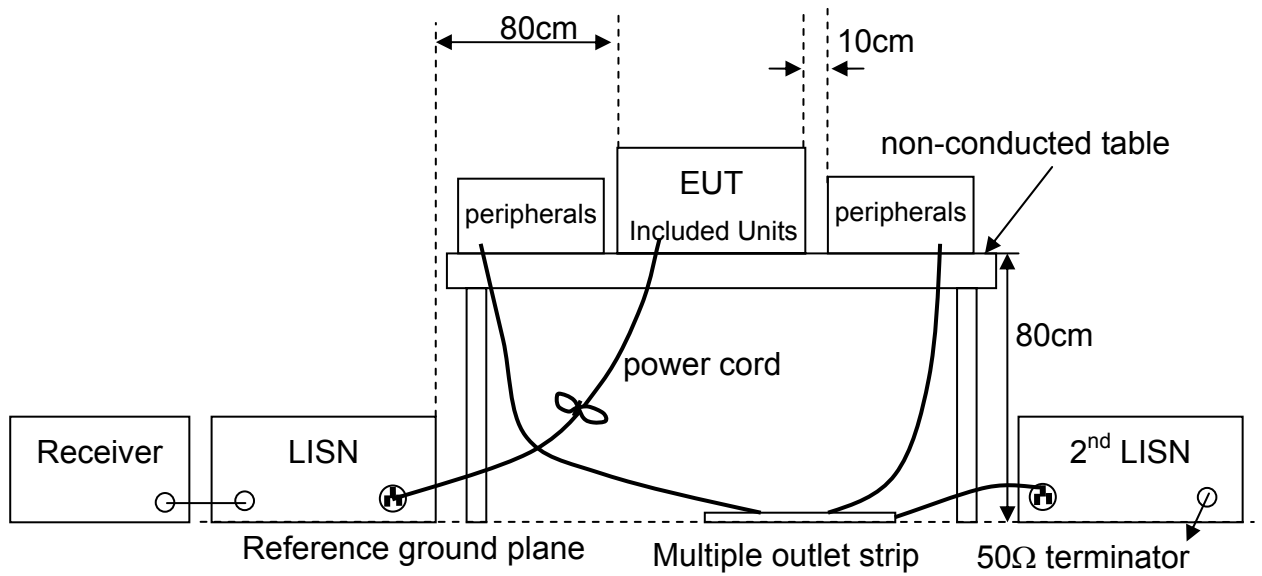

2.5 Test Data

Test Mode : Mode 2, Continuous Transmitting, with antenna
 Tester : Kent Frequency Range : 150kHz~30MHz
 Phase : Line

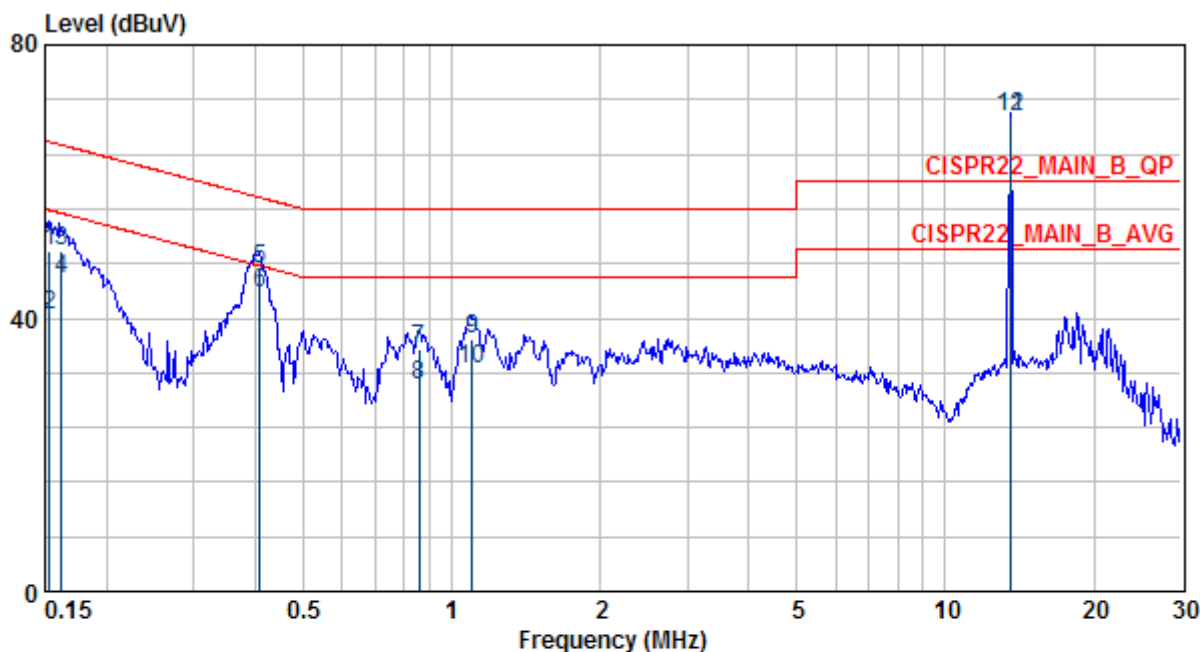

	Freq	Level	Factor	Read Level	Limit Line	Over Limit	Pol/Phase	Remark
	MHz	dBuV	dB	dBuV	dBuV	dB		
1	0.153	49.87	0.24	49.63	65.82	-15.95	LINE	QP
2	0.153	40.42	0.24	40.18	55.82	-15.40	LINE	AVERAGE
3	0.162	49.85	0.24	49.61	65.38	-15.52	LINE	QP
4	0.162	45.83	0.24	45.59	55.38	-9.54	LINE	AVERAGE
5	0.409	47.14	0.27	46.87	57.67	-10.53	LINE	QP
6	0.409	43.57	0.27	43.30	47.67	-4.10	LINE	AVERAGE
7	0.857	35.35	0.30	35.05	56.00	-20.65	LINE	QP
8	0.857	30.33	0.30	30.03	46.00	-15.67	LINE	AVERAGE
9	1.100	36.92	0.33	36.59	56.00	-19.08	LINE	QP
10	1.100	32.65	0.33	32.32	46.00	-13.35	LINE	AVERAGE
11 X	13.560	69.50	0.87	68.63	60.00	9.50	LINE	QP
12 e	13.560	69.48	0.87	68.61	50.00	19.48	LINE	AVERAGE

Note:

1. Emission Level = reading value + correction factor.
2. Correction factor = cable loss + insertion loss of LISN.
3. Q.P. is abbreviation of quasi-peak.
4. Tx Fundamental(marked 11, 12), for reference only. Please refer to next page.

Test Mode : Mode 2, Continuous Transmitting, with dummy load
 Tester : Kent Frequency Range : 150kHz~30MHz
 Phase : Line

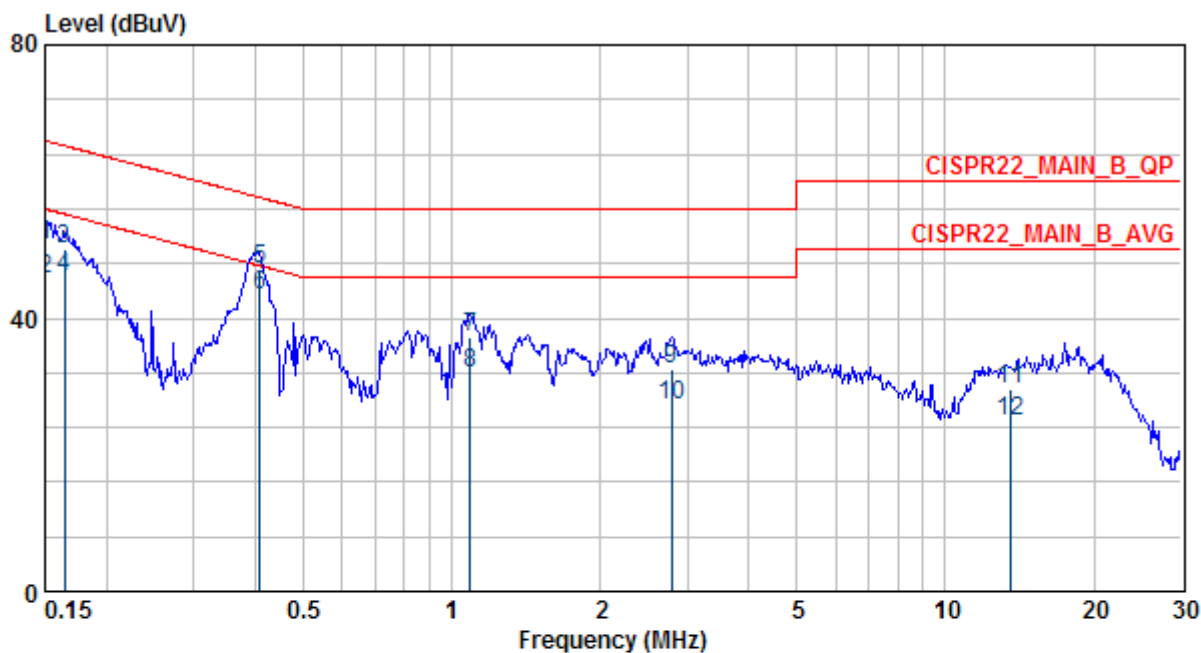

	Freq	Level	Factor	Read Level	Limit Line	Over Limit	Pol/Phase	Remark
	MHz	dBuV	dB	dBuV	dBuV	dB		
1	0.150	50.82	0.24	50.58	66.00	-15.18	LINE	QP
2	0.150	45.69	0.24	45.45	56.00	-10.31	LINE	AVERAGE
3	0.164	50.13	0.24	49.89	65.25	-15.11	LINE	QP
4	0.164	45.91	0.24	45.67	55.25	-9.33	LINE	AVERAGE
5	0.408	47.20	0.27	46.93	57.69	-10.49	LINE	QP
6	0.408	43.45	0.27	43.18	47.69	-4.24	LINE	AVERAGE
7	1.090	37.08	0.33	36.75	56.00	-18.92	LINE	QP
8	1.090	32.04	0.33	31.71	46.00	-13.96	LINE	AVERAGE
9	2.794	32.65	0.39	32.26	56.00	-23.35	LINE	QP
10	2.794	27.27	0.39	26.88	46.00	-18.73	LINE	AVERAGE
11	13.560	29.61	0.87	28.74	60.00	-30.39	LINE	QP
12	13.560	25.00	0.87	24.13	50.00	-25.00	LINE	AVERAGE

Note:

1. Emission Level = reading value + correction factor.
2. Correction factor = cable loss + insertion loss of LISN.
3. Q.P. is abbreviation of quasi-peak.

Test Mode : Mode 2, Continuous Transmitting, with antenna
 Tester : Kent Frequency Range : 150kHz~30MHz
 Phase : Neutral

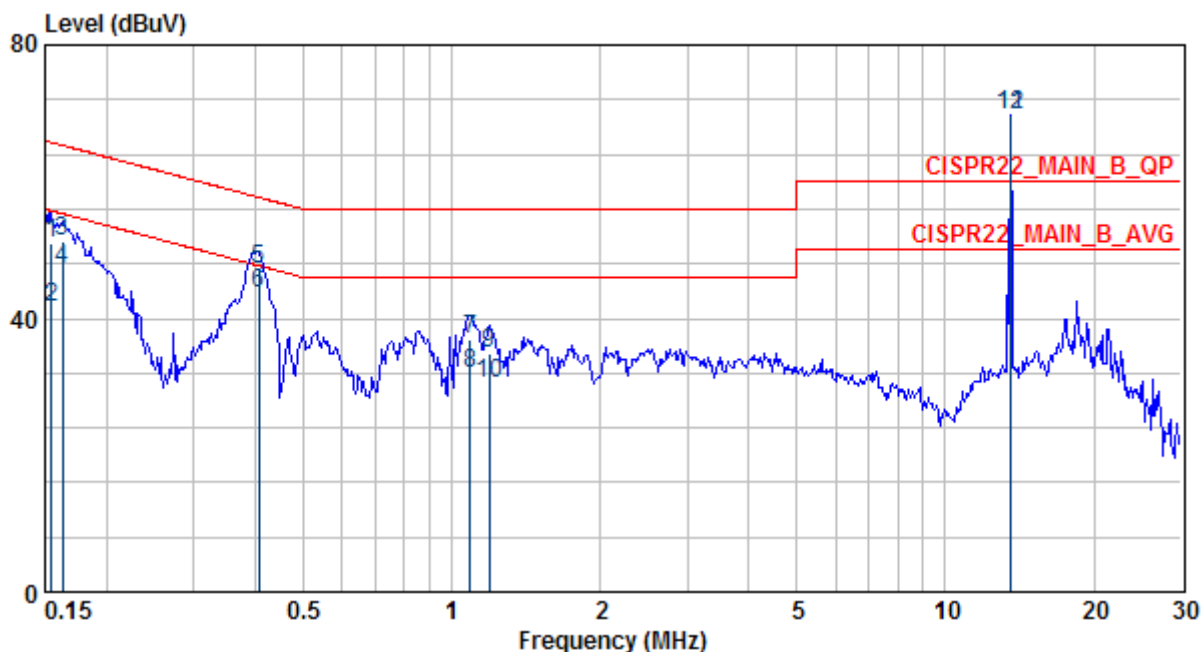

	Freq	Level	Factor	Read	Limit	Over	Pol/Phase	Remark
	MHz	dBuV	dB	dBuV	dBuV	dB		
1	0.155	50.91	0.27	50.64	65.74	-14.82	NEUTRAL	QP
2	0.155	41.49	0.27	41.22	55.74	-14.24	NEUTRAL	AVERAGE
3	0.162	51.28	0.27	51.01	65.34	-14.06	NEUTRAL	QP
4	0.162	47.31	0.27	47.04	55.34	-8.03	NEUTRAL	AVERAGE
5	0.407	47.15	0.30	46.85	57.71	-10.56	NEUTRAL	QP
6	0.407	43.60	0.30	43.30	47.71	-4.11	NEUTRAL	AVERAGE
7	1.091	36.94	0.35	36.59	56.00	-19.06	NEUTRAL	QP
8	1.091	31.92	0.35	31.57	46.00	-14.08	NEUTRAL	AVERAGE
9	1.194	34.92	0.35	34.57	56.00	-21.08	NEUTRAL	QP
10	1.194	30.47	0.35	30.12	46.00	-15.53	NEUTRAL	AVERAGE
11 X	13.560	69.77	0.87	68.90	60.00	9.77	NEUTRAL	QP
12 Ⓢ	13.560	69.85	0.87	68.98	50.00	19.85	NEUTRAL	AVERAGE

Note:

1. Emission Level = reading value + correction factor.
2. Correction factor = cable loss + insertion loss of LISN.
3. Q.P. is abbreviation of quasi-peak.
4. Tx Fundamental(marked 11, 12), for reference only. Please refer to next page.

Test Mode : Mode 2, Continuous Transmitting, with dummy load
 Tester : Kent Frequency Range : 150kHz~30MHz
 Phase : Neutral

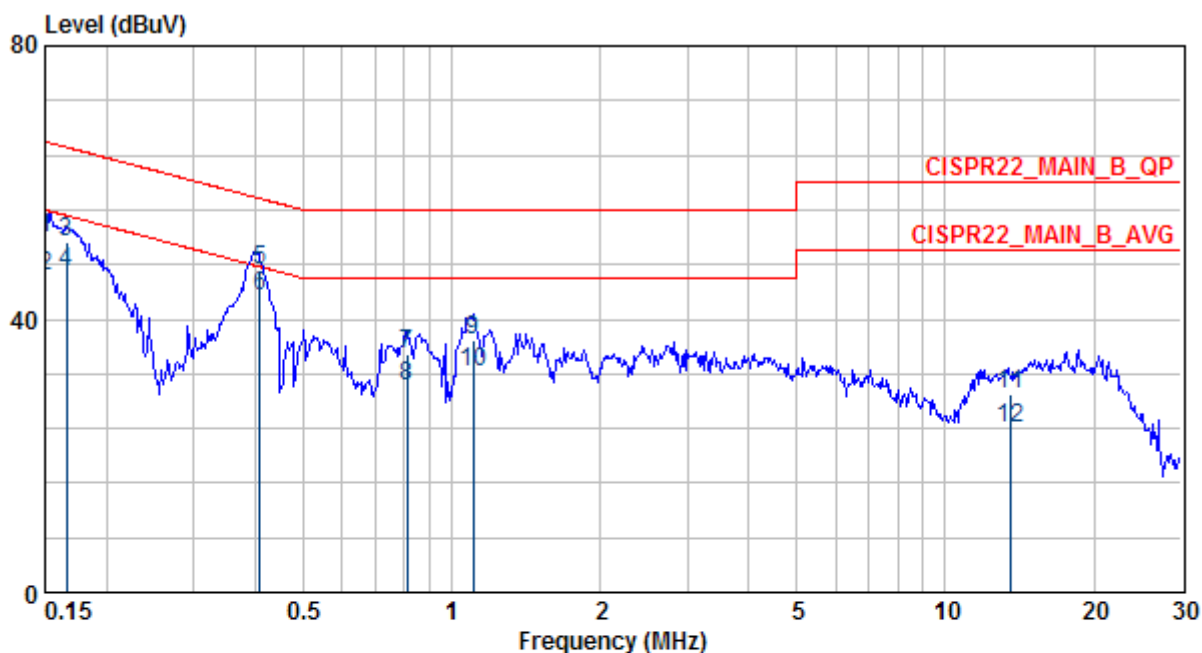

	Freq	Level	Factor	Read Level	Limit Line	Over Limit	Pol/Phase	Remark
	MHz	dBuV	dB	dBuV	dBuV	dB		
1	0.150	51.94	0.27	51.67	66.00	-14.06	NEUTRAL	QP
2	0.150	46.19	0.27	45.92	56.00	-9.81	NEUTRAL	AVERAGE
3	0.166	51.20	0.27	50.93	65.16	-13.96	NEUTRAL	QP
4	0.166	46.88	0.27	46.61	55.16	-8.28	NEUTRAL	AVERAGE
5	0.408	47.31	0.30	47.01	57.69	-10.38	NEUTRAL	QP
6	0.408	43.35	0.30	43.05	47.69	-4.34	NEUTRAL	AVERAGE
7	0.813	34.93	0.32	34.61	56.00	-21.07	NEUTRAL	QP
8	0.813	30.22	0.32	29.90	46.00	-15.78	NEUTRAL	AVERAGE
9	1.106	36.78	0.35	36.43	56.00	-19.22	NEUTRAL	QP
10	1.106	32.30	0.35	31.95	46.00	-13.70	NEUTRAL	AVERAGE
11	13.560	28.95	0.87	28.08	60.00	-31.05	NEUTRAL	QP
12	13.560	23.92	0.87	23.05	50.00	-26.08	NEUTRAL	AVERAGE

Note:

1. Emission Level = reading value + correction factor.
2. Correction factor = cable loss + insertion loss of LISN.
3. Q.P. is abbreviation of quasi-peak.

3 Field Strength of fundamental

Result: Pass

3.1 Applied Standard

According to 15.225(a), The field strength of any emissions within the band 13.553 - 13.567 MHz shall not exceed 15,848 microvolts/meter at 30 meters.

According to 15.225(b), Within the bands 13.410-13.553 MHz and 13.567-13.710 MHz, the field strength of any emissions shall not exceed 334 microvolts/meter at 30 meters.

According to 15.225(c), Within the bands 13.110-13.410 MHz and 13.710-14.010 MHz the field strength of any emissions shall not exceed 106 microvolts/meter at 30 meters.

3.2 Test Instruments

Test Site and Equipment	Manufacturer	Model No./ Serial No.	Last Calibration Date	Calibration Due Date
EMI Test Receiver	R&S	ESCI/ 100019	June 7, 2013	June 7, 2014
Loop Antenna	EMCO	6502/ 20558	Aug. 29, 2013	Aug. 29, 2014
RF Cable	N/A	N/A/ C0080	Feb. 10, 2014	Aug. 10, 2014
Test Software	Audix	e3/ ARD-SPR-000282	NCR	NCR
TR11 Semi – anechoic Chamber	ETS. LINDGREN	TR11/ 906-A	May 11, 2013	May 11, 2014

Note:

1. The calibrations are traceable to NML/ROC.
2. The calibration date of the semi-anechoic chamber listed above is the date of NSA measurement.

Instrument Setting

RBW	VBW	Detector	Trace	Comment
9kHz	N/A	Quasi-Peak	Maxhold	

Climatic Condition

Ambient Temperature : 25°C; Relative Humidity : 65%

3.3 Measurement Procedure

- a. The EUT was set up per the test configuration figured in the next section of this chapter to simulate the typical usage per the user's manual.
- b. If the EUT is tabletop equipment, it should be placed on a wooden table with a height of 0.8 meters above the reference ground plane in the semi-anechoic chamber. If the EUT is floor-standing equipment, it should be placed on a non-conducted support with a height of 12 millimeters above the reference ground plane in the semi-anechoic chamber.
- c. The EUT is set at 3m away from the receiving antenna.
- d. Rapidly sweep the signal in the test frequency range by using the spectrum through the Maximum-peak detector.
- e. Rotate the EUT from 0° to 360° and position the receiving loop antenna at 1~4 meters above the reference ground plane to determine the fundamental frequency and record them.
- f. Finely turn the turntable and the antenna is be positioned with its plane vertical at the specified distance from the EUT and rotated about its vertical axis for maximum response and recorded position of fundamental frequency found from step e.
- g. Record and compare the maximum level with the required limit.
- h. Change the receiving antenna to another polarization to measure Field Strength of fundamental by following step e. to g. again.

3.4 Test Configuration

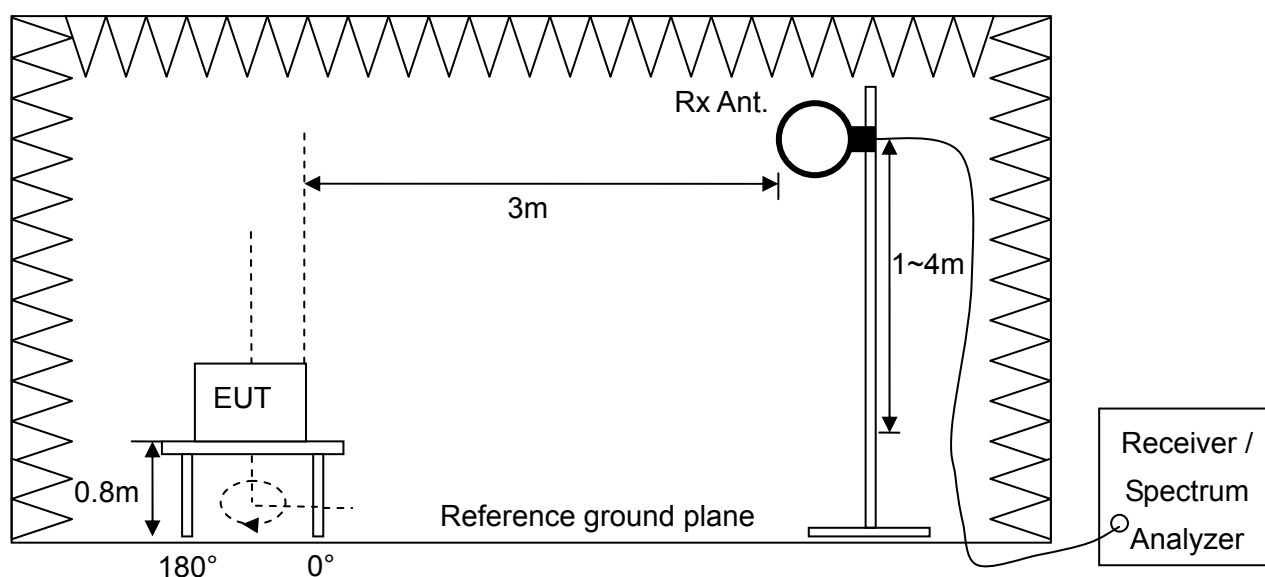

3.5 Test Data

Field strength of fundamental

Test Mode : Mode 2, Continuous Transmitting

Tester : Liu

Freq. (MHz)	Polarization	Reading Data (dBuV)	Correction Factor (dB/m)	Emission Level (dBuV/m)	Limit (dBuV/m)	Margin (dB)
13.56	H	63.21	14.36	77.57	124	46.43
13.56	V	58.69	14.36	73.05	124	50.95

Note :

1. Correction Factor (dB/m) = Cable Loss + Antenna Factor
2. Emission Level (dBuV/m) = Reading Data + Correction Factor
3. The limit is 15848 (uV/m)=84dBuV/m @ 30 m , for main frequency < 30MHz, the formula transfers the limit at 30 m to 3m is $L_{30}(\text{dBuV/m}) + 40 = 124 \text{ dBuV/m}$
4. Margin (dB) = Limit – Emission Level

H Polarization

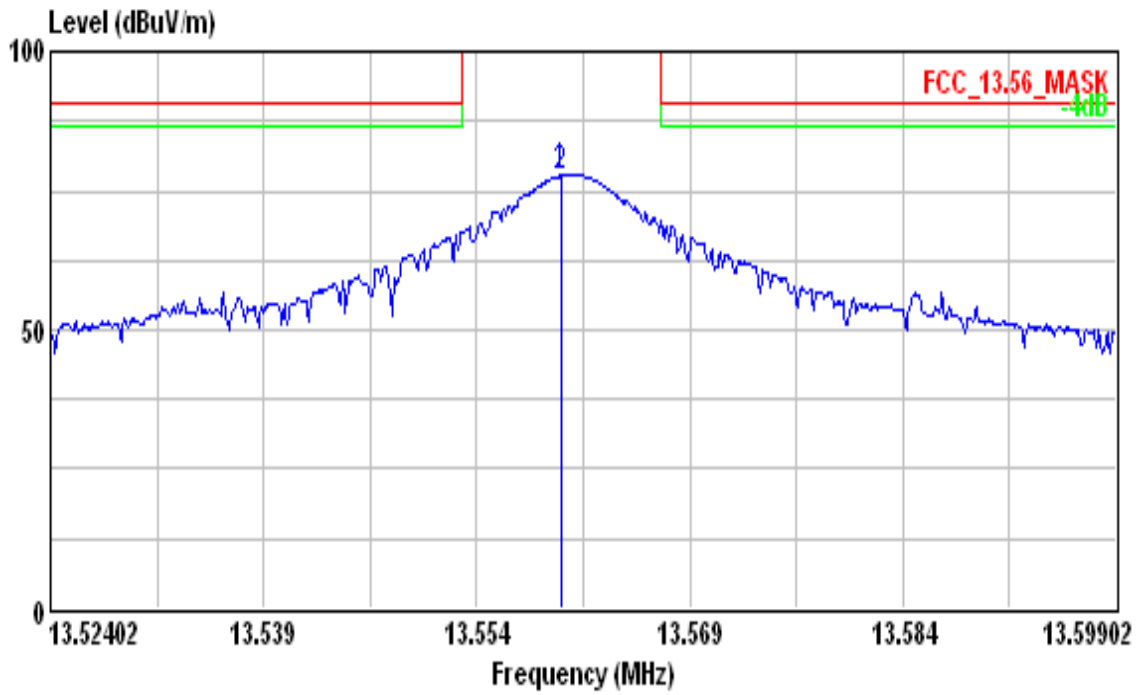

V Polarization

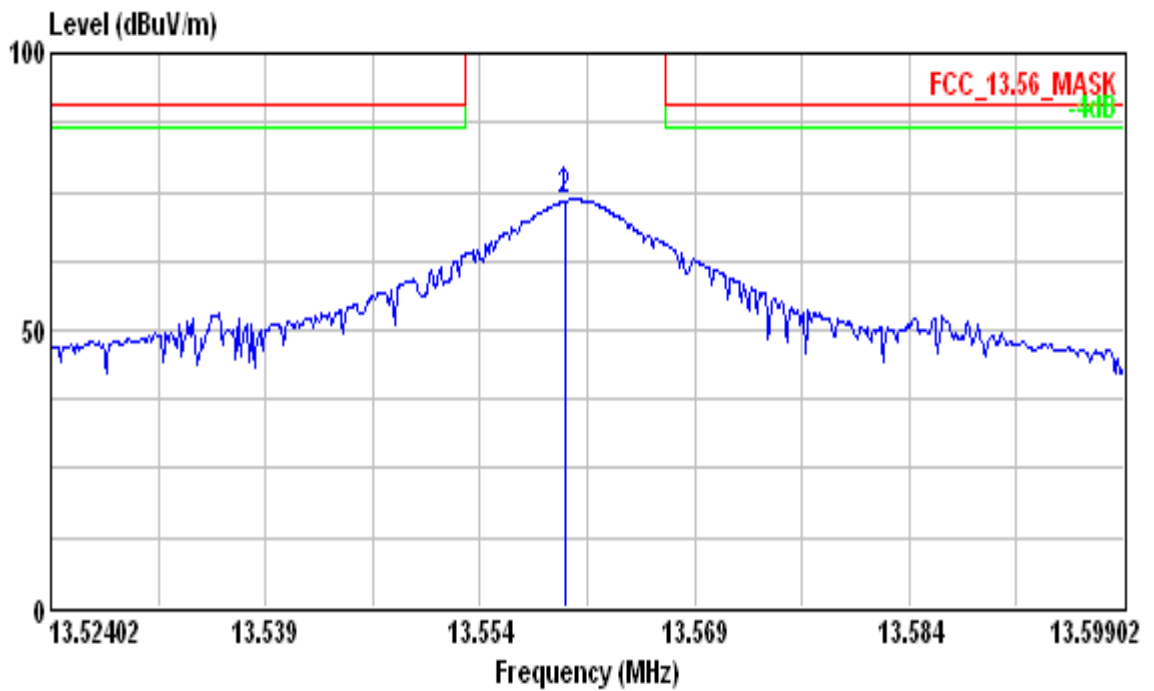

Band Edge

Test Mode : Mode 2, Continuous Transmitting

Tester : Liu

Polarization : Horizontal

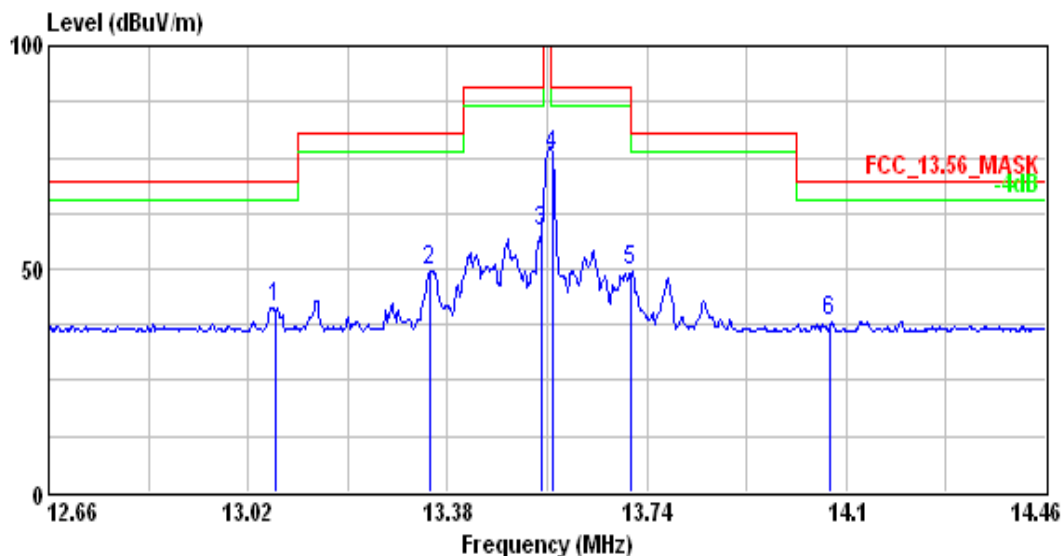

	Read	Limit	Over	Ant	Table				
Freq	Level	Level	Factor	Line	Limit	Pos	Pos	Pol/Phase	Remark
MHz	dBUV/m	dBuV	dB/m	dBUV/m	dB	cm	deg		
1	13.070	41.44	27.03	14.41	69.54	-28.10	---	---	HORIZONTAL QP
2	13.350	49.55	35.17	14.38	80.51	-30.96	---	---	HORIZONTAL QP
3	13.550	58.09	43.73	14.36	90.47	-32.38	---	---	HORIZONTAL QP
4	13.570	75.38	61.02	14.36	90.47	-15.09	---	---	HORIZONTAL QP
5	13.710	49.28	34.94	14.34	80.51	-31.23	---	---	HORIZONTAL QP
6	14.070	38.39	24.08	14.31	69.54	-31.15	---	---	HORIZONTAL QP

Note :

- Factor (dB/m) = Cable Loss + Antenna Factor
- Level (dBUV/m) = Read Level + Factor
- Over Limit (dB) = Level – Limit Line
- For main frequency < 30MHz, the formula transfers the limit at 30 m to 3m is $L_{30}(dBUV/m) + 40$

Test Mode : Mode 2, Continuous Transmitting

Tester : Liu

Polarization : Vertical

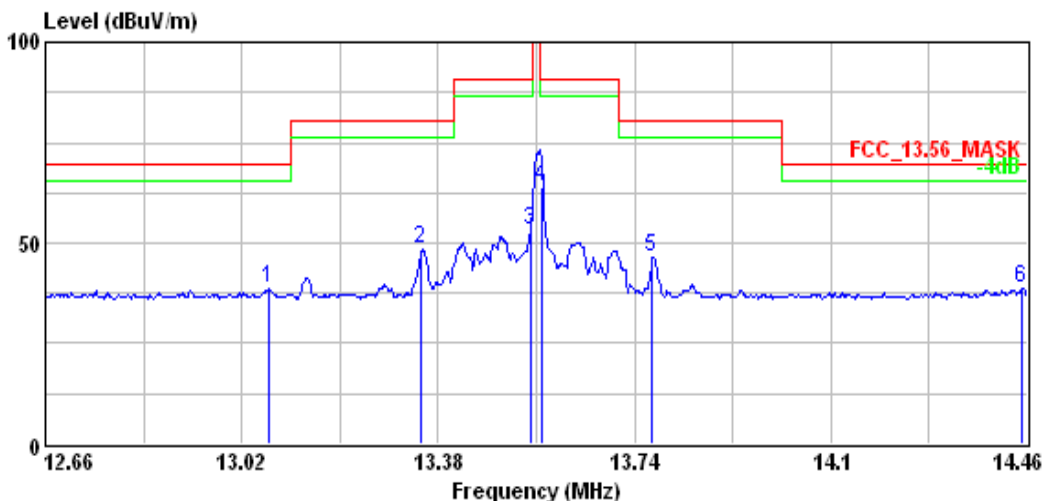

No.	Freq	Level	Read Level	Factor	Limit Line	Over Limit	Ant Pos	Table Pos	Pol/Phase	Remark
1	13.070	38.63	24.22	14.41	69.54	-30.91	---	---	VERTICAL	QP
2	13.350	48.38	34.00	14.38	80.51	-32.13	---	---	VERTICAL	QP
3	13.550	52.89	38.53	14.36	90.47	-37.58	---	---	VERTICAL	QP
4	13.570	63.78	49.42	14.36	90.47	-26.69	---	---	VERTICAL	QP
5	13.770	46.41	32.06	14.35	80.51	-34.10	---	---	VERTICAL	QP
6	14.450	38.68	24.41	14.27	69.54	-30.86	---	---	VERTICAL	QP

Note :

- Factor (dB/m) = Cable Loss + Antenna Factor
- Level (dBuV/m) = Read Level + Factor
- Over Limit (dB) = Level – Limit Line
- For main frequency < 30MHz, the formula transfers the limit at 30 m to 3m is $L_{30}(\text{dBuV/m}) + 40$

40

4 Radiated Emission

Result: Pass

4.1 Applied Standard

According to 15.225(d), The field strength of any emissions appearing outside of the 13.110-14.010 MHz band shall not exceed the general radiated emission limits in § 15.209.

Frequency (MHz)	Field Strength (uV/m)	Measurement Distance (m)
0.009 - 0.490	2400/F(kHz)	300
0.490 - 1.705	24000/F(kHz)	30
1.705 - 30.0	30	30
30 - 88	100 **	3
88 - 216	150 **	3
216 - 960	200 **	3
Above 960	500	3

** Except as provided in paragraph (g), fundamental emissions from intentional radiators operating under this Section shall not be located in the frequency bands 54-72 MHz, 76-88 MHz, 174-216 MHz or 470-806 MHz. However, operation within these frequency bands is permitted under other sections of this Part, e.g., Sections 15.231 and 15.241.

4.2 Test Instruments

Test Site and Equipment	Manufacturer	Model No./ Serial No.	Last Calibration Date	Calibration Due Date
EMI Test Receiver	R&S	ESCI/ 100019	June 7, 2013	June 7, 2014
Spectrum Analyzer	Agilent	E4407B/ MY45106795	May 29, 2013	May 29, 2014
Loop Antenna	EMCO	6502/ 20558	Aug. 29, 2013	Aug. 29, 2014
Bi-Log Antenna	EMCO	3142C/ 52088	May 27, 2013	May 27, 2014
Pre-Amplifier	Mini-circuit	ZKL-2/ 004	Feb. 10, 2014	Aug. 10, 2014
RF Cable	N/A	N/A/ C0080	Feb. 10, 2014	Aug. 10, 2014
Test Software	Audix	e3/ ARD-SPR-0002 82	NCR	NCR
TR11 Semi - anechoic Chamber	ETS. LINDGREN	TR11/ 906-A	May 11, 2013	May 11, 2014

Note:

1. The calibrations are traceable to NML/ROC.
2. NCR:No Calibration Required.

Instrument Setting

RBW	VBW	Detector	Trace	Comment
9kHz	N/A	Quasi-Peak	Maxhold	Below 30MHz
120kHz	N/A	Quasi-Peak	Maxhold	Below 1GHz

Climatic Condition

Ambient Temperature : 20°C; Relative Humidity : 60 %

4.3 Measurement Procedure

- a. The EUT was set up per the test configuration figured in the next section of this chapter to simulate the typical usage per the user's manual.
- b. A software provided by client enabled the EUT to transmit and receive data at specified channel frequencies individually.
- c. If the EUT is tabletop equipment, it was placed on a wooden table with a height of 0.8 meters above the reference ground plane in the semi-anechoic chamber. If the EUT is floor-standing equipment, it was placed on a non-conducted support with a height of 12 millimeters above the reference ground plane in the semi-anechoic chamber.
- d. The EUT was set 3m away from the interference receiving antenna.
- e. Rapidly sweep the signal in the test frequency range by using the spectrum through the Maximum-peak detector.
- f. Rotate the EUT from 0° to 360° and position the receiving antenna at heights from 1 to 4 meters above the reference ground plane continuously to determine at least six frequencies associated with higher emission levels and record them.
- g. Then measure each frequency found from step f. by using the spectrum with rotating the EUT and positioning the receiving antenna height to determine the maximum level.
- h. Record frequency, azimuth angle of the turntable, height, and polarization of the receiving antenna and compare the maximum level with the required limit.
- i. Change the receiving antenna to another polarization to measure radiated emission by following step e. to h. again.
- j. If the peak emission level measured from step f. is 4dB lower than the limit specified, then the emission values presented will be the peak value only. Otherwise, accurate Q.P. value will be measured and presented.

4.4 Test Configuration

Below 30MHz

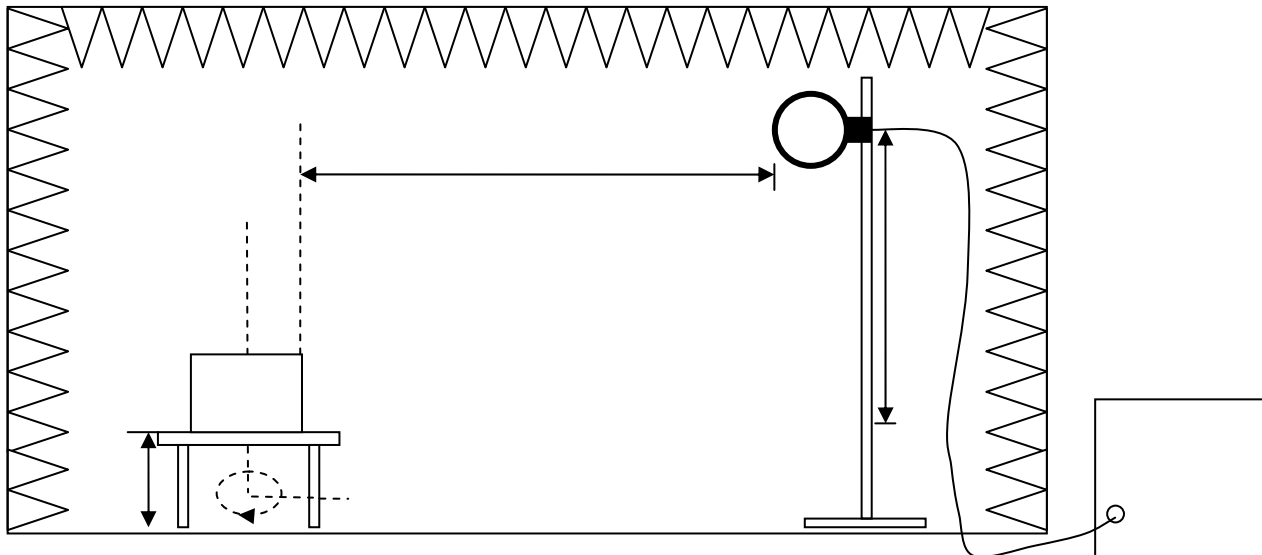

Above 30MHz

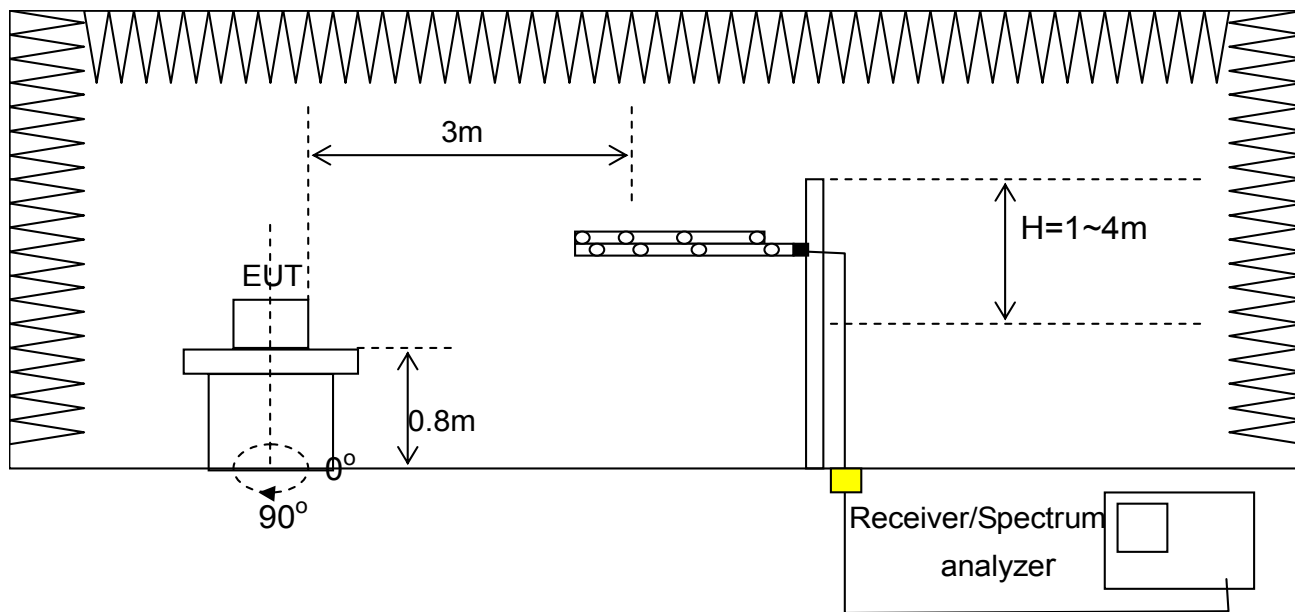

■ : Pre-amplifier

4.5 Test Data

Test Mode : Mode 2, Continuous Transmitting
 Tester : Liu Frequency Range : 9kHz~1GHz
 Polarization : Horizontal

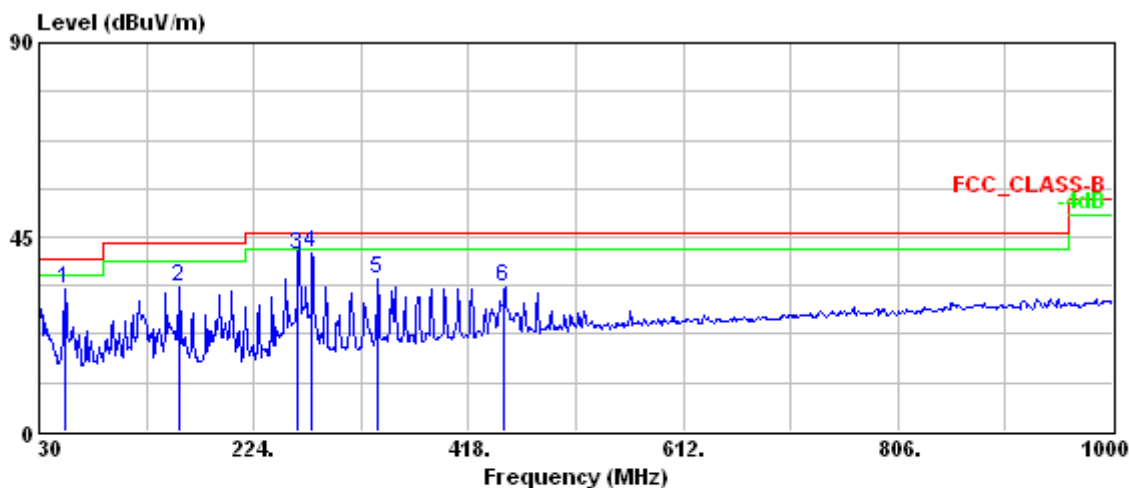

	Freq	Level	Read Level	Limit	Over	Ant	Table	Table	Pol/Phase	Remark
	MHz	dBuV/m	dBuV	dB/m	dBuV/m	dB	cm	deg		
1	54.030	32.74	51.40	-18.66	40.00	-7.26	---	---	HORIZONTAL	Peak
2	156.360	33.57	50.70	-17.13	43.50	-9.93	---	---	HORIZONTAL	Peak
3	263.939	40.79	54.12	-13.33	46.00	-5.21	98	246	HORIZONTAL	QP
4	276.240	41.27	54.08	-12.81	46.00	-4.73	---	---	HORIZONTAL	Peak
5	336.400	35.27	45.87	-10.60	46.00	-10.73	---	---	HORIZONTAL	Peak
6	450.500	33.36	41.00	-7.64	46.00	-12.64	---	---	HORIZONTAL	Peak

Note :

1. Correction Factor (dB/m) = Cable Loss + Antenna Factor – Gain of Preamplifier
2. Emission Level (dBuV/m) = Reading Data + Correction Factor

No signal can be detected from 9kHz to 30MHz, so the graphs are omitted below 30MHz.

Test Mode : Mode 2, Continuous Transmitting
 Tester : Liu Frequency Range : 9kHz~1GHz
 Polarization : Vertical

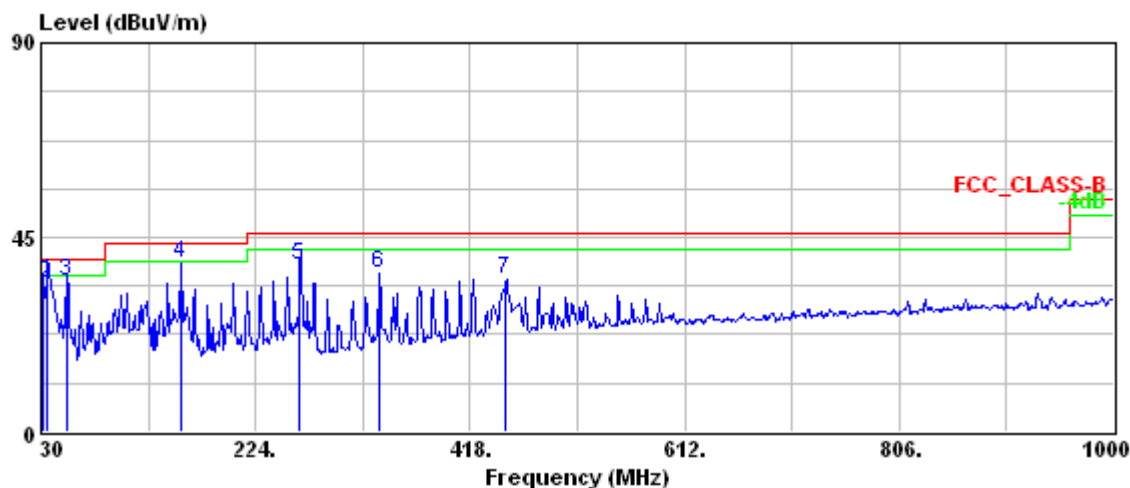

	Freq	Level	Read Level	Limit	Over	Ant	Table		
	MHz	dBuV/m	dBuV	dB/m	dBuV/m	dB	cm	deg	Remark
1	31.080	35.79	45.09	-9.30	40.00	-4.21	---	---	VERTICAL Peak
2	35.130	34.31	45.99	-11.68	40.00	-5.69	100	284	VERTICAL QP
3	54.234	34.92	53.62	-18.70	40.00	-5.08	100	1	VERTICAL QP
4	156.360	38.90	56.03	-17.13	43.50	-4.60	---	---	VERTICAL Peak
5	264.084	38.69	52.00	-13.31	46.00	-7.31	100	291	VERTICAL QP
6	336.400	36.67	47.27	-10.60	46.00	-9.33	---	---	VERTICAL Peak
7	450.500	35.39	43.03	-7.64	46.00	-10.61	---	---	VERTICAL Peak

Note :

1. Correction Factor (dB/m) = Cable Loss + Antenna Factor – Gain of Pre-amplifier
2. Emission Level (dBuV/m) = Reading Data + Correction Factor

No signal can be detected from 9kHz to 30MHz, so the graphs are omitted below 30MHz.

5 Frequency Tolerance

Result: Pass

5.1 Applied Standard

According to 15.225(e), the frequency tolerance of the carrier signal shall be maintained within +/- 0.01% of the operating frequency over a temperature variation of -20 degrees to +50 degrees C at normal supply voltage, and for a variation in the primary supply voltage from 85% to 115% of the rated supply voltage at a temperature of 20 degrees C. For battery operated equipment, the equipment tests shall be performed using a new battery.

5.2 Test Instruments

Test Site and Equipment	Manufacturer	Model No./ Serial No.	Last Calibration Date	Calibration Due Date
Spectrum Analyzer	Agilent	E4405B/ MY45106706	April 9, 2014	April 9, 2015
Temperature Chamber	Terchy	MHG-800LF/ 920224	Aug. 16, 2013	Aug. 16, 2014
Adjustable DC Power Supply	instek	PSP-405/ C120177	NCR	NCR
Test Site	N.A.	TR13	NCR	NCR

Note:

1. The calibrations are traceable to NML/ROC.
2. NCR:No Calibration Required.

Instrument Setting

RBW	VBW	Detector	Trace	Comment
300Hz	1kHz	Peak	Maxhold	

Climatic Condition

Ambient Temperature : 21°C; Relative Humidity : 55%

5.3 Measurement Procedure

- a. The EUT was set up per the test configuration figured in the next section of this chapter to simulate the typical usage described in the user's manual supported by the manufacturer in test site TR13.
- b. Measure the frequency tolerance by using the spectrum analyzer and following the test conditions described in FCC 15.225(e) to perform the normal and extreme conditions test.
- c. Record the value and compare with the required limit.

5.4 Test Configuration

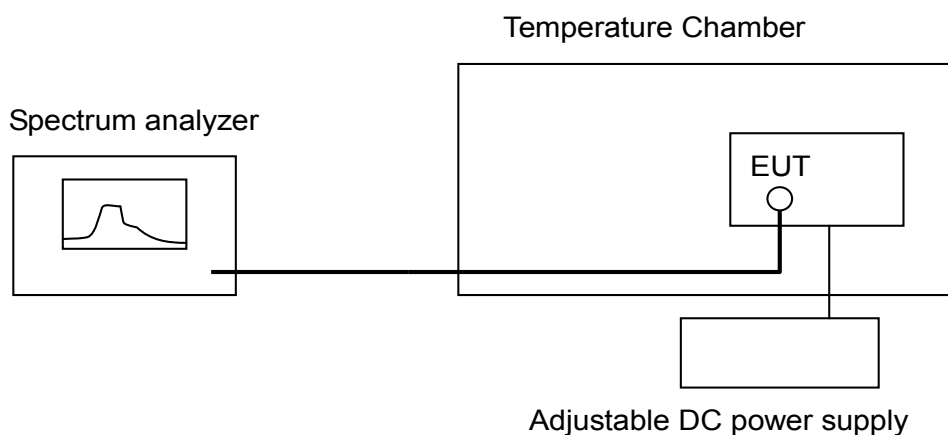

5.5 Test Data

Test Mode : Continuous Transmitting

Tester : Jun

Temperature (°C)	DC Voltage (Volt)	Meas. Frequency (MHz)	Deviation (kHz)	Limit (kHz)	Margin (kHz)
20°C	26.0	13.56049	N/A	1.356	N/A
	22.1	13.56049	0	1.356	1.356
	29.9	13.56049	0	1.356	1.356
-20°C	26.0	13.56052	0.03	1.356	1.326
50°C	26.0	13.56051	0.02	1.356	1.336

Note:

1. Deviation(kHz) = | Meas. Frequency – Meas. Frequency @20°C/26Vdc |
2. Margin (kHz)= Limit – Deviation
3. At the temperature control to highest and Lowest measurement, device turn on after temperature stability and measure at startup and at 2 mins, 5 mins, and 10 mins. Finally, record the worst on the report.
4. The test results with 7.5Vdc and 45Vdc by same test processure are pass. The test data are omitted.

20°C, 26Vdc

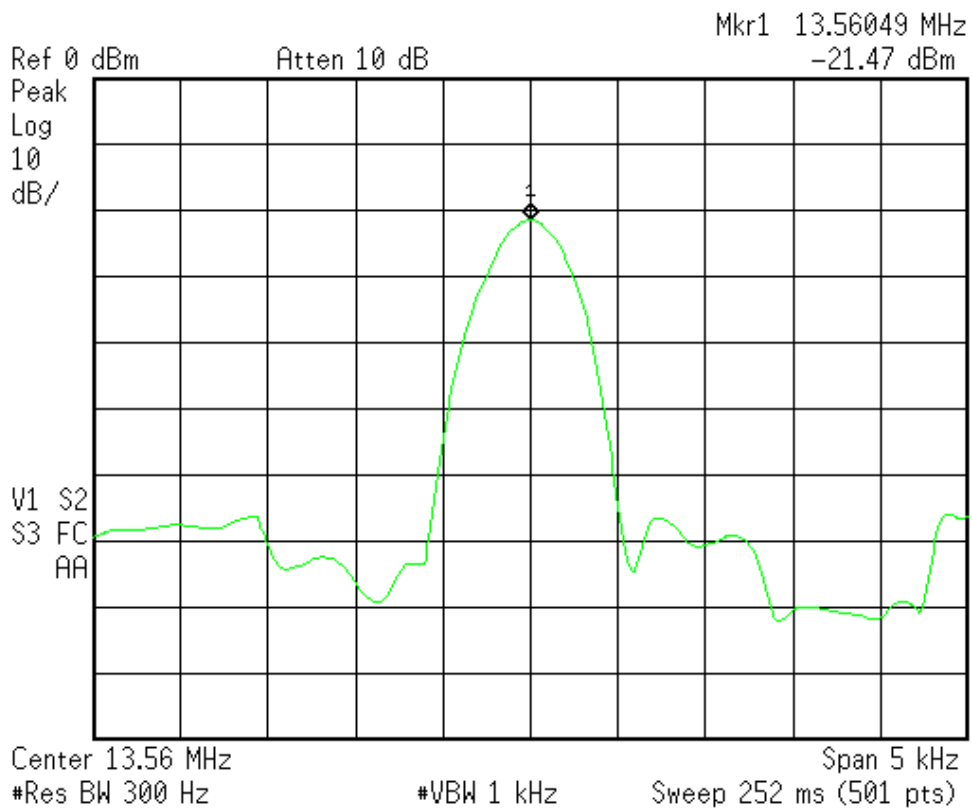

20°C, 22.1Vdc

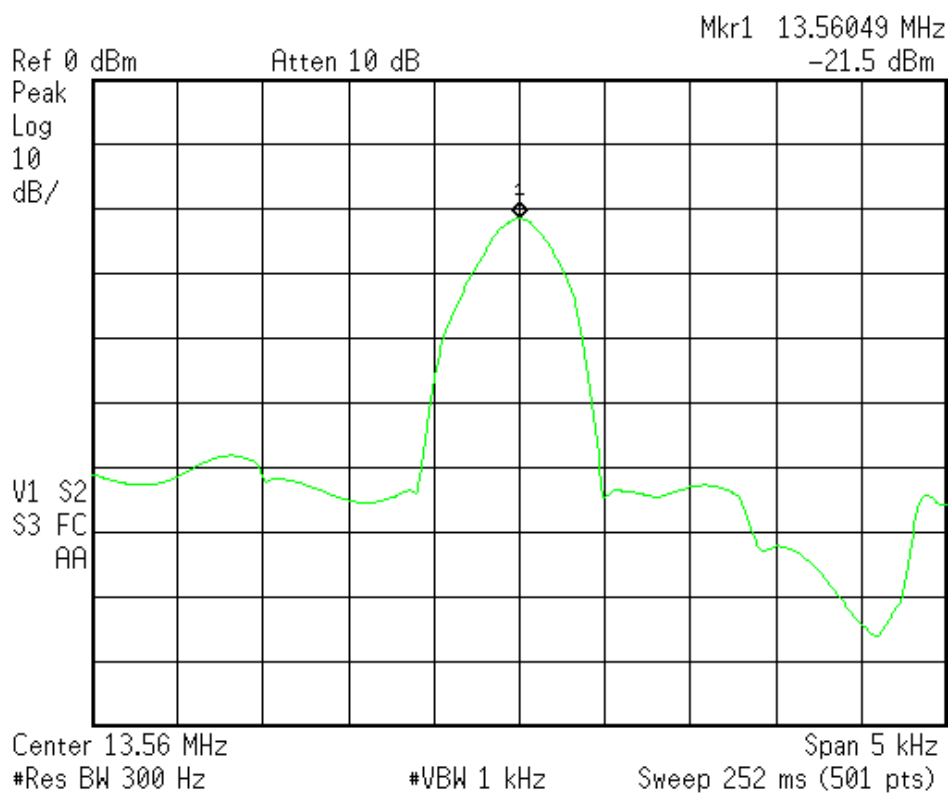

20°C, 29.9Vdc

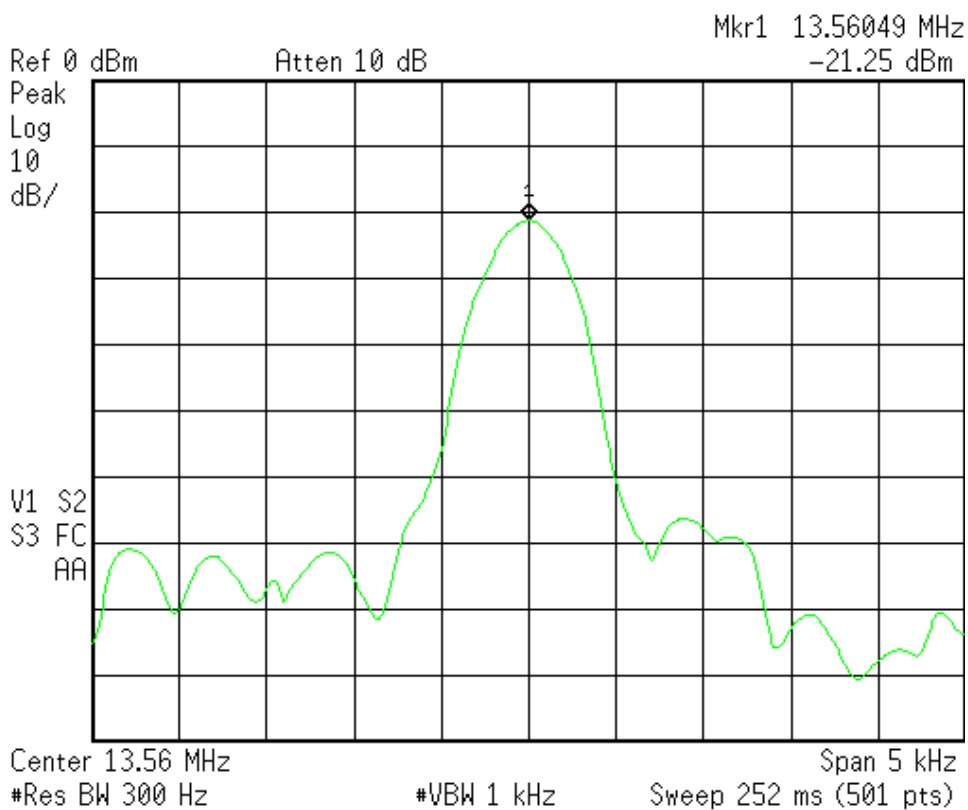

-20°C, 26Vdc

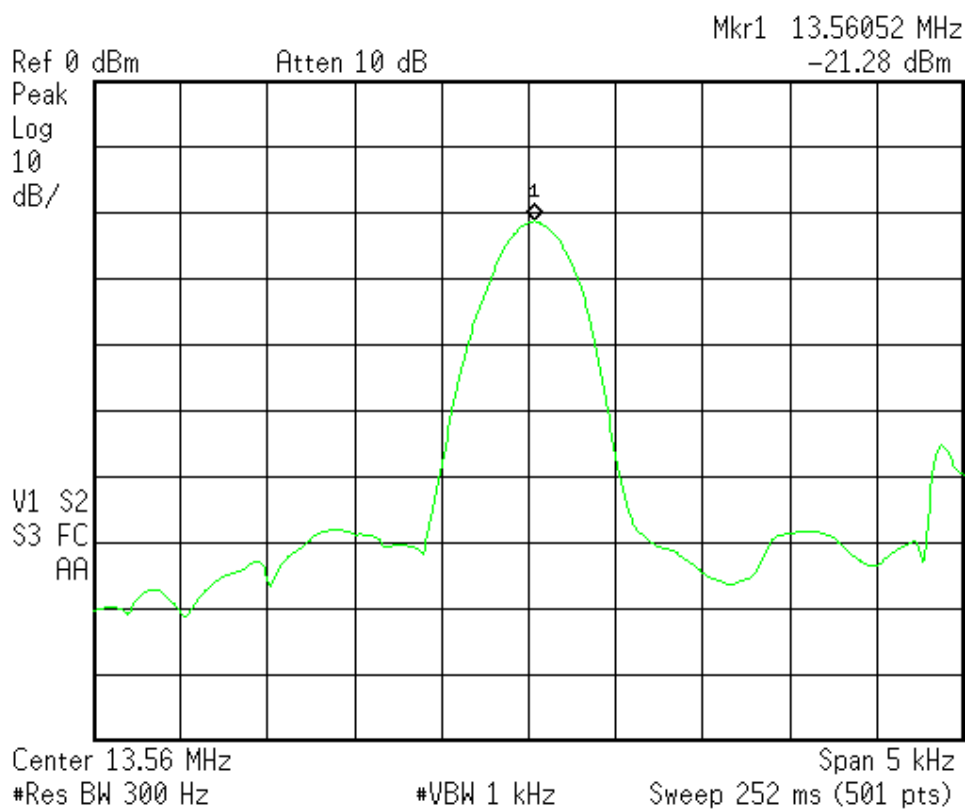

50°C, 5Vdc

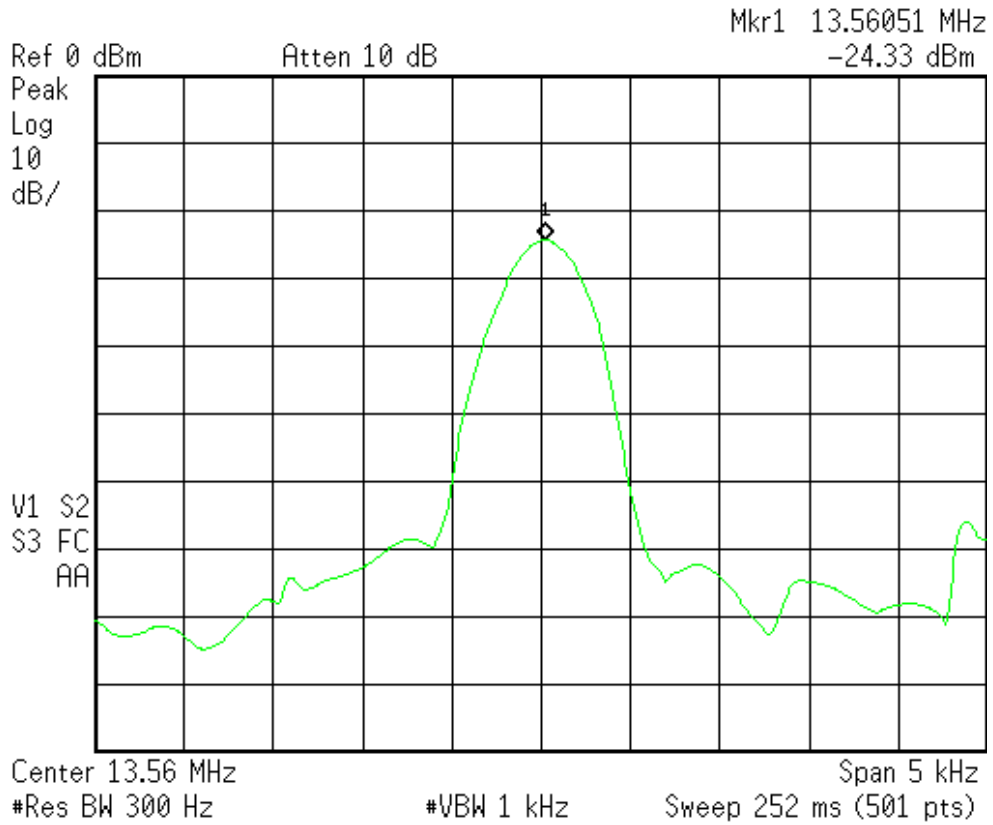

6 20dB Bandwidth

Result: Pass

6.1 Applied Standard

According to 15.215(c) requires the device must be designed to ensure that the 20 dB bandwidth of the emission, or whatever bandwidth may otherwise be specified in the specific rule section under which the equipment operates.

According to 15.225, Operation should within the band 13.110 – 14.010 MHz.

6.2 Test Instruments

Test Site and Equipment	Manufacturer	Model No./ Serial No.	Last Calibration Date	Calibration Due Date
Spectrum Analyzer	Agilent	E4405B/ MY45106706	April 9, 2014	April 9, 2015
Test Site	N.A.	TR13	NCR	NCR

Note:

- 1.The calibrations are traceable to NML/ROC.
- 2.NCR : No Calibration Required.

Instrument Setting

RBW	VBW	Detector	Trace	Comment
300Hz	1kHz	Peak	Maxhold	

Climatic Condition

Ambient Temperature : 21°C; Relative Humidity : 55%

6.3 Measurement Procedure

- a. The EUT was set up per the test configuration figured in the next section of this chapter to simulate the typical usage described in the user's manual supported by the manufacturer in test site TR13.
- b. Measure the 20dB bandwidth by using the spectrum analyzer and following the test conditions described in FCC 15.215.
- c. Record the frequency and compare with the required limit.

6.4 Test Configuration



6.5 Test Data

Test Mode : Continuous Transmitting

Tester : Jun

Operating Frequency (MHz)	The lowest frequency (MHz)	The highest frequency (MHz)	Limit (MHz)
13.56	13.56049	13.56008	13.110~14.01

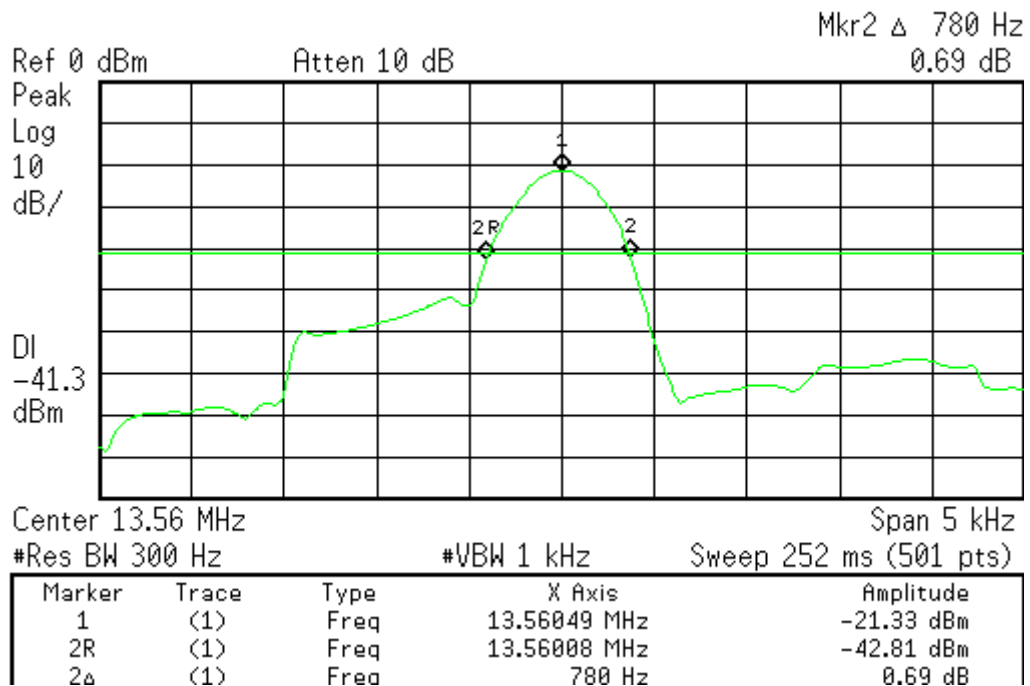

7 Antenna Requirement

7.1 Applied Standard

An intentional radiator shall be designed to ensure that no antenna other than that furnished by the responsible party shall be used with the device. The use of a permanently attached antenna or of an antenna that uses a unique coupling to the intentional radiator shall be considered sufficient to comply with the provisions of this Section. The manufacturer may design the unit so that a broken antenna can be replaced by the user, but the use of a standard antenna jack or electrical connector is prohibited. This requirement does not apply to carrier current devices or to devices operated under the provisions of Sections 15.211, 15.213, 15.217, 15.219, or 15.221. Further, this requirement does not apply to intentional radiators that must be professionally installed, such as perimeter protection systems and some field disturbance sensors, or to other intentional radiators which, in accordance with Section 15.31(d), must be measured at the installation site. However, the installer shall be responsible for ensuring that the proper antenna is employed so that the limits in this Part are not exceeded.

7.2 Antenna Type

The EUT use a permanently attached antenna

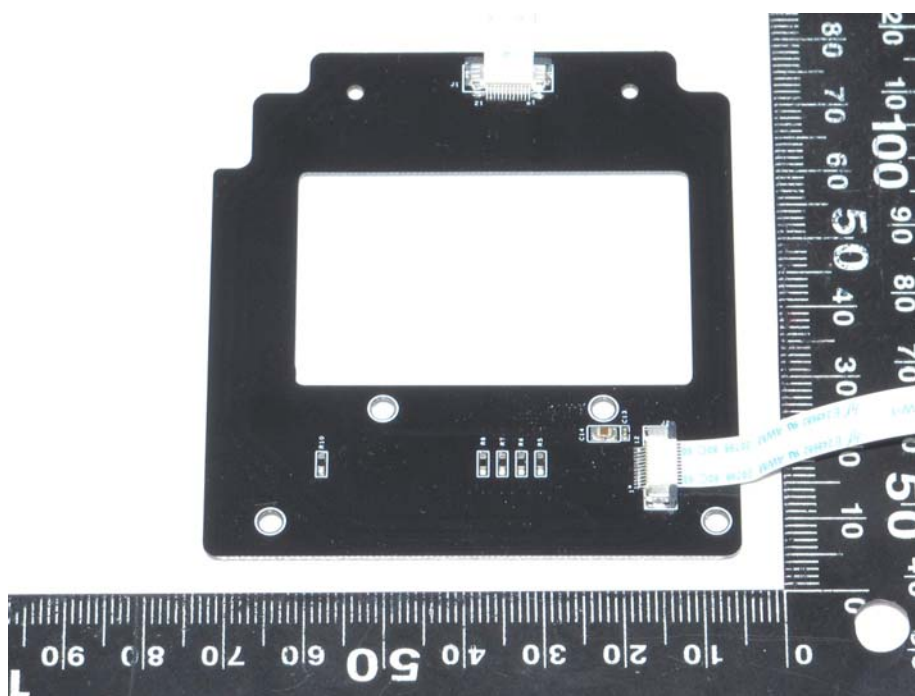

7.3 Applicable Result

Comply the requirement.