

# FCC Test Report

for

## Contactless Card Reader

Trade Name : Uniform  
Model Number : UIC682LT1  
FCC ID : TFJ682LT1  
Report Number : RF-U010-0811-215  
Date of Report : Dec. 9, 2008

Prepared for

### Uniform Industrial Corp.

1st. FL,NO.1,Lane 15,Chih Chiang St., Tu Cheng City, Taipei Hsien, Taiwan,R.O.C.

Prepared by



**Central Research Technology Co.**

**EMC Test Laboratory**

No.11, Lane41, Fushuen St., Jungshan Chiu, Taipei, Taiwan, 104, R.O.C.



NVLAP LAB CODE 200575-0

**This report shall not be reproduced, except in full, without the written approval of Central Research Technology Co.. It may be duplicated completely in its entirety for legal use with the permission of the applicant. It should not be used to claim product endorsement by NVLAP, NIST or any U.S. government agency. The test result in the report applies only to the sample tested.**

# Certification

Equipment under Test : Contactless Card Reader  
Model No. : UIC682LT1  
FCC ID : TFJ682LT1  
Manufacturer : Uniform Industrial Corp.  
Applicant : Uniform Industrial Corp.  
Address : 1st. FL,NO.1,Lane 15,Chih Chiang St., Tu Cheng City,  
Taipei Hsien, Taiwan,R.O.C.  
Date of Testing : Nov. 14~Nov. 17, 2008  
Date of Receipt : Nov. 14, 2008  
Applicable Standards : 47 CFR part 15, Subpart C  
Deviation : N/A  
Condition of Test Sample : Engineering Sample



We, **Central Research Technology Co.**, hereby certify that one sample of the designated product was tested in our facility during the period mentioned above. The test records, data evaluation and Equipment Under Test (EUT) configurations shown in the present report are true and accurate representation of the measurements of the sample's RF characteristics under the conditions herein specified.

The test results show that the EUT as described in the present report is in compliance with the requirements set forth in the standards mentioned above and apply to the tested sample identified in the present report only. The test report shall not be reproduced, except in its entirety, without the written approval of Central Research Technology Co.

PREPARED BY : Cathy Chen , DATE : Dec. 9, 2008  
(Cathy Chen/ Technical Manager)  
APPROVED BY : J. Y. Shih , DATE : Dec. 9, 2008  
(Tsun-Yu Shih/Laboratory Head)

## Contents

<b>1</b>	<b>General Description .....</b>	<b>5</b>
1.1	GENERAL DESCRIPTION OF EUT .....	5
1.2	TEST METHODOLOGY .....	6
1.3	REQUIREMENT FOR COMPLIANCE.....	7
1.4	THE SUPPORT UNITS .....	9
1.5	LAYOUT OF SETUP .....	9
1.6	TEST CAPABILITY .....	10
<b>2</b>	<b>Field Strength of fundamental.....</b>	<b>12</b>
2.1	APPLIED STANDARD .....	12
2.2	TEST INSTRUMENTS .....	12
2.3	MEASUREMENT PROCEDURE.....	13
2.4	TEST CONFIGURATION .....	13
2.5	TEST DATA .....	14
<b>3</b>	<b>Radiated Emission .....</b>	<b>20</b>
3.1	APPLIED STANDARD .....	20
3.2	TEST INSTRUMENTS .....	21
3.3	MEASUREMENT PROCEDURE.....	22
3.4	TEST CONFIGURATION .....	23
3.5	TEST DATA .....	24
<b>4</b>	<b>Frequency Tolerece .....</b>	<b>28</b>
4.1	APPLIED STANDARD .....	28
4.2	TEST INSTRUMENTS .....	28
4.3	MEASUREMENT PROCEDURE.....	29
4.4	TEST CONFIGURATION .....	29
4.5	TEST DATA .....	30
<b>5</b>	<b>20dB Bandwidh .....</b>	<b>33</b>
5.1	APPLIED STANDARD .....	33
5.2	TEST INSTRUMENTS .....	33
5.3	MEASUREMENT PROCEDURE.....	34
5.4	TEST CONFIGURATION .....	34
5.5	TEST DATA .....	35
<b>6</b>	<b>Conducted Emission Measurement .....</b>	<b>36</b>
6.1	LIMITS FOR EMISSION MEASUREMENT .....	36

---

<b>6.2</b>	<b>TEST INSTRUMENTS .....</b>	<b>37</b>
<b>6.3</b>	<b>TEST PROCEDURES .....</b>	<b>38</b>
<b>6.4</b>	<b>TEST CONFIGURATIONS .....</b>	<b>39</b>
<b>6.5</b>	<b>TEST RESULTS .....</b>	<b>40</b>

**Attachment 1 – Photographs of the Test Configurations**

**Attachment 2 – External Photographs of EUT**

**Attachment 3 – Internal Photographs of EUT**

**Attachment 4 – Modifications of EUT**

## 1 General Description

### 1.1 General Description of EUT

Equipment under Test: Contactless Card Reader

Model No. : UIC682LT1

Model Different : Please refer to the P/N# Description in next page

Power in : Power supplied by adaptor

Test Voltage : 120Vac/ 60Hz

Manufacturer : Uniform Industrial Corp.

Channel Numbers : 1

Frequency Range : 13.56MHz

Function Modulation : FSK

Function Description :

The EUT is used to transmit and receive signal and data both. Please refer to the user's manual for the details.

**P/N# Description**

The Contactless Card Reader series P/N# Description defined by manufacturer is listed below:

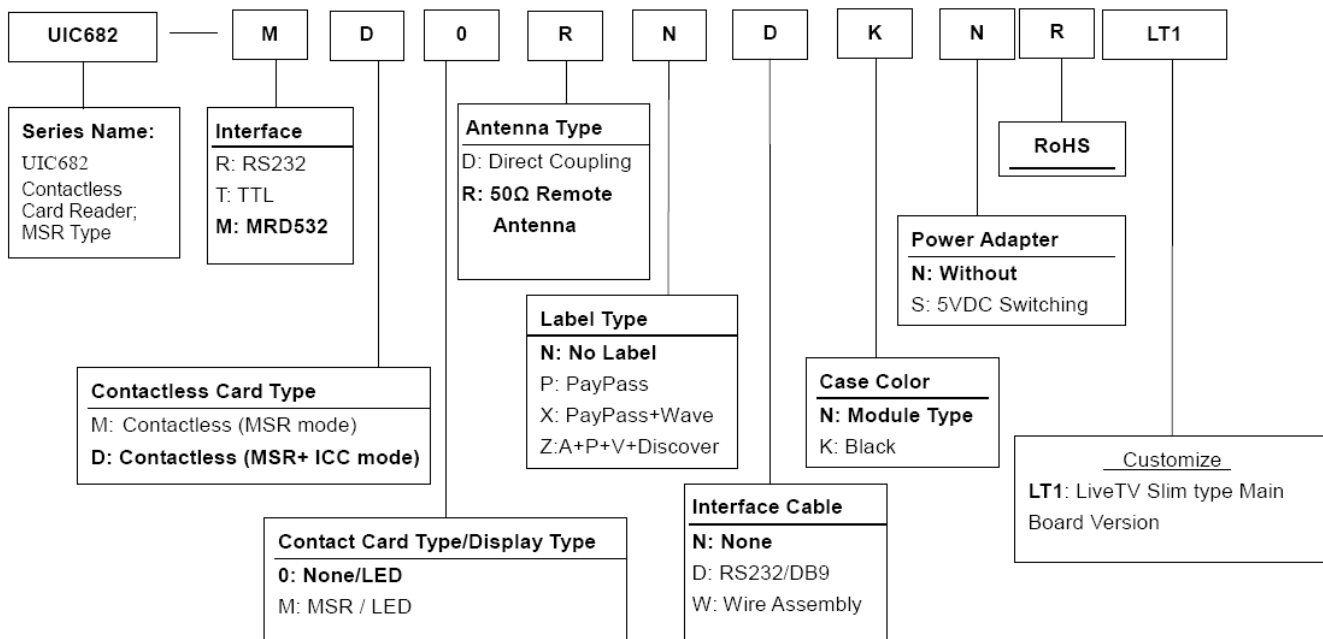

**1.2 Test Methodology**

For this E.U.T., the radiated emissions measurement performed according to the procedures illustrated in ANSI C63.4:2003 and other required were illustrated in separate sections of this test report for detail.

**1.3 Requirement for Compliance**

(1) Field strength of Fundametal

According to 15.225(a), the field strength of any emissions within the band 13.553 - 13.567 MHz shall not exceed 15,848 microvolts/meter at 30 meters.

(2) Band Edge

According to 15.225(b), Within the bands 13.410-13.553 MHz and 13.567-13.710 MHz, the field strength of any emissions shall not exceed 334 microvolts/meter at 30 meters. According to 15.225(c), Within the bands 13.110-13.410 MHz and 13.710-14.010 MHz the field strength of any emissions shall not exceed 106 microvolts/meter at 30 meters.

(3) Radiation emission

According to 15.225(d), the field strength of any emissions appearing outside of the 13.110-14.010 MHz band shall not exceed the general radiated emission limits in § 15.209.

(4) Frequency tolerance

The frequency tolerance of the carrier signal shall be maintained within +/- 0.01% of the operating frequency over a temperature variation of -20 degrees to +50 degrees C at normal supply voltage, and for a variation in the primary supply voltage from 85% to 115% of the rated supply voltage at a temperature of 20 degrees C. For battery operated equipment, the equipment tests shall be performed using a new battery.

(5) Radiated emission limits, general requirements.

According to 15.209, except as provided elsewhere in this Subpart, the emissions from an intentional radiator shall not exceed the field strength levels specified in the following table:

<b>Frequency (MHz)</b>	<b>Field Strength (uV/m)</b>	<b>Measurement Distance (m)</b>
0.009 - 0.490	2400/F(kHz)	300
0.490 - 1.705	24000/F(kHz)	30
1.705 - 30.0	30	30
30 - 88	100 **	3
88 - 216	150 **	3
216 - 960	200 **	3
Above 960	500	3

\*\* Except as provided in paragraph (g), fundamental emissions from intentional radiators operating under this Section shall not be located in the frequency bands 54-72 MHz, 76-88 MHz, 174-216 MHz or 470-806 MHz. However, operation within these frequency bands is permitted under other sections of this Part, e.g., Sections 15.231 and 15.241.

(6) 20dB Bandwidth

According to 15.215(c) requires the device must be designed to ensure that the 20 dB bandwidth of the emission, or whatever bandwidth may otherwise be specified in the specific rule section under which the equipment operates.

(7) Conduction Emission Requirement

For intentional device, according to §15.207(a) line conduction emission limit is as below table.

Frequency of Emission (MHz)	Conducted Limit (dBuV)	
	Quasi-peak	Average
0.15 – 0.5	66 to 56*	56 to 46*
0.5 - 5	56	46
5 - 30	60	50

\* Decreases with the logarithm of the frequency.

(8) Restricted Band

Frequency (MHz)	Frequency (MHz)	Frequency (MHz)	Frequency (GHz)
0.090 - 0.110	16.42 - 16.423	399.9 - 410	4.5 - 5.15
<sup>1</sup> 0.495 - 0.505	16.69475 - 16.69525	608 - 614	5.35 - 5.46
<sup>2</sup> 1735 - 2.1905	16.80425 - 16.80475	960 - 1240	7.25 - 7.75
4.125 - 4.128	25.5 - 25.67	1300 - 1427	8.025 - 8.5
4.17725 - 4.17775	37.5 - 38.25	1435 - 1626.5	9.0 - 9.2
4.20725 - 4.20775	73 - 74.6	1645.5 - 1646.5	9.3 - 9.5
6.215 - 6.218	74.8 - 75.2	1660 - 1710	10.6 - 12.7
6.26775 - 6.26825	108 - 121.94	1718.8 - 1722.2	13.25 - 13.4
6.31175 - 6.31225	123 - 138	2200 - 2300	14.47 - 14.5
8.291 - 8.294	149.9 - 150.05	2310 - 2390	15.35 - 16.2
8.362 - 8.366	156.52475 - 156.52525	2483.5 - 2500	17.7 - 21.4
8.37625 - 8.38675	156.7 - 156.9	2690 - 2900	22.01 - 23.12
8.41425 - 8.41475	162.0125 - 167.17	3260 - 3267	23.6 - 24.0
12.29 - 12.293	167.72 - 173.2	3332 - 3339	31.2 - 31.8
12.51975 - 12.52025	240 - 285	3345.8 - 3358	36.43 - 36.5
12.57675 - 12.57725	322 - 335.4	3600 - 4400	(2)
13.36 - 13.41			

<sup>1</sup> Until February 1, 1999, this restricted band shall be 0.490-0.510 MHz.

<sup>2</sup> Above 38.6



**1.4 The Support Units**

No.	Unit	Model No./ Serial No.	FCC ID	Trade Name	Power Cord	Supported by lab.
1	Notebook	LATITUDE D400/5FL891S	DoC	DELL	0.8m	✓

**1.5 Layout of Setup**

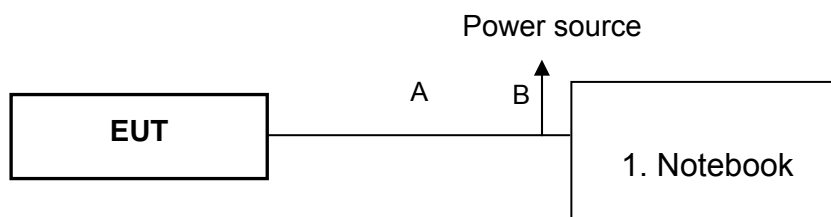

**Connecting Cables :**

No.	Cable	Length	Shielded	Core	Shielded Backshell	Supported by lab.	Note
A	RS232 Cable	1.8m		✓			
B	Power Cord	1.8m					

**Justification:**

For both conducted and radiated emission below 1GHz, the system was configured for typical fashion as a customer could use it normally.

For radiated emission, measurement of radiated emission from digital circuit is performed with normal transmitting.

**1.6 Test Capability**

**Test Facility**

The test facility used for evaluating the conformance of the EUT with each standard in the present report meets what required in CISPR16-1-4, CISPR16-2-3 and ANSI C63.4.

<b>Test Room</b>	<b>Type of Test Room</b>	<b>Descriptions</b>
TR1	10m semi-anechoic chamber (23m×14m×9m)	Complying with the NSA requirements in documents CISPR 22 and ANSI C63.4. For the radiated emission measurement.
TR10	3m semi-anechoic chamber (9m × 6m × 6m)	
TR11	3m semi-anechoic chamber (9m × 6m × 6m)	
TR300	3m fully-anechoic chamber (8m × 5m × 5m)	
TR13	Chamber	For the RF conducted emission measurement.
TR5	Shielding Room (8m×5m×4m)	For the conducted emission measurement.

**Test Laboratory Competence Information**

Central Research Technology Co. has been accredited/filed/authorized by the agencies listed in the following table.

<b>Certificate</b>	<b>Nation</b>	<b>Agency</b>	<b>Code</b>	<b>Mark</b>
Accreditation Certificate	USA	NVLAP	200575-0	ISO/IEC 17025
	R.O.C. (Taiwan)	TAF	0905	ISO/IEC 17025
	R.O.C. (Taiwan)	BSMI	SL2-IN-E-0033, SL2-IS-E-0033, SL2-R1/R2-E-0033, SL2-A1-E-0033	ISO/IEC 17025
Site Filing Document	USA	FCC	474046, TW1021	Test facility list & NSA Data
	Canada	IC	4699A-1,-2,-3	Test facility list & NSA Data
	Japan	VCCI	R-1527,C-1609,T-131,T-1441	Test facility list & NSA Data
Authorization Certificate	Germany	TUV	10021687-2007	ISO/IEC 17025
	Norway	Nemko	ELA212	ISO/IEC 17025

The copy of each certificate can be downloaded from our web site: [www.crc-lab.com](http://www.crc-lab.com)

**2 Field Strength of fundamental**

**Result: Pass**

**2.1 Applied Standard**

According to 15.225(a), The field strength of any emissions within the band 13.553 - 13.567 MHz shall not exceed 15,848 microvolts/meter at 30 meters.

According to 15.225(b), Within the bands 13.410-13.553 MHz and 13.567-13.710 MHz, the field strength of any emissions shall not exceed 334 microvolts/meter at 30 meters.

According to 15.225(c), Within the bands 13.110-13.410 MHz and 13.710-14.010 MHz the field strength of any emissions shall not exceed 106 microvolts/meter at 30 meters.

**2.2 Test Instruments**

<b>Test Site and Equipment</b>	<b>Manufacturer</b>	<b>Model No./ Serial No.</b>	<b>Last Calibration Date</b>	<b>Calibration Due Date</b>
Semi - anechoic Chamber	ETS. LINDGREN	TR11/ 906-A	2008/6/30	2009/6/29
Spectrum Analyzer	Agilent	E4407B/ MY45106706	2008/3/19	2009/3/18
Antenna	EMCO	6502/20558	2008/8/4	2011/8/3

Note:

1. The calibrations are traceable to NML/ROC.
2. NCR : No Calibration Required.
3. The calibration date of the semi-anechoic chamber listed above is the date of NSA measurement.

**Instrument Setting**

<b>RBW</b>	<b>VBW</b>	<b>Detector</b>	<b>Trace</b>	<b>Comment</b>
9kHz	N/A	Quasi-Peak	Maxhold	

**Climatic Condition**

Ambient Temperature : 24°C; Relative Humidity : 55%

## 2.3 Measurement Procedure

- a. The EUT was set up per the test configuration figured in the next section of this chapter to simulate the typical usage per the user's manual.
- b. If the EUT is tabletop equipment, it was placed on a wooden table with a height of 0.8 meters above the reference ground plane in the semi-anechoic chamber. If the EUT is floor-standing equipment, it was placed on a non-conducted support with a height of 12 millimeters above the reference ground plane in the semi-anechoic chamber.
- c. The EUT was set 3m away from the interference receiving antenna.
- d. Rapidly sweep the signal in the test frequency range by using the spectrum through the Maximum-peak detector.
- e. Rotate the EUT from 0° to 360° and position the receiving loop antenna at 1~4 meters above the reference ground plane to determine the fundamental frequency and record them.
- f. Finely turn the turntable and the antenna is be positioned with its plane vertical at the specified distance from the EUT and rotated about its vertical axis for maximum response and recorded position of fundamental frequency found from step e.
- g. Record and compare the maximum level with the required limit.
- h. Change the receiving antenna to another polarization to measure Field Strength of fundamental by following step e. to g. again.

## 2.4 Test Configuration

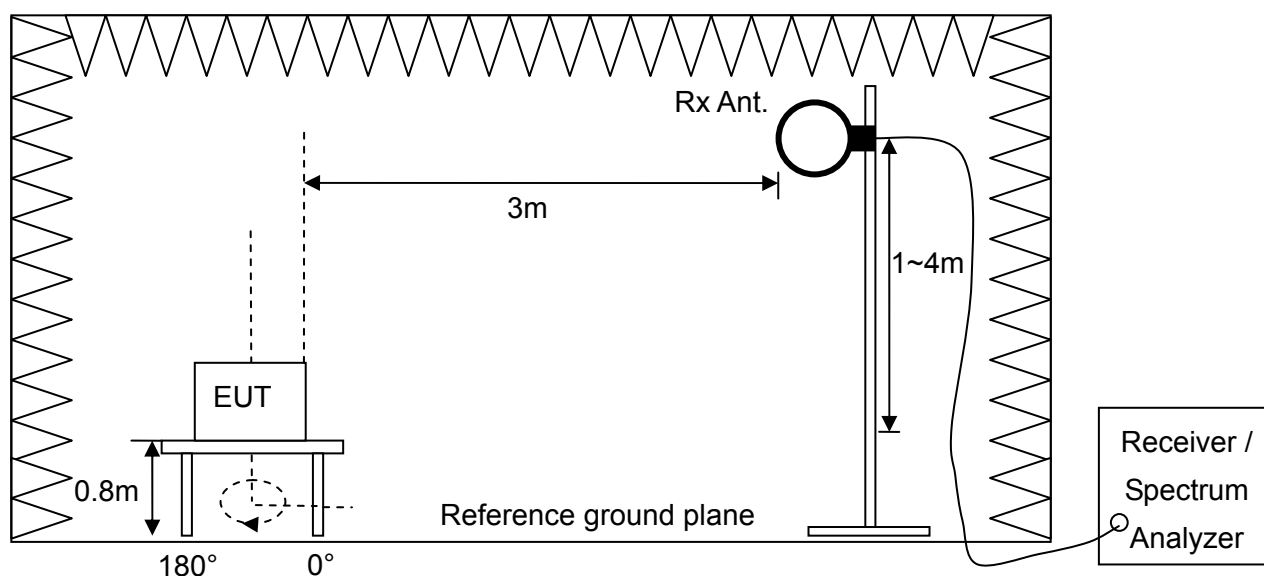

**2.5 Test Data**

**Field strength of fundamental**

**Test Mode : Continuous Transmitting**

**Test Distance : 3m Tester : Jacky**

<b>Freq. (MHz)</b>	<b>Polarization</b>	<b>Reading Data (dBuV)</b>	<b>Correction Factor (dB/m)</b>	<b>Emission Level (dBuV/m)</b>	<b>Limit (dBuV/m)</b>	<b>Margin (dB)</b>
13.56	V	50.87	13.97	64.84	124	59.16
13.56	H	50.03	13.97	64.00	124	60.00

Note :

1. Correction Factor (dB/m) = Cable Loss + Antenna Factor
2. Emission Level (dBuV/m) = Reading Data + Correction Factor
3. The limit is 15848 (uV/m)=84dBuV/m @ 30 m , The formula transfers the limit at 30 m to 3m is  $L_3 = L_{30} \times (d_{30} / d_3)^2 = L_{30}(dBuV/m) + 40 = 124 \text{ dBuV/m}$
4. Margin (dB) = Limit – Emission Level

V Polarization

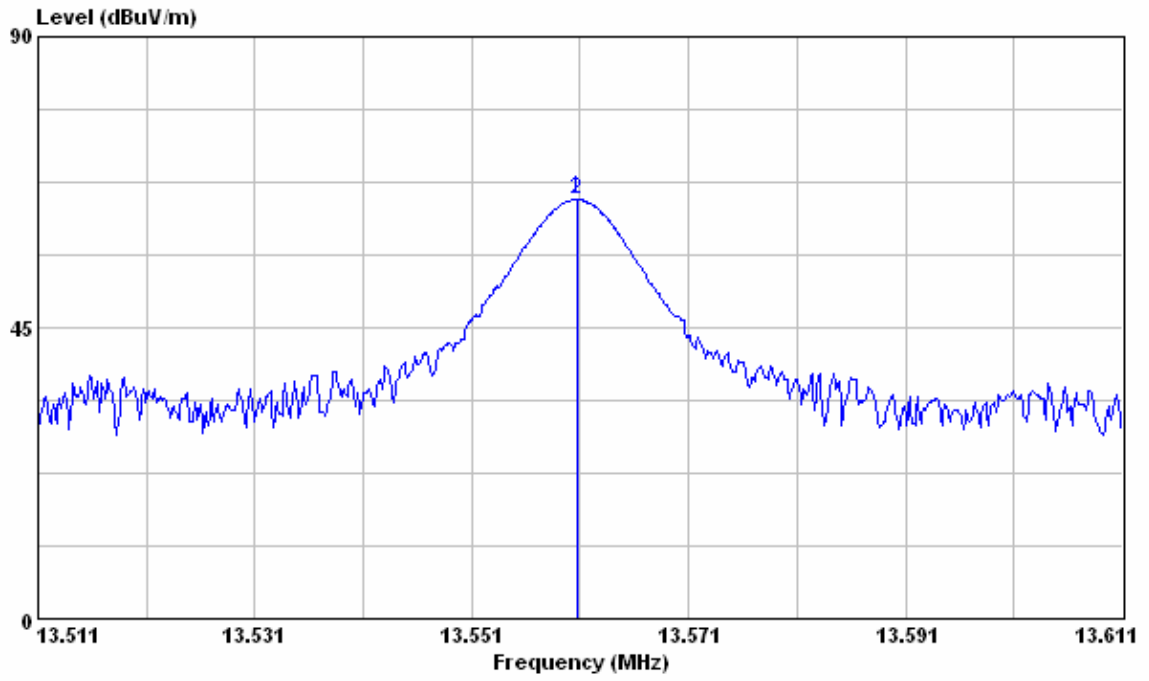

H Polarization

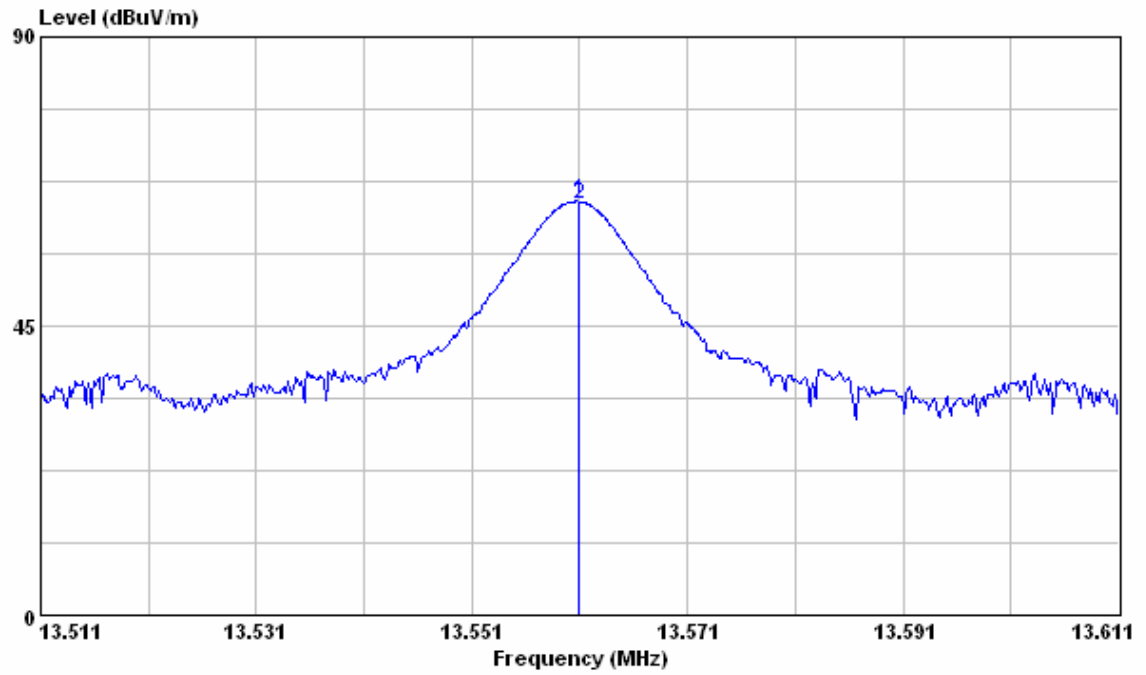

**Band Edge**

**Test Mode : Continuous Transmitting**

**Test Distance : 3m Tester : Jacky**

Emission Freq. (MHz)	Polarizortal	Reading Data (dBuV)	Correction Factor (dB/m)	Maximum Emission within the band (dBuV/m)	Limit (dBuV/m)	Margin (dB)
13.48	V	29.62	13.97	43.59	90.47	46.88
13.49	H	28.72	13.97	42.69	90.47	47.78
13.64	V	28.69	13.96	42.65	90.47	47.82
13.63	H	28.04	13.96	42.00	90.47	48.47
13.35	V	27.47	13.98	41.45	80.51	39.06
13.35	H	26.36	13.98	40.34	80.51	40.17
13.71	V	26.13	13.96	40.09	80.51	40.42
13.71	H	24.37	13.96	38.33	80.51	42.18

Note :

1. Correction Factor (dB/m) = Cable Loss + Antenna Factor
2. Maximum Emission within the band (dBuV/m) = Reading Data + Correction Factor
3. The formula transfers the limit at 30 m to 3m is  $L_3 = L_{30} \times (d_{30} / d_3)^2 = L_{30}(\text{dBuV/m}) + 40$
4. Margin (dB) = Limit – Maximum Emission within the band



13.41~13.553MHz & 13.567~13.710MHz

V Polarization

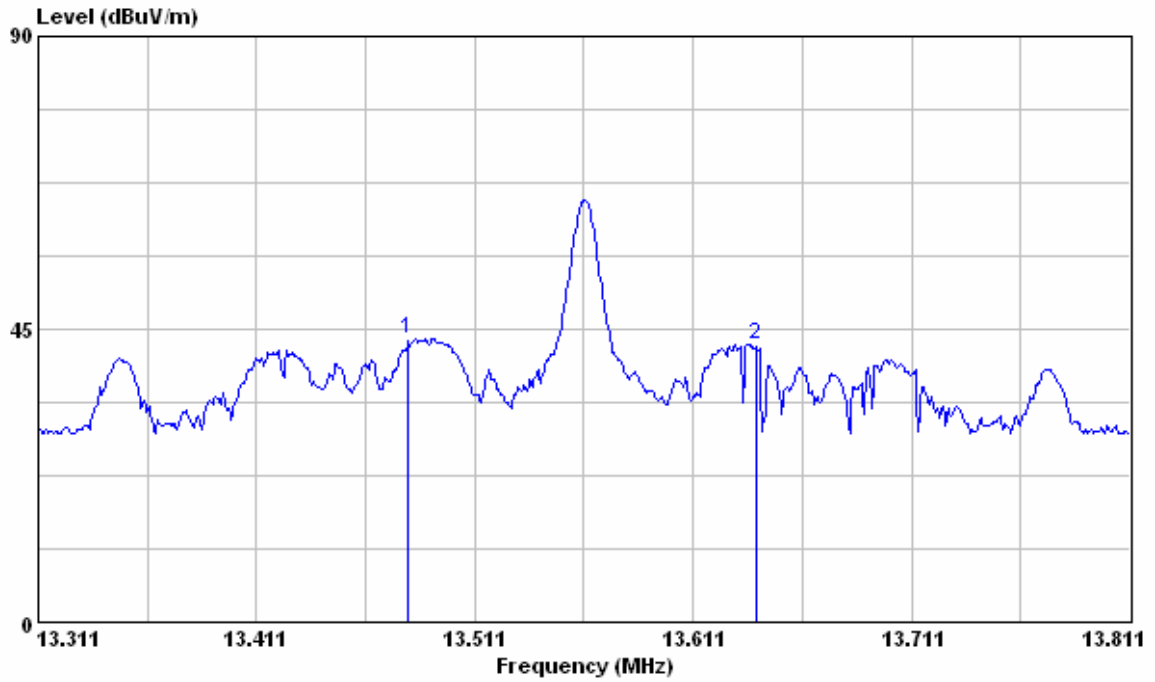

H Polarization

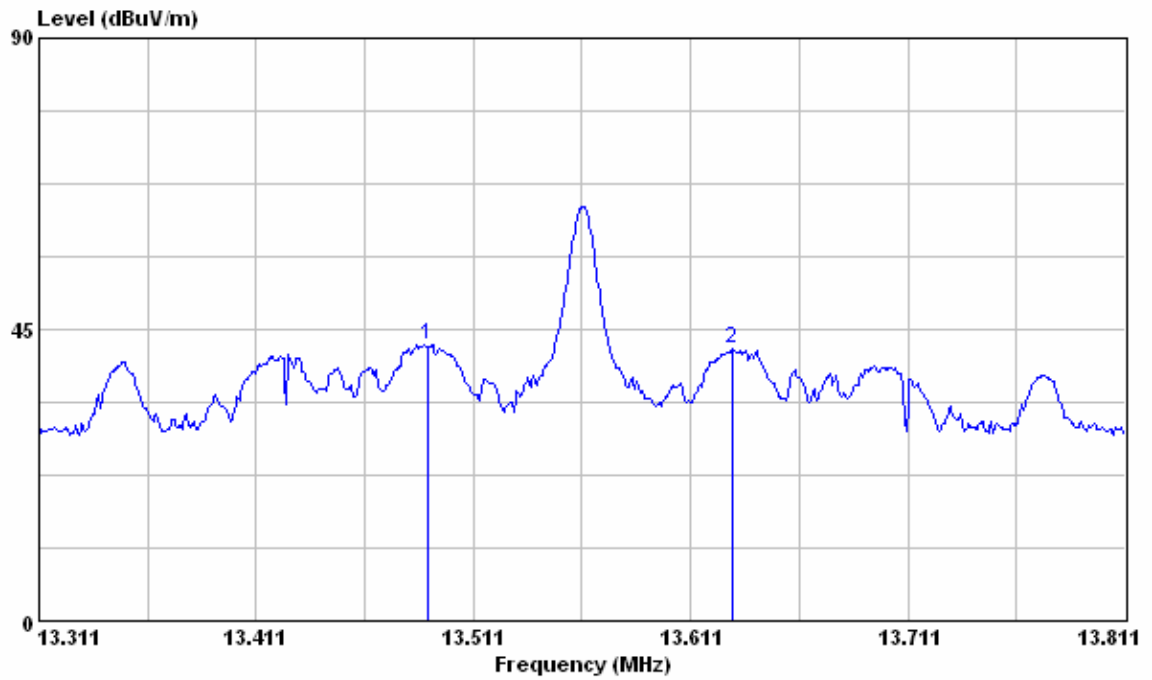

13.110 ~13.410MHz

V Polarization

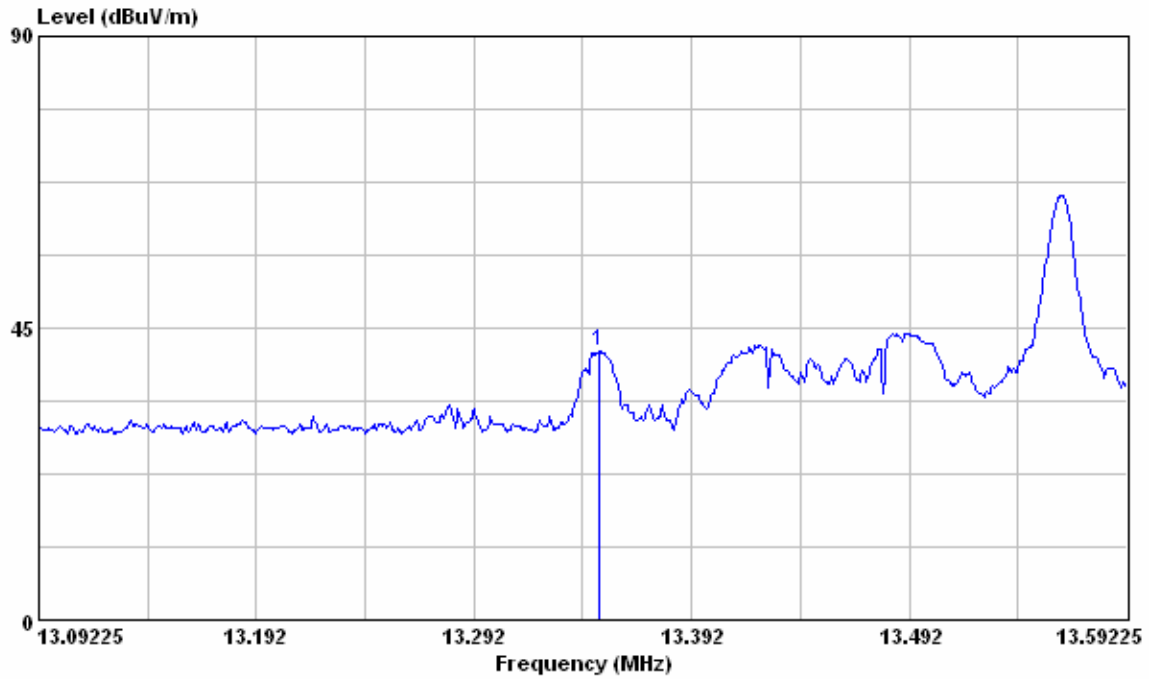

H Polarization

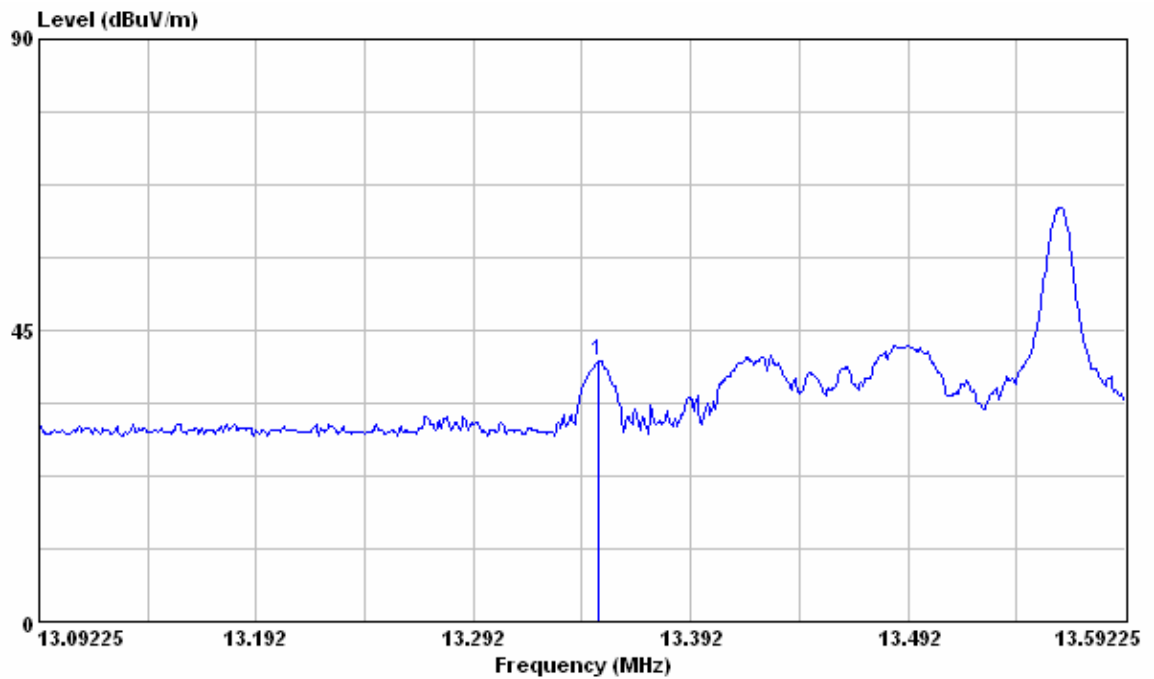

13.710~14.01MHz

V Polarization

Level (dBuV/m)

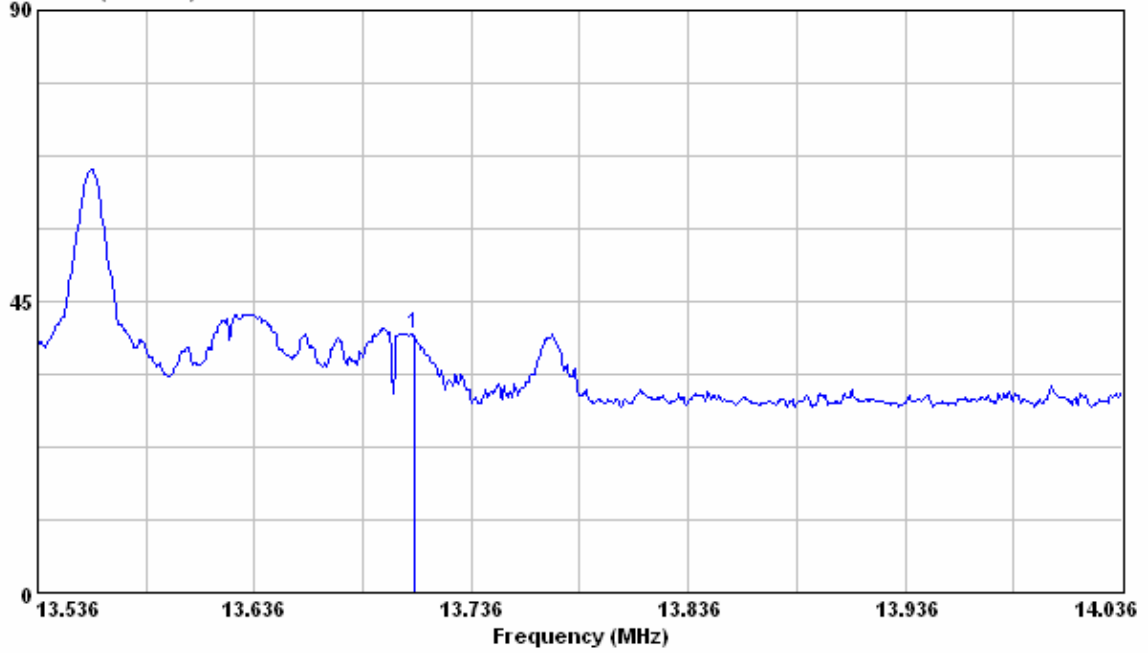

H Polarization

Level (dBuV/m)

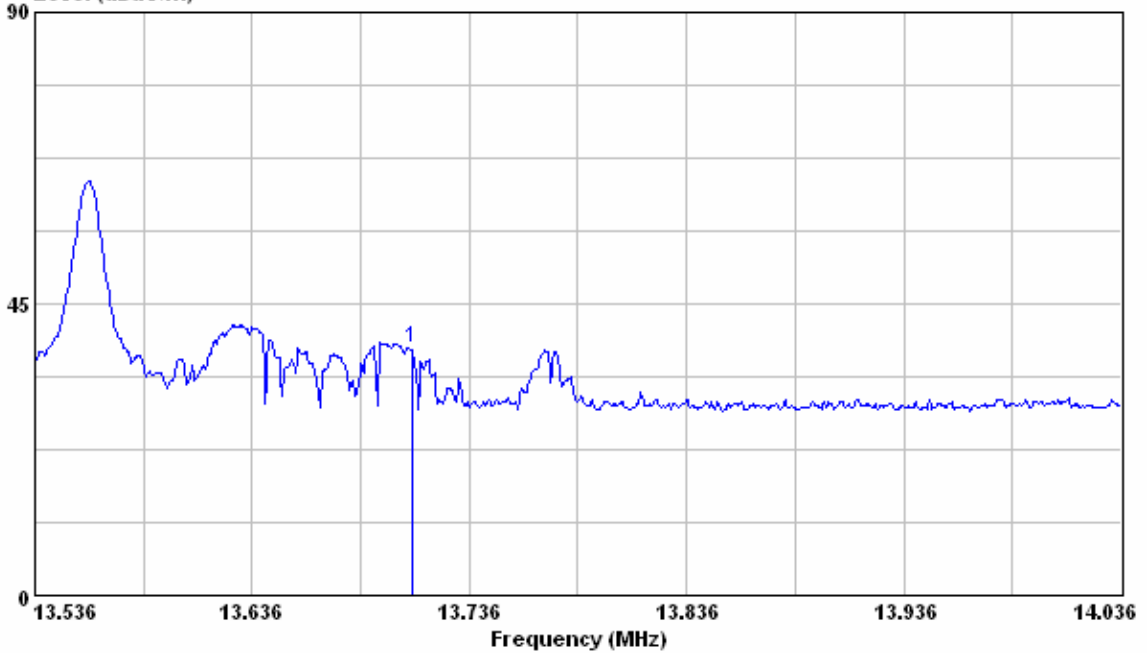

**3 Radiated Emission**

**Result: Pass**

**3.1 Applied Standard**

According to 15.225(d), The field strength of any emissions appearing outside of the 13.110-14.010 MHz band shall not exceed the general radiated emission limits in § 15.209.

<b>Frequency (MHz)</b>	<b>Field Strength (uV/m)</b>	<b>Measurement Distance (m)</b>
0.009 - 0.490	2400/F(kHz)	300
0.490 - 1.705	24000/F(kHz)	30
1.705 - 30.0	30	30
30 - 88	100 **	3
88 - 216	150 **	3
216 - 960	200 **	3
Above 960	500	3

\*\* Except as provided in paragraph (g), fundamental emissions from intentional radiators operating under this Section shall not be located in the frequency bands 54-72 MHz, 76-88 MHz, 174-216 MHz or 470-806 MHz. However, operation within these frequency bands is permitted under other sections of this Part, e.g., Sections 15.231 and 15.241.

**3.2 Test Instruments**

<b>Test Site and Equipment</b>	<b>Manufacturer</b>	<b>Model No./ Serial No.</b>	<b>Last Calibration Date</b>	<b>Calibration Due Date</b>
Semi - anechoic Chamber	ETS. LINDGREN	TR11/ 906-A	2008/6/30	2009/6/29
Spectrum Analyzer	Agilent	E4407B/ MY45106706	2008/3/19	2009/3/18
Antenna	EMCO	6502/20558	2008/8/4	2011/8/3
Broadband Antenna	EMCO	3142C/ 52088	2008/7/27	2009/7/26

Note:

1. The calibrations are traceable to NML/ROC.
2. NCR : No Calibration Required.

**Instrument Setting**

<b>RBW</b>	<b>VBW</b>	<b>Detector</b>	<b>Trace</b>	<b>Comment</b>
9kHz	N/A	Quasi-Peak	Maxhold	Below 30MHz
120kHz	N/A	Quasi-Peak	Maxhold	Below 1GHz

**Climatic Condition**

Ambient Temperature : 24°C; Relative Humidity : 55%

### 3.3 Measurement Procedure

- a. The EUT was set up per the test configuration figured in the next section of this chapter to simulate the typical usage per the user's manual.
- b. A software provided by client enabled the EUT to transmit and receive data at lowest, middle and highest channel frequencies individually.
- c. If the EUT is tabletop equipment, it was placed on a wooden table with a height of 0.8 meters above the reference ground plane in the semi-anechoic chamber. If the EUT is floor-standing equipment, it was placed on a non-conducted support with a height of 12 millimeters above the reference ground plane in the semi-anechoic chamber.
- d. The EUT was set 3m away from the interference receiving antenna.
- e. Rapidly sweep the signal in the test frequency range by using the spectrum through the Maximum-peak detector.
- f. Rotate the EUT from 0° to 360° and position the receiving antenna at heights from 1 to 4 meters above the reference ground plane continuously to determine at least six frequencies associated with higher emission levels and record them.
- g. Then measure each frequency found from step f. by using the spectrum with rotating the EUT and positioning the receiving antenna height to determine the maximum level.
- h. For measurement of frequency above 1000MHz, the beamwidth of receiving horn antenna should keep covering EUT when the receiving horn antenna height varied.
- i. For measurement of frequency above 1000MHz, set the spectrum detector to be Peak or Average to find out the maximum level occurred, if any.
- j. Record frequency, azimuth angle of the turntable, height, and polarization of the receiving antenna and compare the maximum level with the required limit.
- k. Change the receiving antenna to another polarization to measure radiated emission by following step e. to j. again.
- l. If the peak emission level below 1000MHz measured from step f. is 4dB lower than the limit specified, then the emission values presented will be the peak value only. Otherwise, accurate Q.P. value will be measured and presented.
- m. If the peak emission level above 1000MHz measured from step f. is 20dB lower than the limit specified, then the emission values presented will be the peak value only. Otherwise, accurate A.V. value will be measured and presented.

### 3.4 Test Configuration

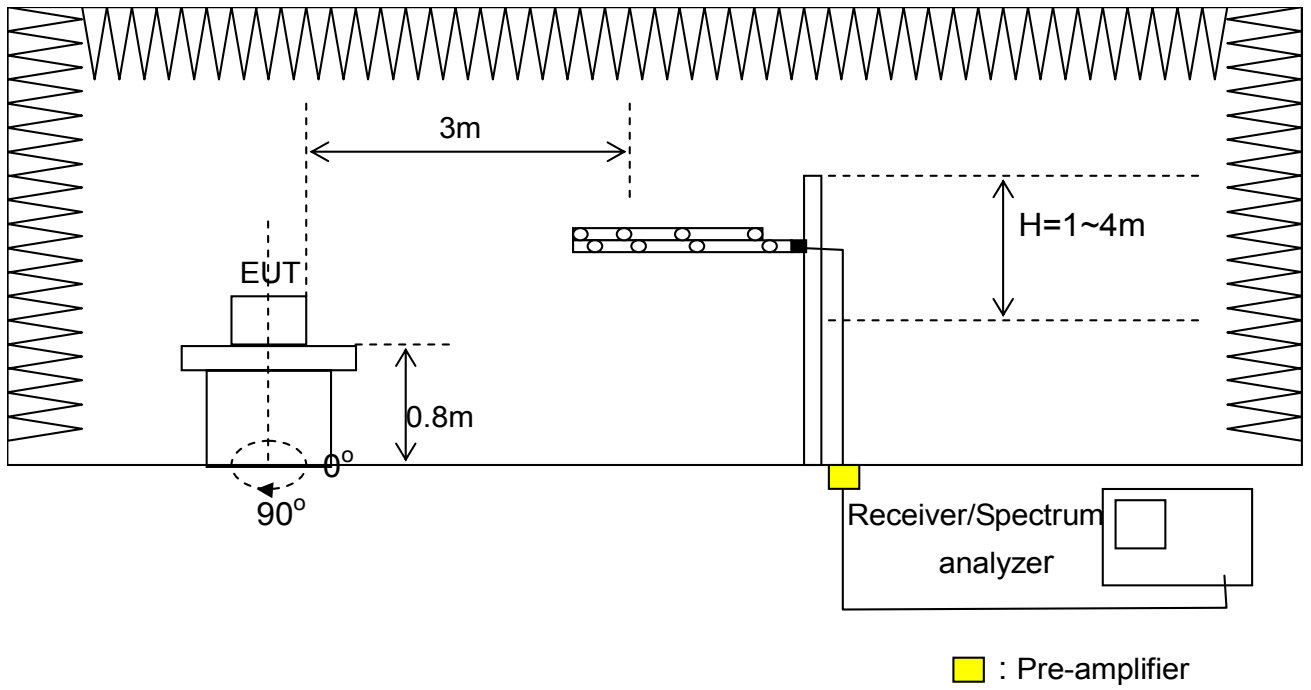

**3.5 Test Data**

**Test Mode** : Continuous Transmitting  
**Test Distance** : 3m **Tester** : Jacky  
**Polarization** : Vertical **Frequency Range** : 10MHz~30MHz

	<b>Freq. (MHz)</b>	<b>Reading Data (dBuV)</b>	<b>Correction Factor (dB/m)</b>	<b>Emission Level (dBuV/m)</b>	<b>Limit (dBuV/m)</b>	<b>Margin (dB)</b>
1	14.80	22.18	13.94	36.12	69.54	33.42
2	18.20	18.49	13.81	32.30	69.54	37.24
3	25.28	18.29	13.11	31.40	69.54	38.14

Note:

1. Correction Factor (dB/m) = Cable Loss + Antenna Factor
2. Emission Level (dBuV/m) = Reading Data + Correction Factor
3. Margin (dB) = Limit – Emission Level
4. The formula transfers the limit at 30 m to 3m is  $L_3 = L_{30} \times (d_{30} / d_3)^2 = L_{30}(\text{dBuV/m}) + 40$

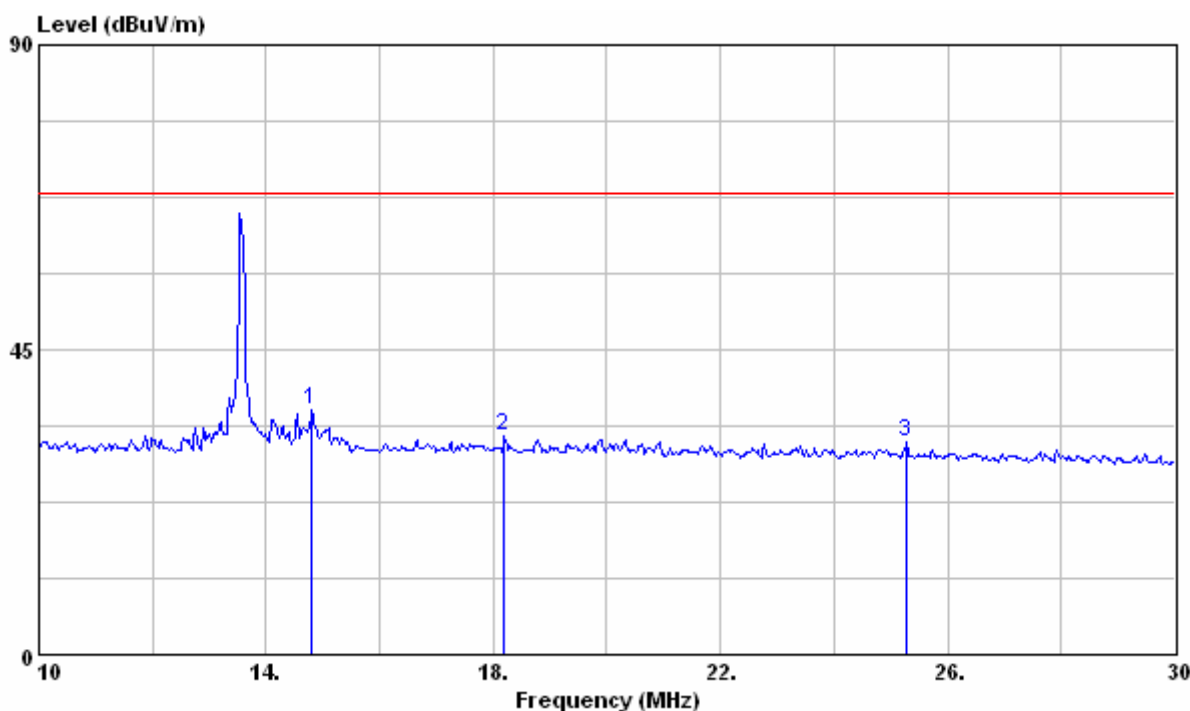



**Test Mode** : Continuous Transmitting  
**Test Distance** :3m **Tester** : Jacky  
**Polarization** : Horizontal **Frequency Range** : 10MHz~30MHz

	<b>Freq. (MHz)</b>	<b>Reading Data (dBuV)</b>	<b>Correction Factor (dB/m)</b>	<b>Emission Level (dBuV/m)</b>	<b>Limit (dBuV/m)</b>	<b>Margin (dB)</b>
1	11.08	17.03	14.04	31.07	69.54	38.47
2	19.90	17.91	13.74	31.65	69.54	37.89
3	25.28	18.29	13.11	31.4	69.54	38.14

Note:

1. Correction Factor (dB/m) = Cable Loss + Antenna Factor
2. Emission Level (dBuV/m) = Reading Data + Correction Factor
3. Margin (dB) = Limit – Emission Level
4. The formula transfers the limit at 30 m to 3m is  $L_3 = L_{30} \times (d_{30} / d_3)^2 = L_{30}(\text{dBuV/m}) + 40$

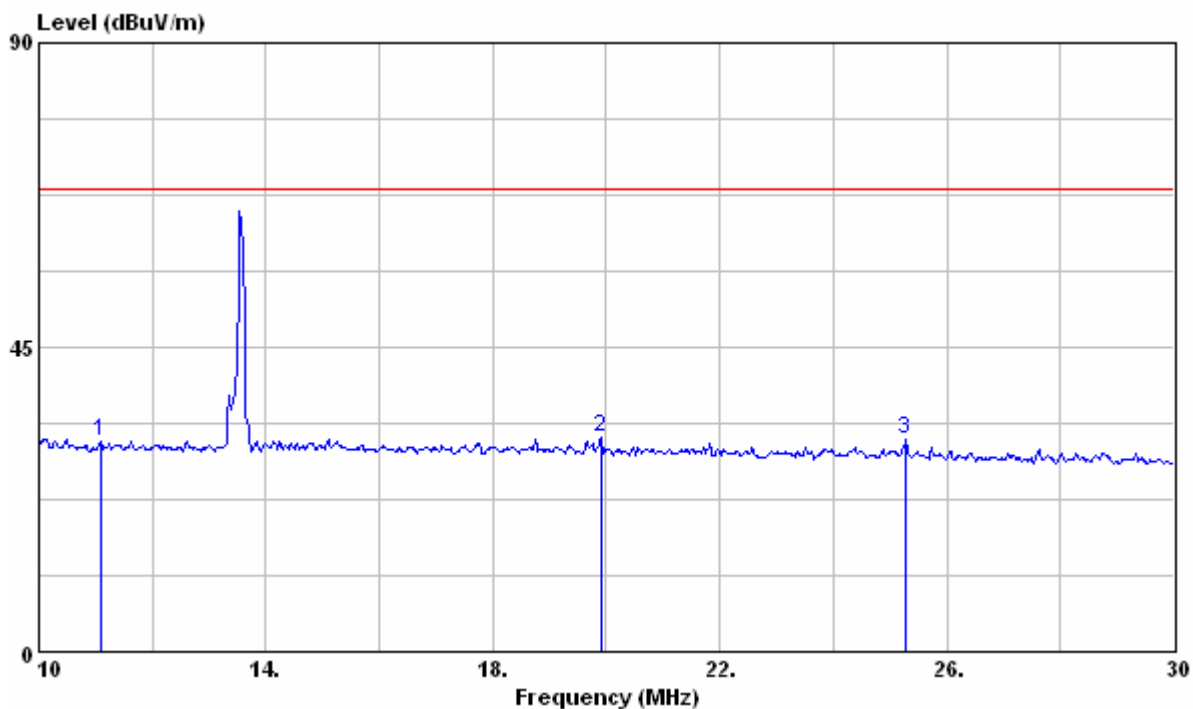

Test Mode : Continuous Transmitting  
 Test Distance : 3m Tester : Jacky  
 Polarization : Vertical Frequency Range : 30MHz~1000MHz

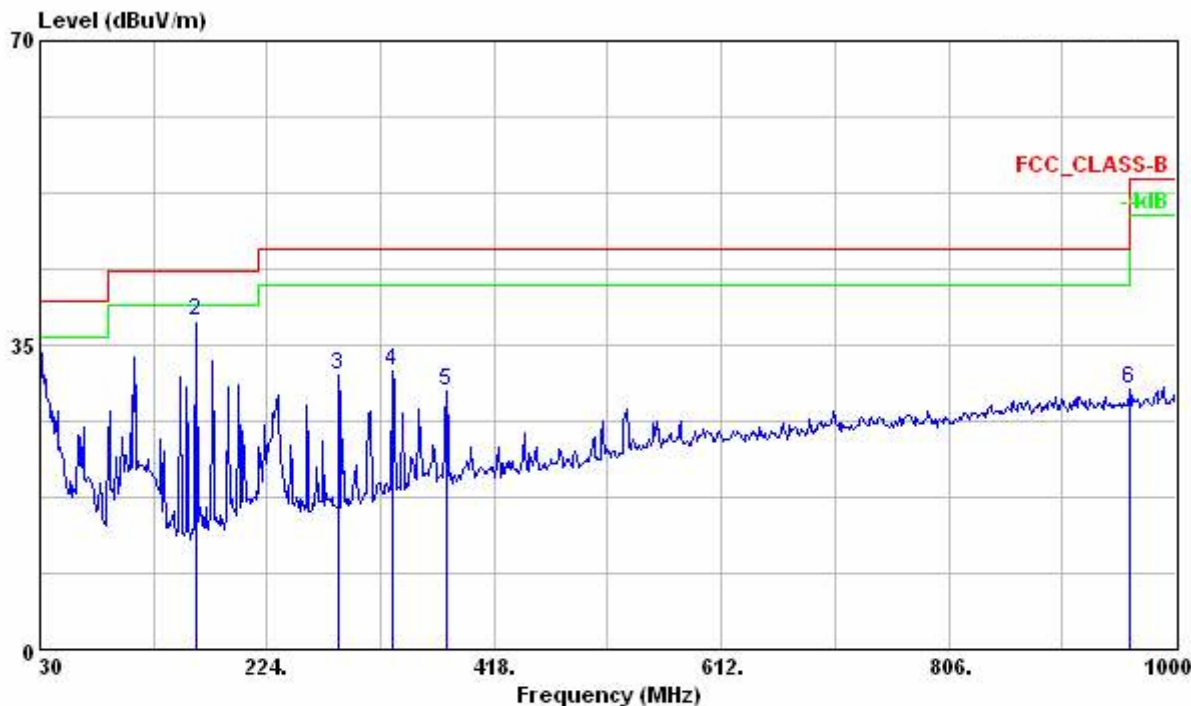

	Freq	Level	Read Level	Limit	Over	Ant	Table	Pol/Phase	Remark
	MHz	dBuV/m	dBuV	dB/m	dBuV/m	dB	cm	deg	
1	30.000	33.84	42.37	-8.53	40.00	-6.16	100	358	VERTICAL QP
2	163.110	37.84	54.85	-17.01	43.50	-5.66	100	184	VERTICAL QP
3	284.880	31.60	44.78	-13.18	46.00	-14.40	---	---	VERTICAL Peak
4	330.800	32.03	43.31	-11.28	46.00	-13.97	---	---	VERTICAL Peak
5	377.260	29.62	39.38	-9.76	46.00	-16.38	---	---	VERTICAL Peak
6	960.800	29.99	30.48	-0.49	54.00	-24.01	---	---	VERTICAL Peak

Note :

1. Correction Factor (dB/m) = Cable Loss + Antenna Factor – Gain of Preamplifier
2. Emission Level (dBuV/m) = Reading Data + Correction Factor

Test Mode : Continuous Transmitting  
 Test Distance :3m Tester : Jacky  
 Polarization : Horizontal Frequency Range : 30MHz~1000MHz

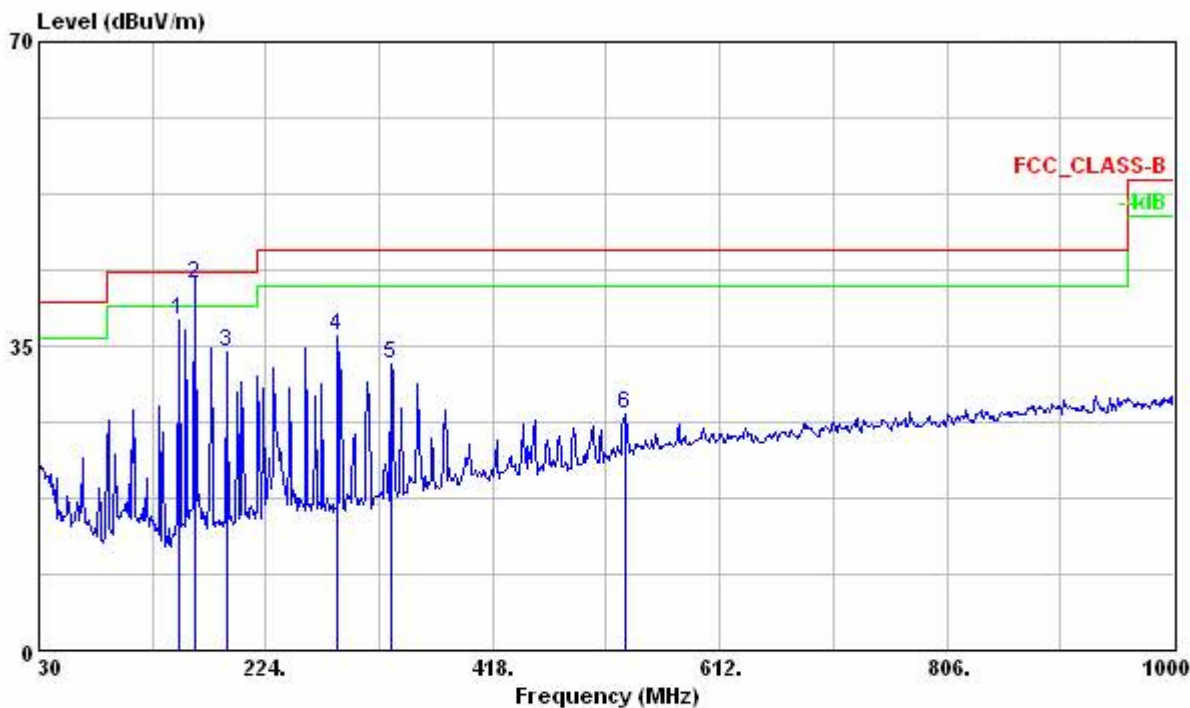

	Freq	Level	Read Level	Factor	Limit Line	Over Limit	Ant Pos	Table Pos	Pol/Phase	Remark
	MHz	dBuV/m	dBuV	dB/m	dBuV/m	dB	cm	deg		
1	149.610	37.96	55.80	-17.84	43.50	-5.54	200	110	HORIZONTAL	QP
2	162.708	42.09	59.12	-17.03	43.50	-1.41	202	101	HORIZONTAL	QP
3	190.110	34.33	50.32	-15.99	43.50	-9.17	---	---	HORIZONTAL	Peak
4	284.880	36.10	49.28	-13.18	46.00	-9.90	---	---	HORIZONTAL	Peak
5	330.800	33.00	44.28	-11.28	46.00	-13.00	---	---	HORIZONTAL	Peak
6	531.000	27.15	33.38	-6.23	46.00	-18.85	---	---	HORIZONTAL	Peak

Note :

1. Correction Factor (dB/m) = Cable Loss + Antenna Factor – Gain of Preamplifier
2. Emission Level (dBuV/m) = Reading Data + Correction Factor

**4 Frequency Tolerance**

**Result: Pass**

**4.1 Applied Standard**

According to 15.225(e), the frequency tolerance of the carrier signal shall be maintained within +/- 0.01% of the operating frequency over a temperature variation of -20 degrees to +50 degrees C at normal supply voltage, and for a variation in the primary supply voltage from 85% to 115% of the rated supply voltage at a temperature of 20 degrees C. For battery operated equipment, the equipment tests shall be performed using a new battery.

**4.2 Test Instruments**

<b>Test Site and Equipment</b>	<b>Manufacturer</b>	<b>Model No./ Serial No.</b>	<b>Last Calibration Date</b>	<b>Calibration Due Data</b>
Spectrum Analyzer	Agilent	E4405B/ MY45106706	2008/3/25	2009/3/24
Temperature Chamber	Terchy	MHG-800LF/ 920224	2008/8/7	2009/8/6
Chamber	N.A.	TR13	NCR	NCR

Note:

1. The calibrations are traceable to NML/ROC.
2. NCR : No Calibration Required.

**Instrument Setting**

<b>RBW</b>	<b>VBW</b>	<b>Detector</b>	<b>Trace</b>	<b>Comment</b>
300Hz	1kHz	Peak	Maxhold	

**Climatic Condition**

Ambient Temperature : 24°C; Relative Humidity : 55%

### 4.3 Measurement Procedure

- a. The EUT was set up per the test configuration figured in the next section of this chapter and to simulate the typical usage described in the user's manual supported by the manufacturer in shielded room TR13.
- b. Measure the frequency tolerance by using the spectrum analyzer and following the test conditions described in FCC 15.225(e) to perform the normal and extreme test conditions tests.
- c. Record the level and compare with the required limit.

### 4.4 Test Configuration

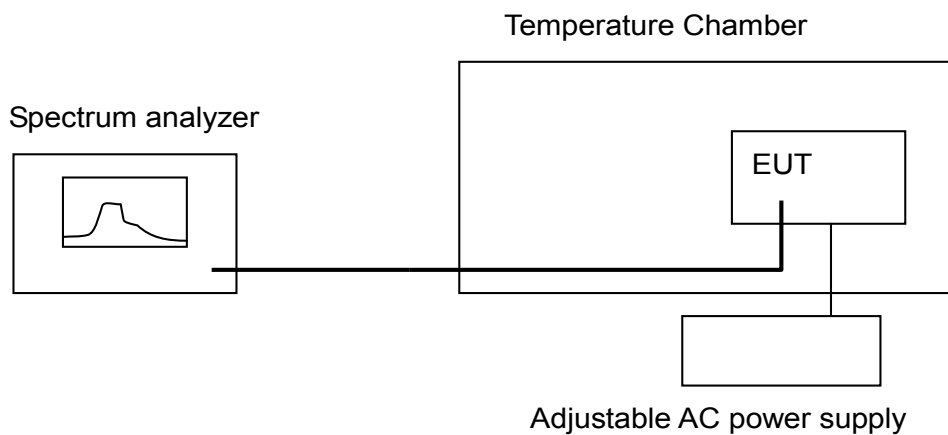

4.5 Test Data

Test Mode : Continuous Transmitting

Tester : Bill

Temperature (°C)	AC Voltage (Volt)	Meas. Frequency (MHz)	Deviation (kHz)	Limit (kHz)	Margin (kHz)
20°C	120	13.56039	NA	NA	NA
	138	13.56039	0	1.356	1.356
	102	13.56039	0	1.356	1.356
-20°C	120	13.56056	0.17	1.356	1.186
50°C	120	13.56027	0.12	1.356	1.236

Note:

1. Deviation(kHz) = | Meas. Frequency – Meas. Frequency @20°C/120Vac |
2. Margin (kHz)= Limit – Deviation

20°C, 120Vac

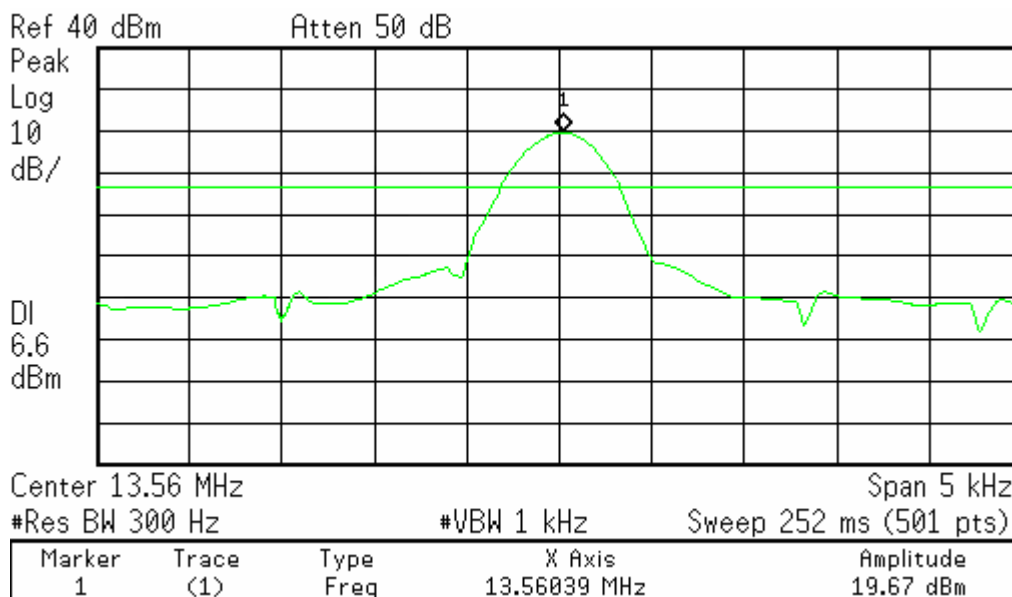

20°C, 138Vac

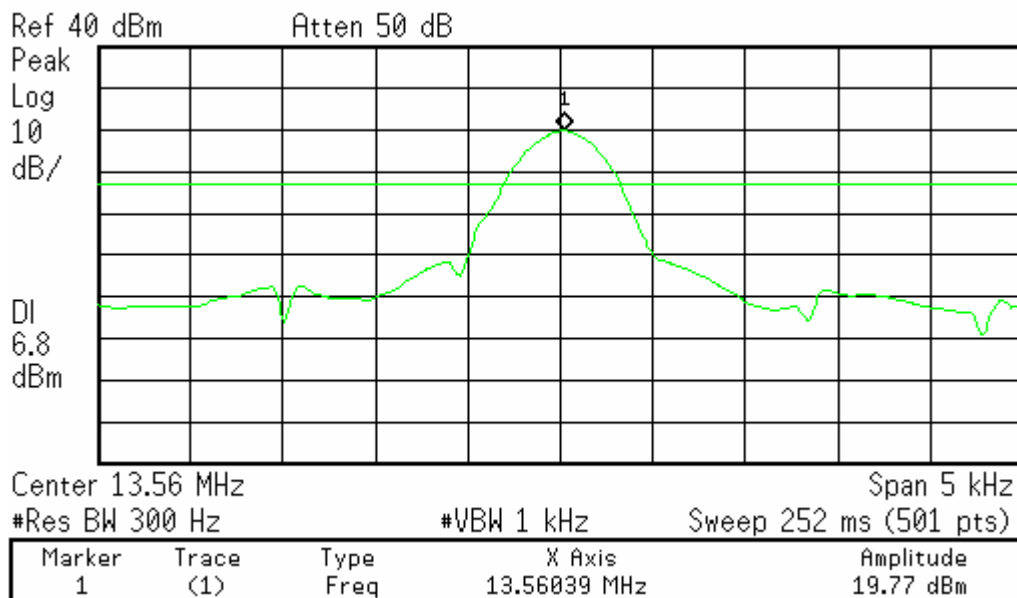

20°C, 102Vac

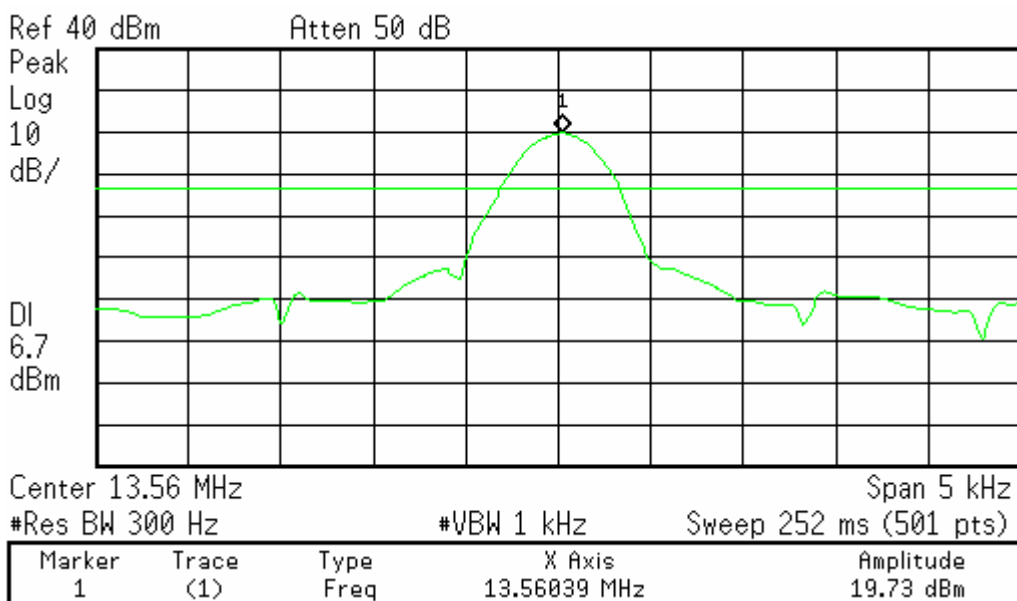

**-20°C, 120Vac**

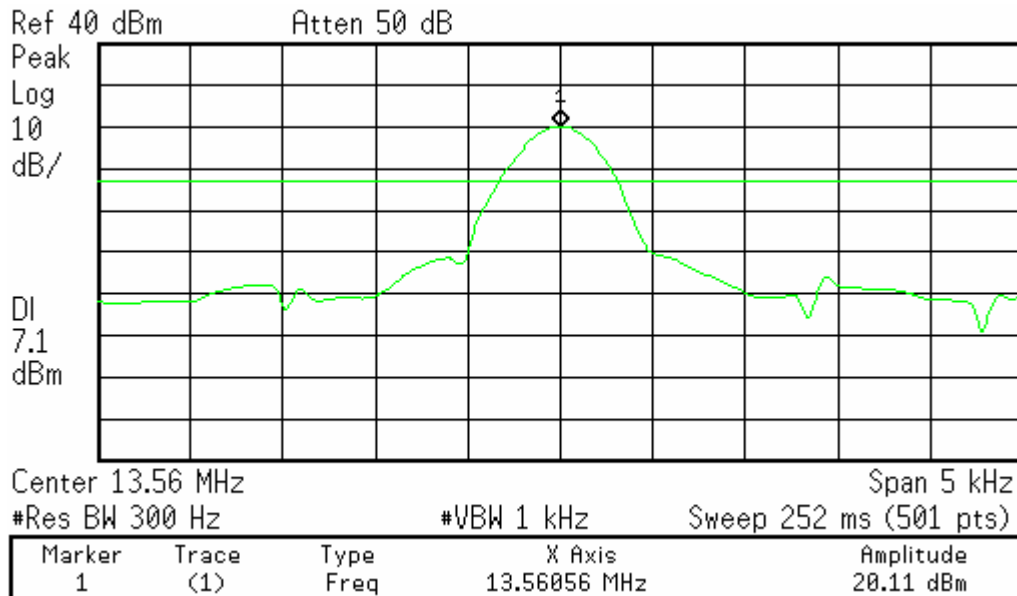

**50°C, 120Vac**

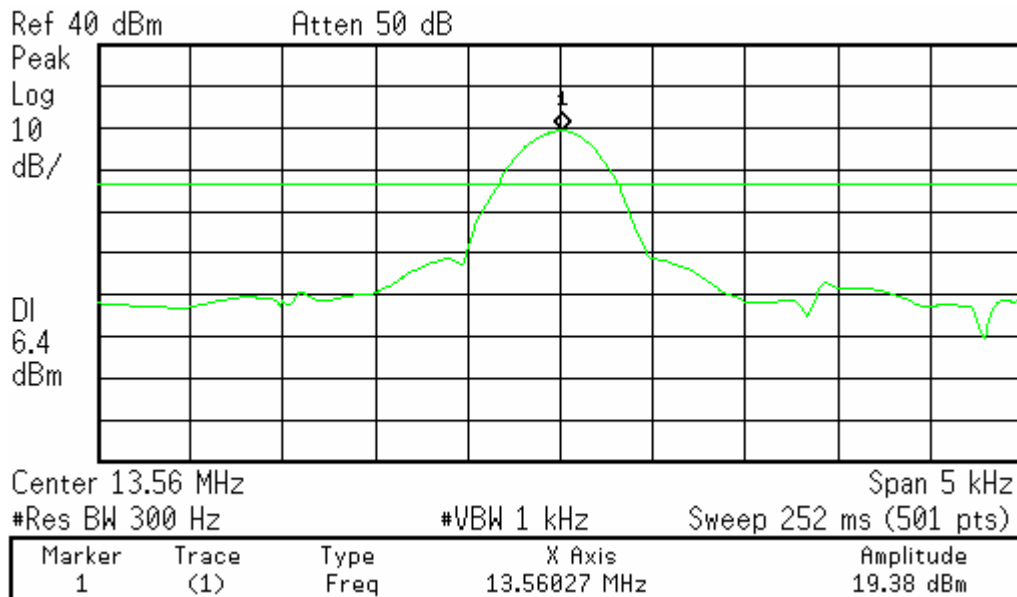



**5 20dB Bandwidth**

**Result: Pass**

**5.1 Applied Standard**

According to 15.215(c) requires the device must be designed to ensure that the 20 dB bandwidth of the emission, or whatever bandwidth may otherwise be specified in the specific rule section under which the equipment operates.

According to 15.225, Operation within the band 13.110 – 14.010 MHz.

**5.2 Test Instruments**

<b>Test Site and Equipment</b>	<b>Manufacturer</b>	<b>Model No./ Serial No.</b>	<b>Last Calibration Date</b>	<b>Calibration Due Data</b>
Spectrum Analyzer	Agilent	E4405B/ MY45106706	2008/3/25	2009/3/24
Chamber	N.A.	TR13	NCR	NCR

Note:

1. The calibrations are traceable to NML/ROC.
2. NCR : No Calibration Required.

**Instrument Setting**

<b>RBW</b>	<b>VBW</b>	<b>Detector</b>	<b>Trace</b>	<b>Comment</b>
300Hz	1kHz	Peak	Maxhold	

**Climatic Condition**

Ambient Temperature : 24°C; Relative Humidity : 55%

### 5.3 Measurement Procedure

- a. The EUT was set up per the test configuration figured in the next section of this chapter and to simulate the typical usage described in the user's manual supported by the manufacturer in chamber TR13.
- b. Measure the 20dB bandwidth by using the spectrum analyzer and following the test conditions described in FCC 15.215.
- c. Record the level and compare with the required limit.

### 5.4 Test Configuration



5.5 Test Data

Test Mode : Continuous Transmitting  
 Tester : Bill

Operating Frequency (MHz)	The latest frequency (MHz)	The highest frequency (MHz)	Limit (MHz)
13.56	13.55995	13.56073	13.110~14.01

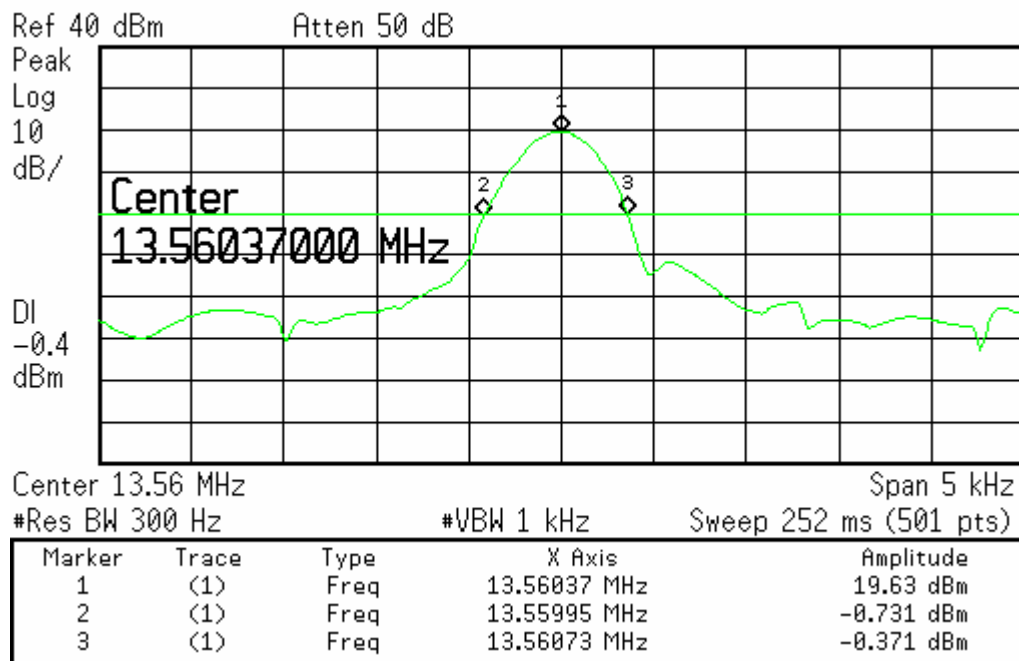

## 6 Conducted Emission Measurement

Test Result: Pass

### 6.1 Limits for Emission Measurement

For intentional device, according to §15.207(a) line conduction emission limit is as below table.

Frequency of Emission (MHz)	Conducted Limit (dBuV)	
	Quasi-peak	Average
0.15 – 0.5	66 to 56*	56 to 46*
0.5 - 5	56	46
5 - 30	60	50

\* Decreases with the logarithm of the frequency.

Note:

For a device with a permanent antenna operating at or below 30 MHz, the FCC will accept measurements done with a suitable dummy load, in lieu of the permanent antenna under the following conditions: (1) perform the AC line conducted tests with the permanent antenna to determine compliance with the Section 15.207 limits outside the transmitter's fundamental emission band; (2) retest with a dummy load in lieu of the permanent antenna to determine compliance with the Section 15.207 limits within the transmitter's fundamental emission band.

## 6.2 Test Instruments

Test Site and Equipment	Manufacturer	Model No./ Serial No.	Last Calibration Date	Calibration Due Date
Test Receiver	R&S	ESCI 30/ 836858/021	2008/1/11	2009/1/10
LISN	R&S	ESH2-Z5/ 836613/001	2008/1/7	2009/1/6
2 <sup>nd</sup> LISN	R&S	ENV4200/ 833209/010	2008/1/14	2009/1/13
50Ω terminator	N/A	N/A/ 001	2008/8/26	2009/8/25
RF Switch	N/A	RSU28/ 338965/002	2008/3/3	2009/3/2
RF Cable	N/A	N/A/ C0052 ~ 56	2008/3/3	2009/3/2
Test Software	Audix	e3/ Ver. 5.4.219.f	NCR	NCR
TR5 shielded room	ETS LINDGREN	TR5/ 15353-F	NCR	NCR

Note:

1. The calibrations are traceable to NML/ROC.
2. NCR : No Calibration Required.

### Instrument Setting

IF BW	Measurement Time	Detector	Trace	Comment
9kHz	1 second	Quasi-Peak / Average	Maxhold	

### Climatic Condition

Ambient Temperature : 27°C;      Relative Humidity : 65%

### 6.3 Test Procedures

- a. The EUT was set up per the test configuration figured in the next section of this chapter to simulate the typical usage per the user's manual.
- b. If the EUT is tabletop equipment, it was placed on a non-conducted table with a height of 0.8 meters above the reference ground plane and 0.4 meters from the conducting wall of the shielded room. Also if the EUT is floor-standing equipment, it was placed on a non-conducted support with a height of 12 millimeters above the reference ground plane.
- c. Connect the EUT's power source to the appropriate power mains through the LISN.
- d. All the other peripherals are connected to the 2<sup>nd</sup> LISN, if any.
- e. The LISN was placed 0.8 meters from the EUT and at least 0.8 meters from other units and other metal planes.
- f. Measure the conducted emissions on each power line (Neutral Line and Line 1 – Hot side) of the EUT's power source by using the test receiver connected to the coupling RF output port of LISN.
- g. Rapidly scan the signal from 150kHz to 30MHz by using the receiver through the Maximum-Peak detector to determine those frequencies associated with higher emission levels for each measured line.
- h. Then measure the maximum level of conducted disturbance for each frequency found from step g. by using the receiver through the Quasi-Peak and Average detectors per CISPR 16-1.
- i. Record the level for each frequency and compare with the required limit.

### 6.4 Test Configurations

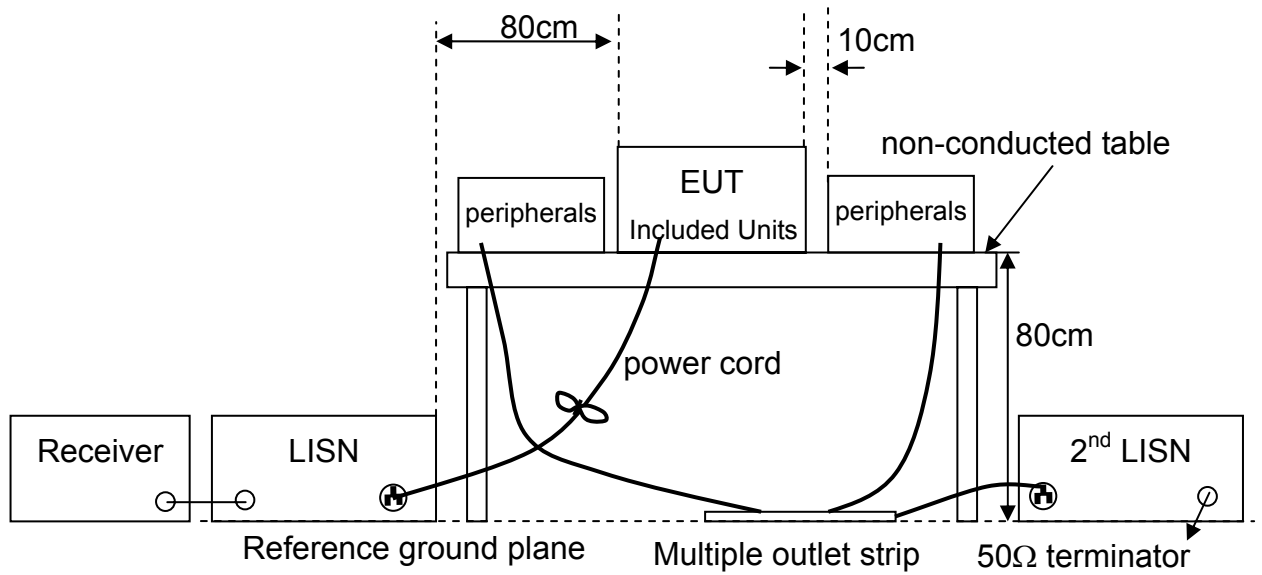

6.5 Test Results

Test Mode : Continuous Transmitting,with antenna  
Tester : CDC Frequency Range : 150kHz~30MHz  
Phase : Line

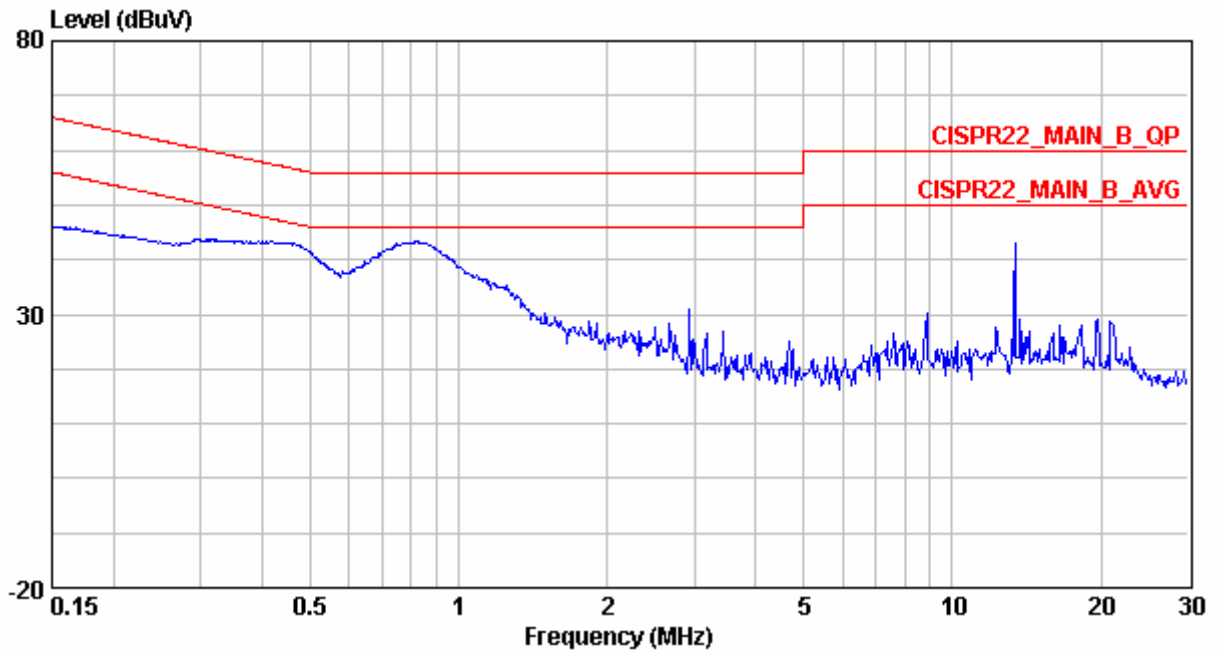

Note:  
Tx Fundamental, for reference only. Please refer to next page.



Test Mode : Continuous Transmitting, with dummy load  
 Tester : CDC Frequency Range : 150kHz~30MHz  
 Phase : Line

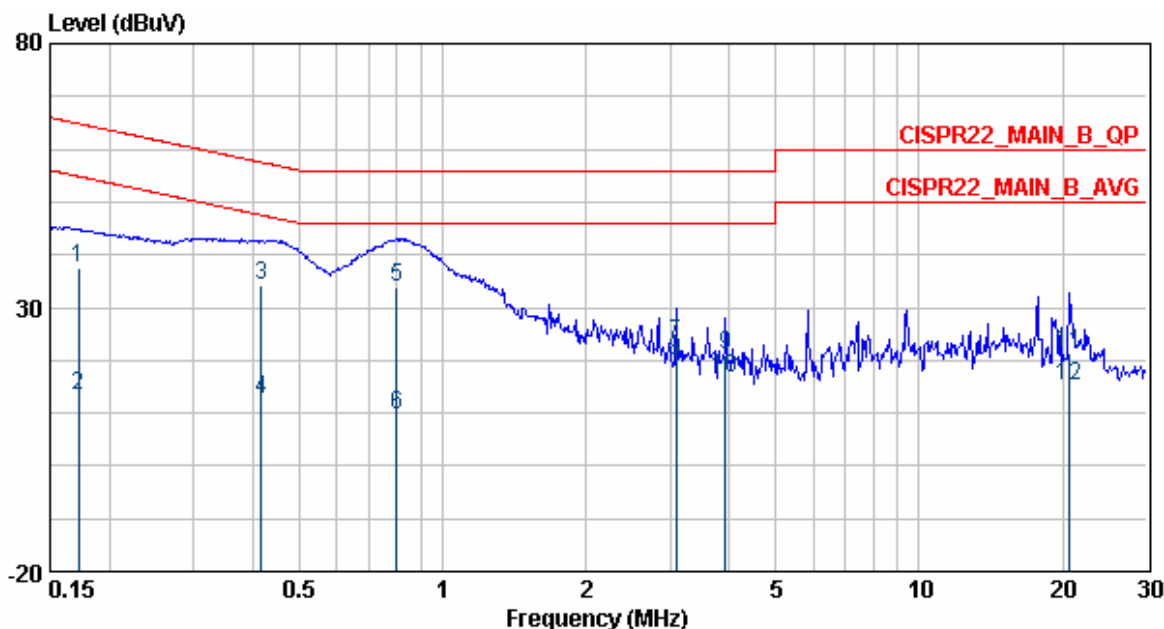

	Freq	Level	Factor	Read	Limit	Over	Ant		Remark
				Level	Line	Limit	Pos	Pol/Phase	
	MHz	dBuV	dB	dBuV	dBuV	dB	cm		
1	0.17	37.60	0.14	37.46	64.86	-27.26	---	LINE	QP
2	0.17	13.26	0.14	13.12	54.86	-41.60	---	LINE	AVERAGE
3	0.42	34.05	0.15	33.90	57.51	-23.46	---	LINE	QP
4	0.42	12.47	0.15	12.32	47.51	-35.04	---	LINE	AVERAGE
5 Q	0.80	33.87	0.19	33.68	56.00	-22.13	---	LINE	QP
6	0.80	9.83	0.19	9.64	46.00	-36.17	---	LINE	AVERAGE
7	3.09	23.33	0.32	23.01	56.00	-32.67	---	LINE	QP
8	3.09	19.92	0.32	19.60	46.00	-26.08	---	LINE	AVERAGE
9	3.92	21.08	0.38	20.70	56.00	-34.92	---	LINE	QP
10	3.92	16.52	0.38	16.14	46.00	-29.48	---	LINE	AVERAGE
11	20.59	21.29	0.63	20.66	60.00	-38.71	---	LINE	QP
12	20.59	15.18	0.63	14.55	50.00	-34.82	---	LINE	AVERAGE

Note:

1. Emission Level = reading value + correction factor.
2. Correction factor = cable loss + insertion loss of LISN.
3. Q.P. is abbreviation of quasi-peak.

**Test Mode** : Continuous Transmitting, with antenna  
**Tester** : CDC **Frequency Range** : 150kHz~30MHz  
**Phase** : Neutral

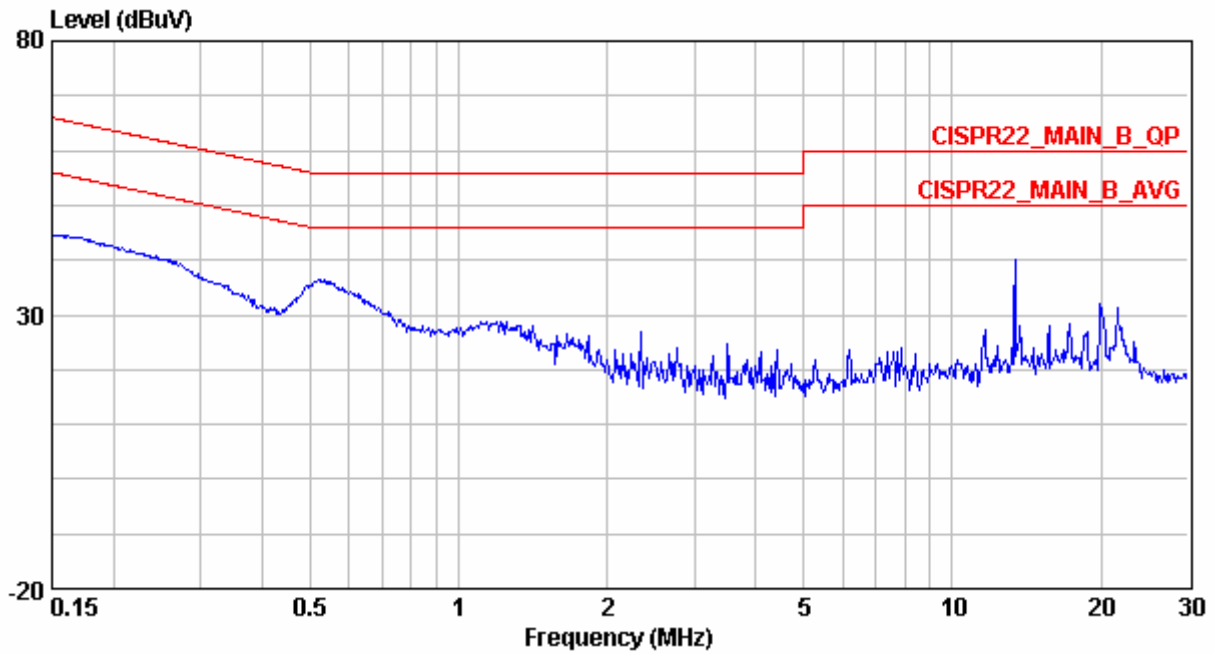

Note:

**Tx Fundamental, for reference only. Please refer to next page.**

Test Mode : Continuous Transmitting, with dummy load  
 Tester : CDC Frequency Range : 150kHz~30MHz  
 Phase : Neutral

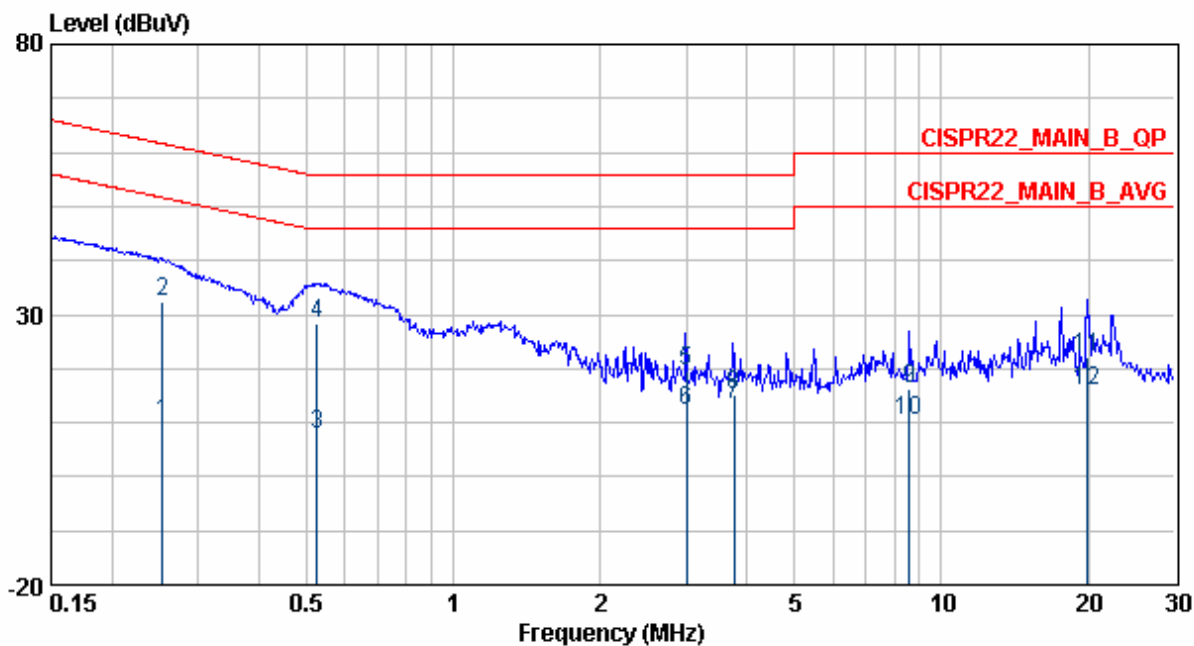

	Freq	Level	Factor	Read Level	Limit Line	Over Limit	Ant Pos	Pol/Phase	Remark
	MHz	dBuV	dB	dBuV	dBuV	dB	cm		
1	0.25	10.18	0.16	10.02	51.64	-41.46	---	NEUTRAL	AVERAGE
2	0.25	32.47	0.16	32.31	61.64	-29.17	---	NEUTRAL	QP
3	0.53	7.75	0.17	7.58	46.00	-38.25	---	NEUTRAL	AVERAGE
4 B	0.53	28.17	0.17	28.00	56.00	-27.83	---	NEUTRAL	QP
5	3.00	19.74	0.34	19.40	56.00	-36.26	---	NEUTRAL	QP
6	3.00	12.40	0.34	12.06	46.00	-33.60	---	NEUTRAL	AVERAGE
7	3.75	13.20	0.38	12.82	46.00	-32.80	---	NEUTRAL	AVERAGE
8	3.75	15.27	0.38	14.89	56.00	-40.73	---	NEUTRAL	QP
9	8.59	16.10	0.68	15.42	60.00	-43.90	---	NEUTRAL	QP
10	8.59	10.31	0.68	9.63	50.00	-39.69	---	NEUTRAL	AVERAGE
11	19.84	22.24	1.32	20.92	60.00	-37.76	---	NEUTRAL	QP
12	19.84	15.88	1.32	14.56	50.00	-34.12	---	NEUTRAL	AVERAGE

Note:

1. Emission Level = reading value + correction factor.
2. Correction factor = cable loss + insertion loss of LISN.
3. Q.P. is abbreviation of quasi-peak.