

RF Test Report

Applicant : Uniform Industrial Corp.
Product Name : Reader
Trade Name : UIC
Model Number : UIC680VG
Applicable Standard : FCC 47 CFR PART 15 SUBPART C
ANSI C63.10:2013
Received Date : Mar. 03, 2022
Test Period : Mar. 25 ~ Mar. 26, 2022
Issued Date : Apr. 13, 2022

Issued by

A Test Lab Techno Corp.
No. 140-1, Changan Street, Bade District,
Taoyuan City 334025, Taiwan (R.O.C.)
Tel : +886-3-2710188 / Fax : +886-3-2710190



Taiwan Accreditation Foundation accreditation number: 1330
Frequency Range : 9 kHz to 40 GHz
Test Firm MRA designation number: TW0010

Note:

- 1.The test results are valid only for samples provided by customers and under the test conditions described in this report.
- 2.This report shall not be reproduced except in full, without the written approval of A Test Lab Technology Corporation.
- 3.The relevant information is provided by customers in this test report. According to the correctness, appropriateness or completeness of the information provided by the customer, if there is any doubt or error in the information which affects the validity of the test results, the laboratory does not take the responsibility.

Revision History

Rev.	Issued Date	Revisions	Revised By
00	Apr. 13, 2022	Initial Issue	Vivien Li

Verification of Compliance

Applicant : Uniform Industrial Corp.
Product Name : Reader
Trade Name : UIC
Model Number : UIC680VG
FCC ID : TFJ680VG
Applicable Standard : FCC 47 CFR PART 15 SUBPART C
ANSI C63.10:2013
Test Result : Complied

Performing Lab. : A Test Lab Techno Corp.
No. 140-1, Changan Street, Bade District,
Taoyuan City 334025, Taiwan (R.O.C.)
Tel : +886-3-2710188 / Fax : +886-3-2710190
Taiwan Accreditation Foundation accreditation number: 1330
<http://www.atl-lab.com.tw/e-index.htm>



A Test Lab Techno Corp. tested the above equipment in accordance with the requirements set forth in the above standards. All indications of Pass/Fail in this report are opinions expressed by A Test Lab Techno Corp. based on interpretations and/or observations of test results. The test results show that the equipment tested is capable of demonstrating compliance with the requirements as documented in this report.

Approved By :

(Kai Yu Yang)

TABLE OF CONTENTS

1	General Information	5
1.1.	Summary of Test Result.....	5
1.2.	Measurement Uncertainty.....	5
2	EUT Description	6
3	Test Methodology	7
3.1.	Mode of Operation	7
3.2.	EUT Test Step.....	7
3.3.	Configuration of Test System Details	8
3.4.	Test Instruments	9
3.5.	Test Site Environment.....	13
4	Measurement Procedure	14
4.1.	AC Power Line Conducted Emission Measurement	14
4.2.	Radiated Emission Measurement.....	16
4.3.	Frequency Stability Measurement.....	20
4.4.	20 dB Bandwidth Measurement.....	21
4.5.	Antenna Requirement.....	22
5	Test Results	23
5.1	Conducted Emission	23
5.2	Conducted Test Results	25
5.3	Radiated Emission Measurement	27

Appendix A. Test Setup Photographs

1 General Information

1.1. Summary of Test Result

Standard	Item	Results	Remark
15.203	Antenna Requirement	Meet Require	---
15.207(a)	Conducted Emissions Voltage	PASS	---
15.225 (a), (b), (c), (d) 15.209	Radiated Emission Limits	PASS	---
15.225(e)	Frequency Stability	PASS	---
15.215(c)	20 dB Bandwidth	-----	---
CFR 47 Part 15.225 / ANSI C63.10:2013			

Standard	Description
CFR47, Part 15, Subpart C	Intentional Radiators
ANSI C63. 10: 2013	American National Standard of Procedures for Compliance Testing of Unlicensed Wireless Devices

Decision Rule

- Uncertainty is not included.
- Uncertainty is included.

1.2. Measurement Uncertainty

Test Item	Frequency Range	Uncertainty
Conducted Emission	150 kHz ~ 30 MHz	2.7 dB
Radiated Emission	9 kHz ~ 30 MHz	2.2 dB
	30 MHz ~ 1000 MHz	5.1 dB
	1000 MHz ~ 18000 MHz	5.2 dB
	18000 MHz ~ 26500 MHz	4.6 dB
	26500 MHz ~ 40000 MHz	4.6 dB
RF Bandwidth		4.7 %
Frequency Stability		1.3×10^{-7}

2 EUT Description

Applicant	Uniform Industrial Corp. 2901 Bayview Dr, Fremont, CA 94538
Product Name	Reader
Trade Name	UIC
Model Number	UIC680VG
FCC ID	TFJ680VG
Frequency Range	13.56 MHz
Modulation Type	ASK
Number of Channels	1 Channel
Antenna Type	Loop Antenna
Operate Temp. Range	-25 ~ +70 °C
EUT Power Rating	DC 5 V, 500 mA

Test Methodology

2.1. Mode of Operation

The following test mode(s) were scanned during the preliminary test :

Test Mode
Mode 1: Continuous TX Mode

After verification, all tests were carried out with the worst case test modes.

ATL has verified the construction and function in typical operation. All the test modes were carried out with the EUT in normal operation.

2.2. EUT Test Step

1.	Setup the EUT shown on "Configuration of Test System Details."
2.	Turn on the power of all equipment.
3.	The EUT will start to operate function.

2.3. Configuration of Test System Details

Conducted Emission & Radiated Emissions

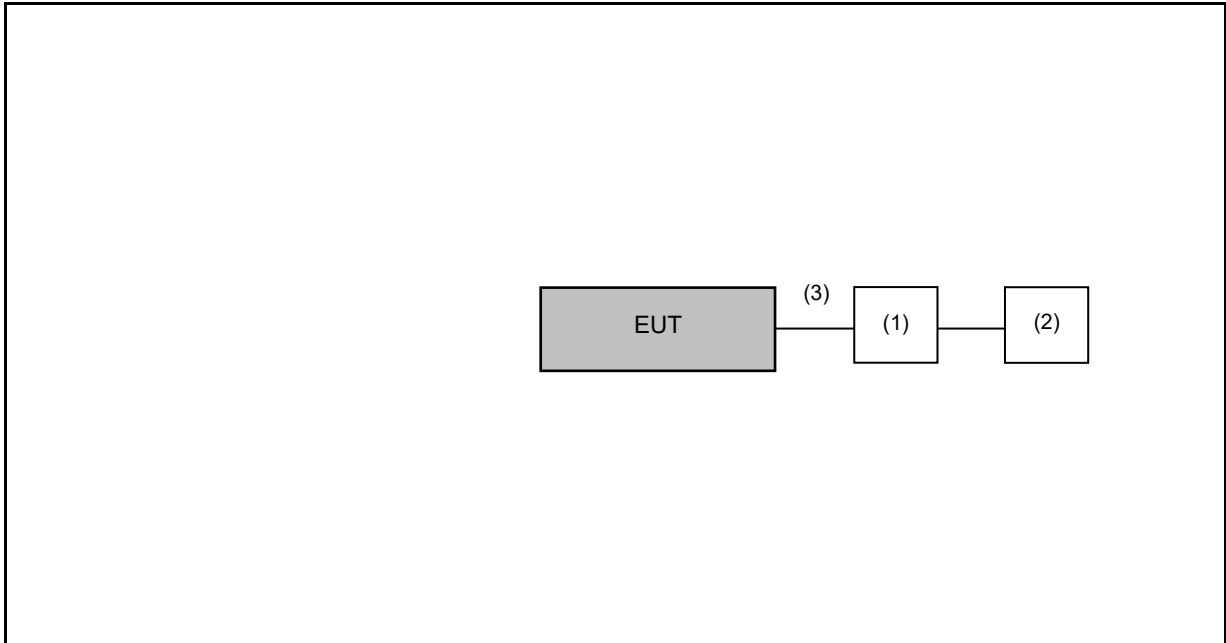

Devices Description					
	Product	Manufacturer	Model Number	Serial Number	Power Cord
(1)	Notebook	ASUS	P2430U	---	---
(2)	AC Adapter	ASUS	ADP-65GD D		
(3)	USB Cable	CHI RUEY Co.,LTD	5611710000-R	---	---

2.4. Test Instruments

For Conducted Emission

Test Period: Mar. 26, 2022

Testing Engineer: Chi Chang

Use	Equipment	Manufacturer	Model Number	Serial Number	Cal. Date	Cal. Period
<input checked="" type="checkbox"/>	Test Receiver	R&S	ESCI	100367	May 21, 2021	1 year
<input type="checkbox"/>	Test Receiver	R&S	ESCI	100722	Nov. 02, 2021	1 year
<input type="checkbox"/>	Test Receiver	R&S	ESCI	101000	Nov. 26, 2021	1 year
<input checked="" type="checkbox"/>	LISN	R&S	ENV216	101040	Mar. 29, 2021	1 year
<input checked="" type="checkbox"/>	LISN	R&S	ENV216	101041	Apr. 08, 2021	1 year
<input checked="" type="checkbox"/>	RF Cable	Woken	00100D1380194M	TE-02-03	May 28, 2021	1 year
<input checked="" type="checkbox"/>	Software	EZ EMC	1.1.4.3	N/A	N.C.R.	---

Note: N.C.R. = No Calibration Request.

For Conducted

Test Period: Mar. 26, 2022

Testing Engineer: Chi Chang

Use	Equipment	Manufacturer	Model Number	Serial Number	Cal. Date	Cal. Period
<input type="checkbox"/>	Power Sensor	Anritsu	MA2411B	1126022	Sep. 03, 2021	1 year
<input type="checkbox"/>	Power Meter	Anritsu	ML2495A	1135009	Sep. 03, 2021	1 year
<input type="checkbox"/>	Power Sensor	Agilent	N1921A	MY45241957	Dec. 06, 2021	1 year
<input type="checkbox"/>	Power Meter	Agilent	N1911A	MY45101619	Dec. 06, 2021	1 year
<input checked="" type="checkbox"/>	Spectrum Analyzer (10 Hz~26.5 GHz)	Keysight	N9010B	MY59071418	Mar. 17, 2021	1 year
<input type="checkbox"/>	Spectrum Analyzer (9 kHz~26.5 GHz)	Agilent	N9010A	MY48030518	Jul. 23, 2021	1 year
<input type="checkbox"/>	Spectrum Analyzer (20 Hz~26.5 GHz)	Agilent	N9020A	US47520902	Sep. 09, 2021	1 year
<input type="checkbox"/>	Spectrum Analyzer (3 Hz~50 GHz)	Agilent	N9030A	MY53120541	Jan. 05, 2022	1 year
<input checked="" type="checkbox"/>	Temperature & Humidity Chamber	TAICHY	MHU-225LA	980729	Mar. 30, 2021	1 year
<input type="checkbox"/>	Signal Generator	Keysight	N5182B	MY53052569	Apr. 20, 2021	1 year
<input type="checkbox"/>	Signal Generator	Keysight	N5182BX07	MY59360221	Apr. 20, 2021	1 year
<input type="checkbox"/>	Bluetooth Tester	R&S	CBT	100350	Mar. 17, 2021	2 years
<input type="checkbox"/>	Wireless Connectivity Tester	R&S	CMW270	102208	Jun. 02, 2021	1 year
<input checked="" type="checkbox"/>	Power Supply	IDRC	CP-268	268711	Nov. 30, 2021	1 year
<input type="checkbox"/>	RF Communication Test Set	HP	8920A	3344A03297	Aug. 10, 2021	1 year

Note: N.C.R. = No Calibration Request.

For Radiated Emissions
 Test Period: Mar. 25, 2022
 Testing Engineer: Hung Chou

Radiation test sites		Semi Anechoic Room				
Use	Equipment	Manufacturer	Model Number	Serial Number	Cal. Date	Cal. Period
<input type="checkbox"/>	Spectrum Analyzer (10 Hz~44 GHz)	Keysight	N9010A	MY52221312	Jan. 13, 2022	1 year
<input type="checkbox"/>	Spectrum Analyzer (3 Hz~50 GHz)	Agilent	N9030A	MY53120541	Jan. 05, 2022	1 year
<input checked="" type="checkbox"/>	Spectrum Analyzer (2 Hz~50 GHz)	Keysight	N9030B	MY57143537	Apr. 19, 2021	1 year
<input checked="" type="checkbox"/>	Amplifier (100 kHz~1.3 GHz)	Agilent	8447D	2944A11119	Jan. 14, 2022	1 year
<input type="checkbox"/>	Amplifier (100 kHz~1.3 GHz)	Agilent	8447D	2944A10961	Jul. 06, 2021	1 year
<input type="checkbox"/>	Broadband Amplifier (100 kHz~1 GHz)	Titan	T0910E00014330A1F	001	Jul. 23, 2021	1 year
<input type="checkbox"/>	Amplifier (1 GHz~26.5 GHz)	Agilent	8449B	3008A02237	Oct. 21, 2021	1 year
<input type="checkbox"/>	Broadband Amplifier (1 GHz~26.5 GHz)	Titan	T0912E01263025A1F	002	Jul. 26, 2021	1 year
<input type="checkbox"/>	Preamplifier (26.5 GHz~40 GHz)	EMCI	EMC2654045	980028	Aug. 19, 2021	1 year
<input type="checkbox"/>	Loop Antenna (9 kHz~30 MHz)	COM-POWER CORPORATION	AL-130	121014	Apr. 07, 2021	1 year
<input checked="" type="checkbox"/>	Active Loop Antenna (9 kHz~30 MHz)	Schwarzbeck Mess-Elektronik	FMZB 1513-60	1513-60-031	Feb. 17, 2022	1 year
<input checked="" type="checkbox"/>	Trilog Broadband Antenna (30 kHz~1 GHz)	Schwarzbeck Mess-Elektronik	VULB9168	01146	Jul. 19, 2021	1 year
<input type="checkbox"/>	Trilog Broadband Antenna (30 kHz~1 GHz)	Schwarzbeck Mess-Elektronik	VULB9168	416	Nov. 17, 2021	1 year
<input type="checkbox"/>	Broadband Horn Antenna (1 GHz~18 GHz)	Schwarzbeck Mess-Elektronik	9120D	02207	Jul. 09, 2021	1 year
<input type="checkbox"/>	Broadband Horn Antenna (1 GHz~18 GHz)	Schwarzbeck Mess-Elektronik	9120D	9120D-550	Aug. 24, 2021	1 year
<input type="checkbox"/>	Broadband Horn Antenna (18 GHz~40 GHz)	Schwarzbeck Mess-Elektronik	9170	9170-320	Aug. 24, 2021	1 year
<input type="checkbox"/>	Horn Antenna (18 GHz~40 GHz)	ETS	3116	00086467	Dec. 03, 2021	1 year

Note: N.C.R. = No Calibration Request.

Radiation test sites		Semi Anechoic Room				
Use	Equipment	Manufacturer	Model Number	Serial Number	Cal. Date	Cal. Period
<input type="checkbox"/>	RF Cable	EMCI	EMC104-N-N-6000	TE01-1	Feb. 18, 2022	1 year
<input type="checkbox"/>	Microwave Cable	EMCI	EMC104-SM-SM-13000	170814	Feb. 18, 2022	1 year
<input type="checkbox"/>	Microwave Cable	EMCI	EMC102-KM-KM-14000	151001	Feb. 18, 2022	1 year
<input checked="" type="checkbox"/>	Coaxial Cable	Titan	T0710AT327A10A100	J11005	Aug. 06, 2021	1 year
<input checked="" type="checkbox"/>	Coaxial Cable	Titan	T0710AT327A10A900	J11004	Aug. 06, 2021	1 year
<input type="checkbox"/>	Coaxial Cable	Titan	CFD400NL-LW	001	Aug. 06, 2021	1 year
<input type="checkbox"/>	Bluetooth Tester	R&S	CBT	100350	Mar. 17, 2021	2 years
<input type="checkbox"/>	Wireless Connectivity Tester	R&S	CMW270	102208	Jun. 02, 2021	1 year
<input type="checkbox"/>	Power Supply	KEITHLEY	2303	4045290	Jan. 19, 2022	1 year
<input checked="" type="checkbox"/>	Software	EZ EMC	1.1.4.4	N/A	N.C.R.	---

Note: N.C.R. = No Calibration Request.

2.5. Test Site Environment

Items	Required (IEC 60068-1)	Actual
Temperature (°C)	15-35	20-30
Humidity (%RH)	25-75	45-75

3 Measurement Procedure

3.1. AC Power Line Conducted Emission Measurement

■ Limit

Frequency (MHz)	Quasi-peak	Average
0.15 - 0.5	66 to 56	56 to 46
0.50 - 5.0	56	46
5.0 - 30.0	60	50

■ Test Setup

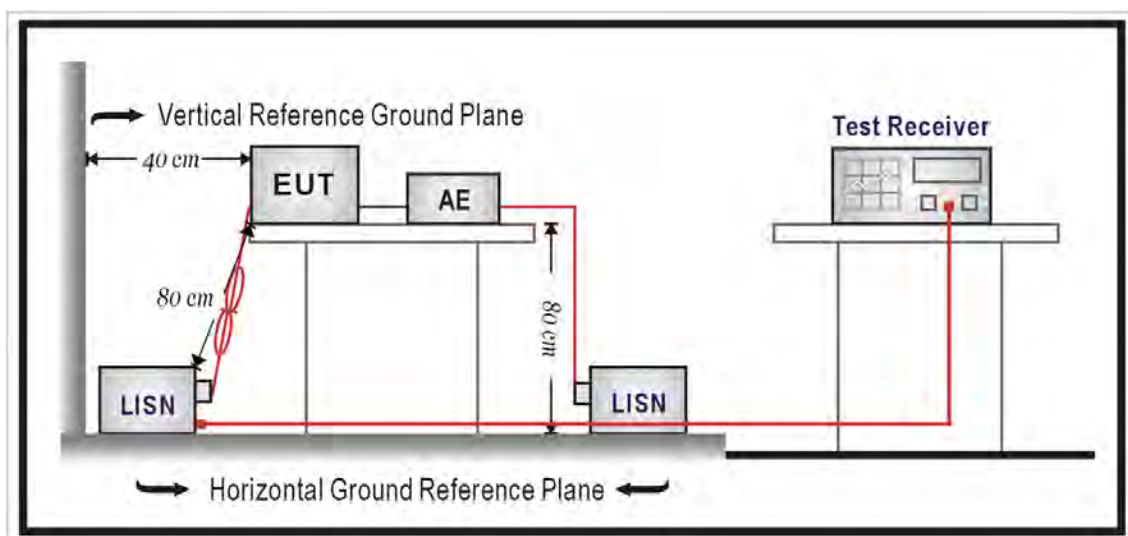

■ Test Procedure

The EUT and simulators are connected to the main power through a line impedance stabilization network (L.I.S.N.). This provides a $50 \Omega // 50 \mu\text{H}$ coupling impedance for the measuring equipment. The peripheral devices are also connected to the main power through a LISN that provides a $50 \Omega // 50 \mu\text{H}$ coupling impedance with 50 ohm termination.

Tabletop device shall be placed on a non-conducting platform, of nominal size 1 m by 1.5 m, raised 80 cm above the reference ground plane. The wall of screened room shall be located 40 cm to the rear of the EUT. Other surfaces of tabletop or floor standing EUT shall be at least 80 cm from any other ground conducting surface including one or more LISNs. For floor-standing device shall be placed under the EUT with a 12 mm insulating material.

Conducted emissions were investigated over the frequency range from 0.15 MHz to 30 MHz using a resolution bandwidth of 9 kHz. The equipment under test (EUT) shall be meet the limits in section 4.1, as applicable, including the average limit and the quasi-peak limit when using respectively, an average detector and quasi-peak detector measured in accordance with the methods described of related standard. When all of peak value were complied with quasi-peak and average limit from 150 kHz to 30 MHz then quasi-peak and average measurement was unnecessary.

The AMN shall be placed 0.8 m from the boundary of the unit under test and bonded to a ground reference plane for AMNs mounted on top of the ground reference plane. This distance is between the closest points of the AMN and the EUT. All other units of the EUT and associated equipment shall be at least 0.8 m from the AMN. If the mains power cable is longer than 1 m then the cable shall be folded back and forth at the centre of the lead to form a bundle no longer than 0.4 m. All of interconnecting cables that hang closer than 40 cm to the ground plane shall be folded back and forth in the center forming a bundle 30 cm to 40 cm long. All of EUT and AE shall be separate place more than 0.1 m. All 50Ω ports of the LISN shall be resistively terminated into 50Ω loads when not connected to the measuring instrument.

If the reading of the measuring receiver shows fluctuations close to the limit, the reading shall be observed for at least 15 s at each measurement frequency; the higher reading shall be recorded with the exception of any brief isolated high reading which shall be ignored.

3.2. Radiated Emission Measurement

■ **Limit**

According to §15.225,

- (a) The field strength of any emissions within the band 13.553 – 13.567 MHz shall not exceed 15,848 microvolt / meter at 30 meters.
- (b) Within the bands 13.410 – 13.553 MHz and 13.567 -13.710 MHz, the field strength of any emissions shall not exceed 334 microvolt / meter at 30 meters.
- (c) Within the bands 13.110 – 13.410 MHz and 13.710 – 14.010 MHz the field strength of any emissions shall not exceed 106 microvolt / meter at 30 meters.
- (d) The field strength of any emissions appearing outside of the 13.110 – 14.010 MHz and shall not exceed the general radiated emission limits in §15.209.

According to §15.225(a), except as provided elsewhere in this Subpart, the emissions from an intentional radiator shall not exceed the field strength levels specified in the following table:

Frequency (MHz)	Field Strength (µV/m at meter)	Measurement Distance (meter)
0.009 – 0.490	2400 / F (kHz)	300
0.490 – 1.705	24000 / F (kHz)	30
1.705 – 30.0	30	30
30 - 88	100**	3
88-216	150**	3
216-960	200**	3
Above 960	500	3

** Except as provided in paragraph (g), fundamental emissions from intentional radiators operating under this Section shall not be located in the frequency bands 54-72 MHz, 76-88 MHz, 174-216 MHz or 470-806 MHz. However, operation within these frequency bands is permitted under other sections of this Part, e.g., Sections 15.231 and 15.241.

■ Setup

9 kHz ~ 30 MHz

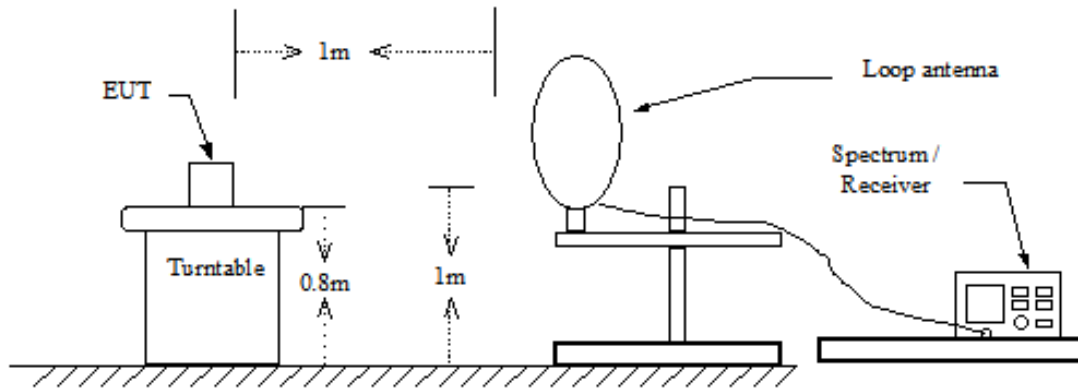

30 MHz ~ 1 GHz

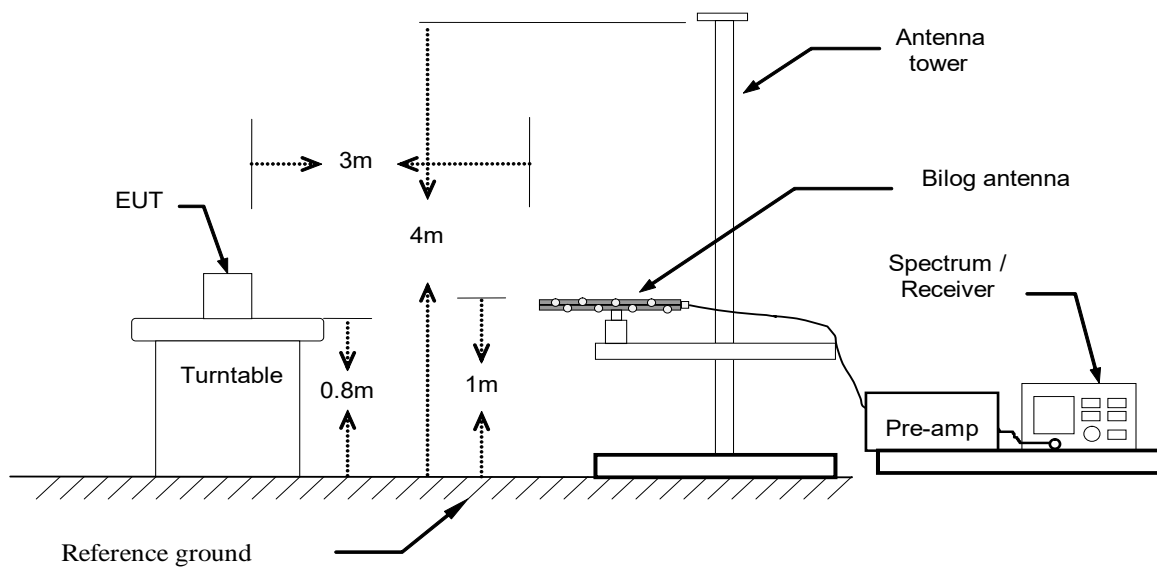

■ Test Procedure

Final radiation measurements were made on a three-meter Semi Anechoic Chamber. The EUT system was placed on a nonconductive turntable which is 0.8 meters height, top surface 1.0 x 1.5 meter. The spectrum was examined from 3 Hz to 44 GHz in order to cover the whole spectrum below 10th harmonic which could generate from the EUT. During the test, EUT was set to transmit continuously.

For measurements below 1 GHz the resolution bandwidth is set to 100 kHz for peak detection measurements or 120 kHz for quasi-peak detection measurements. Peak detection is used unless otherwise noted as quasi-peak.

For measurements above 1 GHz the resolution bandwidth is set to 1 MHz, and then the video bandwidth is set to 3 MHz for peak measurements and 10 Hz for average measurements.

A nonconductive material surrounded the EUT to supporting the EUT for standing on three orthogonal planes. At each condition, the EUT was rotated 360 degrees, and the antenna was raised and lowered from one to four meters to find the maximum emission levels. Measurements were taken using both horizontal and vertical antenna polarization.

Broadband/Horn Antenna were used in frequency 30 MHz to 18 GHz at a distance of 3 meter. Loop/Horn Antenna was used in frequency 9 kHz to 30 MHz and 18 to 26.5 GHz at a distance of 1 meter. All test results were extrapolated to equivalent signal at 3 meters utilizing an inverse linear distance extrapolation Factor (20 dB/decade).

For testing above 1 GHz, the emission level of the EUT in peak mode was 20 dB lower than average limit (that means the emission level in peak mode also complies with the limit in average mode), then testing will be stopped and peak values of EUT will be reported, otherwise, the emissions will be measured in average mode again and reported.

Appropriate preamplifiers were used for improving sensitivity and precautions were taken to avoid overloading or desensitizing the spectrum analyzer. No post – detector video filters were used in the test.

The spectrum analyzer's 6 dB bandwidth was set to 1 MHz, and the analyzer was operated in the peak detection mode, for frequencies both below and up 1 GHz. The average levels were obtained by subtracting the duty cycle correction factor from the peak readings.

The following procedures were used to convert the emission levels measured in decibels referenced to 1 microvolt (dBuV) into field intensity in microvolt pre-meter (uV/m).

The actual field intensity in decibels referenced to 1 microvolt in to field intensity in microvolt per-meter (dBuV/m).

The actual field intensity in referenced to 1 microvolt per meter (dBuV/m) is determined by algebraically adding the measured reading in dBuV, the antenna factor (dB), and cable loss (dB) and Subtracting the gain of preamplifier (dB) is auto calculate in spectrum analyzer.

$$(1) \text{ Amplitude (dBuV/m) = FI (dBuV) +AF (dBuV) +CL (dBuV)-Gain (dB)}$$

FI= Reading of the field intensity.

AF= Antenna factor.

CL= Cable loss.

P.S Amplitude is auto calculate in spectrum analyzer.

$$(2) \text{ Actual Amplitude (dBuV/m) = Amplitude (dBuV)-Dis(dB)}$$

The FCC specified emission limits were calculated according the EUT operating frequency and by following linear interpolation equations:

(a) For fundamental frequency : Transmitter Output < +30 dBm

(b) For spurious frequency : Spurious emission limits = fundamental emission limit /10

Data of measurement within this frequency range without mark in the table above means the reading of emissions are attenuated more than 20 dB below the permissible limits or the field strength is too small to be measured.

3.3. Frequency Stability Measurement

■ Limit

According to §15.207(e), the frequency tolerance of the carrier signal shall be maintained within +/- 0.01 % of the operating frequency over a temperature variation of -20 degrees to +50 degrees C at normal supply voltage, and for a variation in the primary supply voltage from 85 % to 115 % of the rated supply voltage at a temperature of 20 degrees C. For battery operated equipment, the equipment tests shall be performed using a new battery.

■ Test Setup

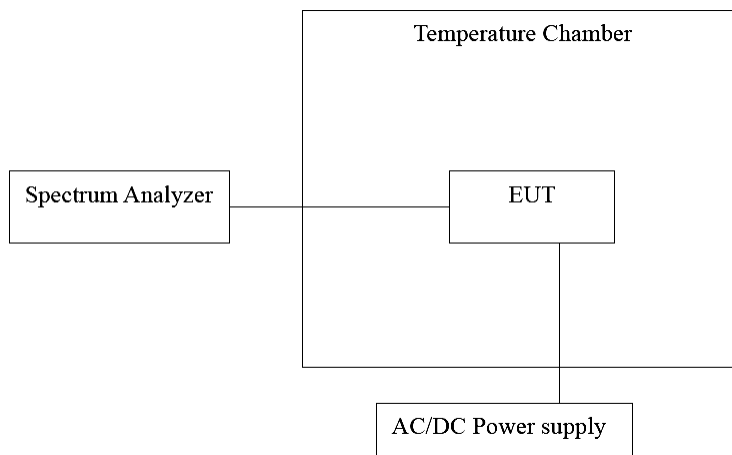

■ Test Procedure

1. Place the EUT on the table and set it in the transmitting mode.
2. Remove the antenna from the EUT and then connect a low loss RF cable from the antenna port to the spectrum analyzer.
3. Set the environment into appropriate environment.
4. Set the spectrum analyzer as RBW = 1 kHz, VBW = RBW, Span = 200 kHz, Sweep = auto.
5. Mark the peak frequency and measure the frequency tolerance using frequency counter function.
6. Repeat until all the results are investigated.

3.4. 20 dB Bandwidth Measurement

■ **Limit**

N/A

■ **Test Setup**

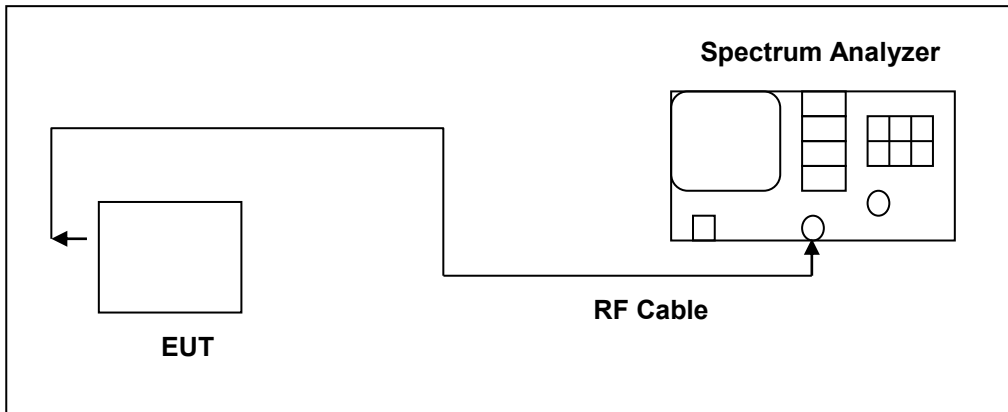

■ **Test Procedure**

Connect RF output port to the input of the spectrum analyzer. Connect the DUT to appropriate power supply. Turn RFID function of DUT on.

Analyzer used the following settings:

1. Span = 60 kHz
2. RBW \geq 1 % of the 20 dB span
3. VBW \geq RBW
4. Sweep = auto
5. Detector function = peak
6. Trace = max hold

The trace was allowed to stabilize. The EUT was transmitting at its maximum data rate. The marker-to-peak function was used to set the marker to the peak of the emission. The marker-delta function was used to measure 20 dB down one side of the emission. The marker-delta function and marker was moved to the other side of the emission until it was even with the reference marker. The marker-delta reading at this point was the 20 dB bandwidth of the emission.

3.5. Antenna Requirement

- **Require**

An intentional radiator shall be designed to ensure that no antenna other than that furnished by the responsible party shall be used with the device. The use of a permanently attached antenna or of an antenna that uses a unique coupling to the intentional radiator shall be considered sufficient to comply with the provisions of this section. The manufacturer may design the unit so that a broken antenna can be replaced by the user, but the use of a standard antenna jack or electrical connector is prohibited.

- **Antenna Connector Construction**

The antenna connector used in this product is internal antenna, cannot be replaced by the end-user. See section 2 – antenna information.

4 Test Results

5.1 Conducted Emission

Standard:	FCC Part 15.225	Line:	L1
Test item:	Conducted Emission	Power:	AC 120 V/60 Hz
Mode:	Mode 1		
Description:			

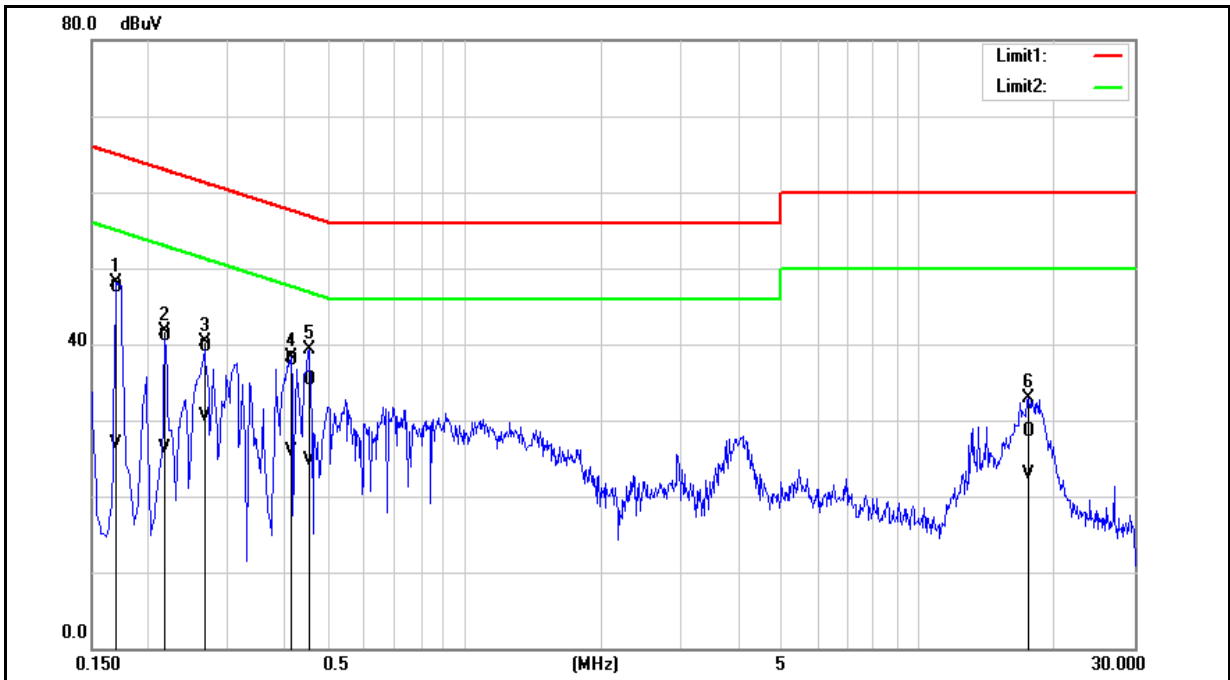

No.	Frequency (MHz)	QP reading (dBuV)	AVG reading (dBuV)	Correction factor (dB)	QP result (dBuV)	AVG result (dBuV)	QP limit (dBuV)	AVG limit (dBuV)	QP margin (dB)	AVG margin (dB)	Remark
1	0.1700	37.73	17.25	9.74	47.47	26.99	64.96	54.96	-17.49	-27.97	Pass
2	0.2180	31.43	16.62	9.74	41.17	26.36	62.89	52.89	-21.72	-26.53	Pass
3	0.2660	29.98	20.69	9.74	39.72	30.43	61.24	51.24	-21.52	-20.81	Pass
4	0.4140	28.23	16.26	9.74	37.97	26.00	57.57	47.57	-19.60	-21.57	Pass
5	0.4540	25.64	15.02	9.74	35.38	24.76	56.80	46.80	-21.42	-22.04	Pass
6	17.5540	18.37	12.95	10.04	28.41	22.99	60.00	50.00	-31.59	-27.01	Pass

Note: 1. Result (dBuV) = Correction factor (dB) + Reading (dBuV).

2. Correction factor (dB) = Cable loss (dB) + L.I.S.N. factor (dB).

Standard:	FCC Part 15.225	Line:	N
Test item:	Conducted Emission	Power:	AC 120 V/60 Hz
Mode:	Mode 1		
Description:			

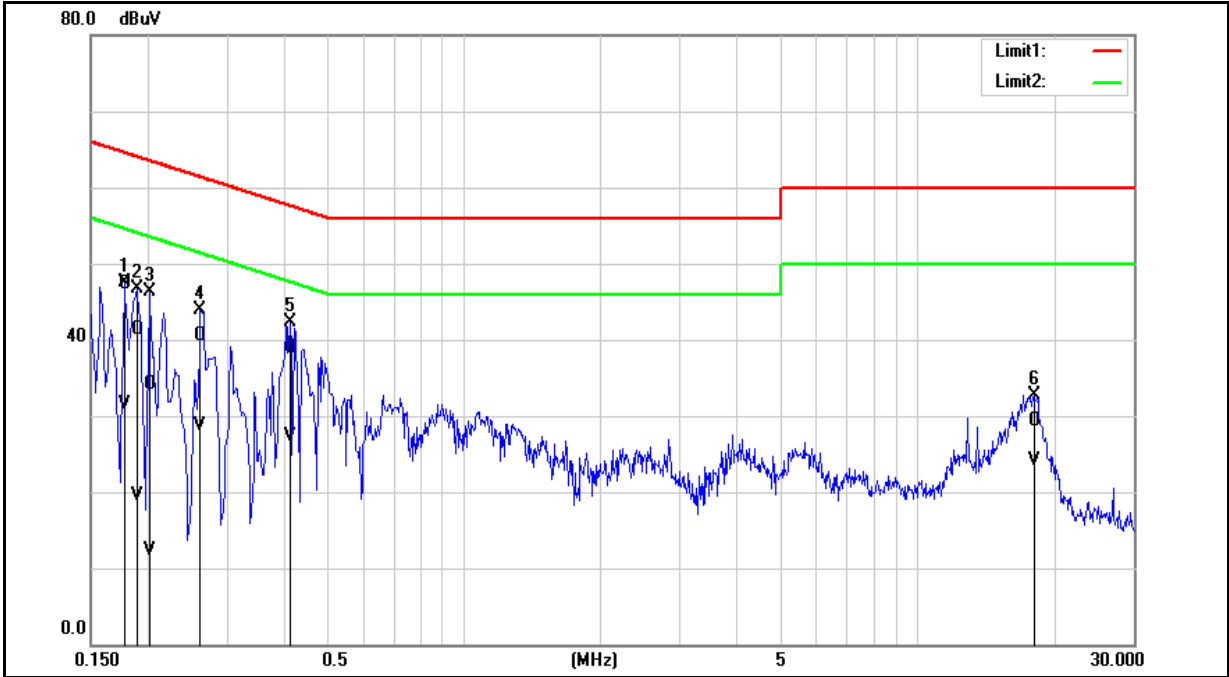

No.	Frequency (MHz)	QP reading (dBuV)	AVG reading (dBuV)	Correction factor (dB)	QP result (dBuV)	AVG result (dBuV)	QP limit (dBuV)	AVG limit (dBuV)	QP margin (dB)	AVG margin (dB)	Remark
1	0.1780	37.54	21.87	9.73	47.27	31.60	64.58	54.58	-17.31	-22.98	Pass
2	0.1900	31.62	9.81	9.73	41.35	19.54	64.04	54.04	-22.69	-34.50	Pass
3	0.2020	24.47	2.58	9.73	34.20	12.31	63.53	53.53	-29.33	-41.22	Pass
4	0.2620	30.77	18.94	9.73	40.50	28.67	61.37	51.37	-20.87	-22.70	Pass
5	0.4140	29.12	17.58	9.73	38.85	27.31	57.57	47.57	-18.72	-20.26	Pass
6	18.0500	19.24	13.93	10.16	29.40	24.09	60.00	50.00	-30.60	-25.91	Pass

Note: 1. Result (dBuV) = Correction factor (dB) + Reading (dBuV).

2. Correction factor (dB) = Cable loss (dB) + L.I.S.N. factor (dB).

5.2 Conducted Test Results

Frequency Stability Measurement

Temperature Variations

Test Mode		Mode 1					
Temp. (°C)	Voltage (VAC)	0 minute Frequency Tolerance (%)	2 minutes Frequency Tolerance (%)	5 minutes Frequency Tolerance (%)	10 minutes Frequency Tolerance (%)	Limit (%)	Result (Pass/Fail)
-20	V _{Nom}	-0.0041	-0.0041	-0.0043	-0.0043	±0.01	Pass
-10	V _{Nom}	-0.0037	-0.0041	-0.0041	-0.0041	±0.01	Pass
0	V _{Nom}	-0.0025	-0.0025	-0.0025	-0.0026	±0.01	Pass
10	V _{Nom}	-0.0025	-0.0025	-0.0025	-0.0025	±0.01	Pass
20	V _{Nom}	-0.0024	-0.0024	-0.0024	-0.0025	±0.01	Pass
30	V _{Nom}	-0.0024	-0.0024	-0.0024	-0.0024	±0.01	Pass
40	V _{Nom}	-0.0024	-0.0024	-0.0024	-0.0023	±0.01	Pass
50	V _{Nom}	-0.0023	-0.0024	-0.0025	-0.0025	±0.01	Pass

Voltage Variations

Test Mode		Mode 1					
Temp. (°C)	Voltage (VAC)	0 minute Frequency Tolerance (%)	2 minutes Frequency Tolerance (%)	5 minutes Frequency Tolerance (%)	10 minutes Frequency Tolerance (%)	Limit (%)	Result (Pass/Fail)
20	V _{Low}	-0.0024	-0.0024	-0.0025	-0.0025	±0.01	Pass
	V _{Nom}	-0.0024	-0.0024	-0.0024	-0.0025	±0.01	Pass
	V _{High}	-0.0024	-0.0024	-0.0024	-0.0025	±0.01	Pass

Note: V_{Low}=V_{Nom}-15 % ; V_{High}=V_{Nom}+15 %

20 dB Bandwidth Measurement

Test Mode	Mode 1
Frequency (MHz)	Measurement Results (kHz)
13.56	110.5

■ Test Graphs

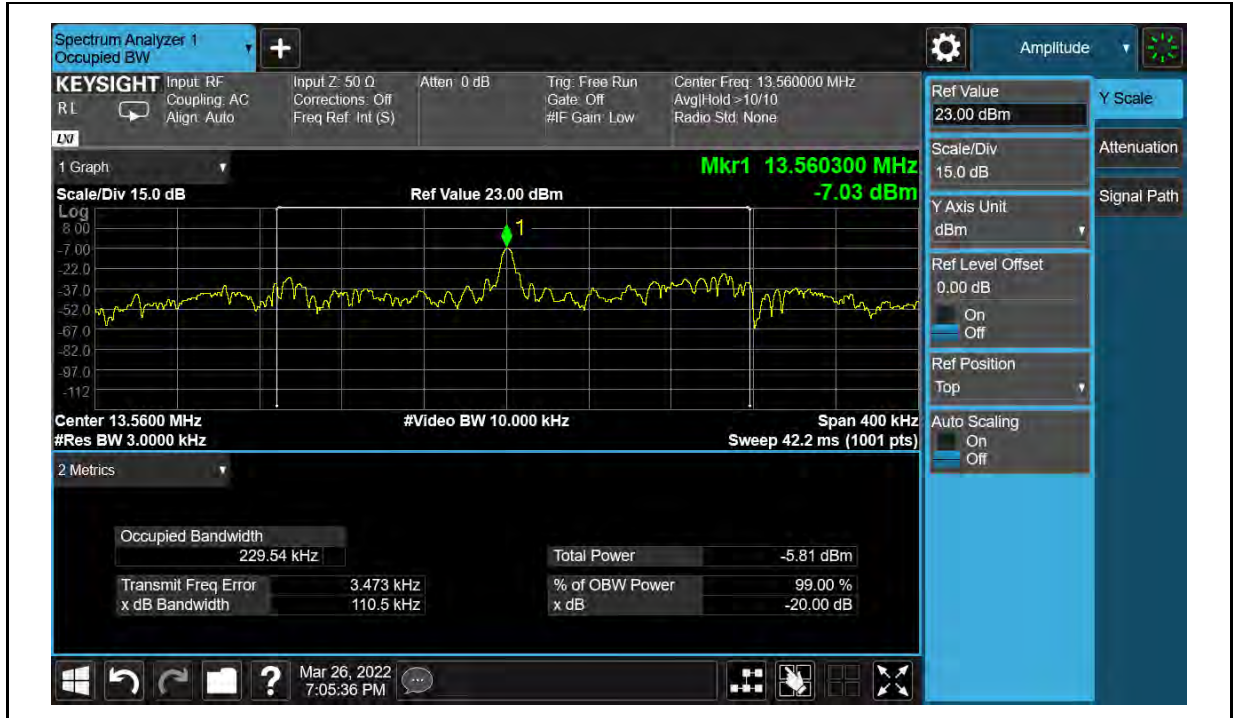

5.3 Radiated Emission Measurement

Fundamental

Standard:	FCC Part 15.225	Test Distance:	1 m
Test item:	Fundamental		
Mode:	Mode 1		
Ant.Polar.:	Horizontal		

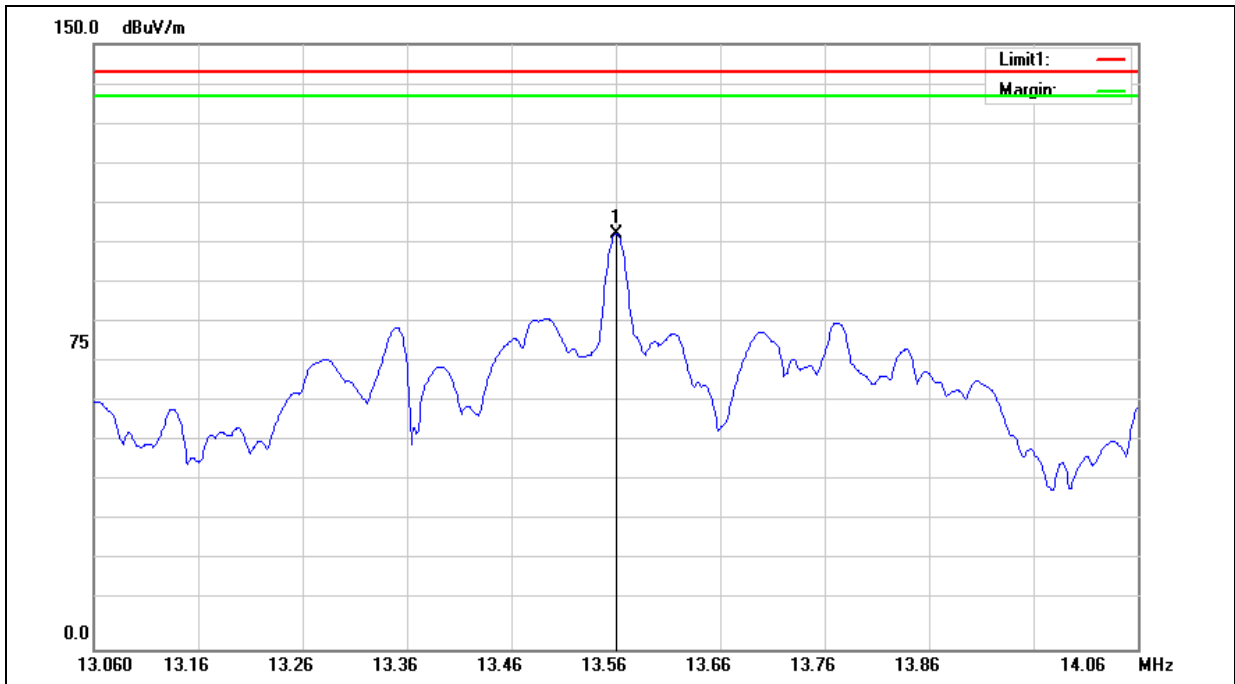

No.	Frequency (MHz)	Reading (dBuV)	Correct Factor (dB/m)	Near-Field Result (dBuV/m)	Derived Value (dBuV/m)	Limit (dBuV/m)	Margin (dB)	Remark
1	13.5600	80.79	22.12	102.91	62.44	84.00	-21.56	peak

Note: The level is measured at 1 meter and is converted into result at 30 meter.

The converted formula listed below:

Measure result (1 meter distance): a

Compute result (30 meter distance): A

$d_{near\ field} = \lambda/2\pi$, $d_{measure} = 1$ meter distance

$A = a - 40 \cdot \log(d_{near\ field} / d_{measure}) - 20 \cdot \log(d_{limit} / d_{near\ field})$

ex. $a = 102.91$ dBuV/m, $A = 102.91 - 40 \cdot \log(3.52 / 1) - 20 \cdot \log(30 / 3.52)$ dBuV/m = 62.44 dBuV/m

Standard:	FCC Part 15.225	Test Distance:	1 m
Test item:	Fundamental		
Mode:	Mode 1		
Ant.Polar.:	Vertical		

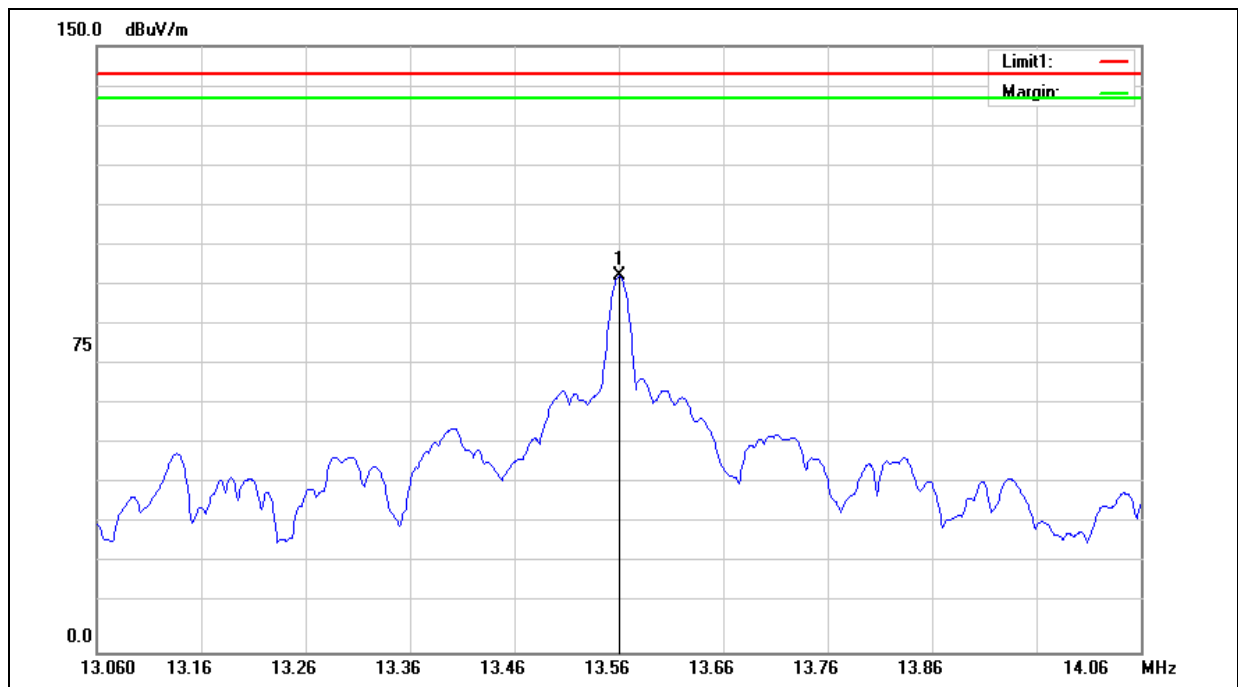

No.	Frequency (MHz)	Reading (dBuV)	Correct Factor (dB/m)	Near-Field Result (dBuV/m)	Derived Value (dBuV/m)	Limit (dBuV/m)	Margin (dB)	Remark
1	13.5600	70.90	22.12	93.02	52.55	84.00	-31.45	peak

Note: The level is measured at 1 meter and is converted into result at 30 meter.

Harmonic

9 kHz ~ 30 MHz:

Standard:	FCC Part 15.225	Test Distance:	300/30 m
Test item:	Harmonic		
Mode:	Mode 1		
Ant.Polar.:	Horizontal		

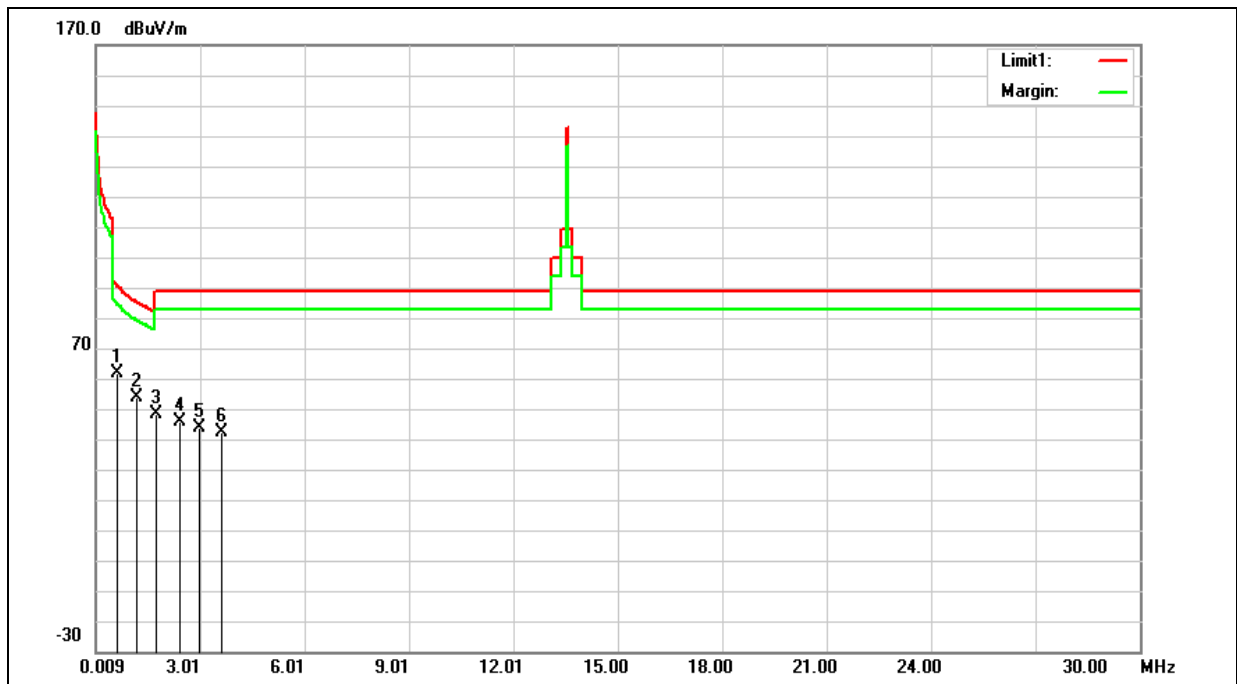

No.	Frequency (MHz)	Reading (dBuV)	Correct Factor (dB/m)	Near-Field Result (dBuV/m)	Derived Value (dBuV/m)	Limit (dBuV/m)	Margin (dB)	Remark
1	0.6088	42.30	19.59	61.89	-5.54	31.91	-37.46	QP
2	1.2085	34.12	19.70	53.82	-7.66	25.96	-33.62	QP
3	1.7484	28.66	19.77	48.43	-9.84	29.54	-39.38	QP
4	2.4083	26.01	19.88	45.89	-9.60	29.54	-39.14	QP
5	2.978	23.56	19.98	43.54	-10.10	29.54	-39.64	QP
6	3.6078	22.40	19.94	42.34	-9.63	29.54	-39.18	QP

Note: The level is measured at 1 meter and is converted into result at 300 or 30 meter.

Standard:	FCC Part 15.225	Test Distance:	300/30 m
Test item:	Harmonic		
Mode:	Mode 1		
Ant.Polar.:	Vertical		

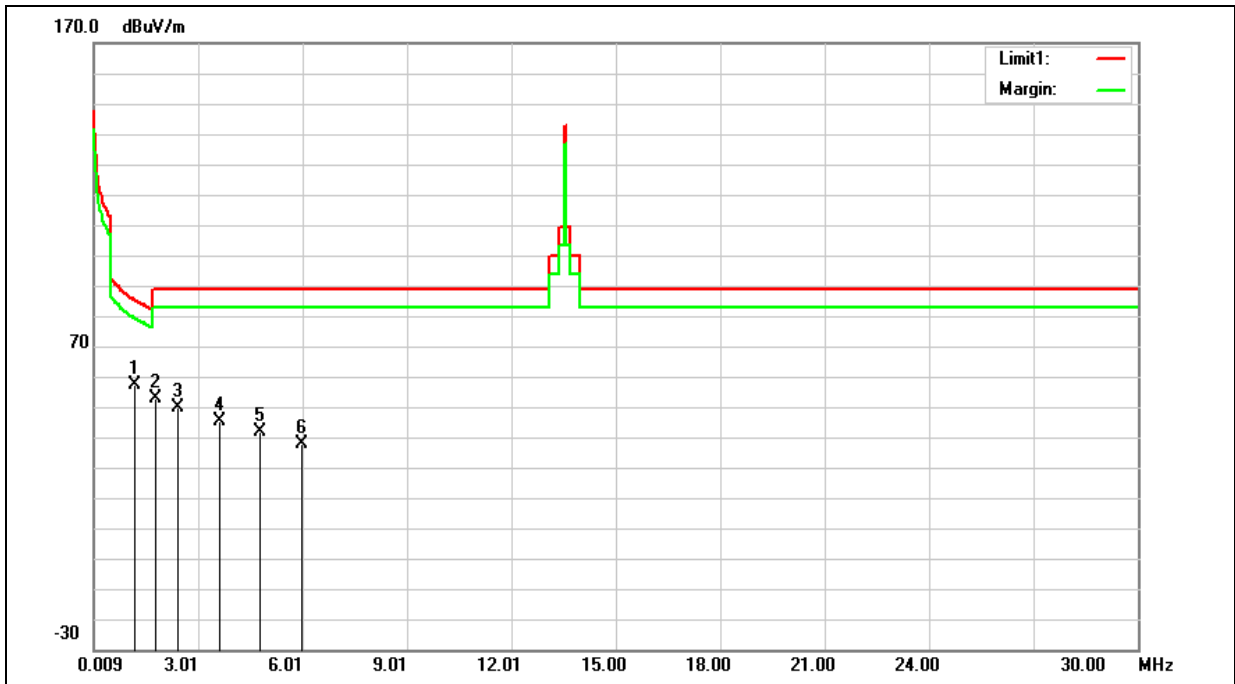

No.	Frequency (MHz)	Reading (dBuV)	Correct Factor (dB/m)	Near-Field Result (dBuV/m)	Derived Value (dBuV/m)	Limit (dBuV/m)	Margin (dB)	Remark
1	1.1786	37.52	19.70	57.22	-4.47	26.18	-30.65	QP
2	1.7784	32.84	19.78	52.62	-5.50	29.54	-35.04	QP
3	2.4083	29.88	19.88	49.76	-5.73	29.54	-35.27	QP
4	3.6078	25.34	19.94	45.28	-6.69	29.54	-36.24	QP
5	4.7775	21.70	19.86	41.56	-7.97	29.54	-37.52	QP
6	5.977	17.36	20.28	37.64	-9.95	29.54	-39.50	QP

Note: The level is measured at 1 meter and is converted into result at 300 or 30 meter.

30 MHz ~ 1 GHz:

Standard:	FCC Part 15.225	Test Distance:	3 m
Test item:	Harmonic		
Mode:	Mode 1		
Ant.Polar.:	Horizontal		

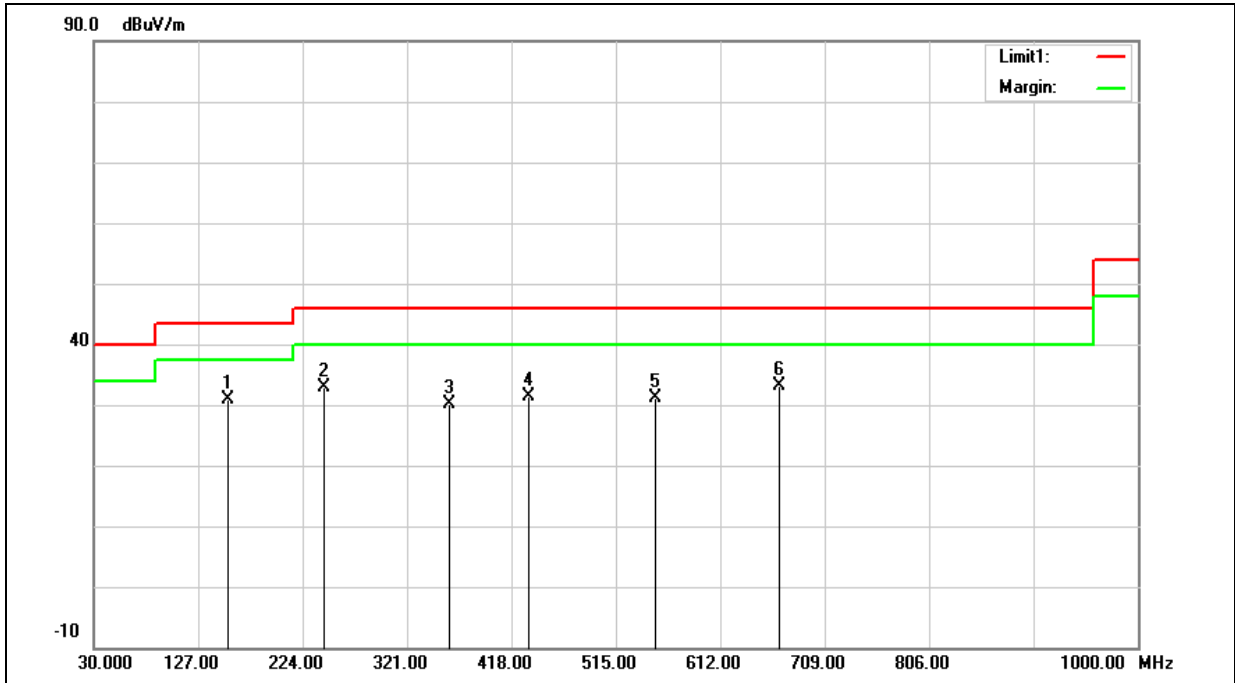

No.	Frequency (MHz)	Reading (dBuV)	Correct Factor (dB/m)	Result (dBuV/m)	Limit (dBuV/m)	Margin (dB)	Remark
1	155.1300	37.23	-6.46	30.77	43.50	-12.73	QP
2	244.3700	40.18	-7.35	32.83	46.00	-13.17	QP
3	359.8000	34.89	-4.64	30.25	46.00	-15.75	QP
4	433.5200	34.22	-2.83	31.39	46.00	-14.61	QP
5	551.8600	31.68	-0.60	31.08	46.00	-14.92	QP
6	666.3200	31.21	1.95	33.16	46.00	-12.84	QP

Standard:	FCC Part 15.225	Test Distance:	3 m
Test item:	Harmonic		
Mode:	Mode 1		
Ant.Polar.:	Vertical		

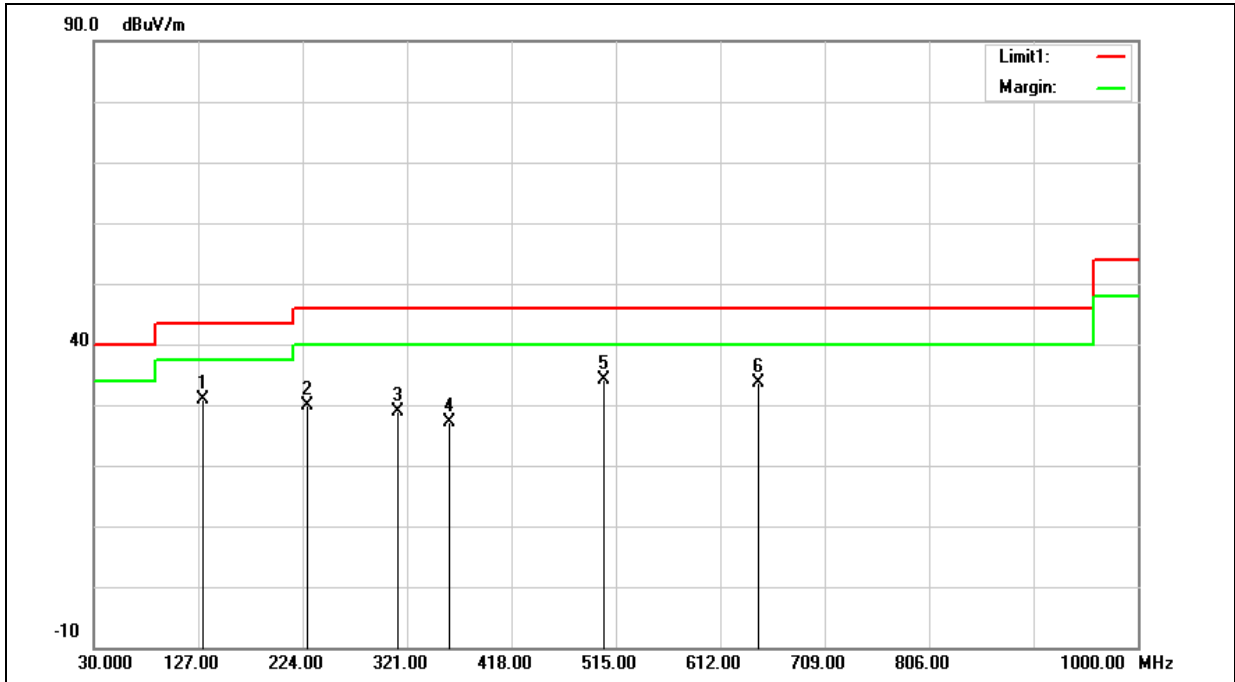

No.	Frequency (MHz)	Reading (dBuV)	Correct Factor (dB/m)	Result (dBuV/m)	Limit (dBuV/m)	Margin (dB)	Remark
1	131.8500	38.91	-8.10	30.81	43.50	-12.69	QP
2	228.8500	38.02	-8.08	29.94	46.00	-16.06	QP
3	312.2700	34.59	-5.67	28.92	46.00	-17.08	QP
4	359.8000	31.69	-4.64	27.05	46.00	-18.95	QP
5	504.3300	35.87	-1.73	34.14	46.00	-11.86	QP
6	647.8900	32.15	1.54	33.69	46.00	-12.31	QP

---END---