



# TEST REPORT

**Report No.** ..... : **CHTEW22070008** Report verification: 

**Project No.** ..... : **SHT2111082704EW**

**FCC ID** ..... : **TEY-A580T**

**Applicant's name** ..... : **ABELL INDUSTRIES CO.,LTD**

**Address**..... : 701-702, 7/F, D Bldg, Qianwan Hard Technology Industrial Park, Nanchang community, Xixiang Rd., Bao An Dist., Shenzhen.

**Test item description** ..... : **Two Way Radio**

**Trade Mark** ..... : ABELL

**Model/Type reference** ..... : A580T

**Listed Model(s)**..... : A580T (LF)

**Standard**..... : **FCC CFR Title 47 Part 90**

**Date of receipt of test sample**..... : Jun.15, 2022

**Date of testing**..... : Jun.16, 2022-Jul.01, 2022

**Date of issue**..... : Jul.05, 2022

**Result** ..... : **PASS**

Compiled by  
 (Position-Printed name-Signature) : File administrators Fanghui Zhu

*Fanghui Zhu*

Supervised by  
 (Position-Printed name-Signature) : Project Engineer Caspar Chen

*Caspar Chen*

Approved by  
 (Position-Printed name-Signature) : RF Manager Hans Hu

*Hans Hu*

**Testing Laboratory Name**..... : **Shenzhen Huatongwei International Inspection Co., Ltd.**

**Address** ..... : 1/F, Bldg 3, Hongfa Hi-tech Industrial Park, Genyu Road, Tianliao, Gongming, Shenzhen, China

**Shenzhen Huatongwei International Inspection Co., Ltd. All rights reserved.**

This publication may be reproduced in whole or in part for non-commercial purposes as long as the Shenzhen Huatongwei International Inspection Co., Ltd. is acknowledged as copyright owner and source of the material. Shenzhen Huatongwei International Inspection Co., Ltd. takes no responsibility for and will not assume liability for damages resulting from the reader's interpretation of the reproduced material due to its placement and context.

*The test report merely correspond to the test sample.*

## Contents

<b>1</b>	<b><u>TEST STANDARDS AND REPORT VERSION</u></b>	<b>3</b>
1.1.	Test standard	3
1.2.	Report revised information	3
<b>2</b>	<b><u>TEST DESCRIPTION</u></b>	<b>4</b>
<b>3</b>	<b><u>SUMMARY</u></b>	<b>5</b>
3.1	Client information	5
3.2	Product description	5
3.3	Radio Specification Description *1	5
3.4	Testing laboratory information	6
<b>4</b>	<b><u>TEST CONFIGURATION</u></b>	<b>7</b>
4.1	Test frequency list	7
4.2	Operation mode	7
4.3	Support unit used in test configuration and system	8
4.4	Testing environmental condition	9
4.5	Measurement uncertainty	9
4.6	Equipment used during the testing	10
<b>5</b>	<b><u>TEST CONDITIONS AND RESULTS</u></b>	<b>11</b>
5.1	Maximum transmitter power	11
5.2	Occupied bandwidth	12
5.3	Emission mask	14
5.4	Modulation limit	16
5.5	Audio frequency response	17
5.6	Frequency stability VS temperature	19
5.7	Frequency stability VS voltage	20
5.8	Transmitter frequency behavior	21
5.9	Spurious emission on antenna port	23
5.10	Transmitter radiated spurious emission	24
<b>6</b>	<b><u>TEST SETUP PHOTOS</u></b>	<b>37</b>
<b>7</b>	<b><u>EXTERNAL AND INTERNAL PHOTOS OF THE EUT</u></b>	<b>39</b>
7.1	External photos	39
7.2	Internal photos	42
<b>8</b>	<b><u>APPENDIX REPORT</u></b>	<b>44</b>

# **1 TEST STANDARDS AND REPORT VERSION**

## **1.1. Test standard**

The tests were performed according to following standards:

[FCC Rules Part 90](#): Private land mobile radio services.

[FCC Rules Part 2](#): Frequency allocations and radio treaty matters; General rules and regulations

[ANSI C63.26-2015](#): American National Standard for Compliance Testing of Transmitters Used in Licensed Radio Services

[ANSI/TIA-603-E \(2016\)](#): Land Mobile FM or PM Communications Equipment and Performance Standards

[ANSI C63.4-2014](#): American National Standard for Methods of Measurement of Radio-Noise Emissions from Low-Voltage Electrical and Electronic Equipment in the Range of 9 kHz to 40 GHz

## **1.2. Report revised information**

Revised No.	Date of issued	Description
N/A	2022-07-05	Original

## 2 TEST DESCRIPTION

Section	Test Item	Section	Result	Test Engineer
5.1	Maximum transmitter power	Part 90.205 Part 2.1046(a)	Pass	Caspar Chen
5.2	Occupied bandwidth	Part 90.209 & 210 Part 2.1049	Pass	Caspar Chen
5.3	Emission mask	Part 90.209 & 210 Part 2.1049	Pass	Caspar Chen
5.4	Modulation limit	Part 2.1047(b)	Pass	Caspar Chen
5.5	Audio frequency response	Part 2.1047(a)	Pass	Caspar Chen
5.6	Frequency stability VS temperature	Part 90.213 Part 2.1055	Pass	Caspar Chen
5.7	Frequency stability VS voltage	Part 90.213 Part 2.1055	Pass	Caspar Chen
5.8	Transient frequency behavior	Part 90.214	Pass	Caspar Chen
5.9	Spurious emission on antenna port	Part 90.210 Part 2.1051	Pass	Caspar Chen
5.10	Transmit radiated spurious emission	Part 90.210 Part 2.1053	Pass	Jianquan Wu

### 3 SUMMARY

#### 3.1 Client information

Applicant:	ABELL INDUSTRIES CO.,LTD
Address:	701-702, 7/F, D Bldg, Qianwan Hard Technology Industrial Park, Nanchang community, Xixiang Rd., Bao An Dist., Shenzhen.
Manufacturer:	ABELL INDUSTRIES CO.,LTD
Address:	701-702, 7/F, D Bldg, Qianwan Hard Technology Industrial Park, Nanchang community, Xixiang Rd., Bao An Dist., Shenzhen.

#### 3.2 Product description

Name of EUT:	Two Way Radio
Trade mark:	ABELL
Model/Type reference:	A580T
Listed model(s):	A580T (LF)
Power supply:	DC7.4V
Battery information:	Model:AB-L2252 7.4V d.c., 2200mA/16Wh
Charger information:	Model: BC-780A Input: 12V d.c., 1000mA Output: 600mA d.c.
Adapter information:	Model:DSA-12PFT-12 FUS 120100 Input:100-240Va.c., 50/60Hz 0.5A Output:12Vd.c., 1A
Hardware version:	V1
Software version:	V1.06.01

#### 3.3 Radio Specification Description <sup>\*1</sup>

Device type:	<input checked="" type="checkbox"/> Portable <input type="checkbox"/> Mobile
Support Frequency Range:	400MHz~480MHz
Permitted frequency range: <sup>*2</sup>	400MHz~406MHz, 406.1MHz~480MHz
Support type:	<input checked="" type="checkbox"/> Analog <input checked="" type="checkbox"/> Digital
Support digital protocol: <sup>*3</sup>	DMR
Support data rate for DMR:	9.6kbps
Modulation type:	Analog: FM
	Digital: 4FSK
Channel Separation:	Analog: <input checked="" type="checkbox"/> 12.5kHz <input type="checkbox"/> 25kHz
	Digital: <input type="checkbox"/> 6.25kHz <input checked="" type="checkbox"/> 12.5kHz
Emission Designator: <sup>*4</sup>	Analog: 11K0F3E
	Digital: 7K60FXW, 7K60FXD
Rated Output Power:	<input checked="" type="checkbox"/> High Power: 4W <input checked="" type="checkbox"/> Low Power: 1.5W

Antenna Type:	Integral
Antenna Gain:	0dBi

**Note:**

- (1) \*<sup>1</sup> This information is provided by this applicant.
- (2) \*<sup>2</sup> Listed frequency range 400MHz~406MHz for Federal use Only.
- (3) \*<sup>3</sup> The DMR standard specifies two-slot Time Division Multiplexing Technology to split the 12.5 kHz channel into two virtual 6.25kHz communication paths. This equates to an efficiency of one voice channel per 6.25 kHz of bandwidth even though it operates in channels of 12.5 kHz
- (4) \*<sup>4</sup> According to FCC Part 2.202 requirements, the Necessary Bandwidth is calculated as follows:
- For FM Voice Modulation  
Channel Spacing = 25 KHz, D = 5 KHz max, K = 1, M = 3 KHz  
 $B_n = 2M + 2DK = 2*3 + 2*5*1 = 16 \text{ KHz}$   
Emission designation: 16K0F3E  
  
Channel Spacing = 12.5 KHz, D = 2.5 KHz max, K = 1, M = 3 KHz  
 $B_n = 2M + 2DK = 2*3 + 2*2.5*1 = 11 \text{ KHz}$   
Emission designation: 11K0F3E
  - For FM Data Modulation  
Channel Spacing = 12.5 KHz, R = 9600 bps, D = 2160 Hz, S = 4, K = 0.518  
 $B_n = (R/\log_2 S) + 2DK = 7037 \approx 7.1 \text{ KHz}$   
Emission designation: 7K10FXE, 7K10FXD

**3.4 Testing laboratory information**

Laboratory Name	Shenzhen Huatongwei International Inspection Co., Ltd.	
Laboratory Location	1/F, Bldg 3, Hongfa Hi-tech Industrial Park, Genyu Road, Tianliao, Gongming, Shenzhen, China	
Connect information:	Tel: 86-755-26715499 E-mail: <a href="mailto:cs@szhtw.com.cn">cs@szhtw.com.cn</a> <a href="http://www.szhtw.com.cn">http://www.szhtw.com.cn</a>	
Qualifications	Type	Accreditation Number
	FCC Test Firm Registration Number	762235
	FCC Designation Number	CN1181

## 4 TEST CONFIGURATION

### 4.1 Test frequency list

According to ANSI C63.26 section 5.1.2.1:

Measurements of transmitters shall be performed and, if required, reported for each frequency band in which the EUT can be operated with the device transmitting at the number of frequencies in each band specified in Table 2.

Frequency range over which EUT operates	Number of frequencies	Location in frequency range of operation
1 MHz or less	1	Middle
1 MHz to 10 MHz	2	1 near top and 1 near bottom
More than 10 MHz	3	1 near top, 1 near middle, and 1 near bottom

So test frequency as follow:

Frequency Bands (MHz)	Test Channel	Test Frequency (MHz)
400MHz ~ 406MHz	CH <sub>L</sub>	400.0125
	CH <sub>M1</sub>	405.9875
406.1MHz ~480MHz	CH <sub>M2</sub>	406.1125
	CH <sub>M3</sub>	443.0000
	CH <sub>H</sub>	479.9875

### 4.2 Operation mode

Test Mode	Transmitting	Digital	Analog	Power Level	
		12.5kHz	12.5kHz	High	Low
TX-DNH	■	■		■	
TX-DNL	■	■			■
TX-ANH	■		■	■	
TX-ANL	■		■		■

Note: ■: is operation mode.

Modulation Type	Description
UM	Un-modulation
AM2	Apply a 1000 Hz tone and adjust the audio frequency generator to produce 20% of the rated system deviation.
AM6	Apply a 1000 Hz modulating signal to the transmitter from the audio frequency generator, and adjust the level to obtain 60% of full rated system deviation, then increase the level from the audio generator by 20 dB
AM5	Modulate the transmitter with a 2500 Hz sine wave at an input level 16 dB greater than that necessary to produce 50% of rated system deviation.
DM	A 511 bit binary pseudo-random bit sequence based on ITU-T Rec. O.153

Pre-scan above all test mode, found below test mode which it was worse case mode, so only show the test data for worse case mode on the test report.

Section	Test Item	Modulation Type	Test mode (Worse case mode)
5.1	Maximum transmitter power	UM	TX-DNH, TX-DNL, TX-ANH, TX-ANL
5.2	Occupied bandwidth	AM6, DM	TX-DNH, TX-DNL, TX-ANH, TX-ANL
5.3	Emission mask	AM5, DM	TX-DNH, TX-DNL, TX-ANH, TX-ANL
5.4	Modulation limit	AM6	TX-ANH
5.5	Audio frequency response	AM2	TX-ANH
5.6	Frequency stability VS temperature	UM	TX-DNH, TX-ANH
5.7	Frequency stability VS voltage	UM	TX-DNH, TX-ANH
5.8	Transient frequency behavior	UM	TX-DNH, TX-ANH
5.9	Spurious emission on antenna port	AM5, DM	TX-DNH, TX-ANH
5.10	Transmit radiated spurious emission	AM5, DM	TX-DNH, TX-ANH

### 4.3 Support unit used in test configuration and system

The EUT has been associated with peripherals and configuration operated in a manner tended to maximize its emission characteristics in a typical application.

The following peripheral devices and interface cables were connected during the measurement:

Whether support unit is used?			
✓ No			
Item	Equipement	Trade Name	Model No.
1			
2			



#### 4.4 Testing environmental condition

Type	Requirement	Actual
Temperature:	15~35°C	25°C
Relative Humidity:	25~75%	50%
Air Pressure:	860~1060mbar	1000mbar
Test voltage:	Normal voltage:	DC 7.4V
	Extreme lower voltage:	DC 6.0V
	Extreme upper voltage:	DC 8.4V

#### 4.5 Measurement uncertainty

Test Items	Measurement Uncertainty
Frequency stability & Occupied Bandwidth	15Hz for <1GHz 70Hz for >1GHz
Conducted Output Power	0.51dB
ERP / EIRP / RSE	2.66dB for <1GHz 3.44dB for >1GHz
Conducted Emission 9KHz-30MHz	3.02dB
Radiated Emission 30~1000MHz	4.90dB
Radiated Emission 1~18GHz	4.96dB
FM deviation	25 Hz
Audio level	0.62 dB
Low Pass Filter Response	0.76 dB
Modulation limiting	0.42 %
Transient frequency behavior	6.8 %

This uncertainty represents an expanded uncertainty expressed at approximately the 95% confidence level using a coverage factor of k=1.96.

#### 4.6 Equipment used during the testing

● TS8613 Test system							
Used	Test Equipment	Manufacturer	Equipment No.	Model No.	Serial No.	Last Cal. Date (YY-MM-DD)	Next Cal. Date (YY-MM-DD)
●	Spectrum Analyzer	Agilent	HTWE0286	N9020A	MY50510187	2021/09/13	2022/09/12
●	Signal & Spectrum Analyzer	R&S	HTWE0262	FSW26	103440	2021/09/13	2022/09/12
●	RF Communication Test Set	HP	HTWE0038	8920A	3813A10206	2021/09/13	2022/09/12
●	Digital intercom communication tester	Aeroflex	HTWE0255	3920B	1001682041	2021/09/13	2022/09/12
●	Signal Generator	R&S	HTWE0191	SML02	100507	2021/09/13	2022/09/12
●	Signal Generator	R&S	HTWE0337	SMC100A	107268	2021/09/13	2022/09/12
●	RF Control Unit	Tonscend	HTWE0294	JS0806-2	N/A	N/A	N/A
●	Filter-VHF	Microwave	HTWE0309	N26460M1	498702	N/A	N/A
●	Filter-UHF	Microwave	HTWE0311	N25155M2	498704	N/A	N/A
●	Power Divider	Microwave	HTWE0043	OPD1040-N-4	N/A	2022/05/16	2023/05/15
●	Attenuator	JFW	HTWE0292	50FH-030-100	N/A	2022/05/16	2023/05/15
●	Attenuator	JFW	HTWE0293	50-A-MFN-20	0322	2022/05/16	2023/05/15
●	Test software	HTW	N/A	Radio ATE	N/A	N/A	N/A

● Radiated Spurious Emission							
Used	Test Equipment	Manufacturer	Equipment No.	Model No.	Serial No.	Last Cal. Date (YY-MM-DD)	Next Cal. Date (YY-MM-DD)
●	Semi-Anechoic Chamber	Albatross projects	HTWE0122	SAC-3m-01	C11121	2018/09/27	2022/09/26
●	Spectrum Analyzer	R&S	HTWE0098	FSP40	100597	2021/09/13	2022/09/12
●	Loop Antenna	R&S	HTWE0170	HFH2-Z2	100020	2021/04/06	2024/04/05
●	Broadband Horn Antenna	SCHWARZBECK	HTWE0103	BBHA9170	BBHA9170472	2020/04/27	2023/04/26
●	Ultra-Broadband Antenna	SCHWARZBECK	HTWE0123	VULB9163	538	2021/04/06	2024/04/05
●	Horn Antenna	SCHWARZBECK	HTWE0126	9120D	1011	2020/04/01	2023/03/31
●	Pre-amplifier	CD	HTWE0071	PAP-0102	12004	2021/11/05	2022/11/04
●	Broadband Preamplifier	SCHWARZBECK	HTWE0201	BBV 9718	9718-248	2022/02/28	2023/02/27
●	RF Connection Cable	HUBER+SUHNER	HTWE0120-01	6m 18GHz S Serisa	N/A	2022/02/25	2023/02/24
●	RF Connection Cable	HUBER+SUHNER	HTWE0120-02	6m 3GHz RG Serisa	N/A	2022/02/25	2023/02/24
●	RF Connection Cable	HUBER+SUHNER	HTWE0119-05	6m 3GHz RG Serisa	N/A	2022/02/25	2023/02/24
●	RF Connection Cable	HUBER+SUHNER	HTWE0120-04	6m 3GHz RG Serisa	N/A	2022/02/25	2023/02/24
●	EMI Test Software	Audix	N/A	E3	N/A	N/A	N/A

## **5 TEST CONDITIONS AND RESULTS**

### **5.1 Maximum transmitter power**

#### **LIMIT**

**FCC Part 90.205, FCC Part 2.1046**

Applicants for licenses must request and use no more power than the actual power necessary for satisfactory operation.

#### **TEST CONFIGURATION**

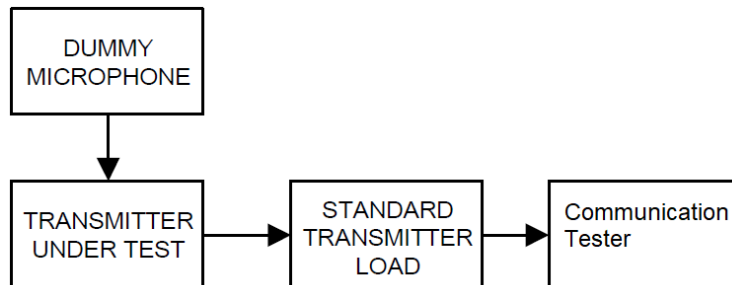

#### **TEST PROCEDURE**

- (1) Connect the equipment as illustrated
- (2) Correct for all losses in the RF path
- (3) Measure the transmitter output power with RMS detector
- (4) If the power output is adjustable, measurements shall be made for the highest and lowest power levels.

#### **TEST MODE**

Please refer to the section 4.2

#### **TEST RESULTS**

**Passed**       **Not Applicable**

Please refer to appendix A on the section 8 appendix report

## 5.2 Occupied bandwidth

### LIMIT

FCC Part 90.209, FCC Part 2.1049

Frequency band (MHz)	Channel spacing (kHz)	Authorized bandwidth (kHz)
Below 25 <sup>2</sup>		
25-50	20	20
72-76	20	20
150-174	17.5	<sup>1</sup> 320/11.25/6
216-220 <sup>5</sup>	6.25	20/11.25/6
220-222	5	4
406-512 <sup>2</sup>	<sup>1</sup> 6.25	<sup>136</sup> 20/11.25/6
806-809/851-854	12.5	20
809-824/854-869	25	<sup>6</sup> 20
896-901/935-940	12.5	13.6
902-928 <sup>4</sup>		
929-930	25	20
1427-1432 <sup>5</sup>	12.5	12.5
<sup>3</sup> 2450-2483.5 <sup>2</sup>		
Above 2500 <sup>2</sup>		

### TEST CONFIGURATION

Test setup for Analog:

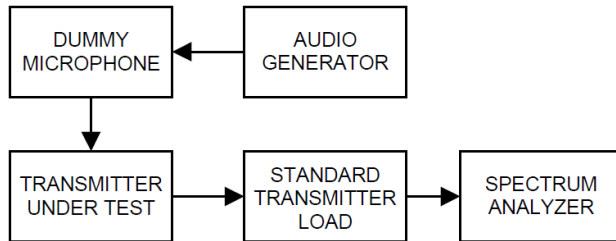

Test setup for Digital:

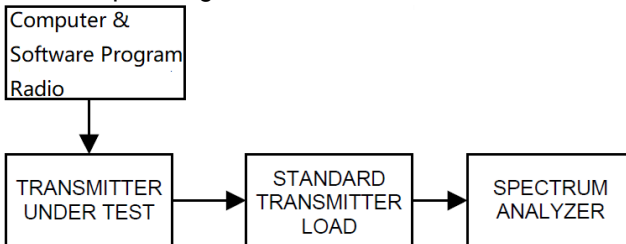

### TEST PROCEDURE

- (1) Connect the equipment as illustrated
- (2) Spectrum set as follow:
  - Centre frequency = the nominal EUT channel center frequency,
  - Span shall be set wide enough to capture all modulation products including the emission skirts (typically a span of 1.5 × OBW is sufficient)
  - RBW = 1% to 5% of the anticipated OBW, VBW ≥ 3 × RBW, Sweep = auto,
  - Detector function = peak, Trace = max hold
- (3) Set 99% Occupied Bandwidth and 26dB Bandwidth
- (4) Measure and record the results in the test report.

**TEST MODE**

Please refer to the section 4.2

**TEST RESULTS**

**Passed**       **Not Applicable**

Please refer to appendix B on the section 8 appendix report

### 5.3 Emission mask

#### LIMIT

FCC Part 90.210, FCC Part 2.1049

Frequency band (MHz)	Mask for equipment with audio low pass filter	Mask for equipment without audio low pass filter
Below 25 <sup>1</sup>	A or B	A or C
25-50	B	C
72-76	B	C
150-174 <sup>2</sup>	B, D, or E	C, D or E
150 paging only	B	C
220-222	F	F
421-512 <sup>2 5</sup>	B, D, or E	C, D, or E
450 paging only	B	G
806-809/851-854 <sup>6</sup>	B	H
809-824/854-869 <sup>3 5</sup>	B	G
896-901/935-940	I	J
902-928	K	K
929-930	B	G
4940-4990 MHz	L or M	L or M
5850-5925 <sup>4</sup>		
All other bands	B	C

#### Emission Mask D — 12.5 kHz channel bandwidth equipment

For transmitters designed to operate with a 12.5 kHz channel bandwidth, any emission must be attenuated below the power (P) of the highest emission contained within the authorized bandwidth as follows:

- (1) On any frequency from the centre of the authorized bandwidth  $f_0$  to 5.625 kHz removed from  $f_0$ : 0dB
- (2) On any frequency removed from the centre of the authorized bandwidth by a displacement frequency ( $f_d$  in kHz) of more than 5.625 kHz but no more than 12.5 kHz: At least  $7.27(f_d - 2.88)$  dB.
- (3) On any frequency removed from the centre of the authorized bandwidth by a displacement frequency ( $f_d$  in kHz) of more than 12.5 kHz: At least  $50 + 10 \log (P)$  dB or 70 dB, whichever is the lesser attenuation.

#### TEST CONFIGURATION

Test setup for Analog:

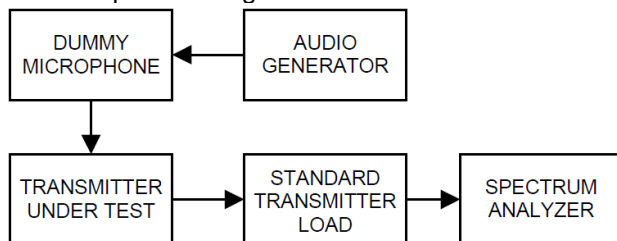

Test setup for Digital:

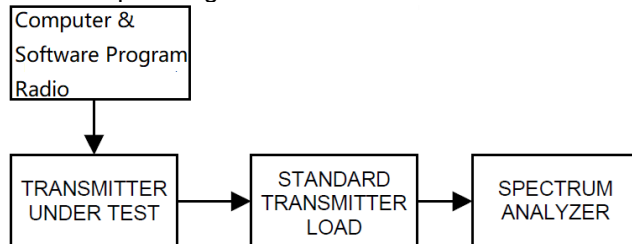

**TEST PROCEDURE**

- 1) Connect the equipment as illustrated.
- 2) Spectrum set as follow:  
Centre frequency = fundamental frequency, span=120kHz for 12.5kHz channel spacing,  
RBW=100Hz, VBW=1000Hz, Sweep = auto,  
Detector function = peak, Trace = max hold
- 3) Key the transmitter, and set the level of the unmodulated carrier to a full scale reference line. This is the 0dB reference for the measurement.
- 4) Apply Input Modulation Signal to EUT according to Section 4.2
- 5) Measure and record the results in the test report.

**TEST MODE**

Please refer to the section 4.2

**TEST RESULTS**

**Passed**       **Not Applicable**

Please refer to appendix C on the section 8 appendix report

## 5.4 Modulation limit

### LIMIT

FCC Part 2.1047(b)

2.5kHz for 12.5 KHz Channel Spacing System.

### TEST CONFIGURATION

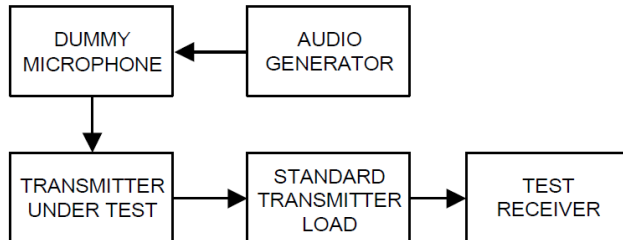

### TEST PROCEDURE

- 1) Connect the equipment as illustrated.
- 2) Adjust the transmitter per the manufacturer's procedure for full rated system deviation.
- 3) Set the test receiver to measure peak positive deviation. Set the audio bandwidth for  $\leq 0.25$  Hz to  $\geq 15,000$  Hz. Turn the de-emphasis function off.
- 4) Apply Input Modulation Signal to EUT according to Section 4.2 and vary the input level from  $-20$  to  $+20$ dB.
- 5) Measure both the instantaneous and steady-state deviation at and after the time of increasing the audio input level
- 6) Repeat step 4-5 with input frequency changing to 300Hz, 1004Hz, 1500Hz and 2500Hz in sequence.

### TEST MODE

Please refer to the section 4.2

### TEST RESULTS

Passed       Not Applicable

Please refer to appendix D on the section 8 appendix report



## 5.5 Audio frequency response

### LIMIT

FCC Part 2.1047(a):

Voice modulated communication equipment. A curve or equivalent data showing the frequency response of the audio modulating circuit over a range of 100 to 5000 Hz shall be submitted. For equipment required to have an audio low-pass filter, a curve showing the frequency response of the filter or of all circuitry installed between the modulation limiter and the modulated stage shall be submitted.

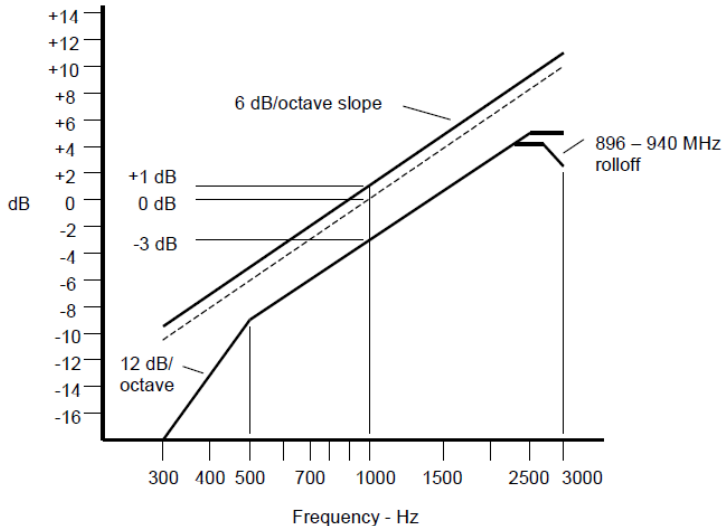

An additional 6 dB per octave attenuation is allowed from 2500 Hz to 3000 Hz in equipment operating in the 25 MHz to 869 MHz range.

### TEST CONFIGURATION

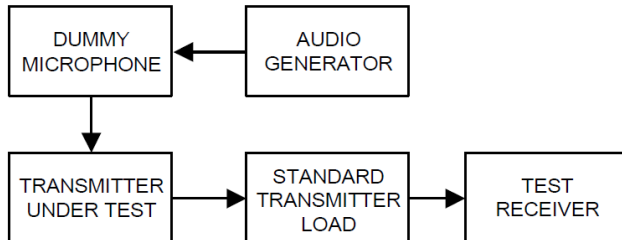

### TEST PROCEDURE

- 1) Connect the equipment as illustrated.
- 2) Set the test receiver to measure peak positive deviation. Set the audio bandwidth for 50 Hz to 15,000 Hz. Turn the de-emphasis function off.
- 3) Set the DMM to measure rms voltage.
- 4) Adjust the transmitter per the manufacturer's procedure for full rated system deviation.
- 5) Apply Input Modulation Signal to EUT according to Section 4.2
- 6) Set the test receiver to measure rms deviation and record the deviation reading.
- 7) Record the DMM reading as  $V_{REF}$ .
- 8) Set the audio frequency generator to the desired test frequency between 300 Hz and 3000 Hz.
- 9) Vary the audio frequency generator output level until the deviation reading that was recorded in step 6) is obtained.
- 10) Record the DMM reading as  $V_{FREQ}$
- 11) Calculate the audio frequency response at the present frequency as:  
audio frequency response =  $20 \log_{10} (V_{FREQ}/V_{REF})$ .
- 12) Repeat steps 8) through 11) for all the desired test frequencies

**TEST MODE**

Please refer to the section 4.2

**TEST RESULTS**

**Passed**       **Not Applicable**

Please refer to appendix E on the section 8 appendix report

## 5.6 Frequency stability VS temperature

### LIMIT

#### FCC Part 90.213, FCC Part 2.1055

Frequency range (MHz)	Fixed and base stations	Mobile stations	
		Over 2 watts output power	2 watts or less output power
Below 25	1 2 3 100	100	200
25-50	20	20	50
72-76	5		50
150-174	5 11 5	6 5	4 6 50
216-220	1.0		1.0
220-222 <sup>12</sup>	0.1	1.5	1.5
421-512	7 11 14 2,5	8 5	8 5
806-809	1 4 1,0	1.5	1.5
809-824	1 4 1,5	2.5	2.5
851-854	1.0	1.5	1.5
854-869	1.5	2.5	2.5
896-901	1 4 0,1	1.5	1.5
902-928	2.5	2.5	2.5
902-928 <sup>13</sup>	2.5	2.5	2.5
929-930	1.5		
935-940	0.1	1.5	1.5
1427-1435	9 300	300	300
Above 2450 <sup>10</sup>			

### TEST CONFIGURATION

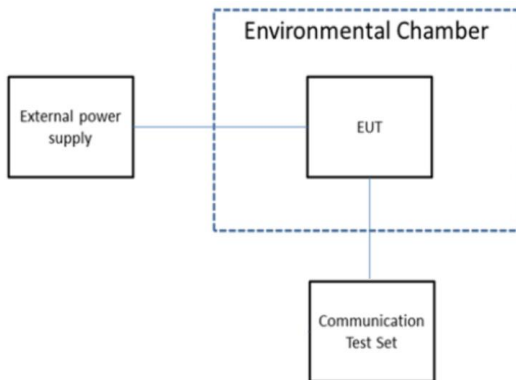

### TEST PROCEDURE

- 1) The EUT output port was connected to communication tester.
- 2) The EUT was placed inside the temperature chamber.
- 3) Turn EUT off and set the chamber temperature to  $-30^{\circ}\text{C}$ . After the temperature stabilized for approximately 30 minutes recorded the frequency as  $MCF_{\text{MHz}}$ .
- 4) Calculate the ppm frequency error by the following:  

$$\text{ppm error} = (MCF_{\text{MHz}} / ACF_{\text{MHz}} - 1) * 10^6$$
 where  
 $MCF_{\text{MHz}}$  is the Measured Carrier Frequency in MHz  
 $ACF_{\text{MHz}}$  is the Assigned Carrier Frequency in MHz
- 5) Repeat step 3 measure with  $10^{\circ}\text{C}$  increased per stage until the highest temperature of  $+50^{\circ}\text{C}$  reached.

### TEST MODE

Please refer to the section 4.2

### TEST RESULTS

Passed       Not Applicable

Please refer to appendix F on the section 8 appendix report

## 5.7 Frequency stability VS voltage

### LIMIT

#### FCC Part 90.213, FCC Part 2.1055

Frequency range (MHz)	Fixed and base stations	Mobile stations	
		Over 2 watts output power	2 watts or less output power
Below 25	1 <sup>2</sup> 3 <sup>1</sup> 100	100	200
25-50	20	20	50
72-76	5		50
150-174	5 <sup>1</sup> 11 <sup>5</sup>	6 <sup>5</sup>	4 <sup>6</sup> 50
216-220	1.0		1.0
220-222 <sup>12</sup>	0.1	1.5	1.5
421-512	7 <sup>1</sup> 11 <sup>14</sup> 2,5	8 <sup>5</sup>	8 <sup>5</sup>
806-809	1 <sup>4</sup> 1,0	1.5	1.5
809-824	1 <sup>4</sup> 1,5	2.5	2.5
851-854	1.0	1.5	1.5
854-869	1.5	2.5	2.5
896-901	1 <sup>4</sup> 0,1	1.5	1.5
902-928	2.5	2.5	2.5
902-928 <sup>13</sup>	2.5	2.5	2.5
929-930	1.5		
935-940	0.1	1.5	1.5
1427-1435	9 <sup>3</sup> 00	300	300
Above 2450 <sup>10</sup>			

### TEST CONFIGURATION

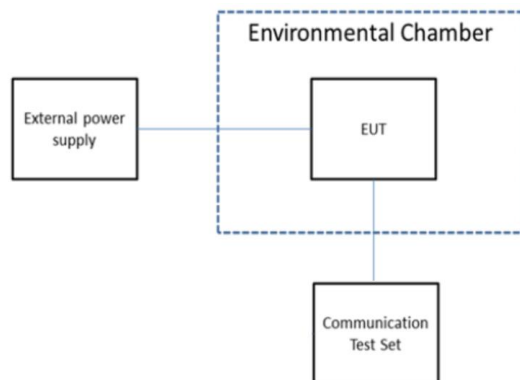

### TEST PROCEDURE

- 1) The EUT output port was connected to communication tester.
- 2) The EUT was placed inside the temperature chamber at 25°C
- 3) Record the carrier frequency of the transmitter as  $MCF_{MHz}$
- 4) Calculate the ppm frequency error by the following:  

$$ppm\ error = (MCF_{MHz} / ACF_{MHz} - 1) * 10^6$$
 where  
 $MCF_{MHz}$  is the Measured Carrier Frequency in MHz  
 $ACF_{MHz}$  is the Assigned Carrier Frequency in MHz
- 5) Repeat step 3 measure with varied  $\pm 15\%$  of the nominal value measured at the input to the EUT

### TEST MODE

Please refer to the section 4.2

### TEST RESULTS

Passed       Not Applicable

Please refer to appendix G on the section 8 appendix report

## 5.8 Transmitter frequency behavior

### LIMIT

#### FCC part 90.214

Transmitters designed to operate in the 150-174 MHz and 421-512 MHz frequency bands must maintain transient frequencies within the maximum frequency difference limits during the time intervals indicated:

Time intervals <sup>1 2</sup>	Maximum frequency difference <sup>3</sup>	All equipment	
		150 to 174 MHz	421 to 512 MHz
Transient Frequency Behavior for Equipment Designed to Operate on 25 kHz Channels			
t <sub>1</sub> <sup>4</sup>	±25.0 kHz	5.0 ms	10.0 ms
t <sub>2</sub>	±12.5 kHz	20.0 ms	25.0 ms
t <sub>3</sub> <sup>4</sup>	±25.0 kHz	5.0 ms	10.0 ms
Transient Frequency Behavior for Equipment Designed to Operate on 12.5 kHz Channels			
t <sub>1</sub> <sup>4</sup>	±12.5 kHz	5.0 ms	10.0 ms
t <sub>2</sub>	±6.25 kHz	20.0 ms	25.0 ms
t <sub>3</sub> <sup>4</sup>	±12.5 kHz	5.0 ms	10.0 ms
Transient Frequency Behavior for Equipment Designed to Operate on 6.25 kHz Channels			
t <sub>1</sub> <sup>4</sup>	±6.25 kHz	5.0 ms	10.0 ms
t <sub>2</sub>	±3.125 kHz	20.0 ms	25.0 ms
t <sub>3</sub> <sup>4</sup>	±6.25 kHz	5.0 ms	10.0 ms

Note:

- On is the instant when a 1 kHz test signal is completely suppressed, including any capture time due to phasing.
  - t<sub>1</sub> is the time period immediately following ton.
  - t<sub>2</sub> is the time period immediately following t<sub>1</sub>.
  - t<sub>3</sub> is the time period from the instant when the transmitter is turned off until toff.
  - t<sub>off</sub> is the instant when the 1 kHz test signal starts to rise.
- During the time from the end of t<sub>2</sub> to the beginning of t<sub>3</sub>, the frequency difference must not exceed the limits specified in §90.213.
- Difference between the actual transmitter frequency and the assigned transmitter frequency.
- If the transmitter carrier output power rating is 6 watts or less, the frequency difference during this time period may exceed the maximum frequency difference for this time period.

### TEST CONFIGURATION

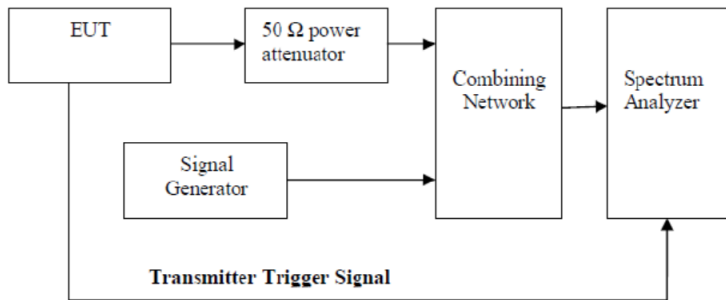

### TEST PROCEDURE

- Connect test equipment as shown in above figure
- Verify RF attenuator power rating for EUT providing adequate protection to the combining network and measurement equipment.
- Tune spectrum analyzer center frequency to EUT frequency and span to at least 100 kHz. Set amplitude according to EUT RF power.
- Switch transmitter on and adjust settings in accordance with step c); switch transmitter to the off position.
- Set analyzer to FM mode; re-tune analyzer to EUT frequency and span according to step c), while in FM demodulation mode.
- An RF test signal of the same frequency as the EUT from the signal generator shall be modulated by a frequency of 1 kHz with a deviation equal to plus or minus the value of the channel spacing (separation). The RF signal strength shall be adjusted allowing the analyzer to demodulate the signal in FM mode.
- Adjust analyzer x axis to capture at least 100 ms of demodulated signal.
- Adjust analyzer y axis for the correct deviation amplitude.
- The analyzer display should show a continuous 1 kHz signal and the channel spacing deviation amplitude.

- j) Change analyzer settings to single sweep and external trigger. For newer analyzers, the channel bandwidth might have to be adjusted for the correct sample rate and sweep speed.
- k) Turn on EUT and adjust analyzer to display desired signal by adjusting trigger settings and considerations in step j). Turn off EUT.
- l) Repeat step k) until optimum set-up is achieved.
- m) Start measurement by turning on EUT. Observe measurements results in analyzer display, EUT<sub>ON</sub> starts at the moment the 1 kHz signal is suppressed (t<sub>2</sub>). See Figure 11 for transient frequency behavior with switch on.
- n) Record values observed in step m) as frequency difference versus time.
- o) Turn off EUT. EUT<sub>OFF</sub> is considered at the start of the 1 kHz signal defined as t<sub>3</sub>. See Figure 12 for transient frequency behavior with switch off.
- p) Record the values observed in step o) as frequency difference versus time.

### **TEST MODE**

Please refer to the section 4.2

### **TEST RESULTS**

**Passed**       **Not Applicable**

Please refer to appendix H on the section 8 appendix report

## 5.9 Spurious emission on antenna port

### LIMIT

FCC Part 90.210, FCC Part 2.1051

**Emission Mask D**—12.5 kHz channel bandwidth equipment. For transmitters designed to operate with a 12.5 kHz channel bandwidth, any emission must be attenuated below the power (P) of the highest emission contained within the authorized bandwidth as follows:

(3) On any frequency removed from the center of the authorized bandwidth by a displacement frequency ( $f_d$  in kHz) of more than 12.5 kHz: At least  $50 + 10 \log (P)$  dB or 70 dB, whichever is the lesser attenuation.

*In general, the worse case attenuation requirement shown above was applied.*

*Calculation: Limit (dBm) = EL-50-10log (P)*

*EL is the emission level of the Output Power expressed in dBm,*

*Limit (dBm) = P(dBm)-50-10 log (Pwatts) = -20dBm*

### TEST CONFIGURATION

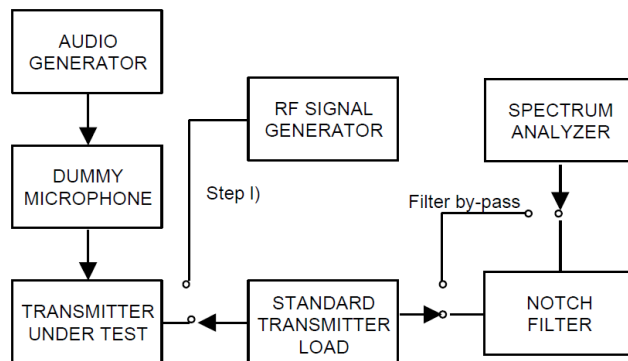

### TEST PROCEDURE

1. Connect the equipment as illustrated, with the notch filter by-passed.
2. Apply Input Modulation Signal to EUT according to Section 4.2
3. Adjust the spectrum analyzer for the following settings:  
Below 1GHz: RBW=100kHz, VBW=300kHz  
Above 1GHz: RBW=1MHz, VBW=3MHz  
Detector=Peak, Sweep time=Auto, Trace=Max hold
4. Scan frequency range up to 10<sup>th</sup> harmonic.
5. Record the frequencies and levels of spurious emissions

### TEST MODE

Please refer to the section 4.2

### TEST RESULTS

Passed       Not Applicable

Please refer to appendix I on the section 8 appendix report

### 5.10 Transmitter radiated spurious emission

#### LIMIT

FCC Part 90.210, FCC Part 2.1051

**Emission Mask D**—12.5 kHz channel bandwidth equipment. For transmitters designed to operate with a 12.5 kHz channel bandwidth, any emission must be attenuated below the power (P) of the highest emission contained within the authorized bandwidth as follows:

(3) On any frequency removed from the center of the authorized bandwidth by a displacement frequency (fd in kHz) of more than 12.5 kHz: At least 50 + 10 log (P) dB or 70 dB, whichever is the lesser attenuation.

*In general, the worse case attenuation requirement shown above was applied.*

*Calculation: Limit (dBm) = EL - 50 - 10 log (P)*

*EL is the emission level of the Output Power expressed in dBm,*

*Limit (dBm) = P(dBm) - 50 - 10 log (Pwatts) = -20dBm*

#### TEST CONFIGURATION

**Below 1GHz:**

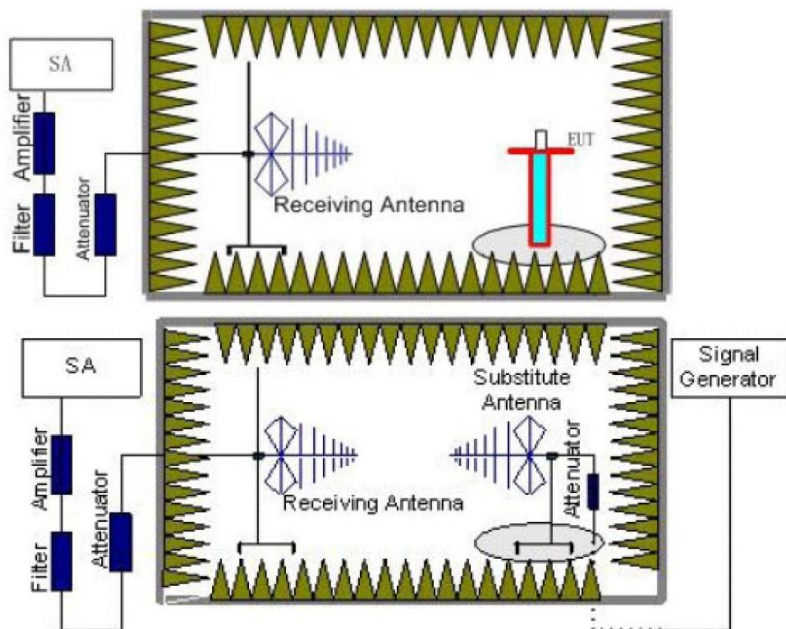

**Above 1GHz:**

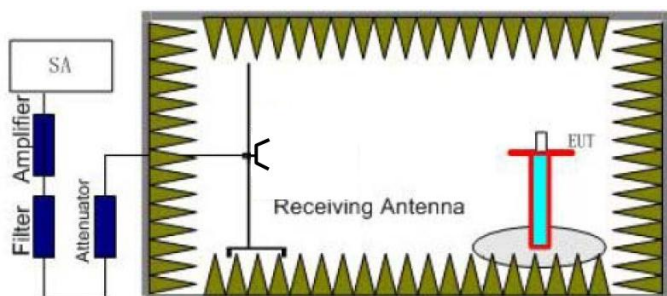



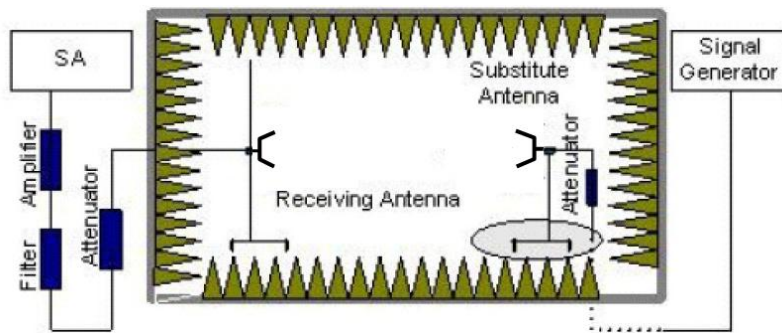

## TEST PROCEDURE

1. Place the EUT in the center of the turntable.
  - a) For radiated emissions measurements performed at frequencies less than or equal to 1 GHz, the EUT shall be placed on a RF-transparent table at a nominal height of 80 cm above the reference ground plane
  - b) For radiated measurements performed at frequencies above 1 GHz, the EUT shall be placed on an RF transparent table at a nominal height of 1.5 m above the ground plane.
2. Unless the EUT uses an integral antenna, the EUT shall be terminated with a non-radiating transmitter load. In cases where the EUT uses an adjustable antenna, the antenna shall be adjusted through typical positions and lengths to maximize emissions levels.
3. The EUT shall be tested while operating on the frequency per manufacturer specification. Set the transmitter to operate in continuous transmit mode.
4. Receiver or Spectrum set as follow:
  - Below 1GHz, RBW=100kHz, VBW=300kHz, Detector=Peak, Sweep time=Auto
  - Above 1GHz, RBW=1MHz, VBW=3MHz, Detector=Peck, Sweep time=Auto
5. Each emission under consideration shall be evaluated:
  - a) Raise and lower the measurement antenna from 1 m to 4 m, as necessary to enable detection of the maximum emission amplitude relative to measurement antenna height.
  - b) Rotate the EUT through 360° to determine the maximum emission level relative to the axial position.
  - c) Return the turntable to the azimuth where the highest emission amplitude level was observed.
  - d) Vary the measurement antenna height again through 1 m to 4 m again to find the height associated with the maximum emission amplitude.
  - e) Record the measured emission amplitude level and frequency
6. Repeat step 5 for each emission frequency with the measurement antenna oriented in both the horizontal and vertical polarizations to determine the orientation that gives the maximum emissions amplitude.
7. Set-up the substitution measurement with the reference point of the substitution antenna located as near as possible to where the center of the EUT radiating element was located during the initial EUT measurement.
8. Maintain the previous measurement instrument settings and test set-up, with the exception that the EUT is removed and replaced by the substitution antenna.
9. Connect a signal generator to the substitution antenna; locate the signal generator so as to minimize any potential influences on the measurement results. Set the signal generator to the frequency where emissions are detected, and set an output power level such that the radiated signal can be detected by the measurement instrument, with sufficient dynamic range relative to the noise floor.
10. For each emission that was detected and measured in the initial test
  - a) Vary the measurement antenna height between 1 m to 4 m to maximize the received (measured) signal amplitude.
  - b) Adjust the signal generator output power level until the amplitude detected by the measurement instrument equals the amplitude level of the emission previously measured directly in step 5 and step 6.
  - c) Record the output power level of the signal generator when equivalence is achieved in step b).
11. Repeat step 8 through step 10 with the measurement antenna oriented in the opposite polarization.
12. Calculate the emission power in dBm referenced to a half-wave dipole using the following equation:
 
$$P_e = P_s(\text{dBm}) - \text{cable loss (dB)} + \text{antenna gain (dBd)}$$
 where
  - $P_e$  = equivalent emission power in dBm
  - $P_s$  = source (signal generator) power in dBm
 NOTE—dBd refers to the measured antenna gain in decibels relative to a half-wave dipole.
13. Correct the antenna gain of the substitution antenna if necessary to reference the emission power to a half-wave dipole. When using measurement antennas with the gain specified in dBi, the equivalent dipole-referenced gain can be determined from:
 
$$\text{gain (dBd)} = \text{gain (dBi)} - 2.15 \text{ dB.}$$
 If necessary, the antenna gain can be calculated from calibrated antenna factor information

14. Provide the complete measurement results as a part of the test report.

**TEST MODE**

Please refer to the section 4.2

**TEST RESULTS**

**Passed**       **Not Applicable**

TEST MODE	TX-DNH	Test Channel:	CH <sub>L</sub>	Polarity:	Horizontal
-----------	--------	---------------	-----------------	-----------	------------

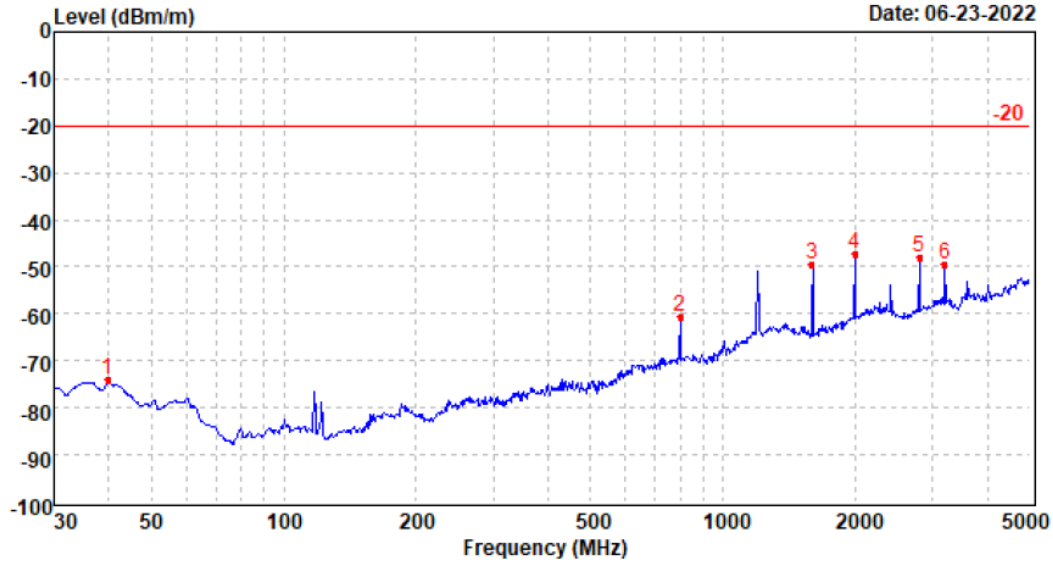

Mark	Frequency MHz	Reading dBm	Antenna dB	Cable dB	Preamp dB	Level dBm	Limit dBm	Over limit	Remark
1	39.75	-77.98	27.74	6.93	30.84	-74.15	-20.00	-54.15	Peak
2	800.80	-71.09	29.86	10.56	29.94	-60.61	-20.00	-40.61	Peak
3	1599.92	-53.01	35.96	4.80	37.18	-49.43	-20.00	-29.43	Peak
4	2001.04	-54.50	39.12	5.58	37.23	-47.03	-20.00	-27.03	Peak
5	2801.18	-57.78	40.73	6.56	37.36	-47.85	-20.00	-27.85	Peak
6	3201.51	-60.62	41.36	7.04	37.12	-49.34	-20.00	-29.34	Peak

TEST MODE	TX-DNH	Test Channel:	CH <sub>L</sub>	Polarity:	Vertical
-----------	--------	---------------	-----------------	-----------	----------

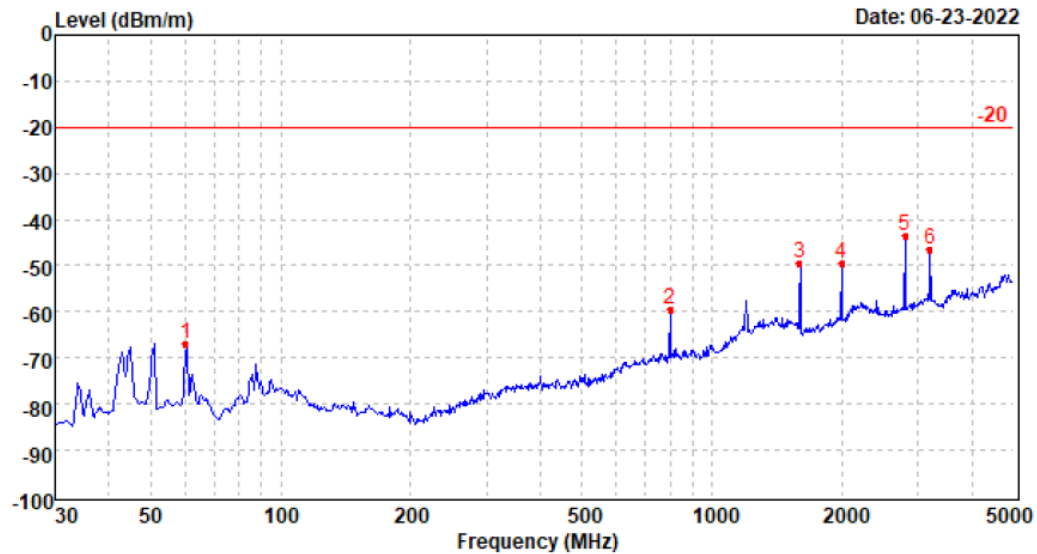

Mark	Frequency MHz	Reading dBm	Antenna dB	Cable dB	Preamp dB	Level dBm	Limit dBm	Over limit	Remark
1	60.40	-66.69	23.58	7.15	31.03	-66.99	-20.00	-46.99	Peak
2	800.80	-69.32	29.40	10.56	29.94	-59.30	-20.00	-39.30	Peak
3	1599.92	-55.00	37.76	4.80	37.18	-49.62	-20.00	-29.62	Peak
4	2001.04	-56.28	38.33	5.58	37.23	-49.60	-20.00	-29.60	Peak
5	2801.18	-53.29	40.68	6.56	37.36	-43.41	-20.00	-23.41	Peak
6	3201.51	-57.97	41.47	7.04	37.12	-46.58	-20.00	-26.58	Peak

B

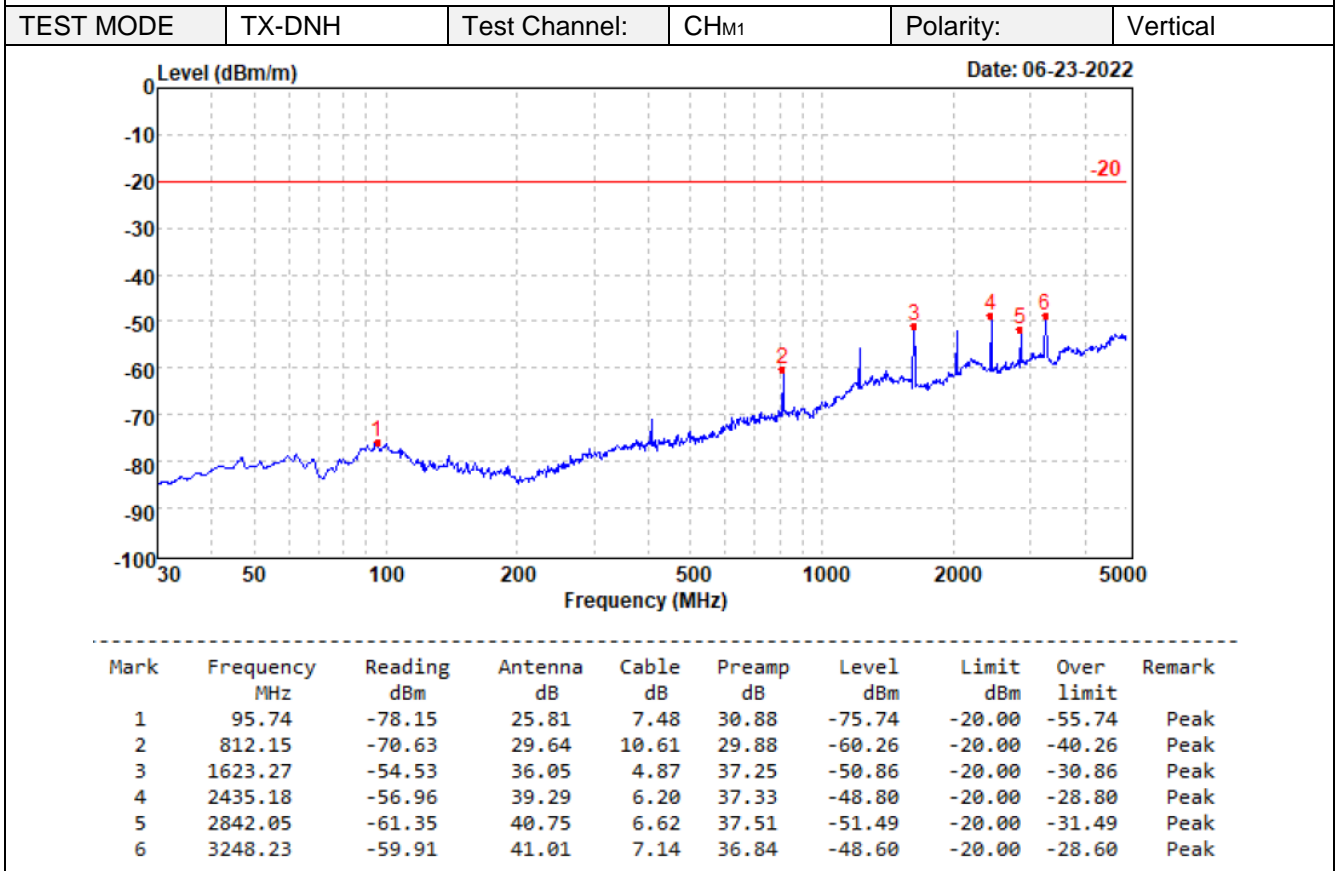
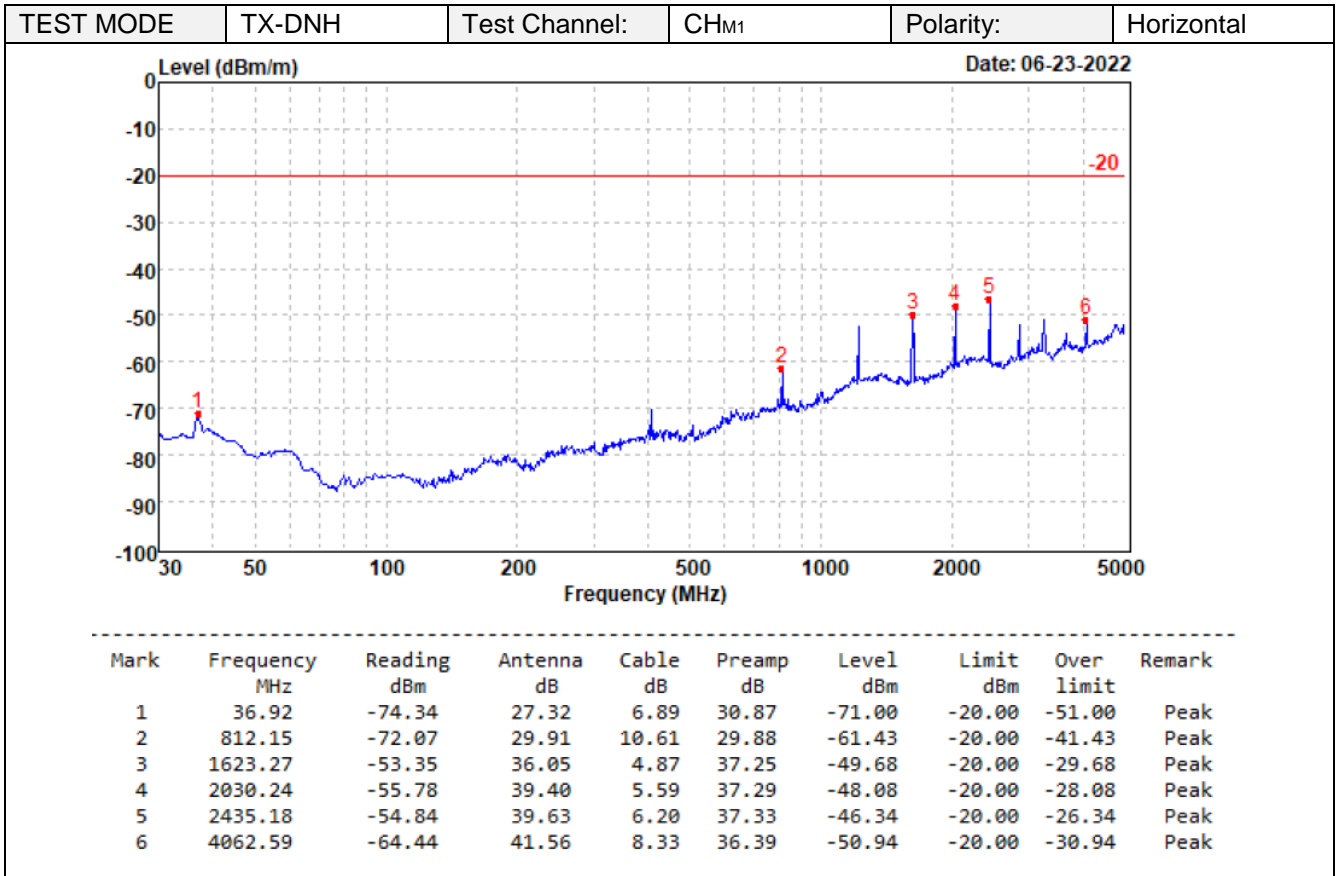

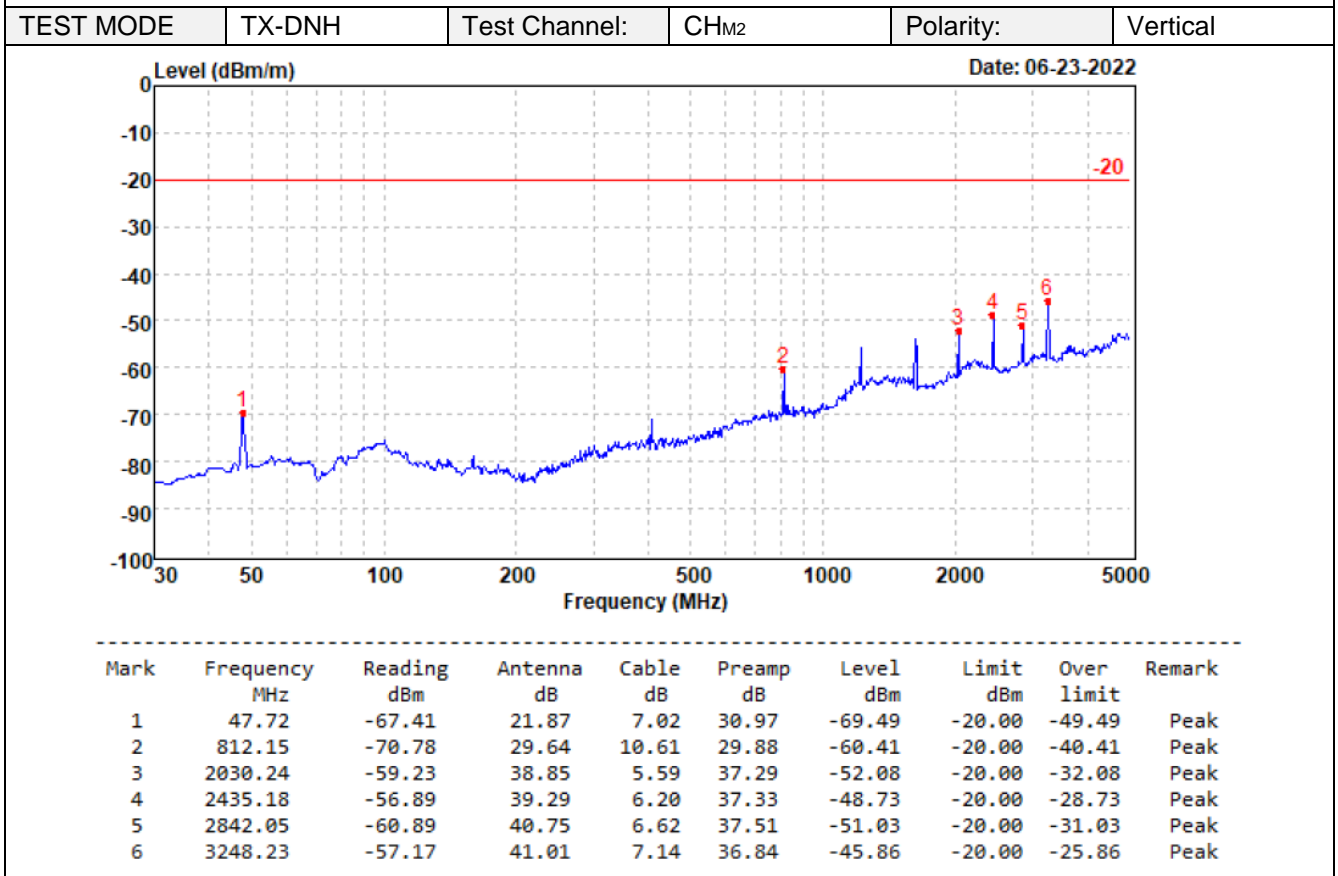
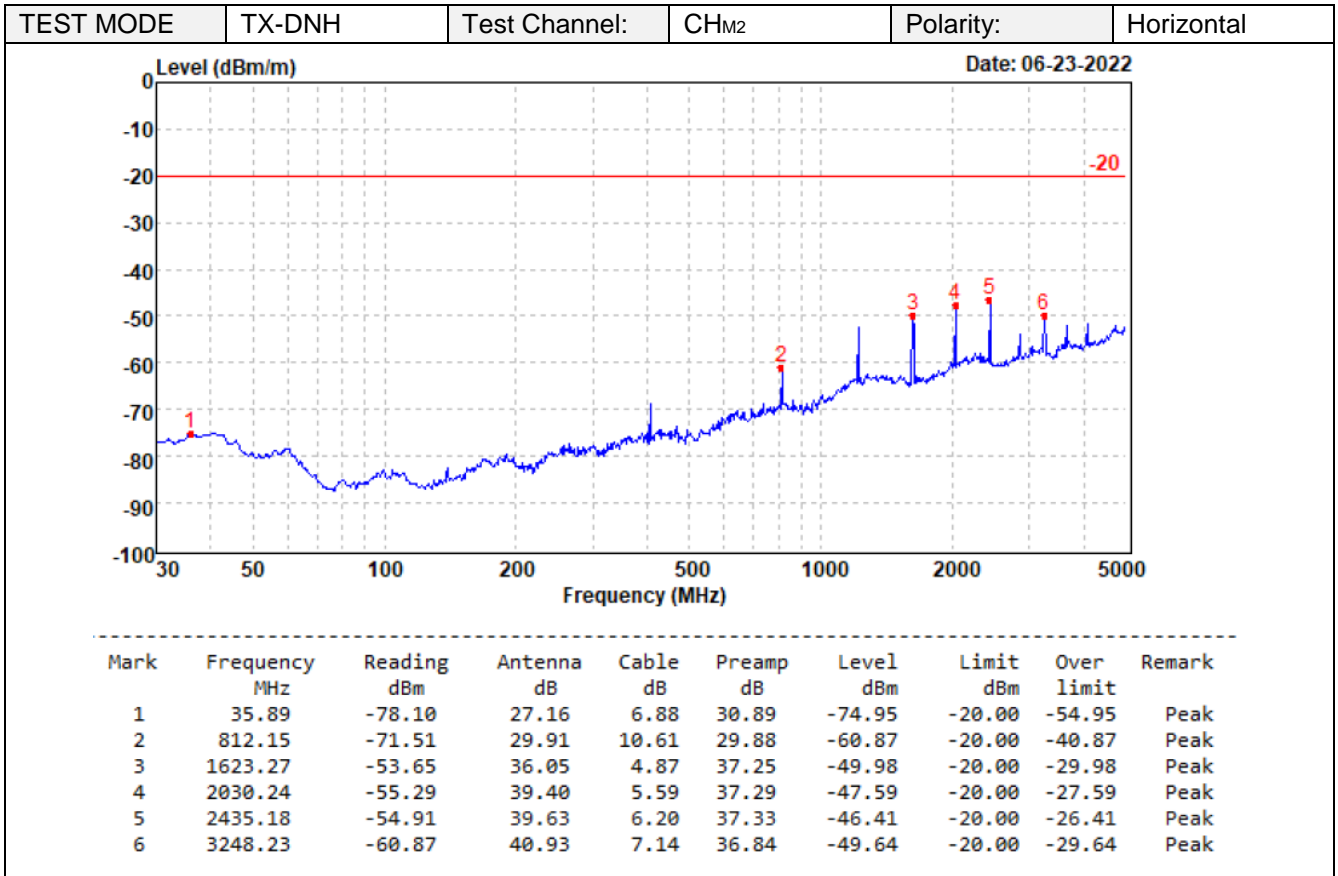

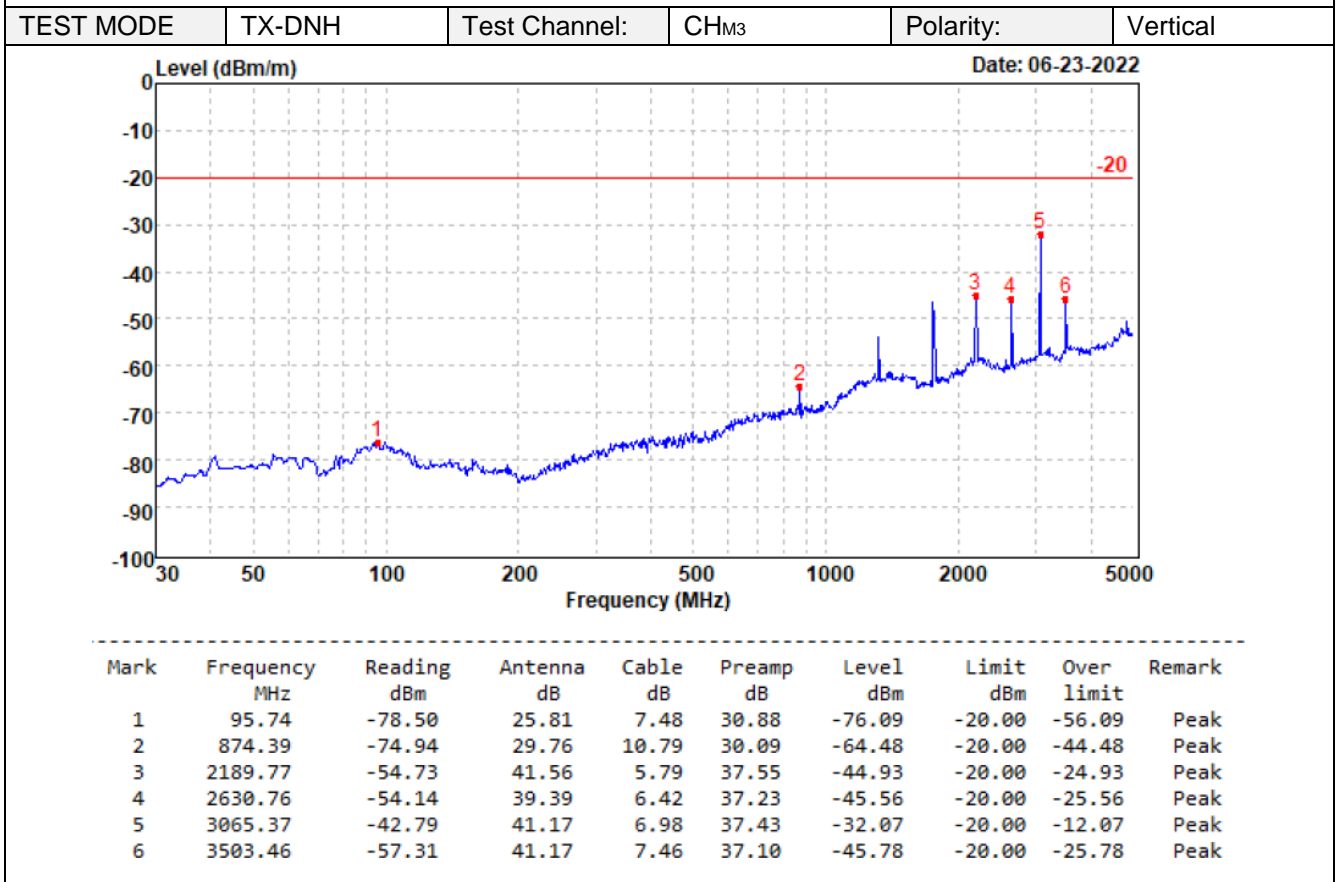
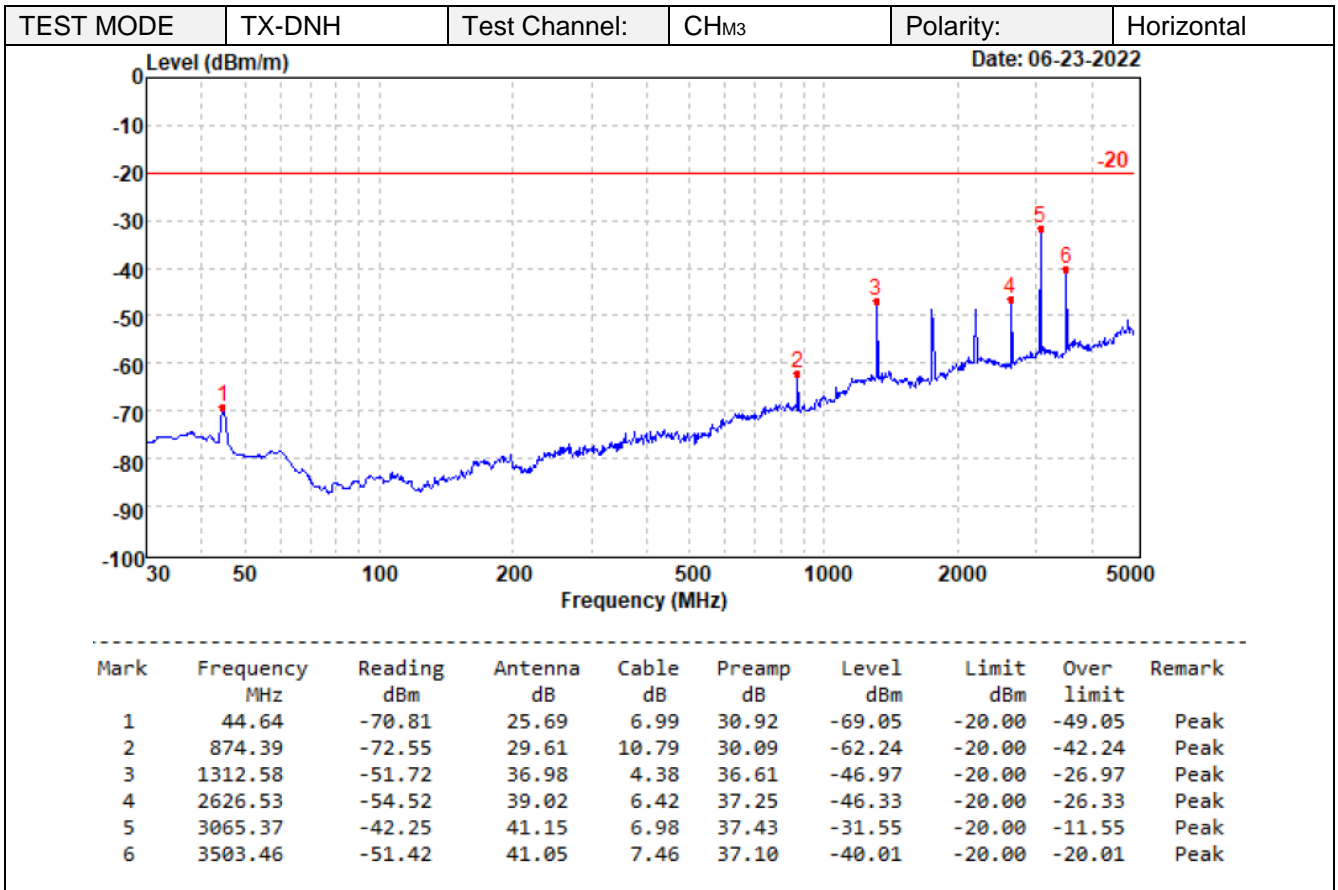

TEST MODE	TX-DNH	Test Channel:	CH <sub>H</sub>	Polarity:	Horizontal
-----------	--------	---------------	-----------------	-----------	------------

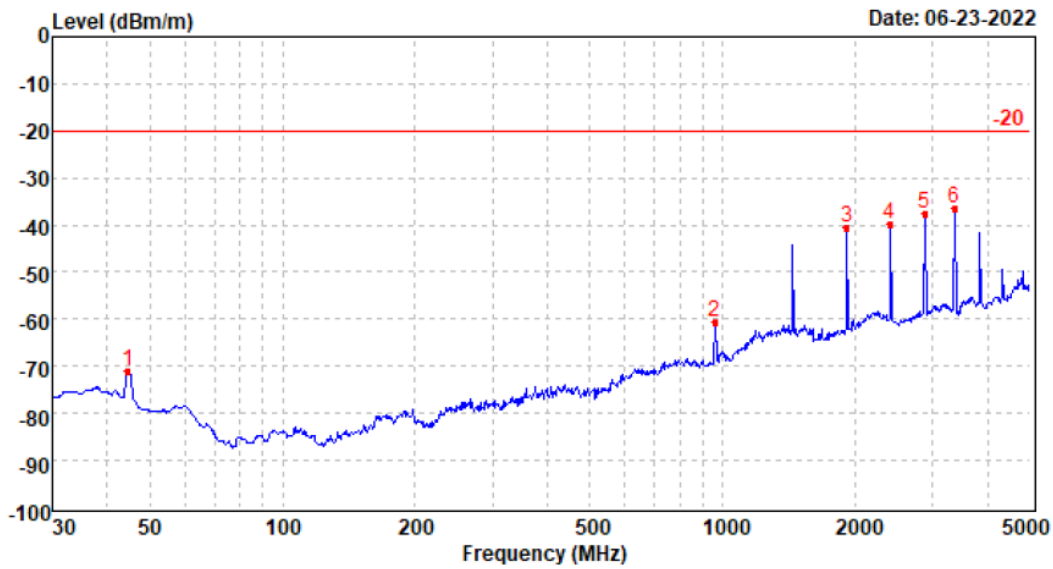

Mark	Frequency MHz	Reading dBm	Antenna dB	Cable dB	Preamp dB	Level dBm	Limit dBm	Over limit	Remark
1	44.64	-72.81	25.69	6.99	30.92	-71.05	-20.00	-51.05	Peak
2	961.48	-71.52	29.67	11.00	29.81	-60.66	-20.00	-40.66	Peak
3	1919.04	-46.78	38.17	5.37	37.18	-40.42	-20.00	-20.42	Peak
4	2400.16	-48.59	39.82	6.22	37.25	-39.80	-20.00	-19.80	Peak
5	2878.88	-47.52	40.85	6.68	37.50	-37.49	-20.00	-17.49	Peak
6	3359.89	-46.39	39.93	7.31	37.36	-36.51	-20.00	-16.51	Peak

TEST MODE	TX-DNH	Test Channel:	CH <sub>H</sub>	Polarity:	Vertical
-----------	--------	---------------	-----------------	-----------	----------

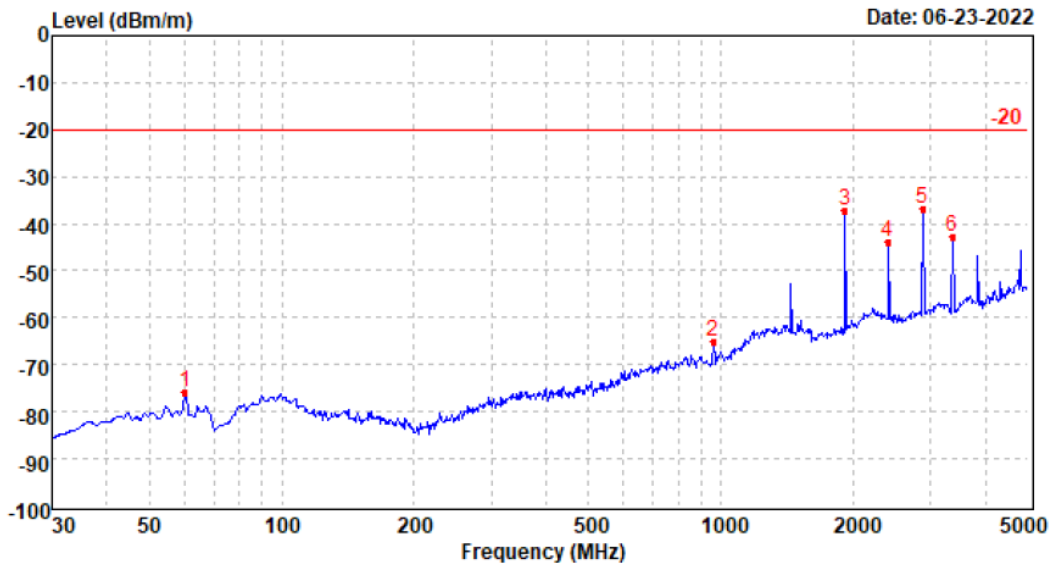

Mark	Frequency MHz	Reading dBm	Antenna dB	Cable dB	Preamp dB	Level dBm	Limit dBm	Over limit	Remark
1	60.40	-75.59	23.58	7.15	31.03	-75.89	-20.00	-55.89	Peak
2	961.48	-75.59	29.45	11.00	29.81	-64.95	-20.00	-44.95	Peak
3	1919.04	-42.91	37.59	5.37	37.18	-37.13	-20.00	-17.13	Peak
4	2400.16	-52.29	39.32	6.22	37.25	-44.00	-20.00	-24.00	Peak
5	2878.88	-46.97	40.82	6.68	37.50	-36.97	-20.00	-16.97	Peak
6	3359.89	-52.80	39.94	7.31	37.36	-42.91	-20.00	-22.91	Peak

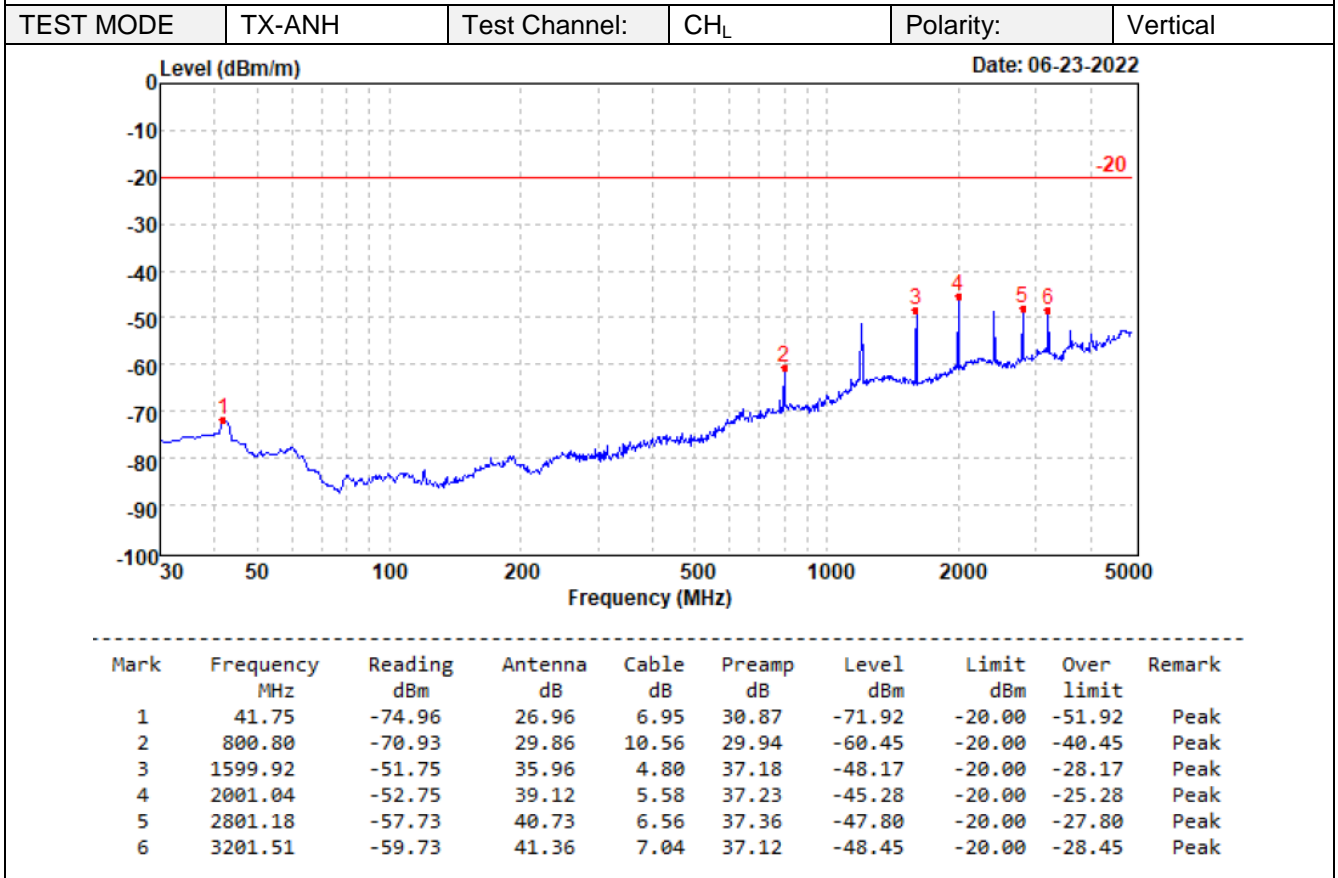
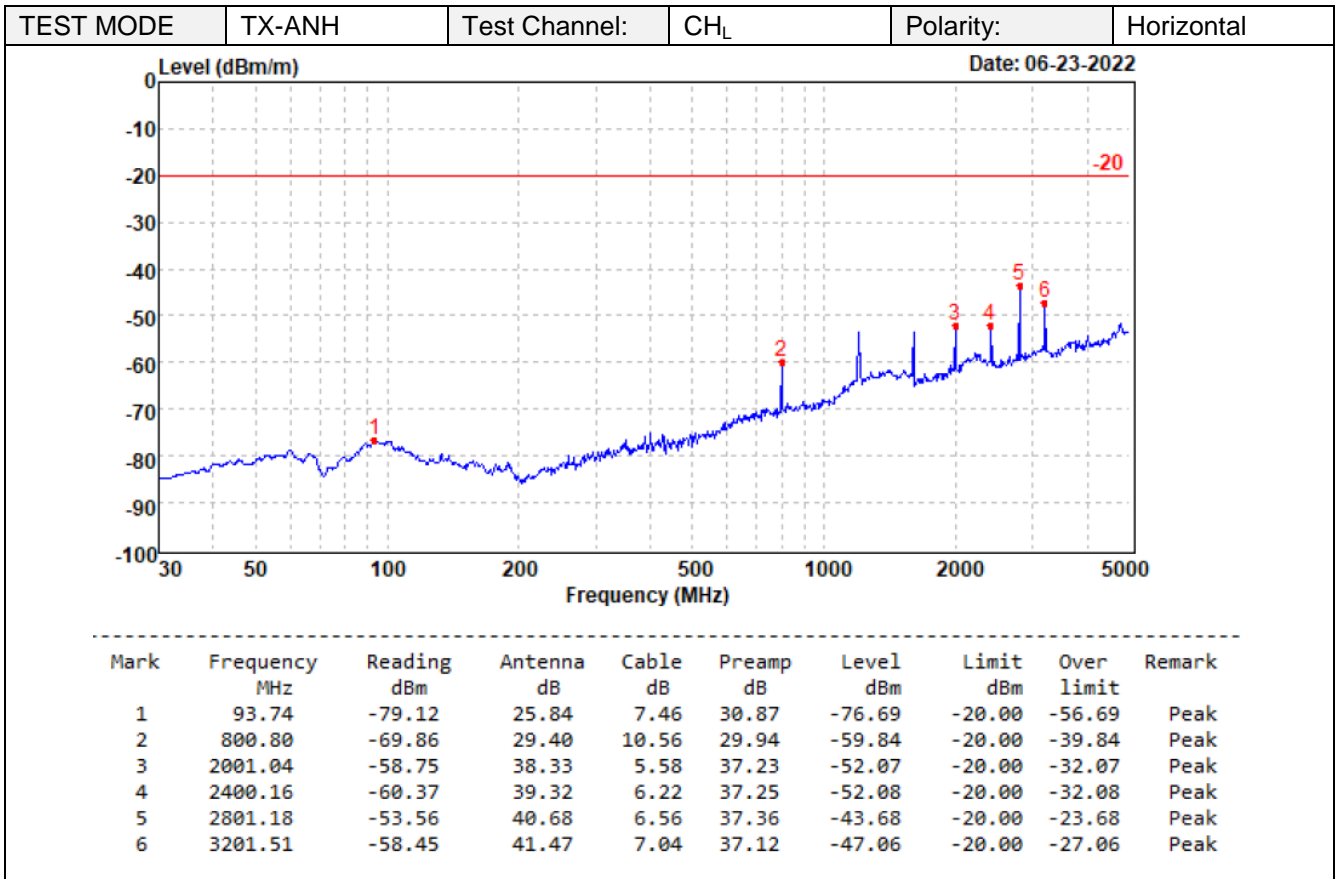



TEST MODE	TX-ANH	Test Channel:	CH <sub>M1</sub>	Polarity:	Horizontal
-----------	--------	---------------	------------------	-----------	------------

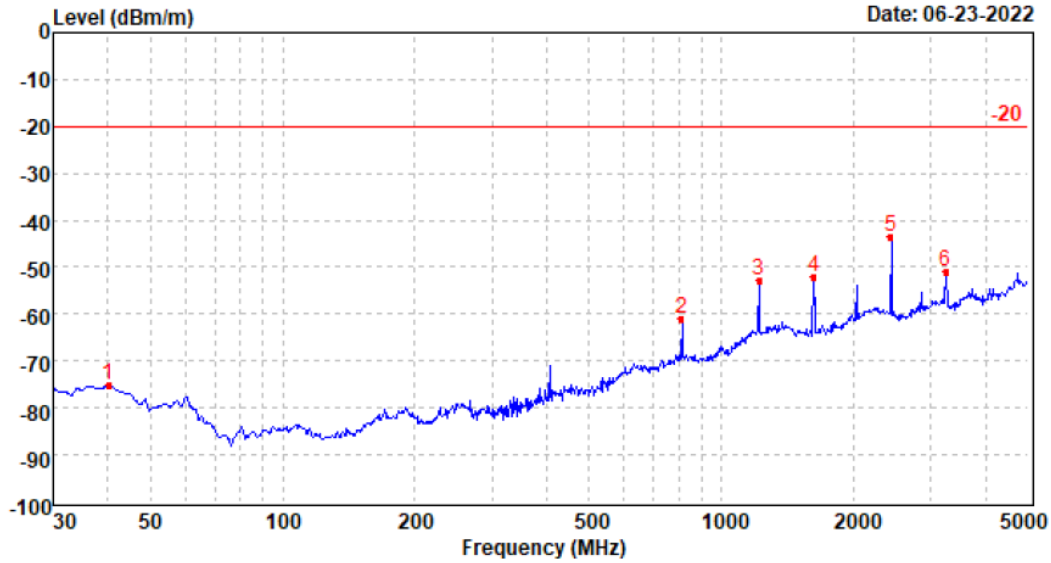

Mark	Frequency MHz	Reading dBm	Antenna dB	Cable dB	Preamp dB	Level dBm	Limit dBm	Over limit	Remark
1	40.03	-78.97	27.77	6.93	30.84	-75.11	-20.00	-55.11	Peak
2	812.15	-71.43	29.91	10.61	29.88	-60.79	-20.00	-40.79	Peak
3	1216.95	-57.09	36.77	4.15	36.77	-52.94	-20.00	-32.94	Peak
4	1623.27	-55.67	36.05	4.87	37.25	-52.00	-20.00	-32.00	Peak
5	2435.18	-52.16	39.63	6.20	37.33	-43.66	-20.00	-23.66	Peak
6	3248.23	-62.16	40.93	7.14	36.84	-50.93	-20.00	-30.93	Peak

TEST MODE	TX-ANH	Test Channel:	CH <sub>M1</sub>	Polarity:	Vertical
-----------	--------	---------------	------------------	-----------	----------

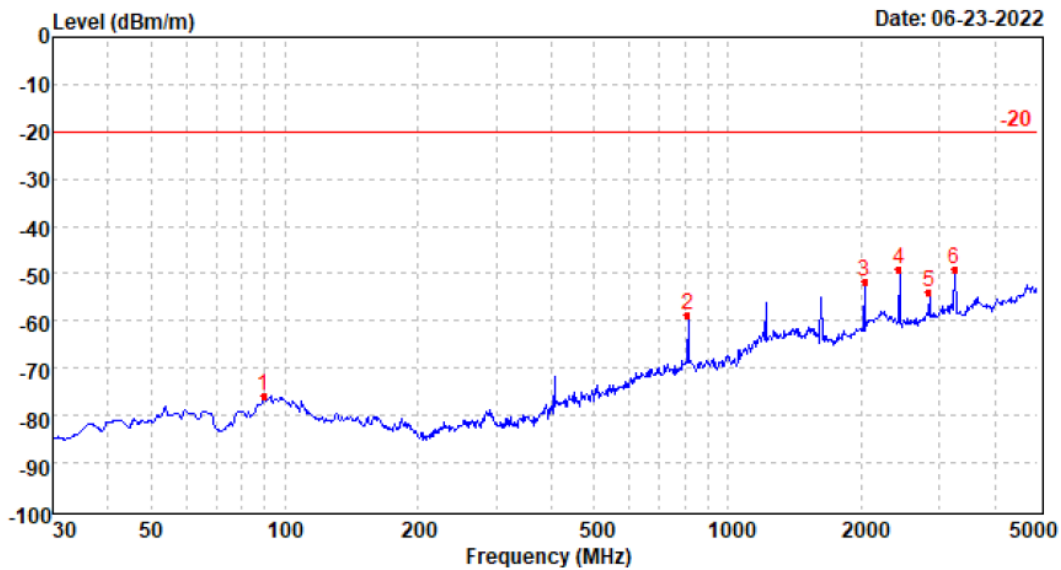

Mark	Frequency MHz	Reading dBm	Antenna dB	Cable dB	Preamp dB	Level dBm	Limit dBm	Over limit	Remark
1	89.87	-78.29	25.83	7.42	30.86	-75.90	-20.00	-55.90	Peak
2	812.15	-69.21	29.64	10.61	29.88	-58.84	-20.00	-38.84	Peak
3	2030.24	-58.92	38.85	5.59	37.29	-51.77	-20.00	-31.77	Peak
4	2435.18	-57.09	39.29	6.20	37.33	-48.93	-20.00	-28.93	Peak
5	2842.05	-63.90	40.75	6.62	37.51	-54.04	-20.00	-34.04	Peak
6	3248.23	-60.50	41.01	7.14	36.84	-49.19	-20.00	-29.19	Peak

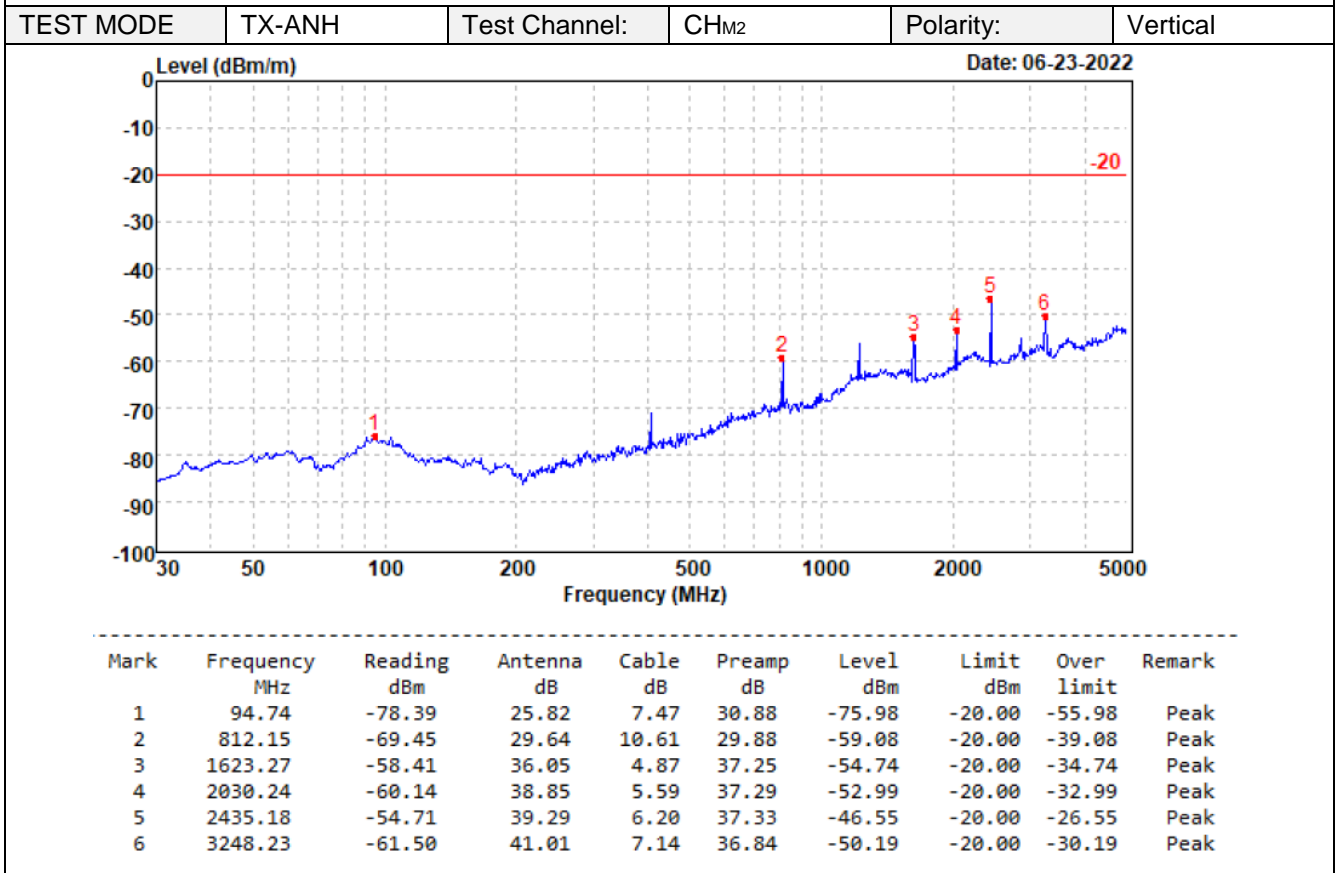
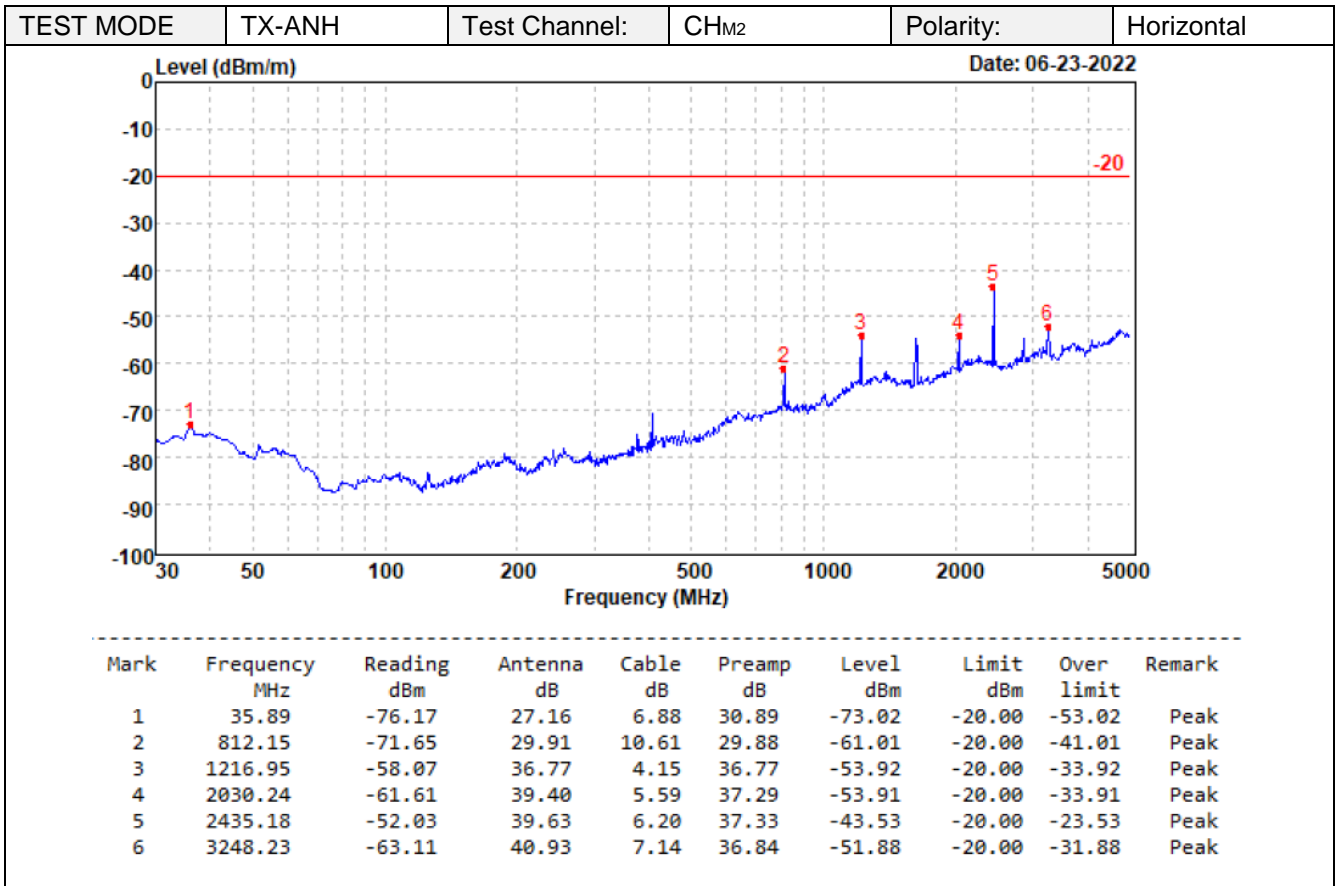

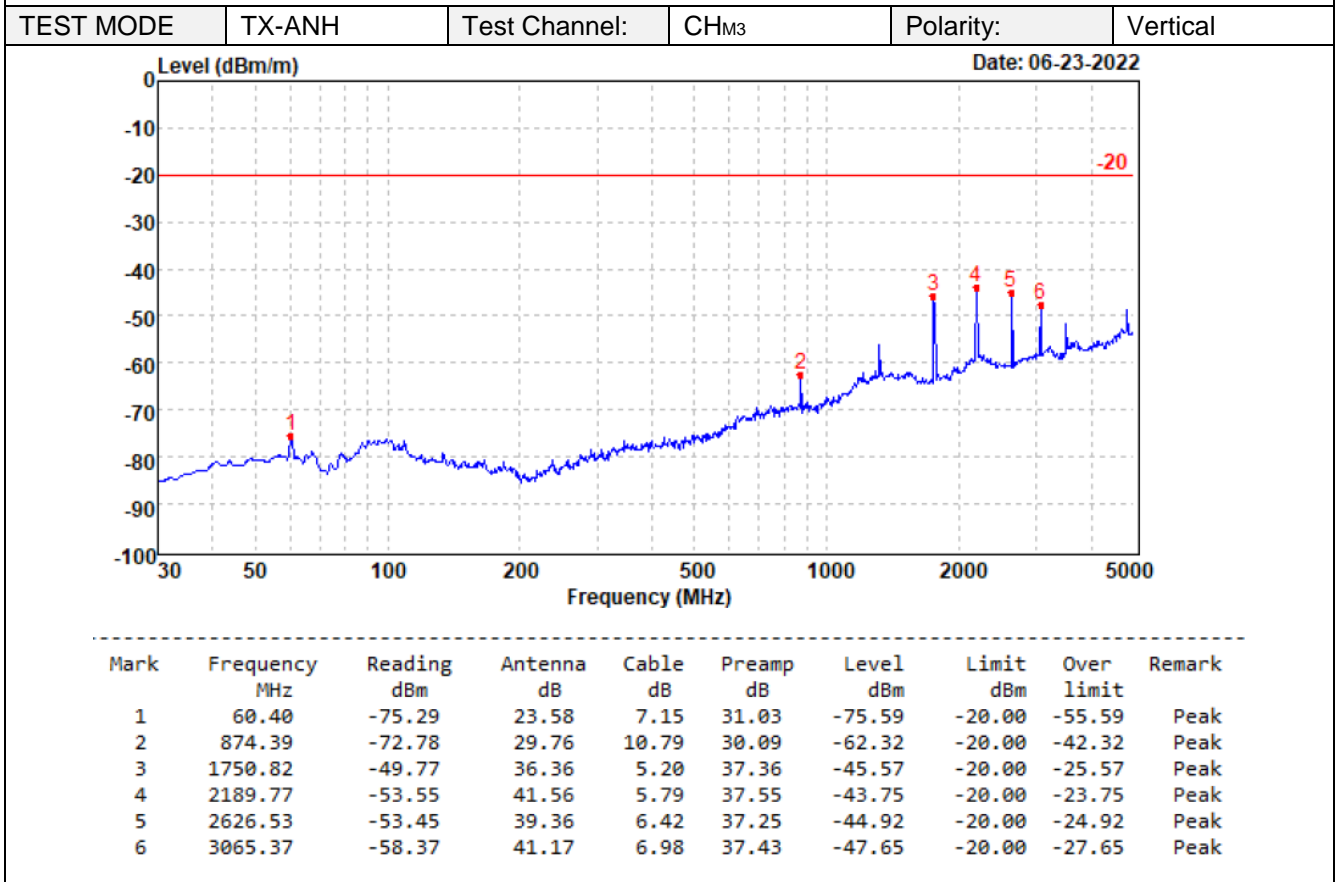
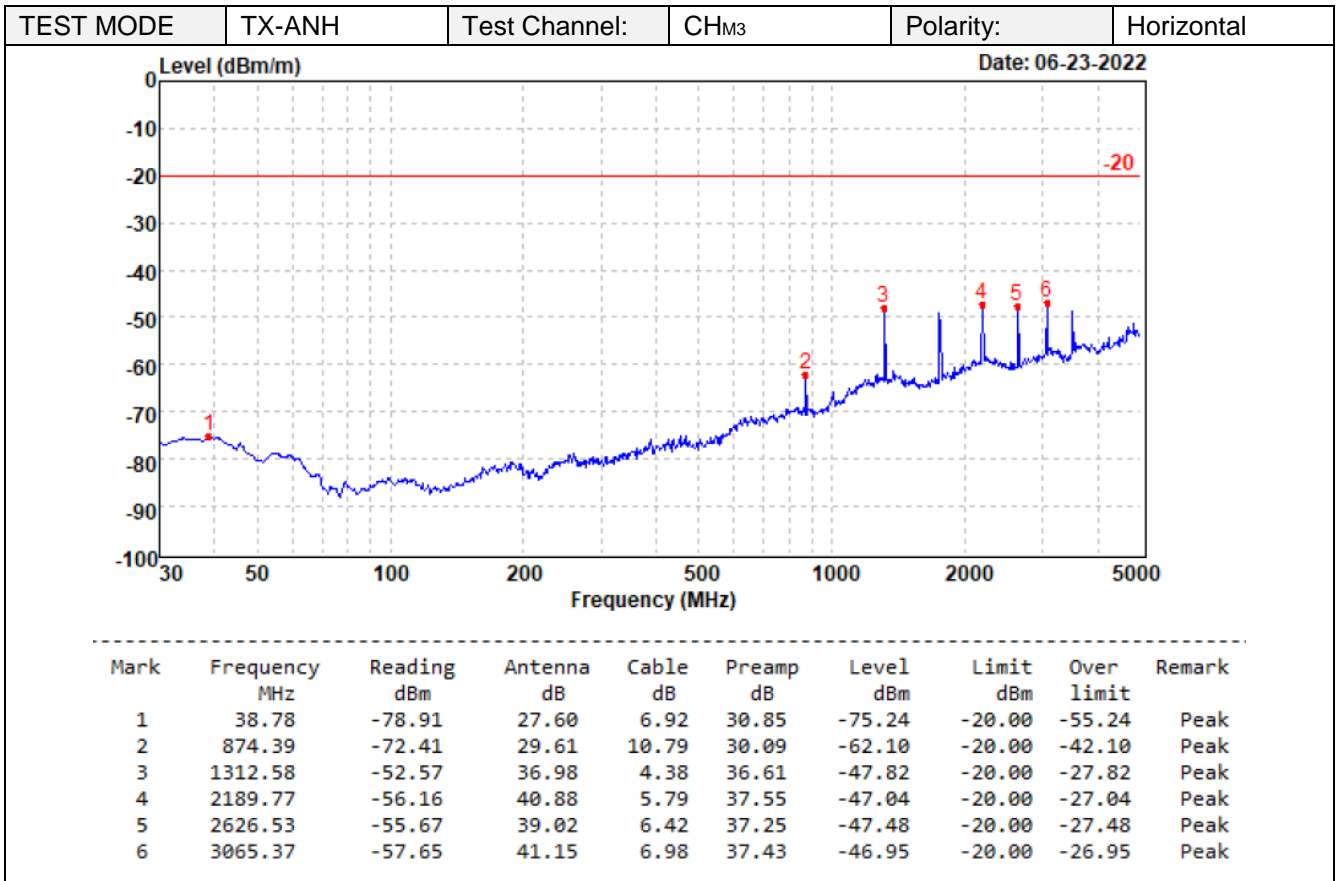

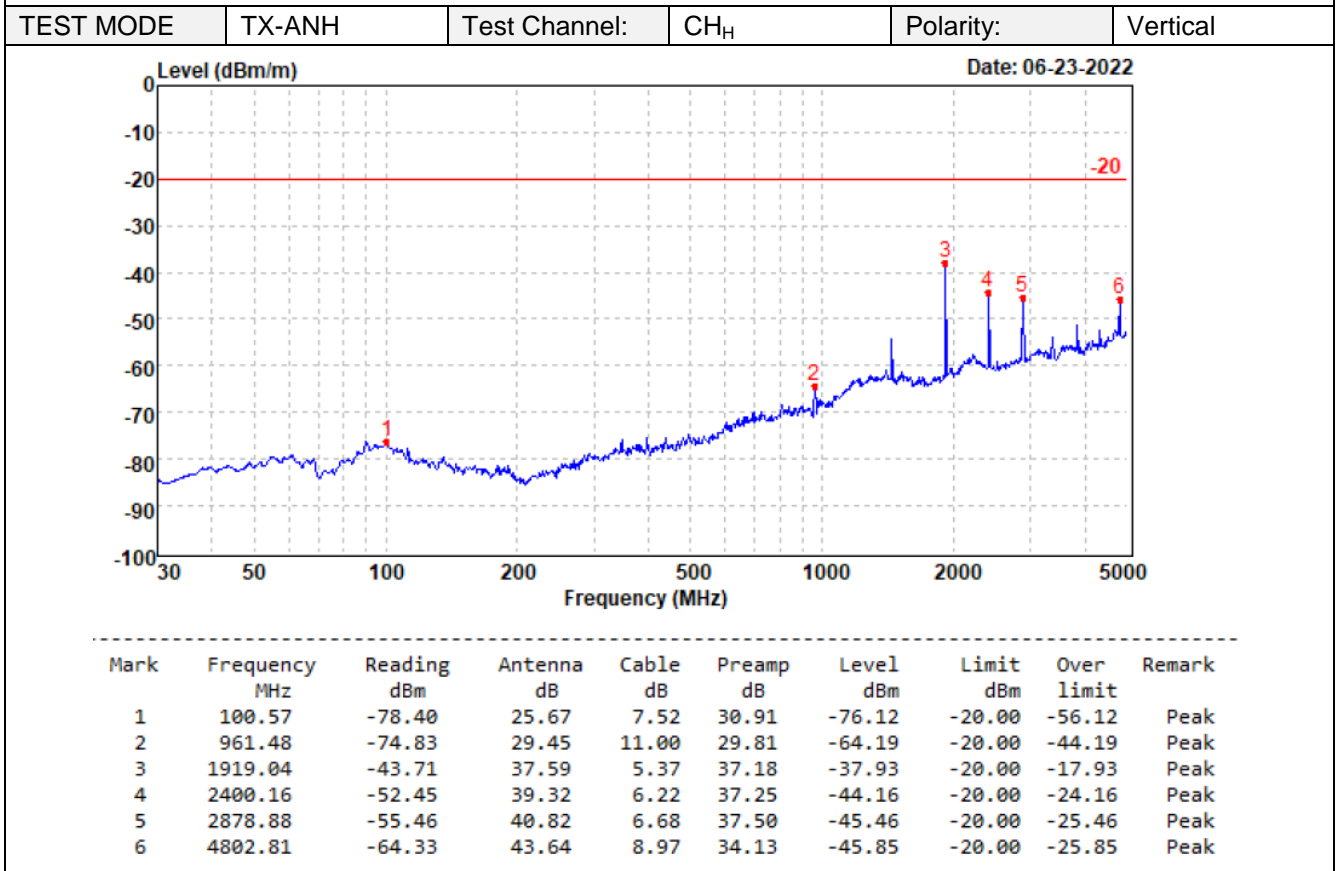
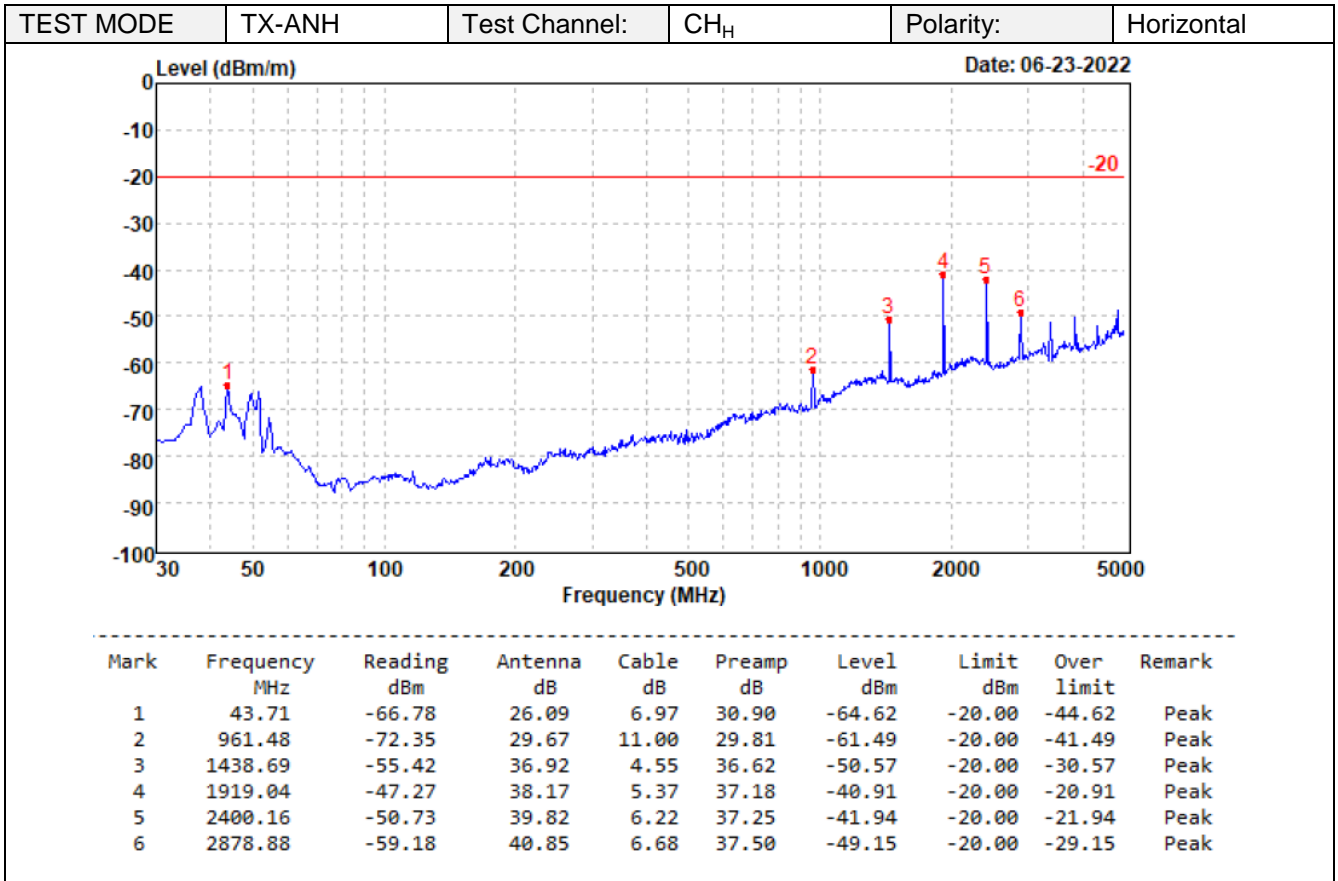

## 6 TEST SETUP PHOTOS

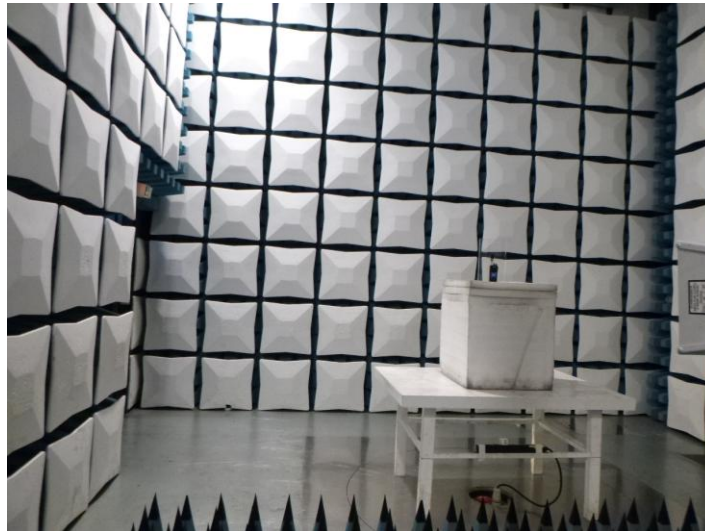
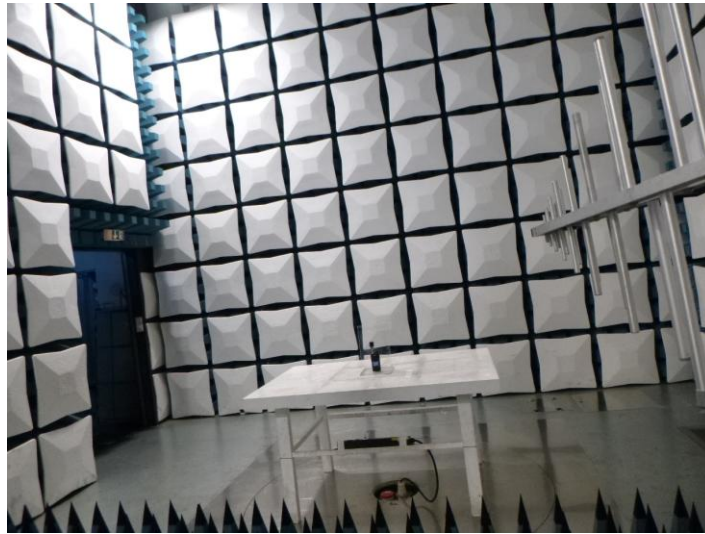



## 7 EXTERNAL AND INTERNAL PHOTOS OF THE EUT

### 7.1 External photos

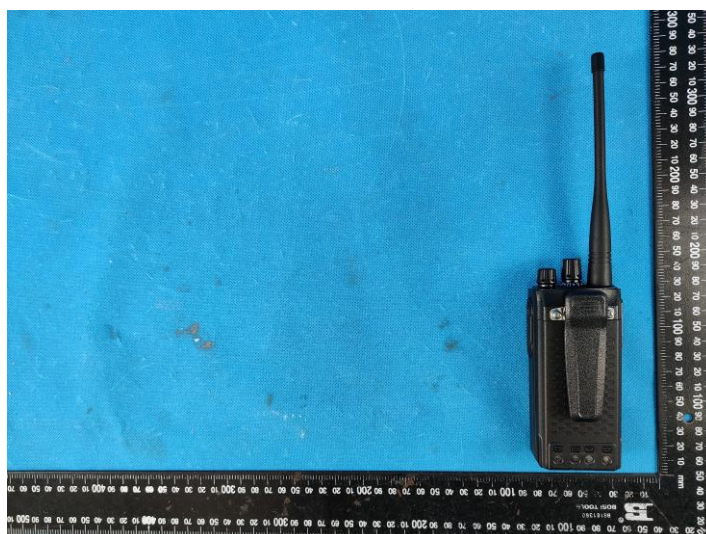
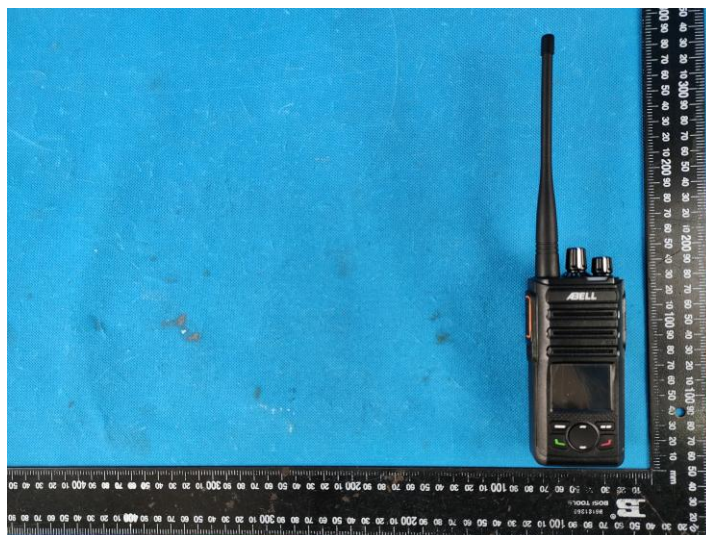





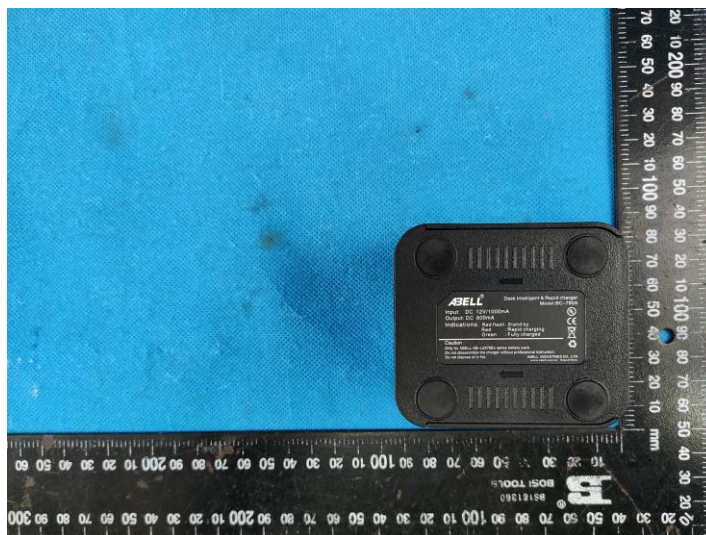

### 7.2 Internal photos



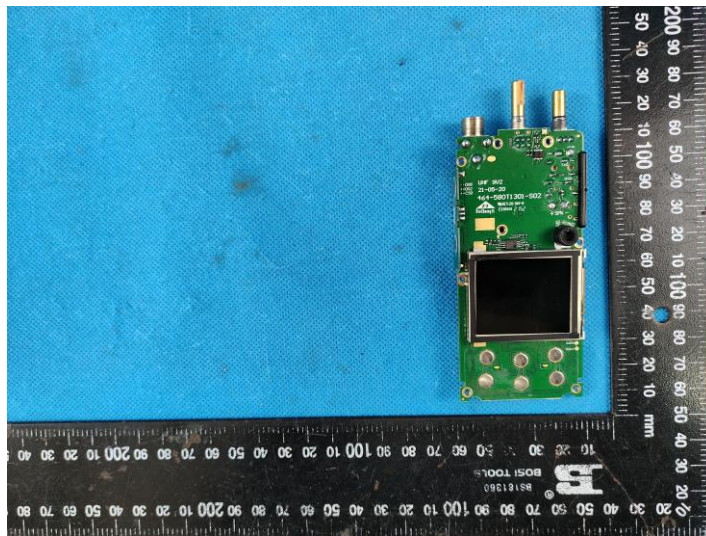
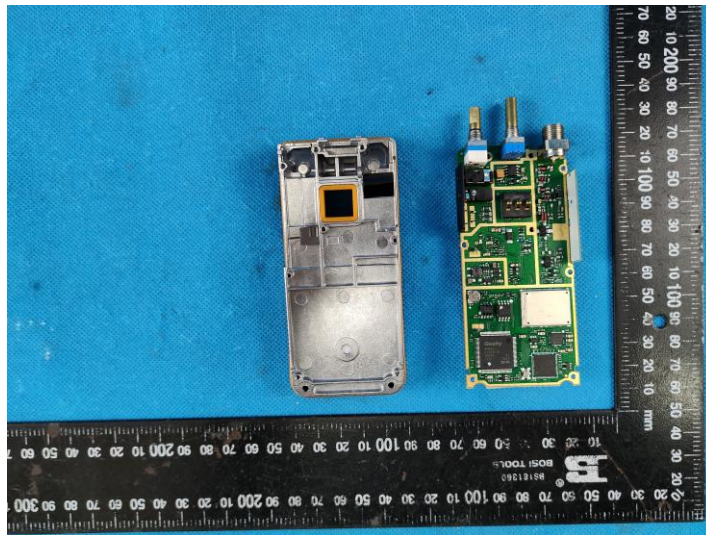

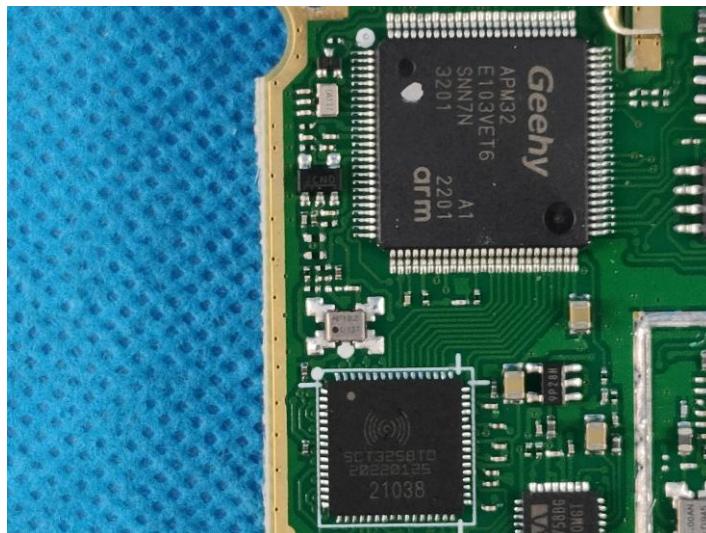
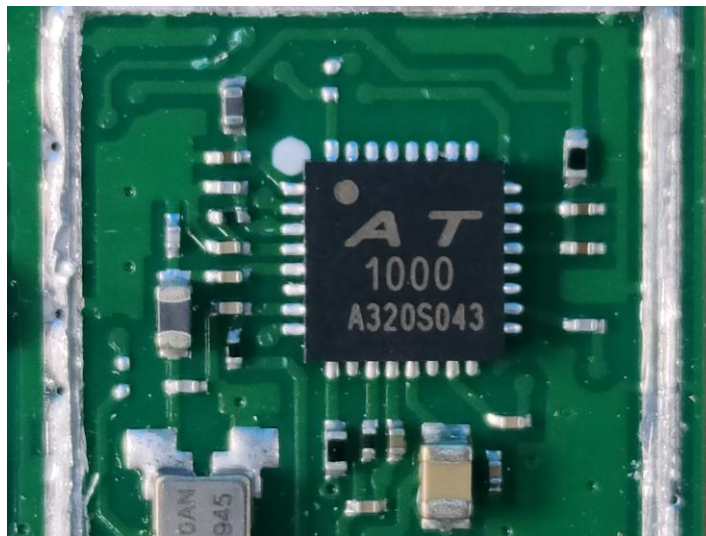
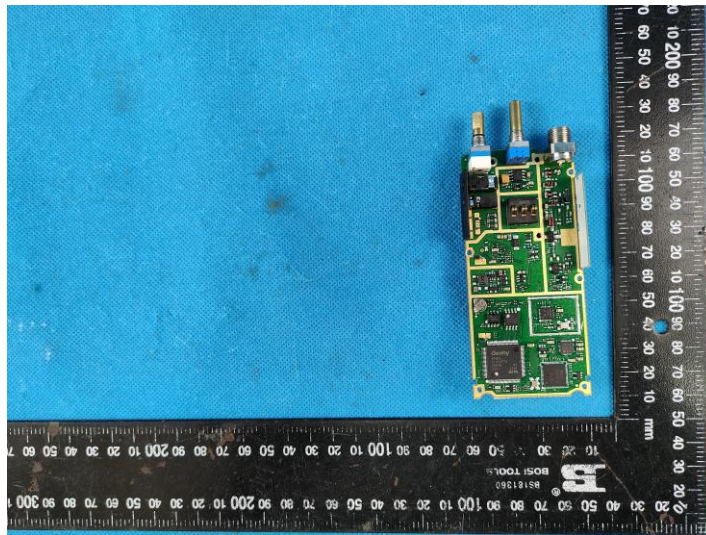

## 8 APPENDIX REPORT