

FCC

SAR

TEST REPORT

ISSUED BY  
Shenzhen BALUN Technology Co., Ltd.



FOR  
**Y50 FDD-LTE Smartphone**

ISSUED TO  
TP-LINK Technologies Co., Ltd.

Building 24-1F/3F/4F/5F, 28-1F/2F/3F/4F Science and Technology Park, Shennan Road, Nanshan District, Shenzhen City, Guangdong Province, P.R. China



Tested by: *Zong Liyao*  
Zong Liyao  
(Engineer)

Date: *Apr. 07, 2017*

Approved by: *Wei Yanquan*  
Wei Yanquan  
(Chief Engineer)

Date: *Apr. 07, 2017*

Report No.: BL-SZ1720011-701

EUT Name: Y50 FDD-LTE Smartphone

Model Name: TP803C

Brand Name: neffos

FCC ID: TE7Y50V1

Test Standard: FCC 47 CFR Part 2.1093  
ANSI C95.1: 1999, IEEE 1528: 2013

Maximum SAR: Head (1 g): 0.353 W/kg

Body (1 g): 0.847 W/kg

Hotspot (1 g): 1.186 W/kg

Test Conclusion: Pass

Test Date: Mar. 14, 2017 ~ Mar. 27, 2017

Date of Issue: Apr. 07, 2017

*NOTE: This test report can be duplicated completely for the legal use with the approval of the applicant; it shall not be reproduced except in full, without the written approval of Shenzhen BALUN Technology Co., Ltd. BALUN Laboratory. Any objections should be raised within thirty days from the date of issue. To validate the report, please visit BALUN website.*

### Revision History

<u>Version</u>	<u>Issue Date</u>	<u>Revisions Content</u>
<u>Rev. 01</u>	<u>Apr. 07, 2017</u>	<u>Initial Issue</u>

## TABLE OF CONTENTS

1	GENERAL INFORMATION.....	5
1.1	Identification of the Testing Laboratory.....	5
1.2	Identification of the Responsible Testing Location.....	5
1.3	Test Environment Condition.....	5
1.4	Announce.....	5
2	PRODUCT INFORMATION.....	6
2.1	Applicant Information.....	6
2.2	Manufacturer Information.....	6
2.3	Factory Information.....	6
2.4	General Description for Equipment under Test (EUT).....	6
2.5	Ancillary Equipment.....	7
2.6	Technical Information.....	8
3	SUMMARY OF TEST RESULTS.....	9
3.1	Test Standards.....	9
3.2	Device Category and SAR Limit.....	9
3.3	Test Result Summary.....	11
3.4	Test Uncertainty.....	12
4	SAR MEASUREMENT SYSTEM.....	13
4.1	Definition of Specific Absorption Rate (SAR).....	13
4.2	SATIMO SAR System.....	13
5	SYSTEM VERIFICATION.....	22
5.1	Antenna Port Test Requirement.....	22
5.2	Purpose of System Check.....	22
5.3	System Check Setup.....	22
6	EUT TEST POSITION CONFIGURATIONS.....	23
6.1	Head Exposure Conditions.....	23

6.2	Body-worn Position Conditions .....	24
6.3	Hotspot Mode Exposure Position Conditions .....	25
7	SAR MEASUREMENT PROCEDURES.....	26
7.1	SAR Measurement Process Diagram .....	26
7.2	SAR Scan General Requirements .....	27
7.3	SAR Measurement Procedure .....	28
7.4	Area & Zoom Scan Procedures .....	28
8	CONDUCTED RF OUPUT POWER .....	29
8.1	GSM.....	29
8.2	WCDMA .....	30
8.3	LTE.....	31
8.4	2.4G WIFI.....	36
8.5	Bluetooth .....	36
8.6	Power Reduction List.....	37
9	EUT ANTENNA LOCATION SKETCH .....	38
9.1	SAR Test Exclusion Consider Table.....	39
10	TEST RESULTS.....	41
10.1	GSM 850 .....	41
10.2	GSM 1900 .....	42
10.3	WCDMA Band 2 .....	43
10.4	WCDMA Band 4 .....	44
10.5	WCDMA Band 5 .....	45
10.6	LTE Band 2 (20MHz Bandwidth) .....	46
10.7	LTE Band 4 (20MHz Bandwidth) .....	47
10.8	LTE Band 7 (20MHz Bandwidth) .....	48
10.9	WIFI 2.4GHZ.....	49
11	SAR Measurement Variability .....	50
12	SIMULTANEOUS TRANSMISSION.....	51
12.1	Simultaneous Transmission Mode Consider.....	51
12.2	Estimated SAR Calculation.....	52
12.3	Sum SAR of Simultaneous Transmission .....	53

13 TEST EQUIPMENTS LIST ..... 54

ANNEX A SIMULATING LIQUID VERIFICATION RESULT ..... 55

ANNEX B SYSTEM CHECK RESULT ..... 56

ANNEX C TEST DATA..... 77

ANNEX D EUT EXTERNAL PHOTOS ..... 104

ANNEX E SAR TEST SETUP PHOTOS ..... 104

ANNEX F CALIBRATION REPORT..... 104

# 1 GENERAL INFORMATION

## 1.1 Identification of the Testing Laboratory

Company Name	Shenzhen BALUN Technology Co., Ltd.
Address	Block B, 1st FL, Baisha Science and Technology Park, Shahe Xi Road, Nanshan District, Shenzhen, Guangdong Province, P. R. China
Phone Number	+86 755 6685 0100

## 1.2 Identification of the Responsible Testing Location

Test Location	Shenzhen BALUN Technology Co., Ltd.
Address	Block B, 1st FL, Baisha Science and Technology Park, Shahe Xi Road, Nanshan District, Shenzhen, Guangdong Province, P. R. China
Accreditation Certificate	<p>The laboratory has been listed by Industry Canada to perform electromagnetic emission measurements. The recognition numbers of test site are 11524A-1.</p> <p>The laboratory has been listed by US Federal Communications Commission to perform electromagnetic emission measurements. The recognition numbers of test site are 832625.</p> <p>The laboratory is a testing organization accredited by China National Accreditation Service for Conformity Assessment (CNAS) according to ISO/IEC 17025. The accreditation certificate number is L6791.</p>
Description	All measurement facilities used to collect the measurement data are located at Block B, FL 1, Baisha Science and Technology Park, Shahe Xi Road, Nanshan District, Shenzhen, Guangdong Province, P. R. China 518055

## 1.3 Test Environment Condition

Ambient Temperature	20 to 23°C
Ambient Relative Humidity	37 to 48%
Ambient Pressure	100 to 102KPa

## 1.4 Announce

- (1) The test report reference to the report template version v2.2.
- (2) The test report is invalid if not marked with the signatures of the persons responsible for preparing and approving the test report.
- (3) The test report is invalid if there is any evidence and/or falsification.
- (4) The results documented in this report apply only to the tested sample, under the conditions and modes of operation as described herein.
- (5) This document may not be altered or revised in any way unless done so by BALUN and all revisions are duly noted in the revisions section.
- (6) Content of the test report, in part or in full, cannot be used for publicity and/or promotional purposes without prior written approval from the laboratory.

## 2 PRODUCT INFORMATION

### 2.1 Applicant Information

Applicant	TP-LINK Technologies Co., Ltd.
Address	Building 24-1F/3F/4F/5F, 28-1F/2F/3F/4F Science and Technology Park, Shennan Road, Nanshan District, Shenzhen City, Guangdong Province, P.R. China

### 2.2 Manufacturer Information

Manufacturer	TP-LINK Technologies Co., Ltd.
Address	Building 24-1F/3F/4F/5F, 28-1F/2F/3F/4F Science and Technology Park, Shennan Road, Nanshan District, Shenzhen City, Guangdong Province, P.R. China

### 2.3 Factory Information

Factory	N/A
Address	N/A

### 2.4 General Description for Equipment under Test (EUT)

EUT Name	Y50 FDD-LTE Smartphone
Model Name Under Test	TP803C
Series Model Name	TP803C, TP803CXXYY
Description of Model Name Differentiation	The Circuit, PCB Layout, Electrical Parts and Outlook of TP803CXXYY are identical to TP803C. (XX= 11 or 21 or 31 (11 indicates Pearl White, 21 indicates Dark Gray, 31 indicates Sunny Yellow); YY indicates different national.)
Hardware Version	N/A
Software Version	N/A
Dimensions (Approx.)	Please refer to the report of BL-SZ1720011-AW.PDF
Weight (Approx.)	N/A
Network and Wireless connectivity	2G Network GSM/GPRS/EDGE 850/1900 MHz, GPRS Class 12, EGPRS Class 12 3G Network WCDMA/HSDPA/HSUPA Band 2/4/5 4G Network FDD LTE Band 2/4/7 WIFI 802.11b, 802.11g and 802.11n (HT20) Bluetooth, FM, GPS, GLONASS

## 2.5 Ancillary Equipment

Ancillary Equipment 1	Battery	
	Brand Name	neffos
	Model No.	NBL-46A2020
	Serial No.	N/A
	Capacitance	2020 mAh
	Rated Voltage	3.8 V
	Limit Charge Voltage	4.35 V
Ancillary Equipment 2	Charger	
	Brand Name	neffos
	Model Name	N050100-2B3
	Rated Input	100-240 V ~, 50/60 Hz, 300 mA
	Rated Output	5 V =, 1 A
Ancillary Equipment 3	USB Cable	
	Length(Approx.)	100 cm



## 2.6 Technical Information

The requirement for the following technical information of the EUT was tested in this report:

Operating Mode	GSM, WCDMA, FDD-LTE, 2.4G WLAN, Bluetooth		
Frequency Range	GSM 850	TX: 824 MHz ~ 849 MHz	RX: 869 MHz ~ 894 MHz
	GSM 1900	TX: 1850 MHz ~ 1910 MHz	RX: 1930 MHz ~ 1990 MHz
	WCDMA Band 2	TX: 1850 MHz ~ 1910 MHz	RX: 1930 MHz ~ 1990 MHz
	WCDMA Band 4	TX: 1710 MHz ~ 1755 MHz	RX: 2110 MHz ~ 2155 MHz
	WCDMA Band 5	TX: 824 MHz ~ 849 MHz	RX: 869 MHz ~ 894 MHz
	LTE Band 2	TX: 1850 MHz ~ 1910 MHz	RX: 1930 MHz ~ 1990 MHz
	LTE Band 4	TX: 1710 MHz ~ 1755 MHz	RX: 2110 MHz ~ 2155 MHz
	LTE Band 7	TX: 2500 MHz ~ 2570 MHz	RX: 2620 MHz ~ 2690 MHz
	802.11b/g/n(HT20)	2400~2483.5 MHz	
	Bluetooth	2400~2483.5 MHz	
Antenna Type	WWAN: PIFA Antenna WLAN: PIFA Antenna Bluetooth: PIFA Antenna		
Hotspot Function	Support		
Power Reduction	Support (When device operating under hotspot mode, that the LTE B7 power reduction will applied for SAR compliance. The reduction power details please refer to section 8.6.)		
Exposure Category	General Population/Uncontrolled exposure		
EUT Stage	Portable Device		
Product	Type		
	<input checked="" type="checkbox"/> Production unit	<input type="checkbox"/> Identical prototype	



### 3 SUMMARY OF TEST RESULTS

#### 3.1 Test Standards

No.	Identity	Document Title
1	47 CFR Part 2	Frequency Allocations and Radio Treaty Matters; General Rules and Regulations
2	ANSI/IEEE Std. C95.1-1999	IEEE Standard for Safety Levels with Respect to Human Exposure to Radio Frequency Electromagnetic Fields, 3 kHz to 300 GHz
3	IEEE Std. 1528-2013	Recommended Practice for Determining the Peak Spatial-Average Specific Absorption Rate (SAR) in the Human Head from Wireless Communications Devices: Measurement Techniques
4	FCC KDB 447498 D01 v06	Mobile and Portable Device RF Exposure Procedures and Equipment Authorization Policies
5	FCC KDB 941225 D01 v03r01	3G SAR MEAUREMENT PROCEDURES
6	FCC KDB 941225 D05 v02r05	SAR Evaluation Considerations for LTE Devices
7	FCC KDB 941225 D06 v02r01	SAR Evaluation Procedures for Portable Devices with Wireless Router Capabilities
8	FCC KDB 865664 D01 v01r04	SAR Measurement 100 MHz to 6 GHz
9	FCC KDB 865664 D02 v01r02	RF Exposure Reporting
10	FCC KDB 648474 D04 v01r03	SAR Evaluation Considerations for Wireless Handsets
11	KDB 248227 D01 v02r02	SAR Guidance for IEEE 802.11 (Wi-Fi) Transmitters

#### 3.2 Device Category and SAR Limit

This device belongs to portable device category because its radiating structure is allowed to be used within 20 centimeters of the body of the user. Limit for General Population/Uncontrolled exposure should be applied for this device, it is 1.6 W/kg as averaged over any 1 gram of tissue.

Table of Exposure Limits:

Body Position	SAR Value (W/Kg)	
	General Population/ Uncontrolled Exposure	Occupational/ Controlled Exposure
Whole-Body SAR (averaged over the entire body)	0.08	0.4
Partial-Body SAR (averaged over any 1 gram of tissue)	1.60	8.0
SAR for hands, wrists, feet and ankles (averaged over any 10 grams of tissue)	4.0	20.0

## NOTE:

**General Population/Uncontrolled:** Locations where there is the exposure of individuals who have no knowledge or control of their exposure. General population/uncontrolled exposure limits are applicable to situations in which the general public may be exposed or in which persons who are exposed as a consequence of their employment may not be made fully aware of the potential for exposure or cannot exercise control over their exposure. Members of the general public would come under this category when exposure is not employment-related; for example, in the case of a wireless transmitter that exposes persons in its vicinity.

**Occupational/Controlled:** Locations where there is exposure that may be incurred by persons who are aware of the potential for exposure. In general, occupational/controlled exposure limits are applicable to situations in which persons are exposed as a consequence of their employment, who have been made fully aware of the potential for exposure and can exercise control over their exposure. This exposure category is also applicable when the exposure is of a transient nature due to incidental passage through a location where the exposure levels may be higher than the general population/uncontrolled limits, but the exposed person is fully aware of the potential for exposure and can exercise control over his or her exposure by leaving the area or by some other appropriate means.

### 3.3 Test Result Summary

#### 3.3.1 Highest SAR (1 g Value)

Band	Maximum Scaled SAR (W/kg)			Maximum Report SAR (W/kg)			Limit (W/kg)
	Head	Body-worn	Hotspot	Head	Body-worn	Hotspot	
GSM 850	<b>0.353</b>	0.482	0.613	0.353	0.847	1.186	1.6
GSM 1900	0.192	0.253	1.086				
WCDMA Band 2	0.237	0.352	0.673				
WCDMA Band 4	0.338	0.666	<b>1.186</b>				
WCDMA Band 5	0.346	0.440	0.489				
LTE Band 2	0.257	0.340	0.726				
LTE Band 4	0.305	0.555	1.132				
LTE Band 7	0.273	<b>0.847</b>	1.176				
2.4G WLAN	0.208	0.111	0.199				
Verdict	Pass						

#### 3.3.2 Highest Simultaneous SAR

Position	Simultaneous Configuration	Simultaneous SAR (W/kg)	Limit (W/kg)	Verdict
Head	GSM Voice + 2.4G WLAN	0.561	1.6	Pass
Body-worn	LTE QPSK + Bluetooth	0.968	1.6	Pass
Hotspot Mode	WCDMA RMC + 2.4G WLAN	1.385	1.6	Pass

### 3.4 Test Uncertainty

According to KDB 865664 D01, when the highest measured 1 g SAR within a frequency band is  $< 1.5$  W/kg, the extensive SAR measurement uncertainty analysis is not required in SAR reports submitted for equipment approval.

The maximum 1 g SAR for the EUT in this report is 1.186 W/kg, which is lower than 1.5 W/kg, so the the extensive SAR measurement uncertainty analysis is not required in this report.

## 4 SAR MEASUREMENT SYSTEM

### 4.1 Definition of Specific Absorption Rate (SAR)

SAR is related to the rate at which energy is absorbed per unit mass in an object exposed to a radio field. The SAR distribution in a biological body is complicated and is usually carried out by experimental techniques or numerical modeling. The standard recommends limits for two tiers of groups, occupational/controlled and general population/uncontrolled, based on a person's awareness and ability to exercise control over his or her exposure. In general, occupational / controlled exposure limits are higher than the limits for general population /uncontrolled.

The SAR definition is the time derivative (rate) of the incremental energy (dW) absorbed by (dissipated in) an incremental mass (dm) contained in a volume element (dv) of a given density ( $\rho$ ). The equation description is as below:

$$\text{SAR} = \frac{d}{dt} \left( \frac{dW}{dm} \right) = \frac{d}{dt} \left( \frac{dW}{\rho dv} \right)$$

SAR is expressed in units of Watts per kilogram (W/kg) SAR measurement can be related to the electrical field in the tissue by

$$\text{SAR} = \frac{\sigma E^2}{\rho}$$

Where:  $\sigma$  is the conductivity of the tissue,

$\rho$  is the mass density of the tissue and E is the RMS electrical field strength.

### 4.2 SATIMO SAR System

#### 4.2.1 SATIMO SAR System Diagram

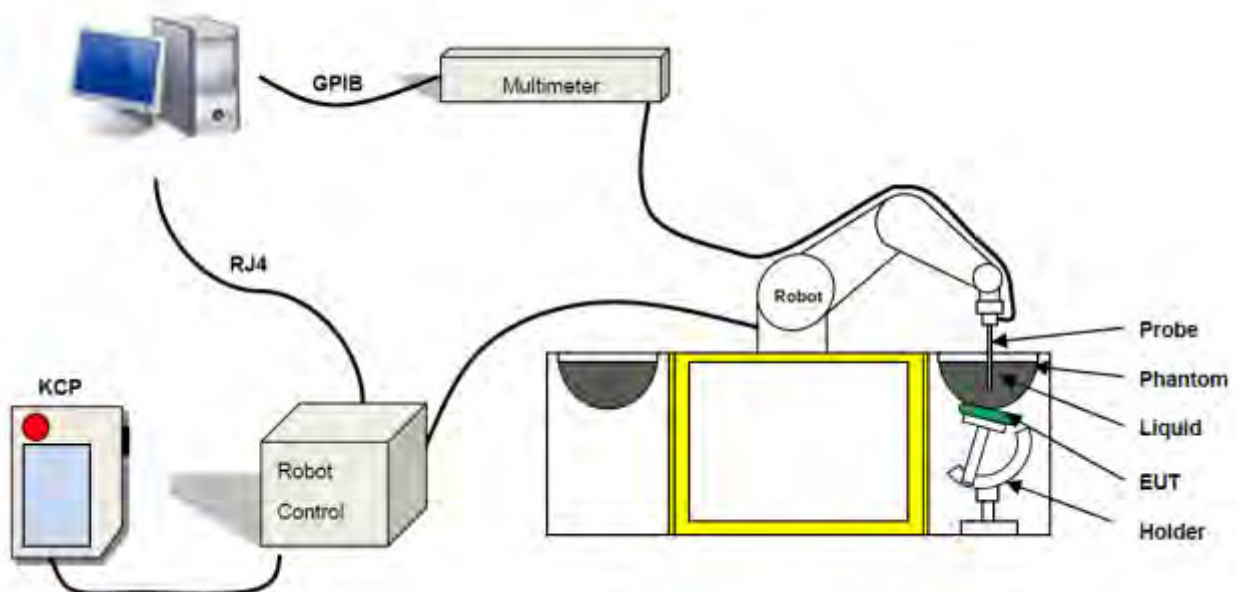

These measurements were performed with the automated near-field scanning system OPENSAR from SATIMO.

The system is based on a high precision robot (working range: 850 mm), which positions the probes with a positional repeatability of better than  $\pm 0.02$  mm. Special E- and H-field probes have been developed for measurements close to material discontinuity, the sensors of which are directly loaded with a Schottky diode and connected via highly resistive lines to the data acquisition unit.

The SAR measurements were conducted with dosimetric probe (manufactured by SATIMO), designed in the classical triangular configuration and optimized for dosimetric evaluation. The probe has been calibrated according to the procedure described in SAR standard with accuracy of better than  $\pm 10\%$ . The spherical isotropy was evaluated with the procedure described in SAR standard and found to be better than  $\pm 0.25$  dB. The phantom used was the SAM Phantom as described in FCC supplement C, IEEE P1528.

#### 4.2.2 Robot

The SATIMO SAR system uses the high precision robots from KUKA. For the 6-axis controller system, the robot controller version (KUKA) from KUKA is used. The KUKA robot series have many features that are important for our application:



- High precision (repeatability  $\pm 0.035$  mm)
- High reliability (industrial design)
- Jerk-free straight movements
- Low ELF interference (the closed metallic construction shields against motor control fields)

#### 4.2.3 E-Field Probe

For the measurements the Specific Dosimetric E-Field Probe SN 34/15 EPGO 265 with following specifications is used

- Dynamic range: 0.01-100 W/kg
- Tip Diameter : 2.5 mm
- Lower detection limit : 7 mW/kg  
(repeatability better than  $\pm 1$ mm)
- Probe linearity:  $\pm 0.07$  dB
- Calibration range: 450 MHz to 5800 MHz for head & body simulating liquid.

Angle between probe axis (evaluation axis) and surface normal line: less than 30°



### E-Field Probe Calibration Process

Probe calibration is realized, in compliance with CENELEC EN 62209-1/-2 and IEEE 1528 std, with CALISAR, Antenna proprietary calibration system. The calibration is performed with the IEC62209-1/2 annexe technique using reference guide at the five frequencies.

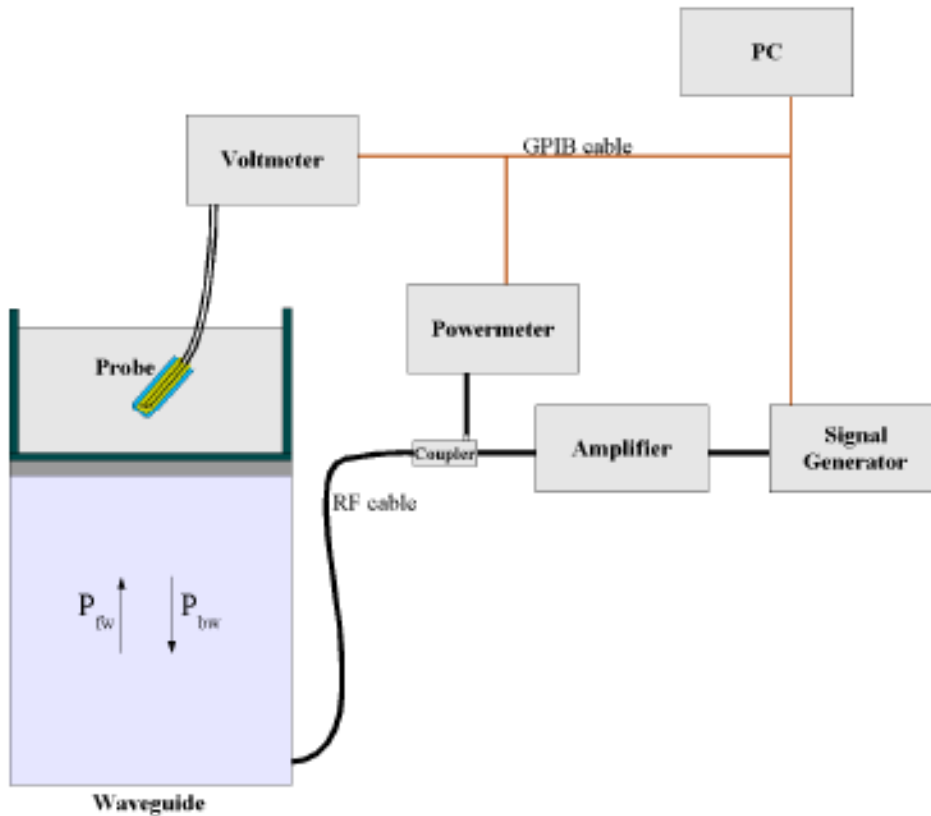

$$SAR = \frac{4(P_{fw} - P_{bw})}{ab\sigma} \cos^2 \left( \pi \frac{y}{a} \right) c^{(2\pi/\sigma)}$$

Where :

- P<sub>fw</sub> = Forward Power
- P<sub>bw</sub> = Backward Power
- a and b = Waveguide Dimensions
- l = Skin Depth

### Keithley configuration

Rate = Medium; Filter = ON; RDGS = 10; FILTER TYPE = MOVING AVERAGE; RANGE AUTO After each calibration, a SAR measurement is performed on a validation dipole and compared with a NPL calibrated probe, to verify it.

The calibration factors, CF(N), for the 3 sensors corresponding to dipole 1, dipole 2 and dipole 3 are:



$$CF(N)=SAR(N)/V_{lin}(N) \quad (N=1,2,3)$$

The linearised output voltage  $V_{lin}(N)$  is obtained from the displayed output voltage  $V(N)$  using

$$V_{lin}(N)=V(N)*(1+V(N)/DCP(N)) \quad (N=1,2,3)$$

Where the DCP is the diode compression point in mV.

#### 4.2.4 Phantoms

For the measurements the Specific Anthropomorphic Mannequin (SAM) defined by the IEEE SCC-34/SC2 group is used. The phantom is a polyurethane shell integrated in a wooden table. The thickness of the phantom amounts to 2mm +/- 0.2mm. It enables the dosimetric evaluation of left and right phone usage and includes an additional flat phantom part for the simplified performance check. The phantom set-up includes a cover, which prevents the evaporation of the liquid.

Photo of Phantom SN 30/13 SAM103



Photo of Phantom SN 30/13 SAM104



Serial Number	Positionner Material	Permittivity	Loss Tangent
SN 30/13 SAM103	Gelcoat with fiberglass	3.4	0.02
SN 30/13 SAM104	Gelcoat with fiberglass	3.4	0.02

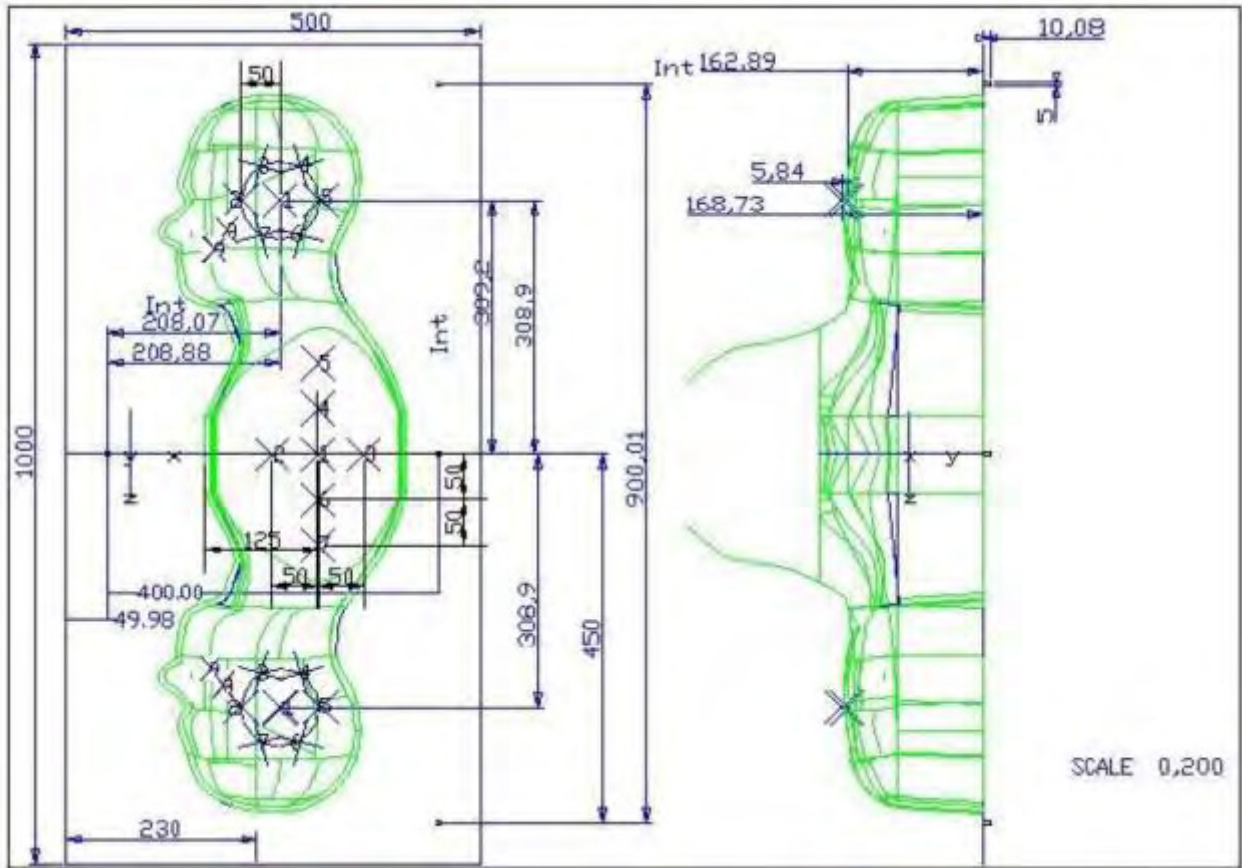

Serial Number	Left Head		Right Head		Flat Part	
SN 30/13 SAM103	2	2.00	2	2.03	1	2.09
	3	2.02	3	2.05	2	2.10
	4	2.04	4	2.04	3	2.09
	5	2.04	5	2.07	4	2.11
	6	2.02	6	2.07	5	2.11
	7	2.01	7	2.09	6	2.09
	8	2.04	8	2.10	7	2.11
	9	2.02	9	2.09	-	-
	SN 30/13 SAM104	2	2.05	2	2.06	1
3		2.08	3	2.03	2	2.03
4		2.05	4	2.03	3	2.01
5		2.06	5	2.02	4	2.03
6		2.08	6	2.02	5	2.03
7		2.06	7	2.04	6	2.00
8		2.07	8	2.04	7	1.98
9		2.07	9	2.05	-	-

#### 4.2.5 Device Holder

The SAR in the phantom is approximately inversely proportional to the square of the distance between the source and the liquid surface. For a source at 5 mm distance, a positioning uncertainty of  $\pm 0.5$  mm would produce a SAR uncertainty of  $\pm 20$  %. Accurate device positioning is therefore crucial for accurate and repeatable measurements. The positions in which the devices must be measured are defined by the standards.



Serial Number	Holder Material	Permittivity	Loss Tangent
SN 25/13 MSH87	Deirin	3.7	0.005
SN 25/13 MSH88	Deirin	3.7	0.005

The positioning system allows obtaining cheek and tilting position with a very good accuracy. In compliance with CENELEC, the tilt angle uncertainty is lower than  $1^\circ$ .

#### 4.2.6 Simulating Liquid

For SAR measurement of the field distribution inside the phantom, the phantom must be filled with homogeneous tissue simulating liquid to a depth of at least 15 cm. For head SAR testing, the liquid height from the ear reference point (ERP) of the phantom to the liquid top surface is larger than 15 cm. For body SAR testing, the liquid height from the center of the flat phantom to the liquid top surface is larger than 15 cm. The nominal dielectric values of the tissue simulating liquids in the phantom and the tolerance of 5%.

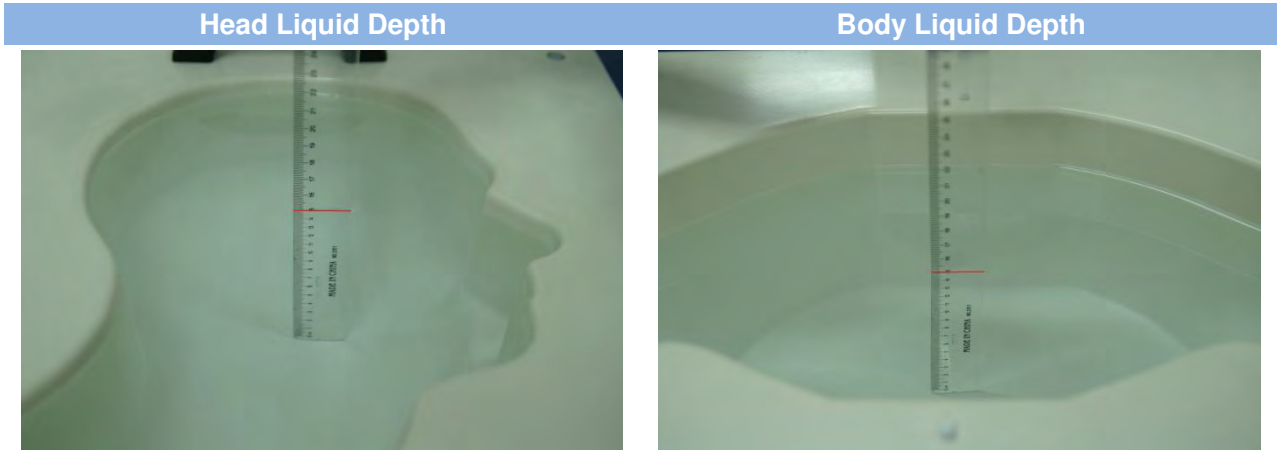

The following table gives the recipes for tissue simulating liquid and the theoretical Conductivity/Permittivity.

Head (Reference IEEE1528)								
Frequency (MHz)	Water (%)	Sugar (%)	Cellulose (%)	Salt (%)	Preventol (%)	DGBE (%)	Conductivity $\sigma$ (S/m)	Permittivity $\epsilon$
750	41.1	57.0	0.2	1.4	0.2	0	0.89	41.9
835	40.3	57.9	0.2	1.4	0.2	0	0.90	41.5
900	40.3	57.9	0.2	1.4	0.2	0	0.97	41.5
1800, 1900, 2000	55.2	0	0	0.3	0	44.5	1.4	40.0
2450	55.0	0	0	0.1	0	44.9	1.80	39.2
2600	54.9	0	0	0.1	0	45.0	1.96	39.0
Frequency(MHz)	Water (%)	Hexyl Carbitol (%)			Triton X-100 (%)		Conductivity $\sigma$ (S/m)	Permittivity $\epsilon$
5200	62.52	17.24			17.24		4.66	36.0
5800	62.52	17.24			17.24		5.27	35.3
Body (From instrument manufacturer)								
Frequency (MHz)	Water (%)	Sugar (%)	Cellulose (%)	Salt (%)	Preventol (%)	DGBE (%)	Conductivity $\sigma$ (S/m)	Permittivity $\epsilon$
750	51.7	47.2	0	0.9	0.1	0	0.96	55.5
835	50.8	48.2	0	0.9	0.1	0	0.97	55.2
900	50.8	48.2	0	0.9	0.1	0	1.05	55.0
1800, 1900, 2000	70.2	0	0	0.4	0	29.4	1.52	53.3
2450	68.6	0	0	0.1	0	31.3	1.95	52.7
2600	68.2	0	0	0.1	0	31.7	2.16	52.5

Frequency(MHz)	Water	DGBE (%)	Salt (%)	Conductivity $\sigma$ (S/m)	Permittivity $\epsilon$
5200	78.60	21.40	/	5.54	47.86
5800	78.50	21.40	0.1	6.0	48.20

## 5 SYSTEM VERIFICATION

### 5.1 Antenna Port Test Requirement

The SATIMO SAR system is equipped with one or more system validation kits. These units together with the predefined measurement procedures within the SATIMO software enable the user to conduct the system performance check and system validation. System validation kit includes a dipole, tripod holder to fix it underneath the flat phantom and a corresponding distance holder.

### 5.2 Purpose of System Check

The system performance check verifies that the system operates within its specifications. System and operator errors can be detected and corrected. It is recommended that the system performance check be performed prior to any usage of the system in order to guarantee reproducible results. The system performance check uses normal SAR measurements in a simplified setup with a well characterized source. This setup was selected to give a high sensitivity to all parameters that might fail or vary over time. The system check does not intend to replace the calibration of the components, but indicates situations where the system uncertainty is exceeded due to drift or failure.

### 5.3 System Check Setup

In the simplified setup for system evaluation, the EUT is replaced by a calibrated dipole and the power source is replaced by a continuous wave that comes from a signal generator. The calibrated dipole must be placed beneath the flat phantom section of the SAM twin phantom with the correct distance holder. The distance holder should touch the phantom surface with a light pressure at the reference marking and be oriented parallel to the long side of the phantom. The equipment setup is shown below:

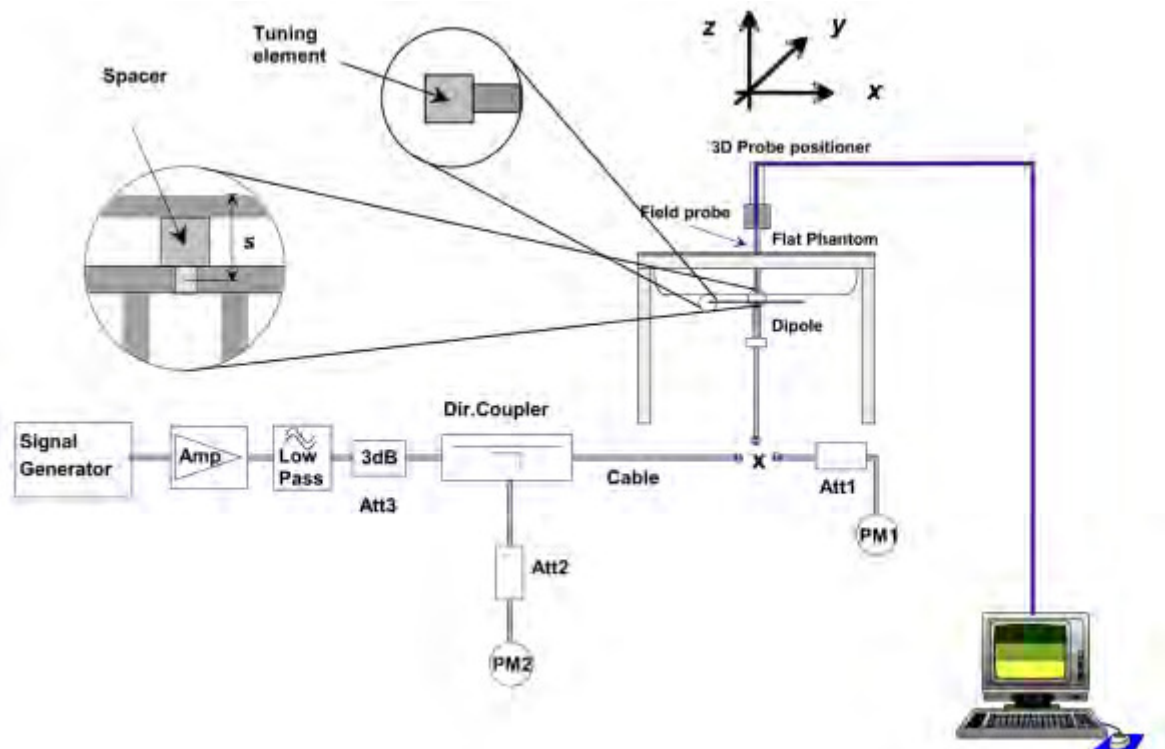



## 6 EUT TEST POSITION CONFIGURATIONS

According to KDB 648474 D04 Handset, handsets are tested for SAR compliance in head, body-worn accessory and other use configurations described in the following subsections.

### 6.1 Head Exposure Conditions

Head exposure is limited to next to the ear voice mode operations. Head SAR compliance is tested according to the test positions defined in IEEE Std 1528-2013 using the SAM phantom illustrated as below.

#### 6.1.1 Define two imaginary lines on the handset

- The vertical center line passes through two points on the front side of the handset - the midpoint of the width  $w_t$  of the handset at the level of the acoustic output, and the midpoint of the width  $w_b$  of the bottom of the handset.
- The horizontal line is perpendicular to the vertical centerline and passes through the center of the acoustic output. The horizontal line is also tangential to the face of the handset at point A.
- The two lines intersect at point A. Note that for many handsets, point A coincides with the center of the acoustic output; however, the acoustic output may be located elsewhere on the horizontal line. Also note that the vertical centerline is not necessarily parallel to the front face of the handset, especially for clamshell handsets, handsets with flip covers, and other irregularly shaped handsets.

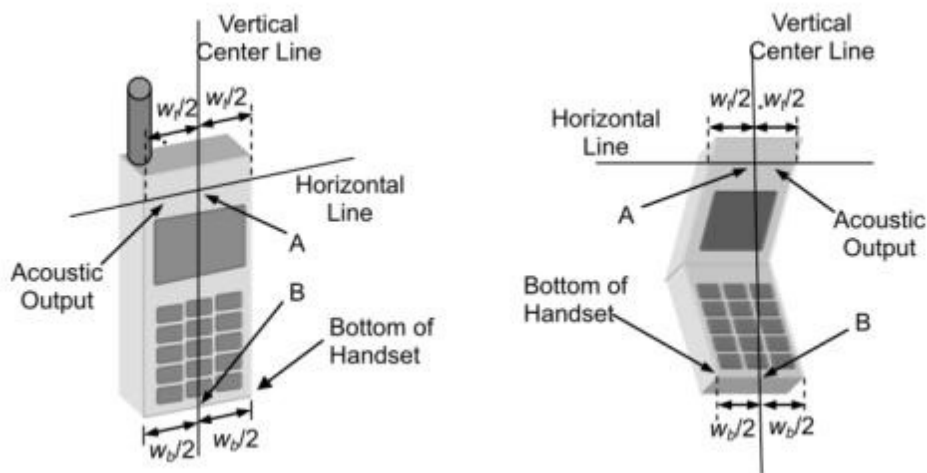

#### 6.1.2 Cheek Position

- To position the device with the vertical center line of the body of the device and the horizontal line crossing the center piece in a plane parallel to the sagittal plane of the phantom. While maintaining the device in this plane, align the vertical center line with the reference plane containing the three ear and mouth reference point (M: Mouth, RE: Right Ear, and LE: Left Ear) and align the center of the ear piece with the line RE-LE.
- To move the device towards the phantom with the ear piece aligned with the line LE-RE until the phone touched the ear. While maintaining the device in the reference plane and maintaining the phone contact with the ear, move the bottom of the phone until any point on the front side is in contact with the cheek of the phantom or until contact with the ear is lost.



### 6.1.3 Tilted Position

- (a) To position the device in the “cheek” position described above.
- (b) While maintaining the device the reference plane described above and pivoting against the ear, moves it outward away from the mouth by an angle of 15 degrees or until contact with the ear is lost.



## 6.2 Body-worn Position Conditions

Body-worn accessory exposure is typically related to voice mode operations when handsets are carried in body-worn accessories. The body-worn accessory procedures in KDB 447498 are used to test for body-worn accessory SAR compliance, without a headset connected to it. This enables the test results for such configuration to be compatible with that required for hotspot mode when the body-worn accessory test separation distance is greater than or equal to that required for hotspot mode. When the reported SAR for a body-worn accessory, measured without a headset connected to the handset, is  $> 1.2 \text{ W/kg}$ , the highest reported SAR configuration for that wireless mode and frequency band should be repeated for that body-worn accessory with a headset attached to the handset.

Body-worn accessories that do not contain metallic or conductive components may be tested according to worst-case exposure configurations, typically according to the smallest test separation distance required for the group of body-worn accessories with similar operating and exposure characteristics. All body-worn accessories containing metallic components are tested in conjunction with the host device.

Body-worn accessory SAR compliance is based on a single minimum test separation distance for all wireless and operating modes applicable to each body-worn accessory used by the host, and according to the relevant voice and/or data mode transmissions and operations. If a body-worn accessory supports voice only operations in its normal and expected use conditions, testing of data mode for body-worn compliance is not required. A conservative minimum test separation distance for supporting off-the-shelf body-worn accessories that may be acquired by

users of consumer handsets is used to test for body-worn accessory SAR compliance. This distance is determined by the handset manufacturer, according to the requirements of Supplement C 01-01. Devices that are designed to operate on the body of users using lanyards and straps, or without requiring additional body-worn accessories, will be tested using a conservative minimum test separation distance  $\leq 5$  mm to support compliance.

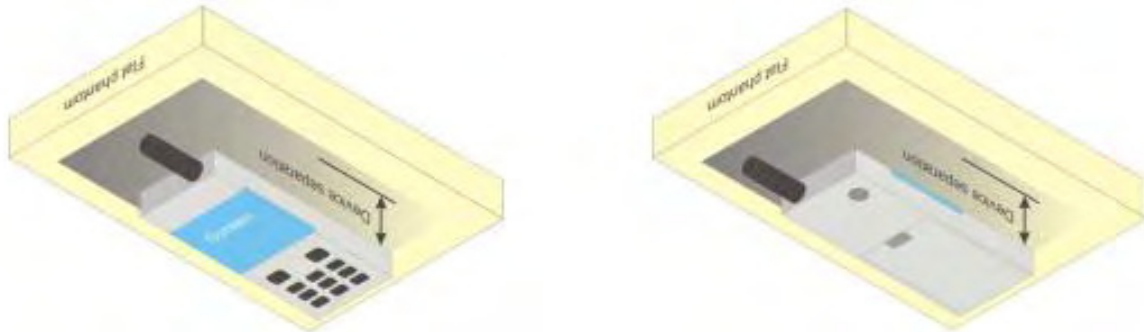

### 6.3 Hotspot Mode Exposure Position Conditions

For handsets that support hotspot mode operations, with wireless router capabilities and various web browsing functions, the relevant hand and body exposure conditions are tested according to the hotspot SAR procedures in KDB 941225. A test separation distance of 10 mm is required between the phantom and all surfaces and edges with a transmitting antenna located within 25 mm from that surface or edge. When the form factor of a handset is smaller than 9 cm x 5 cm, a test separation distance of 5 mm (instead of 10 mm) is required for testing hotspot mode. When the separation distance required for body-worn accessory testing is larger than or equal to that tested for hotspot mode, in the same wireless mode and for the same surface of the phone, the hotspot mode SAR data may be used to support body-worn accessory SAR compliance for that particular configuration (surface).

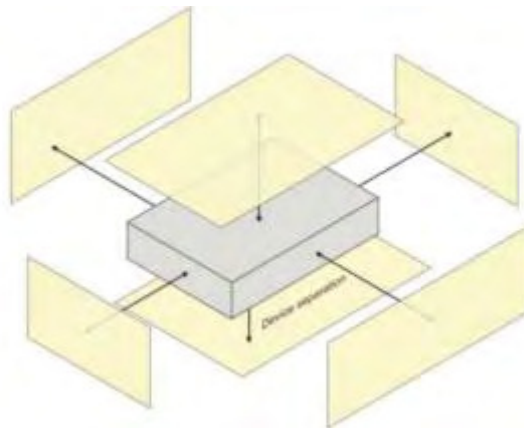

# 7 SAR MEASUREMENT PROCEDURES

## 7.1 SAR Measurement Process Diagram

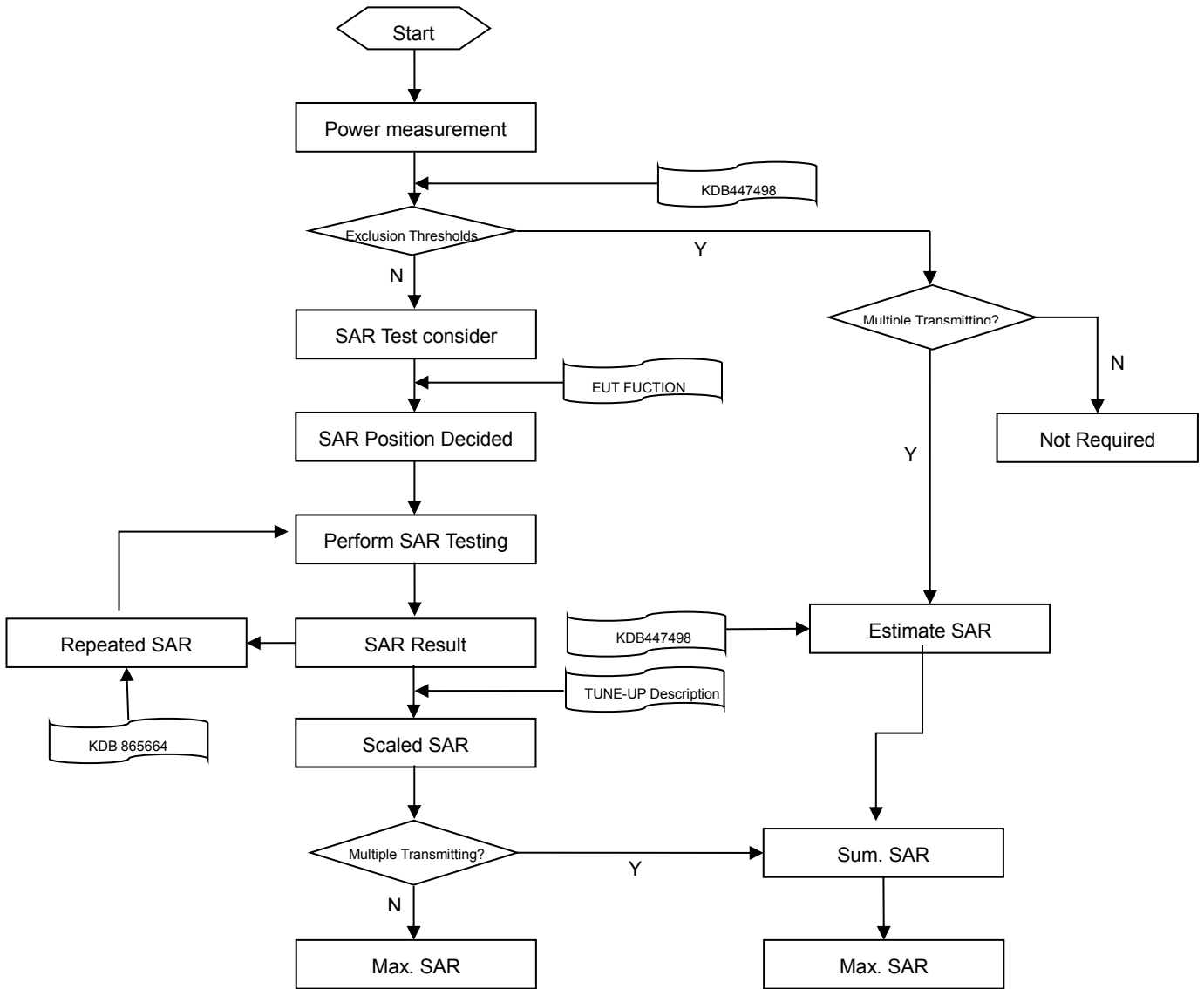

## 7.2 SAR Scan General Requirements

Probe boundary effect error compensation is required for measurements with the probe tip closer than half a probe tip diameter to the phantom surface. Both the probe tip diameter and sensor offset distance must satisfy measurement protocols; to ensure probe boundary effect errors are minimized and the higher fields closest to the phantom surface can be correctly measured and extrapolated to the phantom surface for computing 1-g SAR. Tolerances of the post-processing algorithms must be verified by the test laboratory for the scan resolutions used in the SAR measurements, according to the reference distribution functions specified in IEEE Std 1528-2013.

			≤3GHz	>3GHz
Maximum distance from closest measurement point (geometric center of probe sensors) to phantom surface			5±1 mm	$\frac{1}{2} \cdot \delta \cdot \ln(2) \pm 0.5$ mm
Maximum probe angle from probe axis to phantom surface normal at the measurement location			30°±1°	20°±1°
Maximum area scan spatial resolution: $\Delta x$ Area , $\Delta y$ Area			≤ 2 GHz: ≤ 15 mm 2 – 3 GHz: ≤ 12 mm	3–4 GHz: ≤ 12 mm 4 – 6 GHz: ≤ 10 mm
			When the x or y dimension of the test device, in the measurement plane orientation, is smaller than the above, the measurement resolution must be ≤ the corresponding x or y dimension of the test device with at least one measurement point on the test device.	
Maximum zoom scan spatial resolution: $\Delta x$ Zoom , $\Delta y$ Zoom			≤ 2 GHz: ≤ 8 mm 2 – 3 GHz: ≤ 5 mm*	3–4 GHz: ≤ 5 mm* 4 – 6 GHz: ≤ 4 mm*
Maximum zoom scan spatial resolution, normal to phantom surface	uniform grid: $\Delta z$ Zoom (n)		≤ 5 mm	3–4 GHz: ≤ 4 mm
				4–5 GHz: ≤ 3 mm
				5–6 GHz: ≤ 2 mm
	graded grid	$\Delta z$ Zoom (1): between 1st two points closest to phantom surface	≤ 4 mm	3–4 GHz: ≤ 3 mm
$\Delta z$ Zoom (n>1): between subsequent points		4–5 GHz: ≤ 2.5 mm		
			5–6 GHz: ≤ 2 mm	
			≤ 1.5· $\Delta z$ Zoom (n-1)	
Minimum zoom scan volume	x, y, z		≥30 mm	3–4 GHz: ≥ 28 mm
				4–5 GHz: ≥ 25 mm
				5–6 GHz: ≥ 22 mm

**Note:**

- $\delta$  is the penetration depth of a plane-wave at normal incidence to the tissue medium; see draft standard IEEE P1528-2011 for details.
- \* When zoom scan is required and the reported SAR from the area scan based 1-g SAR estimation procedures of KDB 447498 is ≤ 1.4 W/kg, ≤ 8 mm, ≤ 7 mm and ≤ 5 mm zoom scan resolution may be applied, respectively, for 2 GHz to 3GHz, 3 GHz to 4 GHz and 4 GHz to 6 GHz.

### 7.3 SAR Measurement Procedure

The following steps are used for each test position

- Establish a call with the maximum output power with a base station simulator. The connection between the mobile and the base station simulator is established via air interface
- Measurement of the local E-field value at a fixed location. This value serves as a reference value for calculating a possible power drift.
- Measurement of the SAR distribution with a grid of 8 to 16mm \* 8 to 16 mm and a constant distance to the inner surface of the phantom. Since the sensors cannot directly measure at the inner phantom surface, the values between the sensors and the inner phantom surface are extrapolated. With these values the area of the maximum SAR is calculated by an interpolation scheme.
- Around this point, a cube of 30 \* 30 \* 30 mm or 32 \* 32 \* 32 mm is assessed by measuring 5 or 8 \* 5 or 8\*4 or 5 mm. With these data, the peak spatial-average SAR value can be calculated.

### 7.4 Area & Zoom Scan Procedures

First Area Scan is used to locate the approximate location(s) of the local peak SAR value(s). The measurement grid within an Area Scan is defined by the grid extent, grid step size and grid offset. Next, in order to determine the EM field distribution in a three-dimensional spatial extension, Zoom Scan is required. The Zoom Scan is performed around the highest E-field value to determine the averaged SAR-distribution over 10 g. Area scan and zoom scan resolution setting follows KDB 865664 D01 quoted below.

When the 1-g SAR of the highest peak is within 2 dB of the SAR limit, additional zoom scans are required for other peaks within 2 dB of the highest peak that have not been included in any zoom scan to ensure there is no increase in SAR.

## 8 CONDUCTED RF OUTPUT POWER

### 8.1 GSM

GSM 850 Band	Burst Average Power(dBm)			Frame-averaged power(dBm)		
Channel	128	190	251	128	190	251
GSM (GMSK, 1-Slot)	33.69	33.91	33.96	24.69	24.91	<b>24.96</b>
GPRS (GMSK, 1-Slot)	33.65	33.81	33.81	24.65	24.81	24.81
GPRS (GMSK, 2-Slots)	32.25	32.24	32.04	26.25	26.24	26.04
GPRS (GMSK, 3-Slots)	30.73	30.93	30.75	26.47	<b>26.67</b>	26.49
GPRS (GMSK, 4-Slots)	29.42	29.48	29.48	26.42	26.48	26.48
EGPRS (8PSK, 1-Slot)	30.01	30.04	29.95	21.01	21.04	20.95
EGPRS (8PSK, 2-Slots)	28.18	28.14	28.06	22.18	22.14	22.06
EGPRS (8PSK, 3-Slots)	26.79	26.67	26.51	22.53	22.41	22.25
EGPRS (8PSK, 4-Slots)	25.61	25.30	25.38	<b>22.61</b>	22.30	22.38
GSM 1900 Band	Burst Average Power(dBm)			Frame-averaged power(dBm)		
Channel	512	661	810	512	661	810
GSM (GMSK, 1-Slot)	31.28	31.16	31.05	<b>22.28</b>	22.16	22.05
GPRS (GMSK, 1-Slot)	31.24	31.02	30.86	22.24	22.02	21.86
GPRS (GMSK, 2-Slots)	29.25	29.27	29.29	23.25	23.27	23.29
GPRS (GMSK, 3-Slots)	27.99	27.87	27.79	23.73	23.61	23.53
GPRS (GMSK, 4-Slots)	26.80	26.42	26.37	<b>23.80</b>	23.42	23.37
EGPRS (8PSK, 1-Slot)	29.28	28.95	28.87	20.28	19.95	19.87
EGPRS (8PSK, 2-Slots)	27.19	27.23	27.03	21.19	21.23	21.03
EGPRS (8PSK, 3-Slots)	26.00	25.65	25.59	<b>21.74</b>	21.39	21.33
EGPRS (8PSK, 4-Slots)	24.71	24.32	24.50	21.71	21.32	21.50

Note 1: SAR testing was performed on the maximum frame-Peaked power mode.

Note 2: The frame-averaged power is linearly proportion to the slot number configured and it is linearly scaled the maximum burst-averaged power based on time slots. The calculated method is shown as below:

Frame-averaged power = Burst averaged power (1 Tx Slot) - 9 dB

Frame-averaged power = Burst averaged power (2 Tx Slots) - 6 dB

Frame-averaged power = Burst averaged power (3 Tx Slots) - 4.26 dB

Frame-averaged power = Burst averaged power (4 Tx Slots) - 3 dB



## 8.2 WCDMA

WCDMA Band	Band 2			Band 4		
Channel	9262	9400	9538	1312	1412	1513
RMC 12.2Kbps	22.89	22.57	<b>23.02</b>	23.59	<b>23.64</b>	23.23
HSDPA Subtest-1	20.58	20.37	20.39	21.23	21.24	21.25
HSDPA Subtest-2	20.57	20.43	20.35	21.31	21.16	21.06
HSDPA Subtest-3	20.06	19.98	19.90	20.61	20.67	20.77
HSDPA Subtest-4	20.10	20.04	19.97	20.75	20.52	20.57
HSUPA Subtest-1	20.58	20.25	20.20	20.95	21.30	21.11
HSUPA Subtest-2	19.32	19.00	18.97	19.79	19.94	19.85
HSUPA Subtest-3	19.52	19.22	19.18	20.01	19.44	20.23
HSUPA Subtest-4	19.62	19.27	19.26	20.59	20.06	20.78
HSUPA Subtest-5	20.60	20.34	20.21	21.22	21.20	21.25
Band	Band 5			-		
Channel	4132	4182	4233	-	-	-
RMC 12.2Kbps	22.61	22.57	<b>22.62</b>	-	-	-
HSDPA Subtest-1	20.63	20.52	20.62	-	-	-
HSDPA Subtest-2	20.71	20.56	20.59	-	-	-
HSDPA Subtest-3	20.20	20.13	20.17	-	-	-
HSDPA Subtest-4	20.26	20.13	20.15	-	-	-
HSUPA Subtest-1	19.94	19.94	20.11	-	-	-
HSUPA Subtest-2	19.46	19.38	19.05	-	-	-
HSUPA Subtest-3	19.65	19.13	19.28	-	-	-
HSUPA Subtest-4	19.67	19.70	19.85	-	-	-
HSUPA Subtest-5	20.57	20.56	20.72	-	-	-

### 8.3 LTE

FDD LTE Band 2							
Bandwidth (MHz)	RB Set	Power (dBm)					
		QPSK			16QAM		
	Channel	18700	18900	19100	18700	18900	19100
20MHz	1 (RB_Pos:0)	22.31	22.46	22.50	21.40	21.79	21.89
	1 (RB_Pos:50)	<b>22.67</b>	22.30	22.19	21.37	22.08	21.65
	1 (RB_Pos:99)	22.42	22.21	22.27	21.35	22.01	21.63
	50 (RB_Pos:0)	21.33	21.34	<b>21.43</b>	20.35	20.32	20.39
	50 (RB_Pos:25)	21.32	21.32	21.23	20.36	20.31	20.22
	50 (RB_Pos:50)	21.22	21.29	21.25	20.26	20.17	20.23
	100 (RB_Pos:0)	21.28	21.33	<b>21.34</b>	20.34	20.20	20.31
Bandwidth (MHz)	RB Set	Power (dBm)					
		QPSK			16QAM		
	Channel	18675	18900	19125	18675	18900	19125
15MHz	1 (RB_Pos:0)	22.27	22.55	22.66	22.04	21.93	22.33
	1 (RB_Pos:38)	22.02	22.35	22.45	21.83	22.02	22.15
	1 (RB_Pos:74)	22.11	22.40	22.57	21.87	21.92	22.46
	36 (RB_Pos:0)	21.24	21.26	21.50	20.41	20.27	20.54
	36 (RB_Pos:20)	21.16	21.20	21.52	20.35	20.32	20.49
	36 (RB_Pos:39)	21.18	21.23	21.48	20.39	20.46	20.40
	75 (RB_Pos:0)	21.19	21.27	21.43	20.31	20.37	20.49
Bandwidth (MHz)	RB Set	Power (dBm)					
		QPSK			16QAM		
	Channel	18650	18900	19150	18650	18900	19150
10MHz	1 (RB_Pos:0)	22.28	22.53	22.71	21.34	21.66	21.96
	1 (RB_Pos:25)	22.52	22.64	23.12	21.91	21.98	21.93
	1 (RB_Pos:49)	22.23	22.44	23.00	21.94	21.84	21.87
	25 (RB_Pos:0)	21.36	21.37	21.69	20.41	20.39	20.78
	25 (RB_Pos:12)	21.34	21.30	21.65	20.41	20.44	20.74
	25 (RB_Pos:25)	21.31	21.29	21.68	20.28	20.43	20.75
	50 (RB_Pos:0)	21.39	21.31	21.67	20.46	20.19	20.59
Bandwidth (MHz)	RB Set	Power (dBm)					
		QPSK			16QAM		
	Channel	18625	18900	19175	18625	18900	19175
5MHz	1 (RB_Pos:0)	22.44	22.24	22.51	21.32	21.19	21.94
	1 (RB_Pos:13)	22.17	22.28	22.57	21.30	21.17	21.94
	1 (RB_Pos:24)	22.23	22.40	22.54	21.25	21.15	21.96
	12 (RB_Pos:0)	21.49	21.26	21.59	20.39	20.18	20.41
	12 (RB_Pos:6)	21.48	21.22	21.69	20.35	20.35	20.52
	12 (RB_Pos:13)	21.53	21.22	21.68	20.40	20.36	20.63
	25 (RB_Pos:0)	21.51	21.27	21.61	20.51	20.21	20.57
Bandwidth (MHz)	RB Set	Power (dBm)					
		QPSK			16QAM		

	Channel	18615	18900	19185	18615	18900	19185
3.0MHz	1 (RB_Pos:0)	22.42	22.30	22.59	21.58	21.84	21.85
	1 (RB_Pos:8)	22.41	22.27	22.57	21.43	21.76	21.78
	1 (RB_Pos:14)	22.40	22.33	22.55	21.95	21.77	21.87
	8 (RB_Pos:0)	21.59	21.25	21.59	20.85	20.20	20.62
	8 (RB_Pos:3)	21.58	21.23	21.60	20.85	20.21	20.83
	8 (RB_Pos:7)	21.57	21.25	21.59	20.76	20.21	20.82
	15 (RB_Pos:0)	21.58	21.23	21.59	20.68	20.17	20.66
Bandwidth (MHz)	RB Set	Power (dBm)					
		QPSK			16QAM		
	Channel	18607	18900	19193	18607	18900	19193
1.4MHz	1 (RB_Pos:0)	22.72	22.20	22.71	22.34	21.72	21.73
	1 (RB_Pos:3)	22.88	22.34	22.66	22.36	21.91	21.74
	1 (RB_Pos:5)	22.69	22.27	22.57	22.34	21.74	21.75
	3 (RB_Pos:0)	22.63	22.25	22.57	21.82	21.16	21.64
	3 (RB_Pos:1)	22.62	22.26	22.50	21.68	21.21	21.43
	3 (RB_Pos:3)	22.56	22.28	22.45	21.65	21.26	21.37
	6 (RB_Pos:0)	21.51	21.25	21.61	20.76	19.93	20.51

LTE Band 4							
Bandwidth (MHz)	RB Set	Power (dBm)					
		QPSK			16QAM		
20 MHz	Channel	20050	20175	20300	20050	20175	20300
	1 (RB_Pos:0)	22.19	<b>22.87</b>	22.57	21.32	22.22	21.99
	1 (RB_Pos:50)	22.54	22.77	22.66	21.90	21.98	21.97
	1 (RB_Pos:99)	22.07	22.71	22.35	21.21	21.47	21.71
	50 (RB_Pos:0)	21.33	<b>21.82</b>	21.60	20.35	21.04	20.54
	50 (RB_Pos:25)	21.27	21.68	21.59	20.40	20.91	20.40
	50 (RB_Pos:50)	21.18	21.70	21.44	20.12	20.74	20.37
	100 (RB_Pos:0)	21.21	<b>21.76</b>	21.48	20.20	20.77	20.50
15 MHz	Channel	20025	20175	20325	20025	20175	20325
	1 (RB_Pos:0)	22.31	23.17	22.90	21.56	22.54	22.34
	1 (RB_Pos:38)	22.48	22.81	22.67	21.85	22.02	22.19
	1 (RB_Pos:74)	22.52	22.76	22.58	21.84	22.03	22.29
	36 (RB_Pos:0)	21.27	21.80	21.60	20.45	20.96	20.80
	36 (RB_Pos:20)	21.36	21.64	21.61	20.45	20.82	20.75
	36 (RB_Pos:39)	21.32	21.64	21.58	20.43	20.76	20.64
	75 (RB_Pos:0)	21.24	21.75	21.54	20.28	20.84	20.57
10 MHz	Channel	20000	20175	20350	20000	20175	20350
	1 (RB_Pos:0)	22.43	22.94	22.86	21.52	22.44	21.97
	1 (RB_Pos:25)	22.85	22.87	22.94	22.06	22.38	21.88
	1 (RB_Pos:49)	22.73	22.87	22.54	22.09	22.03	21.62
	25 (RB_Pos:0)	21.59	21.81	21.59	20.54	21.11	20.54
	25 (RB_Pos:12)	21.64	21.73	21.51	20.57	21.05	20.61
	25 (RB_Pos:25)	21.49	21.70	21.37	20.60	20.84	20.47
	50 (RB_Pos:0)	21.54	21.75	21.46	20.57	20.97	20.42
5 MHz	Channel	19975	20175	20375	19975	20175	20375
	1 (RB_Pos:0)	22.35	22.84	22.26	21.32	22.32	21.26
	1 (RB_Pos:13)	22.42	22.60	22.23	21.40	21.59	21.21
	1 (RB_Pos:24)	22.60	22.59	22.21	21.44	21.63	21.50
	12 (RB_Pos:0)	21.61	21.84	21.30	20.51	20.74	20.26
	12 (RB_Pos:6)	21.71	21.78	21.27	20.64	20.59	20.14
	12 (RB_Pos:13)	21.70	21.78	21.28	20.65	20.62	20.15
	25 (RB_Pos:0)	21.61	21.75	21.32	20.64	20.60	20.20
3 MHz	Channel	19965	20175	20385	19965	20175	20385
	1 (RB_Pos:0)	22.79	22.80	22.41	21.66	22.31	21.49
	1 (RB_Pos:8)	22.84	22.83	22.34	21.54	22.24	21.39
	1 (RB_Pos:14)	22.91	22.85	22.40	21.65	22.33	21.46
	8 (RB_Pos:0)	21.75	21.73	21.19	20.62	20.99	20.53
	8 (RB_Pos:3)	21.76	21.68	21.04	20.64	20.97	20.41
	8 (RB_Pos:7)	21.68	21.66	21.11	20.67	20.85	20.37
	15 (RB_Pos:0)	21.76	21.68	21.16	20.67	20.96	20.24

	Channel	19957	20175	20393	19957	20175	20393
1.4 MHz	1 (RB_Pos:0)	22.74	22.73	22.09	22.46	22.31	21.23
	1 (RB_Pos:3)	22.81	22.67	22.23	22.49	22.32	21.32
	1 (RB_Pos:5)	22.83	22.71	22.15	22.47	22.20	21.30
	3 (RB_Pos:0)	22.76	22.76	22.25	21.76	21.68	21.28
	3 (RB_Pos:1)	22.84	22.76	22.36	21.99	21.77	21.08
	3 (RB_Pos:3)	22.78	22.79	22.32	21.78	21.52	21.31
	6 (RB_Pos:0)	21.72	21.83	21.22	20.86	20.44	20.44

LTE Band 7							
Bandwidth (MHz)	RB Set	Power (dBm)					
		QPSK			16QAM		
20 MHz	Channel	20850	21100	21350	20850	21100	21350
	1 (RB_Pos:0)	22.63	22.63	22.55	21.45	22.13	22.06
	1 (RB_Pos:50)	22.44	22.50	<b>23.05</b>	21.32	21.89	22.05
	1 (RB_Pos:99)	22.43	22.43	22.51	21.35	21.52	21.97
	50 (RB_Pos:0)	21.66	21.75	21.71	20.64	20.91	20.75
	50 (RB_Pos:25)	21.45	21.61	21.63	20.52	20.53	20.69
	50 (RB_Pos:50)	21.46	21.58	<b>21.77</b>	20.54	20.59	20.83
	100 (RB_Pos:0)	21.49	21.61	<b>21.71</b>	20.49	20.67	20.80
15 MHz	Channel	20825	21100	21375	20825	21100	21375
	1 (RB_Pos:0)	22.43	22.94	22.82	21.94	22.32	22.36
	1 (RB_Pos:38)	22.34	22.65	22.65	21.87	21.85	22.24
	1 (RB_Pos:74)	22.20	22.65	22.65	21.71	21.49	22.12
	36 (RB_Pos:0)	21.47	21.65	21.69	20.50	20.75	20.56
	36 (RB_Pos:20)	21.43	21.55	21.60	20.37	20.48	20.50
	36 (RB_Pos:39)	21.39	21.49	21.55	20.35	20.33	20.35
	75 (RB_Pos:0)	21.48	21.62	21.61	20.46	20.64	20.52
10 MHz	Channel	20800	21100	21400	20800	21100	21400
	1 (RB_Pos:0)	22.52	22.87	22.78	21.42	22.26	21.91
	1 (RB_Pos:25)	22.52	22.78	22.87	21.49	22.06	21.88
	1 (RB_Pos:49)	22.24	22.65	22.74	21.94	22.16	21.35
	25 (RB_Pos:0)	21.50	21.73	21.79	20.52	20.94	20.95
	25 (RB_Pos:12)	21.45	21.60	21.66	20.50	20.79	20.93
	25 (RB_Pos:25)	21.36	21.56	21.71	20.33	20.55	20.88
	50 (RB_Pos:0)	21.46	21.68	21.63	20.51	20.69	20.76
5 MHz	Channel	20775	21100	21425	20775	21100	21425
	1 (RB_Pos:0)	22.16	22.54	22.58	21.21	21.44	21.92
	1 (RB_Pos:13)	22.02	22.55	22.57	20.88	21.52	21.61
	1 (RB_Pos:24)	22.03	22.53	22.55	20.85	21.42	21.57
	12 (RB_Pos:0)	21.34	21.65	21.76	20.42	20.76	20.80
	12 (RB_Pos:6)	21.39	21.61	21.73	20.27	20.54	20.59
	12 (RB_Pos:13)	21.46	21.55	21.66	20.26	20.49	20.50
	25 (RB_Pos:0)	21.46	21.68	21.71	20.45	20.54	20.65

## 8.4 2.4G WIFI

Band (GHz)	Mode	Channel	Freq. (MHz)	Avg. Power (dBm)	SAR Test Require.
2.4 (2.4~2.4835)	802.11b	1	2412	<b>12.25</b>	Yes
		6	2437	11.87	No
		11	2462	12.17	No
	802.11g	1	2412	9.50	No
		6	2437	8.90	No
		11	2462	9.25	No
	802.11n(HT20)	1	2412	8.54	No
		6	2437	7.98	No
		11	2462	8.31	No

## 8.5 Bluetooth

Mode	GFSK			$\pi/4$ -DQPSK		
Channel	0	39	78	0	39	78
Frequency (MHz)	2402	2441	2480	2402	2441	2480
Avg. Power (dBm)	8.36	<b>9.31</b>	7.87	6.81	7.77	6.32
Mode	8-DPSK			BLE		
Channel	0	39	78	0	19	39
Frequency (MHz)	2402	2441	2480	2402	2440	2480
Avg. Power (dBm)	6.79	7.77	6.34	-0.46	0.42	-0.88



## 8.6 Power Reduction List

When device operating under hotspot mode, the LTE B7 power reduction will applied for SAR compliance.

LTE Band 7							
Bandwidth (MHz)	RB Set	Power (dBm)					
		QPSK			16QAM		
20 MHz	Channel	20850	21100	21350	20850	21100	21350
	1 (RB_Pos:0)	20.50	21.04	21.19	20.21	20.42	20.57
	1 (RB_Pos:50)	20.92	20.95	<b>21.35</b>	20.33	20.13	20.54
	1 (RB_Pos:99)	20.75	20.76	20.96	20.30	19.95	20.49
	50 (RB_Pos:0)	19.56	20.13	<b>20.29</b>	18.72	19.30	19.13
	50 (RB_Pos:25)	19.63	19.98	20.18	18.81	18.97	19.23
	50 (RB_Pos:50)	19.69	19.97	20.14	18.77	18.88	19.01
	100 (RB_Pos:0)	19.60	20.09	<b>20.26</b>	18.70	19.09	19.35
15 MHz	Channel	20825	21100	21375	20825	21100	21375
	1 (RB_Pos:0)	20.89	21.19	21.14	19.79	20.61	20.69
	1 (RB_Pos:38)	20.27	20.89	20.89	19.61	20.06	20.65
	1 (RB_Pos:74)	20.60	20.87	21.05	19.74	19.90	20.59
	36 (RB_Pos:0)	19.54	20.06	20.19	18.70	19.22	19.21
	36 (RB_Pos:20)	19.61	19.91	20.04	18.68	19.01	18.99
	36 (RB_Pos:39)	19.56	19.86	20.09	18.69	19.05	18.94
	75 (RB_Pos:0)	19.55	20.03	20.06	18.64	19.11	19.05
10 MHz	Channel	20800	21100	21400	20800	21100	21400
	1 (RB_Pos:0)	20.65	21.17	21.12	19.59	20.47	20.37
	1 (RB_Pos:25)	20.29	21.12	21.22	20.06	20.30	20.35
	1 (RB_Pos:49)	20.45	20.96	21.18	19.89	20.22	20.33
	25 (RB_Pos:0)	19.57	20.14	20.20	18.68	19.30	19.33
	25 (RB_Pos:12)	19.66	20.06	20.16	18.61	19.23	19.30
	25 (RB_Pos:25)	19.56	20.02	20.16	18.51	19.11	19.14
	50 (RB_Pos:0)	19.60	20.08	20.15	18.62	19.25	19.14
5 MHz	Channel	20775	21100	21425	20775	21100	21425
	1 (RB_Pos:0)	20.43	20.79	20.94	19.49	20.29	20.04
	1 (RB_Pos:13)	20.19	20.74	20.95	19.31	19.87	19.57
	1 (RB_Pos:24)	20.27	20.84	20.94	19.79	19.79	19.62
	12 (RB_Pos:0)	19.42	19.96	20.15	18.41	18.93	18.99
	12 (RB_Pos:6)	19.42	19.87	20.02	18.47	18.82	18.88
	12 (RB_Pos:13)	19.50	19.87	20.07	18.56	18.83	18.93
	25 (RB_Pos:0)	19.47	19.93	20.20	18.45	18.82	19.08

## 9 EUT ANTENNA LOCATION SKETCH

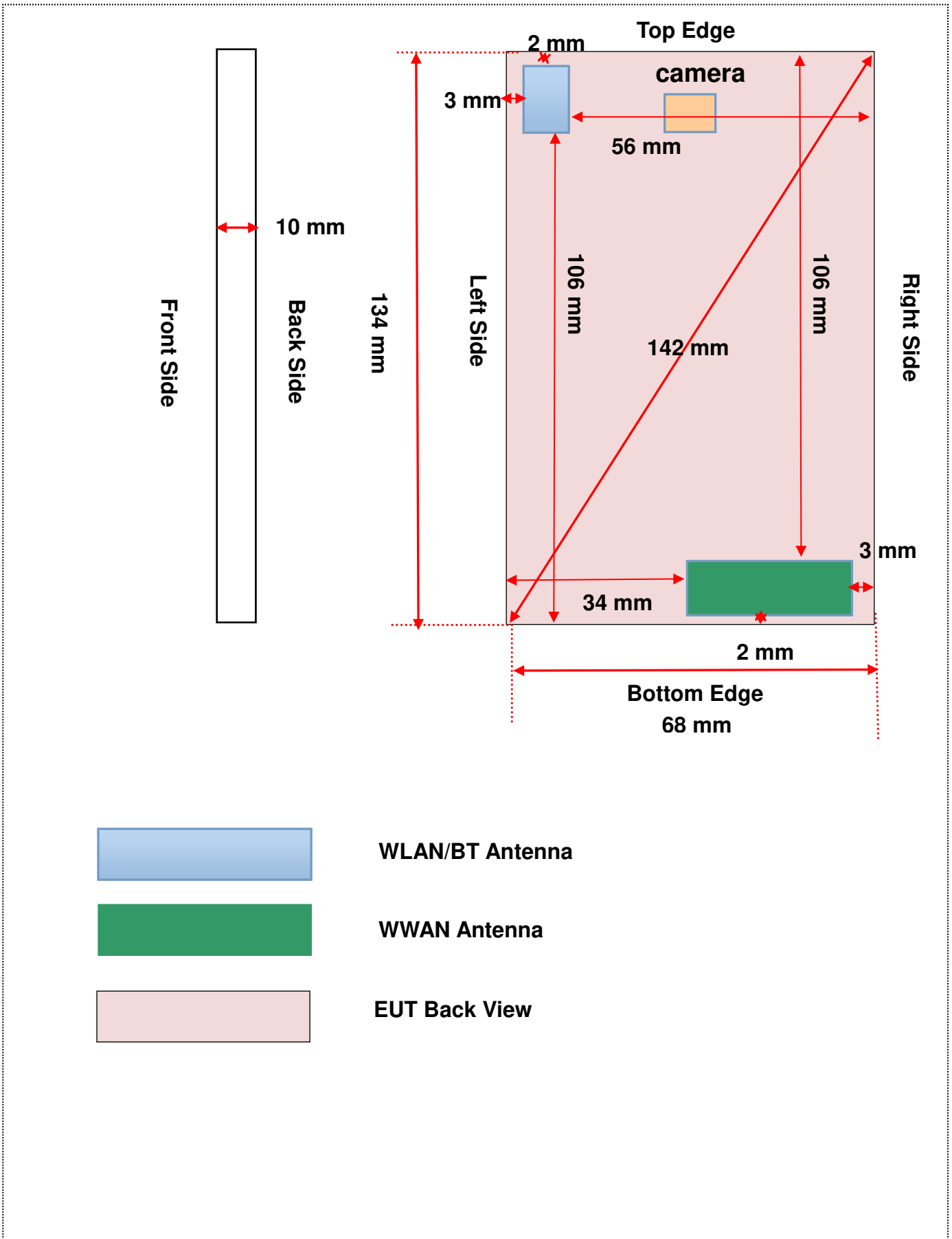

## 9.1 SAR Test Exclusion Consider Table

According with FCC KDB 447498 D01, Appendix A, <SAR Test Exclusion Thresholds for 100 MHz - 6 GHz and ≤ 50 mm> Table, this Device SAR test configurations consider as following :

Band	Mode	Max. Peak Power		Test Position Configurations					
		dBm	mW	Head	Front/ Back	Left Edge	Right Edge	Top Edge	Bottom Edge
GSM 850	Distance to User			<5mm	<5 mm	34 mm	<5 mm	106 mm	<5mm
	Voice	34.05	2540.97	Yes	Yes	Yes	Yes	No	Yes
	Data	33.90	2454.71	No	Yes	Yes	Yes	No	Yes
GSM 1900	Distance to User			<5mm	<5 mm	34 mm	<5 mm	106 mm	<5mm
	Voice	31.40	1380.38	Yes	Yes	Yes	Yes	No	Yes
	Data	31.35	1364.58	No	Yes	Yes	Yes	No	Yes
WCDMA Band 2	Distance to User			<5mm	<5 mm	34 mm	<5 mm	106 mm	<5mm
	RMC	23.15	206.54	Yes	Yes	Yes	Yes	No	Yes
WCDMA Band 4	Distance to User			<5mm	<5 mm	34 mm	<5 mm	106 mm	<5mm
	RMC	23.75	237.14	Yes	Yes	Yes	Yes	No	Yes
WCDMA Band 5	Distance to User			<5mm	<5 mm	34 mm	<5 mm	106 mm	<5mm
	RMC	22.75	188.36	Yes	Yes	Yes	Yes	No	Yes
LTE Band 2	Distance to User			<5mm	<5 mm	34 mm	<5 mm	106 mm	<5mm
	QPSK	22.75	188.36	Yes	Yes	Yes	Yes	No	Yes
LTE Band 4	Distance to User			<5mm	<5 mm	34 mm	<5 mm	106 mm	<5mm
	QPSK	22.95	197.24	Yes	Yes	Yes	Yes	No	Yes
LTE Band 7	Distance to User			<5mm	<5 mm	34 mm	<5 mm	106 mm	<5mm
	QPSK	23.15	206.54	Yes	Yes	Yes	Yes	No	Yes
WLAN 2.4 G	Distance to User			<5mm	<5mm	<5mm	56mm	<5mm	106 mm
	802.11b	12.35	17.18	Yes	Yes	Yes	No	Yes	No
	802.11g	9.60	9.12	No	No	No	No	No	No
	802.11n(HT20)	8.65	7.33	No	No	No	No	No	No
Bluetooth	Distance to User			<5mm	<5mm	<5mm	56mm	<5mm	106 mm
	Bluetooth BR/EDR	9.40	8.71	No	No	No	No	No	No
	Bluetooth BLE	0.55	1.14	No	No	No	No	No	No

Note:

- Maximum power is the source-based time-average power and represents the maximum RF output power among production units.
- Per KDB 447498 D01, for larger devices, the test separation distance of adjacent edge configuration is determined by the closest separation between the antenna and the user.
- Per KDB 447498 D01, standalone SAR test exclusion threshold is applied; If the distance of the antenna to the user is < 5mm, 5mm is used to determine SAR exclusion threshold
- Per KDB 447498 D01, the 1-g and 10-g SAR test exclusion thresholds for 100 MHz to 6 GHz at test separation distances ≤ 50 mm are determined by:
 
$$[(\text{max. power of channel, including tune-up tolerance, mW}) / (\text{min. test separation distance, mm})] \cdot [\sqrt{f(\text{GHz})}] \leq 3.0 \text{ for 1-g SAR and } \leq 7.5 \text{ for 10-g extremity SAR}$$
  - f(GHz) is the RF channel transmit frequency in GHz

- b. Power and distance are rounded to the nearest mW and mm before calculation
- c. The result is rounded to one decimal place for comparison
- d. For < 50 mm distance, we just calculate mW of the exclusion threshold value (3.0) to do compare.

This formula is  $[3.0] / [\sqrt{f(\text{GHz})}] \cdot [(\text{min. test separation distance, mm})] = \text{exclusion threshold of mW}$ .

5. Per KDB 447498 D01, at 100 MHz to 6 GHz and for test separation distances > 50 mm, the SAR test exclusion threshold is determined according to the following:
  - a. [Threshold at 50 mm in step 1) + (test separation distance - 50 mm) · (f(MHz)/150)] mW, at 100 MHz to 1500 MHz
  - b. [Threshold at 50 mm in step 1) + (test separation distance - 50 mm) · 10] mW at > 1500 MHz and ≤ 6 GHz
6. Per KDB 941225 D01, When the maximum output power and tune-up tolerance specified for production units in a secondary mode is ≤ 1/4 dB higher than the primary mode or when the highest reported SAR of the primary mode is scaled by the ratio of specified maximum output power and tune-up tolerance of secondary to primary mode and the adjusted SAR is ≤ 1.2 W/kg, SAR measurement is not required for the secondary mode.
7. Per KDB 941225 D05, SAR test reduction is applied using the following criteria:
  - a. Start with the largest channel bandwidth and measure SAR for QPSK with 1 RB, and 50% RB allocation, using the RB offset and required test channel combination with the highest maximum output power among RB offsets at the upper edge, middle and lower edge of each required test channel.
  - b. When the reported SAR is > 0.8 W/kg, testing for other Channels is performed at the highest output power level for 1RB, and 50% RB configuration for that channel.
  - c. Testing for 100% RB configuration is performed at the highest output power level for 100% RB configuration across the Low, Mid and High Channel when the highest reported SAR for 1 RB and 50% RB are > 0.8 W/kg. Testing for the remaining required channels is not needed because the reported SAR for 100% RB Allocation < 1.45 W/kg.
  - d. Testing for 16-QAM modulation is not required because the reported SAR for QPSK is < 1.45 W/Kg and its output power is not more than 0.5 dB higher than that of QPSK.
  - e. Testing for the other channel bandwidths is not required because the reported SAR for the highest channel bandwidth is < 1.45 W/Kg and its output power is not more than 0.5 dB higher than that of the highest channel bandwidth.
8. Per KDB 248227 D01 SAR is not required for the following 2.4 GHz OFDM conditions.
  - a. When the reported SAR of the highest measured maximum output power channel for the exposure configuration is ≤ 0.8 W/kg, no further SAR testing is required for 802.11b DSSS in that exposure configuration.
  - b. When the reported SAR is > 0.8 W/kg, SAR is required for that exposure configuration using the next highest measured output power channel. When any reported SAR is > 1.2 W/kg, SAR is required for the third channel.
9. Per KDB 248227 D01 SAR is not required for the following 2.4 GHz OFDM conditions.
  - a. When KDB Publication 447498 D01 SAR test exclusion applies to the OFDM configuration.
  - b. When the highest reported SAR for DSSS is adjusted by the ratio of OFDM to DSSS specified maximum output power and the adjusted SAR is ≤ 1.2 W/kg.

# 10 TEST RESULTS

## 10.1 GSM 850

Mode	Position	Dist. (mm)	Ch.	Freq. (MHz)	Power Drift (%)	1 g Meas. SAR (W/Kg)	Meas. Power (dBm)	Max. tune-up Power(dBm)	Scaling Factor	1 g Scaled SAR (W/Kg)	Meas. No.
<b>Head</b>											
Voice	Left Cheek	0	251	848.8	1.14	0.346	33.96	34.05	1.02	<b>0.353</b>	<b>1#</b>
	Left Tilt	0	251	848.8	-0.33	0.291	33.96	34.05	1.02	0.297	/
	Right Cheek	0	251	848.8	-1.91	0.296	33.96	34.05	1.02	0.302	/
	Right Tilt	0	251	848.8	-0.42	0.242	33.96	34.05	1.02	0.247	/
<b>Body-worn Accessory</b>											
Voice	Front Side	15	251	848.8	-0.87	0.354	33.96	34.05	1.02	0.361	/
	Back Side	15	251	848.8	0.09	0.472	33.96	34.05	1.02	<b>0.482</b>	<b>2#</b>
<b>Hotspot</b>											
GPRS 3 slots	Front Side	10	190	836.6	-0.99	0.431	30.93	31.05	1.03	0.443	/
	Back Side	10	190	836.6	-1.85	0.596	30.93	31.05	1.03	<b>0.613</b>	<b>3#</b>
	Left Edge	10	190	836.6	1.37	0.316	30.93	31.05	1.03	0.325	/
	Right Edge	10	190	836.6	-0.03	0.447	30.93	31.05	1.03	0.460	/
	Bottom Edge	10	190	836.6	-0.09	0.174	30.93	31.05	1.03	0.179	/
Note: <ol style="list-style-type: none"> <li>SAR is not required for EGPRS (8PSK) mode because its output power is less than that of GPRS Mode.</li> <li>For this band, the EUT does not support Power Reduction under Hotspot mode.</li> </ol>											

**10.2GSM 1900**

Mode	Position	Dist. (mm)	Ch.	Freq. (MHz)	Power Drift (%)	1 g Meas. SAR (W/Kg)	Meas. Power (dBm)	Max. tune-up Power(dBm)	Scaling Factor	1 g Scaled SAR (W/Kg)	Meas. No.
<b>Head</b>											
Voice	Left Cheek	0	512	1850.2	-4.02	0.187	31.28	31.40	1.03	<b>0.192</b>	<b>4#</b>
	Left Tilt	0	512	1850.2	-2.44	0.052	31.28	31.40	1.03	0.053	/
	Right Cheek	0	512	1850.2	-1.06	0.117	31.28	31.40	1.03	0.120	/
	Right Tilt	0	512	1850.2	3.11	0.045	31.28	31.40	1.03	0.046	/
<b>Body-worn Accessory</b>											
Voice	Front Side	15	512	1850.2	-0.92	0.246	31.28	31.40	1.03	<b>0.253</b>	<b>5#</b>
	Back Side	15	512	1850.2	0.30	0.184	31.28	31.40	1.03	0.189	/
<b>Hotspot</b>											
GPRS 4 slots	Front Side	10	512	1850.2	-2.57	0.990	26.80	26.90	1.02	1.013	/
		10	661	1880.0	0.38	0.963	26.42	26.90	1.12	1.076	/
		10	810	1909.8	-2.01	0.736	26.37	26.90	1.13	0.832	/
	Back Side	10	512	1850.2	0.44	0.818	26.80	26.90	1.02	0.837	/
		10	661	1880.0	0.21	0.802	26.42	26.90	1.12	0.896	/
		10	810	1909.8	0.42	0.691	26.37	26.90	1.13	0.781	/
	Left Edge	10	512	1850.2	-0.05	0.174	26.80	26.90	1.02	0.178	/
	Right Edge	10	512	1850.2	-1.23	0.391	26.80	26.90	1.02	0.400	/
	Bottom Edge	10	512	1850.2	-3.33	0.991	26.80	26.90	1.02	1.014	/
		10	661	1880.0	-0.40	0.972	26.42	26.90	1.12	<b>1.086</b>	<b>6#</b>
10		810	1909.8	-0.40	0.792	26.37	26.90	1.13	0.895	/	
Note:											
1. SAR is not required for EGPRS (8PSK) mode because its output power is less than that of GPRS Mode.											
2. For this band, the EUT does not support Power Reduction under Hotspot mode.											

## 10.3WCDMA Band 2

Mode	Position	Dist. (mm)	Ch.	Freq. (MHz)	Power Drift (%)	1 g Meas. SAR (W/Kg)	Meas. Power (dBm)	Max. tune-up Power(dBm)	Scaling Factor	1 g Scaled SAR (W/Kg)	Meas. No.
<b>Head</b>											
RMC	Left Cheek	0	9538	1907.6	-3.75	0.230	23.02	23.15	1.03	<b>0.237</b>	7#
	Left Tilt	0	9538	1907.6	-4.28	0.058	23.02	23.15	1.03	0.060	/
	Right Cheek	0	9538	1907.6	-1.79	0.150	23.02	23.15	1.03	0.155	/
	Right Tilt	0	9538	1907.6	-3.17	0.053	23.02	23.15	1.03	0.055	/
<b>Body-worn Accessory &amp; Hotspot</b>											
RMC	Front Side	15	9538	1907.6	1.14	0.342	23.02	23.15	1.03	<b>0.352</b>	8#
	Back Side	15	9538	1907.6	0.91	0.275	23.02	23.15	1.03	0.283	/
<b>Hotspot</b>											
RMC	Front Side	10	9538	1907.6	-2.72	0.621	23.02	23.15	1.03	0.640	/
	Back Side	10	9538	1907.6	-1.35	0.562	23.02	23.15	1.03	0.579	/
	Left Edge	10	9538	1907.6	-3.71	0.096	23.02	23.15	1.03	0.099	/
	Right Edge	10	9538	1907.6	0.98	0.211	23.02	23.15	1.03	0.217	/
	Bottom Edge	10	9538	1907.6	1.19	0.653	23.02	23.15	1.03	<b>0.673</b>	9#
Note: For this band, the EUT does not support Power Reduction under Hotspot mode.											

## 10.4WCDMA Band 4

Mode	Position	Dist. (mm)	Ch.	Freq. (MHz)	Power Drift (%)	1 g Meas. SAR (W/Kg)	Meas. Power (dBm)	Max. tune-up Power(dBm)	Scaling Factor	1 g Scaled SAR (W/Kg)	Meas. No.
<b>Head</b>											
RMC	Left Cheek	0	1412	1732.4	-1.45	0.330	23.64	23.75	1.03	<b>0.338</b>	10#
	Left Tilt	0	1412	1732.4	-2.97	0.168	23.64	23.75	1.03	0.172	/
	Right Cheek	0	1412	1732.4	1.94	0.253	23.64	23.75	1.03	0.259	/
	Right Tilt	0	1412	1732.4	-2.92	0.190	23.64	23.75	1.03	0.195	/
<b>Body-worn Accessory</b>											
RMC	Front Side	15	1412	1732.4	-0.73	0.649	23.64	23.75	1.03	<b>0.666</b>	11#
	Back Side	15	1412	1732.4	-0.22	0.464	23.64	23.75	1.03	0.476	/
<b>Hotspot</b>											
RMC	Front Side	10	1412	1732.4	0.70	0.933	23.64	23.75	1.03	0.957	/
		10	1312	1712.4	-0.82	0.988	23.59	23.75	1.04	1.025	/
		10	1513	1752.6	-2.36	0.896	23.23	23.75	1.13	1.010	/
	Back Side	10	1412	1732.4	-1.82	0.767	23.64	23.75	1.03	0.787	/
	Left Edge	10	1412	1732.4	-1.34	0.204	23.64	23.75	1.03	0.209	/
	Right Edge	10	1412	1732.4	-0.12	0.359	23.64	23.75	1.03	0.368	/
	Bottom Edge	10	1412	1732.4	-1.89	0.988	23.64	23.75	1.03	1.013	/
		10	1312	1712.4	-2.97	1.143	23.59	23.75	1.04	<b>1.186</b>	12#
		10	1513	1752.6	-0.09	0.933	23.23	23.75	1.13	1.052	/
Note: For this band, the EUT does not support Power Reduction under Hotspot mode.											



## 10.5WCDMA Band 5

Mode	Position	Dist. (mm)	Ch.	Freq. (MHz)	Power Drift (%)	1 g Meas. SAR (W/Kg)	Meas. Power (dBm)	Max. tune-up Power(dBm)	Scaling Factor	1 g Scaled SAR (W/Kg)	Meas. No.
<b>Head</b>											
RMC	Left Cheek	0	4233	846.6	-0.68	0.336	22.62	22.75	1.03	<b>0.346</b>	13#
	Left Tilt	0	4233	846.6	-2.33	0.251	22.62	22.75	1.03	0.259	/
	Right Cheek	0	4233	846.6	-1.04	0.297	22.62	22.75	1.03	0.306	/
	Right Tilt	0	4233	846.6	-1.21	0.225	22.62	22.75	1.03	0.232	/
<b>Body-worn Accessory</b>											
RMC	Front Side	15	4233	846.6	-3.51	0.333	22.62	22.75	1.03	0.343	/
	Back Side	15	4233	846.6	-0.64	0.427	22.62	22.75	1.03	<b>0.440</b>	14#
<b>Hotspot</b>											
RMC	Front Side	10	4233	846.6	-0.54	0.390	22.62	22.75	1.03	0.402	/
	Back Side	10	4233	846.6	-0.94	0.475	22.62	22.75	1.03	<b>0.489</b>	15#
	Left Edge	10	4233	846.6	-2.66	0.298	22.62	22.75	1.03	0.307	/
	Right Edge	10	4233	846.6	-1.16	0.383	22.62	22.75	1.03	0.395	/
	Bottom Edge	10	4233	846.6	-2.35	0.134	22.62	22.75	1.03	0.138	/
Note: For this band, the EUT does not support Power Reduction under Hotspot mode.											

## 10.6LTE Band 2 (20MHz Bandwidth)

Mode	Position	Dist. (mm)	Ch.	Freq. (MHz)	RB Numb.	RB Start	Power Drift (%)	1 g Meas. SAR (W/Kg)	Meas. Power (dBm)	Max. tune-up Power (dBm)	Scaling Factor	1 g Scaled SAR (W/Kg)	Meas. No.
<b>Head</b>													
QPSK	Left Cheek	0	18700	1860	1	Mid	-3.65	0.252	22.67	22.75	1.02	<b>0.257</b>	16#
			19100	1900	50	Low	-0.28	0.219	21.43	21.55	1.03	0.225	/
	Left Tilt	0	18700	1860	1	Mid	-0.64	0.079	22.67	22.75	1.02	0.080	/
			19100	1900	50	Low	-0.77	0.072	21.43	21.55	1.03	0.074	/
	Right Cheek	0	18700	1860	1	Mid	-1.92	0.174	22.67	22.75	1.02	0.177	/
			19100	1900	50	Low	1.88	0.158	21.43	21.55	1.03	0.162	/
	Right Tilt	0	18700	1860	1	Mid	-2.73	0.064	22.67	22.75	1.02	0.065	/
			19100	1900	50	Low	-4.56	0.060	21.43	21.55	1.03	0.062	/
<b>Body-worn Accessory</b>													
QPSK	Front Side	15	18700	1860	1	Mid	-2.19	0.334	22.67	22.75	1.02	<b>0.340</b>	17#
			19100	1900	50	Low	0.73	0.211	21.43	21.55	1.03	0.217	/
	Back Side	15	18700	1860	1	Mid	0.91	0.241	22.67	22.75	1.02	0.245	/
			19100	1900	50	Low	0.81	0.189	21.43	21.55	1.03	0.194	/
<b>Hotspot</b>													
QPSK	Front Side	10	18700	1860	1	Mid	-1.85	0.622	22.67	22.75	1.02	0.634	/
			19100	1900	50	Low	0.83	0.485	21.43	21.55	1.03	0.499	/
	Back Side	10	18700	1860	1	Mid	-0.79	0.533	22.67	22.75	1.02	0.543	/
			19100	1900	50	Low	2.27	0.432	21.43	21.55	1.03	0.444	/
	Left Edge	10	18700	1860	1	Mid	2.13	0.084	22.67	22.75	1.02	0.086	/
			19100	1900	50	Low	3.43	0.065	21.43	21.55	1.03	0.067	/
	Right Edge	10	18700	1860	1	Mid	4.94	0.214	22.67	22.75	1.02	0.218	/
			19100	1900	50	Low	0.56	0.153	21.43	21.55	1.03	0.157	/
	Bottom Edge	10	18700	1860	1	Mid	-1.78	0.713	22.67	22.75	1.02	<b>0.726</b>	18#
			19100	1900	50	Low	-0.04	0.649	21.43	21.55	1.03	0.667	/

Note: For this band, the EUT does not support Power Reduction under Hotspot mode.

## 10.7LTE Band 4 (20MHz Bandwidth)

Mode	Position	Dist. (mm)	Ch.	Freq. (MHz)	RB Numb.	RB Start	Power Drift (%)	1 g Meas. SAR (W/Kg)	Meas. Power (dBm)	Max. tune-up Power (dBm)	Scaling Factor	1 g Scaled SAR (W/Kg)	Meas. No.
<b>Head</b>													
QPSK	Left Cheek	0	20175	1732.5	1	Low	-2.53	0.299	22.87	22.95	1.02	<b>0.305</b>	19#
			20175	1732.5	50	Low	-2.33	0.262	21.82	21.95	1.03	0.270	/
	Left Tilt	0	20175	1732.5	1	Low	-0.16	0.128	22.87	22.95	1.02	0.130	/
			20175	1732.5	50	Low	-0.07	0.115	21.82	21.95	1.03	0.118	/
	Right Cheek	0	20175	1732.5	1	Low	1.29	0.226	22.87	22.95	1.02	0.230	/
			20175	1732.5	50	Low	0.53	0.201	21.82	21.95	1.03	0.207	/
	Right Tilt	0	20175	1732.5	1	Low	0.69	0.144	22.87	22.95	1.02	0.147	/
			20175	1732.5	50	Low	2.33	0.132	21.82	21.95	1.03	0.136	/
<b>Body-worn Accessory</b>													
QPSK	Front Side	15	20175	1732.5	1	Low	1.40	0.545	22.87	22.95	1.02	<b>0.555</b>	20#
			20175	1732.5	50	Low	-0.73	0.493	21.82	21.95	1.03	0.508	/
	Back Side	15	20175	1732.5	1	Low	0.56	0.403	22.87	22.95	1.02	0.410	/
			20175	1732.5	50	Low	-0.85	0.365	21.82	21.95	1.03	0.376	/
<b>Hotspot</b>													
QPSK	Front Side	10	20175	1732.5	1	Low	-1.37	0.908	22.87	22.95	1.02	0.925	/
			20050	1720	1	Mid	-1.53	0.957	22.54	22.95	1.10	1.052	/
			20300	1745	1	Mid	0.31	0.889	22.66	22.95	1.07	0.950	/
			20175	1732.5	50	Low	-0.91	0.717	21.82	21.95	1.03	0.739	/
			20175	1732.5	100	Low	-2.66	0.709	21.76	21.85	1.02	0.724	/
	Back Side	10	20175	1732.5	1	Low	-4.80	0.738	22.87	22.95	1.02	0.752	/
			20175	1732.5	50	Low	-0.04	0.632	21.82	21.95	1.03	0.651	/
	Left Edge	10	20175	1732.5	1	Low	0.49	0.206	22.87	22.95	1.02	0.210	/
			20175	1732.5	50	Low	0.21	0.188	21.82	21.95	1.03	0.194	/
	Right Edge	10	20175	1732.5	1	Low	-3.02	0.346	22.87	22.95	1.02	0.352	/
			20175	1732.5	50	Low	-4.02	0.301	21.82	21.95	1.03	0.310	/
	Bottom Edge	10	20175	1732.5	1	Low	0.62	1.001	22.87	22.95	1.02	1.020	/
			20050	1720	1	Mid	-3.27	1.030	22.54	22.95	1.10	<b>1.132</b>	21#
			20300	1745	1	Mid	-4.06	0.916	22.66	22.95	1.07	0.979	/
			20175	1732.5	50	Low	-1.56	0.888	21.82	21.95	1.03	0.915	/
			20050	1720	50	Mid	-2.31	0.834	21.33	21.95	1.15	0.962	/
20300			1745	50	Mid	0.83	0.796	21.60	21.95	1.08	0.863	/	
20175	1732.5	100	Low	-1.26	0.885	21.76	21.85	1.02	0.904	/			
Note: For this band, the EUT does not support Power Reduction under Hotspot mode.													

### 10.8LTE Band 7 (20MHz Bandwidth)

Mode	Position	Dist. (mm)	Ch.	Freq. (MHz)	RB Numb.	RB Start	Power Drift (%)	1 g Meas. SAR (W/Kg)	Meas. Power (dBm)	Max. tune-up Power (dBm)	Scaling Factor	1 g Scaled SAR (W/Kg)	Meas. No.
<b>Head</b>													
QPSK	Left Cheek	0	21350	2560	1	Mid	-1.50	0.267	23.05	23.15	1.02	<b>0.273</b>	22#
			21350	2560	50	High	-4.42	0.223	21.77	21.85	1.02	0.227	/
	Left Tilt	0	21350	2560	1	Mid	0.33	0.136	23.05	23.15	1.02	0.139	/
			21350	2560	50	High	1.48	0.120	21.77	21.85	1.02	0.122	/
	Right Cheek	0	21350	2560	1	Mid	-4.06	0.154	23.05	23.15	1.02	0.158	/
			21350	2560	50	High	-2.09	0.127	21.77	21.85	1.02	0.129	/
	Right Tilt	0	21350	2560	1	Mid	2.49	0.105	23.05	23.15	1.02	0.107	/
			21350	2560	50	High	3.47	0.097	21.77	21.85	1.02	0.099	/
<b>Body-worn Accessory</b>													
QPSK	Front Side	15	21350	2560	1	Mid	1.68	0.426	23.05	23.15	1.02	0.436	/
			21350	2560	50	High	2.47	0.337	21.77	21.85	1.02	0.343	/
	Back Side	15	21350	2560	1	Mid	1.86	0.828	23.05	23.15	1.02	<b>0.847</b>	23#
			20850	2510	1	Low	0.28	0.624	22.63	23.15	1.13	0.703	/
			21100	2535	1	Low	-0.33	0.709	22.63	23.15	1.13	0.799	/
			21350	2560	50	High	0.66	0.753	21.77	21.85	1.02	0.767	/
			21350	2560	100	Low	1.23	0.749	21.71	21.80	1.02	0.765	/
<b>Hotspot</b>													
QPSK	Front Side	10	21350	2560	1	Mid	-0.47	0.633	21.35	21.45	1.02	0.648	/
			21350	2560	50	Low	3.34	0.527	20.29	20.40	1.03	0.541	/
	Back Side	10	21350	2560	1	Mid	1.16	1.149	21.35	21.45	1.02	<b>1.176</b>	24#
			20850	2510	1	Mid	-2.08	0.742	20.92	21.45	1.13	0.838	/
			21100	2535	1	Mid	0.93	0.962	21.04	21.45	1.10	1.057	/
			21350	2560	50	Low	-3.17	1.091	20.29	20.40	1.03	1.119	/
			20850	2510	50	High	2.68	0.681	19.69	20.40	1.18	0.802	/
			21100	2535	50	Low	1.69	0.876	20.13	20.40	1.06	0.932	/
			21350	2560	100	Low	3.00	1.033	20.26	20.35	1.02	1.055	/
	Left Edge	10	21350	2560	1	Mid	-2.17	0.099	21.35	21.45	1.02	0.101	/
			21350	2560	50	Low	2.67	0.084	20.29	20.40	1.03	0.086	/
	Right Edge	10	21350	2560	1	Mid	3.11	0.292	21.35	21.45	1.02	0.299	/
			21350	2560	50	Low	2.58	0.236	20.29	20.40	1.03	0.242	/
	Bottom Edge	10	21350	2560	1	Mid	-0.17	0.893	21.35	21.45	1.02	0.914	/
			20850	2510	1	Mid	2.07	0.638	20.92	21.45	1.13	0.721	/
			21100	2535	1	Mid	-0.64	0.717	21.04	21.45	1.10	0.788	/
			21350	2560	50	Low	-2.48	0.743	20.29	20.40	1.03	0.762	/
			21350	2560	100	Low	1.38	0.737	20.26	20.35	1.02	0.752	/
Note: For this band, the EUT supports Power Reduction under Hotspot mode.													

## 10.9WIFI 2.4GHz

Mode	Position	Dist. (mm)	Ch.	Freq. (MHz)	Power Drift (%)	1 g Meas. SAR (W/Kg)	Meas. Power (dBm)	Max. tune-up Power(dBm)	Scaling Factor	1 g Scaled SAR (W/Kg)	Meas. No.
<b>Head</b>											
802.11 b	Left Cheek	0	1	2412	-1.64	0.203	12.25	12.35	1.02	<b>0.208</b>	25#
	Left Tilt	0	1	2412	-2.31	0.145	12.25	12.35	1.02	0.148	/
	Right Cheek	0	1	2412	-2.13	0.162	12.25	12.35	1.02	0.166	/
	Right Tilt	0	1	2412	-3.89	0.127	12.25	12.35	1.02	0.130	/
<b>Body-worn Accessory</b>											
802.11 b	Front Side	15	1	2412	0.36	0.087	12.25	12.35	1.02	0.089	/
	Back Side	15	1	2412	-0.64	0.108	12.25	12.35	1.02	<b>0.111</b>	26#
<b>Hotspot</b>											
802.11 b	Front Side	10	1	2412	-1.08	0.140	12.25	12.35	1.02	0.143	/
	Back Side	10	1	2412	-1.07	0.194	12.25	12.35	1.02	<b>0.199</b>	27#
	Left Edge	10	1	2412	-2.08	0.072	12.25	12.35	1.02	0.074	/
	Bottom Edge	10	1	2412	-1.02	0.103	12.25	12.35	1.02	0.105	/
Note: For this band, the EUT does not support Power Reduction under Hotspot mode.											

## 11 SAR Measurement Variability

According to KDB 865664 D01, SAR measurement variability was assessed for each frequency band, which is determined by the SAR probe calibration point and tissue-equivalent medium used for the device measurements. When both head and body tissue-equivalent media are required for SAR measurements in a frequency band, the variability measurement procedures should be applied to the tissue medium with the highest measured SAR, using the highest measured SAR configuration for that tissue-equivalent medium. Alternatively, if the highest measured SAR for both head and body tissue-equivalent media are  $\leq 1.45$  W/kg and the ratio of these highest SAR values, i.e., largest divided by smallest value, is  $\leq 1.10$ , the highest SAR configuration for either head or body tissue-equivalent medium may be used to perform the repeated measurement. These additional measurements are repeated after the completion of all measurements requiring the same head or body tissue-equivalent medium in a frequency band. The test device should be returned to ambient conditions (normal room temperature) with the battery fully charged before it is re-mounted on the device holder for the repeated measurement(s) to minimize any unexpected variations in the repeated results.

SAR repeated measurement procedure:

1. When the highest measured SAR is  $< 0.80$  W/kg, repeated measurement is not required.
2. When the highest measured SAR is  $\geq 0.80$  W/kg, repeat that measurement once.
3. If the ratio of largest to smallest SAR for the original and first repeated measurements is  $> 1.20$ , or when the original or repeated measurement is  $\geq 1.45$  W/kg, perform a second repeated measurement.
4. If the ratio of largest to smallest SAR for the original, first and second repeated measurements is  $> 1.20$ , and the original, first or second repeated measurement is  $\geq 1.5$  W/kg, perform a third repeated measurement.

Frequency Band (MHz)	Wireless Band	RF Exposure Conditions	Test Position	Highest Measured SAR (W/kg)	Repeated SAR (Yes/No)	Highest Measured SAR (W/kg)	Largest to Smallest SAR Ratio
1750	WCDMA Band 4	Hotspot	Bottom Edge	1.143	Yes	1.088	1.05
	LTE Band 4	Hotspot	Bottom Edge	1.030	Yes	1.018	1.01
1900	GSM 1900	Hotspot	Bottom Edge	0.991	Yes	0.970	1.02
2600	LTE Band 7	Hotspot	Back Side	1.149	Yes	1.124	1.02

**Note:** The ratio of largest to smallest SAR for the original and first repeated measurements is  $< 1.20$ , the second repeated measurement is not required.

## 12 SIMULTANEOUS TRANSMISSION

Simultaneous transmission SAR test exclusion is determined for each operating configuration and exposure condition according to the reported standalone SAR of each applicable simultaneous transmitting antenna. When the sum of SAR 1g of all simultaneously transmitting antennas in an operating mode and exposure condition combination is within the SAR limit (SAR 1g 1.6 W/kg), the simultaneous transmission SAR is not required. When the sum of SAR 1g is greater than the SAR limit (SAR 1g 1.6 W/kg), SAR test exclusion is determined by the SAR to Peak Location Ratio (SPLSR).

### 12.1 Simultaneous Transmission Mode Consider

NO.	Mode	2.4G WLAN & Bluetooth		
		Head	Body-worn	Hotspot
1	GSM (Voice)	+ 2.4G WLAN	+ 2.4G WLAN	--
		--	+ Bluetooth	--
2	GSM (Data)	--	--	+ 2.4G WLAN
3	WCDMA RMC	+ 2.4G WLAN	+ 2.4G WLAN	+ 2.4G WLAN
		--	+ Bluetooth	--
4	LTE	+ 2.4G WLAN	+ 2.4G WLAN	+ 2.4G WLAN
		--	+ Bluetooth	--

Note:

- 2G&3G&4G share the same antenna and can't transmit simultaneously.
- The Bluetooth and 2.4G WLAN share the same antenna, can't transmitting together.
- Held to ear configurations are not applicable to Bluetooth and therefore were not considered for simultaneous transmission.

## 12.2 Estimated SAR Calculation

According to KDB 447498 D01 when standalone SAR test exclusion applies to an antenna that transmits simultaneously with other antennas, the standalone SAR was estimated according to following formula to result in substantially conservative SAR values of  $\leq 0.4$  W/kg to determine simultaneous transmission SAR test exclusion.

$$\text{Estimated SAR} = \frac{\text{Max. Tune Up Power (mw)}}{\text{Min Test Separation Distance}} * \frac{\sqrt{f_{\text{GHz}}}}{x} \quad (\text{where } x = 7.5 \text{ for 1-g SAR})$$

If the minimum test separation distance is  $< 5$  mm, a distance of 5 mm is used for estimated SAR calculation. When the test separation distance is  $> 50$  mm, the 0.4 W/kg is used for SAR-1g.

Band	Mode	Position	Antenna To user (mm)	SAR Testing	Max. Tune-up Power (dBm)	Max. Tune-up Power (mW)	Frequency (GHz)	Calculation Distance/Gap (mm)	Estimated SAR (W/kg)
Bluetooth	GFSK	Right Cheek	5	NO	9.40	8.71	2441	5	0.363
		Left Cheek	5	NO	9.40	8.71	2441	5	0.363
		Front side	15	NO	9.40	8.71	2441	15	0.121
		Back Side	15	NO	9.40	8.71	2441	15	0.121
		Left Edge	15	NO	9.40	8.71	2441	15	0.121
		Top Edge	15	NO	9.40	8.71	2441	15	0.121



## 12.3 Sum SAR of Simultaneous Transmission

### 12.3.1 Sum Head SAR of Simultaneous Transmission

Simultaneous Mode	Mode	Max. 1g SAR (W/kg)	1g Sum SAR (W/kg)	SPLSR (Yes/No)
GSM Voice + 2.4G WLAN	GSM Voice	0.353	<b>0.561</b>	No
	2.4G WLAN	0.208		
WCDMA RMC +2.4G WLAN	WCDMA RMC	0.346	0.554	No
	2.4G WLAN	0.208		
LTE QPSK + 2.4G WLAN	LTE QPSK	0.305	0.513	No
	2.4G WLAN	0.208		

### 12.3.2 Sum Body-worn SAR of Simultaneous Transmission

Simultaneous Mode	Mode	Max. 1g SAR (W/kg)	1g Sum SAR (W/kg)	SPLSR (Yes/No)
GSM Voice +Bluetooth	GSM Voice	0.482	0.603	No
	Bluetooth	0.121		
GSM Voice + 2.4G WLAN	GSM Voice	0.482	0.593	No
	2.4G WLAN	0.111		
WCDMA RMC +Bluetooth	WCDMA RMC	0.666	0.787	No
	Bluetooth	0.121		
WCDMA RMC +2.4G WLAN	WCDMA RMC	0.666	0.777	No
	2.4G WLAN	0.111		
LTE QPSK + Bluetooth	LTE QPSK	0.847	<b>0.968</b>	No
	Bluetooth	0.121		
LTE QPSK + 2.4G WLAN	LTE QPSK	0.847	0.958	No
	2.4G WLAN	0.111		

### 12.3.3 Sum Hotspot mode SAR of Simultaneous Transmission

Simultaneous Mode	Mode	Max. 1g SAR (W/kg)	1g Sum SAR (W/kg)	SPLSR (Yes/No)
GSM DATA + 2.4G WLAN	GSM DATA	1.086	1.285	No
	2.4G WLAN	0.199		
WCDMA RMC + 2.4G WLAN	WCDMA RMC	1.186	<b>1.385</b>	No
	2.4G WLAN	0.199		
LTE QPSK + 2.4G WLAN	LTE QPSK	1.176	1.375	No
	2.4G WLAN	0.199		

## 13 TEST EQUIPMENTS LIST

Description	Manufacturer	Model	Serial No.	Cal. Date	Cal. Due
PC	Dell	N/A	N/A	N/A	N/A
835MHz Dipole	SATIMO	SID 835	S/N 25/13 DIP 0G835-246	2015/03/16	2018/03/15
1800MHz Dipole	SATIMO	SID 1900	S/N 25/13 DIP 1G800-248	2015/03/16	2018/03/15
1900MHz Dipole	SATIMO	SID 1900	S/N 25/13 DIP 1G900-249	2015/03/16	2018/03/15
2450MHz Dipole	SATIMO	SID 2450	S/N 25/13 DIP 2G450-251	2015/03/16	2018/03/15
2600MHz Dipole	SATIMO	SID 2600	SN 25/13 DIP 2G600-254	2015/03/16	2018/03/15
E-Field Probe	MVG	SSE2	S/N 34/15 EPGO 265	2016/09/15	2017/09/14
Antenna	SATIMO	ANTA3	SN 17/13 ZNTA45	N/A	N/A
Phantom1	SATIMO	SAM	SN 30/13 SAM103	N/A	N/A
Phantom2	SATIMO	SAM	SN 30/13 SAM104	N/A	N/A
Dielectric Probe Kit	SATIMO	SCLMP	SN 25/13 OCPG56	2016/07/13	2017/07/12
MultiMeter	Keithley	MultiMeter 2000	4024022	2016/07/13	2017/07/12
Signal Generator	R&S	SMF100A	1167.0000k02/104260	2016/07/13	2017/07/12
Power Meter	Agilent	E4419B	GB40201833	2016/07/13	2017/07/12
Power Sensor	R&S	NRP-Z21	103971	2016/07/13	2017/07/12
Power Amplifier	SATIMO	6552B	22374	N/A	N/A
Wireless Communication Test Set	R&S	CMW 500	138884	2016/07/13	2017/07/12
Wireless Communication Test Set	Agilent	8960-E5515C	MY50260493	2016/07/13	2017/07/12
Network Analyzer	R&S	ZVL-6	101380	2016/07/13	2017/07/12
Temperature Meter	Elitech	RC-4HC	N/A	2017/02/18	2018/02/17
Attenuator	COM-MW	ZA-S1-31	1305003187	N/A	N/A
Directional coupler	AA-MCS	AAMCS-UDC	000272	N/A	N/A

Note: Per KDB 865664 Dipole SAR Validation Verification, BALUN LAB has adopted 3 years calibration intervals. On annual basis, every measurement dipole has been evaluated and is in compliance with the following criteria:

1. There is no physical damage on the dipole;
2. System validation with specific dipole is within 10% of calibrated value;
3. Return-loss in within 20% of calibrated measurement.

## ANNEX A SIMULATING LIQUID VERIFICATION RESULT

The dielectric parameters of the liquids were verified prior to the SAR evaluation using an SCLMP Dielectric Probe Kit.

Date	Liquid Type	Fre. (MHz)	Temp. (°C)	Meas. Conductivity ( $\sigma$ ) (S/m)	Meas. Permittivity ( $\epsilon$ )	Target Conductivity ( $\sigma$ ) (S/m)	Target Permittivity ( $\epsilon$ )	Conductivity Tolerance (%)	Permittivity Tolerance (%)
2017.03.14	Head	835	20.8	0.90	41.82	0.90	41.50	0.00	0.77
2017.03.15	Body	835	21.5	1.00	56.70	0.97	55.20	3.09	2.72
2017.03.18	Head	1800	21.3	1.43	39.61	1.40	40.00	2.14	-0.98
2017.03.19	Body	1800	20.9	1.51	53.56	1.52	53.30	-0.66	0.49
2017.03.16	Head	1900	20.5	1.42	39.80	1.40	40.00	1.43	-0.50
2017.03.17	Body	1900	20.9	1.54	52.76	1.52	53.30	1.32	-1.01
2017.03.20	Head	2450	21.5	1.86	37.97	1.80	39.20	3.33	-3.14
2017.03.21	Body	2450	21.1	1.95	52.61	1.95	52.70	0.00	-0.17
2017.03.24	Head	2600	20.8	1.97	38.17	1.96	39.00	0.51	-2.13
2017.03.27	Body	2600	21.0	2.13	50.48	2.16	52.50	-1.39	-3.85

**Note:** The tolerance limit of Conductivity and Permittivity is  $\pm 5\%$ .

## ANNEX B SYSTEM CHECK RESULT

Comparing to the original SAR value provided by SATIMO, the validation data should be within its specification of 10%(for 1 g).

Date	Liquid Type	Freq. (MHz)	Power (mW)	Measured SAR (W/kg)	Normalized SAR (W/kg)	Dipole SAR (W/kg)	Tolerance (%)	Targeted SAR(W/kg)	Tolerance (%)
2017.03.14	Head	835	100	0.990	9.90	9.81	0.92	9.56	3.56
2017.03.15	Body	835	100	1.013	10.13	10.53	-3.80	9.56	5.96
2017.03.18	Head	1800	100	3.892	38.92	38.72	0.52	38.40	1.35
2017.03.19	Body	1800	100	3.994	39.94	40.42	-1.19	38.40	4.01
2017.03.16	Head	1900	100	3.910	39.10	40.75	-4.05	39.70	-1.51
2017.03.17	Body	1900	100	3.943	39.43	42.06	-6.25	39.70	-0.68
2017.03.20	Head	2450	100	5.356	53.56	54.29	-1.34	52.40	2.21
2017.03.21	Body	2450	100	5.463	54.63	54.70	-0.13	52.40	4.26
2017.03.24	Head	2600	100	5.360	53.60	57.37	-6.57	55.30	-3.07
2017.03.27	Body	2600	100	5.787	57.87	57.62	0.43	55.30	4.65

Note: The tolerance limit of System validation is  $\pm 10\%$ .

# System Performance Check Data(835MHz Head)

Type: Phone measurement (Complete)  
 E-Field Probe: SN 34/15 SSE2 EPGO265  
 Area scan resolution: dx=8mm,dy=8mm  
 Zoom scan resolution: dx=8mm, dy=8mm, dz=5mm  
 Date of measurement: 2017.03.14  
 Measurement duration: 13 minutes 27 seconds

## Experimental conditions.

<b>Phantom File</b>	surf_sam_plan.txt
<b>Phantom</b>	Validation plane
<b>Band</b>	835MHz
<b>Signal</b>	CW
<b>Frequency (MHz)</b>	835.000000
<b>Relative permittivity (real part)</b>	41.823651
<b>Conductivity (S/m)</b>	0.896943
<b>Power drift (%)</b>	-0.100000
<b>Ambient Temperature:</b>	21.9C
<b>Liquid Temperature:</b>	20.8C
<b>ConvF:</b>	2.04
<b>Crest factor:</b>	1:1

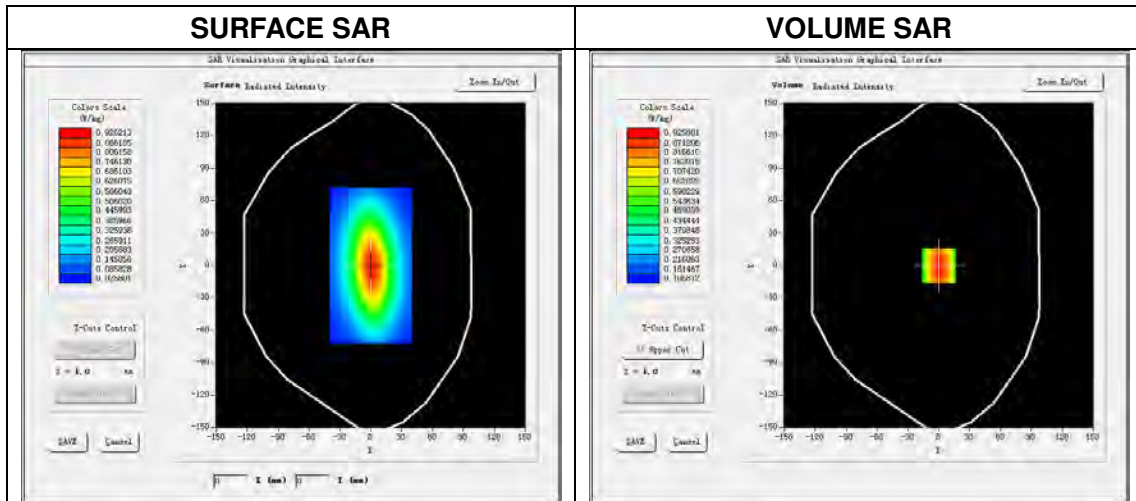

Maximum location: X=0.00, Y=0.00  
 SAR Peak: 1.26 W/kg

SAR 10 g (W/Kg)	0.607177
SAR 1g (W/Kg)	0.989599

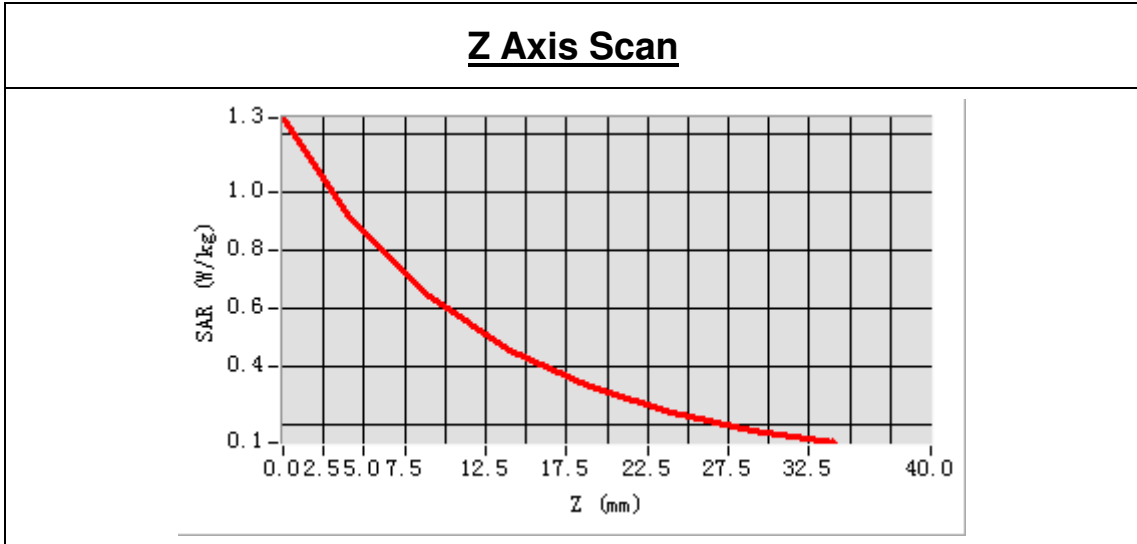

3D screen shot	Hot spot position

# System Performance Check Data(835MHz Body)

Type: Phone measurement (Complete)  
 E-Field Probe: SN 34/15 SSE2 EPGO265  
 Area scan resolution: dx=8mm,dy=8mm  
 Zoom scan resolution: dx=8mm, dy=8mm, dz=5mm  
 Date of measurement: 2017.03.15  
 Measurement duration: 13 minutes 31 seconds

## Experimental conditions.

Phantom File	surf_sam_plan.txt
Phantom	Validation plane
Band	835MHz
Signal	CW
Frequency (MHz)	835.000000
Relative permittivity (real part)	56.70459
Conductivity (S/m)	0.998147
Power drift (%)	0.390000
Ambient Temperature:	22.7C
Liquid Temperature:	21.5C
ConvF:	2.12
Crest factor:	1:1

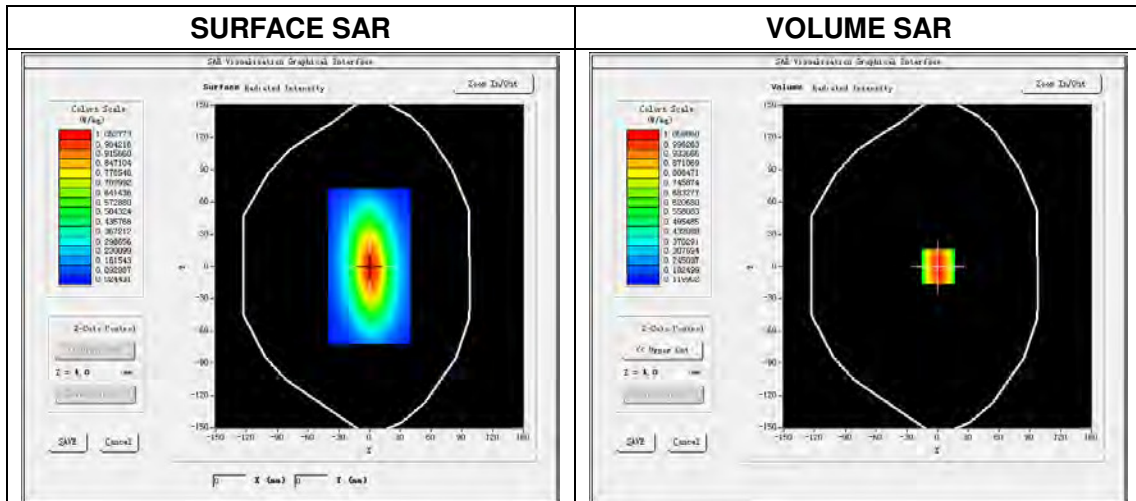

Maximum location: X=1.00, Y=0.00  
 SAR Peak: 1.39 W/kg

SAR 10 g (W/Kg)	0.639168
SAR 1g (W/Kg)	1.013364

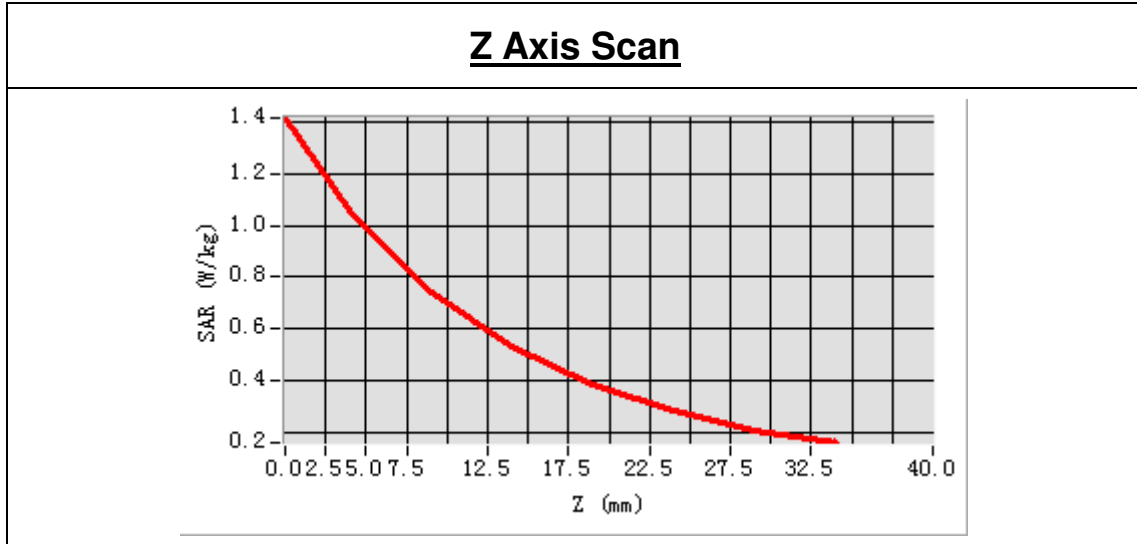

3D screen shot	Hot spot position



# System Performance Check Data(1800MHz Head)

Type: Phone measurement (Complete)  
 E-Field Probe: SN 34/15 SSE2 EPGO265  
 Area scan resolution: dx=8mm,dy=8mm  
 Zoom scan resolution: dx=8mm, dy=8mm, dz=5mm  
 Date of measurement: 2017.03.18  
 Measurement duration: 13 minutes 25 seconds

## Experimental conditions.

<b>Phantom File</b>	surf_sam_plan.txt
<b>Phantom</b>	Validation plane
<b>Band</b>	1800MHz
<b>Signal</b>	CW
<b>Frequency (MHz)</b>	1800.000000
<b>Relative permittivity (real part)</b>	39.611029
<b>Conductivity (S/m)</b>	1.433274
<b>Power drift (%)</b>	0.260000
<b>Ambient Temperature:</b>	22.6C
<b>Liquid Temperature:</b>	21.3C
<b>ConvF:</b>	2.04
<b>Crest factor:</b>	1:1

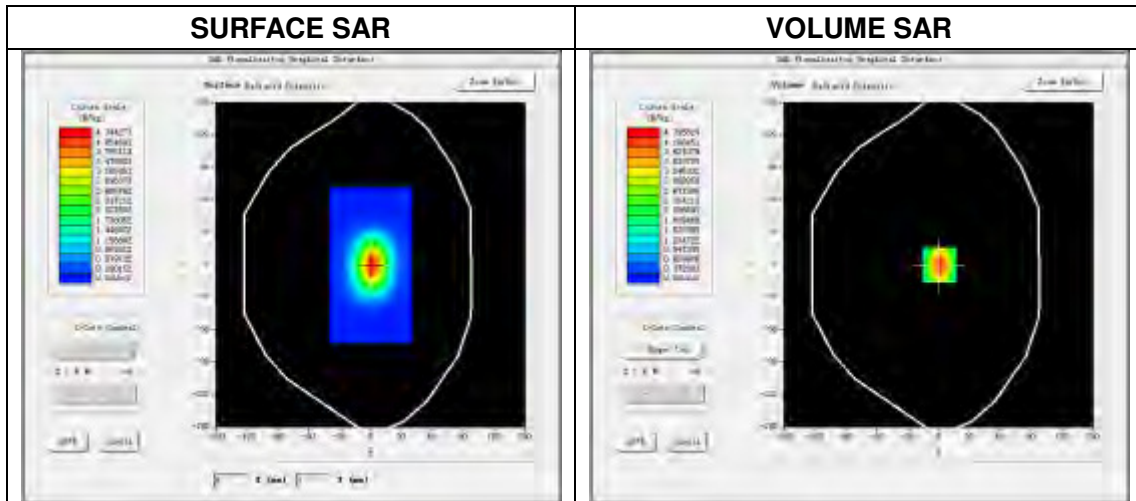

Maximum location: X=0.00, Y=1.00  
 SAR Peak: 6.4 W/kg

SAR 10 g (W/Kg)	2.064125
SAR 1g (W/Kg)	3.892053

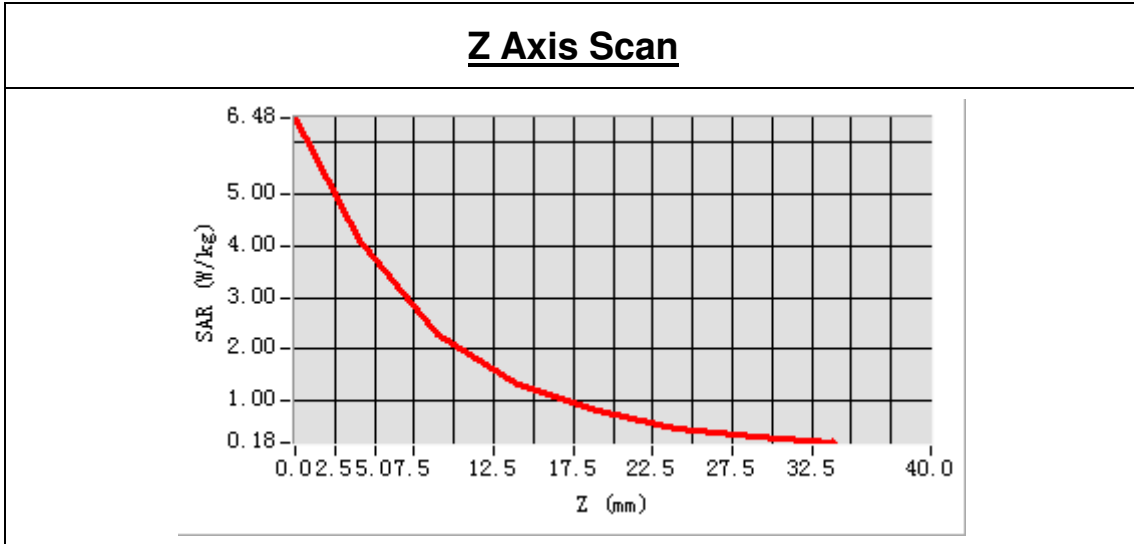

3D screen shot	Hot spot position

# System Performance Check Data(1800MHz Body)

Type: Phone measurement (Complete)  
 E-Field Probe: SN 34/15 SSE2 EPGO265  
 Area scan resolution: dx=8mm,dy=8mm  
 Zoom scan resolution: dx=8mm, dy=8mm, dz=5mm  
 Date of measurement: 2017.03.19  
 Measurement duration: 14 minutes 46 seconds

## Experimental conditions.

<b>Phantom File</b>	surf_sam_plan.txt
<b>Phantom</b>	Validation plane
<b>Band</b>	1800MHz
<b>Signal</b>	CW
<b>Frequency (MHz)</b>	1800.000000
<b>Relative permittivity (real part)</b>	53.562143
<b>Conductivity (S/m)</b>	1.513568
<b>Power drift (%)</b>	0.310000
<b>Ambient Temperature:</b>	22.3C
<b>Liquid Temperature:</b>	20.9C
<b>ConvF:</b>	2.08
<b>Crest factor:</b>	1:1

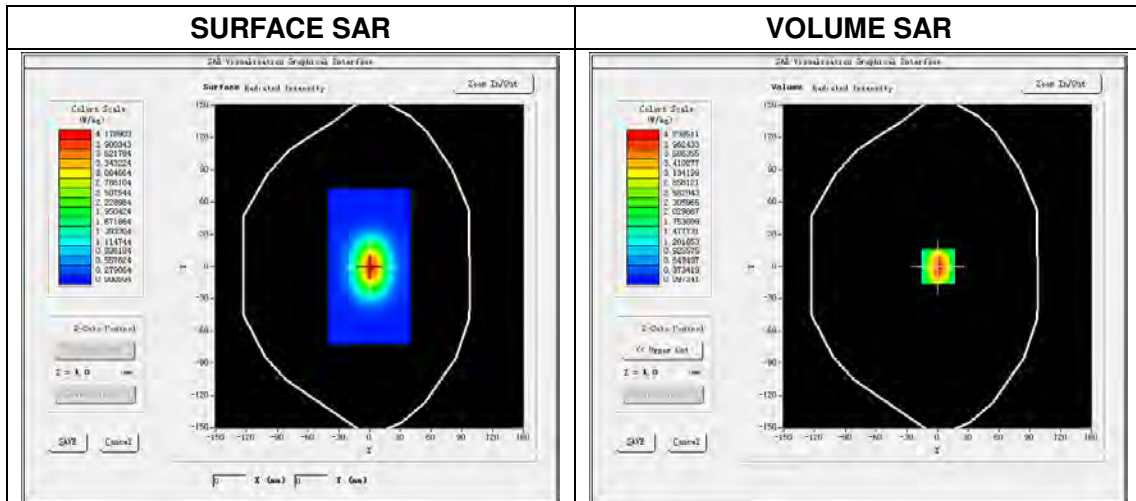

Maximum location: X=2.00, Y=1.00  
 SAR Peak: 6.52 W/kg

SAR 10 g (W/Kg)	2.146460
SAR 1g (W/Kg)	3.993944

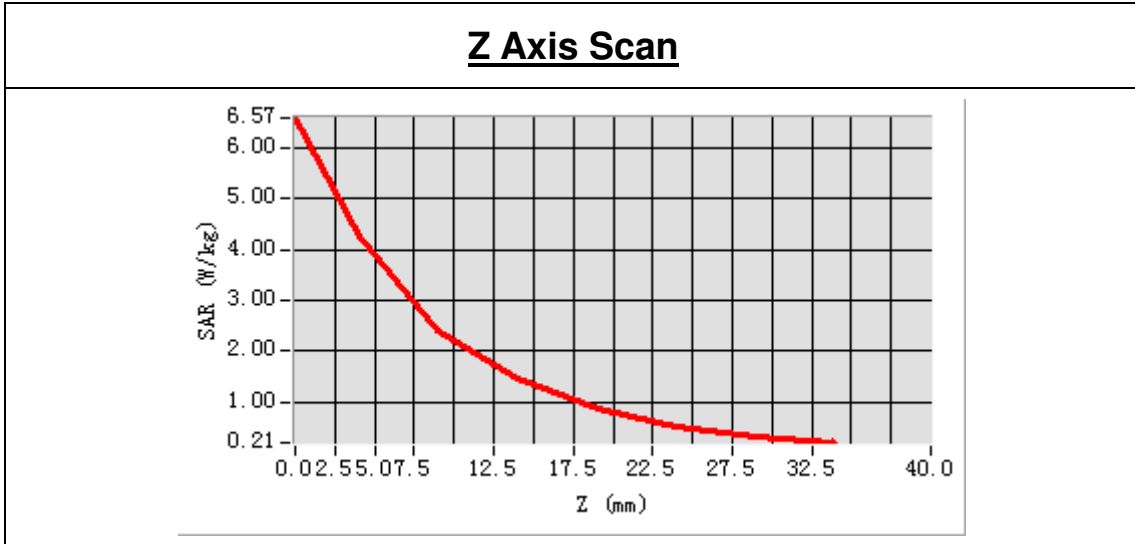

3D screen shot	Hot spot position

# System Performance Check Data(1900MHz Head)

Type: Phone measurement (Complete)  
 E-Field Probe: SN 34/15 SSE2 EPGO265  
 Area scan resolution: dx=8mm,dy=8mm  
 Zoom scan resolution: dx=8mm, dy=8mm, dz=5mm  
 Date of measurement: 2017.03.16  
 Measurement duration: 13 minutes 20 seconds

## Experimental conditions.

<b>Phantom File</b>	surf_sam_plan.txt
<b>Phantom</b>	Validation plane
<b>Band</b>	1900MHz
<b>Signal</b>	CW
<b>Frequency (MHz)</b>	1900.000000
<b>Relative permittivity (real part)</b>	39.802471
<b>Conductivity (S/m)</b>	1.423674
<b>Power drift (%)</b>	1.150000
<b>Ambient Temperature:</b>	21.8C
<b>Liquid Temperature:</b>	20.5C
<b>ConvF:</b>	2.35
<b>Crest factor:</b>	1:1

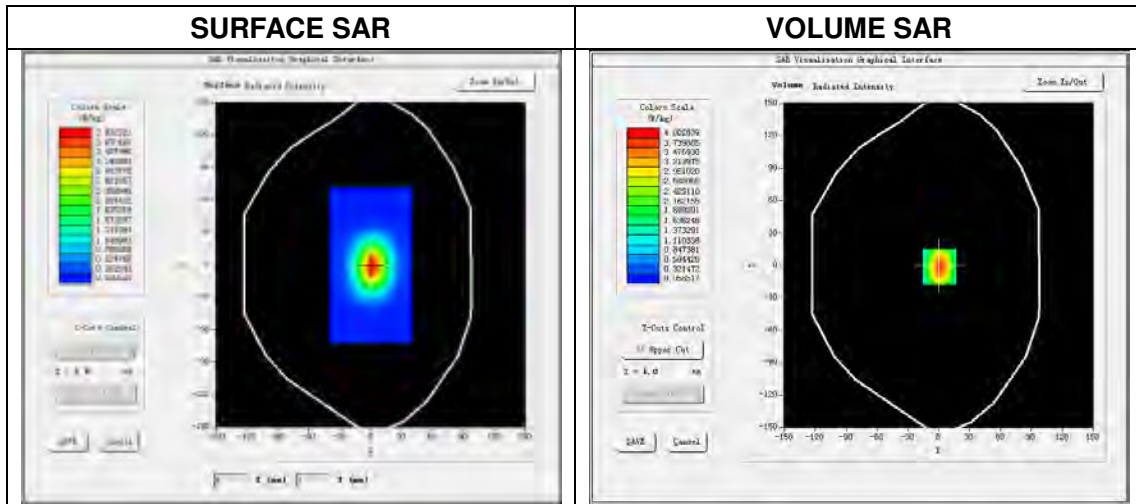

Maximum location: X=1.00, Y=0.00  
 SAR Peak: 6.58W/kg

SAR 10g (W/Kg)	1.974124
SAR 1g (W/Kg)	3.910074

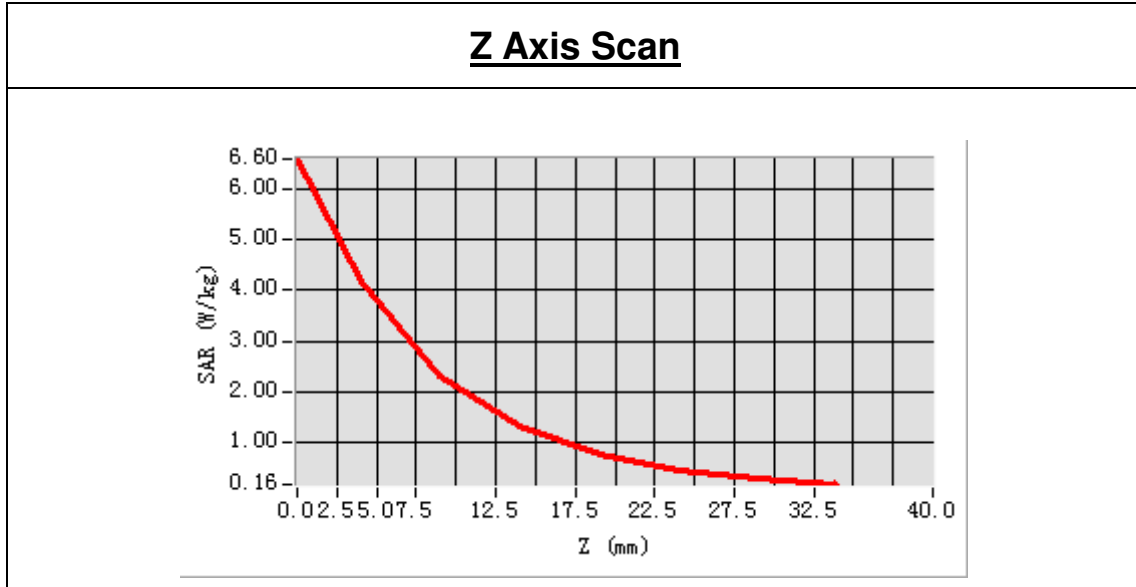

3D screen shot	Hot spot position

# System Performance Check Data(1900MHz Body)

Type: Phone measurement (Complete)  
 E-Field Probe: SN 34/15 SSE2 EPGO265  
 Area scan resolution: dx=8mm,dy=8mm  
 Zoom scan resolution: dx=8mm, dy=8mm, dz=5mm  
 Date of measurement: 2017.03.17  
 Measurement duration: 13 minutes 26 seconds

## Experimental conditions.

<b>Phantom File</b>	surf_sam_plan.txt
<b>Phantom</b>	Validation plane
<b>Band</b>	1900MHz
<b>Signal</b>	CW
<b>Frequency (MHz)</b>	1900.000000
<b>Relative permittivity (real part)</b>	52.763122
<b>Conductivity (S/m)</b>	1.540021
<b>Power drift (%)</b>	0.370000
<b>Ambient Temperature:</b>	22.2C
<b>Liquid Temperature:</b>	20.9C
<b>ConvF:</b>	2.42
<b>Crest factor:</b>	1:1



Maximum location: X=2.00, Y=-2.00  
 SAR Peak: 5.38W/kg

SAR 10g (W/Kg)	2.001651
SAR 1g (W/Kg)	3.943225

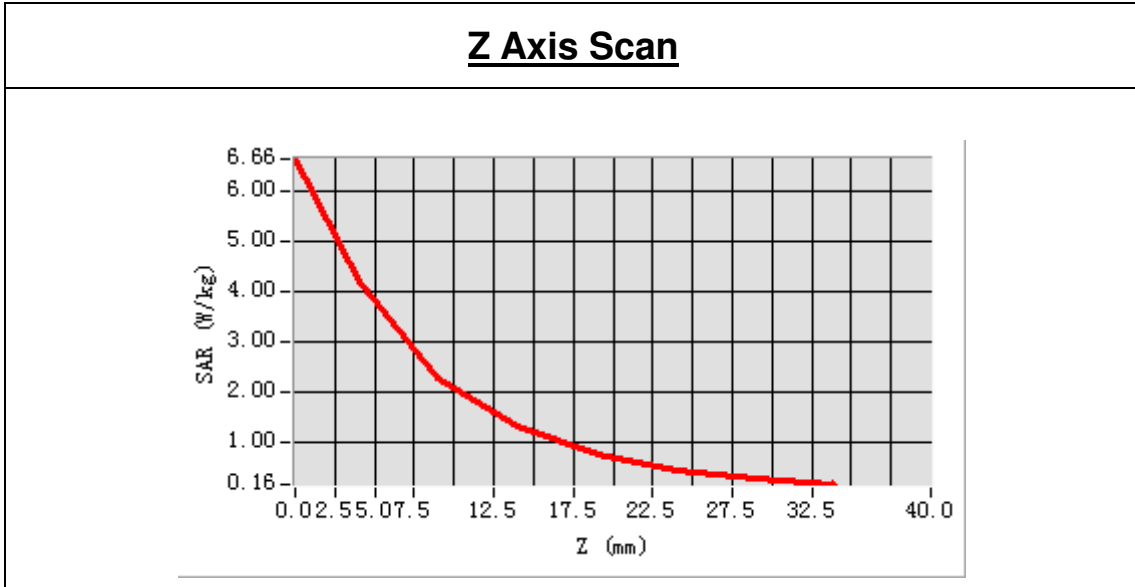

3D screen shot	Hot spot position



# System Performance Check Data(2450MHz Head)

Type: Phone measurement (Complete)  
 E-Field Probe: SN 34/15 SSE2 EPGO265  
 Area scan resolution: dx=8mm,dy=8mm  
 Zoom scan resolution: dx=5mm, dy=5mm, dz=5mm  
 Date of measurement: 2017.03.20  
 Measurement duration: 19 minutes 38 seconds

## Experimental conditions.

<b>Phantom File</b>	surf_sam_plan.txt
<b>Phantom</b>	Validation plane
<b>Band</b>	2450MHz
<b>Signal</b>	CW
<b>Frequency (MHz)</b>	2450.000000
<b>Relative permittivity (real part)</b>	37.970052
<b>Conductivity (S/m)</b>	1.863262
<b>Power drift (%)</b>	-1.200000
<b>Ambient Temperature:</b>	22.3C
<b>Liquid Temperature:</b>	21.5C
<b>ConvF:</b>	2.47
<b>Crest factor:</b>	1:1

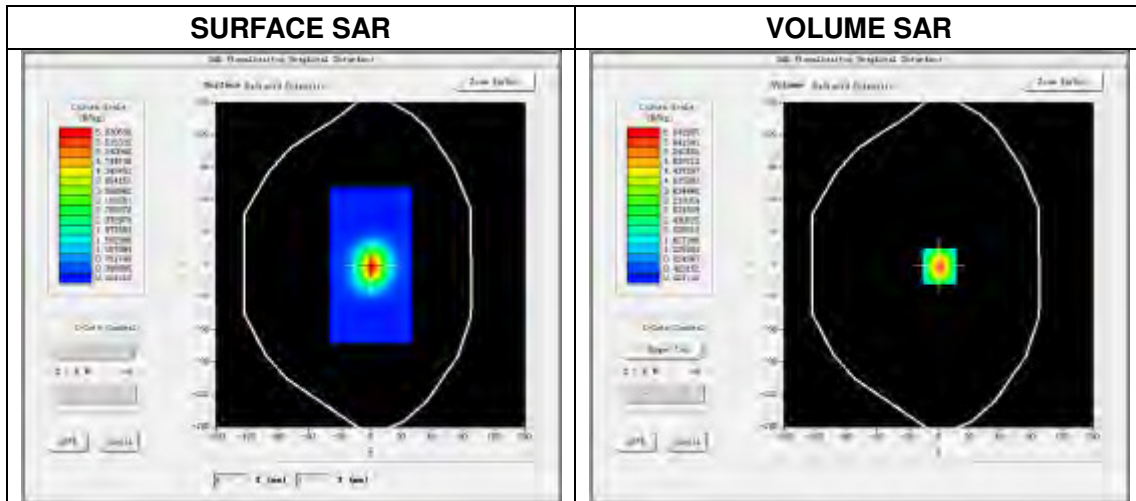

Maximum location: X=1.00, Y=-1.00  
 SAR Peak: 9.56W/kg

SAR 10g (W/Kg)	2.397836
SAR 1g (W/Kg)	5.356203

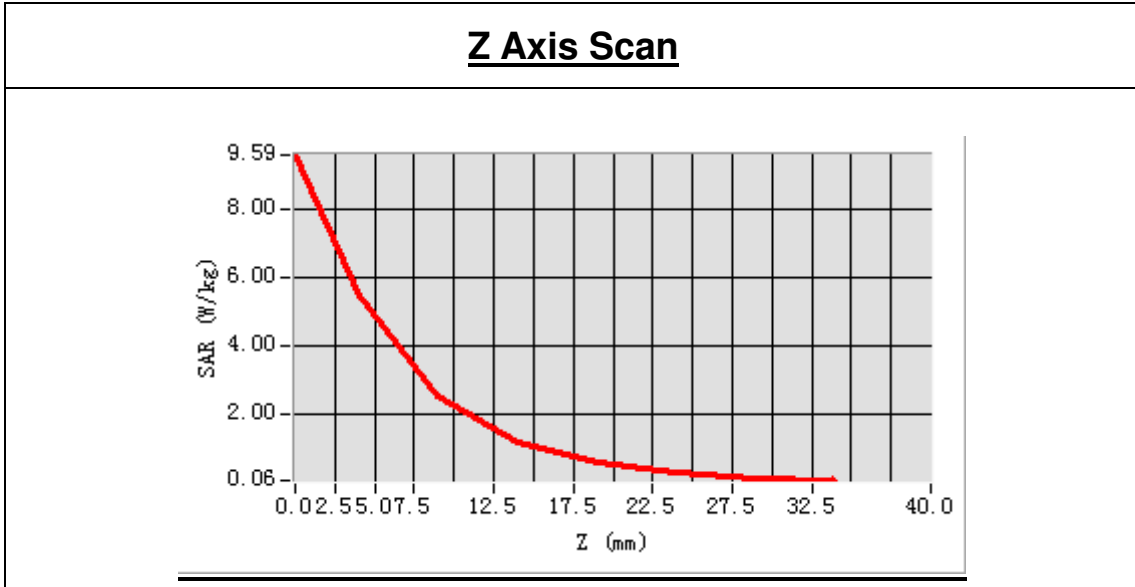

3D screen shot	Hot spot position

# System Performance Check Data(2450MHz Body)

Type: Phone measurement (Complete)  
 E-Field Probe: SN 34/15 SSE2 EPGO265  
 Area scan resolution: dx=8mm,dy=8mm  
 Zoom scan resolution: dx=5mm, dy=5mm, dz=5mm  
 Date of measurement: 2017.03.21  
 Measurement duration: 18 minutes 46 seconds

## Experimental conditions.

<b>Phantom File</b>	surf_sam_plan.txt
<b>Phantom</b>	Validation plane
<b>Band</b>	2450MHz
<b>Signal</b>	CW
<b>Frequency (MHz)</b>	2450.000000
<b>Relative permittivity (real part)</b>	52.609845
<b>Conductivity (S/m)</b>	1.954598
<b>Power drift (%)</b>	0.200000
<b>Ambient Temperature:</b>	22.0C
<b>Liquid Temperature:</b>	21.1C
<b>ConvF:</b>	2.55
<b>Crest factor:</b>	1:1

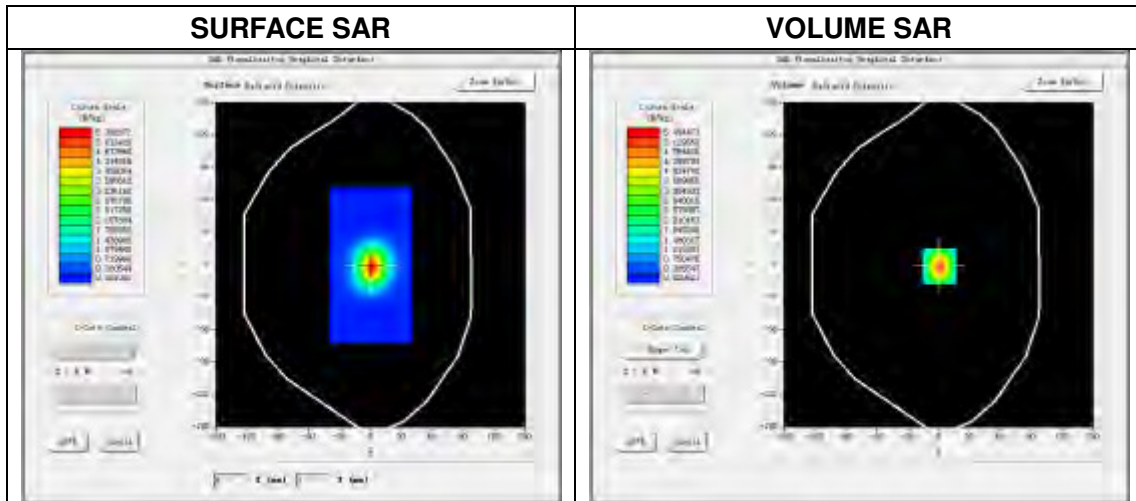

Maximum location: X=1.00, Y=-1.00  
 SAR Peak: 9.68W/kg

SAR 10g (W/Kg)	2.302133
SAR 1g (W/Kg)	5.462953

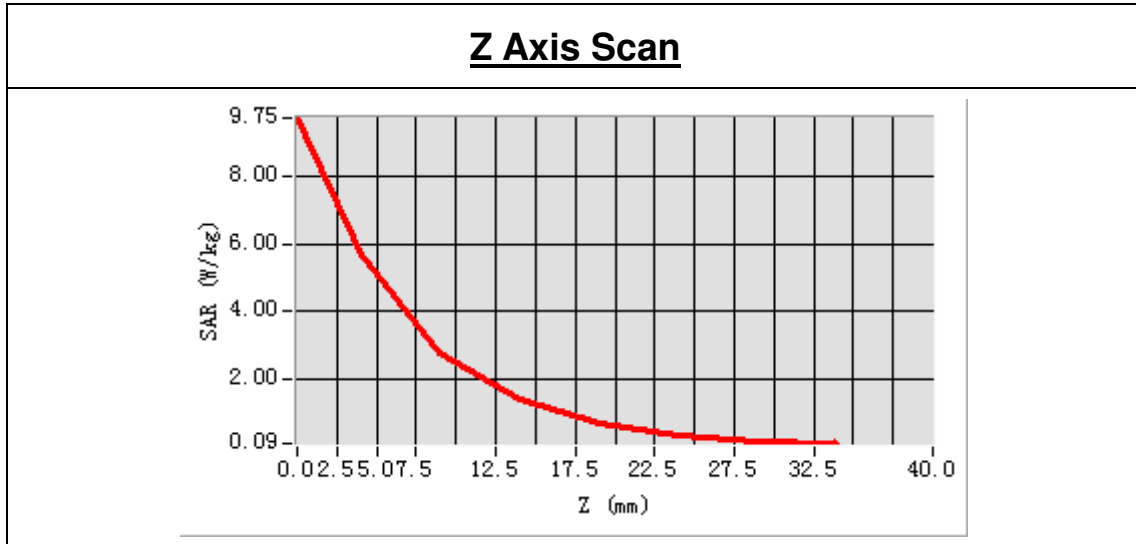

3D screen shot	Hot spot position

# System Performance Check Data(2600 MHz Head)

Type: Phone measurement (Complete)  
 E-Field Probe: SN 34/15 SSE2 EPGO265  
 Area scan resolution: dx=8mm,dy=8mm  
 Zoom scan resolution: dx=5mm, dy=5mm, dz=5mm  
 Date of measurement: 2017.03.24  
 Measurement duration: 19 minutes 20 seconds

## Experimental conditions.

<b>Phantom File</b>	surf_sam_plan.txt
<b>Phantom</b>	Validation plane
<b>Band</b>	2600MHz
<b>Signal</b>	CW
<b>Frequency (MHz)</b>	2600.000000
<b>Relative permittivity (real part)</b>	38.171972
<b>Conductivity (S/m)</b>	1.970794
<b>Power drift (%)</b>	0.250000
<b>Ambient Temperature:</b>	22.0C
<b>Liquid Temperature:</b>	20.8C
<b>ConvF:</b>	2.36
<b>Crest factor:</b>	1:1

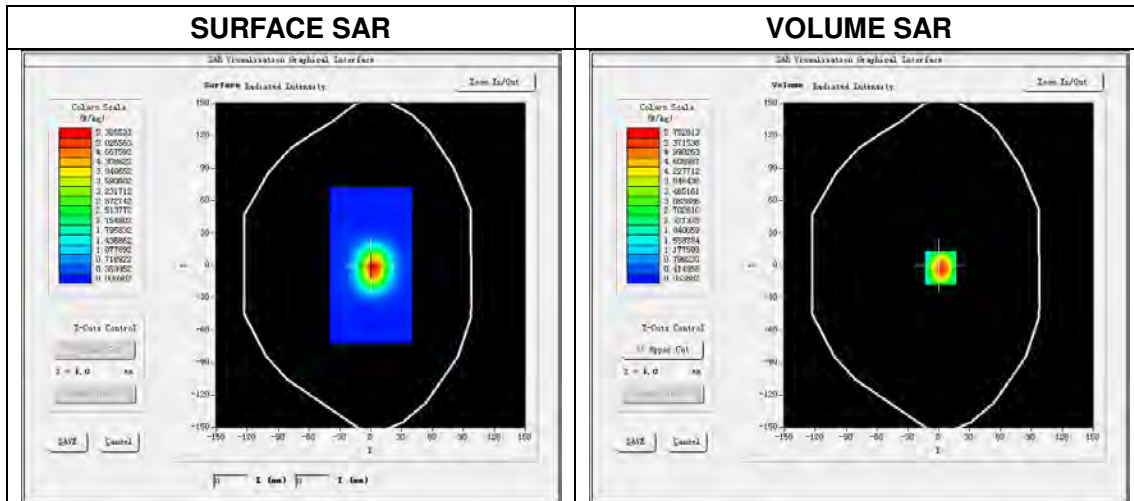

Maximum location: X=2.00, Y=-2.00  
 SAR Peak: 9.63W/kg

SAR 10g (W/Kg)	2.481438
SAR 1g (W/Kg)	5.360173

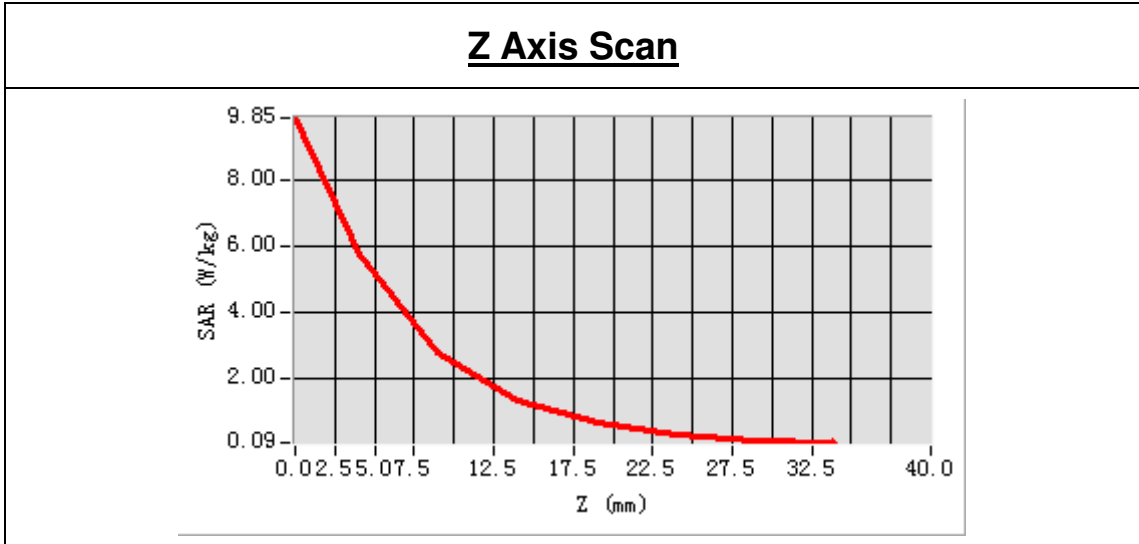

3D screen shot	Hot spot position

# System Performance Check Data(2600MHz Body)

Type: Phone measurement (Complete)  
 E-Field Probe: SN 34/15 SSE2 EPGO265  
 Area scan resolution: dx=8mm,dy=8mm  
 Zoom scan resolution: dx=5mm, dy=5mm, dz=5mm  
 Date of measurement: 2017.03.27  
 Measurement duration: 19 minutes 36 seconds

## Experimental conditions.

Phantom File	surf_sam_plan.txt
Phantom	Validation plane
Band	2600MHz
Signal	CW
Frequency (MHz)	2600.000000
Relative permittivity (real part)	50.480214
Conductivity (S/m)	2.133247
Power drift (%)	-0.210000
Ambient Temperature:	22.3C
Liquid Temperature:	21.0C
ConvF:	2.43
Crest factor:	1:1

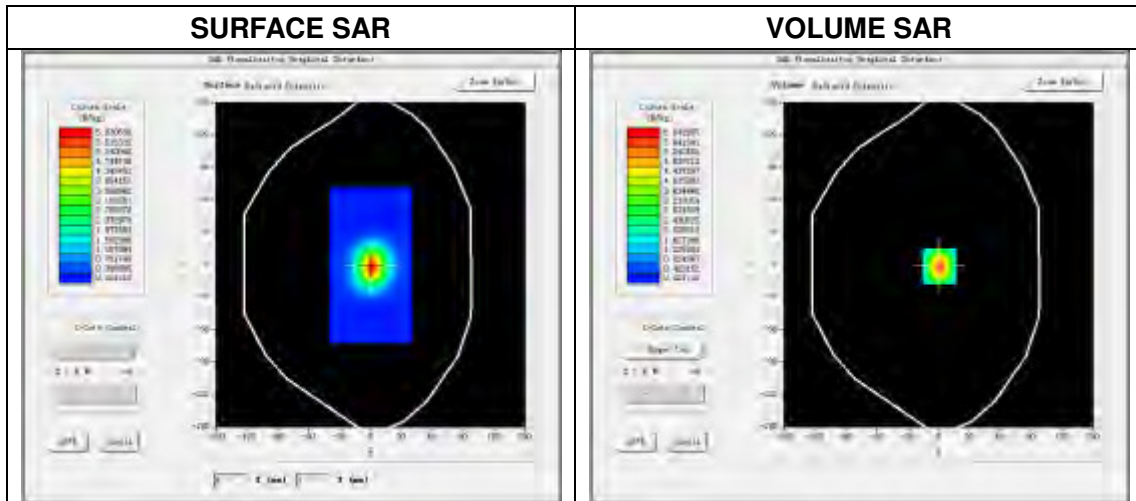

Maximum location: X=1.00, Y=-1.00  
 SAR Peak: 9.54W/kg

SAR 10g (W/Kg)	2.392436
SAR 1g (W/Kg)	5.787018

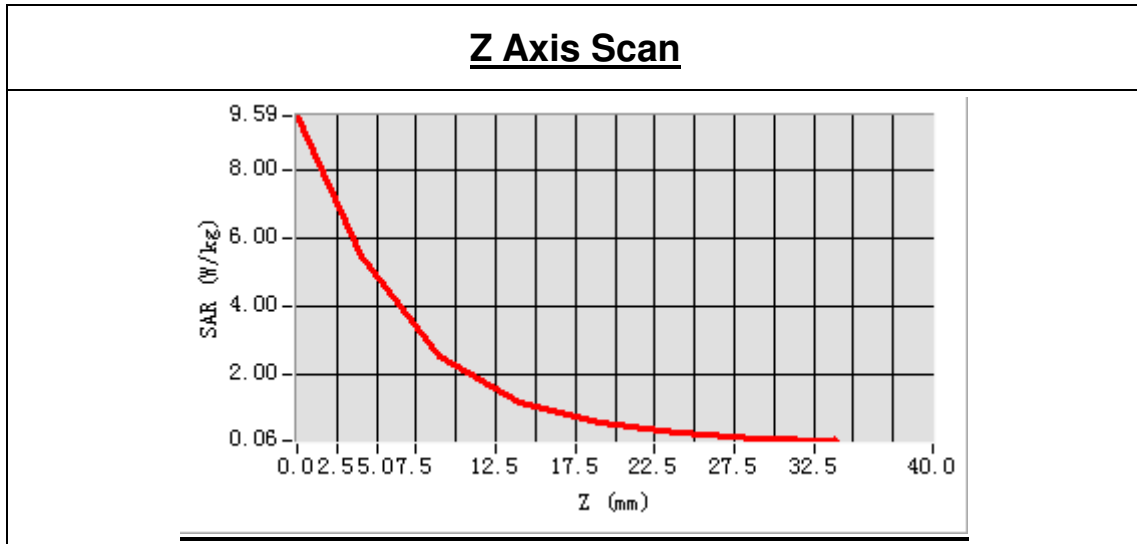

3D screen shot	Hot spot position



## ANNEX C TEST DATA

### MEAS. 1 Left Head with Cheek on High Channel in GSM 850 mode

**Test Date:** 14/3/2017  
**Measurement duration:** 11 minutes 3 seconds  
**Signal:** GSM, f=848.8 MHz, Duty Cycle: 1:8.3  
**Liquid Parameters:** Permittivity: 41.61; Conductivity: 0.91 S/m  
**Test condition:** Ambient Temperature: 21.9°C, Liquid Temperature: 20.8°C  
**Probe:** SN 34/15 SSE2 EPGO265, ConvF: 2.04  
**Area Scan:** sam\_direct\_droit2\_surf10mm.txt, h= 5.00 mm  
**Zoom Scan:** 5x5x7,dx=8mm, dy=8mm, dz=5mm,Complete  
**Maximum location:** X=-46.000000, Y=-36.000000  
**SAR 10g (W/Kg):** 0.256282  
**SAR 1g (W/Kg):** 0.345816  
**Power drift (%):** 1.14  
**3D screen shot**

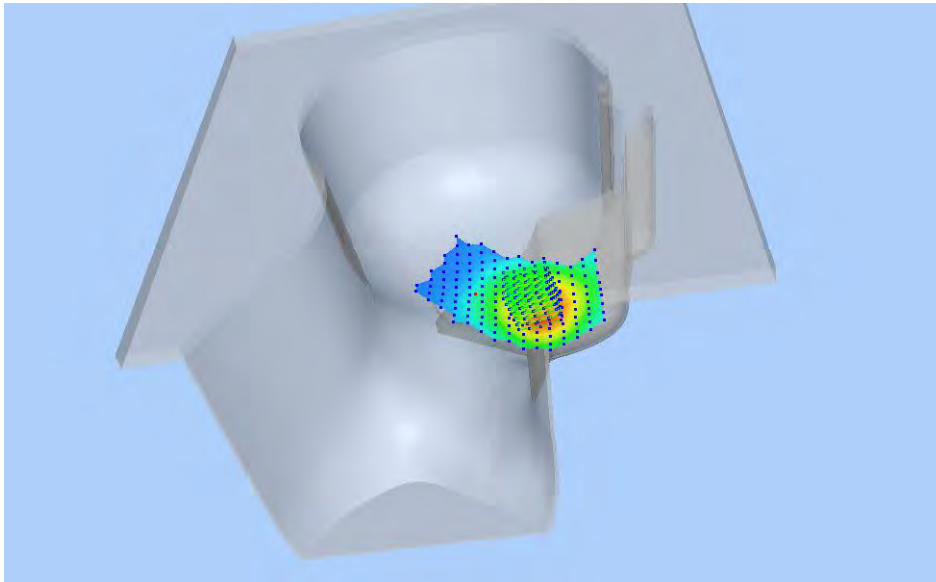

#### Z Axis Scan

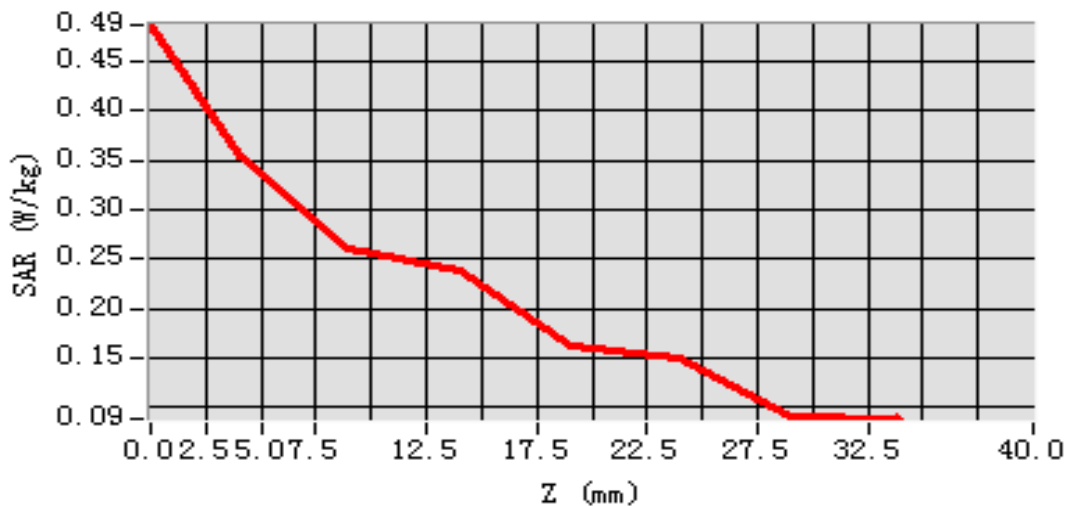

## MEAS. 2 Body Plane with Back Side 15mm on High Channel in GSM 850 mode

**Test Date:** 15/3/2017  
**Measurement duration:** 11 minutes 44 seconds  
**Signal:** GSM, f=848.8 MHz, Duty Cycle: 1:8.3  
**Liquid Parameters:** Permittivity: 55.38; Conductivity: 1.01 S/m  
**Test condition:** Ambient Temperature: 22.7°C, Liquid Temperature: 21.5°C  
**Probe:** SN 34/15 SSE2 EPGO265, ConvF: 2.12  
**Area Scan:** sam\_direct\_droit2\_surf10mm.txt, h= 5.00 mm  
**Zoom Scan:** 5x5x7,dx=8mm, dy=8mm, dz=5mm,Complete  
**Maximum location:** X=8.000000, Y=12.000000  
**SAR 10g (W/Kg):** 0.345990  
**SAR 1g (W/Kg):** 0.472175  
**Power drift (%):** 0.09  
**3D screen shot**

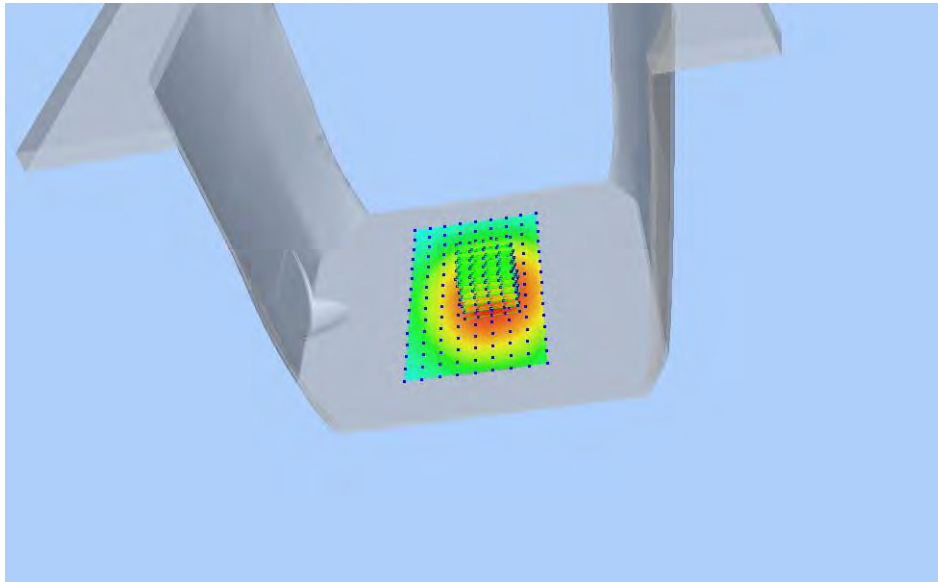

### Z Axis Scan

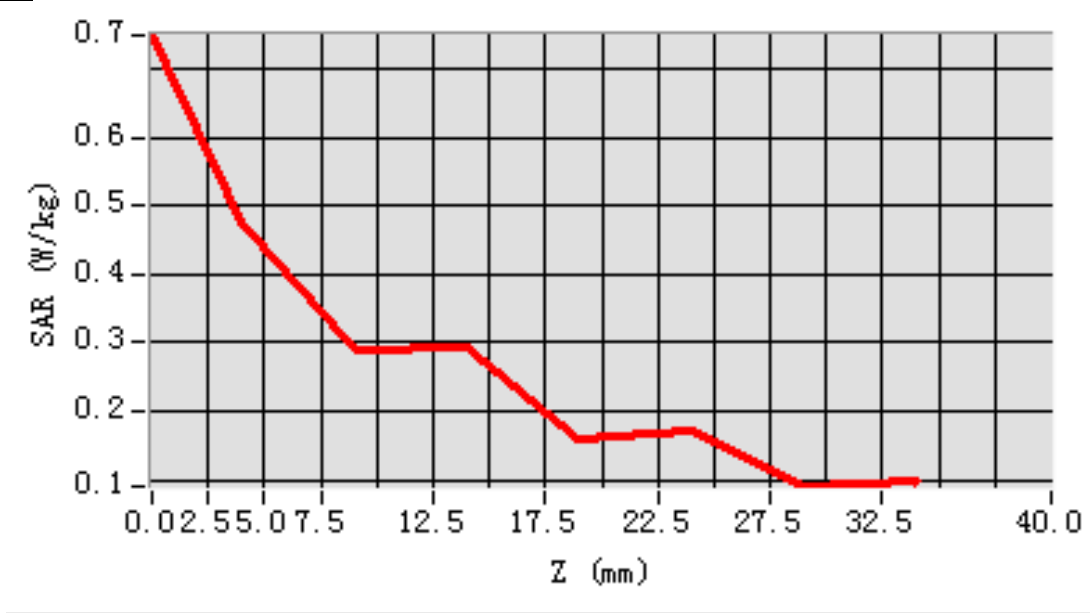

## MEAS. 3 Body Plane with Back Side 10mm on Middle Channel in GPRS 850

### mode

**Test Date:** 15/3/2017  
**Measurement duration:** 11 minutes 50 seconds  
**Signal:** GPRS, f=836.6 MHz, Duty Cycle: 1:2.7  
**Liquid Parameters:** Permittivity: 56.54; Conductivity: 1.00 S/m  
**Test condition:** Ambient Temperature: 22.7°C, Liquid Temperature: 21.5°C  
**Probe:** SN 34/15 SSE2 EPGO265, ConvF: 2.12  
**Area Scan:** sam\_direct\_droit2\_surf10mm.txt, h= 5.00 mm  
**Zoom Scan:** 5x5x7,dx=8mm, dy=8mm, dz=5mm,Complete  
**Maximum location:** X=0.000000, Y=-2.000000  
**SAR 10g (W/Kg):** 0.434745  
**SAR 1g (W/Kg):** 0.596297  
**Power drift (%):** -1.85  
**3D screen shot**

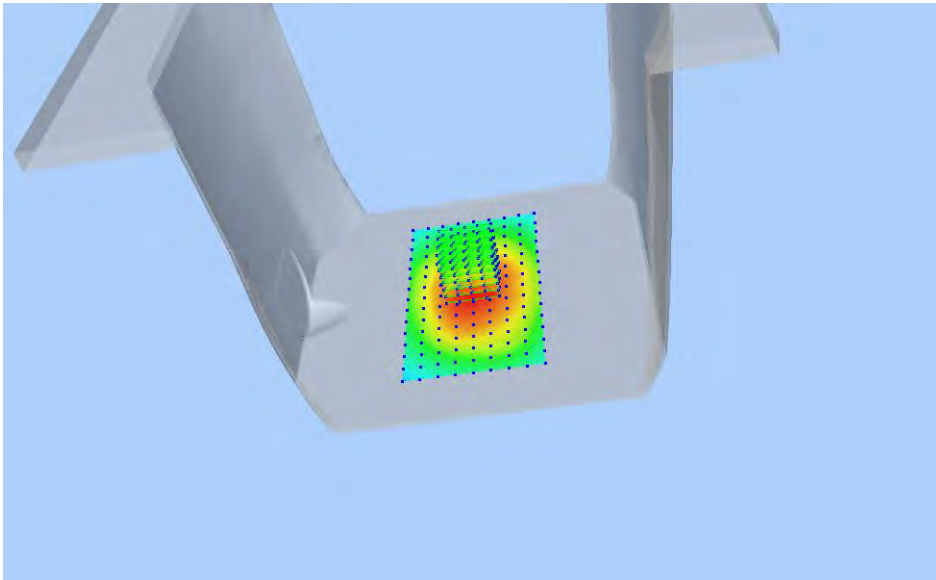

### Z Axis Scan

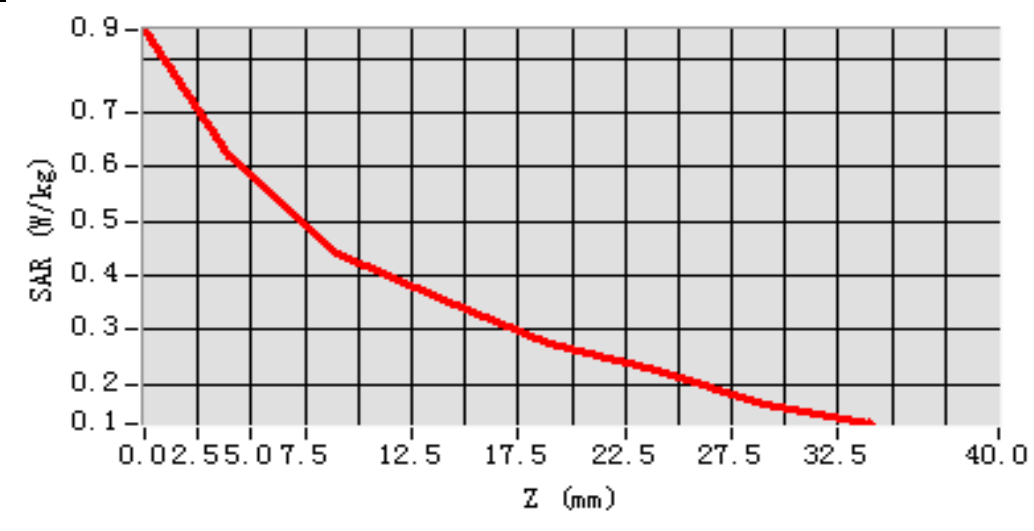

## MEAS. 4 Left Head with Cheek on Low Channel in GSM 1900 mode

**Test Date:** 16/3/2017  
**Measurement duration:** 12 minutes 6 seconds  
**Signal:** GSM, f=1850.2 MHz, Duty Cycle: 1:8.3  
**Liquid Parameters:** Permittivity: 40.05; Conductivity: 1.40 S/m  
**Test condition:** Ambient Temperature: 21.8°C, Liquid Temperature: 20.5°C  
**Probe:** SN 34/15 SSE2 EPGO265, ConvF: 2.35  
**Area Scan:** sam\_direct\_droit2\_surf10mm.txt, h= 5.00 mm  
**Zoom Scan:** 5x5x7,dx=8mm, dy=8mm, dz=5mm,Complete  
**Maximum location:** X=-56.000000, Y=-56.000000  
**SAR 10g (W/Kg):** 0.107835  
**SAR 1g (W/Kg):** 0.187276  
**Power drift (%):** -4.02  
**3D screen shot**

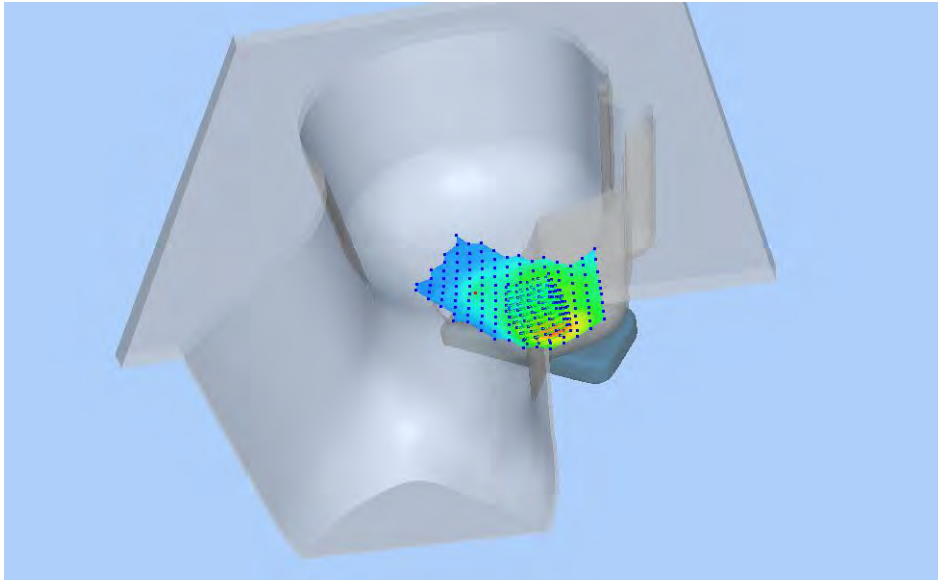

### Z Axis Scan

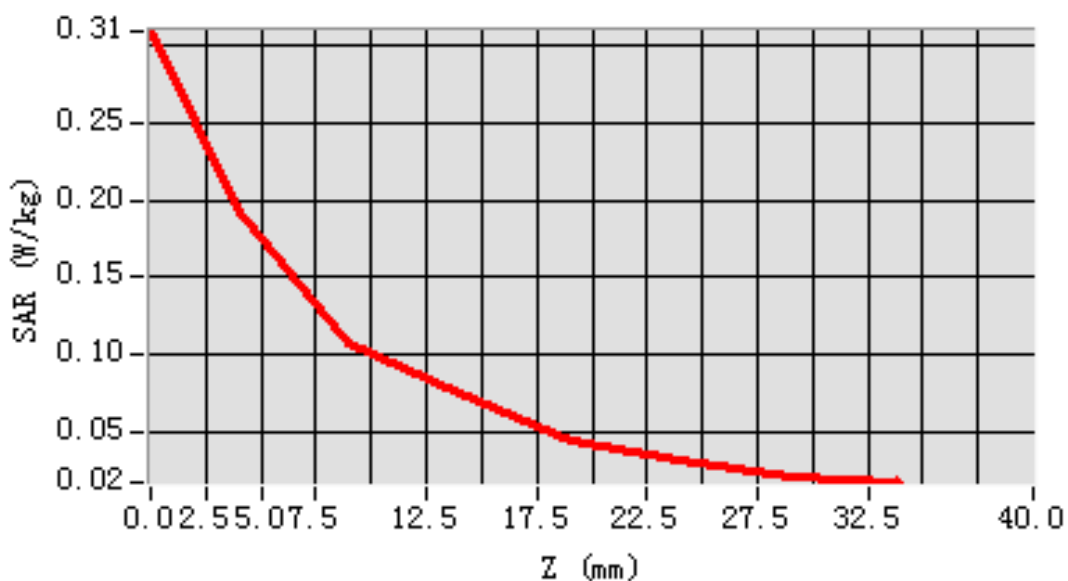

## MEAS. 5 Body Plane with Front Side 15mm on Low Channel in GSM 1900

### mode

**Test Date:** 17/3/2017  
**Measurement duration:** 13 minutes 21 seconds  
**Signal:** GSM, f=1850.2 MHz, Duty Cycle: 1:8.3  
**Liquid Parameters:** Permittivity: 54.47; Conductivity: 1.47 S/m  
**Test condition:** Ambient Temperature: 22.2°C, Liquid Temperature: 20.9°C  
**Probe:** SN 34/15 SSE2 EPGO265, ConvF: 2.42  
**Area Scan:** sam\_direct\_droit2\_surf10mm.txt, h= 5.00 mm  
**Zoom Scan:** 5x5x7,dx=8mm, dy=8mm, dz=5mm,Complete  
**Maximum location:** X=10.000000, Y=8.000000  
**SAR 10g (W/Kg):** 0.141182  
**SAR 1g (W/Kg):** 0.245847  
**Power drift (%):** -0.92  
**3D screen shot**

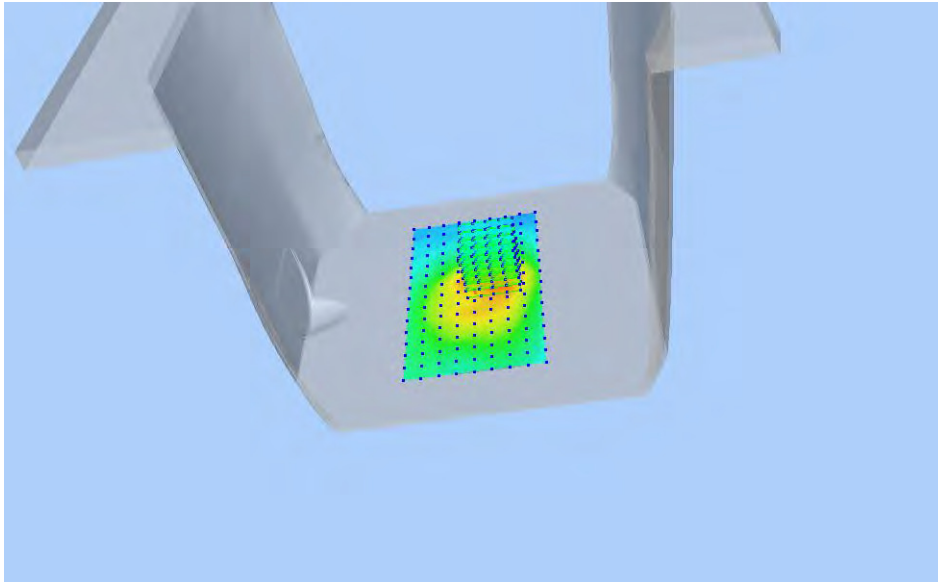

### Z Axis Scan

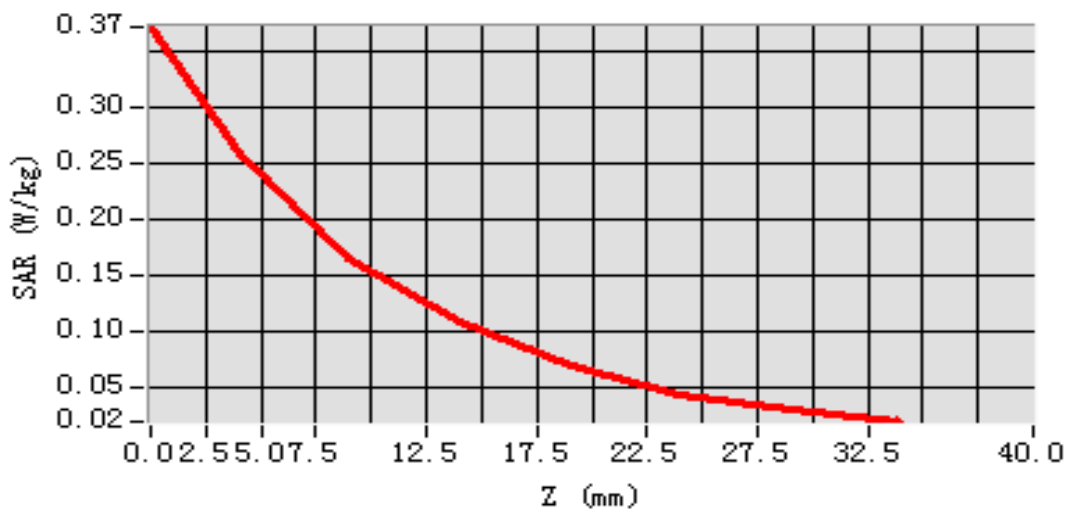

## MEAS. 6 Body Plane with Bottom Edge 10mm on Middle Channel in GPRS

### 1900 mode

**Test Date:** 17/3/2017  
**Measurement duration:** 12 minutes 57 seconds  
**Signal:** GPRS, f=1880.0 MHz, Duty Cycle: 1:2.0  
**Liquid Parameters:** Permittivity: 53.69; Conductivity:1.50 S/m  
**Test condition:** Ambient Temperature: 22.2°C, Liquid Temperature: 20.9°C  
**Probe:** SN 34/15 SSE2 EPGO265, ConvF: 2.42  
**Area Scan:** sam\_direct\_droit2\_surf10mm.txt, h= 5.00 mm  
**Zoom Scan:** 5x5x7,dx=8mm, dy=8mm, dz=5mm,Complete  
**Maximum location:** X=10.000000, Y=-12.000000  
**SAR 10g (W/Kg):** 0.509388  
**SAR 1g (W/Kg):** 0.971640  
**Power drift (%):** -0.40  
**3D screen shot**

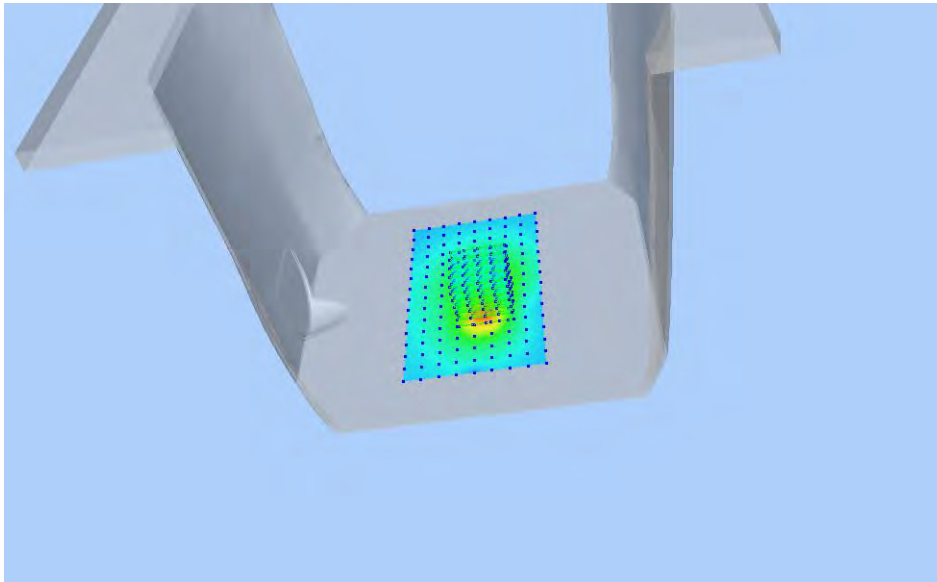

### Z Axis Scan

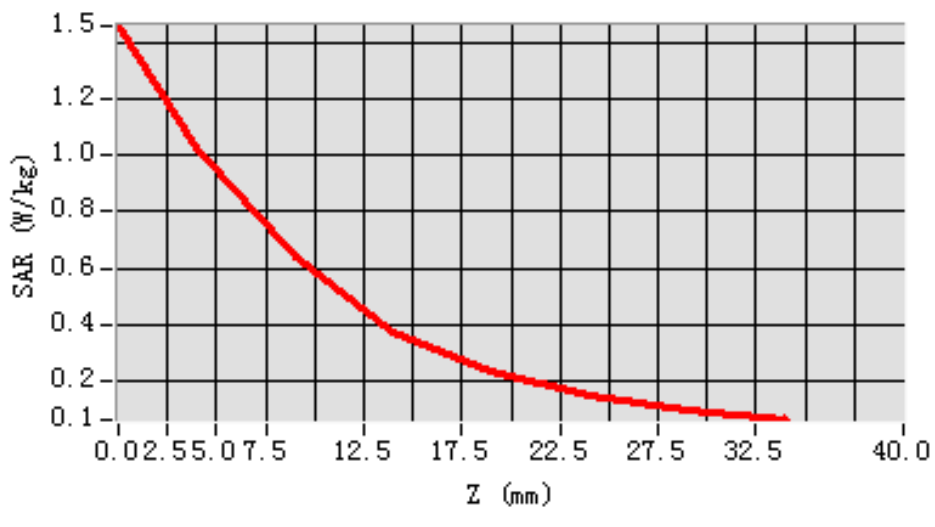

## MEAS. 7 Left Head with Cheek on High Channel in WCDMA Band 2 mode

**Test Date:** 16/3/2017  
**Measurement duration:** 12 minutes 13 seconds  
**Signal:** WCDMA, f=1907.6 MHz, Duty Cycle: 1:1.0  
**Liquid Parameters:** Permittivity: 39.79; Conductivity: 1.43 S/m  
**Test condition:** Ambient Temperature: 21.8°C, Liquid Temperature: 20.5°C  
**Probe:** SN 34/15 SSE2 EPGO265, ConvF: 2.35  
**Area Scan:** sam\_direct\_droit2\_surf10mm.txt, h= 5.00 mm  
**Zoom Scan:** 5x5x7,dx=8mm, dy=8mm, dz=5mm,Complete  
**Maximum location:** X=-56.000000, Y=-56.000000  
**SAR 10g (W/Kg):** 0.137499  
**SAR 1g (W/Kg):** 0.230242  
**Power drift (%):** -3.75  
**3D screen shot**

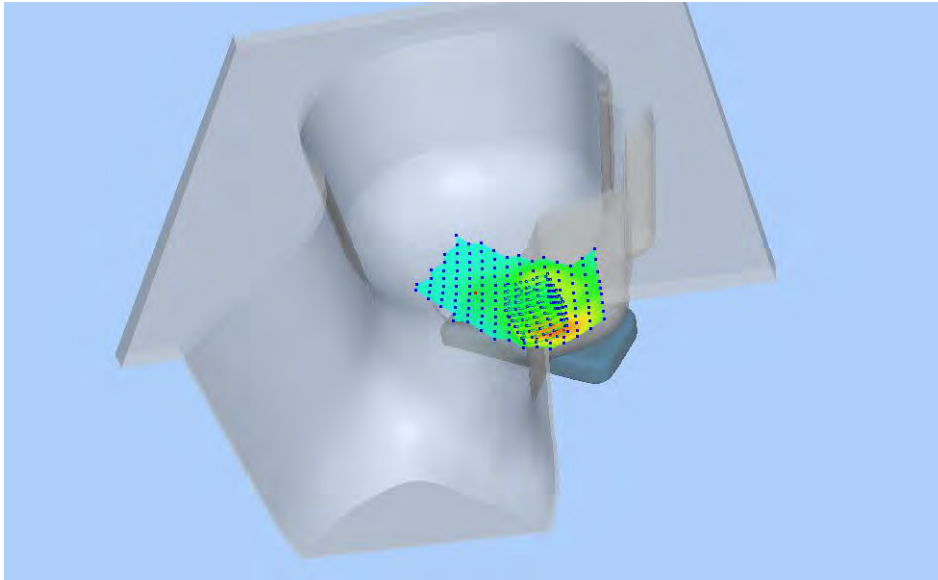

### Z Axis Scan

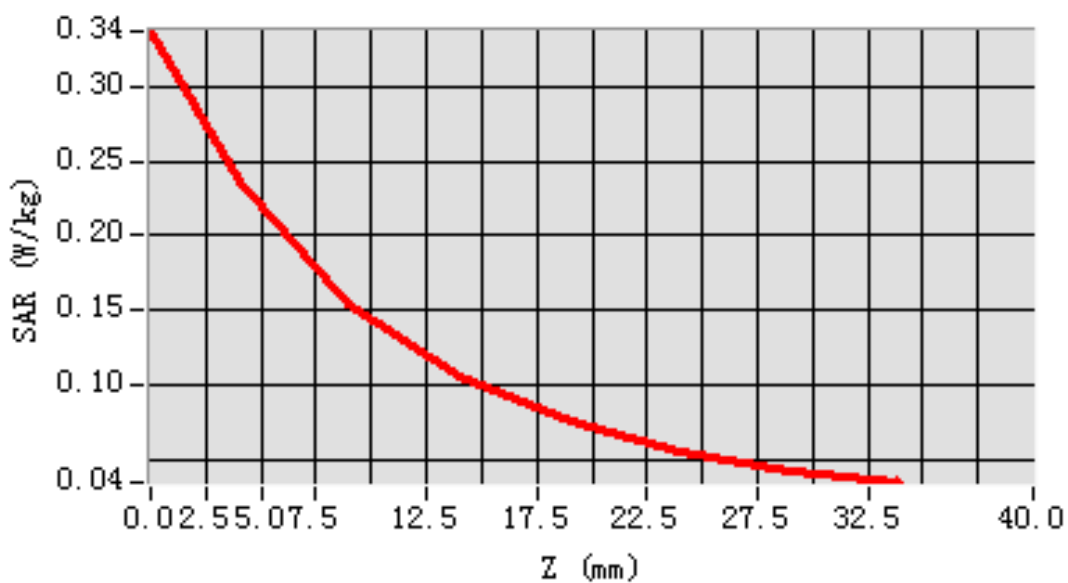

## MEAS. 8 Body Plane with Front Side 15mm on High Channel in WCDMA Band

### 2 mode

**Test Date:** 17/3/2017  
**Measurement duration:** 12 minutes 59 seconds  
**Signal:** WCDMA, f=1907.6 MHz, Duty Cycle: 1:1.0  
**Liquid Parameters:** Permittivity: 51.49; Conductivity: 1.56 S/m  
**Test condition:** Ambient Temperature: 22.2°C, Liquid Temperature: 20.9°C  
**Probe:** SN 34/15 SSE2 EPGO265, ConvF: 2.42  
**Area Scan:** sam\_direct\_droit2\_surf10mm.txt, h= 5.00 mm  
**Zoom Scan:** 5x5x7,dx=8mm, dy=8mm, dz=5mm,Complete  
**Maximum location:** X=20.000000, Y=8.000000  
**SAR 10g (W/Kg):** 0.203292  
**SAR 1g (W/Kg):** 0.342053  
**Power drift (%):** 1.14  
**3D screen shot**

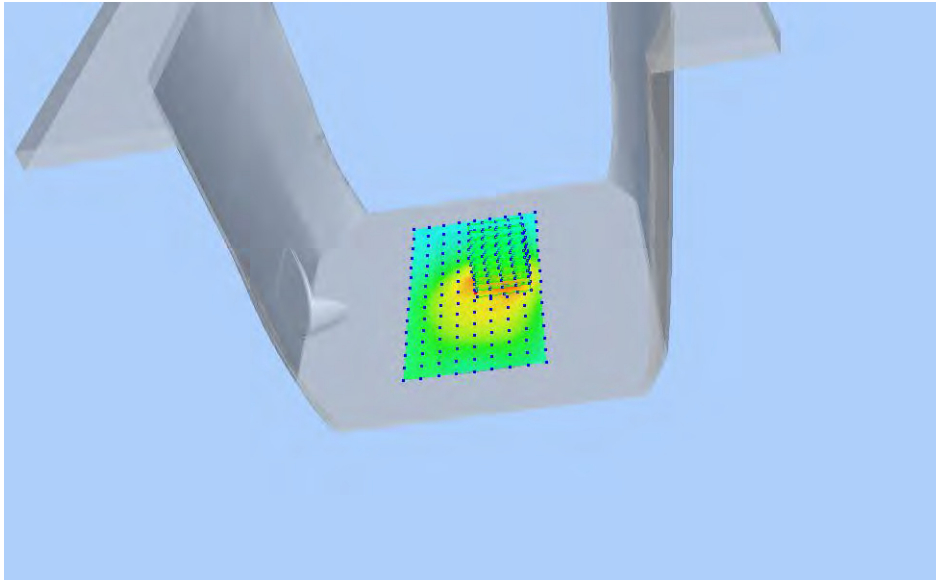

### Z Axis Scan

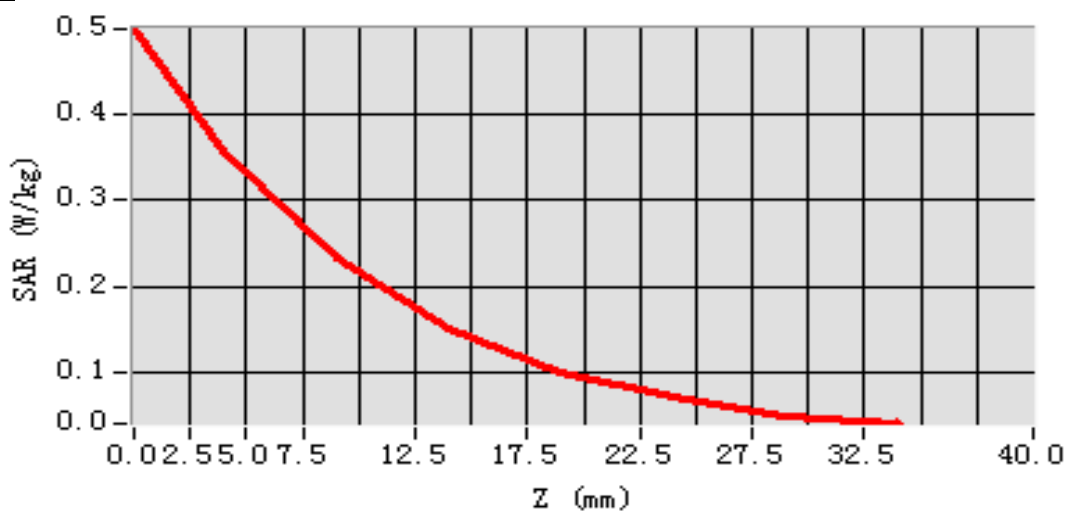



## MEAS. 9 Body Plane with Bottom Edge 10mm on High Channel in WCDMA

### Band 2 mode

**Test Date:** 17/3/2017  
**Measurement duration:** 12 minutes 50 seconds  
**Signal:** WCDMA, f=1907.6 MHz, Duty Cycle: 1:1.0  
**Liquid Parameters:** Permittivity: 51.49; Conductivity: 1.56 S/m  
**Test condition:** Ambient Temperature: 22.2°C, Liquid Temperature: 20.9°C  
**Probe:** SN 34/15 SSE2 EPGO265, ConvF: 2.42  
**Area Scan:** sam\_direct\_droit2\_surf10mm.txt, h= 5.00 mm  
**Zoom Scan:** 5x5x7,dx=8mm, dy=8mm, dz=5mm,Complete  
**Maximum location:** X=10.000000, Y=-22.000000  
**SAR 10g (W/Kg):** 0.347535  
**SAR 1g (W/Kg):** 0.652929  
**Power drift (%):** 1.19  
**3D screen shot**

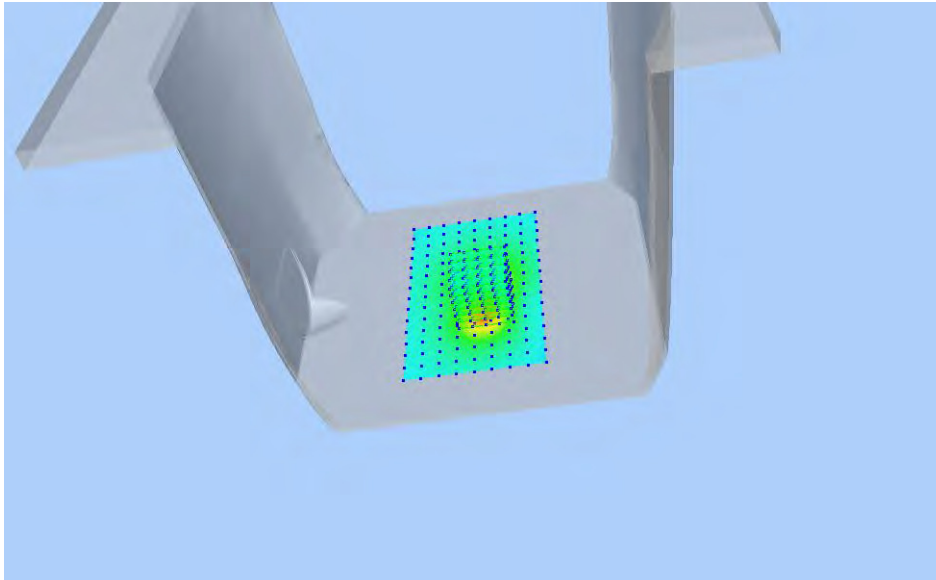

### Z Axis Scan

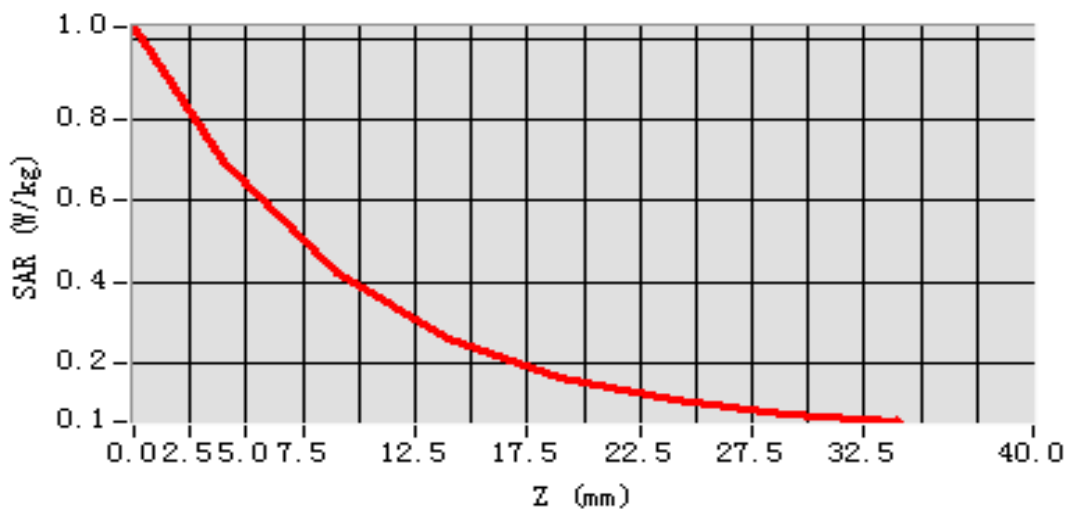

## MEAS. 10 Left Head with Cheek on Middle Channel in WCDMA Band 4 mode

**Test Date:** 18/3/2017  
**Measurement duration:** 12 minutes 16 seconds  
**Signal:** WCDMA, f=1732.4 MHz, Duty Cycle: 1:1.0  
**Liquid Parameters:** Permittivity: 41.43; Conductivity: 1.35 S/m  
**Test condition:** Ambient Temperature: 22.6°C, Liquid Temperature: 21.3°C  
**Probe:** SN 34/15 SSE2 EPGO265, ConvF: 2.04  
**Area Scan:** sam\_direct\_droit2\_surf10mm.txt, h= 5.00 mm  
**Zoom Scan:** 5x5x7,dx=8mm, dy=8mm, dz=5mm,Complete  
**Maximum location:** X=-56.000000, Y=-56.000000  
**SAR 10g (W/Kg):** 0.205507  
**SAR 1g (W/Kg):** 0.330376  
**Power drift (%):** -1.45  
**3D screen shot**

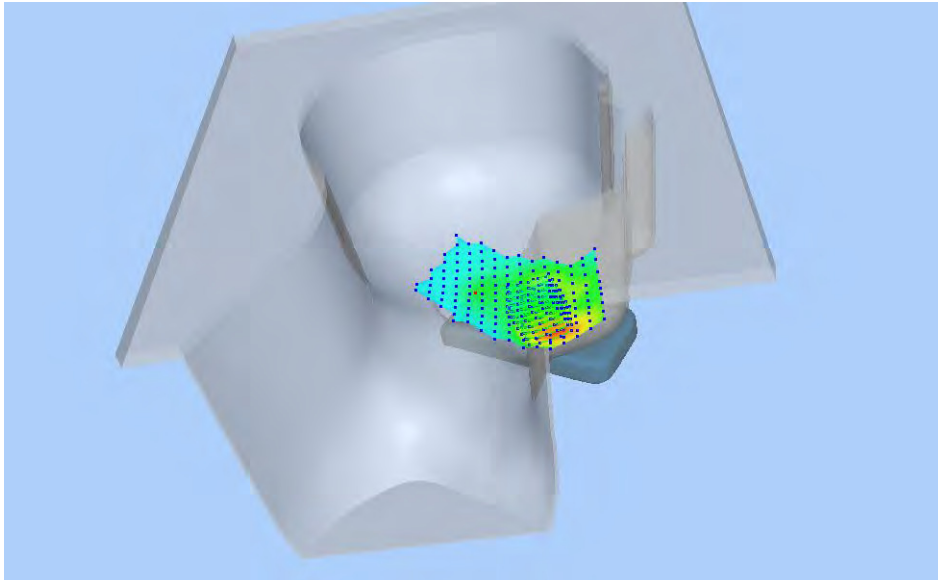

### Z Axis Scan

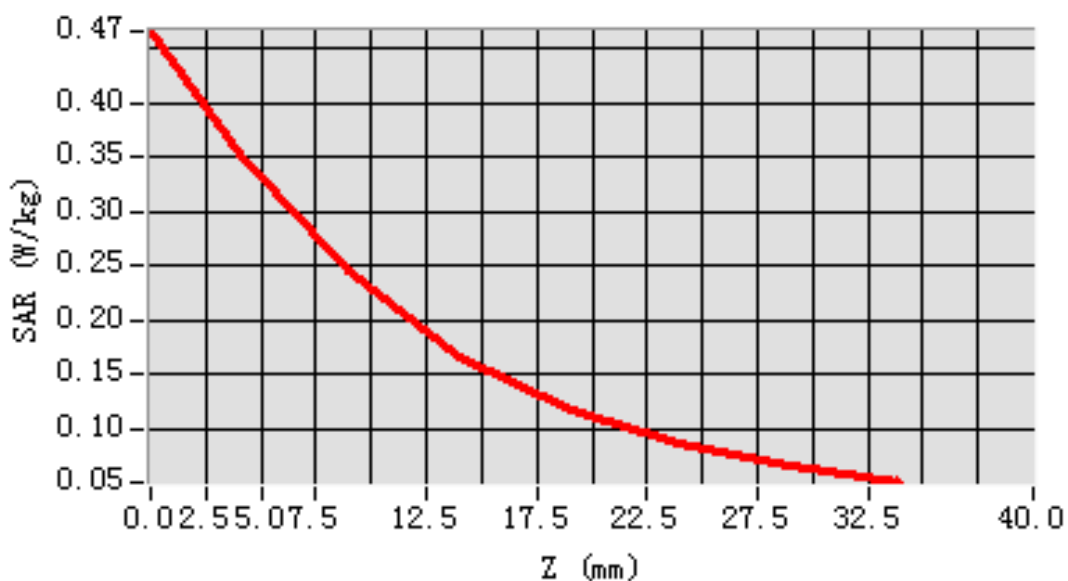

## MEAS. 11 Body Plane with Front Side 15mm on Middle Channel in WCDMA

### Band 4 mode

**Test Date:** 19/3/2017  
**Measurement duration:** 13 minutes 17 seconds  
**Signal:** WCDMA, f=1732.4 MHz, Duty Cycle: 1:1.0  
**Liquid Parameters:** Permittivity: 53.89; Conductivity: 1.49 S/m  
**Test condition:** Ambient Temperature: 22.3°C, Liquid Temperature: 20.9°C  
**Probe:** SN 34/15 SSE2 EPGO265, ConvF: 2.08  
**Area Scan:** sam\_direct\_droit2\_surf10mm.txt, h= 5.00 mm  
**Zoom Scan:** 5x5x7,dx=8mm, dy=8mm, dz=5mm,Complete  
**Maximum location:** X=10.000000, Y=8.000000  
**SAR 10g (W/Kg):** 0.386673  
**SAR 1g (W/Kg):** 0.649334  
**Power drift (%):** -0.73  
**3D screen shot**

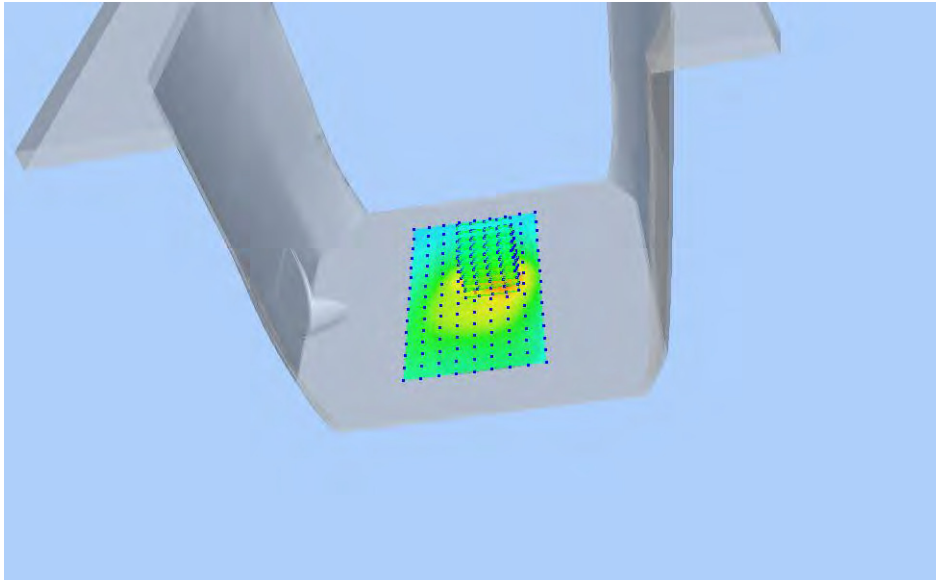

### Z Axis Scan

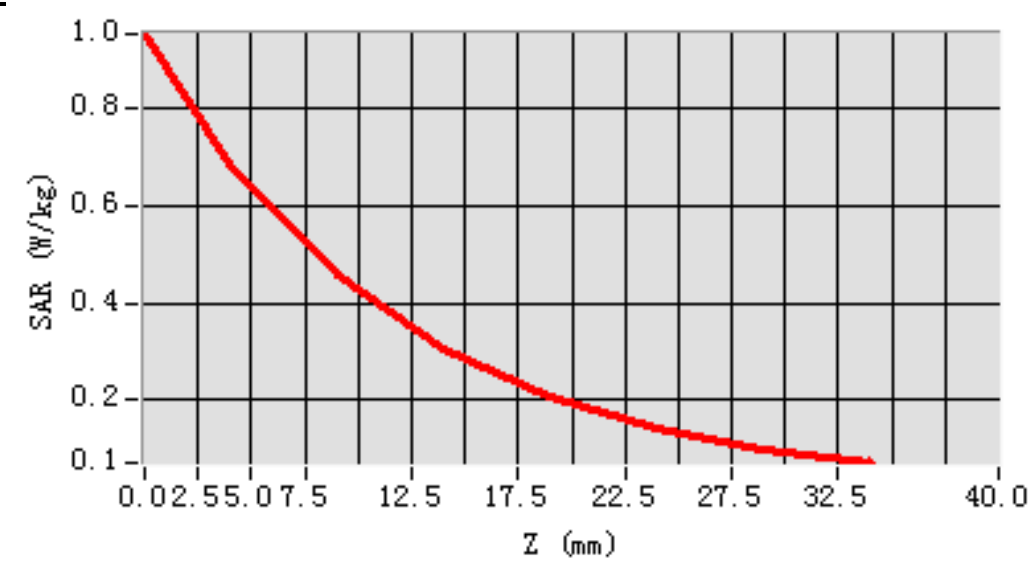

## MEAS. 12 Body Plane with Bottom Edge 10mm on Low Channel in WCDMA

### Band 4 mode

**Test Date:** 19/2/2017  
**Measurement duration:** 11 minutes 46 seconds  
**Signal:** WCDMA, f=1712.4 MHz, Duty Cycle: 1:1.0  
**Liquid Parameters:** Permittivity: 54.29; Conductivity: 1.47 S/m  
**Test condition:** Ambient Temperature: 22.3°C, Liquid Temperature: 20.9°C  
**Probe:** SN 34/15 SSE2 EPGO265, ConvF: 2.08  
**Area Scan:** sam\_direct\_droit2\_surf10mm.txt, h= 5.00 mm  
**Zoom Scan:** 5x5x7,dx=8mm, dy=8mm, dz=5mm,Complete  
**Maximum location:** X=0.000000, Y=-22.000000  
**SAR 10g (W/Kg):** 0.624908  
**SAR 1g (W/Kg):** 1.143481  
**Power drift (%):** -2.97  
**3D screen shot**

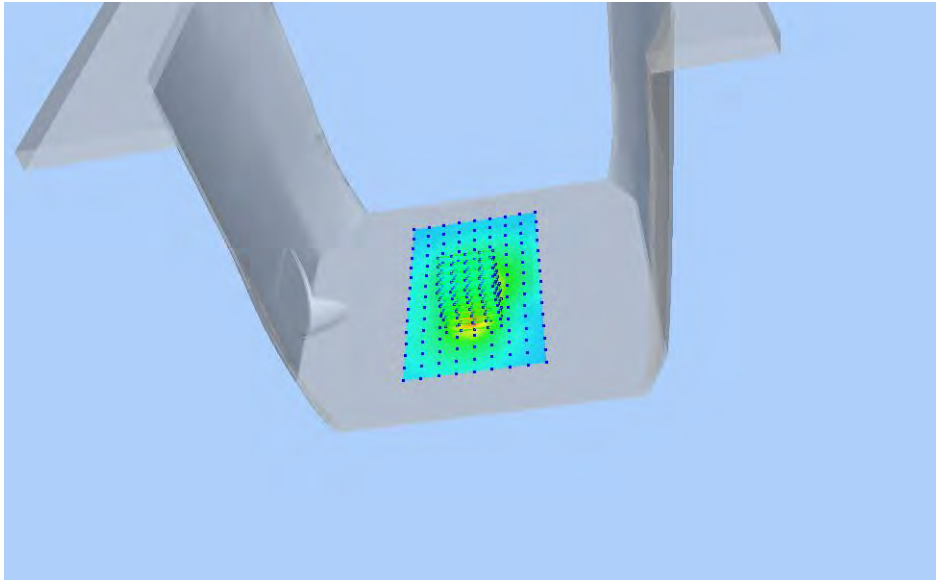

### Z Axis Scan

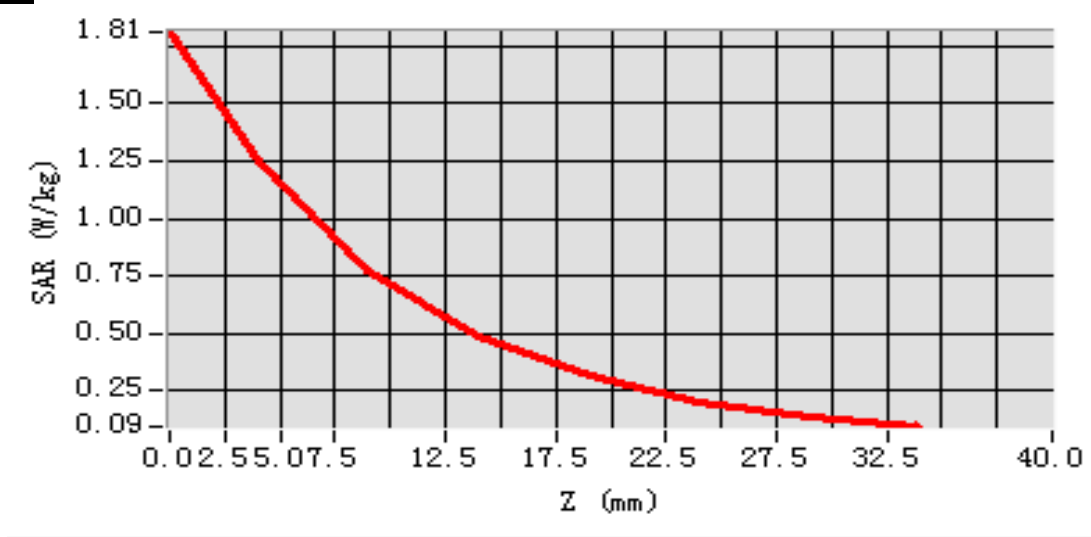

## MEAS. 13 Left Head with Cheek on High Channel in WCDMA Band 5 mode

**Test Date:** 14/3/2017  
**Measurement duration:** 11 minutes 3 seconds  
**Signal:** WCDMA, f=846.6 MHz, Duty Cycle: 1:1.0  
**Liquid Parameters:** Permittivity: 41.67; Conductivity: 0.91 S/m  
**Test condition:** Ambient Temperature: 21.9°C, Liquid Temperature: 20.8°C  
**Probe:** SN 34/15 SSE2 EPGO265, ConvF: 2.04  
**Area Scan:** sam\_direct\_droit2\_surf10mm.txt, h= 5.00 mm  
**Zoom Scan:** 5x5x7,dx=8mm, dy=8mm, dz=5mm,Complete  
**Maximum location:** X=-46.000000, Y=-26.000000  
**SAR 10g (W/Kg):** 0.257507  
**SAR 1g (W/Kg):** 0.336191  
**Power drift (%):** -0.68  
**3D screen shot**

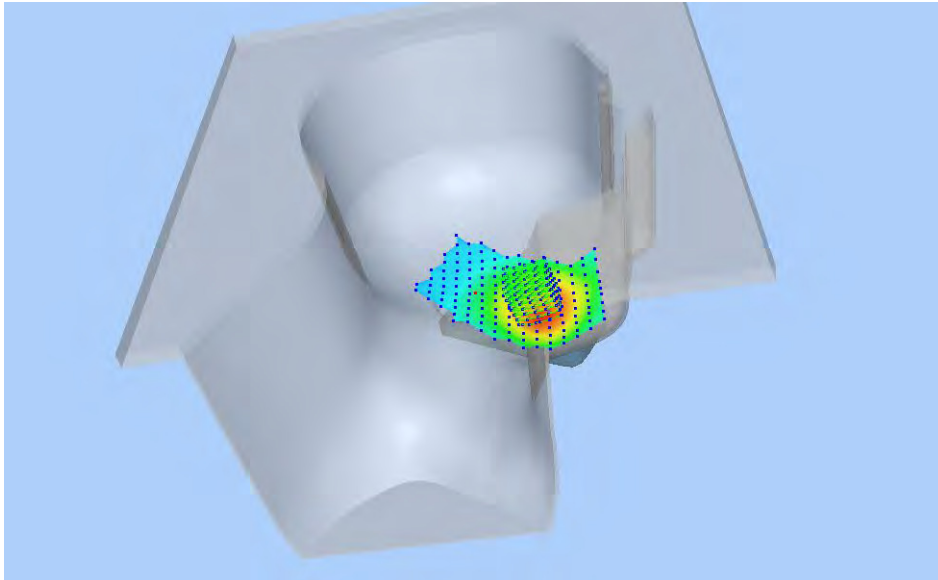

### Z Axis Scan

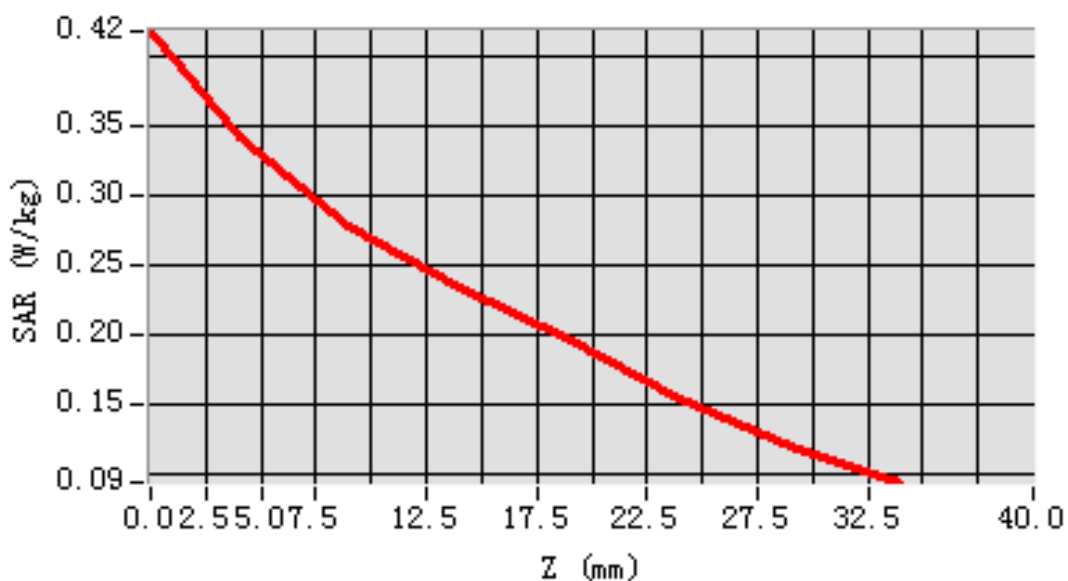

## MEAS. 14 Body Plane with Back Side 15mm on High Channel in WCDMA Band

### 5 mode

**Test Date:** 15/3/2017  
**Measurement duration:** 13 minutes 16 seconds  
**Signal:** WCDMA, f=846.6 MHz, Duty Cycle: 1:1.0  
**Liquid Parameters:** Permittivity: 55.43; Conductivity: 1.01 S/m  
**Test condition:** Ambient Temperature: 22.7°C, Liquid Temperature: 21.5°C  
**Probe:** SN 34/15 SSE2 EPGO265, ConvF: 2.12  
**Area Scan:** sam\_direct\_droit2\_surf10mm.txt, h= 5.00 mm  
**Zoom Scan:** 5x5x7,dx=8mm, dy=8mm, dz=5mm,Complete  
**Maximum location:** X=10.000000, Y=-12.000000  
**SAR 10g (W/Kg):** 0.316649  
**SAR 1g (W/Kg):** 0.426689  
**Power drift (%):** -0.64  
**3D screen shot**

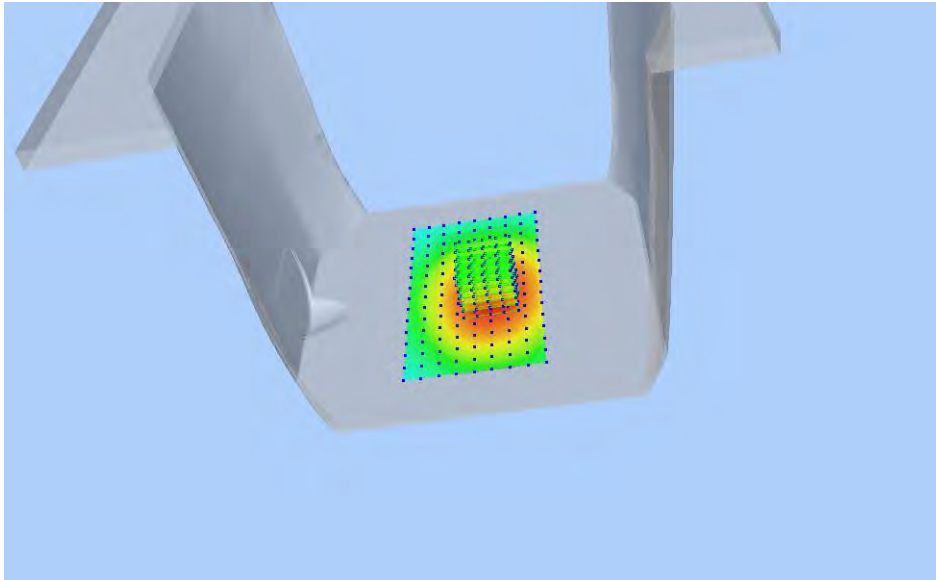

### Z Axis Scan

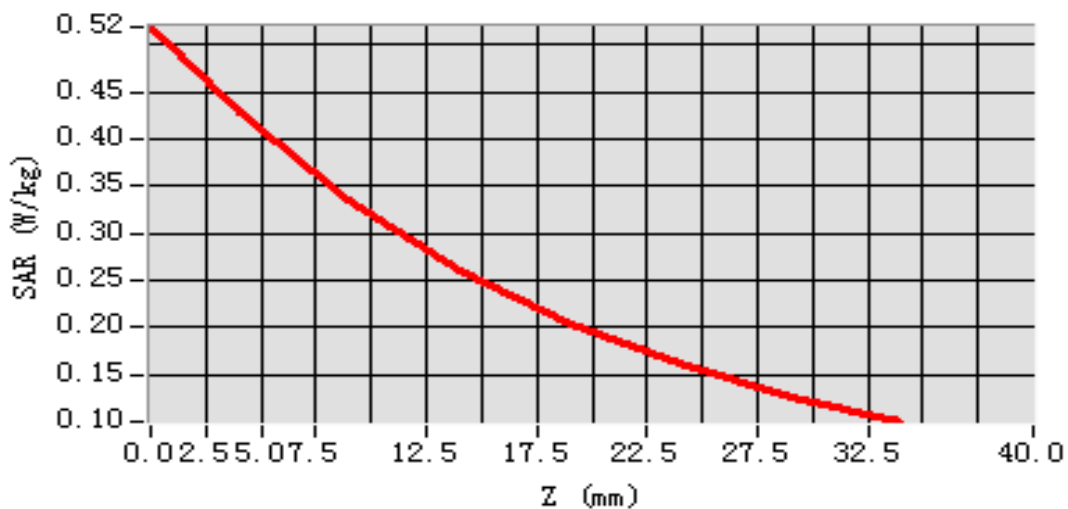

## MEAS. 15 Body Plane with Back Side 10mm on High Channel in WCDMA Band

### 5 mode

**Test Date:** 15/3/2017  
**Measurement duration:** 10 minutes 41 seconds  
**Signal:** WCDMA, f=846.6 MHz, Duty Cycle: 1:1.0  
**Liquid Parameters:** Permittivity: 55.43; Conductivity: 1.01 S/m  
**Test condition:** Ambient Temperature: 22.7°C, Liquid Temperature: 21.5°C  
**Probe:** SN 34/15 SSE2 EPGO265, ConvF: 2.12  
**Area Scan:** sam\_direct\_droit2\_surf10mm.txt, h= 5.00 mm  
**Zoom Scan:** 5x5x7,dx=8mm, dy=8mm, dz=5mm,Complete  
**Maximum location:** X=-10.000000, Y=-12.000000  
**SAR 10g (W/Kg):** 0.356082  
**SAR 1g (W/Kg):** 0.475463  
**Power drift (%):** -0.94  
**3D screen shot**

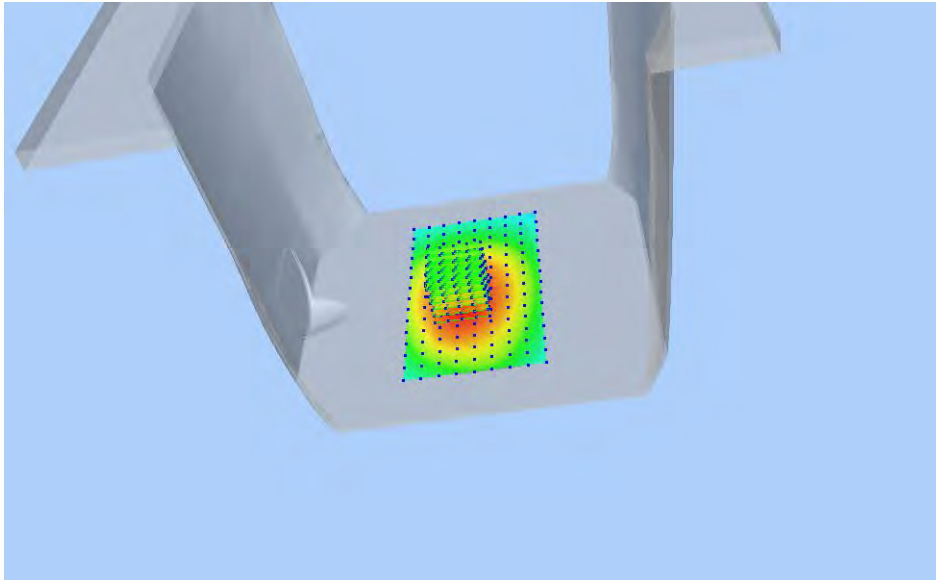

### Z Axis Scan

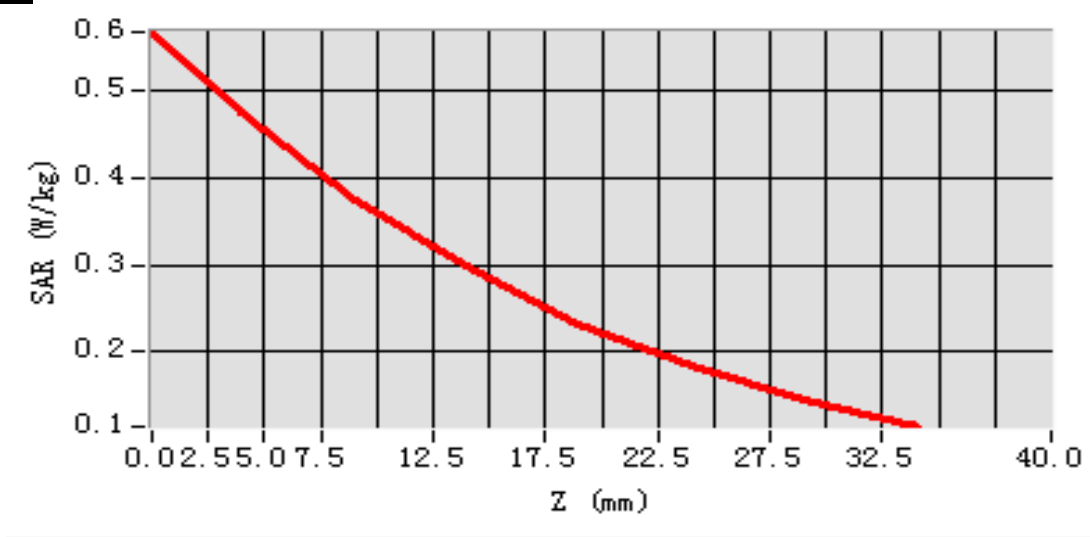

## MEAS. 16 Left Head with Cheek on Low Channel in LTE Band 2 mode

**Test Date:** 16/3/2017  
**Measurement duration:** 12 minutes 11 seconds  
**Signal:** LTE, f=1860 MHz, Duty Cycle: 1:1.0  
**Liquid Parameters:** Permittivity: 39.96; Conductivity: 1.41 S/m  
**Test condition:** Ambient Temperature: 21.8°C, Liquid Temperature: 20.5°C  
**Probe:** SN 34/15 SSE2 EPGO265, ConvF: 2.35  
**Area Scan:** sam\_direct\_droit2\_surf10mm.txt, h= 5.00 mm  
**Zoom Scan:** 5x5x7,dx=8mm, dy=8mm, dz=5mm,Complete  
**Maximum location:** X=-56.000000, Y=-56.000000  
**SAR 10g (W/Kg):** 0.154033  
**SAR 1g (W/Kg):** 0.251618  
**Power drift (%):** -3.65  
**3D screen shot**

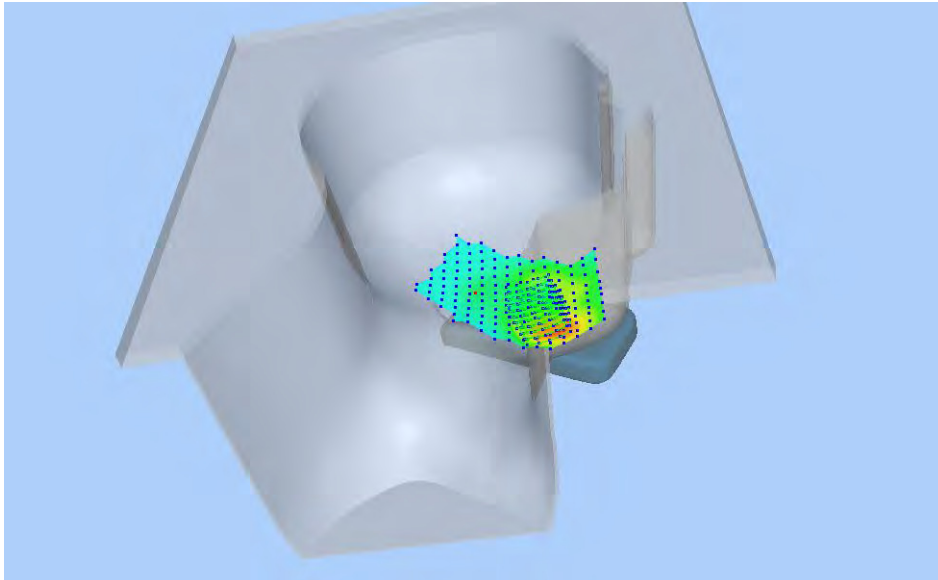

### Z Axis Scan

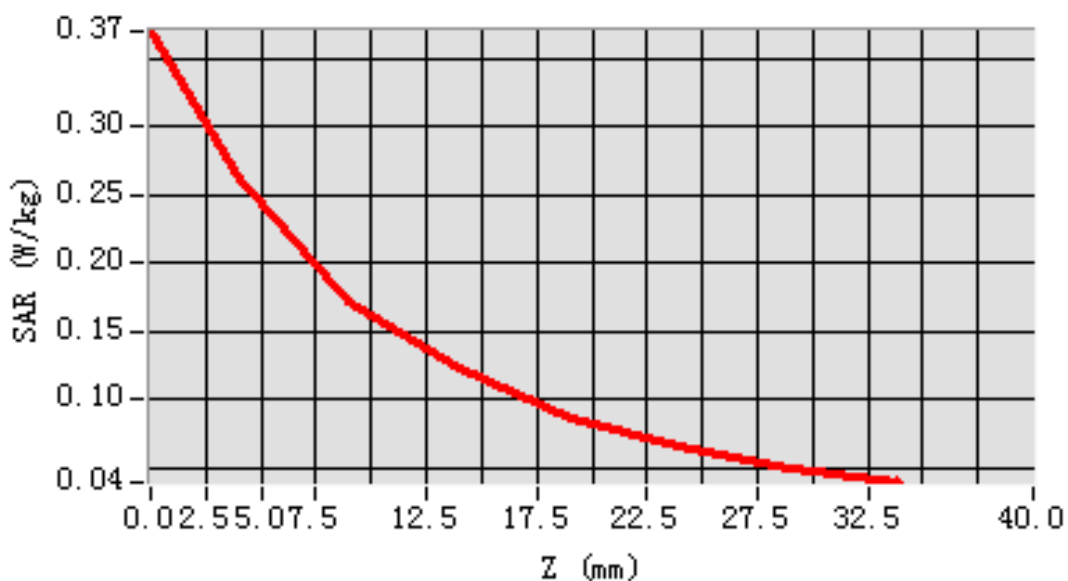



## MEAS. 17 Body Plane with Front Side 15mm on Low Channel in LTE Band 2

### mode

**Test Date:** 17/3/2017  
**Measurement duration:** 11 minutes 50 seconds  
**Signal:** LTE, f=1860 MHz, Duty Cycle: 1:1.0  
**Liquid Parameters:** Permittivity: 53.84; Conductivity: 1.49 S/m  
**Test condition:** Ambient Temperature: 22.2°C, Liquid Temperature: 20.9°C  
**Probe:** SN 34/15 SSE2 EPGO265, ConvF: 2.42  
**Area Scan:** sam\_direct\_droit2\_surf10mm.txt, h= 5.00 mm  
**Zoom Scan:** 5x5x7,dx=8mm, dy=8mm, dz=5mm,Complete  
**Maximum location:** X=0.000000, Y=8.000000  
**SAR 10g (W/Kg):** 0.198899  
**SAR 1g (W/Kg):** 0.333635  
**Power drift (%):** -2.19  
**3D screen shot**

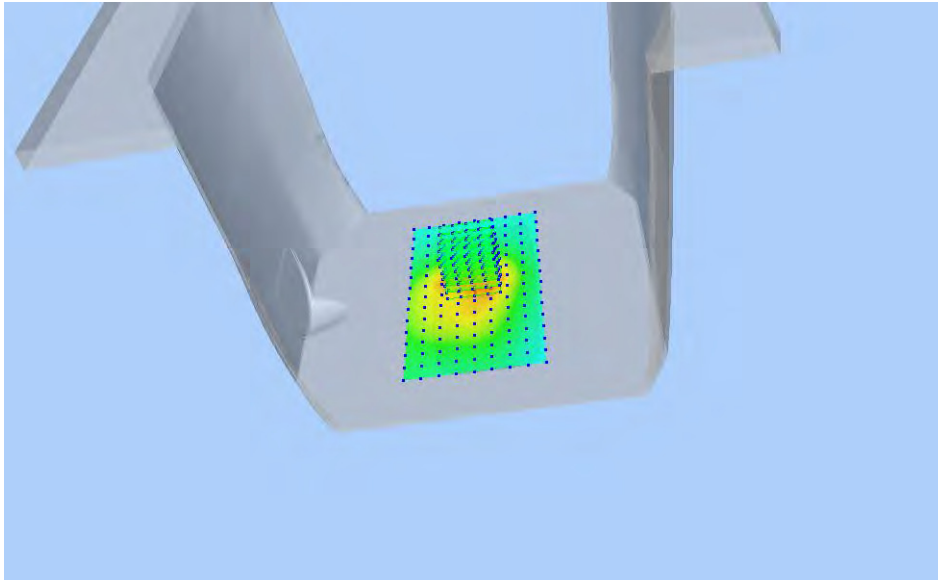

### Z Axis Scan

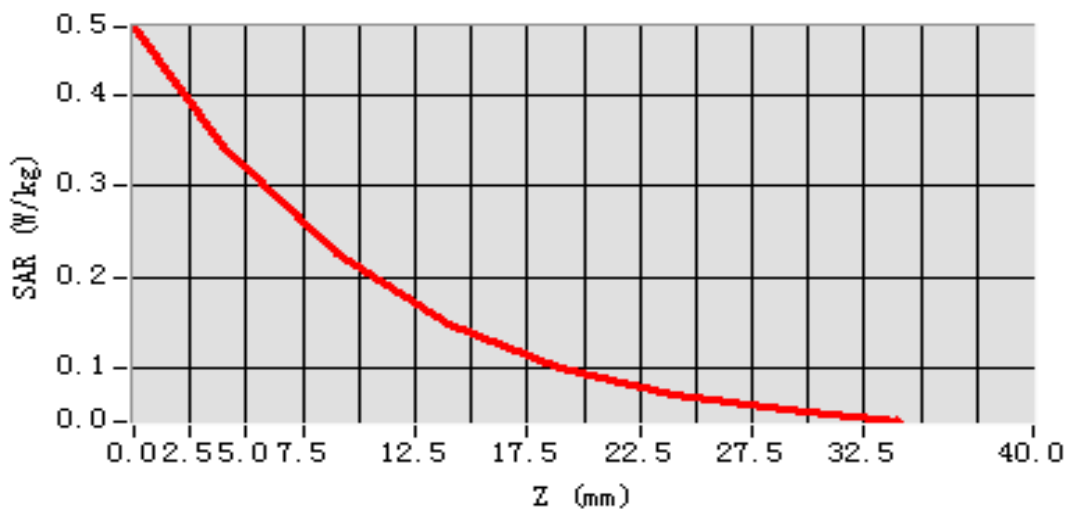

## MEAS. 18 Body Plane with Bottom Edge 10mm on Low Channel in LTE Band 2

### mode

**Test Date:** 17/3/2017  
**Measurement duration:** 12 minutes 0 seconds  
**Signal:** LTE, f=1860 MHz, Duty Cycle: 1:1.0  
**Liquid Parameters:** Permittivity: 53.84; Conductivity: 1.49 S/m  
**Test condition:** Ambient Temperature: 22.2°C, Liquid Temperature: 20.9°C  
**Probe:** SN 34/15 SSE2 EPGO265, ConvF: 2.42  
**Area Scan:** sam\_direct\_droit2\_surf10mm.txt, h= 5.00 mm  
**Zoom Scan:** 5x5x7,dx=8mm, dy=8mm, dz=5mm,Complete  
**Maximum location:** X=0.000000, Y=-22.000000  
**SAR 10g (W/Kg):** 0.383132  
**SAR 1g (W/Kg):** 0.712928  
**Power drift (%):** -1.78  
**3D screen shot**

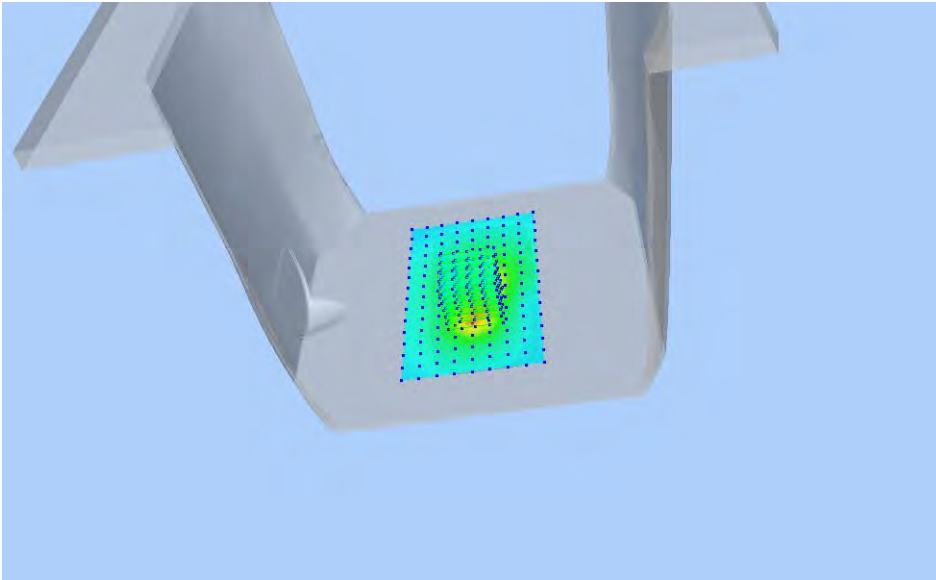

### Z Axis Scan

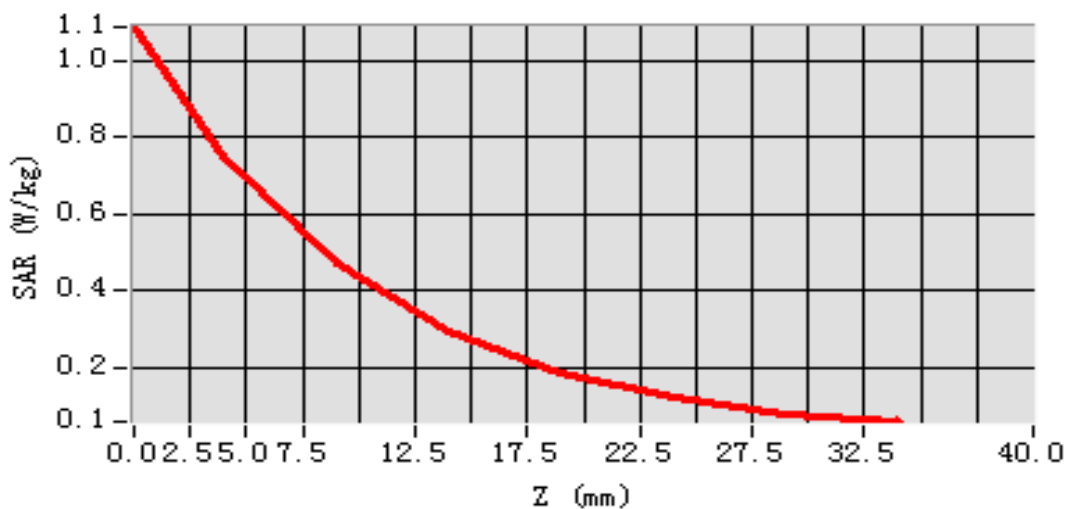

### MEAS. 19 Left Head with Cheek on Middle Channel in LTE Band 4 mode

**Test Date:** 18/3/2017  
**Measurement duration:** 12 minutes 18 seconds  
**Signal:** LTE, f=1732.5 MHz, Duty Cycle: 1:1.0  
**Liquid Parameters:** Permittivity: 41.42; Conductivity: 1.35 S/m  
**Test condition:** Ambient Temperature: 22.6°C, Liquid Temperature: 21.3°C  
**Probe:** SN 34/15 SSE2 EPGO265, ConvF: 2.04  
**Area Scan:** sam\_direct\_droit2\_surf10mm.txt, h= 5.00 mm  
**Zoom Scan:** 5x5x7,dx=8mm, dy=8mm, dz=5mm,Complete  
**Maximum location:** X=-56.000000, Y=-56.000000  
**SAR 10g (W/Kg):** 0.186900  
**SAR 1g (W/Kg):** 0.299064  
**Power drift (%):** -2.53  
**3D screen shot**

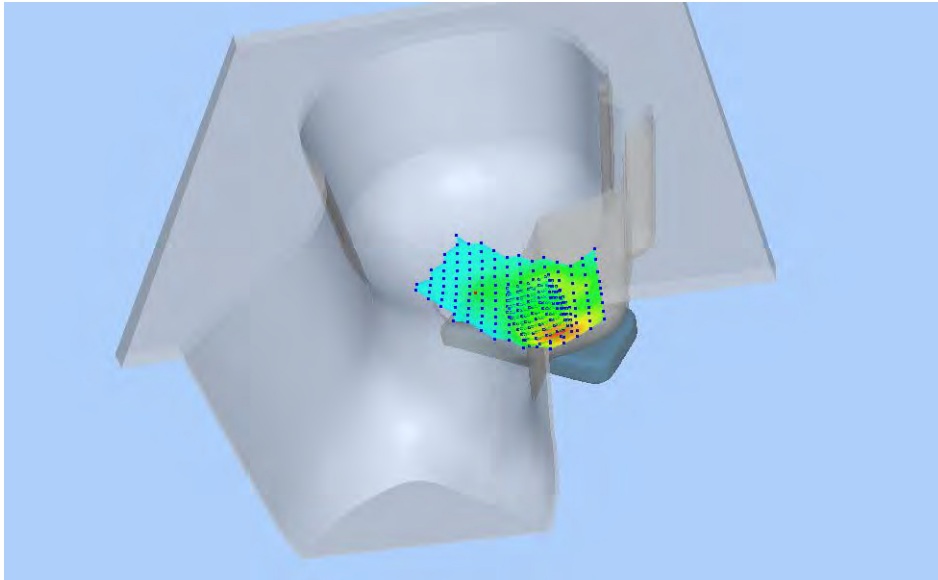

#### Z Axis Scan

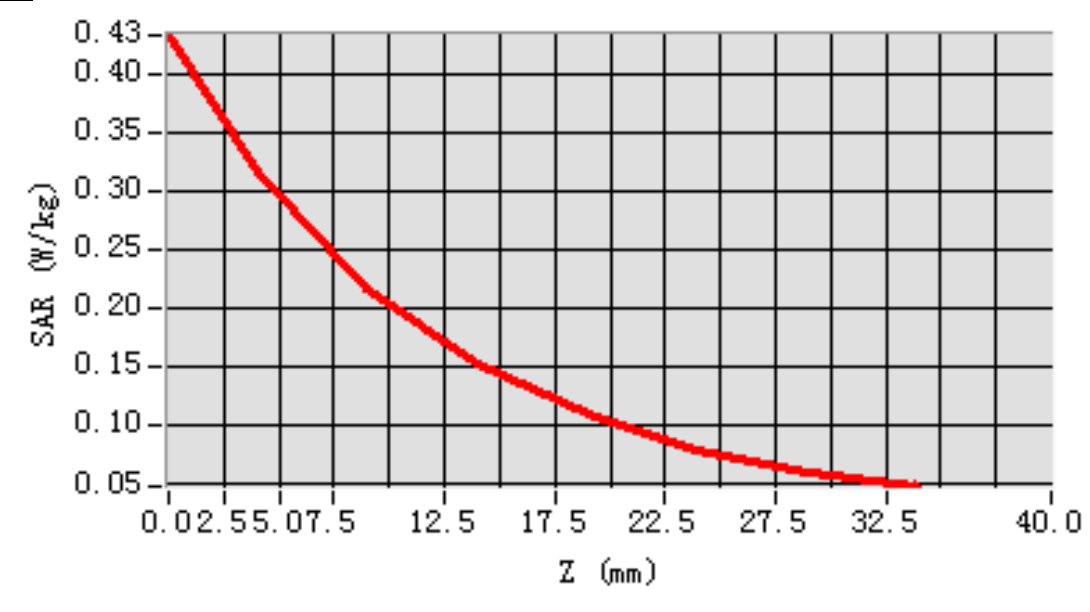

## MEAS. 20 Body Plane with Front Side 15mm on Middle Channel in LTE Band 4

### mode

**Test Date:** 19/3/2017  
**Measurement duration:** 8 minutes 55 seconds  
**Signal:** LTE, f=1732.5 MHz, Duty Cycle: 1:1.0  
**Liquid Parameters:** Permittivity: 53.87; Conductivity: 1.49 S/m  
**Test condition:** Ambient Temperature: 22.3°C, Liquid Temperature: 20.9°C  
**Probe:** SN 34/15 SSE2 EPGO265, ConvF: 2.08  
**Area Scan:** sam\_direct\_droit2\_surf10mm.txt, h= 5.00 mm  
**Zoom Scan:** 5x5x7,dx=8mm, dy=8mm, dz=5mm,Complete  
**Maximum location:** X=-20.000000, Y=-32.000000  
**SAR 10g (W/Kg):** 0.314933  
**SAR 1g (W/Kg):** 0.544697  
**Power drift (%):** 1.40  
**3D screen shot**

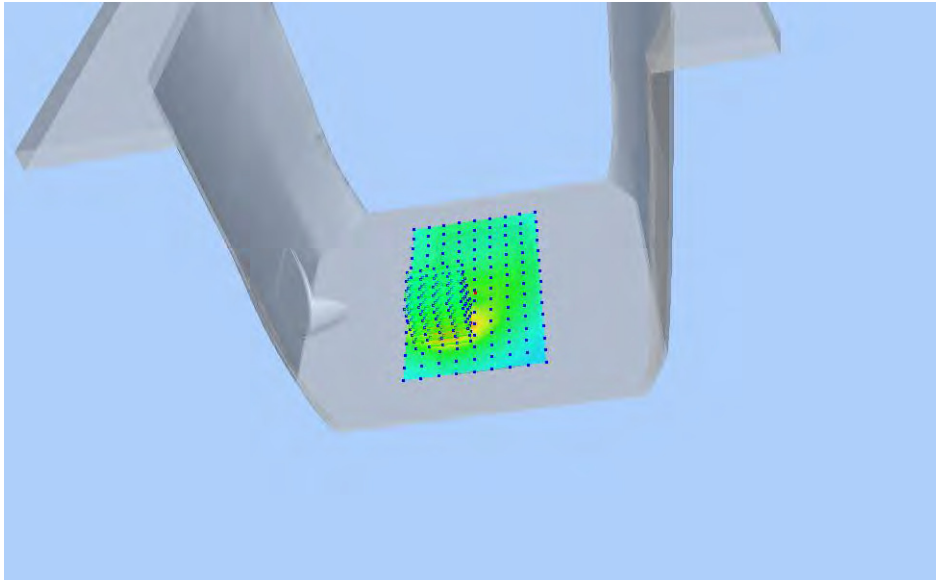

### Z Axis Scan

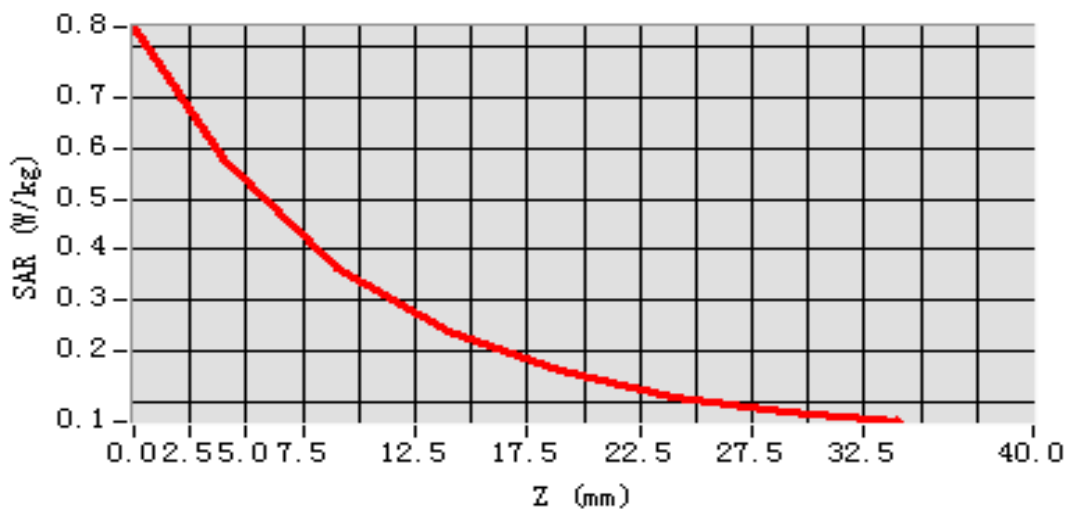

## MEAS. 21 Body Plane with Bottom Edge 10mm on Low Channel in LTE Band 4

### mode

**Test Date:** 19/2/2017  
**Measurement duration:** 12 minutes 9 seconds  
**Signal:** LTE, f=1720 MHz, Duty Cycle: 1:1.0  
**Liquid Parameters:** Permittivity:53.97; Conductivity: 1.48 S/m  
**Test condition:** Ambient Temperature: 22.3°C, Liquid Temperature: 20.9°C  
**Probe:** SN 34/15 SSE2 EPGO265, ConvF: 2.08  
**Area Scan:** sam\_direct\_droit2\_surf10mm.txt, h= 5.00 mm  
**Zoom Scan:** 5x5x7,dx=8mm, dy=8mm, dz=5mm,Complete  
**Maximum location:** X=0.000000, Y=-12.000000  
**SAR 10g (W/Kg):** 0.574031  
**SAR 1g (W/Kg):** 1.029914  
**Power drift (%):** -3.27  
**3D screen shot**

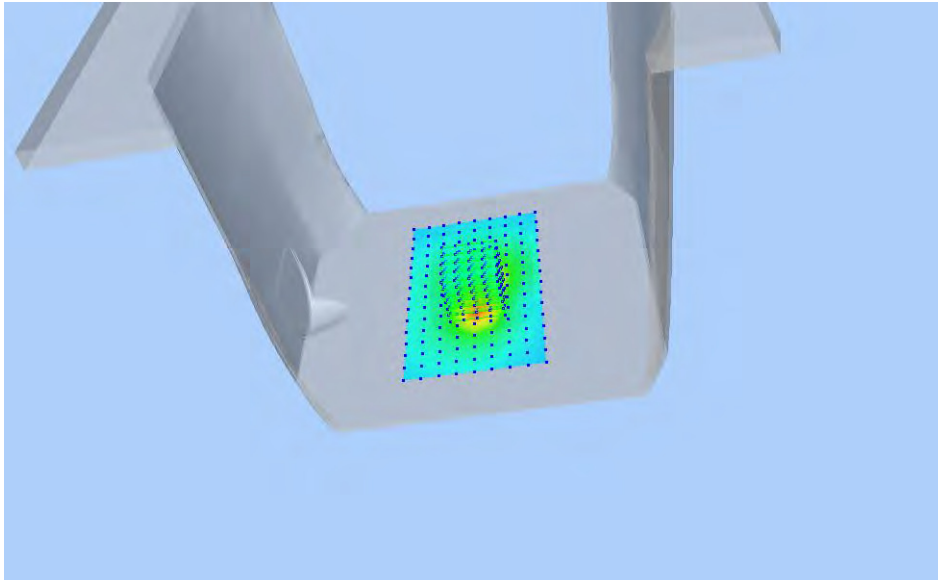

### Z Axis Scan

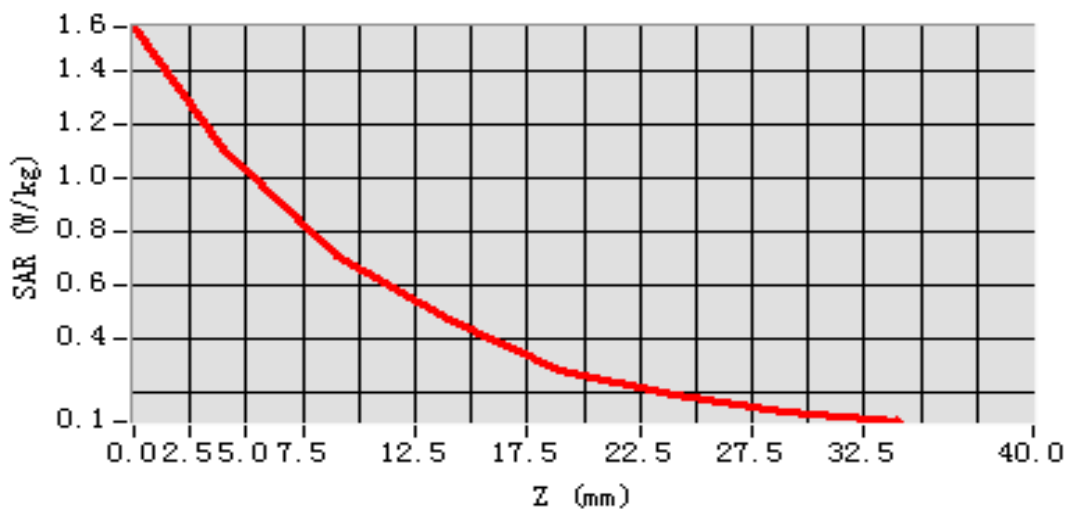

## MEAS. 22 Left Head with Cheek on High Channel in LTE Band 7 mode

**Test Date:** 24/3/2017  
**Measurement duration:** 14 minutes 55 seconds  
**Signal:** LTE, f=2560.0 MHz, Duty Cycle: 1:1.0  
**Liquid Parameters:** Permittivity: 38.69; Conductivity: 1.96 S/m  
**Test condition:** Ambient Temperature: 22.0°C, Liquid Temperature: 20.8°C  
**Probe:** SN 34/15 SSE2 EPGO265, ConvF: 2.36  
**Area Scan:** sam\_direct\_droit2\_surf12mm.txt, h= 5.00 mm  
**Zoom Scan:** 7x7x7,dx=5mm, dy=5mm, dz=5mm,Complete  
**Maximum location:** X=-48.000000, Y=-48.000000  
**SAR 10g (W/Kg):** 0.148891  
**SAR 1g (W/Kg):** 0.266973  
**Power drift (%):** -1.50  
**3D screen shot**

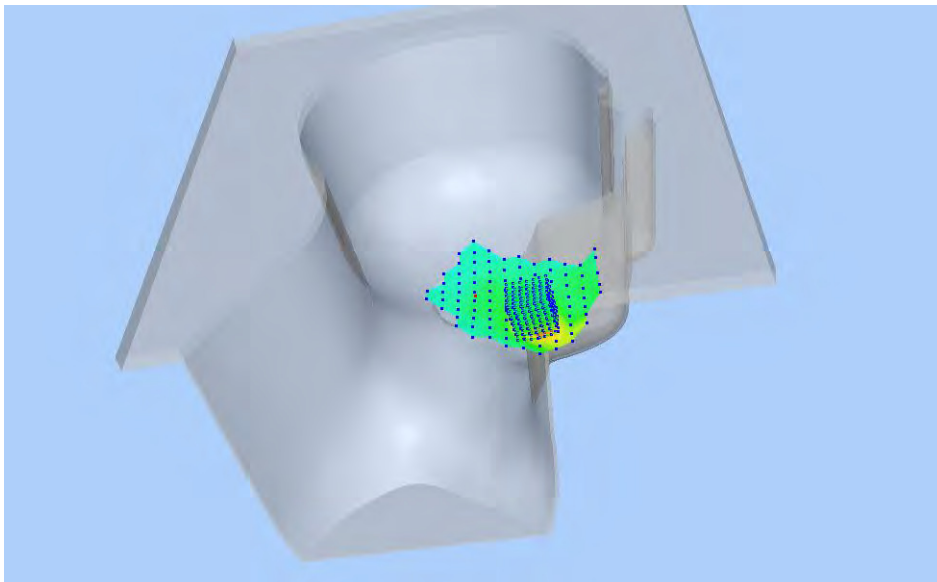

### Z Axis Scan

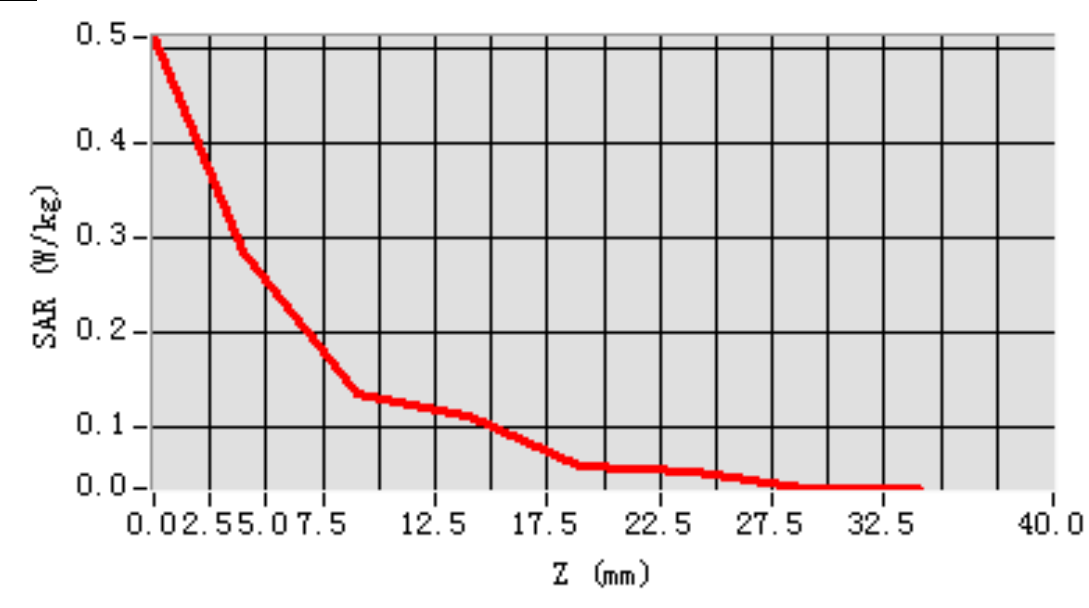

## MEAS. 23 Body Plane with Back side 15mm on High Channel in LTE Band 7

### mode

Test Date:	27/3/2017
Measurement duration:	18 minutes 53 seconds
Signal:	LTE, f=2560.0 MHz, Duty Cycle: 1:1.0
Liquid Parameters:	Permittivity: 52.06; Conductivity: 2.11 S/m
Test condition:	Ambient Temperature: 22.3°C, Liquid Temperature: 21.0°C
Probe:	SN 34/15 SSE2 EPGO265, ConvF: 2.43
Area Scan:	sam_direct_droit2_surf10mm.txt, h= 5.00 mm
Zoom Scan:	7x7x7,dx=5mm, dy=5mm, dz=5mm,Complete
Maximum location:	X=20.000000, Y=-32.000000
SAR 10g (W/Kg):	0.412804
SAR 1g (W/Kg):	0.827743
Power drift (%):	1.86

### 3D screen shot

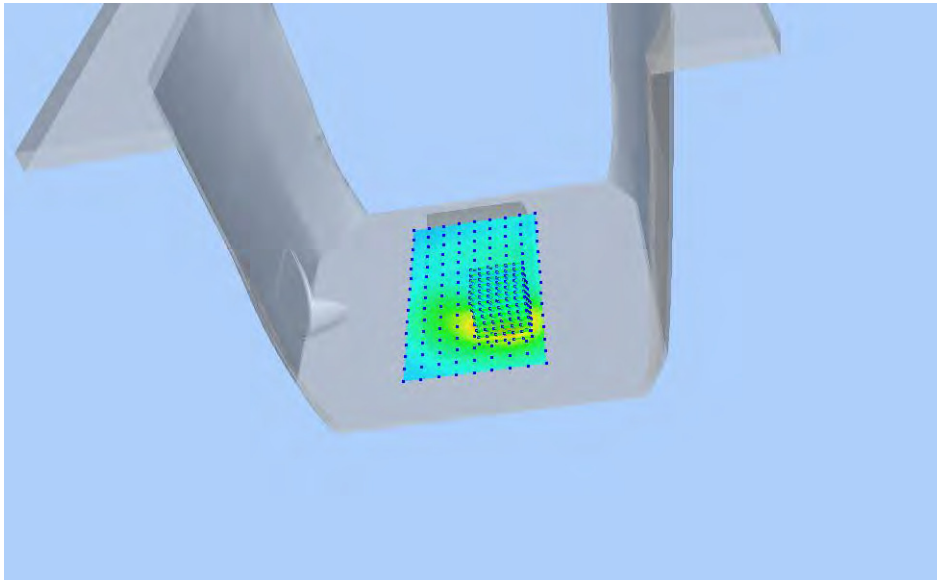

### Z Axis Scan

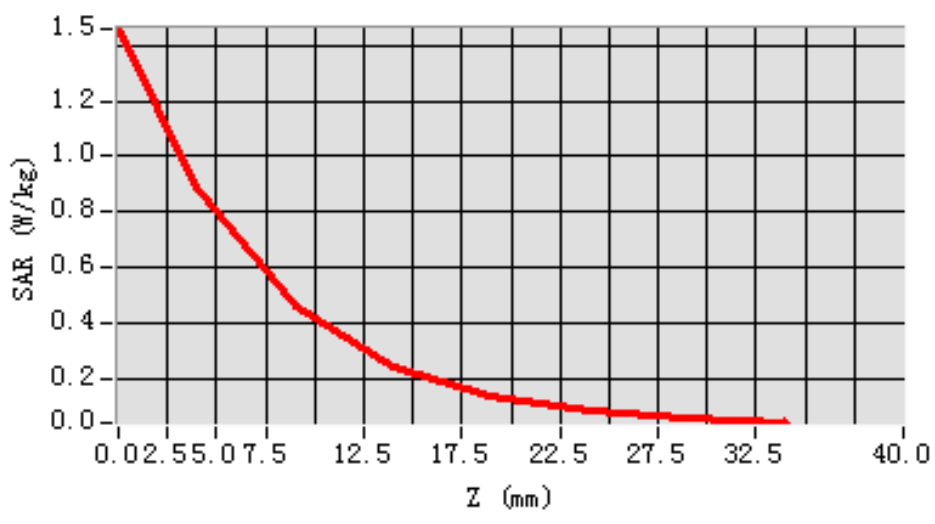

## MEAS. 24 Body Plane with Back side 10mm on High Channel in LTE Band 7

### mode

<b>Test Date:</b>	27/3/2017
<b>Measurement duration:</b>	19 minutes 0 seconds
<b>Signal:</b>	LTE, f=2560.0 MHz, Duty Cycle: 1:1.0
<b>Liquid Parameters:</b>	Permittivity: 52.06; Conductivity: 2.11 S/m
<b>Test condition:</b>	Ambient Temperature: 22.3°C, Liquid Temperature: 21.0°C
<b>Probe:</b>	SN 34/15 SSE2 EPGO265, ConvF: 2.43
<b>Area Scan:</b>	sam_direct_droit2_surf10mm.txt, h= 5.00 mm
<b>Zoom Scan:</b>	7x7x7,dx=5mm, dy=5mm, dz=5mm,Complete
<b>Maximum location:</b>	X=10.000000, Y=-22.000000
<b>SAR 10g (W/Kg):</b>	0.570386
<b>SAR 1g (W/Kg):</b>	1.149167
<b>Power drift (%):</b>	1.16

**3D screen shot**

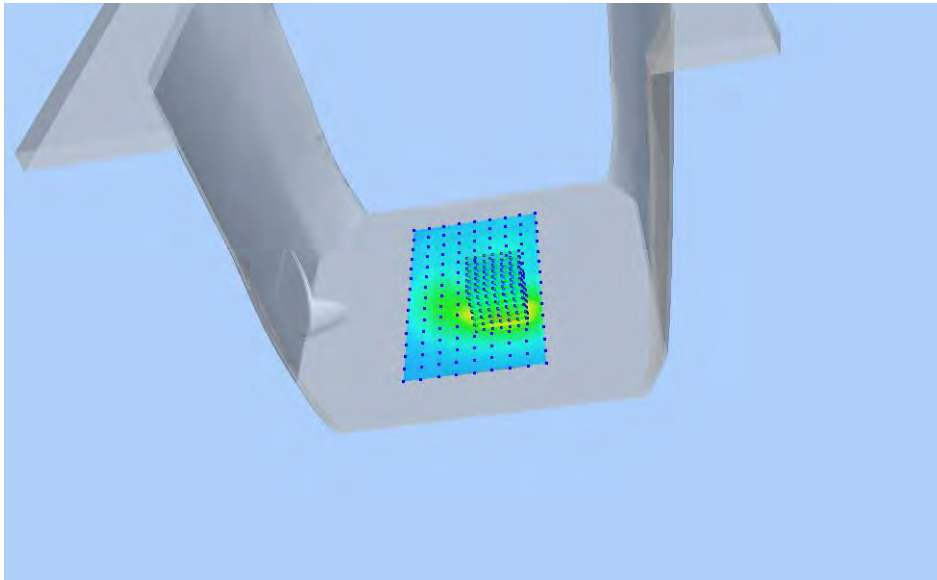

### Z Axis Scan

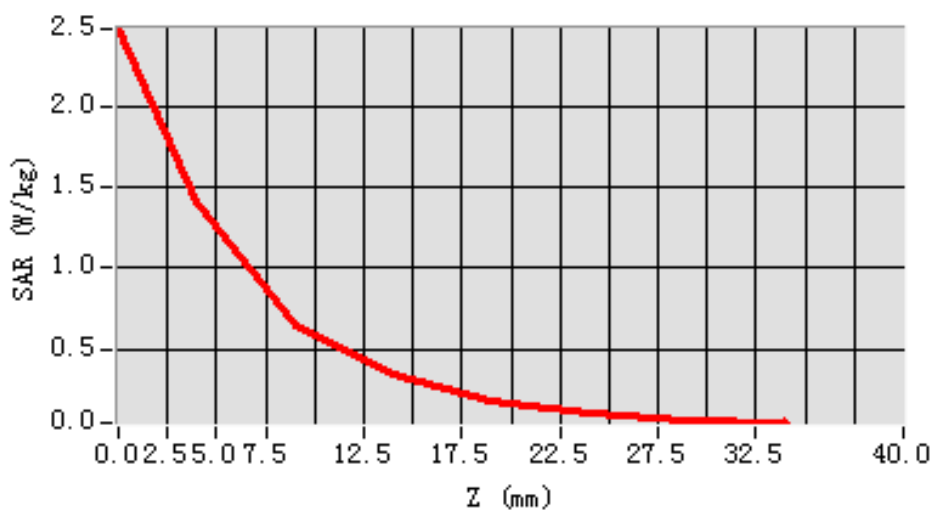



## MEAS. 25 Left Head with Cheek on low Channel in IEEE 802.b mode

**Test Date:** 20/3/2017  
**Measurement duration:** 14 minutes 10 seconds  
**Signal:** WLAN, f=2412.0 MHz, Duty Cycle: 1:1.0  
**Liquid Parameters:** Permittivity: 40.44; Conductivity: 1.82 S/m  
**Test condition:** Ambient Temperature: 22.3°C, Liquid Temperature: 21.5°C  
**Probe:** SN 34/15 SSE2 EPGO265, ConvF: 2.47  
**Area Scan:** sam\_direct\_droit2\_surf10mm.txt, h= 5.00 mm  
**Zoom Scan:** 7x7x7,dx=5mm, dy=5mm, dz=5mm,Complete  
**Maximum location:** X=-16.000000, Y=14.000000  
**SAR 10g (W/Kg):** 0.118267  
**SAR 1g (W/Kg):** 0.202693  
**Power drift (%):** -1.64  
**3D screen shot**

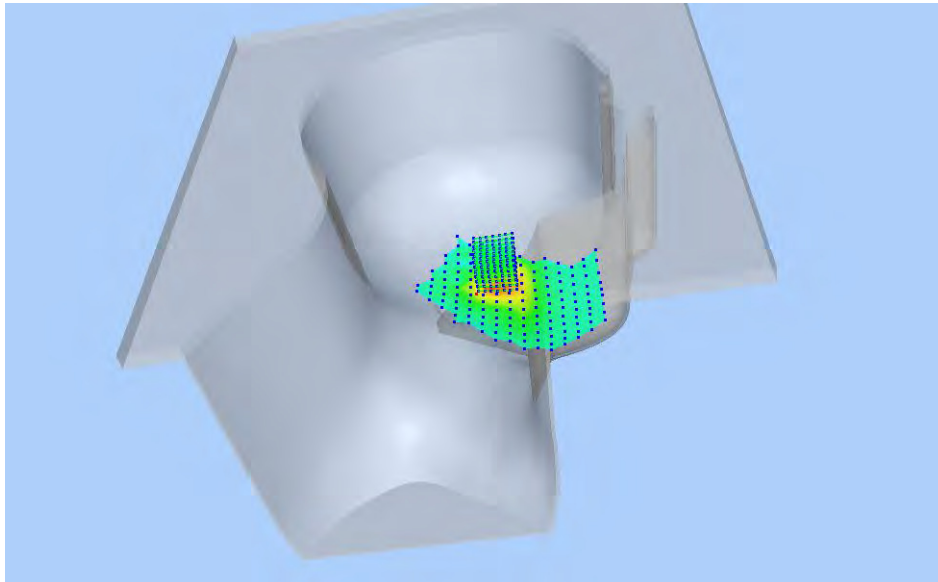

### Z Axis Scan

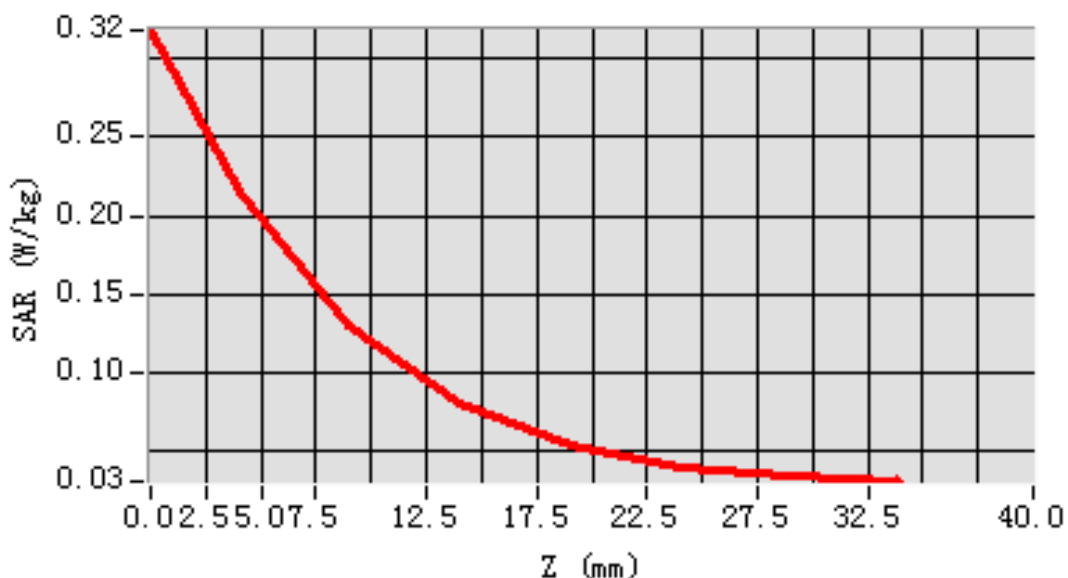

## MEAS. 26 Body Plane with Back side 15mm on Low Channel in IEEE 802.b

### mode

<b>Test Date:</b>	21/3/2017
<b>Measurement duration:</b>	12 minutes 50 seconds
<b>Signal:</b>	WLAN, f=2412.0 MHz, Duty Cycle: 1:1.0
<b>Liquid Parameters:</b>	Permittivity: 53.24; Conductivity: 1.92 S/m
<b>Test condition:</b>	Ambient Temperature: 22.0°C, Liquid Temperature: 21.1°C
<b>Probe:</b>	SN 34/15 SSE2 EPGO265, ConvF: 2.55
<b>Area Scan:</b>	sam_direct_droit2_surf10mm.txt, h= 5.00 mm
<b>Zoom Scan:</b>	7x7x7,dx=5mm, dy=5mm, dz=5mm,Complete
<b>Maximum location:</b>	X=-20.000000, Y=-2.000000
<b>SAR 10g (W/Kg):</b>	0.064345
<b>SAR 1g (W/Kg):</b>	0.108062
<b>Power drift (%):</b>	-0.64
<b>3D screen shot</b>	

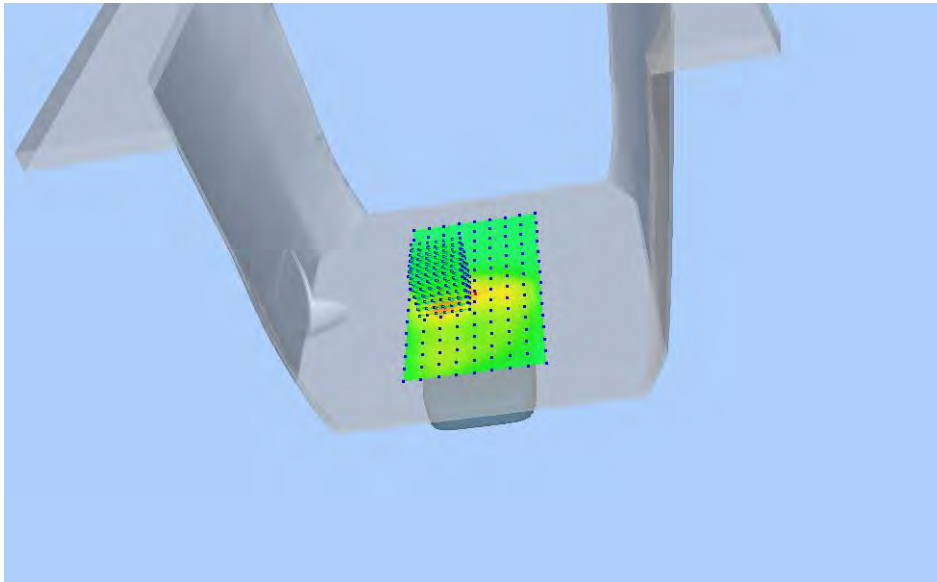

### Z Axis Scan

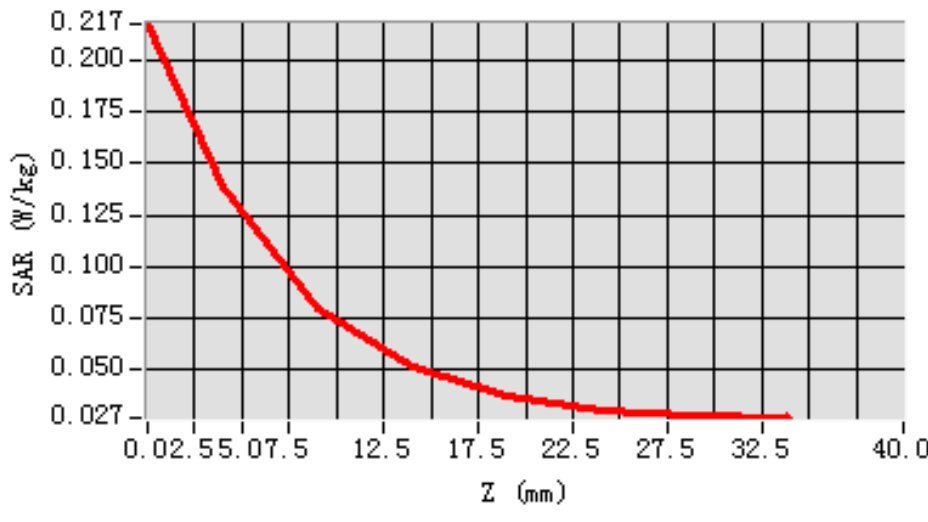

## MEAS. 27 Body Plane with Back Side 10mm on Low Channel in IEEE 802.b

### mode

<b>Test Date:</b>	21/3/2017
<b>Measurement duration:</b>	14 minutes 43 seconds
<b>Signal:</b>	WLAN, f=2412.0 MHz, Duty Cycle: 1:1.0
<b>Liquid Parameters:</b>	Permittivity: 53.24; Conductivity: 1.92 S/m
<b>Test condition:</b>	Ambient Temperature: 22.0°C, Liquid Temperature: 21.1°C
<b>Probe:</b>	SN 34/15 SSE2 EPGO265, ConvF: 2.55
<b>Area Scan:</b>	sam_direct_droit2_surf10mm.txt, h= 5.00 mm
<b>Zoom Scan:</b>	7x7x7,dx=5mm, dy=5mm, dz=5mm,Complete
<b>Maximum location:</b>	X=-10.000000, Y=-2.000000
<b>SAR 10g (W/Kg):</b>	0.097868
<b>SAR 1g (W/Kg):</b>	0.194342
<b>Power drift (%):</b>	-1.07
<b>3D screen shot</b>	

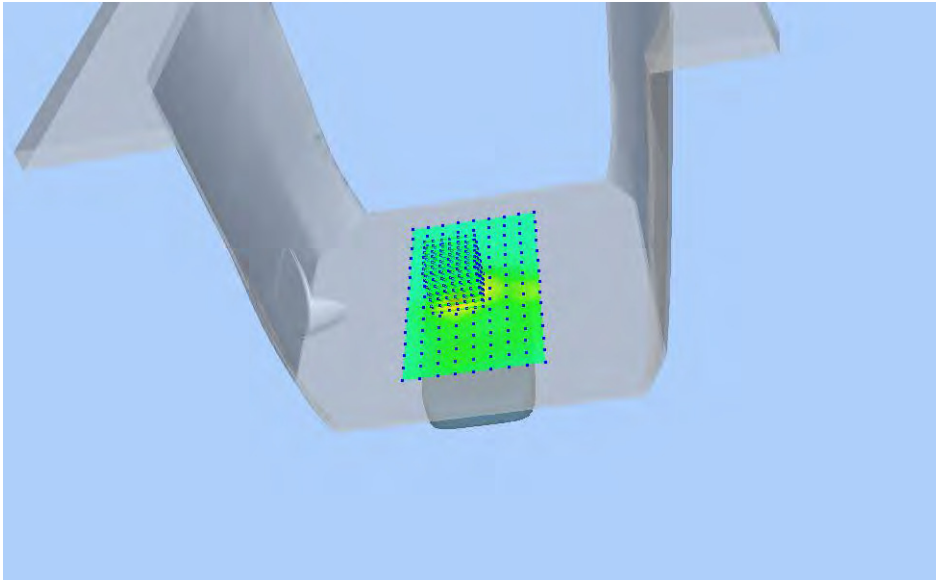

### Z Axis Scan

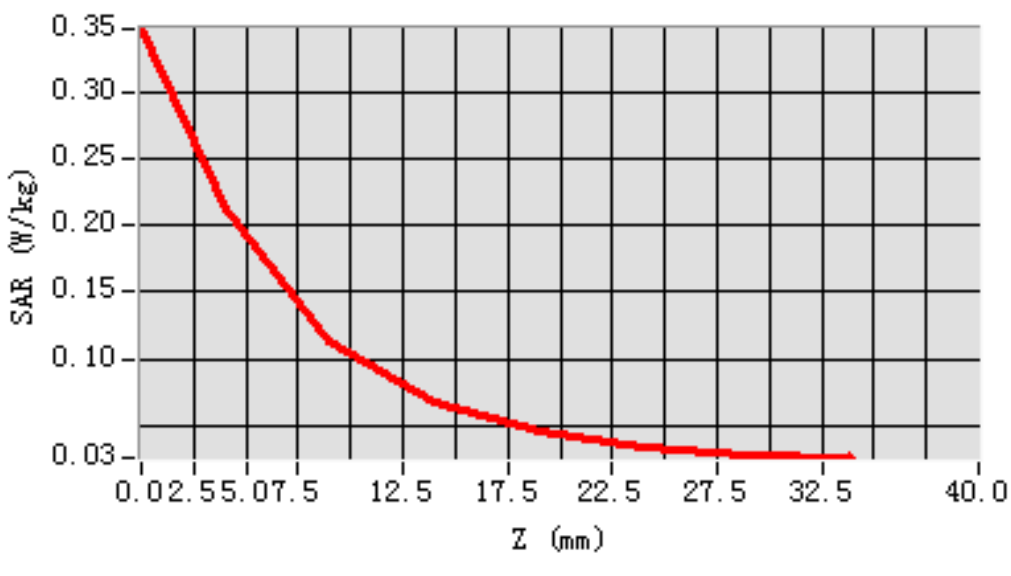

## **ANNEX D EUT EXTERNAL PHOTOS**

Please refer the document "BL-SZ1720011-AW.pdf".

## **ANNEX E SAR TEST SETUP PHOTOS**

Please refer the document "BL-SZ1720011-AS.pdf".

## **ANNEX F CALIBRATION REPORT**

Please refer the document "CALIBRATION REPORT.pdf".

--END OF REPORT--