

FCC Radio Test Report

FCC ID: TE7X60V2

This report concerns: **Original Grant**

Project No. : 2006C089
Equipment : AX3000 Whole Home Mesh Wi-Fi 6 System
Brand Name : tp-link
Test Model : Deco X60
Series Model : N/A
Applicant : TP-Link Technologies Co., Ltd.
Address : Building 24(floors1,3,4,5) and 28(floors1-4) Central Science and Technology Park, Shennan Rd, Nanshan, Shenzhen, China
Manufacturer : TP-Link Technologies Co., Ltd.
Address : Building 24(floors1,3,4,5) and 28(floors1-4) Central Science and Technology Park, Shennan Rd, Nanshan, Shenzhen, China
Date of Receipt : Jun. 11, 2020
Date of Test : Jun. 15, 2020 ~ Jul. 30, 2020
Issued Date : Aug. 24, 2020
Report Version : R01
Test Sample : Engineering Sample No.: DG20200611223 for conducted, DG20200611224 for radiated
Standard(s) : FCC Part15, Subpart C (15.247)
ANSI C63.10-2013
FCC KDB 558074 D01 15.247 Meas Guidance v05r02

The above equipment has been tested and found compliance with the requirement of the relative standards by BTL Inc.

Vincent Tan

Prepared by : Vincent Tan

Ethan Ma

Approved by : Ethan Ma



Certificate #5123.02

Add: No.3, Jinshagang 1st Road, Shixia, Dalang Town, Dongguan, Guangdong, China.

Tel: +86-769-8318-3000

Web: www.newbtl.com

Declaration

BTL represents to the client that testing is done in accordance with standard procedures as applicable and that test instruments used has been calibrated with standards traceable to international standard(s) and/or national standard(s).

BTL's reports apply only to the specific samples tested under conditions. It is manufacture's responsibility to ensure that additional production units of this model are manufactured with the identical electrical and mechanical components. **BTL** shall have no liability for any declarations, inferences or generalizations drawn by the client or others from **BTL** issued reports.

The report must not be used by the client to claim product certification, approval, or endorsement by NVLAP, NIST, A2LA, or any agency of the U.S. Government.

This report is the confidential property of the client. As a mutual protection to the clients, the public and ourselves, the test report shall not be reproduced, except in full, without our written approval.

BTL's laboratory quality assurance procedures are in compliance with the **ISO/IEC 17025** requirements, and accredited by the conformity assessment authorities listed in this test report.

BTL is not responsible for the sampling stage, so the results only apply to the sample as received.

The information, data and test plan are provided by manufacturer which may affect the validity of results, so it is manufacturer's responsibility to ensure that the apparatus meets the essential requirements of applied standards and in all the possible configurations as representative of its intended use.

Limitation

For the use of the authority's logo is limited unless the Test Standard(s)/Scope(s)/Item(s) mentioned in this test report is (are) included in the conformity assessment authorities acceptance respective.

Please note that the measurement uncertainty is provided for informational purpose only and are not use in determining the Pass/Fail results.

Table of Contents	Page
REPORT ISSUED HISTORY	6
1 . SUMMARY OF TEST RESULTS	7
1.1 TEST FACILITY	8
1.2 MEASUREMENT UNCERTAINTY	8
1.3 TEST ENVIRONMENT CONDITIONS	9
2 . GENERAL INFORMATION	10
2.1 GENERAL DESCRIPTION OF EUT	10
2.2 DESCRIPTION OF TEST MODES	12
2.3 PARAMETERS OF TEST SOFTWARE	14
2.4 DUTY CYCLE	15
2.5 BLOCK DIAGRAM SHOWING THE CONFIGURATION OF SYSTEM TESTED	17
2.6 SUPPORT UNITS	17
3 . AC POWER LINE CONDUCTED EMISSIONS TEST	18
3.1 LIMIT	18
3.2 TEST PROCEDURE	18
3.3 DEVIATION FROM TEST STANDARD	18
3.4 TEST SETUP	19
3.5 EUT OPERATION CONDITIONS	19
3.6 TEST RESULTS	19
4 . RADIATED EMISSIONS TEST	20
4.1 LIMIT	20
4.2 TEST PROCEDURE	21
4.3 DEVIATION FROM TEST STANDARD	21
4.4 TEST SETUP	22
4.5 EUT OPERATION CONDITIONS	23
4.6 TEST RESULTS - 9 KHZ TO 30 MHZ	23
4.7 TEST RESULTS - 30 MHZ TO 1000 MHZ	23
4.8 TEST RESULTS - ABOVE 1000 MHZ	23
5 . BANDWIDTH TEST	24
5.1 LIMIT	24
5.2 TEST PROCEDURE	24
5.3 DEVIATION FROM STANDARD	24

Table of Contents	Page
5.4 TEST SETUP	24
5.5 EUT OPERATION CONDITIONS	24
5.6 TEST RESULTS	24
6 . MAXIMUM AVERAGE OUTPUT POWER TEST	25
6.1 LIMIT	25
6.2 TEST PROCEDURE	25
6.3 DEVIATION FROM STANDARD	25
6.4 TEST SETUP	25
6.5 EUT OPERATION CONDITIONS	25
6.6 TEST RESULTS	25
7 . CONDUCTED SPURIOUS EMISSIONS	26
7.1 LIMIT	26
7.2 TEST PROCEDURE	26
7.3 DEVIATION FROM STANDARD	26
7.4 TEST SETUP	26
7.5 EUT OPERATION CONDITIONS	26
7.6 TEST RESULTS	26
8 . POWER SPECTRAL DENSITY TEST	27
8.1 LIMIT	27
8.2 TEST PROCEDURE	27
8.3 DEVIATION FROM STANDARD	27
8.4 TEST SETUP	27
8.5 EUT OPERATION CONDITIONS	27
8.6 TEST RESULTS	27
9 . MEASUREMENT INSTRUMENTS LIST	28
10 . EUT TEST PHOTO	30
APPENDIX A - AC POWER LINE CONDUCTED EMISSIONS	35
APPENDIX B - RADIATED EMISSION - 9 KHZ TO 30 MHZ	38
APPENDIX C - RADIATED EMISSION - 30 MHZ TO 1000 MHZ	43
APPENDIX D - RADIATED EMISSION- ABOVE 1000 MHZ	46
APPENDIX E - BANDWIDTH	107
APPENDIX F - MAXIMUM AVERAGE OUTPUT POWER	114

Table of Contents	Page
APPENDIX G - CONDUCTED SPURIOUS EMISSIONS	121
APPENDIX H - POWER SPECTRAL DENSITY	134

REPORT ISSUED HISTORY

Report Version	Description	Issued Date
R00	Original Issue.	Aug. 03, 2020
R01	Only updated the measurement instruments list.	Aug. 24, 2020

1. SUMMARY OF TEST RESULTS

Test procedures according to the technical standard(s):

FCC Part15, Subpart C (15.247)				
Standard(s) Section	Test Item	Test Result	Judgment	Remark
15.207	AC Power Line Conducted Emissions	APPENDIX A	PASS	-----
15.247(d) 15.205(a) 15.209(a)	Radiated Emissions	APPENDIX B APPENDIX C APPENDIX D	PASS	-----
15.247(a)(2)	Bandwidth	APPENDIX E	PASS	-----
15.247(b)(3)	Maximum Average Output Power	APPENDIX F	PASS	-----
15.247(d)	Conducted Spurious Emissions	APPENDIX G	PASS	-----
15.247(e)	Power Spectral Density	APPENDIX H	PASS	-----
15.203	Antenna Requirement	-----	PASS	Note(2)

Note:

- (1) "N/A" denotes test is not applicable in this test report.
- (2) The device what use a permanently attached antenna were considered sufficient to comply with the provisions of 15.203.

1.1 TEST FACILITY

The test facilities used to collect the test data in this report is at the location of No.3,Jinshagang 1st Road, Shixia, Dalang Town, Dongguan, Guangdong, China.

BTL's Test Firm Registration Number for FCC: 357015

BTL's Designation Number for FCC: CN1240

1.2 MEASUREMENT UNCERTAINTY

ISO/IEC 17025 requires that an estimate of the measurement uncertainties associated with the emissions test results be included in the report. The measurement uncertainties given below are based on a 95% confidence level (based on a coverage factor (k=2))

The BTL measurement uncertainty as below table:

A. AC power line conducted emissions test:

Test Site	Method	Measurement Frequency Range	U, (dB)
DG-C02	CISPR	150kHz ~ 30MHz	2.60

B. Radiated emissions test:

Test Site	Method	Measurement Frequency Range	Ant. H / V	U, (dB)
DG-CB03	CISPR	9kHz ~ 30MHz	V	3.79
		9kHz ~ 30MHz	H	3.57
		30MHz ~ 200MHz	V	4.88
		30MHz ~ 200MHz	H	4.14
		200MHz ~ 1,000MHz	V	4.62
		200MHz ~ 1,000MHz	H	4.80
		1GHz ~ 6GHz	-	4.58
		6GHz ~ 18GHz	-	5.18
		18GHz ~ 26.5GHz	-	3.62
		26.5GHz ~ 40GHz	-	4.00

C. Other Measurement:

Parameter	Uncertainty
Bandwidth	±3.8 %
Maximum Average Output Power	±0.95 dB
Conducted Spurious Emission	±2.71 dB
Power Spectral Density	±0.86 dB
Temperature	±0.08 °C
Time	±0.58 %
Supply voltages	±0.3 %

Note: Unless specifically mentioned, the uncertainty of measurement has not been taken into account to declare the compliance or non-compliance to the specification.

1.3 TEST ENVIRONMENT CONDITIONS

Test Item	Temperature	Humidity	Test Voltage	Tested By
AC Power Line Conducted Emissions	25°C	53%	AC 120V/60Hz	Sheldon Ou
Radiated Emissions-9K-30MHz	25°C	60%	AC 120V/60Hz	Sheldon Ou
Radiated Emissions-30 MHz to 1GHz	22°C	52%	AC 120V/60Hz	Sheldon Ou
Radiated Emissions-Above 1000 MHz	24°C	60%	AC 120V/60Hz	Sheldon Ou
Bandwidth	24°C	52%	AC 120V/60Hz	Hayden Chen
Maximum Average Output Power	24°C	52%	AC 120V/60Hz	Laughing Zhang
Conducted Spurious Emissions	24°C	52%	AC 120V/60Hz	Hayden Chen
Power Spectral Density	24°C	52%	AC 120V/60Hz	Hayden Chen

2. GENERAL INFORMATION

2.1 GENERAL DESCRIPTION OF EUT

Equipment	AX3000 Whole Home Mesh Wi-Fi 6 System
Brand Name	tp-link
Test Model	Deco X60
Series Model	N/A
Model Difference(s)	N/A
Power Source	DC voltage supplied from AC adapter. Model: T120200-2B4
Power Rating	I/P: 100-240V~ 50/60Hz 0.8A O/P: 12V === 2A
Operation Frequency	2412 MHz ~ 2462 MHz
Modulation Type	IEEE 802.11b: DSSS IEEE 802.11g: OFDM IEEE 802.11n: OFDM IEEE 802.11ax: OFDMA
Bit Rate of Transmitter	IEEE 802.11b: 11/5.5/2/1 Mbps IEEE 802.11g: 54/48/36/24/18/12/9/6 Mbps IEEE 802.11n: up to 300 Mbps IEEE 802.11ax: up to 573.6 Mbps
Maximum Average Output Power	IEEE 802.11b: 25.93 dBm (0.3917 W) IEEE 802.11g: 25.54 dBm (0.3581 W) IEEE 802.11n (HT20): 25.80 dBm (0.3802 W) IEEE 802.11n (HT40): 24.79 dBm (0.3013 W) IEEE 802.11ax (HEW20): 25.94 dBm (0.3926 W) IEEE 802.11ax (HEW40): 25.21 dBm (0.3319 W)



Note:

- For a more detailed features description, please refer to the manufacturer's specifications or the user's manual.

2. Channel List:

CH01 - CH11 for IEEE 802.11b, IEEE 802.11g, IEEE 802.11n (HT20), IEEE 802.11ax (HEW20) CH03 - CH09 for IEEE 802.11n (HT40), IEEE 802.11ax (HEW40)							
Channel	Frequency (MHz)	Channel	Frequency (MHz)	Channel	Frequency (MHz)	Channel	Frequency (MHz)
01	2412	04	2427	07	2442	10	2457
02	2417	05	2432	08	2447	11	2462
03	2422	06	2437	09	2452		

3. Antenna Specification:

Ant.	Brand	Model Name	Antenna Type	Connector	Gain (dBi)
1		3101502756	Dipole	I-PEX	1.93
2		3101502757	Dipole	I-PEX	1.94

Note:

This EUT supports CDD, and antenna gains are not equal, so

$$\text{Directional gain} = 10 \log \left[\frac{10^{G1/20} + 10^{G2/20} + \dots + 10^{GN/20}}{N} \right] \text{dBi} = 10 \log \left[\frac{10^{1.93/20} + 10^{1.94/20}}{2} \right] = 4.95 \text{dB}.$$

4. Table for Antenna Configuration:

Operating Mode	TX Mode	2TX
802.11b		V (Ant. 1 + Ant. 2)
802.11g		V (Ant. 1 + Ant. 2)
IEEE 802.11n (HT20)		V (Ant. 1 + Ant. 2)
IEEE 802.11n (HT40)		V (Ant. 1 + Ant. 2)
IEEE 802.11ax (HEW20)		V (Ant. 1 + Ant. 2)
IEEE 802.11ax (HEW40)		V (Ant. 1 + Ant. 2)

2.2 DESCRIPTION OF TEST MODES

The test system was pre-tested based on the consideration of all possible combinations of EUT operation mode.

Pretest Mode	Description
Mode 1	TX B Mode Channel 01/06/11
Mode 2	TX G Mode Channel 01/06/11
Mode 3	TX N-20 MHz Mode Channel 01/06/11
Mode 4	TX N-40 MHz Mode Channel 03/06/09
Mode 5	TX AX-20 MHz Mode Channel 01/06/11
Mode 6	TX AX-40 MHz Mode Channel 03/06/09
Mode 7	TX AX-20 MHz Mode Channel 06
Mode 8	TX B Mode Channel 01/02/06/10/11
Mode 9	TX G Mode Channel 01/02/06/10/11
Mode 10	TX N-20 MHz Mode Channel 01/02/06/10/11
Mode 11	TX N-40 MHz Mode Channel 03/04/06/08/09
Mode 12	TX AX-20 MHz Mode Channel 01/02/06/10/11
Mode 13	TX AX-40 MHz Mode Channel 03/04/06/08/09

Following mode(s) was (were) found to be the worst case(s) and selected for the final test.

AC power line conducted emissions test	
Final Test Mode	Description
Mode 7	TX AX-20 MHz Mode Channel 06

Radiated emissions test - Below 1GHz	
Final Test Mode	Description
Mode 7	TX AX-20 MHz Mode Channel 06

Radiated emissions test- Above 1GHz	
Final Test Mode	Description
Mode 8	TX B Mode Channel 01/02/06/10/11
Mode 9	TX G Mode Channel 01/02/06/10/11
Mode 10	TX N-20 MHz Mode Channel 01/02/06/10/11
Mode 11	TX N-40 MHz Mode Channel 03/04/06/08/09
Mode 12	TX AX-20 MHz Mode Channel 01/02/06/10/11
Mode 13	TX AX-40 MHz Mode Channel 03/04/06/08/09

Conducted test	
Final Test Mode	Description
Mode 1	TX B Mode Channel 01/06/11
Mode 2	TX G Mode Channel 01/06/11
Mode 3	TX N-20 MHz Mode Channel 01/06/11
Mode 4	TX N-40 MHz Mode Channel 03/06/09
Mode 5	TX AX-20 MHz Mode Channel 01/06/11
Mode 6	TX AX-40 MHz Mode Channel 03/06/09

NOTE:

- (1) The measurements are performed at the high, middle, low available channels.
- (2) All the bit rate of transmitter have been tested and found the lowest rate is found to be the worst case and recorded.
- (3) For radiated emission below 1 GHz test, the IEEE 802.11ax (HEW20) Channel 06 is found to be the worst case and recorded.
- (4) For radiated emission above 1 GHz test, 1GHz~26.5GHz have been pre-tested and in this report only recorded the worst case. The remaining spurious points are all below the limit value of 20dB.
- (5) 802.11ax full RU mode was evaluated and measured inside report.
- (6) Radiated emissions above 1GHz have tested the vertical and horizontal polarities, the worst case is vertical, and only the worst case recorded in this report.

2.3 PARAMETERS OF TEST SOFTWARE

Test Software	QSPR		
Frequency (MHz)	2412	2437	2462
IEEE 802.11b	22	22	22
IEEE 802.11g	20.5	22.5	19.5
IEEE 802.11n (HT20)	22	23	21
IEEE 802.11ax (HEW20)	21	23	21
Frequency (MHz)	2422	2437	2452
IEEE 802.11n (HT40)	18.5	21	17.5
IEEE 802.11ax (HEW40)	19.5	21.5	17.5

2.4 DUTY CYCLE

If duty cycle is $\geq 98\%$, duty factor is not required.
 If duty cycle is $< 98\%$, duty factor shall be considered.
 The output power = measured power + duty factor.

IEEE 802.11b

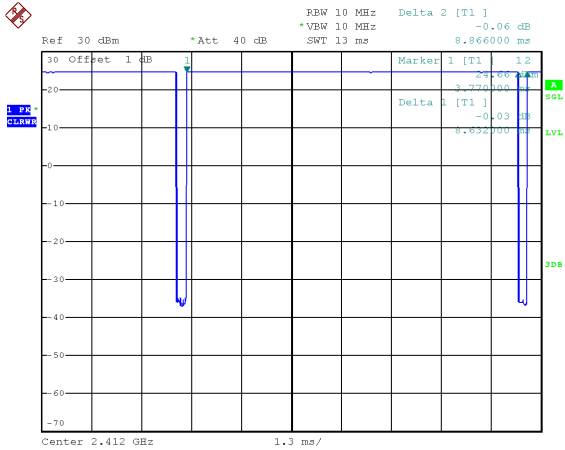

Date: 1.JUL.2020 11:23:22

Duty cycle = $8.632 \text{ ms} / 8.866 \text{ ms} = 97.36\%$
 Duty Factor = $10 \log(1/\text{Duty cycle}) = 0.12$

IEEE 802.11g

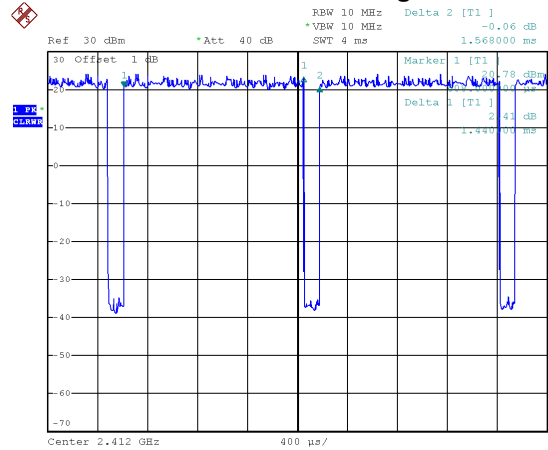

Date: 1.JUL.2020 11:23:45

Duty cycle = $1.440 \text{ ms} / 1.568 \text{ ms} = 91.84\%$
 Duty Factor = $10 \log(1/\text{Duty cycle}) = 0.37$

IEEE 802.11n (HT20)

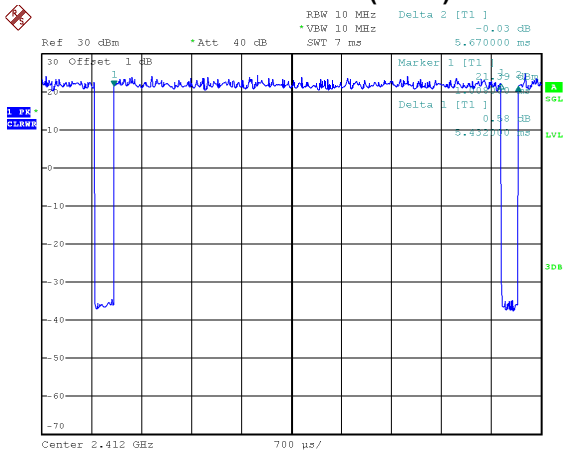

Date: 1.JUL.2020 11:24:14

Duty cycle = $5.432 \text{ ms} / 5.670 \text{ ms} = 95.80\%$
 Duty Factor = $10 \log(1/\text{Duty cycle}) = 0.19$

IEEE 802.11n (HT40)

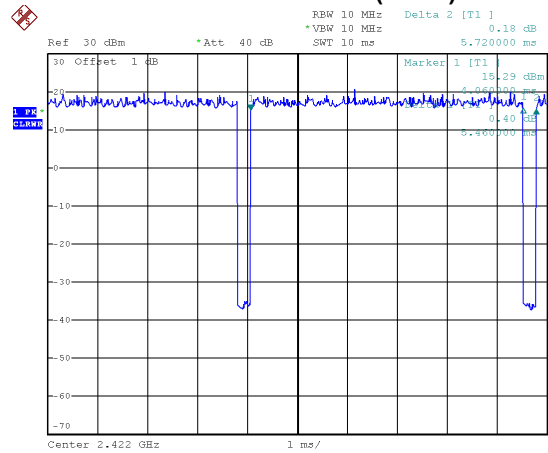

Date: 1.JUL.2020 11:24:37

Duty cycle = $5.460 \text{ ms} / 5.720 \text{ ms} = 95.45\%$
 Duty Factor = $10 \log(1/\text{Duty cycle}) = 0.20$

IEEE 802.11ax (HEW20)

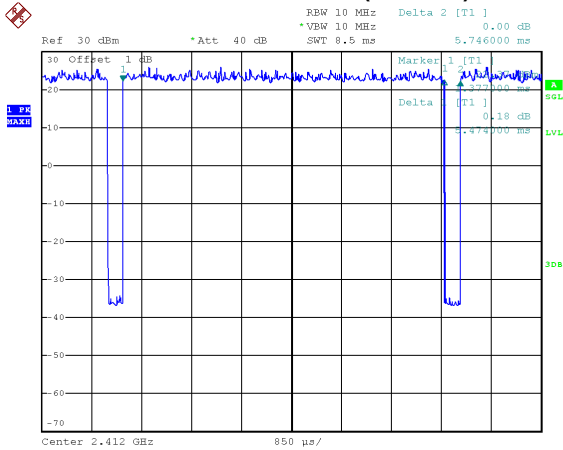

Date: 1.JUL.2020 11:27:11

Duty cycle = 5.474 ms / 5.746 ms = 95.27%
 Duty Factor = 10 log(1/Duty cycle) = 0.21

IEEE 802.11ax (HEW40)

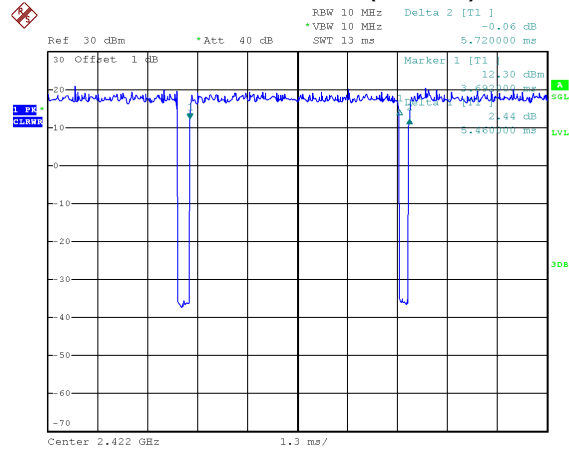

Date: 1.JUL.2020 11:27:38

Duty cycle = 5.460 ms / 5.720 ms = 95.45%
 Duty Factor = 10 log(1/Duty cycle) = 0.20

NOTE:

For IEEE 802.11b, IEEE 802.11g, IEEE 802.11n (HT20) and IEEE 802.11ax (HEW20):
 For radiated emissions frequency above 1 GHz, the resolution bandwidth of test receiver/spectrum analyzer is 1 MHz and the video bandwidth is 1 kHz (Duty cycle < 98%).

For IEEE 802.11n (HT40) and IEEE 802.11ax (HEW40):
 For radiated emissions frequency above 1 GHz, the resolution bandwidth of test receiver/spectrum analyzer is 1 MHz and the video bandwidth is 2 kHz (Duty cycle < 98%).

2.5 BLOCK DIAGRAM SHOWING THE CONFIGURATION OF SYSTEM TESTED

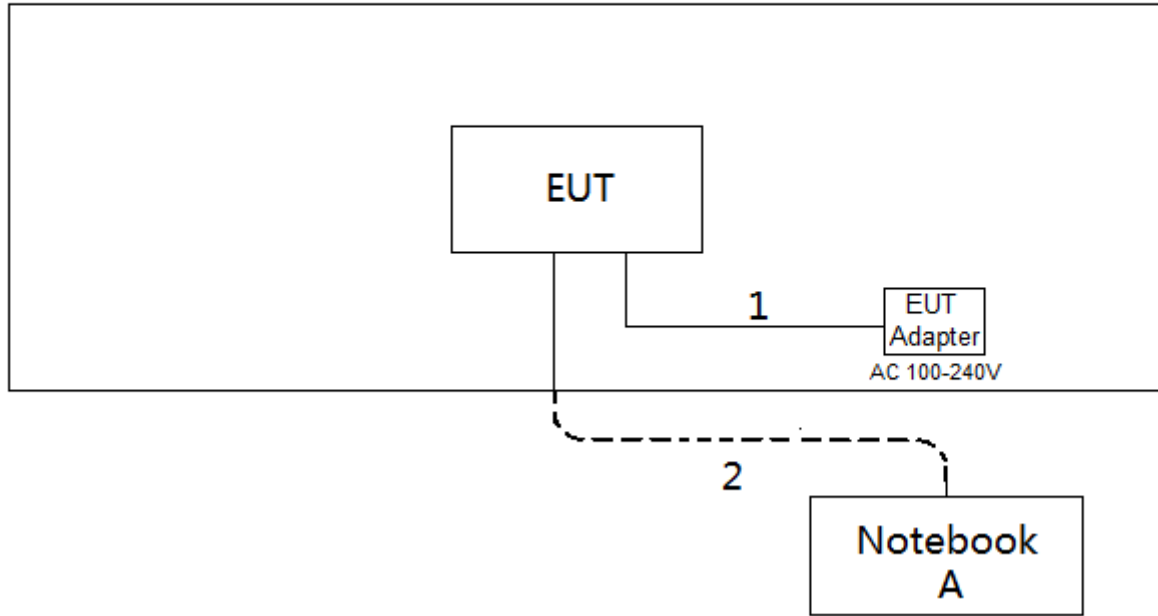

2.6 SUPPORT UNITS

Item	Equipment	Brand	Model No.	Series No.
A	Notebook	Dell	Inspiron 15-7559	N/A

Item	Cable Type	Shielded Type	Ferrite Core	Length
1	DC Cable	NO	NO	1.5m
2	RJ45 Cable	NO	NO	10m

3. AC POWER LINE CONDUCTED EMISSIONS TEST

3.1 LIMIT

Frequency of Emission (MHz)	Limit (dB μ V)	
	Quasi-peak	Average
0.15 - 0.50	66 to 56*	56 to 46*
0.50 - 5.0	56	46
5.0 - 30.0	60	50

NOTE:

- (1) The tighter limit applies at the band edges.
- (2) The limit of "*" marked band means the limitation decreases linearly with the logarithm of the frequency in the range.

The following table is the setting of the receiver

Receiver Parameters	Setting
Attenuation	10 dB
Start Frequency	0.15 MHz
Stop Frequency	30 MHz
IF Bandwidth	9 kHz

3.2 TEST PROCEDURE

- a. The EUT was placed 0.8 meters from the horizontal ground plane with EUT being connected to the power mains through a line impedance stabilization network (LISN). All other support equipment powered from additional LISN(s). The LISN provide 50 Ohm/ 50uH of coupling impedance for the measuring instrument.
- b. Interconnecting cables that hang closer than 40 cm to the ground plane shall be folded back and forth in the center forming a bundle 30 to 40 cm long.
- c. I/O cables that are not connected to a peripheral shall be bundled in the center. The end of the cable may be terminated, if required, using the correct terminating impedance. The overall length shall not exceed 1 m.
- d. LISN at least 80 cm from nearest part of EUT chassis.
- e. For the actual test configuration, please refer to the related Item -EUT Test Photos.

3.3 DEVIATION FROM TEST STANDARD

No deviation

3.4 TEST SETUP

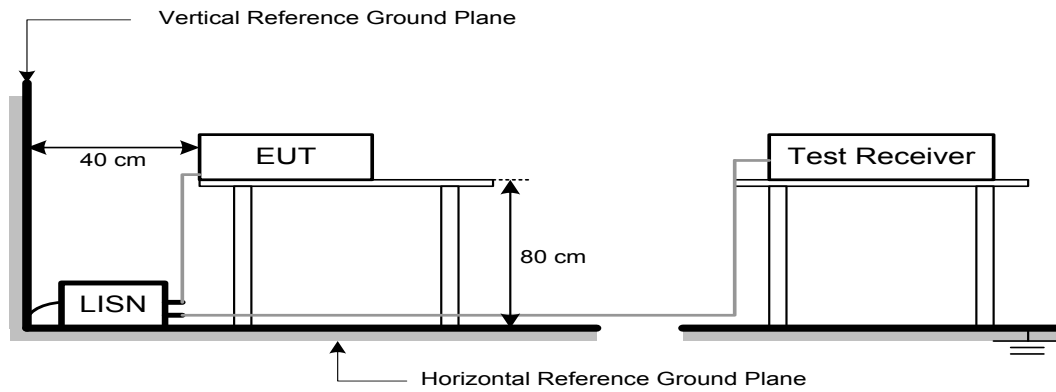

3.5 EUT OPERATION CONDITIONS

EUT was programmed to be in continuously transmitting mode.

3.6 TEST RESULTS

Please refer to the APPENDIX A.

4. RADIATED EMISSIONS TEST

4.1 LIMIT

In case the emission fall within the restricted band specified on 15.205(a), then the 15.209(a) limit in the table below has to be followed.

LIMITS OF RADIATED EMISSION MEASUREMENT (9 kHz-1000 MHz)

Frequency (MHz)	Field Strength (microvolts/meter)	Measurement Distance (meters)
0.009-0.490	2400/F(kHz)	300
0.490-1.705	24000/F(kHz)	30
1.705-30.0	30	30
30-88	100	3
88-216	150	3
216-960	200	3
Above 960	500	3

LIMITS OF RADIATED EMISSION MEASUREMENT (Above 1000 MHz)

Frequency (MHz)	(dBuV/m at 3 m)	
	Peak	Average
Above 1000	74	54

NOTE:

- (1) The limit for radiated test was performed according to FCC PART 15C.
- (2) The tighter limit applies at the band edges.
- (3) Emission level (dBuV/m)=20log Emission level (uV/m).

Spectrum Parameter	Setting
Attenuation	Auto
Start Frequency	1000 MHz
Stop Frequency	10th carrier harmonic
RBW / VBW (Emission in restricted band)	1 MHz / 3 MHz for Peak, 1 MHz / 1/T for Average

Receiver Parameter	Setting
Attenuation	Auto
Start ~ Stop Frequency	9 kHz~90 kHz for PK/AVG detector
Start ~ Stop Frequency	90 kHz~110 kHz for QP detector
Start ~ Stop Frequency	110 kHz~490 kHz for PK/AVG detector
Start ~ Stop Frequency	490 kHz~30 MHz for QP detector
Start ~ Stop Frequency	30 MHz~1000 MHz for QP detector

4.2 TEST PROCEDURE

- a. The measuring distance of 3 m shall be used for measurements. The EUT was placed on the top of a rotating table 0.8 meter above the ground at a 3 meter semi-anechoic chamber. The table was rotated 360 degrees to determine the position of the highest radiation.(below 1 GHz)
- b. The measuring distance of 3 m shall be used for measurements. The EUT was placed on the top of a rotating table 1.5 meter above the ground at a 3 meter semi-anechoic chamber. The table was rotated 360 degrees to determine the position of the highest radiation.(above 1 GHz)
- c. The height of the equipment or of the substitution antenna shall be 0.8m or 1.5m; the height of the test antenna shall vary between 1 m to 4 m. Both horizontal and vertical polarizations of the antenna are set to make the measurement.
- d. For each suspected emission, the EUT was arranged to its worst case and then the antenna was tuned to heights find the maximum reading (used Bore sight function).
- e. The receiver system was set to peak and average detect function and specified bandwidth with maximum hold mode when the test frequency is above 1 GHz.
- f. The initial step in collecting radiated emission data is a receiver peak detector mode pre-scanning the measurement frequency range. Significant peaks are then marked and then Quasi Peak detector mode re-measured.
- g. All readings are Peak unless otherwise stated QP in column of Note. Peak denotes that the Peak reading compliance with the QP Limits and then QP Mode measurement didn't perform.
(below 1 GHz)
- h. All readings are Peak Mode value unless otherwise stated AVG in column of Note. If the Peak Mode Measured value compliance with the Peak Limits and lower than AVG Limits, the EUT shall be deemed to meet both Peak & AVG Limits and then only Peak Mode was measured, but AVG Mode didn't perform. (above 1 GHz)
- i. For the actual test configuration, please refer to the related Item -EUT Test Photos.

4.3 DEVIATION FROM TEST STANDARD

No deviation

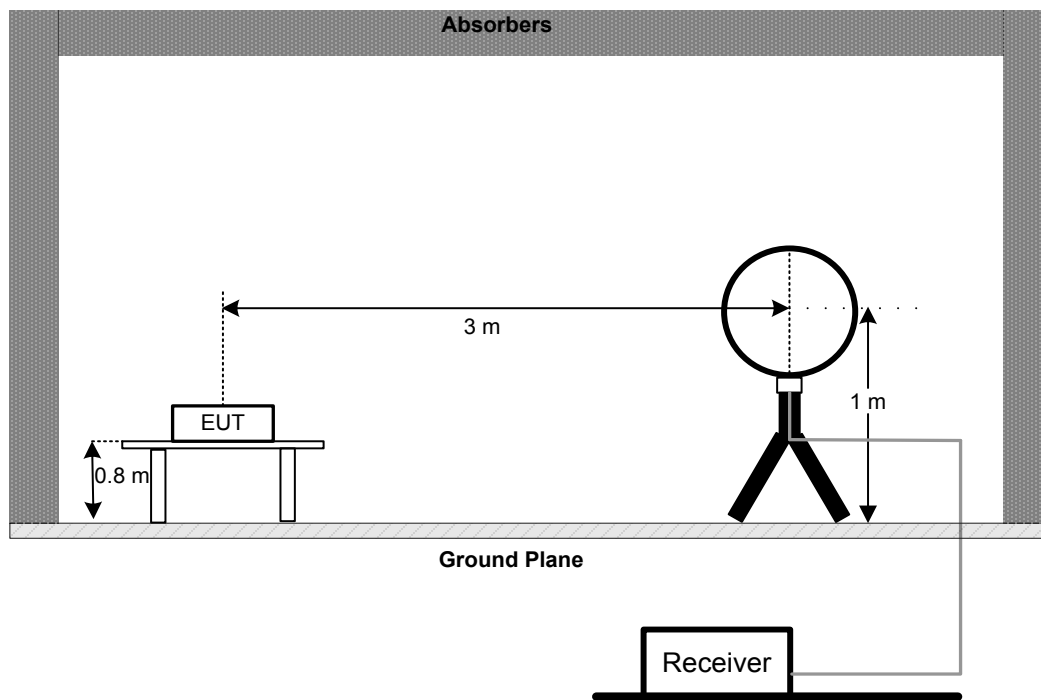
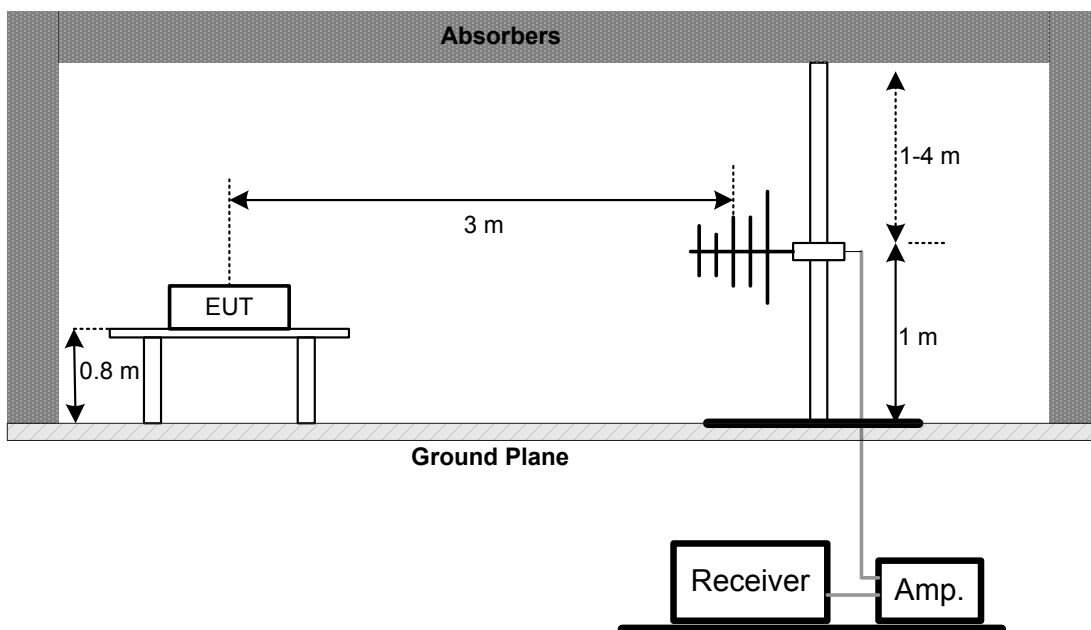
4.4 TEST SETUP**9 kHz-30 MHz****30 MHz to 1 GHz**

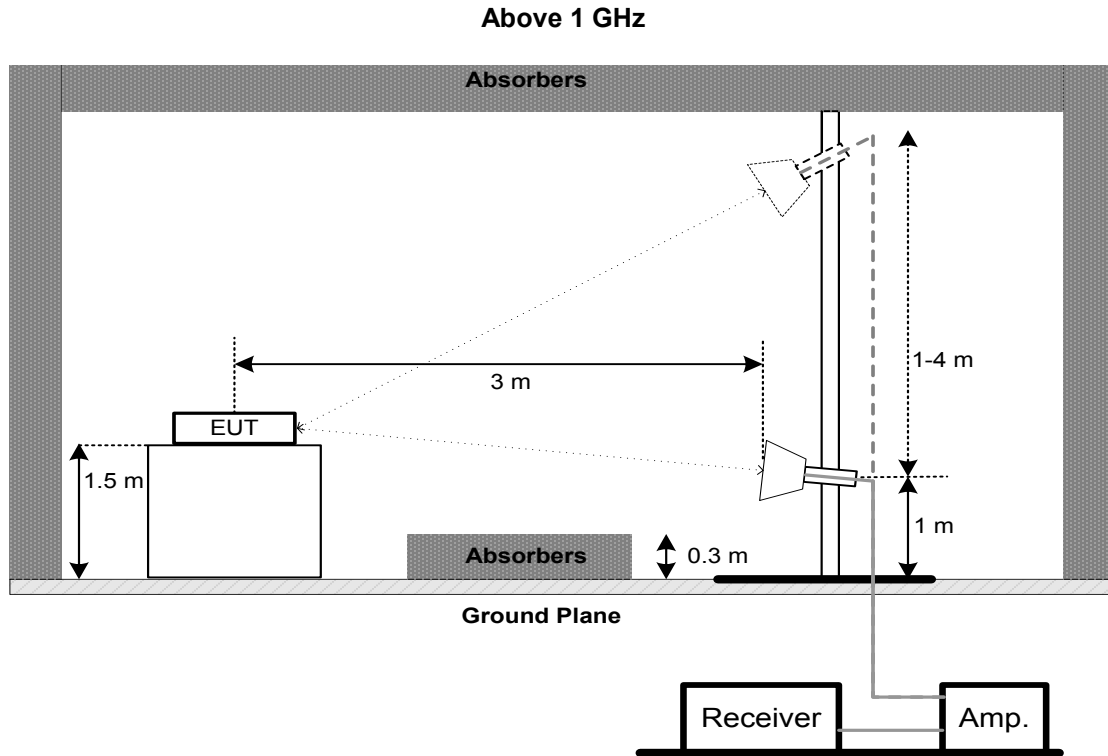

4.5 EUT OPERATION CONDITIONS

The EUT was programmed to be in continuously transmitting mode.

4.6 TEST RESULTS - 9 KHZ TO 30 MHZ

Please refer to the APPENDIX B

Remark:

- (1) Distance extrapolation factor = $40 \log (\text{specific distance} / \text{test distance})$ (dB).
- (2) Limit line = specific limits (dBuV) + distance extrapolation factor.

4.7 TEST RESULTS - 30 MHZ TO 1000 MHZ

Please refer to the APPENDIX C.

4.8 TEST RESULTS - ABOVE 1000 MHZ

Please refer to the APPENDIX D.

Remark:

- (1) No limit: This is fundamental signal, the judgment is not applicable.
For fundamental signal judgment was referred to Peak output test.

5. BANDWIDTH TEST

5.1 LIMIT

FCC Part15, Subpart C (15.247)		
Section	Test Item	Limit
15.247(a)(2)	6 dB Bandwidth	Minimum 500 kHz
	99% Emission Bandwidth	-

5.2 TEST PROCEDURE

- a. The EUT was directly connected to the spectrum analyzer and antenna output port as show in the block diagram below.
- b. Spectrum Setting:
 - For 6 dB Bandwidth: RBW= 100 kHz, VBW=300 kHz, Sweep time = auto.
 - For 99% Emission Bandwidth B/G/N-20/AX-20 Mode: RBW= 300 KHz, VBW=1 MHz, Sweep time = 2.5 ms.
 - For 99% Emission Bandwidth N-40/AX-40 Mode: RBW= 1 MHz, VBW=3 MHz, Sweep time = 2.5 ms.
- c. The bandwidth was performed in accordance with method 11.8.1 of ANSI C63.10-2013.

5.3 DEVIATION FROM STANDARD

No deviation.

5.4 TEST SETUP

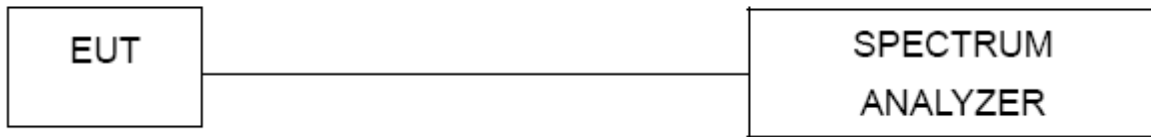

5.5 EUT OPERATION CONDITIONS

The EUT was programmed to be in continuously transmitting mode.

5.6 TEST RESULTS

Please refer to the APPENDIX E.

6. MAXIMUM AVERAGE OUTPUT POWER TEST

6.1 LIMIT

FCC Part15, Subpart C (15.247)		
Section	Test Item	Limit
15.247(b)(3)	Maximum Average Output Power	1 Watt or 30dBm

6.2 TEST PROCEDURE

- The EUT was directly connected to the power meter and antenna output port as show in the block diagram below.
- The maximum conducted output power was performed in accordance with method 11.9.2.3.1 of ANSI C63.10-2013 and FCC KDB 662911 D01 v02r01 Multiple Transmitter Output.

6.3 DEVIATION FROM STANDARD

No deviation.

6.4 TEST SETUP



6.5 EUT OPERATION CONDITIONS

The EUT was programmed to be in continuously transmitting mode.

6.6 TEST RESULTS

Please refer to the APPENDIX F.

7. CONDUCTED SPURIOUS EMISSIONS

7.1 LIMIT

In any 100 kHz bandwidth outside the frequency band in which the spread spectrum or digitally modulated intentional radiator is operating, the radio frequency power that is produced by the intentional radiator shall be at least 20 dB below that in the 100 kHz bandwidth within the band that contains the highest level of the desired power, based on either an RF conducted or a radiated measurement, provided the transmitter demonstrates compliance with the peak Output Power limits. If the transmitter complies with the Output Power limits based on the use of RMS averaging over a time interval, as permitted under paragraph (b)(3) of this section, the attenuation required under this paragraph shall be 30 dB instead of 20 dB. Attenuation below the general limits specified in Section 15.209(a) is not required.

7.2 TEST PROCEDURE

- a. The EUT was directly connected to the spectrum analyzer and antenna output port as show in the block diagram below.
- b. Spectrum Setting: RBW= 100 kHz, VBW=300 kHz, Sweep time = Auto.

7.3 DEVIATION FROM STANDARD

No deviation.

7.4 TEST SETUP

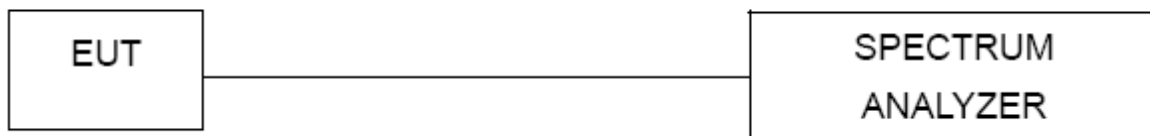

7.5 EUT OPERATION CONDITIONS

The EUT was programmed to be in continuously transmitting mode.

7.6 TEST RESULTS

Please refer to the APPENDIX G.

8. POWER SPECTRAL DENSITY TEST

8.1 LIMIT

FCC Part15, Subpart C (15.247)		
Section	Test Item	Limit
15.247(e)	Power Spectral Density	8 dBm (in any 3 kHz)

8.2 TEST PROCEDURE

- The EUT was directly connected to the spectrum analyzer and antenna output port as show in the block diagram below.
- Spectrum Setting: RBW=3 kHz, VBW=10 kHz, Sweep time = Auto.
- The Power Spectral Density was performed in accordance with method 11.10.2 of ANSI C63.10-2013.

8.3 DEVIATION FROM STANDARD

No deviation.

8.4 TEST SETUP

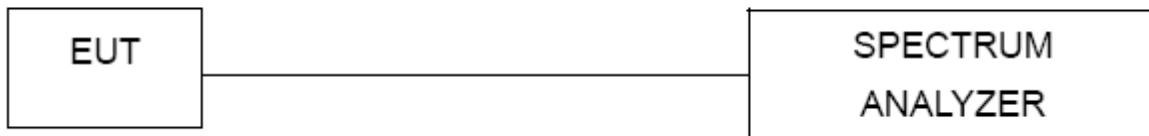

8.5 EUT OPERATION CONDITIONS

The EUT was programmed to be in continuously transmitting mode.

8.6 TEST RESULTS

Please refer to the APPENDIX H.

9. MEASUREMENT INSTRUMENTS LIST

AC Power Line Conducted Emissions					
Item	Kind of Equipment	Manufacturer	Type No.	Serial No.	Calibrated until
1	EMI Test Receiver	R&S	ESCI	100382	Feb. 28, 2021
2	LISN	EMCO	3816/2	52765	Mar. 01, 2021
3	TWO-LINE V-NETWORK	R&S	ENV216	101447	Feb. 28, 2021
4	50Ω Terminator	SHX	TF5-3	15041305	Mar. 01, 2021
5	Measurement Software	Farad	EZ-EMC Ver.NB-03A1-01	N/A	N/A
6	Cable	N/A	RG223	12m	Mar. 10, 2021
7	Shielded Room	ETS-LINDGREN	8.5*4.5*3m	N/A	N/A

Radiated Emissions - 9 kHz to 30 MHz					
Item	Kind of Equipment	Manufacturer	Type No.	Serial No.	Calibrated until
1	Antenna	EM	EM-6876-1	230	Apr. 16, 2021
2	Cable	N/A	RG 213/U	N/A	May 29, 2021
3	EMI Test Receiver	R&S	ESCI	100895	Feb. 28, 2021
4	Measurement Software	Farad	EZ-EMC Ver.NB-03A1-01	N/A	N/A
5	966 Chambe Room	RM	9*6*6	N/A	Jul. 25, 2021

Radiated Emissions - 30 MHz to 1 GHz					
Item	Kind of Equipment	Manufacturer	Type No.	Serial No.	Calibrated until
1	Antenna	Schwarzbeck	VULB9160	9160-3232	Mar. 09, 2021
2*	Amplifier	HP	8447D	2944A09673	Aug. 11, 2021
3	Receiver	Agilent	N9038A	MY52130039	Aug. 03, 2020
4	Cable	emci	LMR-400(30MHz-1 GHz)(8m+5m)	N/A	May 22, 2021
5	Controller	CT	SC100	N/A	N/A
6	Controller	MF	MF-7802	MF780208416	N/A
7	Measurement Software	Farad	EZ-EMC Ver.NB-03A1-01	N/A	N/A
8	966 Chambe Room	RM	9*6*6	N/A	Jul. 25, 2021

Radiated Emissions - Above 1 GHz					
Item	Kind of Equipment	Manufacturer	Type No.	Serial No.	Calibrated until
1	Double Ridged Guide Antenna	ETS	3115	75789	May 12, 2021
2	Broad-Band Horn Antenna	Schwarzbeck	BBHA 9170	9170319	Jul. 07, 2021
3	Amplifier	Agilent	8449B	3008A02333	Mar. 01, 2021
4	Microwave Preampifier With Adaptor	EMC INSTRUMENT	EMC2654045	980039 & HA01	Mar. 07, 2021
5	Receiver	Agilent	N9038A	MY52130039	Aug. 03, 2020
6	Controller	CT	SC100	N/A	N/A
7	Controller	MF	MF-7802	MF780208416	N/A
8	Cable	N/A	EMC104-SM-SM-6000	N/A	May 09, 2021
9	Measurement Software	Farad	EZ-EMC Ver.NB-03A1-01	N/A	N/A
10	HighPass Filter	Wairwright Instruments Gmbh	WHK3.1/18G-10SS	24	Feb. 28, 2021
11	966 Chambe Room	RM	9*6*6	N/A	Jul. 25, 2021

Bandwidth & Antenna Conducted Spurious Emissions & Power Spectral Density					
Item	Kind of Equipment	Manufacturer	Type No.	Serial No.	Calibrated until
1	Spectrum Analyzer	R&S	FSP40	100185	Aug. 03, 2020
2	DC Block	Mini	N/A	N/A	N/A
3	RF Cable	Tongkaichuan	N/A	N/A	N/A

Maximum Average Output Power					
Item	Kind of Equipment	Manufacturer	Type No.	Serial No.	Calibrated until
1	Peak Power Analyzer	Keysight	8990B	MY51000506	Aug. 03, 2020
2	Wideband power sensor	Keysight	N1923A	MY58310004	Aug. 03, 2020
3	Attenuator	WOKEN	6SM3502	VAS1214NL	Feb. 11, 2021

Remark: "N/A" denotes no model name, serial no. or calibration specified.

"**" calibration period of equipment list is three year.

Except * item, all calibration period of equipment list is one year.

10. EUT TEST PHOTO**AC Power Line Conducted Emissions Test Photos**

Radiated Emissions Test Photos**9 kHz to 30 MHz**

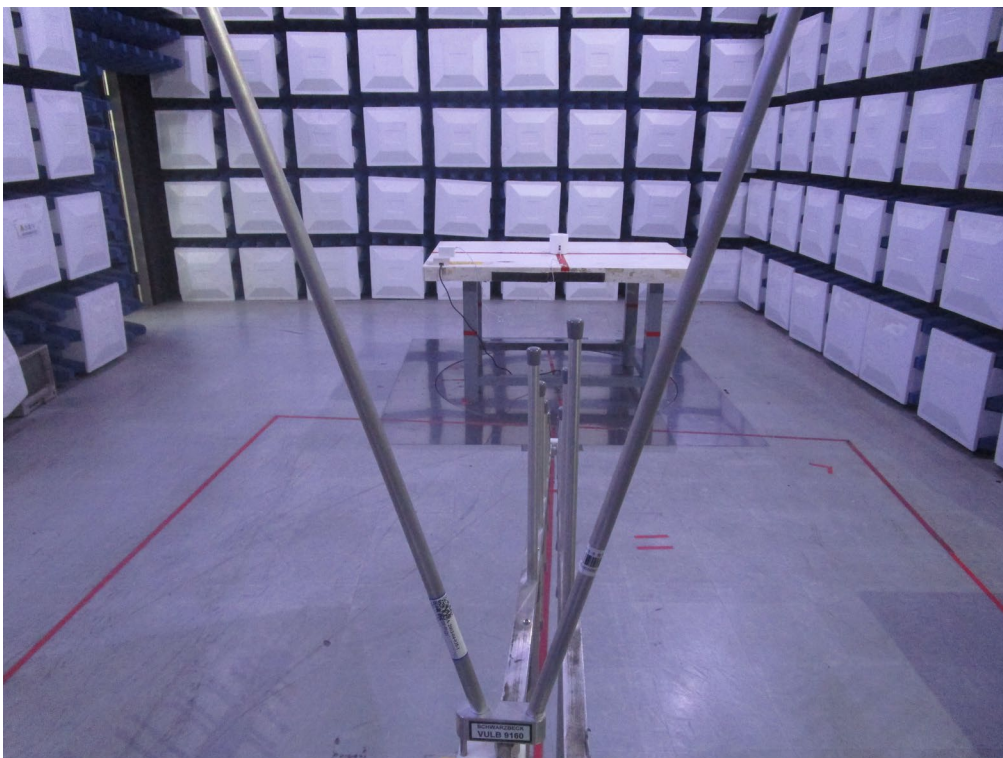
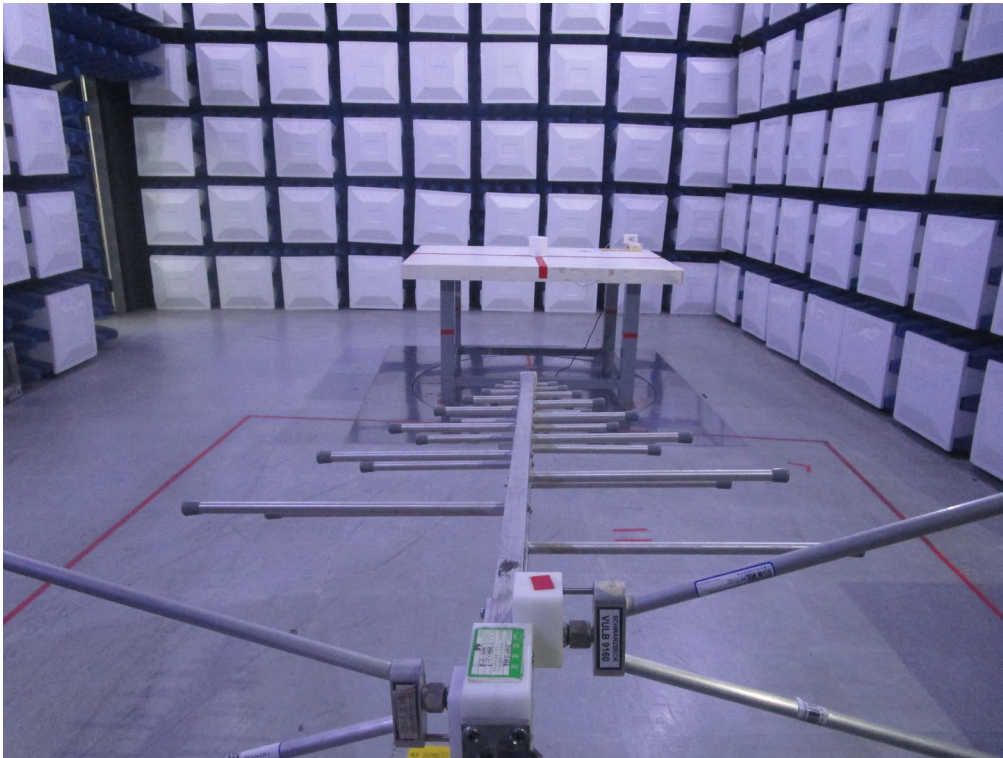
Radiated Emissions Test Photos**30 MHz to 1 GHz**

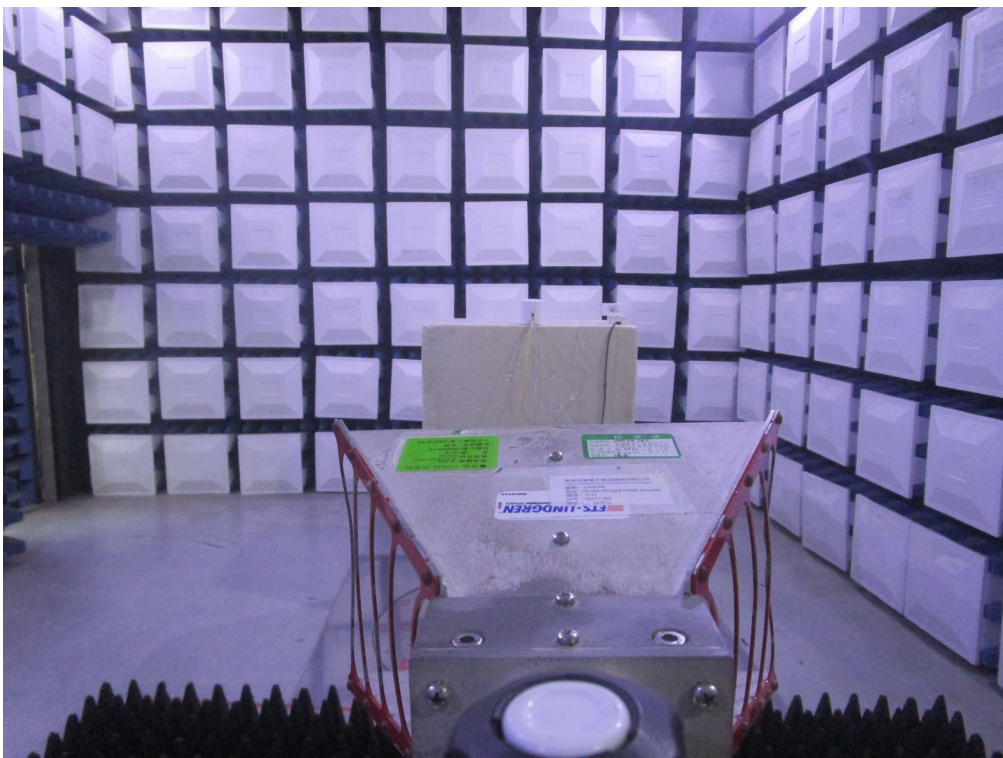
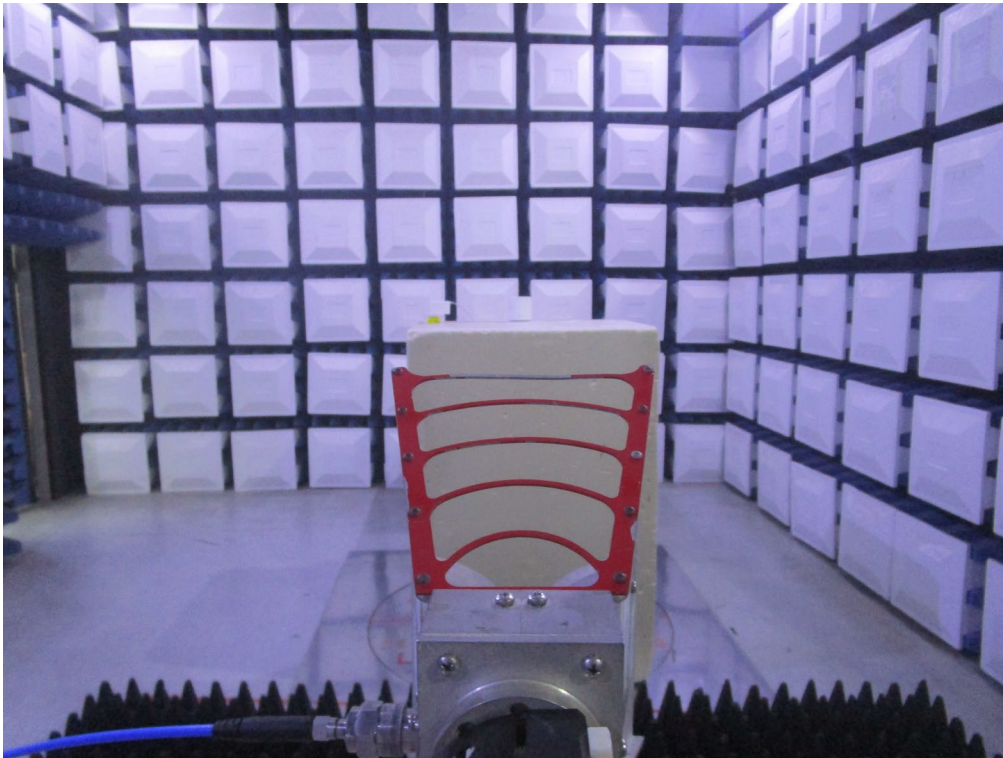
Radiated Emissions Test Photos**Above 1 GHz**

Conducted Emissions Test Photos



APPENDIX A - AC POWER LINE CONDUCTED EMISSIONS

Test Mode: TX AX-20 MHz Mode Channel 06

Line

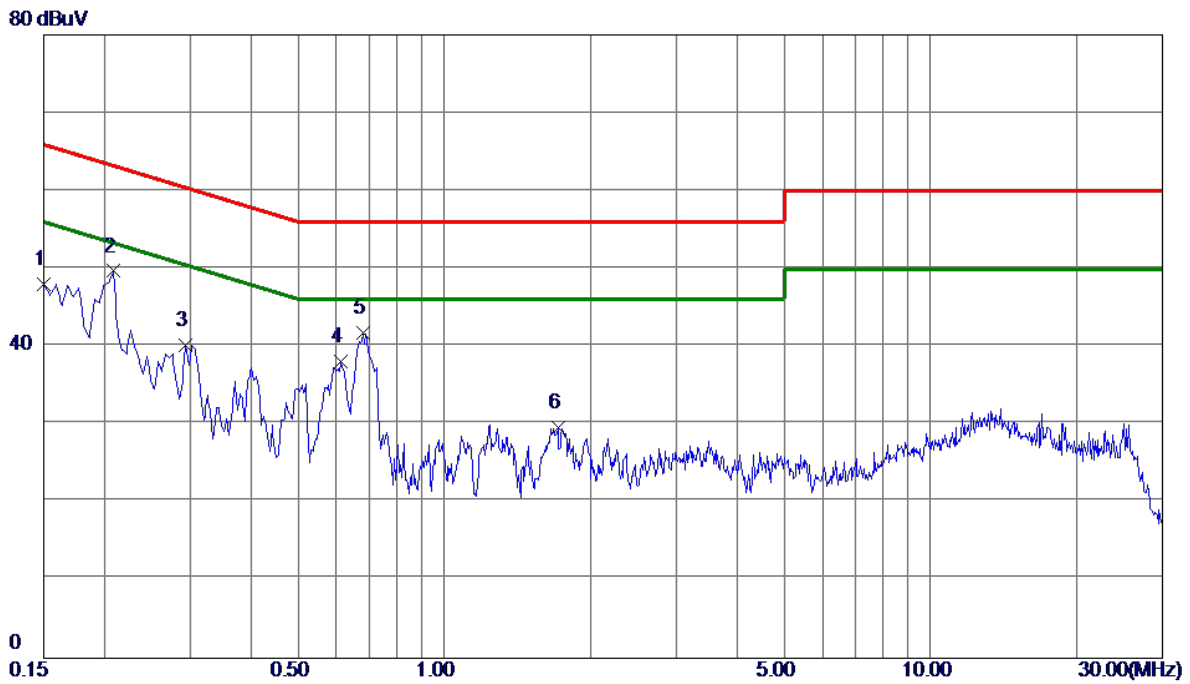

No.	Freq. MHz	Reading Level dBuV	Correct Factor dB	Measure ment dBuV	Limit dBuV	Margin dB	Detector	Comment
1	0.1500	38.34	9.67	48.01	66.00	-17.99	Peak	
2 *	0.2085	39.78	9.90	49.68	63.26	-13.58	Peak	
3	0.2940	30.32	9.89	40.21	60.41	-20.20	Peak	
4	0.6134	28.16	9.95	38.11	56.00	-17.89	Peak	
5	0.6809	31.87	9.89	41.76	56.00	-14.24	Peak	
6	1.7160	19.56	10.06	29.62	56.00	-26.38	Peak	

REMARKS:

- (1) Measurement Value = Reading Level + Correct Factor.
- (2) Margin Level = Measurement Value - Limit Value.

Test Mode: TX AX-20 MHz Mode Channel 06

Neutral

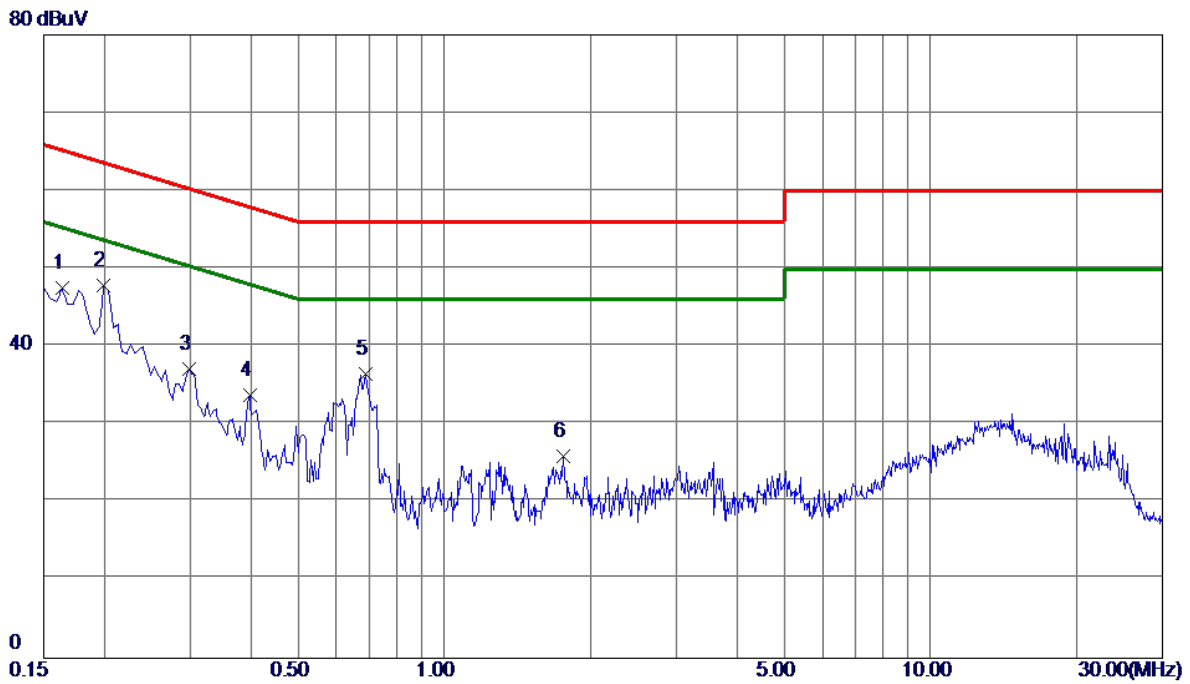

No.	Freq. MHz	Reading Level dBuV	Correct Factor dB	Measure ment dBuV	Limit dBuV	Margin dB	Detector	Comment
1	0.1635	37.71	9.85	47.56	65.28	-17.72	Peak	
2 *	0.1995	37.76	10.01	47.77	63.63	-15.86	Peak	
3	0.2985	27.15	10.02	37.17	60.28	-23.11	Peak	
4	0.3975	23.63	10.09	33.72	57.91	-24.19	Peak	
5	0.6900	26.38	10.12	36.50	56.00	-19.50	Peak	
6	1.7565	15.52	10.39	25.91	56.00	-30.09	Peak	

REMARKS:

- (1) Measurement Value = Reading Level + Correct Factor.
- (2) Margin Level = Measurement Value - Limit Value.

APPENDIX B - RADIATED EMISSION - 9 KHZ TO 30 MHZ

Test Mode: TX AX-20 MHz Mode Channel 06

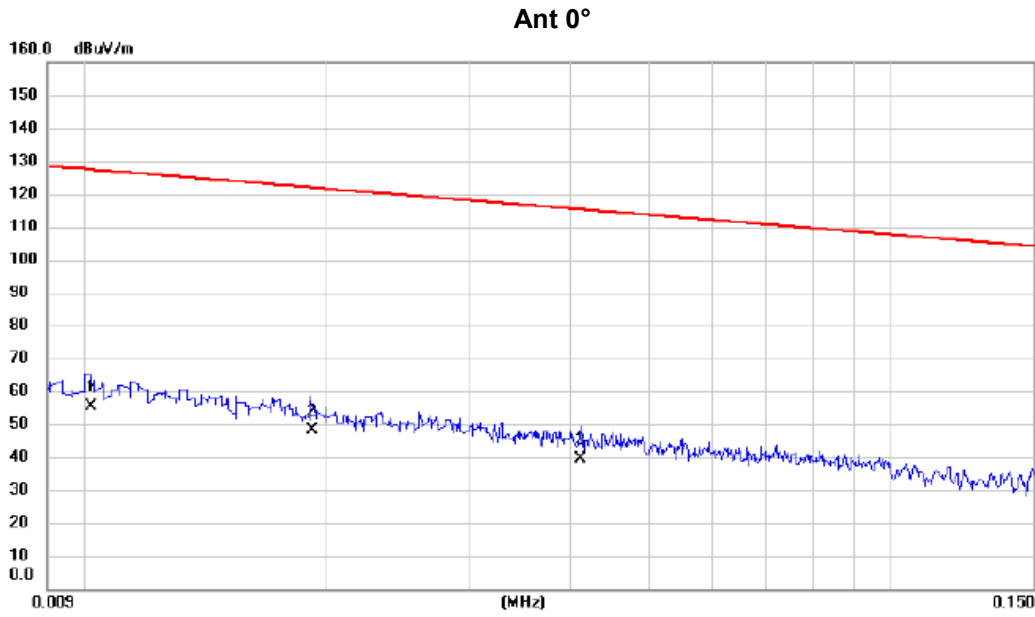

No. Mk.	Freq. MHz	Reading Level dBuV	Correct Factor dB	Measure- ment dBuV/m	Limit dBuV/m	Margin dB	Detector	Comment
1 *	0.0102	39.36	16.17	55.53	127.43	-71.90	AVG	
2	0.0192	34.67	13.38	48.05	121.94	-73.89	AVG	
3	0.0412	26.85	12.57	39.42	115.31	-75.89	AVG	

REMARKS:

- (1) Measurement Value = Reading Level + Correct Factor.
- (2) Margin Level = Measurement Value - Limit Value.

Test Mode: TX AX-20 MHz Mode Channel 06

Ant 0°

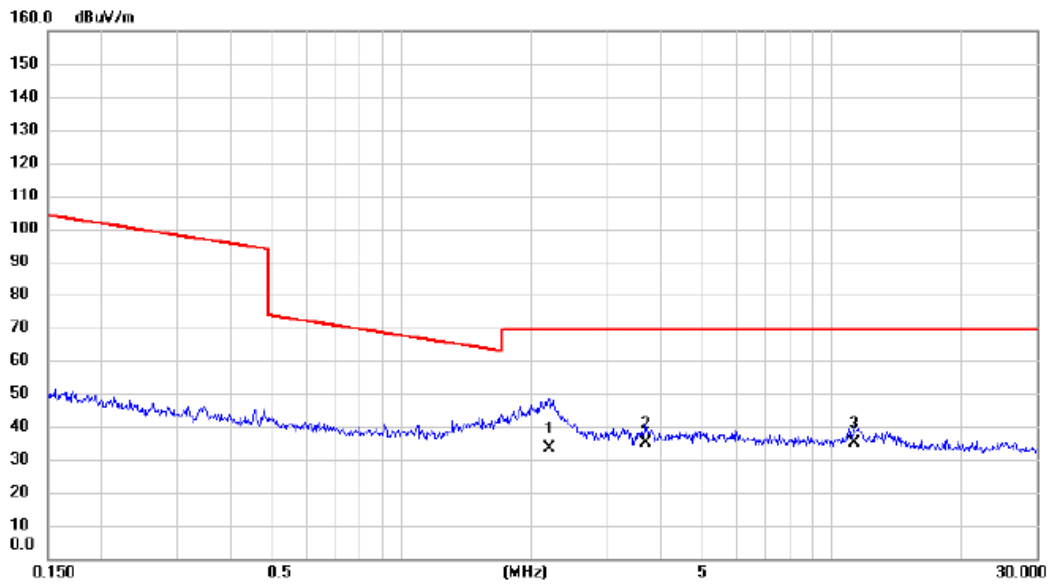

No.	Mk.	Freq.	Reading Level	Correct Factor	Measurement	Limit	Margin	Detector	Comment
		MHz	dBuV	dB	dBuV/m	dBuV/m	dB		
1		2.2015	22.37	10.97	33.34	69.54	-36.20	QP	
2	*	3.6806	24.48	10.58	35.06	69.54	-34.48	QP	
3		11.2572	23.91	11.08	34.99	69.54	-34.55	QP	

REMARKS:

(1) Measurement Value = Reading Level + Correct Factor.

(2) Margin Level = Measurement Value - Limit Value.

Test Mode: TX AX-20 MHz Mode Channel 06

Ant 90°

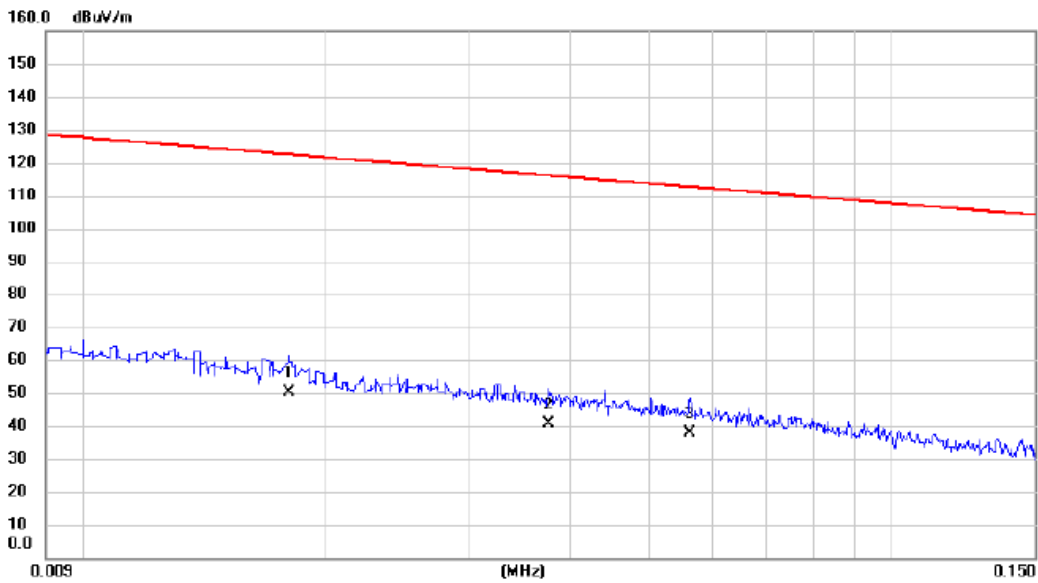

No.	Mk.	Freq.	Reading Level	Correct Factor	Measurement	Limit	Margin	Detector	Comment
		MHz	dBuV	dB	dBuV/m	dBuV/m	dB		
1	*	0.018	35.83	14.42	50.25	122.50	-72.25	AVG	
2		0.038	26.69	13.89	40.58	116.10	-75.52	AVG	
3		0.056	23.84	13.83	37.67	112.59	-74.92	AVG	

REMARKS:

- (1) Measurement Value = Reading Level + Correct Factor.
- (2) Margin Level = Measurement Value - Limit Value.

Test Mode: TX AX-20 MHz Mode Channel 06

Ant 90°

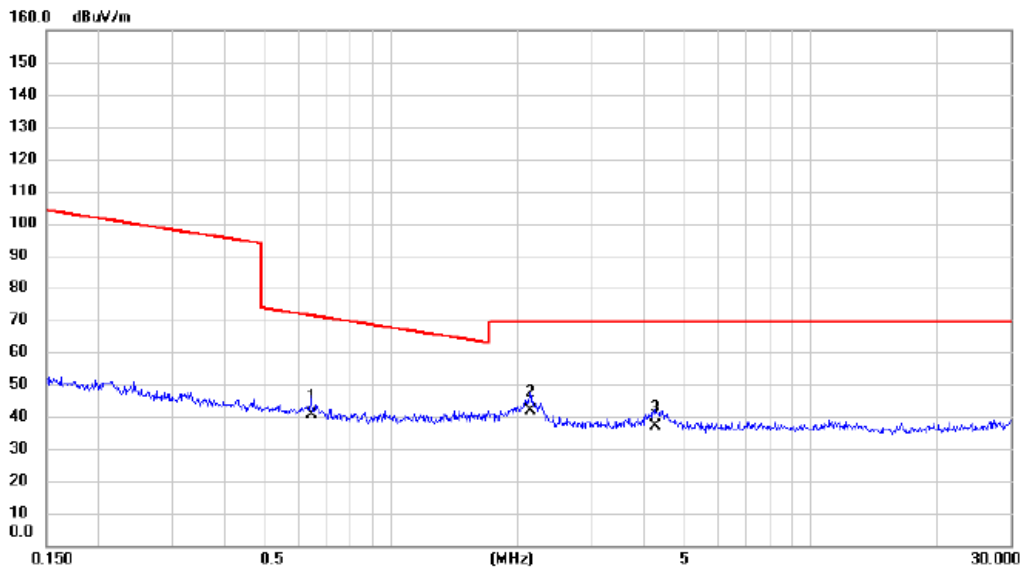

No.	Mk.	Freq.	Reading Level	Correct Factor	Measurement	Limit	Margin	Detector	Comment
		MHz	dBuV	dB	dBuV/m	dBuV/m	dB		
1		0.6440	27.79	12.78	40.57	71.43	-30.86	QP	
2	*	2.1440	29.93	11.73	41.66	69.54	-27.88	QP	
3		4.2465	26.18	10.93	37.11	69.54	-32.43	QP	

REMARKS:

- (1) Measurement Value = Reading Level + Correct Factor.
- (2) Margin Level = Measurement Value - Limit Value.

APPENDIX C - RADIATED EMISSION - 30 MHZ TO 1000 MHZ

Test Mode: TX AX-20 MHz Mode Channel 06

Vertical

80 dBuV/m

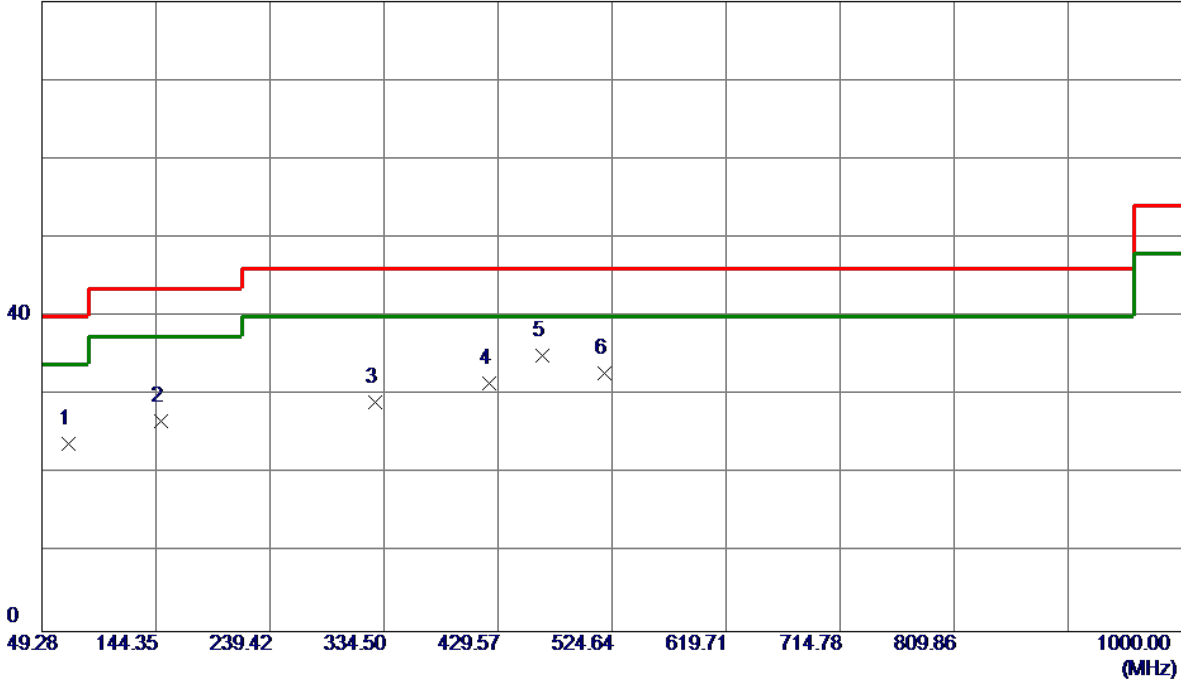

No.	Freq. MHz	Reading Level dBuV/m	Correct Factor dB	Measurement dBuV/m	Limit dBuV/m	Margin dB	Detector	Comment
1	71.1453	40.03	-16.12	23.91	40.00	-16.09	Peak	
2	148.1540	38.82	-12.07	26.75	43.50	-16.75	Peak	
3	326.8894	39.74	-10.57	29.17	46.00	-16.83	Peak	
4	421.9615	39.90	-8.40	31.50	46.00	-14.50	Peak	
5 *	466.6455	42.52	-7.51	35.01	46.00	-10.99	Peak	
6	517.9844	39.83	-7.10	32.73	46.00	-13.27	Peak	

REMARKS:

- (1) Measurement Value = Reading Level + Correct Factor.
- (2) Margin Level = Measurement Value - Limit Value.

Test Mode: TX AX-20 MHz Mode Channel 06

Horizontal

80 dBuV/m

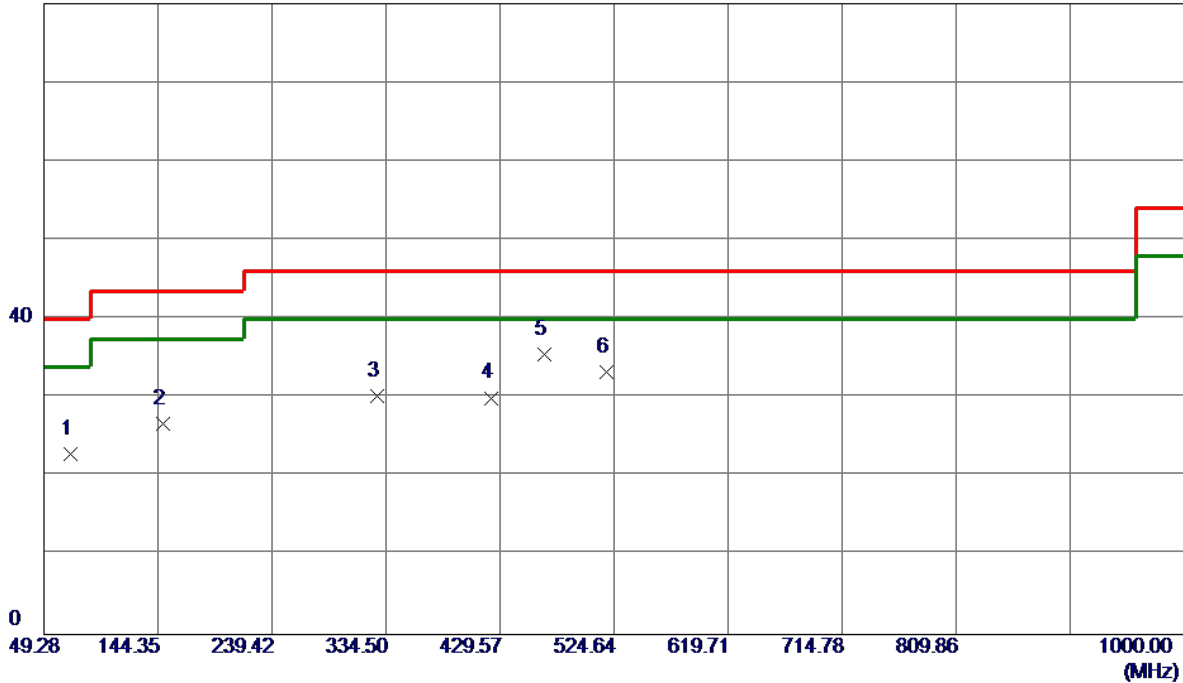

No.	Freq. MHz	Reading Level dBuV/m	Correct Factor dB	Measure ment dBuV/m	Limit dBuV/m	Margin dB	Detector	Comment
1	71.1455	39.03	-16.12	22.91	40.00	-17.09	Peak	
2	148.1540	38.82	-12.07	26.75	43.50	-16.75	Peak	
3	326.8895	40.74	-10.57	30.17	46.00	-15.83	Peak	
4	421.9616	38.40	-8.40	30.00	46.00	-16.00	Peak	
5 *	466.6455	43.02	-7.51	35.51	46.00	-10.49	Peak	
6	517.9844	40.33	-7.10	33.23	46.00	-12.77	Peak	

REMARKS:

- (1) Measurement Value = Reading Level + Correct Factor.
- (2) Margin Level = Measurement Value - Limit Value.

APPENDIX D - RADIATED EMISSION- ABOVE 1000 MHZ

Test Mode: TX B Mode 2412 MHz

Vertical

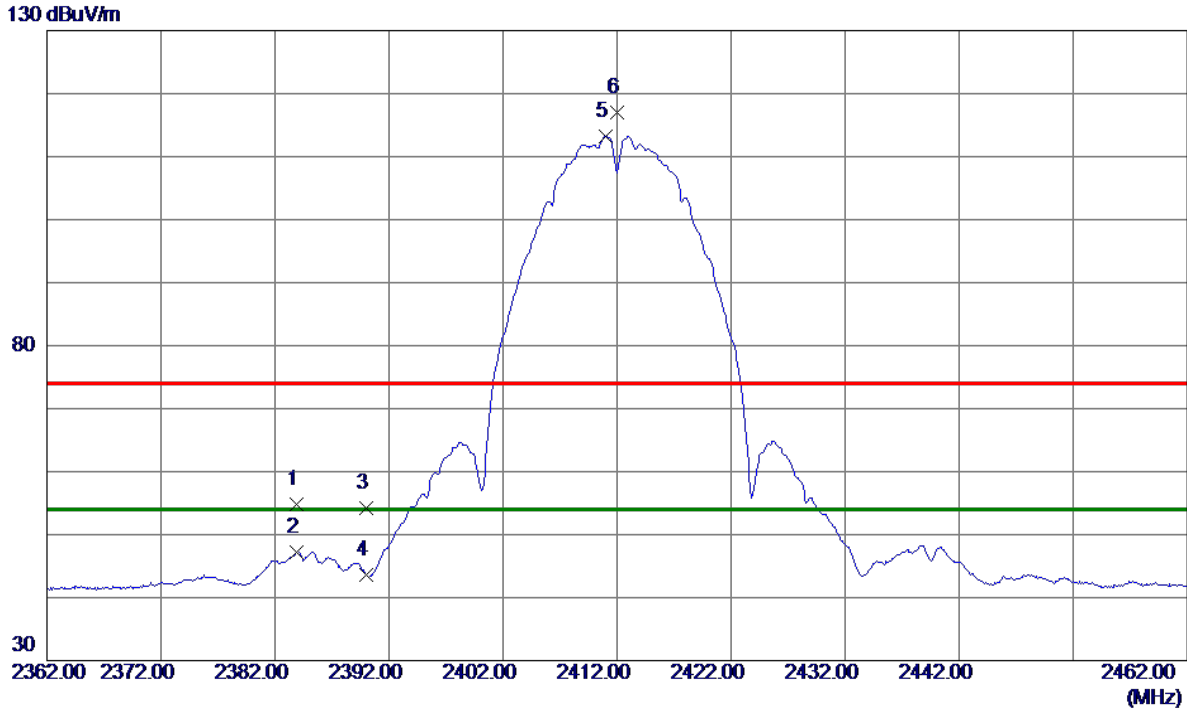

No.	Freq. MHz	Reading Level dBuV/m	Correct Factor dB	Measurement dBuV/m	Limit dBuV/m	Margin dB	Detector	Comment
1	2383.9000	44.41	10.48	54.89	74.00	-19.11	Peak	
2	2383.9000	36.81	10.48	47.29	54.00	-6.71	AVG	
3	2390.0000	43.67	10.50	54.17	74.00	-19.83	Peak	
4	2390.0000	33.03	10.50	43.53	54.00	-10.47	AVG	
5 *	2411.0000	102.67	10.56	113.23	54.00	59.23	AVG	No Limit
6	2412.0000	106.43	10.56	116.99	74.00	42.99	Peak	No Limit

REMARKS:

- (1) Measurement Value = Reading Level + Correct Factor.
- (2) Margin Level = Measurement Value - Limit Value.

Test Mode: TX B Mode 2412 MHz

Vertical

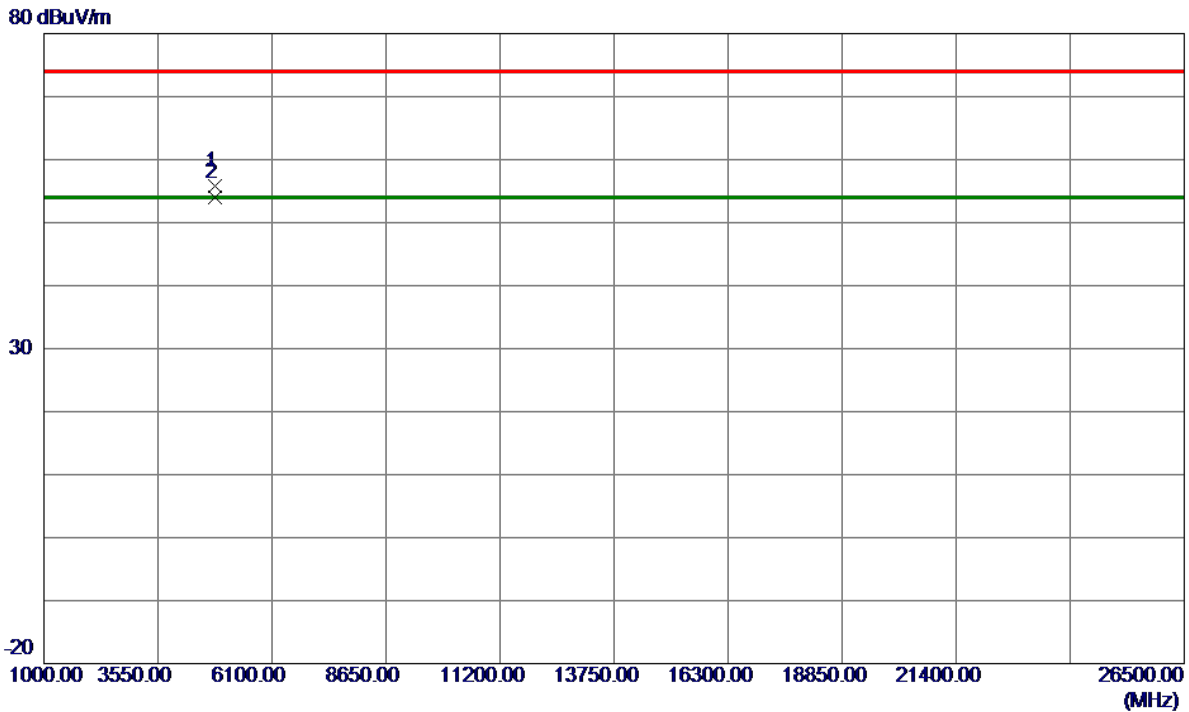

No.	Freq. MHz	Reading Level dBuV/m	Correct Factor dB	Measure ment dBuV/m	Limit dBuV/m	Margin dB	Detector	Comment
1	4823.8750	49.36	6.53	55.89	74.00	-18.11	Peak	
2 *	4823.9250	47.41	6.53	53.94	54.00	-0.06	AVG	

REMARKS:

- (1) Measurement Value = Reading Level + Correct Factor.
- (2) Margin Level = Measurement Value - Limit Value.

Test Mode: TX B Mode 2417 MHz

Vertical

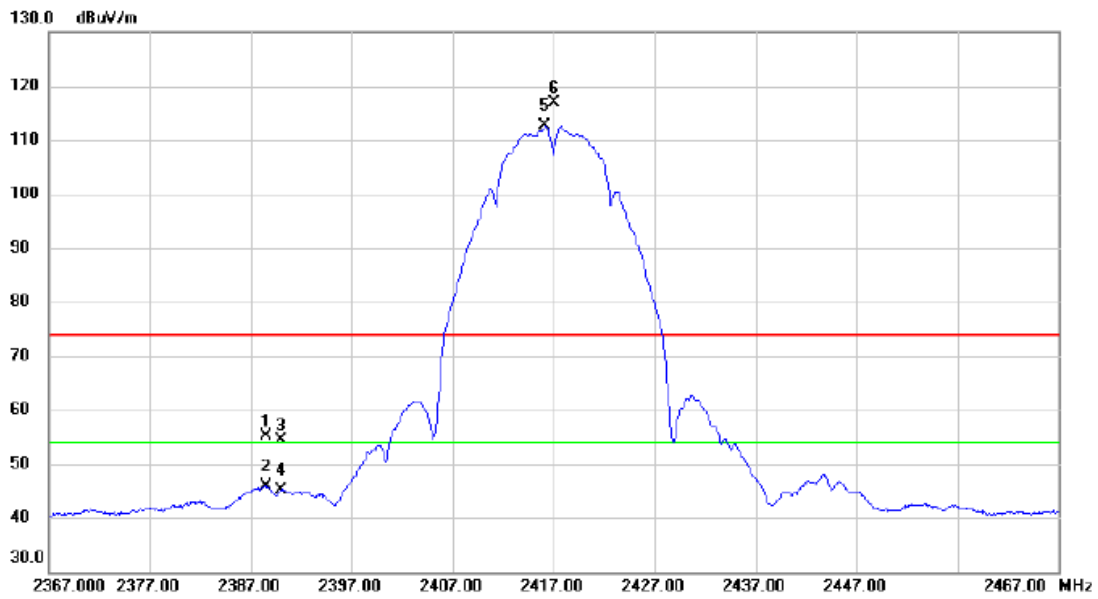

No.	Mk.	Freq. MHz	Reading Level dBuV	Correct Factor dB	Measure- ment dBuV/m	Limit dBuV/m	Margin dB	Detector	Comment
1		2388.500	44.70	10.49	55.19	74.00	-18.81	peak	
2		2388.500	35.32	10.49	45.81	54.00	-8.19	AVG	
3		2390.000	43.99	10.50	54.49	74.00	-19.51	peak	
4		2390.000	34.62	10.50	45.12	54.00	-8.88	AVG	
5	*	2416.200	102.05	10.57	112.62	54.00	58.62	AVG	No Limit
6	X	2417.000	106.36	10.57	116.93	74.00	42.93	peak	No Limit

REMARKS:

- (1) Measurement Value = Reading Level + Correct Factor.
- (2) Margin Level = Measurement Value - Limit Value.

Test Mode: TX B Mode 2417 MHz

Vertical

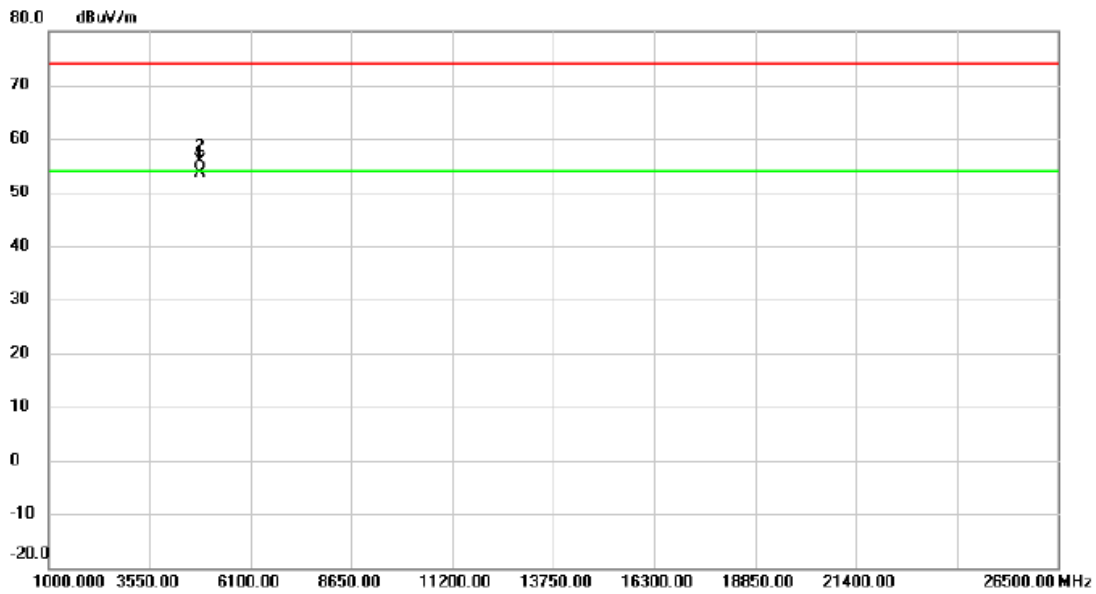

No.	Mk.	Freq. MHz	Reading Level dBuV	Correct Factor dB	Measure- ment dBuV/m	Limit dBuV/m	Margin dB	Detector	Comment
1	*	4833.905	47.16	6.54	53.70	54.00	-0.30	AVG	
2		4833.985	49.40	6.54	55.94	74.00	-18.06	peak	

REMARKS:

- (1) Measurement Value = Reading Level + Correct Factor.
- (2) Margin Level = Measurement Value - Limit Value.

Test Mode: TX B Mode 2437 MHz

Vertical

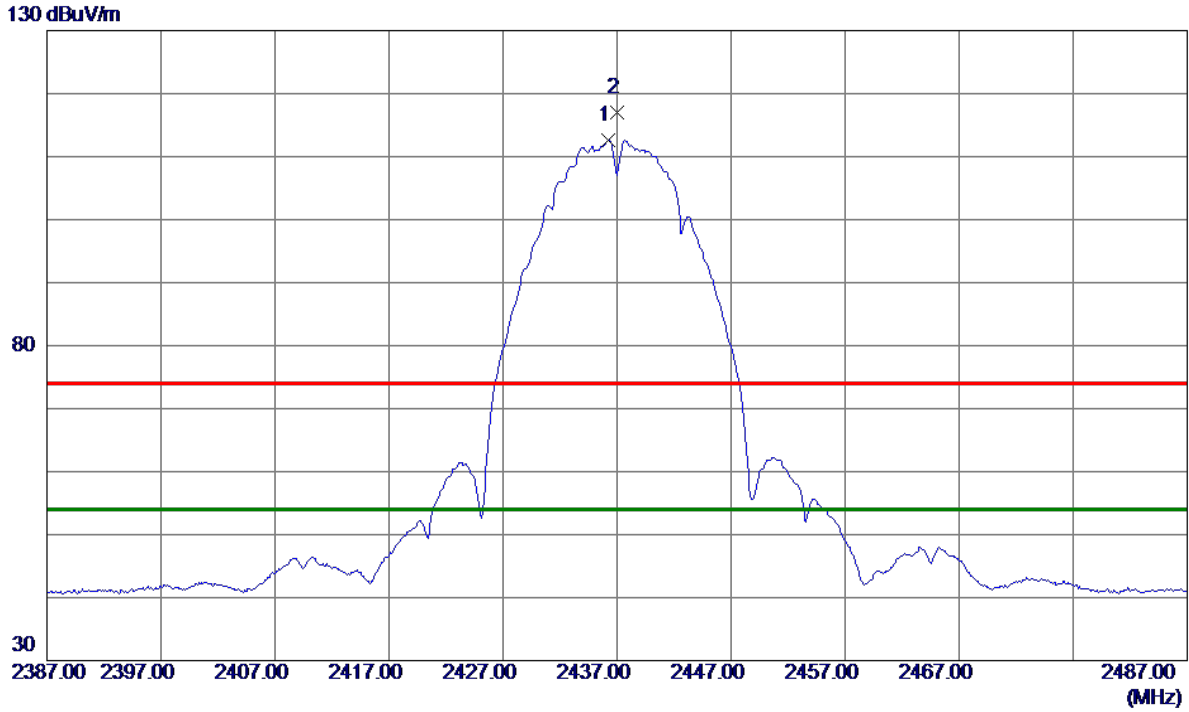

No.	Freq. MHz	Reading Level dBuV/m	Correct Factor dB	Measure ment dBuV/m	Limit dBuV/m	Margin dB	Detector	Comment
1 *	2436.2000	101.91	10.63	112.54	54.00	58.54	AVG	No Limit
2	2437.0000	106.30	10.63	116.93	74.00	42.93	Peak	No Limit

REMARKS:

- (1) Measurement Value = Reading Level + Correct Factor.
- (2) Margin Level = Measurement Value - Limit Value.

Test Mode: TX B Mode 2437 MHz

Vertical

80 dBuV/m

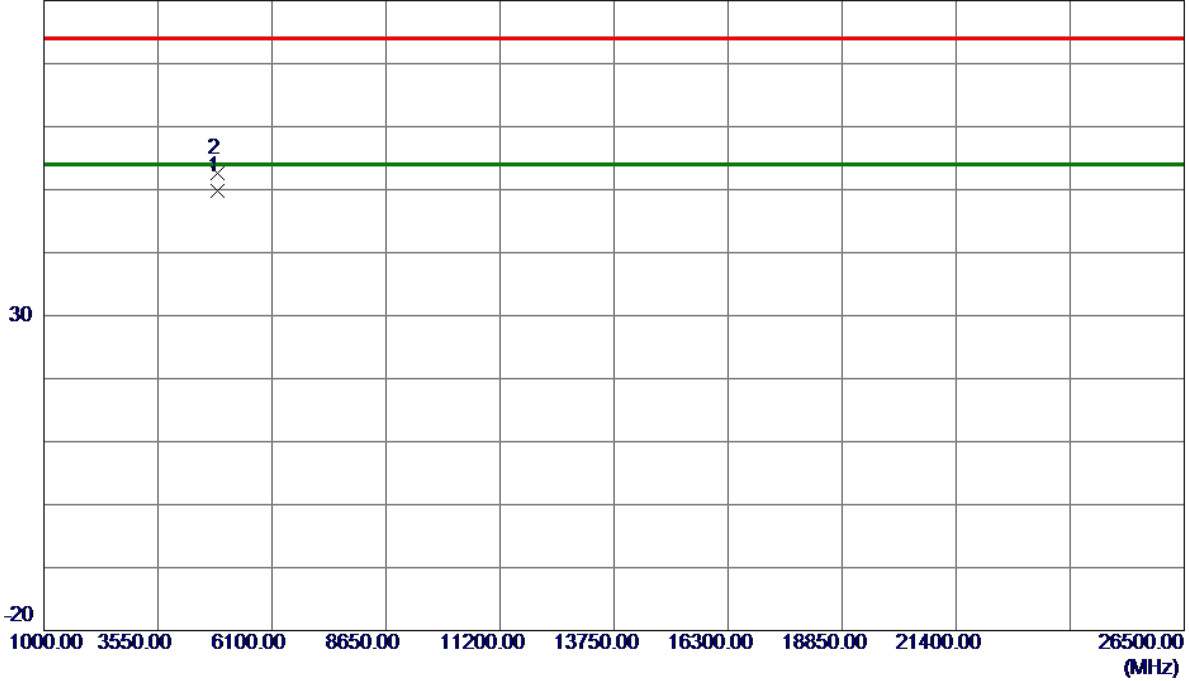

No.	Freq. MHz	Reading Level dBuV/m	Correct Factor dB	Measure ment dBuV/m	Limit dBuV/m	Margin dB	Detector	Comment
1 *	4873.9200	43.21	6.65	49.86	54.00	-4.14	AVG	
2	4874.0000	45.89	6.65	52.54	74.00	-21.46	Peak	

REMARKS:

- (1) Measurement Value = Reading Level + Correct Factor.
- (2) Margin Level = Measurement Value - Limit Value.

Test Mode: TX B Mode 2457 MHz

Vertical

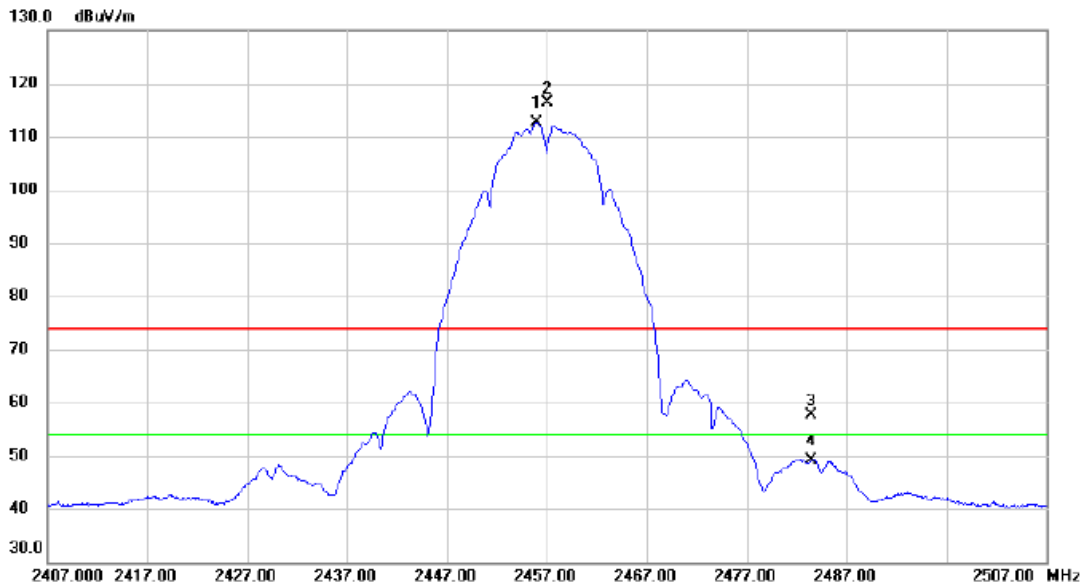

No.	Mk.	Freq. MHz	Reading Level dBuV	Correct Factor dB	Measure- ment dBuV/m	Limit dBuV/m	Margin dB	Detector	Comment
1	*	2456.000	102.06	10.68	112.74	54.00	58.74	AVG	No Limit
2	X	2457.000	105.64	10.69	116.33	74.00	42.33	peak	No Limit
3		2483.500	46.86	10.76	57.62	74.00	-16.38	peak	
4		2483.500	38.41	10.76	49.17	54.00	-4.83	AVG	

REMARKS:

- (1) Measurement Value = Reading Level + Correct Factor.
- (2) Margin Level = Measurement Value - Limit Value.

Test Mode: TX B Mode 2457 MHz

Vertical

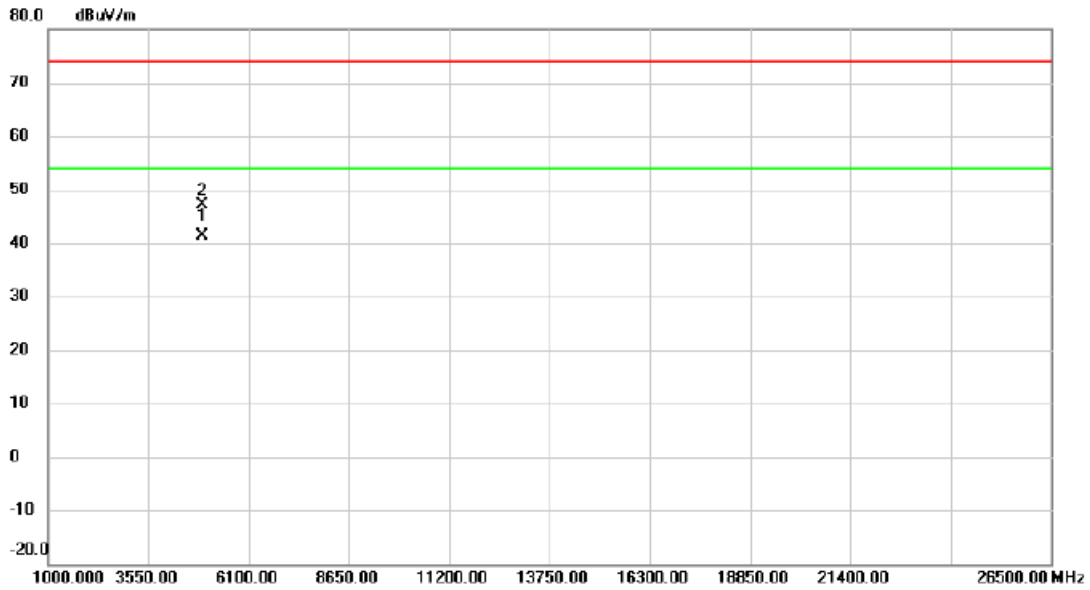

No.	Mk.	Freq.	Reading Level	Correct Factor	Measurement	Limit	Margin	Detector	Comment
		MHz	dBuV	dB	dBuV/m	dBuV/m	dB		
1	*	4913.940	34.64	6.75	41.39	54.00	-12.61	AVG	
2		4913.985	40.29	6.75	47.04	74.00	-26.96	peak	

REMARKS:

- (1) Measurement Value = Reading Level + Correct Factor.
- (2) Margin Level = Measurement Value - Limit Value.

Test Mode: TX B Mode 2462 MHz

Vertical

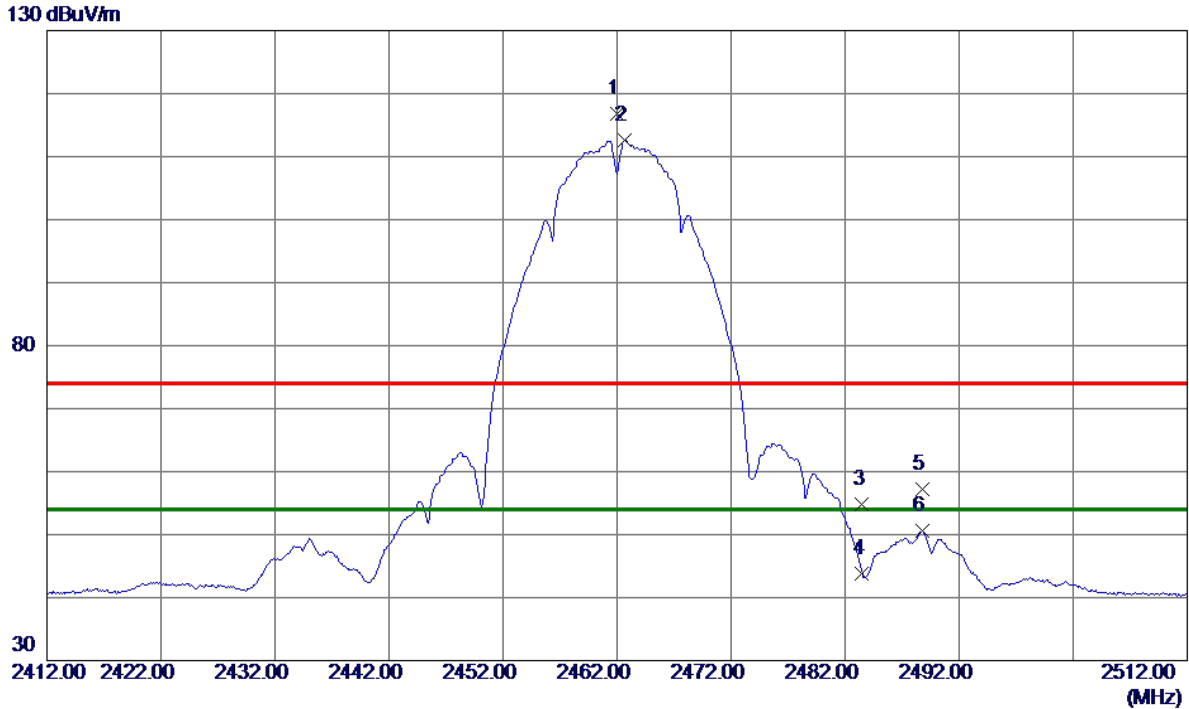

No.	Freq. MHz	Reading Level dBuV/m	Correct Factor dB	Measurement dBuV/m	Limit dBuV/m	Margin dB	Detector	Comment
1	2462.0000	106.12	10.70	116.82	74.00	42.82	Peak	No Limit
2 *	2462.7000	101.89	10.70	112.59	54.00	58.59	AVG	No Limit
3	2483.5000	43.96	10.76	54.72	74.00	-19.28	Peak	
4	2483.5000	33.03	10.76	43.79	54.00	-10.21	AVG	
5	2488.8000	46.38	10.78	57.16	74.00	-16.84	Peak	
6	2488.8000	39.78	10.78	50.56	54.00	-3.44	AVG	

REMARKS:

- (1) Measurement Value = Reading Level + Correct Factor.
- (2) Margin Level = Measurement Value - Limit Value.

Test Mode: TX B Mode 2462 MHz

Vertical

80 dBuV/m

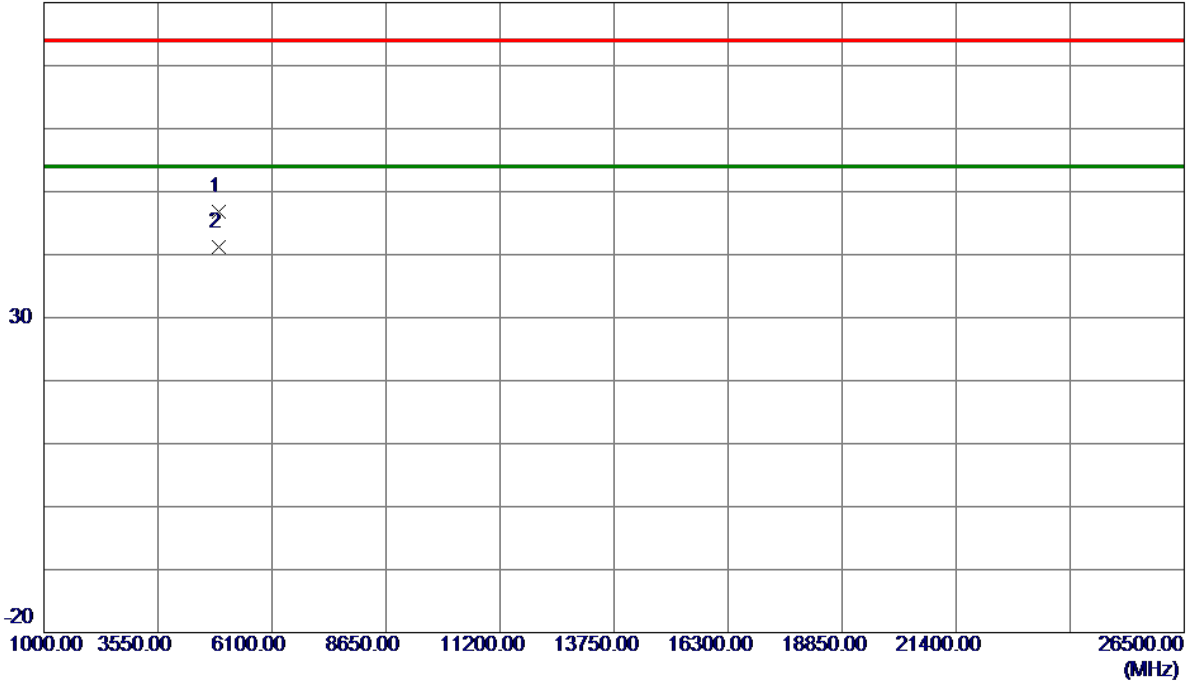

No.	Freq. MHz	Reading Level dBuV/m	Correct Factor dB	Measure ment dBuV/m	Limit dBuV/m	Margin dB	Detector	Comment
1	4923.7400	40.12	6.77	46.89	74.00	-27.11	Peak	
2 *	4923.8900	34.41	6.77	41.18	54.00	-12.82	AVG	

REMARKS:

- (1) Measurement Value = Reading Level + Correct Factor.
- (2) Margin Level = Measurement Value - Limit Value.

Test Mode: TX G Mode 2412 MHz

Vertical

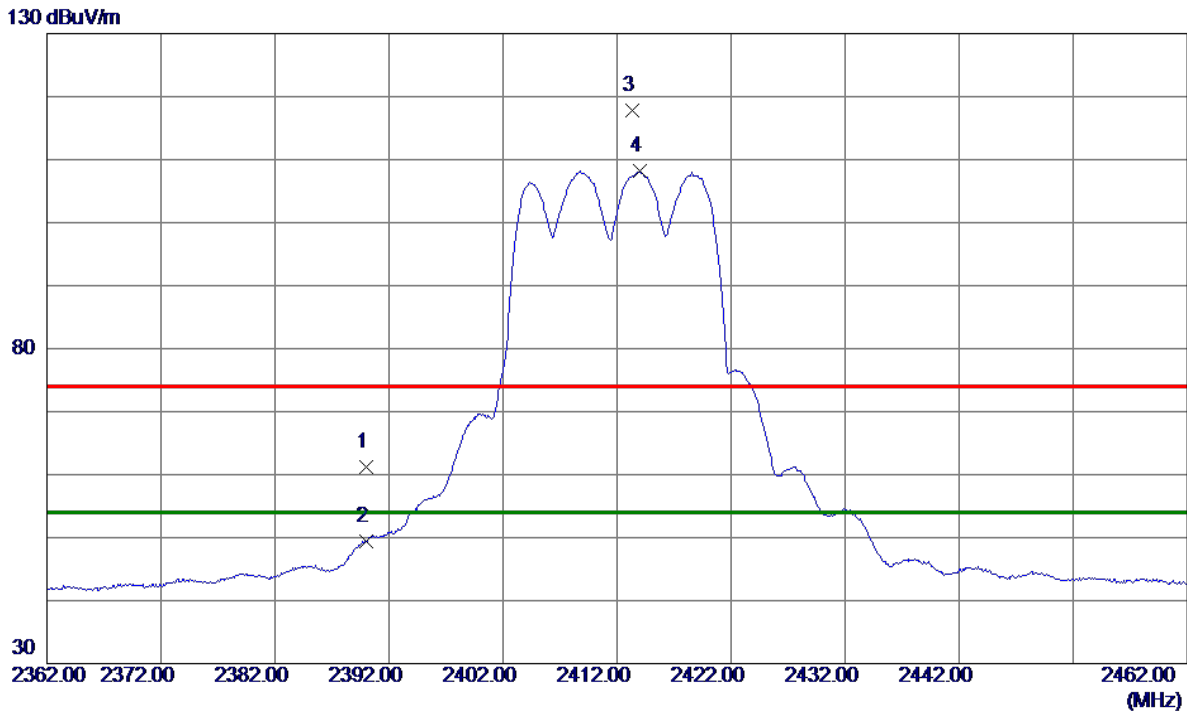

No.	Freq. MHz	Reading Level dBuV/m	Correct Factor dB	Measure ment dBuV/m	Limit dBuV/m	Margin dB	Detector	Comment
1	2390.0000	50.67	10.50	61.17	74.00	-12.83	Peak	
2	2390.0000	38.93	10.50	49.43	54.00	-4.57	AVG	
3	2413.3000	107.32	10.56	117.88	74.00	43.88	Peak	No Limit
4 *	2414.0000	97.58	10.56	108.14	54.00	54.14	AVG	No Limit

REMARKS:

- (1) Measurement Value = Reading Level + Correct Factor.
- (2) Margin Level = Measurement Value - Limit Value.

Test Mode: TX G Mode 2412 MHz

Vertical

80 dBuV/m

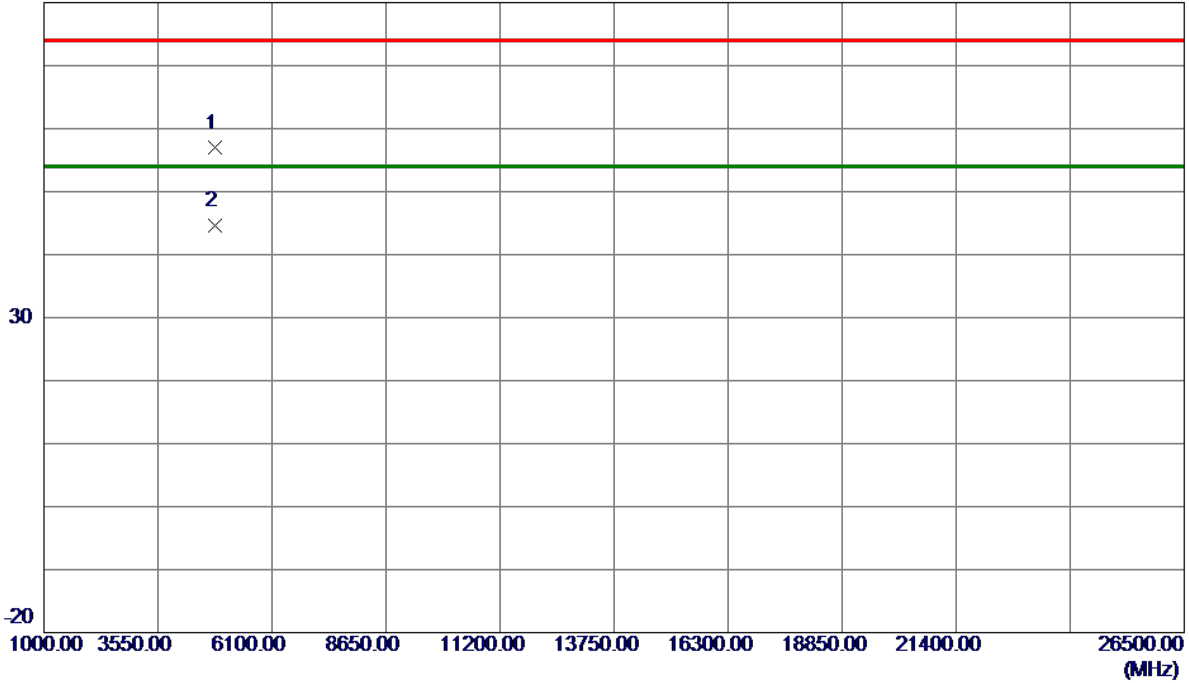

No.	Freq. MHz	Reading Level dBuV/m	Correct Factor dB	Measure ment dBuV/m	Limit dBuV/m	Margin dB	Detector	Comment
1	4825.8400	50.37	6.53	56.90	74.00	-17.10	Peak	
2 *	4826.0800	38.04	6.53	44.57	54.00	-9.43	AVG	

REMARKS:

- (1) Measurement Value = Reading Level + Correct Factor.
- (2) Margin Level = Measurement Value - Limit Value.

Test Mode: TX G Mode 2417 MHz

Vertical

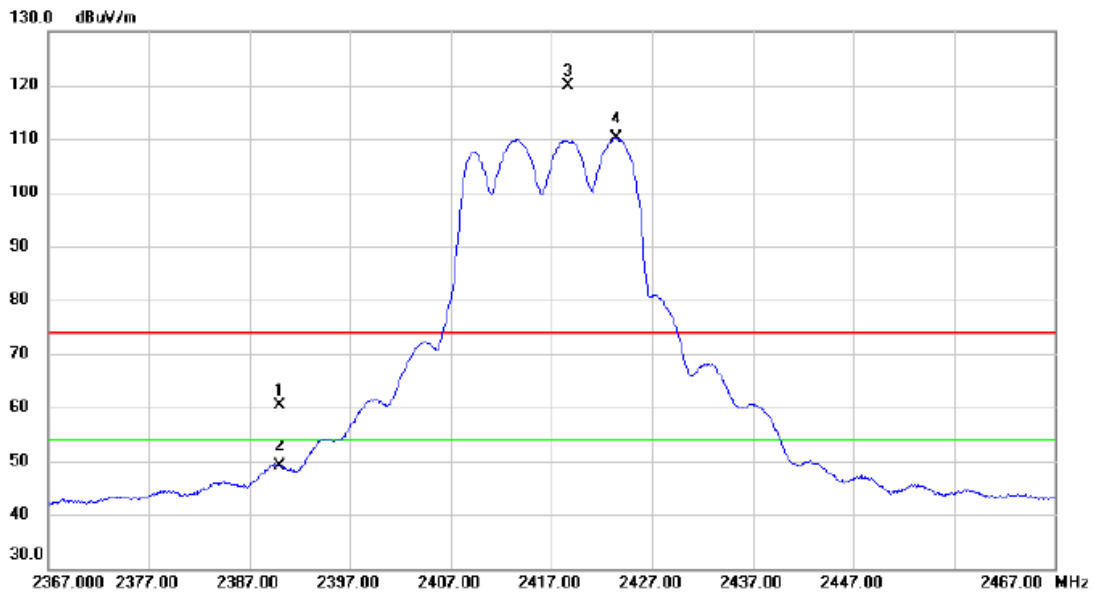

No.	Mk.	Freq. MHz	Reading Level dBuV	Correct Factor dB	Measure- ment dBuV/m	Limit dBuV/m	Margin dB	Detector	Comment
1		2390.000	49.79	10.50	60.29	74.00	-13.71	peak	
2		2390.000	38.63	10.50	49.13	54.00	-4.87	AVG	
3	X	2418.700	109.27	10.58	119.85	74.00	45.85	peak	No Limit
4	*	2423.400	99.54	10.59	110.13	54.00	56.13	AVG	No Limit

REMARKS:

- (1) Measurement Value = Reading Level + Correct Factor.
- (2) Margin Level = Measurement Value - Limit Value.

Test Mode: TX G Mode 2417 MHz

Vertical

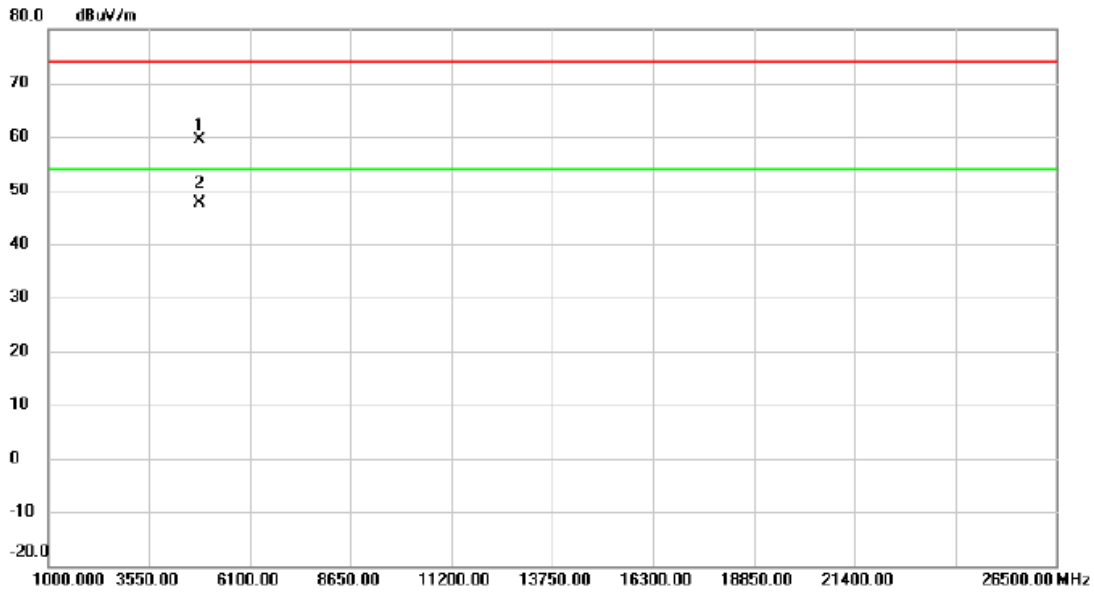

No.	Mk.	Freq. MHz	Reading Level dBuV	Correct Factor dB	Measure- ment dBuV/m	Limit dBuV/m	Margin dB	Detector	Comment
1		4836.040	52.79	6.56	59.35	74.00	-14.65	peak	
2	*	4836.180	41.10	6.56	47.66	54.00	-6.34	AVG	

REMARKS:

- (1) Measurement Value = Reading Level + Correct Factor.
- (2) Margin Level = Measurement Value - Limit Value.

Test Mode: TX G Mode 2437 MHz

Vertical

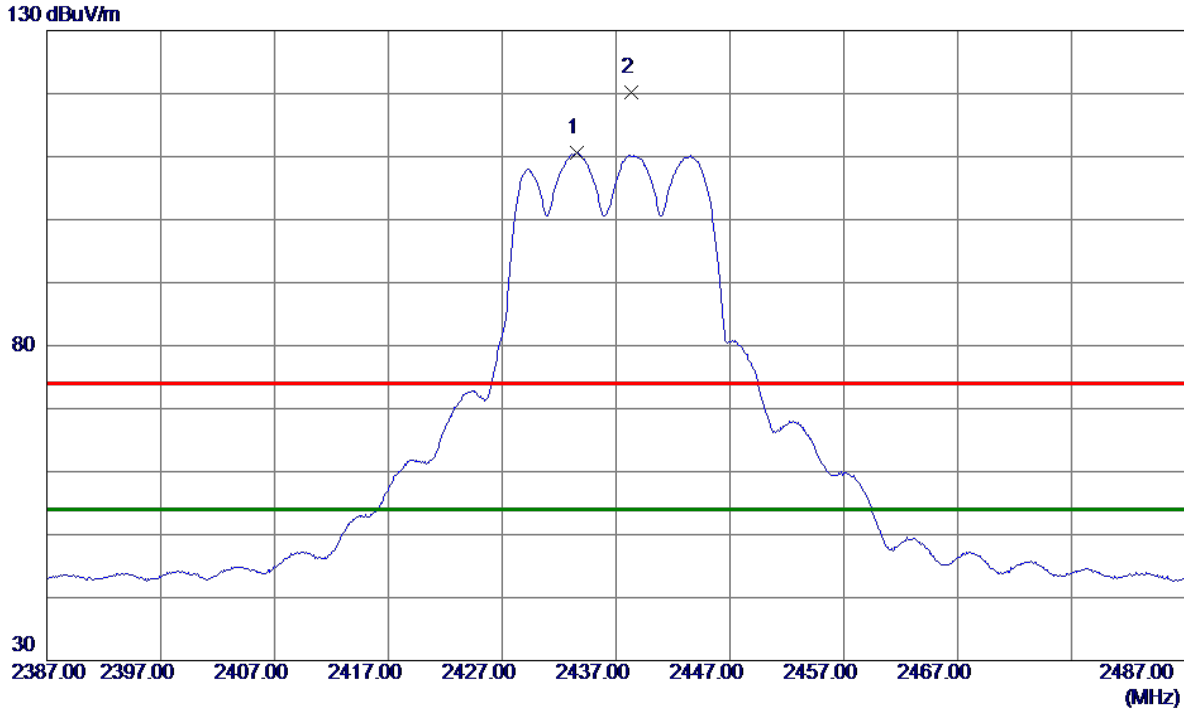

No.	Freq. MHz	Reading Level dBuV/m	Correct Factor dB	Measure ment dBuV/m	Limit dBuV/m	Margin dB	Detector	Comment
1 *	2433.6000	99.96	10.62	110.58	54.00	56.58	AVG	No Limit
2	2438.3000	109.67	10.63	120.30	74.00	46.30	Peak	No Limit

REMARKS:

- (1) Measurement Value = Reading Level + Correct Factor.
- (2) Margin Level = Measurement Value - Limit Value.

Test Mode: TX G Mode 2437 MHz

Vertical

80 dBuV/m

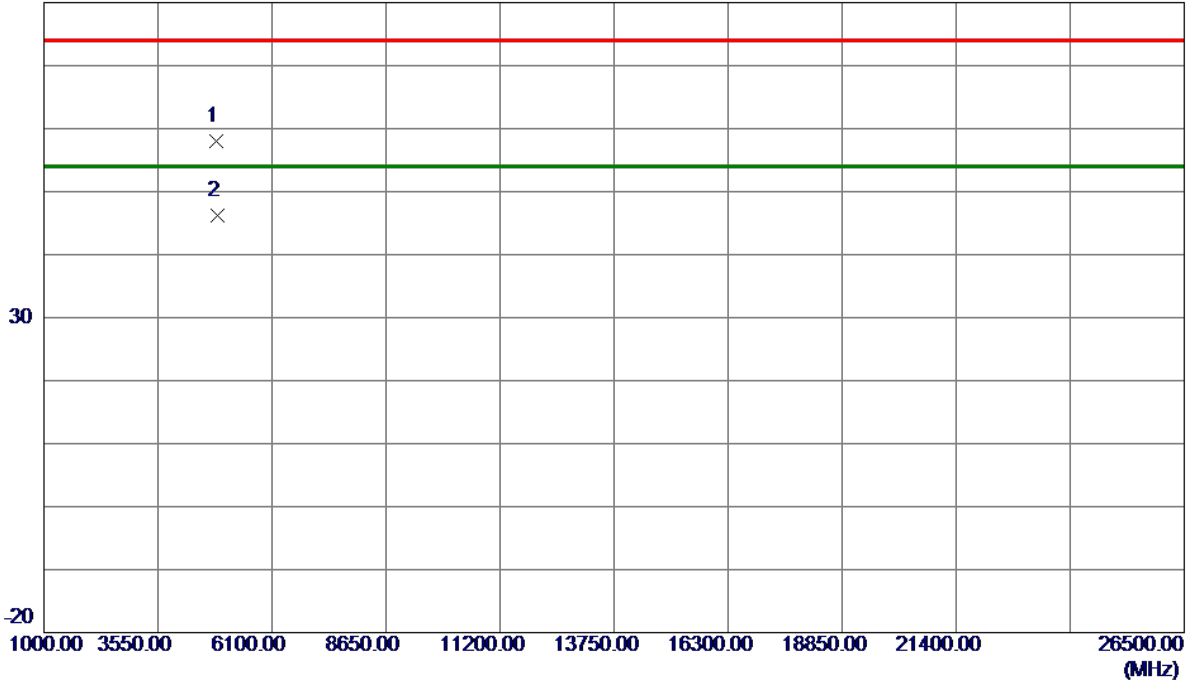

No.	Freq. MHz	Reading Level dBuV/m	Correct Factor dB	Measure ment dBuV/m	Limit dBuV/m	Margin dB	Detector	Comment
1	4866.8000	51.38	6.63	58.01	74.00	-15.99	Peak	
2 *	4876.2400	39.62	6.65	46.27	54.00	-7.73	AVG	

REMARKS:

- (1) Measurement Value = Reading Level + Correct Factor.
- (2) Margin Level = Measurement Value - Limit Value.

Test Mode: TX G Mode 2457 MHz

Vertical

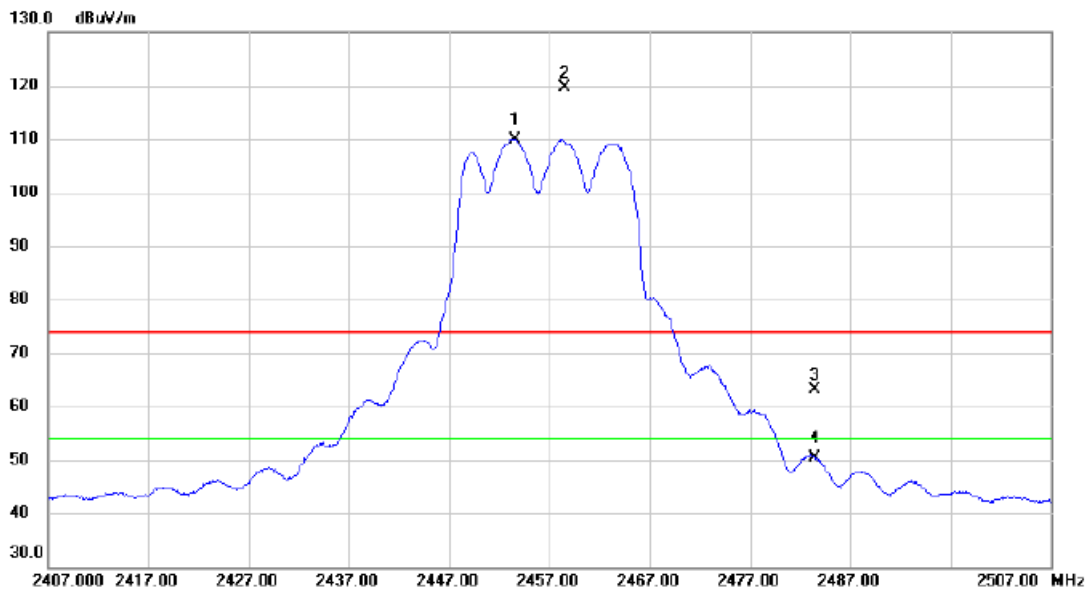

No.	Mk.	Freq. MHz	Reading Level dBuV	Correct Factor dB	Measure- ment dBuV/m	Limit dBuV/m	Margin dB	Detector	Comment
1	*	2453.600	99.22	10.68	109.90	54.00	55.90	AVG	No Limit
2	X	2458.500	108.83	10.69	119.52	74.00	45.52	peak	No Limit
3		2483.500	52.37	10.76	63.13	74.00	-10.87	peak	
4		2483.500	39.51	10.76	50.27	54.00	-3.73	AVG	

REMARKS:

- (1) Measurement Value = Reading Level + Correct Factor.
- (2) Margin Level = Measurement Value - Limit Value.

Test Mode: TX G Mode 2457 MHz

Vertical

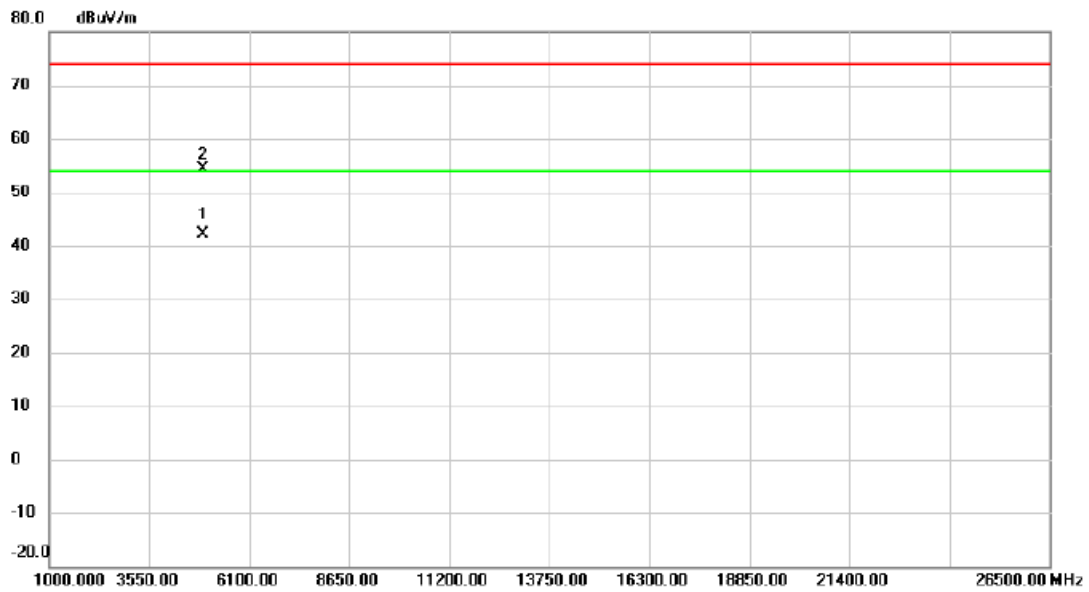

No.	Mk.	Freq. MHz	Reading Level dBuV	Correct Factor dB	Measure- ment dBuV/m	Limit dBuV/m	Margin dB	Detector	Comment
1	*	4916.280	35.49	6.76	42.25	54.00	-11.75	AVG	
2		4917.080	47.74	6.76	54.50	74.00	-19.50	peak	

REMARKS:

- (1) Measurement Value = Reading Level + Correct Factor.
- (2) Margin Level = Measurement Value - Limit Value.

Test Mode: TX G Mode 2462 MHz

Vertical

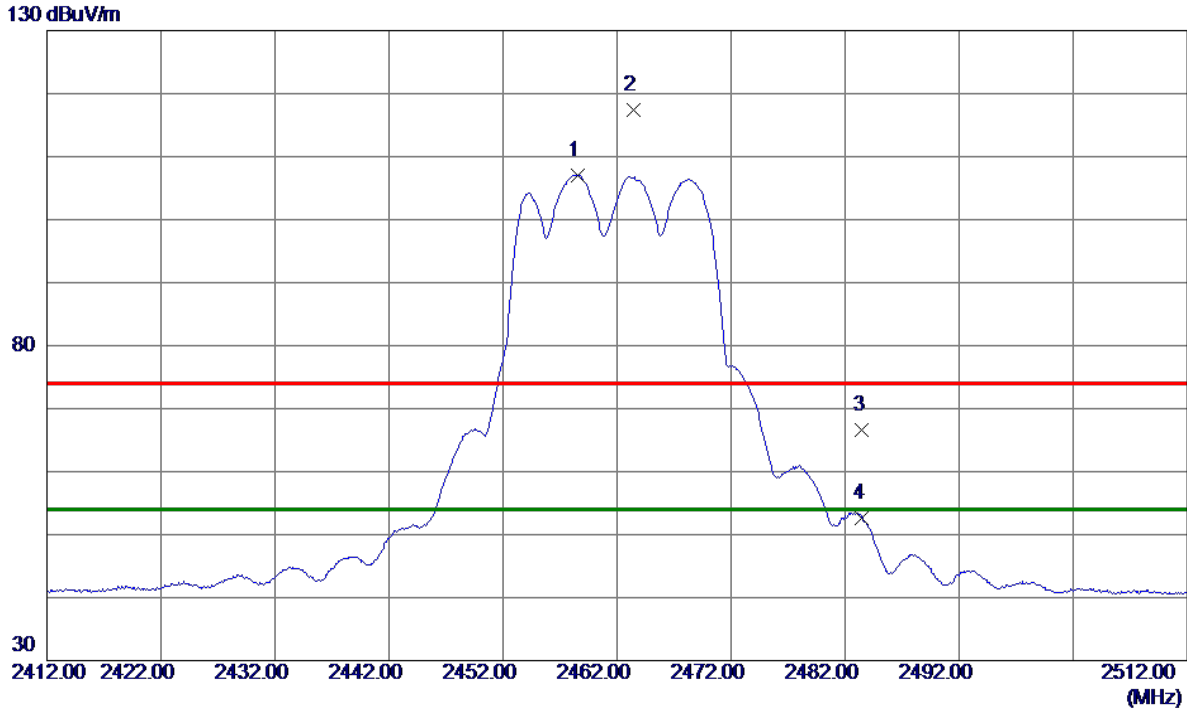

No.	Freq. MHz	Reading Level dBuV/m	Correct Factor dB	Measure ment dBuV/m	Limit dBuV/m	Margin dB	Detector	Comment
1 *	2458.6000	96.30	10.69	106.99	54.00	52.99	AVG	No Limit
2	2463.4000	106.61	10.71	117.32	74.00	43.32	Peak	No Limit
3	2483.5000	55.91	10.76	66.67	74.00	-7.33	Peak	
4	2483.5000	41.90	10.76	52.66	54.00	-1.34	AVG	

REMARKS:

- (1) Measurement Value = Reading Level + Correct Factor.
- (2) Margin Level = Measurement Value - Limit Value.

Test Mode: TX G Mode 2462 MHz

Vertical

80 dBuV/m

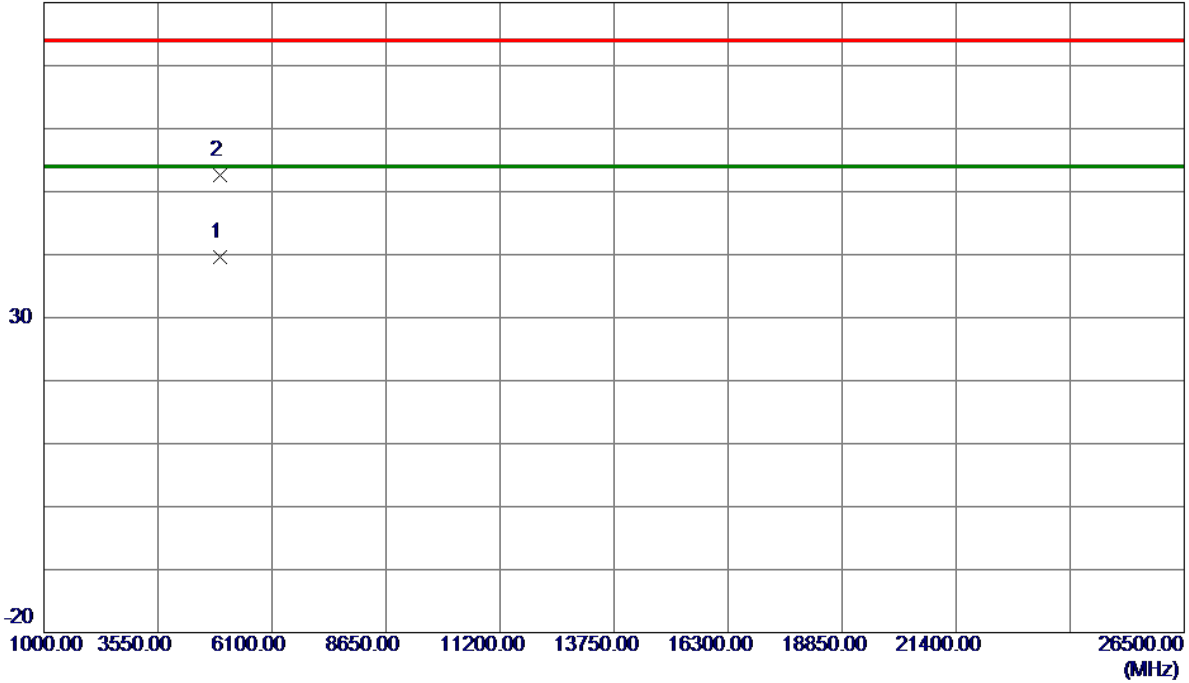

No.	Freq. MHz	Reading Level dBuV/m	Correct Factor dB	Measure ment dBuV/m	Limit dBuV/m	Margin dB	Detector	Comment
1 *	4925.7799	32.85	6.78	39.63	54.00	-14.37	AVG	
2	4926.6200	45.75	6.78	52.53	74.00	-21.47	Peak	

REMARKS:

- (1) Measurement Value = Reading Level + Correct Factor.
- (2) Margin Level = Measurement Value - Limit Value.

Test Mode: TX N-20M Mode 2412 MHz

Vertical

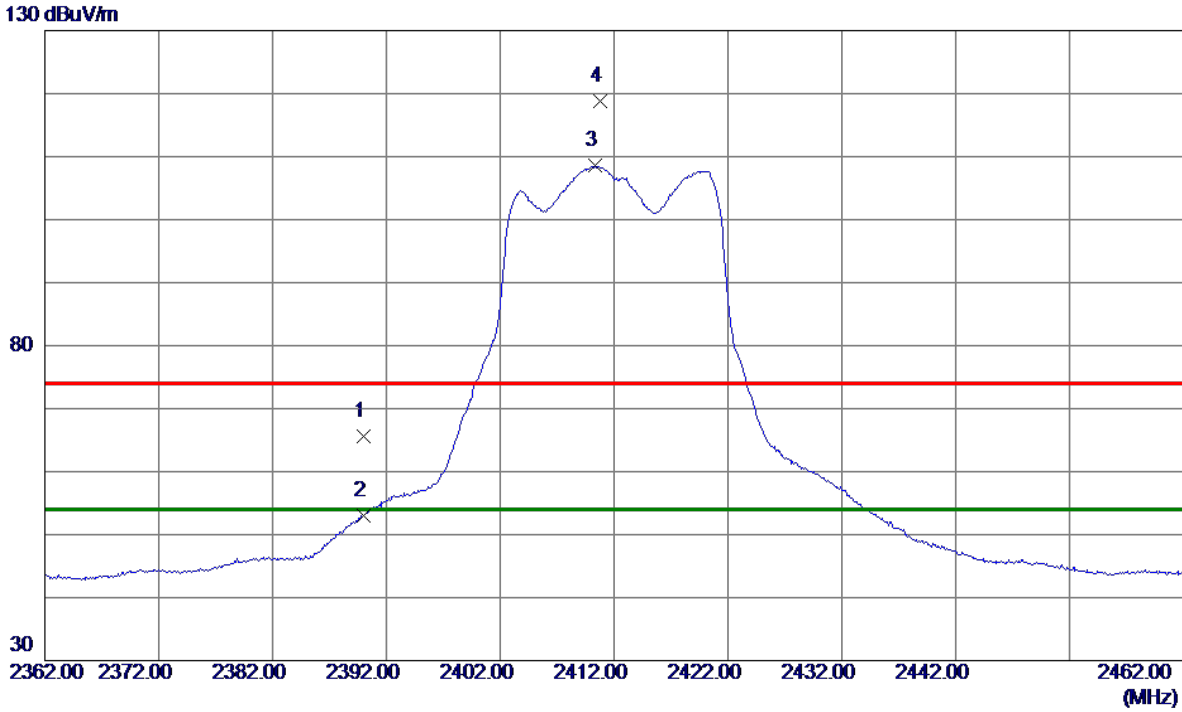

No.	Freq. MHz	Reading Level dBuV/m	Correct Factor dB	Measure ment dBuV/m	Limit dBuV/m	Margin dB	Detector	Comment
1	2390.0000	55.14	10.50	65.64	74.00	-8.36	Peak	
2	2390.0000	42.52	10.50	53.02	54.00	-0.98	AVG	
3 *	2410.3000	98.01	10.55	108.56	54.00	54.56	AVG	No Limit
4	2410.8000	108.31	10.55	118.86	74.00	44.86	Peak	No Limit

REMARKS:

- (1) Measurement Value = Reading Level + Correct Factor.
- (2) Margin Level = Measurement Value - Limit Value.

Test Mode: TX N-20M Mode 2412 MHz

Vertical

80 dBuV/m

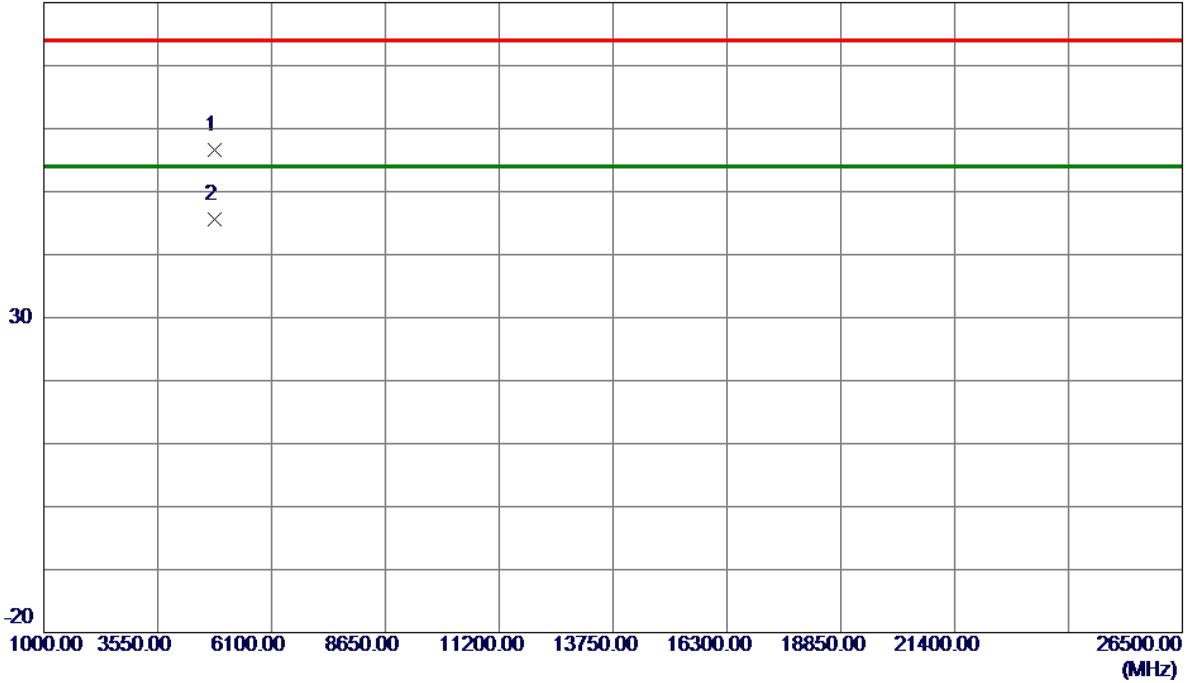

No.	Freq. MHz	Reading Level dBuV/m	Correct Factor dB	Measure ment dBuV/m	Limit dBuV/m	Margin dB	Detector	Comment
1	4819.0600	50.00	6.51	56.51	74.00	-17.49	Peak	
2 *	4827.9200	39.11	6.53	45.64	54.00	-8.36	AVG	

REMARKS:

- (1) Measurement Value = Reading Level + Correct Factor.
- (2) Margin Level = Measurement Value - Limit Value.

Test Mode: TX N-20M Mode 2417 MHz

Vertical

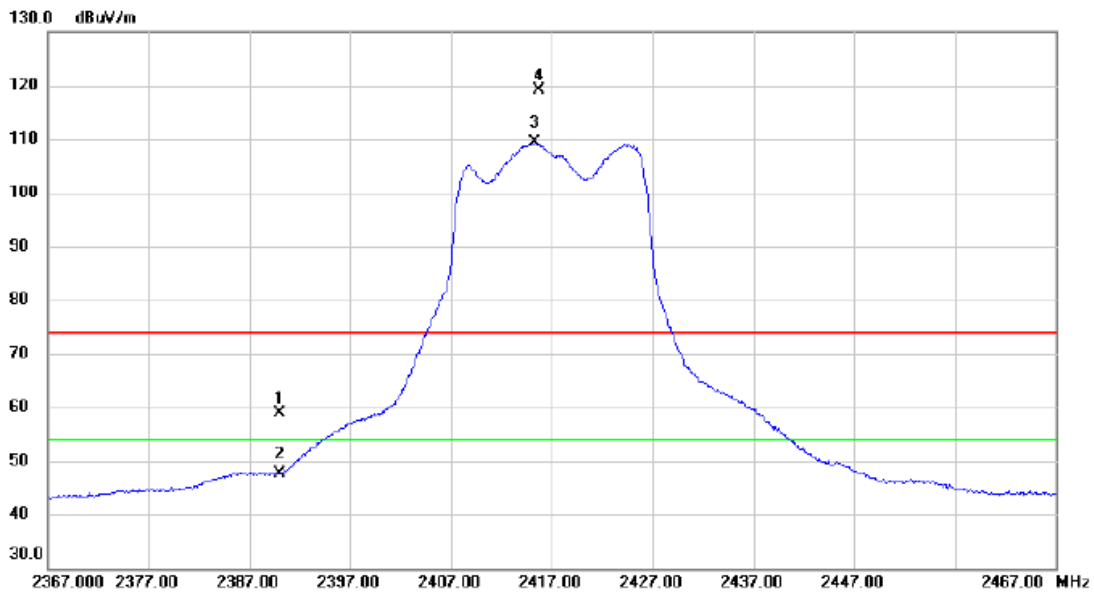

No.	Mk.	Freq. MHz	Reading Level dBuV	Correct Factor dB	Measure- ment dBuV/m	Limit dBuV/m	Margin dB	Detector	Comment
1		2390.000	48.40	10.50	58.90	74.00	-15.10	peak	
2		2390.000	37.05	10.50	47.55	54.00	-6.45	AVG	
3	*	2415.300	98.80	10.56	109.36	54.00	55.36	AVG	No Limit
4	X	2415.700	108.61	10.56	119.17	74.00	45.17	peak	No Limit

REMARKS:

- (1) Measurement Value = Reading Level + Correct Factor.
- (2) Margin Level = Measurement Value - Limit Value.

Test Mode: TX N-20M Mode 2417 MHz

Vertical

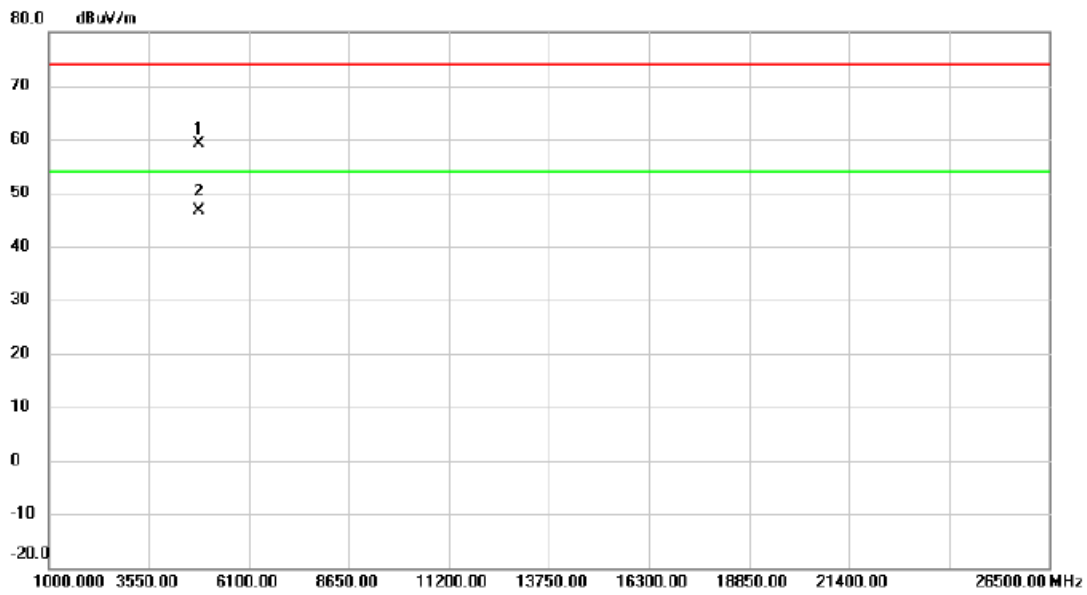

No.	Mk.	Freq. MHz	Reading Level dBuV	Correct Factor dB	Measure- ment dBuV/m	Limit dBuV/m	Margin dB	Detector	Comment
1		4829.820	52.65	6.54	59.19	74.00	-14.81	peak	
2	*	4837.980	40.18	6.56	46.74	54.00	-7.26	AVG	

REMARKS:

- (1) Measurement Value = Reading Level + Correct Factor.
- (2) Margin Level = Measurement Value - Limit Value.

Test Mode: TX N-20M Mode 2437 MHz

Vertical

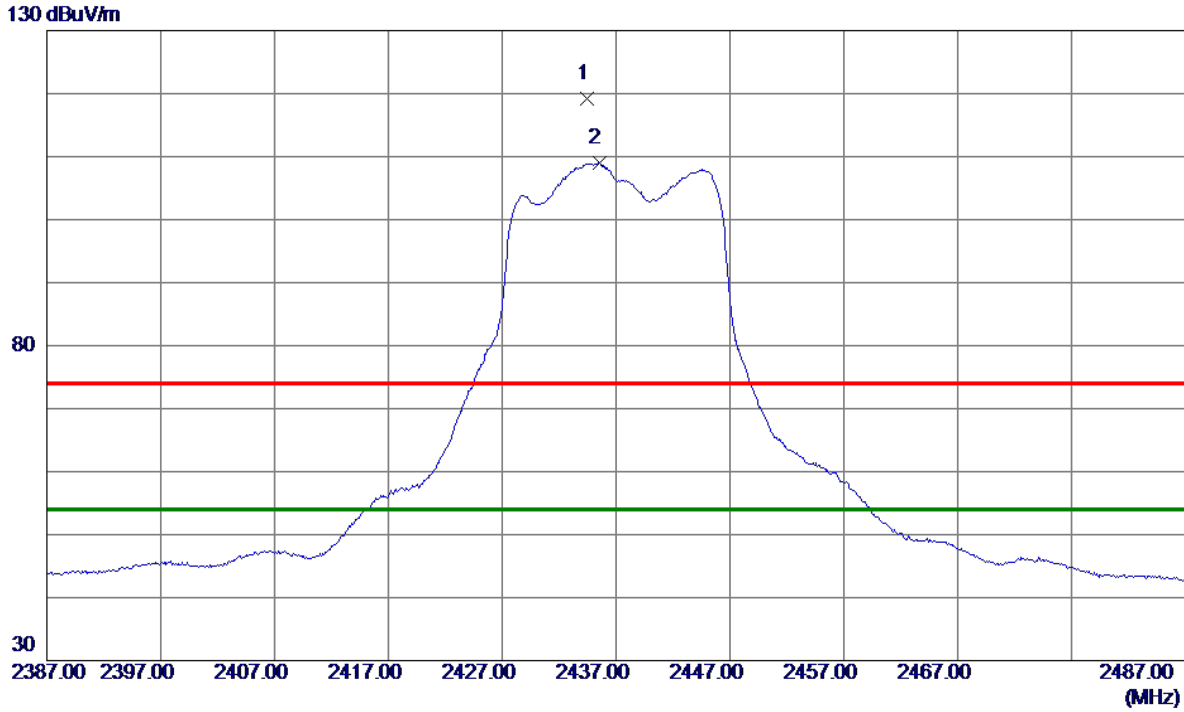

No.	Freq. MHz	Reading Level dBuV/m	Correct Factor dB	Measure ment dBuV/m	Limit dBuV/m	Margin dB	Detector	Comment
1	2434.4000	108.61	10.62	119.23	74.00	45.23	Peak	No Limit
2 *	2435.5000	98.37	10.63	109.00	54.00	55.00	AVG	No Limit

REMARKS:

- (1) Measurement Value = Reading Level + Correct Factor.
- (2) Margin Level = Measurement Value - Limit Value.

Test Mode: TX N-20M Mode 2437 MHz

Vertical

80 dBuV/m

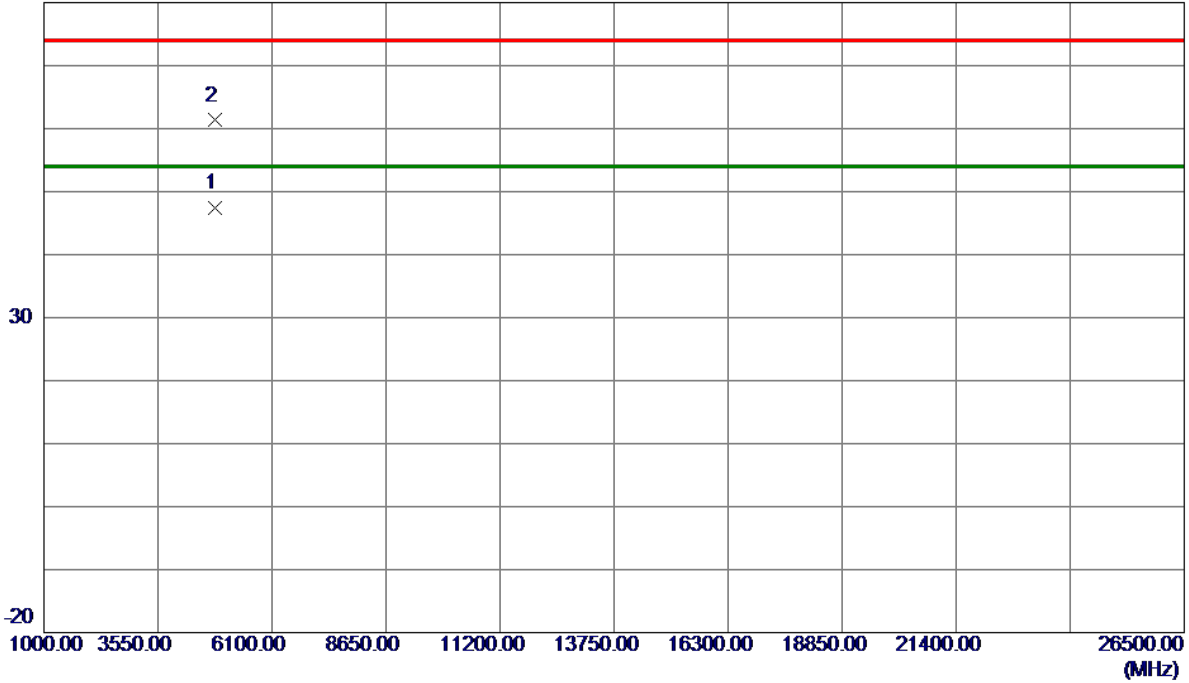

No.	Freq. MHz	Reading Level dBuV/m	Correct Factor dB	Measure ment dBuV/m	Limit dBuV/m	Margin dB	Detector	Comment
1 *	4837.9800	40.83	6.56	47.39	54.00	-6.61	AVG	
2	4838.1000	54.74	6.56	61.30	74.00	-12.70	Peak	

REMARKS:

- (1) Measurement Value = Reading Level + Correct Factor.
- (2) Margin Level = Measurement Value - Limit Value.

Test Mode: TX N-20M Mode 2457 MHz

Vertical

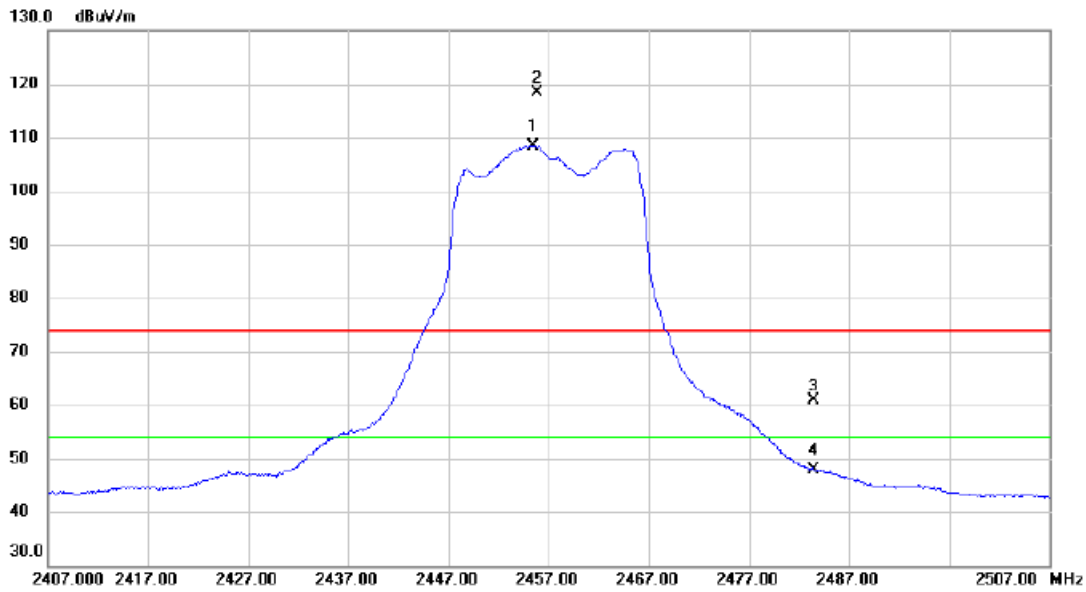

No.	Mk.	Freq. MHz	Reading Level dBuV	Correct Factor dB	Measure- ment dBuV/m	Limit dBuV/m	Margin dB	Detector	Comment
1	*	2455.400	97.80	10.68	108.48	54.00	54.48	AVG	No Limit
2	X	2455.900	107.77	10.68	118.45	74.00	44.45	peak	No Limit
3		2483.500	50.01	10.76	60.77	74.00	-13.23	peak	
4		2483.500	37.12	10.76	47.88	54.00	-6.12	AVG	

REMARKS:

- (1) Measurement Value = Reading Level + Correct Factor.
- (2) Margin Level = Measurement Value - Limit Value.

Test Mode: TX N-20M Mode 2457 MHz

Vertical

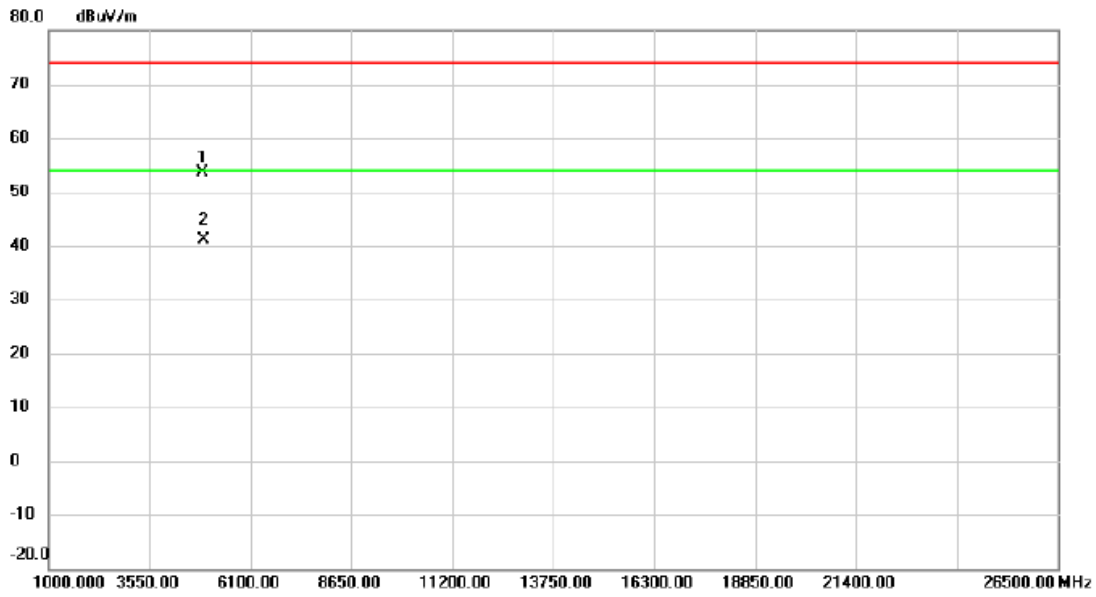

No.	Mk.	Freq. MHz	Reading Level dBuV	Correct Factor dB	Measure- ment dBuV/m	Limit dBuV/m	Margin dB	Detector	Comment
1		4909.880	46.94	6.75	53.69	74.00	-20.31	peak	
2	*	4918.020	34.39	6.76	41.15	54.00	-12.85	AVG	

REMARKS:

- (1) Measurement Value = Reading Level + Correct Factor.
- (2) Margin Level = Measurement Value - Limit Value.

Test Mode: TX N-20M Mode 2462 MHz

Vertical

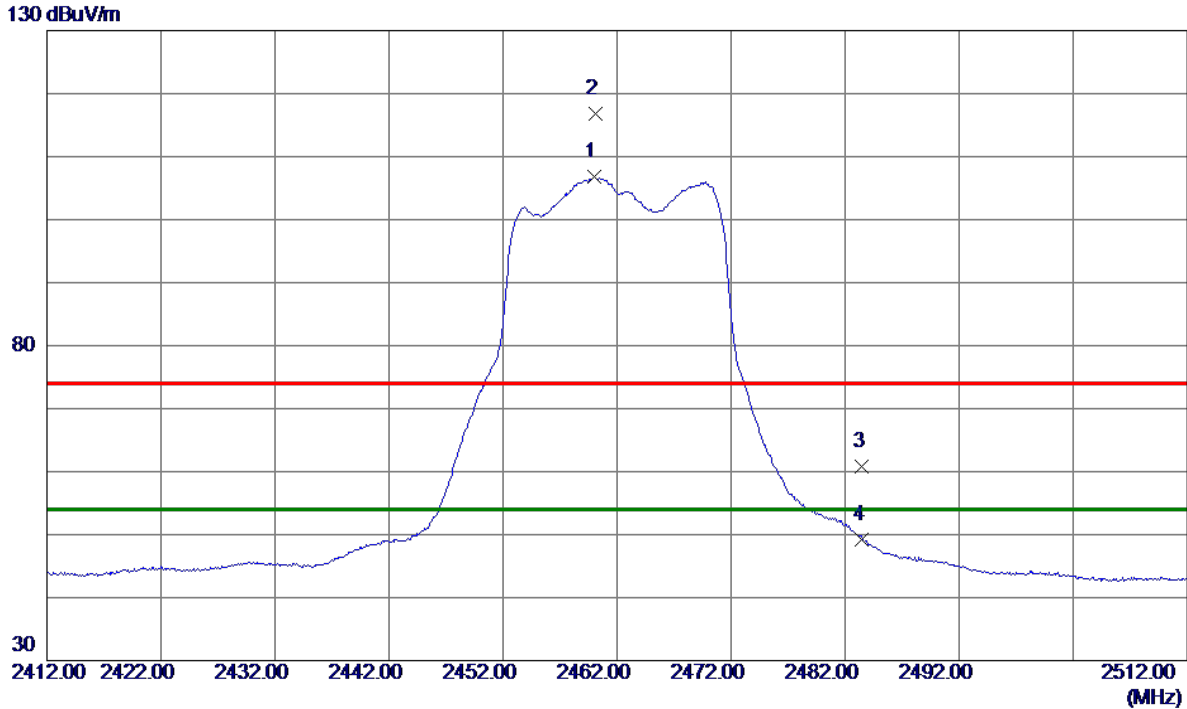

No.	Freq. MHz	Reading Level dBuV/m	Correct Factor dB	Measure ment dBuV/m	Limit dBuV/m	Margin dB	Detector	Comment
1 *	2460.0000	96.04	10.70	106.74	54.00	52.74	AVG	No Limit
2	2460.1000	106.12	10.70	116.82	74.00	42.82	Peak	No Limit
3	2483.5000	50.12	10.76	60.88	74.00	-13.12	Peak	
4	2483.5000	38.40	10.76	49.16	54.00	-4.84	AVG	

REMARKS:

- (1) Measurement Value = Reading Level + Correct Factor.
- (2) Margin Level = Measurement Value - Limit Value.

Test Mode: TX N-20M Mode 2462 MHz

Vertical

80 dBuV/m

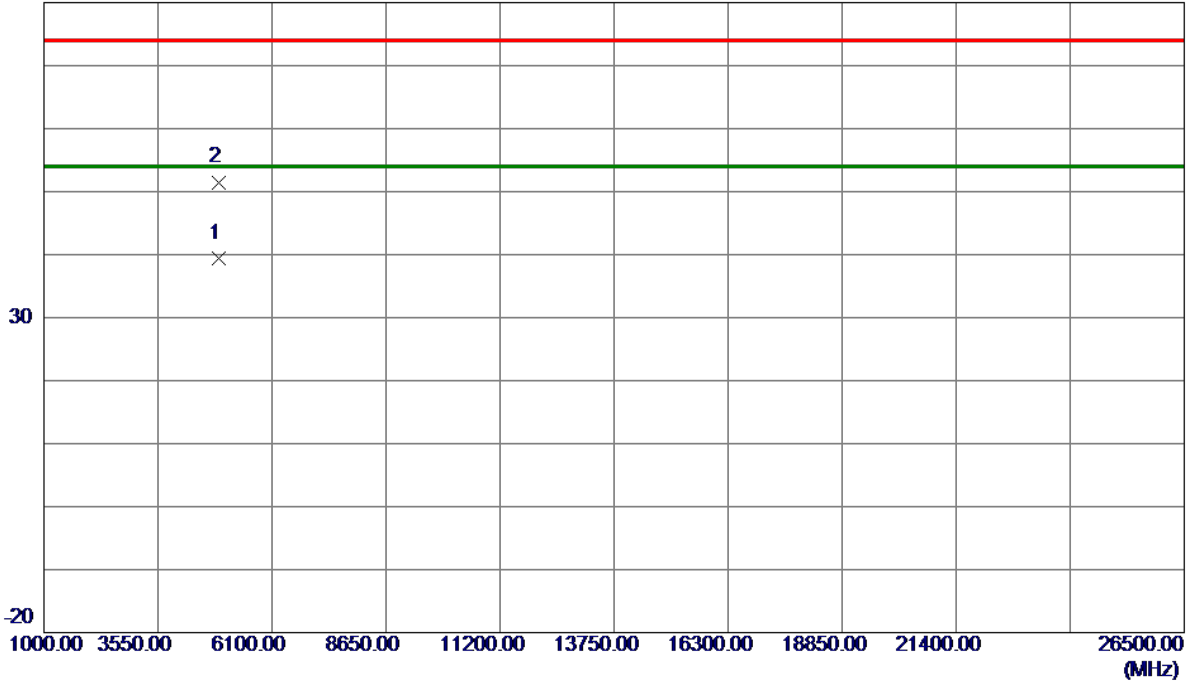

No.	Freq. MHz	Reading Level dBuV/m	Correct Factor dB	Measure ment dBuV/m	Limit dBuV/m	Margin dB	Detector	Comment
1 *	4918.8600	32.65	6.76	39.41	54.00	-14.59	AVG	
2	4919.5000	44.74	6.76	51.50	74.00	-22.50	Peak	

REMARKS:

- (1) Measurement Value = Reading Level + Correct Factor.
- (2) Margin Level = Measurement Value - Limit Value.

Test Mode: TX N-40M Mode 2422 MHz

Vertical

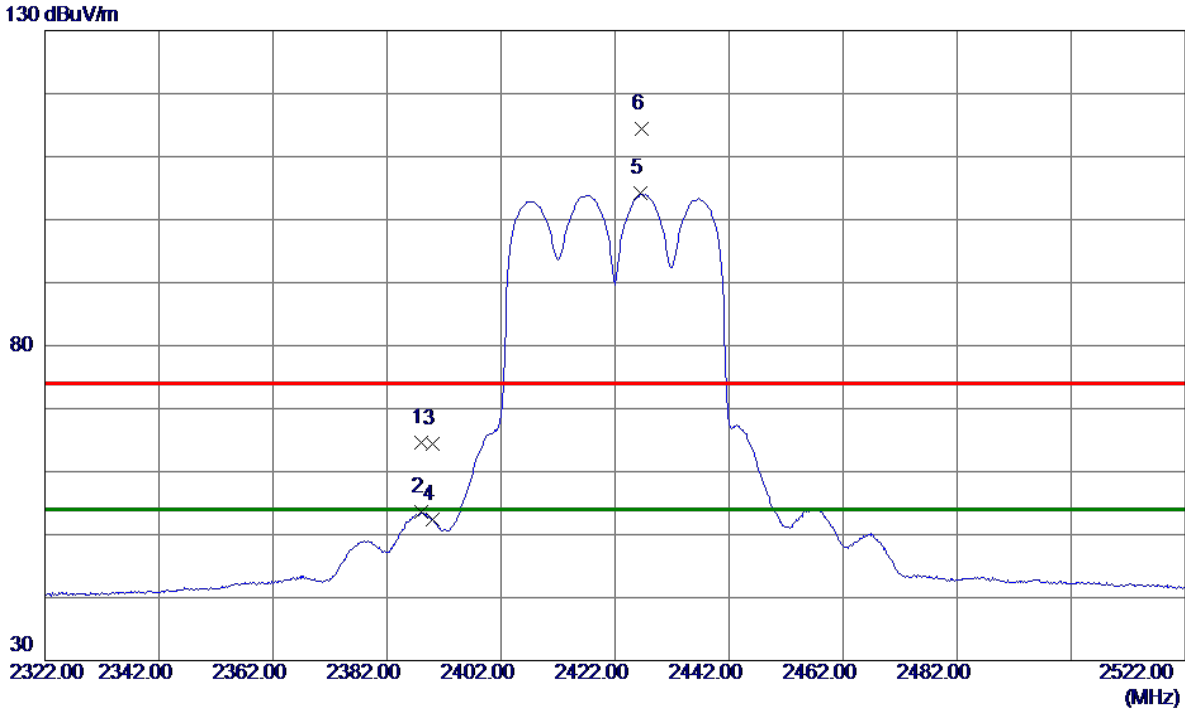

No.	Freq. MHz	Reading Level dBuV/m	Correct Factor dB	Measure ment dBuV/m	Limit dBuV/m	Margin dB	Detector	Comment
1	2388.0000	54.15	10.49	64.64	74.00	-9.36	Peak	
2	2388.0000	43.09	10.49	53.58	54.00	-0.42	AVG	
3	2390.0000	53.93	10.50	64.43	74.00	-9.57	Peak	
4	2390.0000	41.83	10.50	52.33	54.00	-1.67	AVG	
5 *	2426.4000	93.51	10.60	104.11	54.00	50.11	AVG	No Limit
6	2426.6000	103.73	10.60	114.33	74.00	40.33	Peak	No Limit

REMARKS:

- (1) Measurement Value = Reading Level + Correct Factor.
- (2) Margin Level = Measurement Value - Limit Value.

Test Mode: TX N-40M Mode 2422 MHz

Vertical

80 dBuV/m

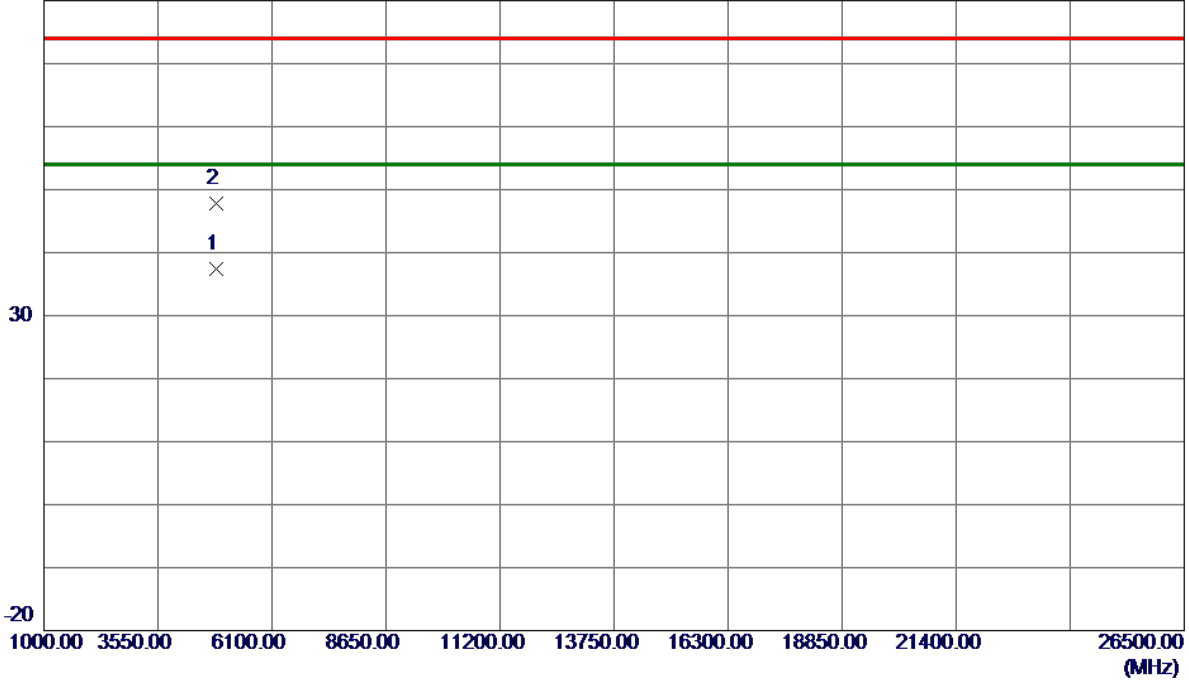

No.	Freq. MHz	Reading Level dBuV/m	Correct Factor dB	Measure ment dBuV/m	Limit dBuV/m	Margin dB	Detector	Comment
1 *	4847.9600	30.78	6.58	37.36	54.00	-16.64	AVG	
2	4848.9200	41.24	6.59	47.83	74.00	-26.17	Peak	

REMARKS:

- (1) Measurement Value = Reading Level + Correct Factor.
- (2) Margin Level = Measurement Value - Limit Value.

Test Mode: TX N-40M Mode 2427 MHz

Vertical

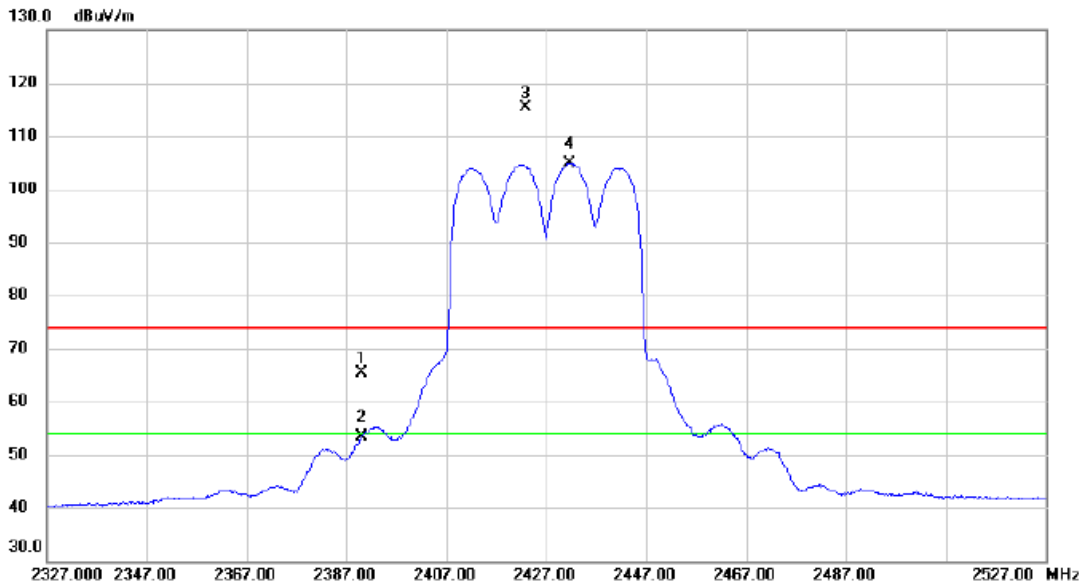

No.	Mk.	Freq. MHz	Reading Level dBuV	Correct Factor dB	Measure- ment dBuV/m	Limit dBuV/m	Margin dB	Detector	Comment
1		2390.000	54.77	10.50	65.27	74.00	-8.73	peak	
2		2390.000	42.96	10.50	53.46	54.00	-0.54	AVG	
3	X	2422.800	104.74	10.59	115.33	74.00	41.33	peak	No Limit
4	*	2431.600	94.31	10.61	104.92	54.00	50.92	AVG	No Limit

REMARKS:

- (1) Measurement Value = Reading Level + Correct Factor.
- (2) Margin Level = Measurement Value - Limit Value.

Test Mode: TX N-40M Mode 2427 MHz

Vertical

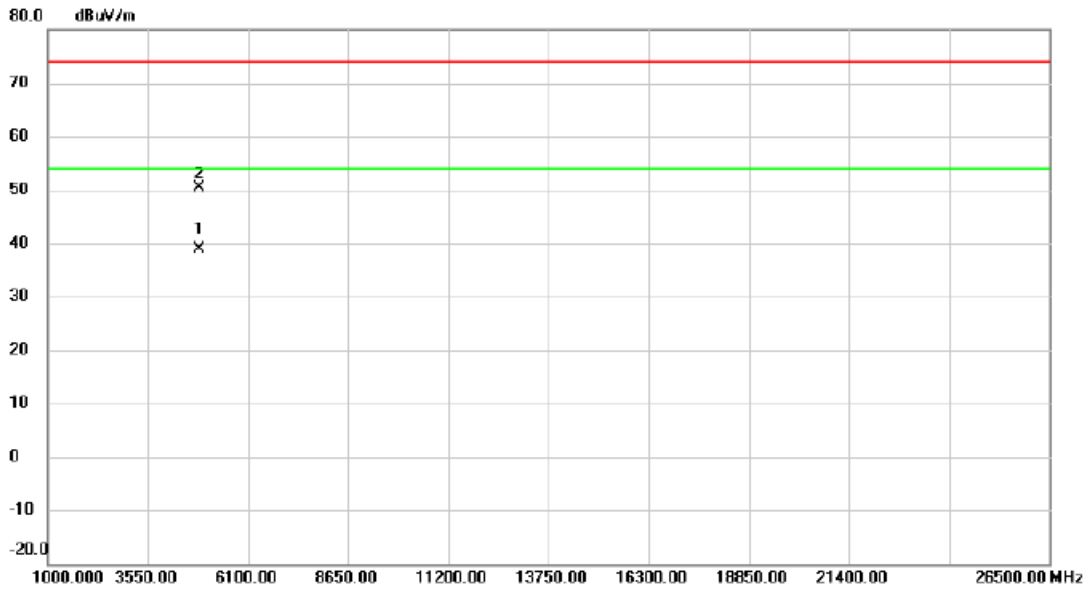

No.	Mk.	Freq. MHz	Reading Level dBuV	Correct Factor dB	Measure- ment dBuV/m	Limit dBuV/m	Margin dB	Detector	Comment
1	*	4848.920	32.31	6.59	38.90	54.00	-15.10	AVG	
2		4859.280	43.85	6.60	50.45	74.00	-23.55	peak	

REMARKS:

- (1) Measurement Value = Reading Level + Correct Factor.
- (2) Margin Level = Measurement Value - Limit Value.

Test Mode: TX N-40M Mode 2437 MHz

Vertical

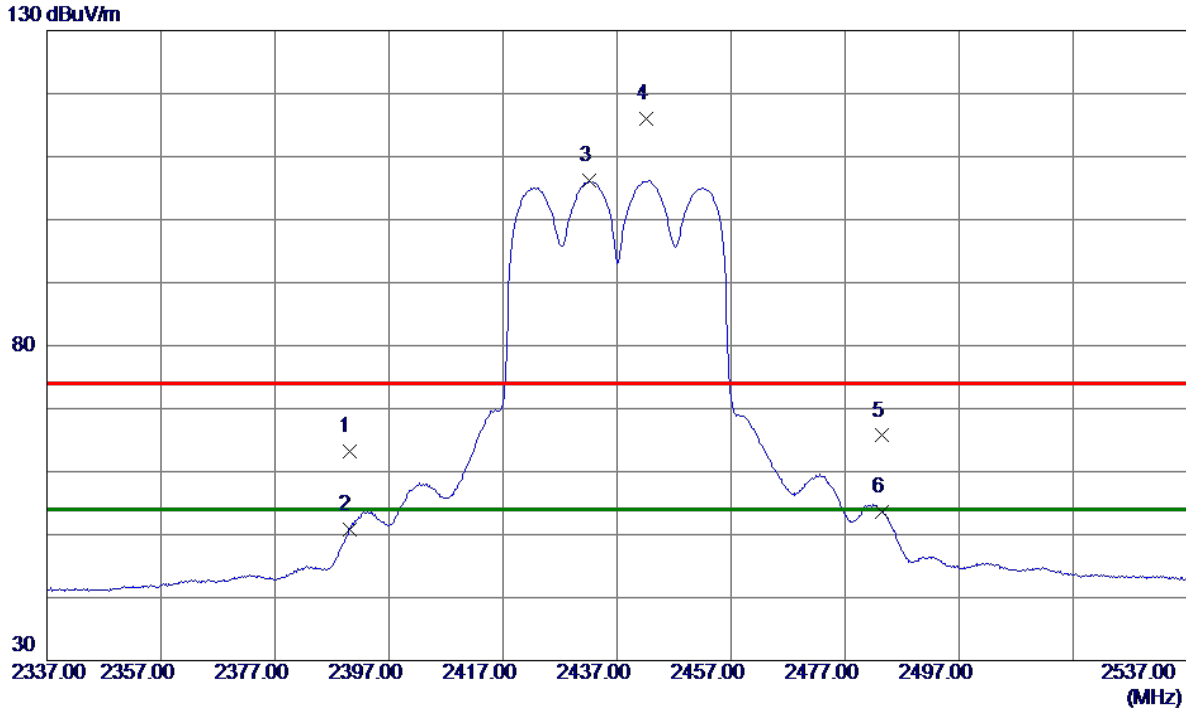

No.	Freq. MHz	Reading Level dBuV/m	Correct Factor dB	Measurement dBuV/m	Limit dBuV/m	Margin dB	Detector	Comment
1	2390.0000	52.62	10.50	63.12	74.00	-10.88	Peak	
2	2390.0000	40.26	10.50	50.76	54.00	-3.24	AVG	
3 *	2432.2000	95.56	10.62	106.18	54.00	52.18	AVG	No Limit
4	2442.2000	105.44	10.64	116.08	74.00	42.08	Peak	No Limit
5	2483.5000	54.94	10.76	65.70	74.00	-8.30	Peak	
6	2483.5000	42.89	10.76	53.65	54.00	-0.35	AVG	

REMARKS:

- (1) Measurement Value = Reading Level + Correct Factor.
- (2) Margin Level = Measurement Value - Limit Value.

Test Mode: TX N-40M Mode 2437 MHz

Vertical

80 dBuV/m

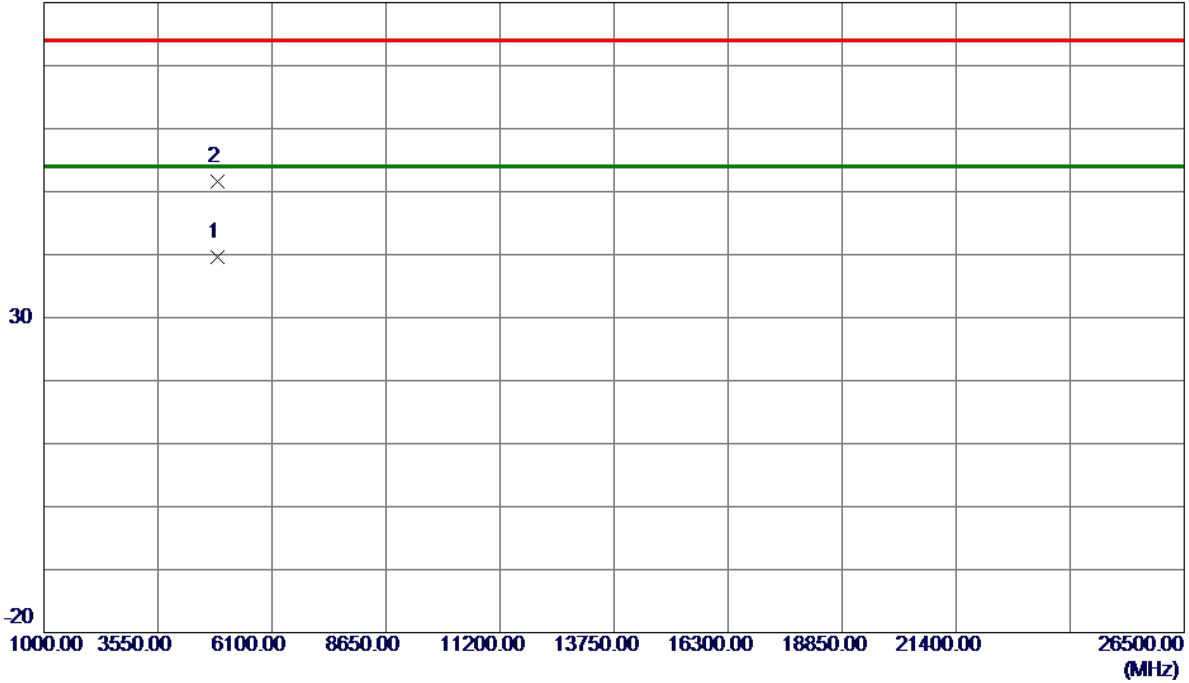

No.	Freq. MHz	Reading Level dBuV/m	Correct Factor dB	Measure ment dBuV/m	Limit dBuV/m	Margin dB	Detector	Comment
1 *	4868.4600	32.94	6.64	39.58	54.00	-14.42	AVG	
2	4879.3200	44.86	6.66	51.52	74.00	-22.48	Peak	

REMARKS:

- (1) Measurement Value = Reading Level + Correct Factor.
- (2) Margin Level = Measurement Value - Limit Value.

Test Mode: TX N-40M Mode 2447 MHz

Vertical

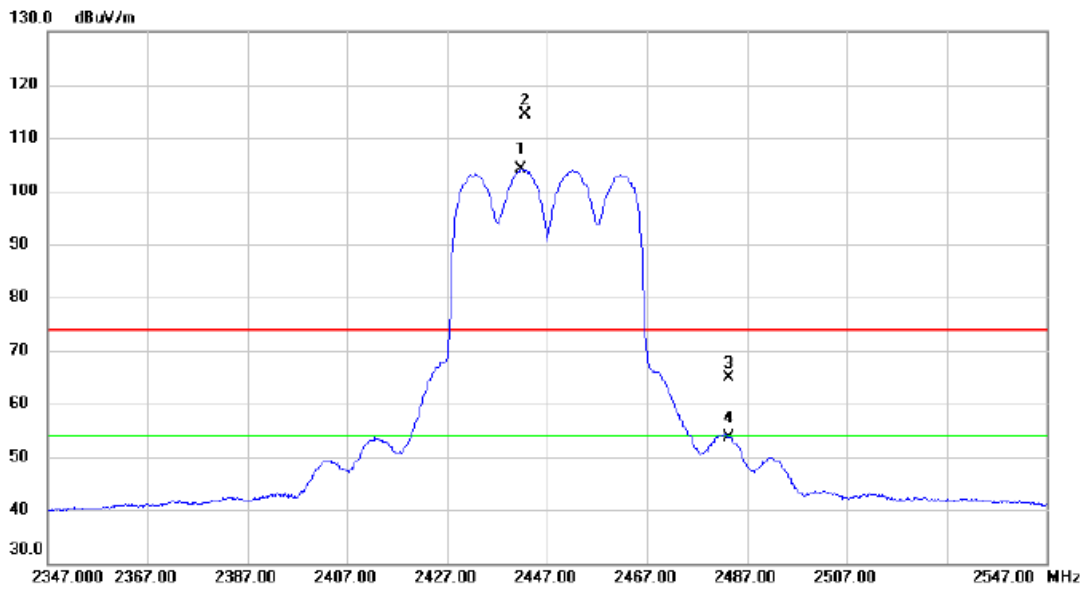

No.	Mk.	Freq. MHz	Reading Level dBuV	Correct Factor dB	Measure- ment dBuV/m	Limit dBuV/m	Margin dB	Detector	Comment
1	*	2441.800	93.39	10.64	104.03	54.00	50.03	AVG	No Limit
2	X	2442.600	103.70	10.64	114.34	74.00	40.34	peak	No Limit
3		2483.500	54.22	10.76	64.98	74.00	-9.02	peak	
4		2483.500	42.83	10.76	53.59	54.00	-0.41	AVG	

REMARKS:

- (1) Measurement Value = Reading Level + Correct Factor.
- (2) Margin Level = Measurement Value - Limit Value.

Test Mode: TX N-40M Mode 2447 MHz

Vertical

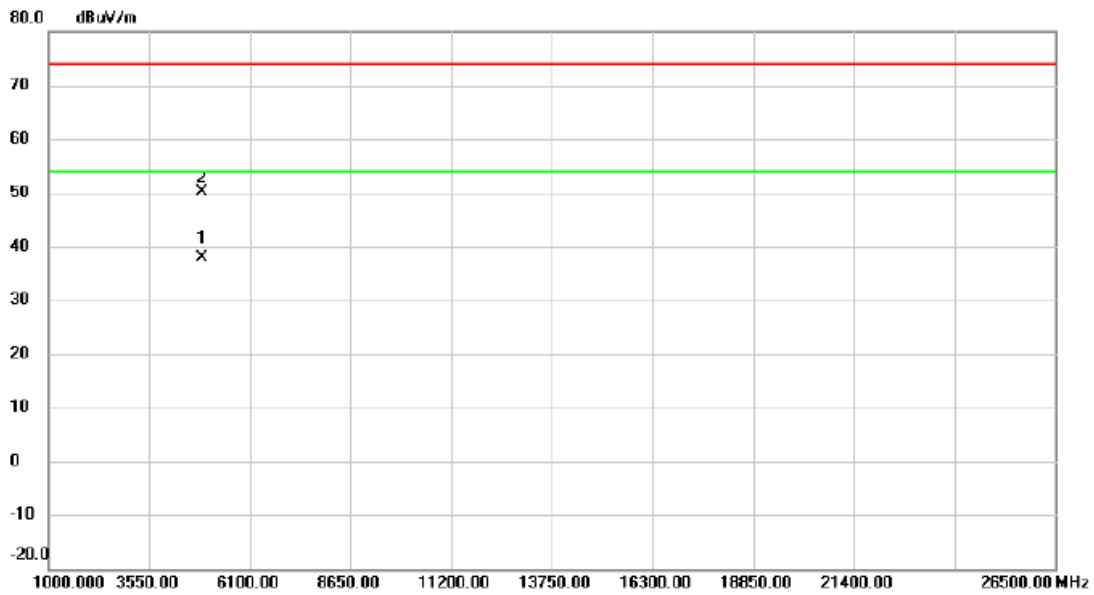

No.	Mk.	Freq. MHz	Reading Level dBuV	Correct Factor dB	Measure- ment dBuV/m	Limit dBuV/m	Margin dB	Detector	Comment
1	*	4879.140	31.17	6.66	37.83	54.00	-16.17	AVG	
2		4879.760	43.57	6.66	50.23	74.00	-23.77	peak	

REMARKS:

- (1) Measurement Value = Reading Level + Correct Factor.
- (2) Margin Level = Measurement Value - Limit Value.

Test Mode: TX N-40M Mode 2452 MHz

Vertical

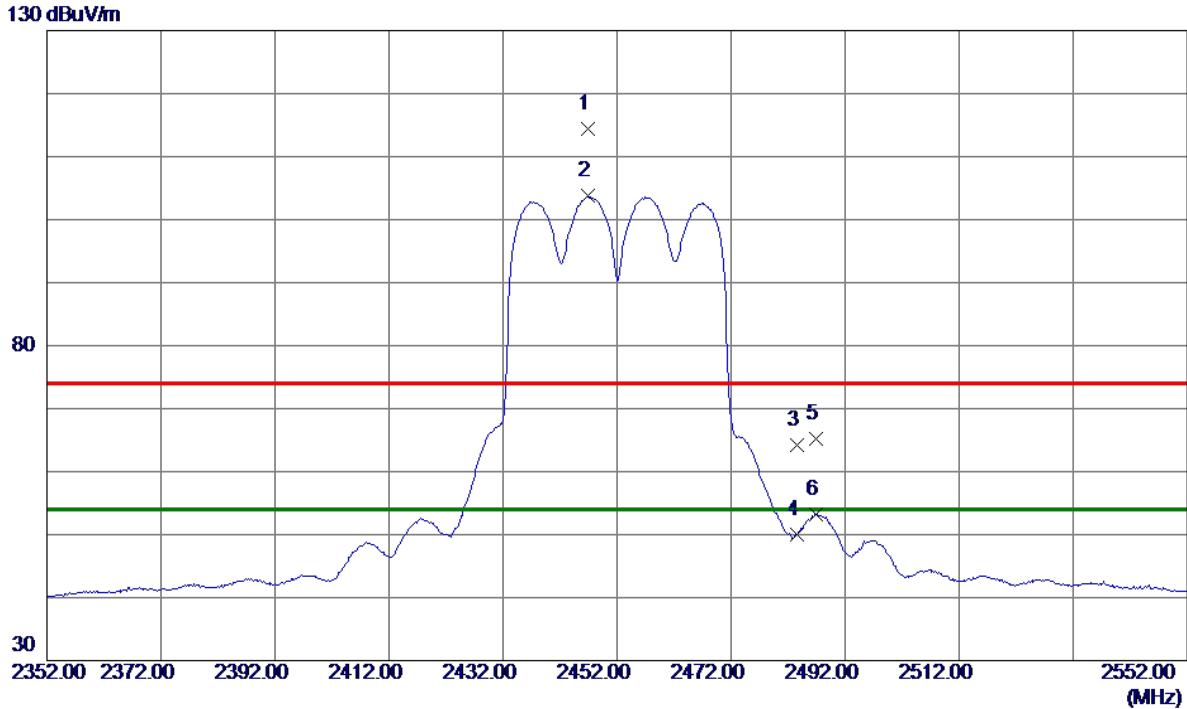

No.	Freq. MHz	Reading Level dBuV/m	Correct Factor dB	Measure ment dBuV/m	Limit dBuV/m	Margin dB	Detector	Comment
1	2446.8000	103.81	10.66	114.47	74.00	40.47	Peak	No Limit
2 *	2446.8000	93.11	10.66	103.77	54.00	49.77	AVG	No Limit
3	2483.5000	53.41	10.76	64.17	74.00	-9.83	Peak	
4	2483.5000	39.33	10.76	50.09	54.00	-3.91	AVG	
5	2486.8000	54.50	10.77	65.27	74.00	-8.73	Peak	
6	2486.8000	42.51	10.77	53.28	54.00	-0.72	AVG	

REMARKS:

- (1) Measurement Value = Reading Level + Correct Factor.
- (2) Margin Level = Measurement Value - Limit Value.

Test Mode: TX N-40M Mode 2452 MHz

Vertical

80 dBuV/m

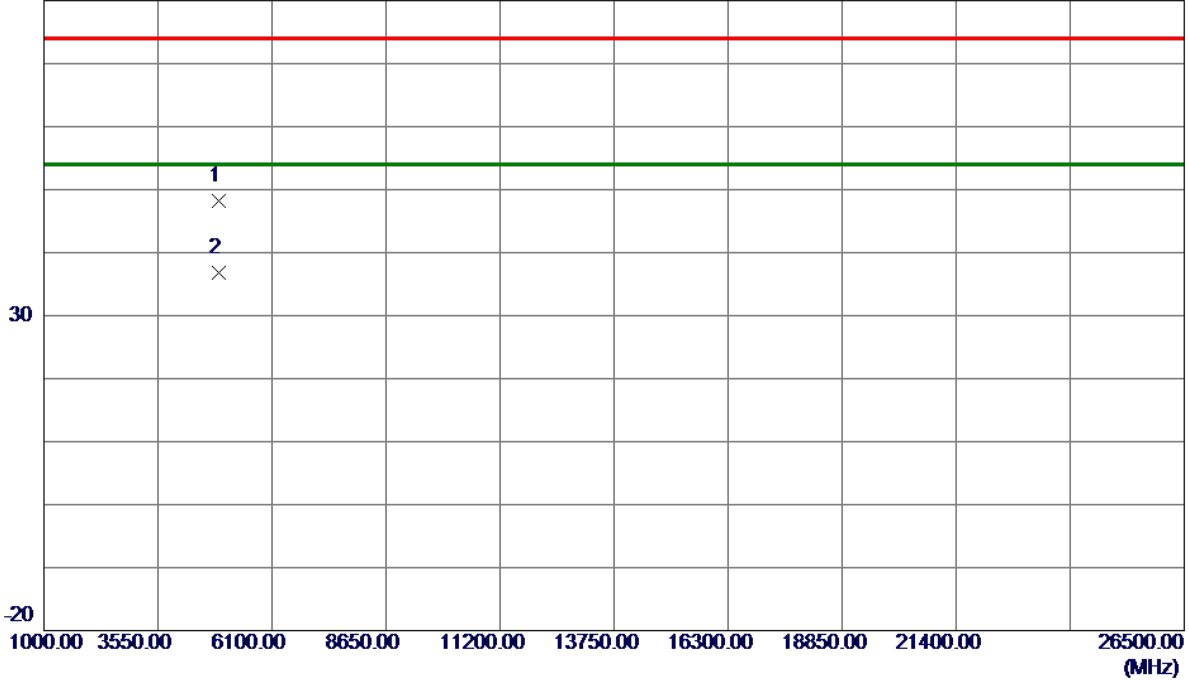

No.	Freq. MHz	Reading Level dBuV/m	Correct Factor dB	Measure ment dBuV/m	Limit dBuV/m	Margin dB	Detector	Comment
1	4897.6000	41.47	6.71	48.18	74.00	-25.82	Peak	
2 *	4898.2200	30.07	6.71	36.78	54.00	-17.22	AVG	

REMARKS:

- (1) Measurement Value = Reading Level + Correct Factor.
- (2) Margin Level = Measurement Value - Limit Value.

Test Mode: TX AX-20M Mode 2412 MHz

Vertical

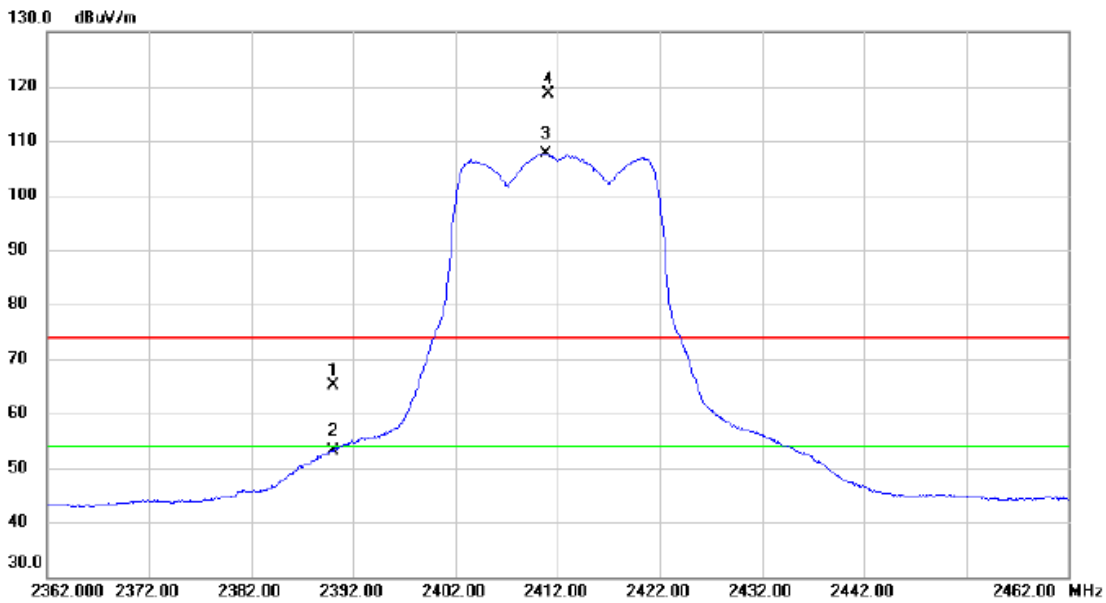

No.	Mk.	Freq. MHz	Reading Level dBuV	Correct Factor dB	Measure- ment dBuV/m	Limit dBuV/m	Margin dB	Detector	Comment
1		2390.000	54.57	10.50	65.07	74.00	-8.93	peak	
2		2390.000	42.68	10.50	53.18	54.00	-0.82	AVG	
3	*	2410.800	97.07	10.55	107.62	54.00	53.62	AVG	No Limit
4	X	2411.100	108.13	10.55	118.68	74.00	44.68	peak	No Limit

REMARKS:

- (1) Measurement Value = Reading Level + Correct Factor.
- (2) Margin Level = Measurement Value - Limit Value.

Test Mode: TX AX-20M Mode 2412 MHz

Vertical

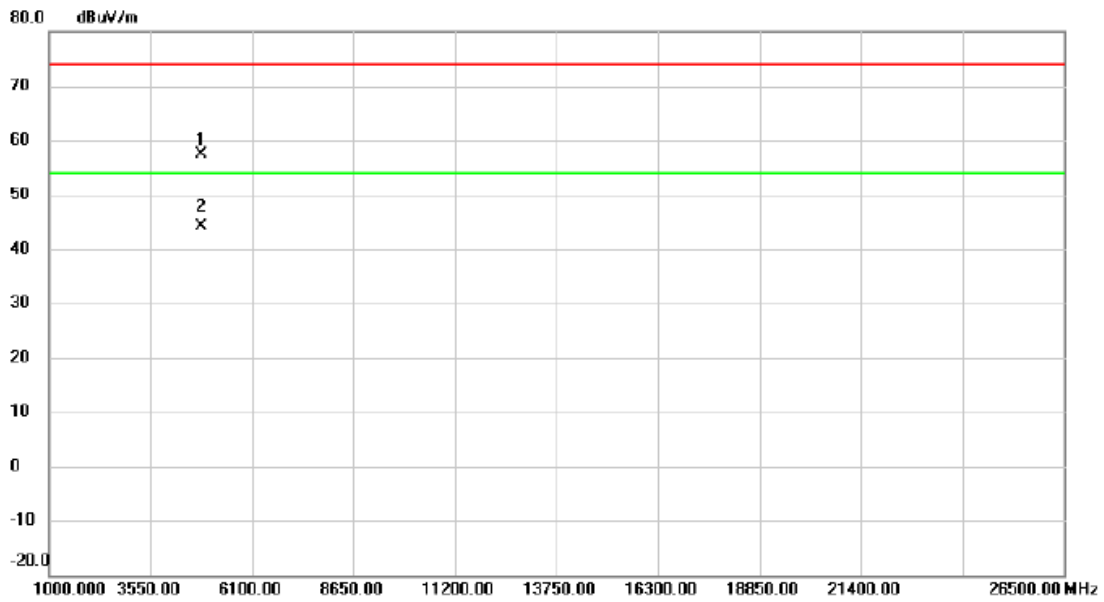

No.	Mk.	Freq. MHz	Reading Level dBuV	Correct Factor dB	Measure- ment dBuV/m	Limit dBuV/m	Margin dB	Detector	Comment
1		4827.760	50.77	6.53	57.30	74.00	-16.70	peak	
2	*	4827.780	37.48	6.53	44.01	54.00	-9.99	AVG	

REMARKS:

- (1) Measurement Value = Reading Level + Correct Factor.
- (2) Margin Level = Measurement Value - Limit Value.

Test Mode: TX AX-20M Mode 2417 MHz

Vertical

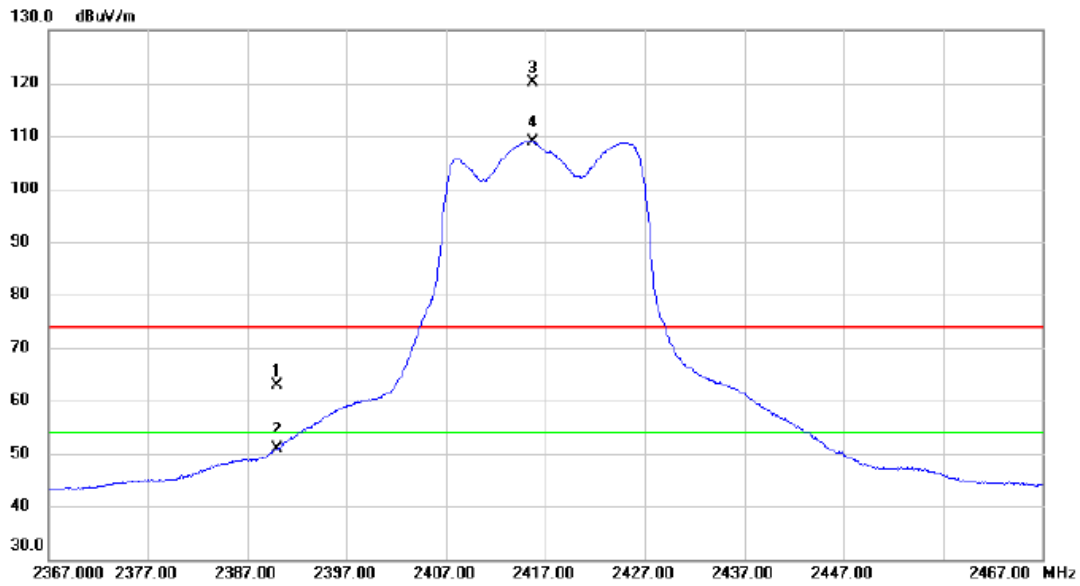

No.	Mk.	Freq. MHz	Reading Level dBuV	Correct Factor dB	Measure- ment dBuV/m	Limit dBuV/m	Margin dB	Detector	Comment
1		2390.000	52.49	10.50	62.99	74.00	-11.01	peak	
2		2390.000	40.41	10.50	50.91	54.00	-3.09	AVG	
3	X	2415.700	109.60	10.56	120.16	74.00	46.16	peak	No Limit
4	*	2415.700	98.44	10.56	109.00	54.00	55.00	AVG	No Limit

REMARKS:

- (1) Measurement Value = Reading Level + Correct Factor.
- (2) Margin Level = Measurement Value - Limit Value.

Test Mode: TX AX-20M Mode 2417 MHz

Vertical

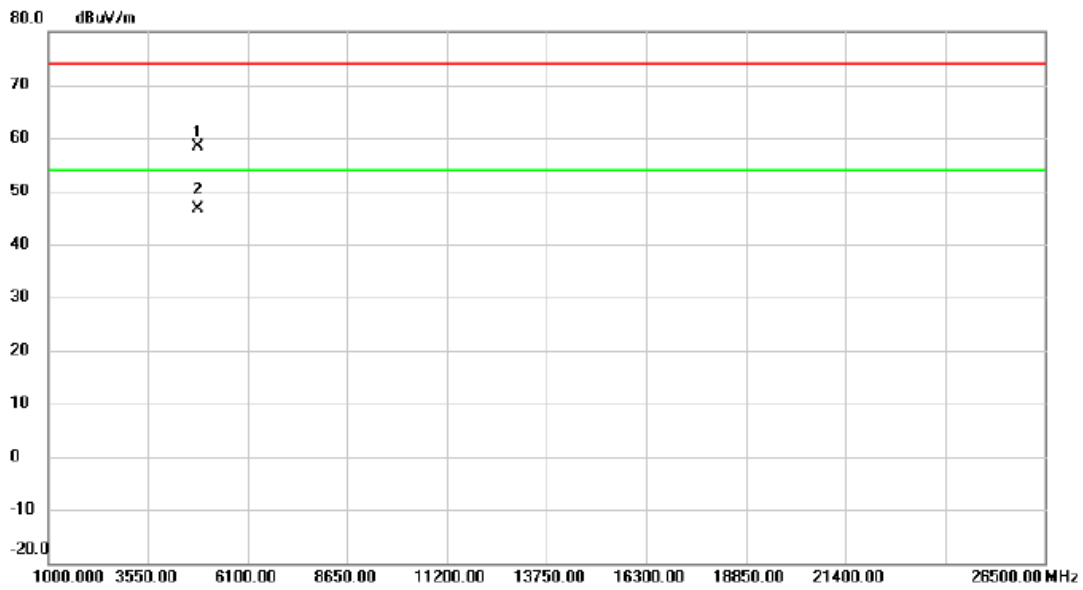

No.	Mk.	Freq. MHz	Reading Level dBuV	Correct Factor dB	Measure- ment dBuV/m	Limit dBuV/m	Margin dB	Detector	Comment
1		4837.340	51.86	6.56	58.42	74.00	-15.58	peak	
2	*	4838.640	39.95	6.56	46.51	54.00	-7.49	AVG	

REMARKS:

(1) Measurement Value = Reading Level + Correct Factor.

(2) Margin Level = Measurement Value - Limit Value.

Test Mode: TX AX-20M Mode 2437 MHz

Vertical

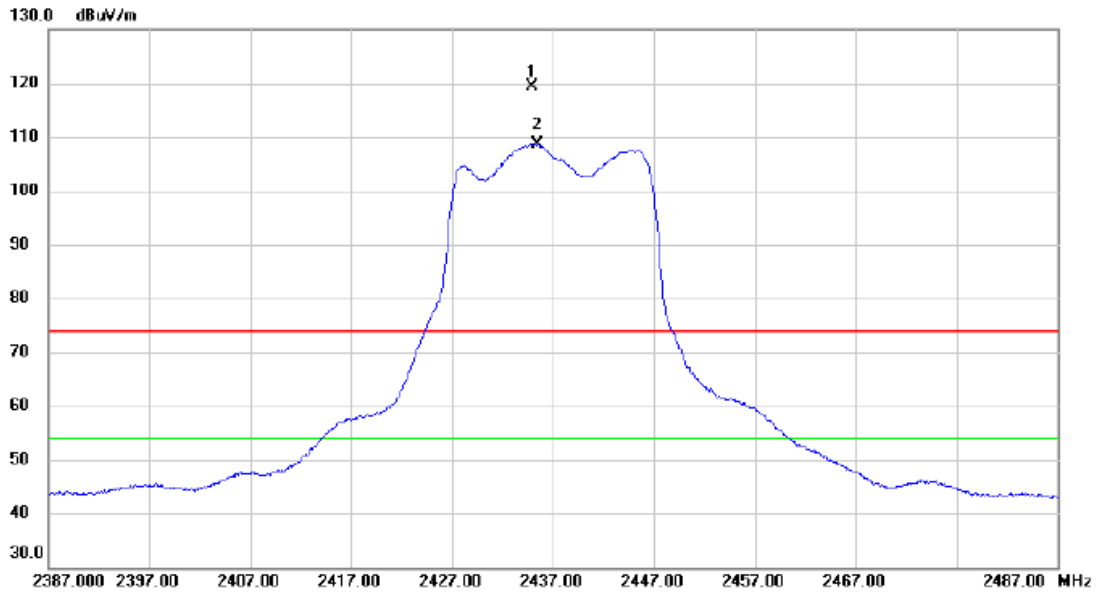

No.	Mk.	Freq. MHz	Reading Level dBuV	Correct Factor dB	Measure- ment dBuV/m	Limit dBuV/m	Margin dB	Detector	Comment
1	X	2434.900	108.81	10.62	119.43	74.00	45.43	peak	No Limit
2	*	2435.500	97.95	10.63	108.58	54.00	54.58	AVG	No Limit

REMARKS:

- (1) Measurement Value = Reading Level + Correct Factor.
- (2) Margin Level = Measurement Value - Limit Value.

Test Mode: TX AX-20M Mode 2437 MHz

Vertical

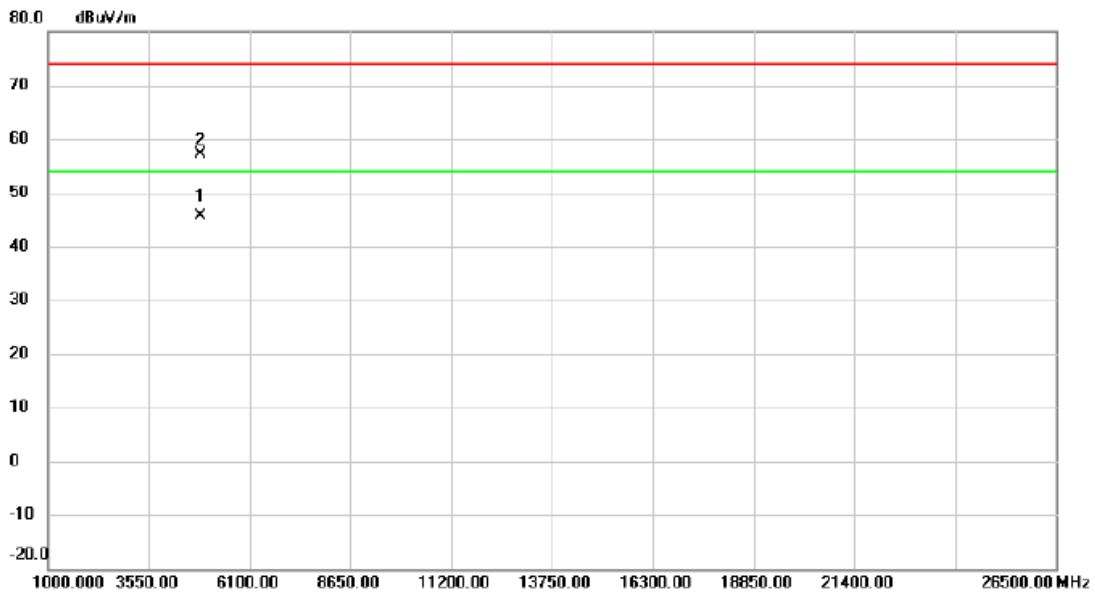

No.	Mk.	Freq. MHz	Reading Level dBuV	Correct Factor dB	Measure- ment dBuV/m	Limit dBuV/m	Margin dB	Detector	Comment
1	*	4868.200	39.04	6.63	45.67	54.00	-8.33	AVG	
2		4868.380	50.44	6.63	57.07	74.00	-16.93	peak	

REMARKS:

- (1) Measurement Value = Reading Level + Correct Factor.
- (2) Margin Level = Measurement Value - Limit Value.

Test Mode: TX AX-20M Mode 2457 MHz

Vertical

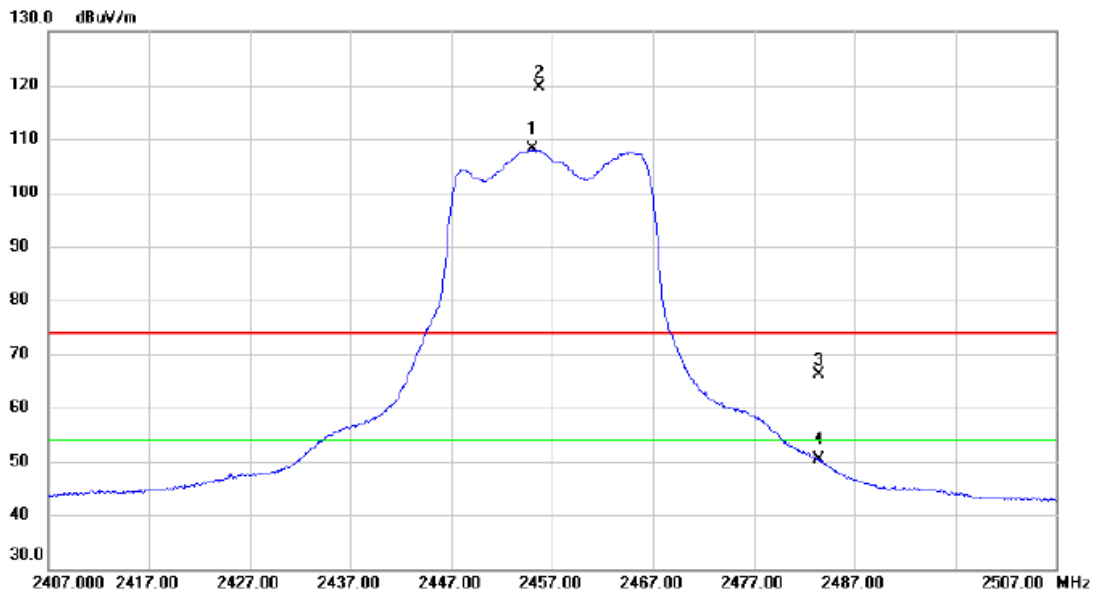

No.	Mk.	Freq. MHz	Reading Level dBuV	Correct Factor dB	Measure- ment dBuV/m	Limit dBuV/m	Margin dB	Detector	Comment
1	*	2455.100	97.41	10.68	108.09	54.00	54.09	AVG	No Limit
2	X	2455.700	108.97	10.68	119.65	74.00	45.65	peak	No Limit
3		2483.500	55.44	10.76	66.20	74.00	-7.80	peak	
4		2483.500	39.68	10.76	50.44	54.00	-3.56	AVG	

REMARKS:

- (1) Measurement Value = Reading Level + Correct Factor.
- (2) Margin Level = Measurement Value - Limit Value.

Test Mode: TX AX-20M Mode 2457 MHz

Vertical

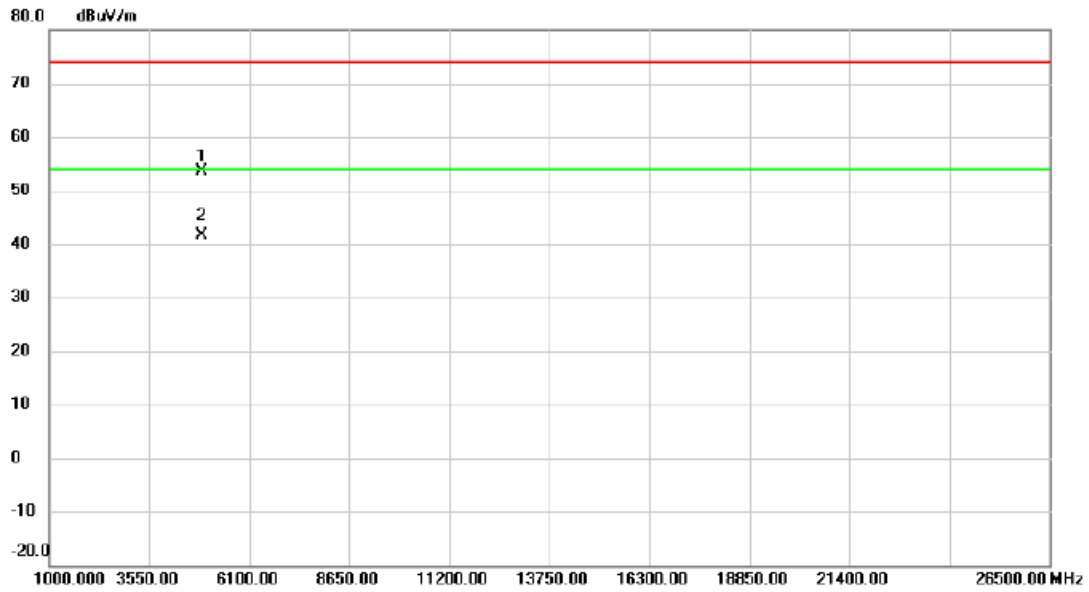

No.	Mk.	Freq. MHz	Reading Level dBuV	Correct Factor dB	Measure- ment dBuV/m	Limit dBuV/m	Margin dB	Detector	Comment
1		4909.300	46.90	6.74	53.64	74.00	-20.36	peak	
2	*	4909.520	34.84	6.75	41.59	54.00	-12.41	AVG	

REMARKS:

- (1) Measurement Value = Reading Level + Correct Factor.
- (2) Margin Level = Measurement Value - Limit Value.

Test Mode: TX AX-20M Mode 2462 MHz

Vertical

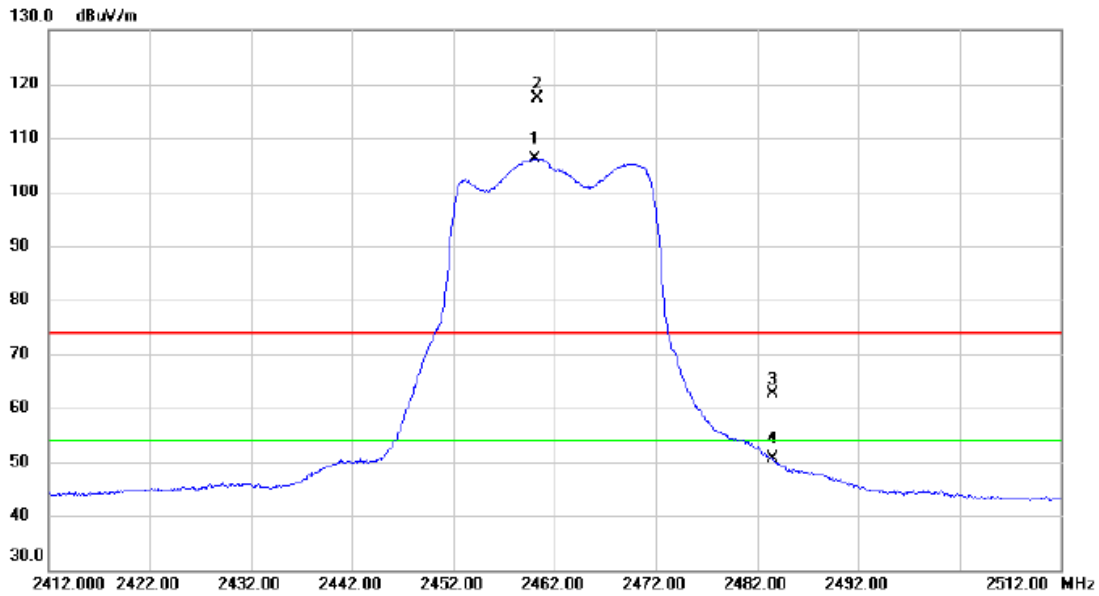

No.	Mk.	Freq. MHz	Reading Level dBuV	Correct Factor dB	Measure- ment dBuV/m	Limit dBuV/m	Margin dB	Detector	Comment
1	*	2460.000	95.51	10.69	106.20	54.00	52.20	AVG	No Limit
2	X	2460.300	106.76	10.69	117.45	74.00	43.45	peak	No Limit
3		2483.500	51.97	10.76	62.73	74.00	-11.27	peak	
4		2483.500	39.97	10.76	50.73	54.00	-3.27	AVG	

REMARKS:

- (1) Measurement Value = Reading Level + Correct Factor.
- (2) Margin Level = Measurement Value - Limit Value.

Test Mode: TX AX-20M Mode 2462 MHz

Vertical

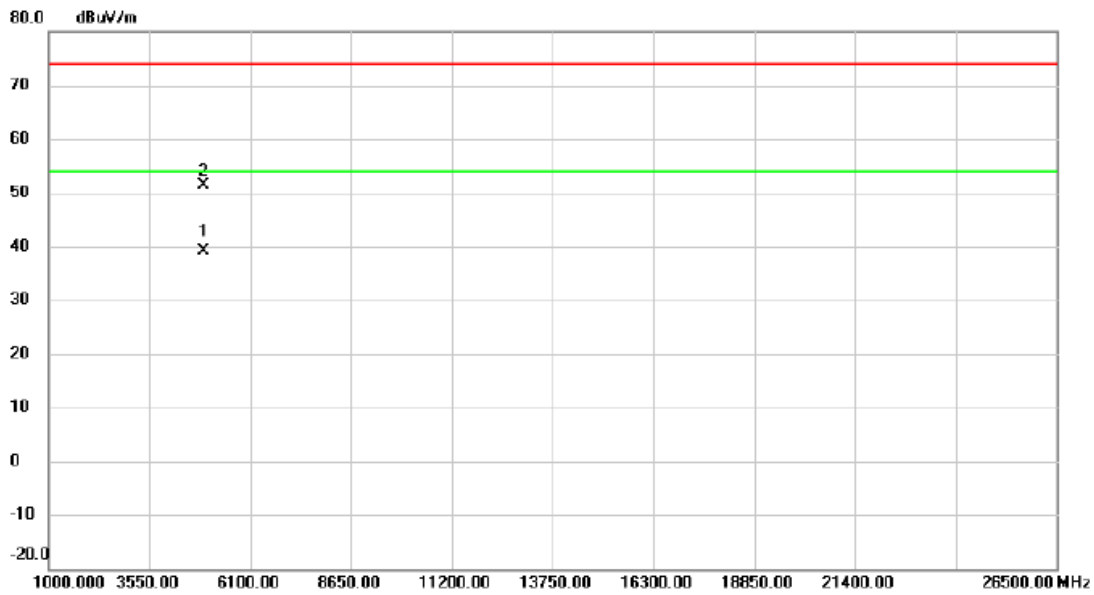

No.	Mk.	Freq. MHz	Reading Level dBuV	Correct Factor dB	Measure- ment dBuV/m	Limit dBuV/m	Margin dB	Detector	Comment
1	*	4918.840	32.39	6.76	39.15	54.00	-14.85	AVG	
2		4919.300	44.50	6.76	51.26	74.00	-22.74	peak	

REMARKS:

- (1) Measurement Value = Reading Level + Correct Factor.
- (2) Margin Level = Measurement Value - Limit Value.

Test Mode: TX AX-40M Mode 2422 MHz

Vertical

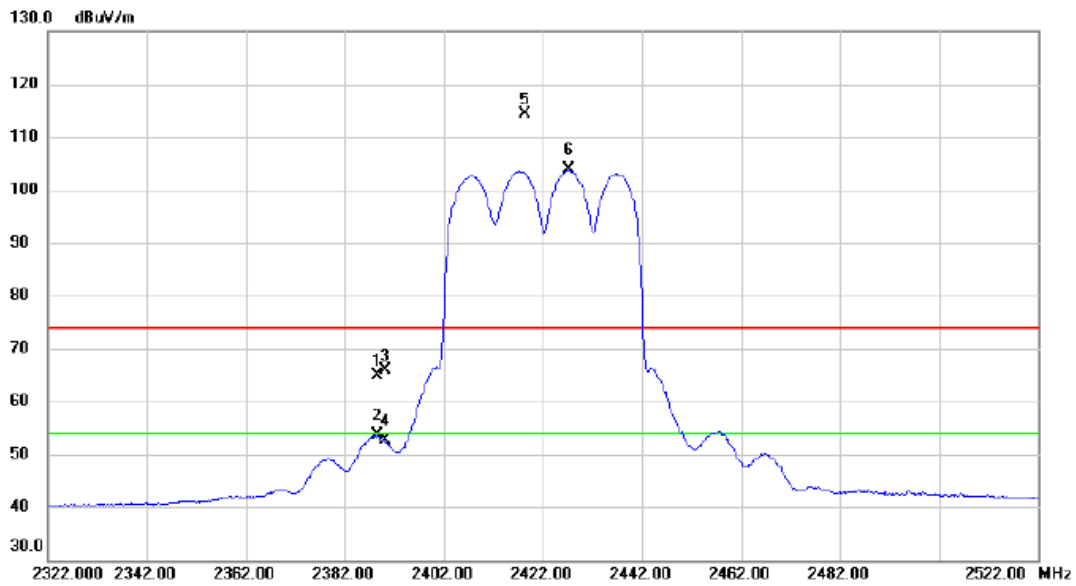

No.	Mk.	Freq. MHz	Reading Level dBuV	Correct Factor dB	Measure- ment dBuV/m	Limit dBuV/m	Margin dB	Detector	Comment
1		2388.600	54.45	10.49	64.94	74.00	-9.06	peak	
2		2388.600	43.11	10.49	53.60	54.00	-0.40	AVG	
3		2390.000	55.42	10.50	65.92	74.00	-8.08	peak	
4		2390.000	42.21	10.50	52.71	54.00	-1.29	AVG	
5	X	2418.400	103.92	10.58	114.50	74.00	40.50	peak	No Limit
6	*	2427.200	93.29	10.61	103.90	54.00	49.90	AVG	No Limit

REMARKS:

- (1) Measurement Value = Reading Level + Correct Factor.
- (2) Margin Level = Measurement Value - Limit Value.

Test Mode: TX AX-40M Mode 2422 MHz

Vertical

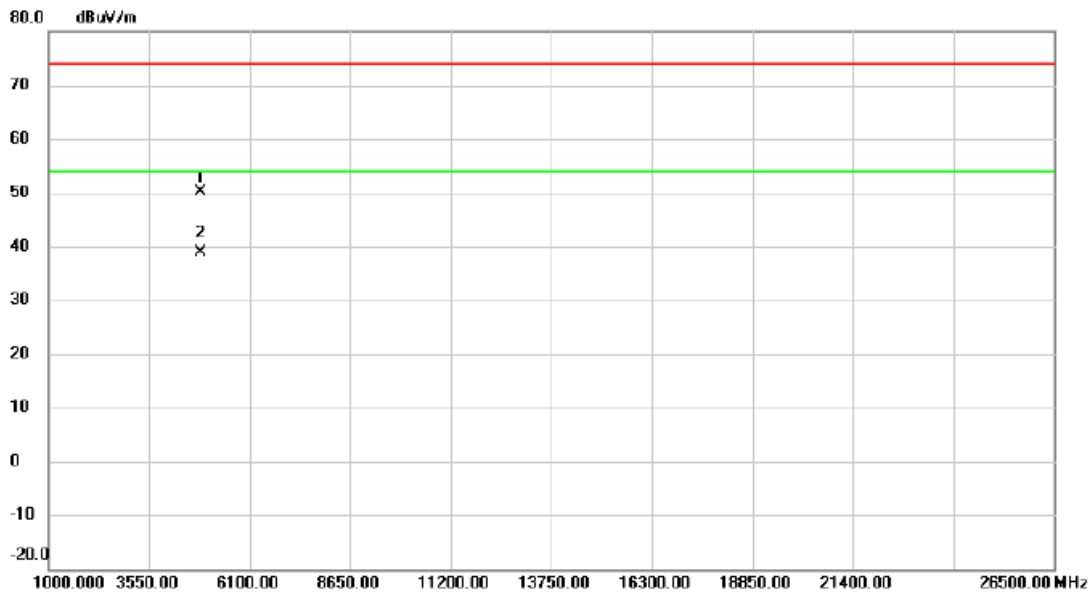

No.	Mk.	Freq. MHz	Reading Level dBuV	Correct Factor dB	Measure- ment dBuV/m	Limit dBuV/m	Margin dB	Detector	Comment
1		4848.200	43.53	6.59	50.12	74.00	-23.88	peak	
2	*	4848.800	32.22	6.59	38.81	54.00	-15.19	AVG	

REMARKS:

- (1) Measurement Value = Reading Level + Correct Factor.
- (2) Margin Level = Measurement Value - Limit Value.

Test Mode: TX AX-40M Mode 2427 MHz

Vertical

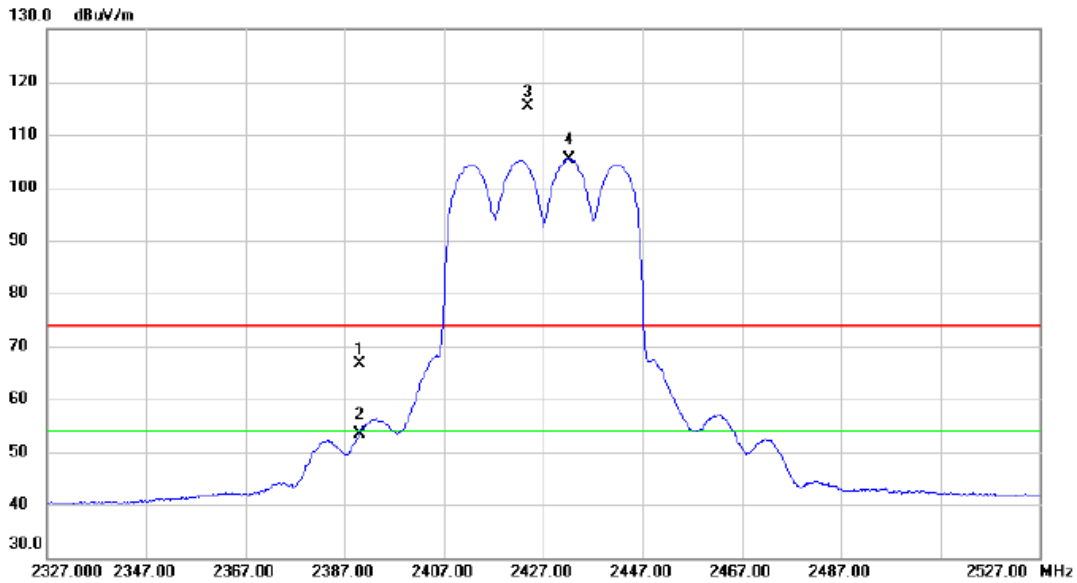

No.	Mk.	Freq. MHz	Reading Level dBuV	Correct Factor dB	Measure- ment dBuV/m	Limit dBuV/m	Margin dB	Detector	Comment
1		2390.000	56.13	10.50	66.63	74.00	-7.37	peak	
2		2390.000	42.84	10.50	53.34	54.00	-0.66	AVG	
3	X	2423.800	104.91	10.59	115.50	74.00	41.50	peak	No Limit
4	*	2432.200	94.84	10.61	105.45	54.00	51.45	AVG	No Limit

REMARKS:

- (1) Measurement Value = Reading Level + Correct Factor.
- (2) Margin Level = Measurement Value - Limit Value.

Test Mode: TX AX-40M Mode 2427 MHz

Vertical

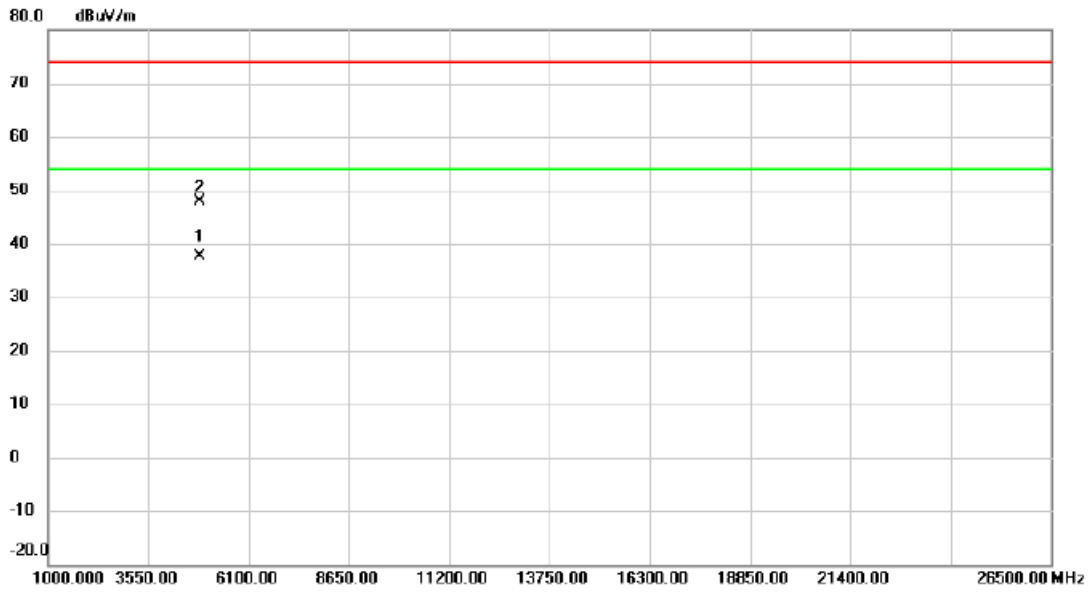

No.	Mk.	Freq. MHz	Reading Level dBuV	Correct Factor dB	Measurement dBuV/m	Limit dBuV/m	Margin dB	Detector	Comment
1	*	4848.200	30.98	6.59	37.57	54.00	-16.43	AVG	
2		4848.500	41.23	6.59	47.82	74.00	-26.18	peak	

REMARKS:

- (1) Measurement Value = Reading Level + Correct Factor.
- (2) Margin Level = Measurement Value - Limit Value.

Test Mode: TX AX-40M Mode 2437 MHz

Vertical

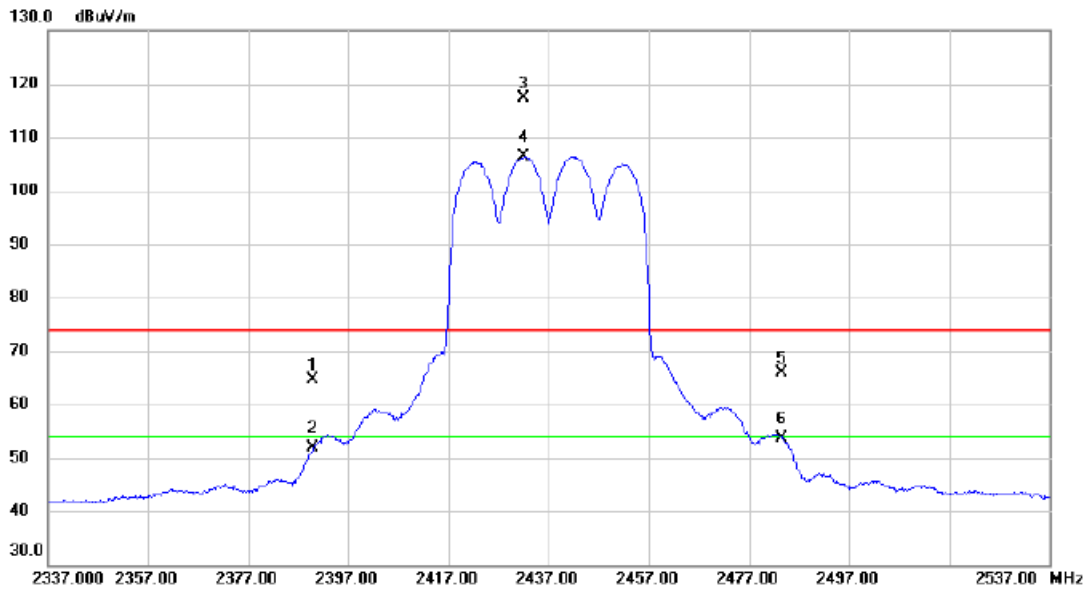

No.	Mk.	Freq. MHz	Reading Level dBuV	Correct Factor dB	Measure- ment dBuV/m	Limit dBuV/m	Margin dB	Detector	Comment
1		2390.000	54.20	10.50	64.70	74.00	-9.30	peak	
2		2390.000	41.34	10.50	51.84	54.00	-2.16	AVG	
3	X	2432.200	106.78	10.61	117.39	74.00	43.39	peak	No Limit
4	*	2432.200	95.78	10.61	106.39	54.00	52.39	AVG	No Limit
5		2483.500	55.03	10.76	65.79	74.00	-8.21	peak	
6		2483.500	42.79	10.76	53.55	54.00	-0.45	AVG	

REMARKS:

- (1) Measurement Value = Reading Level + Correct Factor.
- (2) Margin Level = Measurement Value - Limit Value.

Test Mode: TX AX-40M Mode 2437 MHz

Vertical

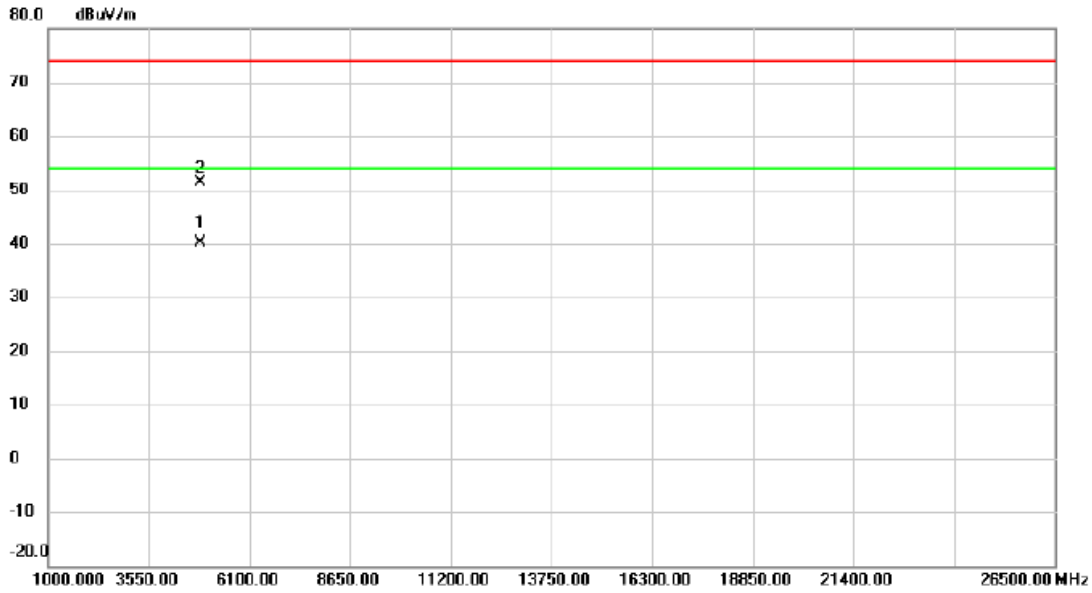

No.	Mk.	Freq.	Reading Level	Correct Factor	Measurement	Limit	Margin	Detector	Comment
		MHz	dBuV	dB	dBuV/m	dBuV/m	dB		
1	*	4868.880	33.61	6.63	40.24	54.00	-13.76	AVG	
2		4869.460	44.87	6.63	51.50	74.00	-22.50	peak	

REMARKS:

- (1) Measurement Value = Reading Level + Correct Factor.
- (2) Margin Level = Measurement Value - Limit Value.

Test Mode: TX AX-40M Mode 2447 MHz

Vertical

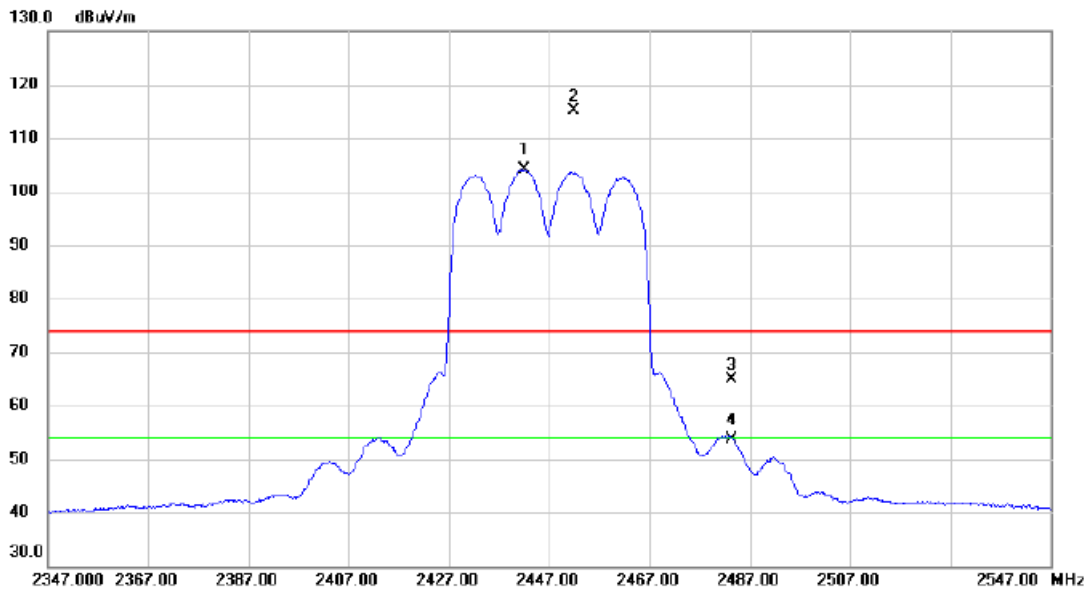

No.	Mk.	Freq. MHz	Reading Level dBuV	Correct Factor dB	Measure- ment dBuV/m	Limit dBuV/m	Margin dB	Detector	Comment
1	*	2442.200	93.47	10.64	104.11	54.00	50.11	AVG	No Limit
2	X	2451.800	104.51	10.66	115.17	74.00	41.17	peak	No Limit
3		2483.500	54.17	10.76	64.93	74.00	-9.07	peak	
4		2483.500	42.83	10.76	53.59	54.00	-0.41	AVG	

REMARKS:

- (1) Measurement Value = Reading Level + Correct Factor.
- (2) Margin Level = Measurement Value - Limit Value.

Test Mode: TX AX-40M Mode 2447 MHz

Vertical

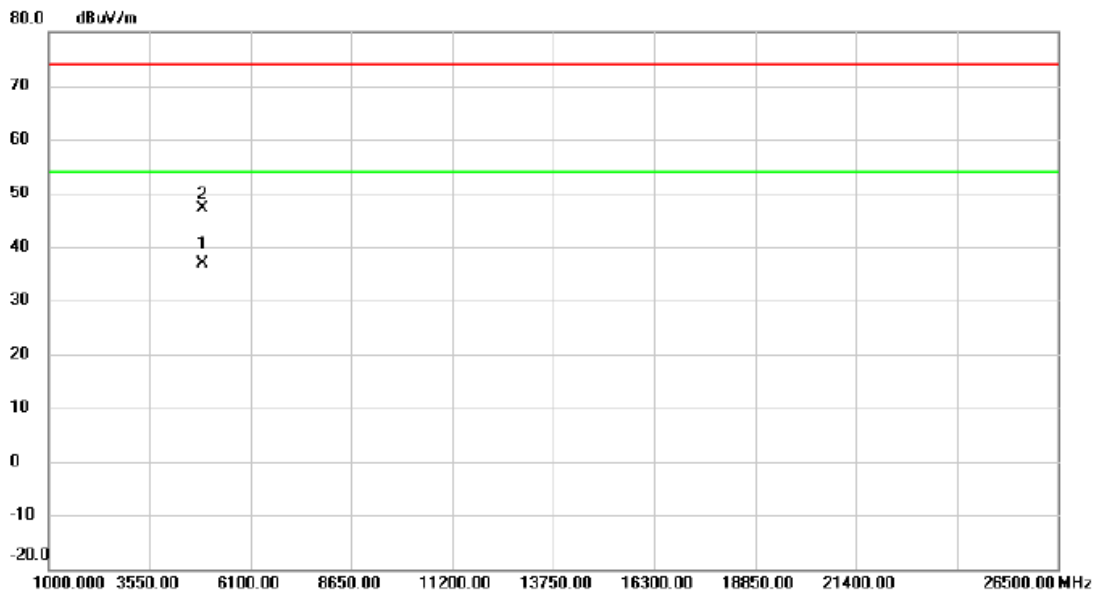

No.	Mk.	Freq. MHz	Reading Level dBuV	Correct Factor dB	Measure- ment dBuV/m	Limit dBuV/m	Margin dB	Detector	Comment
1	*	4888.360	30.16	6.68	36.84	54.00	-17.16	AVG	
2		4889.620	40.56	6.68	47.24	74.00	-26.76	peak	

REMARKS:

- (1) Measurement Value = Reading Level + Correct Factor.
- (2) Margin Level = Measurement Value - Limit Value.

Test Mode: TX AX-40M Mode 2452 MHz

Vertical

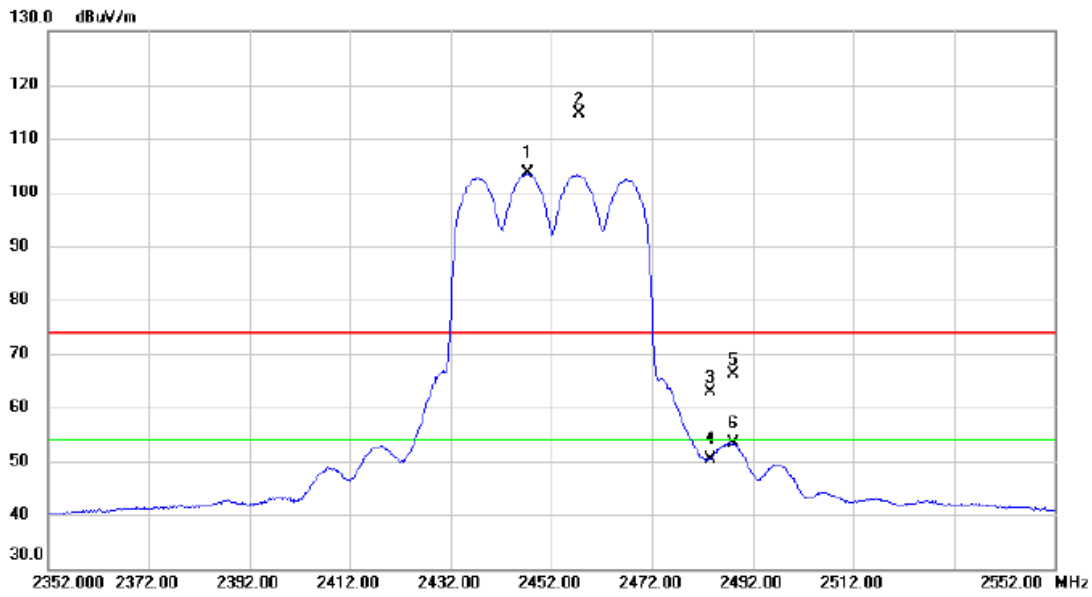

No.	Mk.	Freq. MHz	Reading Level dBuV	Correct Factor dB	Measure- ment dBuV/m	Limit dBuV/m	Margin dB	Detector	Comment
1	*	2447.400	92.85	10.66	103.51	54.00	49.51	AVG	No Limit
2	X	2457.600	103.94	10.69	114.63	74.00	40.63	peak	No Limit
3		2483.500	52.23	10.76	62.99	74.00	-11.01	peak	
4		2483.500	39.74	10.76	50.50	54.00	-3.50	AVG	
5		2488.000	55.43	10.78	66.21	74.00	-7.79	peak	
6		2488.000	42.51	10.78	53.29	54.00	-0.71	AVG	

REMARKS:

(1) Measurement Value = Reading Level + Correct Factor.

(2) Margin Level = Measurement Value - Limit Value.

Test Mode: TX AX-40M Mode 2452 MHz

Vertical

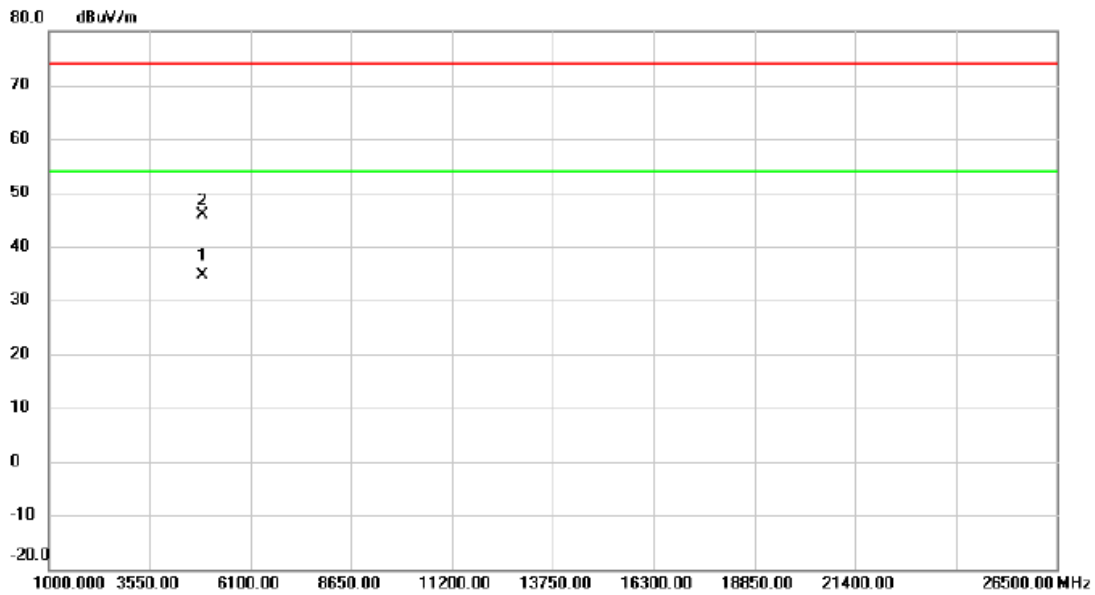

No.	Mk.	Freq. MHz	Reading Level dBuV	Correct Factor dB	Measure- ment dBuV/m	Limit dBuV/m	Margin dB	Detector	Comment
1	*	4898.720	27.92	6.71	34.63	54.00	-19.37	AVG	
2		4907.660	39.19	6.73	45.92	74.00	-28.08	peak	

REMARKS:

- (1) Measurement Value = Reading Level + Correct Factor.
- (2) Margin Level = Measurement Value - Limit Value.

APPENDIX E - BANDWIDTH

Test Mode	TX G Mode
-----------	-----------

Channel	Frequency (MHz)	6 dB Bandwidth (MHz)	6 dB Bandwidth Min. Limit (kHz)	Result
01	2412	15.40	500	Complies
06	2437	15.85	500	Complies
11	2462	15.76	500	Complies

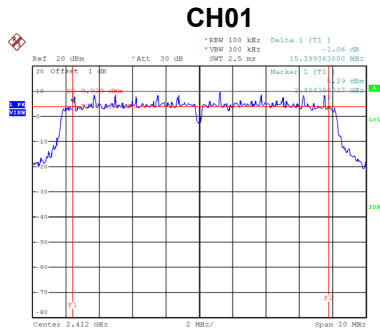

Date: 1.JUL.2020 10:09:22

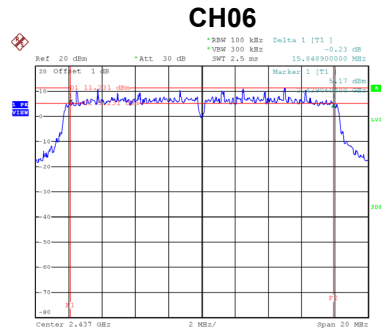

Date: 1.JUL.2020 10:11:57

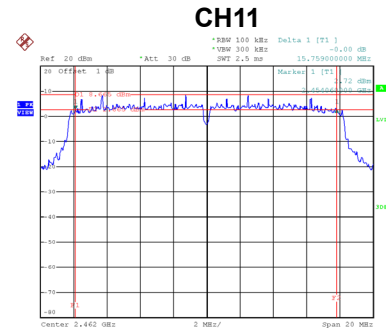

Date: 1.JUL.2020 10:13:30

Channel	Frequency (MHz)	99 % Emission Bandwidth (MHz)	Result
01	2412	16.56	Complies
06	2437	16.56	Complies
11	2462	16.48	Complies

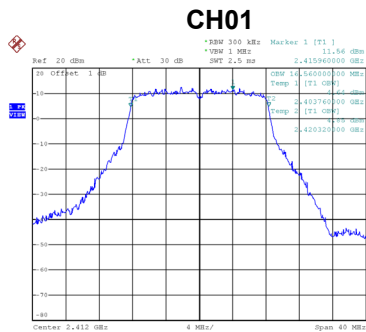

Date: 1.JUL.2020 10:09:29

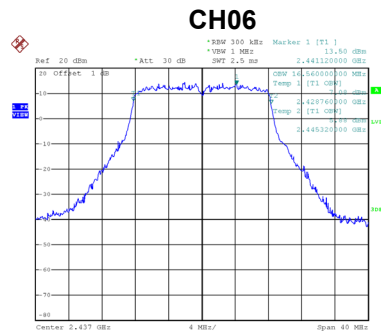

Date: 1.JUL.2020 10:12:03

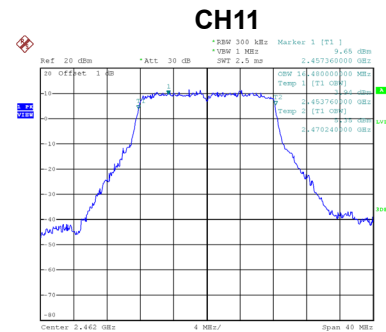

Date: 1.JUL.2020 10:13:37

Test Mode	TX N-20M Mode
-----------	---------------

Channel	Frequency (MHz)	6 dB Bandwidth (MHz)	6 dB Bandwidth Min. Limit (kHz)	Result
01	2412	17.62	500	Complies
06	2437	16.88	500	Complies
11	2462	17.62	500	Complies

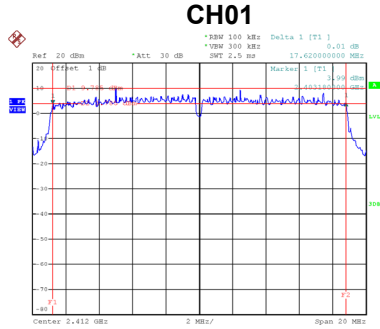

Date: 1.JUL.2020 10:15:05

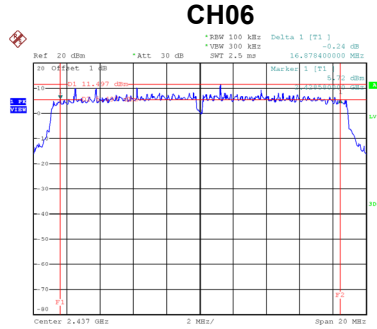

Date: 1.JUL.2020 10:16:34

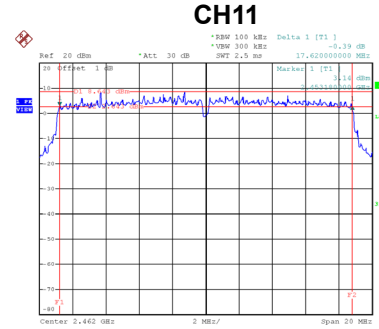

Date: 1.JUL.2020 10:17:59

Channel	Frequency (MHz)	99 % Emission Bandwidth (MHz)	Result
01	2412	17.76	Complies
06	2437	17.76	Complies
11	2462	17.76	Complies

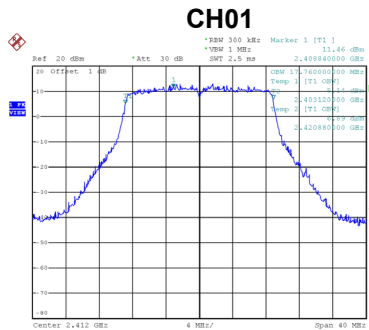

Date: 1.JUL.2020 10:15:12

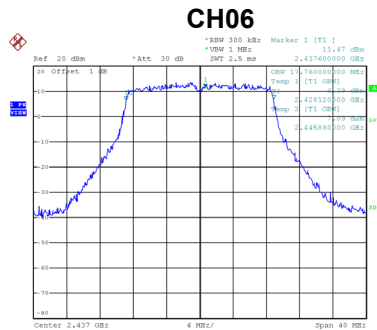

Date: 1.JUL.2020 10:16:41

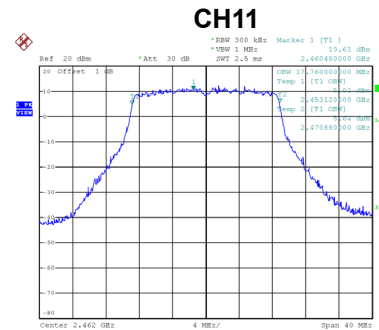

Date: 1.JUL.2020 10:18:06

Test Mode	TX N-40M Mode
-----------	---------------

Channel	Frequency (MHz)	6 dB Bandwidth (MHz)	6 dB Bandwidth Min. Limit (kHz)	Result
03	2422	36.04	500	Complies
06	2437	36.48	500	Complies
09	2452	35.96	500	Complies

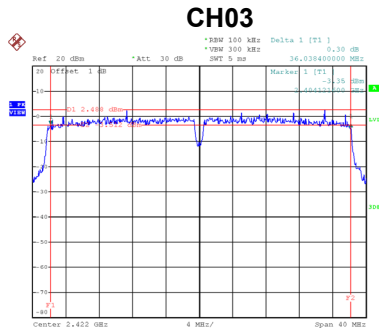

Date: 1.JUL.2020 10:19:51

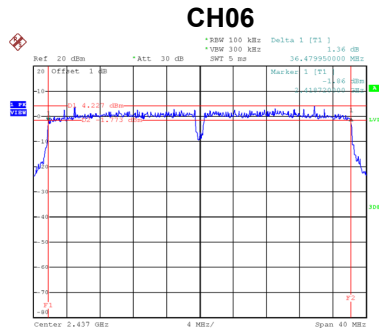

Date: 1.JUL.2020 10:21:20

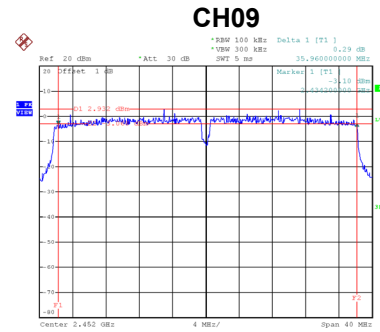

Date: 1.JUL.2020 10:23:12

Channel	Frequency (MHz)	99 % Emission Bandwidth (MHz)	Result
03	2422	36.32	Complies
06	2437	36.32	Complies
09	2452	36.32	Complies

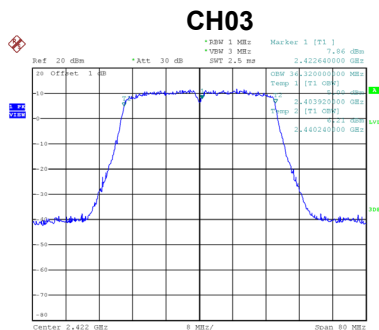

Date: 1.JUL.2020 10:19:58

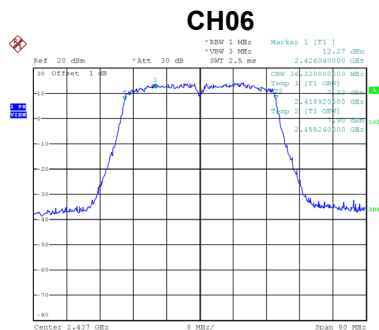

Date: 1.JUL.2020 10:21:27

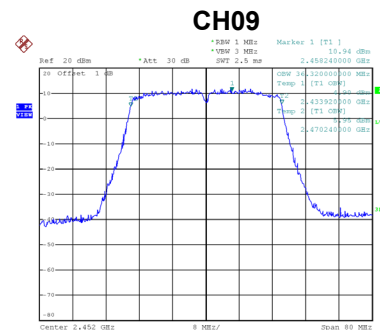

Date: 1.JUL.2020 10:23:19

Test Mode	TX AX-20M Mode
-----------	----------------

Channel	Frequency (MHz)	6 dB Bandwidth (MHz)	6 dB Bandwidth Min. Limit (kHz)	Result
01	2412	18.72	500	Complies
06	2437	18.76	500	Complies
11	2462	18.57	500	Complies

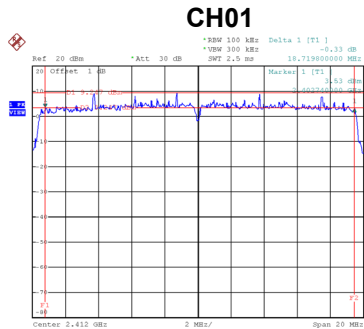

Date: 1.JUL.2020 10:24:58

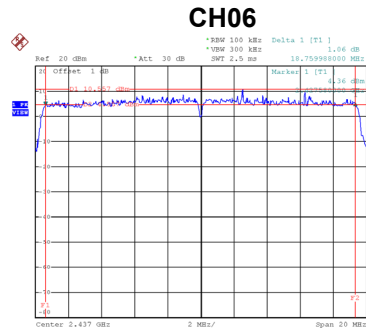

Date: 1.JUL.2020 10:26:22

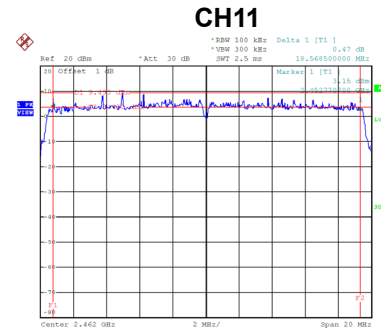

Date: 1.JUL.2020 10:27:43

Channel	Frequency (MHz)	99 % Emission Bandwidth (MHz)	Result
01	2412	19.04	Complies
06	2437	19.04	Complies
11	2462	19.04	Complies

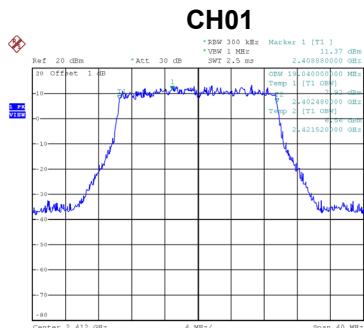

Date: 1.JUL.2020 10:25:05

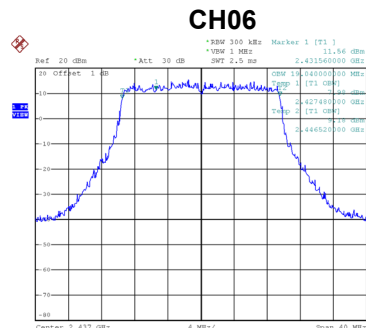

Date: 1.JUL.2020 10:26:29

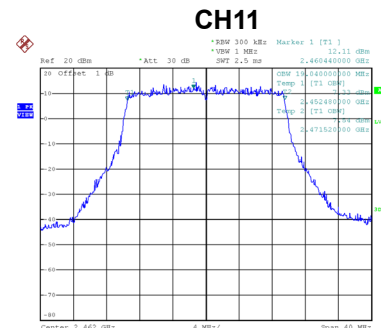

Date: 1.JUL.2020 10:27:49

Test Mode	TX AX-40M Mode
-----------	----------------

Channel	Frequency (MHz)	6 dB Bandwidth (MHz)	6 dB Bandwidth Min. Limit (kHz)	Result
03	2422	38.16	500	Complies
06	2437	37.99	500	Complies
09	2452	38.07	500	Complies

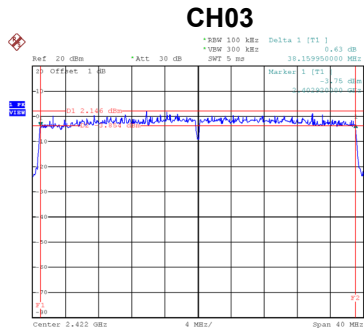

Date: 1.JUL.2020 10:29:12

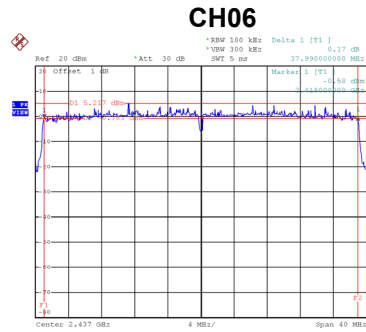

Date: 1.JUL.2020 10:30:47

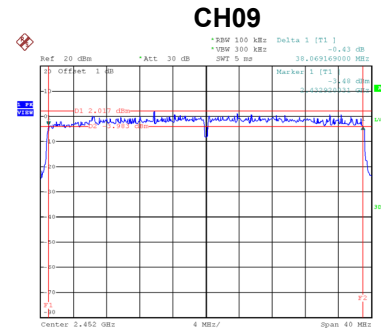

Date: 1.JUL.2020 10:34:46

Channel	Frequency (MHz)	99 % Emission Bandwidth (MHz)	Result
03	2422	37.92	Complies
06	2437	37.92	Complies
09	2452	37.92	Complies

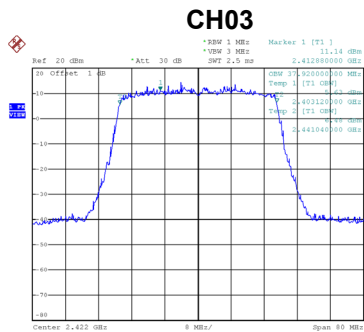

Date: 1.JUL.2020 10:29:19

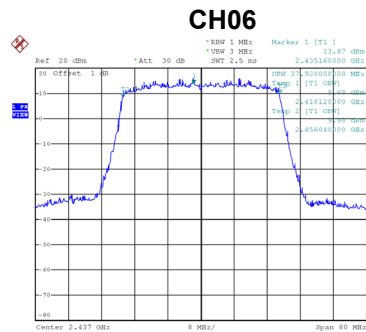

Date: 1.JUL.2020 10:30:53

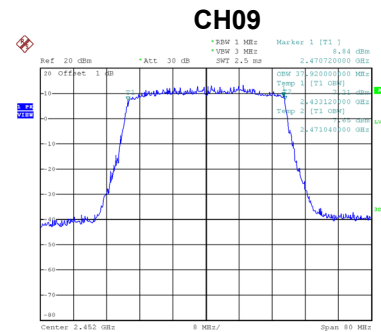

Date: 1.JUL.2020 10:34:52

APPENDIX F - MAXIMUM AVERAGE OUTPUT POWER

Test Mode	TX B Mode_Ant. 1
-----------	------------------

Channel	Frequency (MHz)	Average Output Power (dBm)	Duty Factor	Average Output Power + Duty Factor (dBm)	Max. Limit (dBm)	Max. Limit (W)	Result
01	2412	22.68	0.12	22.80	30.00	1.0000	Complies
06	2437	22.64	0.12	22.76	30.00	1.0000	Complies
11	2462	22.72	0.12	22.84	30.00	1.0000	Complies

Test Mode	TX B Mode_Ant. 2
-----------	------------------

Channel	Frequency (MHz)	Average Output Power (dBm)	Duty Factor	Average Output Power + Duty Factor (dBm)	Max. Limit (dBm)	Max. Limit (W)	Result
01	2412	22.92	0.12	23.04	30.00	1.0000	Complies
06	2437	22.73	0.12	22.85	30.00	1.0000	Complies
11	2462	22.85	0.12	22.97	30.00	1.0000	Complies

Test Mode	TX B Mode_Total
-----------	-----------------

Channel	Frequency (MHz)	Average Output Power (dBm)	Max. Limit (dBm)	Max. Limit (W)	Result
01	2412	25.93	30.00	1.0000	Complies
06	2437	25.81	30.00	1.0000	Complies
11	2462	25.91	30.00	1.0000	Complies