

SAR

Dipole & Waveguide

Performance Measurement Report

ISSUED BY
Shenzhen BALUN Technology Co., Ltd.



FOR
Validation Dipoles & Waveguide

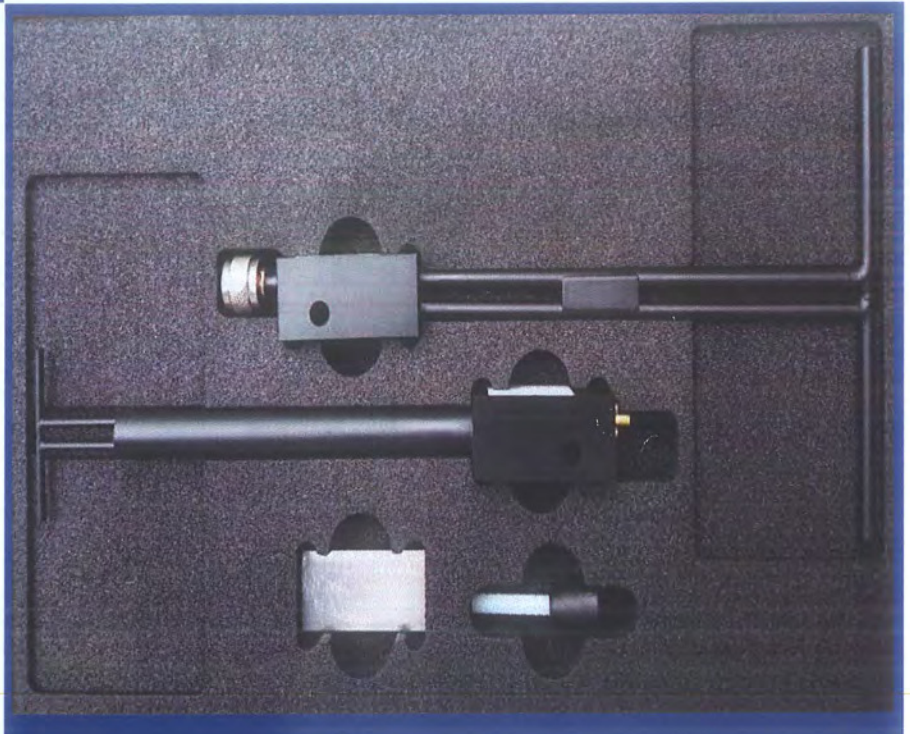

Tested by:

Tu Lang
Tu Lang

(Engineer)

Approved by:

Liao Jianming
Liao Jianming

(Technical Director)



Report No.: LW-SZ17C0366-701

EUT Type: SAR Validation Dipole and Waveguide

Model Name: DIP 0G750-253, DIP 0G835-246
DIP 0G900-247, DIP 1G800-248
DIP 1G900-249, DIP 2G000-250
DIP 2G450-251, DIP 2G600-254
SWG 5500-WGA24

Brand Name: SATIMO

Test Conclusion: Pass

Test Date: Mar. 1, 2017 ~ Mar. 4, 2017

Date of Issue: Mar. 18, 2017

NOTE: This test report can be duplicated completely for the legal use with the approval of the applicant; it shall not be reproduced except in full, without the written approval of Shenzhen BALUN Technology Co., Ltd. BALUN Laboratory. Any objections should be raised within thirty days from the date of issue. To validate the report, please visit BALUN website.



1 GENERAL INFORMATION

1.1 Introduction

This document contains a summary of the requirements set forth by the IEEE 1528, FCC KDB 865664 D01 for reference dipoles used for SAR measurement system validations. Instead of the typical annual calibration recommended by measurement standards, the reference dipoles were demonstrated that the SAR target, impedance and return loss have remain stable, so the longer calibration interval is acceptable.

1.2 General Description for Equipment under Test (EUT)

Model	Frequency	Serial Number	Product Condition (New/ Used)	Last Cal. Date
Dipole				
DIP 0G750	750 MHz	SN 25/13 DIP 0G750-253	Used	2015/03/16
DIP 0G835	835 MHz	SN 25/13 DIP 0G835-246	Used	2015/03/16
DIP 0G900	900 MHz	SN 25/13 DIP 0G900-247	Used	2015/03/16
DIP 1G800	1800 MHz	SN 25/13 DIP 1G900-248	Used	2015/03/16
DIP 1G900	1900 MHz	SN 25/13 DIP 1G900-249	Used	2015/03/16
DIP 2G000	2000 MHz	SN 25/13 DIP 2G000-250	Used	2015/03/16
DIP 2G450	2450 MHz	SN 25/13 DIP 2G450-251	Used	2015/03/16
DIP 2G600	2600 MHz	SN 25/13 DIP 2G600-254	Used	2015/03/16
Waveguide				
SWG5500	5GHz-6GHz	SN 30/13 WGA24	Used	2015/03/16

1.3 EUT Photos

DIP 0G750-253



DIP 0G835-246



DIP 0G900-247



DIP 1G800-248



DIP 1G900-249



DIP 2G000-250



DIP 2G450-251

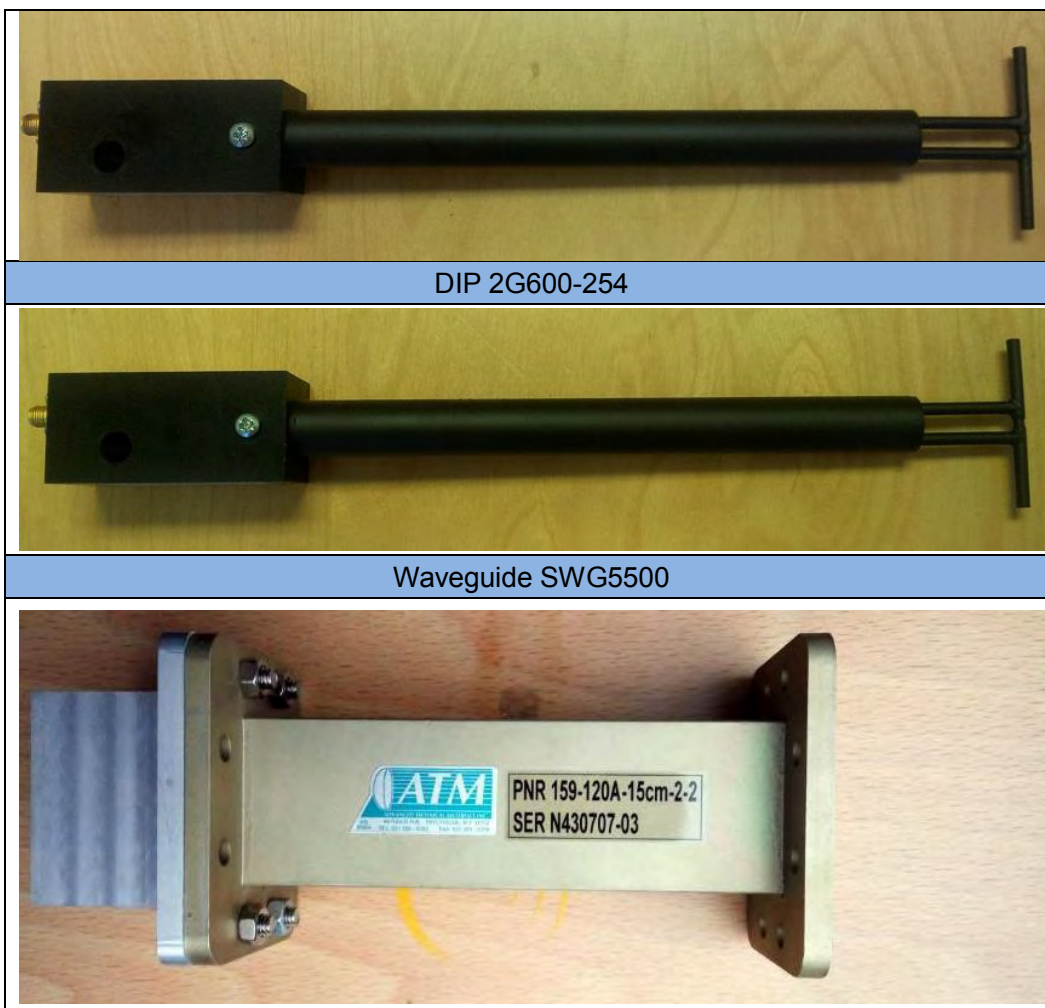

2 SIMULATING LIQUID VERIFICATION

Liquid Type	Fre. (MHz)	Meas. Conductivity (σ) (S/m)	Meas. Permittivity (ϵ)	Target Conductivity (σ) (S/m)	Target Permittivity (ϵ)	Conductivity Tolerance (%)	Permittivity Tolerance (%)
Head	750	0.90	41.88	0.89	41.94	1.12	-0.14
Body		0.93	56.89	0.96	55.53	-3.12	2.45
Head	835	0.88	42.96	0.90	41.50	-2.22	3.52
Body		0.98	54.27	0.97	55.20	1.03	-1.68
Head	900	0.98	41.01	0.97	41.50	1.03	-1.18
Body		1.08	53.62	1.05	55.00	2.86	-2.51
Head	1800	1.42	38.81	1.40	40.00	1.43	-2.97
Body		1.49	54.35	1.52	53.30	-1.97	1.97
Head	1900	1.43	39.83	1.40	40.00	2.14	-0.43
Body		1.54	54.02	1.52	53.30	1.32	1.35
Head	2000	1.43	38.79	1.40	40.00	2.14	-3.03
Body		1.55	51.51	1.52	53.30	1.97	-3.36
Head	2450	1.81	38.86	1.80	39.20	0.56	-0.87
Body		1.95	52.91	1.95	52.70	0.00	0.40
Head	2600	1.98	38.09	1.96	39.01	1.02	-2.36



Body		2.14	53.39	2.16	52.51	-0.93	1.68
Head	5200	4.62	36.73	4.66	35.99	-0.86	2.06
Body		5.21	50.08	5.30	49.01	-1.70	2.18
Head	5400	4.82	36.22	4.86	35.76	-0.82	1.29
Body		5.53	50.13	5.53	48.74	0.00	2.85
Head	5600	5.13	34.25	5.07	35.53	1.18	-3.60
Body		5.91	49.14	5.77	48.47	2.43	1.38
Head	5800	5.33	34.62	5.27	35.30	1.14	-1.93
Body		6.05	47.54	6.00	48.20	0.83	-1.37



3 DIPOLE IMPEDANCE AND RETURN LOSS

The dipoles are designed to have low return loss when presented against a flat phantom at the specified distance. A Vector Network Analyzer was used to perform a return loss measurement on the specific dipole when in the measurement location against the phantom and the distance was specified by the manufacturer with a special, low loss and low relative permittivity spacer.

The impedance was measured at the SMA-connector with the network analyzer.

The measurement of verification with return loss should not deviate by more than 20% and minimum of 20 dB of the return loss, and the impedance (real or imaginary parts) should not deviate by more than 5 Ohms from the previous measurement using network analyzer.

Note:

The "Previous Meas." in the following table refer to dipoles or other equivalent RF sources calibration reports.



3.1 DIP 0G750

RETURN LOSS AND IMPEDANCE IN HEAD LIQUID

Meas. Results	Current Meas.	Previous Meas.	Max. Deviation
Return Loss (dB)	-23.75	-24.73	3.96 %
Impedance	52.9 Ω - 1.5 j Ω	56.1 Ω - 1.3 j Ω	3.2 Ω (Real part)

Return Loss

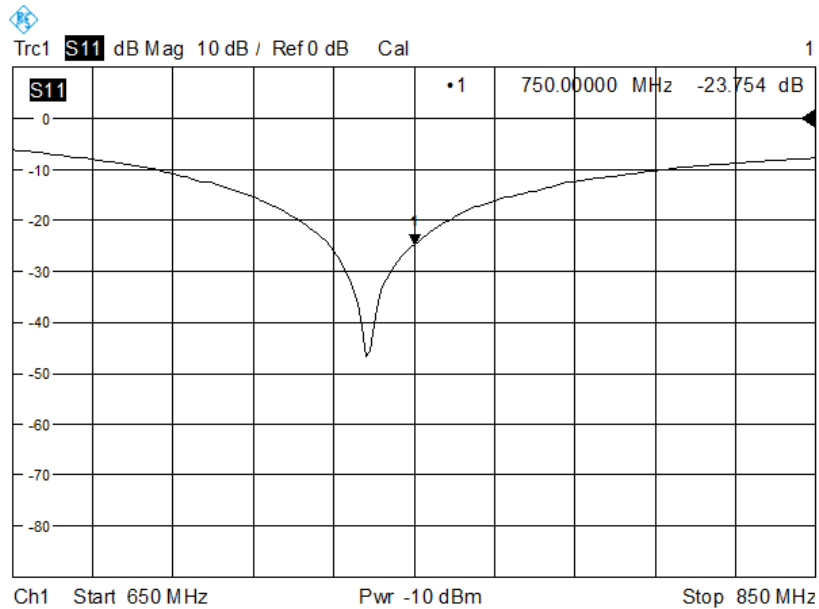

Impedance

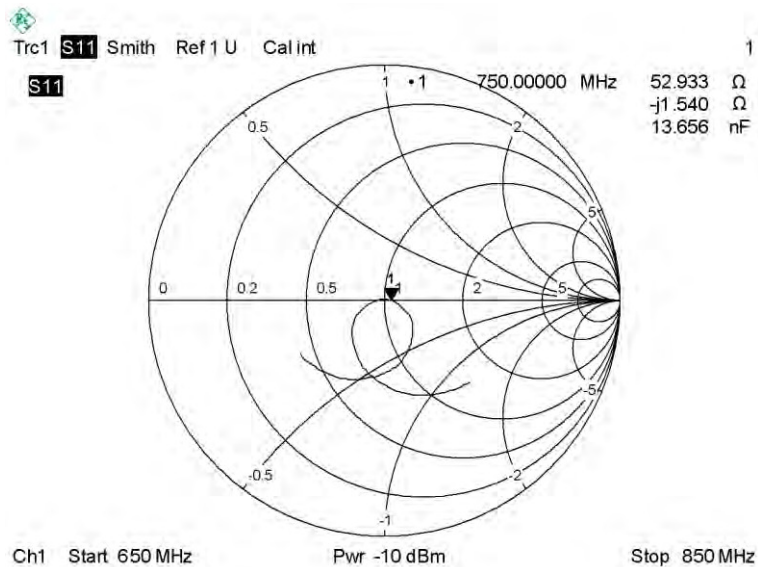



RETURN LOSS AND IMPEDANCE IN BODY LIQUID

Meas. Results	Current Meas.	Previous Meas.	Max. Deviation
Return Loss (dB)	-30.93	-27.47	12.6 %
Impedance	52.3 Ω + 0.9 jΩ	55.8 Ω + 2.6 jΩ	3.5 Ω (Real part)

Return Loss

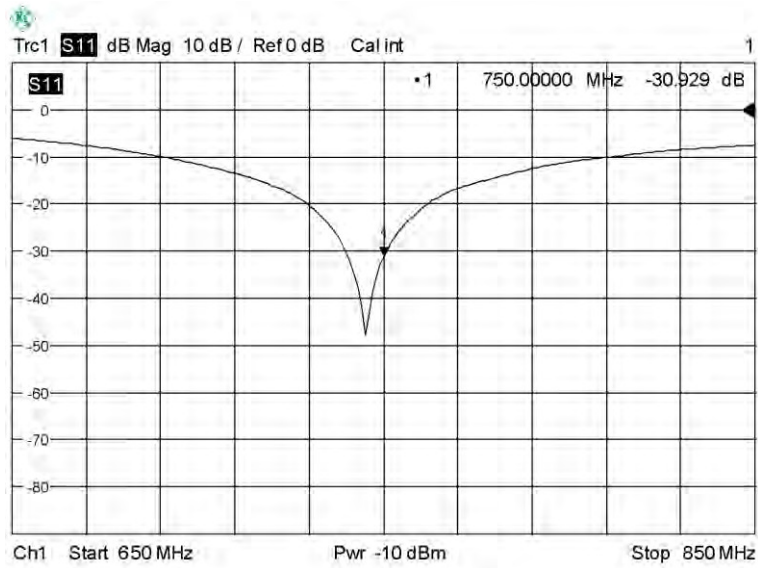

Impedance

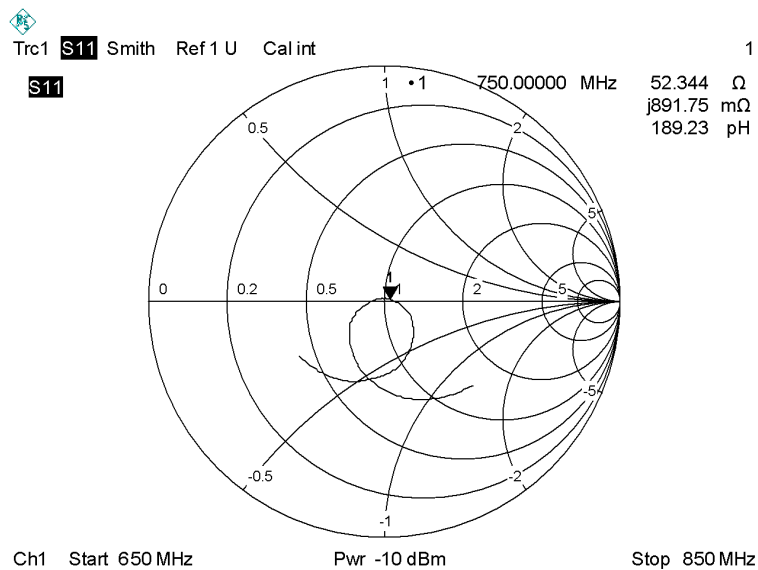



3.2 DIP 0G835

RETURN LOSS AND IMPEDANCE IN HEAD LIQUID

Meas. Results	Current Meas.	Previous Meas.	Max. Deviation
Return Loss (dB)	-27.10	-25.89	4.67 %
Impedance	53.0 Ω + 2.3 j Ω	55.0 Ω + 0.7 j Ω	2.0 Ω (Real part)

Return Loss

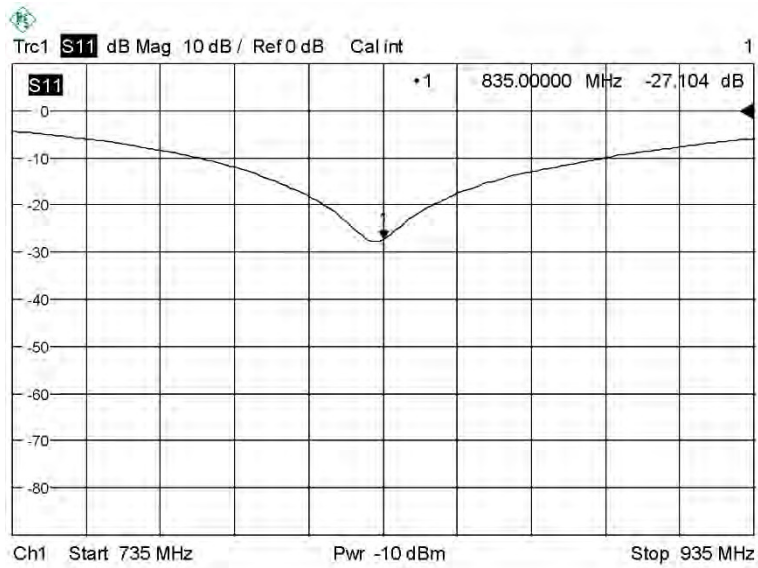

Impedance

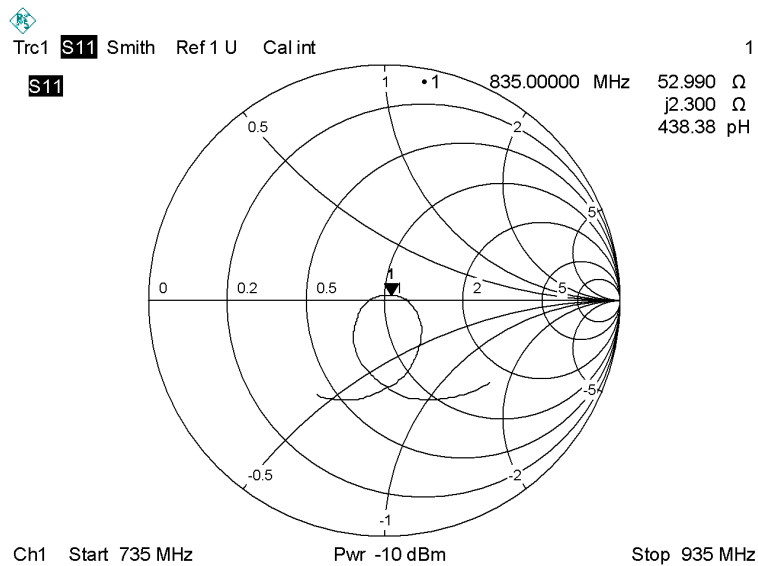



RETURN LOSS AND IMPEDANCE IN BODY LIQUID

Meas. Results	Current Meas.	Previous Meas.	Max. Deviation
Return Loss (dB)	-29.29	-27.60	6.12 %
Impedance	51.0 Ω + 4.3 jΩ	53.6 Ω + 2.5 jΩ	2.6 Ω (Real part)

Return Loss

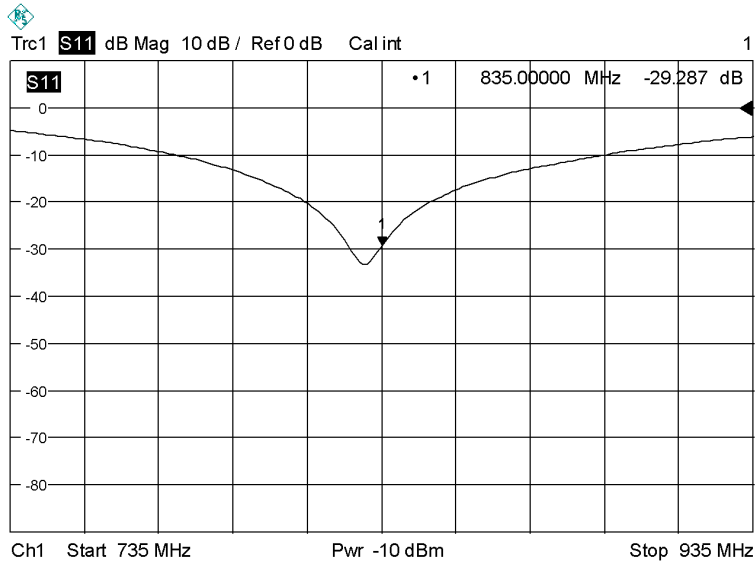

Impedance

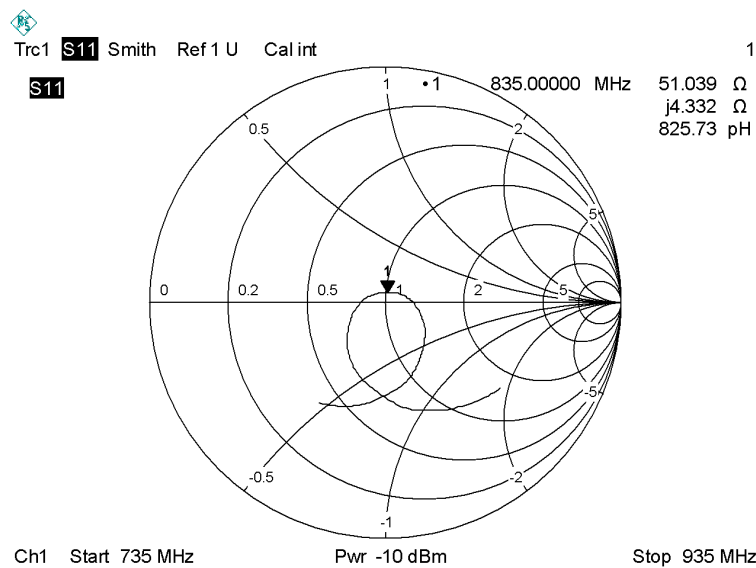



3.3 DIP 0G900

RETURN LOSS AND IMPEDANCE IN HEAD LIQUID

Meas. Results	Current Meas.	Previous Meas.	Max. Deviation
Return Loss (dB)	-31.8	-31.9	0.3 %
Impedance	52.7 Ω + 2.7 j Ω	53.2 Ω + 1.4 j Ω	1.3 Ω (Imaginary part)

Return Loss

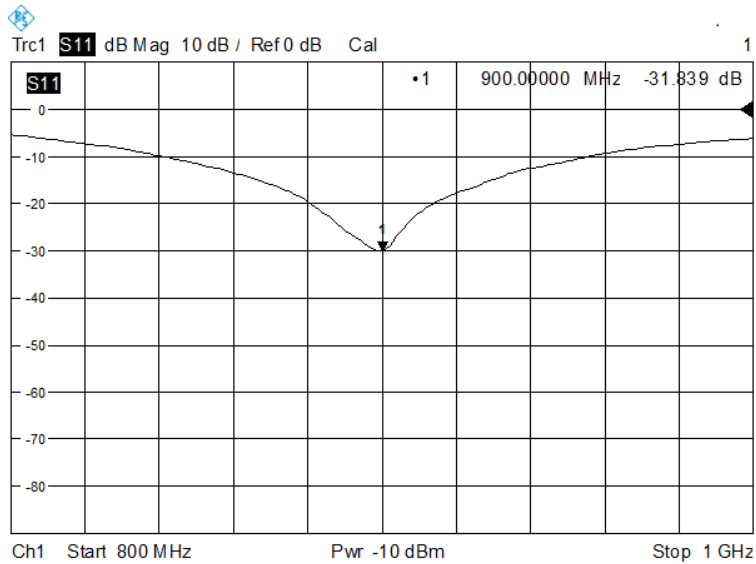

Impedance

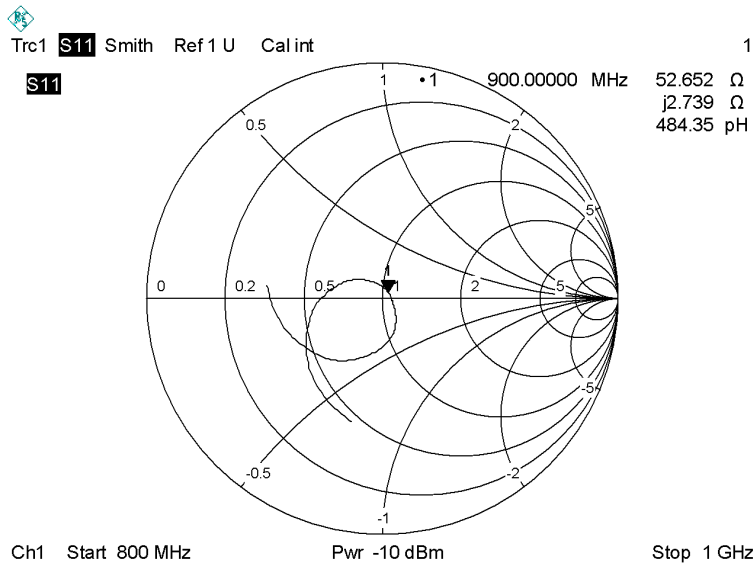



RETURN LOSS AND IMPEDANCE IN BODY LIQUID

Meas. Results	Current Meas.	Previous Meas.	Max. Deviation
Return Loss (dB)	-25.54	-27.20	6.1 %
Impedance	53.0 Ω + 4.2 j Ω	53.2 Ω + 3.2 j Ω	1.0 Ω (Imaginary part)

Return Loss

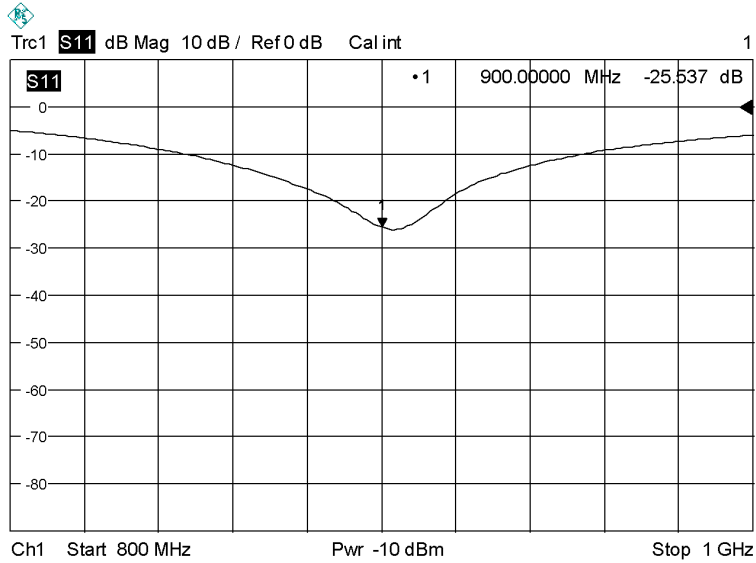

Impedance

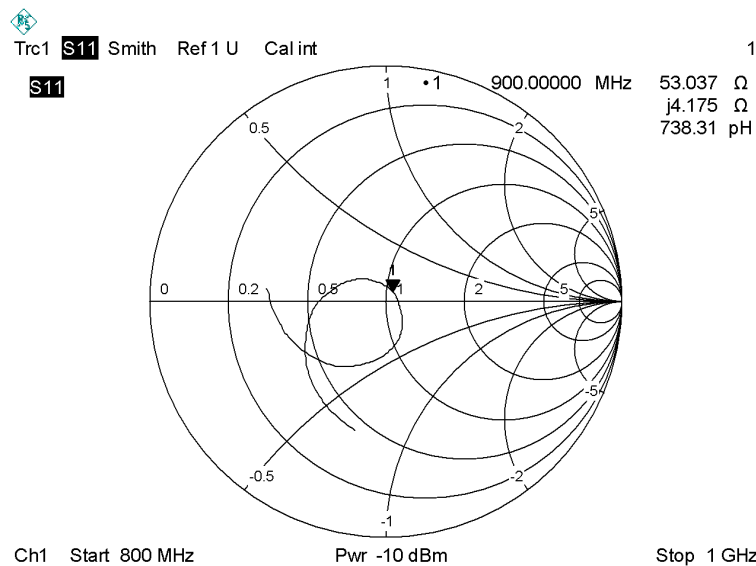



3.4 DIP 1G800

RETURN LOSS AND IMPEDANCE IN HEAD LIQUID

Meas. Results	Current Meas.	Previous Meas.	Max. Deviation
Return Loss (dB)	-20.80	-22.41	7.2 %
Impedance	41.5 Ω + 4.9 j Ω	42.4 Ω + 3.9 j Ω	1.0 Ω (Imaginary part)

Return Loss

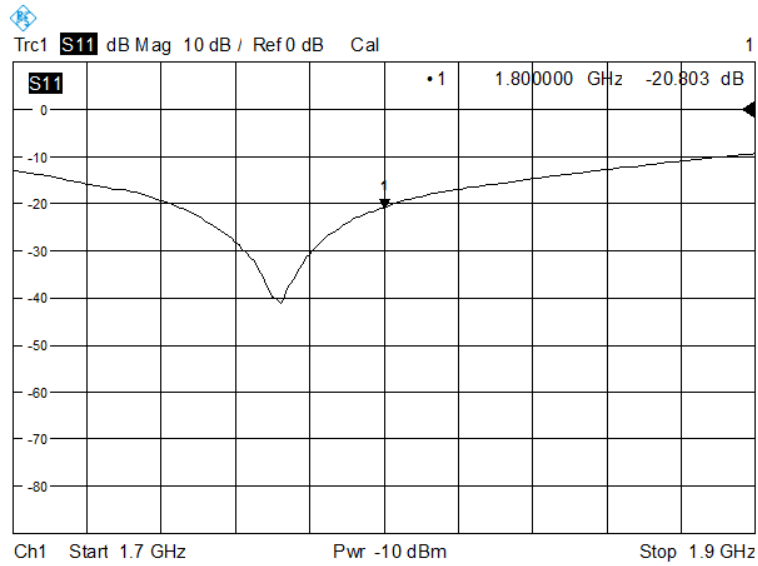

Impedance

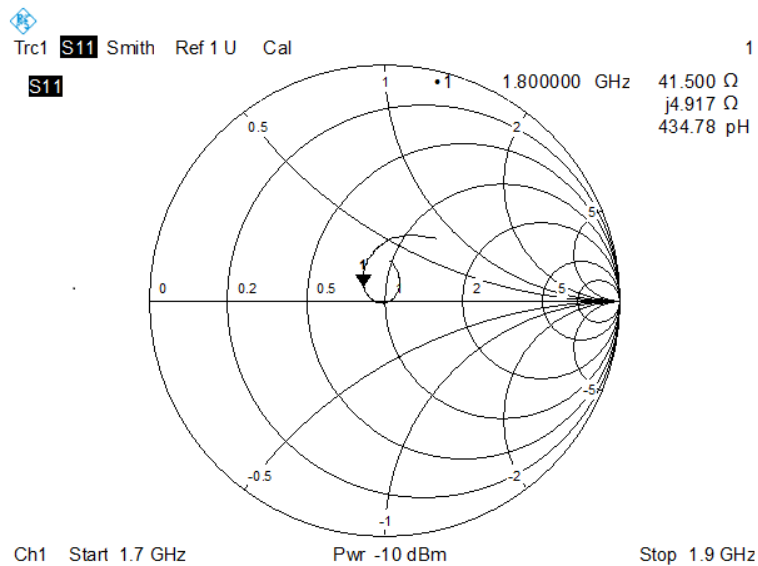



RETURN LOSS AND IMPEDANCE IN BODY LIQUID

Meas. Results	Current Meas.	Previous Meas.	Max. Deviation
Return Loss (dB)	-22.00	-22.09	0.4 %
Impedance	42.1 Ω + 0.3 j Ω	42.9 Ω + 0.7 j Ω	0.8 Ω (Real part)

Return Loss

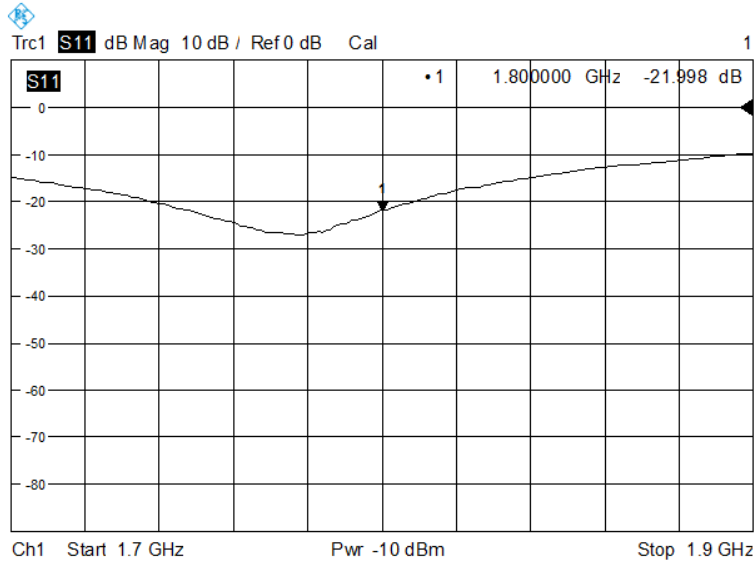

Impedance

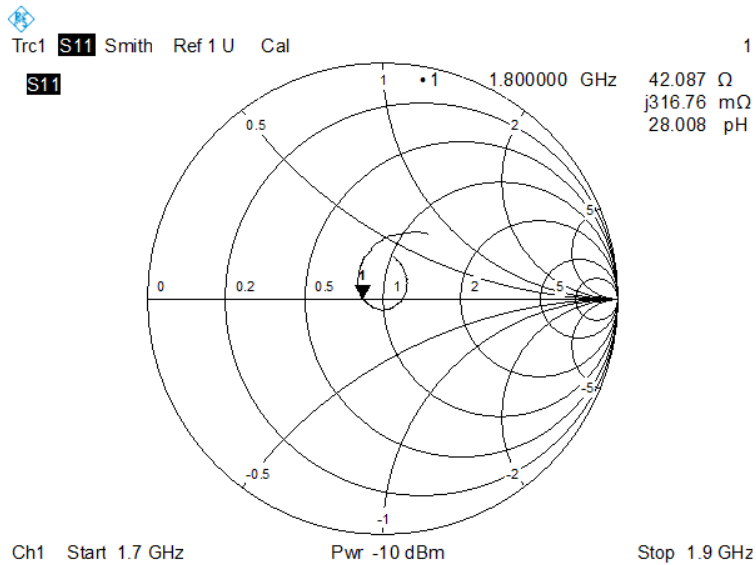



3.5 DIP 1G900

RETURN LOSS AND IMPEDANCE IN HEAD LIQUID

Meas. Results	Current Meas.	Previous Meas.	Max. Deviation
Return Loss (dB)	-21.08	-20.99	0.4 %
Impedance	53.9 Ω + 11.1 j Ω	56.6 Ω + 12.2 j Ω	2.7 Ω (Real part)

Return Loss

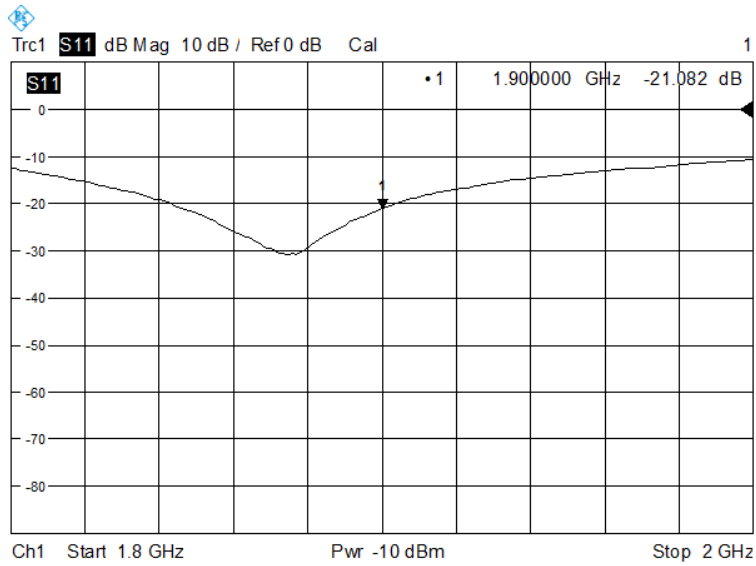

Impedance

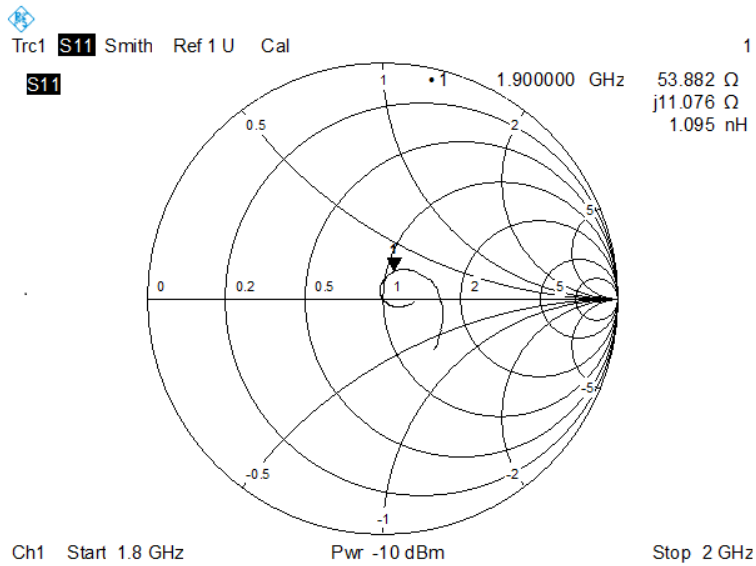



RETURN LOSS AND IMPEDANCE IN BODY LIQUID

Meas. Results	Current Meas.	Previous Meas.	Max. Deviation
Return Loss (dB)	-20.62	-21.79	5.4 %
Impedance	50.2 Ω + 12.6 j Ω	51.0 Ω + 13.2 j Ω	0.8 Ω (Real part)

Return Loss

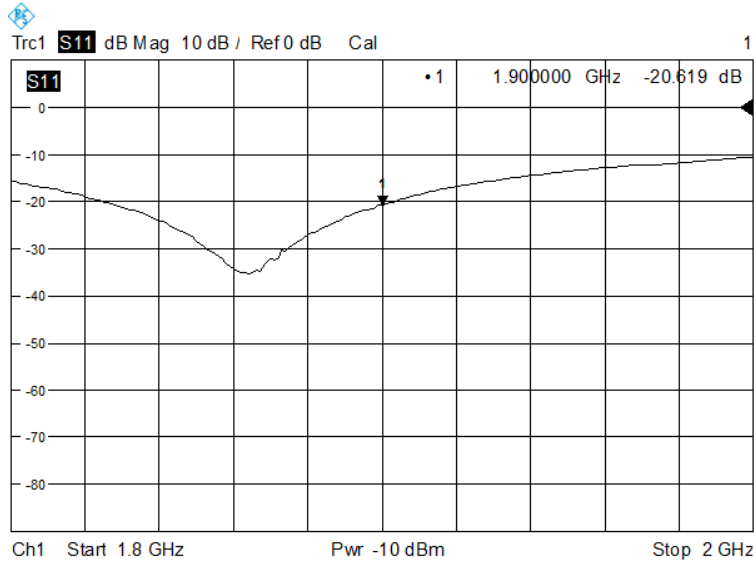

Impedance

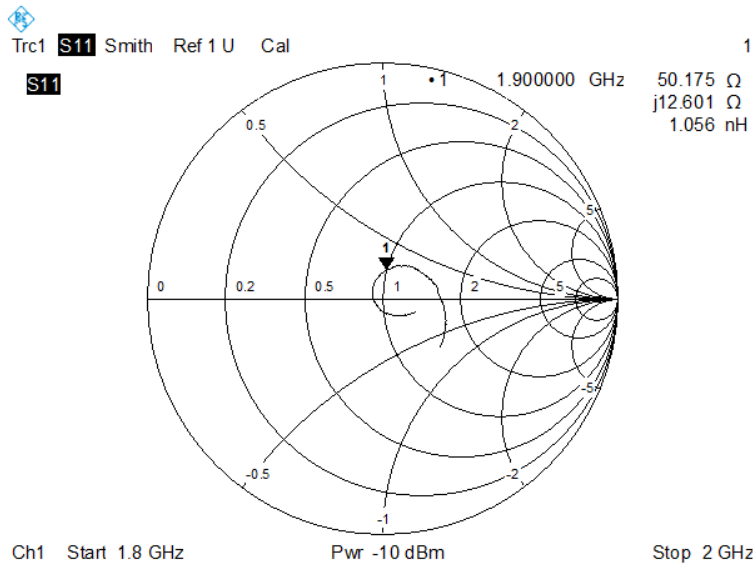

3.6 DIP 2G000

RETURN LOSS AND IMPEDANCE IN HEAD LIQUID

Meas. Results	Current Meas.	Previous Meas.	Max. Deviation
Return Loss (dB)	-23.91	-25.62	.7%
Impedance	56.6 Ω - 0.4 j Ω	54.3 Ω - 4.1 j Ω	3.7 Ω (Imaginary part)

Return Loss

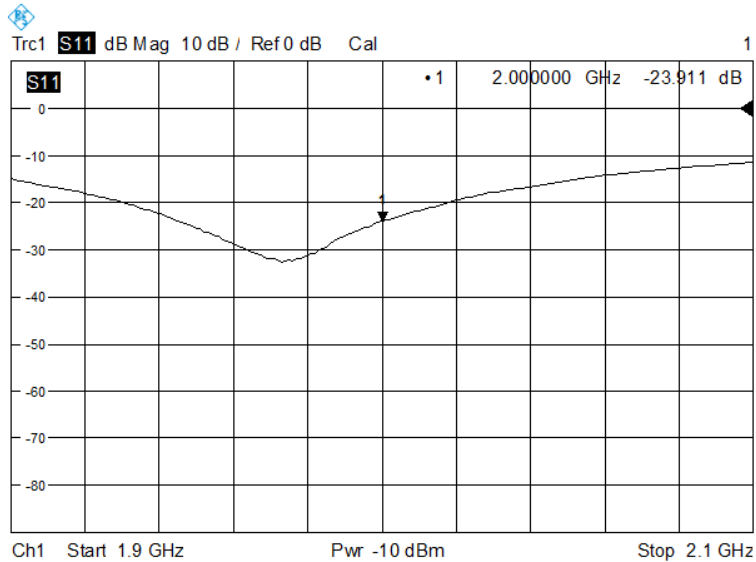

Impedance

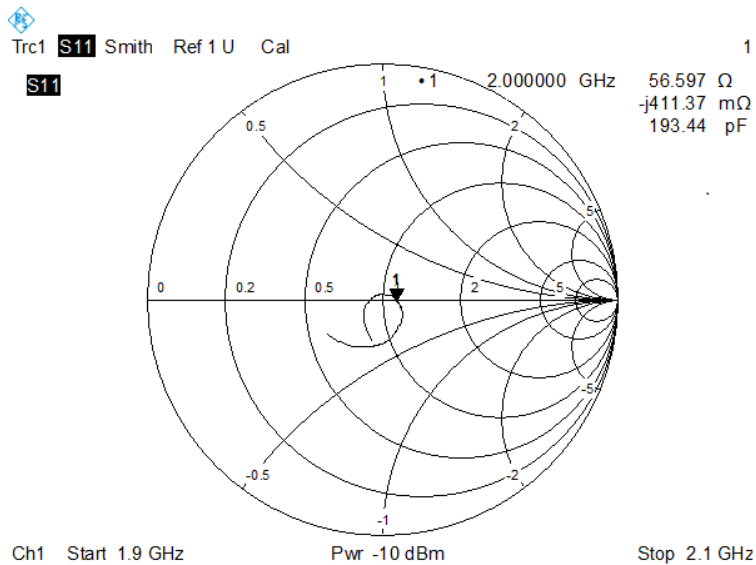

RETURN LOSS AND IMPEDANCE IN BODY LIQUID

Meas. Results	Current Meas.	Previous Meas.	Max. Deviation
Return Loss (dB)	-22.23	-22.40	0.8 %
Impedance	58.6 Ω + 2.20 j Ω	55.7 Ω + 2.61 j Ω	2.9 Ω (Real part)

Return Loss

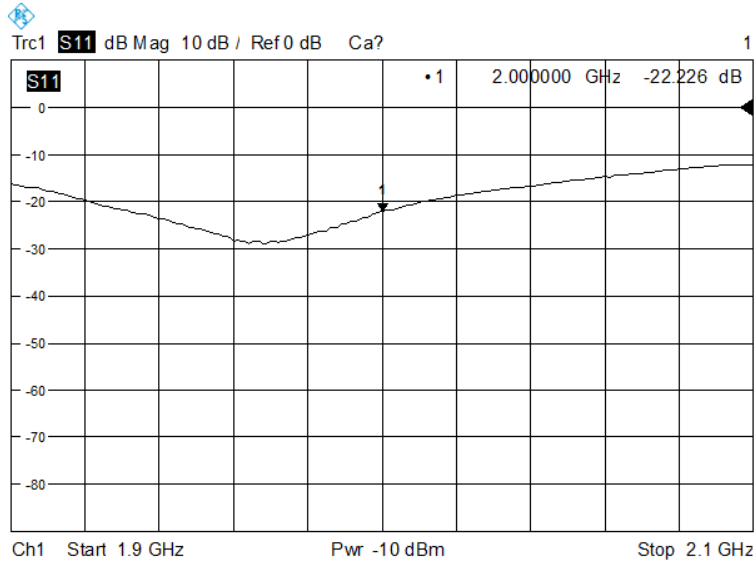

Impedance

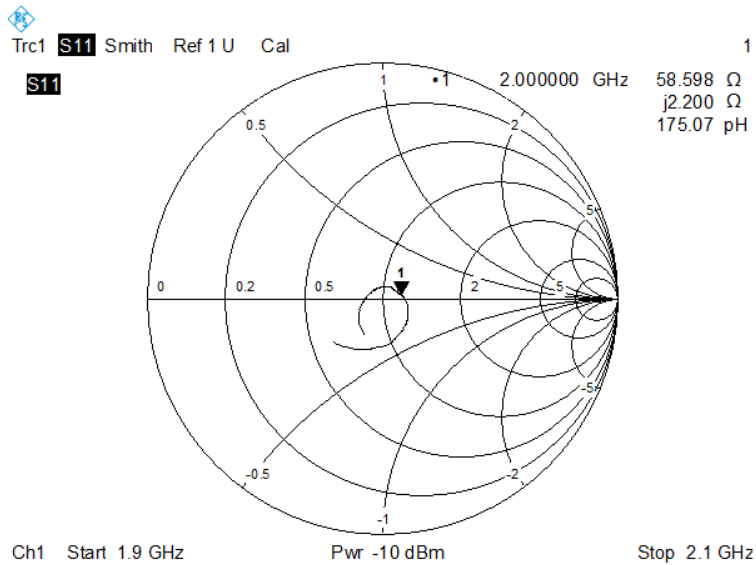

3.7 DIP 2G450

RETURN LOSS AND IMPEDANCE IN HEAD LIQUID

Meas. Results	Current Meas.	Previous Meas.	Max. Deviation
Return Loss (dB)	-23.17	-23.68	2.2 %
Impedance	48.3 Ω + 6.5 j Ω	47.0 Ω + 5.8 j Ω	1.3 Ω (Real part)

Return Loss

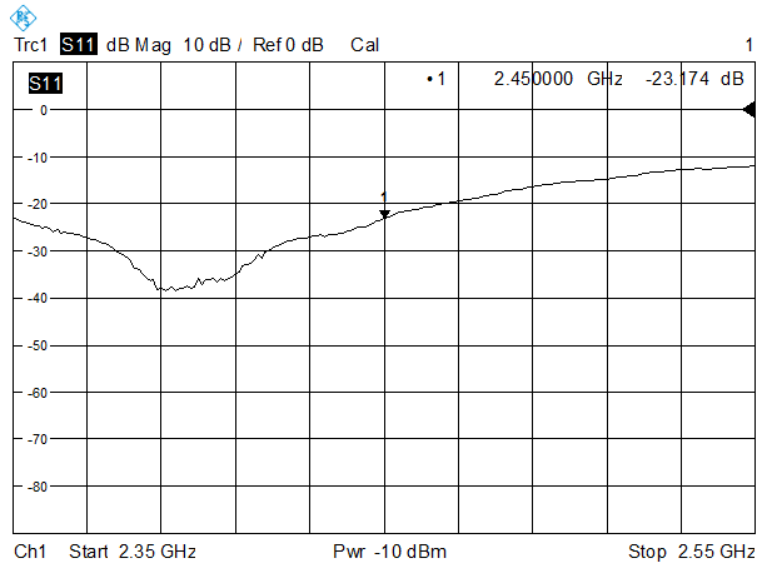

Impedance

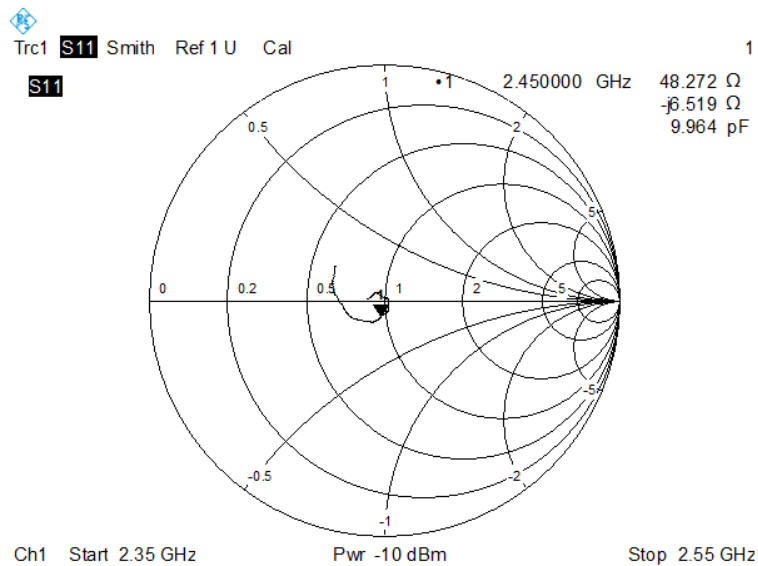

RETURN LOSS AND IMPEDANCE IN BODY LIQUID

Meas. Results	Current Meas.	Previous Meas.	Max. Deviation
Return Loss (dB)	-24.06	-24.48	3.5 %
Impedance	49.8 Ω – 9.4 j Ω	49.4 Ω – 5.9 j Ω	3.5 Ω (Imaginary part)

Return Loss

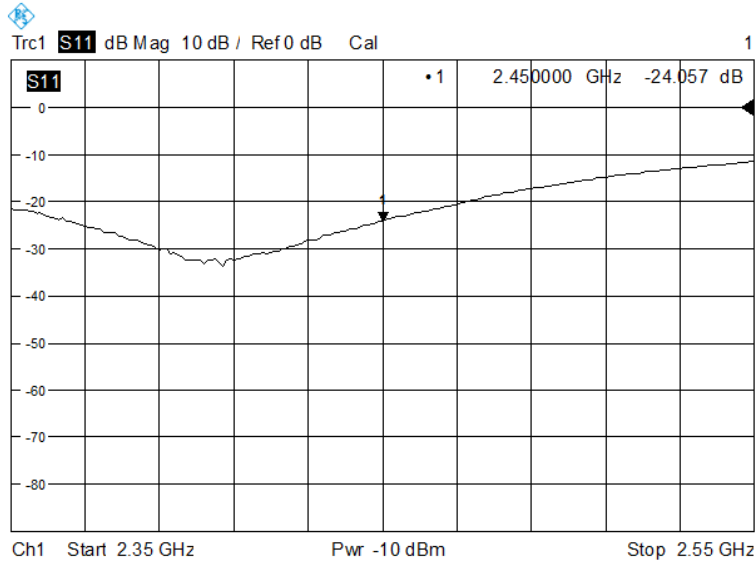

.0

Impedance

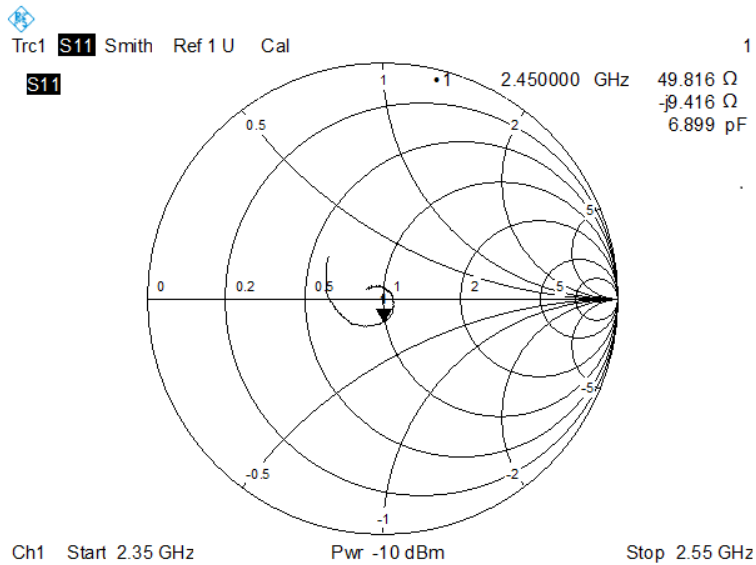



3.8 DIP 2G600

RETURN LOSS AND IMPEDANCE IN HEAD LIQUID

Meas. Results	Current Meas.	Previous Meas.	Max. Deviation
Return Loss (dB)	-21.11	-20.83	1.34 %
Impedance	50.2 Ω + 8.9 j Ω	51.0 Ω + 11.4 j Ω	2.5 Ω (Imaginary part)

Return Loss

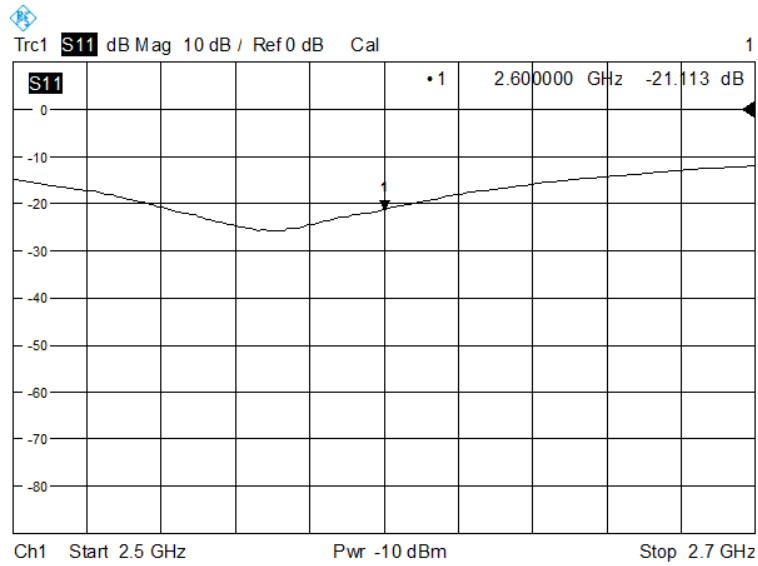

Impedance

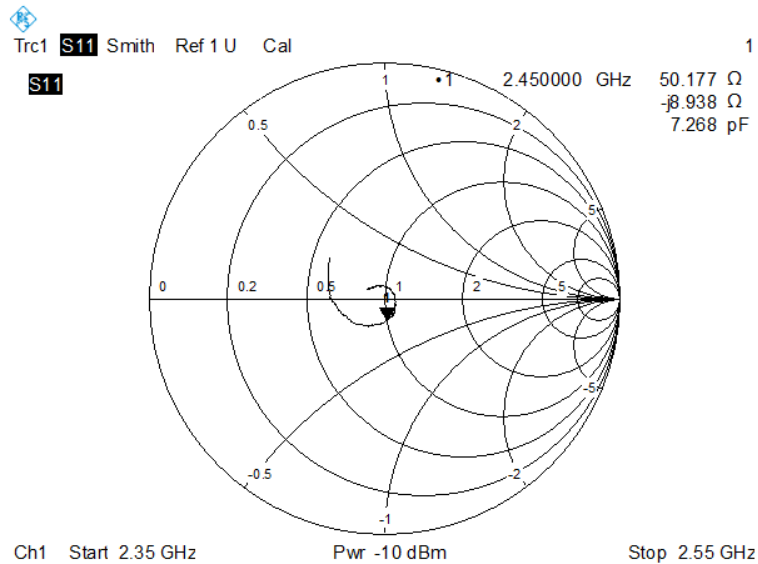



RETURN LOSS AND IMPEDANCE IN BODY LIQUID

Meas. Results	Current Meas.	Previous Meas.	Max. Deviation
Return Loss (dB)	-22.31	-21.11	5.7 %
Impedance	46.7 Ω + 12.4 j Ω	47.6 Ω + 11.1 j Ω	1.3 Ω (Imaginary part)

Return Loss

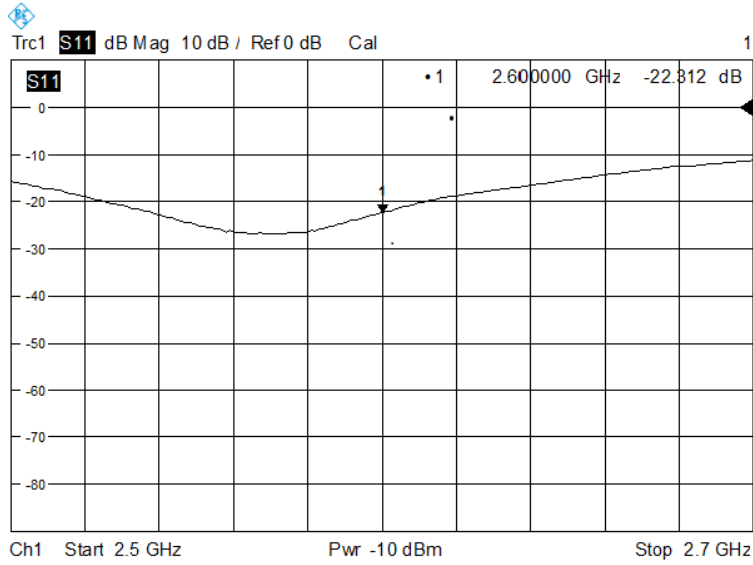

Impedance

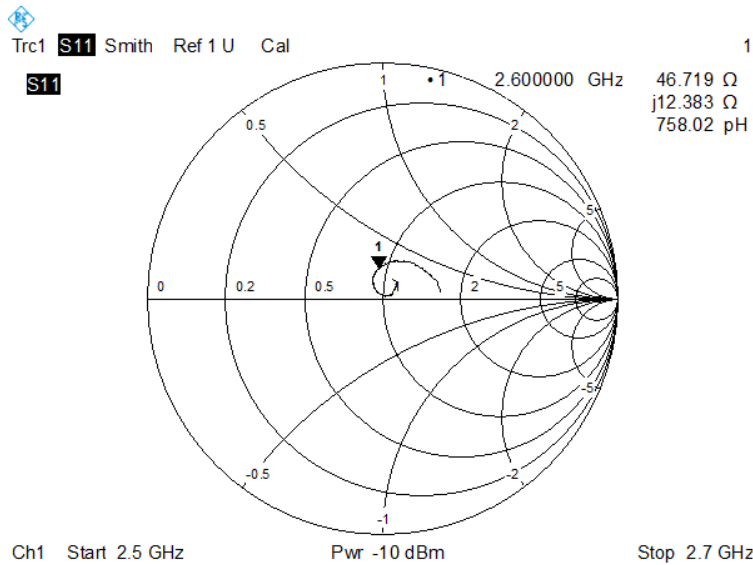

4 WAVEGUIDE IMPEDANCE AND RETURN LOSS

The waveguide are designed to have low return loss when presented against a flat phantom at the specified distance. A Vector Network Analyzer was used to perform a return loss measurement on the specific waveguide when in the measurement location against the phantom and the distance was specified by the manufacturer with a special, low loss and low relative permittivity spacer.

The impedance was measured at the SMA-connector with the network analyzer.

4.1 SWG5500

RETURN LOSS AND IMPEDANCE IN HEAD LIQUID

Frequency (MHz)	Return Loss (dB)	Requirement (dB)	Impedance
5200	-10.94	-8.0	27.8 Ω + 9.6 j Ω
5400	-12.04	-8.0	83.7 Ω + 12.3 j Ω
5600	-17.91	-8.0	42.6 Ω - 7.2 j Ω
5800	-15.79	-8.0	56.4 Ω + 20.3 j Ω

Return Loss

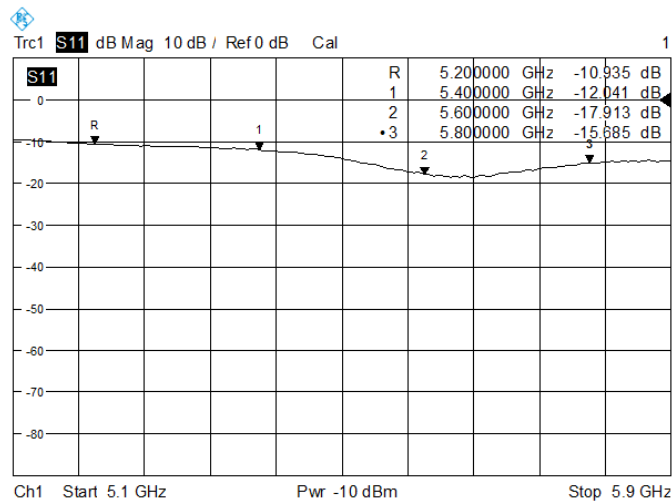

Impedance

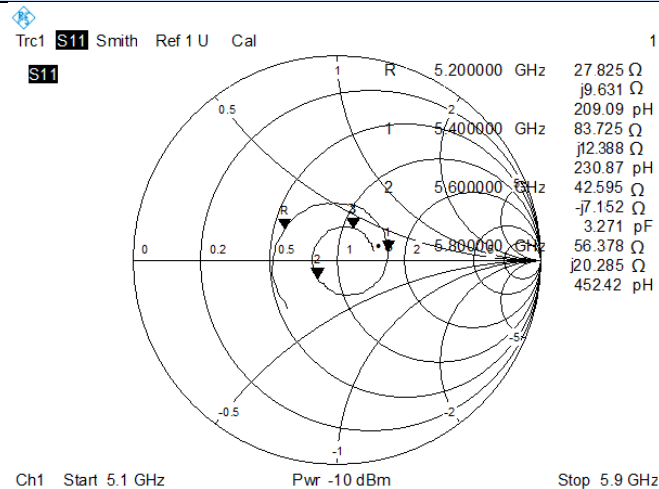



RETURN LOSS AND IMPEDANCE IN BODY LIQUID

Frequency (MHz)	Return Loss (dB)	Requirement (dB)	Impedance
5200	-9.84	-8.0	26.3 Ω + 9.5 jΩ
5400	-10.04	-8.0	95.6 Ω + 7.5 jΩ
5600	-15.91	-8.0	37.0 Ω - 7.8 jΩ
5800	-13.93	-8.0	56.8 Ω + 27.7 jΩ

Return Loss

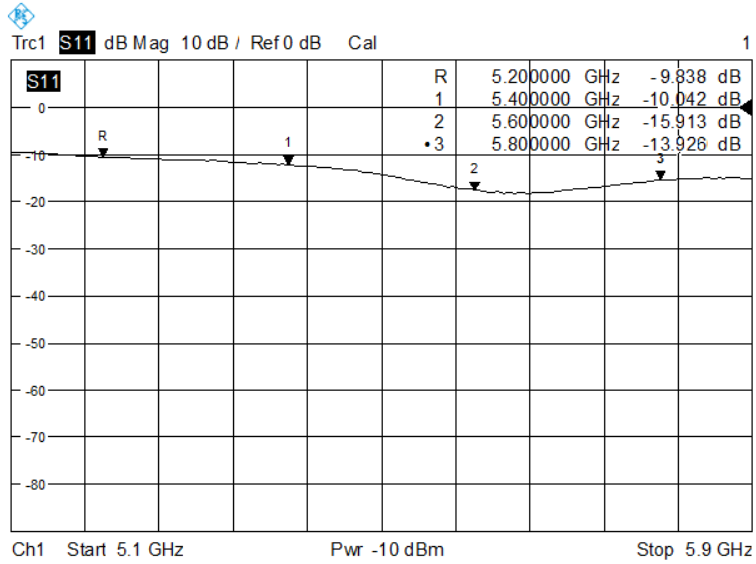

Impedance

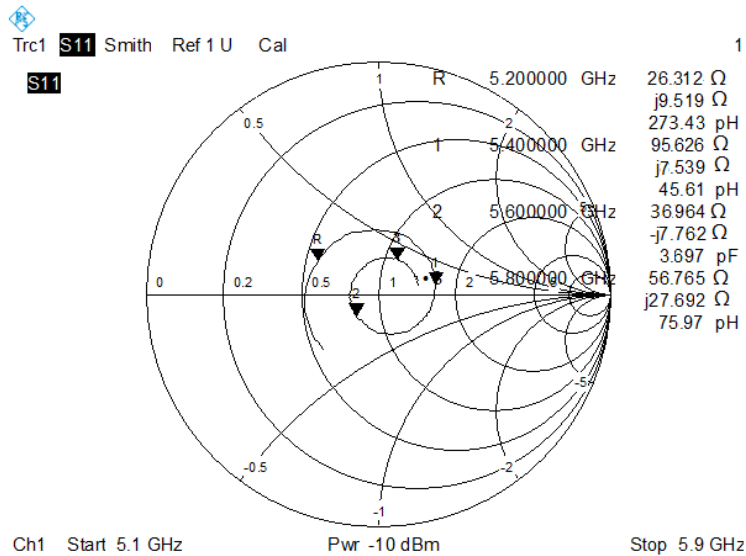



5.1 Dipole and Waveguide SAR Validation Measurement Result

Freq. (MHz)	Liquid Type	Power (mW)	1 g Measured SAR (W/kg)	Normalized SAR (W/kg)	10 g Measured SAR (W/kg)	Normalized SAR (W/kg)	1 g Targeted SAR (W/kg)	Tolerance (%)	10 g Targeted SAR (W/kg)	Tolerance (%)
750	Head	100	0.864	8.64	0.573	5.73	8.49	1.77	5.55	3.24
	Body	100	0.865	8.65	0.589	5.89	8.49	1.88	5.55	6.13
835	Head	100	0.977	9.77	0.603	6.03	9.56	2.20	6.22	-3.05
	Body	100	1.009	10.09	0.661	6.61	9.56	5.54	6.22	6.27
900	Head	100	1.086	10.86	0.723	7.23	10.9	-0.37	6.99	3.43
	Body	100	1.140	11.40	0.752	7.52	10.9	4.59	6.99	7.58
1800	Head	100	3.888	38.88	1.966	19.66	38.40	1.25	20.10	-2.19
	Body	100	3.923	39.23	1.992	19.92	38.40	2.16	20.10	-0.90
1900	Head	100	3.902	39.02	1.922	19.22	39.70	-1.71	20.50	-6.24
	Body	100	3.951	39.51	2.010	20.10	39.70	-0.48	20.50	-1.95
2000	Head	100	4.020	40.20	2.063	20.63	41.10	-2.19	21.10	-2.23
	Body	100	4.215	42.15	2.153	21.53	41.10	2.55	21.10	2.04
2450	Head	100	5.303	53.03	2.479	24.79	52.40	1.20	24.00	3.29
	Body	100	5.103	51.03	2.448	24.48	52.40	-2.61	24.00	2.00
2600	Head	100	5.337	53.37	2.507	25.07	55.30	-3.49	24.60	1.91
	Body	100	5.168	51.68	2.375	23.75	55.30	-6.55	24.60	-3.46
5200	Head	100	15.372	153.72	5.458	54.58	159.00	-3.32	56.90	-4.08
	Body	100	15.227	152.27	5.328	53.28	159.00	-4.23	56.90	-6.36
5400	Head	100	15.893	158.93	5.522	55.22	166.40	-4.49	58.43	-5.49
	Body	100	15.760	157.60	5.602	56.02	166.40	-5.29	58.43	-4.12
5600	Head	100	16.458	164.58	5.788	57.88	173.80	-5.30	59.97	-3.49
	Body	100	15.892	158.92	5.643	56.43	173.80	-8.56	59.97	-5.90
5800	Head	100	17.698	176.98	5.986	59.86	181.20	-2.33	61.50	-2.67
	Body	100	16.971	169.71	5.843	58.43	181.20	-6.34	61.50	-4.99

5.2 DIP 0G750

5.2.1 Dipole 750 MHz Validation Measurement for Head Tissue

System Performance Check Data(750 MHz Head)

Type: Phone measurement (Complete)
 E-Field Probe: SN 34/15 SSE2 EPGO265
 Area scan resolution: dx=8mm,dy=8mm
 Zoom scan resolution: dx=8mm, dy=8mm, dz=5mm
 Date of measurement: 2017.03.01
 Measurement duration: 13 minutes 33 seconds

Experimental conditions.

Phantom File	surf_sam_plan.txt
Phantom	Validation plane
Band	750MHz
Signal	CW
Frequency (MHz)	750MHz
Relative permittivity (real part)	41.882519
Conductivity (S/m)	0.898232
Power drift (%)	-2.200000
Ambient Temperature:	21.9°C
Liquid Temperature:	20.8°C
ConvF:	1.81
Crest factor:	1:1

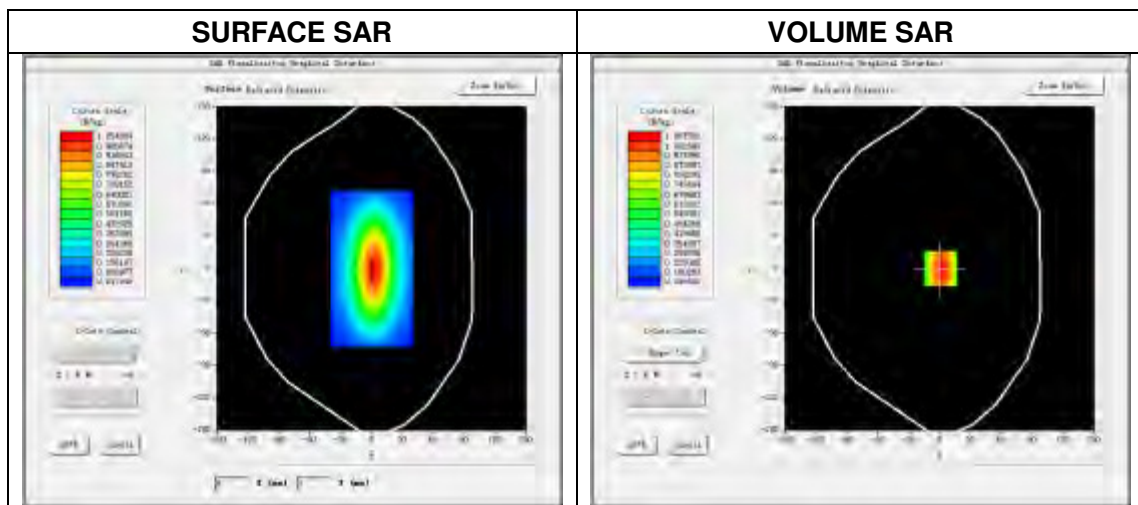

Maximum location: X=1.00, Y=0.00

SAR Peak: 1.19 W/kg

SAR 10g (W/Kg)	0.572936
SAR 1g (W/Kg)	0.863754

Z Axis Scan

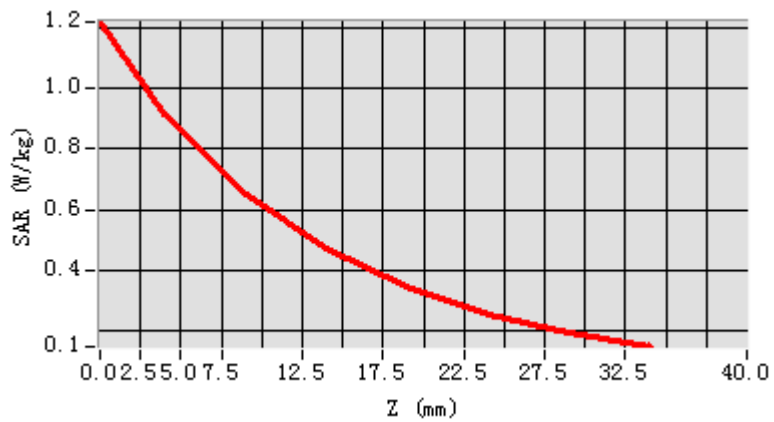

3D screen shot

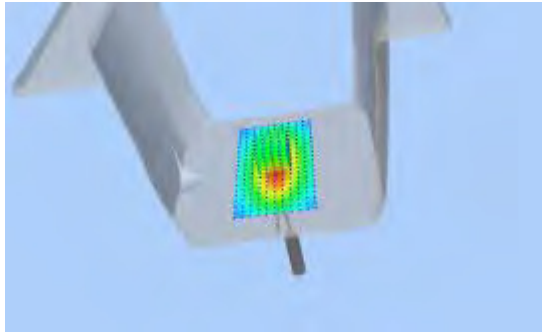

Hot spot position

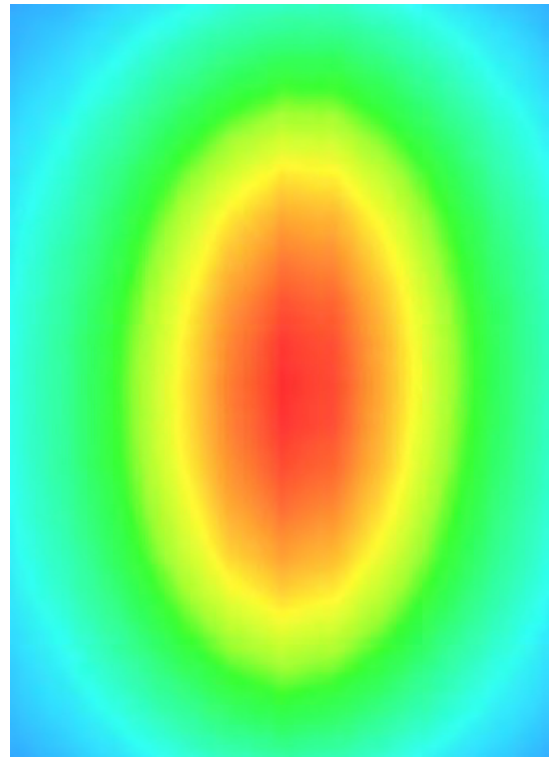

5.2.2 Dipole 750 MHz Validation Measurement for Body Tissue

System Performance Check Data(750 MHz Body)

Type: Phone measurement (Complete)
 E-Field Probe: SN 34/15 SSE2 EPGO265
 Area scan resolution: dx=8mm,dy=8mm
 Zoom scan resolution: dx=8mm, dy=8mm, dz=5mm
 Date of measurement: 2017.03.01
 Measurement duration: 13 minutes 32 seconds

Experimental conditions.

Phantom File	surf_sam_plan.txt
Phantom	Validation plane
Band	750MHz
Signal	CW
Frequency (MHz)	750MHz
Relative permittivity (real part)	56.892521
Conductivity (S/m)	0.931288
Power drift (%)	-0.600000
Ambient Temperature:	21.9°C
Liquid Temperature:	20.8°C
ConvF:	1.88
Crest factor:	1:1

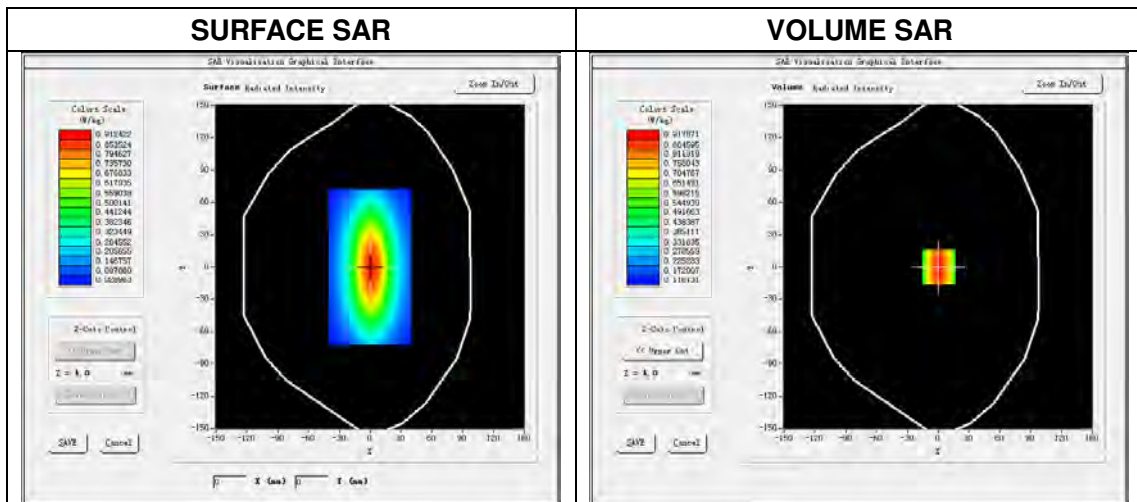

Maximum location: X=1.00, Y=0.00

SAR Peak: 1.29 W/kg

SAR 10g (W/Kg)	0.589147
SAR 1g (W/Kg)	0.865284

Z Axis Scan

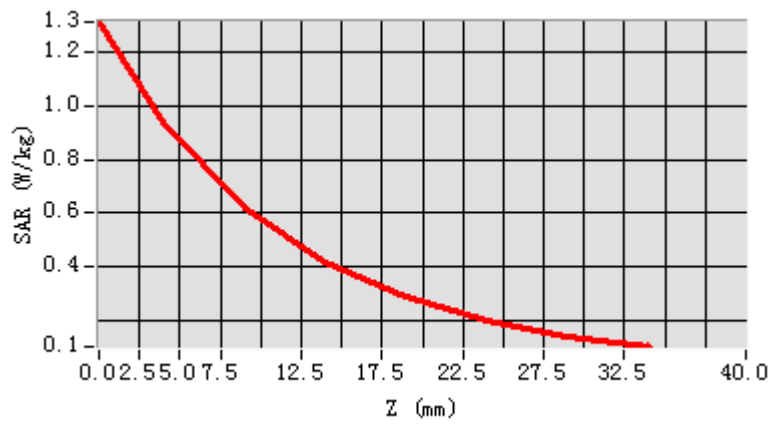

3D screen shot

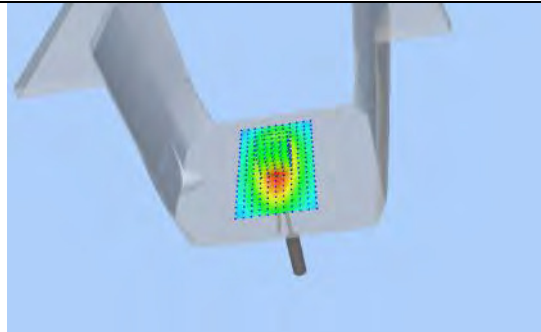

Hot spot position

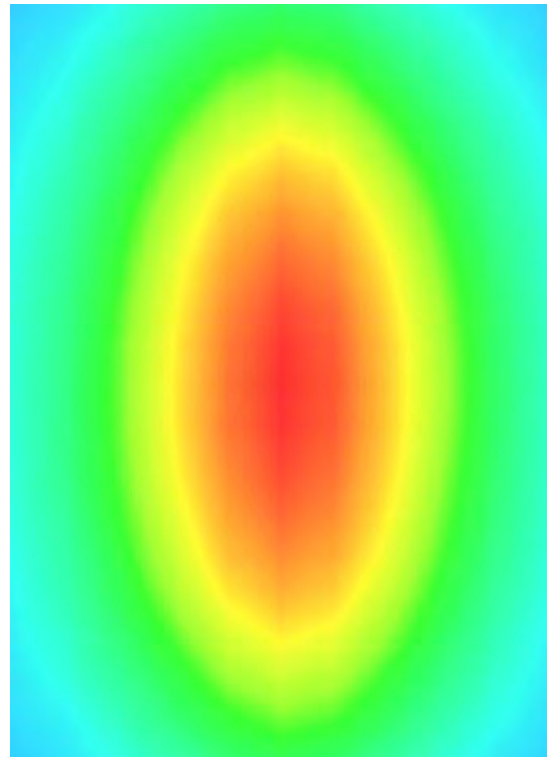

5.3 DIP 0G835

5.3.1 Dipole 835 MHz Validation Measurement for Head Tissue

System Performance Check Data(835 MHz Head)

Type: Phone measurement (Complete)
 E-Field Probe: SN 34/15 SSE2 EPGO265
 Area scan resolution: dx=8 mm,dy=8 mm
 Zoom scan resolution: dx=8 mm, dy=8 mm, dz=5 mm
 Date of measurement: 2017.03.01
 Measurement duration: 14 minutes 12 seconds

Experimental conditions.

Phantom File	surf_sam_plan.txt
Phantom	Validation plane
Band	835 MHz
Signal	CW
Frequency (MHz)	835.000000
Relative permittivity (real part)	42.956251
Conductivity (S/m)	0.883985
Power drift (%)	-0.350000
Ambient Temperature:	21.6°C
Liquid Temperature:	21.1°C
ConvF:	2.04
Crest factor:	1:1

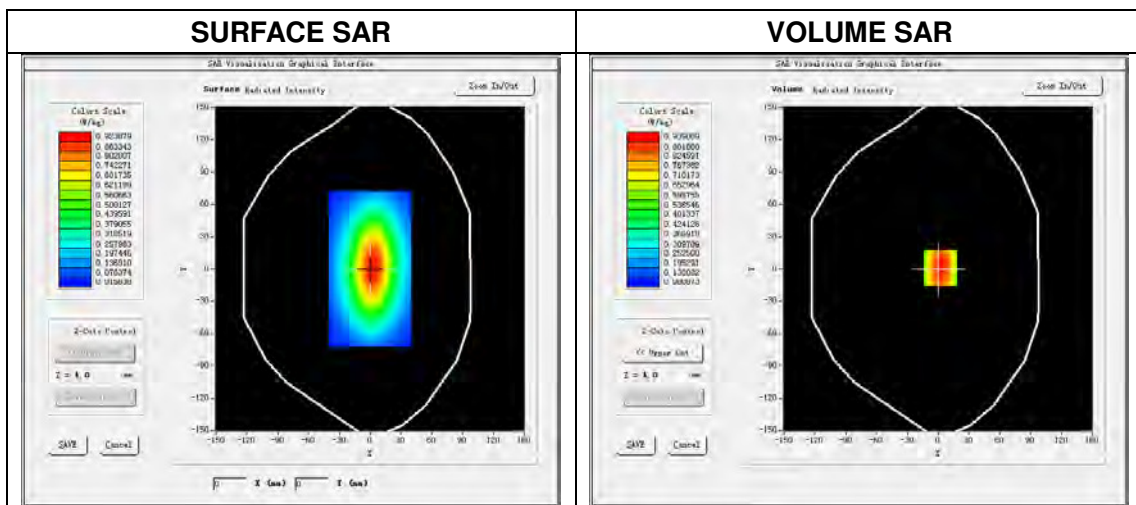

Maximum location: X=0.00, Y=0.00

SAR Peak: 1.40 W/kg

SAR 10 g (W/Kg)	0.602548
SAR 1 g (W/Kg)	0.976925

Z Axis Scan

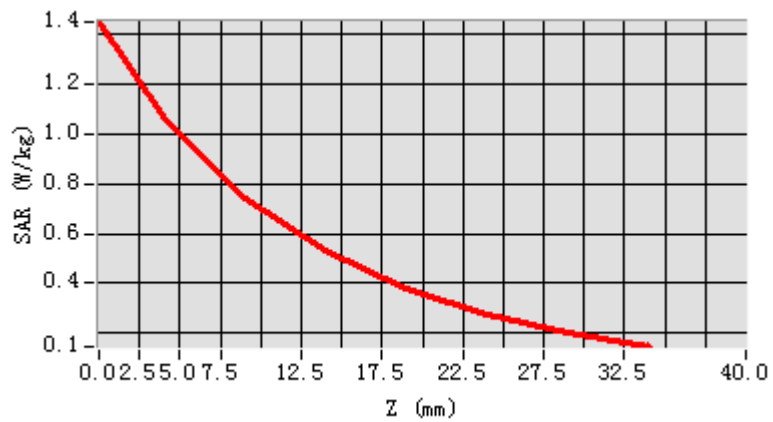

3D screen shot

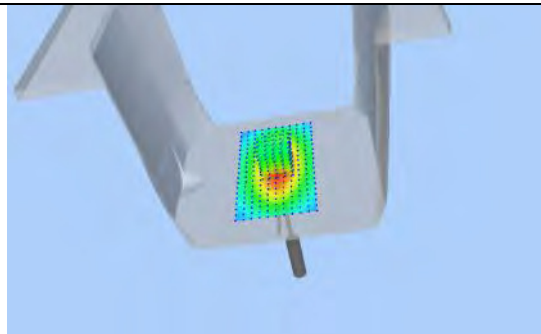

Hot spot position

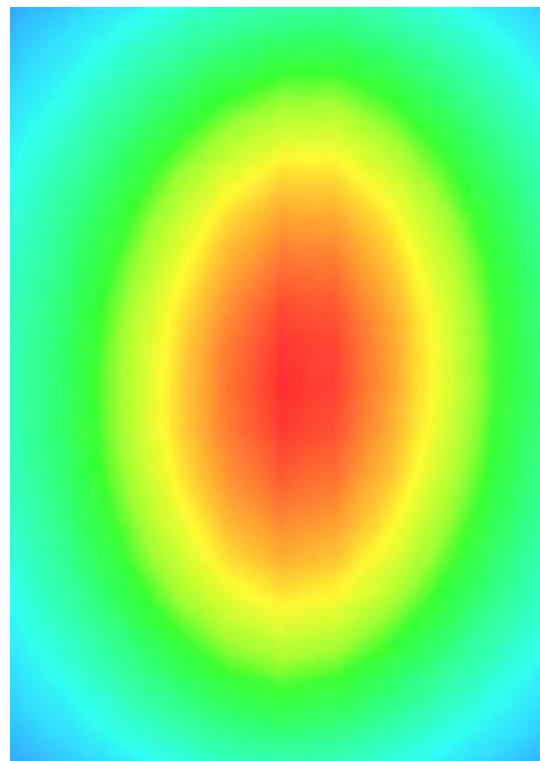

5.3.2 Dipole 835 MHz Validation Measurement for Body Tissue

System Performance Check Data(835 MHz Body)

Type: Phone measurement (Complete)
 E-Field Probe: SN 34/15 SSE2 EPGO265
 Area scan resolution: dx=8 mm,dy=8 mm
 Zoom scan resolution: dx=8 mm, dy=8 mm, dz=5 mm
 Date of measurement: 2017.03.01
 Measurement duration: 14 minutes 8 seconds

Experimental conditions.

Phantom File	surf_sam_plan.txt
Phantom	Validation plane
Band	835 MHz
Signal	CW
Frequency (MHz)	835.000000
Relative permittivity (real part)	54.269521
Conductivity (S/m)	0.980688
Power drift (%)	0.390000
Ambient Temperature:	21.6°C
Liquid Temperature:	21.1°C
ConvF:	2.12
Crest factor:	1:1

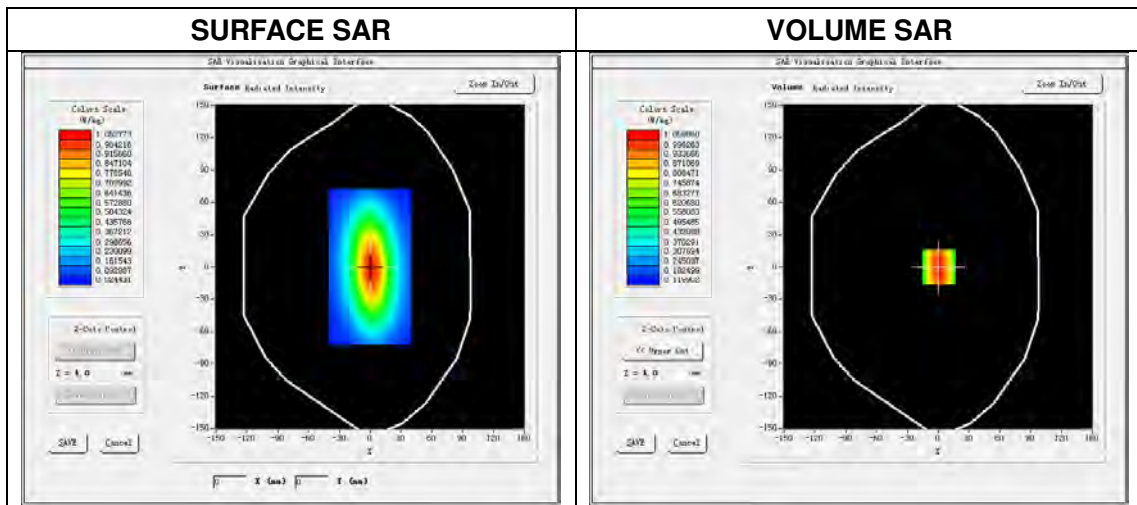

Maximum location: X=0.00, Y=0.00

SAR Peak: 1.46 W/kg

SAR 10 g (W/Kg)	0.661254
SAR 1 g (W/Kg)	1.009362

Z Axis Scan

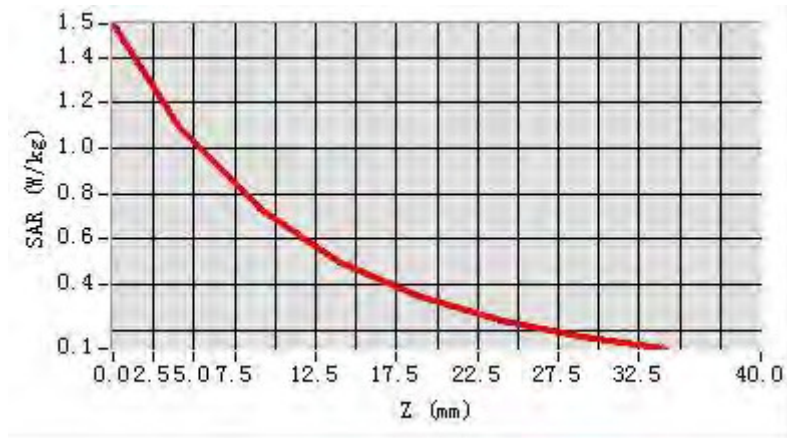

3D screen shot

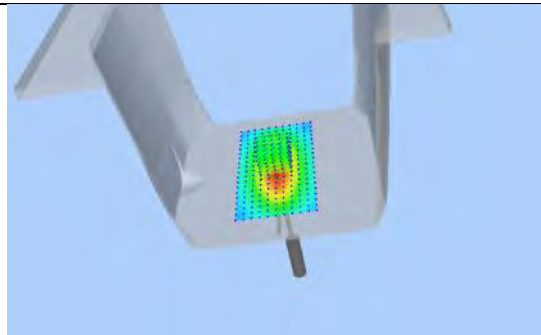

Hot spot position

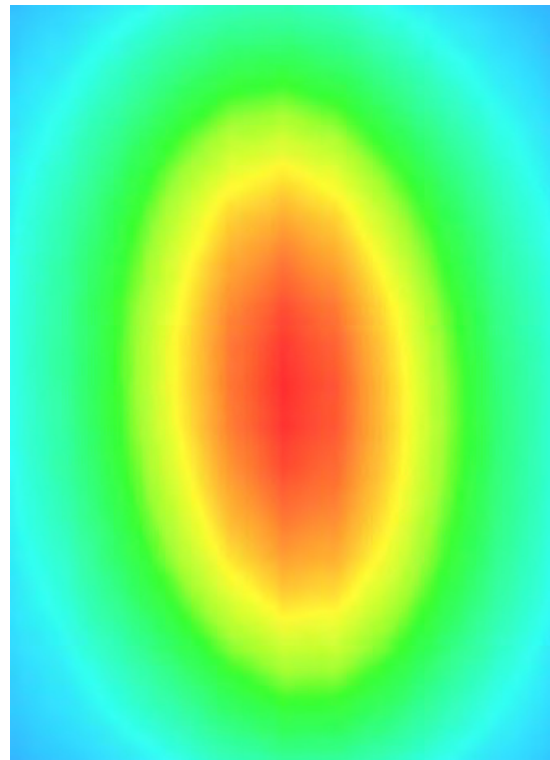

5.4 DIP 0G900

5.4.1 Dipole 900 MHz Validation Measurement for Head Tissue

System Performance Check Data(900 MHz Head)

Type: Phone measurement (Complete)

E-Field Probe: SN 34/15 SSE2 EPGO265

Area scan resolution: dx=8 mm,dy=8 mm

Zoom scan resolution: dx=8 mm, dy=8 mm, dz=5 mm

Date of measurement: 2017.03.01

Measurement duration: 13 minutes 59 seconds

Experimental conditions.

Phantom File	surf_sam_plan.txt
Phantom	Validation plane
Band	900 MHz
Signal	CW
Frequency (MHz)	900.000000
Relative permittivity (real part)	41.012785
Conductivity (S/m)	0.982695
Power drift (%)	0.240000
Ambient Temperature:	21.9°C
Liquid Temperature:	20.8°C
ConvF:	1.86
Crest factor:	1:1

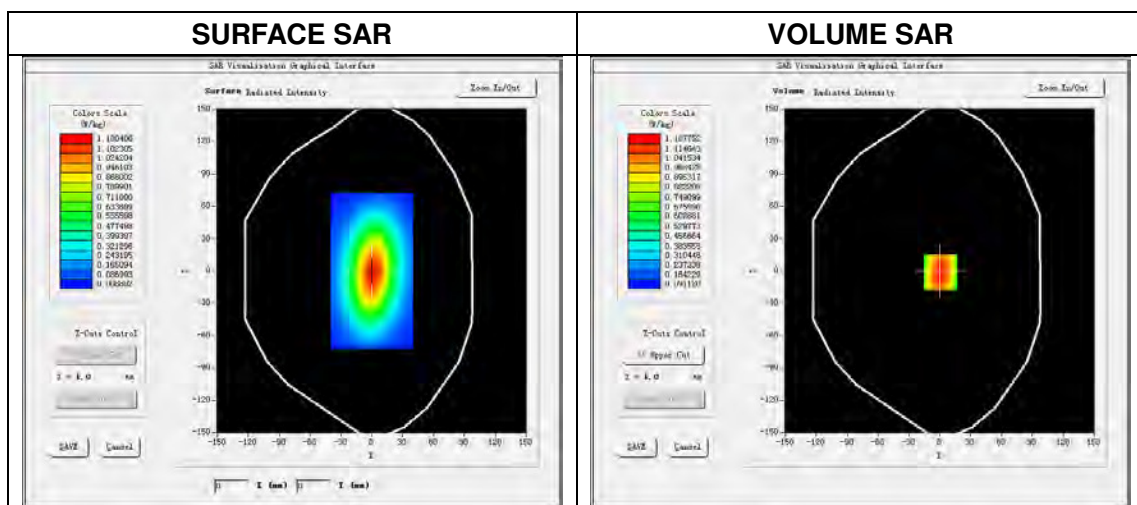

Maximum location: X=0.00, Y=0.00

SAR Peak: 1.59 W/kg

SAR 10 g (W/Kg)	0.722569
SAR 1 g (W/Kg)	1.086216

Z Axis Scan

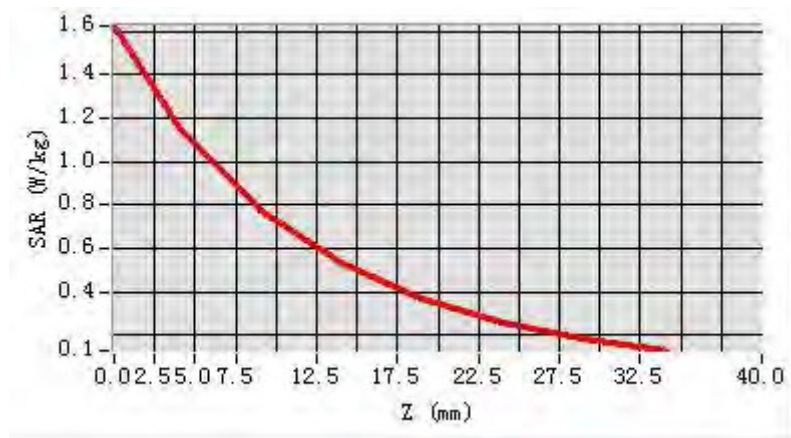

3D screen shot

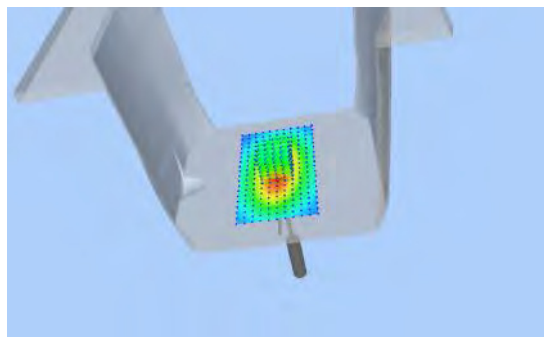

Hot spot position

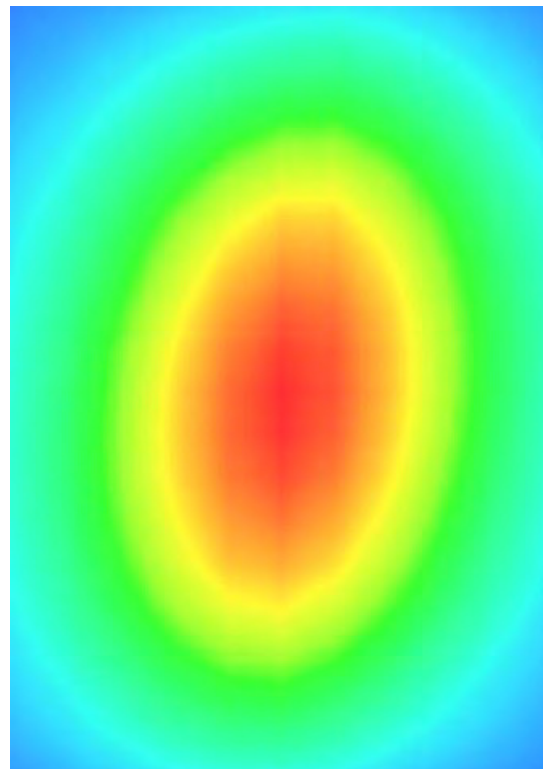

5.4.2 Dipole 900 MHz Validation Measurement for Body Tissue

System Performance Check Data(900 MHz Body)

Type: Phone measurement (Complete)

E-Field Probe: SN 34/15 SSE2 EPGO265

Area scan resolution: dx=8 mm,dy=8 mm

Zoom scan resolution: dx=8 mm, dy=8 mm, dz=5 mm

Date of measurement: 2017.03.01

Measurement duration: 13 minutes 49 seconds

Experimental conditions.

Phantom File	surf_sam_plan.txt
Phantom	Validation plane
Band	900 MHz
Signal	CW
Frequency (MHz)	900.000000
Relative permittivity (real part)	53.623571
Conductivity (S/m)	1.07252
Power drift (%)	-0.370000
Ambient Temperature:	21.9°C
Liquid Temperature:	20.8°C
ConvF:	1.92
Crest factor:	1:1

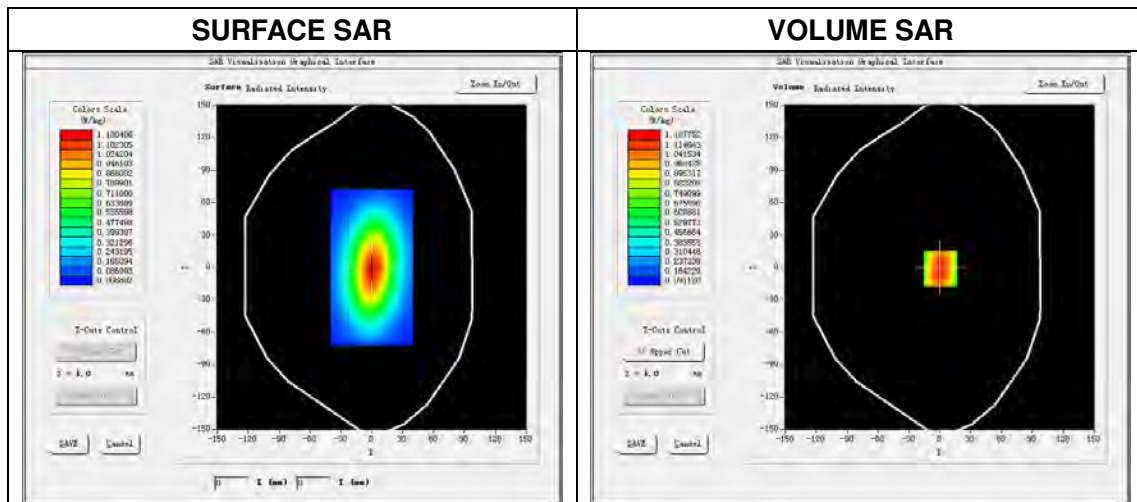

Maximum location: X=0.00, Y=0.00

SAR Peak: 1.69 W/kg

SAR 10 g (W/Kg)	0.752336
SAR 1 g (W/Kg)	1.140385

Z Axis Scan

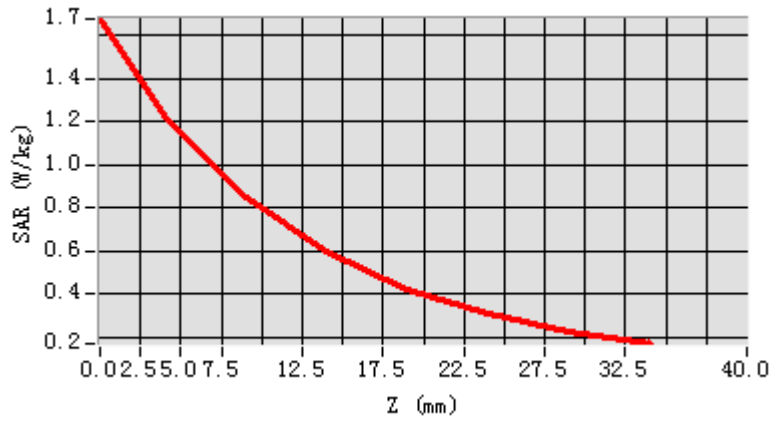

3D screen shot

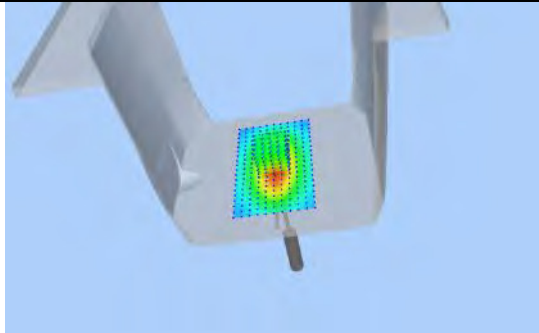

Hot spot position

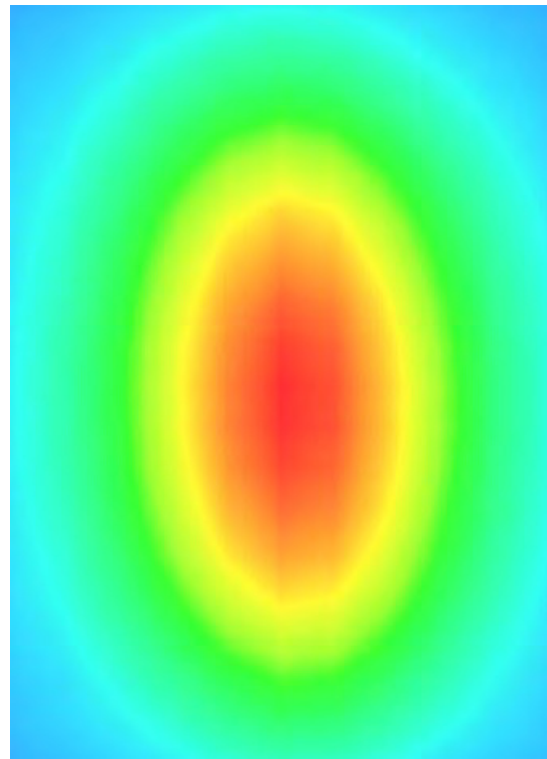

5.5 DIP 1G800

5.5.1 Dipole 1800 MHz Validation Measurement for Head Tissue

System Performance Check Data(1800 MHz Head)

Type: Phone measurement (Complete)
 E-Field Probe: SN 34/15 SSE2 EPGO265
 Area scan resolution: dx=8mm,dy=8mm
 Zoom scan resolution: dx=8mm, dy=8mm, dz=5mm
 Date of measurement: 2017.03.02
 Measurement duration: 13 minutes 39 seconds

Experimental conditions.

Phantom File	surf_sam_plan.txt
Phantom	Validation plane
Band	1800MHz
Signal	CW
Frequency (MHz)	1800.000000
Relative permittivity (real part)	38.812571
Conductivity (S/m)	1.422596
Power drift (%)	0.330000
Ambient Temperature:	22.4°C
Liquid Temperature:	21.3°C
ConvF:	2.04
Crest factor:	1:1

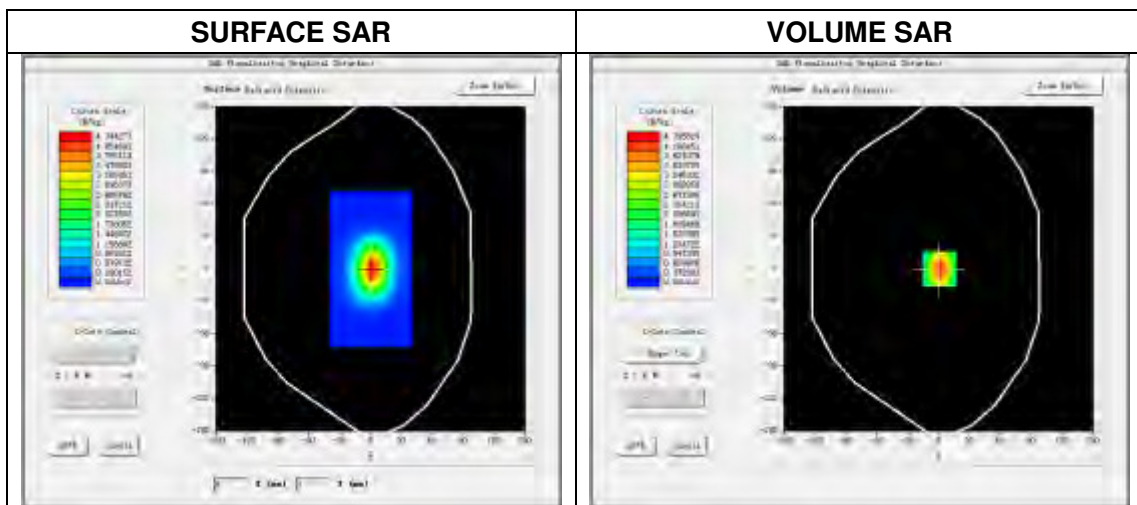

Maximum location: X=0.00, Y=0.00

SAR Peak: 6.48 W/kg

SAR 10 g (W/Kg)	1.965521
SAR 1g (W/Kg)	3.887922

Z Axis Scan

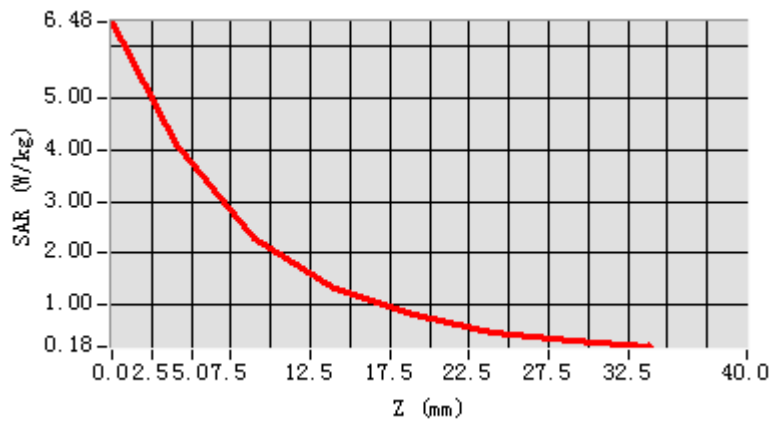

3D screen shot

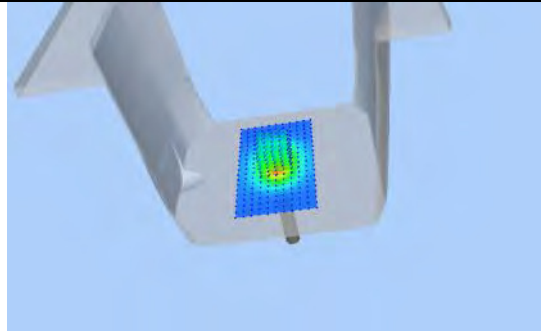

Hot spot position

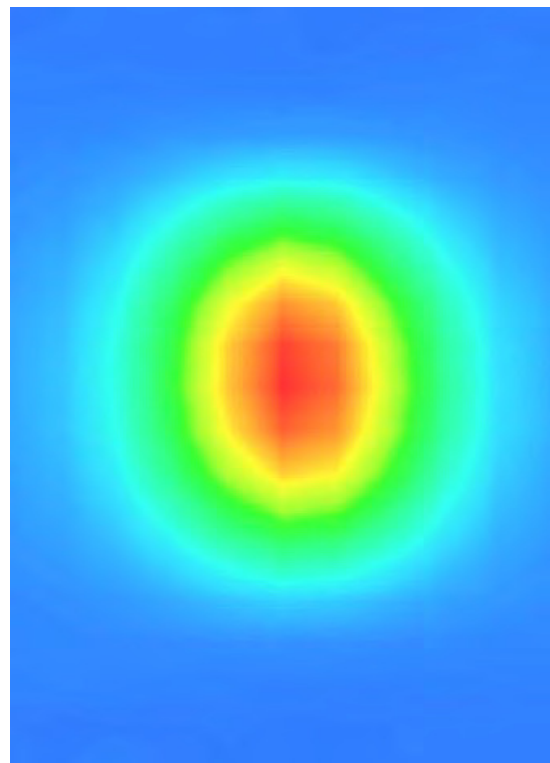

5.5.2 Dipole 1800 MHz Validation Measurement for Body Tissue

System Performance Check Data(1800 MHz Body)

Type: Phone measurement (Complete)
 E-Field Probe: SN 34/15 SSE2 EPGO265
 Area scan resolution: dx=8mm,dy=8mm
 Zoom scan resolution: dx=8mm, dy=8mm, dz=5mm
 Date of measurement: 2017.03.02
 Measurement duration: 13 minutes 52 seconds

Experimental conditions.

Phantom File	surf_sam_plan.txt
Phantom	Validation plane
Band	1800MHz
Signal	CW
Frequency (MHz)	1800.000000
Relative permittivity (real part)	54.352581
Conductivity (S/m)	1.492574
Power drift (%)	0.680000
Ambient Temperature:	22.4°C
Liquid Temperature:	21.3°C
ConvF:	2.08
Crest factor:	1:1

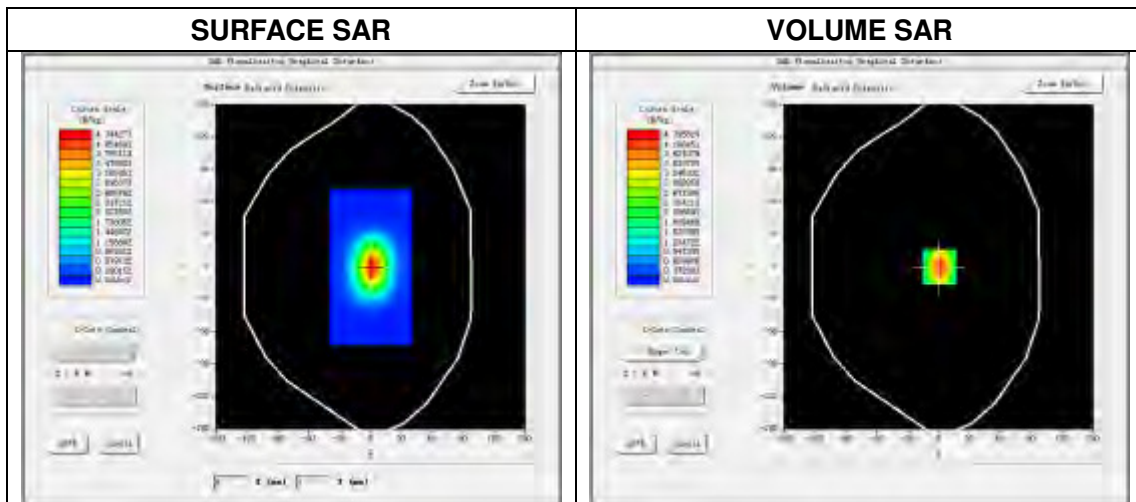

Maximum location: X=0.00, Y=0.00

SAR Peak: 6.55 W/kg

SAR 10 g (W/Kg)	1.992361
SAR 1g (W/Kg)	3.923758

Z Axis Scan

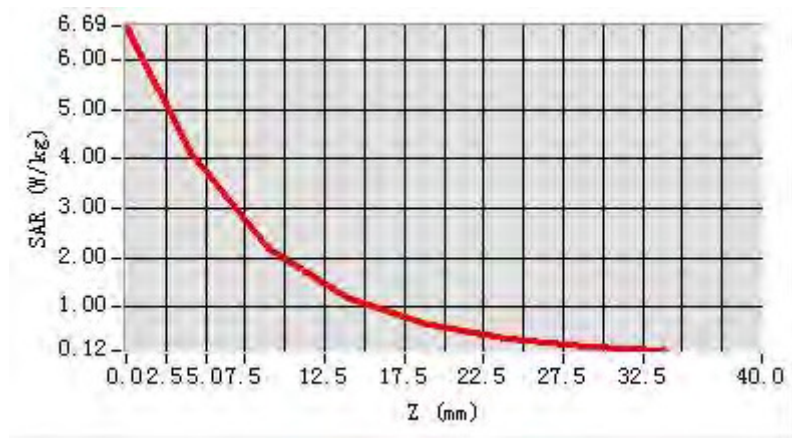

3D screen shot

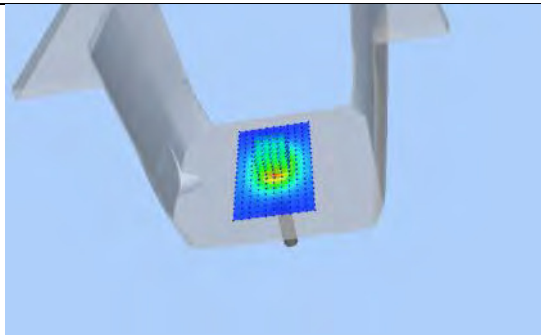

Hot spot position

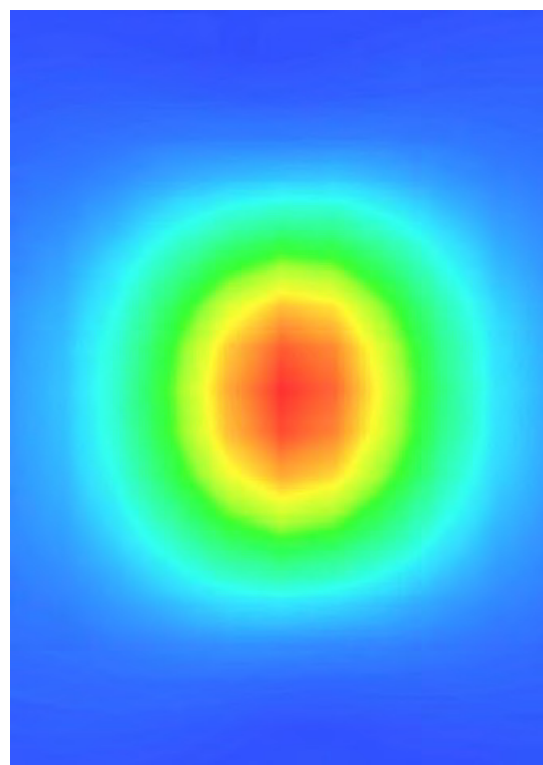

5.6 DIP 1G900

5.6.1 Dipole 1900 MHz Validation Measurement for Head Tissue

System Performance Check Data(1900 MHz Head)

Type: Phone measurement (Complete)
 E-Field Probe: SN 34/15 SSE2 EPGO265
 Area scan resolution: dx=8mm,dy=8mm
 Zoom scan resolution: dx=8mm, dy=8mm, dz=5mm
 Date of measurement: 2017.03.02
 Measurement duration: 13 minutes 42 seconds

Experimental conditions.

Phantom File	surf_sam_plan.txt
Phantom	Validation plane
Band	1900MHz
Signal	CW
Frequency (MHz)	1900.000000
Relative permittivity (real part)	39.826257
Conductivity (S/m)	1.426126
Power drift (%)	1.190000
Ambient Temperature:	22.4°C
Liquid Temperature:	21.3°C
ConvF:	2.35
Crest factor:	1:1

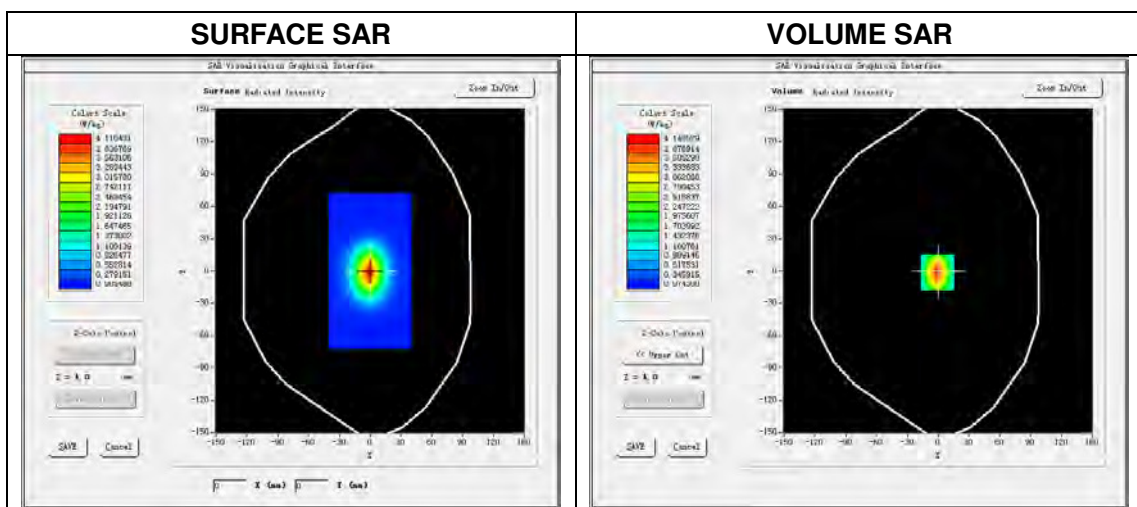

Maximum location: X=0.00, Y=0.00

SAR Peak: 6.49W/kg

SAR 10g (W/Kg)	1.921565
SAR 1g (W/Kg)	3.902425

Z Axis Scan

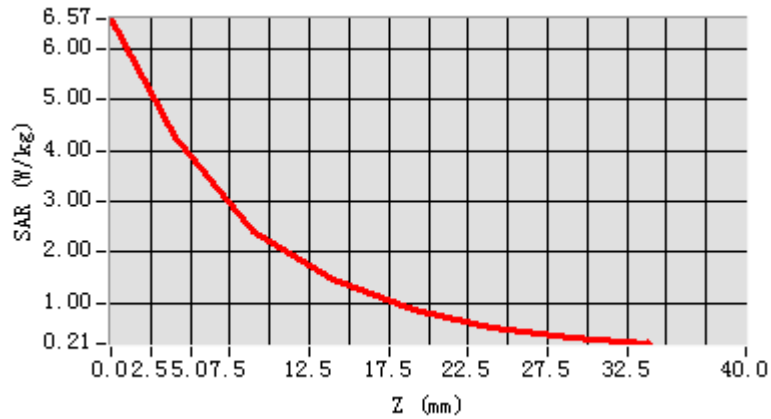

3D screen shot

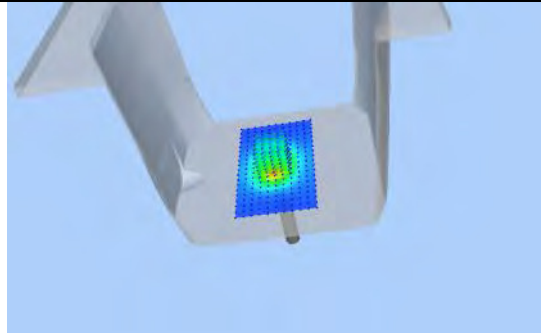

Hot spot position

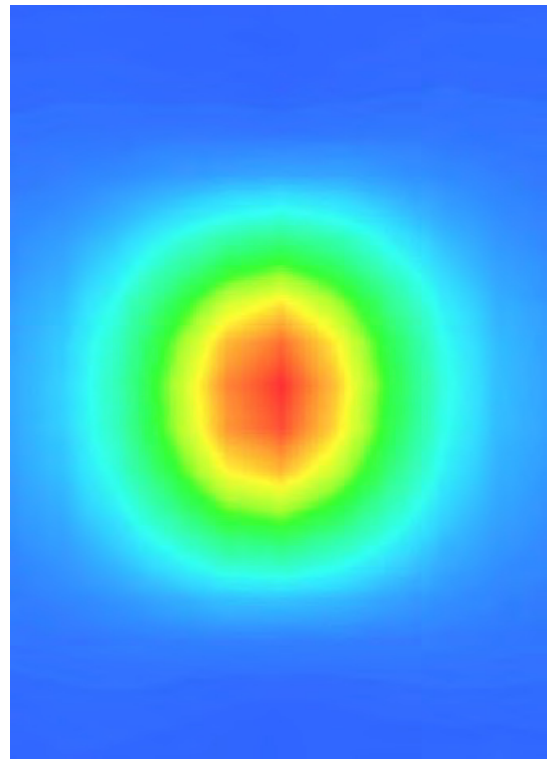

5.6.2 Dipole 1900 MHz Validation Measurement for Body Tissue

System Performance Check Data(1900 MHz Body)

Type: Phone measurement (Complete)
 E-Field Probe: SN 34/15 SSE2 EPGO265
 Area scan resolution: dx=8mm,dy=8mm
 Zoom scan resolution: dx=8mm, dy=8mm, dz=5mm
 Date of measurement: 2017.03.02
 Measurement duration: 13 minutes 38 seconds

Experimental conditions.

Phantom File	surf_sam_plan.txt
Phantom	Validation plane
Band	1900 MHz
Signal	CW
Frequency (MHz)	1900.000000
Relative permittivity (real part)	54.023651
Conductivity (S/m)	1.540215
Power drift (%)	0.230000
Ambient Temperature:	22.4°C
Liquid Temperature:	21.3°C
ConvF:	2.42
Crest factor:	1:1

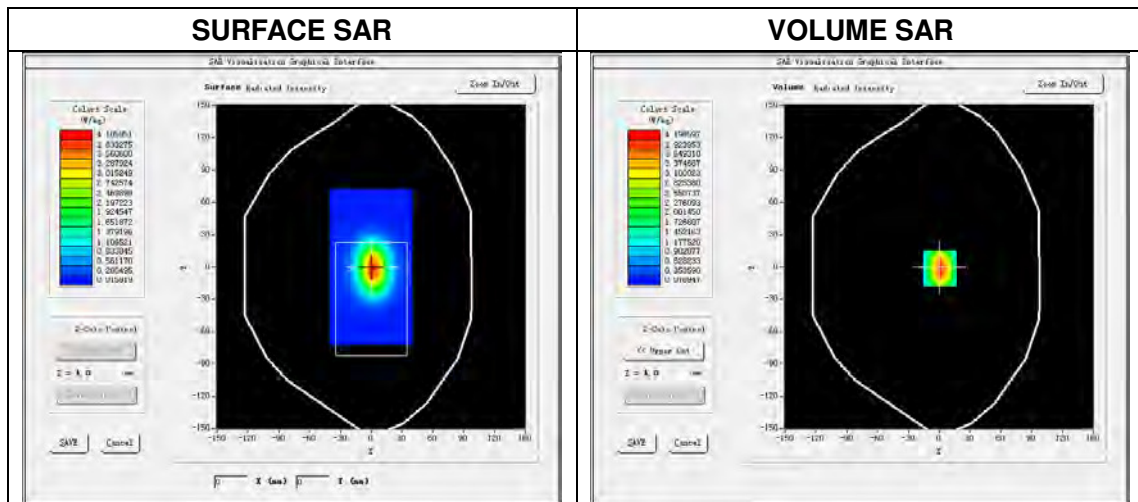

Maximum location: X=0.00, Y=0.00

SAR Peak: 6.66W/kg

SAR 10g (W/Kg)	2.010256
SAR 1g (W/Kg)	3.951364

Z Axis Scan

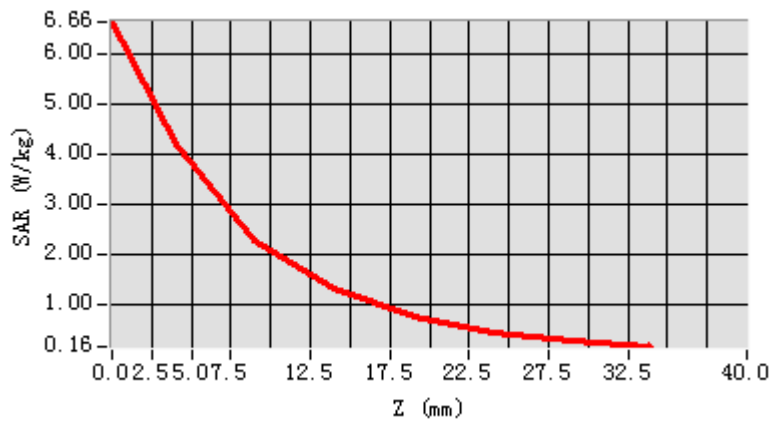

3D screen shot

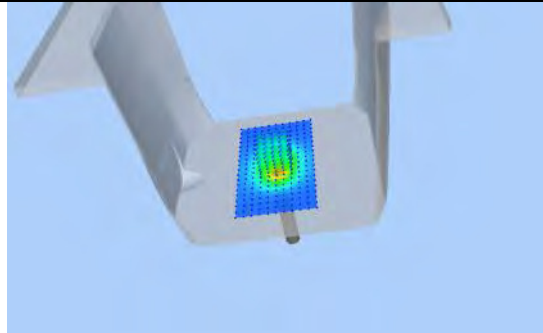

Hot spot position

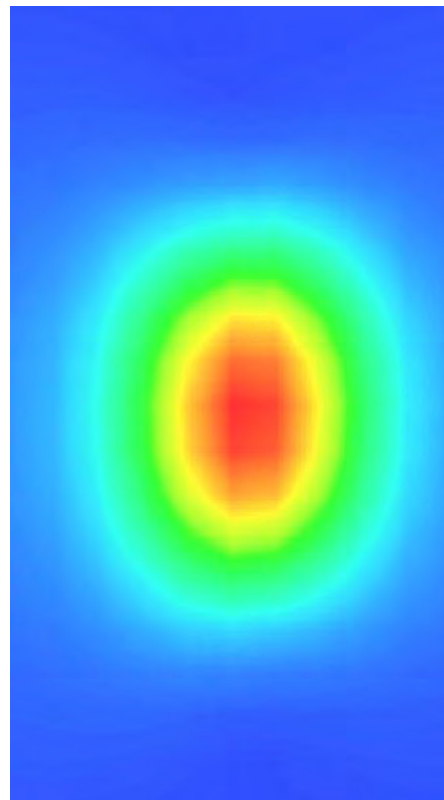

5.7 DIP 2G000

5.7.1 Dipole 2000 MHz Validation Measurement for Head Tissue

System Performance Check Data(2000 MHz Head)

Type: Phone measurement (Complete)

E-Field Probe: SN 34/15 SSE2 EPGO265

Area scan resolution: dx=8 mm,dy=8 mm

Zoom scan resolution: dx=8 mm, dy=8 mm, dz=5 mm

Date of measurement: 2017.03.02

Measurement duration: 14 minutes 17 seconds

Experimental conditions.

Phantom File	surf_sam_plan.txt
Phantom	Validation plane
Band	2000 MHz
Signal	CW
Frequency (MHz)	2000.000000
Relative permittivity (real part)	38.789355
Conductivity (S/m)	1.4251543
Power drift (%)	0.660000
Ambient Temperature:	22.4°C
Liquid Temperature:	21.3°C
ConvF:	2.23
Crest factor:	1:1

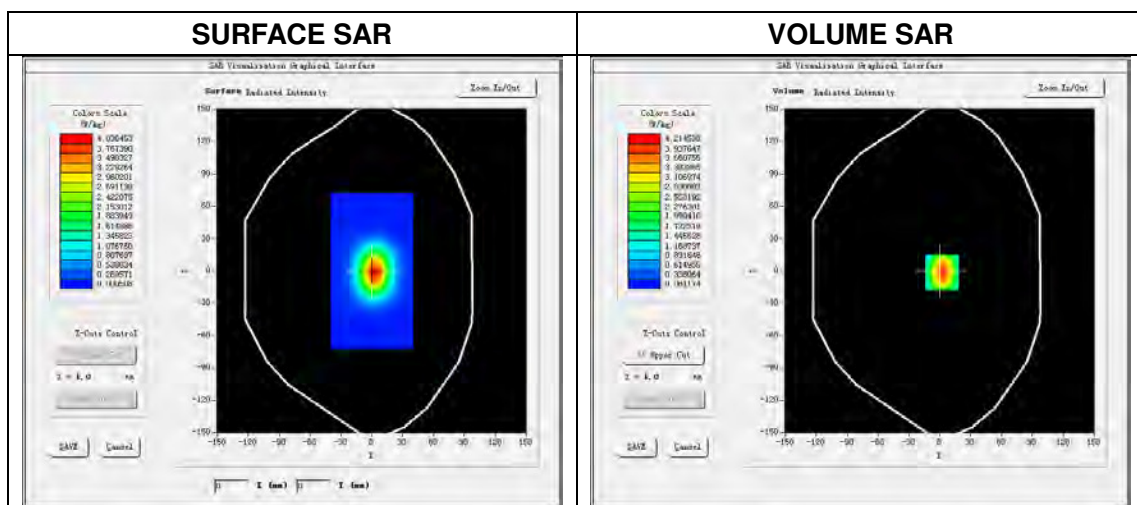

Maximum location: X=0.00, Y=0.00

SAR Peak: 6.69 W/kg

SAR 10 g (W/Kg)	2.062551
SAR 1 g (W/Kg)	4.020365

Z Axis Scan

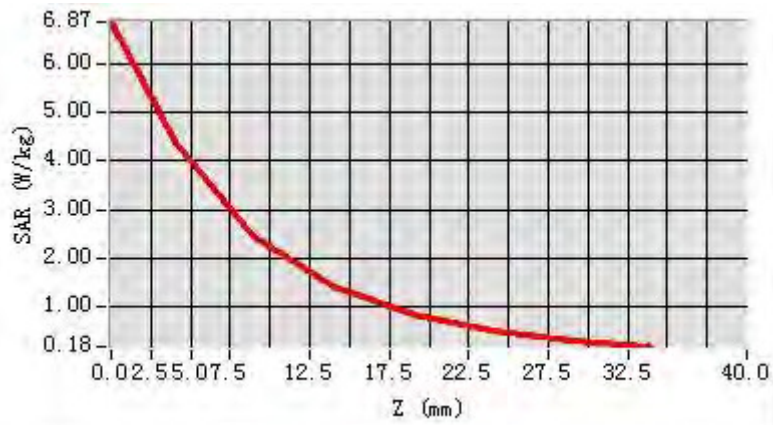

3D screen shot

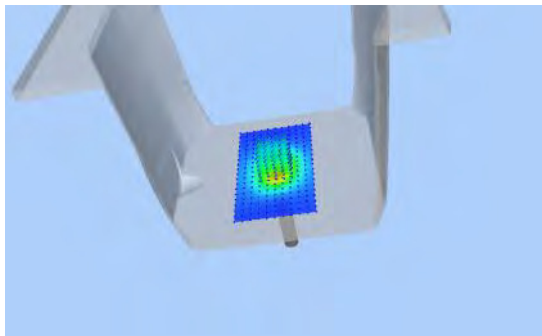

Hot spot position

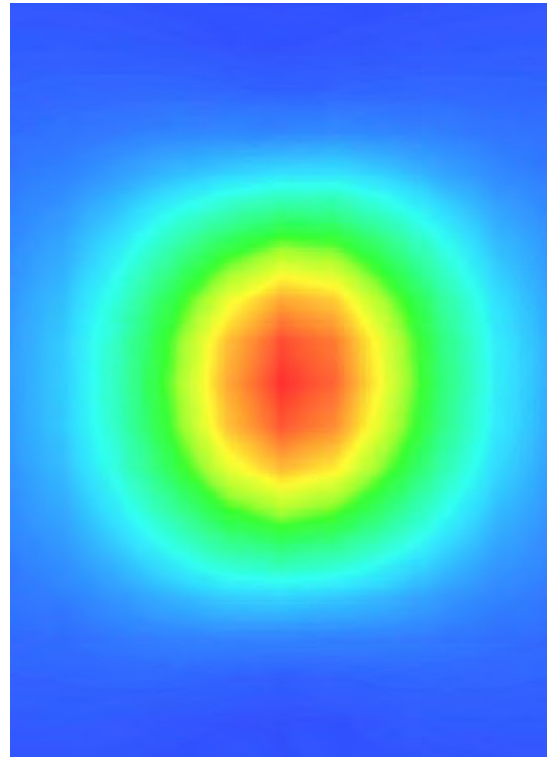

5.7.2 Dipole 2000 MHz Validation Measurement for Body Tissue

System Performance Check Data(2000 MHz Body)

Type: Phone measurement (Complete)

E-Field Probe: SN 34/15 SSE2 EPGO265

Area scan resolution: dx=8 mm,dy=8 mm

Zoom scan resolution: dx=8 mm, dy=8 mm, dz=5 mm

Date of measurement: 2017.03.02

Measurement duration: 14 minutes 11 seconds

Experimental conditions.

Phantom File	surf_sam_plan.txt
Phantom	Validation plane
Band	2000 MHz
Signal	CW
Frequency (MHz)	2000.000000
Relative permittivity (real part)	51.512549
Conductivity (S/m)	1.549334
Power drift (%)	0.510000
Ambient Temperature:	22.4°C
Liquid Temperature:	21.3°C
ConvF:	2.32
Crest factor:	1:1

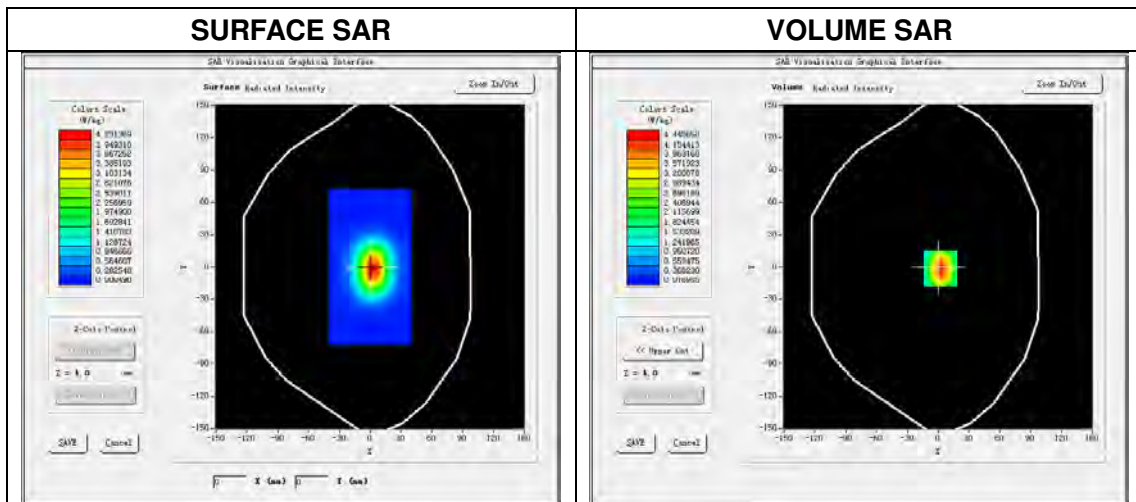

Maximum location: X=0.00, Y=0.00

SAR Peak: 6.98 W/kg

SAR 10 g (W/Kg)	2.189137
SAR 1 g (W/Kg)	4.215283

Z Axis Scan

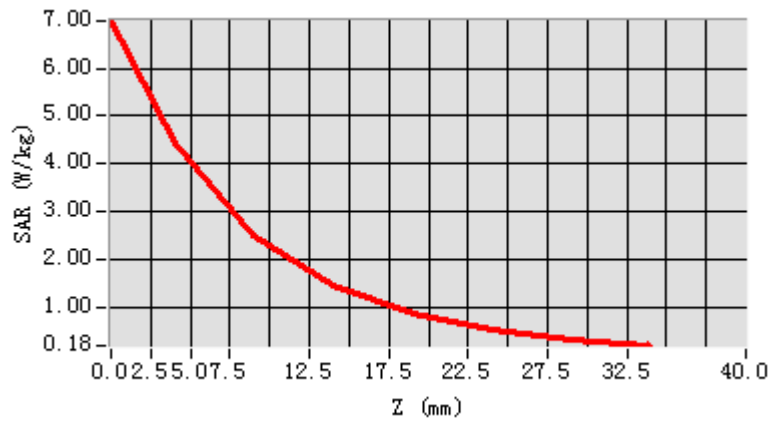

3D screen shot

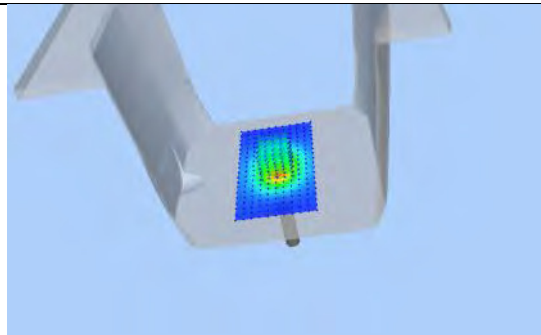

Hot spot position

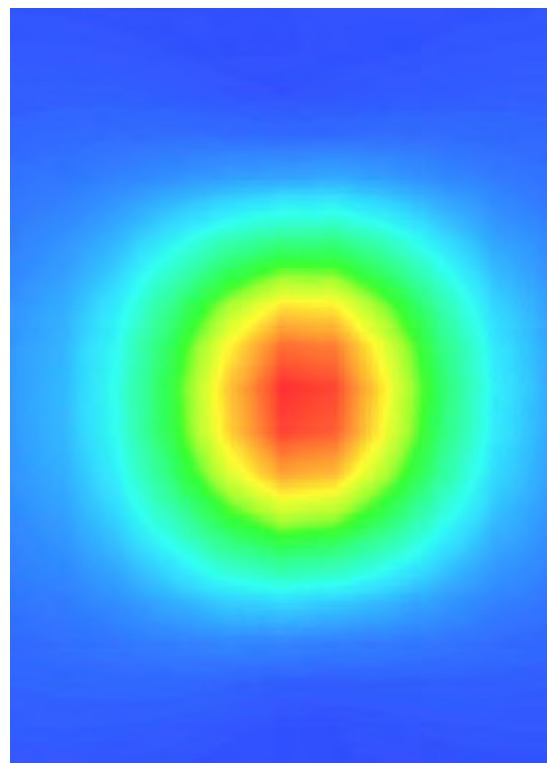

5.8 DIP 2G450

5.8.1 Dipole 2450 MHz Validation Measurement for Head Tissue

System Performance Check Data(2450 MHz Head)

Type: Phone measurement (Complete)
 E-Field Probe: SN 34/15 SSE2 EPGO265
 Area scan resolution: dx=8mm,dy=8mm
 Zoom scan resolution: dx=5mm, dy=5mm, dz=5mm
 Date of measurement: 2017.03.02
 Measurement duration: 18 minutes 37 seconds

Experimental conditions.

Phantom File	surf_sam_plan.txt
Phantom	Validation plane
Band	2450MHz
Signal	CW
Frequency (MHz)	2450.000000
Relative permittivity (real part)	38.863623
Conductivity (S/m)	1.810263
Power drift (%)	1.240000
Ambient Temperature:	22.4°C
Liquid Temperature:	21.3°C
ConvF:	2.47
Crest factor:	1:1

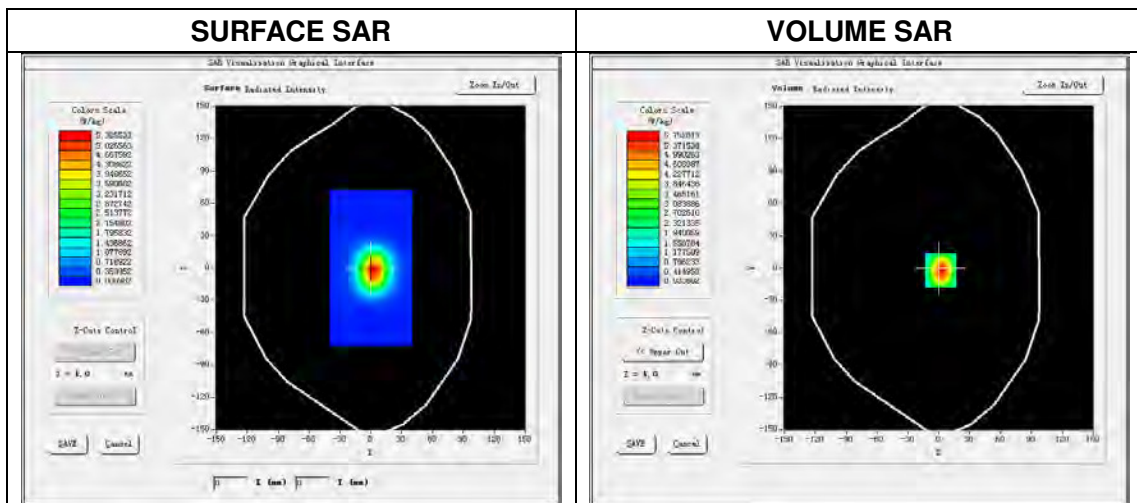

Maximum location: X=0.00, Y=0.00

SAR Peak: 9.79 W/kg

SAR 10g (W/Kg)	2.479365
SAR 1g (W/Kg)	5.302546

Z Axis Scan

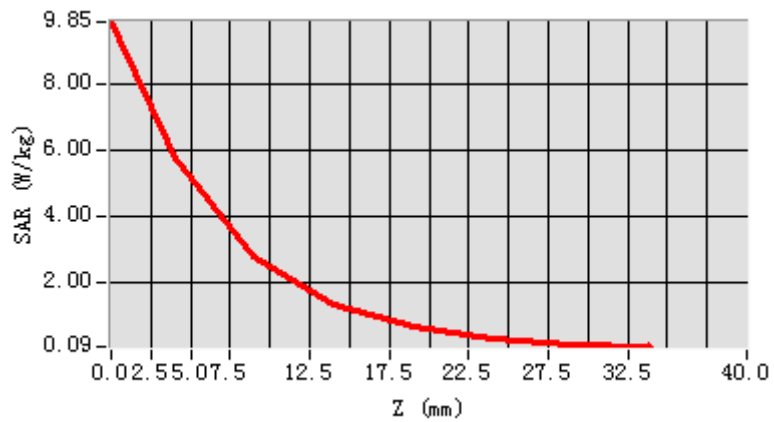

3D screen shot

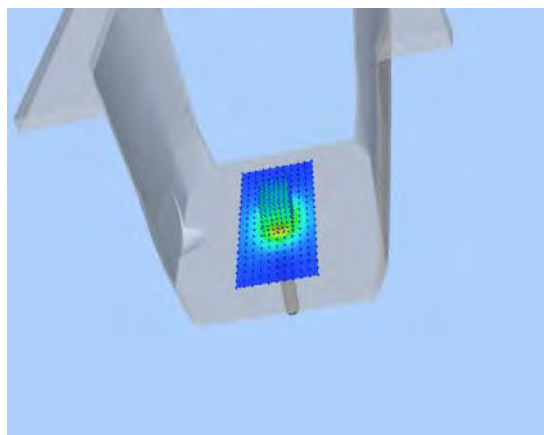

Hot spot position

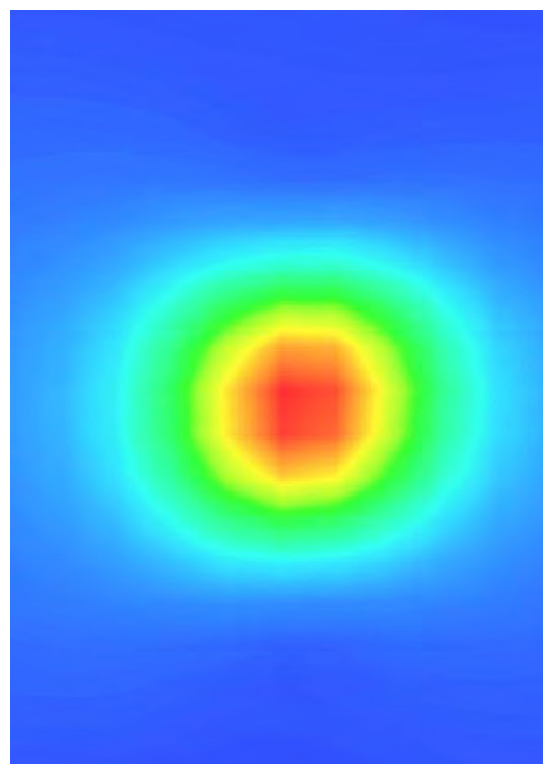

5.8.2 Dipole 2450 MHz Validation Measurement for Body Tissue

System Performance Check Data(2450 MHz Body)

Type: Phone measurement (Complete)

E-Field Probe: SN 34/15 SSE2 EPGO265

Area scan resolution: dx=8 mm,dy=8 mm

Zoom scan resolution: dx=5 mm, dy=5 mm, dz=5 mm

Date of measurement: 2017.03.02

Measurement duration: 19 minutes 15 seconds

Experimental conditions.

Phantom File	surf_sam_plan.txt
Phantom	Validation plane
Band	2450 MHz
Signal	CW
Frequency (MHz)	2450.000000
Relative permittivity (real part)	52.912582
Conductivity (S/m)	1.952326
Power drift (%)	-0.110000
Ambient Temperature:	22.4°C
Liquid Temperature:	21.3°C
ConvF:	2.55
Crest factor:	1:1

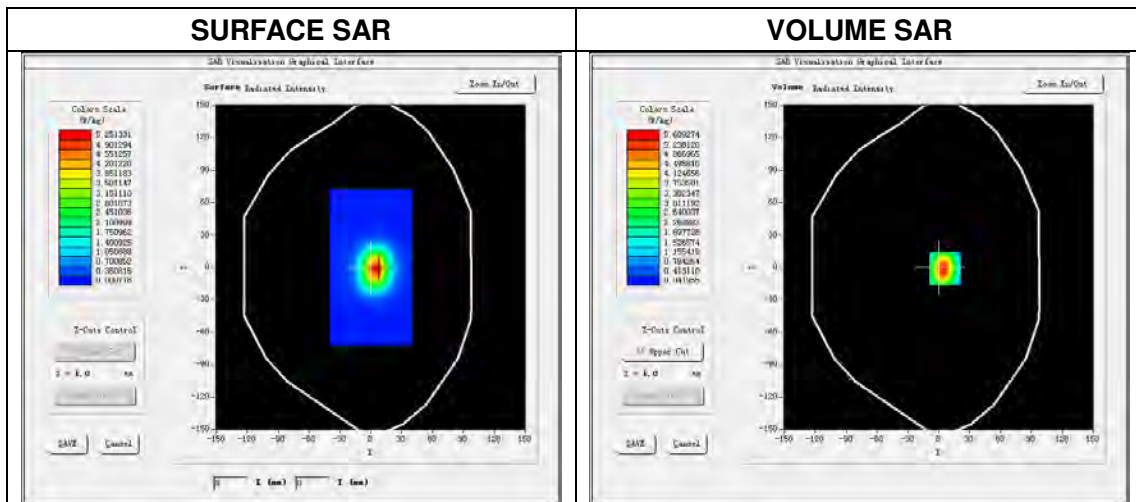

Maximum location: X=0.00, Y=0.00

SAR Peak: 9.01 W/kg

SAR 10 g (W/Kg)	2.448257
SAR 1 g (W/Kg)	5.102686

Z Axis Scan

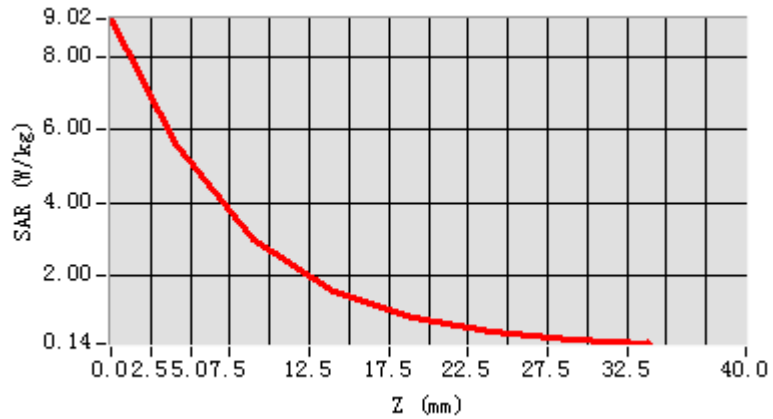

3D screen shot

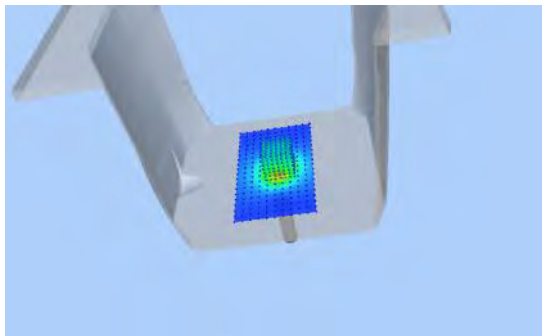

Hot spot position

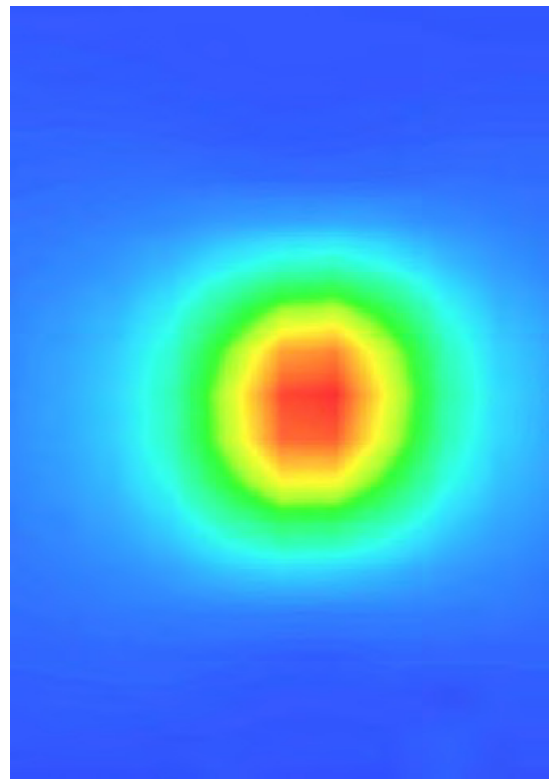

5.9 DIP 2G600

5.9.1 Dipole 2600 MHz Validation Measurement for Head Tissue

System Performance Check Data(2600 MHz Head)

Type: Phone measurement (Complete)

E-Field Probe: SN 34/15 SSE2 EPGO265

Area scan resolution: dx=8 mm,dy=8 mm

Zoom scan resolution: dx=5 mm, dy=5 mm, dz=5 mm

Date of measurement: 2017.03.03

Measurement duration: 19 minutes 16 seconds

Experimental conditions.

Phantom File	surf_sam_plan.txt
Phantom	Validation plane
Band	2600 MHz
Signal	CW
Frequency (MHz)	2600.000000
Relative permittivity (real part)	38.085257
Conductivity (S/m)	1.982546
Power drift (%)	-0.050000
Ambient Temperature:	22.2°C
Liquid Temperature:	21.2°C
ConvF:	2.36
Crest factor:	1:1

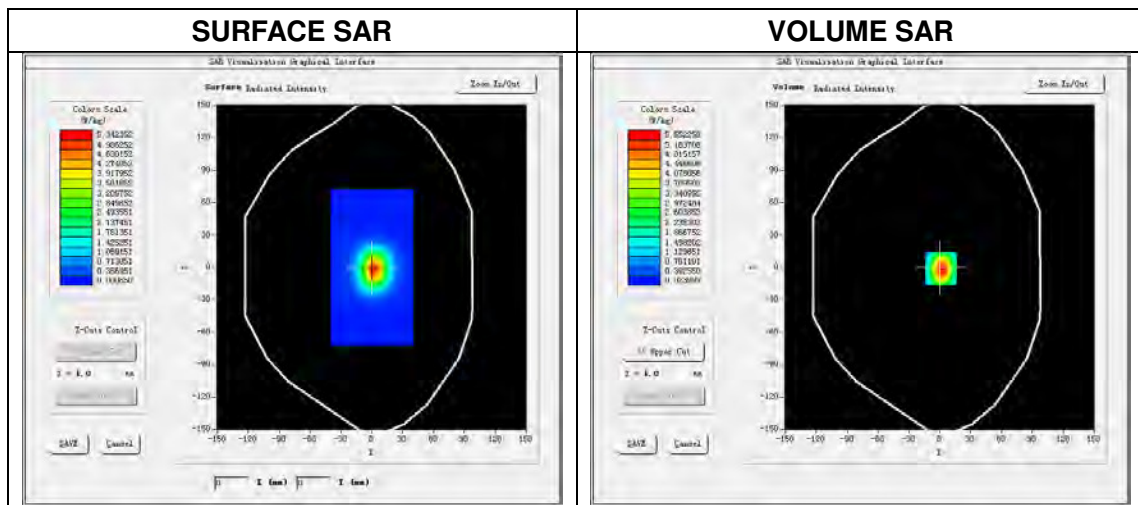

Maximum location: X=0.00, Y=0.00

SAR Peak: 9.66 W/kg

SAR 10 g (W/Kg)	2.506594
SAR 1 g (W/Kg)	5.336598

Z Axis Scan

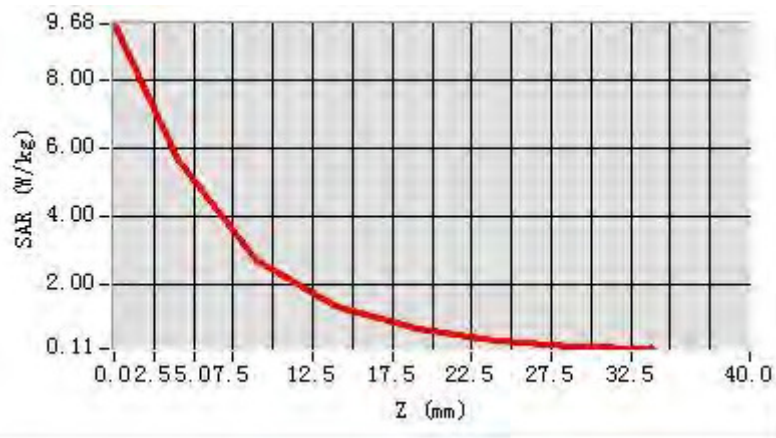

3D screen shot

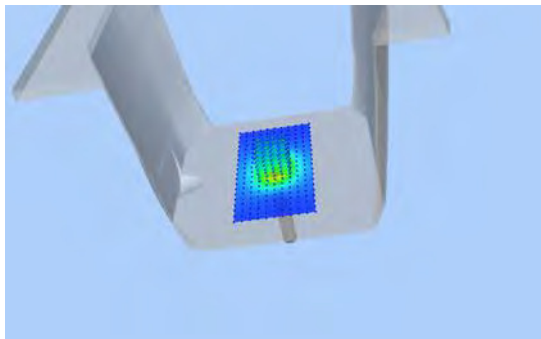

Hot spot position

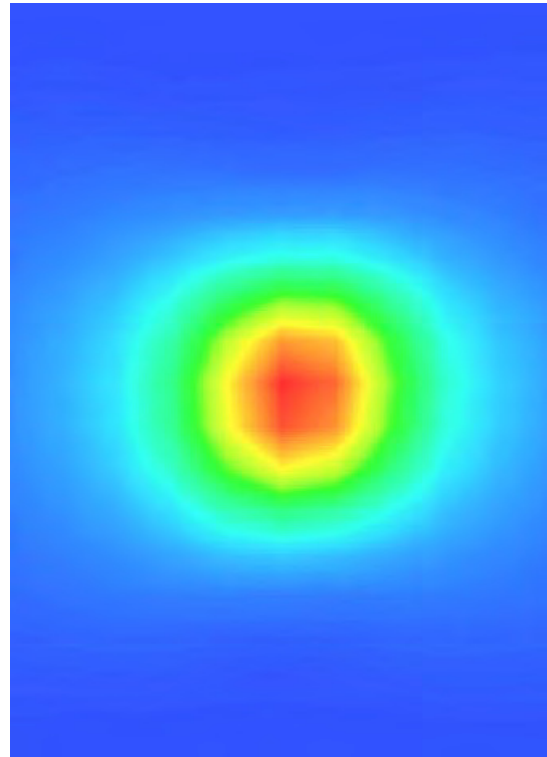

5.9.2 Dipole 2600 MHz Validation Measurement for Body Tissue

System Performance Check Data(2600 MHz Body)

Type: Phone measurement (Complete)

E-Field Probe: SN 34/15 SSE2 EPGO265

Area scan resolution: dx=8 mm,dy=8 mm

Zoom scan resolution: dx=5 mm, dy=5 mm, dz=5 mm

Date of measurement: 2017.03.03

Measurement duration: 19 minutes 11 seconds

Experimental conditions.

Phantom File	surf_sam_plan.txt
Phantom	Validation plane
Band	2600 MHz
Signal	CW
Frequency (MHz)	2600.000000
Relative permittivity (real part)	53.385272
Conductivity (S/m)	2.138941
Power drift (%)	0.550000
Ambient Temperature:	22.2°C
Liquid Temperature:	21.2°C
ConvF:	2.43
Crest factor:	1:1

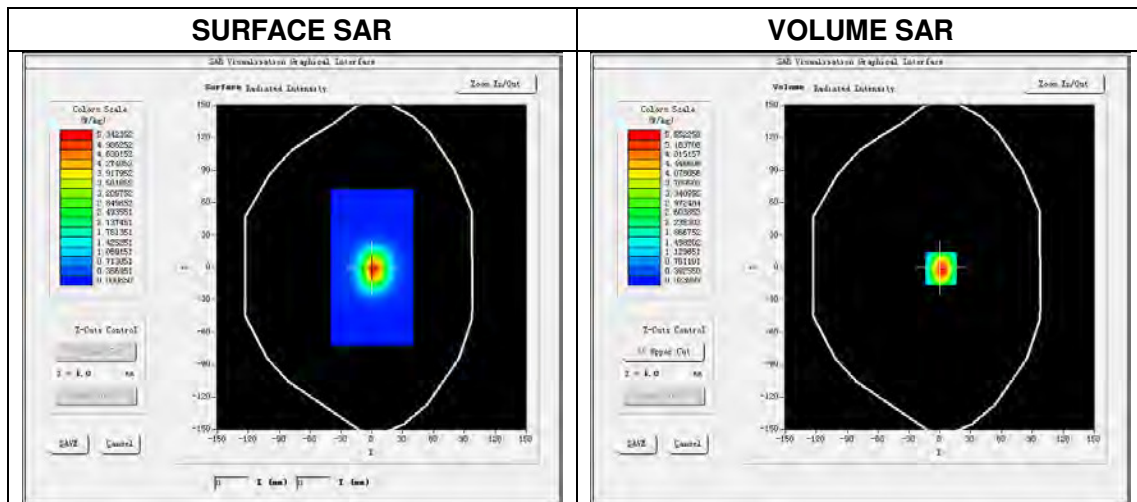

Maximum location: X=0.00, Y=0.00

SAR Peak: 9.33 W/kg

SAR 10 g (W/Kg)	2.375266
SAR 1 g (W/Kg)	5.167828

Z Axis Scan

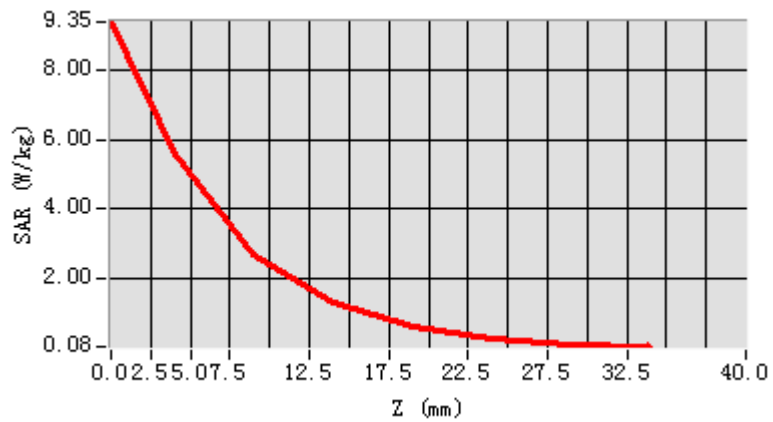

3D screen shot

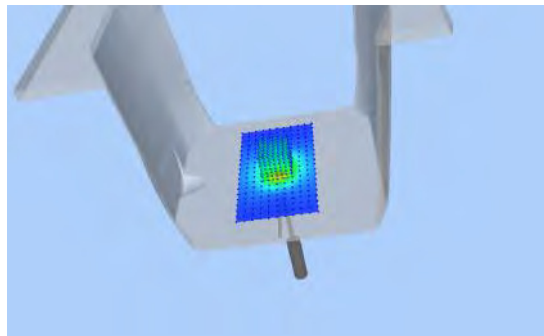

Hot spot position

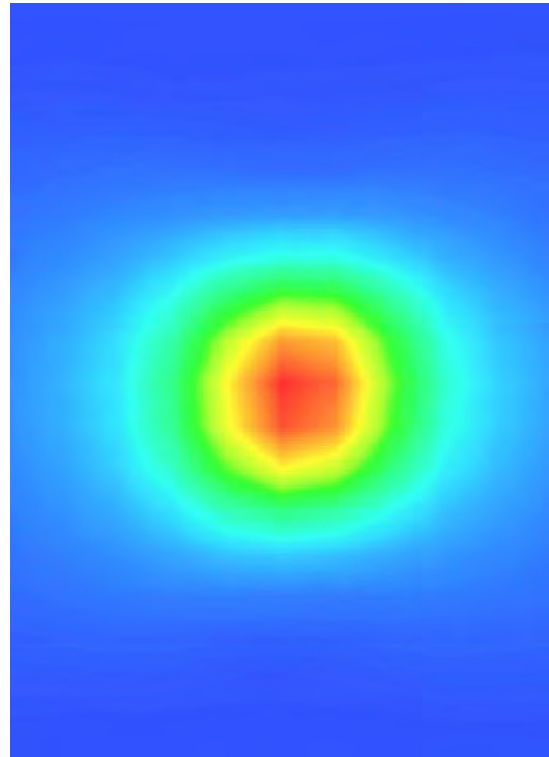

5.10 SWG5500

5.10.1 Waveguide 5 GHz Validation Measurement for Head Tissue

System Performance Check Data(5200 MHz Head)

Type: Phone measurement (Complete)
 E-Field Probe: SN 34/15 SSE2 EPGO265
 Area scan resolution: dx=8mm,dy=8mm
 Zoom scan resolution: dx=4mm, dy=4mm, dz=2mm
 Date of measurement: 2017.03.04
 Measurement duration: 29 minutes 20 seconds

Experimental conditions.

Phantom File	surf_sam_plan.txt
Phantom	Validation plane
Band	5200 MHz
Signal	CW
Frequency (MHz)	5200.000000
Relative permittivity (real part)	36.726545
Conductivity (S/m)	4.619563
Power drift (%)	0.170000
Ambient Temperature:	22.3°C
Liquid Temperature:	21.2°C
ConvF:	1.81
Crest factor:	1:1

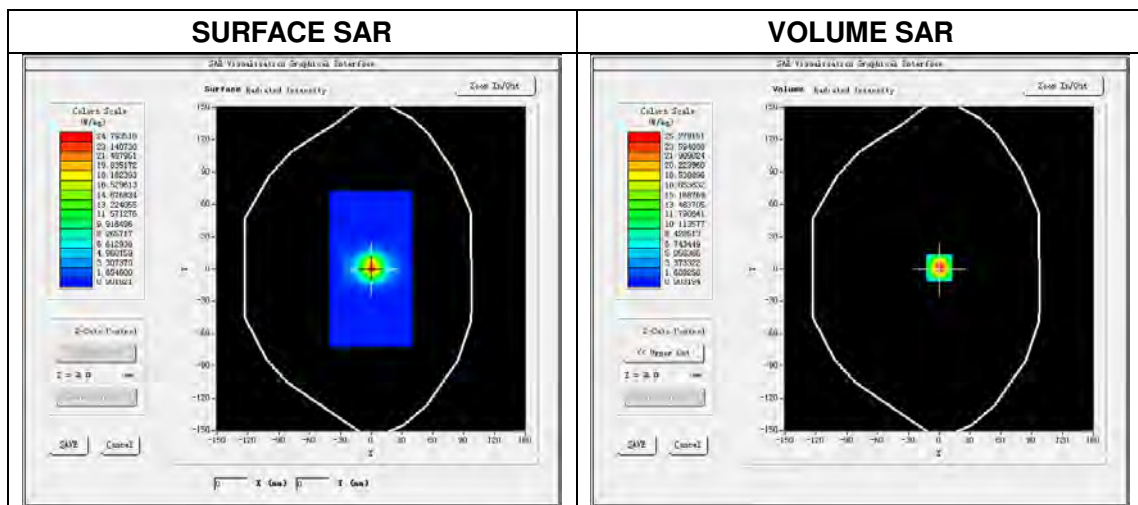

Maximum location: X=3.00, Y=1.00

SAR Peak: 42.16 W/kg

SAR 10g (W/Kg)	5.458332
SAR 1g (W/Kg)	15.372378

Z Axis Scan

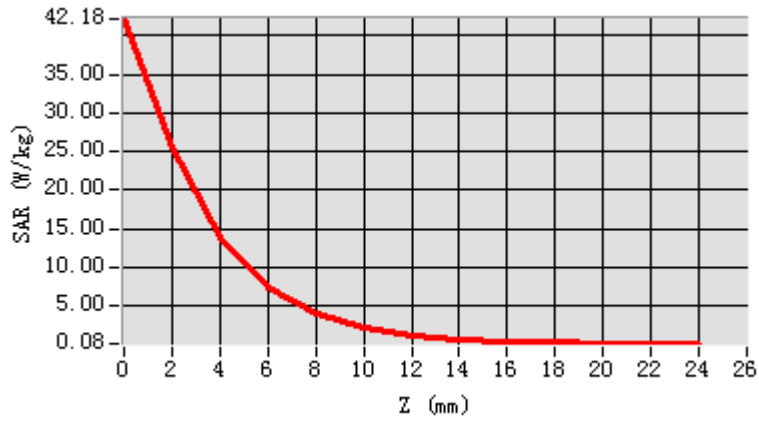

3D screen shot

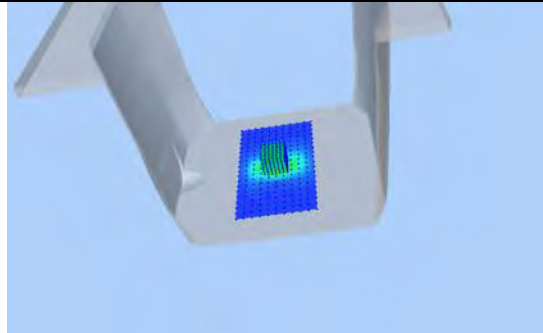

Hot spot position

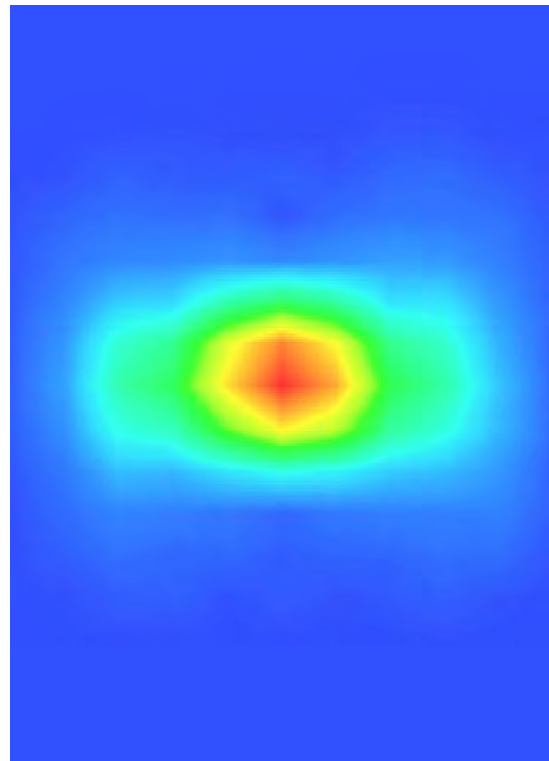

System Performance Check Data(5400 MHz Head)

Type: Phone measurement (Complete)
 E-Field Probe: SN 34/15 SSE2 EPGO265
 Area scan resolution: dx=8mm,dy=8mm
 Zoom scan resolution: dx=4mm, dy=4mm, dz=2mm
 Date of measurement: 2017.03.04
 Measurement duration: 29 minutes 19 seconds

Experimental conditions.

Phantom File	surf_sam_plan.txt
Phantom	Validation plane
Band	5400 MHz
Signal	CW
Frequency (MHz)	5400.000000
Relative permittivity (real part)	36.215425
Conductivity (S/m)	4.818762
Power drift (%)	1.120000
Ambient Temperature:	22.3°C
Liquid Temperature:	21.2°C
ConvF:	2.04
Crest factor:	1:1

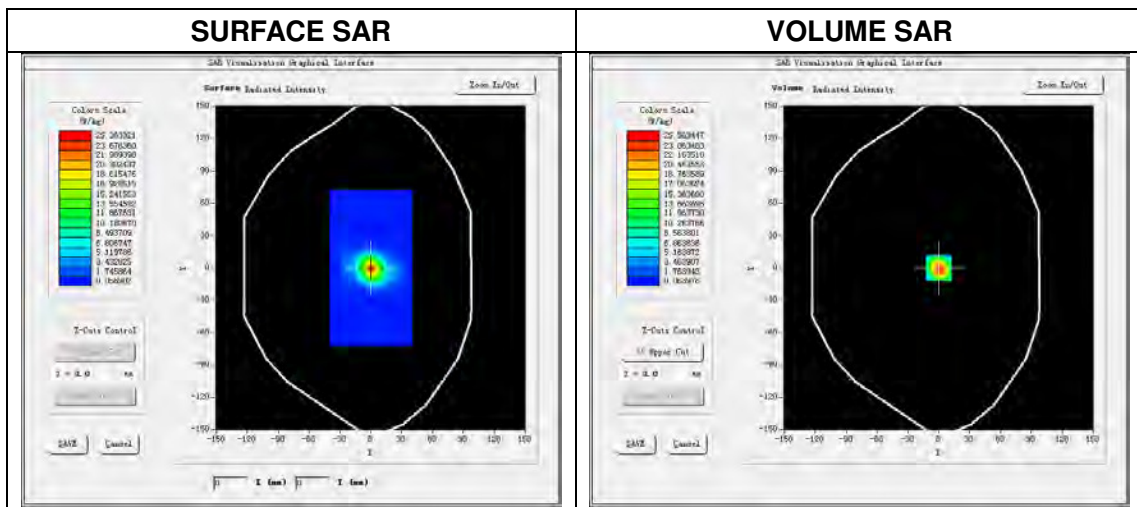

Maximum location: X=0.00, Y=0.00

SAR Peak: 44.75 W/kg

SAR 10g (W/Kg)	5.521578
SAR 1g (W/Kg)	15.893652

Z Axis Scan

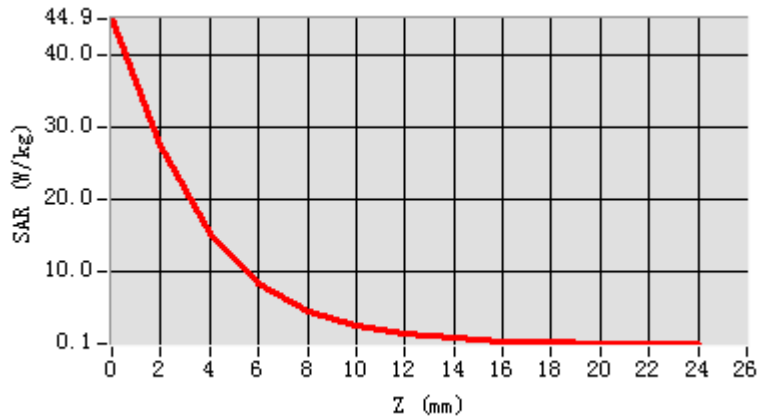

3D screen shot

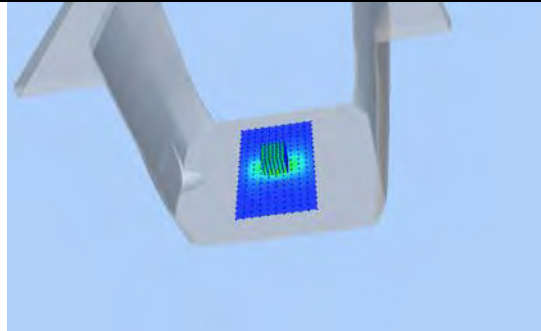

Hot spot position

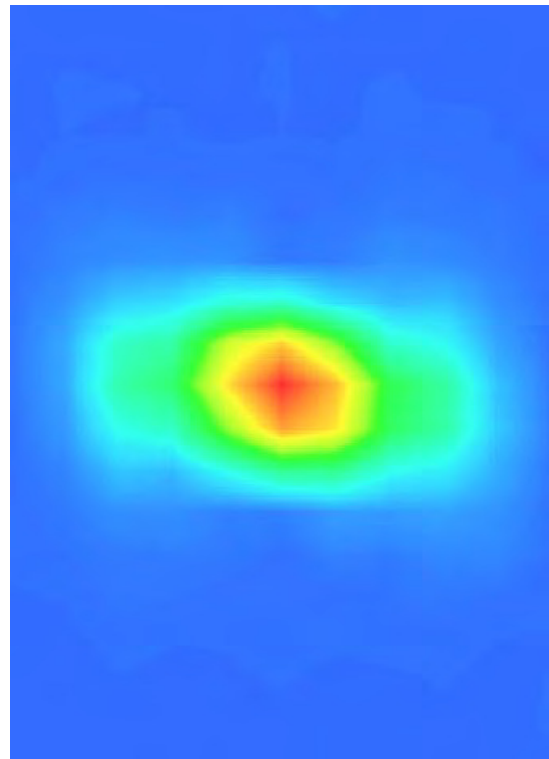

System Performance Check Data(5600 MHz Head)

Type: Phone measurement (Complete)
 E-Field Probe: SN 34/15 SSE2 EPGO265
 Area scan resolution: dx=8mm,dy=8mm
 Zoom scan resolution: dx=4mm, dy=4mm, dz=2mm
 Date of measurement: 2017.03.04
 Measurement duration: 29 minutes 28 seconds

Experimental conditions.

Phantom File	surf_sam_plan.txt
Phantom	Validation plane
Band	5600 MHz
Signal	CW
Frequency (MHz)	5600.000000
Relative permittivity (real part)	34.254845
Conductivity (S/m)	5.132262
Power drift (%)	1.380000
Ambient Temperature:	22.3°C
Liquid Temperature:	21.2°C
ConvF:	2.08
Crest factor:	1:1

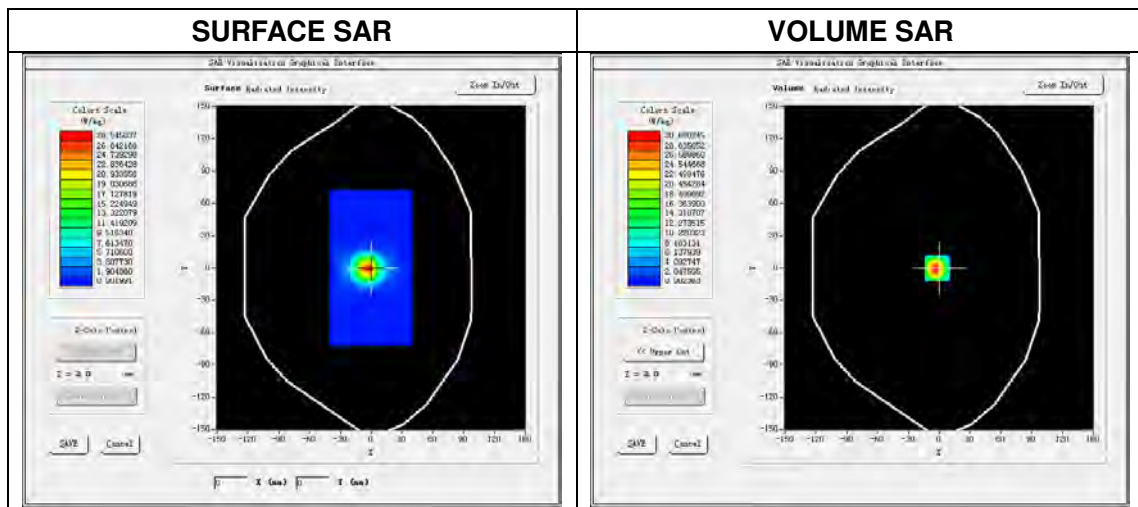

Maximum location: X=1.00, Y=1.00

SAR Peak: 49.55 W/kg

SAR 10g (W/Kg)	5.788135
SAR 1g (W/Kg)	16.458215

Z Axis Scan

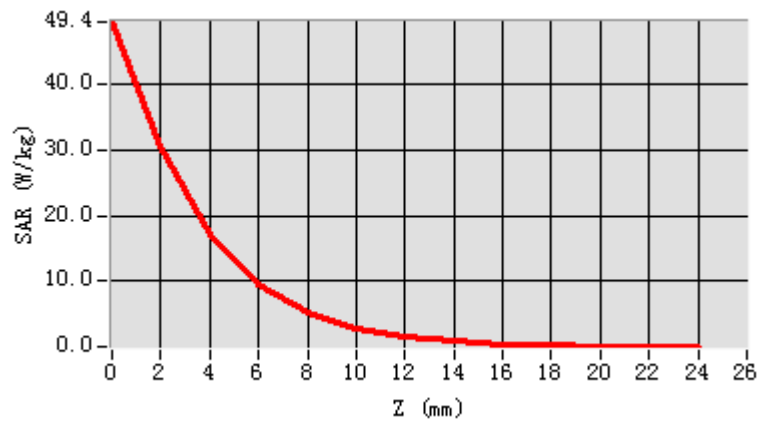

3D screen shot

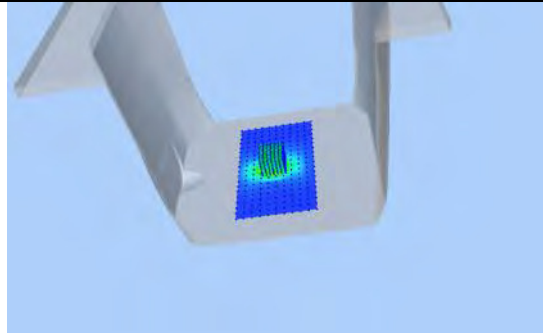

Hot spot position

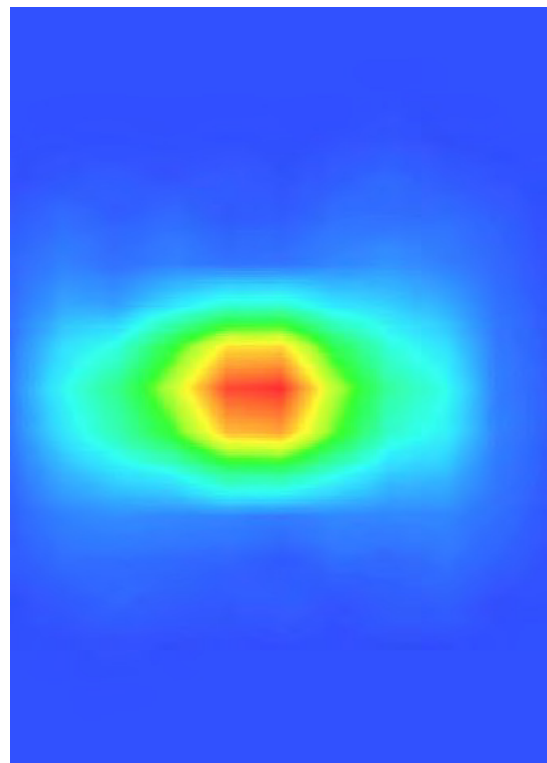

System Performance Check Data(5800 MHz Head)

Type: Phone measurement (Complete)
 E-Field Probe: SN 34/15 SSE2 EPGO265
 Area scan resolution: dx=8mm,dy=8mm
 Zoom scan resolution: dx=4mm, dy=4mm, dz=2mm
 Date of measurement: 2017.03.04
 Measurement duration: 29 minutes 38 seconds

Experimental conditions.

Phantom File	surf_sam_plan.txt
Phantom	Validation plane
Band	5800 MHz
Signal	CW
Frequency (MHz)	5800.000000
Relative permittivity (real part)	34.623258
Conductivity (S/m)	5.332958
Power drift (%)	1.180000
Ambient Temperature:	22.3°C
Liquid Temperature:	21.2°C
ConvF:	1.88
Crest factor:	1:1

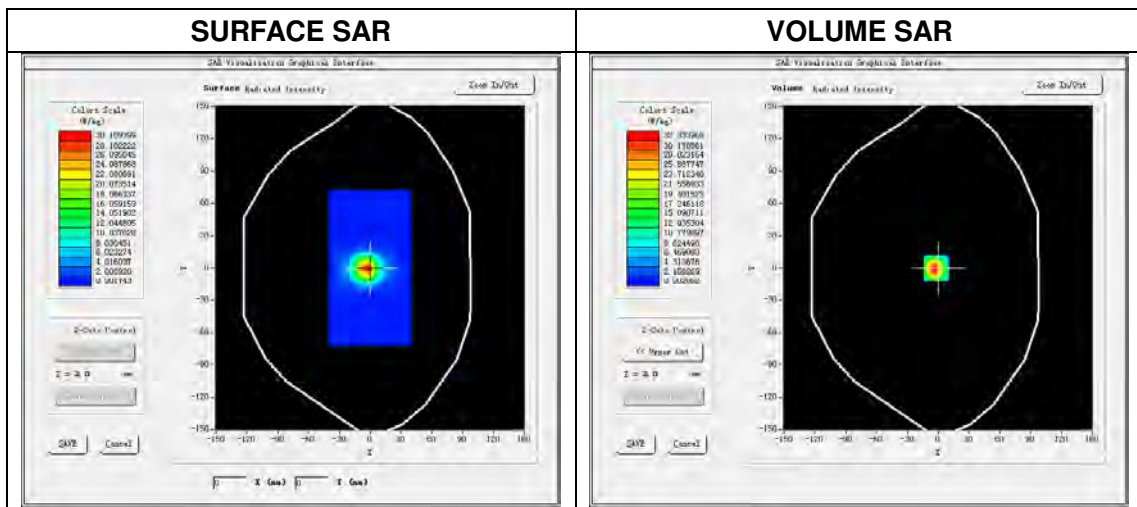

Maximum location: X=0.00, Y=0.00

SAR Peak: 51.75 W/kg

SAR 10g (W/Kg)	5.986358
SAR 1g (W/Kg)	17.698213

Z Axis Scan

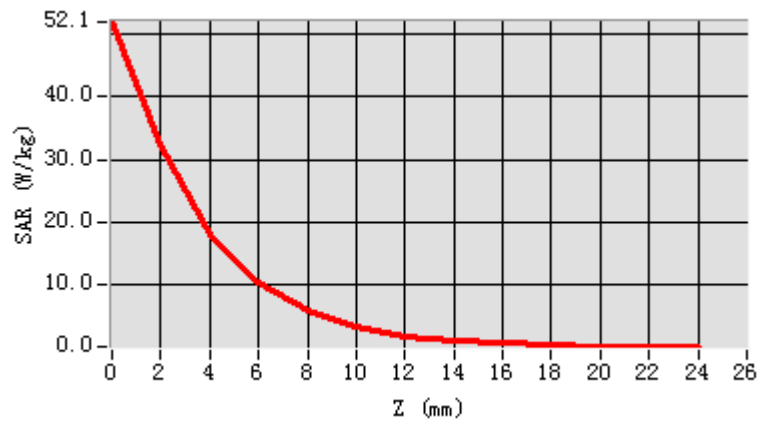

3D screen shot

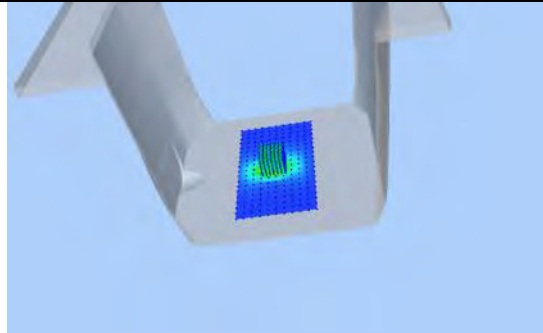

Hot spot position

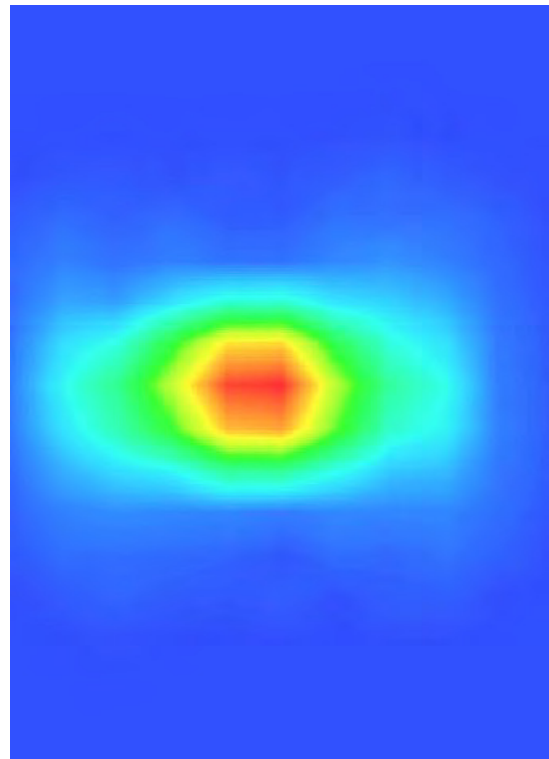

5.10.2 Waveguide 5 GHz Validation Measurement for Body Tissue

System Performance Check Data(5200MHz Body)

Type: Phone measurement (Complete)
 E-Field Probe: SN 34/15 SSE2 EPGO265
 Area scan resolution: dx=8mm,dy=8mm
 Zoom scan resolution: dx=4mm, dy=4mm, dz=2mm
 Date of measurement: 2017.03.04
 Measurement duration: 29 minutes 26 seconds

Experimental conditions.

Phantom File	surf_sam_plan.txt
Phantom	Validation plane
Band	5200 MHz
Signal	CW
Frequency (MHz)	5200.000000
Relative permittivity (real part)	50.082542
Conductivity (S/m)	5.212548
Power drift (%)	0.680000
Ambient Temperature:	22.3C
Liquid Temperature:	21.2C
ConvF:	1.85
Crest factor:	1:1

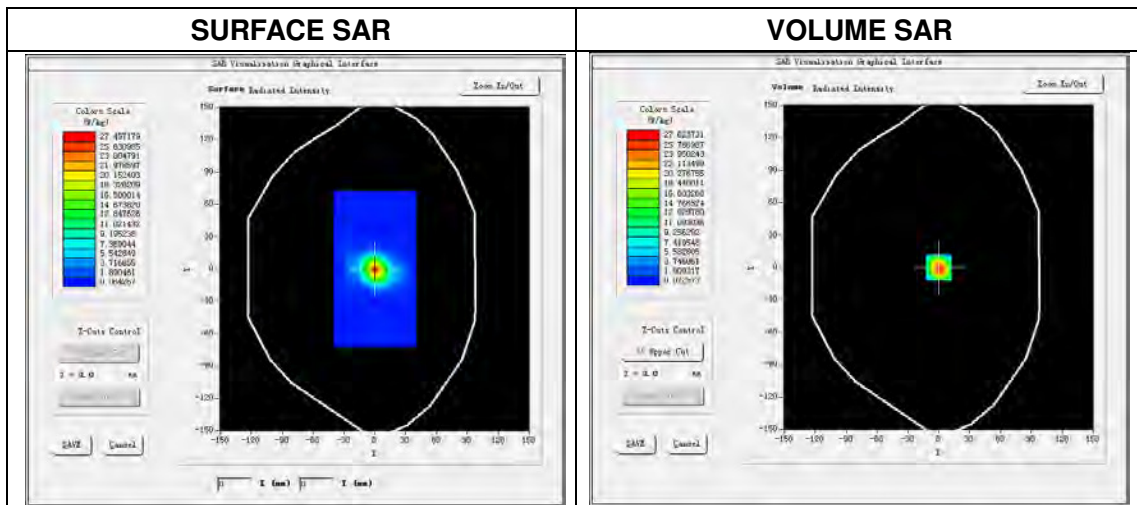

Maximum location: X=0.00, Y=0.00

SAR Peak: 40.52 W/kg

SAR 10g (W/Kg)	5.328147
SAR 1g (W/Kg)	15.226524

Z Axis Scan

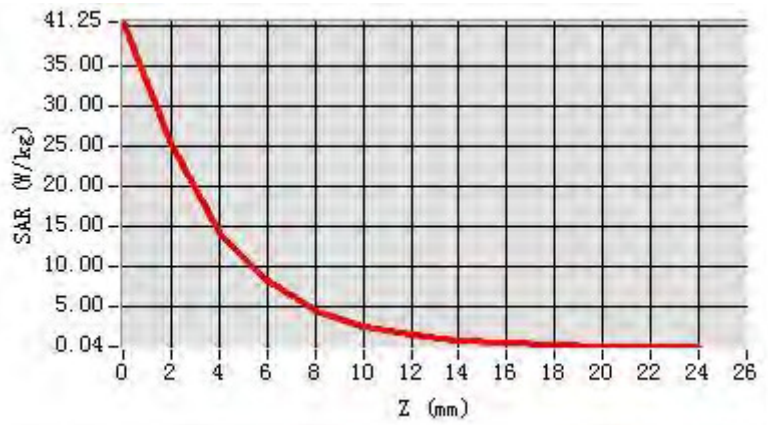

3D screen shot

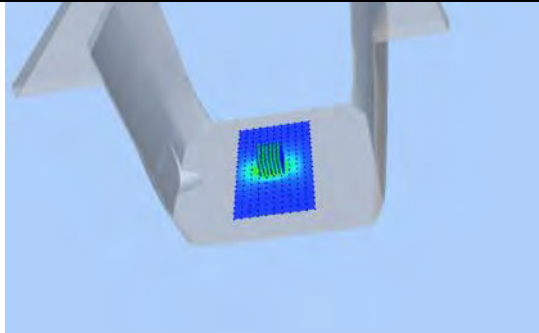

Hot spot position

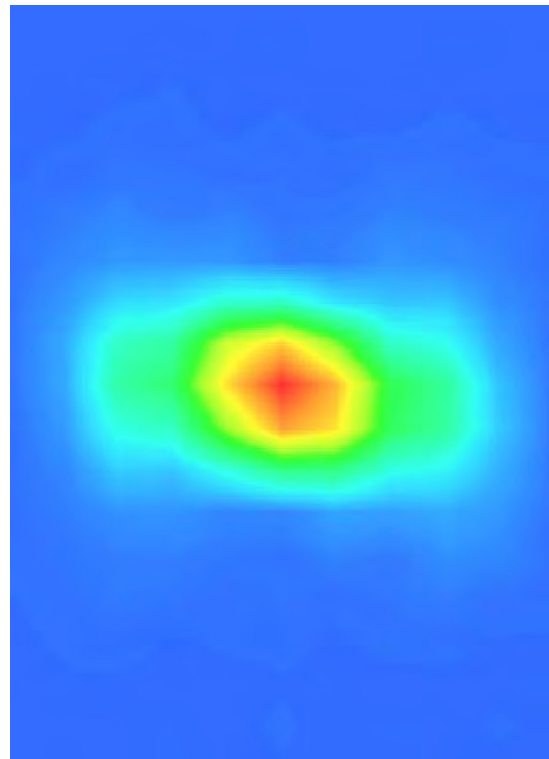

System Performance Check Data (5400 MHz Body)

Type: Phone measurement (Complete)
 E-Field Probe: SN 34/15 SSE2 EPGO265
 Area scan resolution: dx=8mm,dy=8mm
 Zoom scan resolution: dx=4mm, dy=4mm, dz=2mm
 Date of measurement: 2017.03.044
 Measurement duration: 29 minutes 32 seconds

Experimental conditions.

Phantom File	surf_sam_plan.txt
Phantom	Validation plane
Band	5400 MHz
Signal	CW
Frequency (MHz)	5400.000000
Relative permittivity (real part)	50.132355
Conductivity (S/m)	5.525699
Power drift (%)	0.160000
Ambient Temperature:	21.9°C
Liquid Temperature:	20.9°C
ConvF:	2.11
Crest factor:	1:1

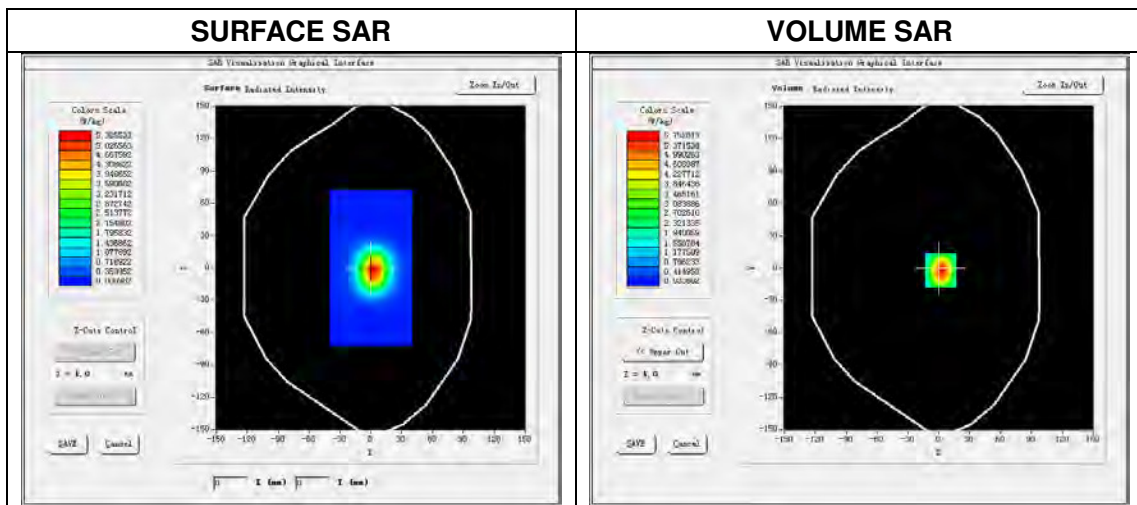

Maximum location: X=0.00, Y=0.00

SAR Peak: 43.88 W/kg

SAR 10g (W/Kg)	5.602659
SAR 1g (W/Kg)	15.759821

Z Axis Scan

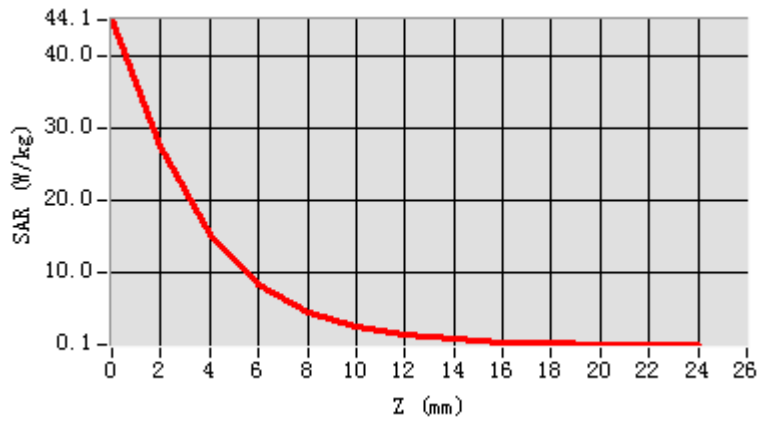

3D screen shot

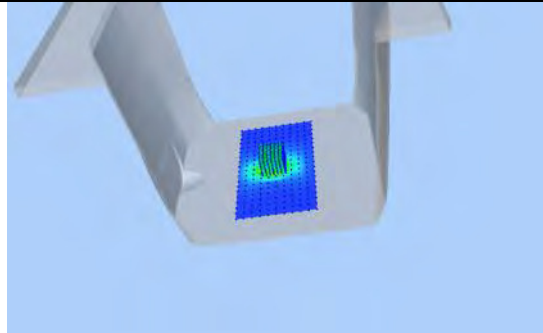

Hot spot position

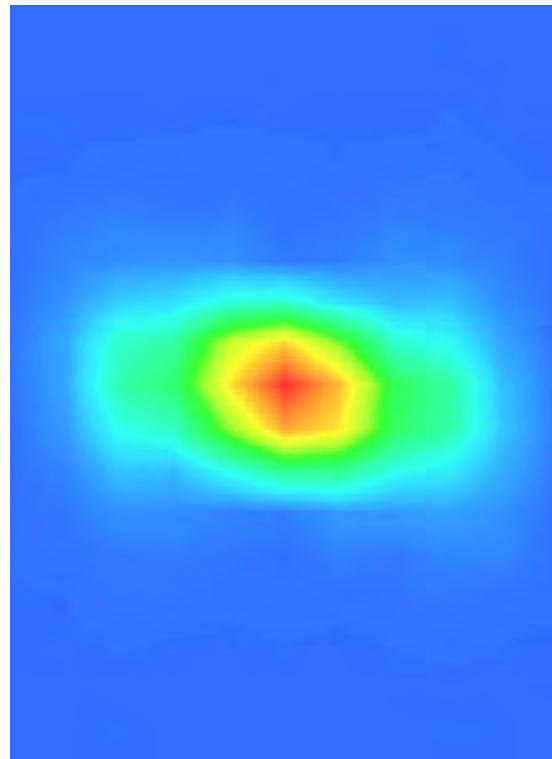

Maximum location: X=0.00, Y=0.00

SAR Peak: 46.38W/kg

SAR 10g (W/Kg)	5.643362
SAR 1g (W/Kg)	15.892147

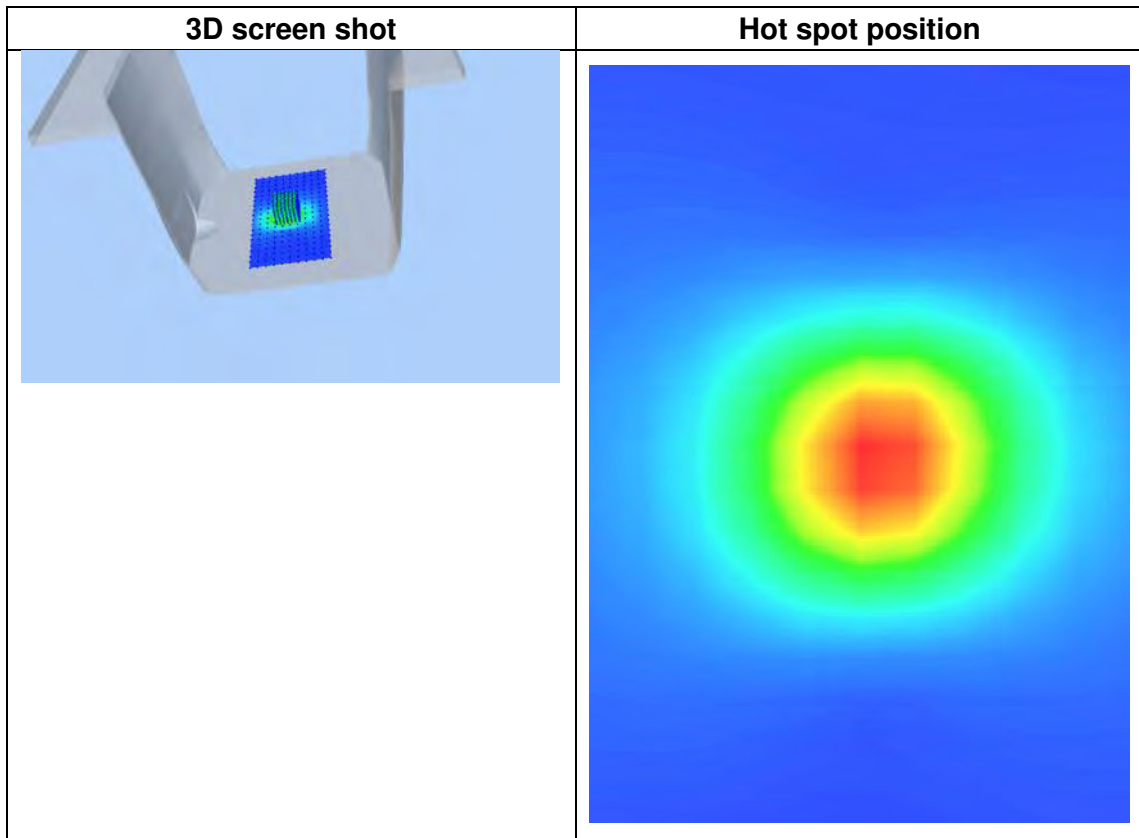
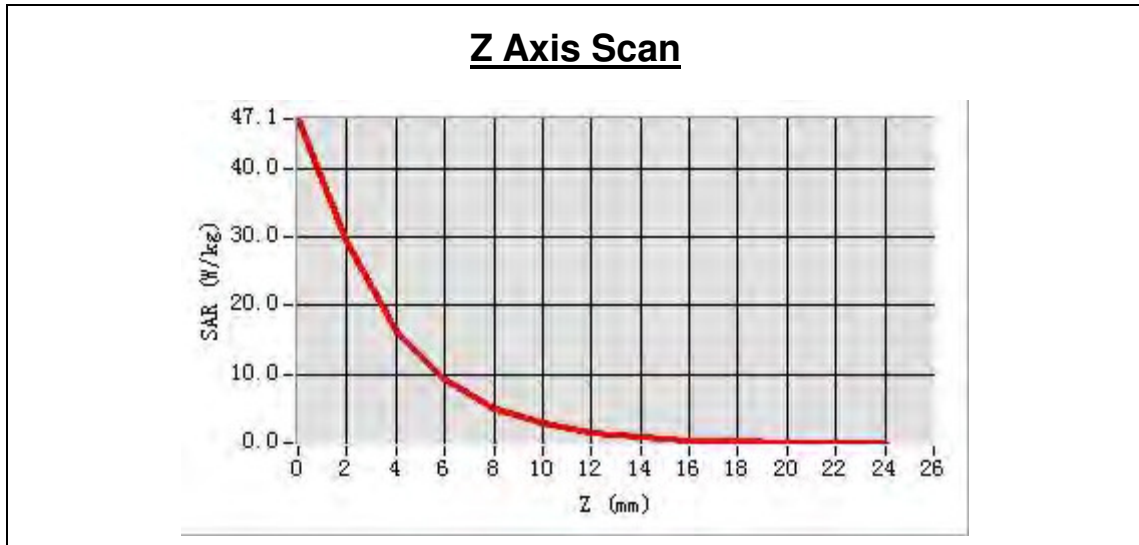

System Performance Check Data (5800 MHz Body)

Type: Phone measurement (Complete)
 E-Field Probe: SN 34/15 SSE2 EPGO265
 Area scan resolution: dx=8mm,dy=8mm
 Zoom scan resolution: dx=4mm, dy=4mm, dz=2mm
 Date of measurement: 2017.03.044
 Measurement duration: 29 minutes 36 seconds

Experimental conditions.

Phantom File	surf_sam_plan.txt
Phantom	Validation plane
Band	5800 MHz
Signal	CW
Frequency (MHz)	5800.000000
Relative permittivity (real part)	47.536522
Conductivity (S/m)	6.052548
Power drift (%)	0.130000
Ambient Temperature:	21.9°C
Liquid Temperature:	20.9°C
ConvF:	1.93
Crest factor:	1:1

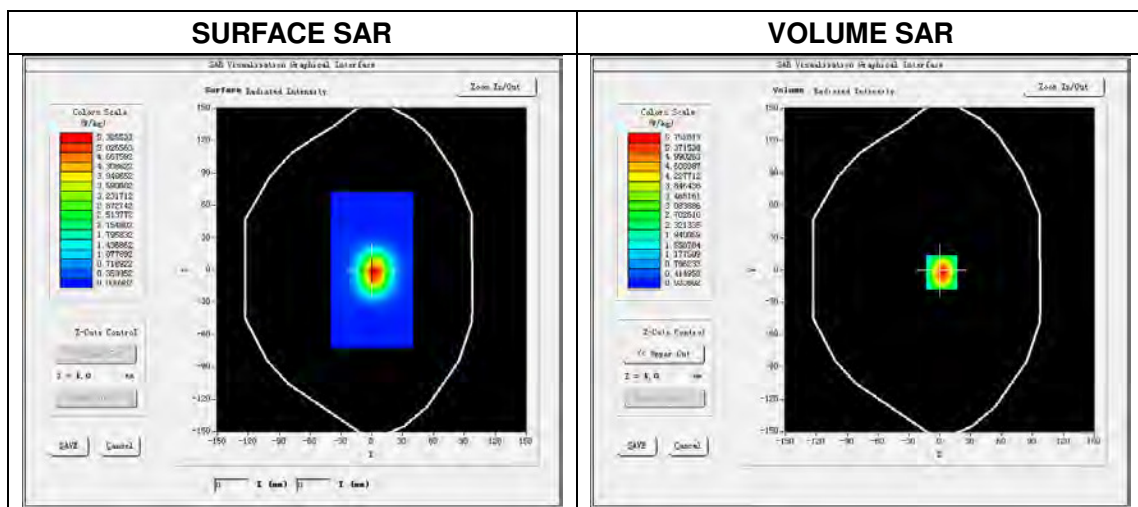

Maximum location: X=0.00, Y=0.00

SAR Peak: 50.15W/kg

SAR 10g (W/Kg)	5.842582
SAR 1g (W/Kg)	16.971256

Z Axis Scan

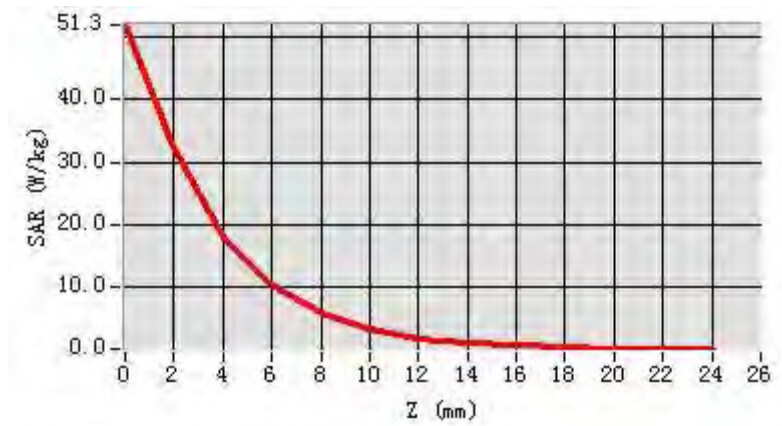

3D screen shot

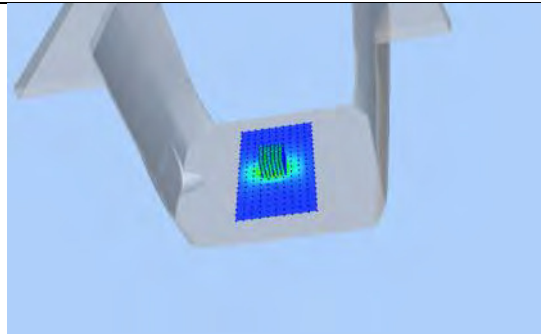

Hot spot position

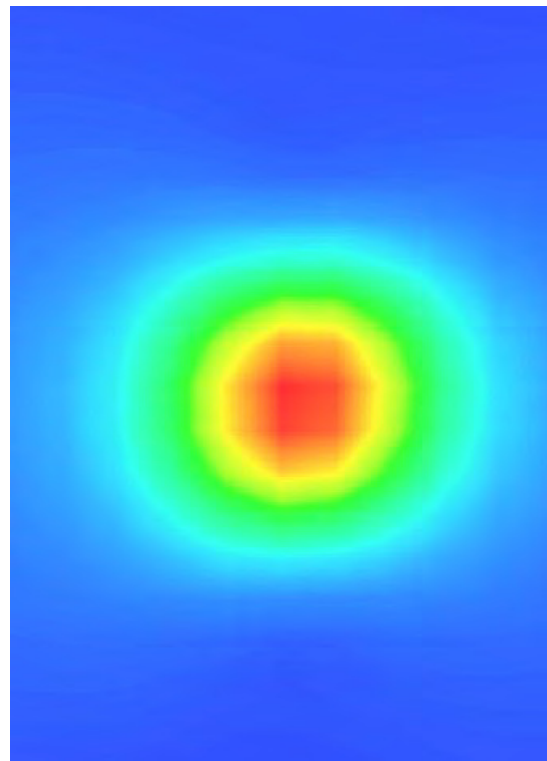

--END OF REPORT--