

FCC PART 15C TEST REPORT FOR CERTIFICATION
On Behalf of

TP-LINK TECHNOLOGIES CO., LTD.

150Mbps Wireless N Router

Model No.: TL-WR720N

FCC ID: TE7WR720N

Prepared for : TP-LINK TECHNOLOGIES CO., LTD.

Building 24(floors 1,3,4,5) and 28 (floors1-4) Central Science
and Technology Park, Shennan Rd, Nanshan, Shenzhen, China

Prepared By : Audix Technology (Shenzhen) Co., Ltd.

No. 6, Ke Feng Rd., 52 Block,
Shenzhen Science & Industrial Park,
Nantou, Shenzhen, Guangdong, China

Tel: (0755) 26639496

Report Number : ACS-F12091

Date of Test : Apr.01~14, 2012

Date of Report : May.10, 2012

TABLE OF CONTENTS

Description	Page
1. SUMMARY OF STANDARDS AND RESULTS	1-5
1.1. Description of Standards and Results	1-5
2. GENERAL INFORMATION	2-1
2.1. Description of Device (EUT)	2-1
2.2. Test Information	2-2
2.3. Tested Supporting System Details.....	2-3
2.4. Block Diagram of Test Setup	2-3
2.5. Test Facility	2-4
2.6. Measurement Uncertainty (95% confidence levels, k=2).....	2-4
3. POWER LINE CONDUCTED EMISSION TEST.....	3-1
3.1. Test Equipments	3-1
3.2. Block Diagram of Test Setup	3-1
3.3. Power Line Conducted Emission Test Limits	3-1
3.4. Configuration of EUT on Test.....	3-1
3.5. Operating Condition of EUT	3-2
3.6. Test Procedure	3-2
3.7. Power Line Conducted Emission Test Results	3-2
4. RADIATED EMISSION TEST	4-1
4.1. Test Equipment.....	4-1
4.2. Block Diagram of Test Setup	4-1
4.3. Radiated Emission Limit	4-2
4.4. EUT Configuration on Test.....	4-3
4.5. Operating Condition of EUT	4-3
4.6. Test Procedure	4-3
4.7. Radiated Emission Test Results	4-4
5. CONDUCTED SPURIOUS EMISSIONS	5-1
5.1. Test Equipment.....	5-1
5.2. Limit	5-1
5.3. Test Procedure	5-1
5.4. Test result	5-1
6. BAND EDGE COMPLIANCE TEST.....	6-1
6.1. Test Equipment.....	6-1
6.2. Limit	6-1
6.3. Test Produce	6-1
6.4. Test Results	6-1
7. 6dB Bandwidth Test	7-1
7.1. Test Equipment.....	7-1
7.2. Limit	7-1
7.3. Test Procedure	7-1
7.4. Test Results	7-1
8. OUTPUT POWER TEST	8-1
8.1. Test Equipment.....	8-1
8.2. Limit (FCC Part 15C 15.247 b(3))	8-1
8.3. Test Procedure	8-1
8.4. Test Results	8-2
9. POWER SPECTRAL DENSITY TEST	9-1
9.1. Test Equipment.....	9-1

9.2.	Limit	9-1
9.3.	Test Procedure	9-1
9.4.	Test Results	9-2
10.	ANTENNA REQUIREMENT	10-1
10.1.	STANDARD APPLICABLE	10-1
10.2.	ANTENNA CONNECTED CONSTRUCTION	10-1
11.	MPE ESTIMATION	11-1
11.1.	Limit for General Population/ Uncontrolled Exposures	11-1
11.2.	Estimation Result.....	11-1
12.	DEVIATION TO TEST SPECIFICATIONS	12-1
13.	PHOTOGRAPH OF TEST.....	13-1
13.1.	Photos of Power Line Conducted Emission Test	13-1
13.2.	Photos of Radiated Emission Test.....	13-2
14.	PHOTOS OF THE EUT	14-4

TEST REPORT CERTIFICATION

Applicant : TP-LINK TECHNOLOGIES CO., LTD.
Manufacturer : TP-LINK TECHNOLOGIES CO., LTD.
EUT Description : 150Mbps Wireless N Router
FCC ID : TE7WR720N
(A) MODEL NO. : TL-WR720N
(B) SERIAL NO. : N/A
(C) POWER SUPPLY : DC 9V
(D) TEST VOLTAGE : DC 9V From Adapter Input AC 120V/60Hz

Tested for comply with:
FCC Rules and Regulations Part 15 Subpart C: 2008

Test procedure used:
ANSI C63.10:2009

The device described above is tested by AUDIX TECHNOLOGY (SHENZHEN) CO., LTD. to confirm comply with all the FCC Part 15 Subpart C requirements. The test results are contained in this test report and AUDIX TECHNOLOGY (SHENZHEN) CO., LTD. is assumed full responsibility for the accuracy and completeness of these tests. Also, this report shows that the Equipment Under Test (EUT) is to be technically compliant with the FCC and IC requirements. This report contains data that are not covered by the NVLAP accreditation.

This Report is made under FCC Part 2.1075. No modifications were required during testing to bring this product into compliance.

This report applies to above tested sample only. This report shall not be reproduced in part without written approval of AUDIX TECHNOLOGY (SHENZHEN) CO., LTD.

The report must not be used by the client to claim product certification, approval, or endorsement by NVLAP, NIST, or any agency of the federal government.

Date of Test : Apr.01~14, 2012 Report of date: May.10, 2012

Prepared by : Selina Liu / Assistant Reviewed by : Sunny Lu / Supervisor

 信華科技(深圳)有限公司
Audix Technology (Shenzhen) Co., Ltd.
EMC 部門報告專用章

Stamp only for EMC Dept. Report

Signature: Ken Lu

Approved & Authorized Signer : Ken Lu / Manager

1. SUMMARY OF STANDARDS AND RESULTS

1.1. Description of Standards and Results

The EUT have been tested according to the applicable standards as referenced below.

EMISSION		
Description of Test Item	Standard	Results
Power Line Conducted Emission	FCC Part 15: 15.207 ANSI C63.10: 2009	PASS
Radiated Emission	FCC Part 15: 15.209 ANSI C63.10: 2009	PASS
Band Edge Compliance	FCC Part 15: 15.247 ANSI C63.10: 2009	PASS
Conducted spurious emissions	FCC Part 15: 15.247 ANSI C63.10: 2009	PASS
6dB Bandwidth	FCC Part 15: 15.247 ANSI C63.10: 2009	PASS
Peak Output Power	FCC Part 15: 15.247 ANSI C63.10: 2009	PASS
Power Spectral Density	FCC Part 15: 15.247 ANSI C63.10: 2009	PASS
Antenna requirement	FCC Part 15: 15.203	PASS

2. GENERAL INFORMATION

2.1. Description of Device (EUT)

Product Name	: 150Mbps Wireless N Router
Model Number	: TL-WR720N
FCC ID	: TE7WR720N
Operation Frequency	: IEEE 802.11b: 2412MHz—2462MHz IEEE 802.11g: 2412MHz—2462MHz IEEE802.11n HT20: 2412MHz—2462MHz IEEE802.11n HT40: 2422MHz—2452MHz
Channel Number	: IEEE 802.11b/g, IEEE 802.11n HT20: 11 Channels IEEE 802.11n HT40: 7Channels
Modulation Technology	: IEEE 802.11b: DSSS(CCK,DQPSK,DBPSK) IEEE 802.11g: OFDM(64QAM, 16QAM, QPSK, BPSK) IEEE 802.11n HT20, HT40: OFDM (64QAM, 16QAM, QPSK,BPSK)
Antenna Assembly Gain	: Integrated PCB antenna, PK gain 1.5dBi
Applicant	: TP-LINK TECHNOLOGIES CO., LTD. Building 24(floors 1,3,4,5) and 28 (floors1-4) Central Science and Technology Park, Shennan Rd, Nanshan, Shenzhen, China
Manufacturer	: TP-LINK TECHNOLOGIES CO., LTD. Building 24(floors 1,3,4,5) and 28 (floors1-4) Central Science and Technology Park, Shennan Rd, Nanshan, Shenzhen, China
Power Adapter	: Manufacturer: TP-LINK TECHNOLOGIES CO., LTD. M/N: T090060-2B1 Cable: Unshielded, Undetachable, 1.5m
Date of Test	: Apr.01~14, 2012
Date of Receipt	: Mar.19, 2012
Sample Type	: Prototype production

2.2. Test Information

A special test software was used to control EUT work in Continuous TX mode(100% duty cycle), and select test channel, wireless mode and data rate.

Tested mode, channel, and data rate information			
Mode	data rate (Mbps)(see Note)	Channel	Frequency (MHz)
IEEE 802.11b	11	Low :CH1	2412
	11	Middle: CH6	2437
	11	High: CH11	2462
IEEE 802.11g	54	Low :CH1	2412
	54	Middle: CH6	2437
	54	High: CH11	2462
IEEE 802.11n HT20	6.5	Low :CH1	2412
	6.5	Middle: CH6	2437
	6.5	High: CH11	2462
IEEE 802.11n HT40	13.5	Low :CH1	2422
	13.5	Middle: CH4	2437
	13.5	High: CH7	2452

Note1: According exploratory test, EUT will have maximum PK output power in those data rate, so those data rate were used for all test.

2.3. Tested Supporting System Details

No.	Description	ACS No.	Manufacturer	Model	Serial Number	Approved type
1	Personal Computer	Test PC P	DELL	Studio 540	124XK2X	<input checked="" type="checkbox"/> FCC DoC <input checked="" type="checkbox"/> BSMI ID:R33002
		Power Cord: Unshielded, Detachable, 1.8m Display Card: HD3450 (DVI+VGA+HDMI)				
2	Monitor	ACS-EMC-LM01R	Viewsonic	VLCDS260 64-2W	A210521A0131	<input checked="" type="checkbox"/> FCC DoC <input checked="" type="checkbox"/> BSMI ID: R31374
		Power Cord: Unshielded, Detachable, 1.8m VGA Cable: Shielded, Detachable, 2.0m (with two cores) DVI Cable: Shielded, Detachable, 2.0m (with two cores)				
3	USB Keyboard	ACS-EMC- K01R	DELL	SK-8115	CN-ODJ313-716 16-711-0J73	<input checked="" type="checkbox"/> FCC DoC <input checked="" type="checkbox"/> BSMI ID: T3A002
		Power Cord: shielded, Undetachable, 2.0m				
4	USB Mouse	ACS-EMC-M01R	DELL	M056UO	512022645	<input checked="" type="checkbox"/> FCC DoC <input checked="" type="checkbox"/> BSMI ID: R41108
		Power Cord: shielded, Undetachable, 1.8m				
5	LAN Cable	Unshielded, Detachable, 10m				

2.4. Block Diagram of Test Setup

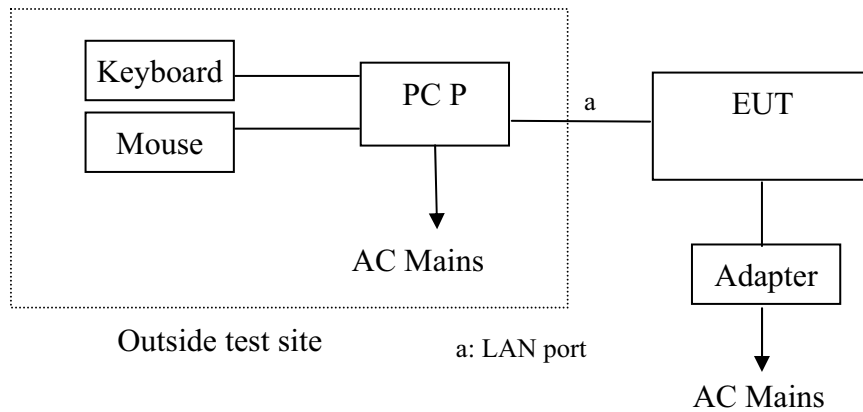

(EUT: 150Mbps Wireless N Router)

2.5. Test Facility

Site Description

Name of Firm : Audix Technology (Shenzhen) Co., Ltd.
No. 6, Ke Feng Rd., 52 Block, Shenzhen
Science & Industrial Park, Nantou,
Shenzhen, Guangdong, China

3m Anechoic Chamber : Certificated by FCC, USA
Registration Number: 90454
Valid Date: Feb.22, 2012

3m & 10m Anechoic Chamber : Certificated by FCC, USA
Registration Number: 794232
Valid Date: Dec.30, 2012

EMC Lab. : Certificated by Industry Canada
Registration Number: IC 5183A-1
Valid Date: Jun.13, 2014

: Certificated by DAkkS, Germany
Registration No: D-PL-12151-01-01
Valid Date: Feb.01, 2014

Accredited by NVLAP, USA
NVLAP Code: 200372-0
Valid Date: Mar.31, 2013

2.6. Measurement Uncertainty (95% confidence levels, k=2)

Test Item	Uncertainty
Uncertainty for Conduction emission test in No. 1 Conduction	3.2 dB (150KHz to 30MHz)
Uncertainty for Radiation Emission test in 3m chamber	3.6 dB(30~200MHz, Polarize: H)
	3.8 dB(30~200MHz, Polarize: V)
	4.2 dB(200M~1GHz, Polarize: H)
	3.8 dB(200M~1GHz, Polarize: V)
Uncertainty for Radiation Emission test in 3m chamber (1GHz-18GHz)	3.1dB (Distance: 3m Polarize: V)
	3.7 dB (Distance: 3m Polarize: H)
Uncertainty for Radiated Spurious Emission test in RF chamber	3.57 dB
Uncertainty for Conduction Spurious emission test	2.00 dB
Uncertainty for Output power test	0.73 dB
Uncertainty for Power density test	2.00 dB
Uncertainty for Frequency range test	7×10^{-8}
Uncertainty for Bandwidth test	83 kHz
Uncertainty for DC power test	0.038 %
Uncertainty for test site temperature and humidity	0.6°C
	3%

3. POWER LINE CONDUCTED EMISSION TEST

3.1. Test Equipments

Item	Equipment	Manufacturer	Model No.	Serial No.	Last Cal.	Cal. Interval
1.	Test Receiver	Rohde & Schwarz	ESHS10	838693/001	Oct.31, 11	1 Year
2.	L.I.S.N.#1	Rohde & Schwarz	ESH2-Z5	834066/011	Oct.31, 11	1 Year
3.	L.I.S.N.#3	Kyoritsu	KNW-242C	8-1920-1	May.08, 11	1 Year
4.	Terminator	Hubersuhner	50Ω	No. 1	May.08, 11	1 Year
5.	Terminator	Hubersuhner	50Ω	No. 2	May.08, 11	1 Year
6.	RF Cable	Fujikura	3D-2W	No.1	May.08, 11	1Year
7.	Coaxial Switch	Anritsu	MP59B	M50564	May.08, 11	1 Year
8.	Pulse Limiter	Rohde & Schwarz	ESH3-Z2	100341	May.08, 11	1 Year

3.2. Block Diagram of Test Setup

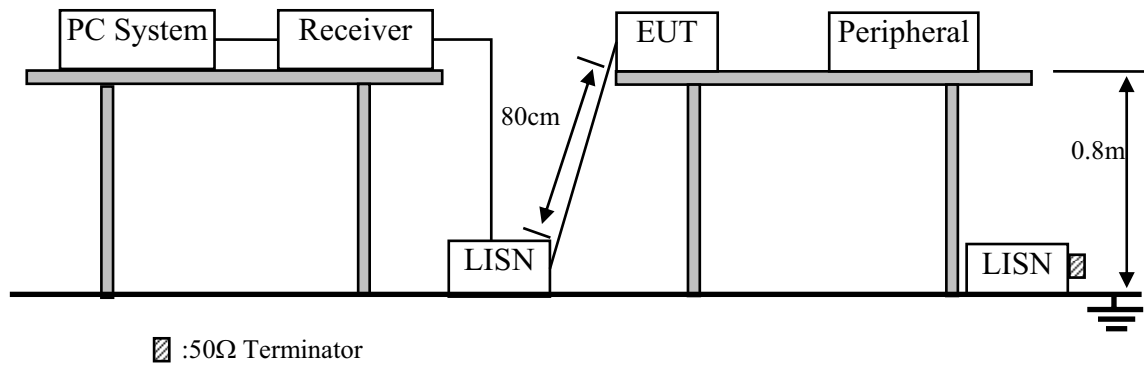

3.3. Power Line Conducted Emission Test Limits

Frequency	Maximum RF Line Voltage	
	Quasi-Peak Level dB(μV)	Average Level dB(μV)
150kHz ~ 500kHz	66 ~ 56*	56 ~ 46*
500kHz ~ 5MHz	56	46
5MHz ~ 30MHz	60	50

Notes: 1. * Decreasing linearly with logarithm of frequency.
 2. The lower limit shall apply at the transition frequencies.

3.4. Configuration of EUT on Test

The following equipment are installed on Power Line Conducted Emission Test to meet the commission requirement and operating regulations in a manner which tends to maximize its emission characteristics in a normal application.

3.4.1. 150Mbps Wireless N Router (EUT)

Model Number : TL-WR720N
 Serial Number : N/A

3.4.2. Support Equipment: As Tested Supporting System Details, in Section 2.2.

3.5. Operating Condition of EUT

- 3.5.1. Setup the EUT and simulator as shown as Section 3.2.
- 3.5.2. Turned on the power of all equipment.
- 3.5.3. PC run test software to control EUT work in Tx mode.

3.6. Test Procedure

The EUT was placed on a non-metallic table, 80cm above the ground plane. The EUT Power connected to the power mains through a line impedance stabilization network (L.I.S.N. 1#). This provides a 50 ohm coupling impedance for the EUT (Please refer the block diagram of the test setup and photographs). The AC line are checked to find out the maximum conducted emission. In order to find the maximum emission levels, the relative positions of equipment and all of the interface cables shall be changed according to ANSI C63.10: 2009 on Conducted Emission Test.

The bandwidth of test receiver (R & S ESHS10) is set at 10kHz.

The frequency range from 150kHz to 30MHz is checked.

3.7. Power Line Conducted Emission Test Results

PASS. (All emissions not reported below are too low against the prescribed limits.)

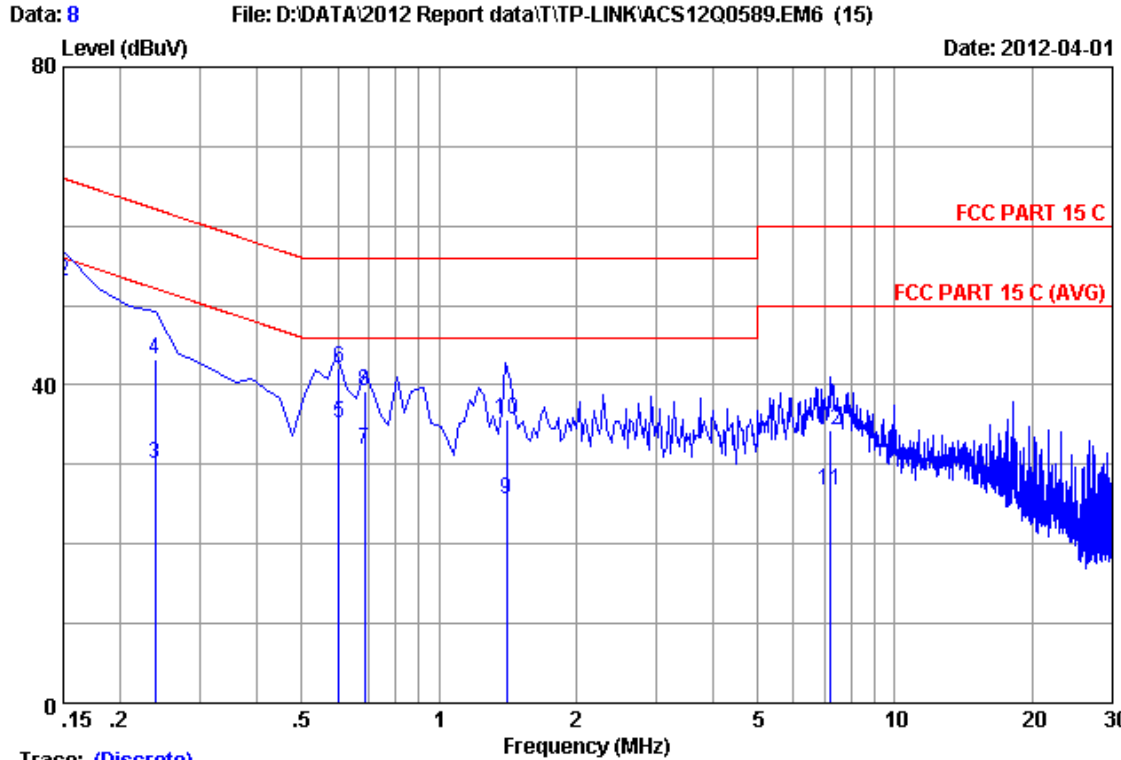

Trace: (Discrete)

Site no :1#conduction Data No :8
 Dis./Ant. :** 2011 ESH2-25 LINE
 Limit :FCC PART 15 C
 Env./Ins. :24.5*C/55% Engineer :Leo_Li
 EUT :150Mbps Wireless N Router
 Power Rating :DC 9V From Adapter Input AC 120V/60Hz
 Test Mode :Tx Mode
 :M/N:TL-WR720N

No	Freq (MHz)	LISN Factor (dB)	Cable Loss (dB)	Reading (dBuV)	Emission Level (dBuV)	Limits (dBuV)	Margin (dB)	Remark
1	0.15000	0.16	9.98	27.51	37.65	56.00	18.35	Average
2	0.15000	0.16	9.98	43.01	53.15	66.00	12.85	QP
3	0.23900	0.15	9.98	20.00	30.13	52.13	22.00	Average
4	0.23900	0.15	9.98	33.20	43.33	62.13	18.80	QP
5	0.60330	0.16	9.98	25.10	35.24	46.00	10.76	Average
6	0.60330	0.16	9.98	32.00	42.14	56.00	13.86	QP
7	0.68700	0.16	9.97	21.70	31.83	46.00	14.17	Average
8	0.68700	0.16	9.97	29.00	39.13	56.00	16.87	QP
9	1.405	0.18	9.98	15.50	25.66	46.00	20.34	Average
10	1.405	0.18	9.98	25.60	35.76	56.00	20.24	QP
11	7.190	0.30	9.92	16.50	26.72	50.00	23.28	Average
12	7.190	0.30	9.92	24.00	34.22	60.00	25.78	QP

Remarks: 1.Emission Level=LISN Factor+Cable Loss(Include 10dB pulse limit)+Reading.
 2.If the average limit is met when using a quasi-peak detector, the EUT shall be deemed to meet both limits and measurement with average detector is unnecessary.

Data: 9 File: D:\DATA\2012 Report data\T\TP-LINK\ACS12Q0589.EM6 (15) Date: 2012-04-01

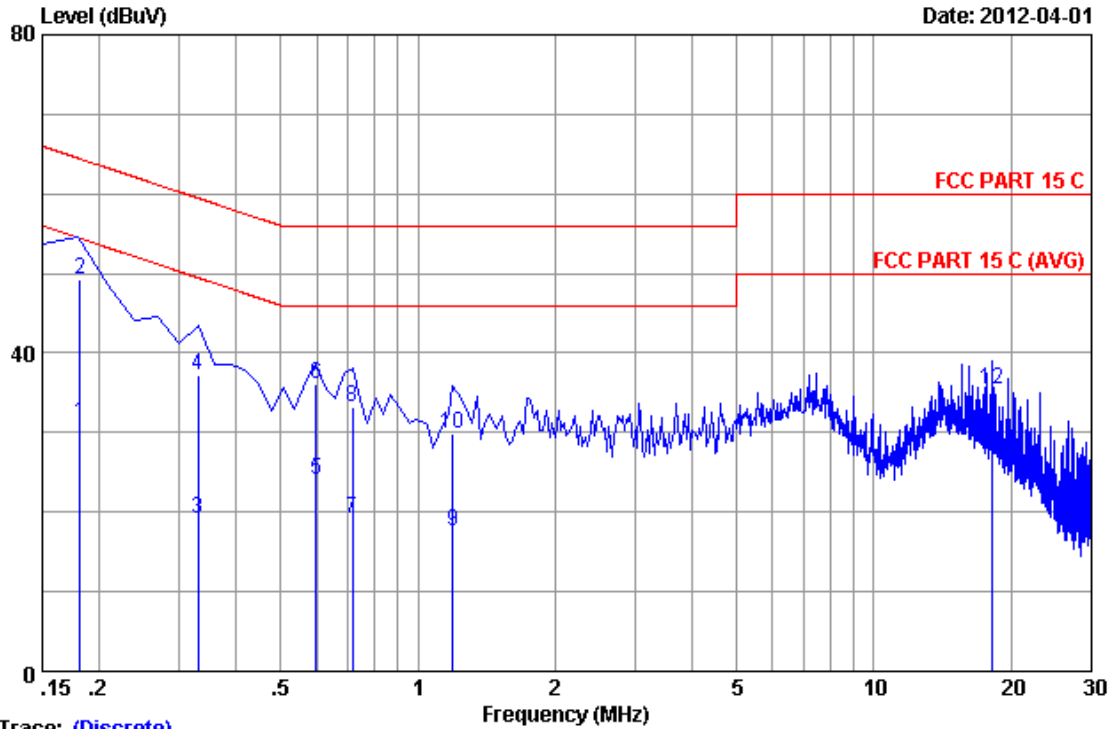

Trace: (Discrete)

Site no :1#conduction Data No :9
 Dis./Ant. :** 2011 ESH2-25 NEUTRAL
 Limit :FCC PART 15 C
 Env./Ins. :24.5°C/55% Engineer :Leo_Li
 EUT :150Mbps Wireless N Router
 Power Rating :DC 9V From Adapter Input AC 120V/60Hz
 Test Mode :Tx Mode
 :M/N:TL-WR720N

No	Freq (MHz)	LISN Factor (dB)	Cable Loss (dB)	Reading (dBUV)	Emission Level (dBUV)	Limits (dBUV)	Margin (dB)	Remark
1	0.18145	0.14	9.98	21.00	31.12	54.42	23.30	Average
2	0.18145	0.14	9.98	39.20	49.32	64.42	15.10	QP
3	0.32900	0.15	9.98	8.99	19.12	49.48	30.36	Average
4	0.32900	0.15	9.98	26.99	37.12	59.48	22.36	QP
5	0.59700	0.16	9.98	13.99	24.13	46.00	21.87	Average
6	0.59700	0.16	9.98	25.99	36.13	56.00	19.87	QP
7	0.71700	0.16	9.97	9.00	19.13	46.00	26.87	Average
8	0.71700	0.16	9.97	23.00	33.13	56.00	22.87	QP
9	1.190	0.18	9.98	7.49	17.65	46.00	28.35	Average
10	1.190	0.18	9.98	19.79	29.95	56.00	26.05	QP
11	18.239	0.38	9.98	17.00	27.36	50.00	22.64	Average
12	18.239	0.38	9.98	25.00	35.36	60.00	24.64	QP

Remarks: 1.Emission Level=LISN Factor+Cable Loss(Include 10dB pulse limit)+Reading.
 2.If the average limit is met when using a quasi-peak detector, the EUT shall be deemed to meet both limits and measurement with average detector is unnecessary.

4. RADIATED EMISSION TEST

4.1. Test Equipment

4.1.1. For frequency range 30MHz~1000MHz (At Anechoic Chamber)

Item	Equipment	Manufacturer	Model No.	Serial No.	Last Cal.	Cal. Interval
1	3#Chamber	AUDIX	N/A	N/A	Nov.28,11	1 Year
2	EMI Spectrum	Agilent	E4407B	MY41440292	May.08, 11	1 Year
3	Test Receiver	Rohde & Schwarz	ESVS10	834468/011	May.08, 11	1 Year
4	Amplifier	HP	8447D	2648A04738	May.08, 11	1 Year
5	Bilog Antenna	Schaffner	CBL6111C	2598	Oct.26, 10	1.5 Year
6	RF Cable	MIYAZAKI	CFD400-NL	3# Chamber No.1	Dec.06, 11	0.5Year
7	Coaxial Switch	Anritsu	MP59B	M74389	May.08, 11	1 Year

4.1.2. For frequency range 1GHz~6GHz (At Anechoic Chamber)

Item	Equipment	Manufacturer	Model No.	Serial No.	Last Cal.	Cal. Interval
1	Spectrum Analyzer	Agilent	E4407B	MY41440292	May.08, 11	1 Year
2	Horn Antenna	EMCO	3115	9607-4877	July.01, 11	1 Year
3	Amplifier	Agilent	8449B	3008A00863	May.08, 11	1 Year
4	RF Cable	Hubersuhner	SUCOFLEX106	77980/6	Dec.06, 11	0.5Year
5	RF Cable	Hubersuhner	SUCOFLEX106	77977/6	Dec.06, 11	0.5Year

4.2. Block Diagram of Test Setup

For frequency range 30MHz-1000MHz

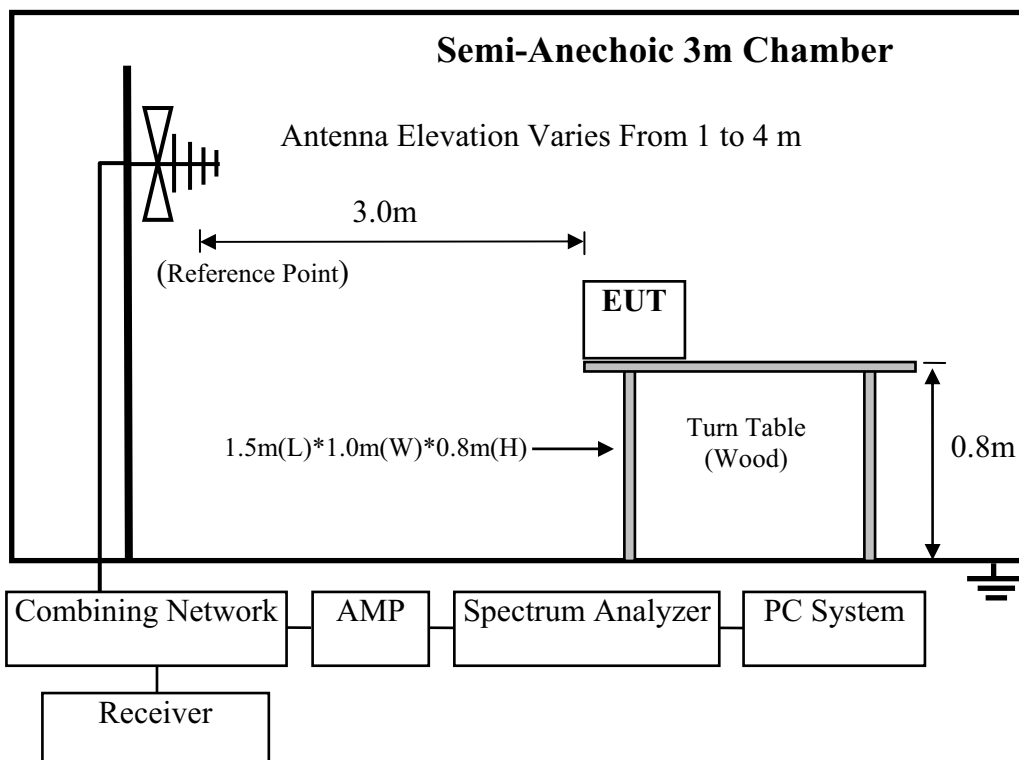

For frequency range 1GHz-25GHz

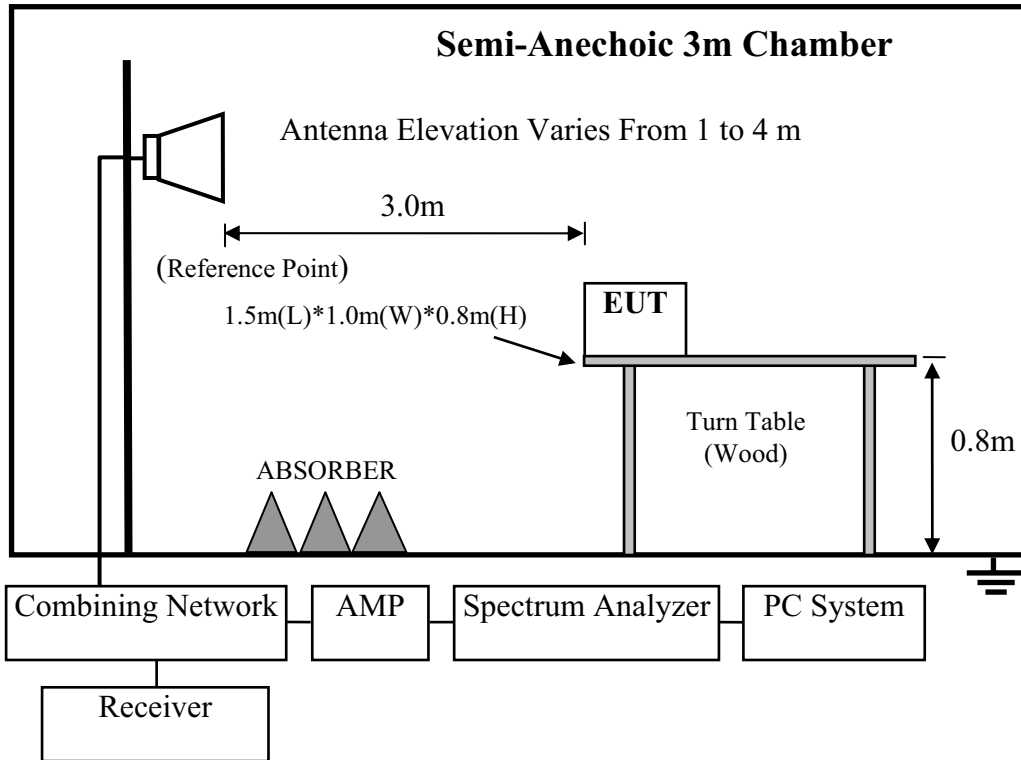

4.3. Radiated Emission Limit

4.3.1. 15.209 limits

FREQUENCY MHz	DISTANCE Meters	FIELD STRENGTHS LIMIT	
		$\mu\text{V}/\text{m}$	$\text{dB}(\mu\text{V})/\text{m}$
30 ~ 88	3	100	40.0
88 ~ 216	3	150	43.5
216 ~ 960	3	200	46.0
960 ~ 1000	3	500	54.0
Above 1000	3	74.0 $\text{dB}(\mu\text{V})/\text{m}$ (Peak) 54.0 $\text{dB}(\mu\text{V})/\text{m}$ (Average)	

Remark : (1) Emission level $\text{dB}\mu\text{V} = 20 \log$ Emission level $\mu\text{V}/\text{m}$

(2) The smaller limit shall apply at the cross point between two frequency bands.

(3) Distance is the distance in meters between the measuring instrument, antenna and the closest point of any part of the device or system.

4.3.2. 15.205 Restricted bands of operation

MHz	MHz	MHz	GHz
0.090 - 0.110	16.42 - 16.423	399.9 - 410	4.5 - 5.15
¹ 0.495 - 0.505	16.69475 - 16.69525	608 - 614	5.35 - 5.46
2.1735 - 2.1905	16.80425 - 16.80475	960 - 1240	7.25 - 7.75
4.125 - 4.128	25.5 - 25.67	1300 - 1427	8.025 - 8.5
4.17725 - 4.17775	37.5 - 38.25	1435 - 1626.5	9.0 - 9.2
4.20725 - 4.20775	73 - 74.6	1645.5 - 1646.5	9.3 - 9.5
6.215 - 6.218	74.8 - 75.2	1660 - 1710	10.6 - 12.7
6.26775 - 6.26825	108 - 121.94	1718.8 - 1722.2	13.25 - 13.4
6.31175 - 6.31225	123 - 138	2200 - 2300	14.47 - 14.5
8.291 - 8.294	149.9 - 150.05	2310 - 2390	15.35 - 16.2
8.362 - 8.366	156.52475 - 156.52525	2483.5 - 2500	17.7 - 21.4
8.37625 - 8.38675	156.7 - 156.9	2690 - 2900	22.01 - 23.12
8.41425 - 8.41475	162.0125 - 167.17	3260 - 3267	23.6 - 24.0
12.29 - 12.293	167.72 - 173.2	3332 - 3339	31.2 - 31.8
12.51975 - 12.52025	240 - 285	3345.8 - 3358	36.43 - 36.5
12.57675 - 12.57725	322 - 335.4	3600 - 4400	(²)

All the emissions appearing within 15.205 restricted frequency bands shall not exceed the limits shown in 15.209, all the other emissions shall be at least 20dB below the fundamental emissions, or comply with 15.209 limits.

4.4.EUT Configuration on Test

The configurations of EUT are listed in Section 3.5.

4.5.Operating Condition of EUT

Same as Conducted Emission test that is listed in Section 3.6. except the test set up replaced by Section 4.2.

4.6.Test Procedure

EUT and its simulators are placed on a turn table, which is 0.8 meter high above ground. The turn table can rotate 360 degrees to determine the position of the maximum emission level. Power on the EUT and let it working in test mode, then test it. EUT is set 3 meters away from the receiving antenna, which is mounted on a antenna tower. The antenna can be moved up and down between 1 meter and 4 meters to find out the maximum emission level. Broadband antenna (calibrated bilog antenna) is used as receiving antenna. Both horizontal and vertical polarization of the antenna are set on test.

The bandwidth of the EMI test receiver (R&S ESVS10) is set at 120kHz for frequency range from 30MHz to 1000 MHz.

The bandwidth of the Spectrum's VBW is set at 3MHz and RBW is set at 1MHz for peak emissions measurement above 1GHz and 1MHz RBW, 10Hz VBW for average emissions measure above 1GHz

The frequency range from 30MHz to 10th harmonic (25GHz) are checked. and no any emissions were found from 18GHz to 25 GHz, So the radiated emissions from 18GHz to 25GHz were not record.

4.7.Radiated Emission Test Results

PASS.

All the emissions from 30MHz to 25 GHz were comply with 15.209 limits.

Note: For emissions above 1GHz, if peak level comply with average limit, then the average level is deemed to comply with average limit.

Frequency: 30MHz~1GHz

Data: 2

File: E:\2012 Report Data\T\TP-LINK\ACS1200589.EM6 (8)

Date: 2012-04-02

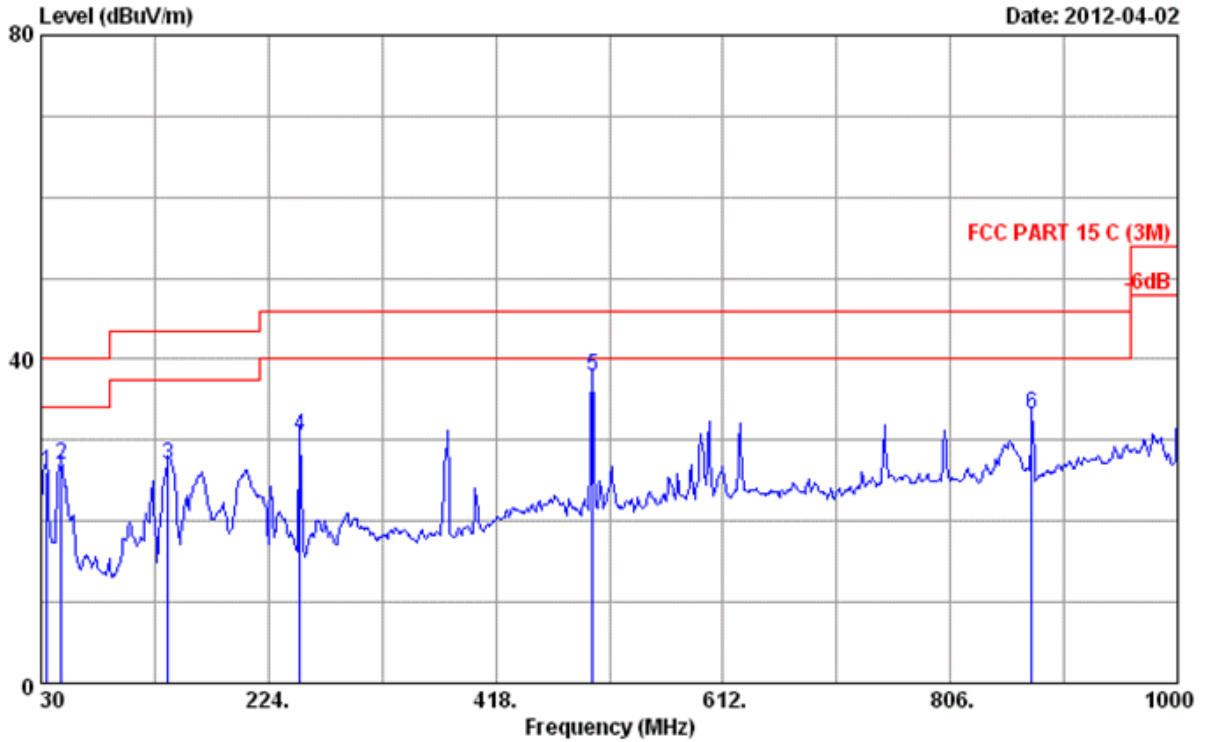

Site no. : 3m Chamber Data no. : 2
 Dis. / Ant. : 3m 2010 CBL6111C 2598 Ant. pol. : HORIZONTAL
 Limit : FCC PART 15 C (3M)
 Env. / Ins. : 24°C/56% Engineer : Leo_Li
 EUT : 150Mbps Wireless N Router
 Power rating : DC 9V From PC Input AC 120V/60Hz
 Test Mode : Tx Mode
 : M/N:TL-WR720N
 :

No.	Freq. (MHz)	Ant. Factor (dB/m)	Cable Loss (dB)	Reading (dBuV)	Emission Level (dBuV/m)	Limits (dBuV/m)	Margin (dB)	Remark
1	34.850	17.20	0.30	8.63	26.13	40.00	13.87	QP
2	47.460	10.55	0.34	16.18	27.07	40.00	12.93	QP
3	138.640	12.02	0.79	14.21	27.02	43.50	16.48	QP
4	251.160	12.90	1.16	16.53	30.59	46.00	15.41	QP
5	500.450	18.30	1.50	17.98	37.78	46.00	8.22	QP
6	875.840	22.80	2.28	8.02	33.10	46.00	12.90	QP

Remarks: 1. Emission Level= Antenna Factor + Cable Loss + Reading.
 2. The emission levels that are 20dB below the official limit are not reported.

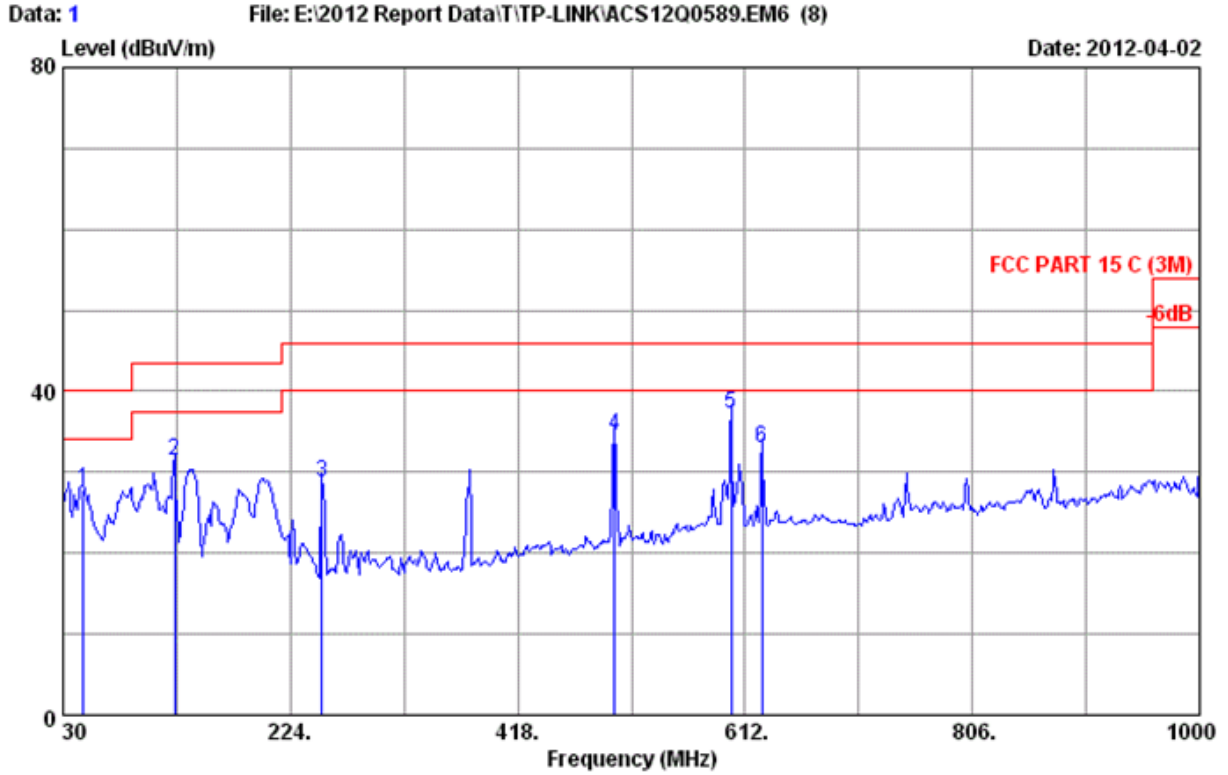

Site no. : 3m Chamber Data no. : 1
 Dis. / Ant. : 3m 2010 CBL6111C 2598 Ant. pol. : VERTICAL
 Limit : FCC PART 15 C (3M)
 Env. / Ins. : 24°C/56% Engineer : Leo_Li
 EUT : 150Mbps Wireless N Router
 Power rating : DC 9V From PC Input AC 120V/60Hz
 Test Mode : Tx Mode
 : M/N: TL-WR720N
 :

No.	Freq. (MHz)	Ant. Factor (dB/m)	Cable Loss (dB)	Reading (dBuV)	Emission Level (dBuV/m)	Limits (dBuV/m)	Margin (dB)	Remark
1	47.460	10.55	0.34	17.03	27.92	40.00	12.08	QP
2	125.060	12.10	0.65	18.56	31.31	43.50	12.19	QP
3	251.160	12.90	1.16	14.72	28.78	46.00	17.22	QP
4	500.450	18.30	1.50	14.76	34.56	46.00	11.44	QP
5	600.360	19.90	1.50	15.92	37.32	46.00	8.68	QP
6	626.550	20.13	1.77	11.16	33.06	46.00	12.94	QP

Remarks: 1. Emission Level= Antenna Factor + Cable Loss + Reading.
 2. The emission levels that are 20dB below the official limit are not reported.

Frequency: 1GHz~18GHz

Data: 1

File: E:\2012 Report\TTP-LINK\ACS12Q0589.EM6 (216)

Date: 2012-04-01

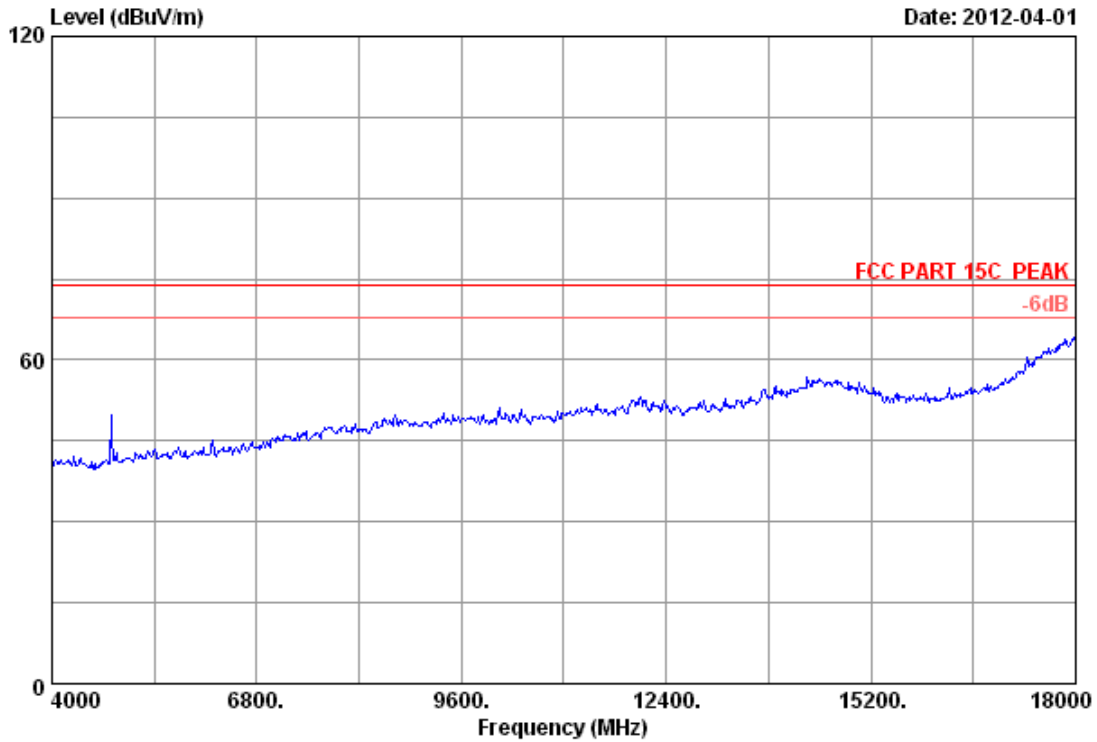

Site no. : 3m Chamber Data no. : 1
Dis. / Ant. : 3m 2011 3115 4580 Ant. pol. : HORIZONTAL
Limit : FCC PART 15C PEAK
Env. / Ins. : 23°C/54% Engineer : Leo-Li
EUT : 150Mbps Wireless N Router
Power supply : DC 9V From Adapter Input AC 120V/60Hz
Test mode : IEEE802.11b CH 1 2412MHz Tx
M/N : TL-WR720N

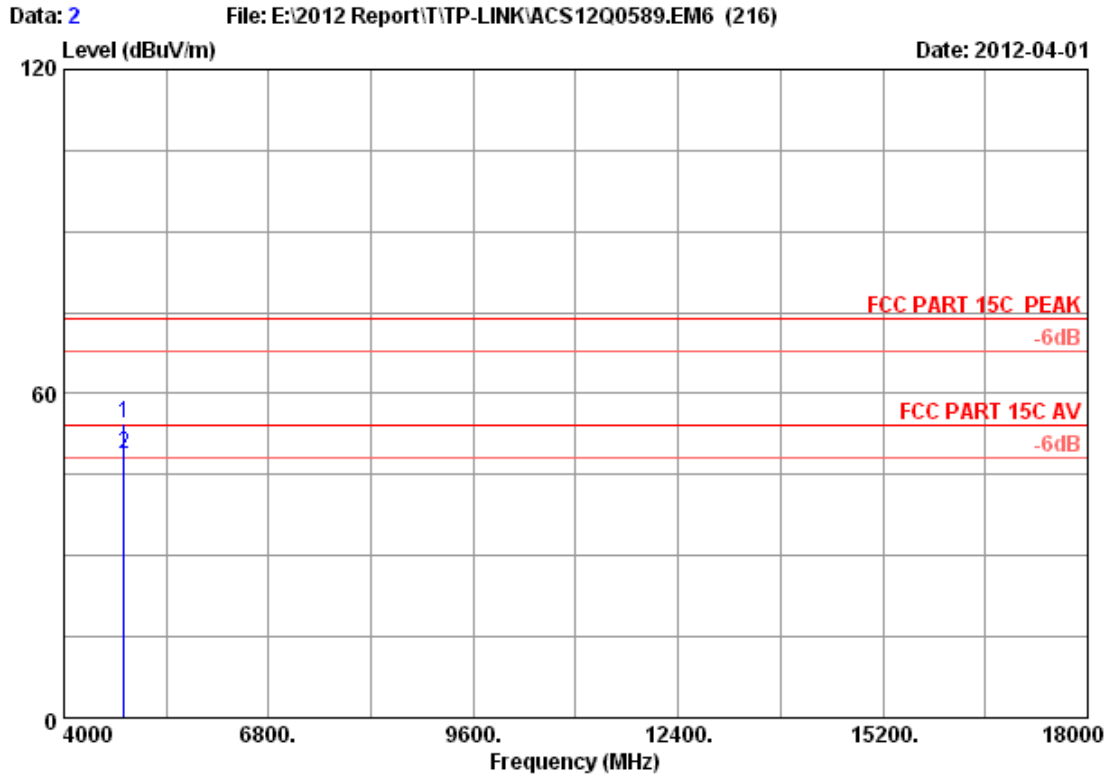

Site no. : 3m Chamber Data no. : 2
 Dis. / Ant. : 3m 2011 3115 4580 Ant. pol. : HORIZONTAL
 Limit : FCC PART 15C PEAK
 Env. / Ins. : 23°C/54% Engineer : Leo-Li
 EUT : 150Mbps Wireless N Router
 Power supply : DC 9V From Adapter Input AC 120V/60Hz
 Test mode : IEEE802.11b CH 1 2412MHz Tx
 M/N : TL-WR720N

	Freq. (MHz)	Ant. Factor (dB/m)	Cable loss (dB)	Amp. Factor (dB)	Reading (dBuV)	Emission Level (dBuV/m)	Limits (dBuV/m)	Margin (dB)	Remark
1	4824.000	32.89	8.53	34.60	47.70	54.52	74.00	19.48	Peak
2	4824.000	32.89	8.53	34.60	42.05	48.87	54.00	5.13	Average

Remarks:

1. Emission Level= Antenna Factor + Cable Loss -Amp Factor + Reading.
2. The emission levels that are 20dB below the official limit are not reported.

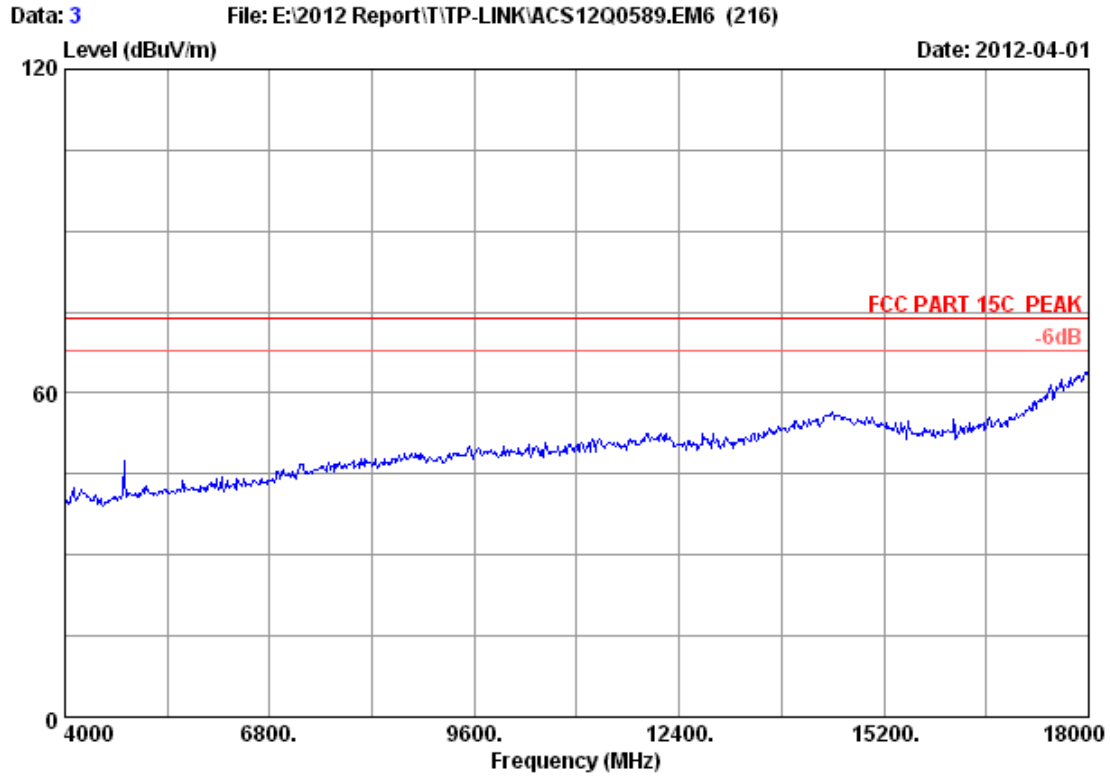

Site no. : 3m Chamber Data no. : 3
Dis. / Ant. : 3m 2011 3115 4580 Ant. pol. : VERTICAL
Limit : FCC PART 15C PEAK
Env. / Ins. : 23°C/54% Engineer : Leo-Li
EUT : 150Mbps Wireless N Router
Power supply : DC 9V From Adapter Input AC 120V/60Hz
Test mode : IEEE802.11b CH 1 2412MHz Tx
M/N : TL-WR720N

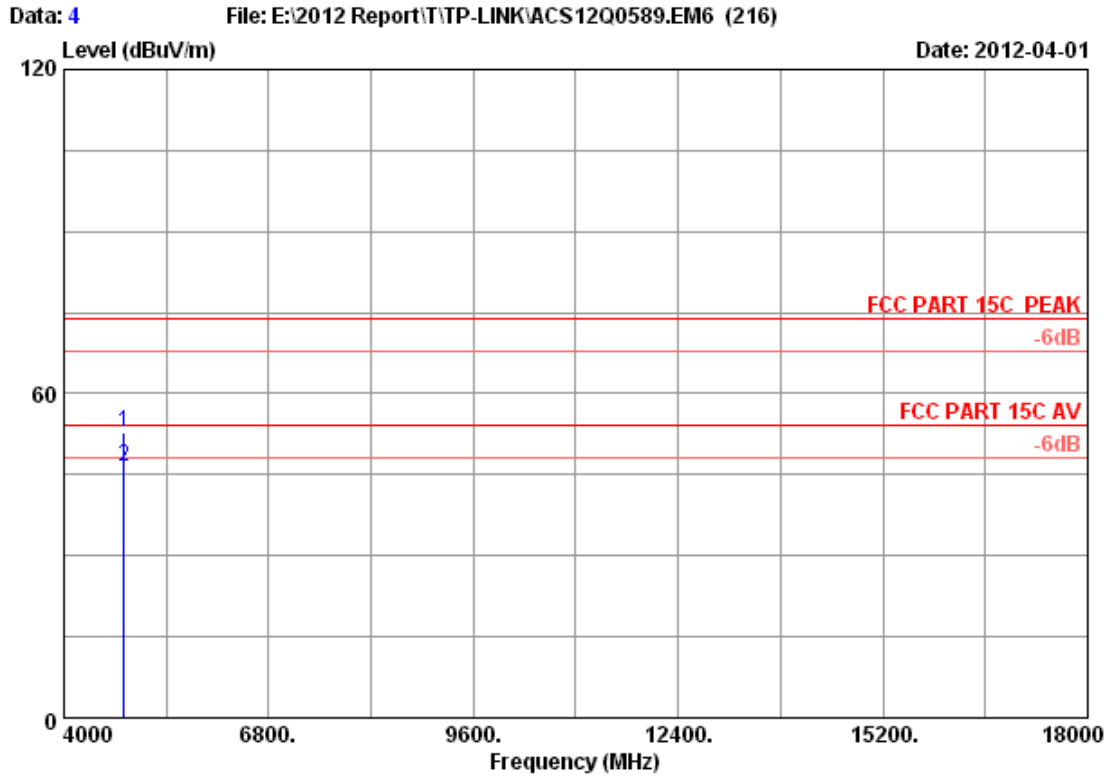

Site no. : 3m Chamber Data no. : 4
 Dis. / Ant. : 3m 2011 3115 4580 Ant. pol. : VERTICAL
 Limit : FCC PART 15C PEAK
 Env. / Ins. : 23°C/54% Engineer : Leo-Li
 EUT : 150Mbps Wireless N Router
 Power supply : DC 9V From Adapter Input AC 120V/60Hz
 Test mode : IEEE802.11b CH 1 2412MHz Tx
 M/N : TL-WR720N

	Freq. (MHz)	Ant. Factor (dB/m)	Cable loss (dB)	Amp. Factor (dB)	Reading (dBuV)	Emission Level (dBuV/m)	Limits (dBuV/m)	Margin (dB)	Remark
1	4824.000	32.89	8.53	34.60	45.93	52.75	74.00	21.25	Peak
2	4824.000	32.89	8.53	34.60	39.80	46.62	54.00	7.38	Average

Remarks:

1. Emission Level= Antenna Factor + Cable Loss -Amp Factor + Reading.
2. The emission levels that are 20dB below the official limit are not reported.

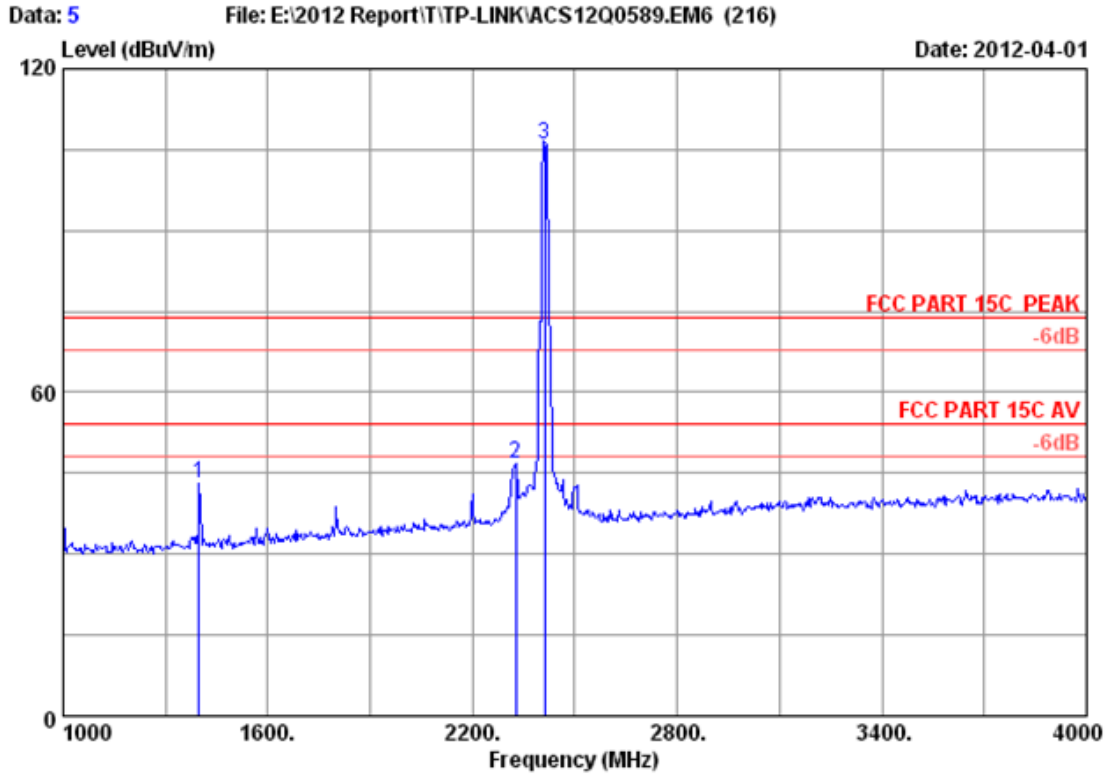

Site no. : 3m Chamber Data no. : 5
 Dis. / Ant. : 3m 2011 3115 4580 Ant. pol. : VERTICAL
 Limit : FCC PART 15C PEAK
 Env. / Ins. : 23°C/54% Engineer : Leo-Li
 EUT : 150Mbps Wireless N Router
 Power supply : DC 9V From Adapter Input AC 120V/60Hz
 Test mode : IEEE802.11b CH 1 2412MHz Tx
 M/N : TL-WR720N

	Freq. (MHz)	Ant. Factor (dB/m)	Cable loss (dB)	Amp. Factor (dB)	Reading (dBuV)	Emission Level (dBuV/m)	Limits (dBuV/m)	Margin (dB)	Remark
1	1399.000	24.99	4.44	34.70	48.28	43.01	74.00	30.99	Peak
2	2326.000	27.86	5.89	34.43	47.39	46.71	74.00	27.29	Peak
3	2412.000	27.98	6.03	34.44	106.32	105.89	74.00	-31.89	Peak

Remarks:

1. Emission Level= Antenna Factor + Cable Loss -Amp Factor + Reading.
2. The emission levels that are 20dB below the official limit are not reported.

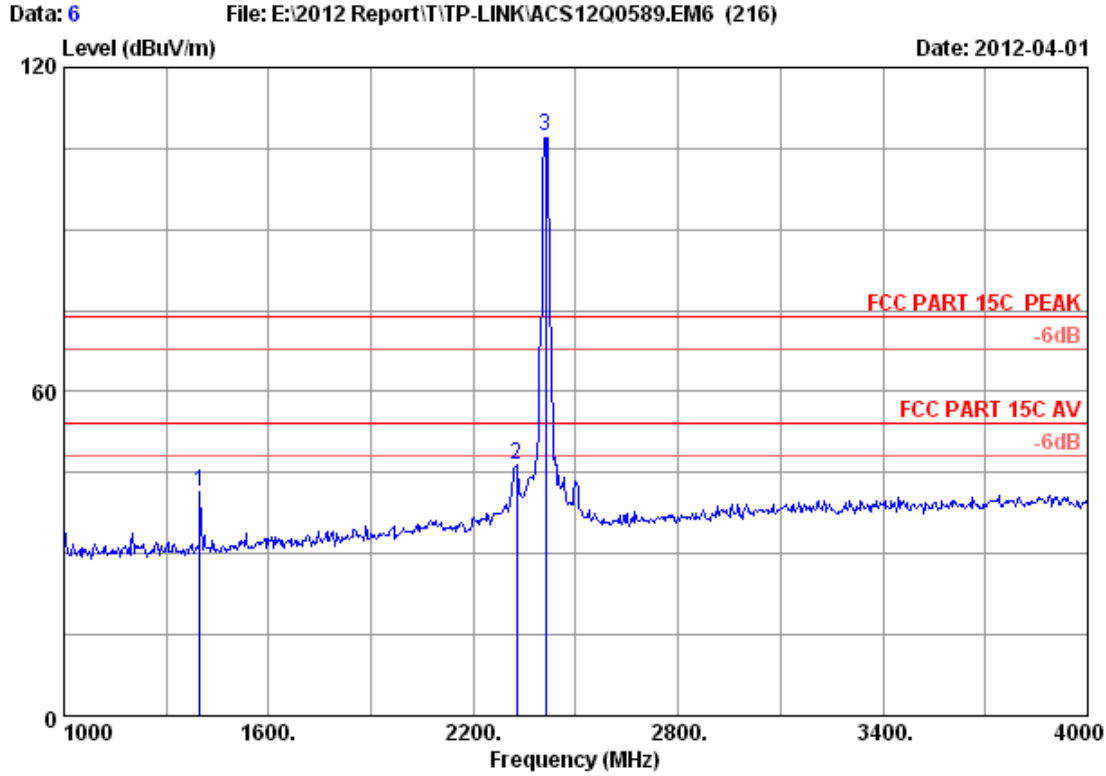

Site no. : 3m Chamber Data no. : 6
 Dis. / Ant. : 3m 2011 3115 4580 Ant. pol. : HORIZONTAL
 Limit : FCC PART 15C PEAK
 Env. / Ins. : 23°C/54% Engineer : Leo-Li
 EUT : 150Mbps Wireless N Router
 Power supply : DC 9V From Adapter Input AC 120V/60Hz
 Test mode : IEEE802.11b CH 1 2412MHz Tx
 M/N : TL-WR720N

	Freq. (MHz)	Ant. Factor (dB/m)	Cable loss (dB)	Amp. Factor (dB)	Reading (dBuV)	Emission Level (dBuV/m)	Limits (dBuV/m)	Margin (dB)	Remark
1	1399.000	24.99	4.44	34.70	46.75	41.48	74.00	32.52	Peak
2	2326.000	27.86	5.89	34.43	47.24	46.56	74.00	27.44	Peak
3	2412.000	27.98	6.03	34.44	107.70	107.27	74.00	-33.27	Peak

Remarks:

1. Emission Level= Antenna Factor + Cable Loss -Amp Factor + Reading.
2. The emission levels that are 20dB below the official limit are not reported.

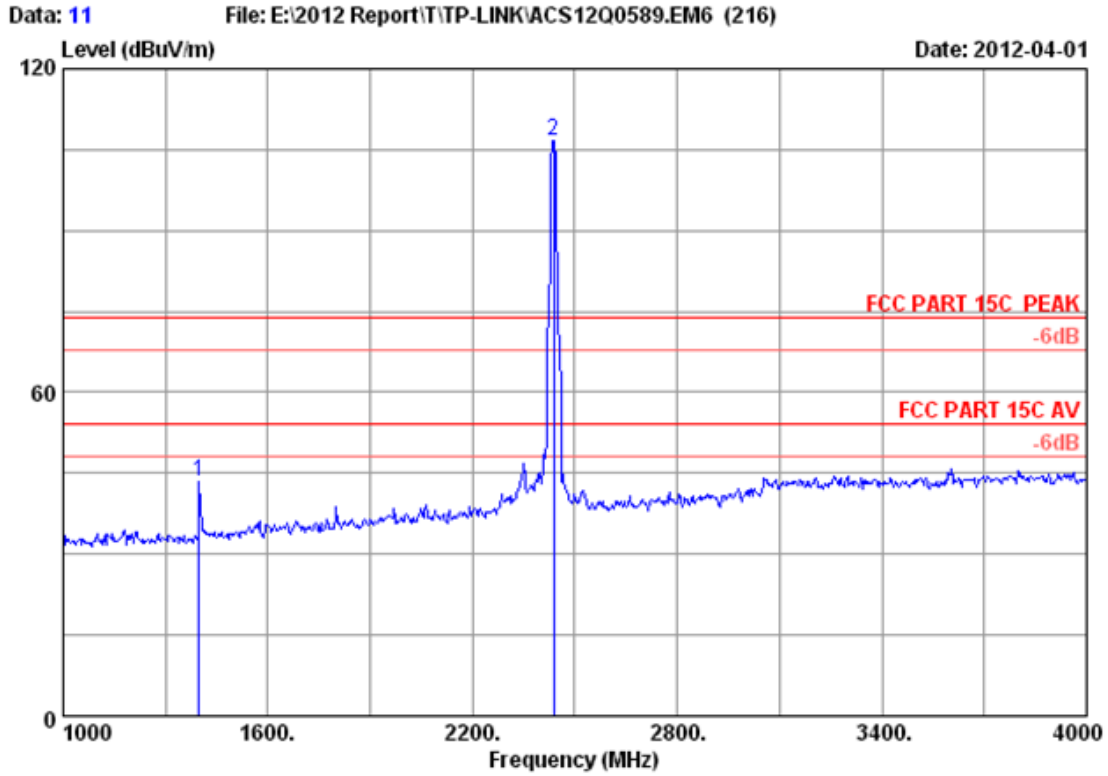

Site no. : 3m Chamber Data no. : 11
 Dis. / Ant. : 3m 2011 3115 4580 Ant. pol. : VERTICAL
 Limit : FCC PART 15C PEAK
 Env. / Ins. : 23°C/54% Engineer : Leo-Li
 EUT : 150Mbps Wireless N Router
 Power supply : DC 9V From Adapter Input AC 120V/60Hz
 Test mode : IEEE802.11b CH 6 2437MHz Tx
 M/N : TL-WR720N

	Freq. (MHz)	Ant. Factor (dB/m)	Cable loss (dB)	Amp. Factor (dB)	Reading (dBuV)	Emission Level (dBuV/m)	Limits (dBuV/m)	Margin (dB)	Remark
1	1399.000	24.99	4.44	34.70	48.58	43.31	74.00	30.69	Peak
2	2437.000	28.03	6.06	34.44	106.89	106.54	74.00	-32.54	Peak

Remarks:

1. Emission Level= Antenna Factor + Cable Loss -Amp Factor + Reading.
2. The emission levels that are 20dB below the official limit are not reported.

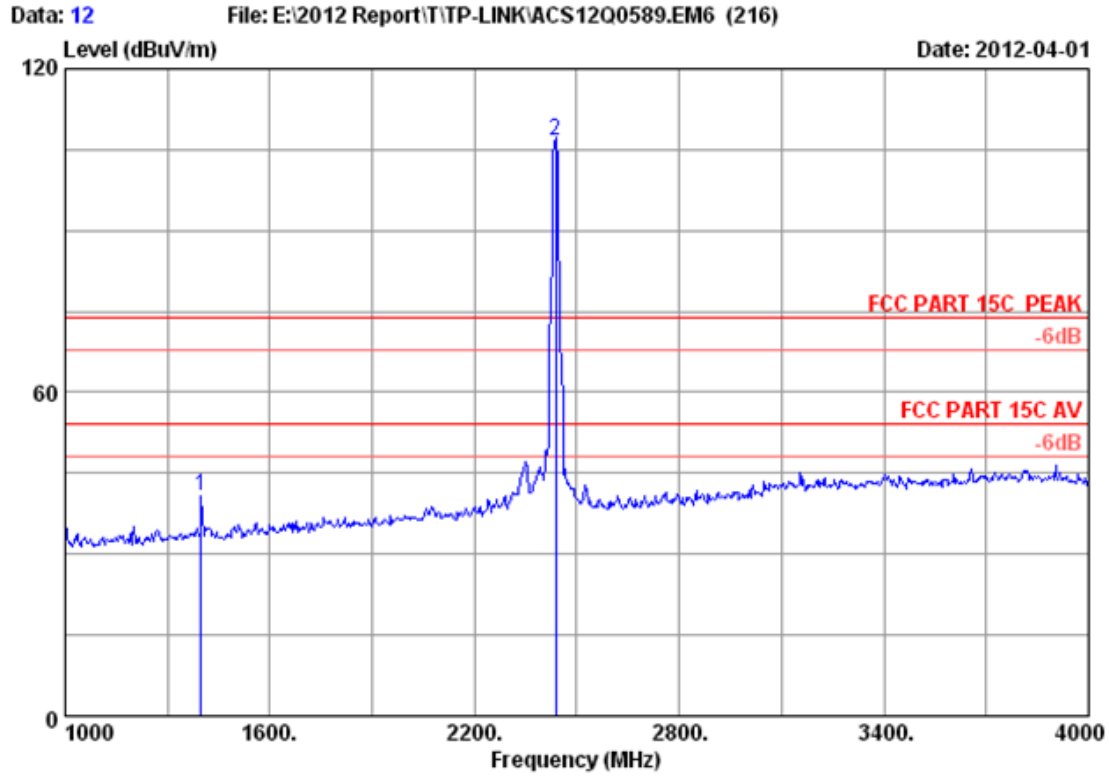

Site no. : 3m Chamber Data no. : 12
 Dis. / Ant. : 3m 2011 3115 4580 Ant. pol. : HORIZONTAL
 Limit : FCC PART 15C PEAK
 Env. / Ins. : 23°C/54% Engineer : Leo-Li
 EUT : 150Mbps Wireless N Router
 Power supply : DC 9V From Adapter Input AC 120V/60Hz
 Test mode : IEEE802.11b CH 6 2437MHz Tx
 M/N : TL-WR720N

	Freq. (MHz)	Ant. Factor (dB/m)	Cable loss (dB)	Amp. Factor (dB)	Reading (dBuV)	Emission Level (dBuV/m)	Limits (dBuV/m)	Margin (dB)	Remark
1	1399.000	24.99	4.44	34.70	46.19	40.92	74.00	33.08	Peak
2	2437.000	28.03	6.06	34.44	107.05	106.70	74.00	-32.70	Peak

Remarks:

1. Emission Level= Antenna Factor + Cable Loss -Amp Factor + Reading.
2. The emission levels that are 20dB below the official limit are not reported.

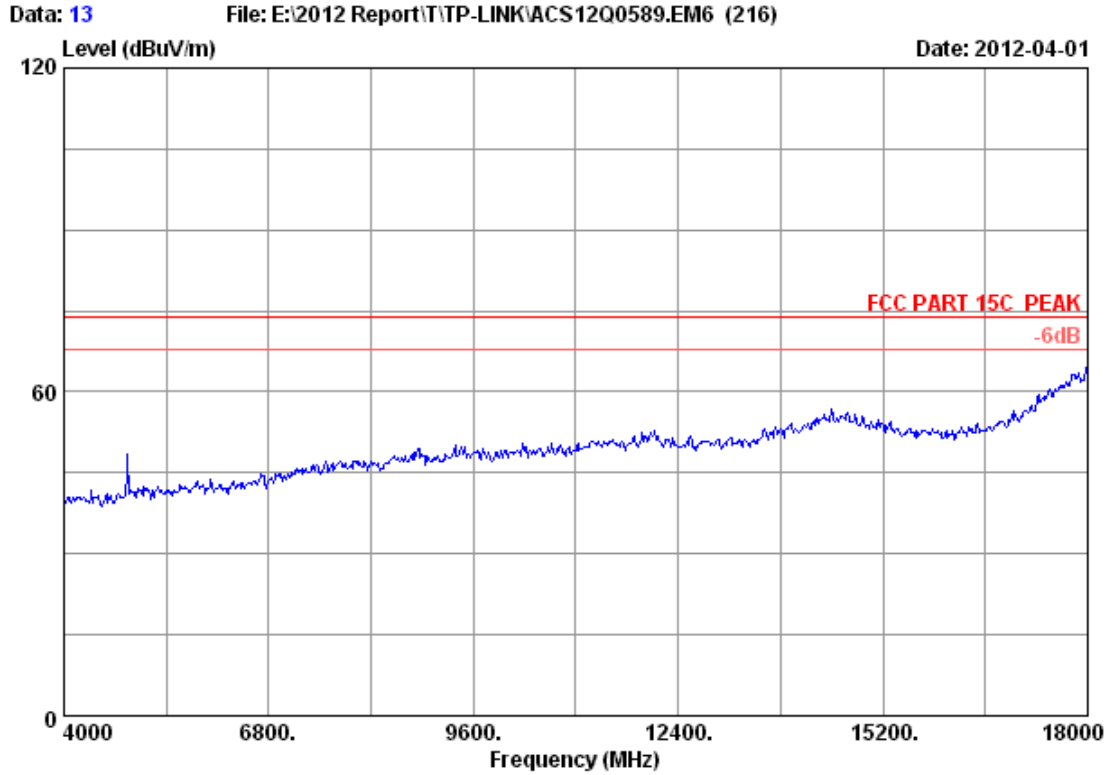

Site no. : 3m Chamber Data no. : 13
Dis. / Ant. : 3m 2011 3115 4580 Ant. pol. : HORIZONTAL
Limit : FCC PART 15C PEAK
Env. / Ins. : 23°C/54% Engineer : Leo-Li
EUT : 150Mbps Wireless N Router
Power supply : DC 9V From Adapter Input AC 120V/60Hz
Test mode : IEEE802.11b CH 6 2437MHz Tx
M/N : TL-WR720N

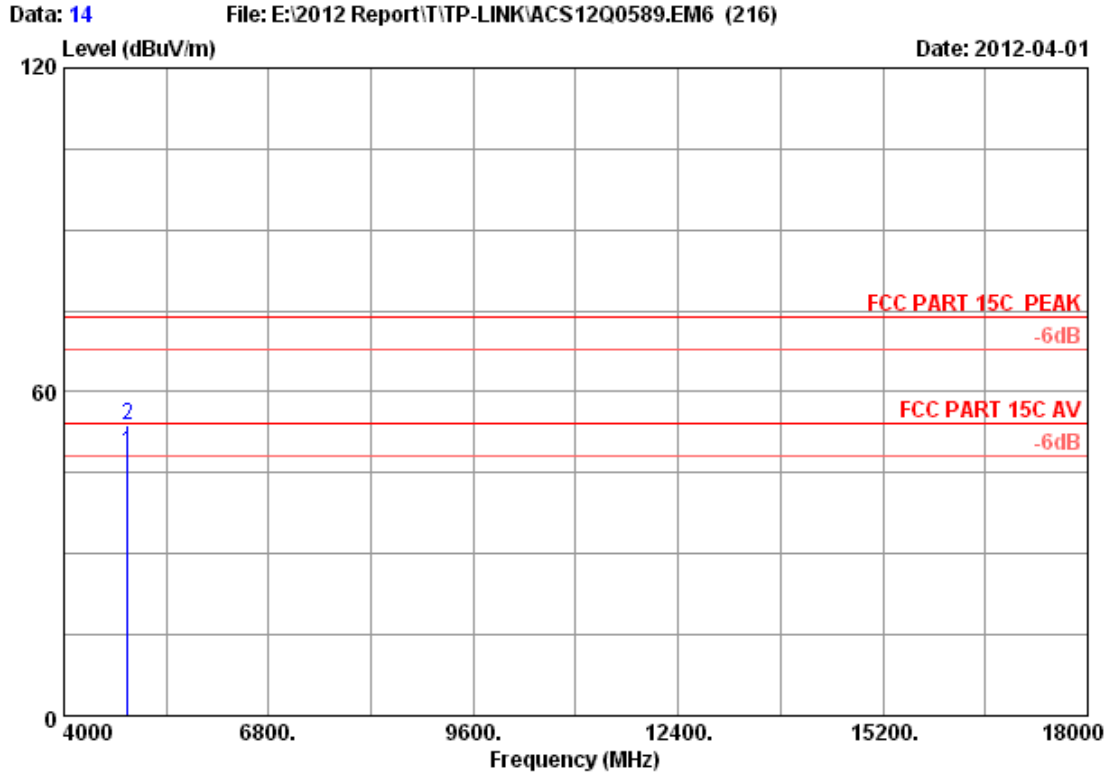

Site no. : 3m Chamber Data no. : 14
 Dis. / Ant. : 3m 2011 3115 4580 Ant. pol. : HORIZONTAL
 Limit : FCC PART 15C PEAK
 Env. / Ins. : 23°C/54% Engineer : Leo-Li
 EUT : 150Mbps Wireless N Router
 Power supply : DC 9V From Adapter Input AC 120V/60Hz
 Test mode : IEEE802.11b CH 6 2437MHz Tx
 M/N : TL-WR720N

	Freq. (MHz)	Ant. Factor (dB/m)	Cable loss (dB)	Amp. Factor (dB)	Reading (dBuV)	Emission Level (dBuV/m)	Limits (dBuV/m)	Margin (dB)	Remark
1	4874.000	32.98	8.58	34.60	41.75	48.71	54.00	5.29	Average
2	4874.000	32.98	8.58	34.60	46.98	53.94	74.00	20.06	Peak

Remarks:

1. Emission Level= Antenna Factor + Cable Loss -Amp Factor + Reading.
2. The emission levels that are 20dB below the official limit are not reported.

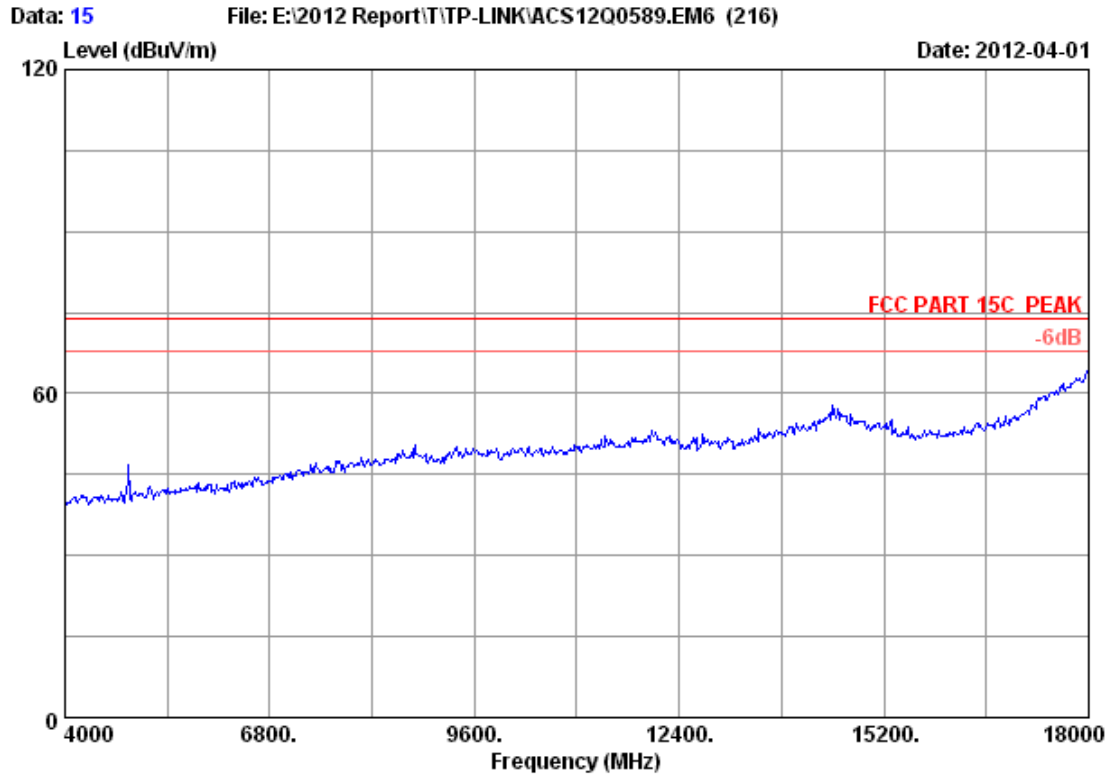

Site no. : 3m Chamber Data no. : 15
Dis. / Ant. : 3m 2011 3115 4580 Ant. pol. : VERTICAL
Limit : FCC PART 15C PEAK
Env. / Ins. : 23°C/54% Engineer : Leo-Li
EUT : 150Mbps Wireless N Router
Power supply : DC 9V From Adapter Input AC 120V/60Hz
Test mode : IEEE802.11b CH 6 2437MHz Tx
M/N : TL-WR720N

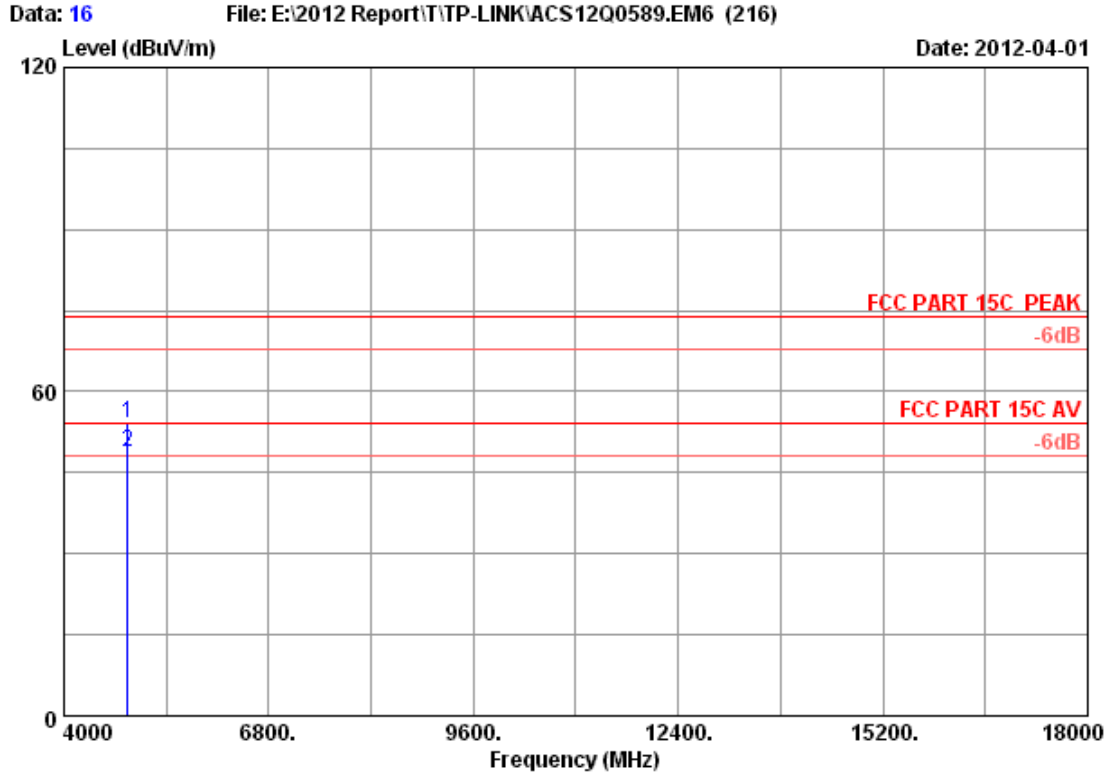

Site no. : 3m Chamber Data no. : 16
 Dis. / Ant. : 3m 2011 3115 4580 Ant. pol. : VERTICAL
 Limit : FCC PART 15C PEAK
 Env. / Ins. : 23°C/54% Engineer : Leo-Li
 EUT : 150Mbps Wireless N Router
 Power supply : DC 9V From Adapter Input AC 120V/60Hz
 Test mode : IEEE802.11b CH 6 2437MHz Tx
 M/N : TL-WR720N

	Freq. (MHz)	Ant. Factor (dB/m)	Cable loss (dB)	Amp. Factor (dB)	Reading (dBuV)	Emission Level (dBuV/m)	Limits (dBuV/m)	Margin (dB)	Remark
1	4874.000	32.98	8.58	34.60	47.35	54.31	74.00	19.69	Peak
2	4874.000	32.98	8.58	34.60	41.78	48.74	54.00	5.26	Average

Remarks:

1. Emission Level= Antenna Factor + Cable Loss -Amp Factor + Reading.
2. The emission levels that are 20dB below the official limit are not reported.

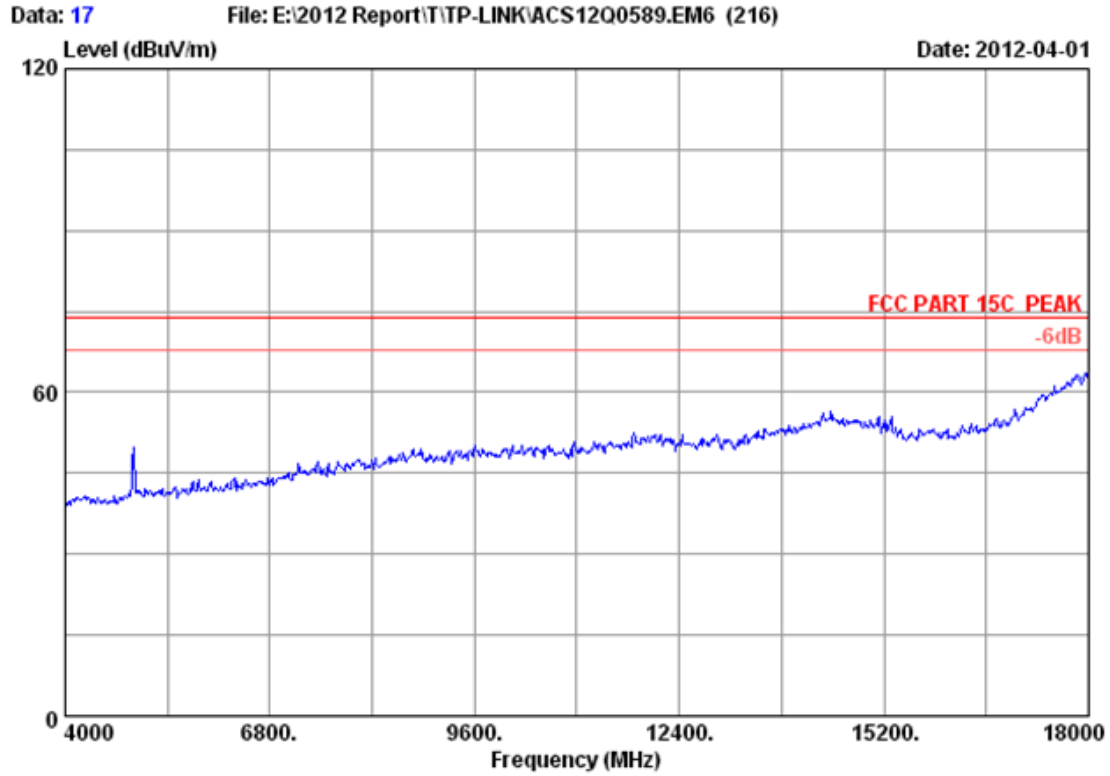

Site no. : 3m Chamber Data no. : 17
Dis. / Ant. : 3m 2011 3115 4580 Ant. pol. : VERTICAL
Limit : FCC PART 15C PEAK
Env. / Ins. : 23°C/54% Engineer : Leo-Li
EUT : 150Mbps Wireless N Router
Power supply : DC 9V From Adapter Input AC 120V/60Hz
Test mode : IEEE802.11b CH 11 2462MHz Tx
M/N : TL-WR720N

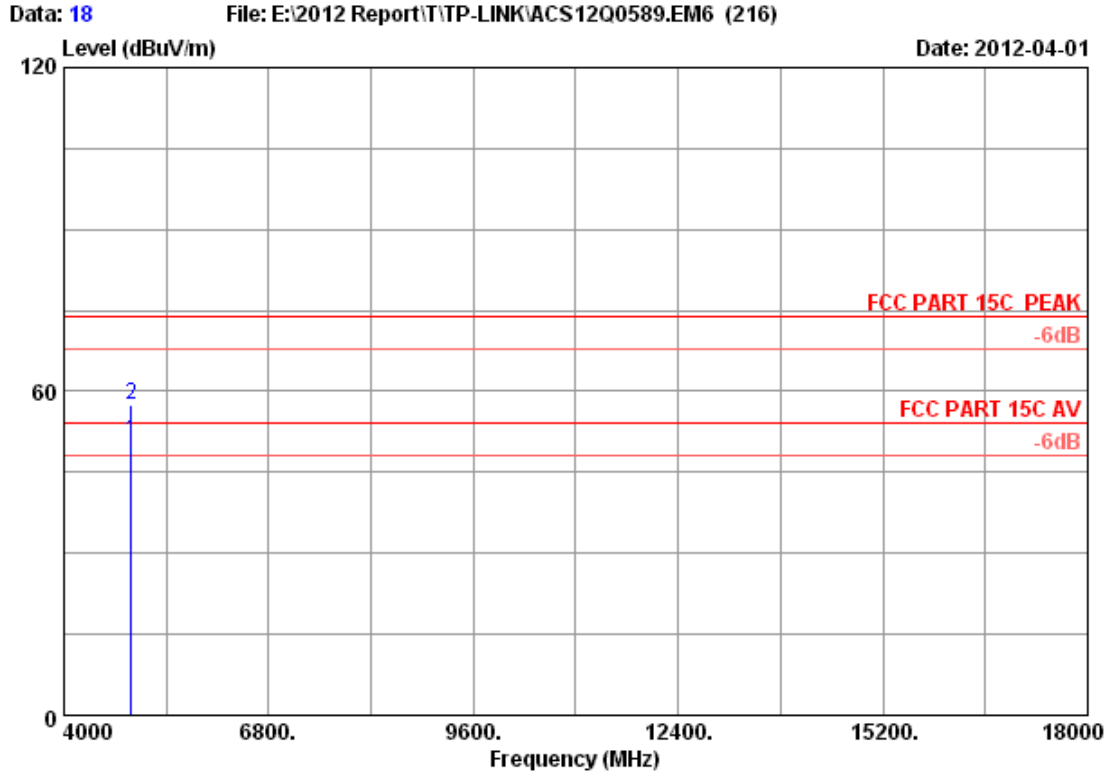

Site no. : 3m Chamber Data no. : 18
 Dis. / Ant. : 3m 2011 3115 4580 Ant. pol. : VERTICAL
 Limit : FCC PART 15C PEAK
 Env. / Ins. : 23°C/54% Engineer : Leo-Li
 EUT : 150Mbps Wireless N Router
 Power supply : DC 9V From Adapter Input AC 120V/60Hz
 Test mode : IEEE802.11b CH 11 2462MHz Tx
 M/N : TL-WR720N

	Freq. (MHz)	Ant. Factor (dB/m)	Cable loss (dB)	Amp. Factor (dB)	Reading (dBuV)	Emission Level (dBuV/m)	Limits (dBuV/m)	Margin (dB)	Remark
1	4924.000	33.08	8.62	34.60	43.68	50.78	54.00	3.22	Average
2	4924.000	33.08	8.62	34.60	50.34	57.44	74.00	16.56	Peak

Remarks:

- Emission Level= Antenna Factor + Cable Loss -Amp Factor + Reading.
- The emission levels that are 20dB below the official limit are not reported.

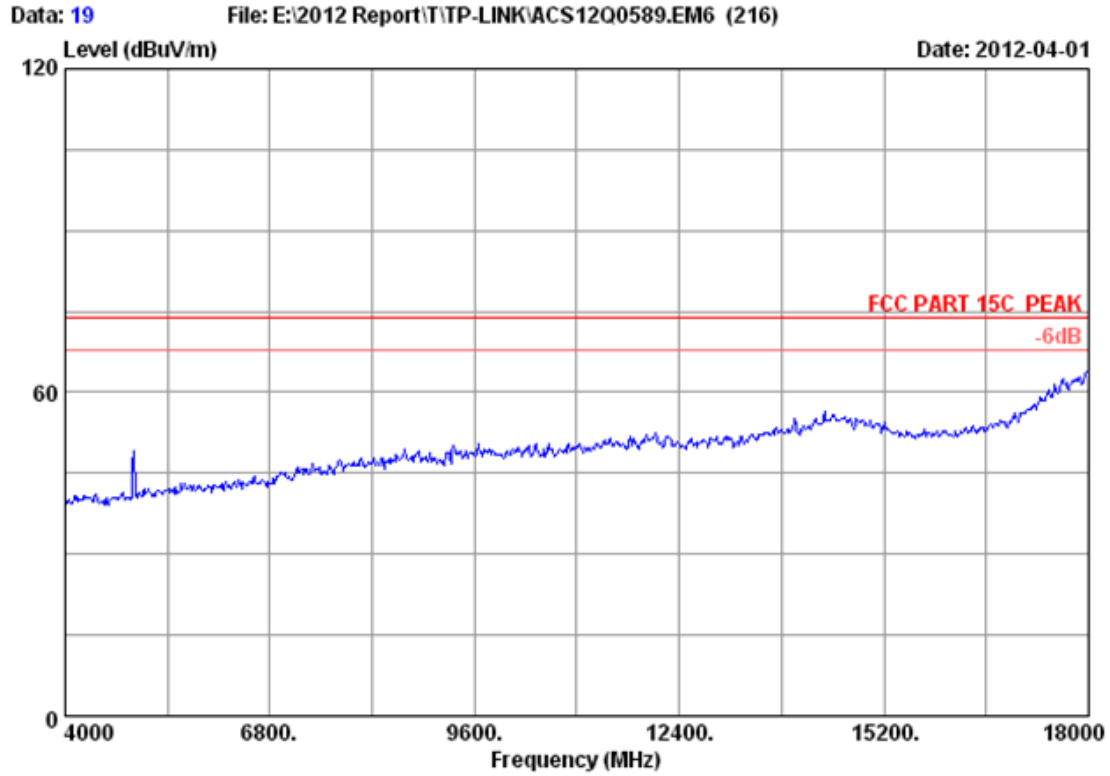

Site no. : 3m Chamber Data no. : 19
Dis. / Ant. : 3m 2011 3115 4580 Ant. pol. : HORIZONTAL
Limit : FCC PART 15C PEAK
Env. / Ins. : 23°C/54% Engineer : Leo-Li
EUT : 150Mbps Wireless N Router
Power supply : DC 9V From Adapter Input AC 120V/60Hz
Test mode : IEEE802.11b CH 11 2462MHz Tx
M/N : TL-WR720N

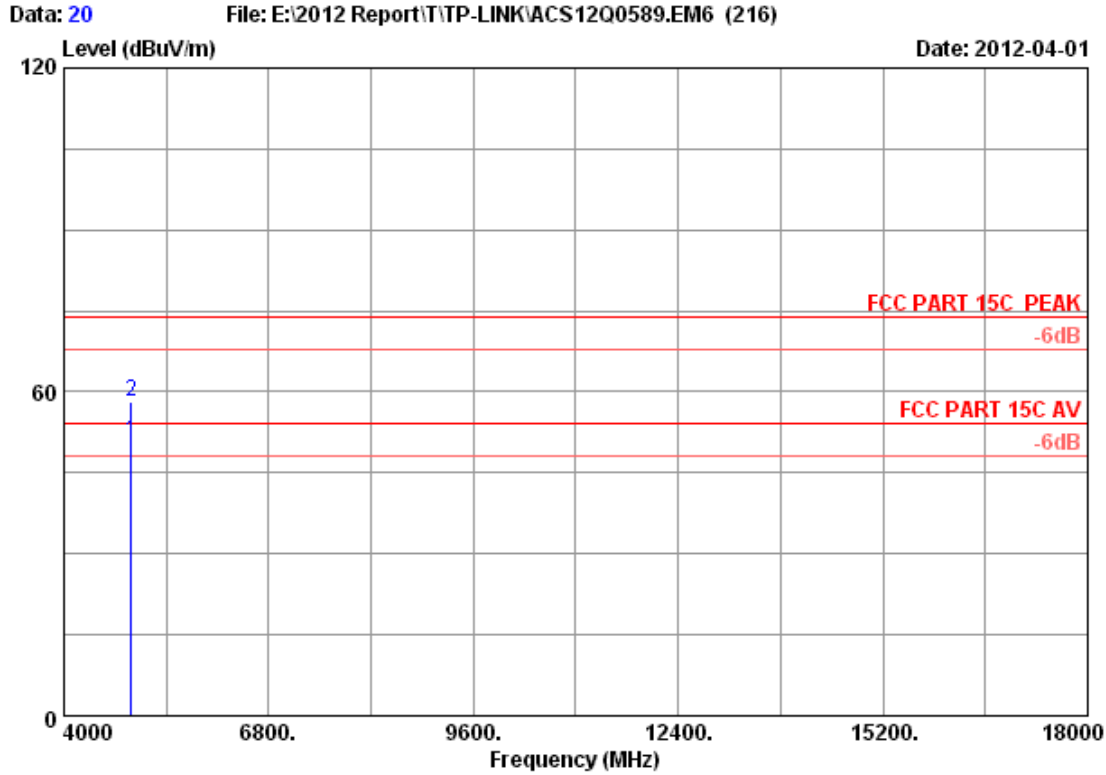

Site no. : 3m Chamber Data no. : 20
 Dis. / Ant. : 3m 2011 3115 4580 Ant. pol. : HORIZONTAL
 Limit : FCC PART 15C PEAK
 Env. / Ins. : 23°C/54% Engineer : Leo-Li
 EUT : 150Mbps Wireless N Router
 Power supply : DC 9V From Adapter Input AC 120V/60Hz
 Test mode : IEEE802.11b CH 11 2462MHz Tx
 M/N : TL-WR720N

	Freq. (MHz)	Ant. Factor (dB/m)	Cable loss (dB)	Amp. Factor (dB)	Reading (dBuV)	Emission Level (dBuV/m)	Limits (dBuV/m)	Margin (dB)	Remark
1	4924.000	33.08	8.62	34.60	43.77	50.87	54.00	3.13	Average
2	4924.000	33.08	8.62	34.60	51.03	58.13	74.00	15.87	Peak

Remarks:

- Emission Level= Antenna Factor + Cable Loss -Amp Factor + Reading.
- The emission levels that are 20dB below the official limit are not reported.

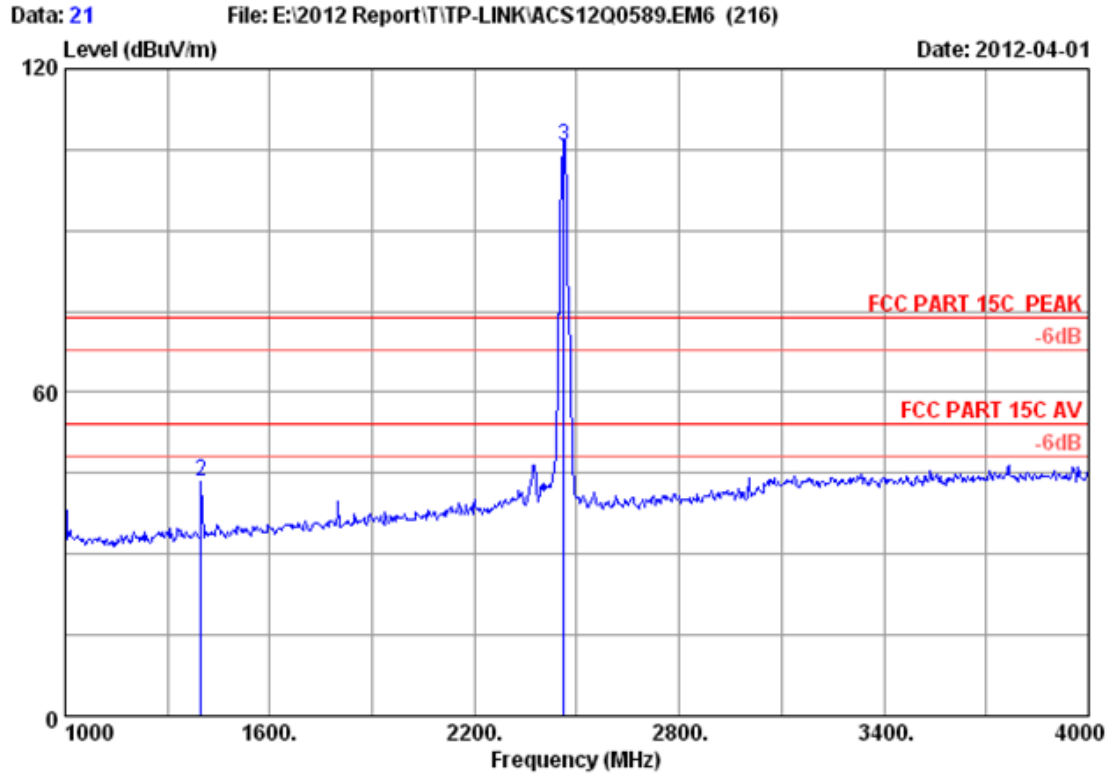

Site no. : 3m Chamber Data no. : 21
 Dis. / Ant. : 3m 2011 3115 4580 Ant. pol. : HORIZONTAL
 Limit : FCC PART 15C PEAK
 Env. / Ins. : 23°C/54% Engineer : Leo-Li
 EUT : 150Mbps Wireless N Router
 Power supply : DC 9V From Adapter Input AC 120V/60Hz
 Test mode : IEEE802.11b CH 11 2462MHz Tx
 M/N : TL-WR720N

	Freq. (MHz)	Ant. Factor (dB/m)	Cable loss (dB)	Amp. Factor (dB)	Reading (dBuV)	Emission Level (dBuV/m)	Limits (dBuV/m)	Margin (dB)	Remark
1	1000.000	23.80	3.82	34.90	47.52	40.24	74.00	33.76	Peak
2	1399.000	24.99	4.44	34.70	48.72	43.45	74.00	30.55	Peak
3	2462.000	28.05	6.12	34.44	106.02	105.75	74.00	-31.75	Peak

Remarks:

1. Emission Level= Antenna Factor + Cable Loss -Amp Factor + Reading.
2. The emission levels that are 20dB below the official limit are not reported.

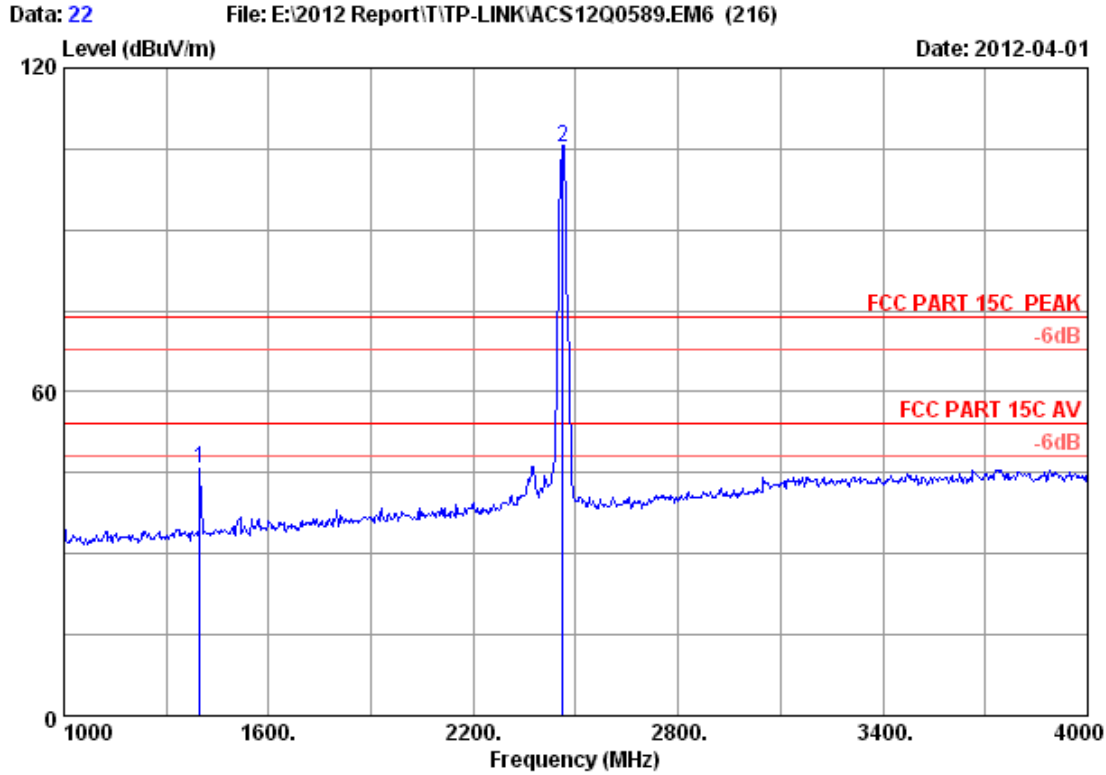

Site no. : 3m Chamber Data no. : 22
 Dis. / Ant. : 3m 2011 3115 4580 Ant. pol. : VERTICAL
 Limit : FCC PART 15C PEAK
 Env. / Ins. : 23°C/54% Engineer : Leo-Li
 EUT : 150Mbps Wireless N Router
 Power supply : DC 9V From Adapter Input AC 120V/60Hz
 Test mode : IEEE802.11b CH 11 2462MHz Tx
 M/N : TL-WR720N

	Freq. (MHz)	Ant. Factor (dB/m)	Cable loss (dB)	Amp. Factor (dB)	Reading (dBuV)	Emission Level (dBuV/m)	Limits (dBuV/m)	Margin (dB)	Remark
1	1399.000	24.99	4.44	34.70	51.07	45.80	74.00	28.20	Peak
2	2462.000	28.05	6.12	34.44	105.57	105.30	74.00	-31.30	Peak

Remarks:

1. Emission Level= Antenna Factor + Cable Loss -Amp Factor + Reading.
2. The emission levels that are 20dB below the official limit are not reported.

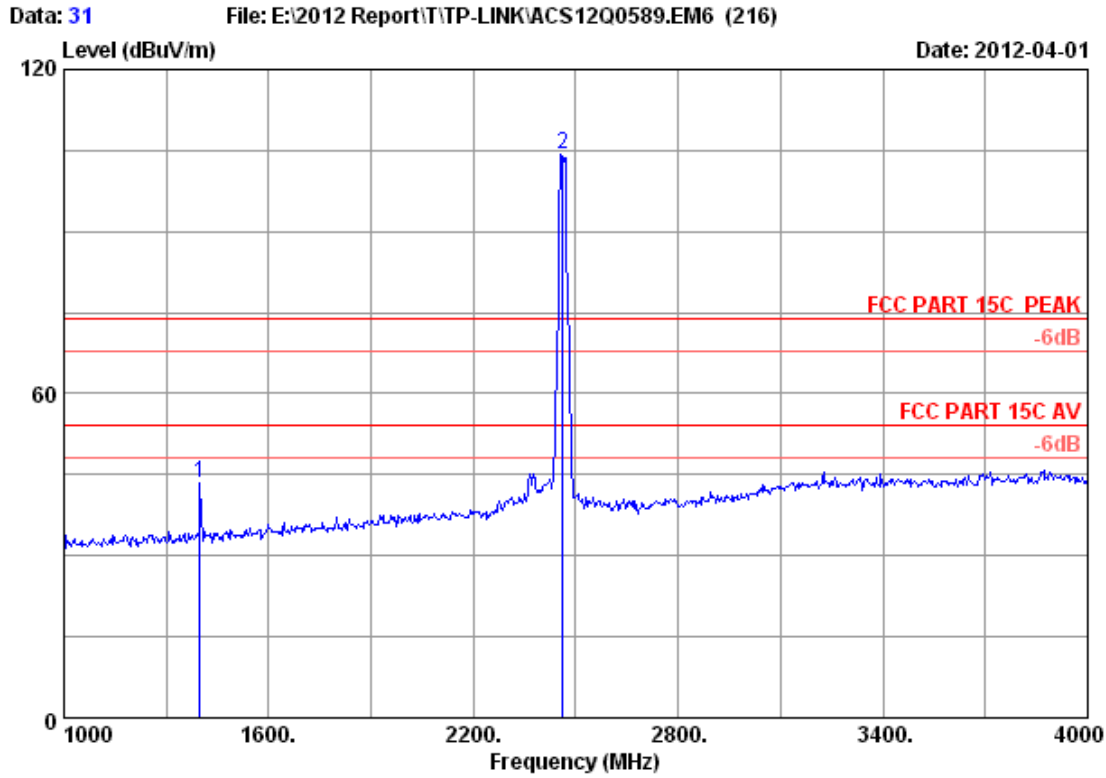

```

Site no.      : 3m Chamber           Data no.   : 31
Dis. / Ant.  : 3m 2011 3115 4580    Ant. pol.  : VERTICAL
Limit        : FCC PART 15C PEAK
Env. / Ins.  : 23°C/54%             Engineer   : Leo-Li
EUT         : 150Mbps Wireless N Router
Power supply : DC 9V From Adapter Input AC 120V/60Hz
Test mode    : IEEE802.11g CH 11 2462MHz Tx
M/N         : TL-WR720N
    
```

	Freq. (MHz)	Ant. Factor (dB/m)	Cable loss (dB)	Amp. Factor (dB)	Reading (dBuV)	Emission Level (dBuV/m)	Limits (dBuV/m)	Margin (dB)	Remark
1	1399.000	24.99	4.44	34.70	48.68	43.41	74.00	30.59	Peak
2	2462.000	28.05	6.12	34.44	104.59	104.32	74.00	-30.32	Peak

Remarks:

1. Emission Level= Antenna Factor + Cable Loss -Amp Factor + Reading.
2. The emission levels that are 20dB below the official limit are not reported.

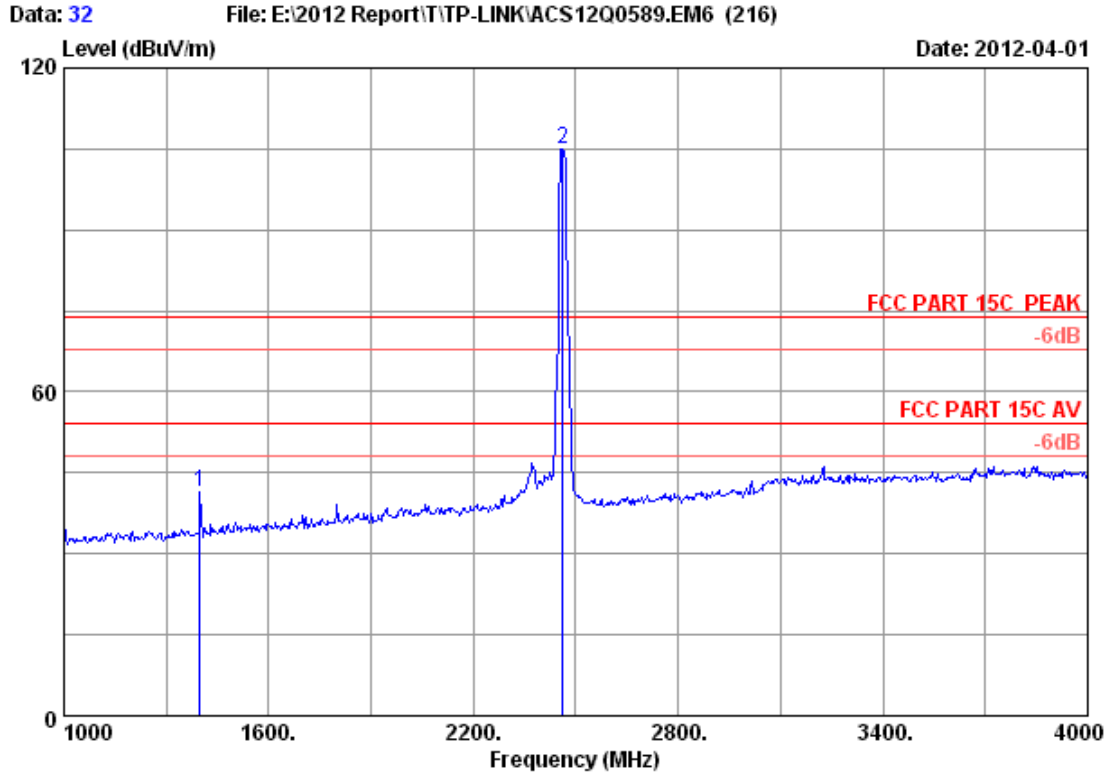

Site no. : 3m Chamber Data no. : 32
 Dis. / Ant. : 3m 2011 3115 4580 Ant. pol. : HORIZONTAL
 Limit : FCC PART 15C PEAK
 Env. / Ins. : 23°C/54% Engineer : Leo-Li
 EUT : 150Mbps Wireless N Router
 Power supply : DC 9V From Adapter Input AC 120V/60Hz
 Test mode : IEEE802.11g CH 11 2462MHz Tx
 M/N : TL-WR720N

	Freq. (MHz)	Ant. Factor (dB/m)	Cable loss (dB)	Amp. Factor (dB)	Reading (dBuV)	Emission Level (dBuV/m)	Limits (dBuV/m)	Margin (dB)	Remark
1	1399.000	24.99	4.44	34.70	46.65	41.38	74.00	32.62	Peak
2	2462.000	28.05	6.12	34.44	105.38	105.11	74.00	-31.11	Peak

Remarks:

1. Emission Level= Antenna Factor + Cable Loss -Amp Factor + Reading.
2. The emission levels that are 20dB below the official limit are not reported.

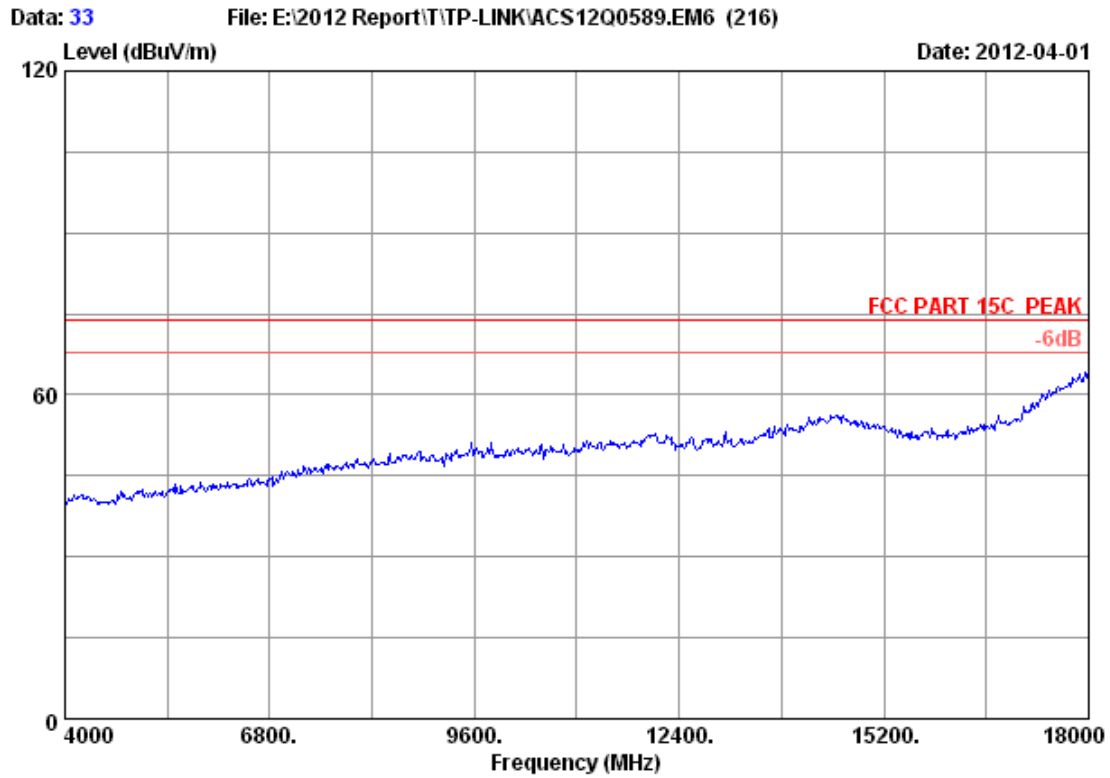

Site no. : 3m Chamber Data no. : 33
Dis. / Ant. : 3m 2011 3115 4580 Ant. pol. : HORIZONTAL
Limit : FCC PART 15C PEAK
Env. / Ins. : 23°C/54% Engineer : Leo-Li
EUT : 150Mbps Wireless N Router
Power supply : DC 9V From Adapter Input AC 120V/60Hz
Test mode : IEEE802.11g CH 11 2462MHz Tx
M/N : TL-WR720N

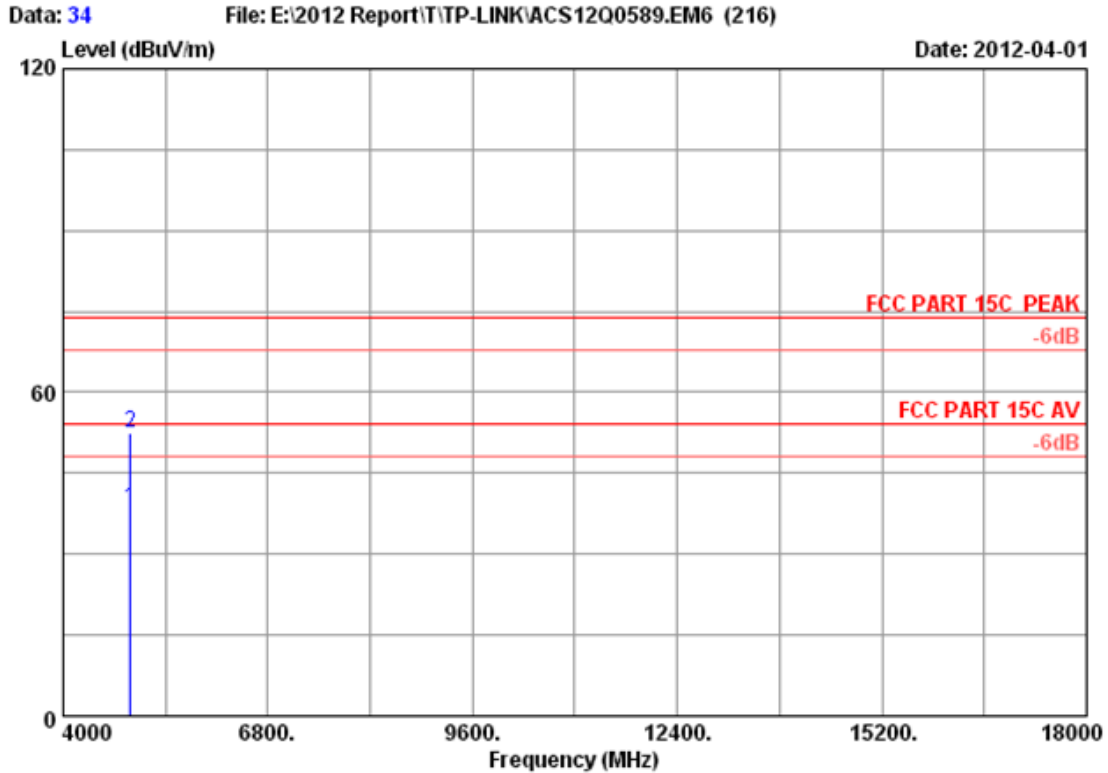

Site no. : 3m Chamber Data no. : 34
 Dis. / Ant. : 3m 2011 3115 4580 Ant. pol. : HORIZONTAL
 Limit : FCC PART 15C PEAK
 Env. / Ins. : 23°C/54% Engineer : Leo-Li
 EUT : 150Mbps Wireless N Router
 Power supply : DC 9V From Adapter Input AC 120V/60Hz
 Test mode : IEEE802.11g CH 11 2462MHz Tx
 M/N : TL-WR720N

	Freq. (MHz)	Ant. Factor (dB/m)	Cable loss (dB)	Amp. Factor (dB)	Reading (dBuV)	Emission Level (dBuV/m)	Limits (dBuV/m)	Margin (dB)	Remark
1	4924.000	33.08	8.62	34.60	31.44	38.54	54.00	15.46	Average
2	4924.000	33.08	8.62	34.60	45.52	52.62	74.00	21.38	Peak

Remarks:

1. Emission Level= Antenna Factor + Cable Loss -Amp Factor + Reading.
2. The emission levels that are 20dB below the official limit are not reported.

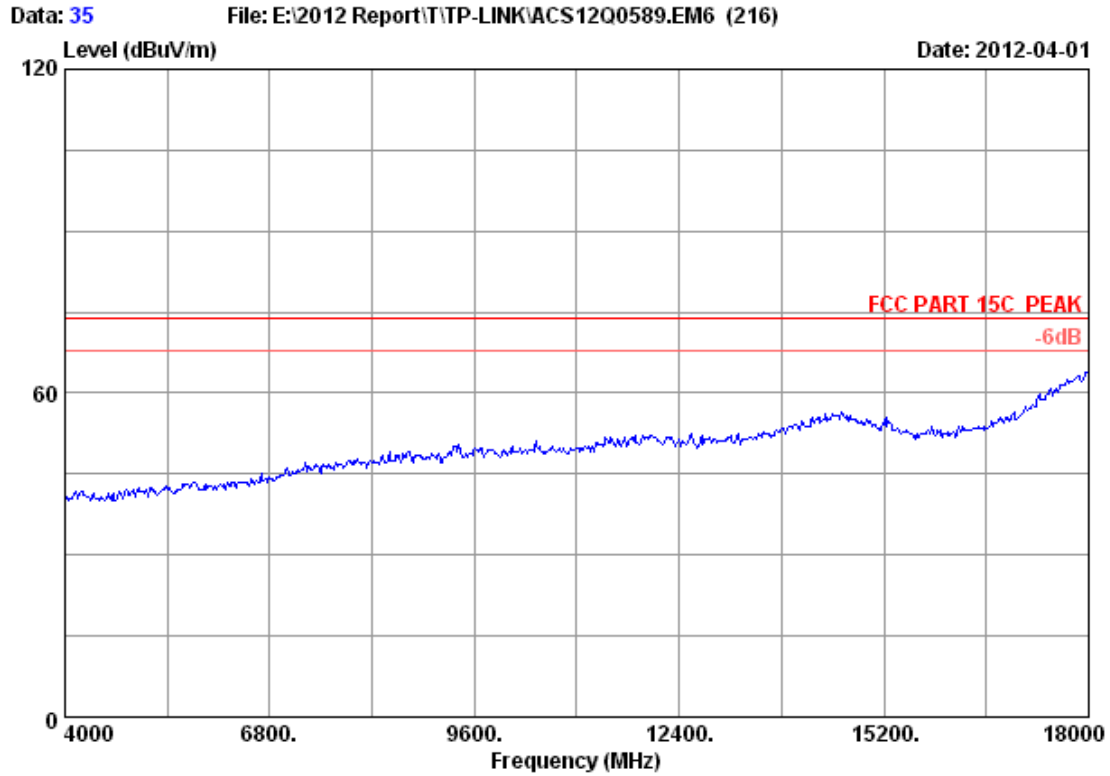

Site no. : 3m Chamber Data no. : 35
Dis. / Ant. : 3m 2011 3115 4580 Ant. pol. : VERTICAL
Limit : FCC PART 15C PEAK
Env. / Ins. : 23*C/54% Engineer : Leo-Li
EUT : 150Mbps Wireless N Router
Power supply : DC 9V From Adapter Input AC 120V/60Hz
Test mode : IEEE802.11g CH 11 2462MHz Tx
M/N : TL-WR720N

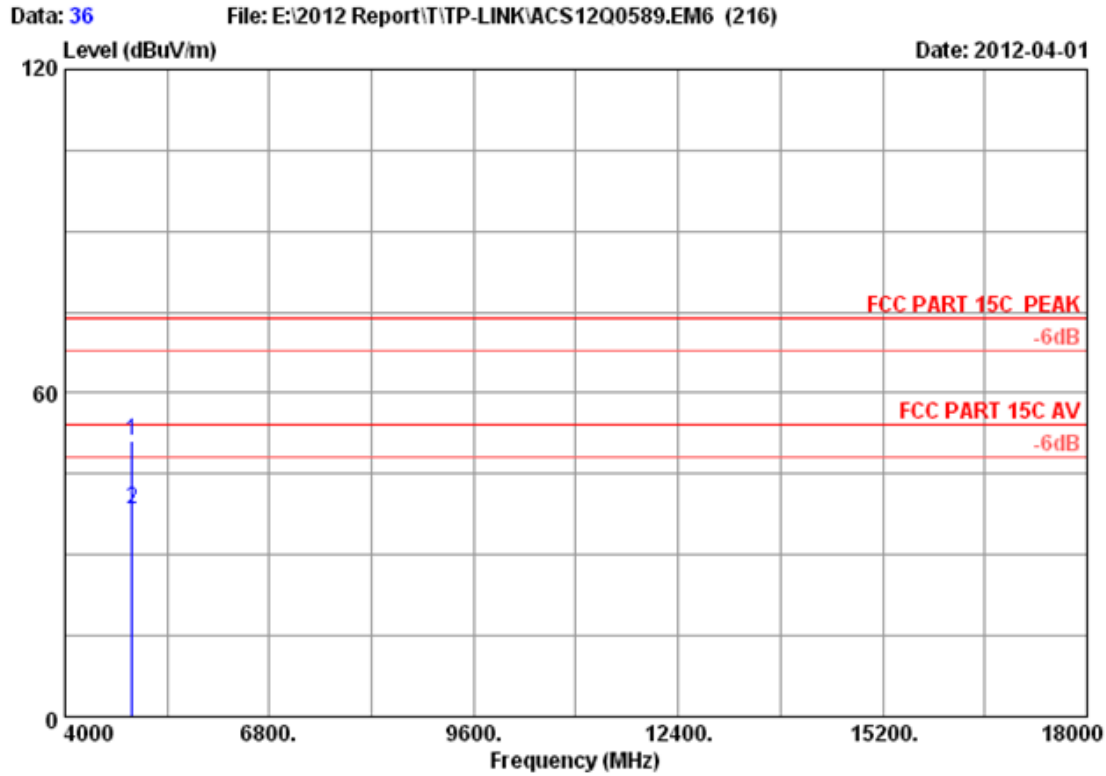

Site no. : 3m Chamber Data no. : 36
 Dis. / Ant. : 3m 2011 3115 4580 Ant. pol. : VERTICAL
 Limit : FCC PART 15C PEAK
 Env. / Ins. : 23°C/54% Engineer : Leo-Li
 EUT : 150Mbps Wireless N Router
 Power supply : DC 9V From Adapter Input AC 120V/60Hz
 Test mode : IEEE802.11g CH 11 2462MHz Tx
 M/N : TL-WR720N

	Freq. (MHz)	Ant. Factor (dB/m)	Cable loss (dB)	Amp. Factor (dB)	Reading (dBuV)	Emission Level (dBuV/m)	Limits (dBuV/m)	Margin (dB)	Remark
1	4924.000	33.08	8.62	34.60	44.18	51.28	74.00	22.72	Peak
2	4924.000	33.08	8.62	34.60	31.41	38.51	54.00	15.49	Average

Remarks:

1. Emission Level= Antenna Factor + Cable Loss -Amp Factor + Reading.
2. The emission levels that are 20dB below the official limit are not reported.

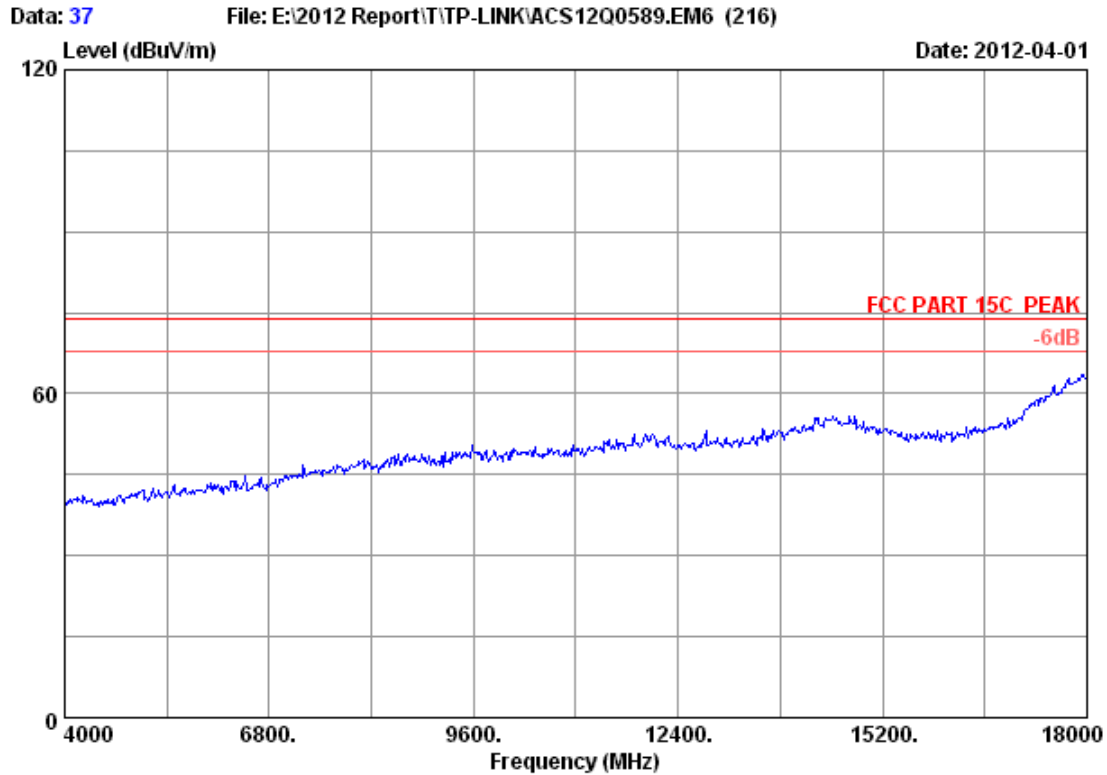

Site no. : 3m Chamber Data no. : 37
Dis. / Ant. : 3m 2011 3115 4580 Ant. pol. : VERTICAL
Limit : FCC PART 15C PEAK
Env. / Ins. : 23°C/54% Engineer : Leo-Li
EUT : 150Mbps Wireless N Router
Power supply : DC 9V From Adapter Input AC 120V/60Hz
Test mode : IEEE802.11g CH 6 2437MHz Tx
M/N : TL-WR720N

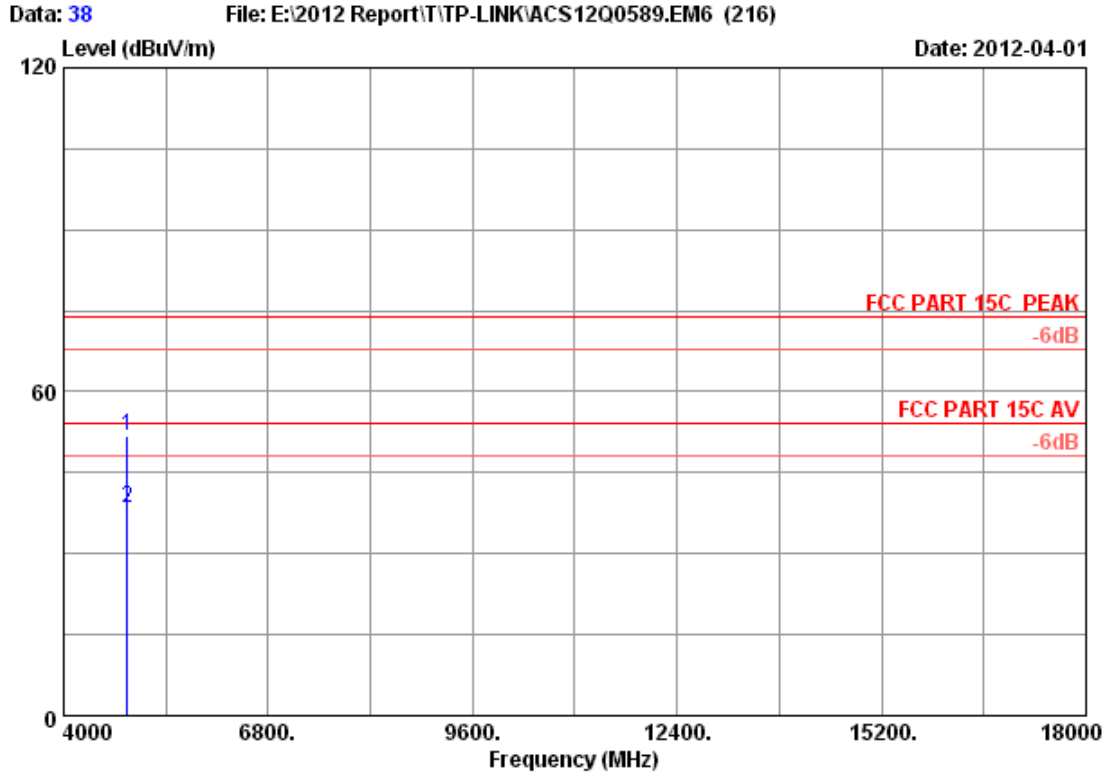

Site no. : 3m Chamber Data no. : 38
 Dis. / Ant. : 3m 2011 3115 4580 Ant. pol. : VERTICAL
 Limit : FCC PART 15C PEAK
 Env. / Ins. : 23°C/54% Engineer : Leo-Li
 EUT : 150Mbps Wireless N Router
 Power supply : DC 9V From Adapter Input AC 120V/60Hz
 Test mode : IEEE802.11g CH 6 2437MHz Tx
 M/N : TL-WR720N

	Freq. (MHz)	Ant. Factor (dB/m)	Cable loss (dB)	Amp. Factor (dB)	Reading (dBuV)	Emission Level (dBuV/m)	Limits (dBuV/m)	Margin (dB)	Remark
1	4874.000	32.98	8.58	34.60	44.73	51.69	74.00	22.31	Peak
2	4874.000	32.98	8.58	34.60	31.52	38.48	54.00	15.52	Average

Remarks:

1. Emission Level= Antenna Factor + Cable Loss -Amp Factor + Reading.
2. The emission levels that are 20dB below the official limit are not reported.

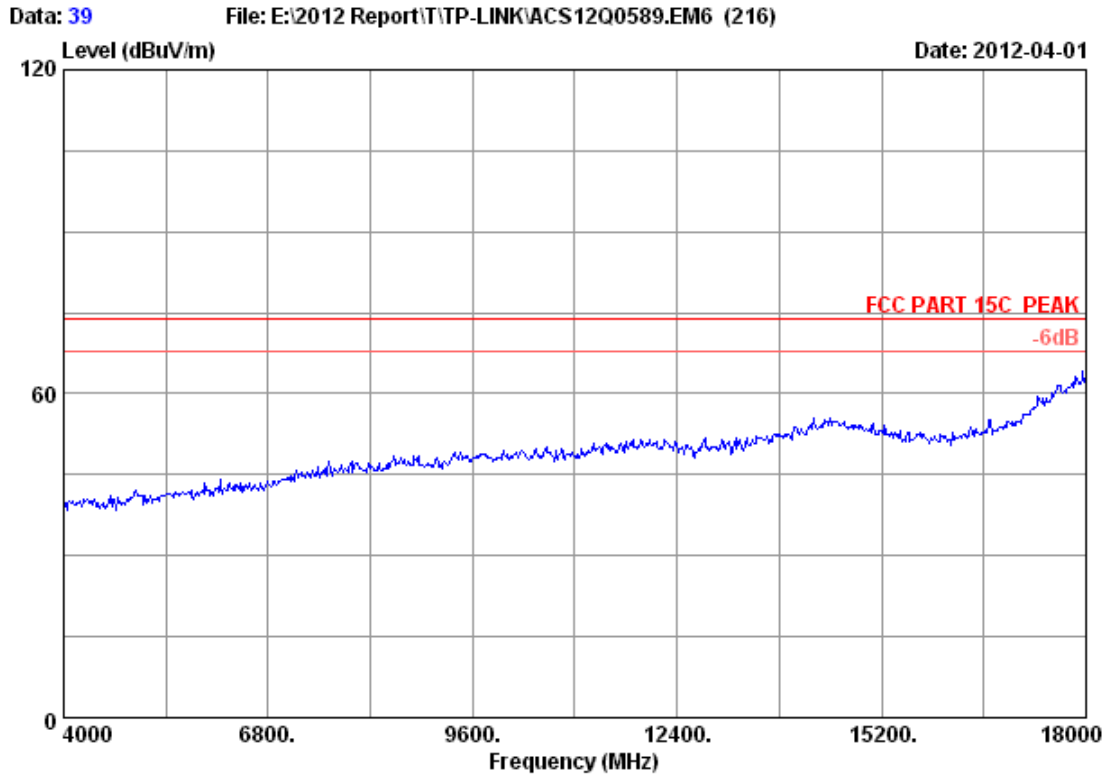

Site no. : 3m Chamber Data no. : 39
Dis. / Ant. : 3m 2011 3115 4580 Ant. pol. : HORIZONTAL
Limit : FCC PART 15C PEAK
Env. / Ins. : 23°C/54% Engineer : Leo-Li
EUT : 150Mbps Wireless N Router
Power supply : DC 9V From Adapter Input AC 120V/60Hz
Test mode : IEEE802.11g CH 6 2437MHz Tx
M/N : TL-WR720N

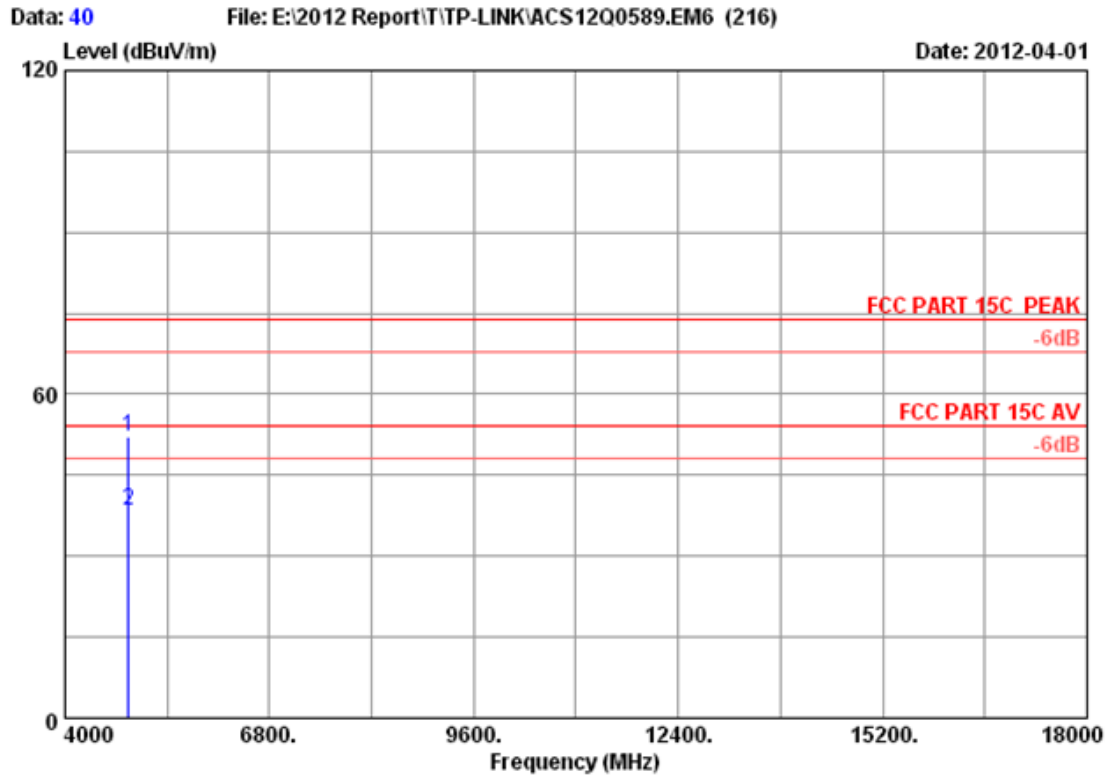

Site no. : 3m Chamber Data no. : 40
 Dis. / Ant. : 3m 2011 3115 4580 Ant. pol. : HORIZONTAL
 Limit : FCC PART 15C PEAK
 Env. / Ins. : 23°C/54% Engineer : Leo-Li
 EUT : 150Mbps Wireless N Router
 Power supply : DC 9V From Adapter Input AC 120V/60Hz
 Test mode : IEEE802.11g CH 6 2437MHz Tx
 M/N : TL-WR720N

	Freq. (MHz)	Ant. Factor (dB/m)	Cable loss (dB)	Amp. Factor (dB)	Reading (dBuV)	Emission Level (dBuV/m)	Limits (dBuV/m)	Margin (dB)	Remark
1	4874.000	32.98	8.58	34.60	45.33	52.29	74.00	21.71	Peak
2	4874.000	32.98	8.58	34.60	31.59	38.55	54.00	15.45	Average

Remarks:

1. Emission Level= Antenna Factor + Cable Loss -Amp Factor + Reading.
2. The emission levels that are 20dB below the official limit are not reported.

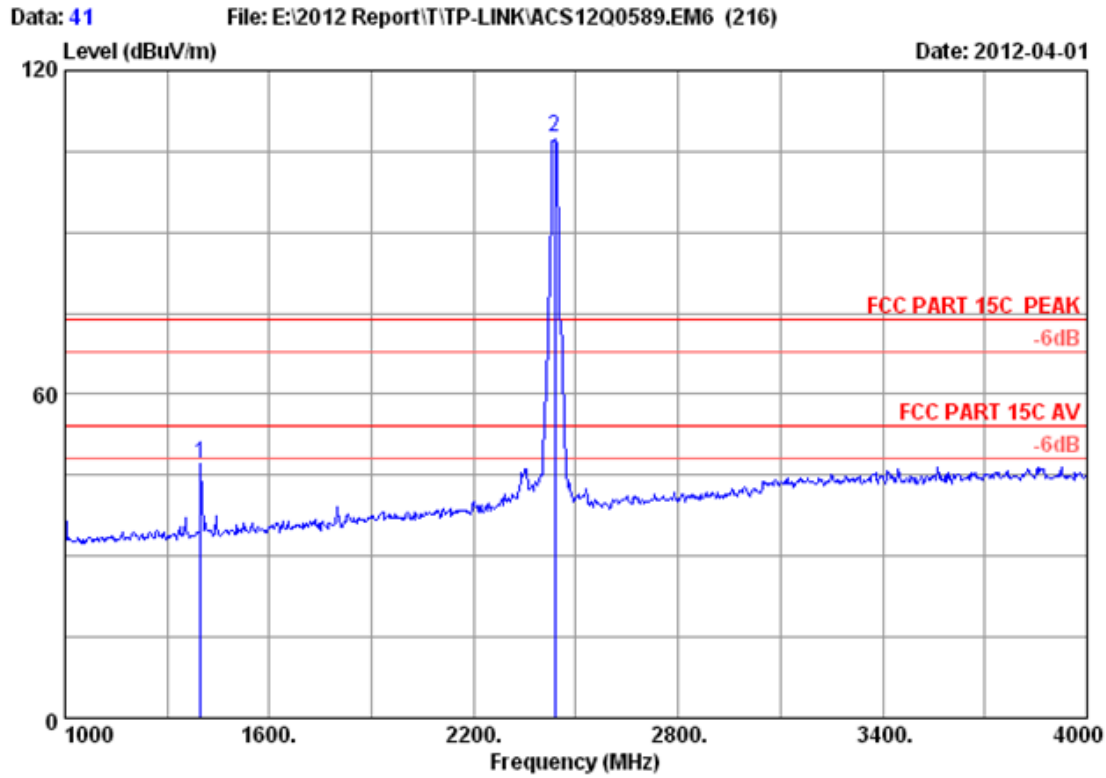

Site no. : 3m Chamber Data no. : 41
 Dis. / Ant. : 3m 2011 3115 4580 Ant. pol. : VERTICAL
 Limit : FCC PART 15C PEAK
 Env. / Ins. : 23°C/54% Engineer : Leo-Li
 EUT : 150Mbps Wireless N Router
 Power supply : DC 9V From Adapter Input AC 120V/60Hz
 Test mode : IEEE802.11g CH 6 2437MHz Tx
 M/N : TL-WR720N

	Freq. (MHz)	Ant. Factor (dB/m)	Cable loss (dB)	Amp. Factor (dB)	Reading (dBuV)	Emission Level (dBuV/m)	Limits (dBuV/m)	Margin (dB)	Remark
1	1399.000	24.99	4.44	34.70	52.32	47.05	74.00	26.95	Peak
2	2437.000	28.03	6.06	34.44	107.96	107.61	74.00	-33.61	Peak

Remarks:

1. Emission Level= Antenna Factor + Cable Loss -Amp Factor + Reading.
2. The emission levels that are 20dB below the official limit are not reported.

Data: 42 File: E:\2012 Report\T\TP-LINK\ACS1200589.EM6 (216) Date: 2012-04-01

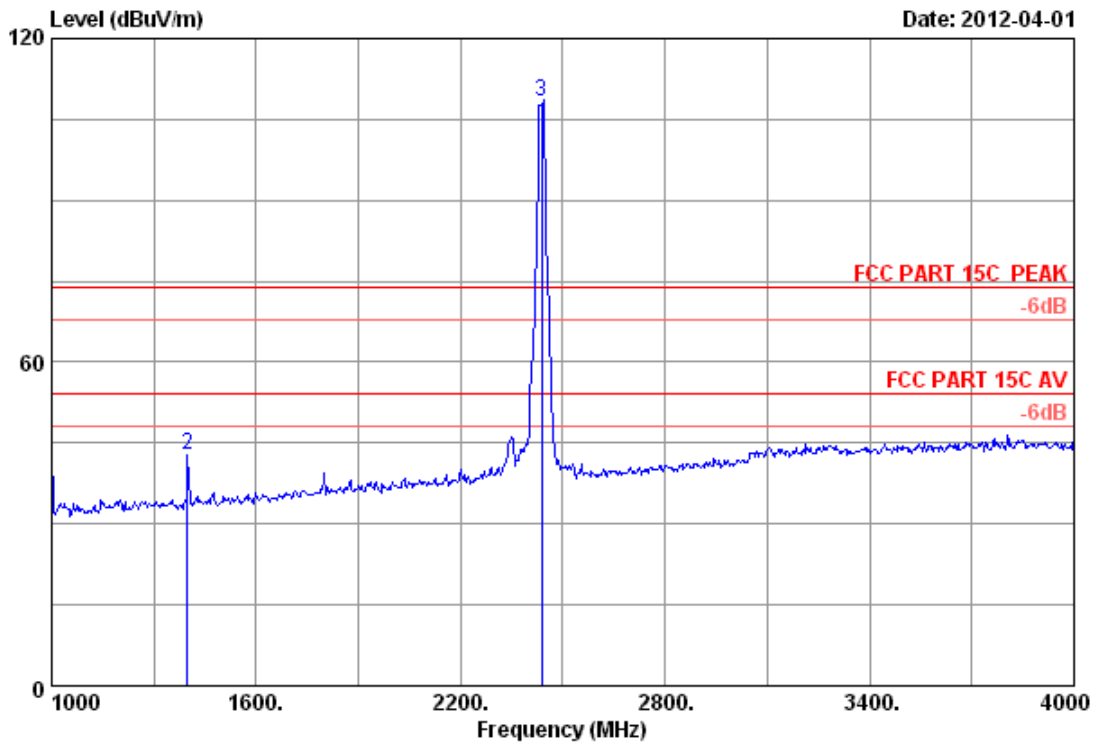

Site no. : 3m Chamber Data no. : 42
 Dis. / Ant. : 3m 2011 3115 4580 Ant. pol. : HORIZONTAL
 Limit : FCC PART 15C PEAK
 Env. / Ins. : 23°C/54% Engineer : Leo-Li
 EUT : 150Mbps Wireless N Router
 Power supply : DC 9V From Adapter Input AC 120V/60Hz
 Test mode : IEEE802.11g CH 6 2437MHz Tx
 M/N : TL-WR720N

	Freq. (MHz)	Ant. Factor (dB/m)	Cable loss (dB)	Amp. Factor (dB)	Reading (dBuV)	Emission Level (dBuV/m)	Limits (dBuV/m)	Margin (dB)	Remark
1	1000.000	23.80	3.82	34.90	48.78	41.50	74.00	32.50	Peak
2	1399.000	24.99	4.44	34.70	47.92	42.65	74.00	31.35	Peak
3	2437.000	28.03	6.06	34.44	108.63	108.28	74.00	-34.28	Peak

Remarks:

1. Emission Level= Antenna Factor + Cable Loss -Amp Factor + Reading.
2. The emission levels that are 20dB below the official limit are not reported.

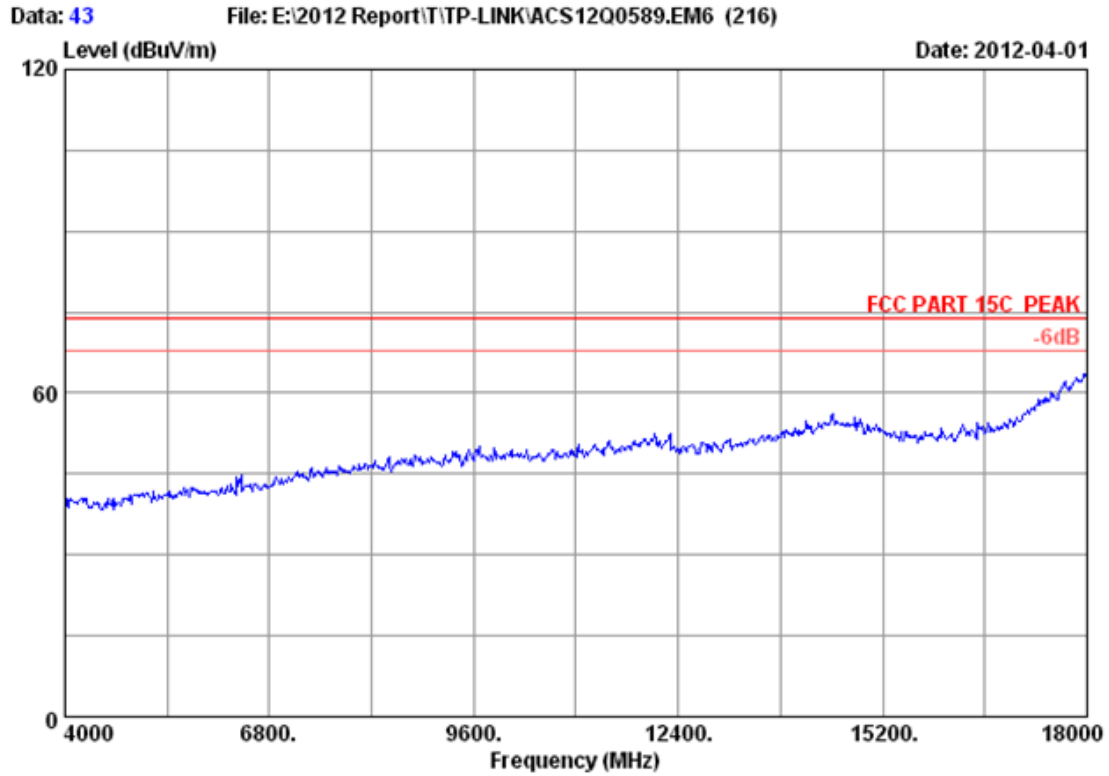

Site no. : 3m Chamber Data no. : 43
Dis. / Ant. : 3m 2011 3115 4580 Ant. pol. : HORIZONTAL
Limit : FCC PART 15C PEAK
Env. / Ins. : 23°C/54% Engineer : Leo-Li
EUT : 150Mbps Wireless N Router
Power supply : DC 9V From Adapter Input AC 120V/60Hz
Test mode : IEEE802.11g CH 1 2412MHz Tx
M/N : TL-WR720N

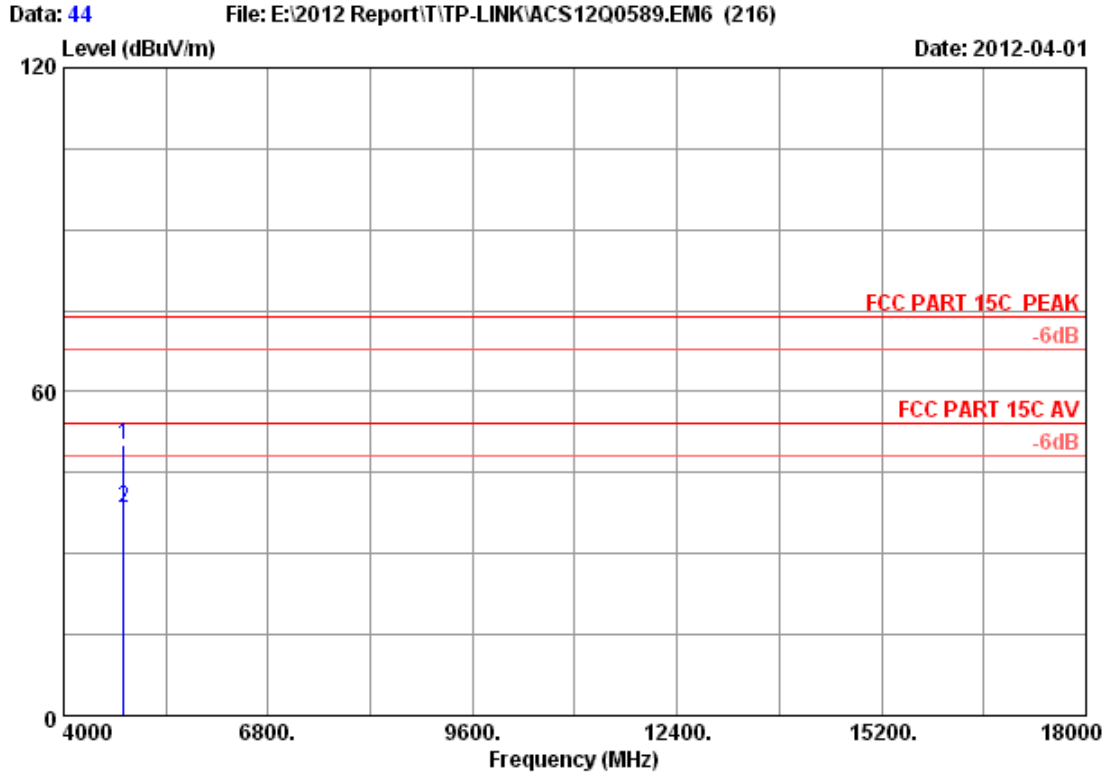

Site no. : 3m Chamber Data no. : 44
 Dis. / Ant. : 3m 2011 3115 4580 Ant. pol. : HORIZONTAL
 Limit : FCC PART 15C PEAK
 Env. / Ins. : 23°C/54% Engineer : Leo-Li
 EUT : 150Mbps Wireless N Router
 Power supply : DC 9V From Adapter Input AC 120V/60Hz
 Test mode : IEEE802.11g CH 1 2412MHz Tx
 M/N : TL-WR720N

	Freq. (MHz)	Ant. Factor (dB/m)	Cable loss (dB)	Amp. Factor (dB)	Reading (dBuV)	Emission Level (dBuV/m)	Limits (dBuV/m)	Margin (dB)	Remark
1	4824.000	32.89	8.53	34.60	43.27	50.09	74.00	23.91	Peak
2	4824.000	32.89	8.53	34.60	31.68	38.50	54.00	15.50	Average

Remarks:

1. Emission Level= Antenna Factor + Cable Loss -Amp Factor + Reading.
2. The emission levels that are 20dB below the official limit are not reported.

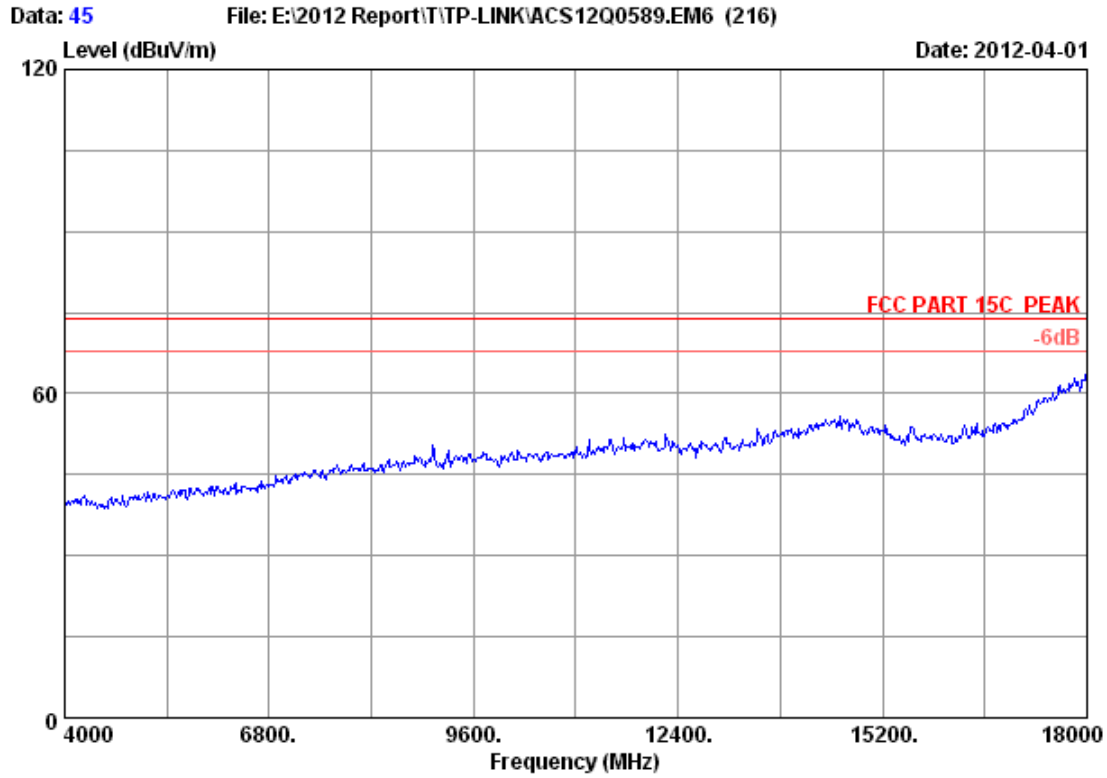

Site no. : 3m Chamber Data no. : 45
Dis. / Ant. : 3m 2011 3115 4580 Ant. pol. : VERTICAL
Limit : FCC PART 15C PEAK
Env. / Ins. : 23°C/54% Engineer : Leo-Li
EUT : 150Mbps Wireless N Router
Power supply : DC 9V From Adapter Input AC 120V/60Hz
Test mode : IEEE802.11g CH 1 2412MHz Tx
M/N : TL-WR720N

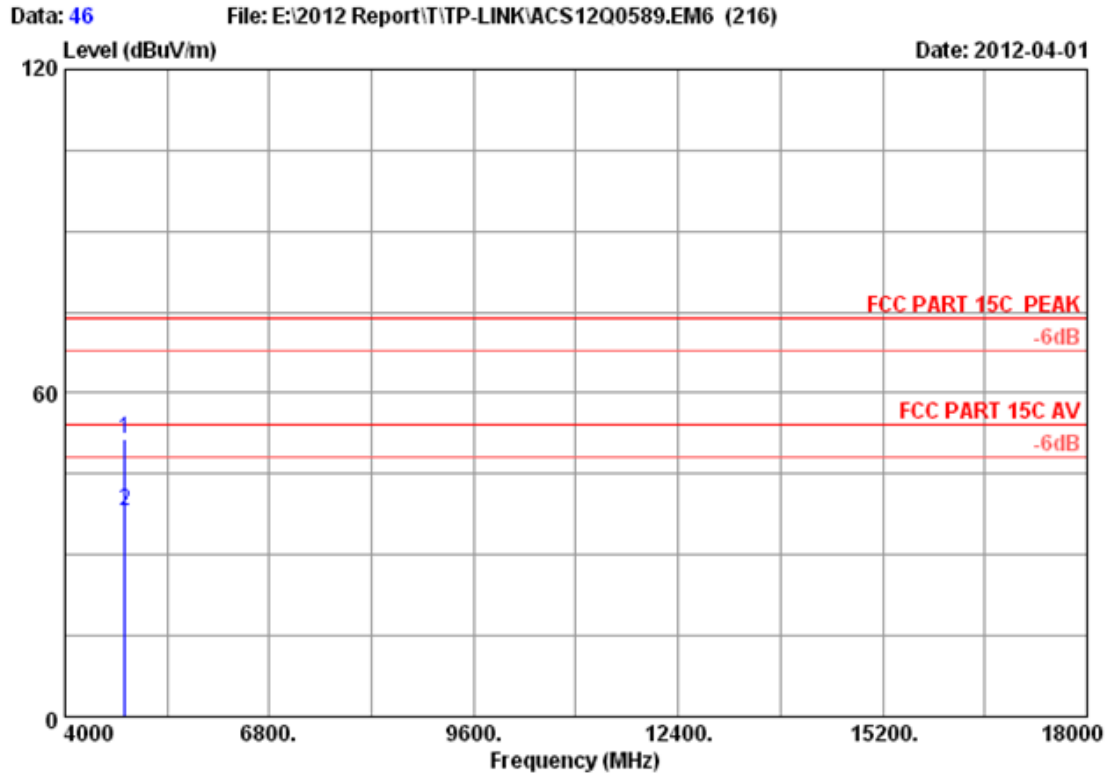

Site no. : 3m Chamber Data no. : 46
 Dis. / Ant. : 3m 2011 3115 4580 Ant. pol. : VERTICAL
 Limit : FCC PART 15C PEAK
 Env. / Ins. : 23°C/54% Engineer : Leo-Li
 EUT : 150Mbps Wireless N Router
 Power supply : DC 9V From Adapter Input AC 120V/60Hz
 Test mode : IEEE802.11g CH 1 2412MHz Tx
 M/N : TL-WR720N

	Freq. (MHz)	Ant. Factor (dB/m)	Cable loss (dB)	Amp. Factor (dB)	Reading (dBuV)	Emission Level (dBuV/m)	Limits (dBuV/m)	Margin (dB)	Remark
1	4824.000	32.89	8.53	34.60	44.76	51.58	74.00	22.42	Peak
2	4824.000	32.89	8.53	34.60	31.35	38.17	54.00	15.83	Average

Remarks:

1. Emission Level= Antenna Factor + Cable Loss -Amp Factor + Reading.
2. The emission levels that are 20dB below the official limit are not reported.

Data: 47 File: E:\2012 Report\T\TP-LINK\ACS12Q0589.EM6 (216) Date: 2012-04-01

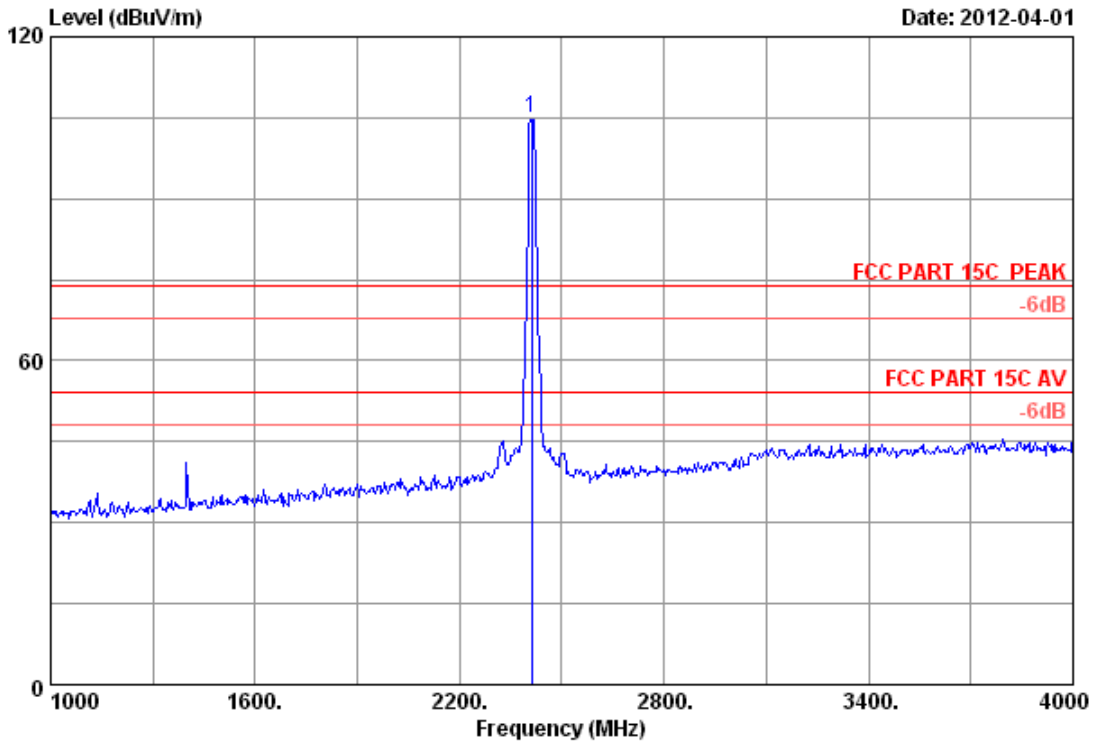

Site no. : 3m Chamber Data no. : 47
 Dis. / Ant. : 3m 2011 3115 4580 Ant. pol. : VERTICAL
 Limit : FCC PART 15C PEAK
 Env. / Ins. : 23°C/54% Engineer : Leo-Li
 EUT : 150Mbps Wireless N Router
 Power supply : DC 9V From Adapter Input AC 120V/60Hz
 Test mode : IEEE802.11g CH 1 2412MHz Tx
 M/N : TL-WR720N

	Freq. (MHz)	Ant. Factor (dB/m)	Cable loss (dB)	Amp. Factor (dB)	Reading (dBuV)	Emission Level (dBuV/m)	Limits (dBuV/m)	Margin (dB)	Remark
1	2412.000	27.98	6.03	34.44	105.34	104.91	74.00	-30.91	Peak

Remarks:

1. Emission Level= Antenna Factor + Cable Loss -Amp Factor + Reading.
2. The emission levels that are 20dB below the official limit are not reported.

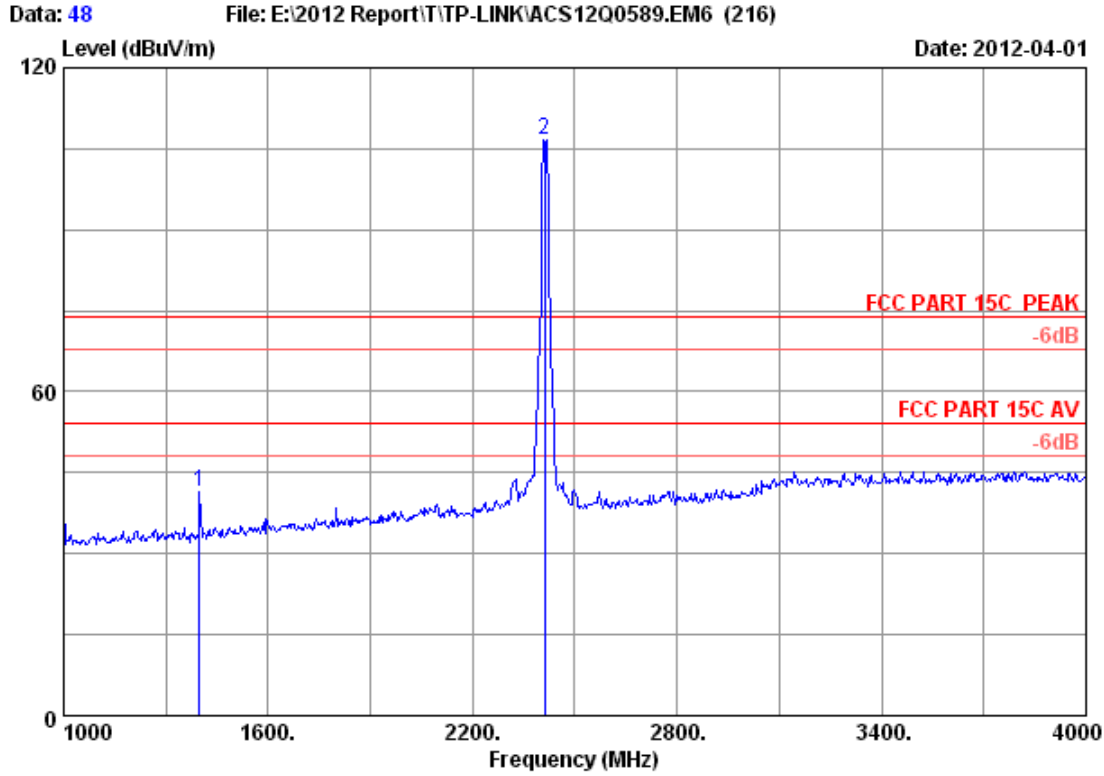

Site no. : 3m Chamber Data no. : 48
 Dis. / Ant. : 3m 2011 3115 4580 Ant. pol. : HORIZONTAL
 Limit : FCC PART 15C PEAK
 Env. / Ins. : 23°C/54% Engineer : Leo-Li
 EUT : 150Mbps Wireless N Router
 Power supply : DC 9V From Adapter Input AC 120V/60Hz
 Test mode : IEEE802.11g CH 1 2412MHz Tx
 M/N : TL-WR720N

	Freq. (MHz)	Ant. Factor (dB/m)	Cable loss (dB)	Amp. Factor (dB)	Reading (dBuV)	Emission Level (dBuV/m)	Limits (dBuV/m)	Margin (dB)	Remark
1	1399.000	24.99	4.44	34.70	46.71	41.44	74.00	32.56	Peak
2	2412.000	27.98	6.03	34.44	107.08	106.65	74.00	-32.65	Peak

Remarks:

1. Emission Level= Antenna Factor + Cable Loss -Amp Factor + Reading.
2. The emission levels that are 20dB below the official limit are not reported.

Data: 53 File: E:\2012 Report\T\TP-LINK\ACS1200589.EM6 (216) Date: 2012-04-01

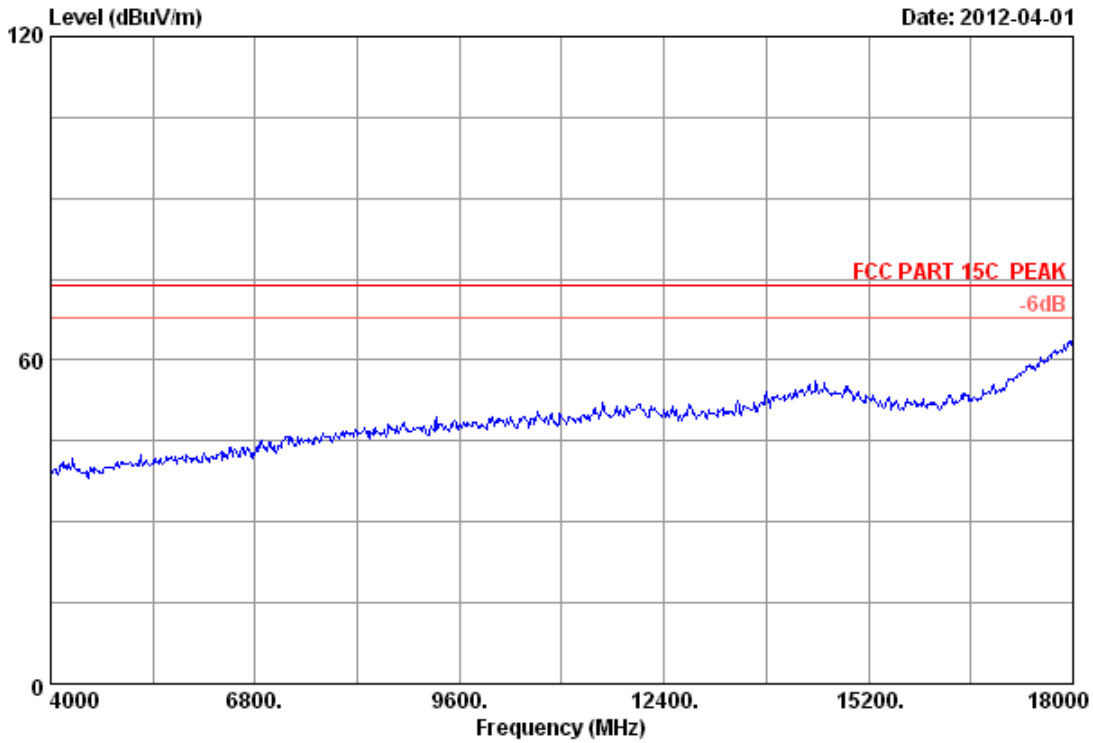

Site no. : 3m Chamber Data no. : 53
Dis. / Ant. : 3m 2011 3115 4580 Ant. pol. : VERTICAL
Limit : FCC PART 15C PEAK
Env. / Ins. : 23°C/54% Engineer : Leo-Li
EUT : 150Mbps Wireless N Router
Power supply : DC 9V From Adapter Input AC 120V/60Hz
Test mode : IEEE802.11nHT20 CH 1 2412MHz Tx
M/N : TL-WR720N

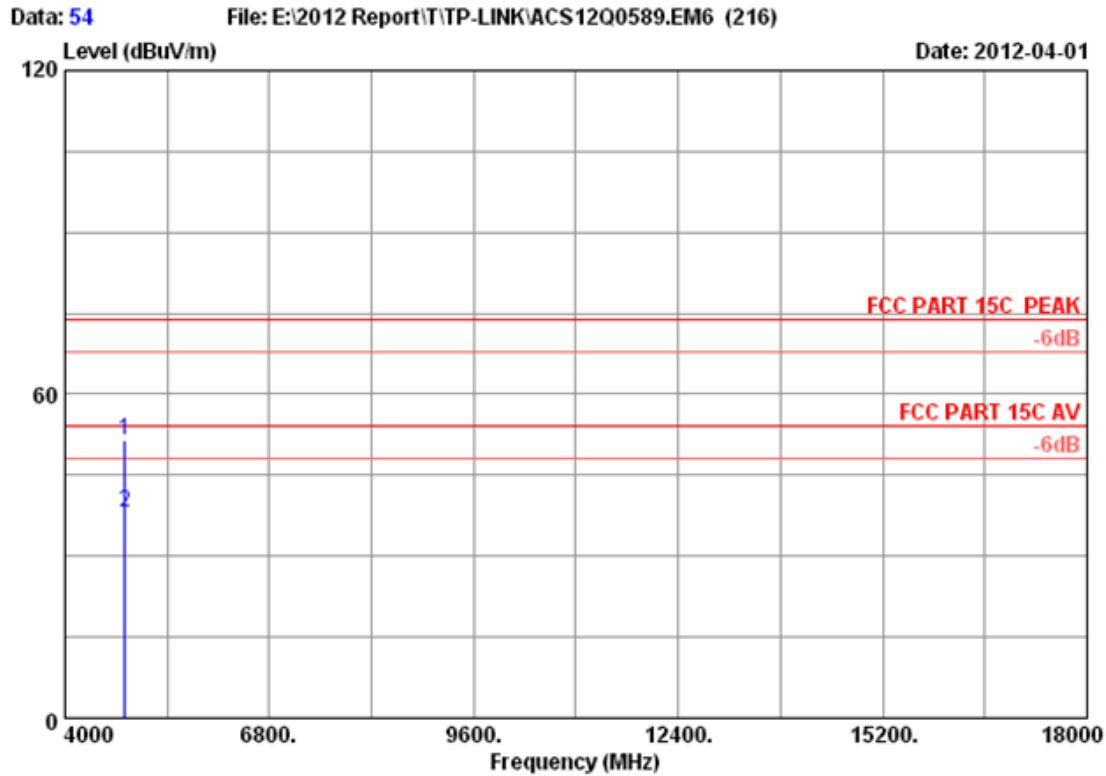

Site no. : 3m Chamber Data no. : 54
 Dis. / Ant. : 3m 2011 3115 4580 Ant. pol. : VERTICAL
 Limit : FCC PART 15C PEAK
 Env. / Ins. : 23°C/54% Engineer : Leo-Li
 EUT : 150Mbps Wireless N Router
 Power supply : DC 9V From Adapter Input AC 120V/60Hz
 Test mode : IEEE802.11nHT20 CH 1 2412MHz Tx
 M/N : TL-WR720N

	Freq. (MHz)	Ant. Factor (dB/m)	Cable loss (dB)	Amp. Factor (dB)	Reading (dBuV)	Emission Level (dBuV/m)	Limits (dBuV/m)	Margin (dB)	Remark
1	4824.000	32.89	8.53	34.60	44.61	51.43	74.00	22.57	Peak
2	4824.000	32.89	8.53	34.60	31.42	38.24	54.00	15.76	Average

Remarks:

1. Emission Level= Antenna Factor + Cable Loss -Amp Factor + Reading.
2. The emission levels that are 20dB below the official limit are not reported.

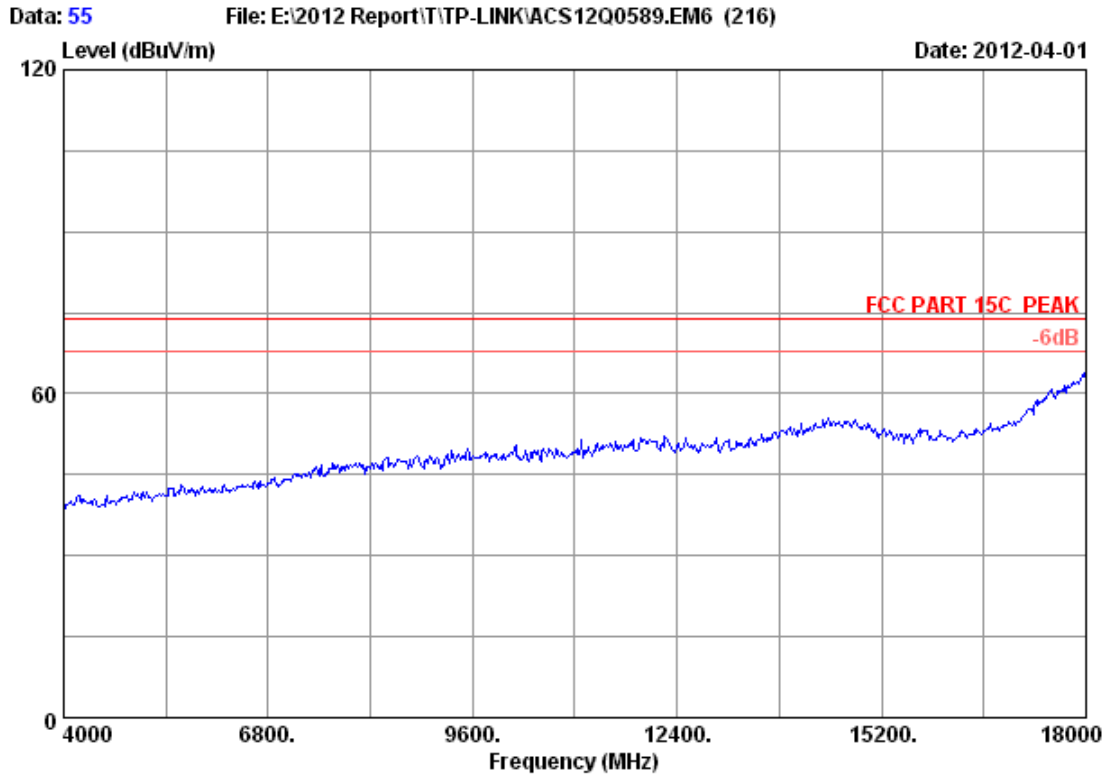

Site no. : 3m Chamber Data no. : 55
Dis. / Ant. : 3m 2011 3115 4580 Ant. pol. : HORIZONTAL
Limit : FCC PART 15C PEAK
Env. / Ins. : 23°C/54% Engineer : Leo-Li
EUT : 150Mbps Wireless N Router
Power supply : DC 9V From Adapter Input AC 120V/60Hz
Test mode : IEEE802.11nHT20 CH 1 2412MHz Tx
M/N : TL-WR720N

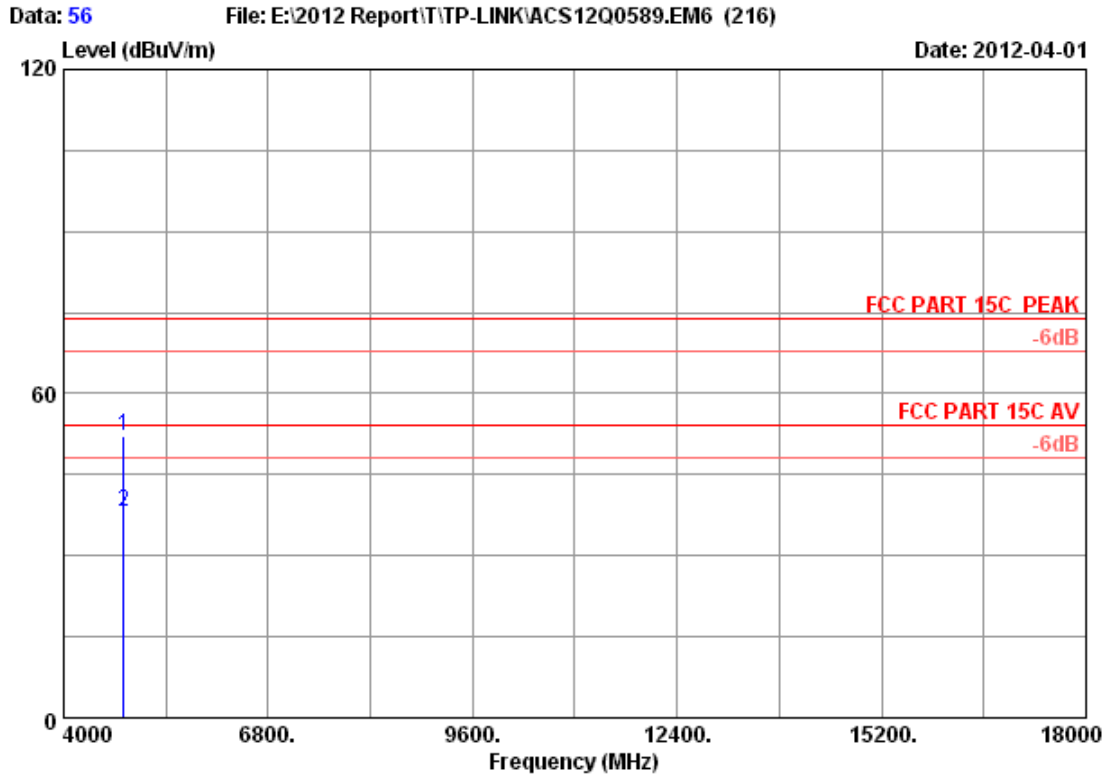

Site no. : 3m Chamber Data no. : 56
 Dis. / Ant. : 3m 2011 3115 4580 Ant. pol. : HORIZONTAL
 Limit : FCC PART 15C PEAK
 Env. / Ins. : 23°C/54% Engineer : Leo-Li
 EUT : 150Mbps Wireless N Router
 Power supply : DC 9V From Adapter Input AC 120V/60Hz
 Test mode : IEEE802.11nHT20 CH 1 2412MHz Tx
 M/N : TL-WR720N

	Freq. (MHz)	Ant. Factor (dB/m)	Cable loss (dB)	Amp. Factor (dB)	Reading (dBuV)	Emission Level (dBuV/m)	Limits (dBuV/m)	Margin (dB)	Remark
1	4824.000	32.89	8.53	34.60	45.16	51.98	74.00	22.02	Peak
2	4824.000	32.89	8.53	34.60	31.29	38.11	54.00	15.89	Average

Remarks:

1. Emission Level= Antenna Factor + Cable Loss -Amp Factor + Reading.
2. The emission levels that are 20dB below the official limit are not reported.

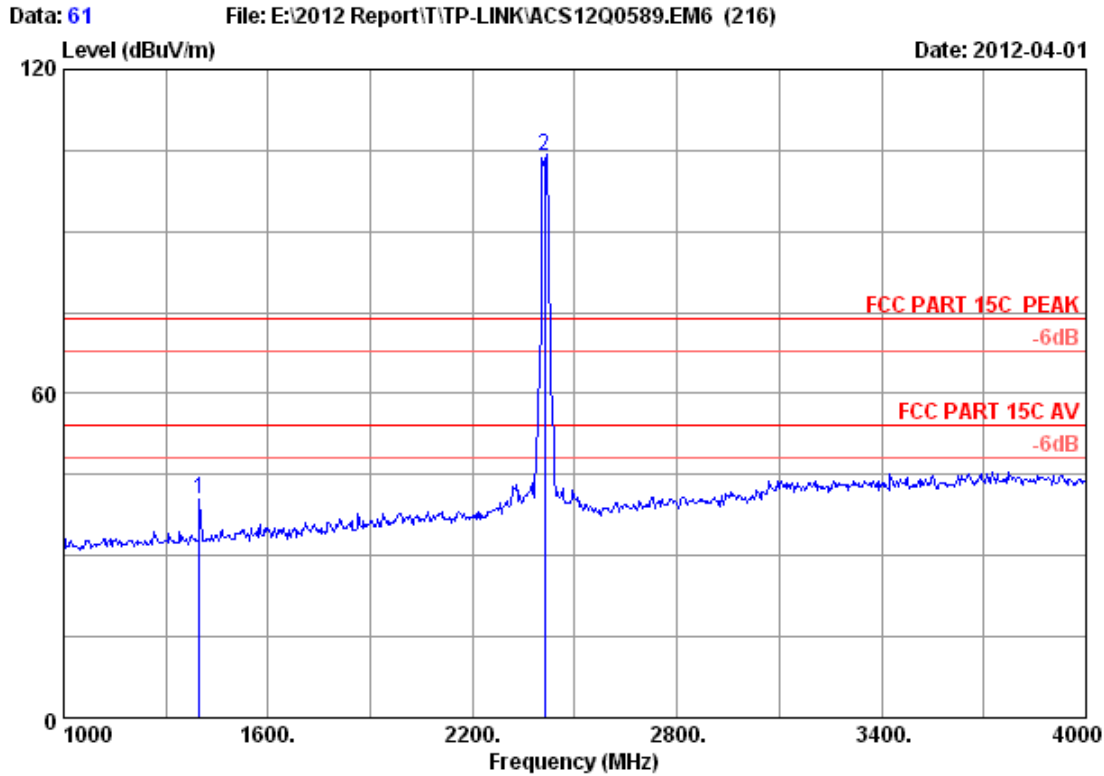

Site no. : 3m Chamber Data no. : 61
 Dis. / Ant. : 3m 2011 3115 4580 Ant. pol. : VERTICAL
 Limit : FCC PART 15C PEAK
 Env. / Ins. : 23°C/54% Engineer : Leo-Li
 EUT : 150Mbps Wireless N Router
 Power supply : DC 9V From Adapter Input AC 120V/60Hz
 Test mode : IEEE802.11nHT20 CH 1 2412MHz Tx
 M/N : TL-WR720N

	Freq. (MHz)	Ant. Factor (dB/m)	Cable loss (dB)	Amp. Factor (dB)	Emission Reading (dBuV)	Emission Level (dBuV/m)	Limits (dBuV/m)	Margin (dB)	Remark
1	1399.000	24.99	4.44	34.70	45.73	40.46	74.00	33.54	Peak
2	2412.000	27.98	6.03	34.44	104.37	103.94	74.00	-29.94	Peak

Remarks:

- Emission Level= Antenna Factor + Cable Loss -Amp Factor + Reading.
- The emission levels that are 20dB below the official limit are not reported.

Data: 62 File: E:\2012 Report\T\TP-LINK\ACS1200589.EM6 (216) Date: 2012-04-01

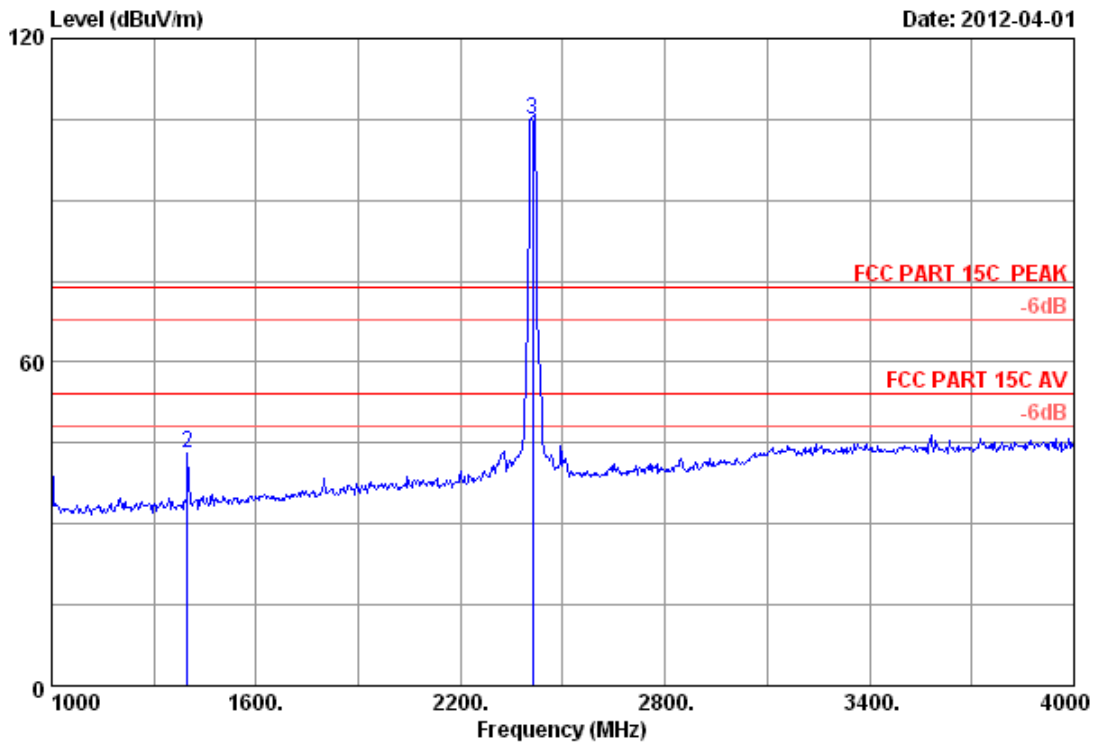

Site no. : 3m Chamber Data no. : 62
 Dis. / Ant. : 3m 2011 3115 4580 Ant. pol. : HORIZONTAL
 Limit : FCC PART 15C PEAK
 Env. / Ins. : 23°C/54% Engineer : Leo-Li
 EUT : 150Mbps Wireless N Router
 Power supply : DC 9V From Adapter Input AC 120V/60Hz
 Test mode : IEEE802.11nHT20 CH 1 2412MHz Tx
 M/N : TL-WR720N

	Freq. (MHz)	Ant. Factor (dB/m)	Cable loss (dB)	Amp. Factor (dB)	Reading (dBuV)	Emission Level (dBuV/m)	Limits (dBuV/m)	Margin (dB)	Remark
1	1000.000	23.80	3.82	34.90	48.09	40.81	74.00	33.19	Peak
2	1399.000	24.99	4.44	34.70	48.39	43.12	74.00	30.88	Peak
3	2412.000	27.98	6.03	34.44	105.45	105.02	74.00	-31.02	Peak

Remarks:

1. Emission Level= Antenna Factor + Cable Loss -Amp Factor + Reading.
2. The emission levels that are 20dB below the official limit are not reported.

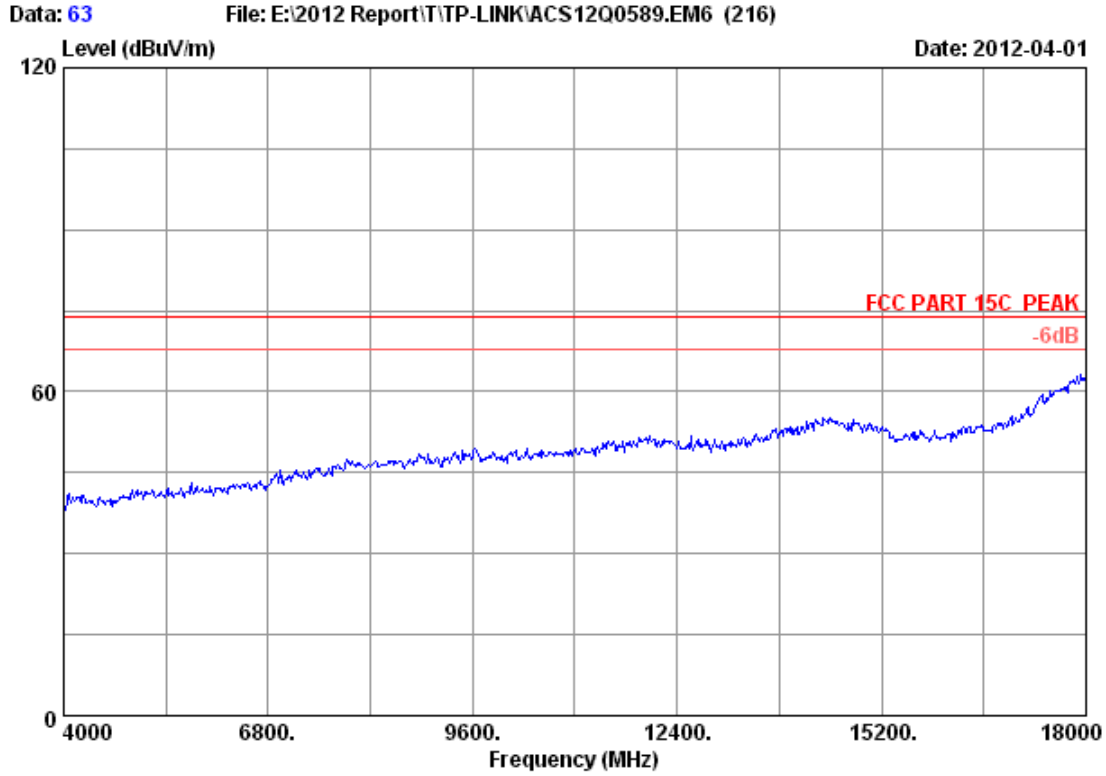

Site no. : 3m Chamber Data no. : 63
Dis. / Ant. : 3m 2011 3115 4580 Ant. pol. : HORIZONTAL
Limit : FCC PART 15C PEAK
Env. / Ins. : 23°C/54% Engineer : Leo-Li
EUT : 150Mbps Wireless N Router
Power supply : DC 9V From Adapter Input AC 120V/60Hz
Test mode : IEEE802.11nHT20 CH 6 2437MHz Tx
M/N : TL-WR720N

Data: 64 File: E:\2012 Report\T\TP-LINK\ACS1200589.EM6 (216) Date: 2012-04-01

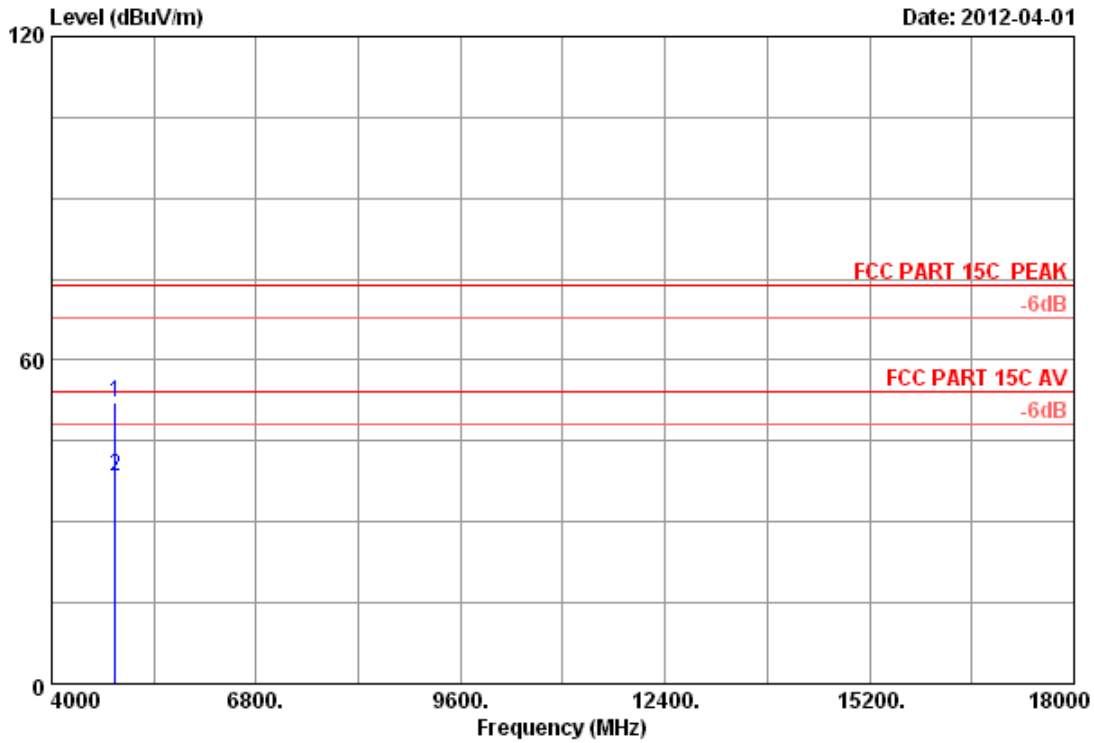

Site no. : 3m Chamber Data no. : 64
 Dis. / Ant. : 3m 2011 3115 4580 Ant. pol. : HORIZONTAL
 Limit : FCC PART 15C PEAK
 Env. / Ins. : 23°C/54% Engineer : Leo-Li
 EUT : 150Mbps Wireless N Router
 Power supply : DC 9V From Adapter Input AC 120V/60Hz
 Test mode : IEEE802.11nHT20 CH 6 2437MHz Tx
 M/N : TL-WR720N

	Freq. (MHz)	Ant. Factor (dB/m)	Cable loss (dB)	Amp. Factor (dB)	Reading (dBuV)	Emission Level (dBuV/m)	Limits (dBuV/m)	Margin (dB)	Remark
1	4874.000	32.98	8.58	34.60	45.03	51.99	74.00	22.01	Peak
2	4874.000	32.98	8.58	34.60	31.38	38.34	54.00	15.66	Average

Remarks:

1. Emission Level= Antenna Factor + Cable Loss -Amp Factor + Reading.
2. The emission levels that are 20dB below the official limit are not reported.

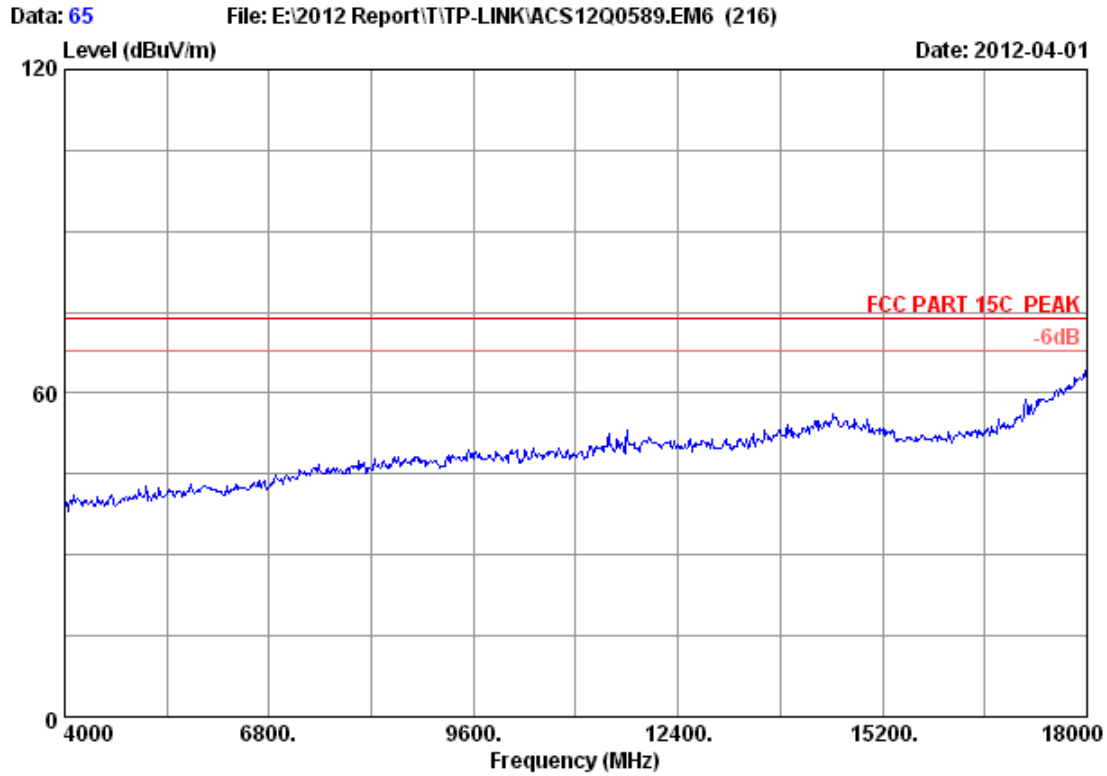

Site no. : 3m Chamber Data no. : 65
Dis. / Ant. : 3m 2011 3115 4580 Ant. pol. : VERTICAL
Limit : FCC PART 15C PEAK
Env. / Ins. : 23°C/54% Engineer : Leo-Li
EUT : 150Mbps Wireless N Router
Power supply : DC 9V From Adapter Input AC 120V/60Hz
Test mode : IEEE802.11nHT20 CH 6 2437MHz Tx
M/N : TL-WR720N

Data: 66 File: E:\2012 Report\T\TP-LINK\ACS1200589.EM6 (216) Date: 2012-04-01

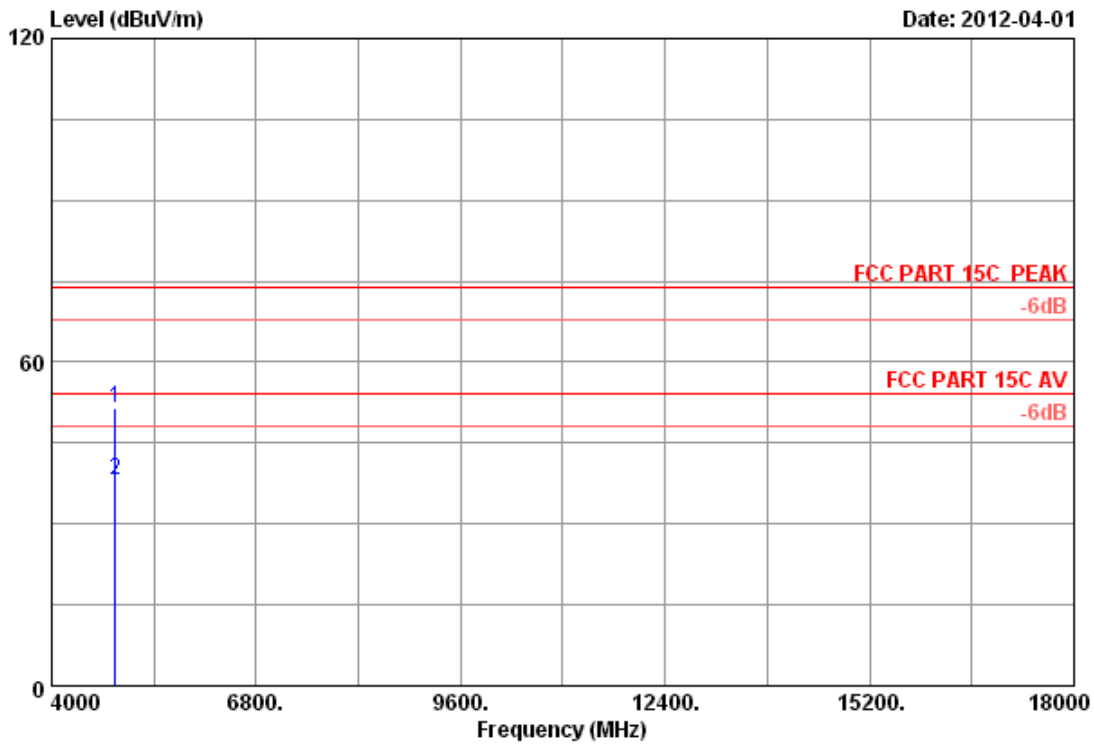

Site no. : 3m Chamber Data no. : 66
 Dis. / Ant. : 3m 2011 3115 4580 Ant. pol. : VERTICAL
 Limit : FCC PART 15C PEAK
 Env. / Ins. : 23°C/54% Engineer : Leo-Li
 EUT : 150Mbps Wireless N Router
 Power supply : DC 9V From Adapter Input AC 120V/60Hz
 Test mode : IEEE802.11nHT20 CH 6 2437MHz Tx
 M/N : TL-WR720N

	Freq. (MHz)	Ant. Factor (dB/m)	Cable loss (dB)	Amp. Factor (dB)	Reading (dBuV)	Emission Level (dBuV/m)	Limits (dBuV/m)	Margin (dB)	Remark
1	4874.000	32.98	8.58	34.60	44.65	51.61	74.00	22.39	Peak
2	4874.000	32.98	8.58	34.60	31.27	38.23	54.00	15.77	Average

Remarks:

1. Emission Level= Antenna Factor + Cable Loss -Amp Factor + Reading.
2. The emission levels that are 20dB below the official limit are not reported.

Data: 67 File: E:\2012 Report\T\TP-LINK\ACS1200589.EM6 (216) Date: 2012-04-01

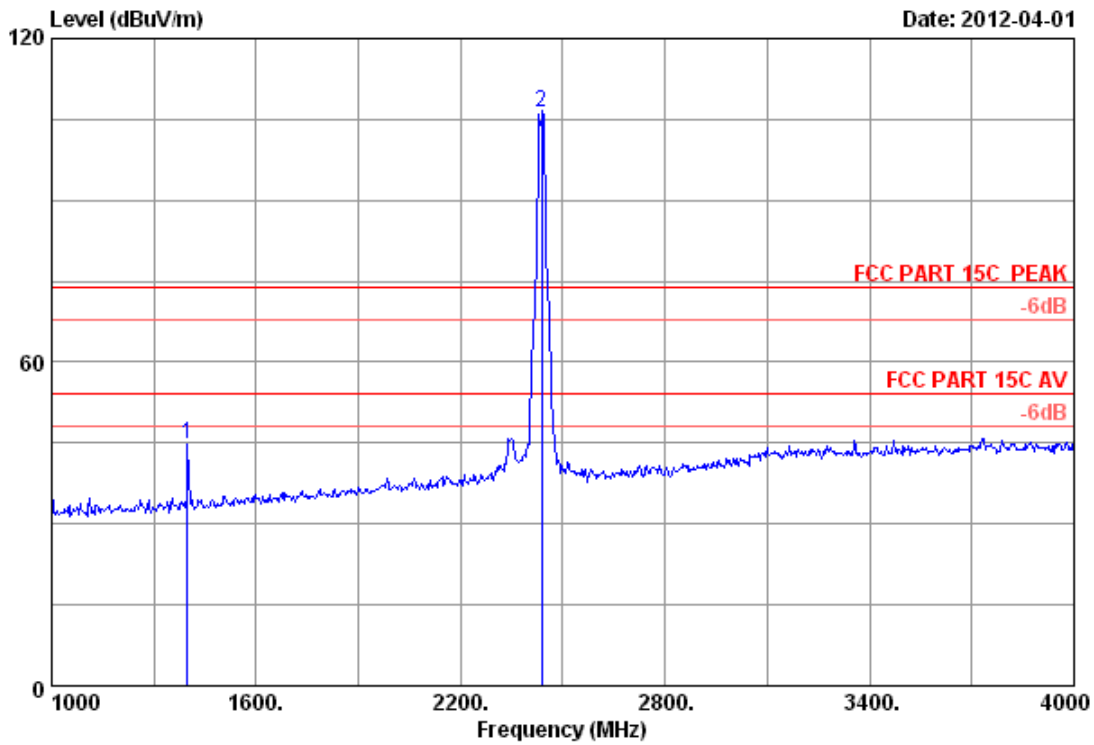

Site no. : 3m Chamber Data no. : 67
 Dis. / Ant. : 3m 2011 3115 4580 Ant. pol. : VERTICAL
 Limit : FCC PART 15C PEAK
 Env. / Ins. : 23°C/54% Engineer : Leo-Li
 EUT : 150Mbps Wireless N Router
 Power supply : DC 9V From Adapter Input AC 120V/60Hz
 Test mode : IEEE802.11nHT20 CH 6 2437MHz Tx
 M/N : TL-WR720N

	Freq. (MHz)	Ant. Factor (dB/m)	Cable loss (dB)	Amp. Factor (dB)	Reading (dBuV)	Emission Level (dBuV/m)	Limits (dBuV/m)	Margin (dB)	Remark
1	1399.000	24.99	4.44	34.70	49.90	44.63	74.00	29.37	Peak
2	2437.000	28.03	6.06	34.44	106.74	106.39	74.00	-32.39	Peak

Remarks:

1. Emission Level= Antenna Factor + Cable Loss -Amp Factor + Reading.
2. The emission levels that are 20dB below the official limit are not reported.

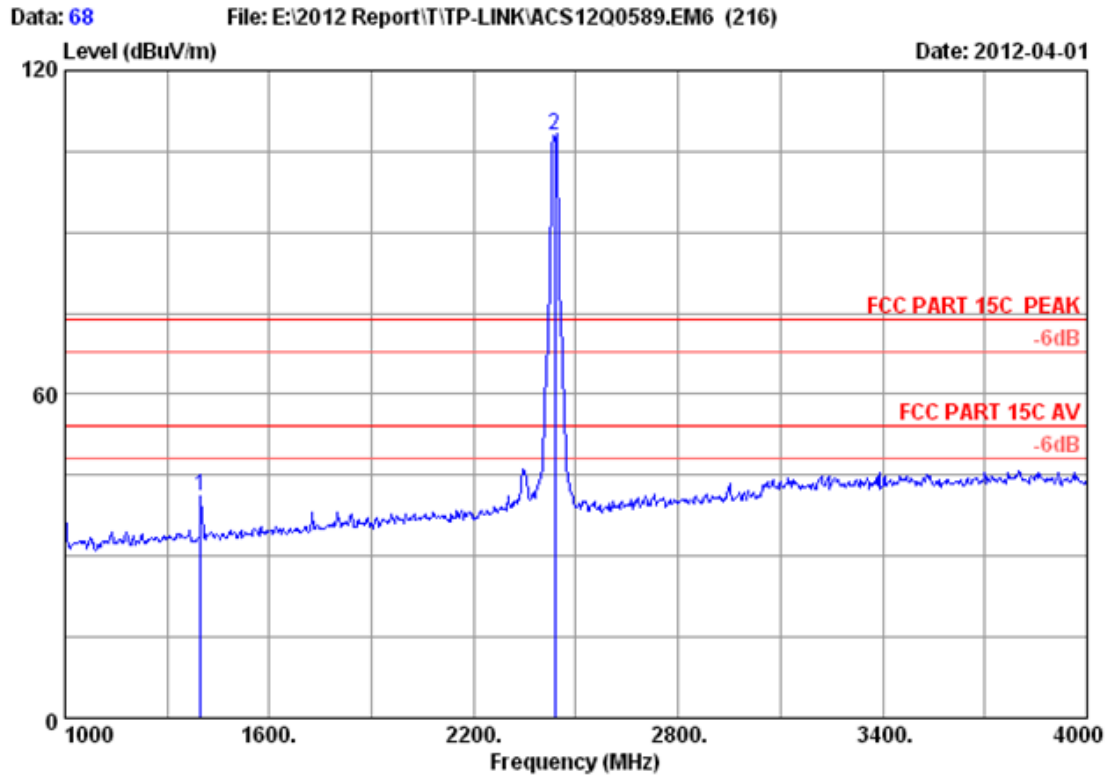

Site no. : 3m Chamber Data no. : 68
 Dis. / Ant. : 3m 2011 3115 4580 Ant. pol. : HORIZONTAL
 Limit : FCC PART 15C PEAK
 Env. / Ins. : 23°C/54% Engineer : Leo-Li
 EUT : 150Mbps Wireless N Router
 Power supply : DC 9V From Adapter Input AC 120V/60Hz
 Test mode : IEEE802.11nHT20 CH 6 2437MHz Tx
 M/N : TL-WR720N

	Freq. (MHz)	Ant. Factor (dB/m)	Cable loss (dB)	Amp. Factor (dB)	Reading (dBuV)	Emission Level (dBuV/m)	Limits (dBuV/m)	Margin (dB)	Remark
1	1399.000	24.99	4.44	34.70	46.38	41.11	74.00	32.89	Peak
2	2437.000	28.03	6.06	34.44	108.47	108.12	74.00	-34.12	Peak

Remarks:

1. Emission Level= Antenna Factor + Cable Loss -Amp Factor + Reading.
2. The emission levels that are 20dB below the official limit are not reported.

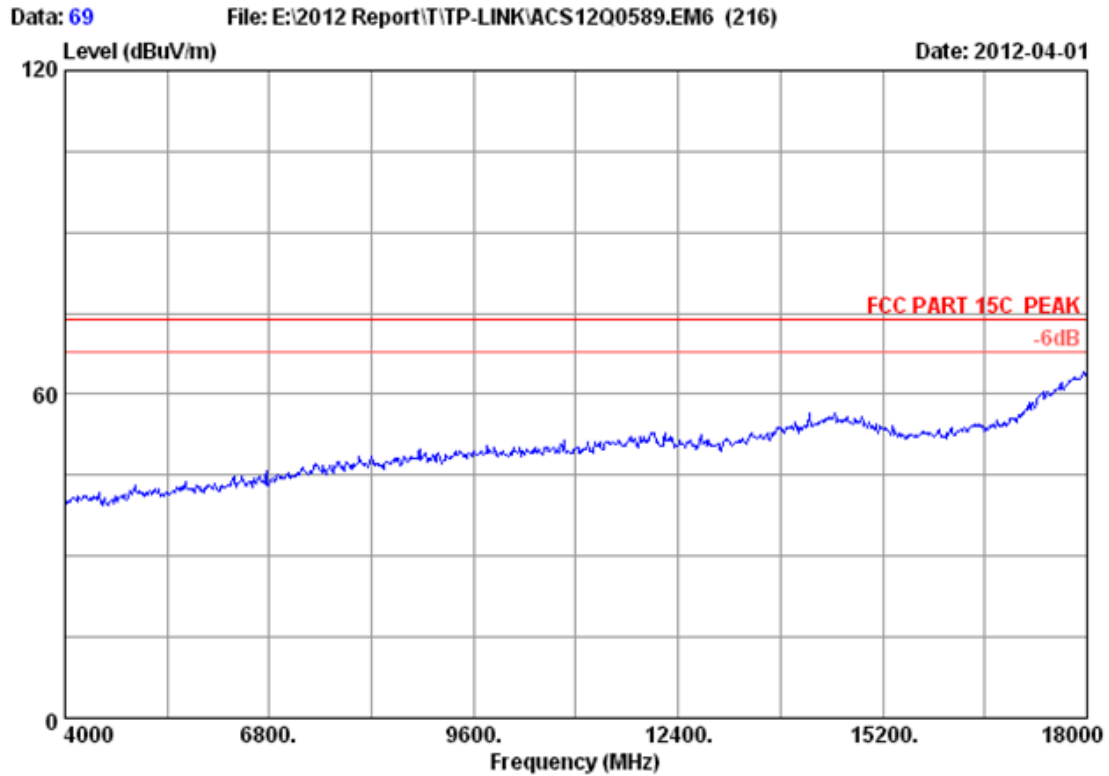

Site no. : 3m Chamber Data no. : 69
Dis. / Ant. : 3m 2011 3115 4580 Ant. pol. : VERTICAL
Limit : FCC PART 15C PEAK
Env. / Ins. : 23°C/54% Engineer : Leo-Li
EUT : 150Mbps Wireless N Router
Power supply : DC 9V From Adapter Input AC 120V/60Hz
Test mode : IEEE802.11nHT20 CH 11 2462MHz Tx
M/N : TL-WR720N

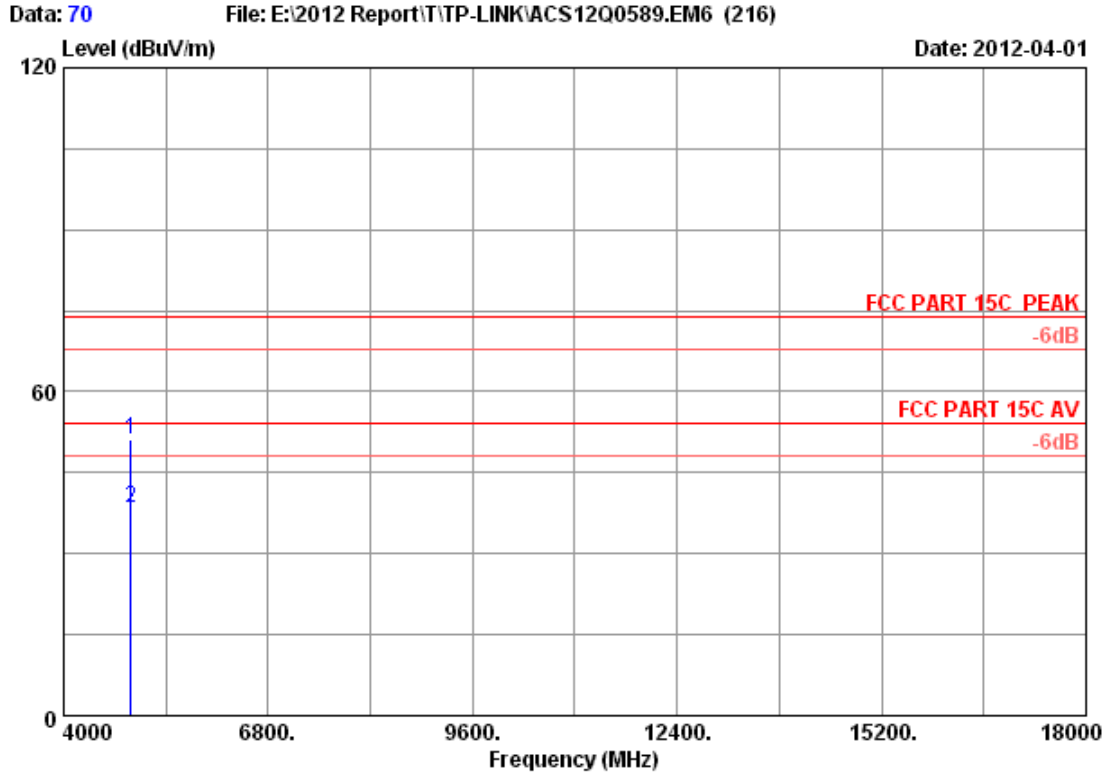

Site no. : 3m Chamber Data no. : 70
 Dis. / Ant. : 3m 2011 3115 4580 Ant. pol. : VERTICAL
 Limit : FCC PART 15C PEAK
 Env. / Ins. : 23°C/54% Engineer : Leo-Li
 EUT : 150Mbps Wireless N Router
 Power supply : DC 9V From Adapter Input AC 120V/60Hz
 Test mode : IEEE802.11nHT20 CH 11 2462MHz Tx
 M/N : TL-WR720N

	Freq. (MHz)	Ant. Factor (dB/m)	Cable loss (dB)	Amp. Factor (dB)	Reading (dBuV)	Emission Level (dBuV/m)	Limits (dBuV/m)	Margin (dB)	Remark
1	4924.000	33.08	8.62	34.60	44.00	51.10	74.00	22.90	Peak
2	4924.000	33.08	8.62	34.60	31.25	38.35	54.00	15.65	Average

Remarks:

1. Emission Level= Antenna Factor + Cable Loss -Amp Factor + Reading.
2. The emission levels that are 20dB below the official limit are not reported.

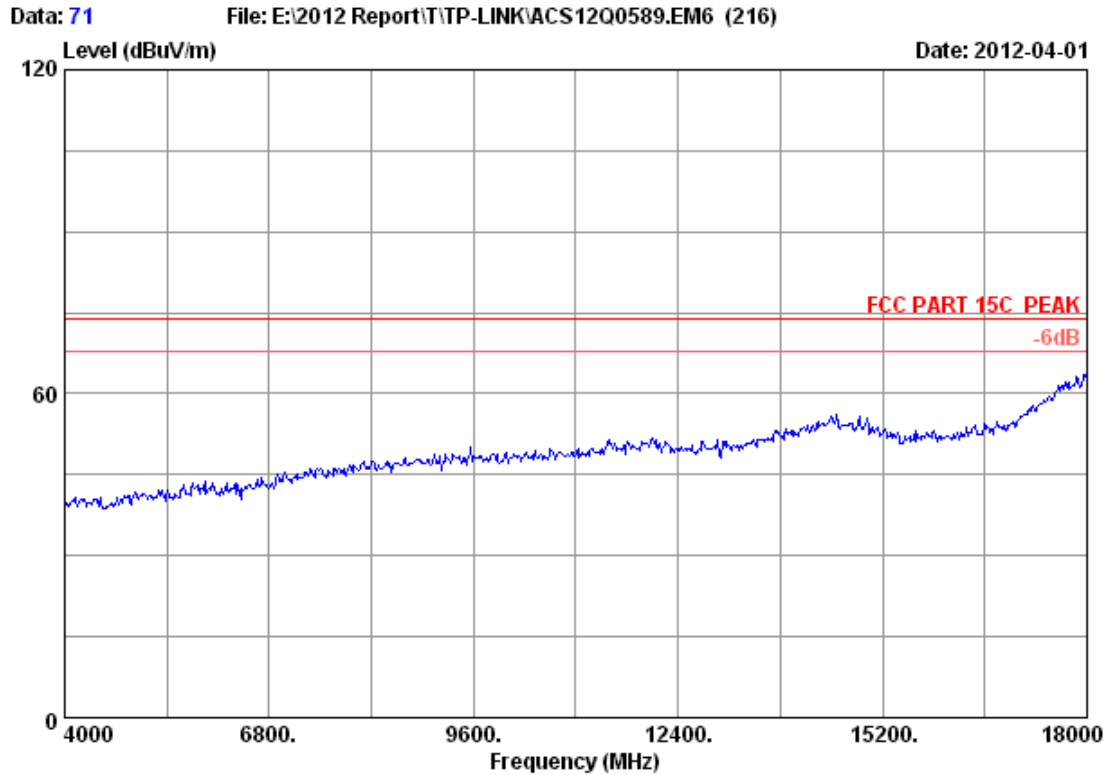

Site no. : 3m Chamber Data no. : 71
Dis. / Ant. : 3m 2011 3115 4580 Ant. pol. : HORIZONTAL
Limit : FCC PART 15C PEAK
Env. / Ins. : 23°C/54% Engineer : Leo-Li
EUT : 150Mbps Wireless N Router
Power supply : DC 9V From Adapter Input AC 120V/60Hz
Test mode : IEEE802.11nHT20 CH 11 2462MHz Tx
M/N : TL-WR720N

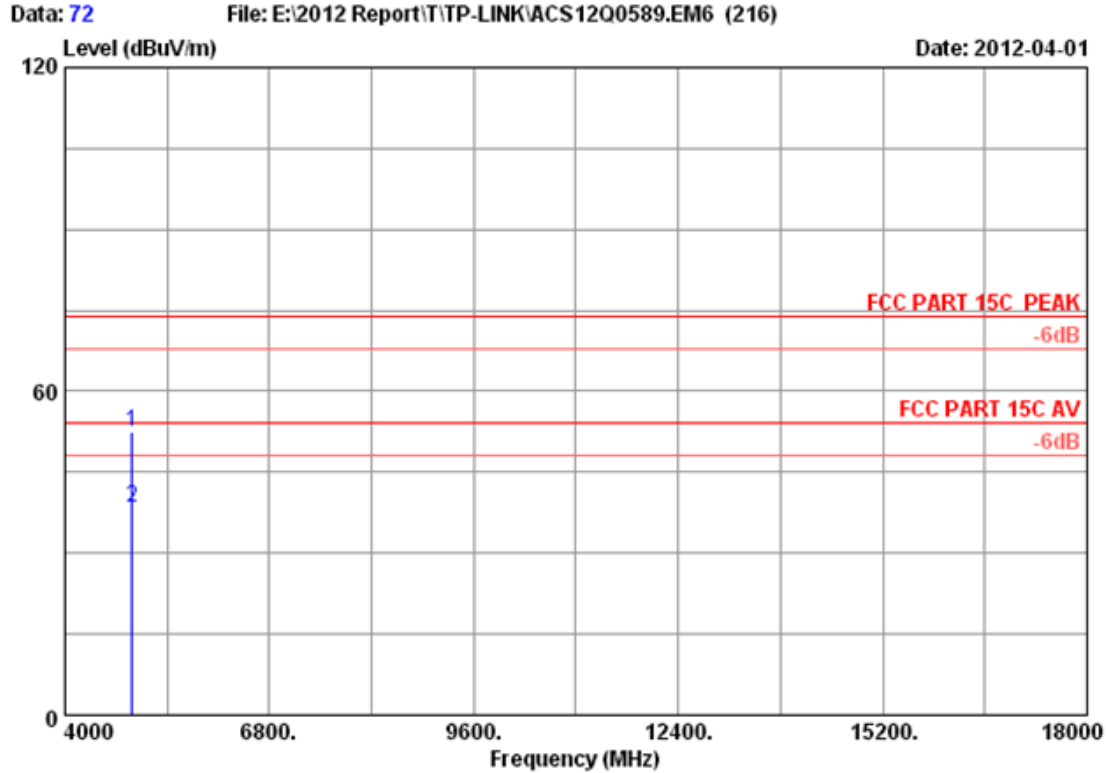

Site no. : 3m Chamber Data no. : 72
 Dis. / Ant. : 3m 2011 3115 4580 Ant. pol. : HORIZONTAL
 Limit : FCC PART 15C PEAK
 Env. / Ins. : 23°C/54% Engineer : Leo-Li
 EUT : 150Mbps Wireless N Router
 Power supply : DC 9V From Adapter Input AC 120V/60Hz
 Test mode : IEEE802.11nHT20 CH 11 2462MHz Tx
 M/N : TL-WR720N

	Freq. (MHz)	Ant. Factor (dB/m)	Cable loss (dB)	Amp. Factor (dB)	Reading (dBuV)	Emission Level (dBuV/m)	Limits (dBuV/m)	Margin (dB)	Remark
1	4924.000	33.08	8.62	34.60	45.37	52.47	74.00	21.53	Peak
2	4924.000	33.08	8.62	34.60	31.46	38.56	54.00	15.44	Average

Remarks:

1. Emission Level= Antenna Factor + Cable Loss -Amp Factor + Reading.
2. The emission levels that are 20dB below the official limit are not reported.

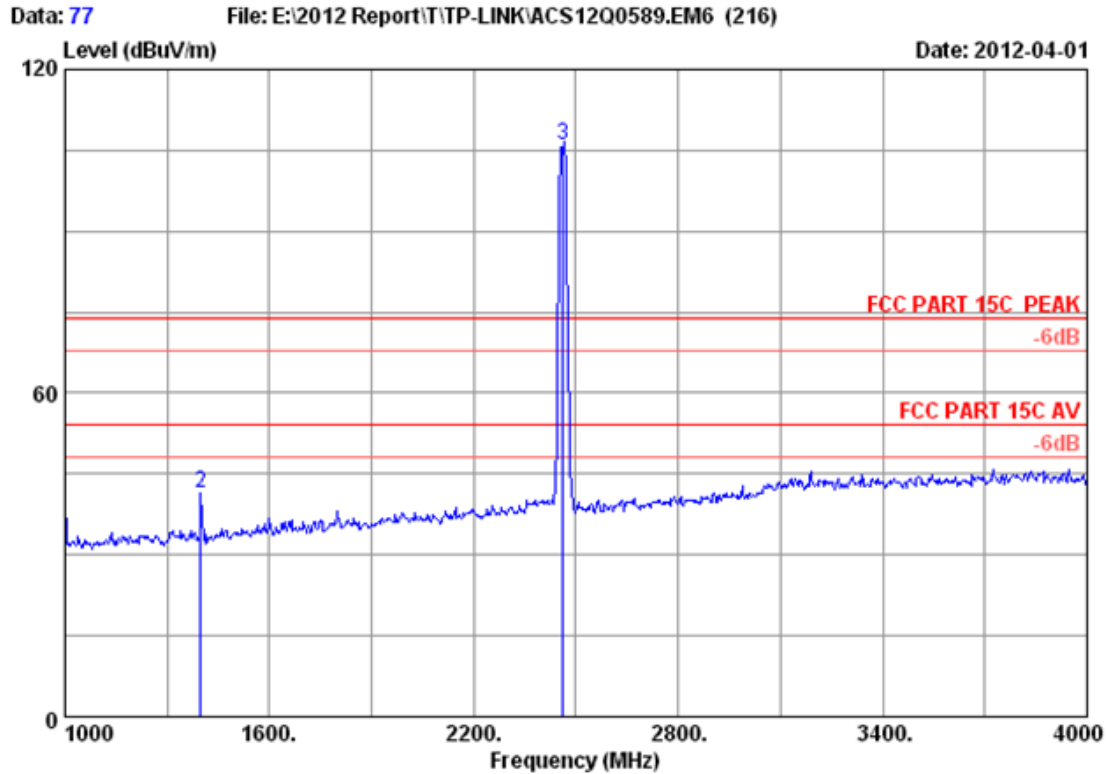

```

Site no.      : 3m Chamber           Data no.   : 77
Dis. / Ant.  : 3m 2011 3115 4580     Ant. pol.  : HORIZONTAL
Limit        : FCC PART 15C PEAK
Env. / Ins.  : 23°C/54%              Engineer   : Leo-Li
EUT          : 150Mbps Wireless N Router
Power supply : DC 9V From Adapter Input AC 120V/60Hz
Test mode    : IEEE802.11nHT20      CH 11     2462MHz Tx
M/N         : TL-WR720N
    
```

	Freq. (MHz)	Ant. Factor (dB/m)	Cable loss (dB)	Amp. Factor (dB)	Reading (dBuV)	Emission Level (dBuV/m)	Limits (dBuV/m)	Margin (dB)	Remark
1	1000.000	23.80	3.82	34.90	46.10	38.82	74.00	35.18	Peak
2	1399.000	24.99	4.44	34.70	46.74	41.47	74.00	32.53	Peak
3	2462.000	28.05	6.12	34.44	106.13	105.86	74.00	-31.86	Peak

Remarks:

1. Emission Level= Antenna Factor + Cable Loss -Amp Factor + Reading.
2. The emission levels that are 20dB below the official limit are not reported.

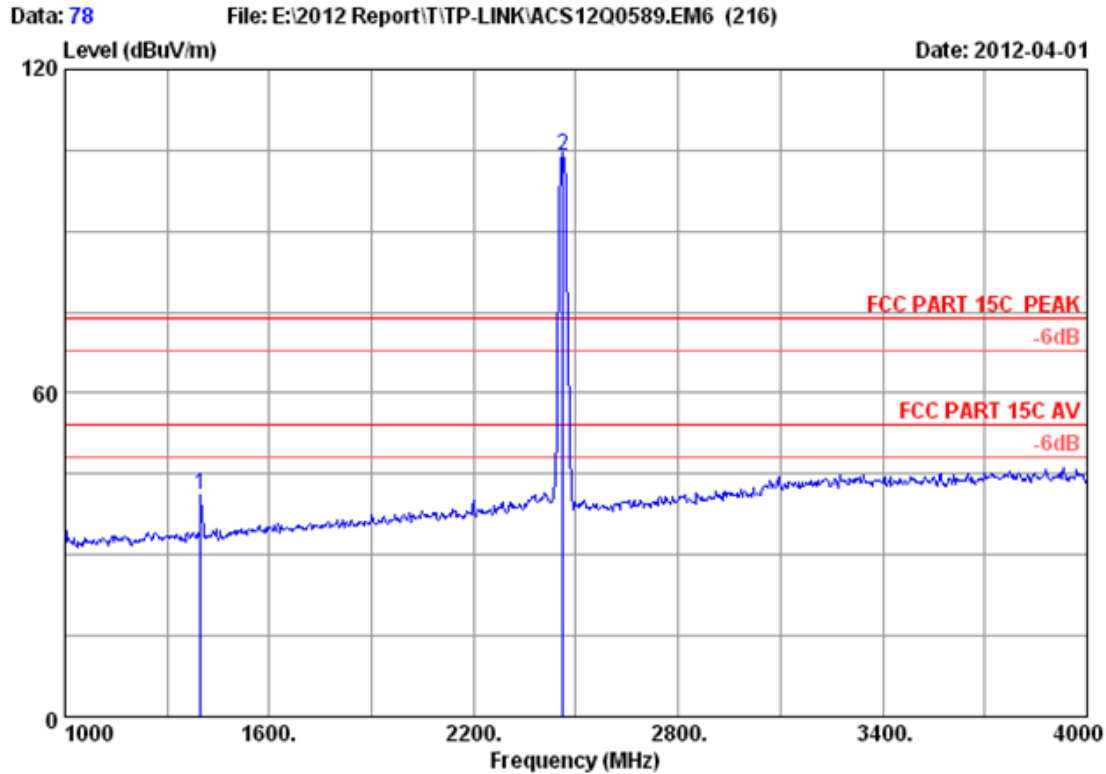

Site no. : 3m Chamber Data no. : 78
 Dis. / Ant. : 3m 2011 3115 4580 Ant. pol. : VERTICAL
 Limit : FCC PART 15C PEAK
 Env. / Ins. : 23°C/54% Engineer : Leo-Li
 EUT : 150Mbps Wireless N Router
 Power supply : DC 9V From Adapter Input AC 120V/60Hz
 Test mode : IEEE802.11nHT20 CH 11 2462MHz Tx
 M/N : TL-WR720N

	Freq. (MHz)	Ant. Factor (dB/m)	Cable loss (dB)	Amp. Factor (dB)	Reading (dBuV)	Emission Level (dBuV/m)	Limits (dBuV/m)	Margin (dB)	Remark
1	1399.000	24.99	4.44	34.70	46.49	41.22	74.00	32.78	Peak
2	2462.000	28.05	6.12	34.44	104.28	104.01	74.00	-30.01	Peak

Remarks:

1. Emission Level= Antenna Factor + Cable Loss -Amp Factor + Reading.
2. The emission levels that are 20dB below the official limit are not reported.

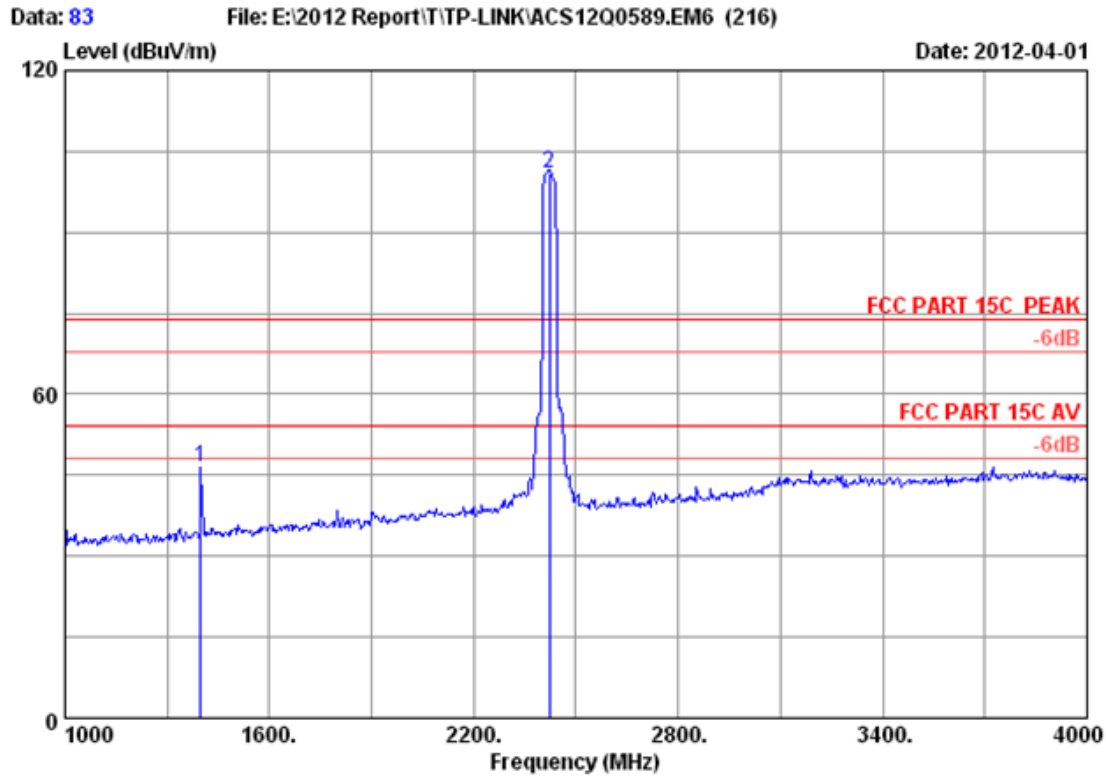

Site no. : 3m Chamber Data no. : 83
 Dis. / Ant. : 3m 2011 3115 4580 Ant. pol. : VERTICAL
 Limit : FCC PART 15C PEAK
 Env. / Ins. : 23°C/54% Engineer : Leo-Li
 EUT : 150Mbps Wireless N Router
 Power supply : DC 9V From Adapter Input AC 120V/60Hz
 Test mode : IEEE802.11nHT40 CH 1 2422MHz Tx
 M/N : TL-WR720N

	Freq. (MHz)	Ant. Factor (dB/m)	Cable loss (dB)	Amp. Factor (dB)	Reading (dBuV)	Emission Level (dBuV/m)	Limits (dBuV/m)	Margin (dB)	Remark
1	1399.000	24.99	4.44	34.70	51.61	46.34	74.00	27.66	Peak
2	2422.000	28.00	6.06	34.44	101.28	100.90	74.00	-26.90	Peak

Remarks:

1. Emission Level= Antenna Factor + Cable Loss -Amp Factor + Reading.
2. The emission levels that are 20dB below the official limit are not reported.

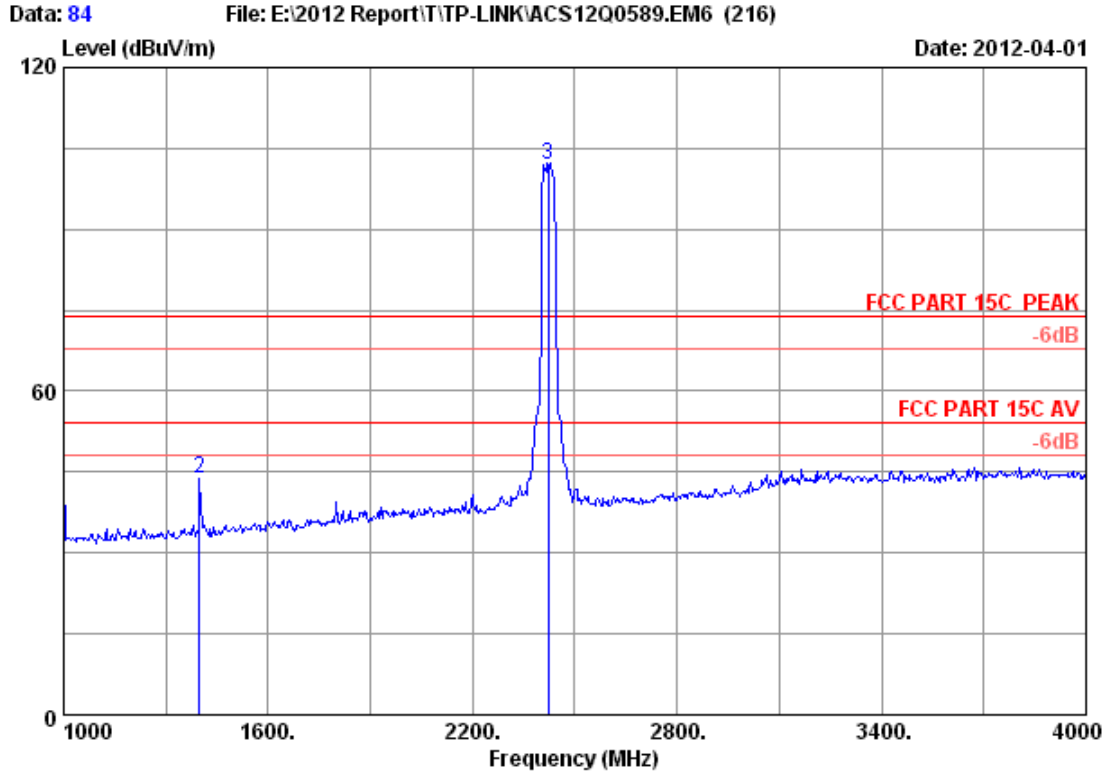

Site no. : 3m Chamber Data no. : 84
 Dis. / Ant. : 3m 2011 3115 4580 Ant. pol. : HORIZONTAL
 Limit : FCC PART 15C PEAK
 Env. / Ins. : 23°C/54% Engineer : Leo-Li
 EUT : 150Mbps Wireless N Router
 Power supply : DC 9V From Adapter Input AC 120V/60Hz
 Test mode : IEEE802.11nHT40 CH 1 2422MHz Tx
 M/N : TL-WR720N

	Freq. (MHz)	Ant. Factor (dB/m)	Cable loss (dB)	Amp. Factor (dB)	Reading (dBuV)	Emission Level (dBuV/m)	Limits (dBuV/m)	Margin (dB)	Remark
1	1000.000	23.80	3.82	34.90	48.30	41.02	74.00	32.98	Peak
2	1399.000	24.99	4.44	34.70	49.01	43.74	74.00	30.26	Peak
3	2422.000	28.00	6.06	34.44	102.19	101.81	74.00	-27.81	Peak

Remarks:

1. Emission Level= Antenna Factor + Cable Loss -Amp Factor + Reading.
2. The emission levels that are 20dB below the official limit are not reported.

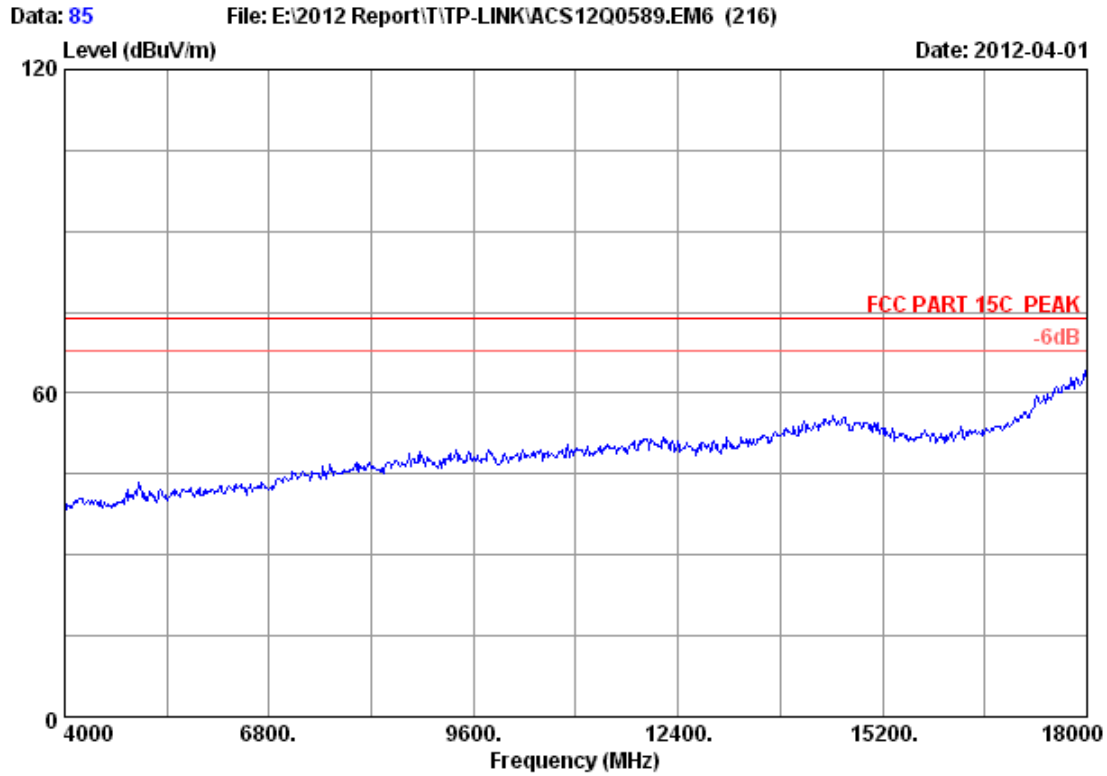

Site no. : 3m Chamber Data no. : 85
Dis. / Ant. : 3m 2011 3115 4580 Ant. pol. : HORIZONTAL
Limit : FCC PART 15C PEAK
Env. / Ins. : 23°C/54% Engineer : Leo-Li
EUT : 150Mbps Wireless N Router
Power supply : DC 9V From Adapter Input AC 120V/60Hz
Test mode : IEEE802.11nHT40 CH 1 2422MHz Tx
M/N : TL-WR720N

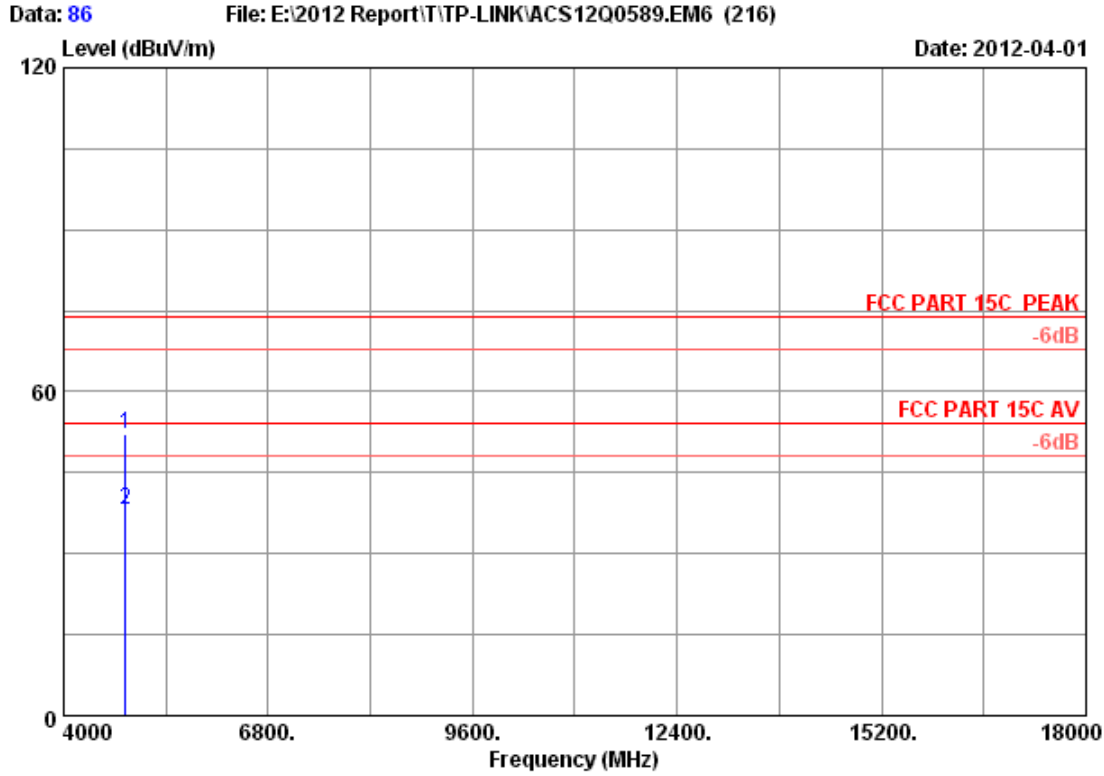

Site no. : 3m Chamber Data no. : 86
 Dis. / Ant. : 3m 2011 3115 4580 Ant. pol. : HORIZONTAL
 Limit : FCC PART 15C PEAK
 Env. / Ins. : 23°C/54% Engineer : Leo-Li
 EUT : 150Mbps Wireless N Router
 Power supply : DC 9V From Adapter Input AC 120V/60Hz
 Test mode : IEEE802.11nHT40 CH 1 2422MHz Tx
 M/N : TL-WR720N

	Freq. (MHz)	Ant. Factor (dB/m)	Cable loss (dB)	Amp. Factor (dB)	Reading (dBuV)	Emission Level (dBuV/m)	Limits (dBuV/m)	Margin (dB)	Remark
1	4844.000	32.92	8.55	34.60	45.36	52.23	74.00	21.77	Peak
2	4844.000	32.92	8.55	34.60	31.26	38.13	54.00	15.87	Average

Remarks:

1. Emission Level= Antenna Factor + Cable Loss -Amp Factor + Reading.
2. The emission levels that are 20dB below the official limit are not reported.

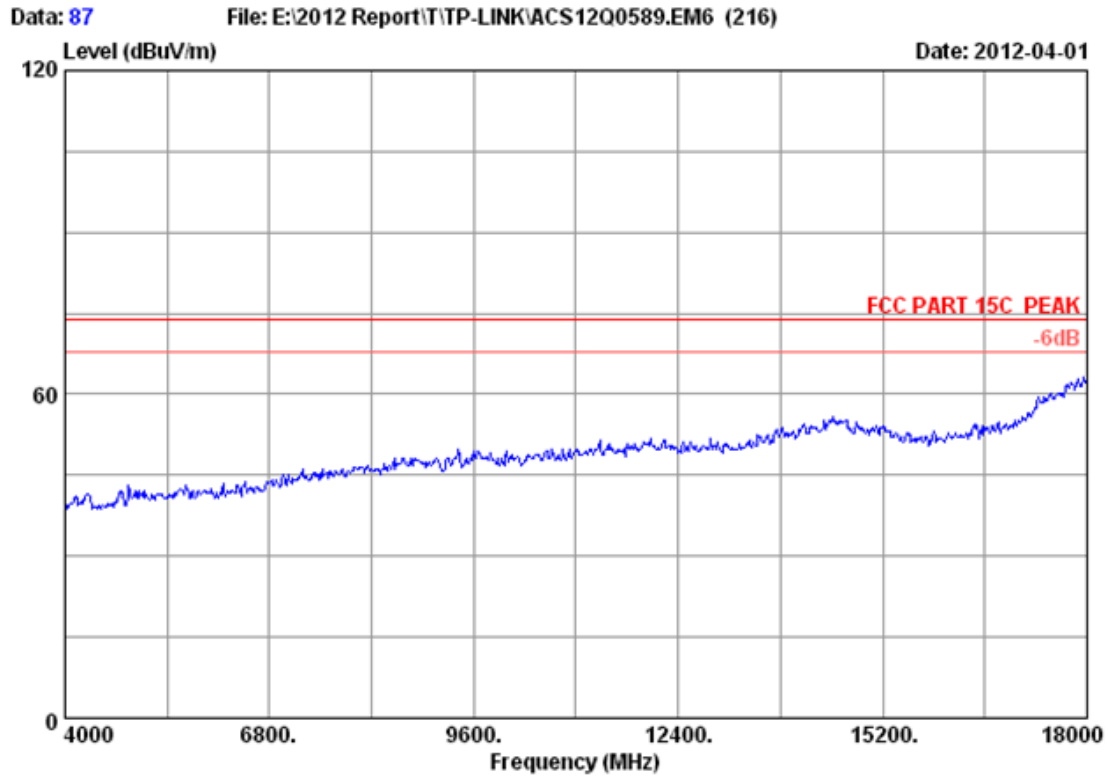

Site no. : 3m Chamber Data no. : 87
Dis. / Ant. : 3m 2011 3115 4580 Ant. pol. : VERTICAL
Limit : FCC PART 15C PEAK
Env. / Ins. : 23°C/54% Engineer : Leo-Li
EUT : 150Mbps Wireless N Router
Power supply : DC 9V From Adapter Input AC 120V/60Hz
Test mode : IEEE802.11nHT40 CH 1 2422MHz Tx
M/N : TL-WR720N

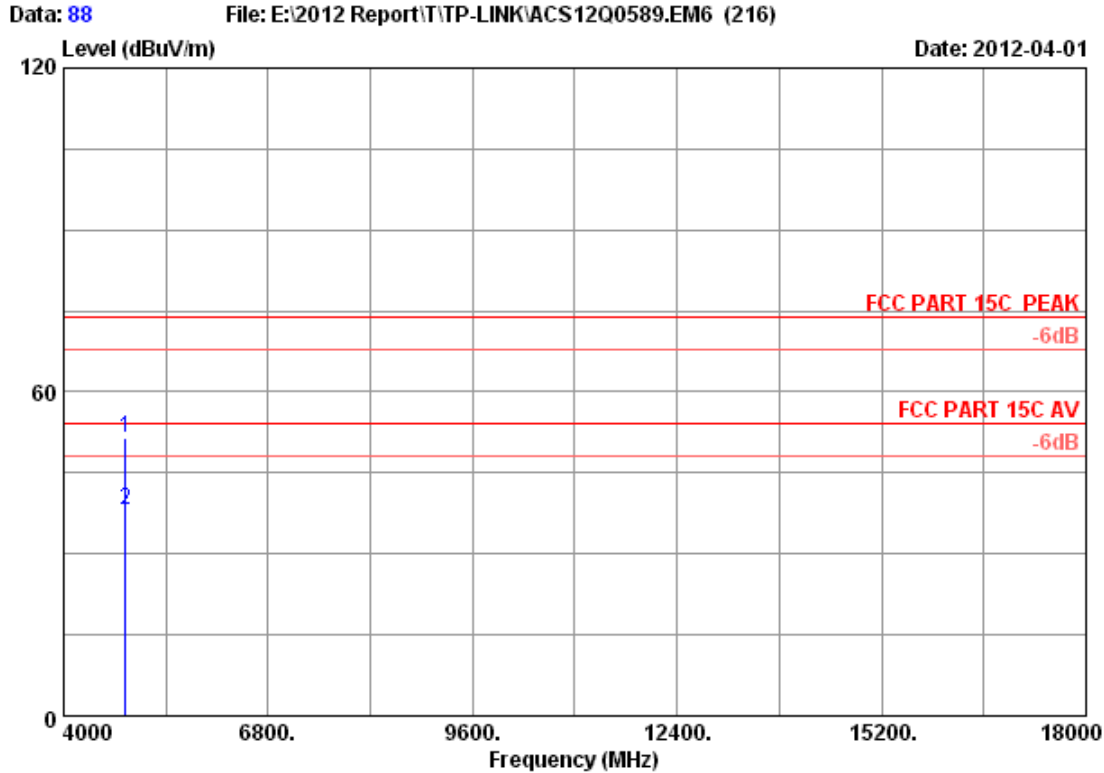

Site no. : 3m Chamber Data no. : 88
 Dis. / Ant. : 3m 2011 3115 4580 Ant. pol. : VERTICAL
 Limit : FCC PART 15C PEAK
 Env. / Ins. : 23°C/54% Engineer : Leo-Li
 EUT : 150Mbps Wireless N Router
 Power supply : DC 9V From Adapter Input AC 120V/60Hz
 Test mode : IEEE802.11nHT40 CH 1 2422MHz Tx
 M/N : TL-WR720N

	Freq. (MHz)	Ant. Factor (dB/m)	Cable loss (dB)	Amp. Factor (dB)	Reading (dBuV)	Emission Level (dBuV/m)	Limits (dBuV/m)	Margin (dB)	Remark
1	4844.000	32.92	8.55	34.60	44.75	51.62	74.00	22.38	Peak
2	4844.000	32.92	8.55	34.60	31.19	38.06	54.00	15.94	Average

Remarks:

1. Emission Level= Antenna Factor + Cable Loss -Amp Factor + Reading.
2. The emission levels that are 20dB below the official limit are not reported.

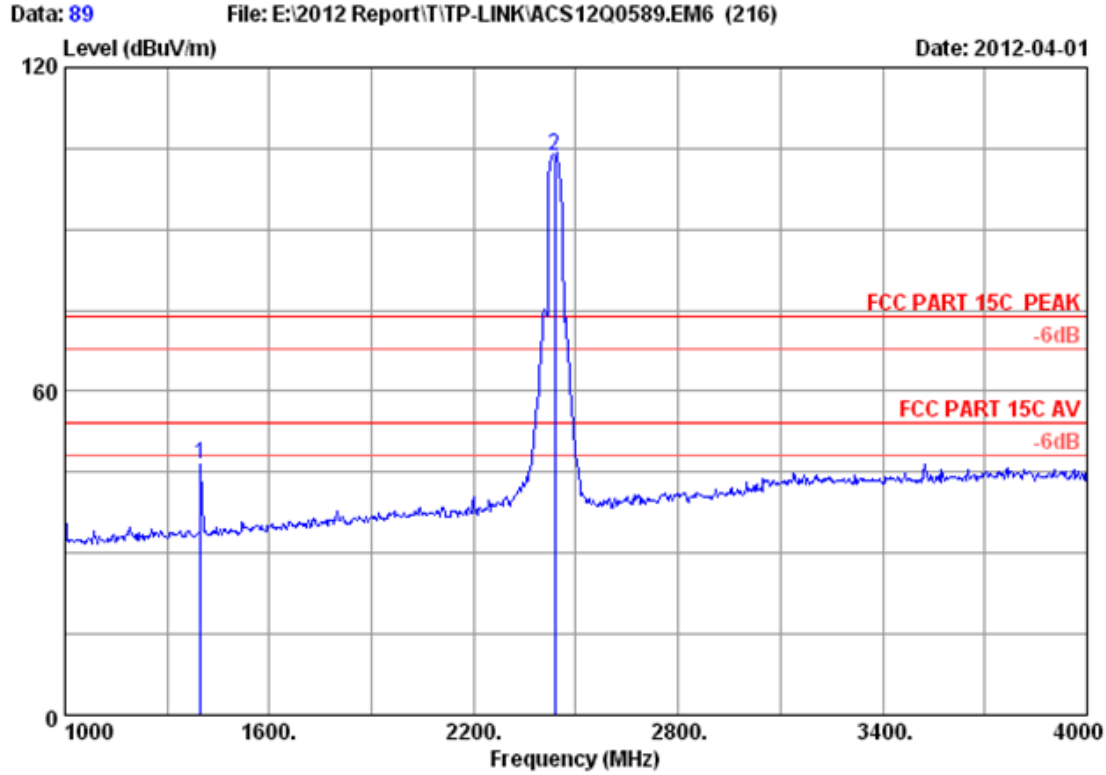

Site no. : 3m Chamber Data no. : 89
 Dis. / Ant. : 3m 2011 3115 4580 Ant. pol. : VERTICAL
 Limit : FCC PART 15C PEAK
 Env. / Ins. : 23°C/54% Engineer : Leo-Li
 EUT : 150Mbps Wireless N Router
 Power supply : DC 9V From Adapter Input AC 120V/60Hz
 Test mode : IEEE802.11nHT40 CH 4 2437MHz Tx
 M/N : TL-WR720N

	Freq. (MHz)	Ant. Factor (dB/m)	Cable loss (dB)	Amp. Factor (dB)	Reading (dBuV)	Emission Level (dBuV/m)	Limits (dBuV/m)	Margin (dB)	Remark
1	1399.000	24.99	4.44	34.70	51.70	46.43	74.00	27.57	Peak
2	2437.000	28.03	6.06	34.44	103.84	103.49	74.00	-29.49	Peak

Remarks:

1. Emission Level= Antenna Factor + Cable Loss -Amp Factor + Reading.
2. The emission levels that are 20dB below the official limit are not reported.

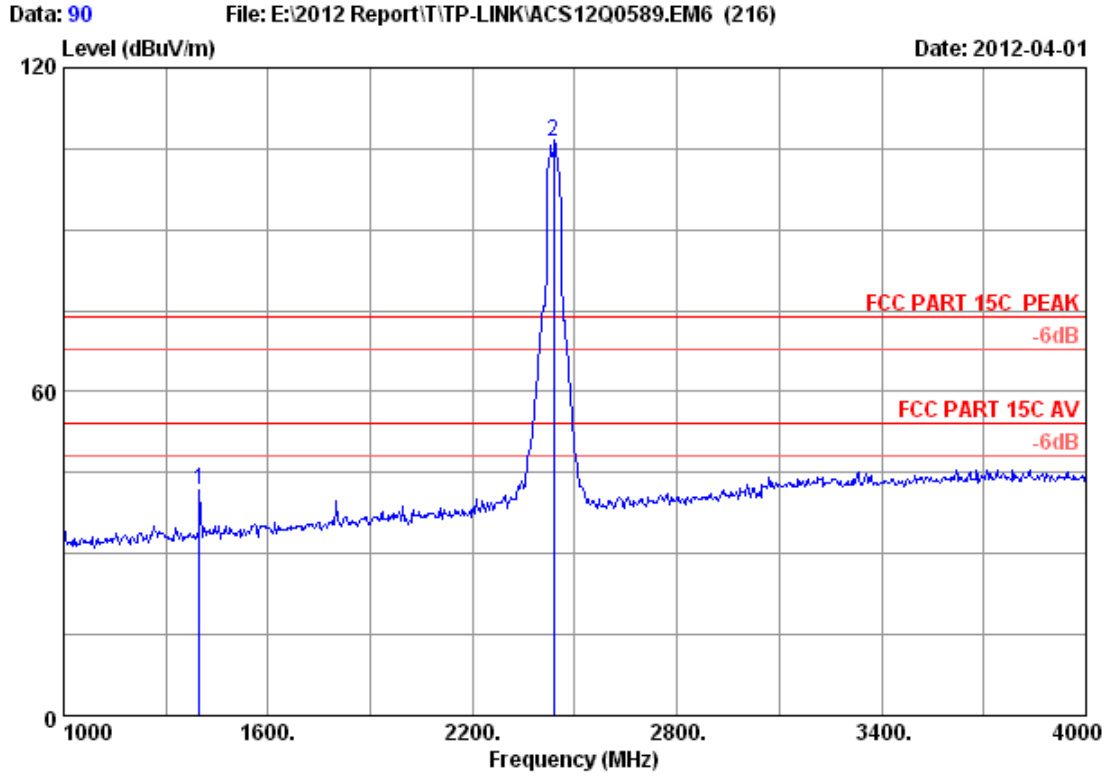

Site no. : 3m Chamber Data no. : 90
 Dis. / Ant. : 3m 2011 3115 4580 Ant. pol. : HORIZONTAL
 Limit : FCC PART 15C PEAK
 Env. / Ins. : 23°C/54% Engineer : Leo-Li
 EUT : 150Mbps Wireless N Router
 Power supply : DC 9V From Adapter Input AC 120V/60Hz
 Test mode : IEEE802.11nHT40 CH 4 2437MHz Tx
 M/N : TL-WR720N

	Freq. (MHz)	Ant. Factor (dB/m)	Cable loss (dB)	Amp. Factor (dB)	Reading (dBuV)	Emission Level (dBuV/m)	Limits (dBuV/m)	Margin (dB)	Remark
1	1399.000	24.99	4.44	34.70	46.92	41.65	74.00	32.35	Peak
2	2437.000	28.03	6.06	34.44	106.56	106.21	74.00	-32.21	Peak

Remarks:

1. Emission Level= Antenna Factor + Cable Loss -Amp Factor + Reading.
2. The emission levels that are 20dB below the official limit are not reported.

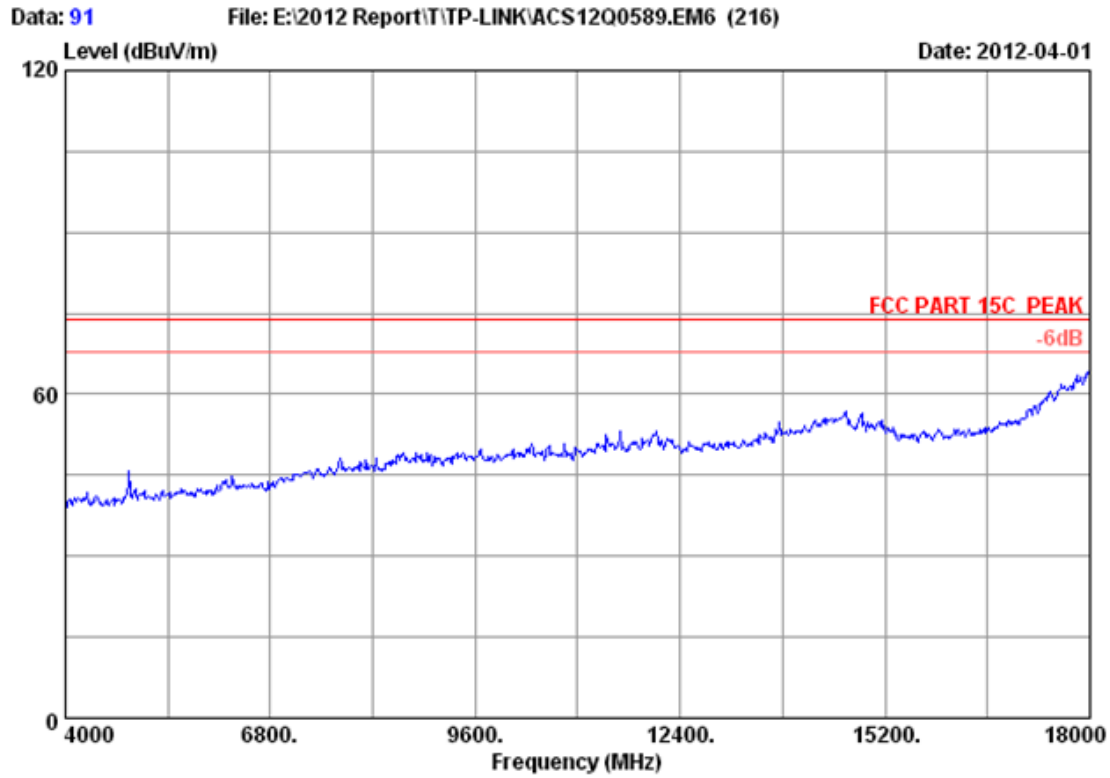

Site no. : 3m Chamber Data no. : 91
Dis. / Ant. : 3m 2011 3115 4580 Ant. pol. : VERTICAL
Limit : FCC PART 15C PEAK
Env. / Ins. : 23°C/54% Engineer : Leo-Li
EUT : 150Mbps Wireless N Router
Power supply : DC 9V From Adapter Input AC 120V/60Hz
Test mode : IEEE802.11nHT40 CH 4 2437MHz Tx
M/N : TL-WR720N

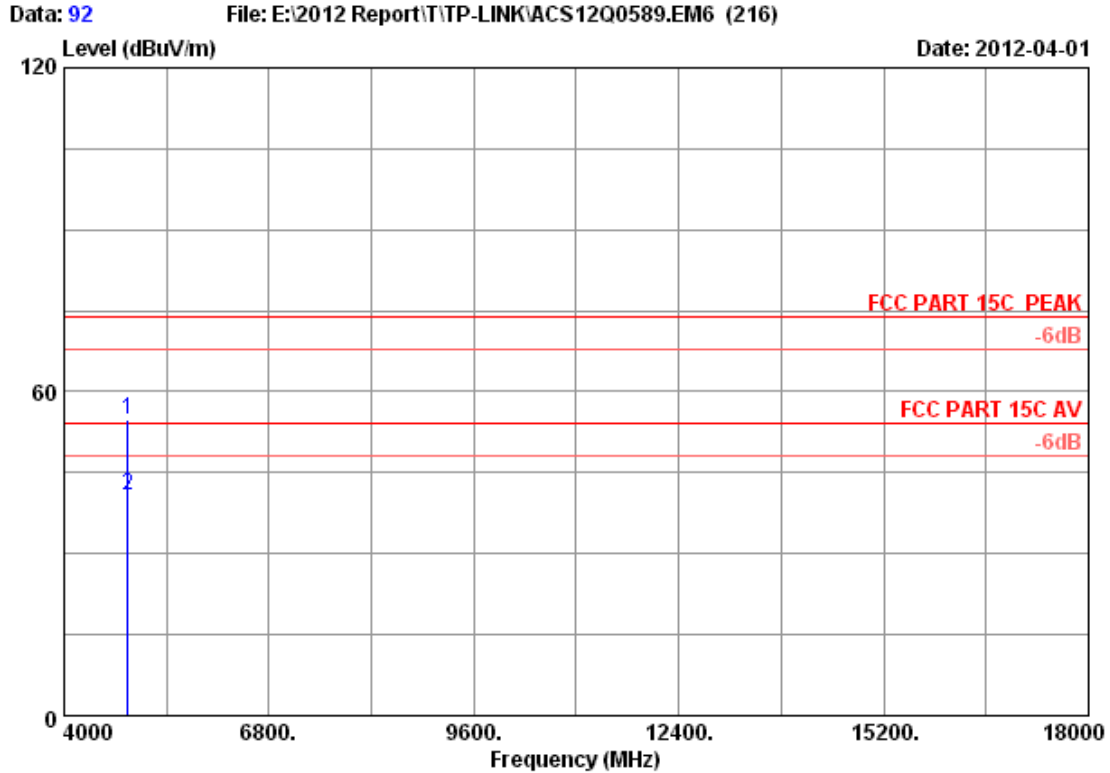

Site no. : 3m Chamber Data no. : 92
 Dis. / Ant. : 3m 2011 3115 4580 Ant. pol. : VERTICAL
 Limit : FCC PART 15C PEAK
 Env. / Ins. : 23°C/54% Engineer : Leo-Li
 EUT : 150Mbps Wireless N Router
 Power supply : DC 9V From Adapter Input AC 120V/60Hz
 Test mode : IEEE802.11nHT40 CH 4 2437MHz Tx
 M/N : TL-WR720N

	Freq. (MHz)	Ant. Factor (dB/m)	Cable loss (dB)	Amp. Factor (dB)	Reading (dBuV)	Emission Level (dBuV/m)	Limits (dBuV/m)	Margin (dB)	Remark
1	4874.000	32.98	8.58	34.60	47.86	54.82	74.00	19.18	Peak
2	4874.000	32.98	8.58	34.60	33.79	40.75	54.00	13.25	Average

Remarks:

1. Emission Level= Antenna Factor + Cable Loss -Amp Factor + Reading.
2. The emission levels that are 20dB below the official limit are not reported.

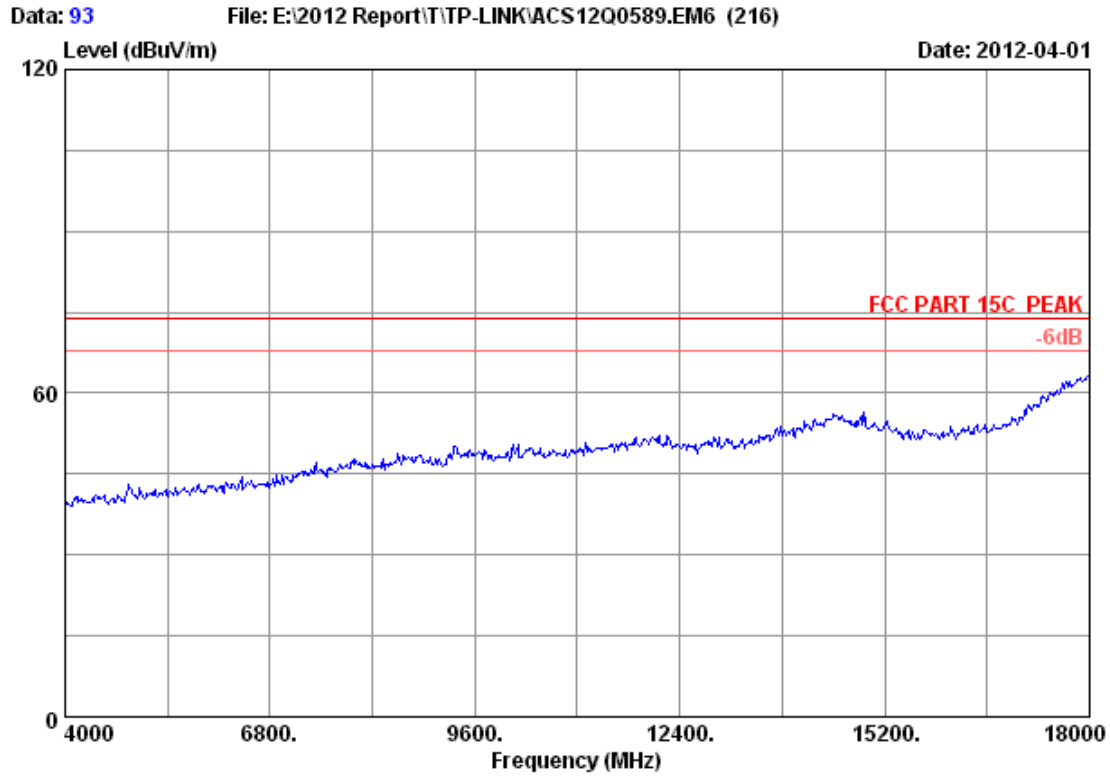

Site no. : 3m Chamber Data no. : 93
Dis. / Ant. : 3m 2011 3115 4580 Ant. pol. : HORIZONTAL
Limit : FCC PART 15C PEAK
Env. / Ins. : 23°C/54% Engineer : Leo-Li
EUT : 150Mbps Wireless N Router
Power supply : DC 9V From Adapter Input AC 120V/60Hz
Test mode : IEEE802.11nHT40 CH 4 2437MHz Tx
M/N : TL-WR720N

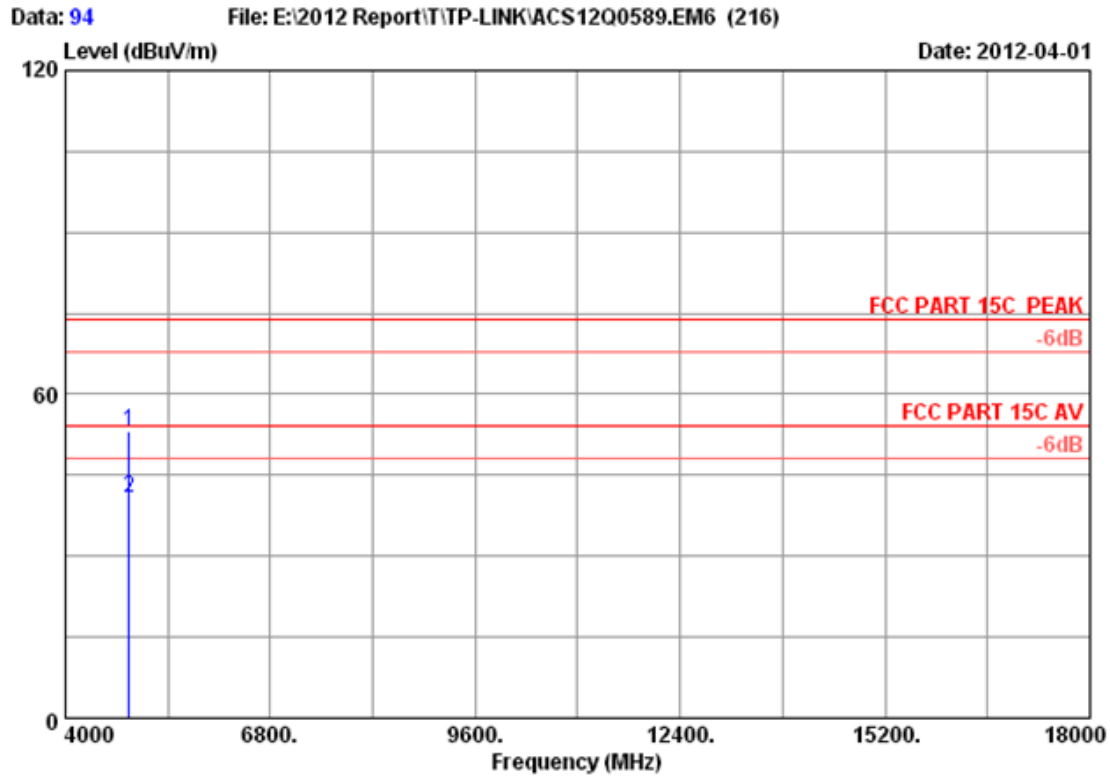

Site no. : 3m Chamber Data no. : 94
 Dis. / Ant. : 3m 2011 3115 4580 Ant. pol. : HORIZONTAL
 Limit : FCC PART 15C PEAK
 Env. / Ins. : 23°C/54% Engineer : Leo-Li
 EUT : 150Mbps Wireless N Router
 Power supply : DC 9V From Adapter Input AC 120V/60Hz
 Test mode : IEEE802.11nHT40 CH 4 2437MHz Tx
 M/N : TL-WR720N

	Freq. (MHz)	Ant. Factor (dB/m)	Cable loss (dB)	Amp. Factor (dB)	Reading (dBuV)	Emission Level (dBuV/m)	Limits (dBuV/m)	Margin (dB)	Remark
1	4874.000	32.98	8.58	34.60	46.15	53.11	74.00	20.89	Peak
2	4874.000	32.98	8.58	34.60	33.67	40.63	54.00	13.37	Average

Remarks:

1. Emission Level= Antenna Factor + Cable Loss -Amp Factor + Reading.
2. The emission levels that are 20dB below the official limit are not reported.

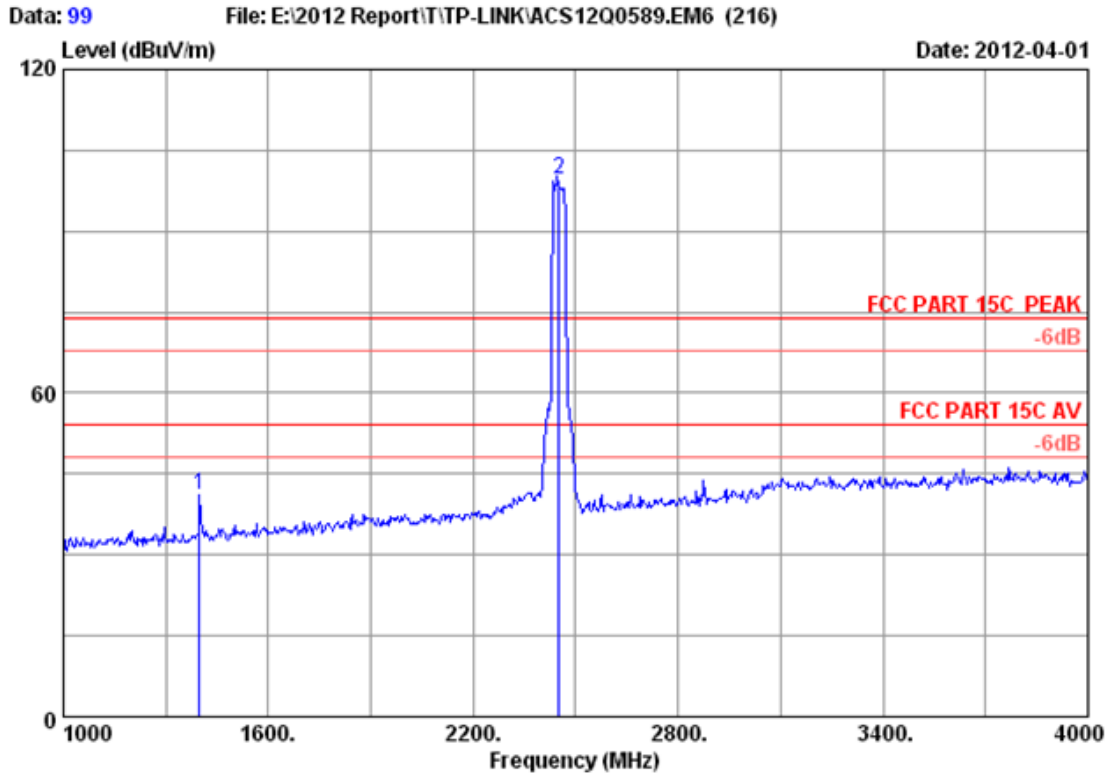

Site no. : 3m Chamber Data no. : 99
 Dis. / Ant. : 3m 2011 3115 4580 Ant. pol. : VERTICAL
 Limit : FCC PART 15C PEAK
 Env. / Ins. : 23°C/54% Engineer : Leo-Li
 EUT : 150Mbps Wireless N Router
 Power supply : DC 9V From Adapter Input AC 120V/60Hz
 Test mode : IEEE802.11nHT40 CH 7 2452MHz Tx
 M/N : TL-WR720N

	Freq. (MHz)	Ant. Factor (dB/m)	Cable loss (dB)	Amp. Factor (dB)	Reading (dBuV)	Emission Level (dBuV/m)	Limits (dBuV/m)	Margin (dB)	Remark
1	1399.000	24.99	4.44	34.70	46.31	41.04	74.00	32.96	Peak
2	2452.000	28.03	6.09	34.44	100.02	99.70	74.00	-25.70	Peak

Remarks:

1. Emission Level= Antenna Factor + Cable Loss -Amp Factor + Reading.
2. The emission levels that are 20dB below the official limit are not reported.

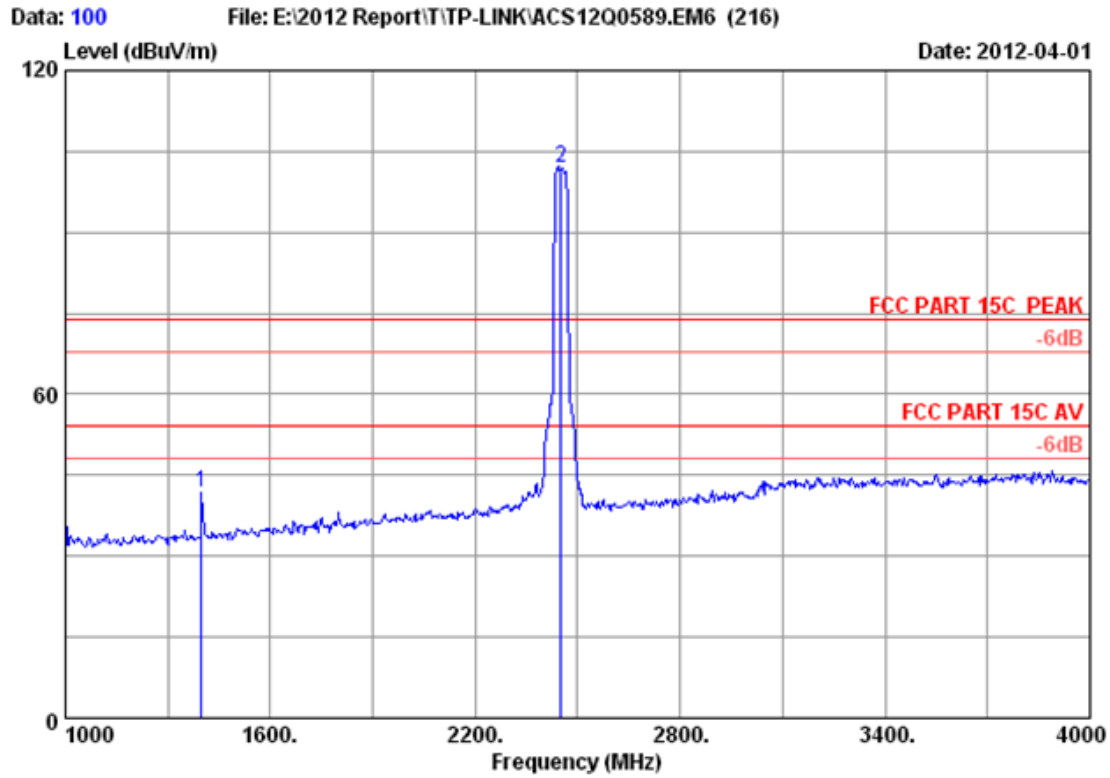

Site no. : 3m Chamber Data no. : 100
 Dis. / Ant. : 3m 2011 3115 4580 Ant. pol. : HORIZONTAL
 Limit : FCC PART 15C PEAK
 Env. / Ins. : 23°C/54% Engineer : Leo-Li
 EUT : 150Mbps Wireless N Router
 Power supply : DC 9V From Adapter Input AC 120V/60Hz
 Test mode : IEEE802.11nHT40 CH 7 2452MHz Tx
 M/N : TL-WR720N

	Freq. (MHz)	Ant. Factor (dB/m)	Cable loss (dB)	Amp. Factor (dB)	Reading (dBuV)	Emission Level (dBuV/m)	Limits (dBuV/m)	Margin (dB)	Remark
1	1399.000	24.99	4.44	34.70	47.00	41.73	74.00	32.27	Peak
2	2452.000	28.03	6.09	34.44	102.36	102.04	74.00	-28.04	Peak

Remarks:

1. Emission Level= Antenna Factor + Cable Loss -Amp Factor + Reading.
2. The emission levels that are 20dB below the official limit are not reported.

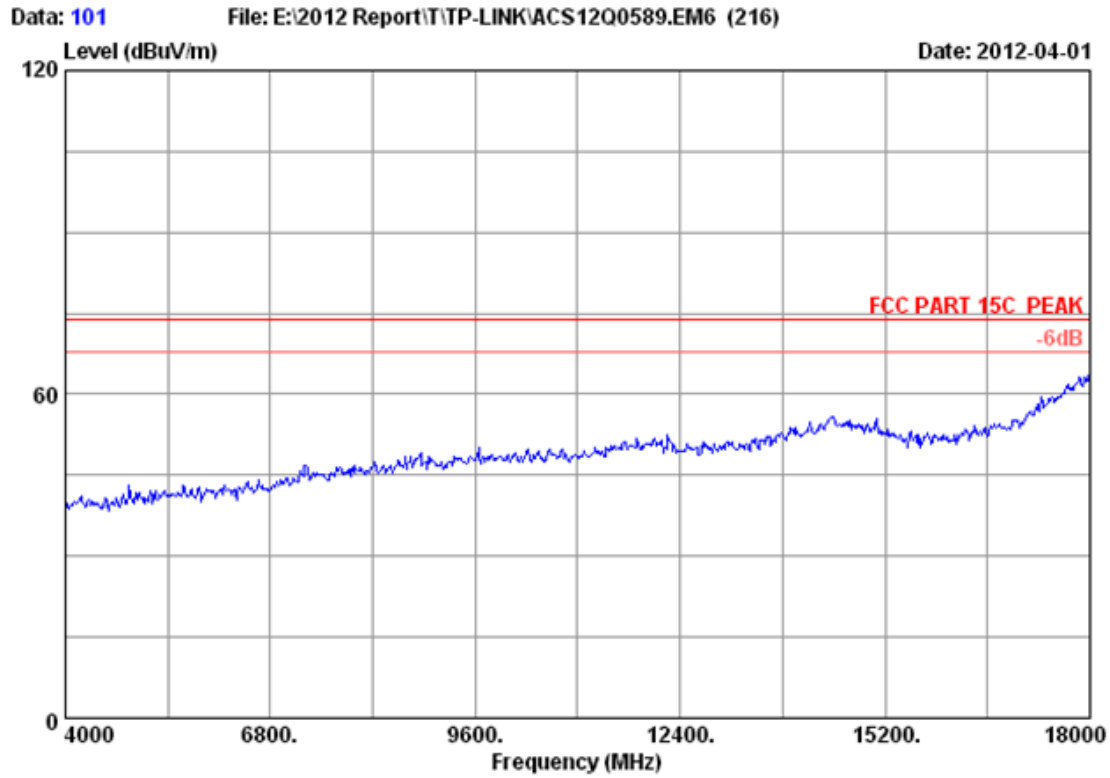

Site no. : 3m Chamber Data no. : 101
Dis. / Ant. : 3m 2011 3115 4580 Ant. pol. : VERTICAL
Limit : FCC PART 15C PEAK
Env. / Ins. : 23°C/54% Engineer : Leo-Li
EUT : 150Mbps Wireless N Router
Power supply : DC 9V From Adapter Input AC 120V/60Hz
Test mode : IEEE802.11nHT40 CH 7 2452MHz Tx
M/N : TL-WR720N

Data: 102 File: E:\2012 Report\TTP-LINK\ACS12Q0589.EM6 (216) Date: 2012-04-01

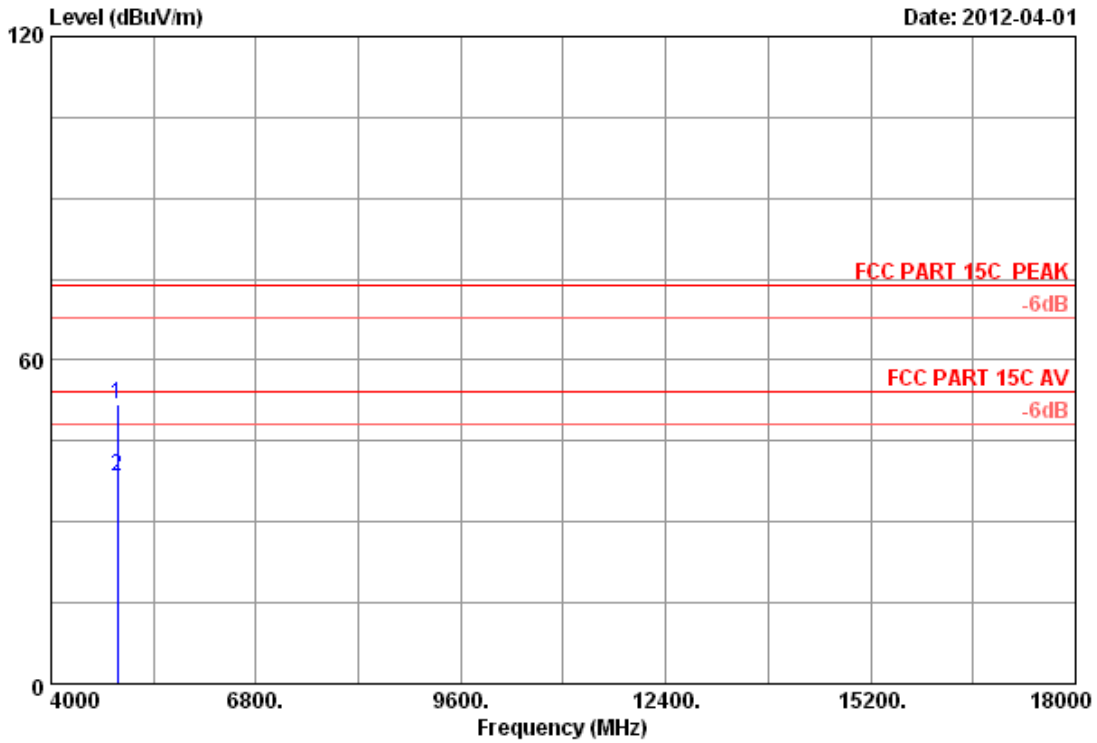

Site no. : 3m Chamber Data no. : 102
 Dis. / Ant. : 3m 2011 3115 4580 Ant. pol. : VERTICAL
 Limit : FCC PART 15C PEAK
 Env. / Ins. : 23°C/54% Engineer : Leo-Li
 EUT : 150Mbps Wireless N Router
 Power supply : DC 9V From Adapter Input AC 120V/60Hz
 Test mode : IEEE802.11nHT40 CH 7 2452MHz Tx
 M/N : TL-WR720N

	Freq. (MHz)	Ant. Factor (dB/m)	Cable loss (dB)	Amp. Factor (dB)	Reading (dBuV)	Emission Level (dBuV/m)	Limits (dBuV/m)	Margin (dB)	Remark
1	4904.000	33.04	8.61	34.60	44.68	51.73	74.00	22.27	Peak
2	4904.000	33.04	8.61	34.60	31.51	38.56	54.00	15.44	Average

Remarks:

1. Emission Level= Antenna Factor + Cable Loss -Amp Factor + Reading.
2. The emission levels that are 20dB below the official limit are not reported.

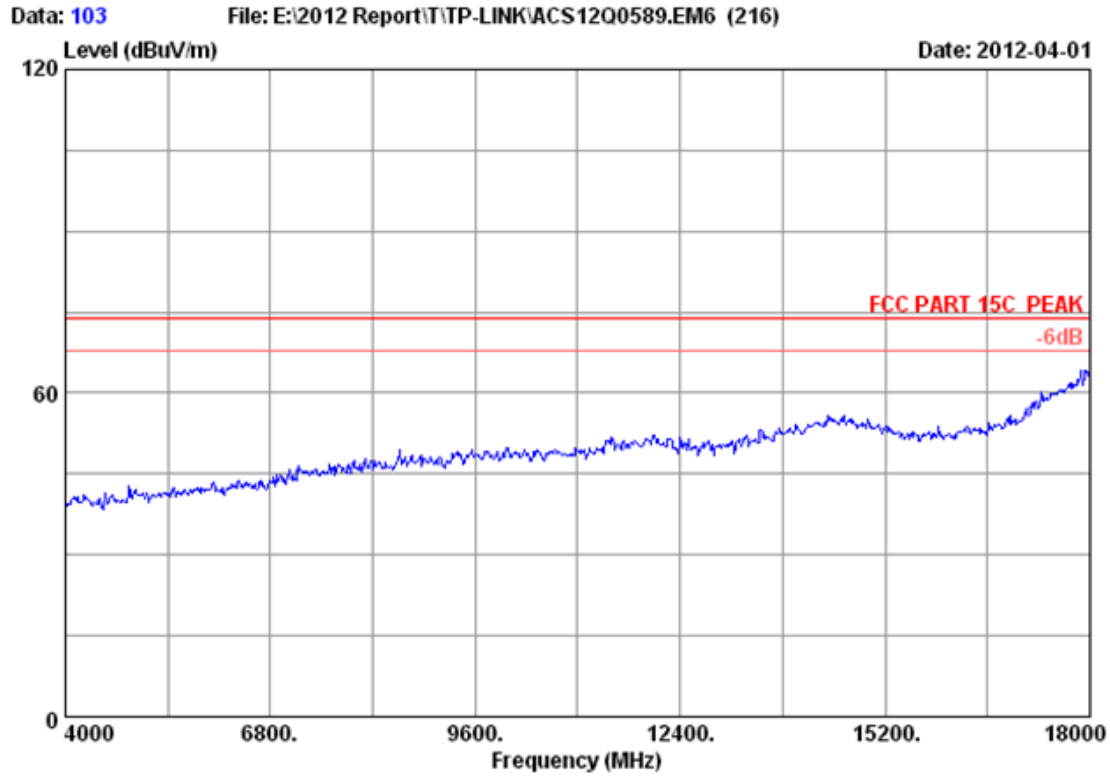

Site no. : 3m Chamber Data no. : 103
Dis. / Ant. : 3m 2011 3115 4580 Ant. pol. : HORIZONTAL
Limit : FCC PART 15C PEAK
Env. / Ins. : 23°C/54% Engineer : Leo-Li
EUT : 150Mbps Wireless N Router
Power supply : DC 9V From Adapter Input AC 120V/60Hz
Test mode : IEEE802.11nHT40 CH 7 2452MHz Tx
M/N : TL-WR720N

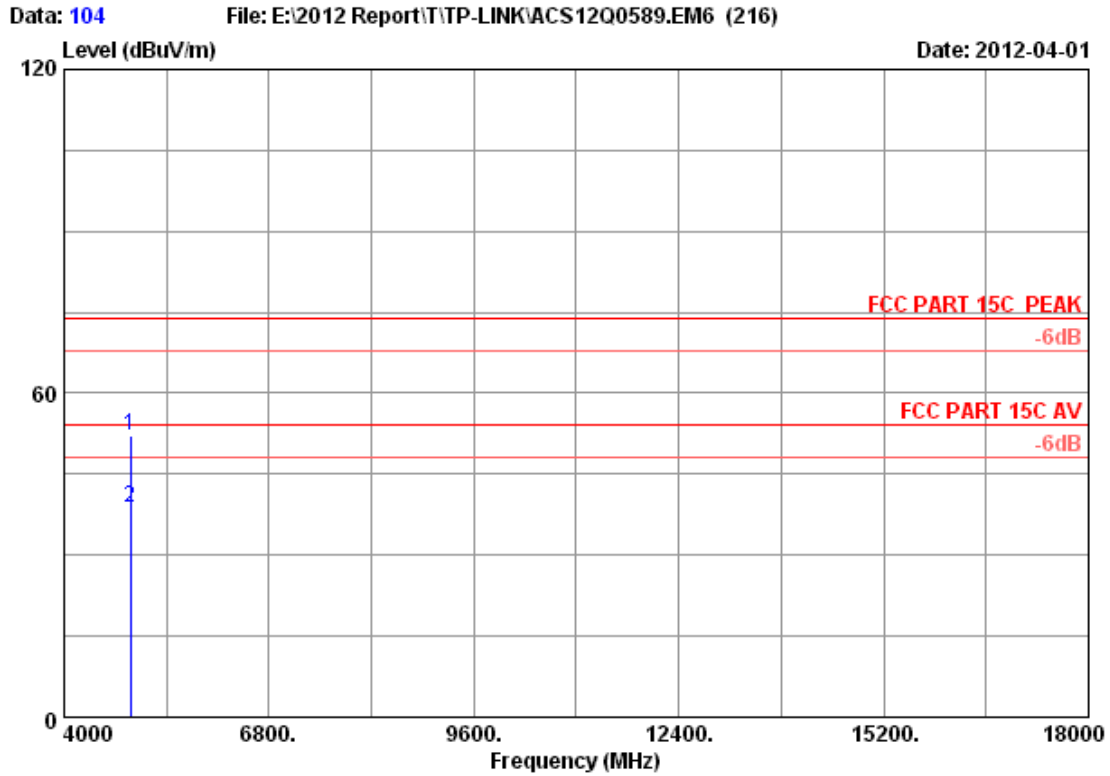

Site no. : 3m Chamber Data no. : 104
 Dis. / Ant. : 3m 2011 3115 4580 Ant. pol. : HORIZONTAL
 Limit : FCC PART 15C PEAK
 Env. / Ins. : 23°C/54% Engineer : Leo-Li
 EUT : 150Mbps Wireless N Router
 Power supply : DC 9V From Adapter Input AC 120V/60Hz
 Test mode : IEEE802.11nHT40 CH 7 2452MHz Tx
 M/N : TL-WR720N

	Freq. (MHz)	Ant. Factor (dB/m)	Cable loss (dB)	Amp. Factor (dB)	Reading (dBuV)	Emission Level (dBuV/m)	Limits (dBuV/m)	Margin (dB)	Remark
1	4904.000	33.04	8.61	34.60	45.23	52.28	74.00	21.72	Peak
2	4904.000	33.04	8.61	34.60	31.66	38.71	54.00	15.29	Average

Remarks:

1. Emission Level= Antenna Factor + Cable Loss -Amp Factor + Reading.
2. The emission levels that are 20dB below the official limit are not reported.

5. CONDUCTED SPURIOUS EMISSIONS

5.1. Test Equipment

Item	Equipment	Manufacturer	Model No.	Serial No.	Last Cal.	Cal. Interval
1.	Spectrum Analyzer	Agilent	E4446A	US44300459	May.08,11	1 Year
2.	Attenuator	Agilent	8491B	MY39262165	May.08,11	1 Year
3.	RF Cable	Hubersuhner	SUCOFLEX102	28618/2	May.08,11	1Year

5.2. Limit

In any 100kHz bandwidth outside the frequency bands in which the spread spectrum intentional radiator is operating, the radio frequency power that is produced by the intentional radiator shall be at least 20dB below that in the 100kHz bandwidth within the band that contains the highest level of the desired power.

5.3. Test Procedure

The transmitter output was connected to a spectrum analyzer, The resolution bandwidth is set to 100 kHz, The video bandwidth is set to 300 kHz and measure all the emissions detected.

5.4. Test result

PASS (The testing data was attached in the next pages.)

Chain 0:

Test Mode: IEEE 802.11b TX

Test CH1: 2412MHz

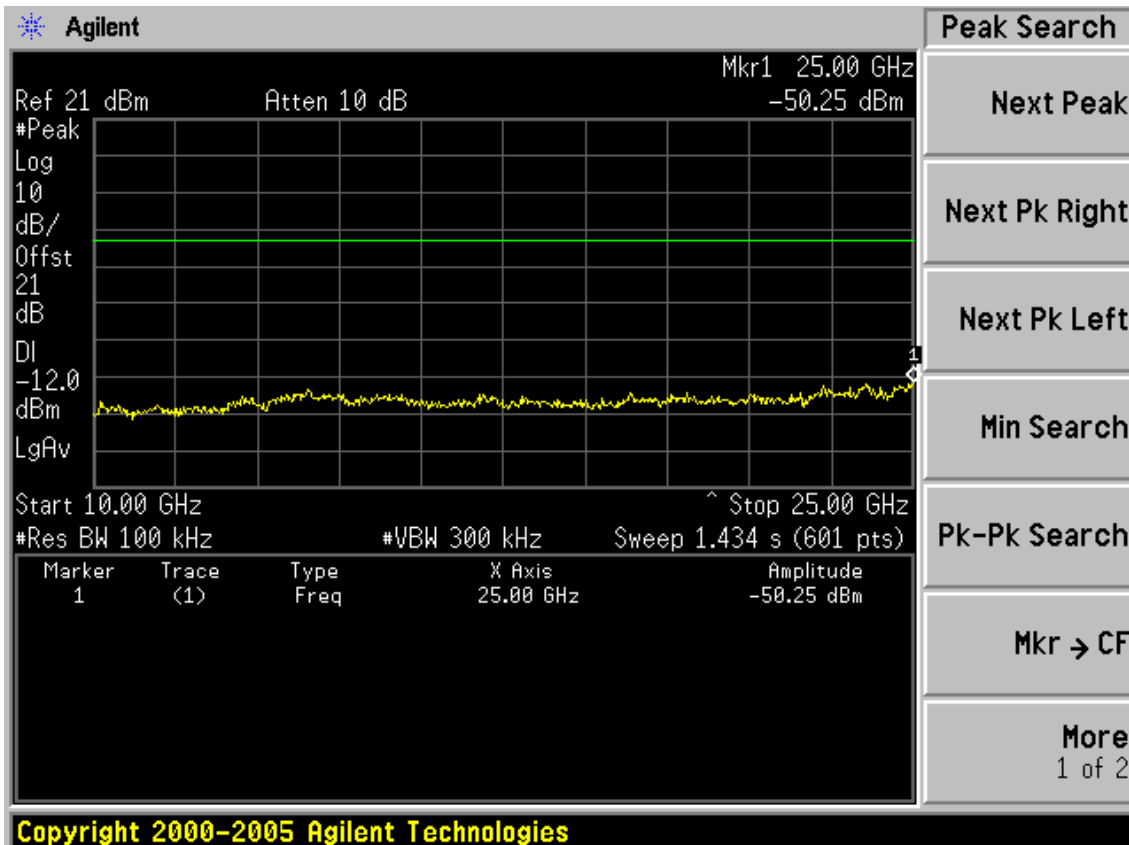
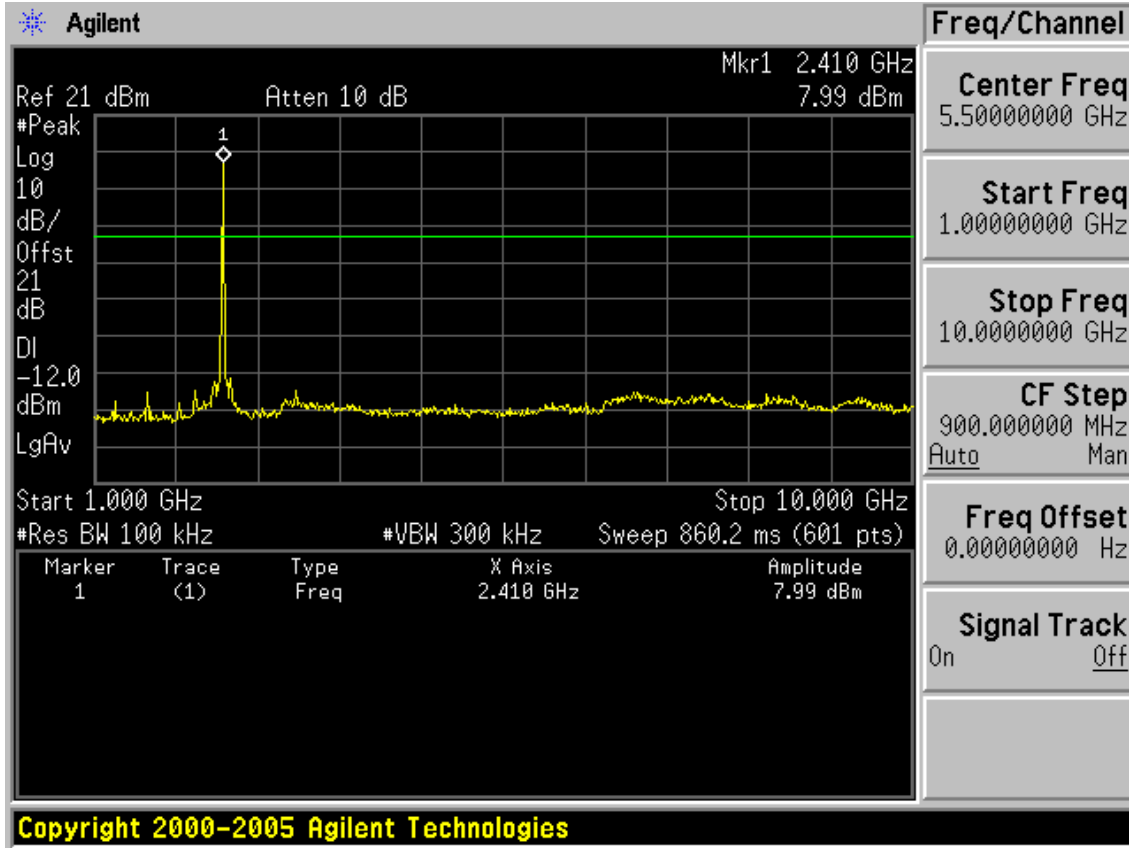

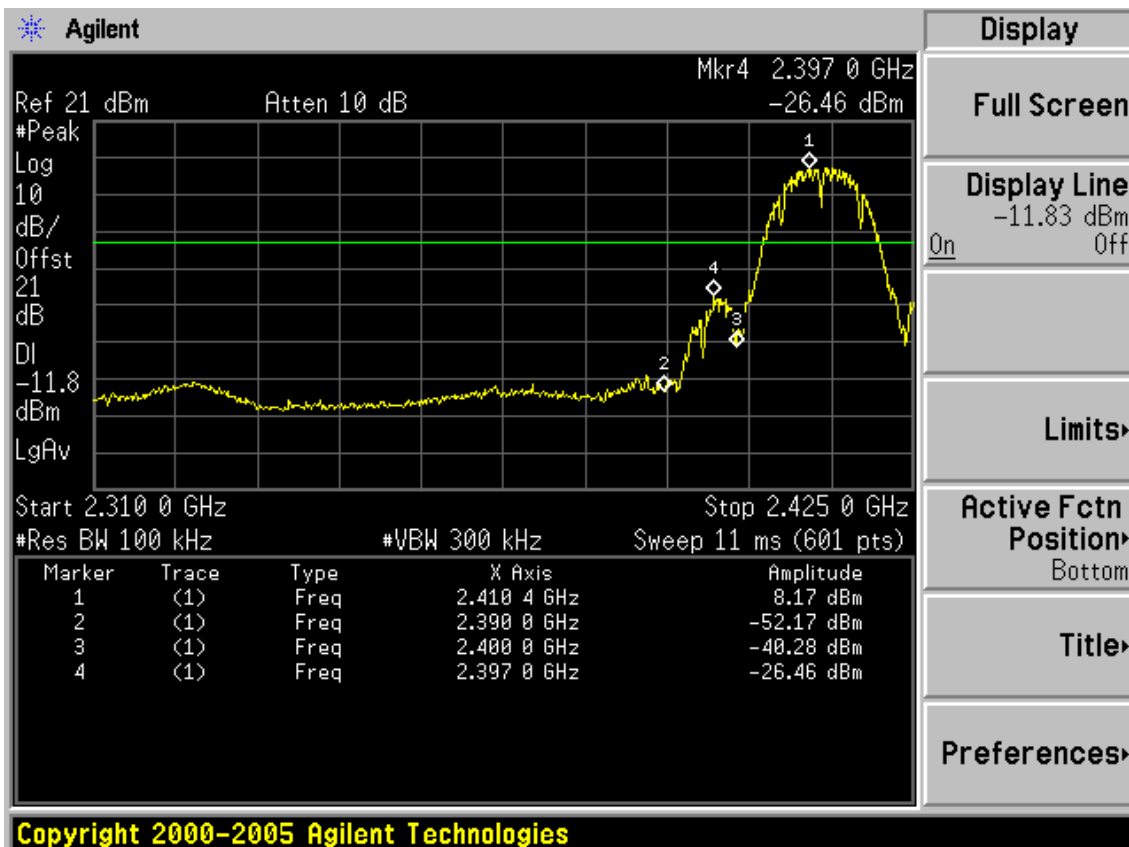
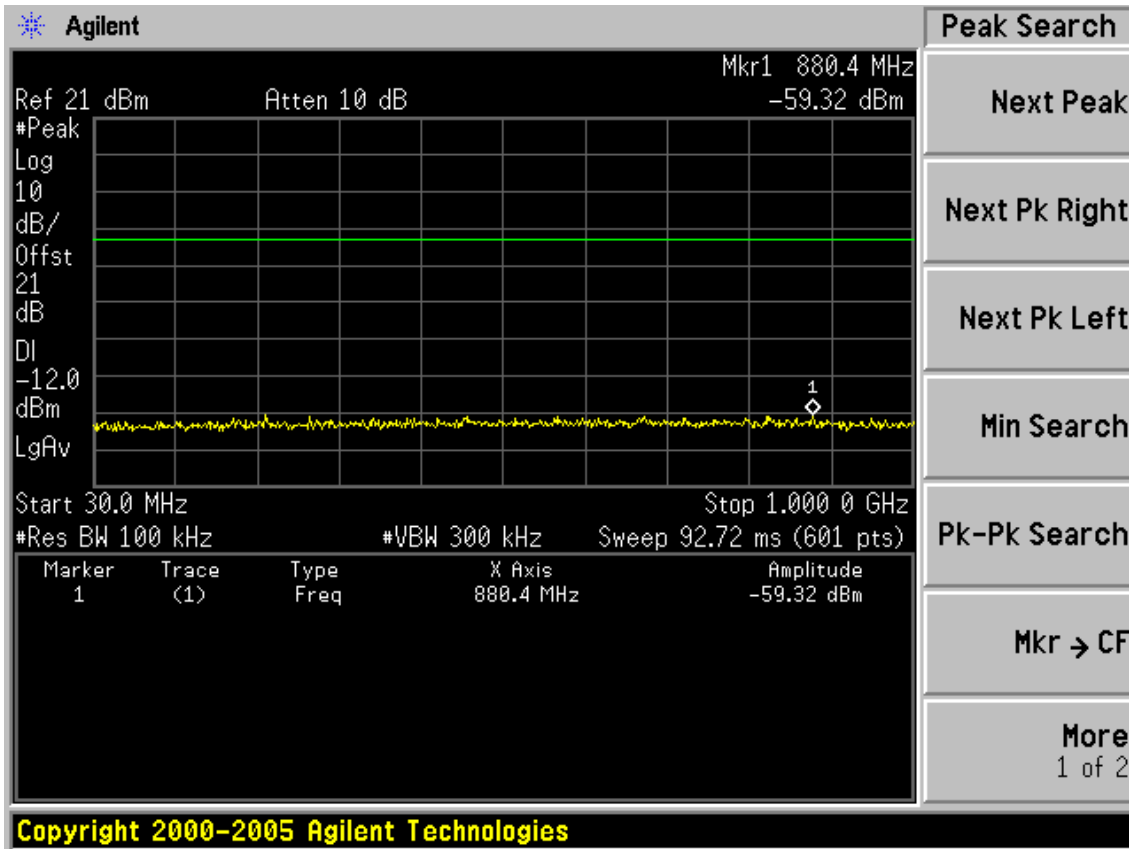

Test CH6: 2437MHz

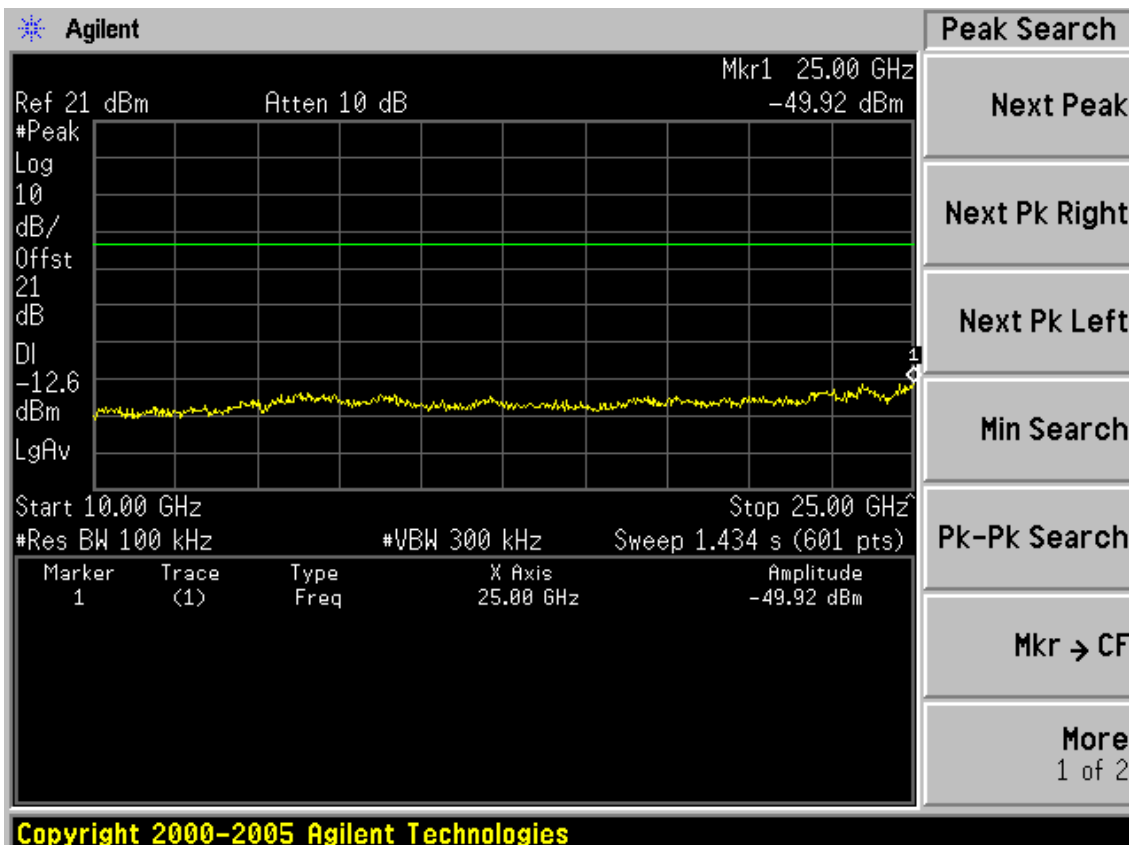
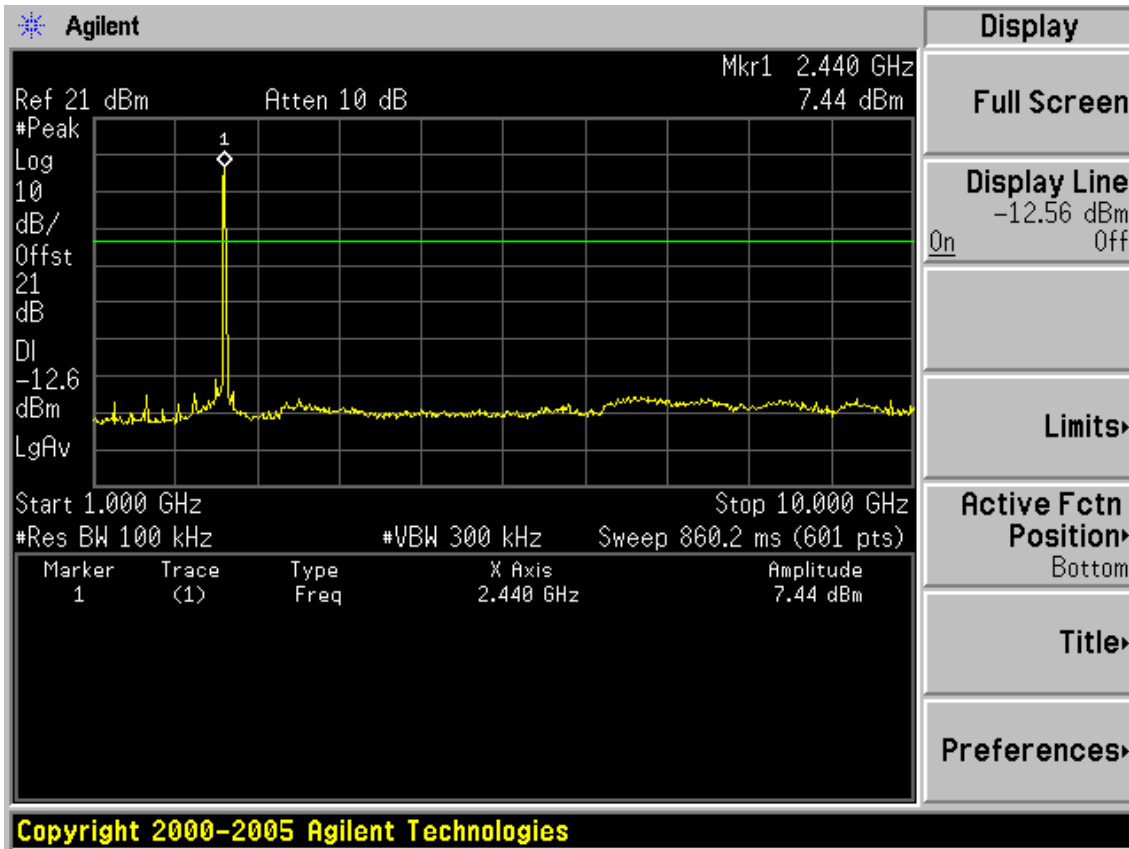

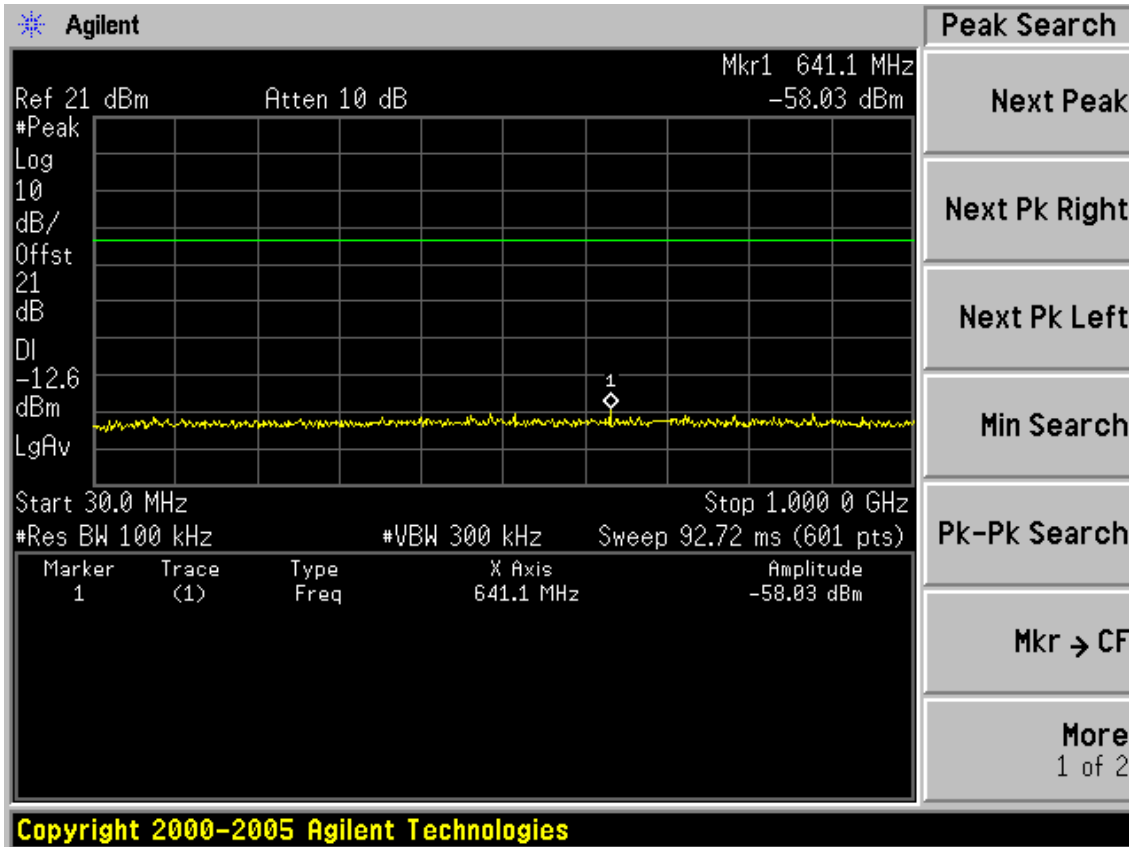

Test CH11: 2462MHz

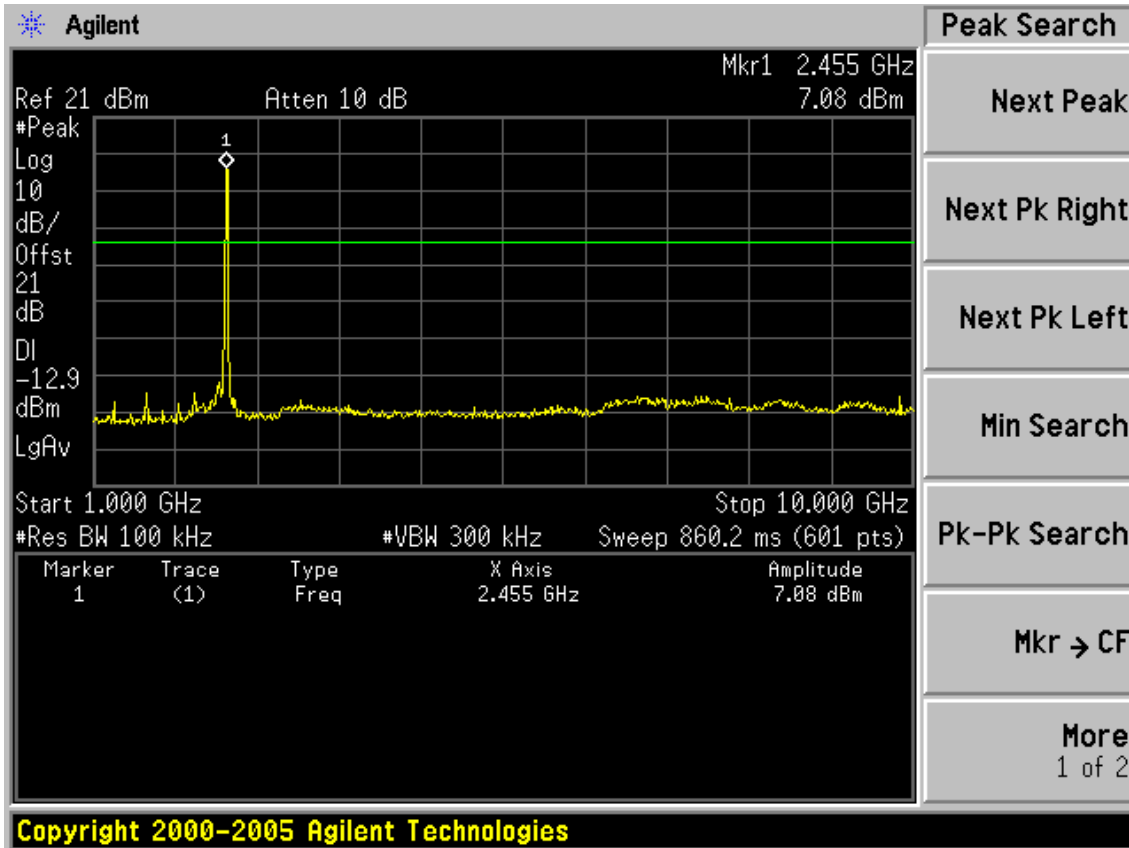

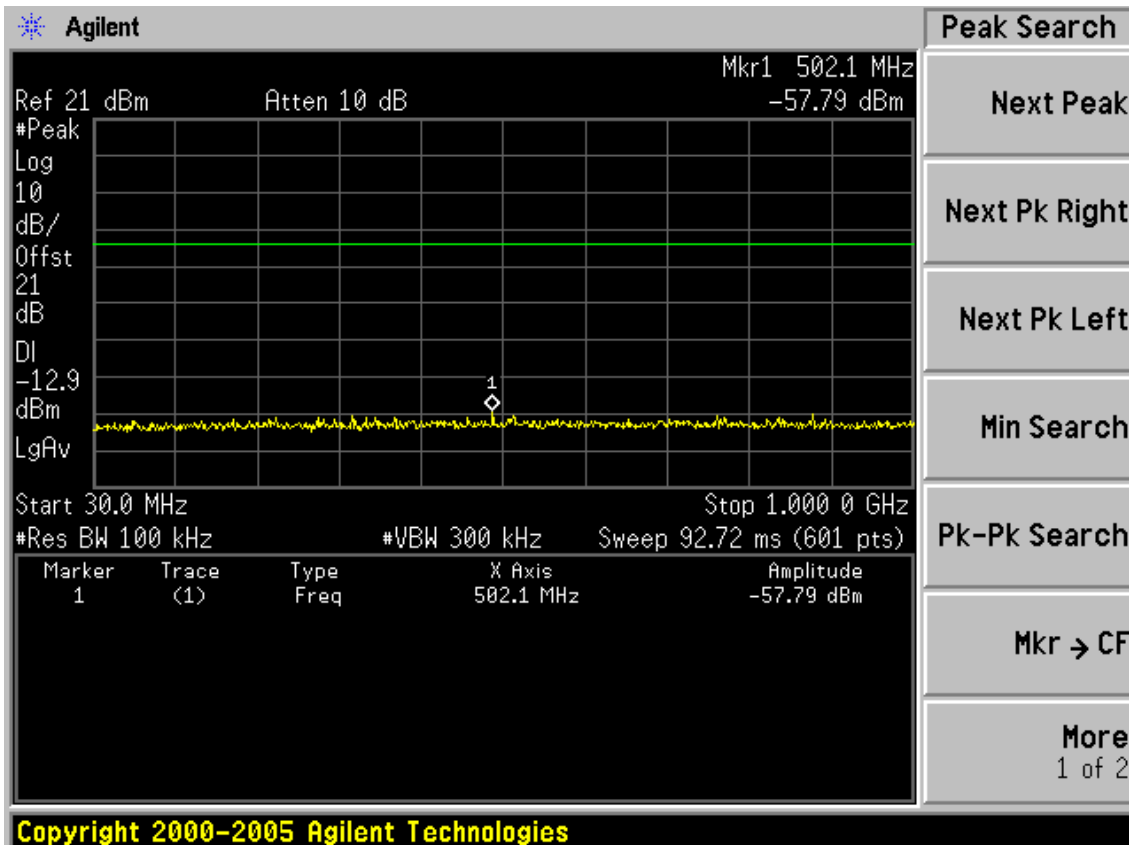
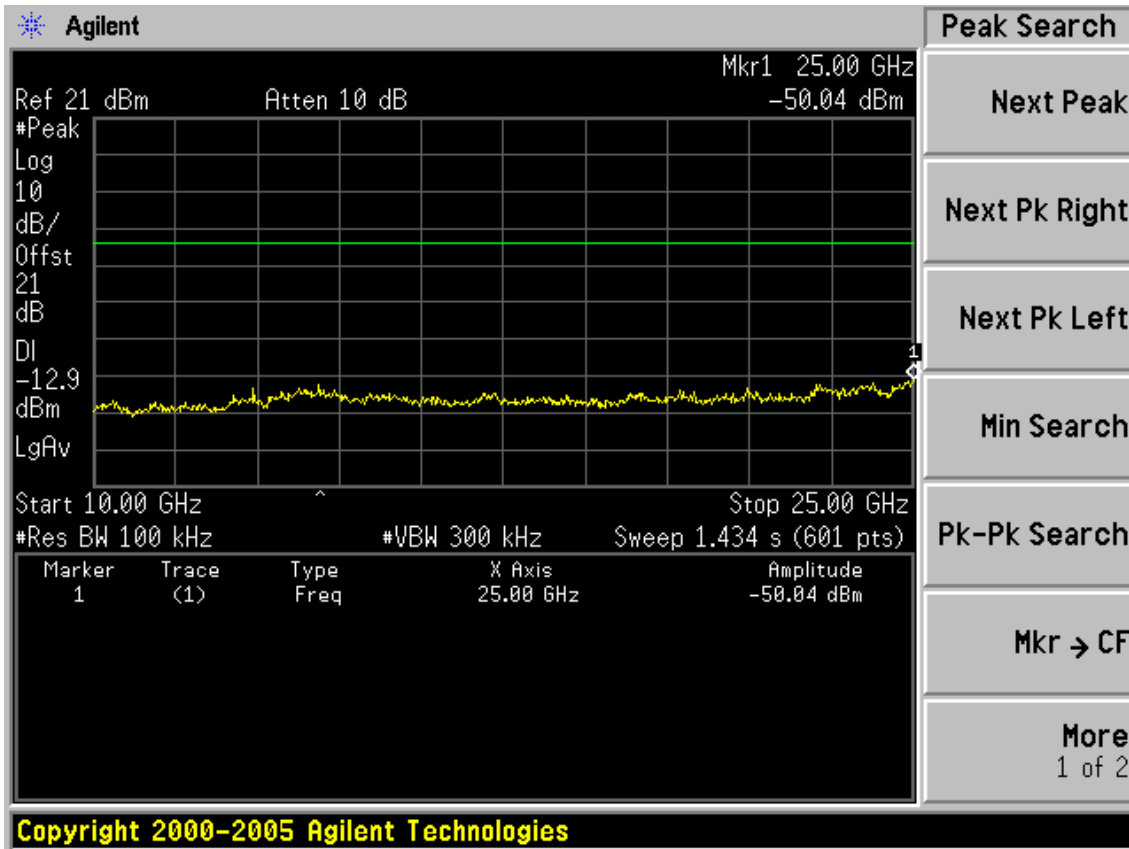

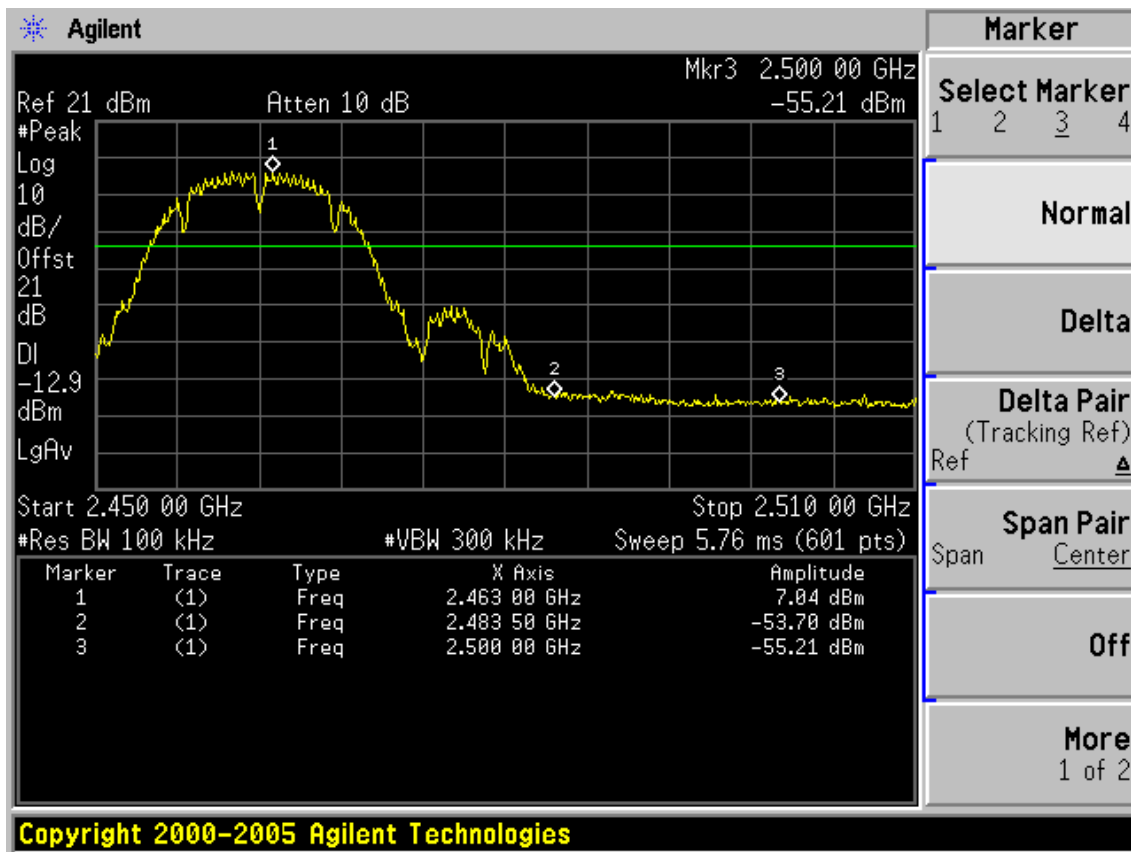

Test Mode: IEEE 802.11g TX
 Test CH1: 2412MHz

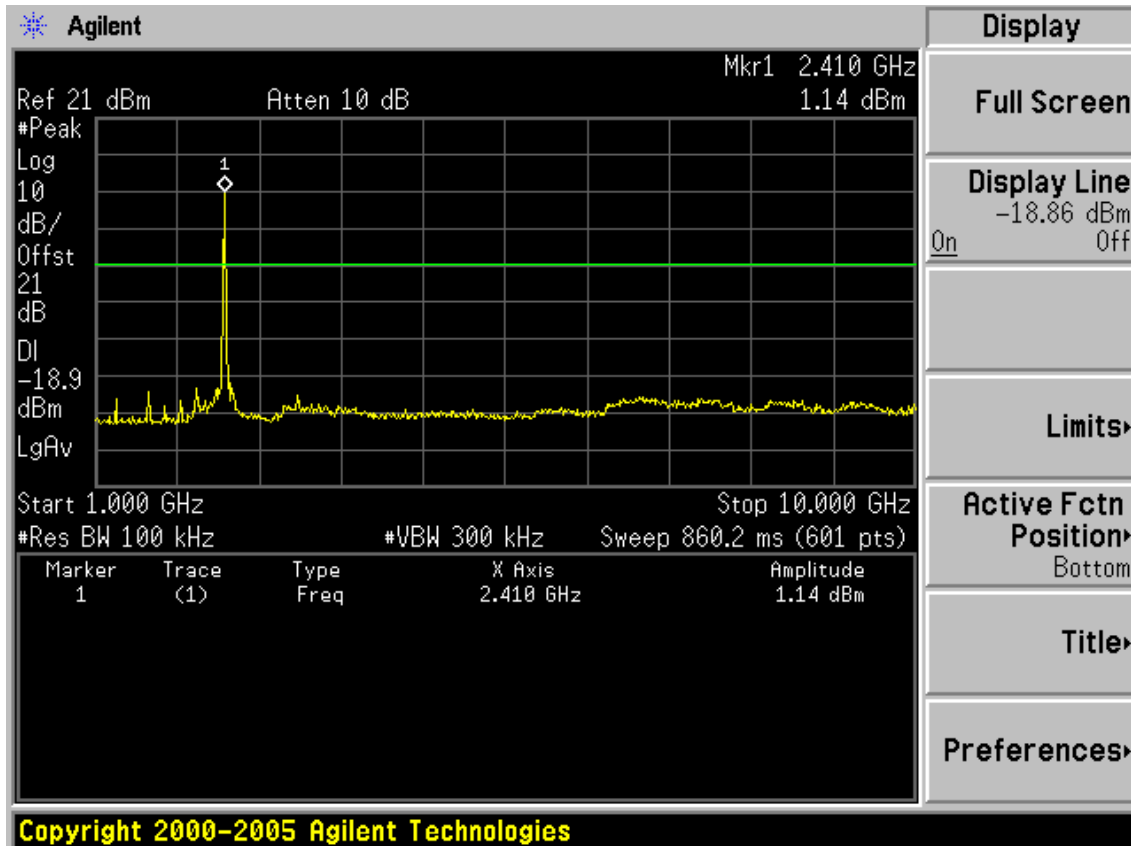

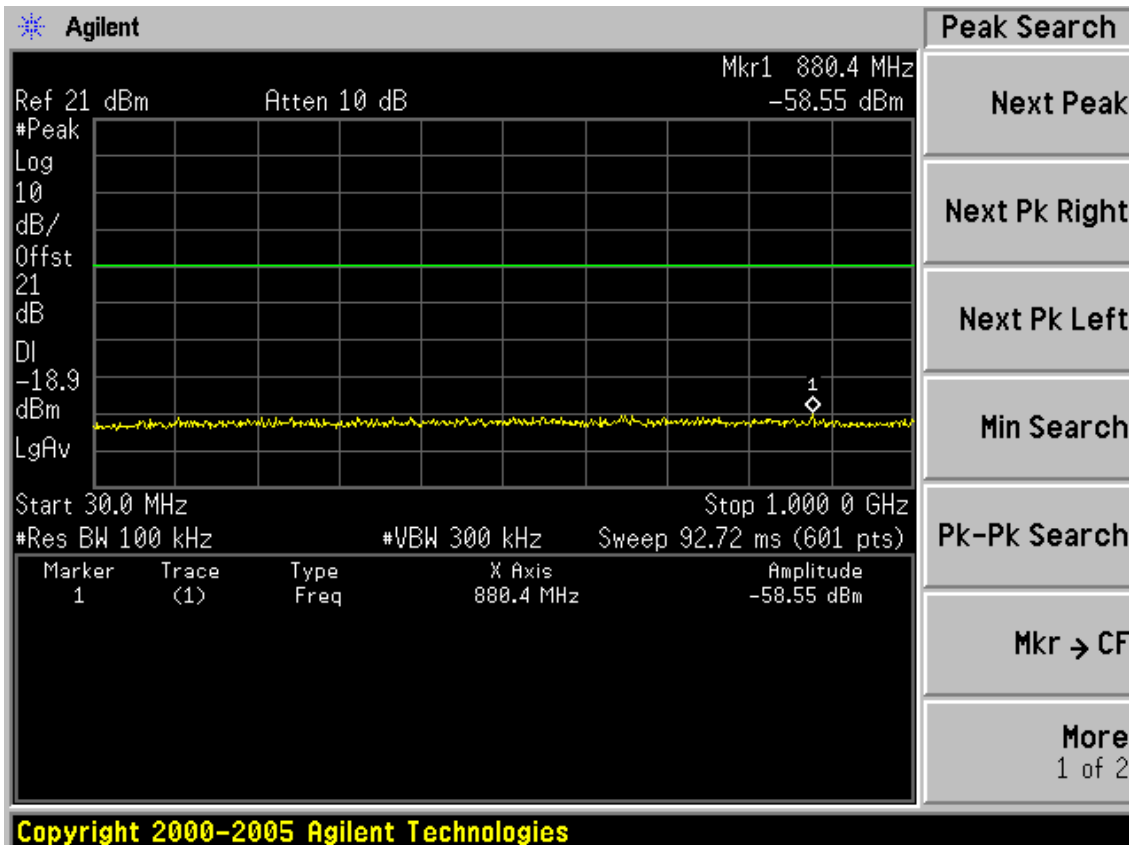
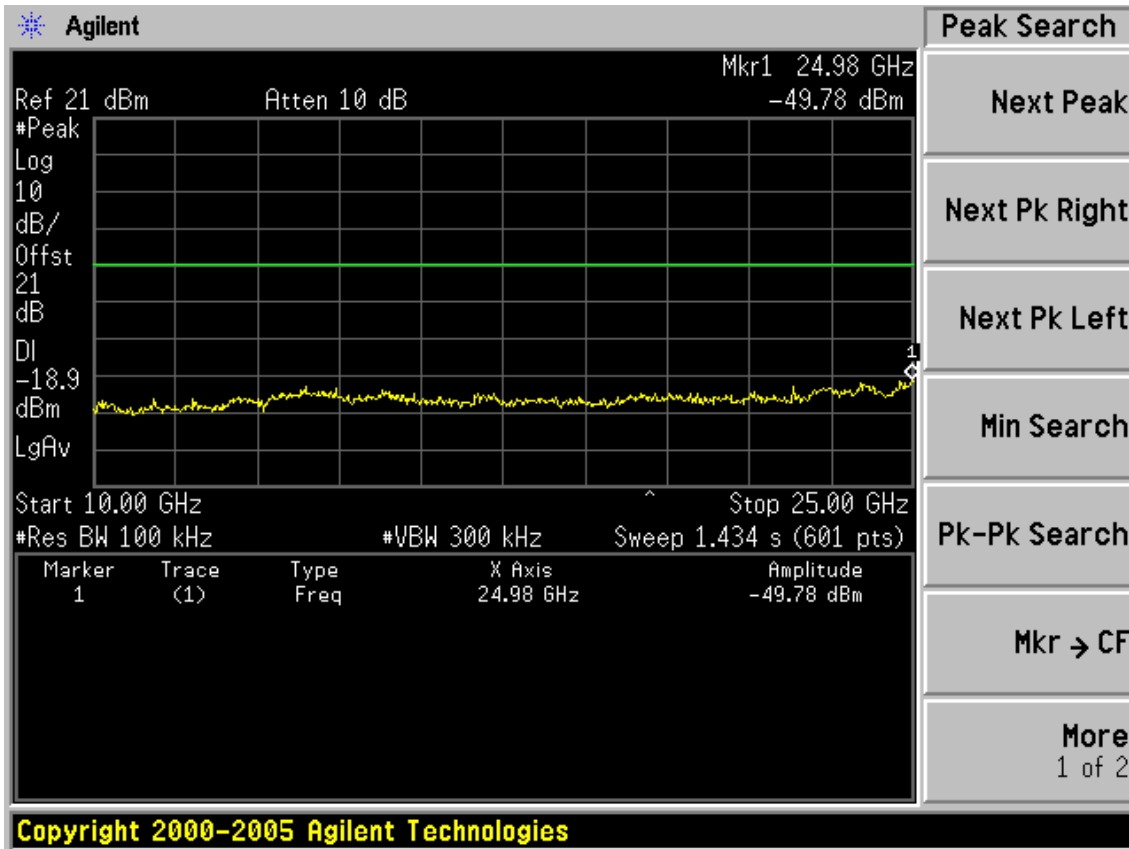

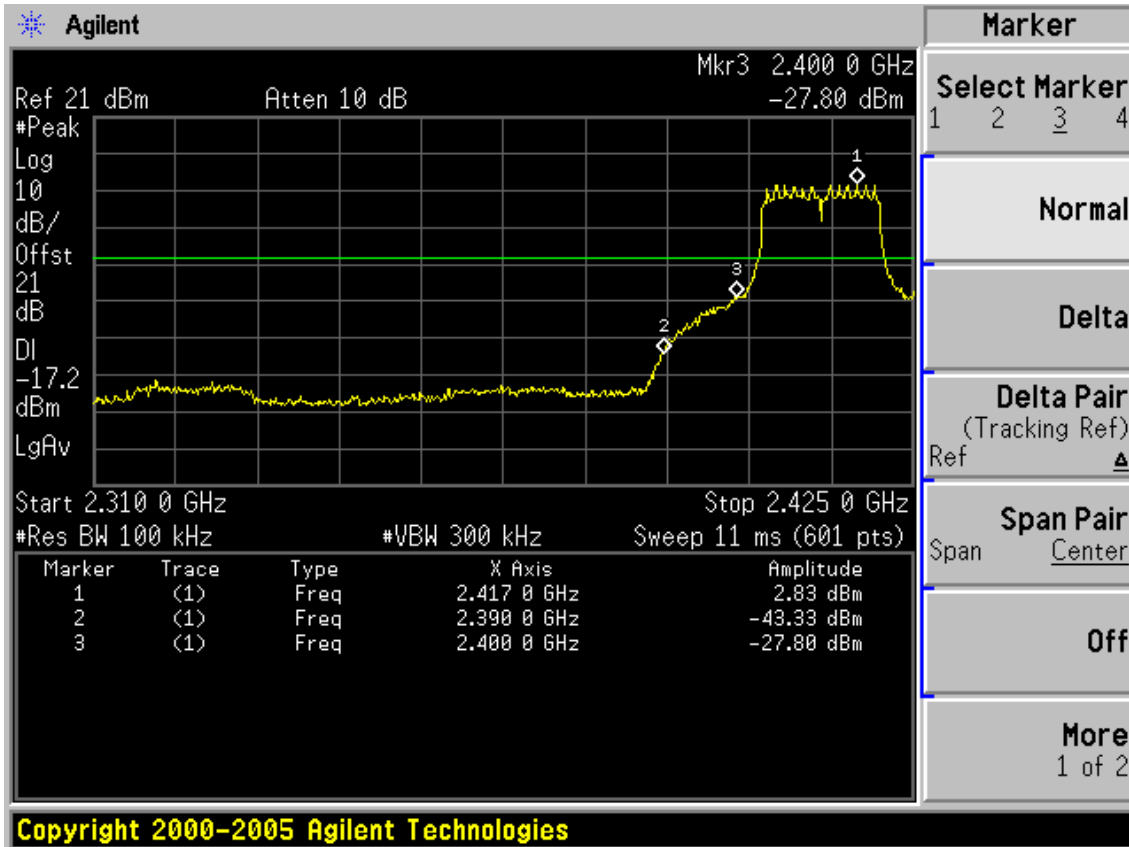

Test CH6: 2437MHz

