



A D T

FCC TEST REPORT

REPORT NO.: RF110715C03

MODEL NO.: TL-WN822N

FCC ID: TE7WN822NV2

RECEIVED: Jul. 15, 2011

TESTED: Jul. 21 ~ Aug. 01, 2011

ISSUED: Aug. 04, 2011

APPLICANT: TP-LINK TECHNOLOGIES CO., LTD.

ADDRESS: Building 24 (floors 1,3,4,5) and 28 (floors1-4)
Central Science and Technology Park, Shennan Rd,
Nanshan, Shenzhen, China

ISSUED BY: Bureau Veritas Consumer Products Services (H.K.)
Ltd., Taoyuan Branch

LAB ADDRESS: No. 47, 14th Ling, Chia Pau Tsuen, Lin Kou Hsiang,
Taipei Hsien 244, Taiwan, R.O.C.

TEST LOCATION: No. 19, Hwa Ya 2nd Rd, Wen Hwa Tsuen, Kwei
Shan Hsiang, Taoyuan Hsien 333, Taiwan, R.O.C.

This test report consists of 89 pages in total. It may be duplicated completely for legal use with the approval of the applicant. It should not be reproduced except in full, without the written approval of our laboratory. The client should not use it to claim product, certification, approval or endorsement by TAF or any government agency. The test results in the report only apply to the tested sample. The test results in this report are traceable to the national or international standards.



Testing Laboratory
2021



A D T

TABLE OF CONTENTS

RELEASE CONTROL RECORD.....	4
1. CERTIFICATION	5
2. SUMMARY OF TEST RESULTS	6
2.1 MEASUREMENT UNCERTAINTY	6
3. GENERAL INFORMATION.....	7
3.1 GENERAL DESCRIPTION OF EUT.....	7
3.2 DESCRIPTION OF TEST MODES.....	8
3.2.1 CONFIGURATION OF SYSTEM UNDER TEST.....	8
3.2.2 TEST MODE APPLICABILITY AND TESTED CHANNEL DETAIL.....	9
3.3 GENERAL DESCRIPTION OF APPLIED STANDARDS	11
3.4 DESCRIPTION OF SUPPORT UNITS	11
4. TEST TYPES AND RESULTS.....	12
4.1 RADIATED EMISSION MEASUREMENT	12
4.1.1 LIMITS OF RADIATED EMISSION MEASUREMENT.....	12
4.1.2 TEST INSTRUMENTS.....	13
4.1.3 TEST PROCEDURES	14
4.1.4 DEVIATION FROM TEST STANDARD	14
4.1.5 TEST SETUP.....	15
4.1.6 EUT OPERATING CONDITIONS	15
4.1.7 TEST RESULTS	16
4.2 CONDUCTED EMISSION MEASUREMENT	29
4.2.1 LIMITS OF CONDUCTED EMISSION MEASUREMENT.....	29
4.2.2 TEST INSTRUMENTS.....	29
4.2.3 TEST PROCEDURES	30
4.2.4 DEVIATION FROM TEST STANDARD	30
4.2.5 TEST SETUP.....	31
4.2.6 EUT OPERATING CONDITIONS	31
4.2.7 TEST RESULTS	32
4.3 6dB BANDWIDTH MEASUREMENT	34
4.3.1 LIMITS OF 6dB BANDWIDTH MEASUREMENT	34
4.3.2 TEST INSTRUMENTS.....	34
4.3.3 TEST PROCEDURE.....	34
4.3.4 DEVIATION FROM TEST STANDARD	34
4.3.5 TEST SETUP.....	35
4.3.6 EUT OPERATING CONDITIONS	35
4.3.7 TEST RESULTS	36
4.4 MAXIMUM OUTPUT POWER.....	40
4.4.1 LIMITS OF MAXIMUM OUTPUT POWER MEASUREMENT	40
4.4.2 INSTRUMENTS.....	40
4.4.3 TEST PROCEDURES	40
4.4.4 DEVIATION FROM TEST STANDARD	41
4.4.5 TEST SETUP.....	41



A D T

4.4.6	EUT OPERATING CONDITIONS	41
4.4.7	TEST RESULTS	42
4.5	POWER SPECTRAL DENSITY MEASUREMENT	43
4.5.1	LIMITS OF POWER SPECTRAL DENSITY MEASUREMENT	43
4.5.2	TEST INSTRUMENTS.....	43
4.5.3	TEST PROCEDURE.....	43
4.5.4	DEVIATION FROM TEST STANDARD	44
4.5.5	TEST SETUP.....	44
4.5.6	EUT OPERATING CONDITION	44
4.5.7	TEST RESULTS	45
4.6	BAND EDGES MEASUREMENT	49
4.6.1	LIMITS OF BAND EDGES MEASUREMENT.....	49
4.6.2	TEST INSTRUMENTS.....	49
4.6.3	TEST PROCEDURE.....	50
4.6.4	DEVIATION FROM TEST STANDARD	50
4.6.5	EUT OPERATING CONDITION	50
4.6.6	TEST RESULTS	51
5.	PHOTOGRAPHS OF THE TEST CONFIGURATION.....	87
6.	INFORMATION ON THE TESTING LABORATORIES	88
7.	APPENDIX A - MODIFICATIONS RECORDERS FOR ENGINEERING CHANGES TO THE EUT BY THE LAB.....	89



A D T

RELEASE CONTROL RECORD

ISSUE NO.	REASON FOR CHANGE	DATE ISSUED
Original release	NA	Aug. 04, 2011



A D T

1. CERTIFICATION

PRODUCT: 300Mbps High Gain Wireless N USB Adapter

MODEL: TL-WN822N

BRAND: TP-LINK

APPLICANT: TP-LINK TECHNOLOGIES CO., LTD.

TEST SAMPLE: ENGINEERING SAMPLE

TESTED: Jul. 21 ~ Aug. 01, 2011

STANDARDS: **FCC Part 15, Subpart C (Section 15.247)**

ANSI C63.4-2003

ANSI C63.10-2009

The above equipment (Model: TL-WN822N) has been tested by **Bureau Veritas Consumer Products Services (H.K.) Ltd., Taoyuan Branch**, and found compliance with the requirement of the above standards. The test record, data evaluation & Equipment Under Test (EUT) configurations represented herein are true and accurate accounts of the measurements of the sample's EMC characteristics under the conditions specified in this report.

PREPARED BY :  , DATE: Aug. 04, 2011
Polly Chien / Specialist

APPROVED BY :  , DATE: Aug. 04, 2011
Gary Chang / Technical Manager



A D T

2. SUMMARY OF TEST RESULTS

The EUT has been tested according to the following specifications:

APPLIED STANDARD: FCC PART 15, SUBPART C (SECTION 15.247)			
STANDARD SECTION	TEST TYPE AND LIMIT	RESULT	REMARK
15.207	AC Power Conducted Emission	PASS	Meet the requirement of limit. Minimum passing margin is -13.64dB at 0.185MHz.
15.247(a)(2)	Spectrum Bandwidth of a Direct Sequence Spread Spectrum System Limit: min. 500kHz	PASS	Meet the requirement of limit.
15.247(b)	Maximum Output Power Limit: max. 30dBm	PASS	Meet the requirement of limit.
15.247(d)	Radiated Emissions Limit: Table 15.209	PASS	Meet the requirement of limit. Minimum passing margin is -1.0dB at 2390.0MHz & 2483.5MHz.
15.247(e)	Power Spectral Density Limit: max. 8dBm	PASS	Meet the requirement of limit.
15.247(d)	Band Edge Measurement Limit: 20dB less than the peak value of fundamental frequency	PASS	Meet the requirement of limit.
15.203	Antenna Requirement	PASS	No antenna connector is used.

2.1 MEASUREMENT UNCERTAINTY

Where relevant, the following measurement uncertainty levels have been estimated for tests performed on the EUT as specified in CISPR 16-4-2:

MEASUREMENT	FREQUENCY	UNCERTAINTY
Conducted emissions	9kHz~30MHz	2.44 dB
Radiated emissions	30MHz ~ 200MHz	2.93 dB
	200MHz ~1000MHz	2.95 dB
	1GHz ~ 18GHz	2.26 dB
	18GHz ~ 40GHz	1.94 dB

This uncertainty represents an expanded uncertainty expressed at approximately the 95% confidence level using a coverage factor of $k = 2$.



3. GENERAL INFORMATION

3.1 GENERAL DESCRIPTION OF EUT

EUT	300Mbps High Gain Wireless N USB Adapter
MODEL NO.	TL-WN822N
FCC ID	TE7WN822NV2
POWER SUPPLY	5Vdc (Host equipment)
MODULATION TYPE	CCK, DQPSK, DBPSK for DSSS 64QAM, 16QAM, QPSK, BPSK for OFDM
MODULATION TECHNOLOGY	DSSS, OFDM
TRANSFER RATE	802.11b: 11.0/ 5.5/ 2.0/ 1.0Mbps 802.11g: 54.0/ 48.0/ 36.0/ 24.0/ 18.0/ 12.0/ 9.0/ 6.0Mbps 802.11n: up to 300.0Mbps
OPERATING FREQUENCY	2412 ~ 2462MHz
NUMBER OF CHANNEL	11 for 802.11b, 802.11g, 802.11n (20MHz) 7 for 802.11n (40MHz)
OUTPUT POWER	385.9mW
ANTENNA TYPE	Foliaceous Omni-directional antenna with 2.5dBi gain
ANTENNA CONNECTOR	NA
DATA CABLE	1.45m non-shielded USB cable without core
I/O PORTS	USB
ACCESSORY DEVICES	NA

NOTE:

1. The EUT incorporates a MIMO function. Physically, the EUT provides two completed transmitters and two receivers.

MODULATION MODE	TX FUNCTION
802.11b	2TX
802.11g	2TX
802.11n (20MHz)	2TX
802.11n (40MHz)	2TX

2. The above EUT information is declared by manufacturer and for more detailed features description, please refer to the manufacturer's specifications or user's manual.

3.2 DESCRIPTION OF TEST MODES

11 channels are provided for 802.11b, 802.11g and 802.11n (20MHz):

CHANNEL	FREQUENCY	CHANNEL	FREQUENCY
1	2412MHz	7	2442MHz
2	2417MHz	8	2447MHz
3	2422MHz	9	2452MHz
4	2427MHz	10	2457MHz
5	2432MHz	11	2462MHz
6	2437MHz		

7 channels are provided for 802.11n (40MHz):

CHANNEL	FREQUENCY	CHANNEL	FREQUENCY
1	2422MHz	5	2442MHz
2	2427MHz	6	2447MHz
3	2432MHz	7	2452MHz
4	2437MHz		

3.2.1 CONFIGURATION OF SYSTEM UNDER TEST

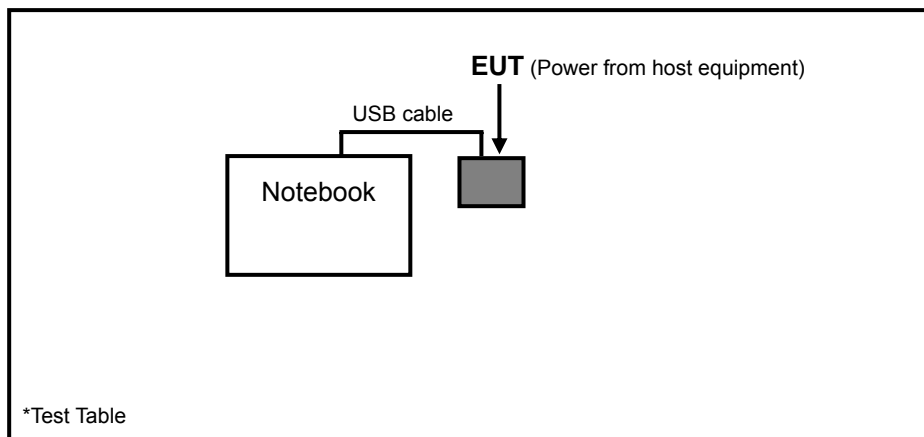



3.2.2 TEST MODE APPLICABILITY AND TESTED CHANNEL DETAIL

EUT CONFIGURE MODE	APPLICABLE TO				DESCRIPTION
	RE≥1G	RE<1G	PLC	APCM	
-	√	√	√	√	-

Where **RE≥1G**: Radiated Emission above 1GHz **RE<1G**: Radiated Emission below 1GHz
PLC: Power Line Conducted Emission **APCM**: Antenna Port Conducted Measurement

RADIATED EMISSION TEST (ABOVE 1GHz):

- Pre-Scan has been conducted to determine the worst-case mode from all possible combinations between available modulations, data rates and antenna ports (if EUT with antenna diversity architecture).
- Following channel(s) was (were) selected for the final test as listed below.

MODE	AVAILABLE CHANNEL	TESTED CHANNEL	MODULATION TECHNOLOGY	MODULATION TYPE	DATA RATE (Mbps)	ANT.
802.11b	1 to 11	1, 6, 11	DSSS	DBPSK	1.0	Vertical
802.11g	1 to 11	1, 6, 11	OFDM	BPSK	6.0	
802.11n (20MHz)	1 to 11	1, 6, 11	OFDM	BPSK	7.2	
802.11n (40MHz)	1 to 7	1, 4, 7	OFDM	BPSK	15.0	

RADIATED EMISSION TEST (BELOW 1GHz):

- Pre-Scan has been conducted to determine the worst-case mode from all possible combinations between available modulations, data rates and antenna ports (if EUT with antenna diversity architecture).
- Following channel(s) was (were) selected for the final test as listed below.

MODE	AVAILABLE CHANNEL	TESTED CHANNEL	MODULATION TECHNOLOGY	MODULATION TYPE	DATA RATE (Mbps)	ANT.
802.11g	1 to 11	6	OFDM	BPSK	6.0	Vertical

POWER LINE CONDUCTED EMISSION TEST:

- Pre-Scan has been conducted to determine the worst-case mode from all possible combinations between available modulations, data rates and antenna ports (if EUT with antenna diversity architecture).
- Following channel(s) was (were) selected for the final test as listed below.

MODE	AVAILABLE CHANNEL	TESTED CHANNEL	MODULATION TECHNOLOGY	MODULATION TYPE	DATA RATE (Mbps)	ANT.
802.11g	1 to 11	6	OFDM	BPSK	6.0	Vertical



BANDEDGE MEASUREMENT:

- Pre-Scan has been conducted to determine the worst-case mode from all possible combinations between available modulations, data rates and antenna ports (if EUT with antenna diversity architecture).
- Following channel(s) was (were) selected for the final test as listed below.

MODE	AVAILABLE CHANNEL	TESTED CHANNEL	MODULATION TECHNOLOGY	MODULATION TYPE	DATA RATE (Mbps)	ANT.
802.11b	1 to 11	1, 11	DSSS	DBPSK	1.0	Vertical
802.11g	1 to 11	1, 11	OFDM	BPSK	6.0	
802.11n (20MHz)	1 to 11	1, 11	OFDM	BPSK	7.2	
802.11n (40MHz)	1 to 7	1, 7	OFDM	BPSK	15.0	

ANTENNA PORT CONDUCTED MEASUREMENT:

- This item includes all test value of each mode, but only includes spectrum plot of worst value of each mode.
- Pre-Scan has been conducted to determine the worst-case mode from all possible combinations between available modulations, data rates and antenna ports (if EUT with antenna diversity architecture).
- Following channel(s) was (were) selected for the final test as listed below.

MODE	AVAILABLE CHANNEL	TESTED CHANNEL	MODULATION TECHNOLOGY	MODULATION TYPE	DATA RATE (Mbps)	ANT.
802.11b	1 to 11	1, 6, 11	DSSS	DBPSK	1.0	Vertical
802.11g	1 to 11	1, 6, 11	OFDM	BPSK	6.0	
802.11n (20MHz)	1 to 11	1, 6, 11	OFDM	BPSK	7.2	
802.11n (40MHz)	1 to 7	1, 4, 7	OFDM	BPSK	15.0	

TEST CONDITION:

APPLICABLE TO	ENVIRONMENTAL CONDITIONS	INPUT POWER (SYSTEM)	TESTED BY
RE≥1G	23deg. C, 66%RH	120Vac, 60Hz	Antony Lee
RE<1G	25deg. C, 68%RH	120Vac, 60Hz	Sun Lin
PLC	25deg. C, 68%RH	120Vac, 60Hz	Sun Lin
APCM	28deg. C, 68%RH	120Vac, 60Hz	Antony Lee



3.3 GENERAL DESCRIPTION OF APPLIED STANDARDS

The EUT is a RF Product. According to the specifications of the manufacturer, it must comply with the requirements of the following standards:

FCC Part 15, Subpart C (15.247)

ANSI C63.4-2003

ANSI C63.10-2009

All test items have been performed and recorded as per the above standards.

NOTE: The EUT is also considered as a kind of computer peripheral, because the connection to computer is necessary for typical use. It has been verified to comply with the requirements of FCC Part 15, Subpart B, Class B (DoC). The test report has been issued separately.

3.4 DESCRIPTION OF SUPPORT UNITS

The EUT has been tested as an independent unit together with other necessary accessories or support units. The following support units or accessories were used to form a representative test configuration during the tests.

NO.	PRODUCT	BRAND	MODEL NO.	SERIAL NO.	FCC ID
1	NOTEBOOK	DELL	PP05L	25191592336	E2K24CLNS

NO.	SIGNAL CABLE DESCRIPTION OF THE ABOVE SUPPORT UNITS
1	NA

NOTE: All power cords of the above support units are non shielded (1.8m).



4. TEST TYPES AND RESULTS

4.1 RADIATED EMISSION MEASUREMENT

4.1.1 LIMITS OF RADIATED EMISSION MEASUREMENT

Emissions radiated outside of the specified bands, shall be according to the general radiated limits in 15.209 as following:

FREQUENCIES (MHz)	FIELD STRENGTH (microvolts/meter)	MEASUREMENT DISTANCE (meters)
0.009 ~ 0.490	2400/F(kHz)	300
0.490 ~ 1.705	24000/F(kHz)	30
1.705 ~ 30.0	30	30
30 ~ 88	100	3
88 ~ 216	150	3
216 ~ 960	200	3
Above 960	500	3

NOTE:

1. The lower limit shall apply at the transition frequencies.
2. Emission level (dBuV/m) = 20 log Emission level (uV/m).
3. As shown in 15.35(b), for frequencies above 1000MHz, the field strength limits are based on average detector, however, the peak field strength of any emission shall not exceed the maximum permitted average limits, specified above by more than 20dB under any condition of modulation.



A D T

4.1.2 TEST INSTRUMENTS

DESCRIPTION & MANUFACTURER	MODEL NO.	SERIAL NO.	DATE OF CALIBRATION	DUE DATE OF CALIBRATION
Test Receiver ROHDE & SCHWARZ	ESCI	100424	Aug. 04, 2010	Aug. 03, 2011
Spectrum Analyzer ROHDE & SCHWARZ	FSP40	100269	Jan. 06, 2011	Jan. 05, 2012
BILOG Antenna SCHWARZBECK	VULB9168	9168-156	Apr. 12, 2011	Apr. 11, 2012
HORN Antenna SCHWARZBECK	BBHA 9120 D	9120D-563	Aug. 30, 2010	Aug. 29, 2011
HORN Antenna SCHWARZBECK	BBHA 9170	BBHA9170243	Dec. 27, 2010	Dec. 26, 2011
Preamplifier Agilent	8449B	3008A01910	Sep. 09, 2010	Sep. 08, 2011
Preamplifier Agilent	8447D	2944A10638	Nov. 03, 2010	Nov. 02, 2011
RF signal cable HUBER+SUHNNER	SUCOFLEX 104	295013/4 283403/4	Sep 03, 2010	Sep 03, 2011
RF signal cable Worken	8D-FB	Cable-HYCH9-01	Aug. 20, 2010	Aug. 19, 2011
Software	ADT_Radiated_ V7.6.15.9.2	NA	NA	NA
Antenna Tower EMCO	2070/2080	512.835.4684	NA	NA
Turn Table EMCO	2087-2.03	NA	NA	NA
Antenna Tower & Turn Table Controller EMCO	2090	NA	NA	NA

- NOTE:**
1. The calibration interval of the above test instruments is 12 months and the calibrations are traceable to NML/ROC and NIST/USA.
 2. The test was performed in HwaYa Chamber 9.
 3. The horn antenna and HP preamplifier (model: 8449B) are used only for the measurement of emission frequency above 1GHz if tested.
 4. The FCC Site Registration No. is 460141.
 5. The IC Site Registration No. is IC 7450F-4.



A D T

4.1.3 TEST PROCEDURES

- a. The EUT was placed on the top of a rotating table 0.8 meters above the ground at a 3 meters semi-anechoic chamber. The table was rotated 360 degrees to determine the position of the highest radiation.
- b. The EUT was set 3 meters away from the interference-receiving antenna, which was mounted on the top of a variable-height antenna tower.
- c. The antenna is a broadband antenna, and its height is varied from one meter to four meters above the ground to determine the maximum value of the field strength. Both horizontal and vertical polarizations of the antenna are set to make the measurement.
- d. For each suspected emission, the EUT was arranged to its worst case and then the antenna was tuned to heights from 1 meter to 4 meters and the rotatable table was turned from 0 degrees to 360 degrees to find the maximum reading.
- e. The test-receiver system was set to Peak Detect Function and Specified Bandwidth with Maximum Hold Mode.
- f. If the emission level of the EUT in peak mode was lower than the limit specified, then testing could be stopped and the peak values of the EUT would be reported. Otherwise the emissions would be re-tested one by one using peak, quasi-peak or average method as specified and then reported in a data sheet.

NOTE:

1. The resolution bandwidth and video bandwidth of test receiver/spectrum analyzer is 120kHz for Quasi-peak detection at frequency below 1GHz.
2. The resolution bandwidth of test receiver/spectrum analyzer is 1MHz and video bandwidth is 3MHz for Peak detection at frequency above 1GHz.
3. The resolution bandwidth of test receiver/spectrum analyzer is 1MHz and the video bandwidth is 10Hz for Average detection (AV) at frequency above 1GHz.
4. All modes of operation were investigated and the worst-case emissions are reported.

4.1.4 DEVIATION FROM TEST STANDARD

No deviation.

4.1.5 TEST SETUP

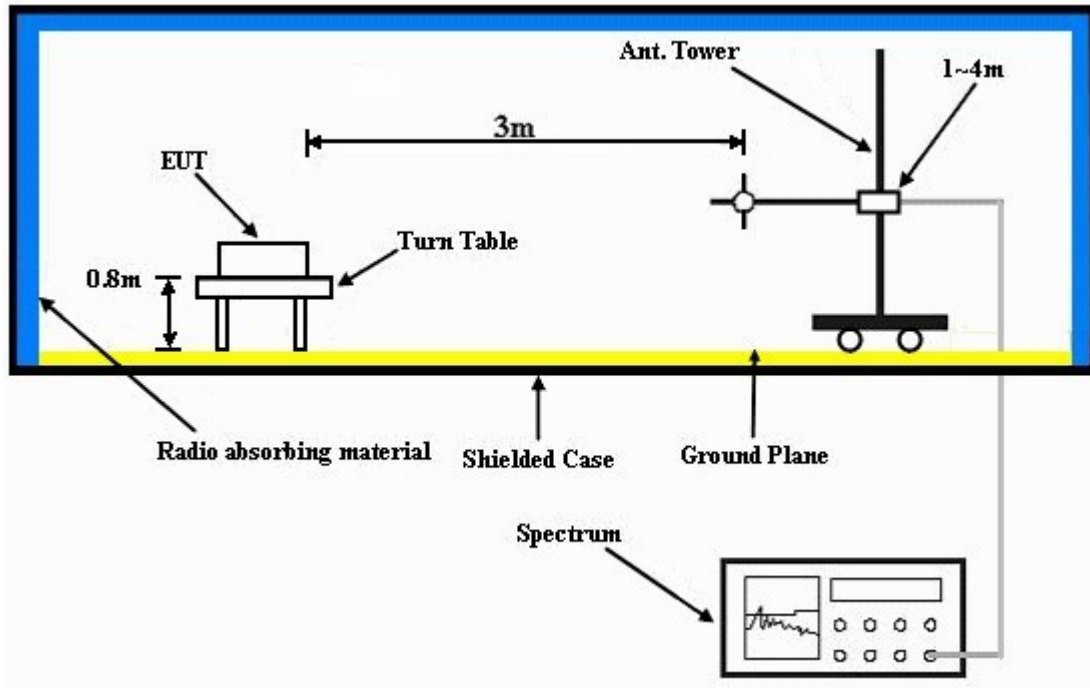

For the actual test configuration, please refer to the attached file (Test Setup Photo).

4.1.6 EUT OPERATING CONDITIONS

- Connected the EUT with notebook via USB cable and placed them on the testing table.
- The notebook system ran a test program (provided by manufacturer) to enable EUT under transmission condition continuously at specific channel frequency.
- The necessary accessories enable the system in full functions.



A D T

4.1.7 TEST RESULTS

802.11b

EUT TEST CONDITION		MEASUREMENT DETAIL	
CHANNEL	Channel 1	FREQUENCY RANGE	1 ~ 25GHz
INPUT POWER (SYSTEM)	120Vac, 60Hz	DETECTOR FUNCTION	Peak (PK) Average (AV)
ENVIRONMENTAL CONDITIONS	23deg. C, 66%RH	TESTED BY	Antony Lee

ANTENNA POLARITY & TEST DISTANCE: HORIZONTAL AT 3 M								
NO.	FREQ. (MHz)	EMISSION LEVEL (dBuV/m)	LIMIT (dBuV/m)	MARGIN (dB)	ANTENNA HEIGHT (m)	TABLE ANGLE (Degree)	RAW VALUE (dBuV)	CORRECTION FACTOR (dB/m)
1	2390.00	58.8 PK	74.0	-15.2	1.07 H	159	27.40	31.40
2	2390.00	50.2 AV	54.0	-3.8	1.07 H	159	18.80	31.40
3	*2412.00	104.7 PK			1.00 H	212	73.20	31.50
4	*2412.00	99.5 AV			1.00 H	212	68.00	31.50
5	4824.00	51.1 PK	74.0	-22.9	1.00 H	61	13.50	37.60
6	4824.00	47.3 AV	54.0	-6.7	1.00 H	61	9.70	37.60
ANTENNA POLARITY & TEST DISTANCE: VERTICAL AT 3 M								
NO.	FREQ. (MHz)	EMISSION LEVEL (dBuV/m)	LIMIT (dBuV/m)	MARGIN (dB)	ANTENNA HEIGHT (m)	TABLE ANGLE (Degree)	RAW VALUE (dBuV)	CORRECTION FACTOR (dB/m)
1	2332.00	58.2 PK	74.0	-15.8	1.00 V	152	27.00	31.20
2	2332.00	50.4 AV	54.0	-3.6	1.00 V	152	19.20	31.20
3	2390.00	62.6 PK	74.0	-11.4	1.02 V	27	31.20	31.40
4	2390.00	53.0 AV	54.0	-1.0	1.02 V	27	21.60	31.40
5	*2412.00	115.7 PK			1.44 V	178	84.20	31.50
6	*2412.00	111.6 AV			1.44 V	178	80.10	31.50
7	4824.00	53.9 PK	74.0	-20.1	1.00 V	1	16.30	37.60
8	4824.00	49.1 AV	54.0	-4.9	1.00 V	1	11.50	37.60
9	#9648.00	61.4 PK	95.7	-34.3	1.50 V	81	14.30	47.10
10	#9648.00	57.5 AV	91.6	-34.1	1.50 V	81	10.40	47.10

- REMARKS:**
1. Emission level (dBuV/m) = Raw Value (dBuV) + Correction Factor (dB/m).
 2. Correction Factor (dB/m) = Antenna Factor (dB/m) + Cable Factor (dB).
 3. The other emission levels were very low against the limit.
 4. Margin value = Emission level – Limit value.
 5. “ * “: Fundamental frequency.
 6. “#”: The radiated frequency is out the restricted band.



A D T

EUT TEST CONDITION		MEASUREMENT DETAIL	
CHANNEL	Channel 6	FREQUENCY RANGE	1 ~ 25GHz
INPUT POWER (SYSTEM)	120Vac, 60Hz	DETECTOR FUNCTION	Peak (PK) Average (AV)
ENVIRONMENTAL CONDITIONS	23deg. C, 66%RH	TESTED BY	Antony Lee

ANTENNA POLARITY & TEST DISTANCE: HORIZONTAL AT 3 M								
NO.	FREQ. (MHz)	EMISSION LEVEL (dBuV/m)	LIMIT (dBuV/m)	MARGIN (dB)	ANTENNA HEIGHT (m)	TABLE ANGLE (Degree)	RAW VALUE (dBuV)	CORRECTION FACTOR (dB/m)
1	*2437.00	104.1 PK			1.00 H	213	72.50	31.60
2	*2437.00	99.6 AV			1.00 H	213	68.00	31.60
3	4874.00	52.5 PK	74.0	-21.5	1.04 H	207	14.80	37.70
4	4874.00	39.0 AV	54.0	-15.0	1.04 H	207	1.30	37.70
5	7311.00	49.4 PK	74.0	-24.6	1.12 H	59	5.70	43.70
6	7311.00	39.2 AV	54.0	-14.8	1.12 H	59	-4.50	43.70
ANTENNA POLARITY & TEST DISTANCE: VERTICAL AT 3 M								
NO.	FREQ. (MHz)	EMISSION LEVEL (dBuV/m)	LIMIT (dBuV/m)	MARGIN (dB)	ANTENNA HEIGHT (m)	TABLE ANGLE (Degree)	RAW VALUE (dBuV)	CORRECTION FACTOR (dB/m)
1	*2437.00	114.6 PK			1.16 V	6	83.00	31.60
2	*2437.00	110.6 AV			1.16 V	6	79.00	31.60
3	4874.00	54.5 PK	74.0	-19.5	1.02 V	6	16.80	37.70
4	4874.00	50.6 AV	54.0	-3.4	1.02 V	6	12.90	37.70
5	7311.00	48.9 PK	74.0	-25.1	1.00 V	36	5.20	43.70
6	7311.00	38.9 AV	54.0	-15.1	1.00 V	36	-4.80	43.70

- REMARKS:**
1. Emission level (dBuV/m) = Raw Value (dBuV) + Correction Factor (dB/m).
 2. Correction Factor (dB/m) = Antenna Factor (dB/m) + Cable Factor (dB).
 3. The other emission levels were very low against the limit.
 4. Margin value = Emission level – Limit value.
 5. “ * “: Fundamental frequency.



A D T

EUT TEST CONDITION		MEASUREMENT DETAIL	
CHANNEL	Channel 11	FREQUENCY RANGE	1 ~ 25GHz
INPUT POWER (SYSTEM)	120Vac, 60Hz	DETECTOR FUNCTION	Peak (PK) Average (AV)
ENVIRONMENTAL CONDITIONS	23deg. C, 66%RH	TESTED BY	Antony Lee

ANTENNA POLARITY & TEST DISTANCE: HORIZONTAL AT 3 M								
NO.	FREQ. (MHz)	EMISSION LEVEL (dBuV/m)	LIMIT (dBuV/m)	MARGIN (dB)	ANTENNA HEIGHT (m)	TABLE ANGLE (Degree)	RAW VALUE (dBuV)	CORRECTION FACTOR (dB/m)
1	*2462.00	103.4 PK			1.00 H	156	71.70	31.70
2	*2462.00	98.8 AV			1.00 H	156	67.10	31.70
3	2483.50	57.7 PK	74.0	-16.3	1.02 H	156	25.90	31.80
4	2483.50	46.7 AV	54.0	-7.3	1.02 H	156	14.90	31.80
5	4924.00	48.8 PK	74.0	-25.2	1.00 H	156	11.00	37.80
6	4924.00	44.0 AV	54.0	-10.0	1.00 H	156	6.20	37.80
ANTENNA POLARITY & TEST DISTANCE: VERTICAL AT 3 M								
NO.	FREQ. (MHz)	EMISSION LEVEL (dBuV/m)	LIMIT (dBuV/m)	MARGIN (dB)	ANTENNA HEIGHT (m)	TABLE ANGLE (Degree)	RAW VALUE (dBuV)	CORRECTION FACTOR (dB/m)
1	*2462.00	114.4 PK			1.16 V	191	82.70	31.70
2	*2462.00	110.5 AV			1.16 V	191	78.80	31.70
3	2483.50	60.2 PK	74.0	-13.8	1.19 V	54	28.40	31.80
4	2483.50	52.6 AV	54.0	-1.4	1.19 V	54	20.80	31.80
5	4924.00	51.3 PK	74.0	-22.7	1.00 V	2	13.50	37.80
6	4924.00	46.7 AV	54.0	-7.3	1.00 V	2	8.90	37.80

- REMARKS:**
1. Emission level (dBuV/m) = Raw Value (dBuV) + Correction Factor (dB/m).
 2. Correction Factor (dB/m) = Antenna Factor (dB/m) + Cable Factor (dB).
 3. The other emission levels were very low against the limit.
 4. Margin value = Emission level – Limit value.
 5. “ * “: Fundamental frequency.



A D T

802.11g OFDM MODULATION

EUT TEST CONDITION		MEASUREMENT DETAIL	
CHANNEL	Channel 1	FREQUENCY RANGE	1 ~ 25GHz
INPUT POWER (SYSTEM)	120Vac, 60Hz	DETECTOR FUNCTION	Peak (PK) Average (AV)
ENVIRONMENTAL CONDITIONS	23deg. C, 66%RH	TESTED BY	Antony Lee

ANTENNA POLARITY & TEST DISTANCE: HORIZONTAL AT 3 M								
NO.	FREQ. (MHz)	EMISSION LEVEL (dBuV/m)	LIMIT (dBuV/m)	MARGIN (dB)	ANTENNA HEIGHT (m)	TABLE ANGLE (Degree)	RAW VALUE (dBuV)	CORRECTION FACTOR (dB/m)
1	2390.00	66.4 PK	74.0	-7.6	1.25 H	220	35.00	31.40
2	2390.00	47.8 AV	54.0	-6.2	1.25 H	220	16.40	31.40
3	*2412.00	103.2 PK			1.28 H	216	71.70	31.50
4	*2412.00	90.7 AV			1.28 H	216	59.20	31.50
5	4824.00	47.5 PK	74.0	-26.5	1.00 H	263	9.90	37.60
6	4824.00	33.9 AV	54.0	-20.1	1.00 H	263	-3.70	37.60
ANTENNA POLARITY & TEST DISTANCE: VERTICAL AT 3 M								
NO.	FREQ. (MHz)	EMISSION LEVEL (dBuV/m)	LIMIT (dBuV/m)	MARGIN (dB)	ANTENNA HEIGHT (m)	TABLE ANGLE (Degree)	RAW VALUE (dBuV)	CORRECTION FACTOR (dB/m)
1	2390.00	72.9 PK	74.0	-1.1	1.00 V	4	41.50	31.40
2	2390.00	52.7 AV	54.0	-1.3	1.00 V	4	21.30	31.40
3	*2412.00	109.6 PK			1.18 V	3	78.10	31.50
4	*2412.00	98.5 AV			1.18 V	3	67.00	31.50
5	4824.00	44.5 PK	74.0	-29.5	1.00 V	263	6.90	37.60
6	4824.00	34.1 AV	54.0	-19.9	1.00 V	263	-3.50	37.60

- REMARKS:**
1. Emission level (dBuV/m) = Raw Value (dBuV) + Correction Factor (dB/m).
 2. Correction Factor (dB/m) = Antenna Factor (dB/m) + Cable Factor (dB).
 3. The other emission levels were very low against the limit.
 4. Margin value = Emission level – Limit value.
 5. “ * ”: Fundamental frequency.



A D T

EUT TEST CONDITION		MEASUREMENT DETAIL	
CHANNEL	Channel 6	FREQUENCY RANGE	1 ~ 25GHz
INPUT POWER (SYSTEM)	120Vac, 60Hz	DETECTOR FUNCTION	Peak (PK) Average (AV)
ENVIRONMENTAL CONDITIONS	23deg. C, 66%RH	TESTED BY	Antony Lee

ANTENNA POLARITY & TEST DISTANCE: HORIZONTAL AT 3 M								
NO.	FREQ. (MHz)	EMISSION LEVEL (dBuV/m)	LIMIT (dBuV/m)	MARGIN (dB)	ANTENNA HEIGHT (m)	TABLE ANGLE (Degree)	RAW VALUE (dBuV)	CORRECTION FACTOR (dB/m)
1	*2437.00	106.8 PK			1.29 H	156	75.20	31.60
2	*2437.00	95.7 AV			1.29 H	156	64.10	31.60
3	4874.00	52.6 PK	74.0	-21.4	1.00 H	210	14.90	37.70
4	4874.00	39.5 AV	54.0	-14.5	1.00 H	210	1.80	37.70
5	7311.00	50.3 PK	74.0	-23.7	1.10 H	63	6.60	43.70
6	7311.00	40.8 AV	54.0	-13.2	1.10 H	63	-2.90	43.70
ANTENNA POLARITY & TEST DISTANCE: VERTICAL AT 3 M								
NO.	FREQ. (MHz)	EMISSION LEVEL (dBuV/m)	LIMIT (dBuV/m)	MARGIN (dB)	ANTENNA HEIGHT (m)	TABLE ANGLE (Degree)	RAW VALUE (dBuV)	CORRECTION FACTOR (dB/m)
1	*2437.00	116.2 PK			1.68 V	6	84.60	31.60
2	*2437.00	104.3 AV			1.68 V	6	72.70	31.60
3	4874.00	49.2 PK	74.0	-24.8	1.00 V	56	11.50	37.70
4	4874.00	38.5 AV	54.0	-15.5	1.00 V	56	0.80	37.70
5	7311.00	49.6 PK	74.0	-24.4	1.00 V	33	5.90	43.70
6	7311.00	39.3 AV	54.0	-14.7	1.00 V	33	-4.40	43.70

- REMARKS:**
1. Emission level (dBuV/m) = Raw Value (dBuV) + Correction Factor (dB/m).
 2. Correction Factor (dB/m) = Antenna Factor (dB/m) + Cable Factor (dB).
 3. The other emission levels were very low against the limit.
 4. Margin value = Emission level – Limit value.
 5. “ * “: Fundamental frequency.



A D T

EUT TEST CONDITION		MEASUREMENT DETAIL	
CHANNEL	Channel 11	FREQUENCY RANGE	1 ~ 25GHz
INPUT POWER (SYSTEM)	120Vac, 60Hz	DETECTOR FUNCTION	Peak (PK) Average (AV)
ENVIRONMENTAL CONDITIONS	23deg. C, 66%RH	TESTED BY	Antony Lee

ANTENNA POLARITY & TEST DISTANCE: HORIZONTAL AT 3 M								
NO.	FREQ. (MHz)	EMISSION LEVEL (dBuV/m)	LIMIT (dBuV/m)	MARGIN (dB)	ANTENNA HEIGHT (m)	TABLE ANGLE (Degree)	RAW VALUE (dBuV)	CORRECTION FACTOR (dB/m)
1	*2462.00	102.1 PK			1.00 H	160	70.40	31.70
2	*2462.00	89.9 AV			1.00 H	160	58.20	31.70
3	2483.50	65.7 PK	74.0	-8.3	1.00 H	158	33.90	31.80
4	2483.50	49.4 AV	54.0	-4.6	1.00 H	158	17.60	31.80
5	4924.00	48.3 PK	74.0	-25.7	1.00 H	259	10.50	37.80
6	4924.00	34.6 AV	54.0	-19.4	1.00 H	259	-3.20	37.80
ANTENNA POLARITY & TEST DISTANCE: VERTICAL AT 3 M								
NO.	FREQ. (MHz)	EMISSION LEVEL (dBuV/m)	LIMIT (dBuV/m)	MARGIN (dB)	ANTENNA HEIGHT (m)	TABLE ANGLE (Degree)	RAW VALUE (dBuV)	CORRECTION FACTOR (dB/m)
1	*2462.00	110.2 PK			1.16 V	18	78.50	31.70
2	*2462.00	99.8 AV			1.16 V	18	68.10	31.70
3	2483.50	72.1 PK	74.0	-1.9	1.40 V	61	40.30	31.80
4	2483.50	52.9 AV	54.0	-1.1	1.40 V	61	21.10	31.80
5	4924.00	45.6 PK	74.0	-28.4	1.00 V	271	7.80	37.80
6	4924.00	35.8 AV	54.0	-18.2	1.00 V	271	-2.00	37.80

- REMARKS:**
1. Emission level (dBuV/m) = Raw Value (dBuV) + Correction Factor (dB/m).
 2. Correction Factor (dB/m) = Antenna Factor (dB/m) + Cable Factor (dB).
 3. The other emission levels were very low against the limit.
 4. Margin value = Emission level – Limit value.
 5. “ * “: Fundamental frequency.



A D T

802.11n (20MHz)

EUT TEST CONDITION		MEASUREMENT DETAIL	
CHANNEL	Channel 1	FREQUENCY RANGE	1 ~ 25GHz
INPUT POWER (SYSTEM)	120Vac, 60Hz	DETECTOR FUNCTION	Peak (PK) Average (AV)
ENVIRONMENTAL CONDITIONS	23deg. C, 66%RH	TESTED BY	Antony Lee

ANTENNA POLARITY & TEST DISTANCE: HORIZONTAL AT 3 M								
NO.	FREQ. (MHz)	EMISSION LEVEL (dBuV/m)	LIMIT (dBuV/m)	MARGIN (dB)	ANTENNA HEIGHT (m)	TABLE ANGLE (Degree)	RAW VALUE (dBuV)	CORRECTION FACTOR (dB/m)
1	2390.00	56.9 PK	74.0	-17.1	1.00 H	105	25.50	31.40
2	2390.00	46.1 AV	54.0	-7.9	1.00 H	105	14.70	31.40
3	*2412.00	98.1 PK			1.00 H	108	66.60	31.50
4	*2412.00	86.1 AV			1.00 H	108	54.60	31.50
5	4824.00	45.1 PK	74.0	-28.9	1.00 H	15	7.50	37.60
6	4824.00	34.0 AV	54.0	-20.0	1.00 H	15	-3.60	37.60
ANTENNA POLARITY & TEST DISTANCE: VERTICAL AT 3 M								
NO.	FREQ. (MHz)	EMISSION LEVEL (dBuV/m)	LIMIT (dBuV/m)	MARGIN (dB)	ANTENNA HEIGHT (m)	TABLE ANGLE (Degree)	RAW VALUE (dBuV)	CORRECTION FACTOR (dB/m)
1	2390.00	63.5 PK	74.0	-10.5	1.41 V	350	32.10	31.40
2	2390.00	49.9 AV	54.0	-4.1	1.41 V	350	18.50	31.40
3	*2412.00	107.5 PK			1.39 V	349	76.00	31.50
4	*2412.00	95.2 AV			1.39 V	349	63.70	31.50
5	4824.00	47.4 PK	74.0	-26.6	1.00 V	213	9.80	37.60
6	4824.00	34.1 AV	54.0	-19.9	1.00 V	213	-3.50	37.60

- REMARKS:**
1. Emission level (dBuV/m) = Raw Value (dBuV) + Correction Factor (dB/m).
 2. Correction Factor (dB/m) = Antenna Factor (dB/m) + Cable Factor (dB).
 3. The other emission levels were very low against the limit.
 4. Margin value = Emission level – Limit value.
 5. “ * ”: Fundamental frequency.



A D T

EUT TEST CONDITION		MEASUREMENT DETAIL	
CHANNEL	Channel 6	FREQUENCY RANGE	1 ~ 25GHz
INPUT POWER (SYSTEM)	120Vac, 60Hz	DETECTOR FUNCTION	Peak (PK) Average (AV)
ENVIRONMENTAL CONDITIONS	23deg. C, 66%RH	TESTED BY	Antony Lee

ANTENNA POLARITY & TEST DISTANCE: HORIZONTAL AT 3 M								
NO.	FREQ. (MHz)	EMISSION LEVEL (dBuV/m)	LIMIT (dBuV/m)	MARGIN (dB)	ANTENNA HEIGHT (m)	TABLE ANGLE (Degree)	RAW VALUE (dBuV)	CORRECTION FACTOR (dB/m)
1	*2437.00	103.1 PK			1.00 H	207	71.50	31.60
2	*2437.00	91.9 AV			1.00 H	207	60.30	31.60
3	4874.00	45.5 PK	74.0	-28.5	1.02 H	53	7.80	37.70
4	4874.00	35.0 AV	54.0	-19.0	1.02 H	53	-2.70	37.70
5	7311.00	50.6 PK	74.0	-23.4	1.10 H	69	6.90	43.70
6	7311.00	40.8 AV	54.0	-13.2	1.10 H	69	-2.90	43.70
ANTENNA POLARITY & TEST DISTANCE: VERTICAL AT 3 M								
NO.	FREQ. (MHz)	EMISSION LEVEL (dBuV/m)	LIMIT (dBuV/m)	MARGIN (dB)	ANTENNA HEIGHT (m)	TABLE ANGLE (Degree)	RAW VALUE (dBuV)	CORRECTION FACTOR (dB/m)
1	2390.00	59.1 PK	74.0	-14.9	1.00 V	256	27.70	31.40
2	2390.00	50.4 AV	54.0	-3.6	1.00 V	256	19.00	31.40
3	*2437.00	113.5 PK			1.68 V	352	81.90	31.60
4	*2437.00	101.9 AV			1.68 V	352	70.30	31.60
5	4874.00	48.7 PK	74.0	-25.3	1.00 V	56	11.00	37.70
6	4874.00	34.6 AV	54.0	-19.4	1.00 V	56	-3.10	37.70

- REMARKS:**
1. Emission level (dBuV/m) = Raw Value (dBuV) + Correction Factor (dB/m).
 2. Correction Factor (dB/m) = Antenna Factor (dB/m) + Cable Factor (dB).
 3. The other emission levels were very low against the limit.
 4. Margin value = Emission level – Limit value.
 5. “ * “: Fundamental frequency.



A D T

EUT TEST CONDITION		MEASUREMENT DETAIL	
CHANNEL	Channel 11	FREQUENCY RANGE	1 ~ 25GHz
INPUT POWER (SYSTEM)	120Vac, 60Hz	DETECTOR FUNCTION	Peak (PK) Average (AV)
ENVIRONMENTAL CONDITIONS	23deg. C, 66%RH	TESTED BY	Antony Lee

ANTENNA POLARITY & TEST DISTANCE: HORIZONTAL AT 3 M								
NO.	FREQ. (MHz)	EMISSION LEVEL (dBuV/m)	LIMIT (dBuV/m)	MARGIN (dB)	ANTENNA HEIGHT (m)	TABLE ANGLE (Degree)	RAW VALUE (dBuV)	CORRECTION FACTOR (dB/m)
1	*2462.00	100.9 PK			1.02 H	159	69.20	31.70
2	*2462.00	88.4 AV			1.02 H	159	56.70	31.70
3	2483.50	65.5 PK	74.0	-8.5	1.00 H	162	33.70	31.80
4	2483.50	50.3 AV	54.0	-3.7	1.00 H	162	18.50	31.80
5	4924.00	52.3 PK	74.0	-21.7	1.00 H	158	14.50	37.80
6	4924.00	48.9 AV	54.0	-5.1	1.00 H	158	11.10	37.80
ANTENNA POLARITY & TEST DISTANCE: VERTICAL AT 3 M								
NO.	FREQ. (MHz)	EMISSION LEVEL (dBuV/m)	LIMIT (dBuV/m)	MARGIN (dB)	ANTENNA HEIGHT (m)	TABLE ANGLE (Degree)	RAW VALUE (dBuV)	CORRECTION FACTOR (dB/m)
1	*2462.00	109.3 PK			1.11 V	18	77.60	31.70
2	*2462.00	97.1 AV			1.11 V	18	65.40	31.70
3	2483.50	72.6 PK	74.0	-1.4	1.11 V	18	40.80	31.80
4	2483.50	53.0 AV	54.0	-1.0	1.11 V	18	21.20	31.80
5	4924.00	54.6 PK	74.0	-19.4	1.00 V	250	16.80	37.80
6	4924.00	50.8 AV	54.0	-3.2	1.00 V	250	13.00	37.80

- REMARKS:**
1. Emission level (dBuV/m) = Raw Value (dBuV) + Correction Factor (dB/m).
 2. Correction Factor (dB/m) = Antenna Factor (dB/m) + Cable Factor (dB).
 3. The other emission levels were very low against the limit.
 4. Margin value = Emission level – Limit value.
 5. “ * “: Fundamental frequency.



A D T

802.11n (40MHz)

EUT TEST CONDITION		MEASUREMENT DETAIL	
CHANNEL	Channel 1	FREQUENCY RANGE	1 ~ 25GHz
INPUT POWER (SYSTEM)	120Vac, 60Hz	DETECTOR FUNCTION	Peak (PK) Average (AV)
ENVIRONMENTAL CONDITIONS	23deg. C, 66%RH	TESTED BY	Antony Lee

ANTENNA POLARITY & TEST DISTANCE: HORIZONTAL AT 3 M								
NO.	FREQ. (MHz)	EMISSION LEVEL (dBuV/m)	LIMIT (dBuV/m)	MARGIN (dB)	ANTENNA HEIGHT (m)	TABLE ANGLE (Degree)	RAW VALUE (dBuV)	CORRECTION FACTOR (dB/m)
1	2390.00	60.9 PK	74.0	-13.1	1.29 H	218	29.50	31.40
2	2390.00	46.2 AV	54.0	-7.8	1.29 H	218	14.80	31.40
3	*2422.00	93.8 PK			1.31 H	220	62.30	31.50
4	*2422.00	82.5 AV			1.31 H	220	51.00	31.50
5	4844.00	49.8 PK	74.0	-24.2	1.05 H	48	12.10	37.70
6	4844.00	37.7 AV	54.0	-16.3	1.05 H	48	0.00	37.70
ANTENNA POLARITY & TEST DISTANCE: VERTICAL AT 3 M								
NO.	FREQ. (MHz)	EMISSION LEVEL (dBuV/m)	LIMIT (dBuV/m)	MARGIN (dB)	ANTENNA HEIGHT (m)	TABLE ANGLE (Degree)	RAW VALUE (dBuV)	CORRECTION FACTOR (dB/m)
1	2390.00	66.9 PK	74.0	-7.1	1.02 V	5	35.50	31.40
2	2390.00	52.5 AV	54.0	-1.5	1.02 V	5	21.10	31.40
3	*2422.00	103.5 PK			1.45 V	185	72.00	31.50
4	*2422.00	91.9 AV			1.45 V	185	60.40	31.50
5	4844.00	46.7 PK	74.0	-27.3	1.12 V	23	9.00	37.70
6	4844.00	34.8 AV	54.0	-19.2	1.12 V	23	-2.90	37.70

- REMARKS:**
1. Emission level (dBuV/m) = Raw Value (dBuV) + Correction Factor (dB/m).
 2. Correction Factor (dB/m) = Antenna Factor (dB/m) + Cable Factor (dB).
 3. The other emission levels were very low against the limit.
 4. Margin value = Emission level – Limit value.
 5. “ * ”: Fundamental frequency.



A D T

EUT TEST CONDITION		MEASUREMENT DETAIL	
CHANNEL	Channel 4	FREQUENCY RANGE	1 ~ 25GHz
INPUT POWER (SYSTEM)	120Vac, 60Hz	DETECTOR FUNCTION	Peak (PK) Average (AV)
ENVIRONMENTAL CONDITIONS	23deg. C, 66%RH	TESTED BY	Antony Lee

ANTENNA POLARITY & TEST DISTANCE: HORIZONTAL AT 3 M								
NO.	FREQ. (MHz)	EMISSION LEVEL (dBuV/m)	LIMIT (dBuV/m)	MARGIN (dB)	ANTENNA HEIGHT (m)	TABLE ANGLE (Degree)	RAW VALUE (dBuV)	CORRECTION FACTOR (dB/m)
1	*2437.00	98.5 PK			1.00 H	159	66.90	31.60
2	*2437.00	87.1 AV			1.00 H	159	55.50	31.60
3	4874.00	47.2 PK	74.0	-26.8	1.00 H	56	9.50	37.70
4	4874.00	34.1 AV	54.0	-19.9	1.00 H	56	-3.60	37.70
5	7311.00	49.0 PK	74.0	-25.0	1.02 H	147	5.30	43.70
6	7311.00	39.1 AV	54.0	-14.9	1.02 H	147	-4.60	43.70

ANTENNA POLARITY & TEST DISTANCE: VERTICAL AT 3 M								
NO.	FREQ. (MHz)	EMISSION LEVEL (dBuV/m)	LIMIT (dBuV/m)	MARGIN (dB)	ANTENNA HEIGHT (m)	TABLE ANGLE (Degree)	RAW VALUE (dBuV)	CORRECTION FACTOR (dB/m)
1	2390.00	65.3 PK	74.0	-8.7	1.33 V	310	33.90	31.40
2	2390.00	52.5 AV	54.0	-1.5	1.33 V	310	21.10	31.40
3	*2437.00	108.3 PK			1.17 V	199	76.70	31.60
4	*2437.00	97.3 AV			1.17 V	199	65.70	31.60
5	4874.00	47.8 PK	74.0	-26.2	1.00 V	236	10.10	37.70
6	4874.00	34.8 AV	54.0	-19.2	1.00 V	236	-2.90	37.70
7	7311.00	50.1 PK	74.0	-23.9	1.20 V	36	6.40	43.70
8	7311.00	39.0 AV	54.0	-15.0	1.20 V	36	-4.70	43.70

- REMARKS:**
1. Emission level (dBuV/m) = Raw Value (dBuV) + Correction Factor (dB/m).
 2. Correction Factor (dB/m) = Antenna Factor (dB/m) + Cable Factor (dB).
 3. The other emission levels were very low against the limit.
 4. Margin value = Emission level – Limit value.
 5. “ * “: Fundamental frequency.



A D T

EUT TEST CONDITION		MEASUREMENT DETAIL	
CHANNEL	Channel 7	FREQUENCY RANGE	1 ~ 25GHz
INPUT POWER (SYSTEM)	120Vac, 60Hz	DETECTOR FUNCTION	Peak (PK) Average (AV)
ENVIRONMENTAL CONDITIONS	23deg. C, 66%RH	TESTED BY	Antony Lee

ANTENNA POLARITY & TEST DISTANCE: HORIZONTAL AT 3 M								
NO.	FREQ. (MHz)	EMISSION LEVEL (dBuV/m)	LIMIT (dBuV/m)	MARGIN (dB)	ANTENNA HEIGHT (m)	TABLE ANGLE (Degree)	RAW VALUE (dBuV)	CORRECTION FACTOR (dB/m)
1	*2452.00	94.6 PK			1.30 H	222	62.90	31.70
2	*2452.00	83.5 AV			1.30 H	222	51.80	31.70
3	2483.50	62.5 PK	74.0	-11.5	1.35 H	225	30.70	31.80
4	2483.50	48.3 AV	54.0	-5.7	1.35 H	225	16.50	31.80
5	4904.00	50.2 PK	74.0	-23.8	1.00 H	66	12.40	37.80
6	4904.00	38.6 AV	54.0	-15.4	1.00 H	66	0.80	37.80
ANTENNA POLARITY & TEST DISTANCE: VERTICAL AT 3 M								
NO.	FREQ. (MHz)	EMISSION LEVEL (dBuV/m)	LIMIT (dBuV/m)	MARGIN (dB)	ANTENNA HEIGHT (m)	TABLE ANGLE (Degree)	RAW VALUE (dBuV)	CORRECTION FACTOR (dB/m)
1	*2452.00	104.5 PK			1.14 V	18	72.80	31.70
2	*2452.00	92.9 AV			1.14 V	18	61.20	31.70
3	2483.50	72.3 PK	74.0	-1.7	1.14 V	16	40.50	31.80
4	2483.50	52.7 AV	54.0	-1.3	1.14 V	16	20.90	31.80
5	4904.00	46.9 PK	74.0	-27.1	1.10 V	26	9.10	37.80
6	4904.00	35.1 AV	54.0	-18.9	1.10 V	26	-2.70	37.80

- REMARKS:**
1. Emission level (dBuV/m) = Raw Value (dBuV) + Correction Factor (dB/m).
 2. Correction Factor (dB/m) = Antenna Factor (dB/m) + Cable Factor (dB).
 3. The other emission levels were very low against the limit.
 4. Margin value = Emission level – Limit value.
 5. “ * “: Fundamental frequency.



A D T

BELOW 1GHz WORST-CASE DATA : 802.11g

EUT TEST CONDITION		MEASUREMENT DETAIL	
CHANNEL	Channel 6	FREQUENCY RANGE	Below 1000MHz
INPUT POWER (SYSTEM)	120Vac, 60Hz	DETECTOR FUNCTION	Quasi-Peak
ENVIRONMENTAL CONDITIONS	25deg. C, 68%RH	TESTED BY	Sun Lin

ANTENNA POLARITY & TEST DISTANCE: HORIZONTAL AT 3 M								
NO.	FREQ. (MHz)	EMISSION LEVEL (dBuV/m)	LIMIT (dBuV/m)	MARGIN (dB)	ANTENNA HEIGHT (m)	TABLE ANGLE (Degree)	RAW VALUE (dBuV)	CORRECTION FACTOR (dB/m)
1	59.06	29.5 QP	40.0	-10.5	1.50 H	211	16.50	13.00
2	166.00	39.4 QP	43.5	-4.1	2.00 H	268	25.90	13.50
3	220.44	40.5 QP	46.0	-5.5	1.50 H	214	29.30	11.20
4	304.04	31.1 QP	46.0	-14.9	1.00 H	220	16.30	14.80
5	840.67	33.6 QP	46.0	-12.4	1.50 H	190	8.50	25.10
6	910.66	42.5 QP	46.0	-3.5	2.00 H	337	16.30	26.20
ANTENNA POLARITY & TEST DISTANCE: VERTICAL AT 3 M								
NO.	FREQ. (MHz)	EMISSION LEVEL (dBuV/m)	LIMIT (dBuV/m)	MARGIN (dB)	ANTENNA HEIGHT (m)	TABLE ANGLE (Degree)	RAW VALUE (dBuV)	CORRECTION FACTOR (dB/m)
1	57.12	31.9 QP	40.0	-8.1	1.00 V	346	18.80	13.10
2	166.00	36.9 QP	43.5	-6.6	1.00 V	346	23.40	13.50
3	220.44	32.6 QP	46.0	-13.4	1.50 V	337	21.40	11.20
4	305.99	30.4 QP	46.0	-15.6	1.50 V	271	15.60	14.80
5	529.58	29.0 QP	46.0	-17.0	1.25 V	265	8.60	20.40
6	840.67	34.7 QP	46.0	-11.3	1.25 V	154	9.60	25.10

- REMARKS:**
1. Emission level (dBuV/m) = Raw Value (dBuV) + Correction Factor (dB/m).
 2. Correction Factor (dB/m) = Antenna Factor (dB/m) + Cable Factor (dB).
 3. The other emission levels were very low against the limit.
 4. Margin value = Emission level – Limit value.



A D T

4.2 CONDUCTED EMISSION MEASUREMENT

4.2.1 LIMITS OF CONDUCTED EMISSION MEASUREMENT

FREQUENCY OF EMISSION (MHz)	CONDUCTED LIMIT (dBµV)	
	Quasi-peak	Average
0.15 ~ 0.5	66 to 56	56 to 46
0.5 ~ 5	56	46
5 ~ 30	60	50

- NOTE:** 1. The lower limit shall apply at the transition frequencies.
2. The limit decreases in line with the logarithm of the frequency in the range of 0.15 to 0.50MHz.
3. All emanations from a class A/B digital device or system, including any network of conductors and apparatus connected thereto, shall not exceed the level of field strengths specified above.

4.2.2 TEST INSTRUMENTS

DESCRIPTION & MANUFACTURER	MODEL NO.	SERIAL NO.	DATE OF CALIBRATION	DUE DATE OF CALIBRATION
Test Receiver ROHDE & SCHWARZ	ESCS30	100289	Nov. 23, 2010	Nov. 22, 2011
RF signal cable Woken	5D-FB	Cable-HYCO2-01	Dec. 30, 2010	Dec. 29, 2011
LISN ROHDE & SCHWARZ	ESH2-Z5	100100	Jan. 06, 2011	Jan. 05, 2012
LISN ROHDE & SCHWARZ	ESH3-Z5	100312	Jul. 07, 2011	Jul. 06, 2012
Software ADT	ADT_Cond_ V7.3.7	NA	NA	NA

- NOTE:** 1. The calibration interval of the above test instruments is 12 months and the calibrations are traceable to NML/ROC and NIST/USA.
2. The test was performed in HwaYa Shielded Room 2.
3. The VCCI Site Registration No. is C-2047.



4.2.3 TEST PROCEDURES

- a. The EUT was placed 0.4 meters from the conducting wall of the shielded room with EUT being connected to the power mains through a line impedance stabilization network (LISN). Other support units were connected to the power mains through another LISN. The two LISNs provide 50 ohm/ 50uH of coupling impedance for the measuring instrument.
- b. Both lines of the power mains connected to the EUT were checked for maximum conducted interference.
- c. The frequency range from 150kHz to 30MHz was searched. Emission levels under (Limit - 20dB) was not recorded.

NOTE: All modes of operation were investigated and the worst-case emissions are reported.

4.2.4 DEVIATION FROM TEST STANDARD

No deviation.

4.2.5 TEST SETUP

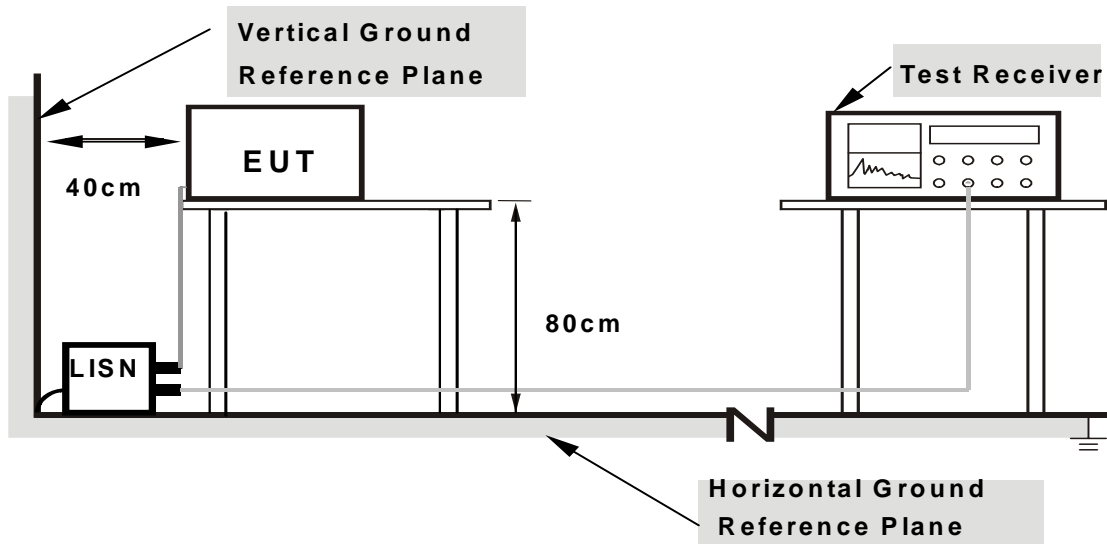

Note: 1.Support units were connected to second LISN.

2.Both of LISNs (AMN) are 80 cm from EUT and at least 80 from other units and other metal planes

For the actual test configuration, please refer to the attached file (Test Setup Photo).

4.2.6 EUT OPERATING CONDITIONS

Same as 4.1.6.

4.2.7 TEST RESULTS

CONDUCTED WORST-CASE DATA : 802.11g

PHASE	Line 1	6dB BANDWIDTH	9kHz
-------	--------	---------------	------

No	Freq. [MHz]	Corr. Factor (dB)	Reading Value		Emission Level		Limit		Margin	
			[dB (uV)]		[dB (uV)]		[dB (uV)]		(dB)	
			Q.P.	AV.	Q.P.	AV.	Q.P.	AV.	Q.P.	AV.
1	0.150	0.15	49.36	-	49.51	-	66.00	56.00	-16.49	-
2	0.185	0.15	50.03	-	50.18	-	64.25	54.25	-14.07	-
3	0.248	0.15	40.52	-	40.67	-	61.84	51.84	-21.16	-
4	0.334	0.16	30.66	-	30.82	-	59.36	49.36	-28.54	-
5	2.027	0.22	19.15	-	19.37	-	56.00	46.00	-36.63	-
6	4.039	0.32	16.48	-	16.80	-	56.00	46.00	-39.20	-

- REMARKS:**
1. Q.P. and AV. are abbreviations of quasi-peak and average individually.
 2. "-": The Quasi-peak reading value also meets average limit and measurement with the average detector is unnecessary.
 3. The emission levels of other frequencies were very low against the limit.
 4. Margin value = Emission level - Limit value
 5. Correction factor = Insertion loss + Cable loss
 6. Emission Level = Correction Factor + Reading Value.

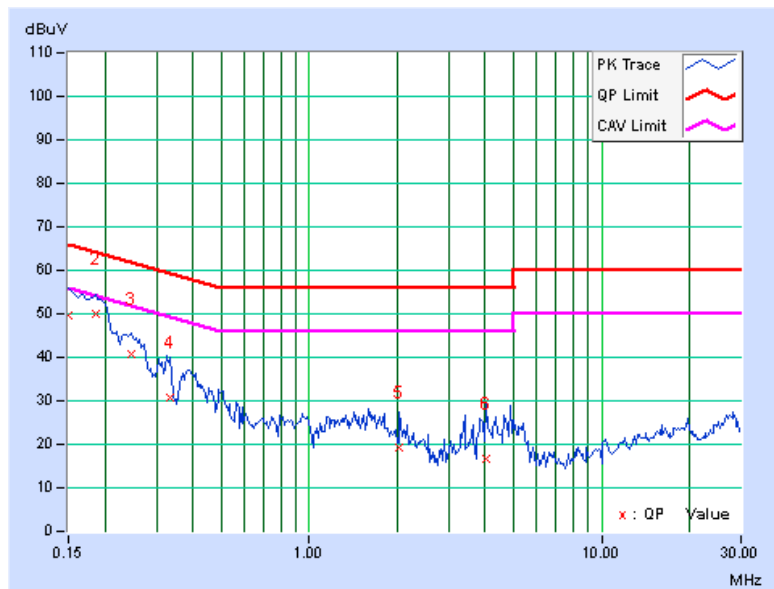

PHASE	Line 2	6dB BANDWIDTH	9kHz
-------	--------	---------------	------

No	Freq. [MHz]	Corr.	Reading Value		Emission Level		Limit		Margin	
		Factor	[dB (uV)]		[dB (uV)]		[dB (uV)]		(dB)	
		(dB)	Q.P.	AV.	Q.P.	AV.	Q.P.	AV.	Q.P.	AV.
1	0.158	0.16	49.52	-	49.68	-	65.58	55.58	-15.90	-
2	0.185	0.17	50.45	-	50.62	-	64.25	54.25	-13.64	-
3	0.244	0.17	40.04	-	40.21	-	61.97	51.97	-21.75	-
4	0.338	0.18	32.05	-	32.23	-	59.26	49.26	-27.03	-
5	3.934	0.32	16.19	-	16.51	-	56.00	46.00	-39.49	-
6	5.035	0.35	16.64	-	16.99	-	60.00	50.00	-43.01	-

- REMARKS:**
1. Q.P. and AV. are abbreviations of quasi-peak and average individually.
 2. "-": The Quasi-peak reading value also meets average limit and measurement with the average detector is unnecessary.
 3. The emission levels of other frequencies were very low against the limit.
 4. Margin value = Emission level - Limit value
 5. Correction factor = Insertion loss + Cable loss
 6. Emission Level = Correction Factor + Reading Value.

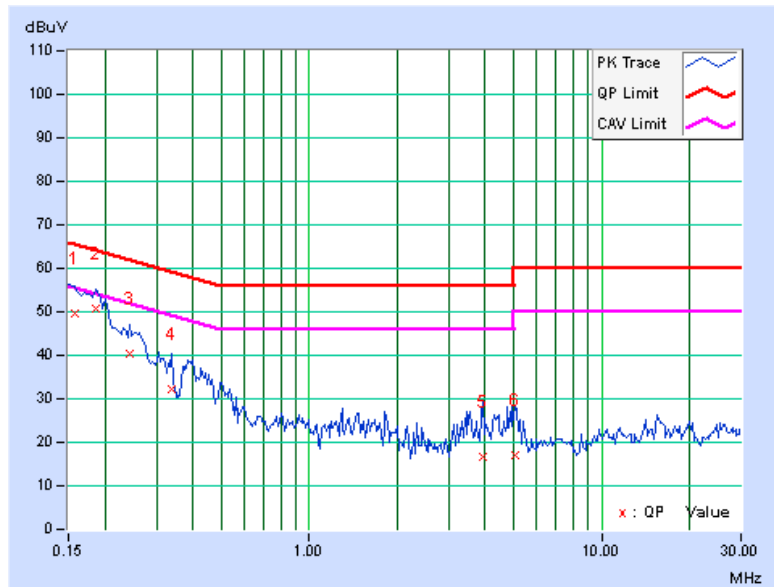

4.3 6dB BANDWIDTH MEASUREMENT

4.3.1 LIMITS OF 6dB BANDWIDTH MEASUREMENT

The minimum of 6dB Bandwidth Measurement is 0.5 MHz.

4.3.2 TEST INSTRUMENTS

DESCRIPTION & MANUFACTURER	MODEL NO.	SERIAL NO.	DATE OF CALIBRATION	DUE DATE OF CALIBRATION
SPECTRUM ANALYZER R&S	FSP40	100039	Feb. 23, 2011	Feb. 22, 2012

NOTE: The calibration interval of the above test instruments is 12 months and the calibrations are traceable to NML/ROC and NIST/USA.

4.3.3 TEST PROCEDURE

The transmitter output was connected to the spectrum analyzer through an attenuator. The bandwidth of the fundamental frequency was measured by spectrum analyzer with 100kHz RBW and 300kHz VBW. The 6dB bandwidth is defined as the total spectrum the power of which is higher than peak power minus 6dB.

4.3.4 DEVIATION FROM TEST STANDARD

No deviation.

4.3.5 TEST SETUP

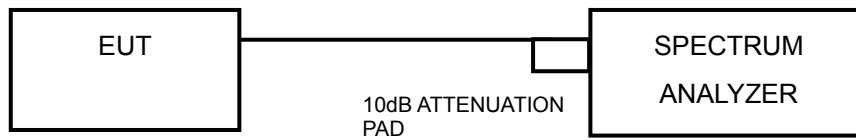

4.3.6 EUT OPERATING CONDITIONS

The software provided by client to enable the EUT under transmission condition continuously at lowest, middle and highest channel frequencies individually.



A D T

4.3.7 TEST RESULTS

802.11b

CHANNEL	CHANNEL FREQUENCY (MHz)	6dB BANDWIDTH (MHz)		MINIMUM LIMIT (MHz)	PASS / FAIL
		CHAIN 0	CHAIN 1		
1	2412	10.11	10.08	0.5	PASS
6	2437	10.11	10.13	0.5	PASS
11	2462	10.15	10.12	0.5	PASS

FOR CHAIN 0: CH 11

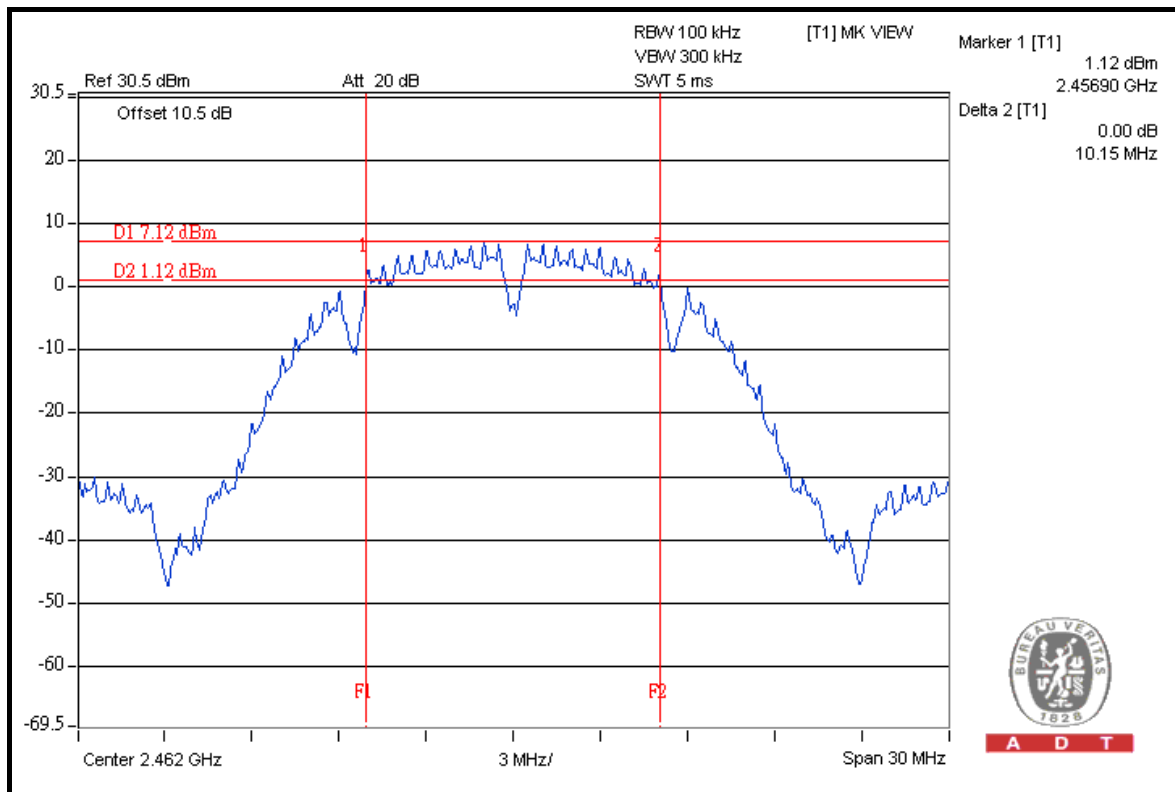



A D T

802.11g

CHANNEL	CHANNEL FREQUENCY (MHz)	6dB BANDWIDTH (MHz)		MINIMUM LIMIT (MHz)	PASS / FAIL
		CHAIN 0	CHAIN 1		
1	2412	16.44	16.45	0.5	PASS
6	2437	16.45	16.44	0.5	PASS
11	2462	16.46	16.43	0.5	PASS

FOR CHAIN 0: CH 11

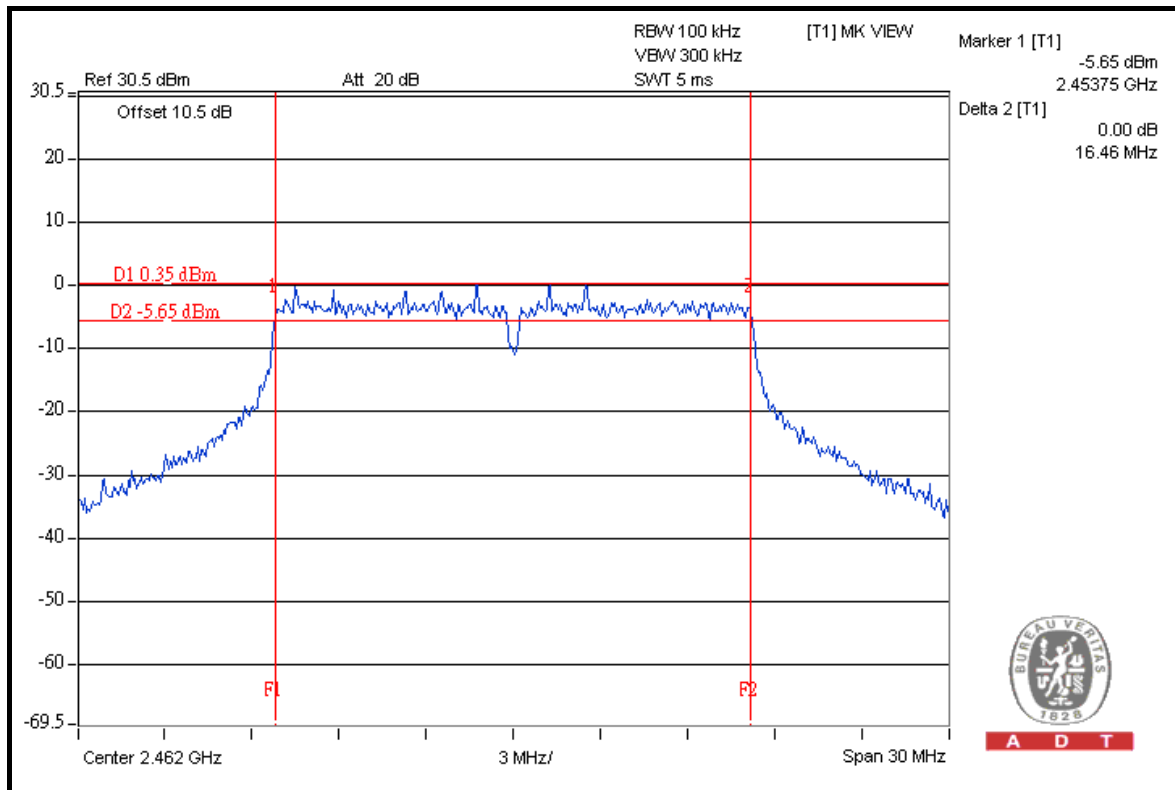



A D T

802.11n (20MHz)

CHANNEL	CHANNEL FREQUENCY (MHz)	6dB BANDWIDTH (MHz)		MINIMUM LIMIT (MHz)	PASS / FAIL
		CHAIN 0	CHAIN 1		
1	2412	17.68	17.69	0.5	PASS
6	2437	17.67	17.68	0.5	PASS
11	2462	17.67	17.69	0.5	PASS

FOR CHAIN 1: CH 11

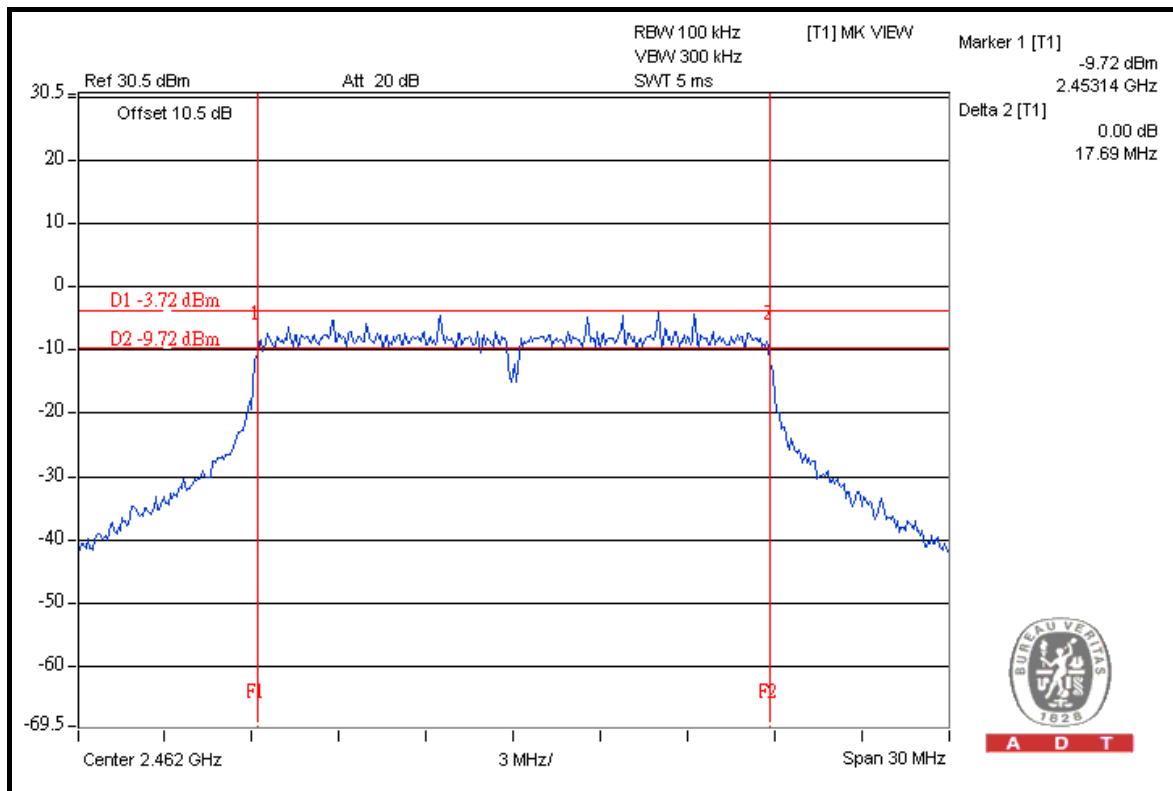

A D T



A D T

802.11n (40MHz)

CHANNEL	CHANNEL FREQUENCY (MHz)	6dB BANDWIDTH (MHz)		MINIMUM LIMIT (MHz)	PASS / FAIL
		CHAIN 0	CHAIN 1		
1	2422	36.43	36.48	0.5	PASS
4	2437	36.47	36.47	0.5	PASS
7	2452	36.46	36.46	0.5	PASS

FOR CHAIN 1: CH 1

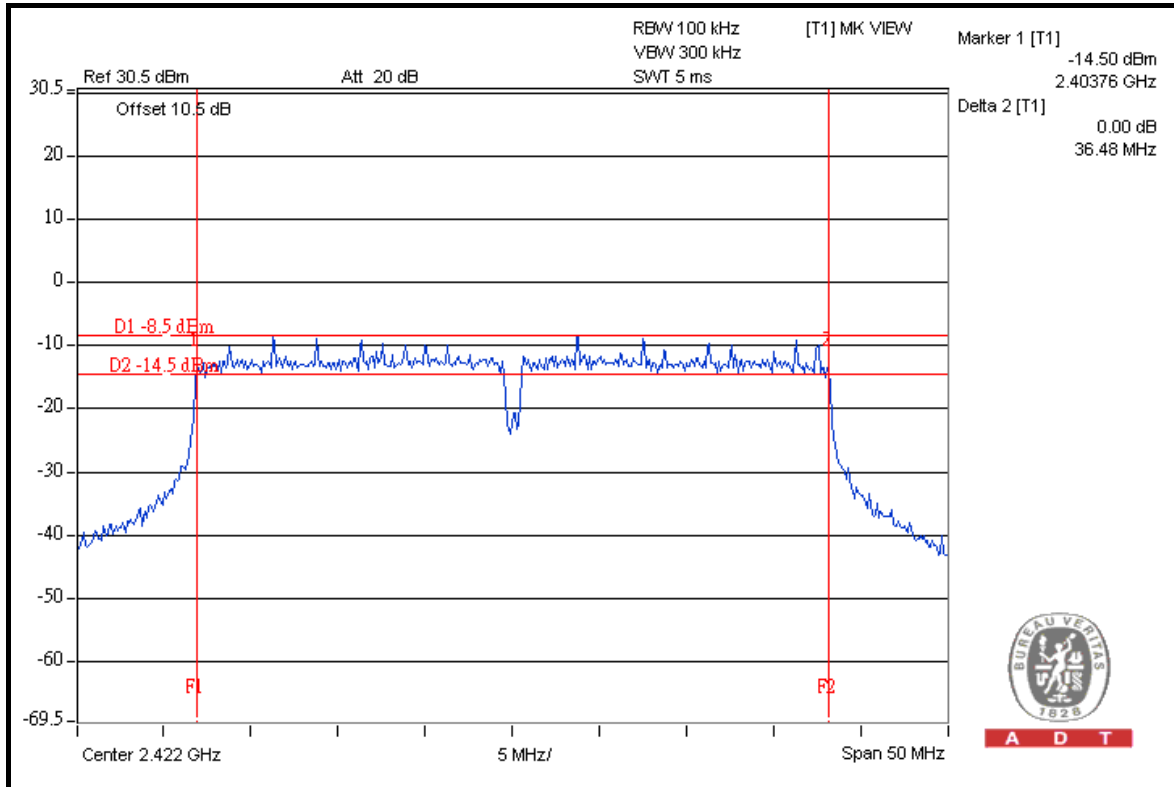



A D T

4.4 MAXIMUM OUTPUT POWER

4.4.1 LIMITS OF MAXIMUM OUTPUT POWER MEASUREMENT

The Maximum Output Power Measurement is 30dBm.

4.4.2 INSTRUMENTS

DESCRIPTION & MANUFACTURER	MODEL NO.	SERIAL NO.	DATE OF CALIBRATION	DUE DATE OF CALIBRATION
High Speed Peak Power Meter	ML2495A	0824011	Aug. 02, 2010	Aug. 01, 2011
Power Sensor	MA2411B	0738171	Aug. 02, 2010	Aug. 01, 2011

NOTE:

1. The calibration interval of the above test instruments is 12 months and the calibrations are traceable to NML/ROC and NIST/USA.
2. Measurement Bandwidth of ML2495A is 65MHz greater than 6dB bandwidth of emission.

4.4.3 TEST PROCEDURES

A power sensor was used on the output port of the EUT. A power meter was used to read the response of the power sensor. Record the power level.

4.4.4 DEVIATION FROM TEST STANDARD

No deviation.

4.4.5 TEST SETUP

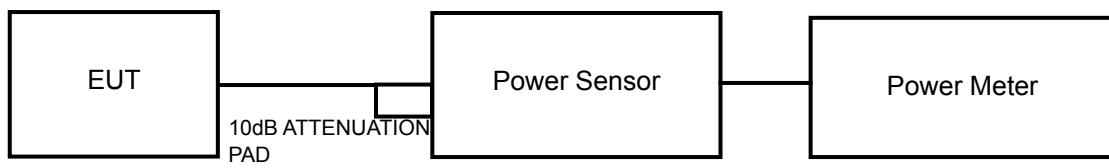

4.4.6 EUT OPERATING CONDITIONS

Same as Item 4.3.6.



4.4.7 TEST RESULTS

802.11b

CHAN.	CHAN. FREQ. (MHz)	POWER OUTPUT (dBm)		TOTAL POWER (mW)	TOTAL POWER (dBm)	POWER LIMIT (dBm)	PASS / FAIL
		CHAIN 0	CHAIN 1				
1	2412	19.4	19.1	168.4	22.3	30	PASS
6	2437	19.4	19.3	172.2	22.4	30	PASS
11	2462	18.6	18.5	143.2	21.6	30	PASS

NOTE: Directional gain = $2.5\text{dBi} + 10\log(2) = 5.51\text{dBi} < 6\text{dBi}$, so the conducted power limit is not reduced.

802.11g

CHAN.	CHAN. FREQ. (MHz)	POWER OUTPUT (dBm)		TOTAL POWER (mW)	TOTAL POWER (dBm)	POWER LIMIT (dBm)	PASS / FAIL
		CHAIN 0	CHAIN 1				
1	2412	19.6	19.5	180.3	22.6	30	PASS
6	2437	21.1	24.1	385.9	25.9	30	PASS
11	2462	19.8	19.5	184.6	22.7	30	PASS

NOTE: Directional gain = $2.5\text{dBi} + 10\log(2) = 5.51\text{dBi} < 6\text{dBi}$, so the conducted power limit is not reduced.

802.11n (20MHz)

CHAN.	CHAN. FREQ. (MHz)	POWER OUTPUT (dBm)		TOTAL POWER (mW)	TOTAL POWER (dBm)	POWER LIMIT (dBm)	PASS / FAIL
		CHAIN 0	CHAIN 1				
1	2412	16.0	16.5	84.5	19.3	30	PASS
6	2437	22.0	21.6	303.0	24.8	30	PASS
11	2462	19.3	17.6	142.7	21.5	30	PASS

802.11n (40MHz)

CHAN.	CHAN. FREQ. (MHz)	POWER OUTPUT (dBm)		TOTAL POWER (mW)	TOTAL POWER (dBm)	POWER LIMIT (dBm)	PASS / FAIL
		CHAIN 0	CHAIN 1				
1	2422	13.2	14.3	47.8	16.8	30	PASS
4	2437	19.1	18.8	157.1	22.0	30	PASS
7	2452	15.2	15.7	70.3	18.5	30	PASS



A D T

4.5 POWER SPECTRAL DENSITY MEASUREMENT

4.5.1 LIMITS OF POWER SPECTRAL DENSITY MEASUREMENT

The Maximum of Power Spectral Density Measurement is 8dBm.

4.5.2 TEST INSTRUMENTS

DESCRIPTION & MANUFACTURER	MODEL NO.	SERIAL NO.	DATE OF CALIBRATION	DUE DATE OF CALIBRATION
SPECTRUM ANALYZER R&S	FSP40	100039	Feb. 23, 2011	Feb. 22, 2012

NOTE: The calibration interval of the above test instruments is 12 months and the calibrations are traceable to NML/ROC and NIST/USA.

4.5.3 TEST PROCEDURE

The transmitter output was connected to the spectrum analyzer through an attenuator, the bandwidth of the fundamental frequency was measured with the spectrum analyzer using 3kHz RBW and 30kHz VBW, set sweep time = span/3kHz. The power spectral density was measured and recorded.

The sweep time is allowed to be longer than span/3kHz for a full response of the mixer in the spectrum analyzer.

Follow method 2 of KDB 662911 D01 Multiple Transmitter Output v01 to calculate total power density of 2 TX port.

4.5.4 DEVIATION FROM TEST STANDARD

No deviation.

4.5.5 TEST SETUP

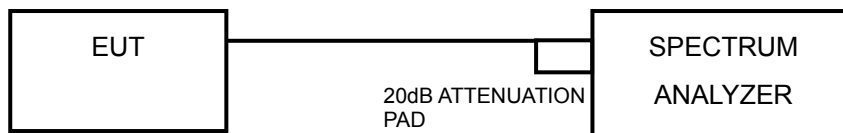

4.5.6 EUT OPERATING CONDITION

Same as Item 4.3.6.



A D T

4.5.7 TEST RESULTS

802.11b

CHAIN	CHAN.	CHAN. FREQ. (MHz)	RF POWER LEVEL IN 3kHz BW (dBm)		TOTAL POWER DENSITY (dBm)	MAX. LIMIT (dBm)	PASS / FAIL
			MEASURED	10 log (N=2) dB			
0	1	2412	-6.6	3.01	-3.6	8	PASS
	6	2437	-6.5	3.01	-3.5	8	PASS
	11	2462	-7.2	3.01	-4.2	8	PASS
1	1	2412	-6.9	3.01	-3.9	8	PASS
	6	2437	-6.5	3.01	-3.5	8	PASS
	11	2462	-7.3	3.01	-4.3	8	PASS

NOTE: Directional gain = 2.5dBi + 10log(2)=5.51dBi < 6dBi, so the power density limit is not reduced.

FOR CHAIN 0: CH 6

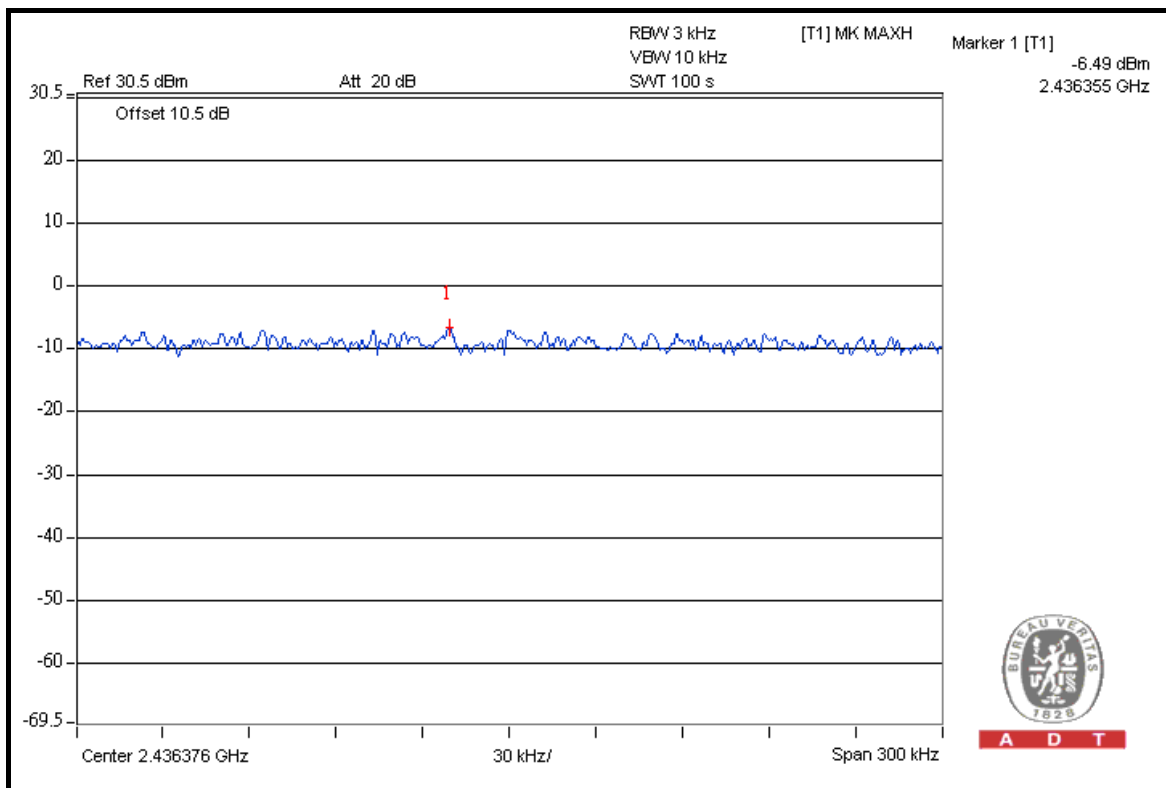

A D T



A D T

802.11g

CHAIN	CHAN.	CHAN. FREQ. (MHz)	RF POWER LEVEL IN 3kHz BW (dBm)		TOTAL POWER DENSITY (dBm)	MAX. LIMIT (dBm)	PASS / FAIL
			MEASURED	10 log (N=2) dB			
0	1	2412	-13.4	3.01	-10.4	8	PASS
	6	2437	-11.7	3.01	-8.7	8	PASS
	11	2462	-13.1	3.01	-10.1	8	PASS
1	1	2412	-13.5	3.01	-10.5	8	PASS
	6	2437	-9.0	3.01	-6.0	8	PASS
	11	2462	-13.4	3.01	-10.4	8	PASS

NOTE: Directional gain = 2.5dBi + 10log(2)=5.51dBi < 6dBi, so the power density limit is not reduced.

FOR CHAIN 1: CH 6

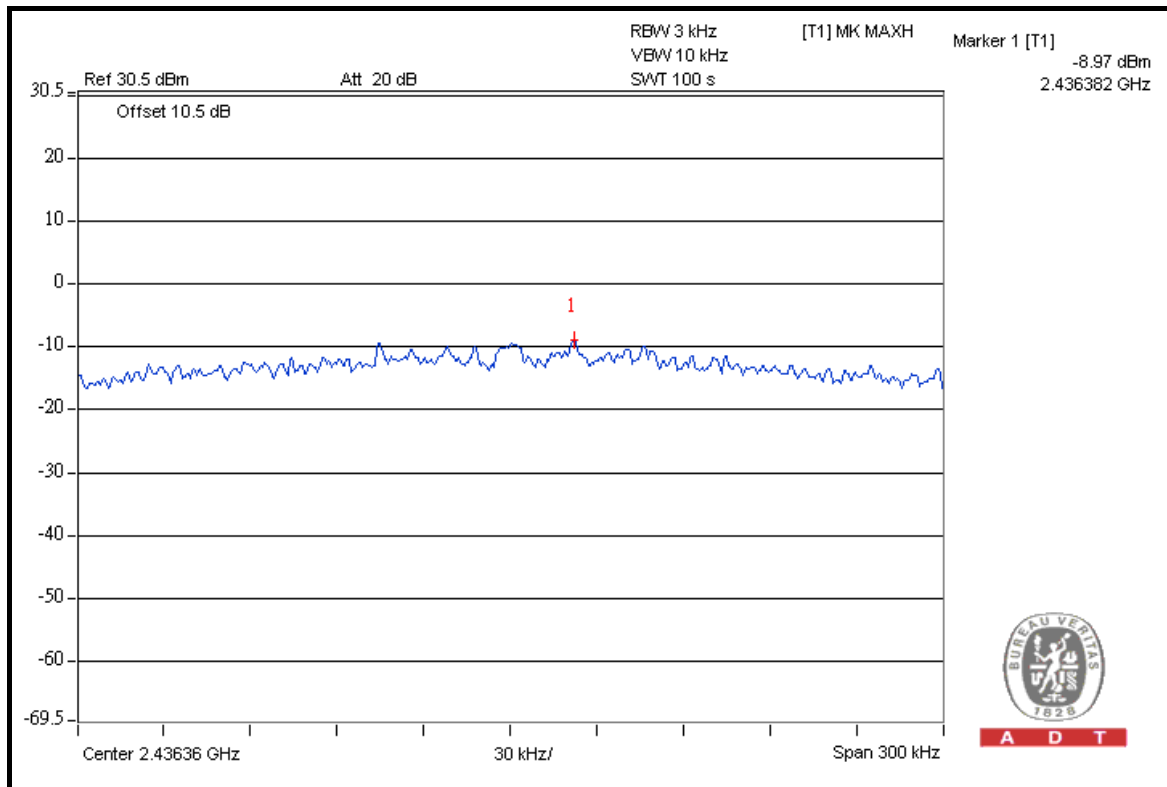

A D T



A D T

802.11n (20MHz)

CHAIN	CHAN.	CHAN. FREQ. (MHz)	RF POWER LEVEL IN 3kHz BW (dBm)		TOTAL POWER DENSITY (dBm)	MAX. LIMIT (dBm)	PASS / FAIL
			MEASURED	10 log (N=2) dB			
0	1	2412	-18.6	3.01	-15.6	8	PASS
	6	2437	-12.8	3.01	-9.8	8	PASS
	11	2462	-15.4	3.01	-12.4	8	PASS
1	1	2412	-19.4	3.01	-16.4	8	PASS
	6	2437	-14.3	3.01	-11.3	8	PASS
	11	2462	-18.1	3.01	-15.1	8	PASS

FOR CHAIN 0: CH 6

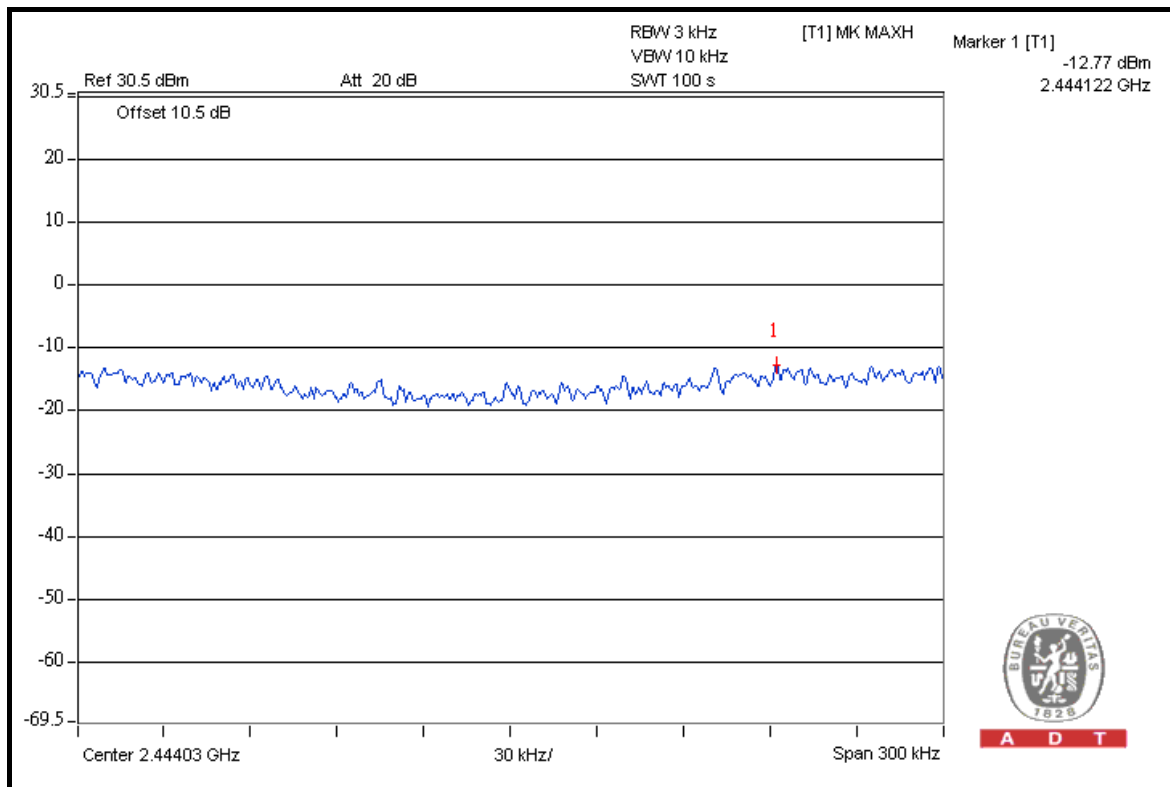

A D T



A D T

802.11n (40MHz)

CHAIN	CHAN.	CHAN. FREQ. (MHz)	RF POWER LEVEL IN 3kHz BW (dBm)		TOTAL POWER DENSITY (dBm)	MAX. LIMIT (dBm)	PASS / FAIL
			MEASURED	10 log (N=2) dB			
0	1	2422	-23.4	3.01	-20.4	8	PASS
	4	2437	-17.5	3.01	-14.5	8	PASS
	7	2452	-21.5	3.01	-18.5	8	PASS
1	1	2422	-21.9	3.01	-18.9	8	PASS
	4	2437	-17.4	3.01	-14.4	8	PASS
	7	2452	-20.6	3.01	-17.6	8	PASS

FOR CHAIN 1: CH 4

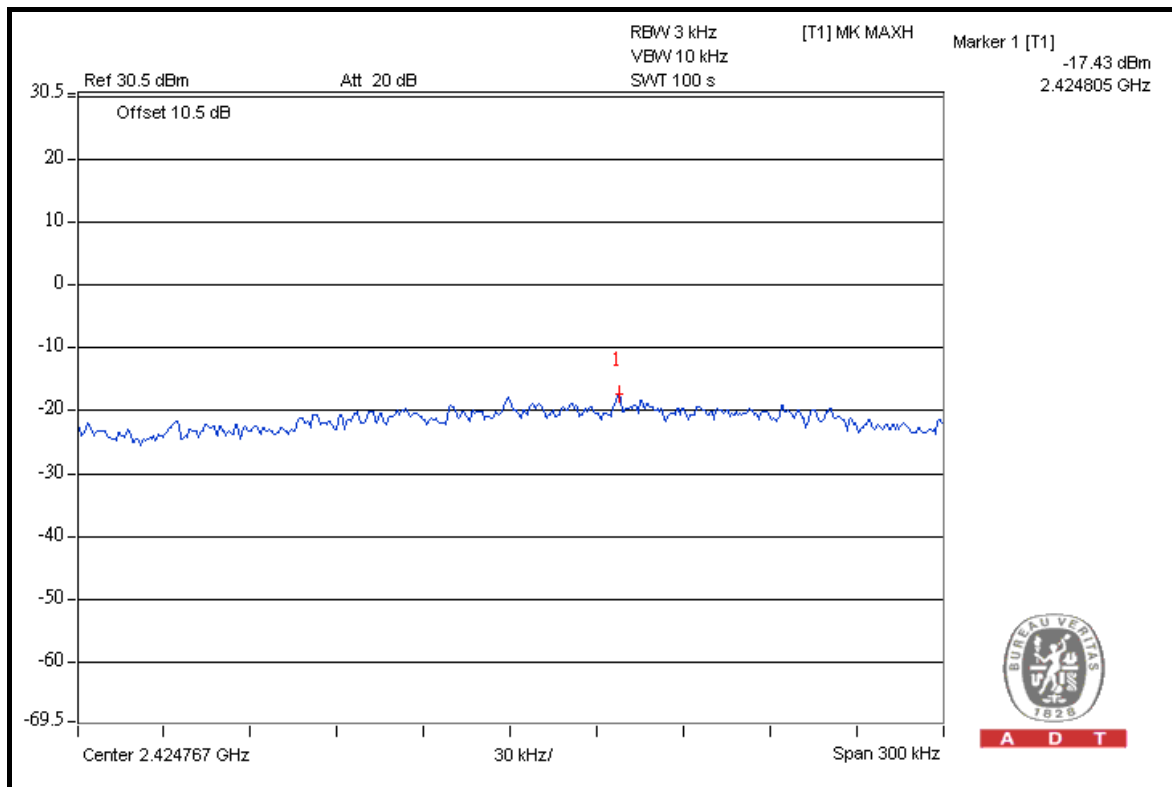

A D T

4.6 BAND EDGES MEASUREMENT

4.6.1 LIMITS OF BAND EDGES MEASUREMENT

Below -20dB of the highest emission level of operating band (in 100kHz Resolution Bandwidth).

4.6.2 TEST INSTRUMENTS

DESCRIPTION & MANUFACTURER	MODEL NO.	SERIAL NO.	DATE OF CALIBRATION	DUE DATE OF CALIBRATION
FOR CONDUCTED MEASUREMENT				
SPECTRUM ANALYZER R&S	FSP40	100039	Feb. 23, 2011	Feb. 22, 2012
FOR RADIATED MEASUREMENT				
Test Receiver ROHDE & SCHWARZ	ESCI	100424	Aug. 04, 2010	Aug. 03, 2011
Spectrum Analyzer ROHDE & SCHWARZ	FSP40	100269	Jan. 06, 2011	Jan. 05, 2012
BILOG Antenna SCHWARZBECK	VULB9168	9168-156	Apr. 12, 2011	Apr. 11, 2012
HORN Antenna SCHWARZBECK	BBHA 9120 D	9120D-563	Aug. 30, 2010	Aug. 29, 2011
HORN Antenna SCHWARZBECK	BBHA 9170	BBHA9170243	Dec. 27, 2010	Dec. 26, 2011
Preamplifier Agilent	8449B	3008A01910	Sep. 09, 2010	Sep. 08, 2011
Preamplifier Agilent	8447D	2944A10638	Nov. 03, 2010	Nov. 02, 2011
RF signal cable HUBER+SUHNNER	SUCOFLEX 104	295013/4 283403/4	Sep 03, 2010	Sep 03, 2011
RF signal cable Worken	8D-FB	Cable-HYCH9-01	Aug. 20, 2010	Aug. 19, 2011
Software	ADT_Radiated_ V7.6.15.9.2	NA	NA	NA
Antenna Tower EMCO	2070/2080	512.835.4684	NA	NA
Turn Table EMCO	2087-2.03	NA	NA	NA
Antenna Tower & Turn Table Controller EMCO	2090	NA	NA	NA

NOTE: The calibration interval of the above test instruments is 12 months and the calibrations are traceable to NML/ROC and NIST/USA.



4.6.3 TEST PROCEDURE

The transmitter output was connected to the spectrum analyzer via a low loss cable. Set both RBW and VBW of spectrum analyzer to 100kHz with suitable frequency span including 300kHz bandwidth from band edge. The band edges was measured and recorded.

The spectrum plots (Peak RBW = 100kHz, VBW = 300kHz; Average RBW = 1MHz, VBW = 10Hz) are attached on the following pages.

- a. The EUT was placed on the top of a rotating table 0.8 meters above the ground at a 3 meter semi-anechoic chamber. The table was rotated 360 degrees to determine the position of the highest radiation.
- b. The EUT was set 3 meters away from the interference-receiving antenna, which was mounted on the top of a variable-height antenna tower.
- c. The antenna is a broadband antenna, and its height is varied from one meter to four meters above the ground to determine the maximum value of the field strength. Both horizontal and vertical polarizations of the antenna are set to make the measurement.
- d. For each suspected emission, the EUT was arranged to its worst case and then the antenna was tuned to heights from 1 meter to 4 meters and the rotatable table was turned from 0 degrees to 360 degrees to find the maximum reading.
- e. Set both RBW and VBW of spectrum analyzer to 100kHz and 300kHz with suitable frequency span including 100MHz bandwidth from band edge. The band edges was measured and recorded.

The spectrum plots (Peak RBW = 100kHz, VBW = 300kHz) are attached on the following pages.

NOTE: The resolution bandwidth of test receiver/spectrum analyzer is 1MHz and the video bandwidth is 10Hz for Average detection (AV) at frequency above 1GHz.

4.6.4 DEVIATION FROM TEST STANDARD

No deviation.

4.6.5 EUT OPERATING CONDITION

Same as Item 4.3.6.



4.6.6 TEST RESULTS

The spectrum plots are attached on the following pages. D1 line indicates the highest level, and D2 line indicates the 20dB offset below D1. It shows compliance with the requirement in part 15.247(d).

802.11b

RESTRICT BAND (2310 ~ 2390 MHz)

FREQUENCY (MHz)	FUNDAMENTAL EMISSION (dBuV/m)	DELTA (dB)	MAXIMUM FIELD STRENGTH IN RESTRICT BAND (dBuV/m)	LIMIT (dBuV/m)
2412.00 (PK)	115.7	57.40	58.30	74.00
2412.00 (AV)	111.6	59.94	51.66	54.00

RESTRICT BAND (2483.5 ~ 2500 MHz)

FREQUENCY (MHz)	FUNDAMENTAL EMISSION (dBuV/m)	DELTA (dB)	MAXIMUM FIELD STRENGTH IN RESTRICT BAND (dBuV/m)	LIMIT (dBuV/m)
2462.00 (PK)	114.4	55.91	58.49	74.00
2462.00 (AV)	110.5	60.64	49.86	54.00

NOTE:

1. Delta = Amplitude between the peak of the fundamental and the peak of the band edge emission. Please check following 2 pages.
2. Maximum field strength in restrict band = Fundamental emission – Delta.



A D T

FOR RADIATED MEASURED (BOTH CHAINS ON)

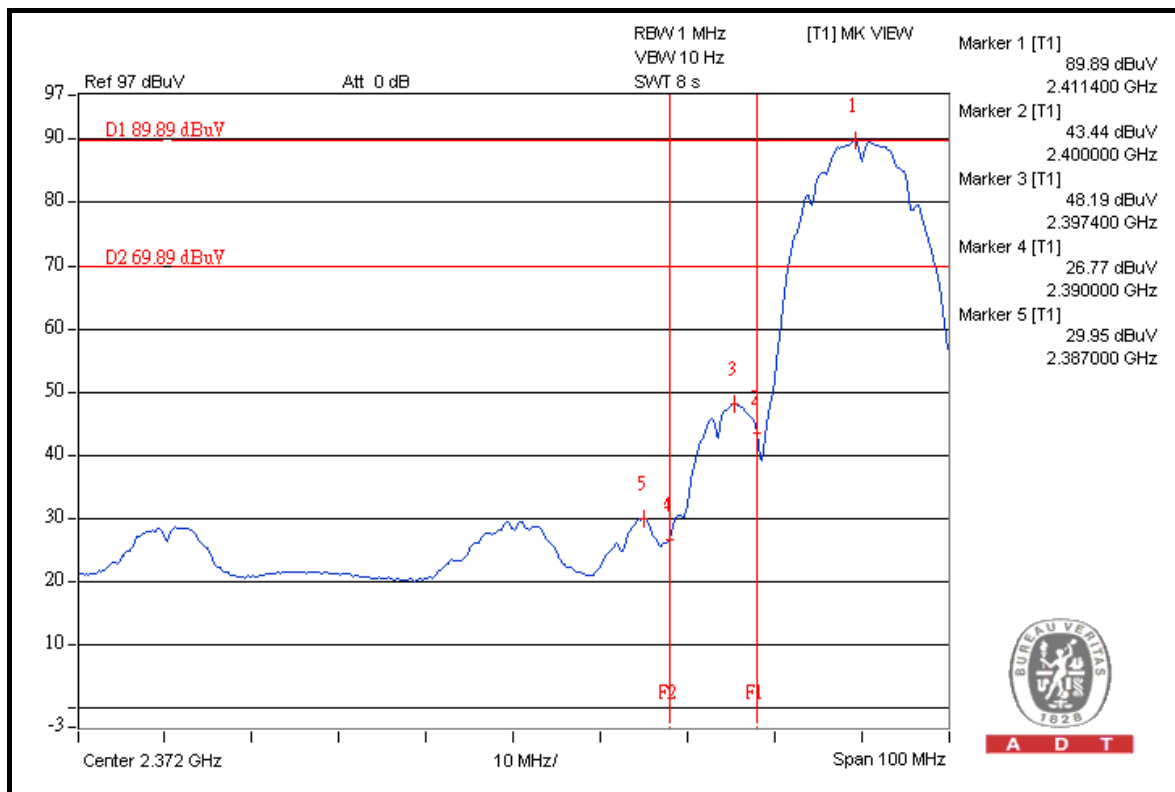
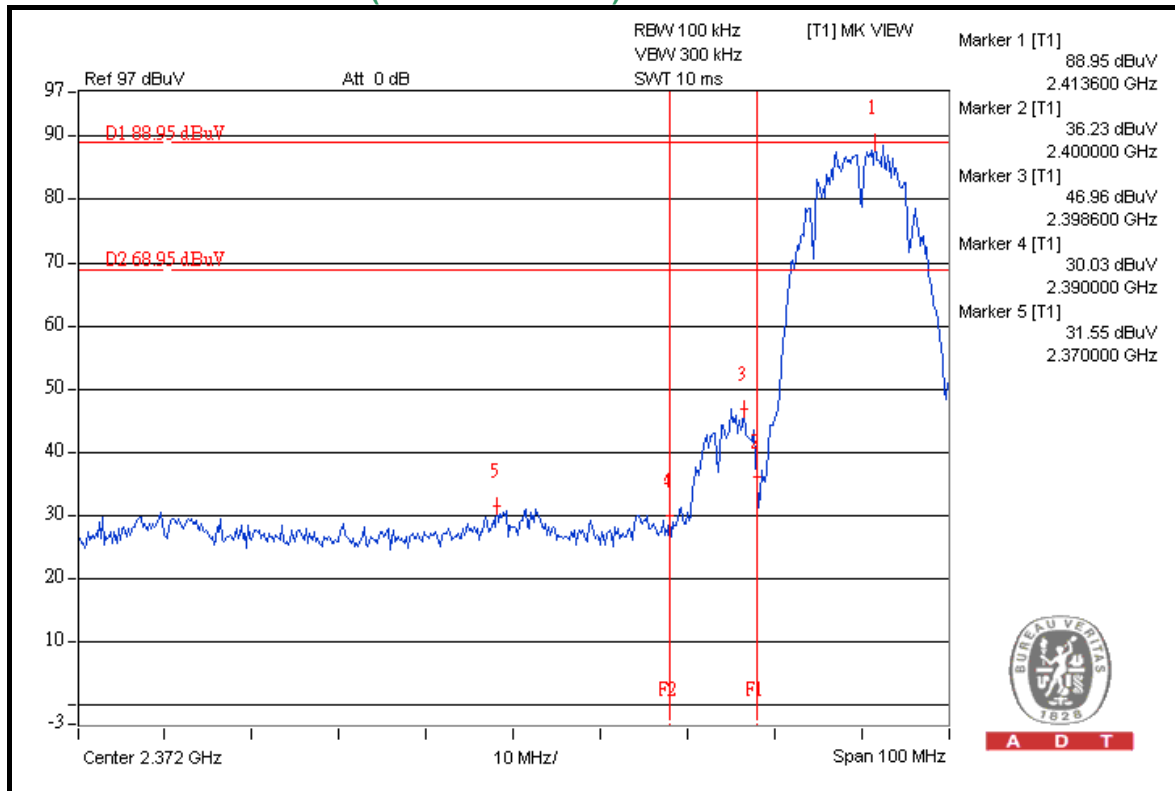



A D T

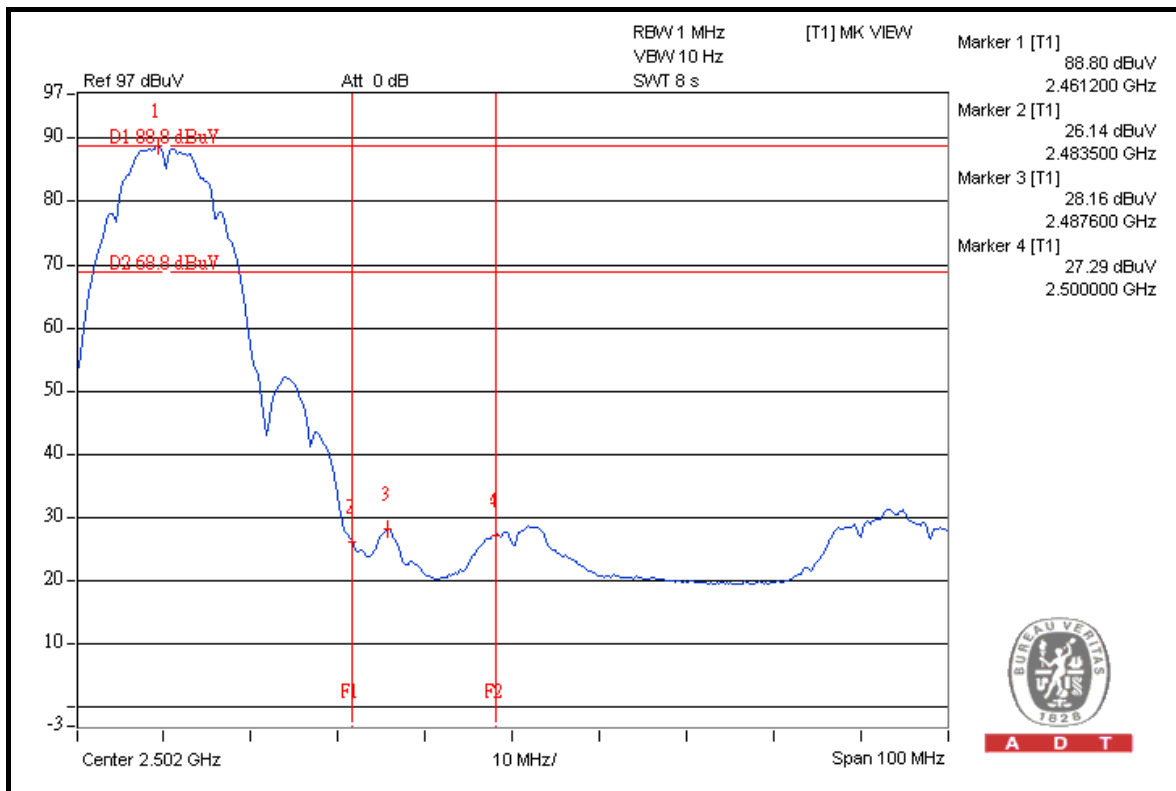
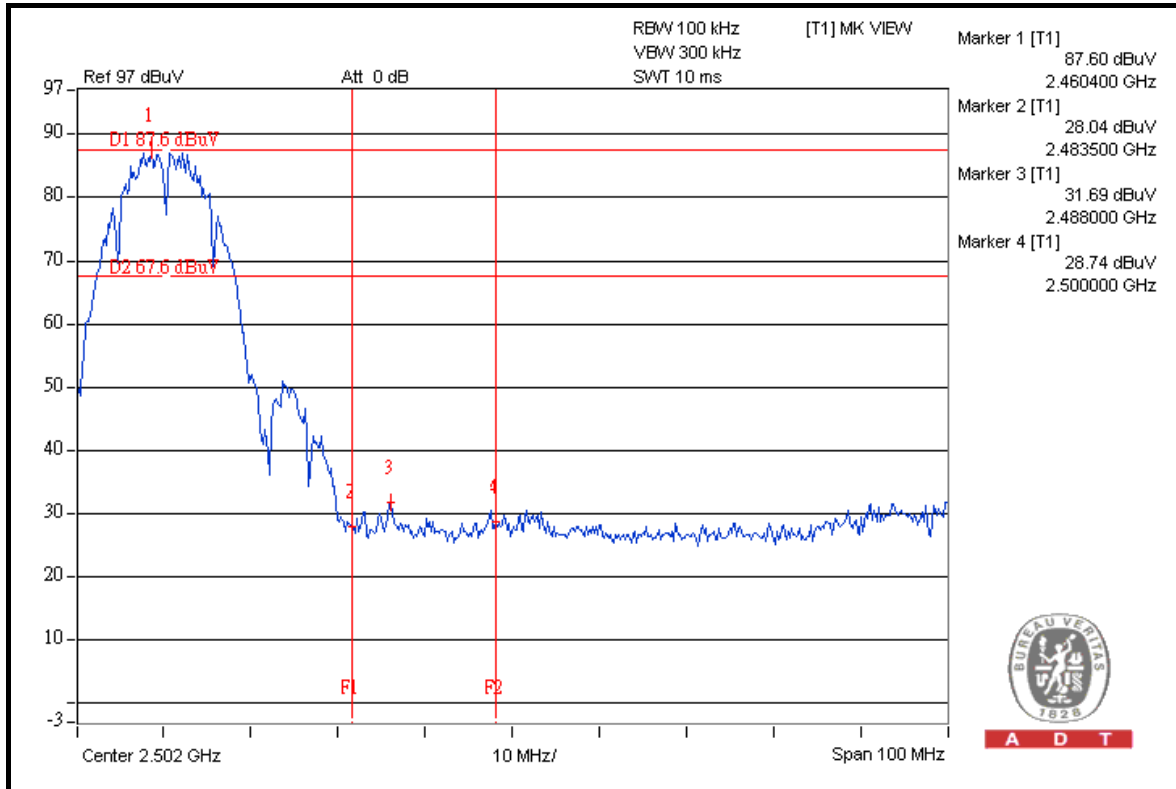



A D T

FOR CONDUCTED MEASURED

CHAIN 0

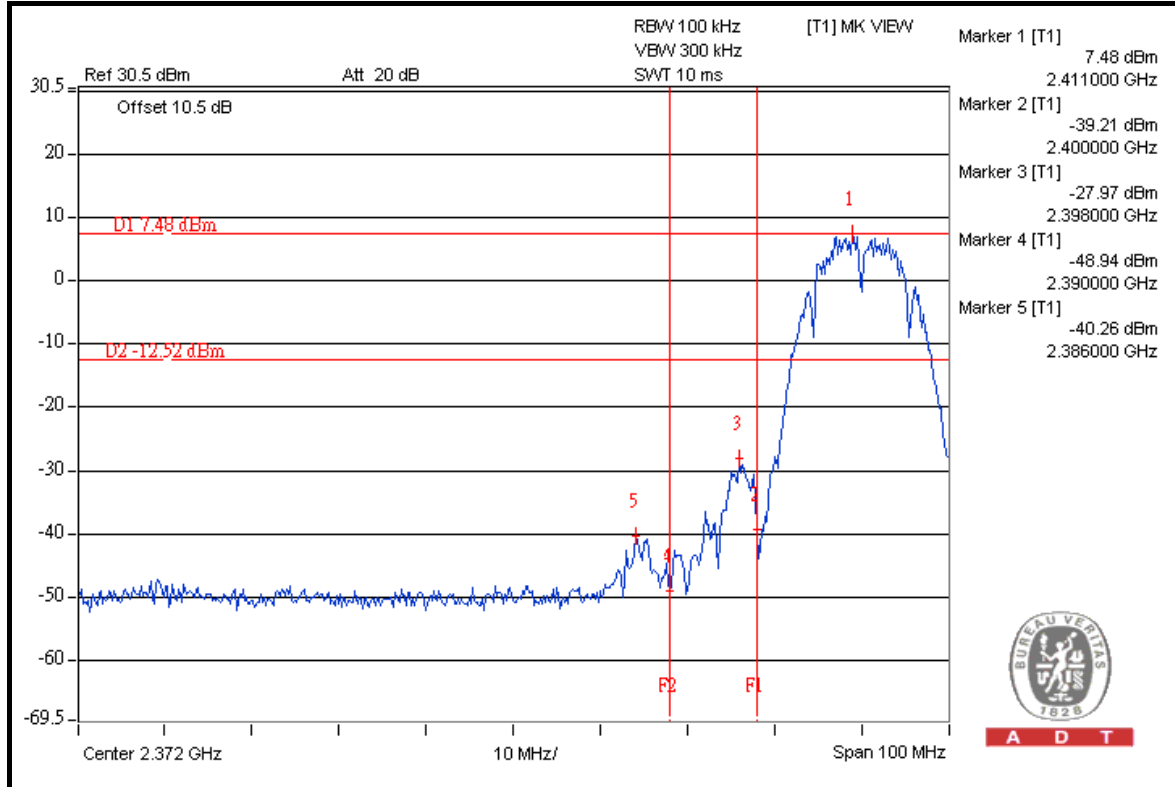

A D T

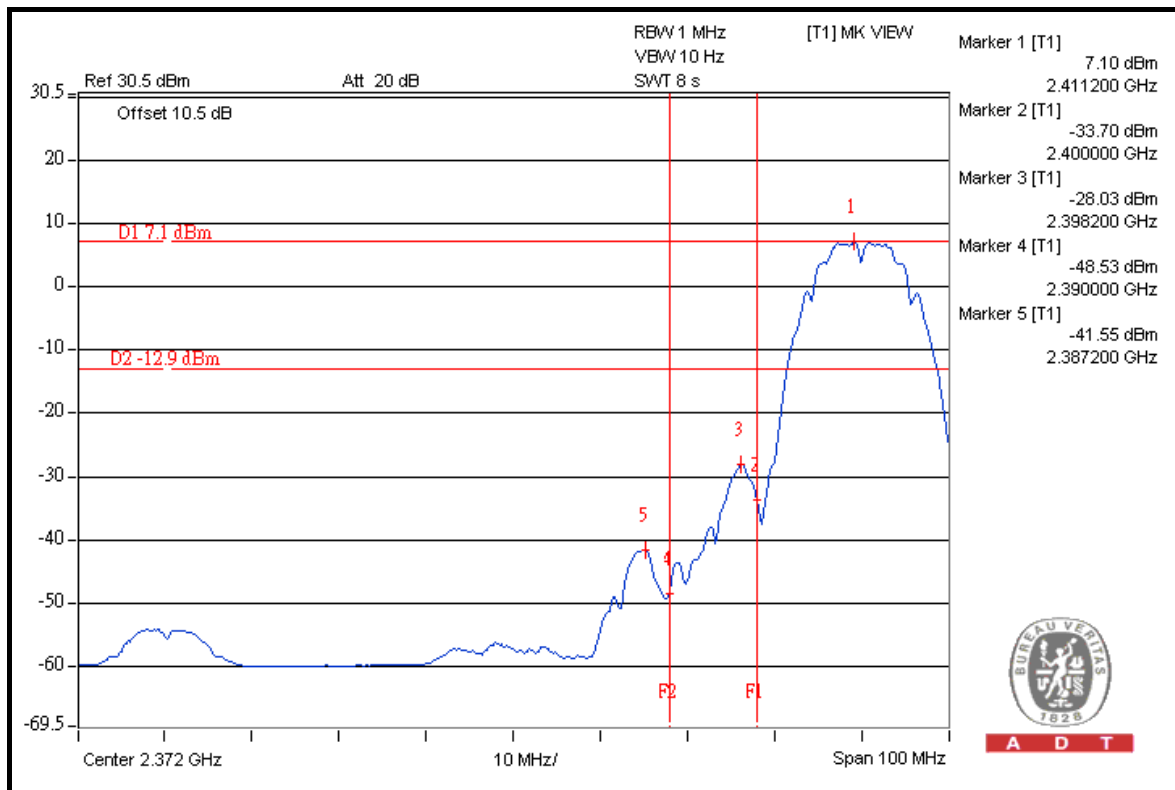

A D T



A D T

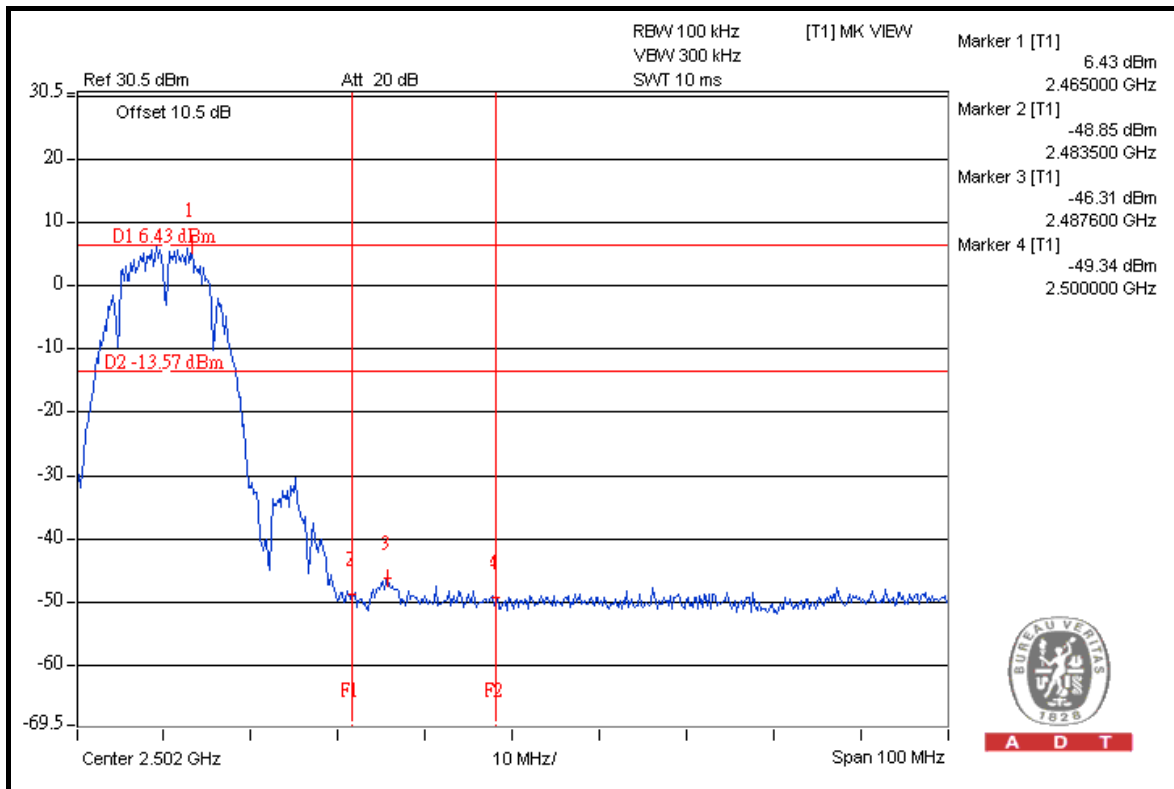
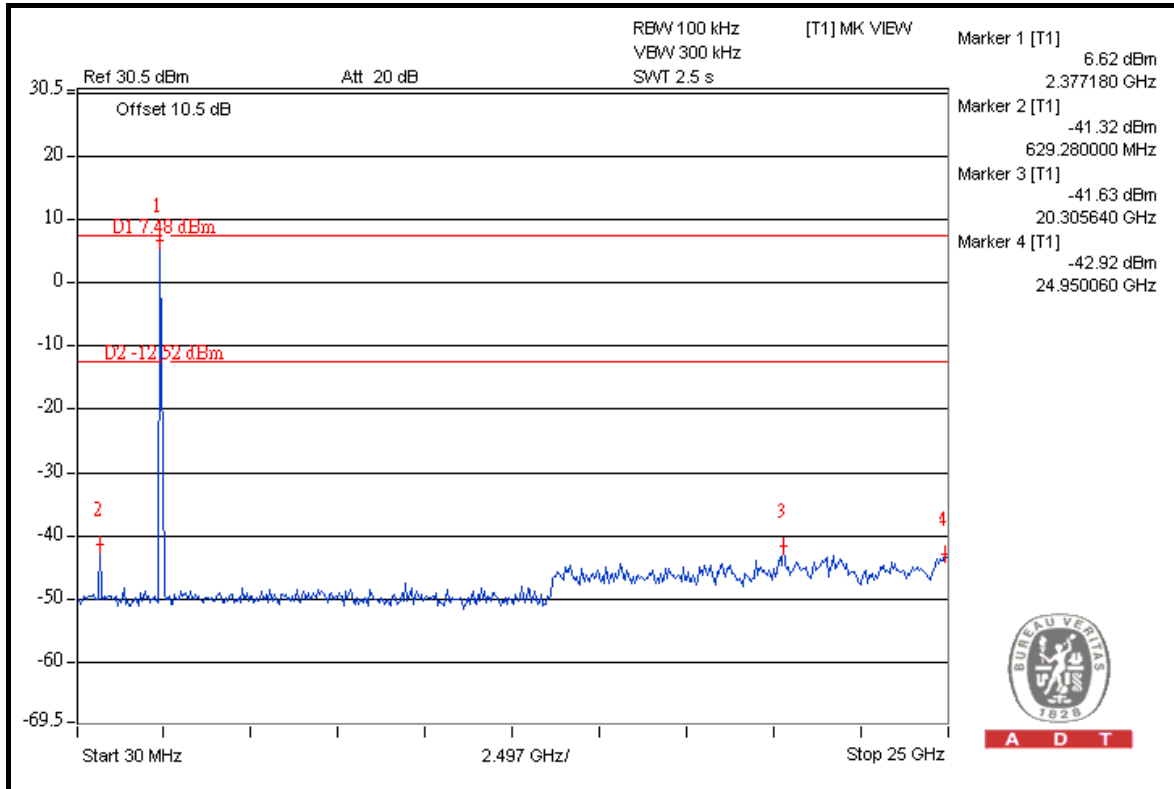



A D T

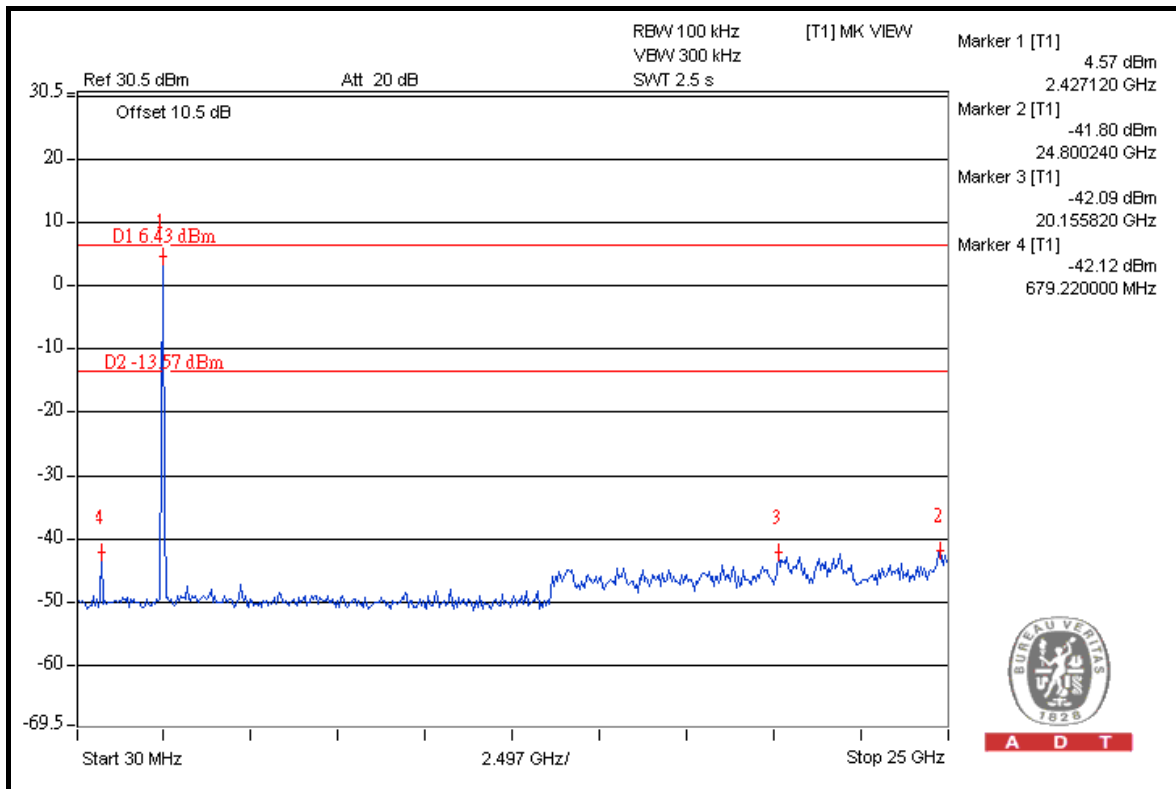
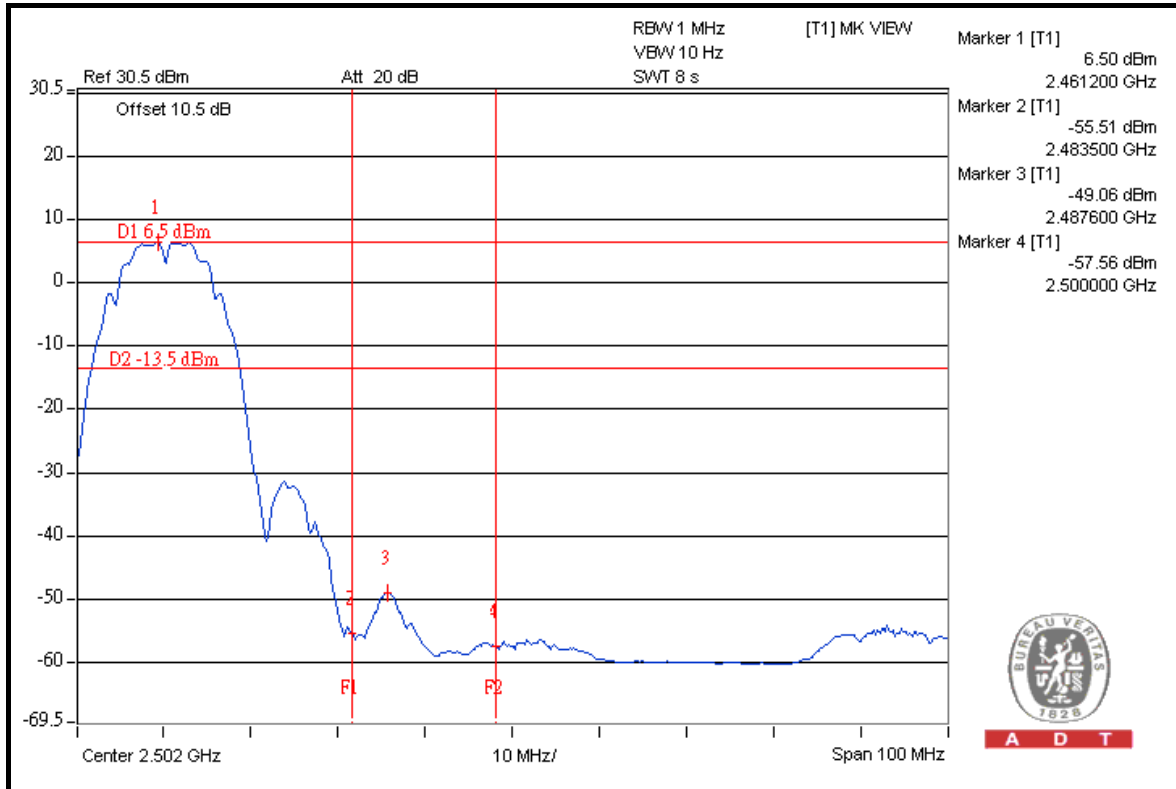



A D T

CHAIN 1

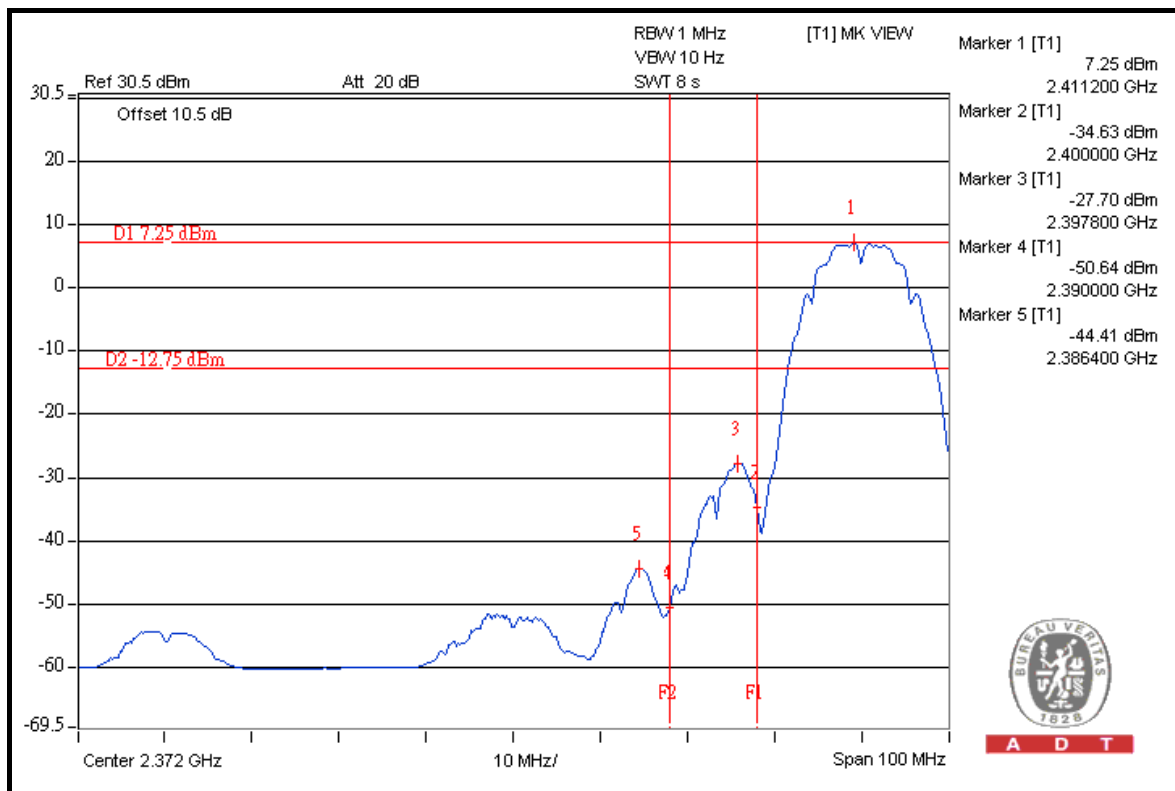
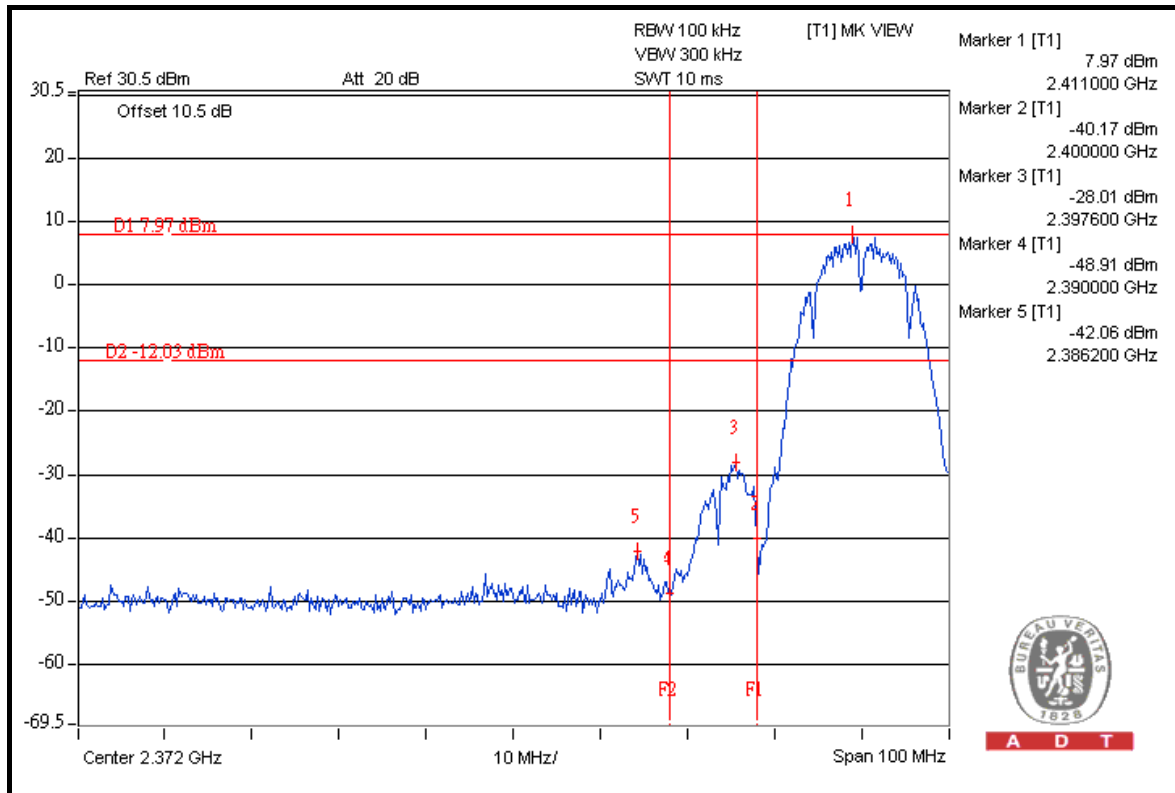



A D T

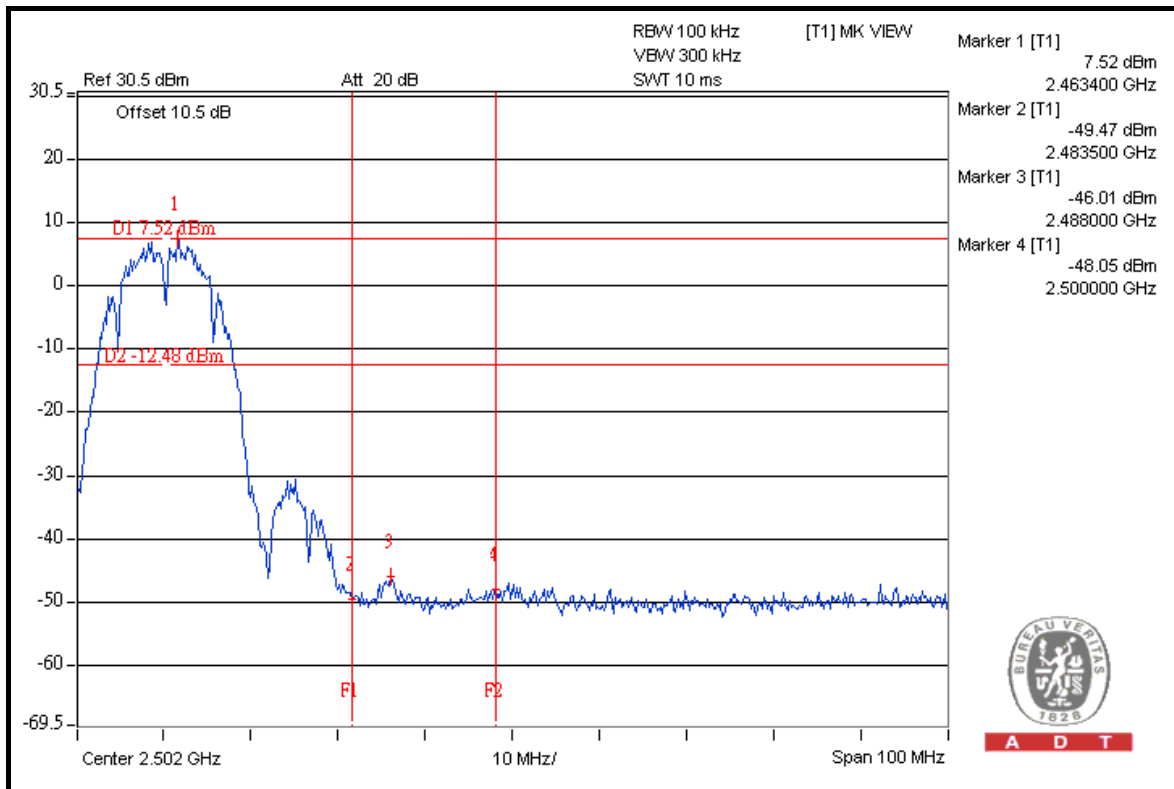
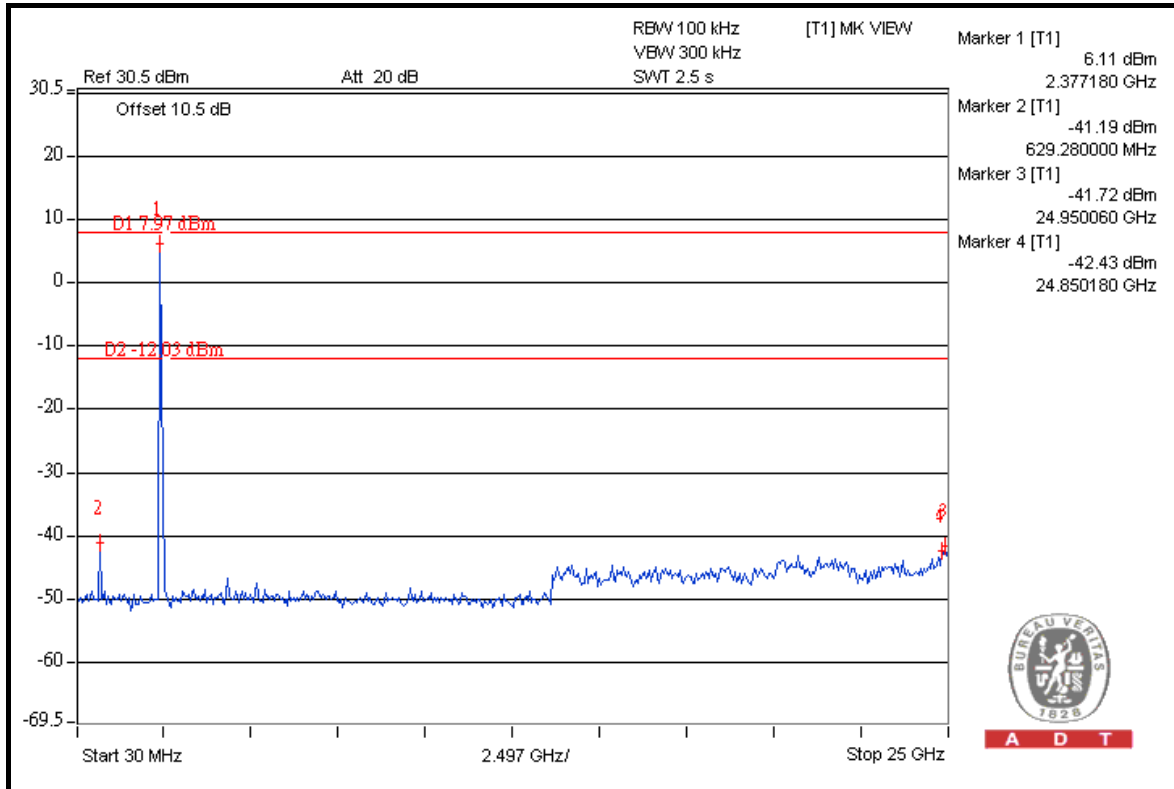



A D T

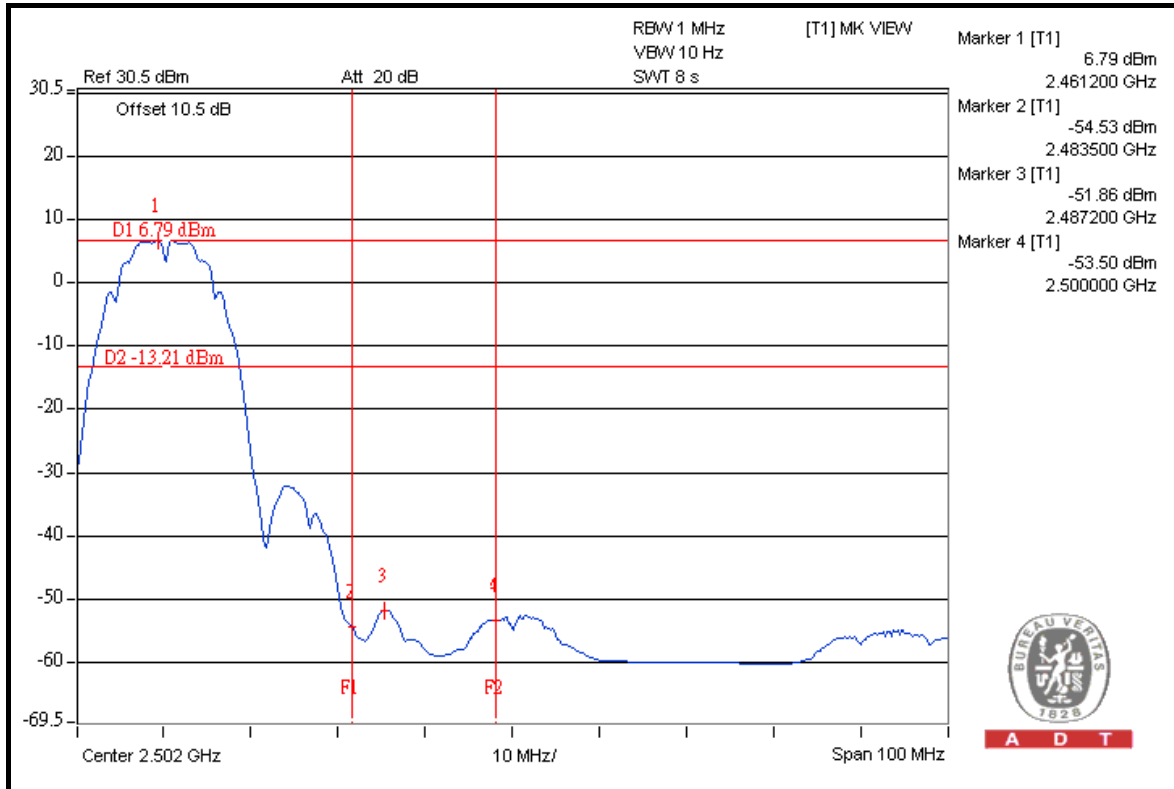

A D T

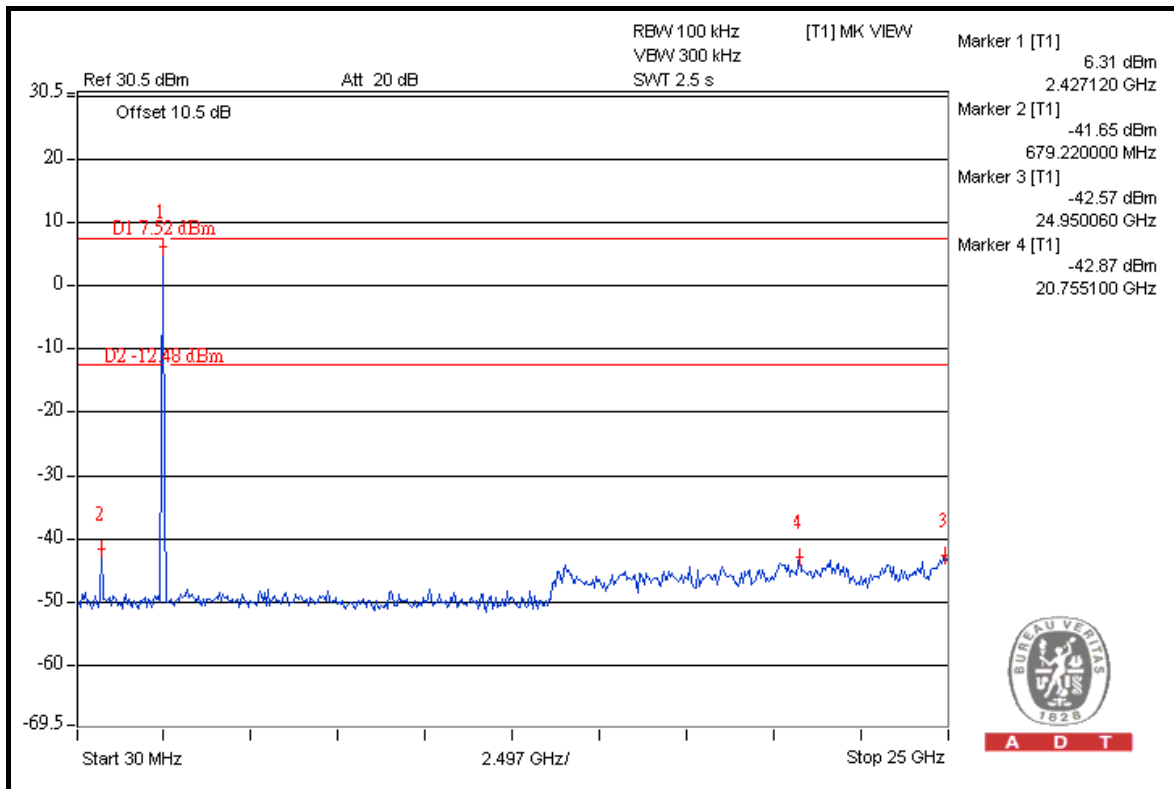

A D T



A D T

802.11g

RESTRICT BAND (2310 ~ 2390 MHz)

FREQUENCY (MHz)	FUNDAMENTAL EMISSION (dBuV/m)	DELTA (dB)	MAXIMUM FIELD STRENGTH IN RESTRICT BAND (dBuV/m)	LIMIT (dBuV/m)
2412.00 (PK)	109.6	43.93	65.67	74.00
2412.00 (AV)	98.5	47.15	51.35	54.00

RESTRICT BAND (2483.5 ~ 2500 MHz)

FREQUENCY (MHz)	FUNDAMENTAL EMISSION (dBuV/m)	DELTA (dB)	MAXIMUM FIELD STRENGTH IN RESTRICT BAND (dBuV/m)	LIMIT (dBuV/m)
2462.00 (PK)	110.2	43.01	67.19	74.00
2462.00 (AV)	99.8	47.35	52.45	54.00

NOTE:

1. Delta = Amplitude between the peak of the fundamental and the peak of the band edge emission. Please check following 2 pages.
2. Maximum field strength in restrict band = Fundamental emission – Delta.



A D T

FOR RADIATED MEASURED (BOTH CHAINS ON)

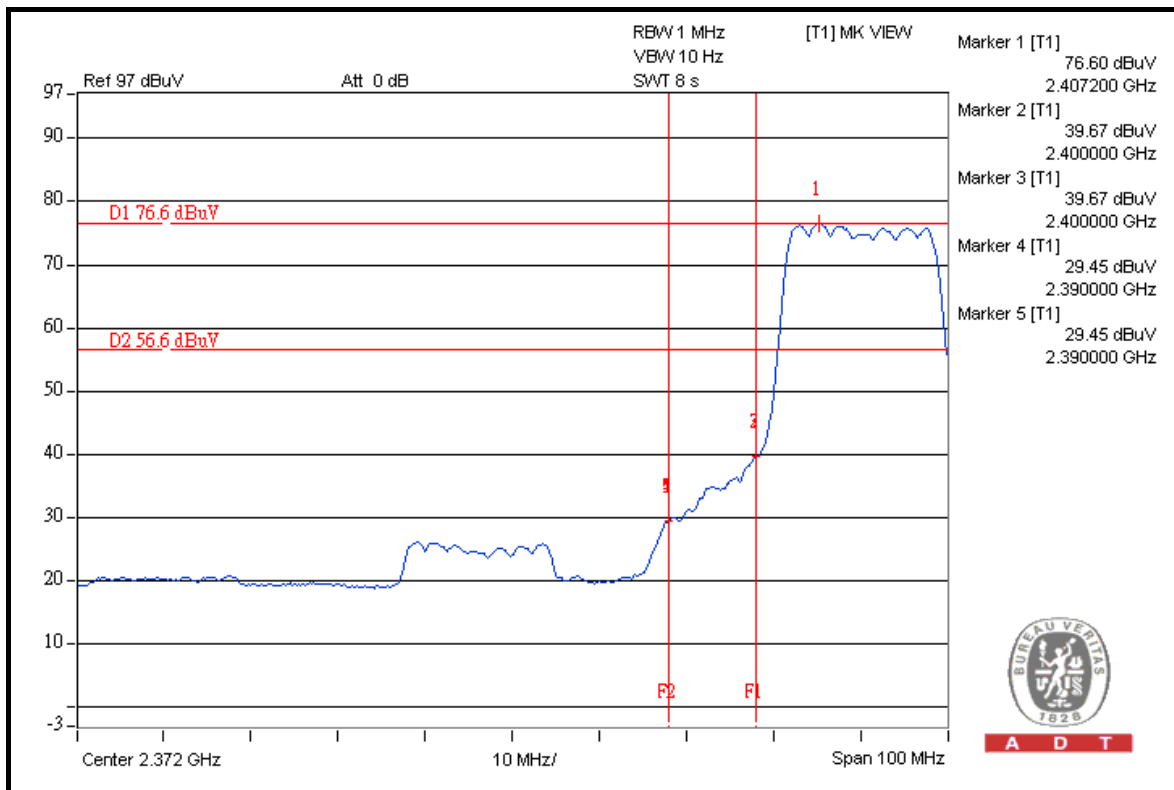
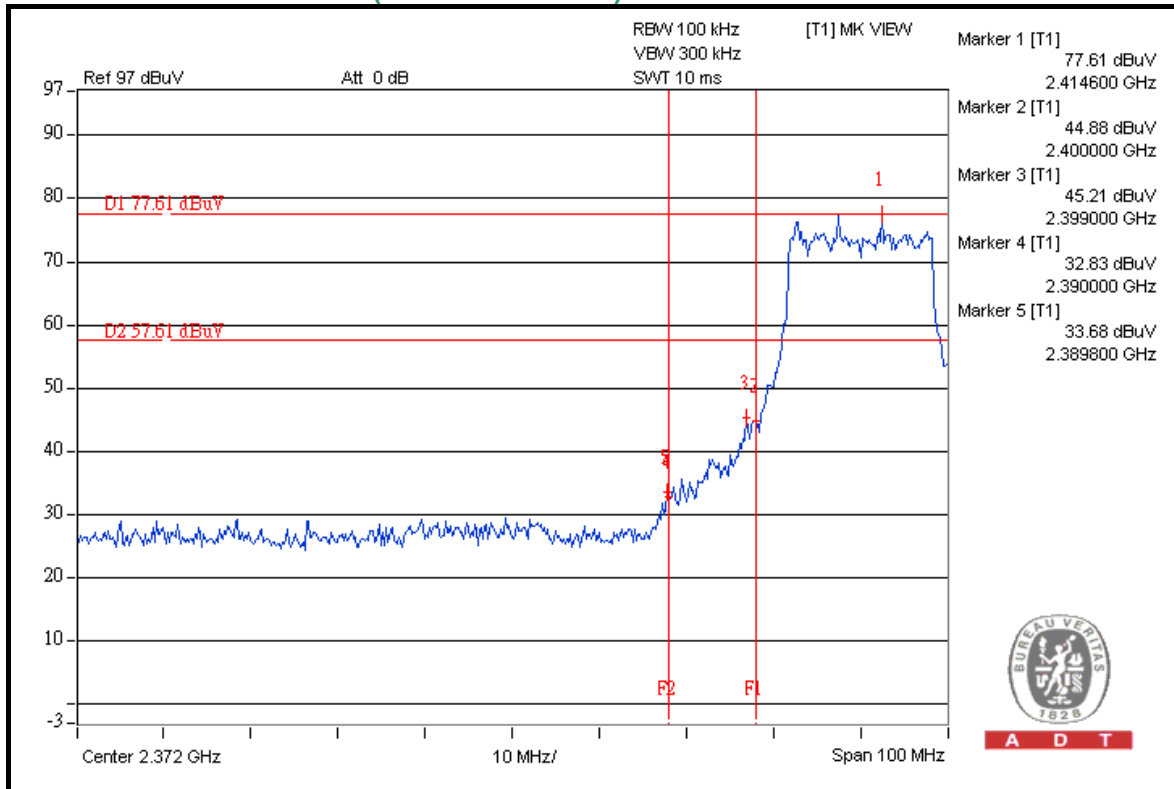



A D T

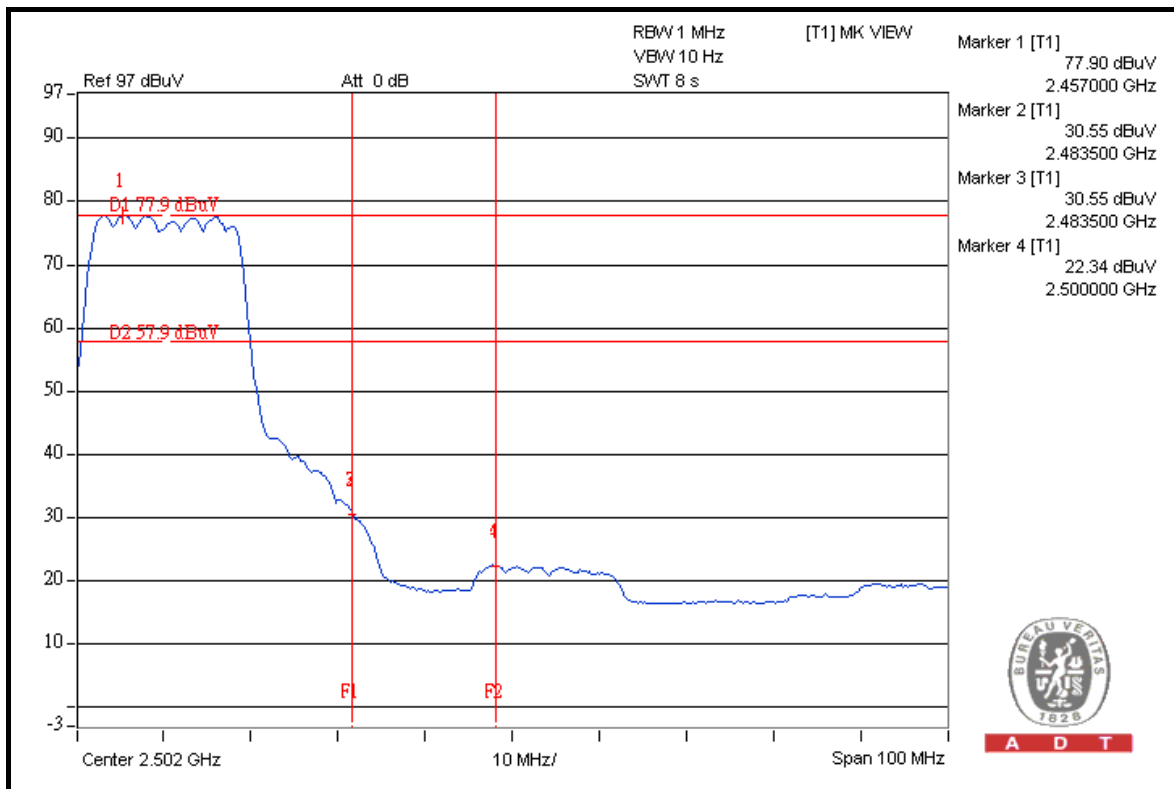
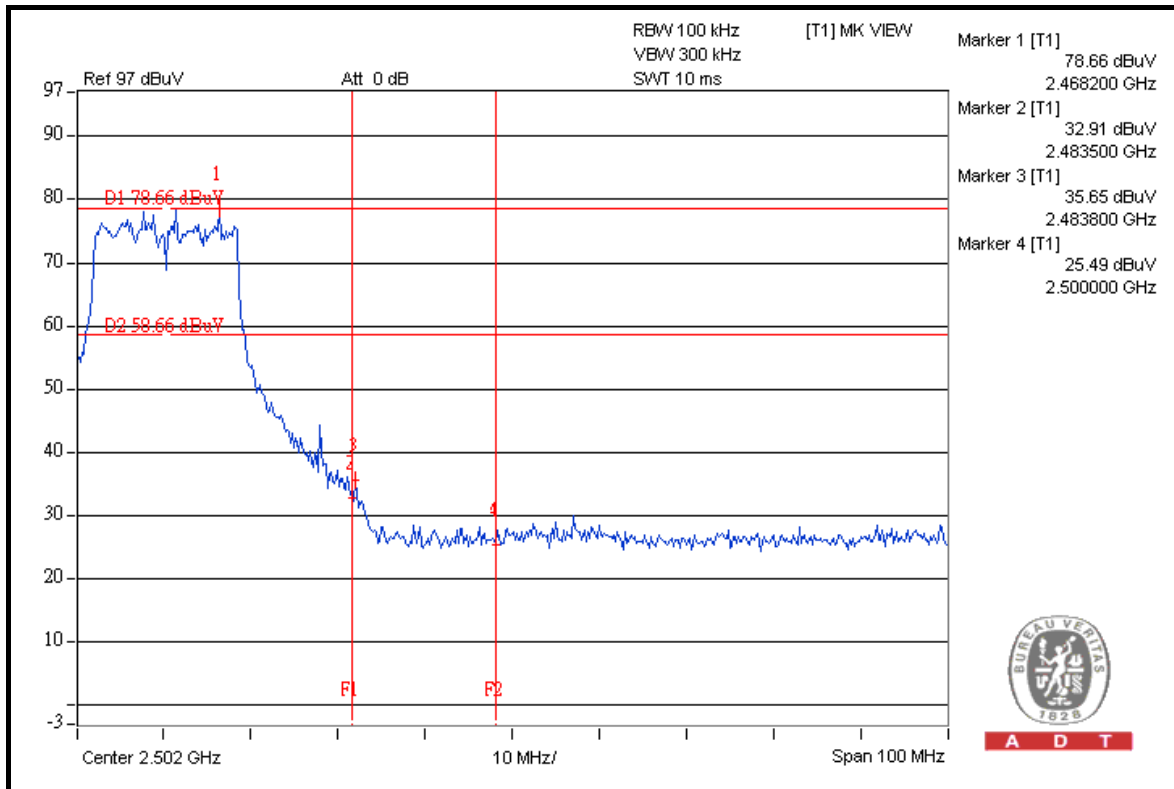



A D T

FOR CONDUCTED MEASURED

CHAIN 0

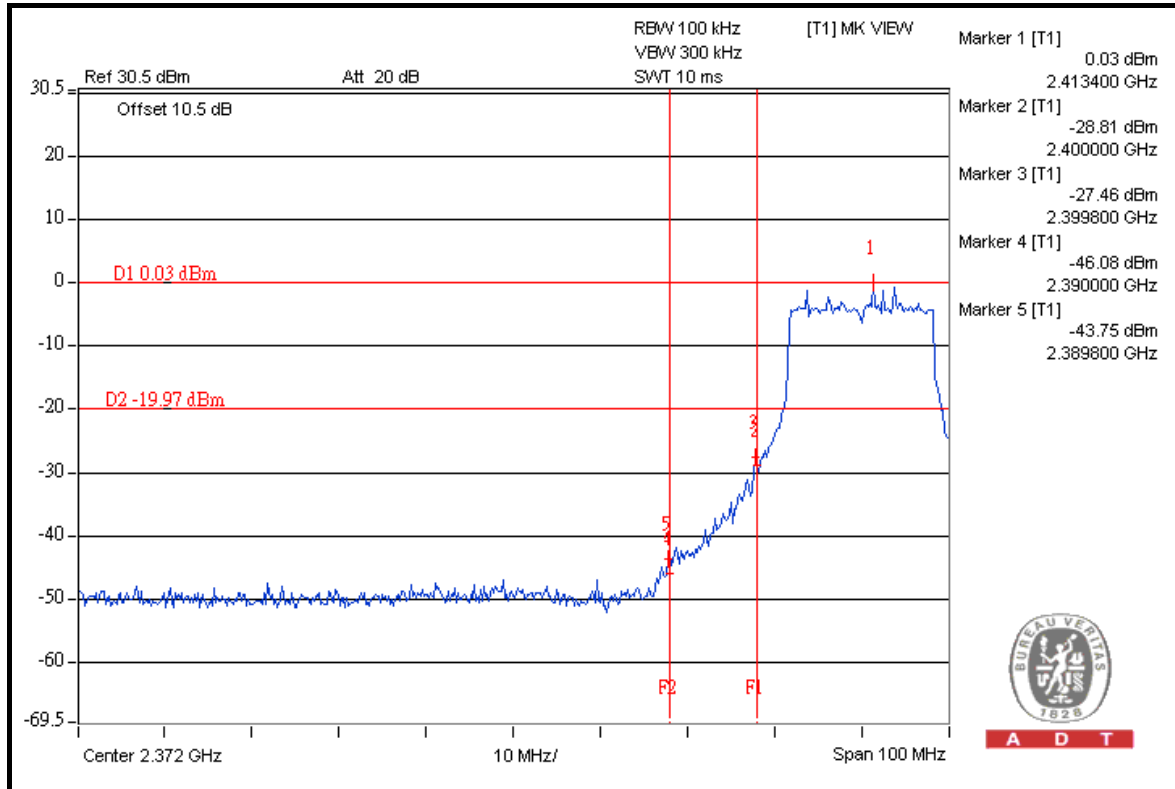

A D T

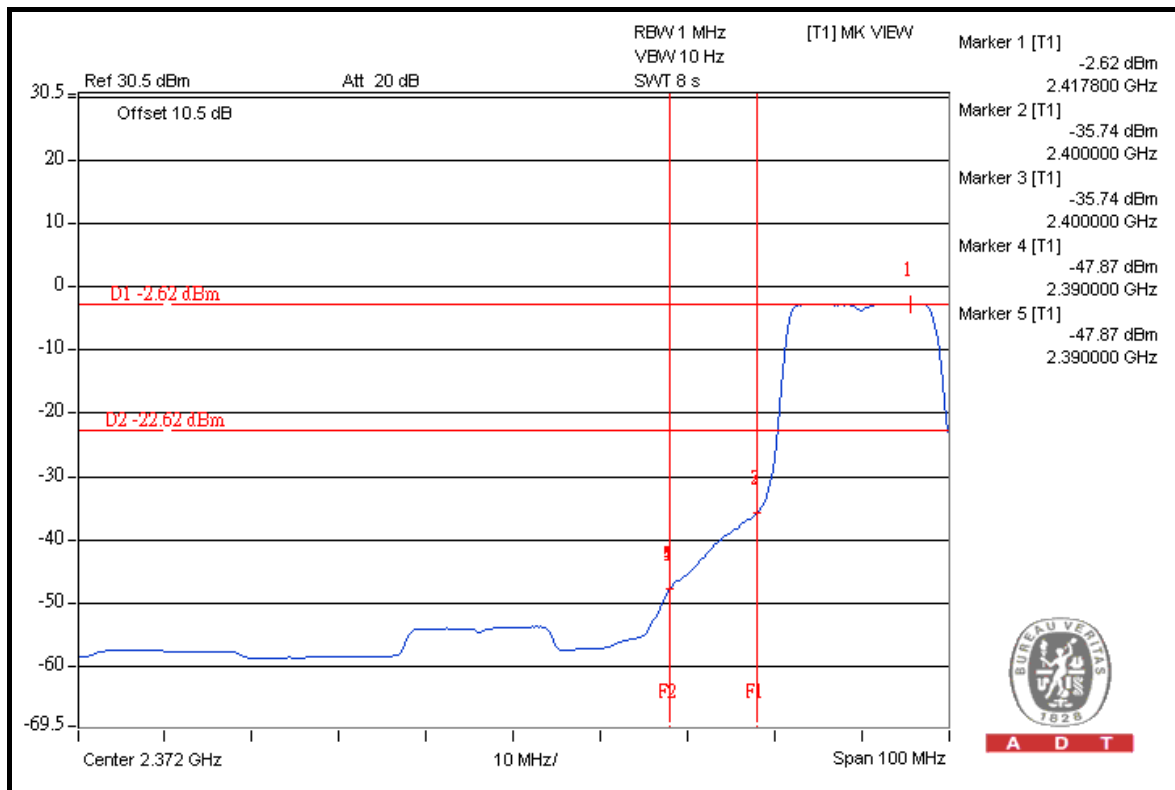

A D T



A D T

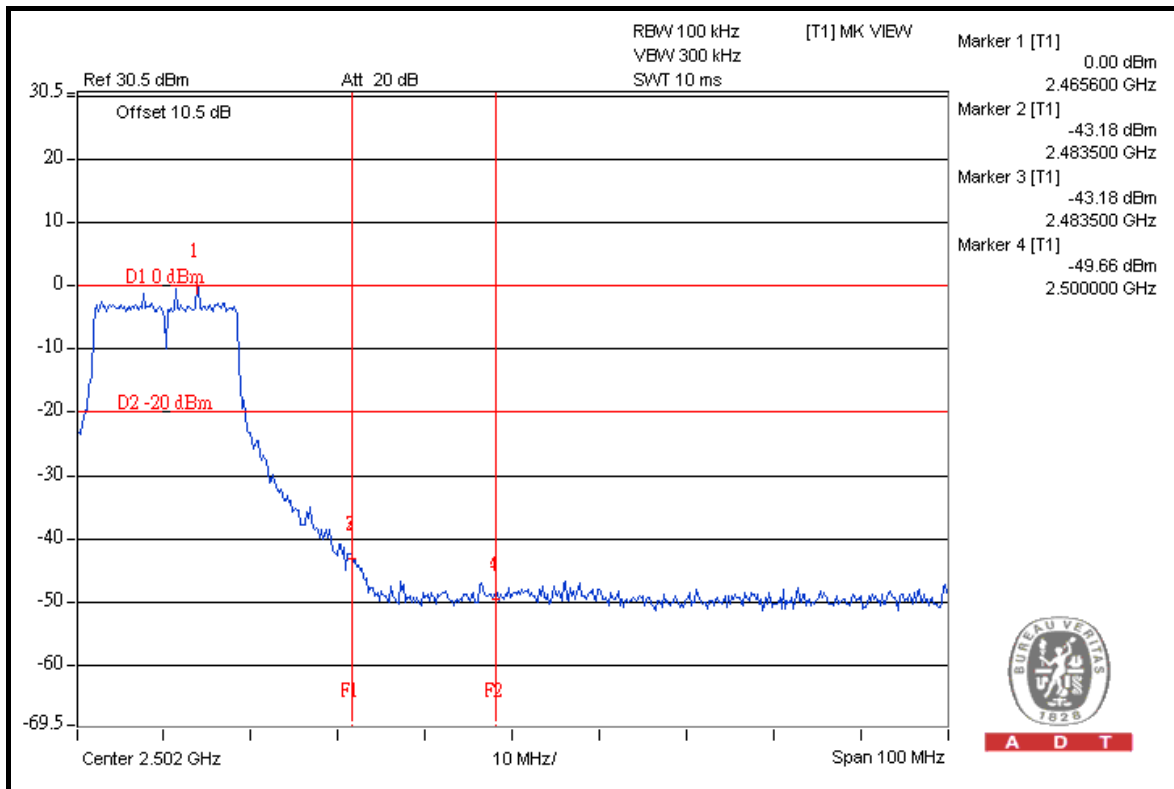
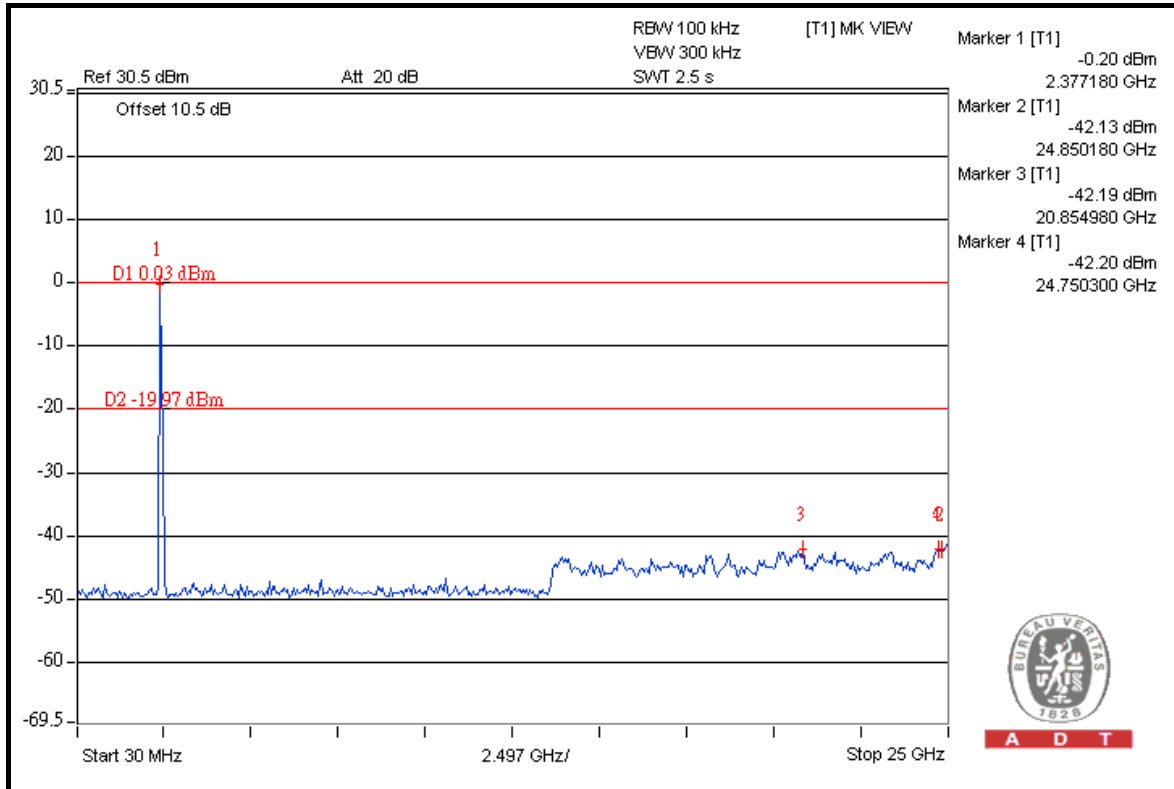



A D T

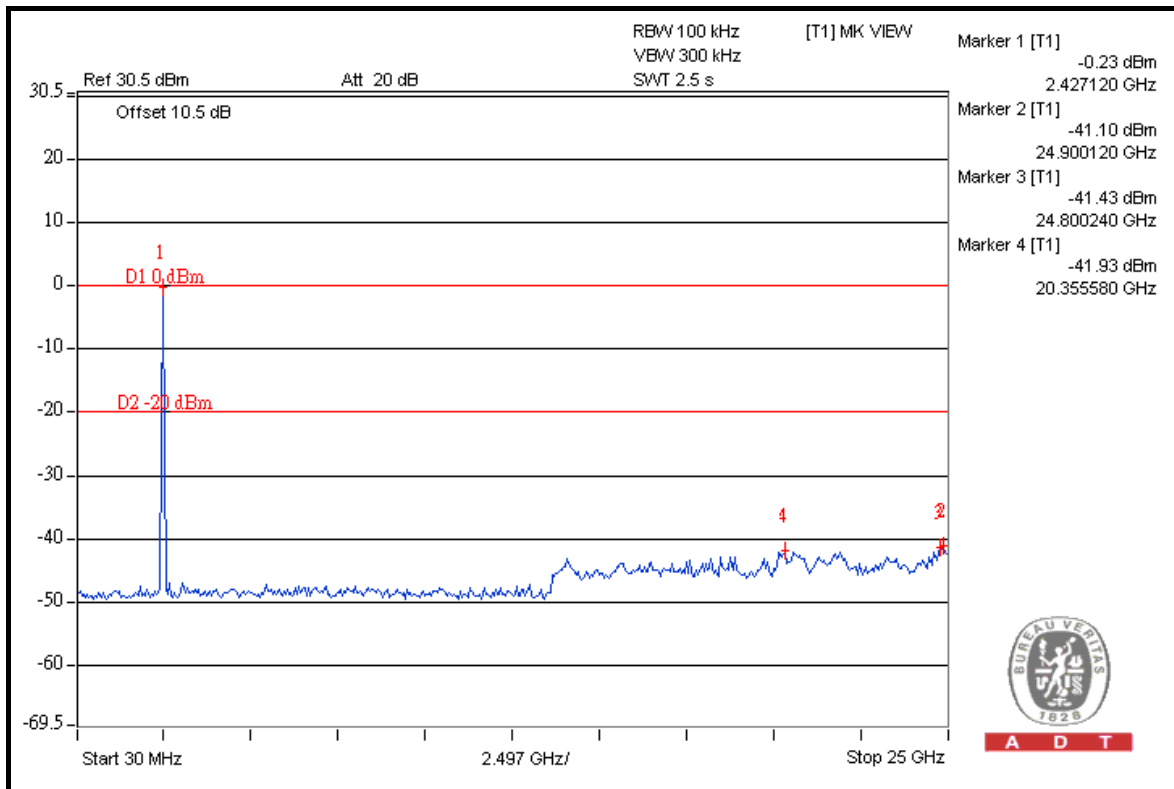
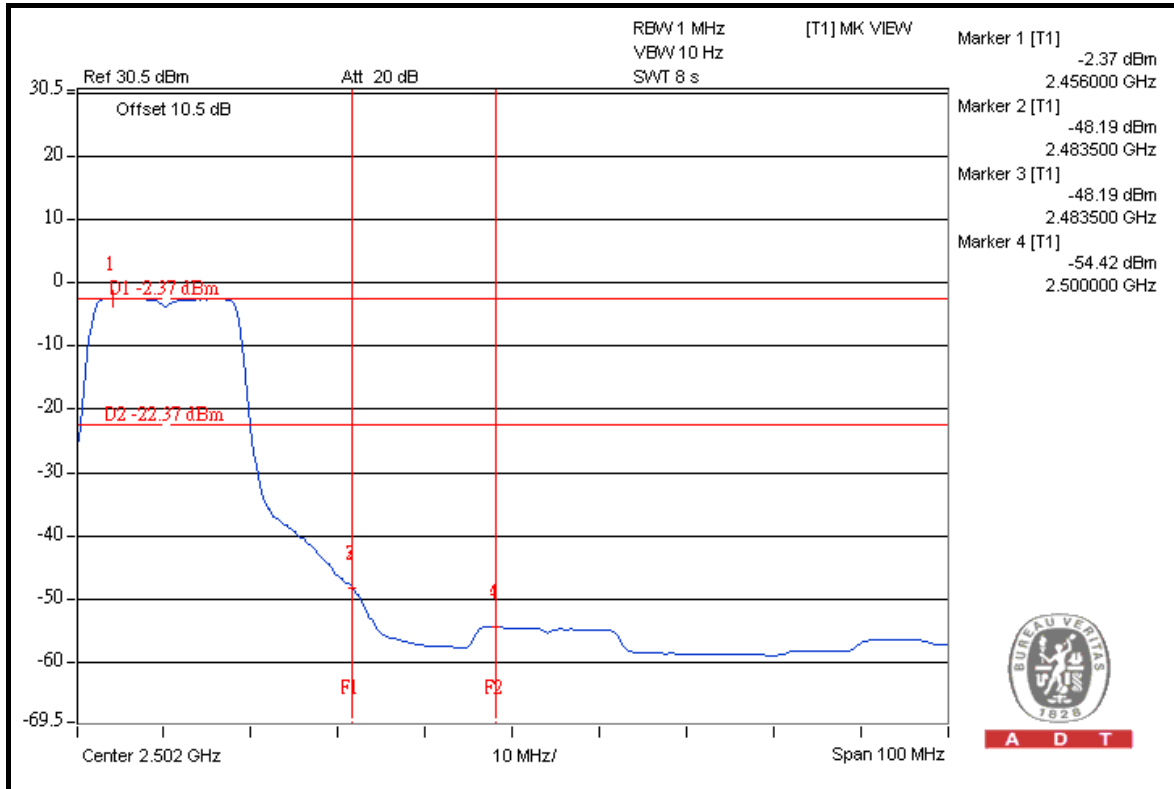



A D T

CHAIN 1

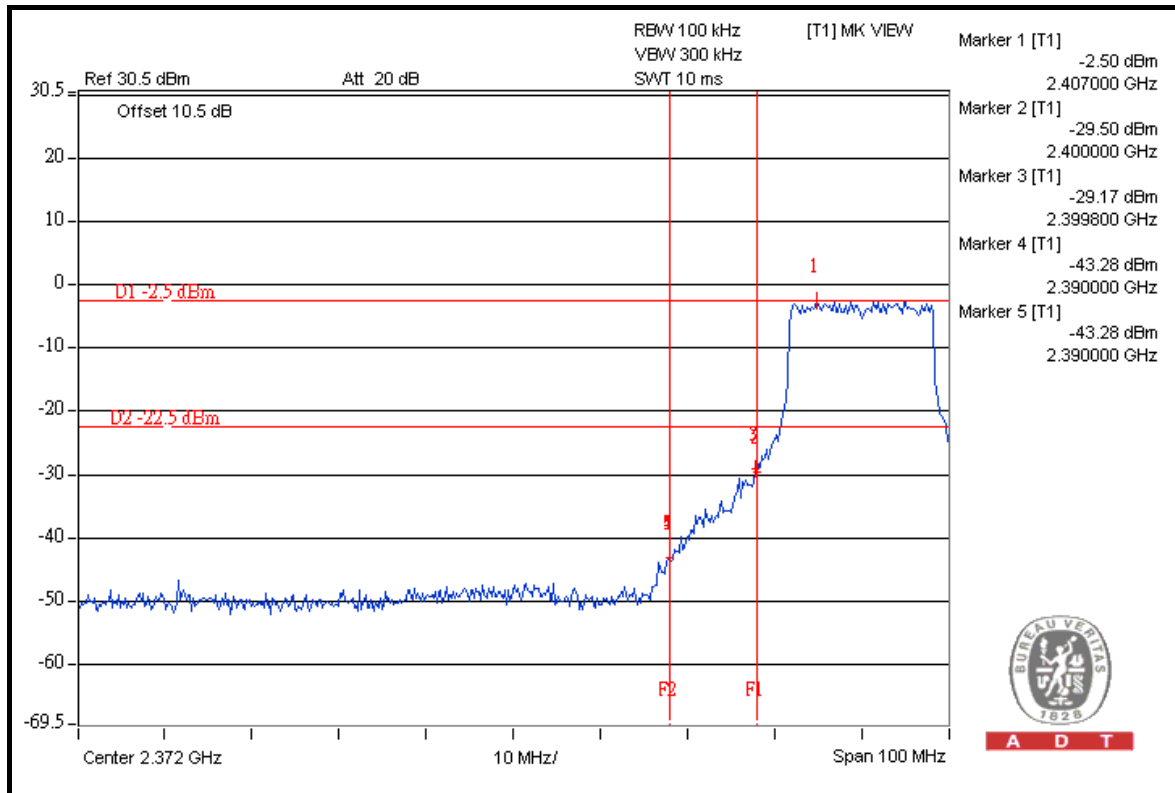

A D T

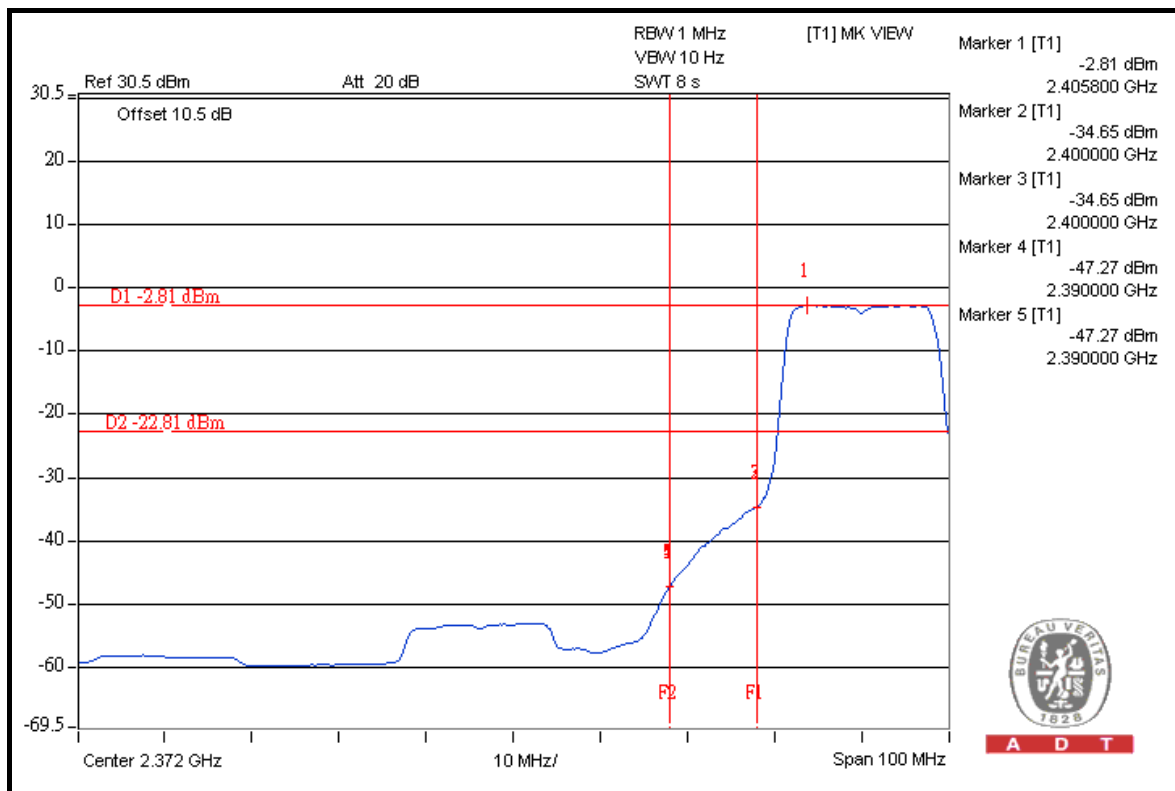

A D T



A D T

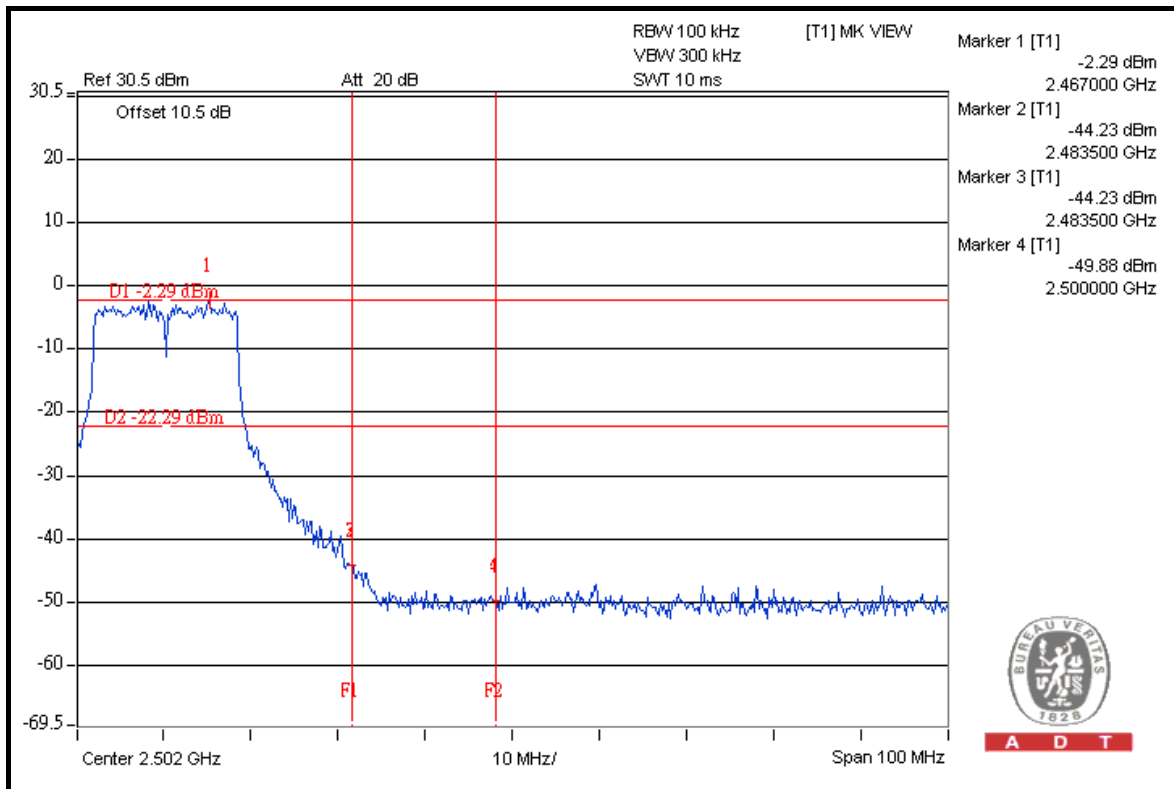
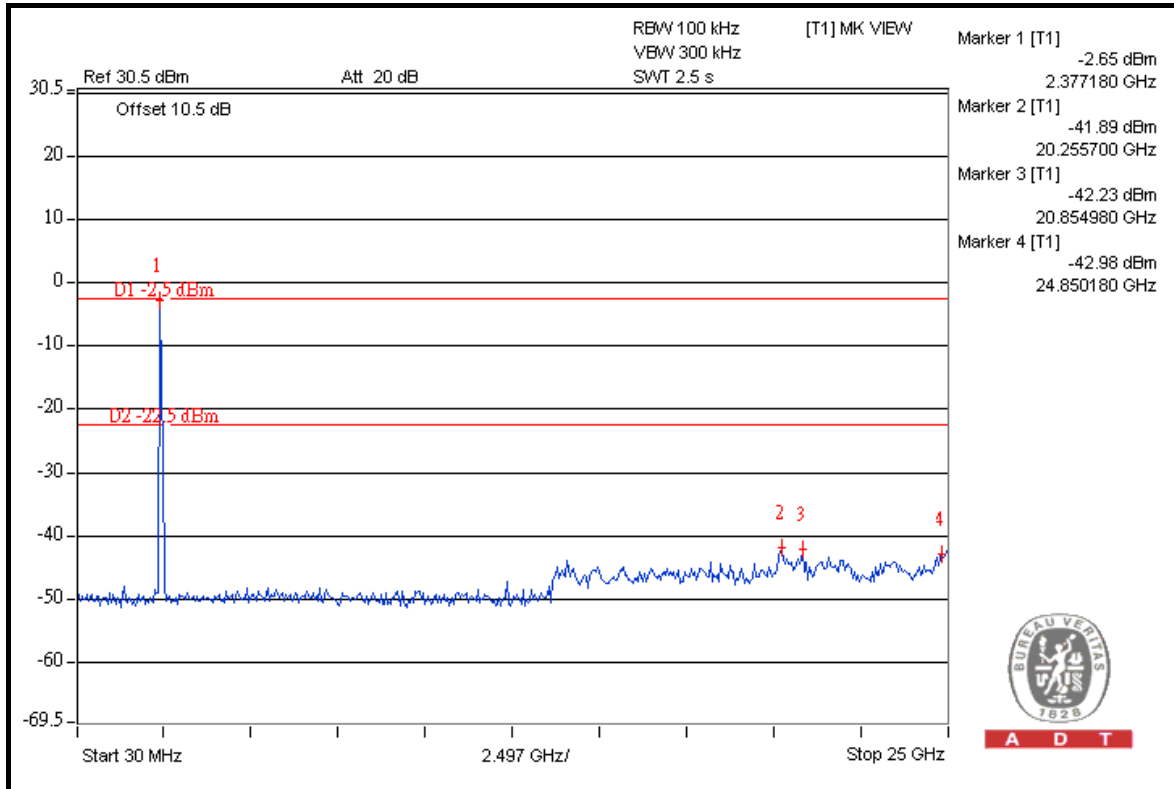



A D T

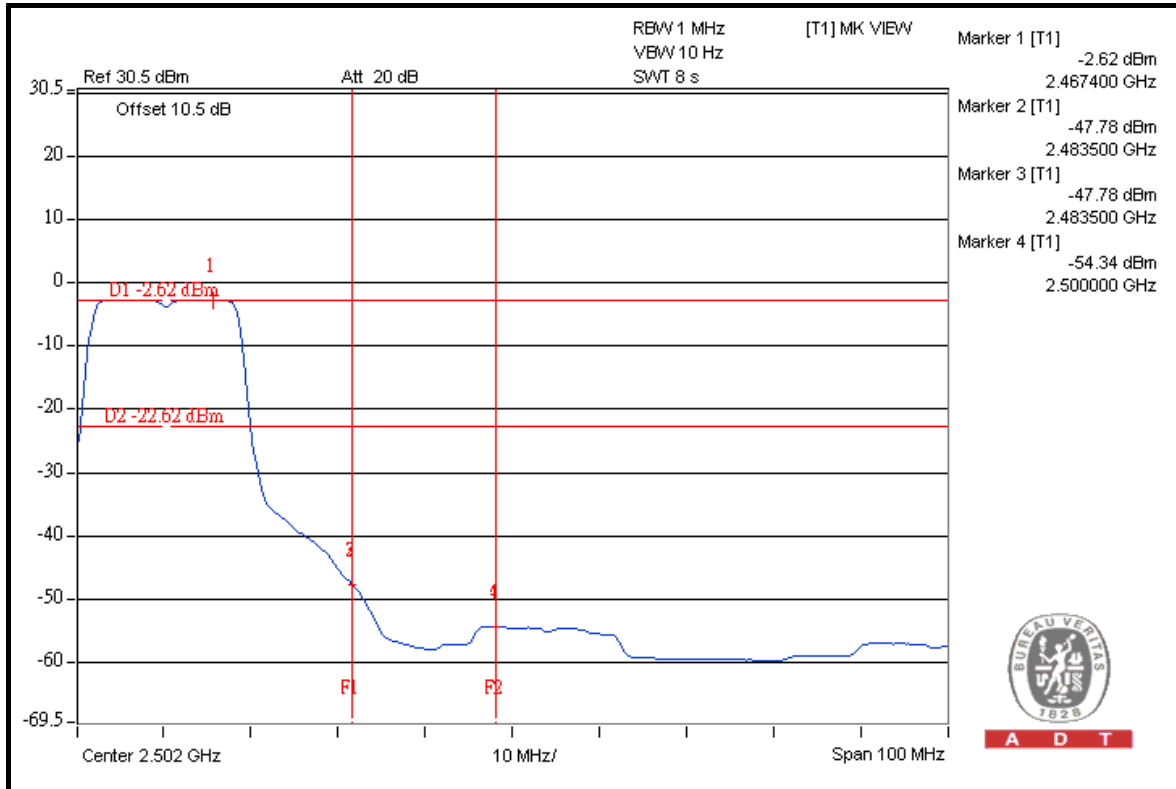

A D T

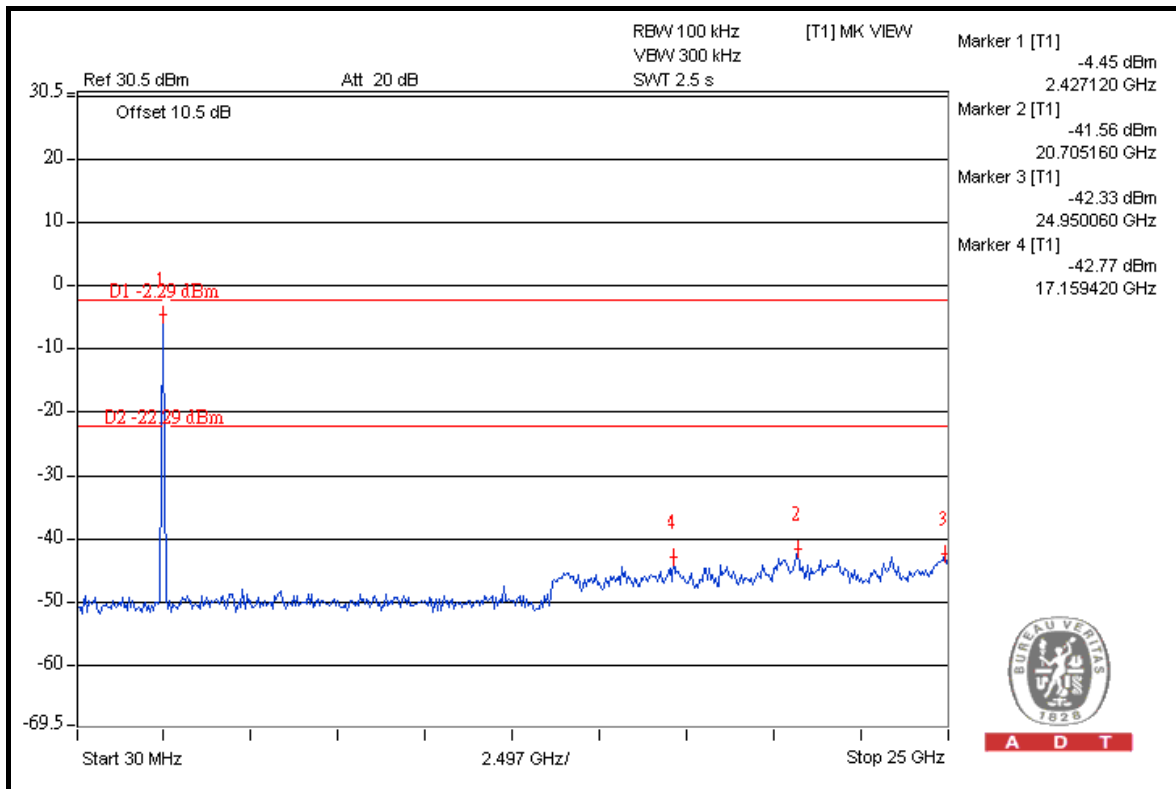

A D T



A D T

802.11n (20MHz)

RESTRICT BAND (2310 ~ 2390 MHz)

FREQUENCY (MHz)	FUNDAMENTAL EMISSION (dBuV/m)	DELTA (dB)	MAXIMUM FIELD STRENGTH IN RESTRICT BAND (dBuV/m)	LIMIT (dBuV/m)
2412.00 (PK)	107.5	46.36	61.14	74.00
2412.00 (AV)	95.2	47.46	47.74	54.00

RESTRICT BAND (2483.5 ~ 2500 MHz)

FREQUENCY (MHz)	FUNDAMENTAL EMISSION (dBuV/m)	DELTA (dB)	MAXIMUM FIELD STRENGTH IN RESTRICT BAND (dBuV/m)	LIMIT (dBuV/m)
2462.00 (PK)	109.3	45.40	63.90	74.00
2462.00 (AV)	97.1	44.84	52.26	54.00

NOTE:

1. Delta = Amplitude between the peak of the fundamental and the peak of the band edge emission. Please check following 2 pages.
2. Maximum field strength in restrict band = Fundamental emission – Delta.



A D T

FOR RADIATED MEASURED (BOTH CHAINS ON)

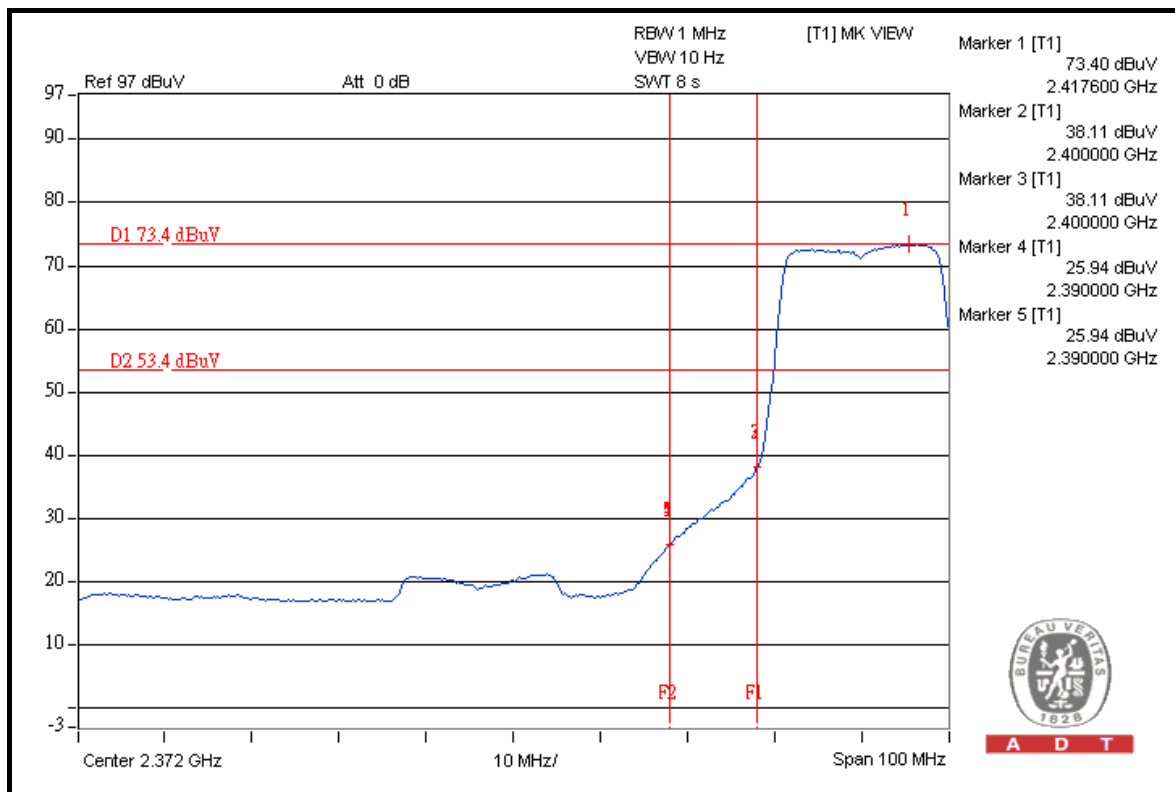
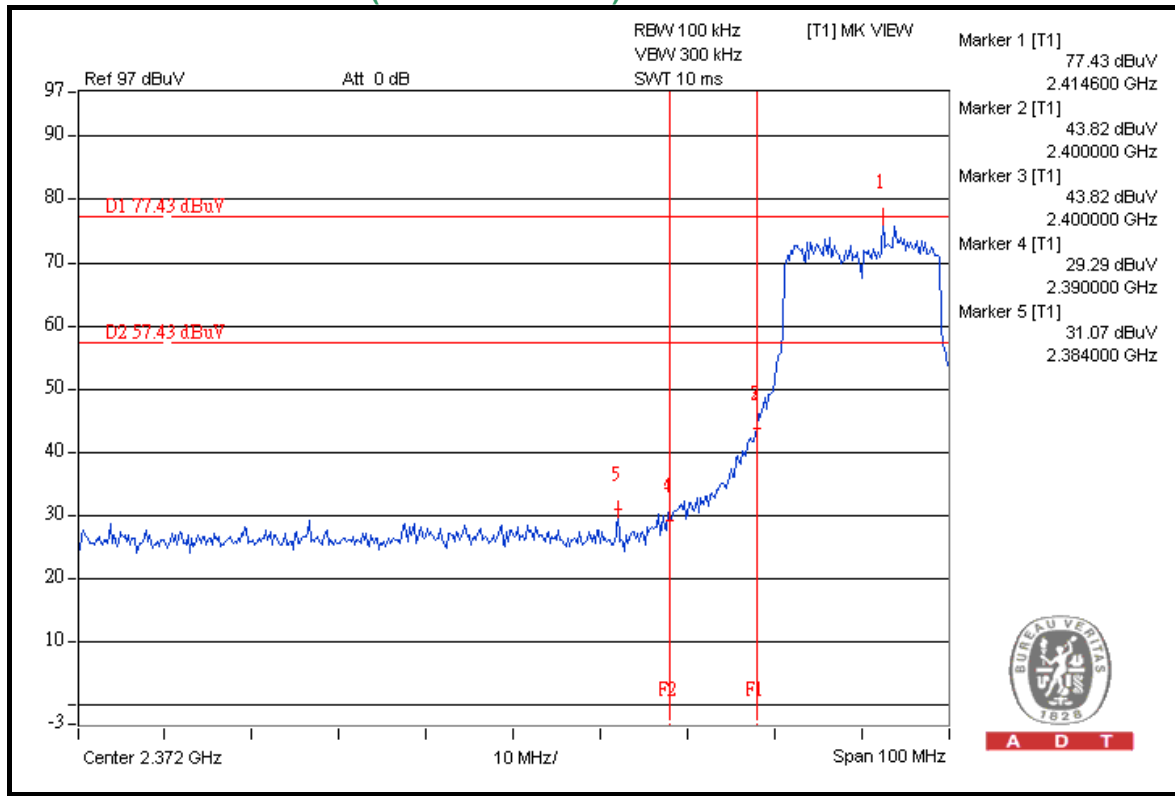



A D T

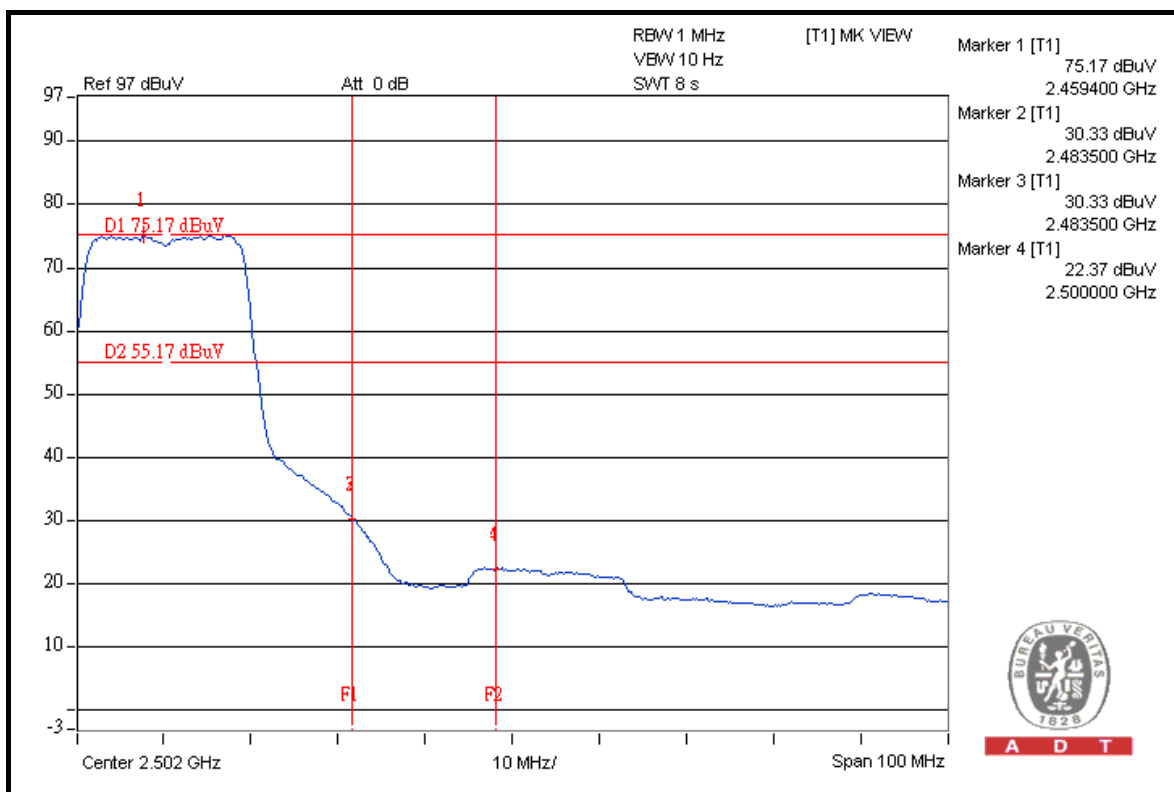
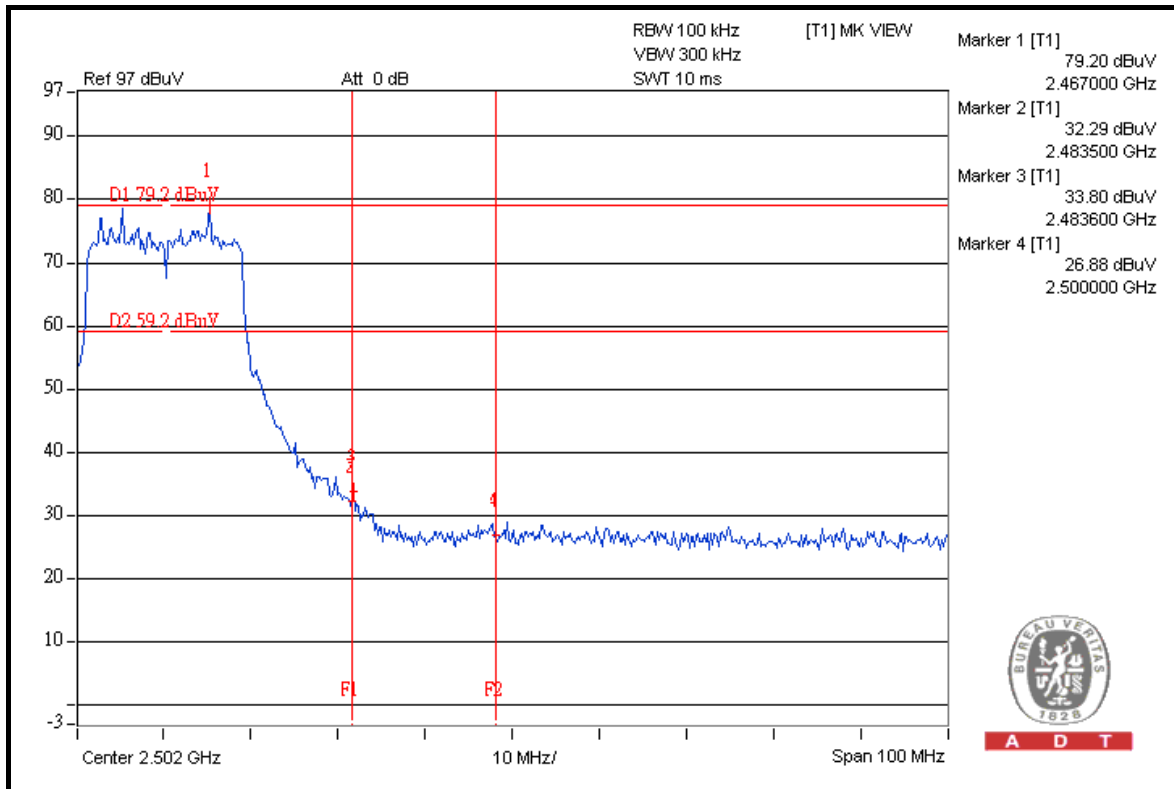



A D T

FOR CONDUCTED MEASURED

CHAIN 0

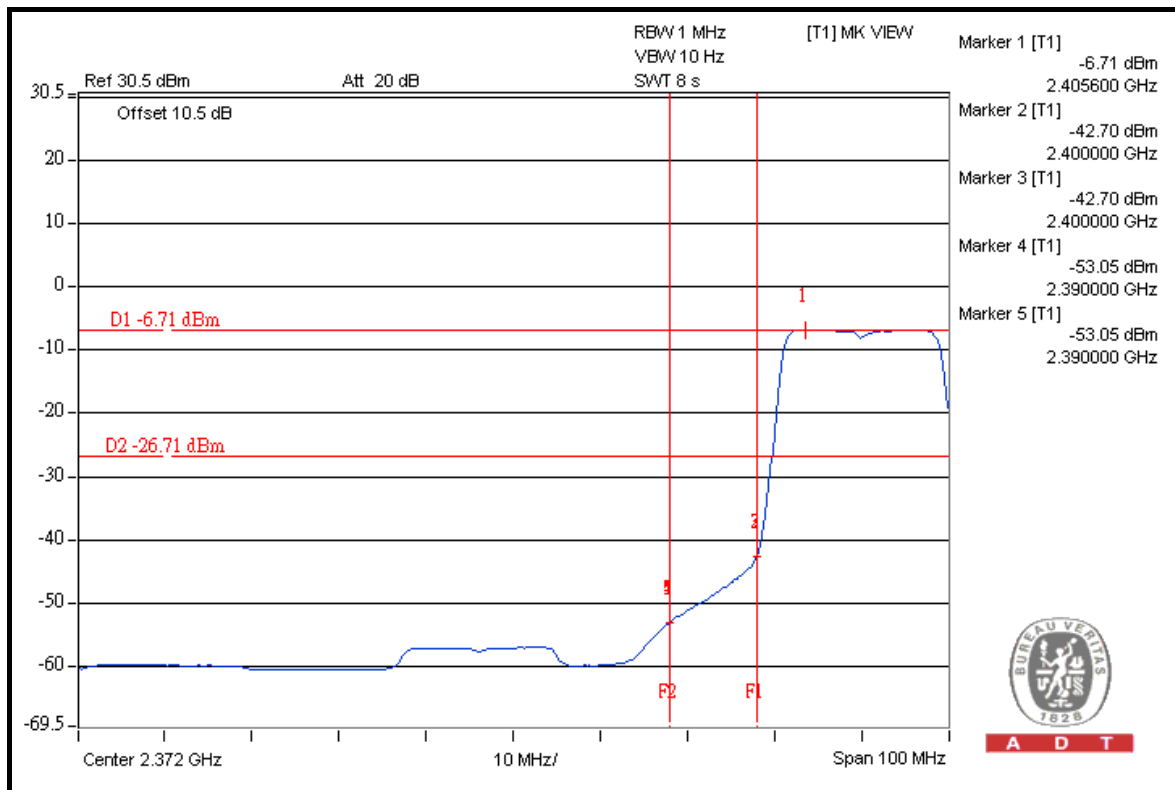
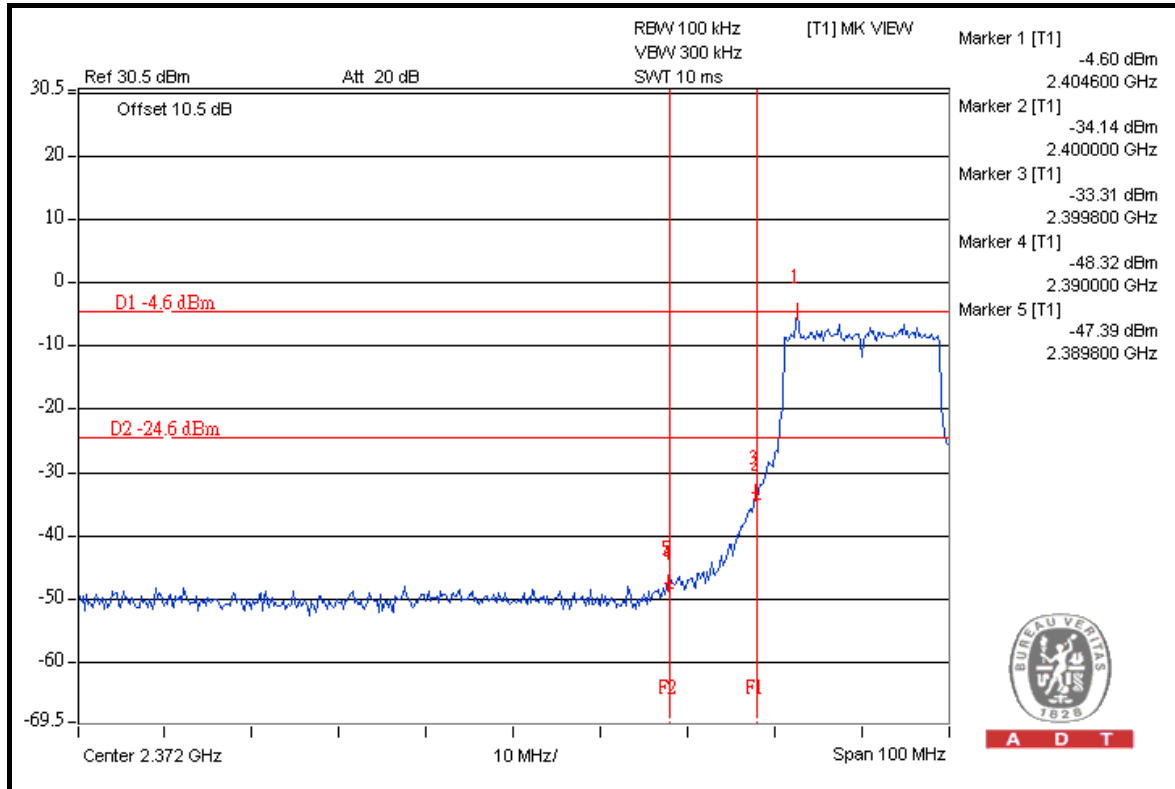



A D T

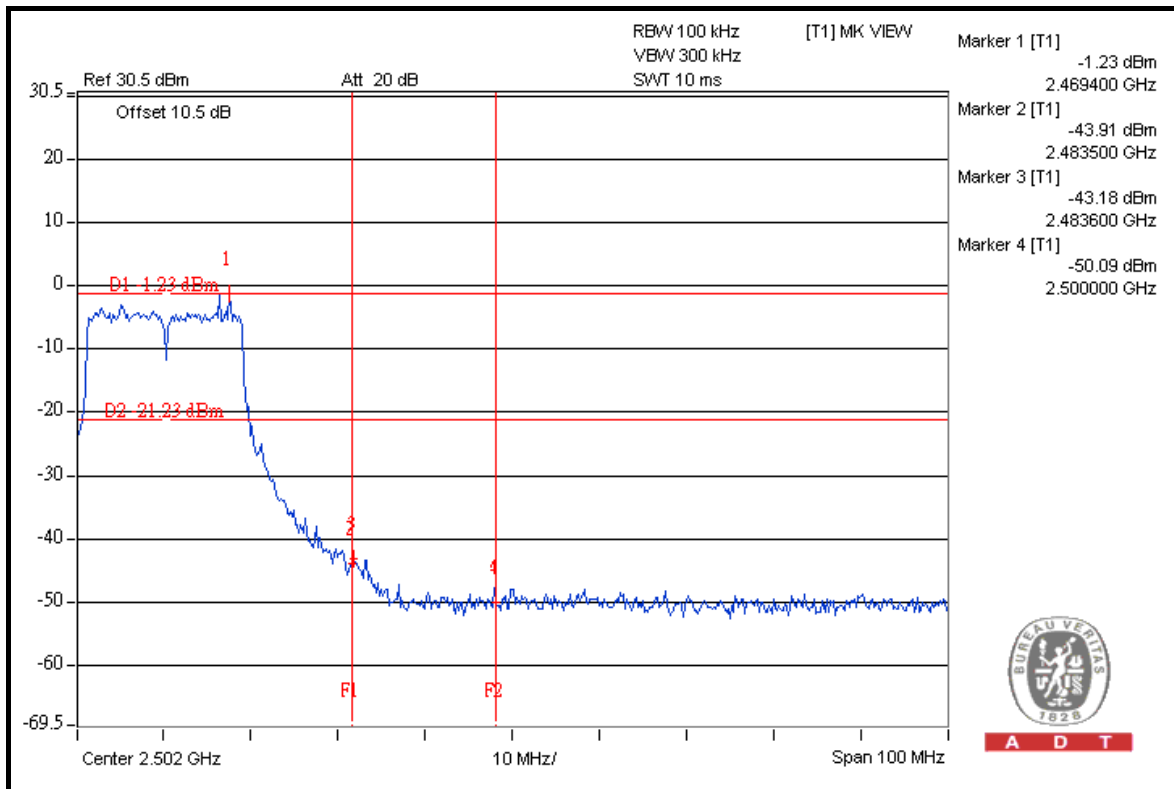
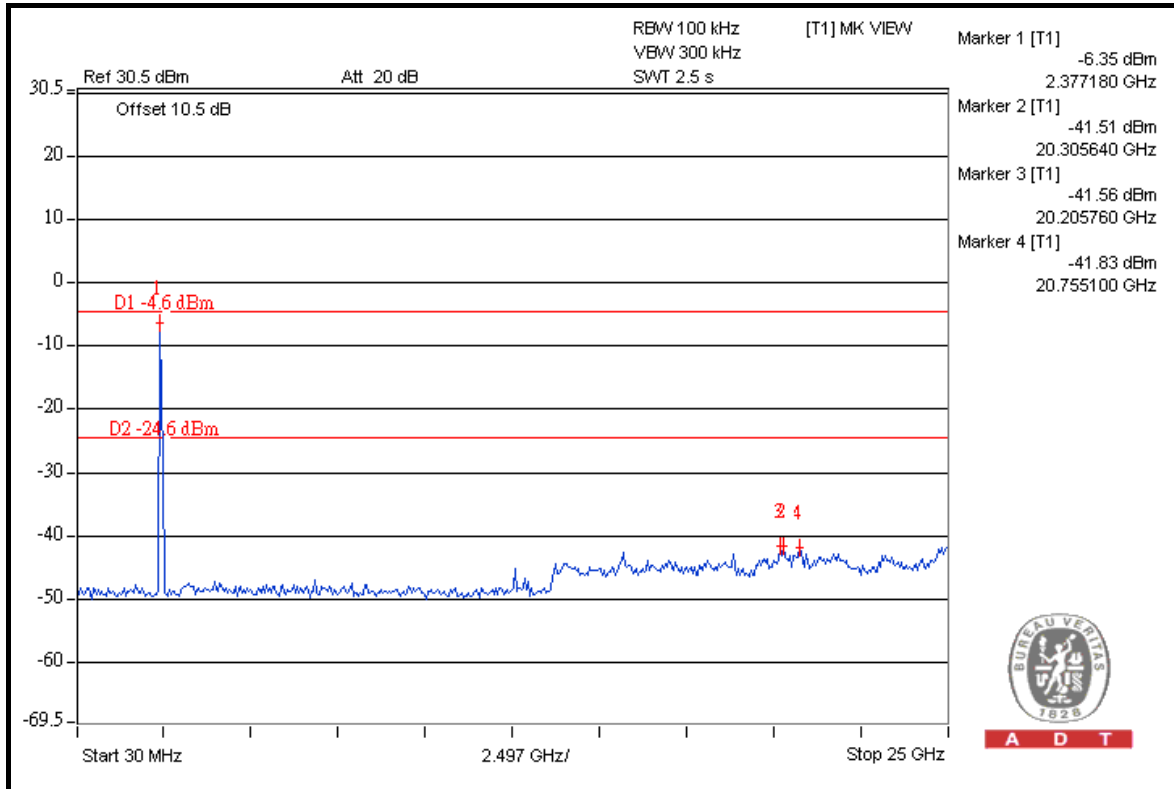



A D T

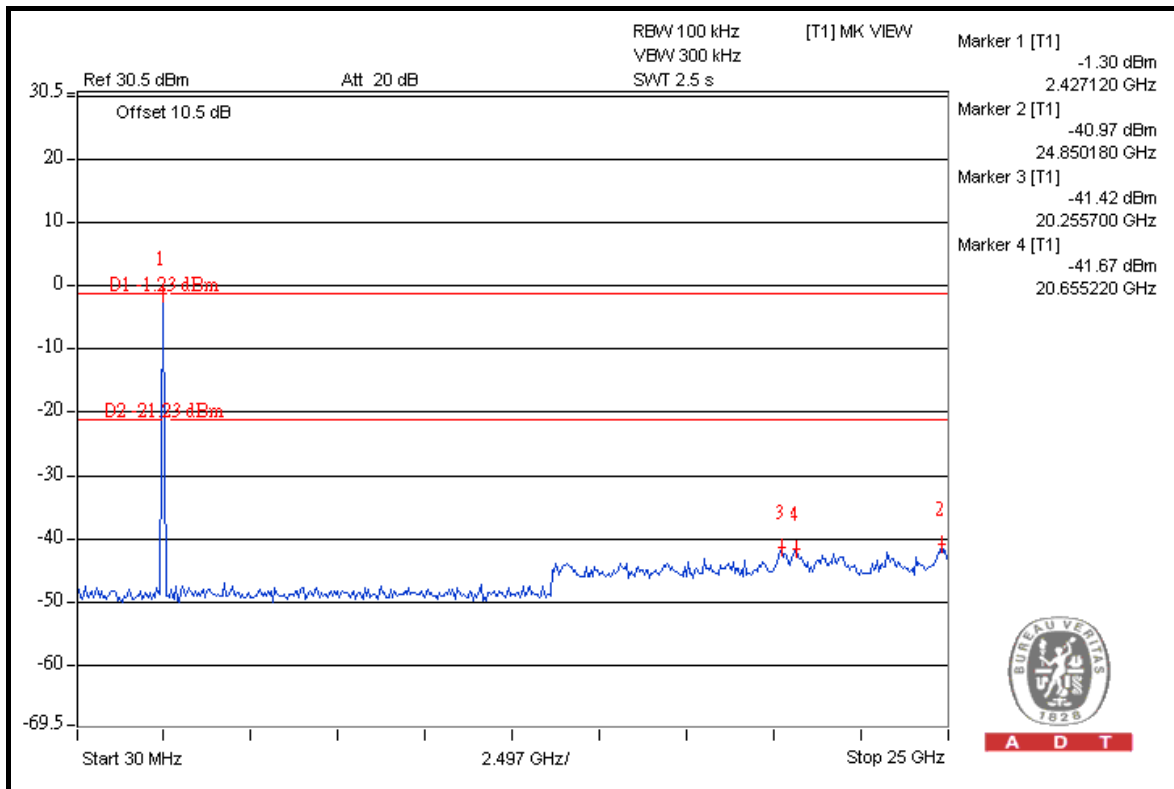
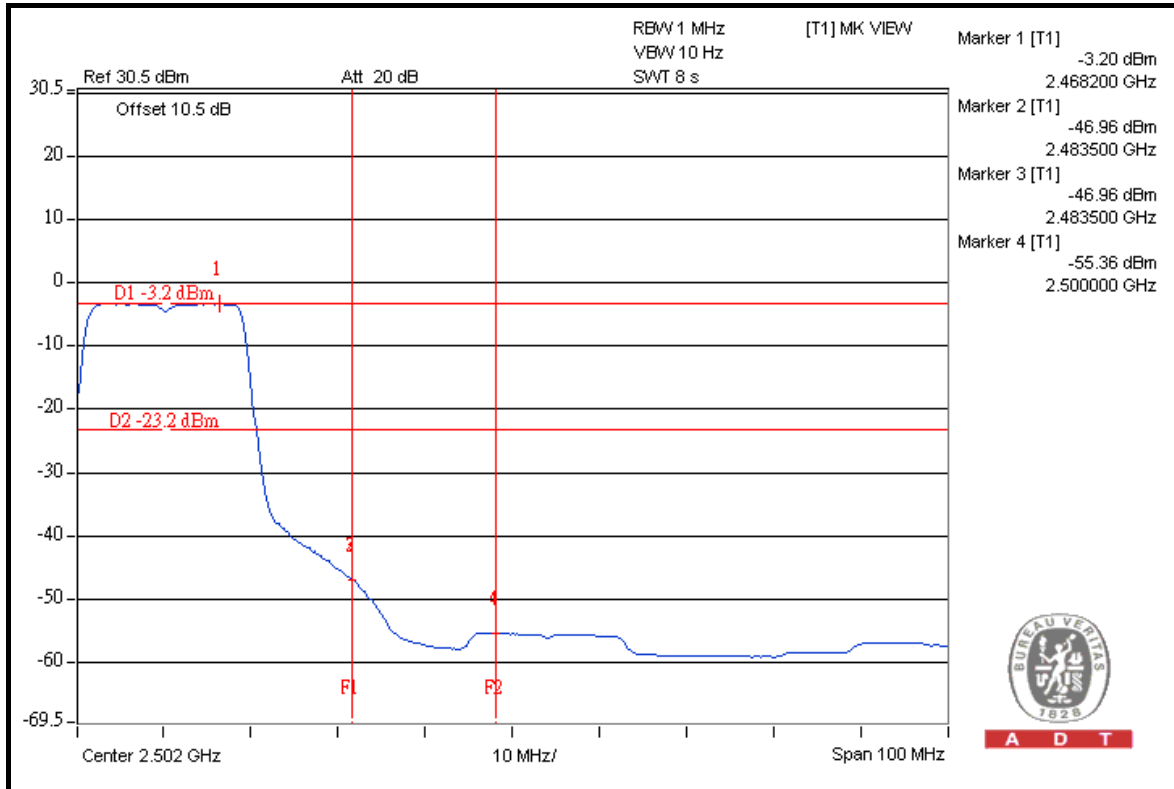



A D T

CHAIN 1

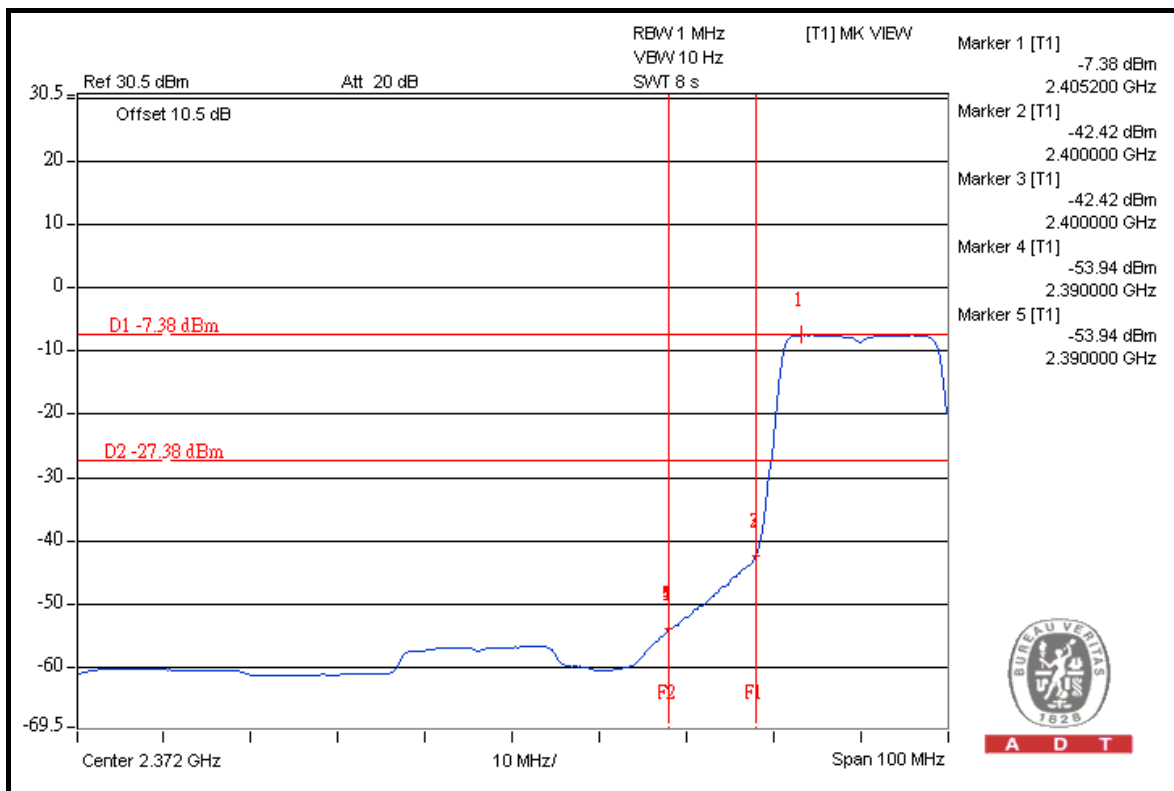
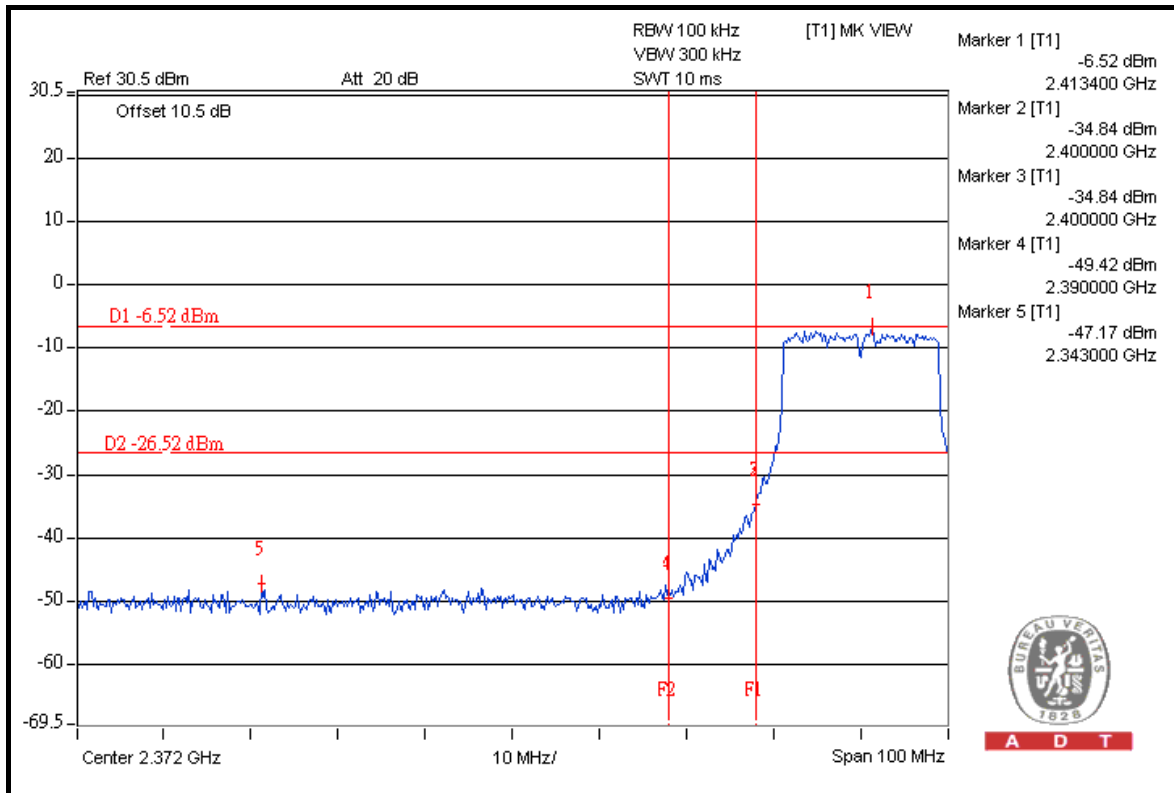



A D T

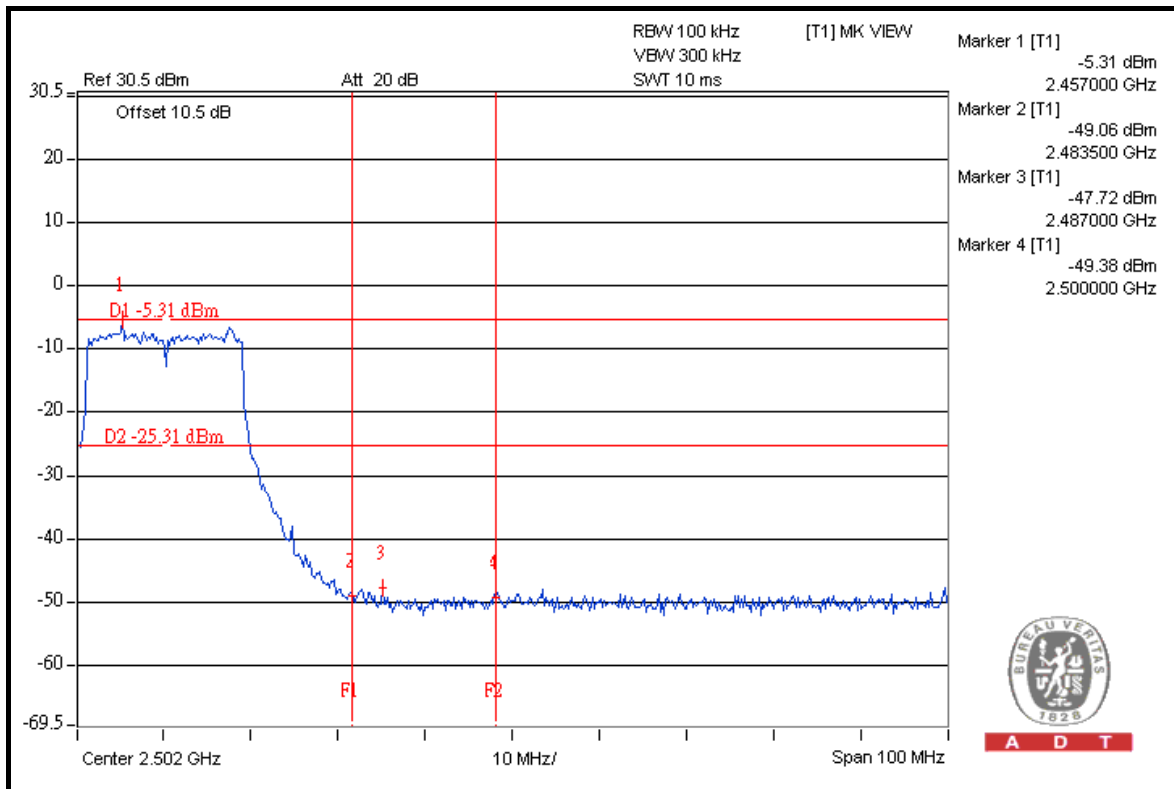
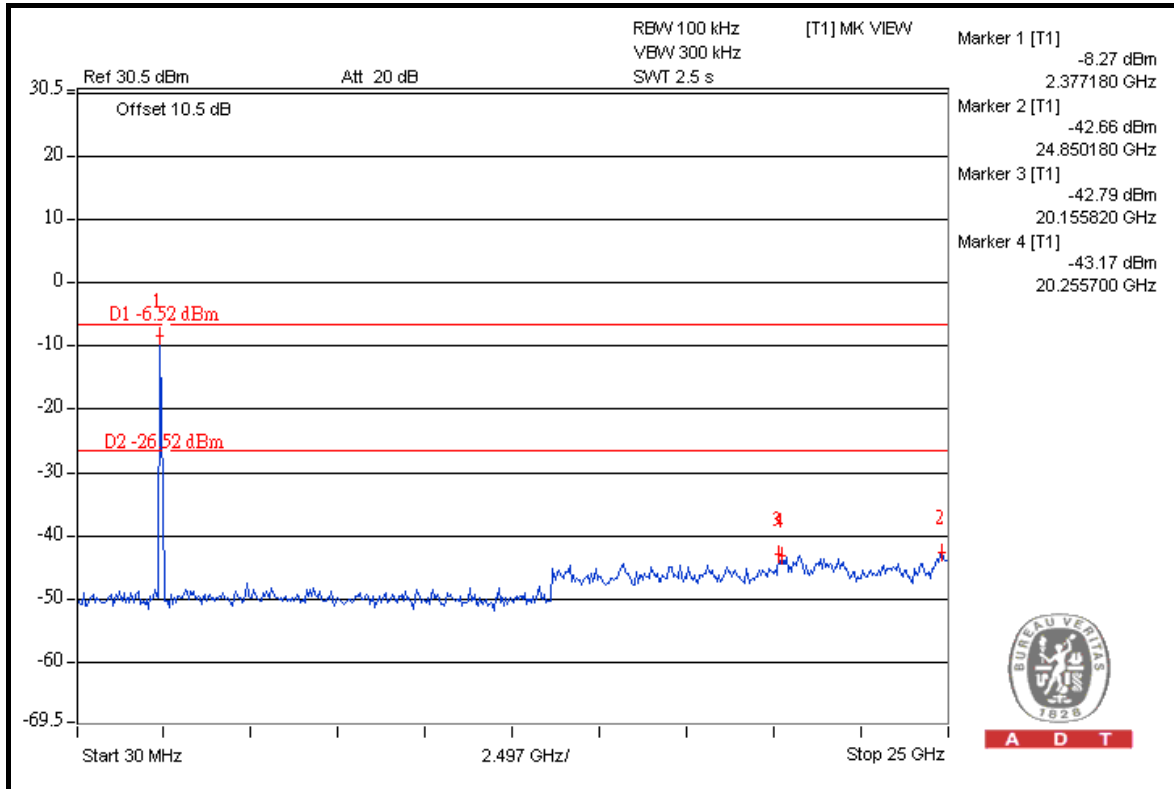



A D T

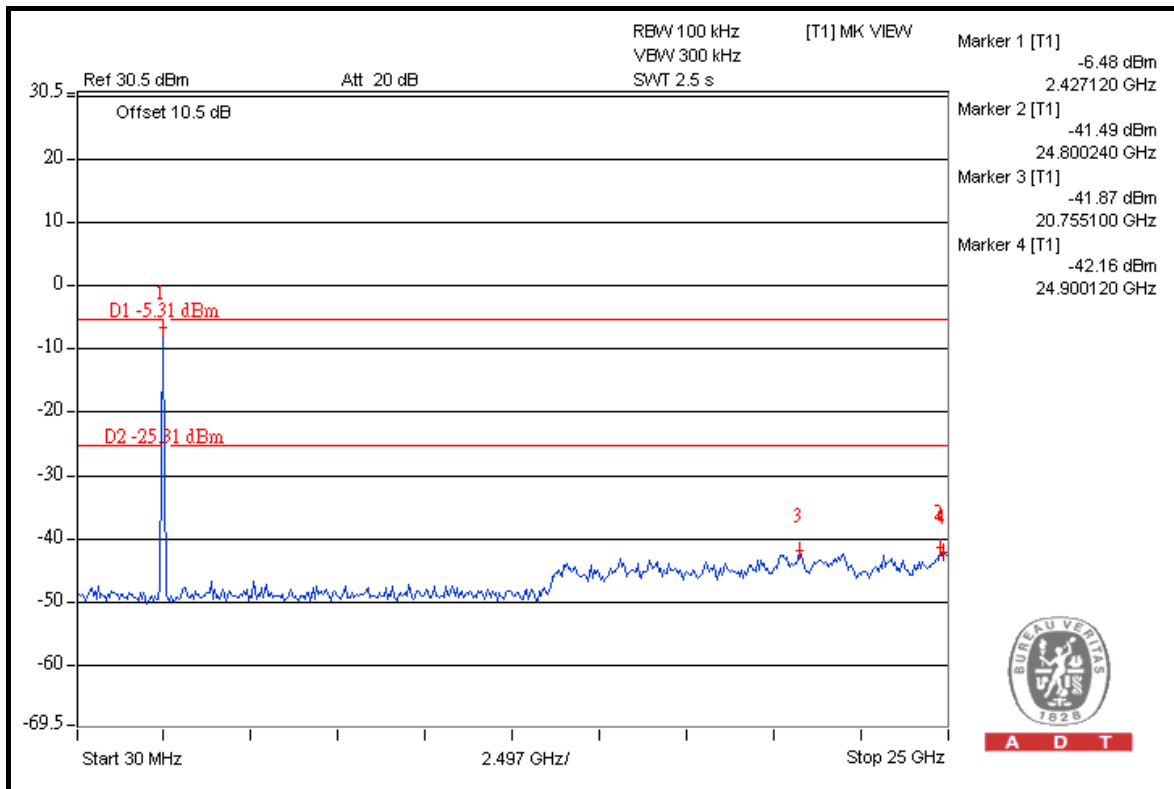
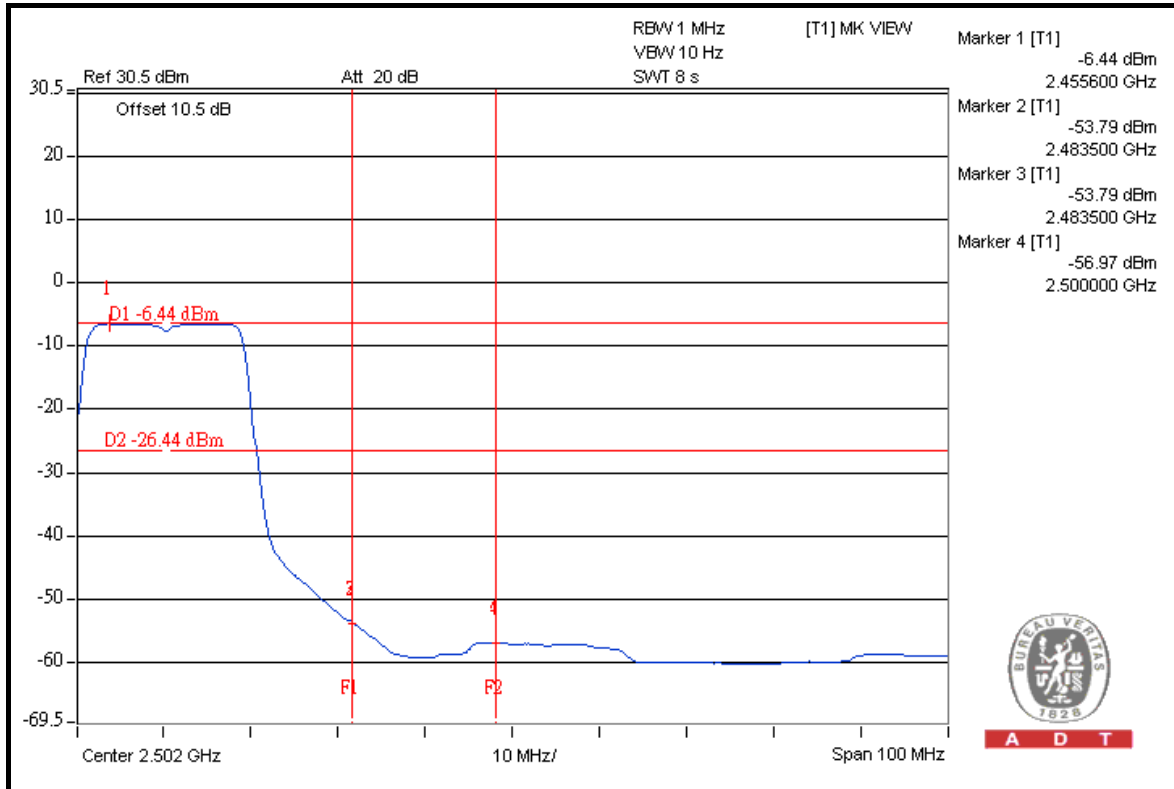



A D T

802.11n (40MHz)

RESTRICT BAND (2310 ~ 2390 MHz)

FREQUENCY (MHz)	FUNDAMENTAL EMISSION (dBuV/m)	DELTA (dB)	MAXIMUM FIELD STRENGTH IN RESTRICT BAND (dBuV/m)	LIMIT (dBuV/m)
2422.00 (PK)	103.5	37.28	66.22	74.00
2422.00 (AV)	91.9	39.75	52.15	54.00

RESTRICT BAND (2483.5 ~ 2500 MHz)

FREQUENCY (MHz)	FUNDAMENTAL EMISSION (dBuV/m)	DELTA (dB)	MAXIMUM FIELD STRENGTH IN RESTRICT BAND (dBuV/m)	LIMIT (dBuV/m)
2452.00 (PK)	104.5	40.22	64.28	74.00
2452.00 (AV)	92.9	41.07	51.83	54.00

NOTE:

1. Delta = Amplitude between the peak of the fundamental and the peak of the band edge emission. Please check following 2 pages.
2. Maximum field strength in restrict band = Fundamental emission – Delta.



A D T

FOR RADIATED MEASURED (BOTH CHAINS ON)

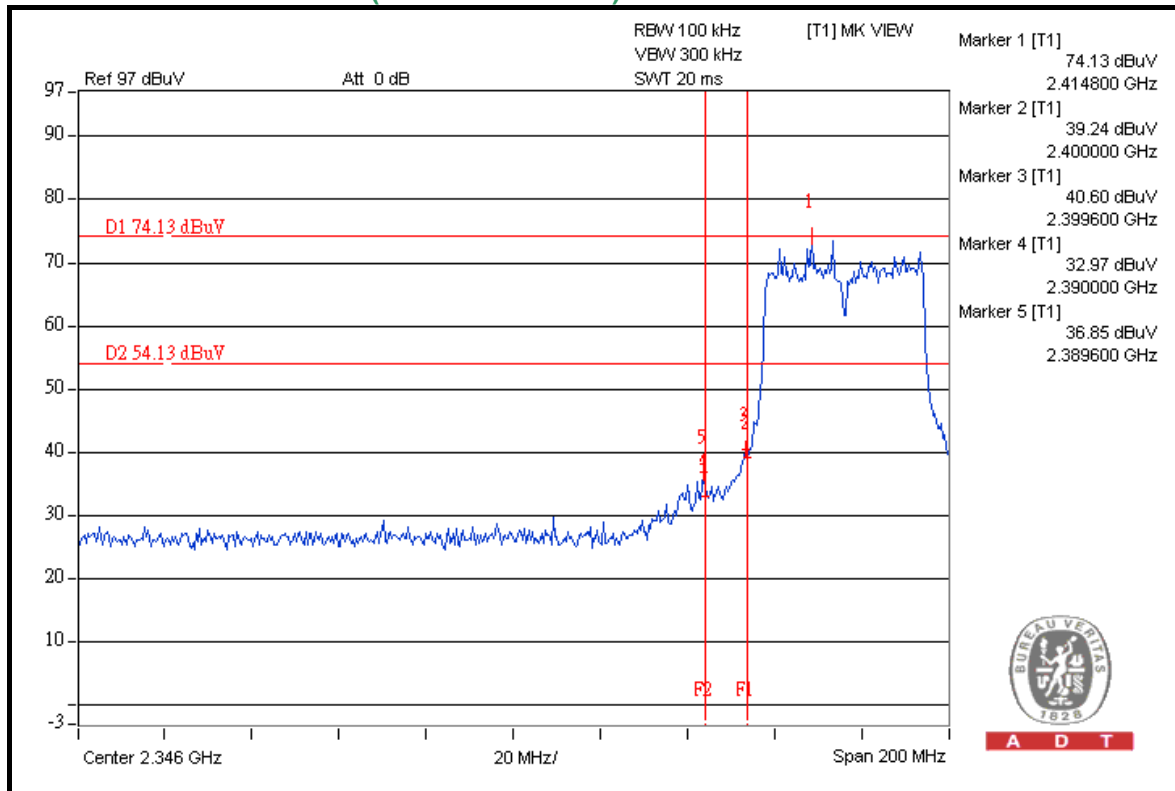

A D T

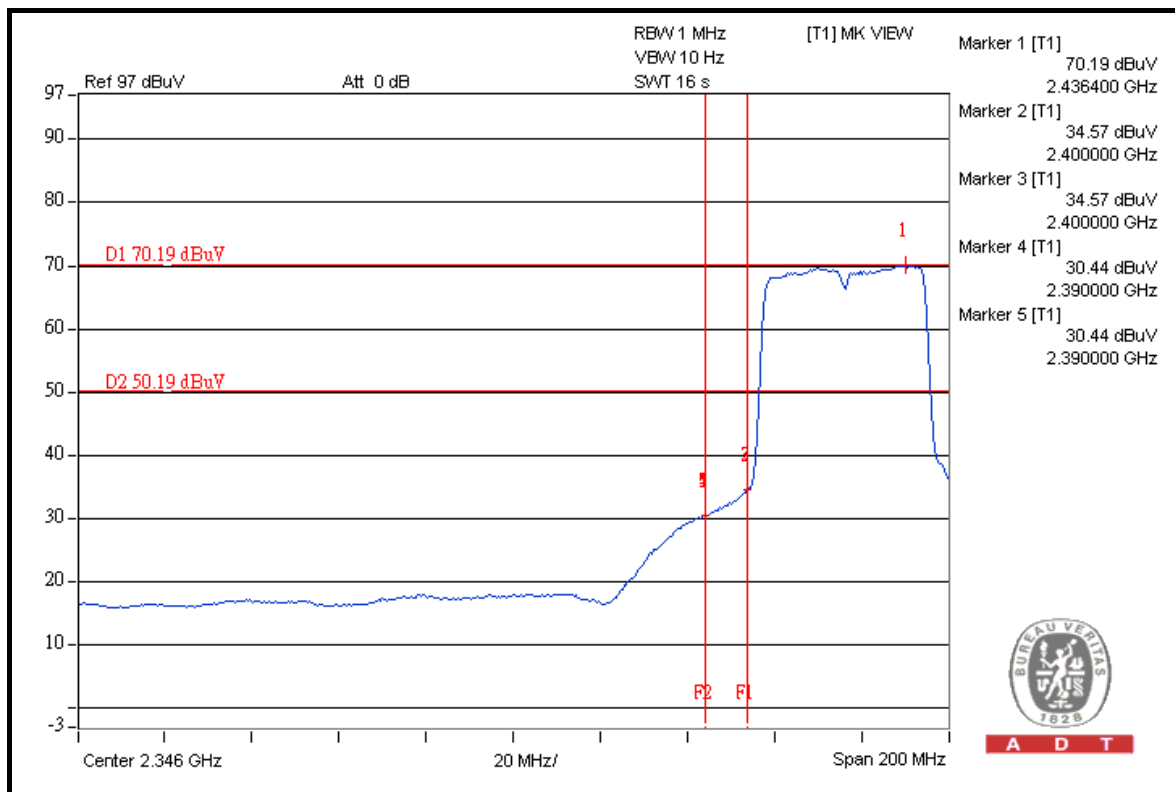

A D T



A D T

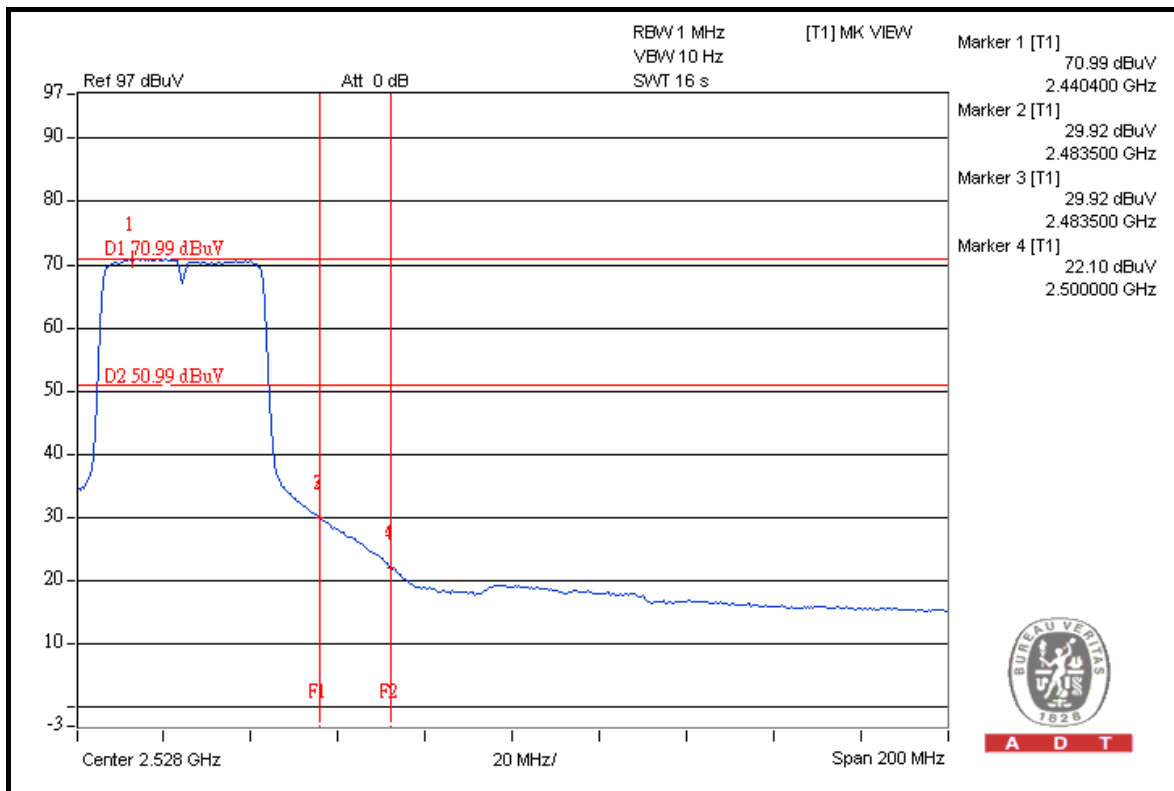
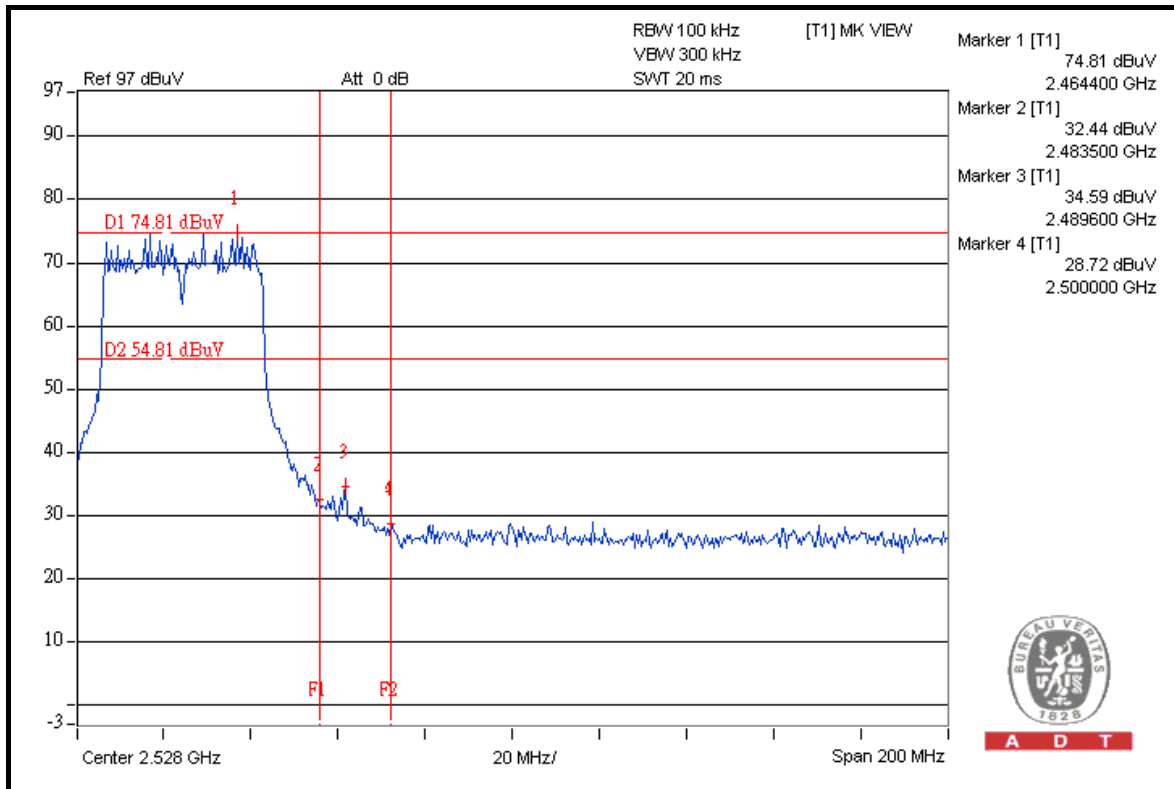



A D T

FOR CONDUCTED MEASURED

CHAIN 0

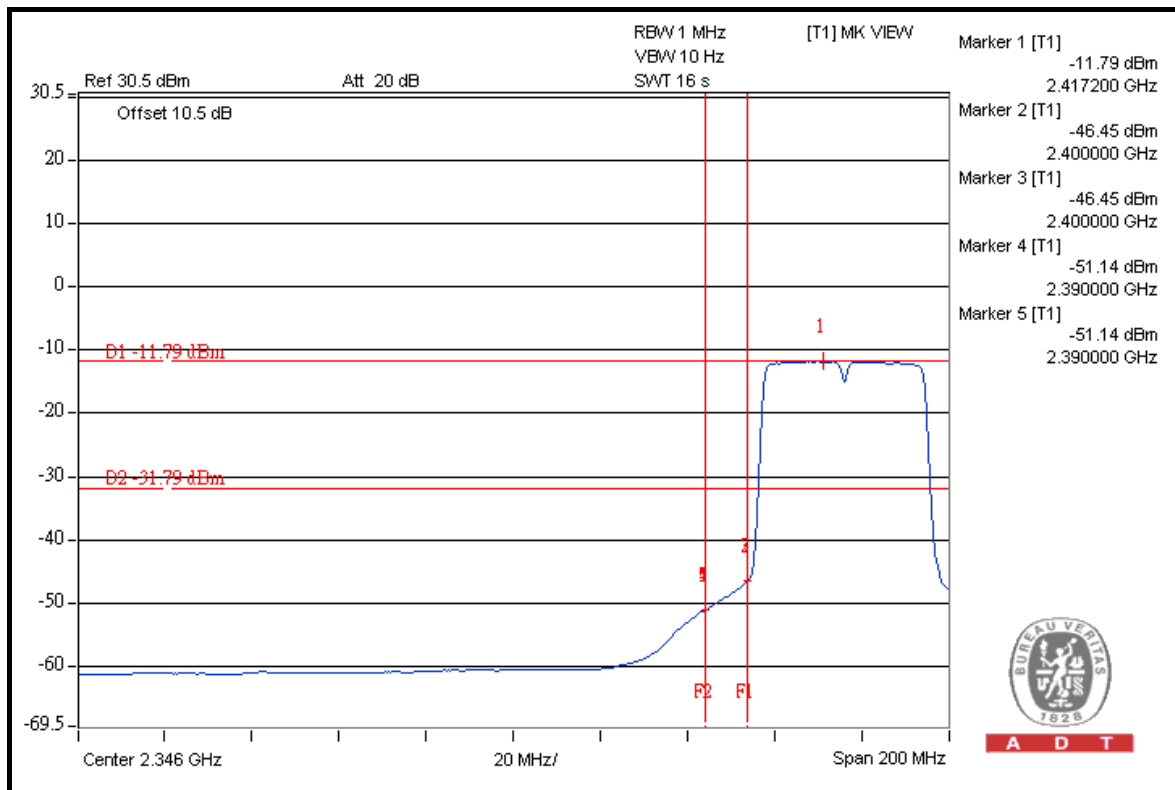
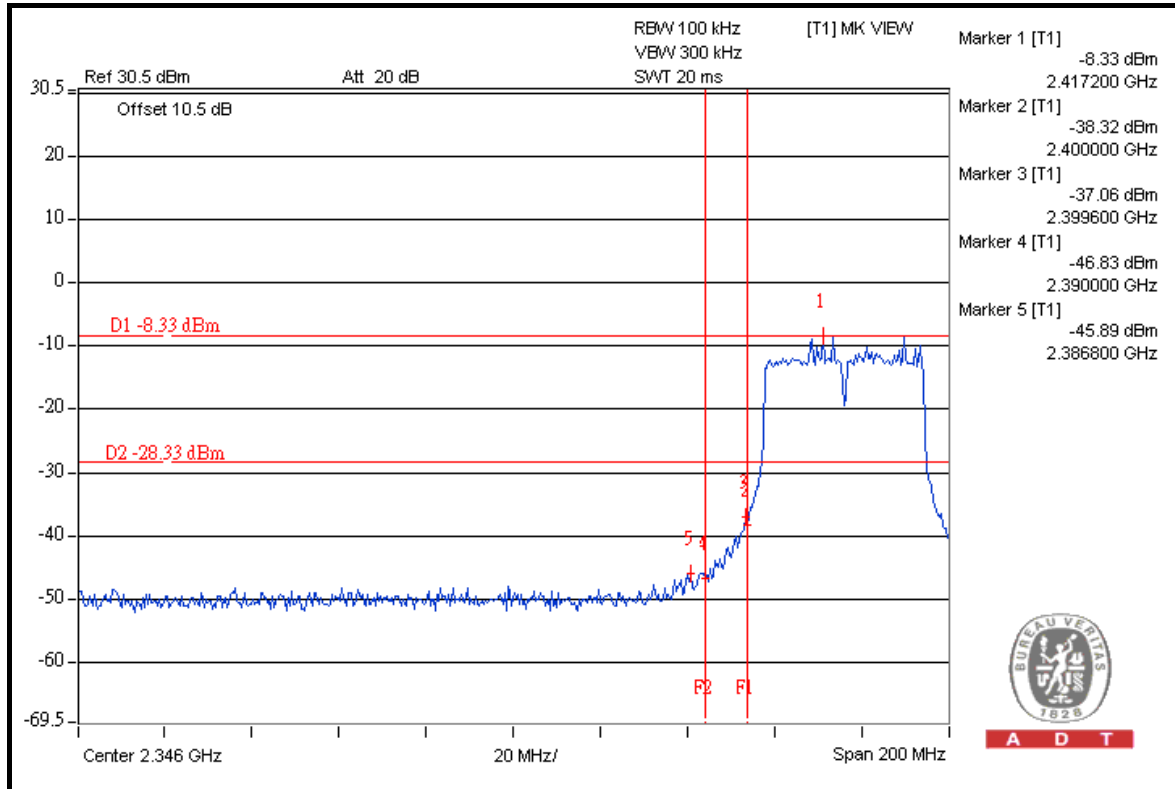



A D T

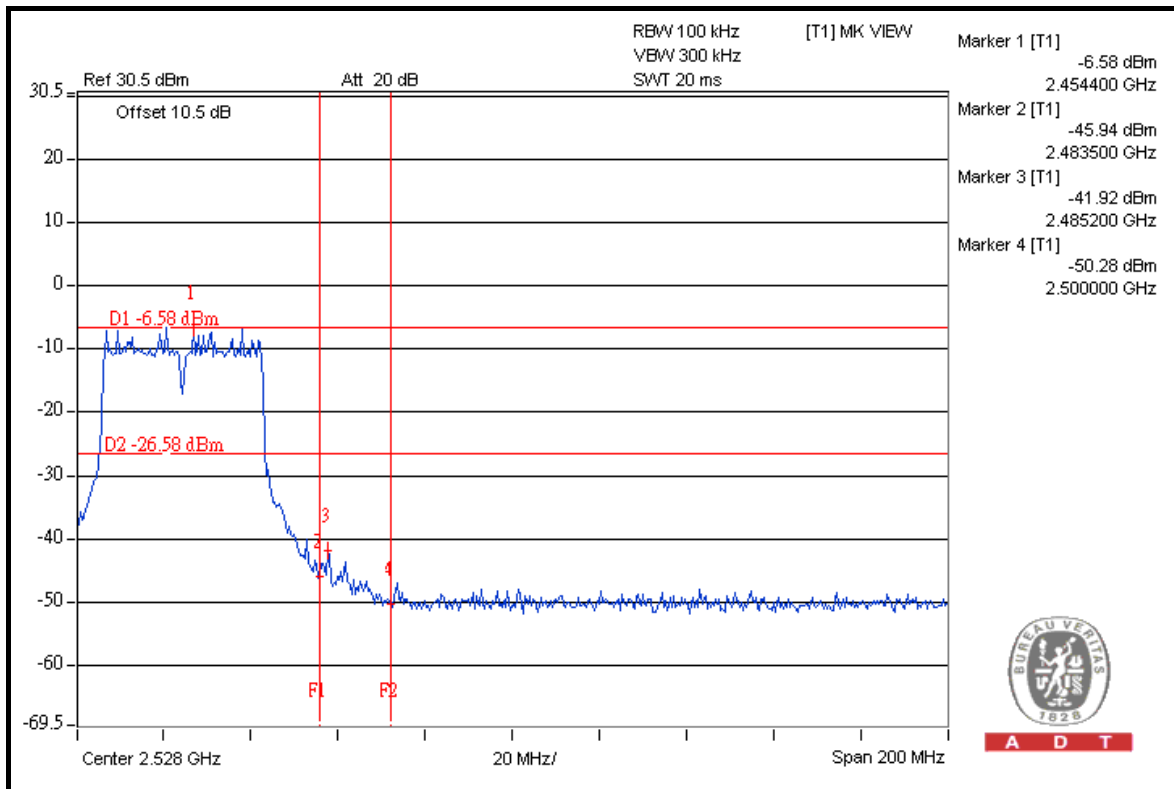
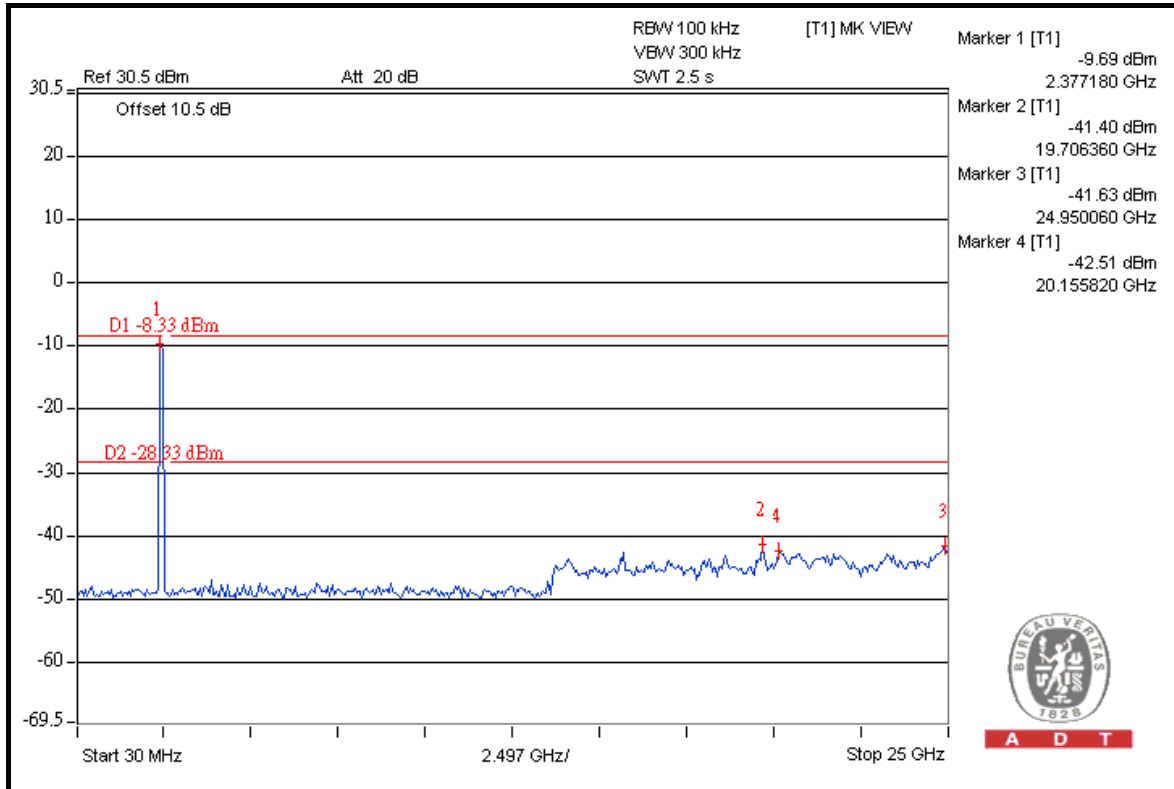



A D T

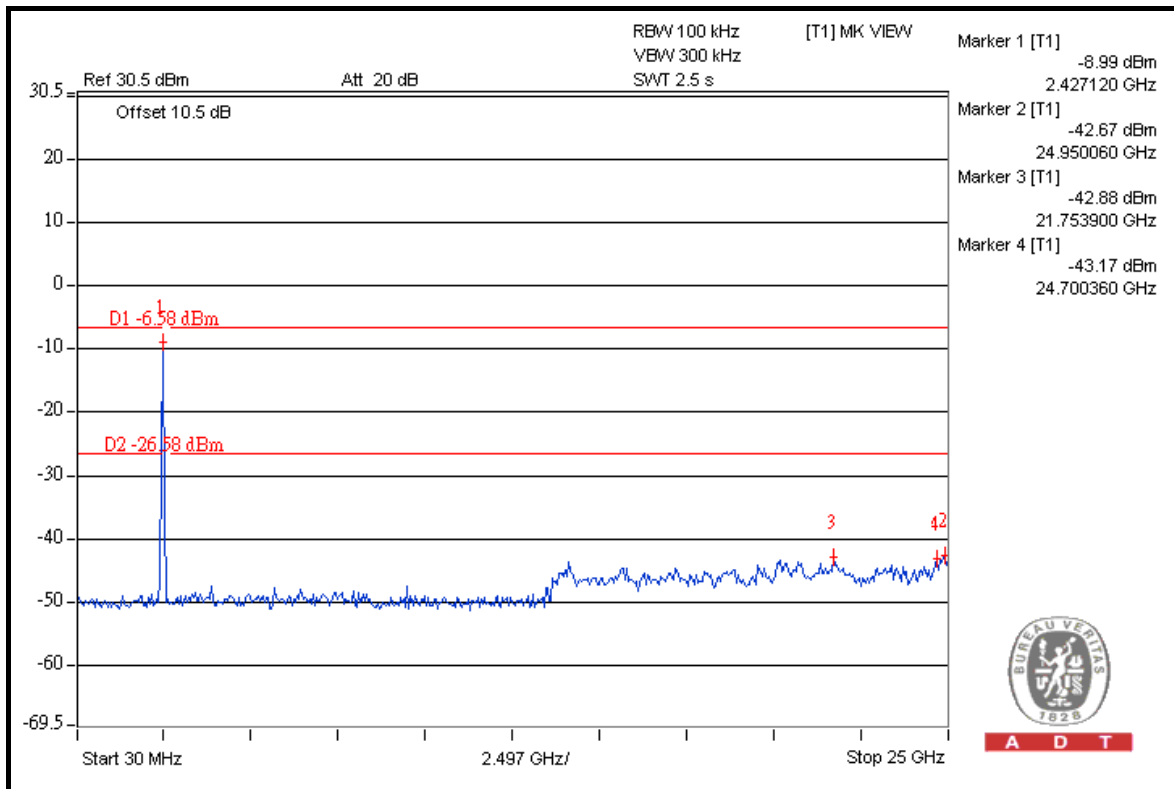
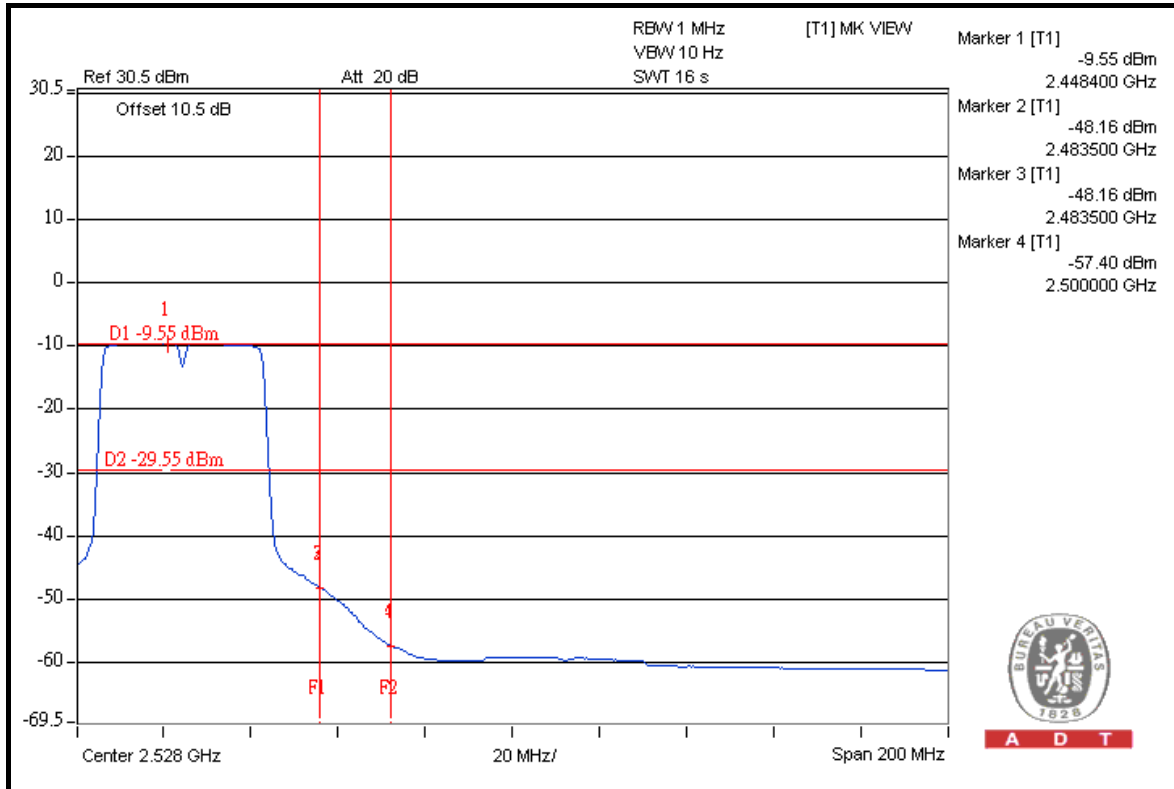



A D T

CHAIN 1

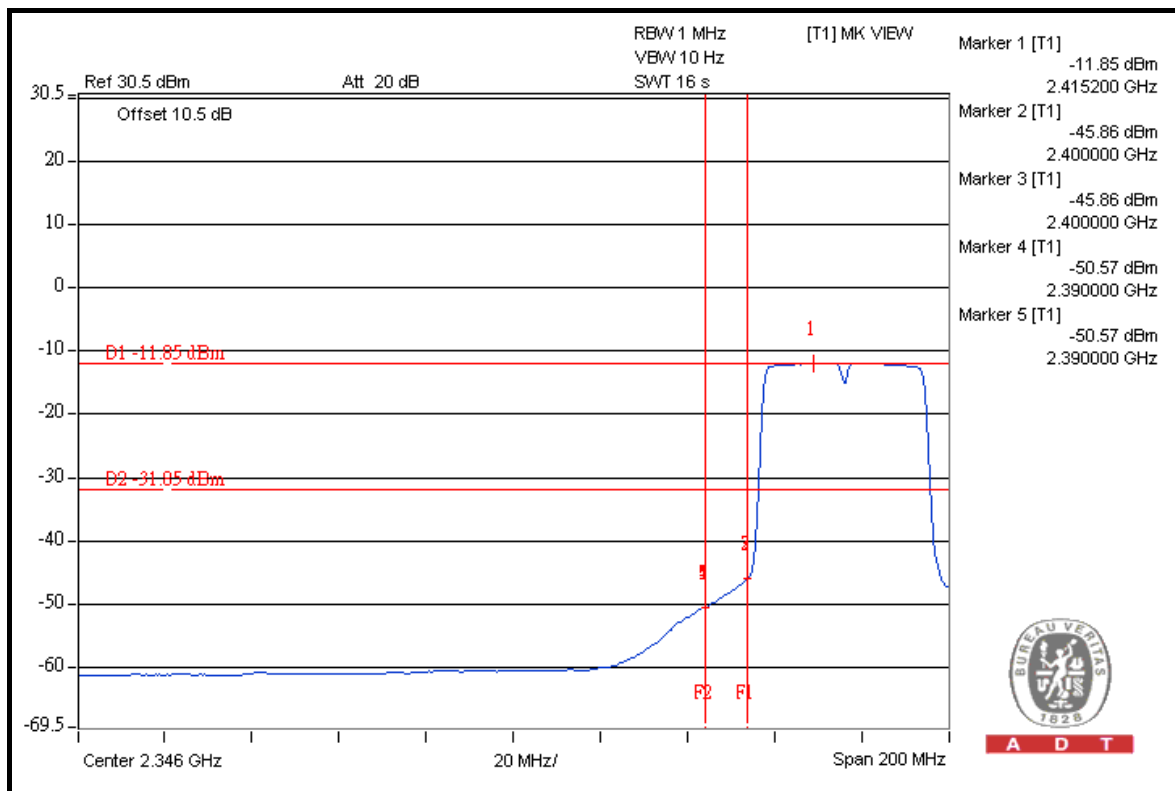
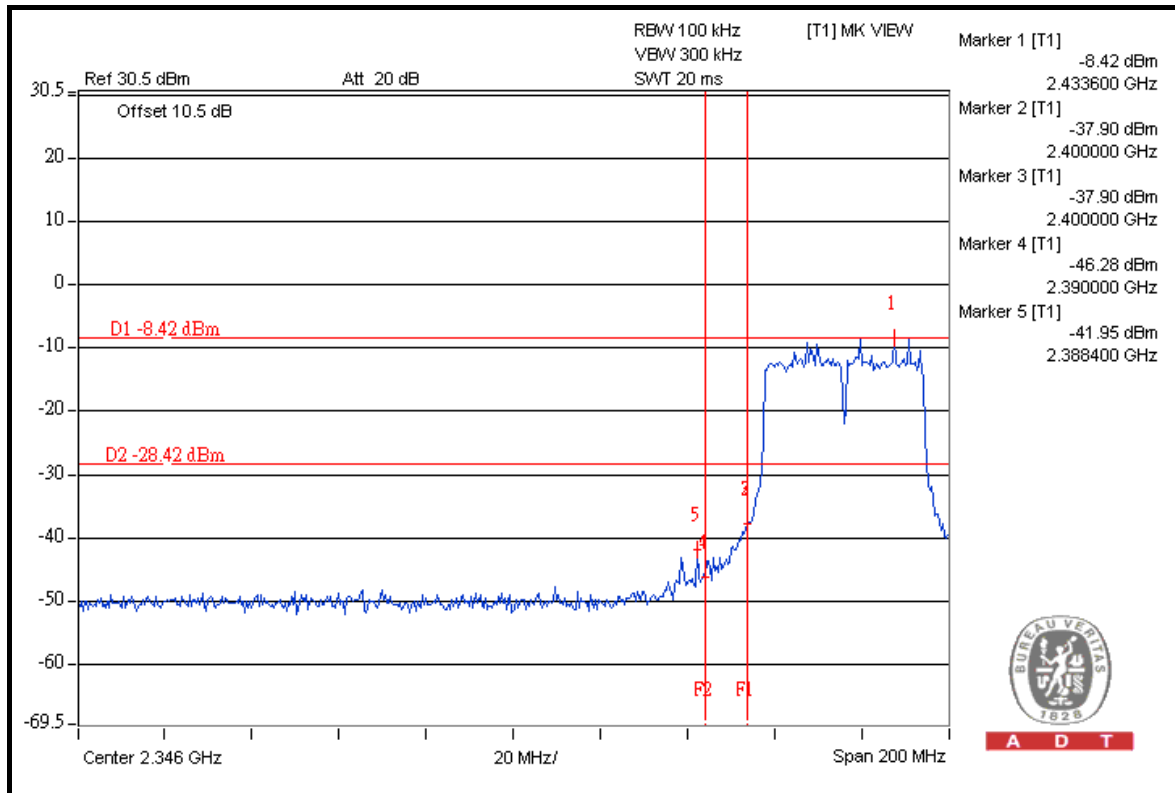



A D T

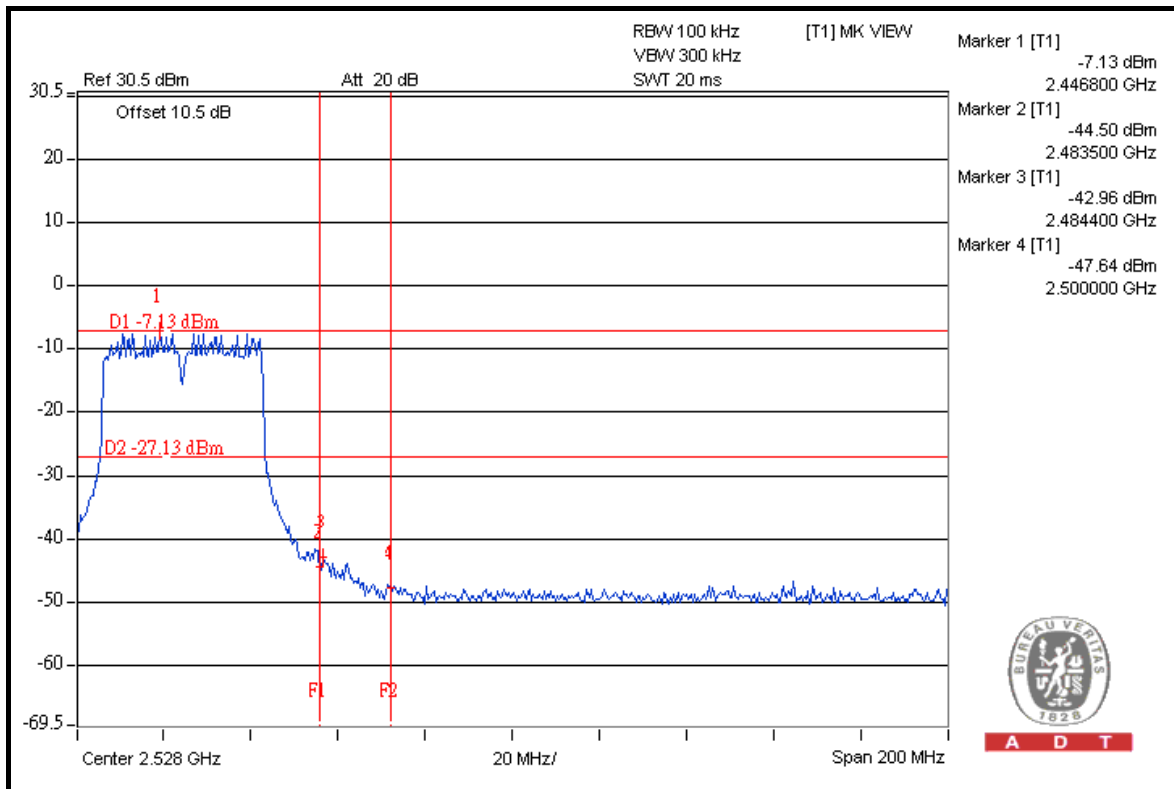
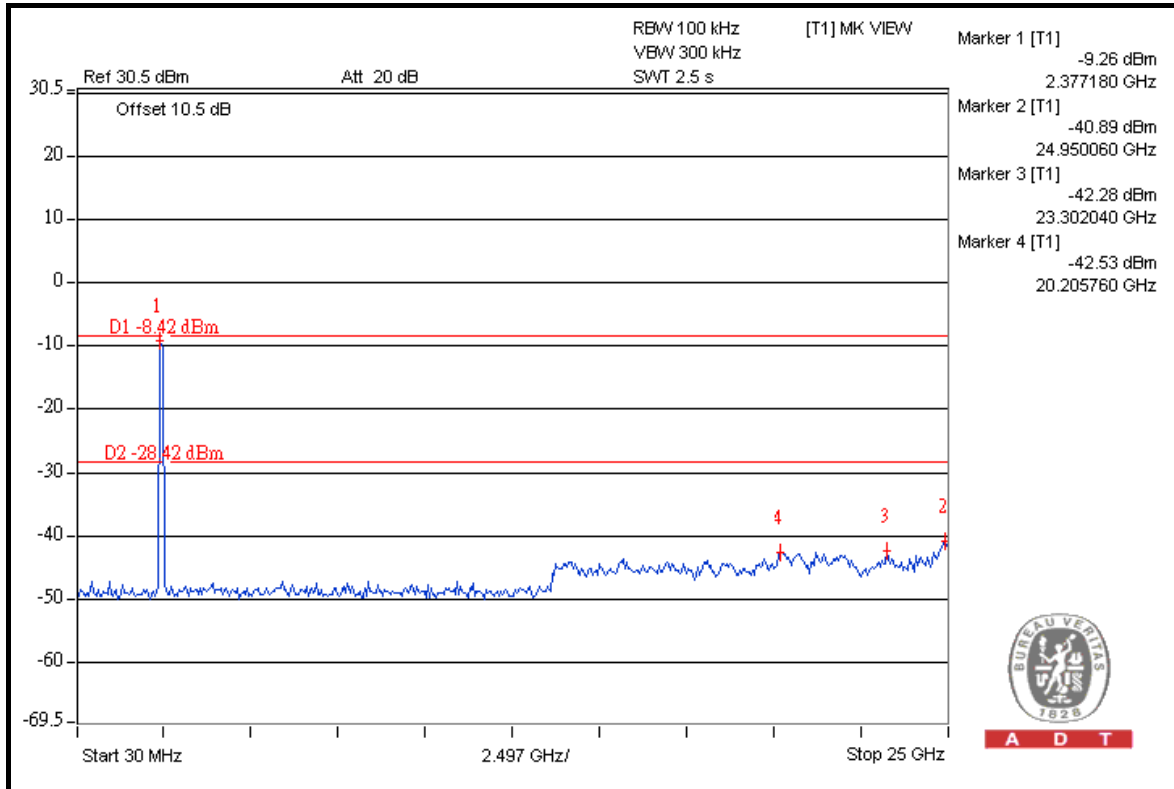



A D T

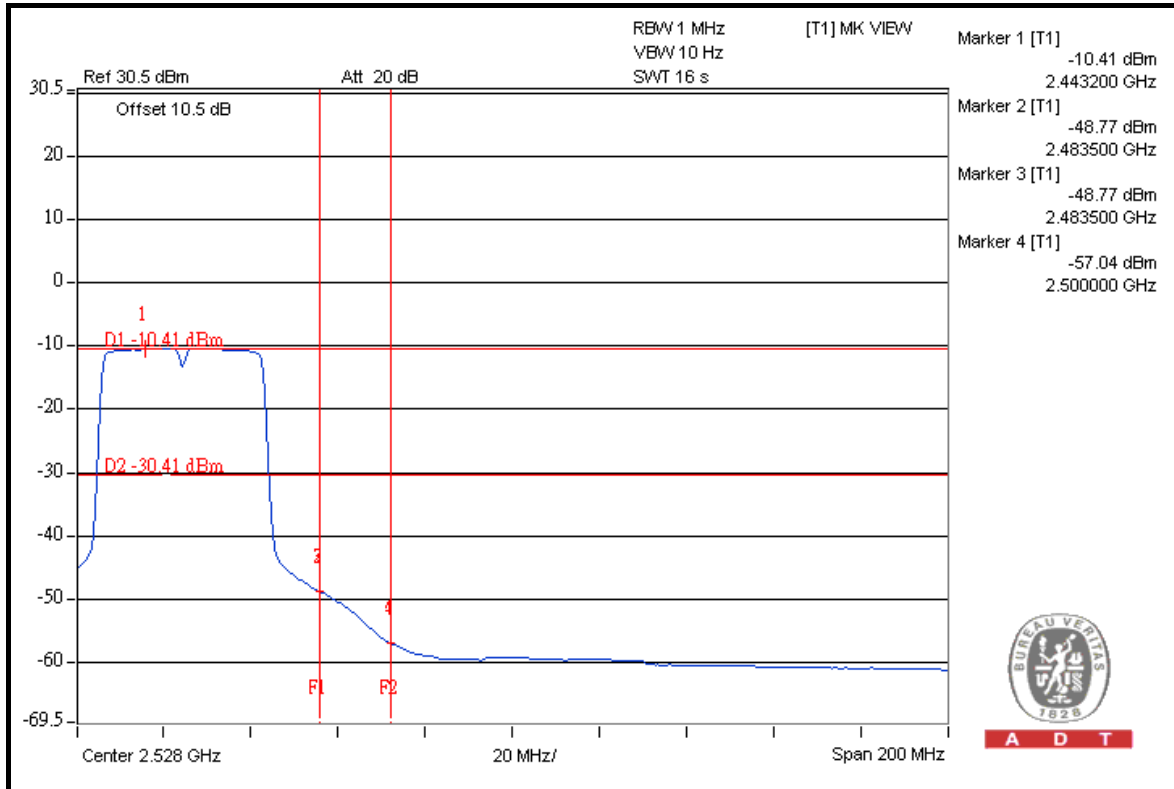

A D T

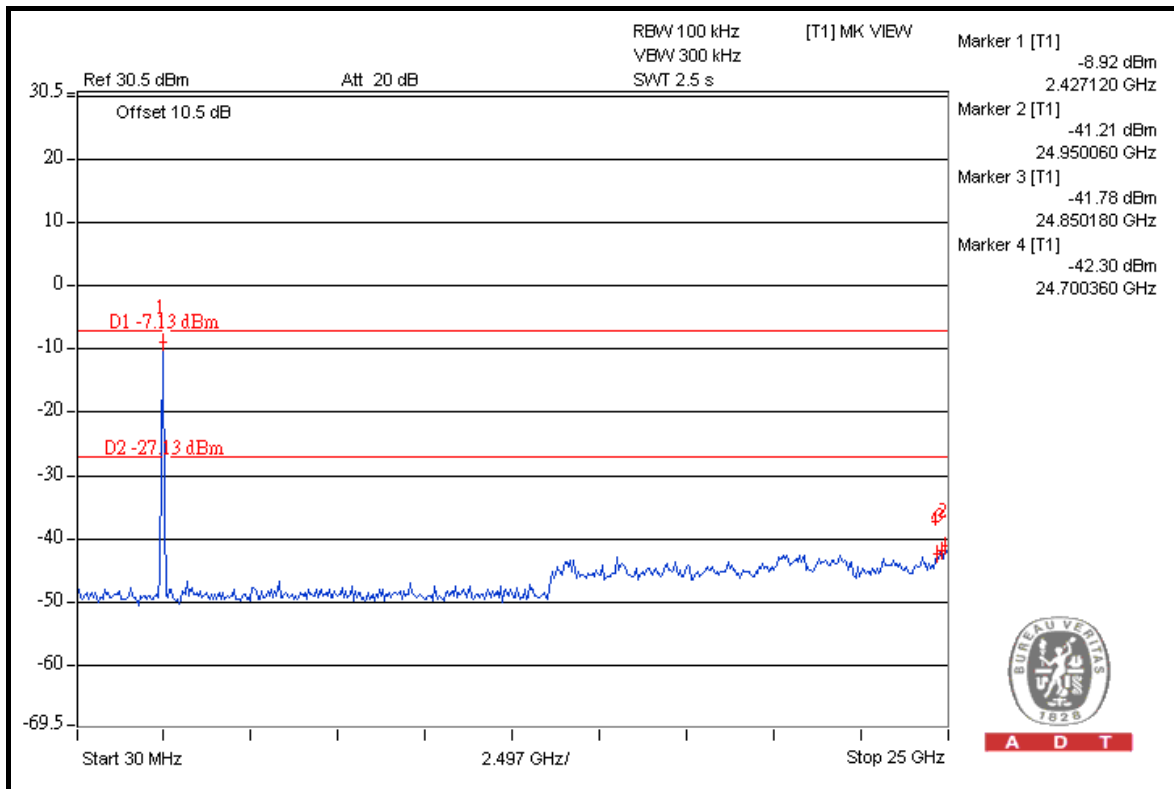

A D T



A D T

5. PHOTOGRAPHS OF THE TEST CONFIGURATION

Please refer to the attached file (Test Setup Photo).



A D T

6. INFORMATION ON THE TESTING LABORATORIES

We, Bureau Veritas Consumer Products Services (H.K.) Ltd., Taoyuan Branch, were founded in 1988 to provide our best service in EMC, Radio, Telecom and Safety consultation. Our laboratories are accredited and approved according to ISO/IEC 17025.

Copies of accreditation certificates of our laboratories obtained from approval agencies can be downloaded from our web site: www.adt.com.tw/index.5/phtml. If you have any comments, please feel free to contact us at the following:

Linko EMC/RF Lab:

Tel: 886-2-26052180

Fax: 886-2-26051924

Hsin Chu EMC/RF Lab:

Tel: 886-3-5935343

Fax: 886-3-5935342

Hwa Ya EMC/RF/Safety Telecom Lab:

Tel: 886-3-3183232

Fax: 886-3-3185050

Email: service.adt@tw.bureauveritas.com

Web Site: www.adt.com.tw

The address and road map of all our labs can be found in our web site also.



A D T

7. APPENDIX A - MODIFICATIONS RECORDERS FOR ENGINEERING CHANGES TO THE EUT BY THE LAB

No any modifications are made to the EUT by the lab during the test.

---END---