



FCC TEST REPORT

REPORT NO.: RF121107E10

MODEL NO.: TL-WN751ND, TL-WN751N

FCC ID: TE7WN751NX

RECEIVED: Nov. 07, 2012

TESTED: Nov. 12 to Dec. 28, 2012

ISSUED: Jan. 08, 2013

APPLICANT: TP-LINK TECHNOLOGIES CO., LTD.

ADDRESS: Building 24 (floors 1,3,4,5) and 28 (floors1-4) Central Science and Technology Park,Shennan Rd, Nanshan, Shenzhen,China

ISSUED BY: Bureau Veritas Consumer Products Services (H.K.) Ltd., Taoyuan Branch Hsin Chu Laboratory

LAB ADDRESS : No. 81-1, Lu Liao Keng, 9th Ling, Wu Lung Tsuen, Chiung Lin Hsiang, Hsin Chu Hsien 307, Taiwan, R.O.C.

TEST LOCATION (1): No. 81-1, Lu Liao Keng, 9th Ling, Wu Lung Tsuen, Chiung Lin Hsiang, Hsin Chu Hsien 307, Taiwan, R.O.C.

TEST LOCATION (2): No. 49, Ln. 206, Wende Rd., Shangshan Tsuen, Chiung Lin Hsiang, Hsin Chu Hsien 307, Taiwan, R.O.C.

This report should not be used by the client to claim product certification, approval, or endorsement by TAF or any government agencies.



This report is for your exclusive use. Any copying or replication of this report to or for any other person or entity, or use of our name or trademark, is permitted only with our prior written permission. This report sets forth our findings solely with respect to the test samples identified herein. The results set forth in this report are not indicative or representative of the quality or characteristics of the lot from which a test sample was taken or any similar or identical product unless specifically and expressly noted. Our report includes all of the tests requested by you and the results thereof based upon the information that you provided to us. You have 60 days from date of issuance of this report to notify us of any material error or omission caused by our negligence, provided, however, that such notice shall be in writing and shall specifically address the issue you wish to raise. A failure to raise such issue within the prescribed time shall constitute your unqualified acceptance of the completeness of this report, the tests conducted and the correctness of the report contents. Unless specific mention, the uncertainty of measurement has been explicitly taken into account to declare the compliance or non-compliance to the specification



A D T

Table of Contents

RELEASE CONTROL RECORD	4
1. CERTIFICATION	5
2. SUMMARY OF TEST RESULTS	6
2.1 MEASUREMENT UNCERTAINTY	7
3. GENERAL INFORMATION	8
3.1 GENERAL DESCRIPTION OF EUT	8
3.2 DESCRIPTION OF TEST MODES	10
3.2.1 TEST MODE APPLICABILITY AND TESTED CHANNEL DETAIL	11
3.3 GENERAL DESCRIPTION OF APPLIED STANDARDS	14
3.4 DESCRIPTION OF SUPPORT UNITS.....	15
3.5 CONFIGURATION OF SYSTEM UNDER TEST	17
4. TEST TYPES AND RESULTS	18
4.1 CONDUCTED EMISSION MEASUREMENT	18
4.1.1 LIMITS OF CONDUCTED EMISSION MEASUREMENT	18
4.1.2 TEST INSTRUMENTS.....	18
4.1.3 TEST PROCEDURES	19
4.1.4 DEVIATION FROM TEST STANDARD	19
4.1.5 TEST SETUP	20
4.1.6 EUT OPERATING CONDITIONS	20
4.1.7 TEST RESULTS	21
4.2 RADIATED EMISSION AND BANDEDGE MEASUREMENT	23
4.2.1 LIMITS OF RADIATED EMISSION AND BANDEDGE MEASUREMENT	23
4.2.2 TEST INSTRUMENTS.....	24
4.2.3 TEST PROCEDURES	26
4.2.4 DEVIATION FROM TEST STANDARD	26
4.2.5 TEST SETUP	27
4.2.6 EUT OPERATING CONDITIONS	27
4.2.7 TEST RESULTS	28
4.3 6dB BANDWIDTH MEASUREMENT	41
4.3.1 LIMITS OF 6dB BANDWIDTH MEASUREMENT	41
4.3.2 TEST INSTRUMENTS.....	41
4.3.3 TEST PROCEDURE.....	41
4.3.4 DEVIATION FROM TEST STANDARD	41
4.3.5 TEST SETUP	42
4.3.6 EUT OPERATING CONDITIONS	42
4.3.7 TEST RESULTS	43
4.4 CONDUCTED OUTPUT POWER MEASUREMENT	44
4.4.1 LIMITS OF CONDUCTED OUTPUT POWER MEASUREMENT	44
4.4.2 INSTRUMENTS.....	44
4.4.3 TEST PROCEDURES	44



A D T

4.4.4	DEVIATION FROM TEST STANDARD	44
4.4.5	TEST SETUP	45
4.4.6	EUT OPERATING CONDITIONS	45
4.4.7	TEST RESULTS	46
4.5	POWER SPECTRAL DENSITY MEASUREMENT	47
4.5.1	LIMITS OF POWER SPECTRAL DENSITY MEASUREMENT	47
4.5.2	TEST INSTRUMENTS.....	47
4.5.3	TEST PROCEDURE.....	47
4.5.4	DEVIATION FROM TEST STANDARD	47
4.5.5	TEST SETUP	47
4.5.6	EUT OPERATING CONDITION.....	47
4.5.7	TEST RESULTS	48
4.6	CONDUCTED OUT-BAND EMISSION MEASUREMENT	49
4.6.1	LIMITS OF CONDUCTED OUT-BAND EMISSION MEASUREMENT.....	49
4.6.2	TEST INSTRUMENTS.....	49
4.6.3	TEST PROCEDURE.....	49
4.6.4	DEVIATION FROM TEST STANDARD	50
4.6.5	TEST SETUP	50
4.6.6	EUT OPERATING CONDITION.....	50
4.6.7	TEST RESULTS	50
5.	PHOTOGRAPHS OF THE TEST CONFIGURATION.....	55
6.	INFORMATION ON THE TESTING LABORATORIES	56
7.	APPENDIX A - MODIFICATIONS RECORDERS FOR ENGINEERING CHANGES TO THE EUT BY THE LAB	57



A D T

RELEASE CONTROL RECORD

ISSUE NO.	REASON FOR CHANGE	DATE ISSUED
RF121107E10	Original release	Jan. 08, 2013



A D T

1. CERTIFICATION

PRODUCT: 150Mbps Wireless N PCI Adapter
BRAND NAME: TP-LINK
MODEL NO.: TL-WN751ND, TL-WN751N
TEST SAMPLE: PROTOTYPE
APPLICANT: TP-LINK TECHNOLOGIES CO., LTD.
TESTED: Nov. 12 to Dec. 28, 2012
STANDARDS: FCC Part 15, Subpart C (Section 15.247)
ANSI C63.10-2009

The above equipment (Model: TL-WN751ND) has been tested by **Bureau Veritas Consumer Products Services (H.K.) Ltd., Taoyuan Branch**, and found compliance with the requirement of the above standards. The test record, data evaluation & Equipment Under Test (EUT) configurations represented herein are true and accurate accounts of the measurements of the sample's EMC characteristics under the conditions specified in this report.

PREPARED BY : Phoenix Huang , **DATE:** Jan. 08, 2013
(Phoenix Huang, Specialist)

APPROVED BY : May Chen , **DATE:** Jan. 08, 2013
(May Chen, Deputy Manager)



A D T

2. SUMMARY OF TEST RESULTS

The EUT has been tested according to the following specifications:

APPLIED STANDARD: FCC PART 15, SUBPART C (SECTION 15.247)			
STANDARD SECTION	TEST TYPE	RESULT	REMARK
15.207	AC Power Conducted Emission	PASS	Meet the requirement of limit. Minimum passing margin is -13.36dB at 16.68359MHz.
15.247(d) 15.209	Radiated Emissions	PASS	Meet the requirement of limit. Minimum passing margin is -0.9dB at 2390.00MHz
15.247(d)	Band Edge Measurement	PASS	Meet the requirement of limit.
15.247(a)(2)	6dB bandwidth	PASS	Meet the requirement of limit.
15.247(b)	Conducted power	PASS	Meet the requirement of limit.
15.247(e)	Power Spectral Density	PASS	Meet the requirement of limit.
15.203	Antenna Requirement	PASS	Antenna connector is RP-SMA not a standard connector.



A D T

2.1 MEASUREMENT UNCERTAINTY

Where relevant, the following measurement uncertainty levels have been estimated for tests performed on the EUT as specified in CISPR 16-4-2:

This uncertainty represents an expanded uncertainty expressed at approximately the 95% confidence level using a coverage factor of $k=2$.

Measurement	Value
Conducted emissions	2.98 dB
Radiated emissions (30MHz-1GHz)	5.59 dB
Radiated emissions (1GHz -6GHz)	3.56 dB
Radiated emissions (6GHz -18GHz)	4.10 dB
Radiated emissions (18GHz -40GHz)	4.24 dB



A D T

3. GENERAL INFORMATION

3.1 GENERAL DESCRIPTION OF EUT

PRODUCT	150Mbps Wireless N PCI Adapter
MODEL NO.	TL-WN751ND, TL-WN751N
POWER SUPPLY	DC 3.3V from host equipment
MODULATION TYPE	CCK, DQPSK, DBPSK for DSSS 64QAM, 16QAM, QPSK, BPSK for OFDM
MODULATION TECHNOLOGY	DSSS, OFDM
TRANSFER RATE	802.11b: up to 11Mbps 802.11g: up to 54Mbps 802.11n: up to 150Mbps
OPERATING FREQUENCY	2.412 ~ 2.462GHz
NUMBER OF CHANNEL	11 for 802.11b, 802.11g, 802.11n (HT20) 7 for 802.11n (HT40)
MAXIMUM OUTPUT POWER	802.11b: 64.565mW 802.11g: 89.125mW 802.11n (HT20): 110.917mW 802.11n (HT40): 72.444mW
ANTENNA TYPE	Please see NOTE
DATA CABLE	NA
I/O PORTS	Refer to user's manual
ASSOCIATED DEVICES	NA

NOTE:

1. The EUT has below model names, which are identical to each other in all aspects except for the following table:

Product name	Model No.	Difference
150Mbps Wireless N PCI Adapter	TL-WN751ND	dipole antenna (dedicated)
	TL-WN751N	dipole antenna (Integral)

From the above model names, the radiated emission worst case was found in Model No. **TL-WN751ND**. Therefore only the test data of the mode was recorded in this report.



A D T

2. The antennas provided to the EUT, please refer to the following table:

For model : TL-WN751ND used							
Brand	Model	Antenna Type	Antenna Gain (dBi) Without cable loss	Antenna cable loss(dB)	Antenna Net Gain (dBi)	Cable Length (cm)	Connector
WHA YU INDUSTRIAL CO.,LTD	SSR-00193-01	dipole	1.8	NA	1.8	NA	RP-SMA
For model : TL-WN751N used							
Brand	Model	Antenna Type	Antenna Gain (dBi) Without cable loss	Antenna cable loss(dB)	Antenna Net Gain (dBi)	Cable Length (cm)	Connector
TP-LINK	AN2400-55A23BO	dipole	2.0	0.2	1.8	3.2	NA

3. The EUT is 1 * 1 SISO without 802.11n beam forming function.

MODULATION MODE	Tx/Rx FUNCTION
802.11b	1Tx/1Rx
802.11g	1Tx/1Rx
802.11n (HT20)	1Tx/1Rx
802.11n (HT40)	1Tx/1Rx

- When the EUT operating in 802.11n, the software operation, which is defined by manufacturer, MCS (Modulation and Coding Schemes) from 0 to 7.
- The above EUT information was declared by the manufacturer and for more detailed features description, please refer to the manufacturer's specifications or User's Manual.

3.2 DESCRIPTION OF TEST MODES

Operated in 2400 ~ 2483.5MHz band:

11 channels are provided for 802.11b, 802.11g, 802.11n (HT20):

CHANNEL	FREQUENCY	CHANNEL	FREQUENCY
1	2412MHz	7	2442MHz
2	2417MHz	8	2447MHz
3	2422MHz	9	2452MHz
4	2427MHz	10	2457MHz
5	2432MHz	11	2462MHz
6	2437MHz		

7 channels are provided for 802.11n (HT40):

CHANNEL	FREQUENCY	CHANNEL	FREQUENCY
3	2422MHz	7	2442MHz
4	2427MHz	8	2447MHz
5	2432MHz	9	2452MHz
6	2437MHz		



A D T

3.2.1 TEST MODE APPLICABILITY AND TESTED CHANNEL DETAIL

EUT CONFIGURE MODE	APPLICABLE TO					DESCRIPTION
	PLC	RE < 1G	RE ≥ 1G	APCM	OB	
1	√	√	√	√	√	-

Where **PLC**: Power Line Conducted Emission

RE < 1G: Radiated Emission below 1GHz

RE ≥ 1G: Radiated Emission above 1GHz

APCM: Antenna Port Conducted Measurement

OB: Conducted Out-Band Emission Measurement

NOTE: "-" means no effect.

POWER LINE CONDUCTED EMISSION TEST:

- Pre-Scan has been conducted to determine the worst-case mode from all possible combinations between available modulations, data rates and antenna ports (if EUT with antenna diversity architecture).
- Following channel(s) was (were) selected for the final test as listed below.

MODE	AVAILABLE CHANNEL	TESTED CHANNEL	MODULATION TECHNOLOGY	MODULATION TYPE	DATA RATE (Mbps)
802.11n (HT20)	1 to 11	6	OFDM	BPSK	6.5

RADIATED EMISSION TEST (BELOW 1 GHz):

- Pre-Scan has been conducted to determine the worst-case mode from all possible combinations between available modulations, data rates and antenna ports (if EUT with antenna diversity architecture).
- Following channel(s) was (were) selected for the final test as listed below.

MODE	AVAILABLE CHANNEL	TESTED CHANNEL	MODULATION TECHNOLOGY	MODULATION TYPE	DATA RATE (Mbps)
802.11n (HT20)	1 to 11	6	OFDM	BPSK	6.5

RADIATED EMISSION TEST (ABOVE 1 GHz):

- Pre-Scan has been conducted to determine the worst-case mode from all possible combinations between available modulations, data rates and antenna ports (if EUT with antenna diversity architecture).
- Following channel(s) was (were) selected for the final test as listed below.

MODE	AVAILABLE CHANNEL	TESTED CHANNEL	MODULATION TECHNOLOGY	MODULATION TYPE	DATA RATE (Mbps)
802.11b	1 to 11	1, 6, 11	DSSS	DBPSK	1
802.11g	1 to 11	1, 6, 11	OFDM	BPSK	6
802.11n (HT20)	1 to 11	1, 6, 11	OFDM	BPSK	6.5
802.11n (HT40)	3 to 9	3, 6, 9	OFDM	BPSK	13.5

ANTENNA PORT CONDUCTED MEASUREMENT:

- Pre-Scan has been conducted to determine the worst-case mode from all possible combinations between available modulations, data rates and antenna ports (if EUT with antenna diversity architecture).
- Following channel(s) was (were) selected for the final test as listed below.

MODE	AVAILABLE CHANNEL	TESTED CHANNEL	MODULATION TECHNOLOGY	MODULATION TYPE	DATA RATE (Mbps)
802.11b	1 to 11	1, 6, 11	DSSS	DBPSK	1
802.11g	1 to 11	1, 6, 11	OFDM	BPSK	6
802.11n (HT20)	1 to 11	1, 6, 11	OFDM	BPSK	6.5
802.11n (HT40)	3 to 9	3, 6, 9	OFDM	BPSK	13.5

CONDUCTED OUT-BAND EMISSION MEASUREMENT:

- Pre-Scan has been conducted to determine the worst-case mode from all possible combinations between available modulations, data rates and antenna ports (if EUT with antenna diversity architecture).
- Following channel(s) was (were) selected for the final test as listed below.

MODE	AVAILABLE CHANNEL	TESTED CHANNEL	MODULATION TECHNOLOGY	MODULATION TYPE	DATA RATE (Mbps)
802.11b	1 to 11	1, 6, 11	DSSS	DBPSK	1
802.11g	1 to 11	1, 6, 11	OFDM	BPSK	6
For 2.4 GHz 802.11n (HT20)	1 to 11	1, 6, 11	OFDM	BPSK	6.5
For 2.4 GHz 802.11n (HT40)	3 to 9	3, 6, 9	OFDM	BPSK	13.5



A D T

TEST CONDITION:

APPLICABLE TO	ENVIRONMENTAL CONDITIONS	INPUT POWER	TESTED BY
PLC	24deg. C, 68%RH	120Vac, 60Hz	Bear Lee
RE<1G	22deg. C, 74%RH	120Vac, 60Hz	Amos Chuang
RE ³ 1G	23deg. C, 71%RH	120Vac, 60Hz	Amos Chuang
APCM	25deg. C, 60%RH	120Vac, 60Hz	James Chan
OB	25deg. C, 60%RH	120Vac, 60Hz	James Chan

3.3 GENERAL DESCRIPTION OF APPLIED STANDARDS

The EUT is a RF product. According to the specifications of the manufacturer, it must comply with the requirements of the following standards:

FCC Part 15, Subpart C (15.247)
558074 D01 DTS Meas Guidance
662911 D01 Multiple Transmitter Output
ANSI C63.10-2009

All test items have been performed and recorded as per the above standards.

NOTE: The EUT is also considered as a kind of computer peripheral, because the connection to computer is necessary for typical use. It has been verified to comply with the requirements of FCC Part 15, Subpart B, Class B (DoC). The test report has been issued separately.



A D T

3.4 DESCRIPTION OF SUPPORT UNITS

The EUT has been tested as an independent unit together with other necessary accessories or support units. The following support units or accessories were used to form a representative test configuration during the tests.

For Conducted test					
NO.	PRODUCT	BRAND	MODEL NO.	SERIAL NO.	FCC ID
1	PERSONAL COMPUTER	DELL	DCSM	294QL1S	FCC DoC
2	MONITOR	DELL	U2410F	CNOJ257M72872 9AG159L	FCC DoC
3	PRINTER	EPSON	LQ-300+II	G88Y074083	FCC DoC
4	MODEM	ACEEX	1414	0206026778	IFAXDM1414
5	KEYBOARD	DELL	SK-8115	MY-0DJ325-7161 9-99B-0476	FCC DoC
6	MOUSE	DELL	MOC5UO	I1401LVG	FCC DoC
For Other test items					
NO.	PRODUCT	BRAND	MODEL NO.	SERIAL NO.	FCC ID
1	PERSONAL COMPUTER	DELL	DCNE	HRJB32S	FCC DoC
2	MONITOR	HANNS	HSG1061	935MW3JY0055 6	NA
3	PRINTER	EPSON	LQ-300+II	G88Y074015	FCC DoC
4	MODEM	ACEEX	1414	0206026779	IFAXDM1414
5	KEYBOARD	BTC	KB-5200T	F24800406	E5XKB5122WTH01 10
6	MOUSE	DELL	MOC5UO	I1406CUN	FCC DoC



A D T

For Conducted test	
NO.	SIGNAL CABLE DESCRIPTION OF THE ABOVE SUPPORT UNITS
1	NA
2	VGA cable (1.8m with two cores)
3	USB cable (1.8m)
4	RS232 cable (1.1m)
5	USB cable (1.8m with one core)
6	USB cable (1.8m)
For Other test items	
NO.	SIGNAL CABLE DESCRIPTION OF THE ABOVE SUPPORT UNITS
1	NA
2	VGA cable, shielded (1.8m with two cores)
3	LPT cable, shielded (1.8m)
4	RS232 cable, unshielded (1.2m)
5	USB cable (1.5m with one core)
6	USB cable (1.5m)

NOTE: All power cords of the above support units are non shielded (1.8m).

3.5 CONFIGURATION OF SYSTEM UNDER TEST

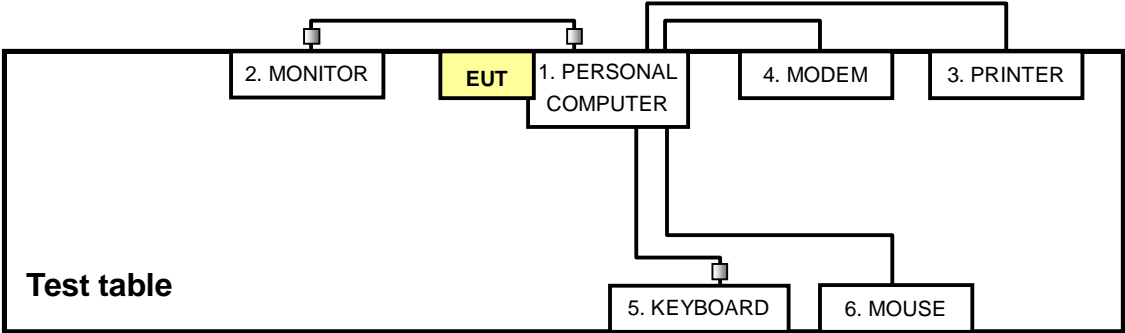



A D T

4. TEST TYPES AND RESULTS

4.1 CONDUCTED EMISSION MEASUREMENT

4.1.1 LIMITS OF CONDUCTED EMISSION MEASUREMENT

FREQUENCY OF EMISSION (MHz)	CONDUCTED LIMIT (dB μ V)	
	Quasi-peak	Average
0.15-0.5	66 to 56	56 to 46
0.5-5	56	46
5-30	60	50

- NOTE:**
1. The lower limit shall apply at the transition frequencies.
 2. The limit decreases in line with the logarithm of the frequency in the range of 0.15 to 0.50 MHz.

4.1.2 TEST INSTRUMENTS

DESCRIPTION & MANUFACTURER	MODEL NO.	SERIAL NO.	CALIBRATED DATE	CALIBRATED UNTIL
Test Receiver ROHDE & SCHWARZ	ESCS 30	100287	Feb. 29, 2012	Feb. 28, 2013
Line-Impedance Stabilization Network (for EUT) SCHWARZBECK	NSLK 8127	8127-523	Sep. 19, 2012	Sep. 20, 2013
Line-Impedance Stabilization Network (for Peripheral) ROHDE & SCHWARZ	ESH3-Z5	848773/004	Oct. 29, 2012	Oct. 28, 2013
RF Cable (JYEBAO)	5DFB	COACAB-002	Aug. 05, 2012	Aug. 04, 2013
50 ohms Terminator	50	3	Oct. 23, 2012	Oct. 22, 2013
Software ADT	BV ADT_Cond_V7.3.7 .3	NA	NA	NA

Note:

1. The calibration interval of the above test instruments is 12 months and the calibrations are traceable to NML/ROC and NIST/USA.
2. The test was performed in Shielded Room No. A.
3. The VCCI Con A Registration No. is C-817.
4. Tested Date: Nov. 12, 2012

4.1.3 TEST PROCEDURES

- a. The EUT was placed 0.4 meters from the conducting wall of the shielded room with EUT being connected to the power mains through a line impedance stabilization network (LISN). Other support units were connected to the power mains through another LISN.
- b. The two LISNs provide 50 ohm/ 50uH of coupling impedance for the measuring instrument.
- c. Both lines of the power mains connected to the EUT were checked for maximum conducted interference.
- d. The frequency range from 150kHz to 30MHz was searched. Emission levels under (Limit – 20dB) were not recorded.

NOTE:

1. The resolution bandwidth of test receiver is 9kHz for Quasi-peak detection (QP) & Average detection (AV).

4.1.4 DEVIATION FROM TEST STANDARD

No deviation

4.1.5 TEST SETUP

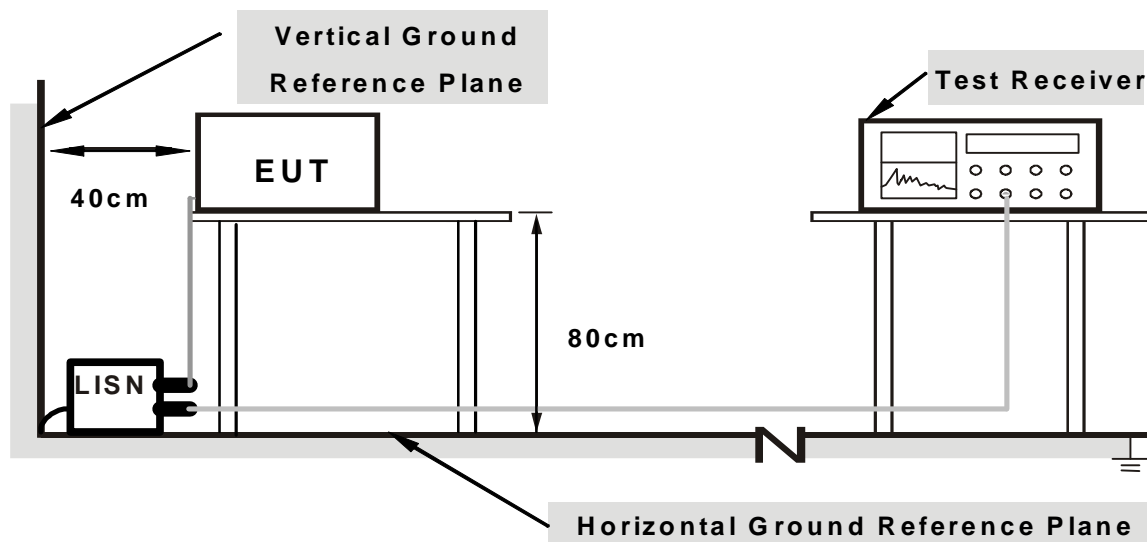

Note: 1.Support units were connected to second LISN.

For the actual test configuration, please refer to the related item – Photographs of the Test Configuration.

4.1.6 EUT OPERATING CONDITIONS

1. Turn on the power of all equipment.
2. The communication partner run test program “Art 0.9 Build #27.exe” to enable EUT under transmission/receiving condition continuously at specific channel frequency.



A D T

4.1.7 TEST RESULTS

PHASE	Line (L)	DETECTOR FUNCTION	Quasi-Peak (QP) / Average (AV)
--------------	----------	--------------------------	--------------------------------

No	Freq. [MHz]	Corr. Factor (dB)	Reading Value [dB (uV)]		Emission Level [dB (uV)]		Limit [dB (uV)]		Margin (dB)	
			Q.P.	AV.	Q.P.	AV.	Q.P.	AV.	Q.P.	AV.
	1	0.16172	0.09	41.15	40.52	41.24	40.61	65.38	55.38	-24.14
2	0.19687	0.10	37.64	36.76	37.74	36.86	63.74	53.74	-26.00	-16.88
3	0.78281	0.17	23.15	21.89	23.32	22.06	56.00	46.00	-32.68	-23.94
4	1.56250	0.22	29.11	28.88	29.33	29.10	56.00	46.00	-26.67	-16.90
5	9.26984	0.50	30.80	30.68	31.30	31.18	60.00	50.00	-28.70	-18.82
6	16.68359	0.66	38.74	35.98	39.40	36.64	60.00	50.00	-20.60	-13.36

REMARKS:

1. Q.P. and AV. are abbreviations of quasi-peak and average individually.
2. The emission levels of other frequencies were very low against the limit.
3. Margin value = Emission level - Limit value
4. Correction factor = Insertion loss + Cable loss
5. Emission Level = Correction Factor + Reading Value.

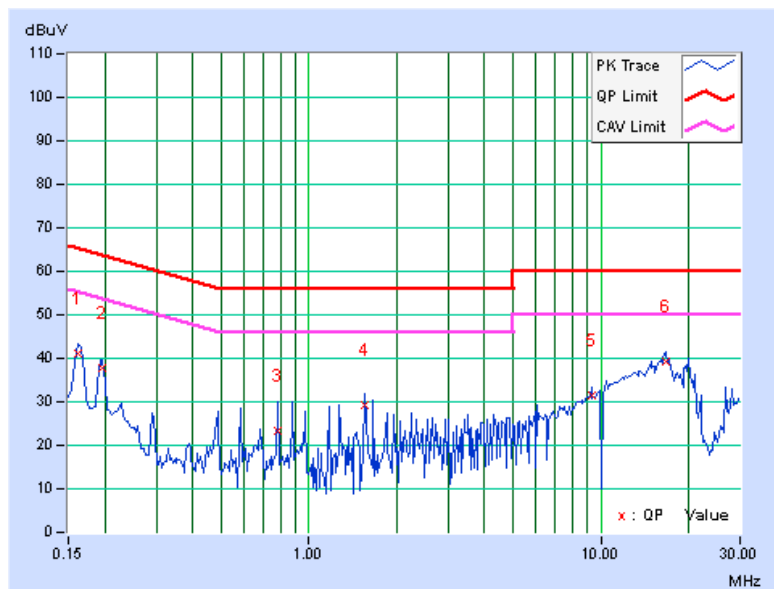

PHASE	Neutral (N)	DETECTOR FUNCTION	Quasi-Peak (QP) / Average (AV)
--------------	-------------	--------------------------	--------------------------------

No	Freq. [MHz]	Corr. Factor (dB)	Reading Value [dB (uV)]		Emission Level [dB (uV)]		Limit [dB (uV)]		Margin (dB)	
			Q.P.	AV.	Q.P.	AV.	Q.P.	AV.	Q.P.	AV.
	1	0.16172	0.10	40.64	40.22	40.74	40.32	65.38	55.38	-24.64
2	0.19687	0.11	40.60	39.61	40.71	39.72	63.74	53.74	-23.03	-14.02
3	0.29453	0.13	29.33	28.80	29.46	28.93	60.40	50.40	-30.93	-21.46
4	1.85547	0.23	27.68	26.78	27.91	27.01	56.00	46.00	-28.09	-18.99
5	12.39063	0.55	32.82	31.96	33.37	32.51	60.00	50.00	-26.63	-17.49
6	16.97266	0.64	33.60	29.78	34.24	30.42	60.00	50.00	-25.76	-19.58

REMARKS:

1. Q.P. and AV. are abbreviations of quasi-peak and average individually.
2. The emission levels of other frequencies were very low against the limit.
3. Margin value = Emission level - Limit value
4. Correction factor = Insertion loss + Cable loss
5. Emission Level = Correction Factor + Reading Value.

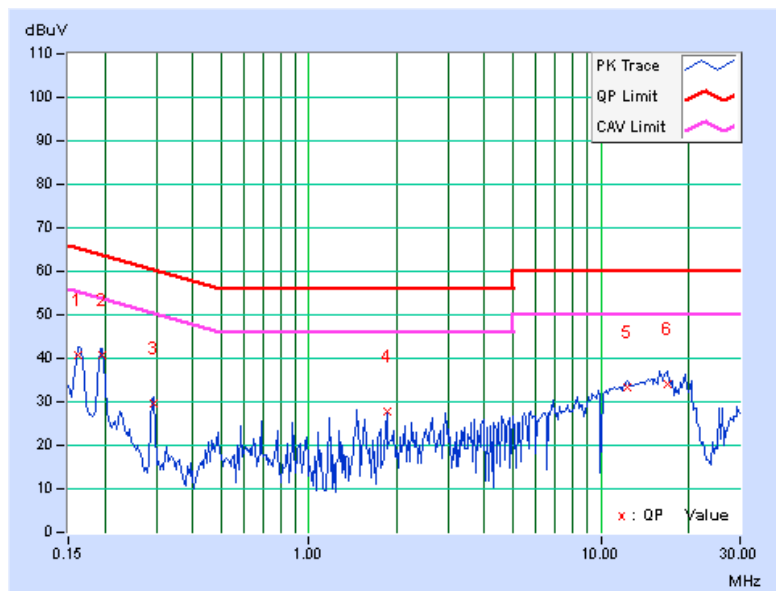

4.2 RADIATED EMISSION AND BANDEDGE MEASUREMENT

4.2.1 LIMITS OF RADIATED EMISSION AND BANDEDGE MEASUREMENT

Radiated emissions which fall in the restricted bands must comply with the radiated emission limits specified as below table. Other emissions shall be at least 20dB below the highest level of the desired power:

Frequencies (MHz)	Field strength (microvolts/meter)	Measurement distance (meters)
0.009-0.490	2400/F(kHz)	300
0.490-1.705	24000/F(kHz)	30
1.705-30.0	30	30
30-88	100	3
88-216	150	3
216-960	200	3
Above 960	500	3

NOTE:

1. The lower limit shall apply at the transition frequencies.
2. Emission level (dBuV/m) = 20 log Emission level (uV/m).
3. For frequencies above 1000MHz, the field strength limits are based on average detector, however, the peak field strength of any emission shall not exceed the maximum permitted average limits, specified above by more than 20dB under any condition of modulation.



A D T

4.2.2 TEST INSTRUMENTS

For Below 1GHz:

DESCRIPTION & MANUFACTURER	MODEL NO.	SERIAL NO.	CALIBRATED DATE	CALIBRATED UNTIL
Spectrum Analyzer Agilent	E4446A	MY48250253	Sep. 03, 2012	Sep. 02, 2013
Pre-Selector Agilent	N9039A	MY46520310	Sep. 03, 2012	Sep. 02, 2013
Signal Generator Agilent	N5181A	MY49060347	July 24, 2012	July 23, 2013
Pre-Amplifier Mini-Circuits	ZFL-1000VH2 B	AMP-ZFL-04	Nov. 14, 2012	Nov. 13, 2013
Pre-Amplifier Agilent	8449B	3008A02465	Feb. 27, 2012	Feb. 26, 2013
SPACEK LABS	SLKKa-48-6	9K16	Nov. 14, 2012	Nov. 13, 2013
Trilog Broadband Antenna SCHWARZBECK	VULB 9168	9168-361	Apr. 06, 2012	Apr. 05, 2013
Horn_Antenna AISI	AIH.8018	0000220091110	Nov. 27, 2012	Nov. 26, 2013
Horn_Antenna SCHWARZBECK	BBHA 9170	9170-424	Oct. 12, 2012	Oct. 11, 2013
RF Cable	NA	RF104-205 RF104-207 RF104-202	Dec. 26, 2012	Dec. 25, 2013
RF Cable	NA	CHHCAB_001	Oct. 07, 2012	Oct. 06, 2013
Software	ADT_Radiated _V8.7.05	NA	NA	NA
Antenna Tower & Turn Table CT	NA	NA	NA	NA

Note:

1. The calibration interval of the above test instruments is 12 months and the calibrations are traceable to NML/ROC and NIST/USA.
2. The horn antenna, preamplifier (model: 8449B) are used only for the measurement of emission frequency above 1GHz if tested.
3. The test was performed in 966 Chamber No. H.
4. The FCC Site Registration No. is 797305.
5. The CANADA Site Registration No. is IC 7450H-3.
6. Tested Date: Dec. 26, 2012



A D T

For Above 1GHz:

DESCRIPTION & MANUFACTURER	MODEL NO.	SERIAL NO.	CALIBRATED DATE	CALIBRATED UNTIL
Spectrum Analyzer Agilent	E4446A	MY48250254	July 09, 2012	July 08, 2013
Pre-Selector Agilent	N9039A	MY46520311	July 09, 2012	July 08, 2013
Signal Generator Agilent	N5181A	MY49060517	July 09, 2012	July 08, 2013
Pre-Amplifier Mini-Circuits	ZFL-1000VH2 B	AMP-ZFL-03	Nov. 14, 2012	Nov. 13, 2013
Pre-Amplifier Agilent	8449B	3008A02578	June 26, 2012	June 25, 2013
Pre-Amplifier SPACEK LABS	SLKKa-48-6	9K16	Nov. 14, 2012	Nov. 13, 2013
Trilog Broadband Antenna SCHWARZBECK	VULB 9168	9168-360	Apr. 09, 2012	Apr. 08, 2013
Horn_Antenna AISI	AIH.8018	0000320091110	Nov. 19, 2012	Nov. 18, 2013
Horn_Antenna SCHWARZBECK	BBHA 9170	9170-424	Oct. 12, 2012	Oct. 11, 2013
RF Cable	NA	RF104-201 RF104-203 RF104-204	Dec. 25, 2012	Dec. 24, 2013
RF Cable	NA	CHGCAB_001	Oct. 06, 2012	Oct. 05, 2013
Software	ADT_Radiated _V8.7.05	NA	NA	NA
Antenna Tower & Turn Table CT	NA	NA	NA	NA

Note:

1. The calibration interval of the above test instruments is 12 months and the calibrations are traceable to NML/ROC and NIST/USA.
2. The horn antenna, preamplifier (model: 8449B) are used only for the measurement of emission frequency above 1GHz if tested.
- 3 The test was performed in 966 Chamber No. G.
4. The FCC Site Registration No. is 966073.
- 5 The VCCI Site Registration No. is G-137.
- 6 The CANADA Site Registration No. is IC 7450H-2.
- 7 Tested Date: Dec. 26, 2012

4.2.3 TEST PROCEDURES

- a. The EUT was placed on the top of a rotating table 0.8 meters above the ground at a 3 meters chamber. The table was rotated 360 degrees to determine the position of the highest radiation.
- b. The EUT was set 3 meters away from the interference-receiving antenna, which was mounted on the top of a variable-height antenna tower.
- c. The height of antenna is varied from one meter to four meters above the ground to determine the maximum value of the field strength. Both horizontal and vertical polarizations of the antenna are set to make the measurement.
- d. For each suspected emission, the EUT was arranged to its worst case and then the antenna was tuned to heights from 1 meter to 4 meters and the rotatable table was turned from 0 degrees to 360 degrees to find the maximum reading.
- e. The test-receiver system was set to quasi-peak detect function and specified bandwidth with maximum hold mode when the test frequency is below 1 GHz.
- f. The test-receiver system was set to peak and average detect function and specified bandwidth with maximum hold mode when the test frequency is above 1 GHz. If the peak reading value also meets average limit, measurement with the average detector is unnecessary.

NOTE:

2. The resolution bandwidth and video bandwidth of test receiver/spectrum analyzer is 120kHz for Quasi-peak detection (QP) at frequency below 1GHz.
3. The resolution bandwidth of test receiver/spectrum analyzer is 1 MHz and the video bandwidth is 3 MHz for Peak detection (PK) at frequency above 1GHz.
4. The resolution bandwidth of test receiver/spectrum analyzer is 1 MHz and the video bandwidth is 10 Hz for Average detection (AV) at frequency above 1GHz.
5. All modes of operation were investigated and the worst-case emissions are reported.

4.2.4 DEVIATION FROM TEST STANDARD

No deviation

4.2.5 TEST SETUP

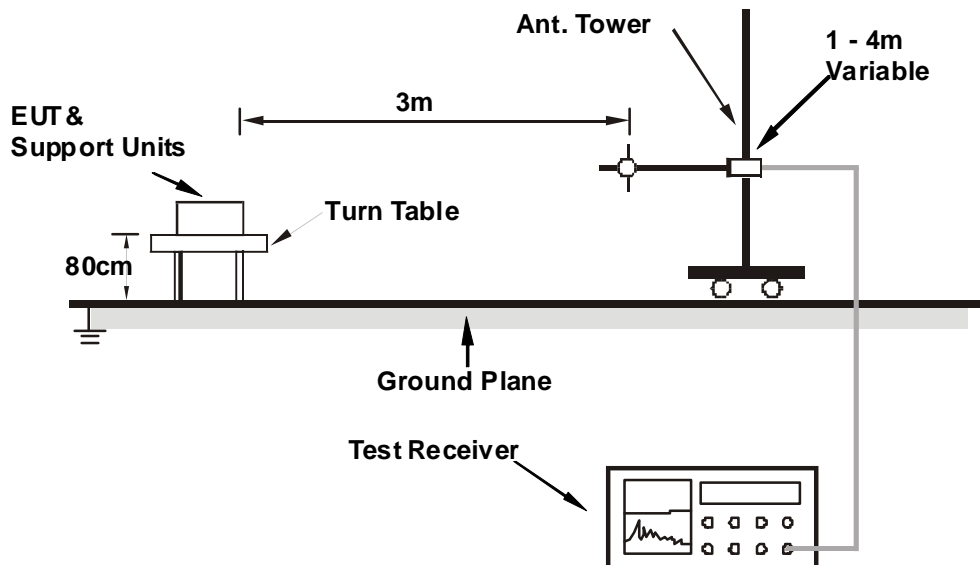

For the actual test configuration, please refer to the related item – Photographs of the Test Configuration.

4.2.6 EUT OPERATING CONDITIONS

Same as Item 4.1.6

4.2.7 TEST RESULTS

BELOW 1GHz WORST-CASE DATA

802.11n (HT20)

CHANNEL	TX Channel 6	DETECTOR FUNCTION	Quasi-Peak (QP)
FREQUENCY RANGE	Below 1GHz		

ANTENNA POLARITY & TEST DISTANCE: HORIZONTAL AT 3 M								
NO.	FREQ. (MHz)	EMISSION LEVEL (dBuV/m)	LIMIT (dBuV/m)	MARGIN (dB)	ANTENNA HEIGHT (m)	TABLE ANGLE (Degree)	RAW VALUE (dBuV)	CORRECTION FACTOR (dB/m)
1	166.30	36.2 QP	43.5	-7.3	2.00 H	44	22.29	13.90
2	232.27	28.2 QP	46.0	-17.8	1.25 H	196	15.68	12.50
3	366.56	28.1 QP	46.0	-17.9	2.00 H	65	11.17	16.94
4	699.68	36.5 QP	46.0	-9.5	1.00 H	231	12.81	23.71
5	766.35	38.6 QP	46.0	-7.4	1.00 H	222	13.61	24.98
6	796.55	34.5 QP	46.0	-11.5	1.50 H	225	8.93	25.61
ANTENNA POLARITY & TEST DISTANCE: VERTICAL AT 3 M								
NO.	FREQ. (MHz)	EMISSION LEVEL (dBuV/m)	LIMIT (dBuV/m)	MARGIN (dB)	ANTENNA HEIGHT (m)	TABLE ANGLE (Degree)	RAW VALUE (dBuV)	CORRECTION FACTOR (dB/m)
1	166.54	34.1 QP	43.5	-9.5	1.50 V	8	20.16	13.89
2	374.97	31.2 QP	46.0	-14.8	1.00 V	179	14.02	17.15
3	466.39	31.7 QP	46.0	-14.3	1.00 V	357	12.44	19.28
4	697.55	39.0 QP	46.0	-7.0	1.25 V	124	15.29	23.67
5	766.35	38.0 QP	46.0	-8.0	1.75 V	201	13.06	24.98
6	802.71	34.7 QP	46.0	-11.3	1.50 V	215	8.96	25.72

REMARKS:

1. Emission level (dBuV/m) = Raw Value (dBuV) + Correction Factor (dB/m).
2. Correction Factor (dB/m) = Antenna Factor (dB/m) + Cable Factor (dB).
3. The other emission levels were very low against the limit.
4. Margin value = Emission level – Limit value.



ABOVE 1GHz DATA

802.11b

CHANNEL	TX Channel 1	DETECTOR FUNCTION	Peak (PK)
FREQUENCY RANGE	1GHz ~ 25GHz		Average (AV)

ANTENNA POLARITY & TEST DISTANCE: HORIZONTAL AT 3 M

NO.	FREQ. (MHz)	EMISSION LEVEL (dBuV/m)	LIMIT (dBuV/m)	MARGIN (dB)	ANTENNA HEIGHT (m)	TABLE ANGLE (Degree)	RAW VALUE (dBuV)	CORRECTION FACTOR (dB/m)
1	2390.00	57.8 PK	74.0	-16.2	1.00 H	57	25.02	32.78
2	2390.00	44.9 AV	54.0	-9.1	1.00 H	57	12.12	32.78
3	*2412.00	102.8 PK			1.00 H	57	69.96	32.84
4	*2412.00	100.6 AV			1.00 H	57	67.76	32.84
5	4824.00	49.7 PK	74.0	-24.3	1.00 H	310	7.43	42.27
6	4824.00	38.6 AV	54.0	-15.4	1.00 H	310	-3.67	42.27

ANTENNA POLARITY & TEST DISTANCE: VERTICAL AT 3 M

NO.	FREQ. (MHz)	EMISSION LEVEL (dBuV/m)	LIMIT (dBuV/m)	MARGIN (dB)	ANTENNA HEIGHT (m)	TABLE ANGLE (Degree)	RAW VALUE (dBuV)	CORRECTION FACTOR (dB/m)
1	2390.00	57.4 PK	74.0	-16.6	1.73 V	142	24.62	32.78
2	2390.00	45.6 AV	54.0	-8.4	1.73 V	142	12.82	32.78
3	*2412.00	107.6 PK			1.73 V	142	74.76	32.84
4	*2412.00	105.3 AV			1.73 V	142	72.46	32.84
5	4824.00	51.1 PK	74.0	-22.9	1.00 V	358	8.83	42.27
6	4824.00	42.5 AV	54.0	-11.5	1.00 V	358	0.23	42.27

REMARKS:

1. Emission level (dBuV/m) = Raw Value (dBuV) + Correction Factor (dB/m).
2. Correction Factor (dB/m) = Antenna Factor (dB/m) + Cable Factor (dB).
3. The other emission levels were very low against the limit.
4. Margin value = Emission level – Limit value.
5. " * ": Fundamental frequency.



A D T

CHANNEL	TX Channel 6	DETECTOR FUNCTION	Peak (PK)
FREQUENCY RANGE	1GHz ~ 25GHz		Average (AV)

ANTENNA POLARITY & TEST DISTANCE: HORIZONTAL AT 3 M

NO.	FREQ. (MHz)	EMISSION LEVEL (dBuV/m)	LIMIT (dBuV/m)	MARGIN (dB)	ANTENNA HEIGHT (m)	TABLE ANGLE (Degree)	RAW VALUE (dBuV)	CORRECTION FACTOR (dB/m)
1	2358.00	57.6 PK	74.0	-16.4	1.00 H	60	24.92	32.68
2	2358.00	44.5 AV	54.0	-9.5	1.00 H	60	11.82	32.68
3	*2437.00	102.7 PK			1.00 H	60	69.79	32.91
4	*2437.00	100.6 AV			1.00 H	60	67.69	32.91
5	4874.00	49.8 PK	74.0	-24.2	1.00 H	296	7.48	42.32
6	4874.00	38.5 AV	54.0	-15.5	1.00 H	296	-3.82	42.32
7	7311.00	55.8 PK	74.0	-18.2	1.00 H	155	8.85	46.95
8	7311.00	43.8 AV	54.0	-10.2	1.00 H	155	-3.15	46.95

ANTENNA POLARITY & TEST DISTANCE: VERTICAL AT 3 M

NO.	FREQ. (MHz)	EMISSION LEVEL (dBuV/m)	LIMIT (dBuV/m)	MARGIN (dB)	ANTENNA HEIGHT (m)	TABLE ANGLE (Degree)	RAW VALUE (dBuV)	CORRECTION FACTOR (dB/m)
1	2358.00	57.6 PK	74.0	-16.4	1.73 V	140	24.92	32.68
2	2358.00	46.3 AV	54.0	-7.7	1.73 V	140	13.62	32.68
3	*2437.00	107.4 PK			1.73 V	140	74.49	32.91
4	*2437.00	105.1 AV			1.73 V	140	72.19	32.91
5	4874.00	51.3 PK	74.0	-22.7	1.00 V	351	8.98	42.32
6	4874.00	42.5 AV	54.0	-11.5	1.00 V	351	0.18	42.32
7	7311.00	56.1 PK	74.0	-17.9	1.00 V	214	9.15	46.95
8	7311.00	43.9 AV	54.0	-10.1	1.00 V	214	-3.05	46.95

REMARKS:

1. Emission level (dBuV/m) = Raw Value (dBuV) + Correction Factor (dB/m).
2. Correction Factor (dB/m) = Antenna Factor (dB/m) + Cable Factor (dB).
3. The other emission levels were very low against the limit.
4. Margin value = Emission level – Limit value.
5. " * ": Fundamental frequency.

CHANNEL	TX Channel 11	DETECTOR FUNCTION	Peak (PK)
FREQUENCY RANGE	1GHz ~ 25GHz		Average (AV)

ANTENNA POLARITY & TEST DISTANCE: HORIZONTAL AT 3 M								
NO.	FREQ. (MHz)	EMISSION LEVEL (dBuV/m)	LIMIT (dBuV/m)	MARGIN (dB)	ANTENNA HEIGHT (m)	TABLE ANGLE (Degree)	RAW VALUE (dBuV)	CORRECTION FACTOR (dB/m)
1	*2462.00	102.6 PK			1.00 H	59	69.63	32.97
2	*2462.00	100.5 AV			1.00 H	59	67.53	32.97
3	2483.50	58.1 PK	74.0	-15.9	1.00 H	59	25.07	33.03
4	2483.50	44.8 AV	54.0	-9.2	1.00 H	59	11.77	33.03
5	4924.00	50.4 PK	74.0	-23.6	1.00 H	308	8.08	42.32
6	4924.00	39.0 AV	54.0	-15.0	1.00 H	308	-3.32	42.32
7	7386.00	55.4 PK	74.0	-18.6	1.00 H	155	8.21	47.19
8	7386.00	43.4 AV	54.0	-10.6	1.00 H	155	-3.79	47.19

ANTENNA POLARITY & TEST DISTANCE: VERTICAL AT 3 M								
NO.	FREQ. (MHz)	EMISSION LEVEL (dBuV/m)	LIMIT (dBuV/m)	MARGIN (dB)	ANTENNA HEIGHT (m)	TABLE ANGLE (Degree)	RAW VALUE (dBuV)	CORRECTION FACTOR (dB/m)
1	*2462.00	107.5 PK			1.69 V	140	74.53	32.97
2	*2462.00	105.1 AV			1.69 V	140	72.13	32.97
3	2483.50	57.8 PK	74.0	-16.2	1.69 V	140	24.77	33.03
4	2483.50	45.6 AV	54.0	-8.4	1.69 V	140	12.57	33.03
5	4924.00	50.8 PK	74.0	-23.2	1.00 V	336	8.48	42.32
6	4924.00	42.1 AV	54.0	-11.9	1.00 V	336	-0.22	42.32
7	7386.00	55.7 PK	74.0	-18.3	1.00 V	230	8.51	47.19
8	7386.00	43.7 AV	54.0	-10.3	1.00 V	230	-3.49	47.19

REMARKS:

1. Emission level (dBuV/m) = Raw Value (dBuV) + Correction Factor (dB/m).
2. Correction Factor (dB/m) = Antenna Factor (dB/m) + Cable Factor (dB).
3. The other emission levels were very low against the limit.
4. Margin value = Emission level – Limit value.
5. " * " : Fundamental frequency.

802.11g

CHANNEL	TX Channel 1	DETECTOR FUNCTION	Peak (PK)
FREQUENCY RANGE	1GHz ~ 25GHz		Average (AV)

ANTENNA POLARITY & TEST DISTANCE: HORIZONTAL AT 3 M								
NO.	FREQ. (MHz)	EMISSION LEVEL (dBuV/m)	LIMIT (dBuV/m)	MARGIN (dB)	ANTENNA HEIGHT (m)	TABLE ANGLE (Degree)	RAW VALUE (dBuV)	CORRECTION FACTOR (dB/m)
1	2390.00	60.3 PK	74.0	-13.7	1.04 H	57	27.52	32.78
2	2390.00	47.1 AV	54.0	-6.9	1.04 H	57	14.32	32.78
3	*2412.00	100.3 PK			1.04 H	57	67.46	32.84
4	*2412.00	90.4 AV			1.04 H	57	57.56	32.84
5	4824.00	47.7 PK	74.0	-26.3	1.00 H	326	5.43	42.27
6	4824.00	35.5 AV	54.0	-18.5	1.00 H	326	-6.77	42.27
ANTENNA POLARITY & TEST DISTANCE: VERTICAL AT 3 M								
NO.	FREQ. (MHz)	EMISSION LEVEL (dBuV/m)	LIMIT (dBuV/m)	MARGIN (dB)	ANTENNA HEIGHT (m)	TABLE ANGLE (Degree)	RAW VALUE (dBuV)	CORRECTION FACTOR (dB/m)
1	2390.00	63.1 PK	74.0	-10.9	1.75 V	144	30.32	32.78
2	2390.00	49.7 AV	54.0	-4.3	1.75 V	144	16.92	32.78
3	*2412.00	105.9 PK			1.75 V	144	73.06	32.84
4	*2412.00	95.6 AV			1.75 V	144	62.76	32.84
5	4824.00	47.6 PK	74.0	-26.4	1.02 V	338	5.33	42.27
6	4824.00	35.2 AV	54.0	-18.8	1.02 V	338	-7.07	42.27

REMARKS:

1. Emission level (dBuV/m) = Raw Value (dBuV) + Correction Factor (dB/m).
2. Correction Factor (dB/m) = Antenna Factor (dB/m) + Cable Factor (dB).
3. The other emission levels were very low against the limit.
4. Margin value = Emission level – Limit value.
5. " * ": Fundamental frequency.



A D T

CHANNEL	TX Channel 6	DETECTOR FUNCTION	Peak (PK)
FREQUENCY RANGE	1GHz ~ 25GHz		Average (AV)

ANTENNA POLARITY & TEST DISTANCE: HORIZONTAL AT 3 M

NO.	FREQ. (MHz)	EMISSION LEVEL (dBuV/m)	LIMIT (dBuV/m)	MARGIN (dB)	ANTENNA HEIGHT (m)	TABLE ANGLE (Degree)	RAW VALUE (dBuV)	CORRECTION FACTOR (dB/m)
1	*2437.00	100.8 PK			1.05 H	68	67.89	32.91
2	*2437.00	90.8 AV			1.05 H	68	57.89	32.91
3	4874.00	47.9 PK	74.0	-26.1	1.00 H	333	5.58	42.32
4	4874.00	35.5 AV	54.0	-18.5	1.00 H	333	-6.82	42.32
5	7311.00	52.1 PK	74.0	-21.9	1.00 H	156	5.15	46.95
6	7311.00	40.3 AV	54.0	-13.7	1.00 H	156	-6.65	46.95

ANTENNA POLARITY & TEST DISTANCE: VERTICAL AT 3 M

NO.	FREQ. (MHz)	EMISSION LEVEL (dBuV/m)	LIMIT (dBuV/m)	MARGIN (dB)	ANTENNA HEIGHT (m)	TABLE ANGLE (Degree)	RAW VALUE (dBuV)	CORRECTION FACTOR (dB/m)
1	*2437.00	105.9 PK			1.73 V	140	72.99	32.91
2	*2437.00	95.9 AV			1.73 V	140	62.99	32.91
3	4874.00	47.8 PK	74.0	-26.2	1.03 V	360	5.48	42.32
4	4874.00	35.8 AV	54.0	-18.2	1.03 V	360	-6.52	42.32
5	7311.00	52.2 PK	74.0	-21.8	1.04 V	218	5.25	46.95
6	7311.00	40.1 AV	54.0	-13.9	1.04 V	218	-6.85	46.95

REMARKS:

1. Emission level (dBuV/m) = Raw Value (dBuV) + Correction Factor (dB/m).
2. Correction Factor (dB/m) = Antenna Factor (dB/m) + Cable Factor (dB).
3. The other emission levels were very low against the limit.
4. Margin value = Emission level – Limit value.
5. " * ": Fundamental frequency.



CHANNEL	TX Channel 11	DETECTOR FUNCTION	Peak (PK)
FREQUENCY RANGE	1GHz ~ 25GHz		Average (AV)

ANTENNA POLARITY & TEST DISTANCE: HORIZONTAL AT 3 M								
NO.	FREQ. (MHz)	EMISSION LEVEL (dBuV/m)	LIMIT (dBuV/m)	MARGIN (dB)	ANTENNA HEIGHT (m)	TABLE ANGLE (Degree)	RAW VALUE (dBuV)	CORRECTION FACTOR (dB/m)
1	*2462.00	100.6 PK			1.04 H	60	67.63	32.97
2	*2462.00	90.5 AV			1.04 H	60	57.53	32.97
3	2483.50	60.9 PK	74.0	-13.1	1.04 H	60	27.87	33.03
4	2483.50	46.6 AV	54.0	-7.4	1.04 H	60	13.57	33.03
5	4924.00	47.9 PK	74.0	-26.1	1.00 H	325	5.58	42.32
6	4924.00	35.5 AV	54.0	-18.5	1.00 H	325	-6.82	42.32
7	7386.00	52.9 PK	74.0	-21.1	1.07 H	145	5.71	47.19
8	7386.00	40.6 AV	54.0	-13.4	1.07 H	145	-6.59	47.19

ANTENNA POLARITY & TEST DISTANCE: VERTICAL AT 3 M								
NO.	FREQ. (MHz)	EMISSION LEVEL (dBuV/m)	LIMIT (dBuV/m)	MARGIN (dB)	ANTENNA HEIGHT (m)	TABLE ANGLE (Degree)	RAW VALUE (dBuV)	CORRECTION FACTOR (dB/m)
1	*2462.00	105.7 PK			1.69 V	141	72.73	32.97
2	*2462.00	95.3 AV			1.69 V	141	62.33	32.97
3	2483.50	65.3 PK	74.0	-8.7	1.69 V	141	32.27	33.03
4	2483.50	49.5 AV	54.0	-4.5	1.69 V	141	16.47	33.03
5	4924.00	48.0 PK	74.0	-26.0	1.03 V	344	5.68	42.32
6	4924.00	35.5 AV	54.0	-18.5	1.03 V	344	-6.82	42.32
7	7386.00	53.0 PK	74.0	-21.0	1.05 V	237	5.81	47.19
8	7386.00	41.0 AV	54.0	-13.0	1.05 V	237	-6.19	47.19

REMARKS:

1. Emission level (dBuV/m) = Raw Value (dBuV) + Correction Factor (dB/m).
2. Correction Factor (dB/m) = Antenna Factor (dB/m) + Cable Factor (dB).
3. The other emission levels were very low against the limit.
4. Margin value = Emission level – Limit value.
5. " * " : Fundamental frequency.



A D T

802.11n (HT20)

CHANNEL	TX Channel 1	DETECTOR FUNCTION	Peak (PK)
FREQUENCY RANGE	1GHz ~ 25GHz		Average (AV)

ANTENNA POLARITY & TEST DISTANCE: HORIZONTAL AT 3 M

NO.	FREQ. (MHz)	EMISSION LEVEL (dBuV/m)	LIMIT (dBuV/m)	MARGIN (dB)	ANTENNA HEIGHT (m)	TABLE ANGLE (Degree)	RAW VALUE (dBuV)	CORRECTION FACTOR (dB/m)
1	2390.00	62.8 PK	74.0	-11.2	1.03 H	57	30.02	32.78
2	2390.00	48.6 AV	54.0	-5.4	1.03 H	57	15.82	32.78
3	*2412.00	100.1 PK			1.03 H	57	67.26	32.84
4	*2412.00	90.3 AV			1.03 H	57	57.46	32.84
5	4824.00	48.2 PK	74.0	-25.8	1.00 H	336	5.93	42.27
6	4824.00	35.4 AV	54.0	-18.6	1.00 H	336	-6.87	42.27

ANTENNA POLARITY & TEST DISTANCE: VERTICAL AT 3 M

NO.	FREQ. (MHz)	EMISSION LEVEL (dBuV/m)	LIMIT (dBuV/m)	MARGIN (dB)	ANTENNA HEIGHT (m)	TABLE ANGLE (Degree)	RAW VALUE (dBuV)	CORRECTION FACTOR (dB/m)
1	2390.00	70.2 PK	74.0	-3.8	1.75 V	143	37.42	32.78
2	2390.00	53.1 AV	54.0	-0.9	1.75 V	143	20.32	32.78
3	*2412.00	106.3 PK			1.75 V	143	73.46	32.84
4	*2412.00	96.1 AV			1.75 V	143	63.26	32.84
5	4824.00	47.7 PK	74.0	-26.3	1.01 V	336	5.43	42.27
6	4824.00	35.4 AV	54.0	-18.6	1.01 V	336	-6.87	42.27

REMARKS:

1. Emission level (dBuV/m) = Raw Value (dBuV) + Correction Factor (dB/m).
2. Correction Factor (dB/m) = Antenna Factor (dB/m) + Cable Factor (dB).
3. The other emission levels were very low against the limit.
4. Margin value = Emission level – Limit value.
5. " * ": Fundamental frequency.



A D T

CHANNEL	TX Channel 6	DETECTOR FUNCTION	Peak (PK)
FREQUENCY RANGE	1GHz ~ 25GHz		Average (AV)

ANTENNA POLARITY & TEST DISTANCE: HORIZONTAL AT 3 M

NO.	FREQ. (MHz)	EMISSION LEVEL (dBuV/m)	LIMIT (dBuV/m)	MARGIN (dB)	ANTENNA HEIGHT (m)	TABLE ANGLE (Degree)	RAW VALUE (dBuV)	CORRECTION FACTOR (dB/m)
1	*2437.00	100.6 PK			1.05 H	68	67.69	32.91
2	*2437.00	90.6 AV			1.05 H	68	57.69	32.91
3	4874.00	47.8 PK	74.0	-26.2	1.03 H	327	5.48	42.32
4	4874.00	35.5 AV	54.0	-18.5	1.03 H	327	-6.82	42.32
5	7311.00	52.6 PK	74.0	-21.4	1.03 H	153	5.65	46.95
6	7311.00	40.6 AV	54.0	-13.4	1.03 H	153	-6.35	46.95

ANTENNA POLARITY & TEST DISTANCE: VERTICAL AT 3 M

NO.	FREQ. (MHz)	EMISSION LEVEL (dBuV/m)	LIMIT (dBuV/m)	MARGIN (dB)	ANTENNA HEIGHT (m)	TABLE ANGLE (Degree)	RAW VALUE (dBuV)	CORRECTION FACTOR (dB/m)
1	*2437.00	106.5 PK			1.74 V	140	73.59	32.91
2	*2437.00	96.4 AV			1.74 V	140	63.49	32.91
3	4874.00	47.9 PK	74.0	-26.1	1.02 V	350	5.58	42.32
4	4874.00	35.6 AV	54.0	-18.4	1.02 V	350	-6.72	42.32
5	7311.00	52.5 PK	74.0	-21.5	1.03 V	221	5.55	46.95
6	7311.00	40.5 AV	54.0	-13.5	1.03 V	221	-6.45	46.95

REMARKS:

1. Emission level (dBuV/m) = Raw Value (dBuV) + Correction Factor (dB/m).
2. Correction Factor (dB/m) = Antenna Factor (dB/m) + Cable Factor (dB).
3. The other emission levels were very low against the limit.
4. Margin value = Emission level – Limit value.
5. " * " : Fundamental frequency.



A D T

CHANNEL	TX Channel 11	DETECTOR FUNCTION	Peak (PK)
FREQUENCY RANGE	1GHz ~ 25GHz		Average (AV)

ANTENNA POLARITY & TEST DISTANCE: HORIZONTAL AT 3 M

NO.	FREQ. (MHz)	EMISSION LEVEL (dBuV/m)	LIMIT (dBuV/m)	MARGIN (dB)	ANTENNA HEIGHT (m)	TABLE ANGLE (Degree)	RAW VALUE (dBuV)	CORRECTION FACTOR (dB/m)
1	*2462.00	100.3 PK			1.04 H	62	67.33	32.97
2	*2462.00	90.4 AV			1.04 H	62	57.43	32.97
3	2483.50	62.4 PK	74.0	-11.6	1.04 H	62	29.37	33.03
4	2483.50	47.7 AV	54.0	-6.3	1.04 H	62	14.67	33.03
5	4924.00	47.2 PK	74.0	-26.8	1.01 H	324	4.88	42.32
6	4924.00	35.2 AV	54.0	-18.8	1.01 H	324	-7.12	42.32
7	7386.00	52.8 PK	74.0	-21.2	1.06 H	162	5.61	47.19
8	7386.00	40.6 AV	54.0	-13.4	1.06 H	162	-6.59	47.19

ANTENNA POLARITY & TEST DISTANCE: VERTICAL AT 3 M

NO.	FREQ. (MHz)	EMISSION LEVEL (dBuV/m)	LIMIT (dBuV/m)	MARGIN (dB)	ANTENNA HEIGHT (m)	TABLE ANGLE (Degree)	RAW VALUE (dBuV)	CORRECTION FACTOR (dB/m)
1	*2462.00	105.7 PK			1.73 V	141	72.73	32.97
2	*2462.00	94.7 AV			1.73 V	141	61.73	32.97
3	2483.50	68.1 PK	74.0	-5.9	1.73 V	141	35.07	33.03
4	2483.50	50.8 AV	54.0	-3.2	1.73 V	141	17.77	33.03
5	4924.00	48.0 PK	74.0	-26.0	1.07 V	350	5.68	42.32
6	4924.00	35.4 AV	54.0	-18.6	1.07 V	350	-6.92	42.32
7	7386.00	52.0 PK	74.0	-22.0	1.06 V	217	4.81	47.19
8	7386.00	40.2 AV	54.0	-13.8	1.06 V	217	-6.99	47.19

REMARKS:

1. Emission level (dBuV/m) = Raw Value (dBuV) + Correction Factor (dB/m).
2. Correction Factor (dB/m) = Antenna Factor (dB/m) + Cable Factor (dB).
3. The other emission levels were very low against the limit.
4. Margin value = Emission level – Limit value.
5. " * ": Fundamental frequency.

802.11n (HT40)

CHANNEL	TX Channel 3	DETECTOR FUNCTION	Peak (PK)
FREQUENCY RANGE	1GHz ~ 25GHz		Average (AV)

ANTENNA POLARITY & TEST DISTANCE: HORIZONTAL AT 3 M								
NO.	FREQ. (MHz)	EMISSION LEVEL (dBuV/m)	LIMIT (dBuV/m)	MARGIN (dB)	ANTENNA HEIGHT (m)	TABLE ANGLE (Degree)	RAW VALUE (dBuV)	CORRECTION FACTOR (dB/m)
1	2390.00	63.6 PK	74.0	-10.4	1.03 H	60	30.82	32.78
2	2390.00	50.4 AV	54.0	-3.6	1.03 H	60	17.62	32.78
3	*2422.00	96.3 PK			1.03 H	60	63.43	32.87
4	*2422.00	86.5 AV			1.03 H	60	53.63	32.87
5	4844.00	47.4 PK	74.0	-26.6	1.00 H	318	5.11	42.29
6	4844.00	36.5 AV	54.0	-17.5	1.00 H	318	-5.79	42.29
7	7266.00	51.8 PK	74.0	-22.2	1.00 H	156	4.99	46.81
8	7266.00	40.8 AV	54.0	-13.2	1.00 H	156	-6.01	46.81

ANTENNA POLARITY & TEST DISTANCE: VERTICAL AT 3 M								
NO.	FREQ. (MHz)	EMISSION LEVEL (dBuV/m)	LIMIT (dBuV/m)	MARGIN (dB)	ANTENNA HEIGHT (m)	TABLE ANGLE (Degree)	RAW VALUE (dBuV)	CORRECTION FACTOR (dB/m)
1	2390.00	70.1 PK	74.0	-3.9	1.74 V	143	37.32	32.78
2	2390.00	52.9 AV	54.0	-1.1	1.74 V	143	20.12	32.78
3	*2422.00	101.9 PK			1.74 V	143	69.03	32.87
4	*2422.00	90.6 AV			1.74 V	143	57.73	32.87
5	4844.00	47.3 PK	74.0	-26.7	1.00 V	336	5.01	42.29
6	4844.00	36.4 AV	54.0	-17.6	1.00 V	336	-5.89	42.29
7	7266.00	52.6 PK	74.0	-21.4	1.00 V	232	5.79	46.81
8	7266.00	48.6 AV	54.0	-5.4	1.00 V	232	1.79	46.81

REMARKS:

1. Emission level (dBuV/m) = Raw Value (dBuV) + Correction Factor (dB/m).
2. Correction Factor (dB/m) = Antenna Factor (dB/m) + Cable Factor (dB).
3. The other emission levels were very low against the limit.
4. Margin value = Emission level – Limit value.
5. " * ": Fundamental frequency.



A D T

CHANNEL	TX Channel 6	DETECTOR FUNCTION	Peak (PK)
FREQUENCY RANGE	1GHz ~ 25GHz		Average (AV)

ANTENNA POLARITY & TEST DISTANCE: HORIZONTAL AT 3 M

NO.	FREQ. (MHz)	EMISSION LEVEL (dBuV/m)	LIMIT (dBuV/m)	MARGIN (dB)	ANTENNA HEIGHT (m)	TABLE ANGLE (Degree)	RAW VALUE (dBuV)	CORRECTION FACTOR (dB/m)
1	*2437.00	97.5 PK			1.00 H	62	64.59	32.91
2	*2437.00	87.3 AV			1.00 H	62	54.39	32.91
3	4874.00	47.5 PK	74.0	-26.5	1.00 H	315	5.18	42.32
4	4874.00	36.6 AV	54.0	-17.4	1.00 H	315	-5.72	42.32
5	7311.00	51.6 PK	74.0	-22.4	1.00 H	153	4.65	46.95
6	7311.00	40.7 AV	54.0	-13.3	1.00 H	153	-6.25	46.95

ANTENNA POLARITY & TEST DISTANCE: VERTICAL AT 3 M

NO.	FREQ. (MHz)	EMISSION LEVEL (dBuV/m)	LIMIT (dBuV/m)	MARGIN (dB)	ANTENNA HEIGHT (m)	TABLE ANGLE (Degree)	RAW VALUE (dBuV)	CORRECTION FACTOR (dB/m)
1	*2437.00	102.2 PK			1.66 V	173	69.29	32.91
2	*2437.00	91.6 AV			1.66 V	173	58.69	32.91
3	4874.00	47.5 PK	74.0	-26.5	1.00 V	331	5.18	42.32
4	4874.00	36.5 AV	54.0	-17.5	1.00 V	331	-5.82	42.32
5	7311.00	52.3 PK	74.0	-21.7	1.00 V	236	5.35	46.95
6	7311.00	40.8 AV	54.0	-13.2	1.00 V	236	-6.15	46.95

REMARKS:

1. Emission level (dBuV/m) = Raw Value (dBuV) + Correction Factor (dB/m).
2. Correction Factor (dB/m) = Antenna Factor (dB/m) + Cable Factor (dB).
3. The other emission levels were very low against the limit.
4. Margin value = Emission level – Limit value.
5. " * " : Fundamental frequency.

CHANNEL	TX Channel 9	DETECTOR FUNCTION	Peak (PK)
FREQUENCY RANGE	1GHz ~ 25GHz		Average (AV)

ANTENNA POLARITY & TEST DISTANCE: HORIZONTAL AT 3 M								
NO.	FREQ. (MHz)	EMISSION LEVEL (dBuV/m)	LIMIT (dBuV/m)	MARGIN (dB)	ANTENNA HEIGHT (m)	TABLE ANGLE (Degree)	RAW VALUE (dBuV)	CORRECTION FACTOR (dB/m)
1	*2452.00	94.3 PK			1.00 H	56	61.35	32.95
2	*2452.00	84.5 AV			1.00 H	56	51.55	32.95
3	2483.50	61.1 PK	74.0	-12.9	1.00 H	56	28.07	33.03
4	2483.50	47.2 AV	54.0	-6.8	1.00 H	56	14.17	33.03
5	4904.00	47.6 PK	74.0	-26.4	1.00 H	311	5.26	42.34
6	4904.00	36.4 AV	54.0	-17.6	1.00 H	311	-5.94	42.34
7	7356.00	51.5 PK	74.0	-22.5	1.00 H	151	4.41	47.09
8	7356.00	40.9 AV	54.0	-13.1	1.00 H	151	-6.19	47.09

ANTENNA POLARITY & TEST DISTANCE: VERTICAL AT 3 M								
NO.	FREQ. (MHz)	EMISSION LEVEL (dBuV/m)	LIMIT (dBuV/m)	MARGIN (dB)	ANTENNA HEIGHT (m)	TABLE ANGLE (Degree)	RAW VALUE (dBuV)	CORRECTION FACTOR (dB/m)
1	*2452.00	99.2 PK			1.73 V	140	66.25	32.95
2	*2452.00	88.4 AV			1.73 V	140	55.45	32.95
3	2483.50	63.6 PK	74.0	-10.4	1.73 V	140	30.57	33.03
4	2483.50	49.2 AV	54.0	-4.8	1.73 V	140	16.17	33.03
5	4904.00	47.4 PK	74.0	-26.6	1.00 V	333	5.06	42.34
6	4904.00	36.7 AV	54.0	-17.3	1.00 V	333	-5.64	42.34
7	7356.00	52.6 PK	74.0	-21.4	1.00 V	239	5.51	47.09
8	7356.00	40.5 AV	54.0	-13.5	1.00 V	239	-6.59	47.09

REMARKS:

1. Emission level (dBuV/m) = Raw Value (dBuV) + Correction Factor (dB/m).
2. Correction Factor (dB/m) = Antenna Factor (dB/m) + Cable Factor (dB).
3. The other emission levels were very low against the limit.
4. Margin value = Emission level – Limit value.
5. " * ": Fundamental frequency.



A D T

4.3 6dB BANDWIDTH MEASUREMENT

4.3.1 LIMITS OF 6dB BANDWIDTH MEASUREMENT

The minimum of 6dB Bandwidth Measurement is 0.5 MHz.

4.3.2 TEST INSTRUMENTS

DESCRIPTION & MANUFACTURER	MODEL NO.	SERIAL NO.	CALIBRATED DATE	CALIBRATED UNTIL
R&S SPECTRUM ANALYZER	FSP40	100060	May 09, 2012	May 08, 2013

Note:

1. The calibration interval of the above test instruments is 12 months and the calibrations are traceable to NML/ROC and NIST/USA.
2. Tested date : Dec. 28, 2012

4.3.3 TEST PROCEDURE

1. Set resolution bandwidth (RBW) = approximately 1% of the emission bandwidth
2. Set the video bandwidth (VBW) $\geq 3 \times$ RBW, Detector = Peak.
3. Trace mode = max hold.
4. Sweep = auto couple.
5. Measure the maximum width of the emission that is constrained by the frequencies associated with the two amplitude points (upper and lower) that are attenuated by 6 dB relative to the maximum level measured in the fundamental emission

4.3.4 DEVIATION FROM TEST STANDARD

No deviation

4.3.5 TEST SETUP

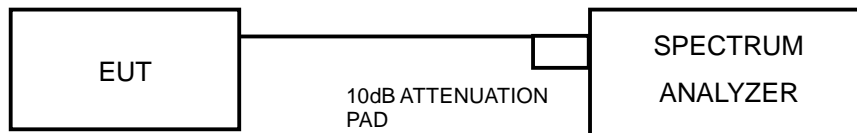

4.3.6 EUT OPERATING CONDITIONS

The software provided by client to enable the EUT under transmission condition continuously at lowest, middle and highest channel frequencies individually.



A D T

4.3.7 TEST RESULTS

802.11b

CHANNEL	FREQUENCY (MHz)	6dB BANDWIDTH (MHz)	MINIMUM LIMIT (MHz)	PASS / FAIL
1	2412	10.76	0.5	PASS
6	2437	10.19	0.5	PASS
11	2462	9.44	0.5	PASS

802.11g

CHANNEL	FREQUENCY (MHz)	6dB BANDWIDTH (MHz)	MINIMUM LIMIT (MHz)	PASS / FAIL
1	2412	16.50	0.5	PASS
6	2437	16.47	0.5	PASS
11	2462	16.49	0.5	PASS

802.11n (HT20)

CHANNEL	FREQUENCY (MHz)	6dB BANDWIDTH (MHz)	MINIMUM LIMIT (MHz)	PASS / FAIL
1	2412	17.69	0.5	PASS
6	2437	17.70	0.5	PASS
11	2462	17.69	0.5	PASS

802.11n (HT40)

CHANNEL	FREQUENCY (MHz)	6dB BANDWIDTH (MHz)	MINIMUM LIMIT (MHz)	PASS / FAIL
3	2422	36.47	0.5	PASS
6	2437	36.45	0.5	PASS
9	2452	36.46	0.5	PASS

4.4 CONDUCTED OUTPUT POWER MEASUREMENT

4.4.1 LIMITS OF CONDUCTED OUTPUT POWER MEASUREMENT

For systems using digital modulation in the 2400–2483.5 MHz bands: 1 Watt (30dBm)

Per KDB 662911 D01 Multiple Transmitter Output v01r02 Method of conducted output power measurement on IEEE 802.11 devices,

Array Gain = 0 dB (i.e., no array gain) for NANT \leq 4;

Array Gain = 0 dB (i.e., no array gain) for channel widths \geq 40 MHz for any NANT;

Array Gain = 5 log(NANT/NSS) dB or 3 dB, whichever is less for 20-MHz channel widths with NANT \geq 5.

For power measurements on all other devices: Array Gain = 10 log(NANT/NSS) dB.

4.4.2 INSTRUMENTS

DESCRIPTION & MANUFACTURER	MODEL NO.	SERIAL NO.	CALIBRATED DATE	CALIBRATED UNTIL
Power Meter	ML2495A	0824006	May 10, 2012	May 09, 2013
Power Sensor	MA2411B	0738172	May 10, 2012	May 09, 2013

- Note:**
1. The calibration interval of the above test instruments is 12 months and the calibrations are traceable to NML/ROC and NIST/USA.
 2. Tested date : Dec. 28, 2012

4.4.3 TEST PROCEDURES

A peak power sensor was used on the output port of the EUT. A power meter was used to read the response of the peak power sensor. Record the peak power level.

4.4.4 DEVIATION FROM TEST STANDARD

No deviation

4.4.5 TEST SETUP

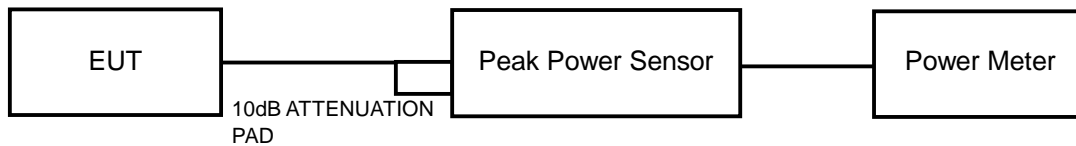

4.4.6 EUT OPERATING CONDITIONS

Same as Item 4.3.6



A D T

4.4.7 TEST RESULTS

802.11b

CHANNEL	FREQUENCY (MHz)	PEAK POWER (mW)	PEAK POWER (dBm)	LIMIT (dBm)	PASS/FAIL
1	2412	63.096	18.00	30	PASS
6	2437	64.565	18.10	30	PASS
11	2462	63.387	18.02	30	PASS

802.11g

CHANNEL	FREQUENCY (MHz)	PEAK POWER (mW)	PEAK POWER (dBm)	LIMIT (dBm)	PASS/FAIL
1	2412	89.125	19.50	30	PASS
6	2437	85.114	19.30	30	PASS
11	2462	83.176	19.20	30	PASS

802.11n (HT20)

CHANNEL	FREQUENCY (MHz)	PEAK POWER (mW)	PEAK POWER (dBm)	LIMIT (dBm)	PASS/FAIL
1	2412	109.648	20.40	30	PASS
6	2437	110.917	20.45	30	PASS
11	2462	86.497	19.37	30	PASS

802.11n (HT40)

CHANNEL	FREQUENCY (MHz)	PEAK POWER (mW)	PEAK POWER (dBm)	LIMIT (dBm)	PASS/FAIL
3	2422	61.660	17.90	30	PASS
6	2437	72.444	18.60	30	PASS
9	2452	42.658	16.30	30	PASS

4.5 POWER SPECTRAL DENSITY MEASUREMENT

4.5.1 LIMITS OF POWER SPECTRAL DENSITY MEASUREMENT

The Maximum of Power Spectral Density Measurement is 8dBm.

4.5.2 TEST INSTRUMENTS

DESCRIPTION & MANUFACTURER	MODEL NO.	SERIAL NO.	CALIBRATED DATE	CALIBRATED UNTIL
R&S Spectrum Analyzer	FSP40	100060	May 09, 2012	May 08, 2013

Note:

1. The calibration interval of the above test instruments is 12 months and the calibrations are traceable to NML/ROC and NIST/USA.
2. Tested date : Dec. 28, 2012

4.5.3 TEST PROCEDURE

1. Set the RBW = 3 kHz, VBW =10 kHz, Detector = peak.
2. Sweep time = auto couple, Trace mode = max hold, allow trace to fully stabilize.
3. Use the peak marker function to determine the maximum amplitude level.

4.5.4 DEVIATION FROM TEST STANDARD

No deviation

4.5.5 TEST SETUP

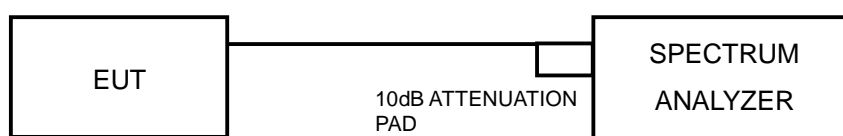

4.5.6 EUT OPERATING CONDITION

Same as Item 4.3.6



A D T

4.5.7 TEST RESULTS

802.11b

Channel	FREQUENCY (MHz)	PSD (dBm/3kHz)	Limit (dBm/3kHz)	PASS /FAIL
1	2412	-8.99	8	PASS
6	2437	-8.56	8	PASS
11	2462	-7.93	8	PASS

802.11g

Channel	FREQUENCY (MHz)	PSD (dBm/3kHz)	Limit (dBm/3kHz)	PASS /FAIL
1	2412	-14.59	8	PASS
6	2437	-14.90	8	PASS
11	2462	-13.58	8	PASS

802.11n (HT20)

Channel	FREQUENCY (MHz)	PSD (dBm/3kHz)	Limit (dBm/3kHz)	PASS /FAIL
1	2412	-15.36	8	PASS
6	2437	-14.43	8	PASS
11	2462	-15.20	8	PASS

802.11n (HT40)

Channel	FREQUENCY (MHz)	PSD (dBm/3kHz)	Limit (dBm/3kHz)	PASS /FAIL
3	2422	-20.23	8	PASS
6	2437	-17.24	8	PASS
9	2452	-17.23	8	PASS



A D T

4.6 CONDUCTED OUT-BAND EMISSION MEASUREMENT

4.6.1 LIMITS OF CONDUCTED OUT-BAND EMISSION MEASUREMENT

Below 20dB of the highest emission level of operating band (in 100kHz Resolution Bandwidth).

4.6.2 TEST INSTRUMENTS

DESCRIPTION & MANUFACTURER	MODEL NO.	SERIAL NO.	CALIBRATED DATE	CALIBRATED UNTIL
R&S Spectrum Analyzer	FSP40	100060	May 09, 2012	May 08, 2013

Note:

1. The calibration interval of the above test instruments is 12 months and the calibrations are traceable to NML/ROC and NIST/USA.
2. Tested date : Dec. 28, 2012

4.6.3 TEST PROCEDURE

Measurement Procedure - Reference Level

1. Set the RBW = 100 kHz.
2. Set the VBW \geq 300 kHz.
3. Detector = peak.
4. Sweep time = auto couple.
5. Trace mode = max hold.
6. Allow trace to fully stabilize.
7. Use the peak marker function to determine the maximum power level in any 100 kHz band segment within the fundamental EBW.

Measurement Procedure –Unwanted Emission Level

1. Set RBW = 100 kHz.
2. Set VBW \geq 300 kHz.
3. Set span to encompass the spectrum to be examined
4. Detector = peak.
5. Trace Mode = max hold.
6. Sweep = auto couple.

4.6.4 DEVIATION FROM TEST STANDARD

No deviation

4.6.5 TEST SETUP

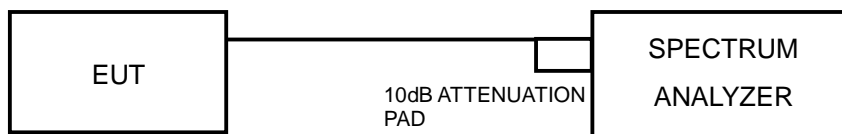

4.6.6 EUT OPERATING CONDITION

Same as Item 4.3.6

4.6.7 TEST RESULTS

The spectrum plots are attached on the following pages. D1 line indicates the highest level, and D2 line indicates the 20dB offset below D1. It shows compliance with the requirement



A D T

802.11b:

CH 1

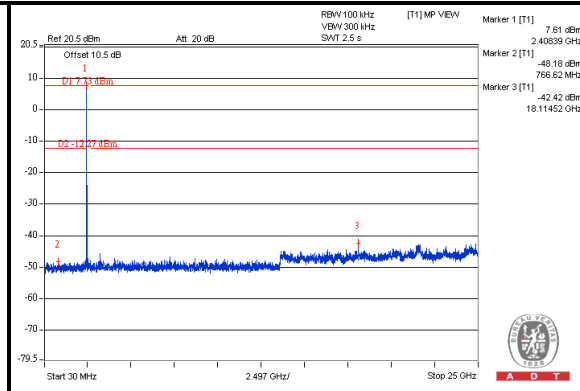
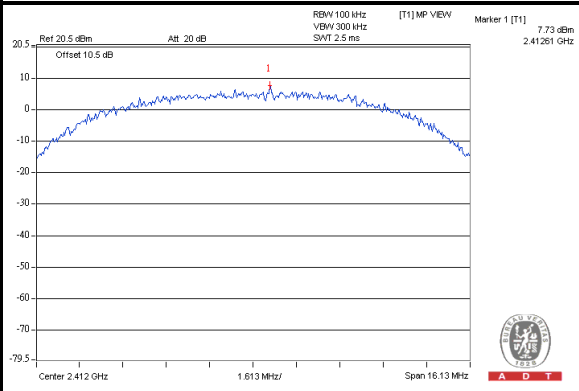

CH 6

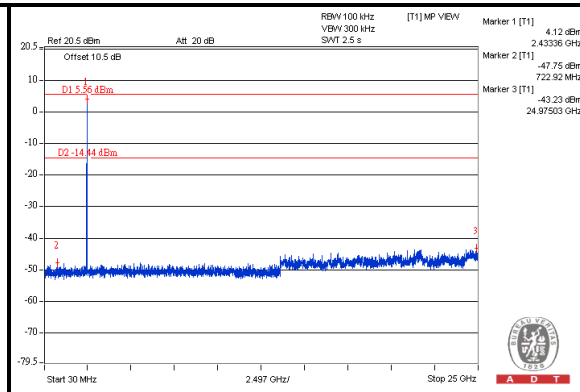
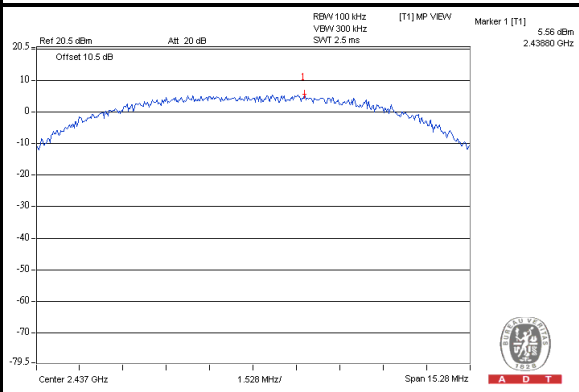

CH 11

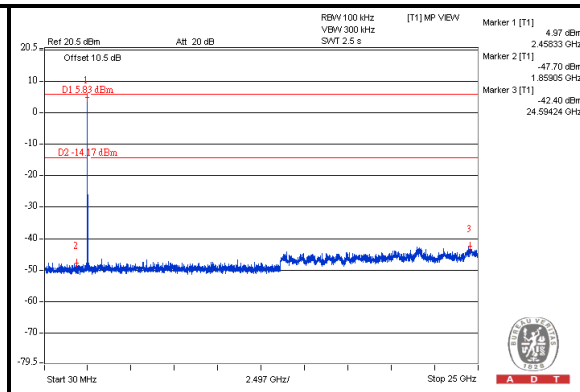
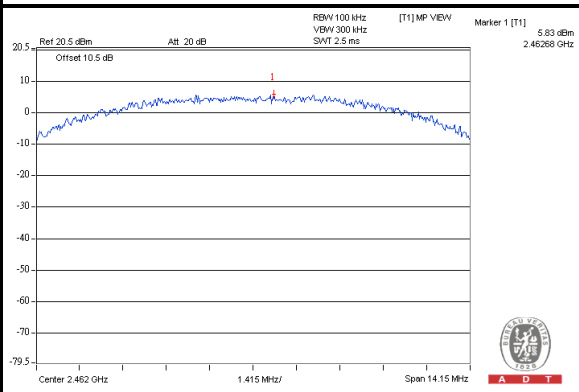



A D T

802.11g:

CH 1

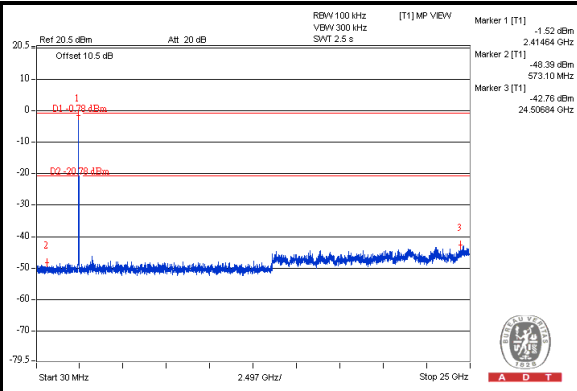
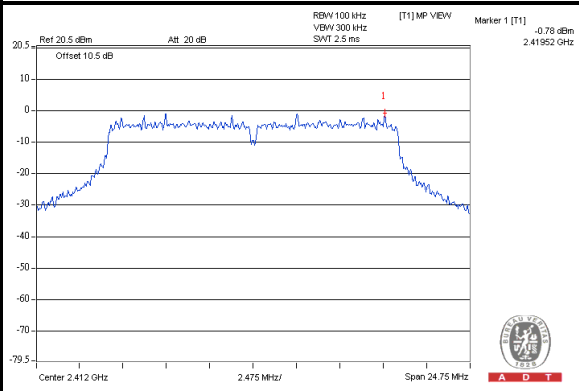

CH 6

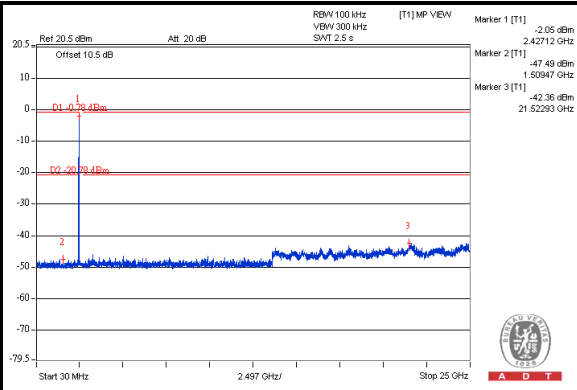
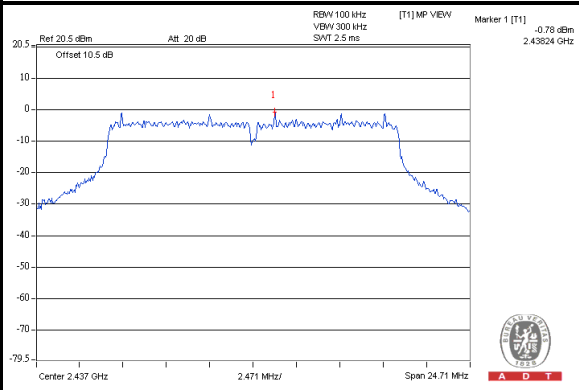

CH 11

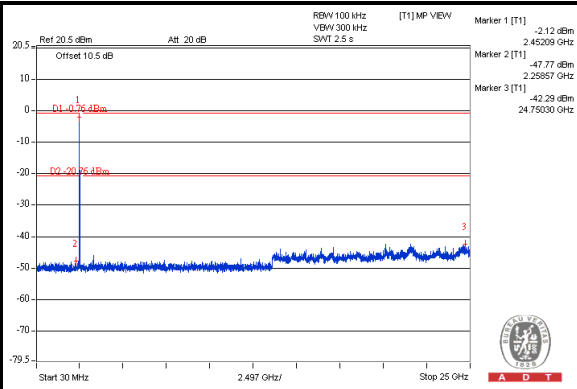
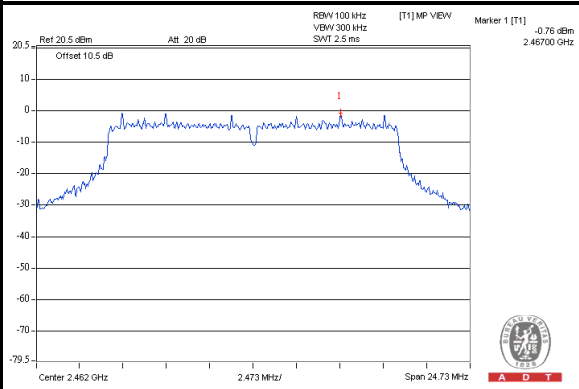



A D T

802.11n (HT20):

CH 1

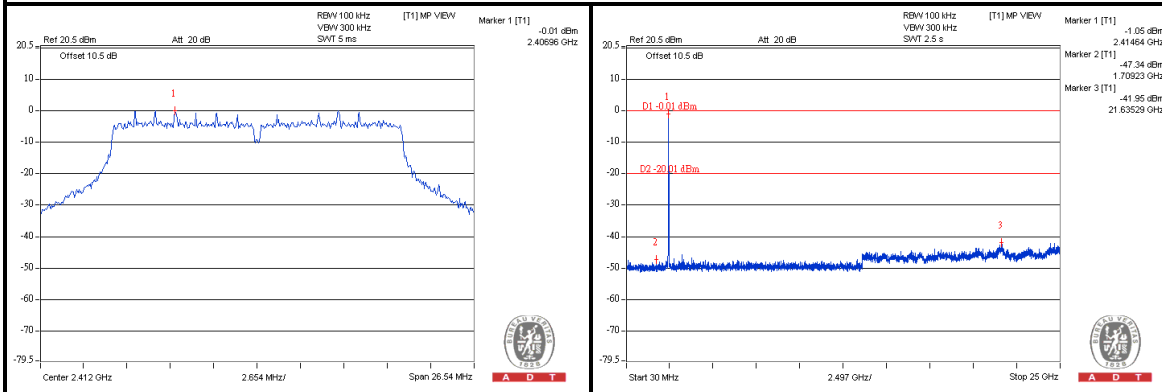

CH 6

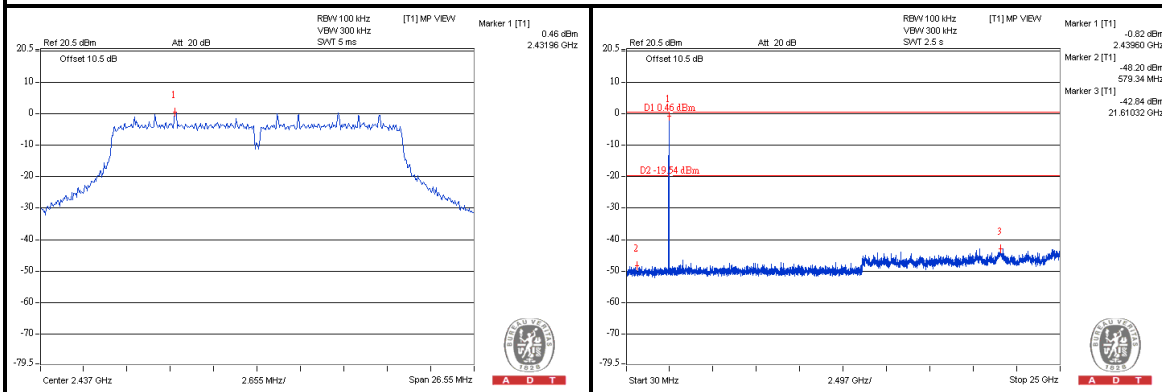

CH 11

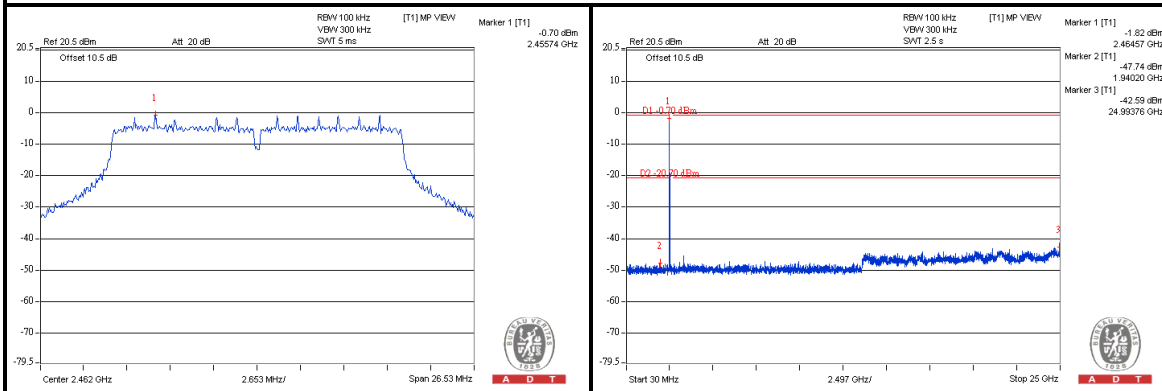



A D T

802.11n (HT40):

CH 3

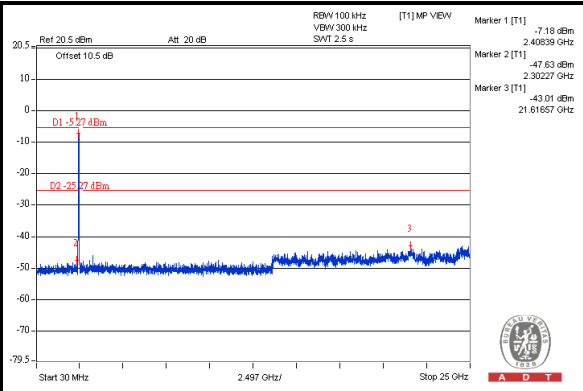
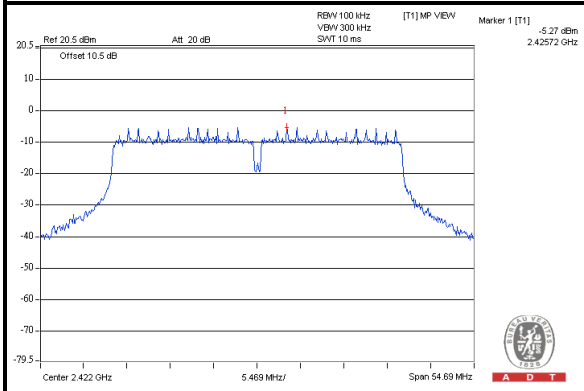

CH 6

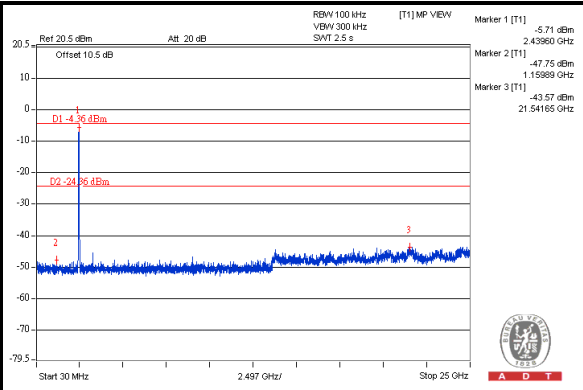
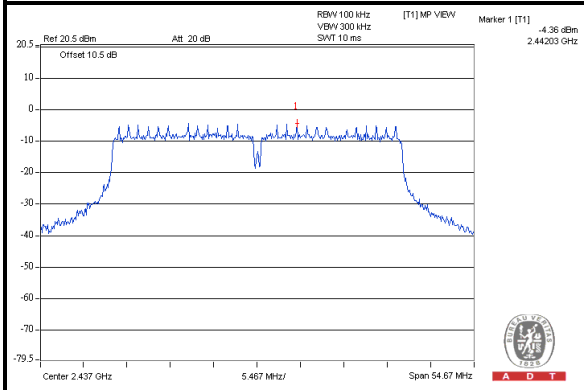

CH 9

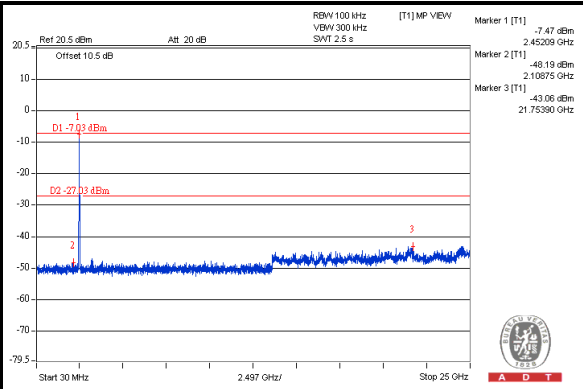
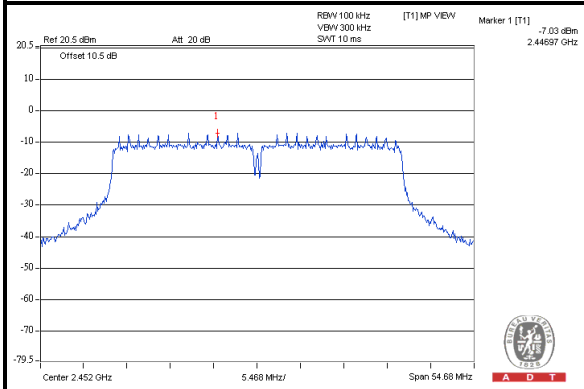



A D T

5. PHOTOGRAPHS OF THE TEST CONFIGURATION

Please refer to the attached file (Test Setup Photo).





6. INFORMATION ON THE TESTING LABORATORIES

We, Bureau Veritas Consumer Products Services (H.K.) Ltd., Taoyuan Branch, were founded in 1988 to provide our best service in EMC, Radio, Telecom and Safety consultation. Our laboratories are accredited and approved according to ISO/IEC 17025.

If you have any comments, please feel free to contact us at the following:

Linko EMC/RF Lab:

Tel: 886-2-26052180

Fax: 886-2-26052943

Hsin Chu EMC/RF Lab:

Tel: 886-3-5935343

Fax: 886-3-5935342

Hwa Ya EMC/RF/Safety/Telecom Lab:

Tel: 886-3-3183232

Fax: 886-3-3270892

Email: service.adt@tw.bureauveritas.com

Web Site: www.bureauveritas-adt.com

The address and road map of all our labs can be found in our web site also.



A D T

7. APPENDIX A - MODIFICATIONS RECORDERS FOR ENGINEERING CHANGES TO THE EUT BY THE LAB

No modifications were made to the EUT by the lab during the test.

--- END ---