

APPENDIX B: ADT SAR MEASUREMENT SYSTEM



APPENDIX C: PHOTOGRAPHS OF SYSTEM VALIDATION





APPENDIX D: SYSTEM CERTIFICATE & CALIBRATION

D1: SAM PHANTOM

Schmid & Partner Engineering AG

Zeughausstrasse 43, 8004 Zurich, Switzerland, Phone +41 1 245 97 00, Fax +41 1 245 97 79

Certificate of conformity / First Article Inspection

Item	SAM Twin Phantom V4.0
Type No	QD 000 P40 CA
Series No	TP-1150 and higher
Manufacturer / Origin	Untersee Composites Hauptstr. 69 CH-8559 Fruthwilen Switzerland

Tests

The series production process used allows the limitation to test of first articles. Complete tests were made on the pre-series Type No. QD 000 P40 AA, Serial No. TP-1001 and on the series first article Type No. QD 000 P40 BA, Serial No. TP-1006. Certain parameters have been retested using further series units (called samples).

Test	Requirement	Details	Units tested
Shape	Compliance with the geometry according to the CAD model.	IT'IS CAD File (*)	First article, Samples
Material thickness	Compliant with the requirements according to the standards	2mm +/- 0.2mm in specific areas	First article, Samples
Material parameters	Dielectric parameters for required frequencies	200 MHz – 3 GHz Relative permittivity < 5 Loss tangent < 0.05.	Material sample TP 104-5
Material resistivity	The material has been tested to be compatible with the liquids defined in the standards	Liquid type HSL 1800 and others according to the standard.	Pre-series, First article

Standards

- [1] CENELEC EN 50361
- [2] IEEE P1528-200x draft 6.5
- [3] IEC PT 62209 draft 0.9

(*) The IT'IS CAD file is derived from [2] and is also within the tolerance requirements of the shapes of [1] and [3].

Conformity

Based on the sample tests above, we certify that this item is in compliance with the uncertainty requirements of SAR measurements specified in standard [1] and draft standards [2] and [3].

Date 28.02.2002

Signature / Stamp

F. Bombault

**Schmid & Partner
Engineering AG**

Zeughausstrasse 43, CH-8004 Zurich
Tel. +41 1 245 97 00, Fax +41 1 245 97 79

Johannes Kofler



Accredited by the Swiss Accreditation Service (SAS)
The Swiss Accreditation Service is one of the signatories to the EA
Multilateral Agreement for the recognition of calibration certificates

Accreditation No.: **SCS 108**

Client **ADT (Auden)**

Certificate No. **ET3-1790_Nov07**

CALIBRATION CERTIFICATE

Object **ET3DV6 - SN 1790**

Calibration procedure(s) **QA CAL-01 v6
Calibration procedure for dosimetric E-field probes**

Calibration date: **November 20, 2007**

Condition of the calibrated item **In Tolerance**

This calibration certificate documents the traceability to national standards, which realize the physical units of measurements (SI).
The measurements and the uncertainties with confidence probability are given on the following pages and are part of the certificate.

All calibrations have been conducted in the closed laboratory facility: environment temperature (22 ± 3)°C and humidity < 70%.

Calibration Equipment used (M&TE critical for calibration)

Primary Standards	ID #	Cal Date (Calibrated by, Certificate No.)	Scheduled Calibration
Power meter E4419B	GB41293874	29-Mar-07 (METAS, No. 217-00670)	Mar-08
Power sensor E4412A	MY41495277	29-Mar-07 (METAS, No. 217-00670)	Mar-08
Power sensor E4412A	MY41498087	29-Mar-07 (METAS, No. 217-00670)	Mar-08
Reference 3 dB Attenuator	SN: S5054 (3c)	8-Aug-07 (METAS, No. 217-00719)	Aug-08
Reference 20 dB Attenuator	SN: S5086 (20b)	29-Mar-07 (METAS, No. 217-00671)	Mar-08
Reference 30 dB Attenuator	SN: S5129 (30b)	8-Aug-07 (METAS, No. 217-00720)	Aug-08
Reference Probe ES3DV2	SN: 3013	4-Jan-07 (SPEAG, No. ES3-3013_Jan07)	Jan-08
DAE4	SN: 654	20-Apr-07 (SPEAG, No. DAE4-654_Apr07)	Apr-08
Secondary Standards	ID #	Check Date (in house)	Scheduled Check
RF generator HP 8648C	US3642U01700	4-Aug-99 (SPEAG, in house check Oct-07)	In house check: Oct-09
Network Analyzer HP 8753E	US37390585	18-Oct-01 (SPEAG, in house check Oct-07)	In house check: Oct-08

	Name	Function	Signature
Calibrated by:	Katja Pokovic	Technical Manager	
Approved by:	Niels Kusler	Quality Manager	

Issued: November 20, 2007

This calibration certificate shall not be reproduced except in full without written approval of the laboratory.



Accredited by the Swiss Accreditation Service (SAS)
The Swiss Accreditation Service is one of the signatories to the EA
Multilateral Agreement for the recognition of calibration certificates

Accreditation No.: **SCS 108**

Glossary:

TSL	tissue simulating liquid
NORM _{x,y,z}	sensitivity in free space
ConvF	sensitivity in TSL / NORM _{x,y,z}
DCP	diode compression point
Polarization ϕ	ϕ rotation around probe axis
Polarization ϑ	ϑ rotation around an axis that is in the plane normal to probe axis (at measurement center), i.e., $\vartheta = 0$ is normal to probe axis

Calibration is Performed According to the Following Standards:

- IEEE Std 1528-2003, "IEEE Recommended Practice for Determining the Peak Spatial-Averaged Specific Absorption Rate (SAR) in the Human Head from Wireless Communications Devices: Measurement Techniques", December 2003
- IEC 62209-1, "Procedure to measure the Specific Absorption Rate (SAR) for hand-held devices used in close proximity to the ear (frequency range of 300 MHz to 3 GHz)", February 2005

Methods Applied and Interpretation of Parameters:

- NORM_{x,y,z}**: Assessed for E-field polarization $\vartheta = 0$ ($f \leq 900$ MHz in TEM-cell; $f > 1800$ MHz: R22 waveguide). NORM_{x,y,z} are only intermediate values, i.e., the uncertainties of NORM_{x,y,z} does not effect the E^2 -field uncertainty inside TSL (see below *ConvF*).
- NORM(f)_{x,y,z} = NORM_{x,y,z} * frequency_response** (see Frequency Response Chart). This linearization is implemented in DASY4 software versions later than 4.2. The uncertainty of the frequency response is included in the stated uncertainty of *ConvF*.
- DCP_{x,y,z}**: DCP are numerical linearization parameters assessed based on the data of power sweep (no uncertainty required). DCP does not depend on frequency nor media.
- ConvF and Boundary Effect Parameters**: Assessed in flat phantom using E-field (or Temperature Transfer Standard for $f \leq 800$ MHz) and inside waveguide using analytical field distributions based on power measurements for $f > 800$ MHz. The same setups are used for assessment of the parameters applied for boundary compensation (alpha, depth) of which typical uncertainty values are given. These parameters are used in DASY4 software to improve probe accuracy close to the boundary. The sensitivity in TSL corresponds to NORM_{x,y,z} * ConvF whereby the uncertainty corresponds to that given for ConvF. A frequency dependent ConvF is used in DASY version 4.4 and higher which allows extending the validity from ± 50 MHz to ± 100 MHz.
- Spherical isotropy (3D deviation from isotropy)**: in a field of low gradients realized using a flat phantom exposed by a patch antenna.
- Sensor Offset**: The sensor offset corresponds to the offset of virtual measurement center from the probe tip (on probe axis). No tolerance required.

Probe ET3DV6

SN:1790

Manufactured:	May 28, 2003
Last calibrated:	November 23, 2006
Recalibrated:	November 20, 2007

Calibrated for DASY Systems

(Note: non-compatible with DASY2 system!)

DASY - Parameters of Probe: ET3DV6 SN:1790

Sensitivity in Free Space ^A			Diode Compression ^B	
NormX	2.10 ± 10.1%	$\mu\text{V}/(\text{V}/\text{m})^2$	DCP X	92 mV
NormY	2.11 ± 10.1%	$\mu\text{V}/(\text{V}/\text{m})^2$	DCP Y	92 mV
NormZ	1.77 ± 10.1%	$\mu\text{V}/(\text{V}/\text{m})^2$	DCP Z	92 mV

Sensitivity in Tissue Simulating Liquid (Conversion Factors)

Please see Page 8.

Boundary Effect

TSL	900 MHz	Typical SAR gradient: 5 % per mm	
	Sensor Center to Phantom Surface Distance	3.7 mm	4.7 mm
	SAR _{be} [%] Without Correction Algorithm	6.2	3.3
	SAR _{be} [%] With Correction Algorithm	0.8	0.5

TSL	1750 MHz	Typical SAR gradient: 10 % per mm	
	Sensor Center to Phantom Surface Distance	3.7 mm	4.7 mm
	SAR _{be} [%] Without Correction Algorithm	12.2	8.1
	SAR _{be} [%] With Correction Algorithm	0.9	0.0

Sensor Offset

Probe Tip to Sensor Center	2.7 mm
----------------------------	--------

The reported uncertainty of measurement is stated as the standard uncertainty of measurement multiplied by the coverage factor k=2, which for a normal distribution corresponds to a coverage probability of approximately 95%.

^A The uncertainties of NormX,Y,Z do not affect the E²-field uncertainty inside TSL (see Page 8).

^B Numerical linearization parameter: uncertainty not required.

Frequency Response of E-Field

(TEM-Cell:ifi110 EXX, Waveguide: R22)

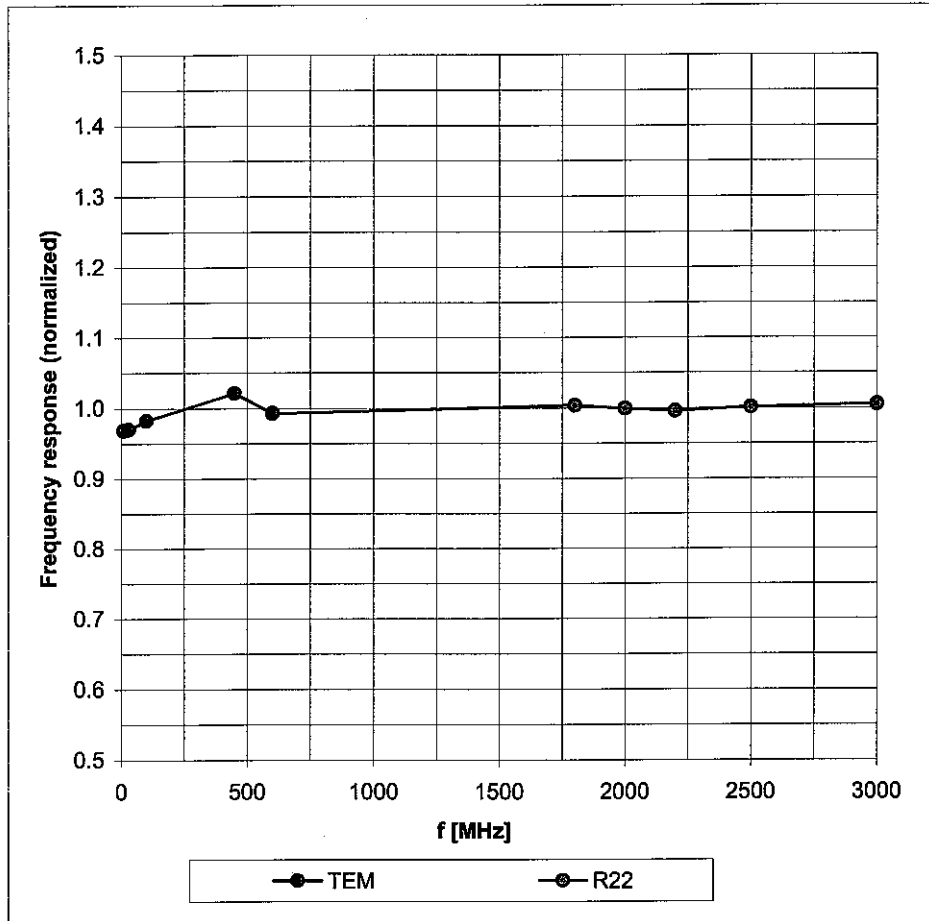

Uncertainty of Frequency Response of E-field: $\pm 6.3\%$ (k=2)

Receiving Pattern (ϕ), $\vartheta = 0^\circ$

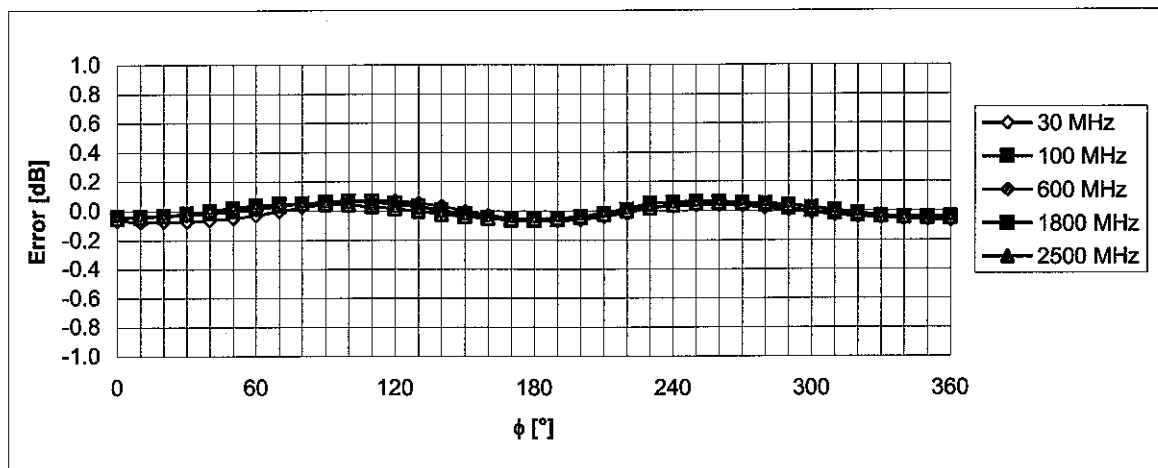
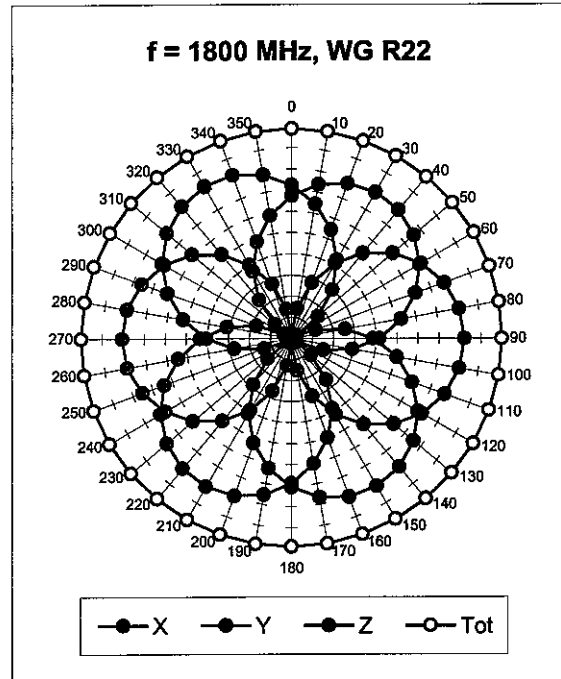
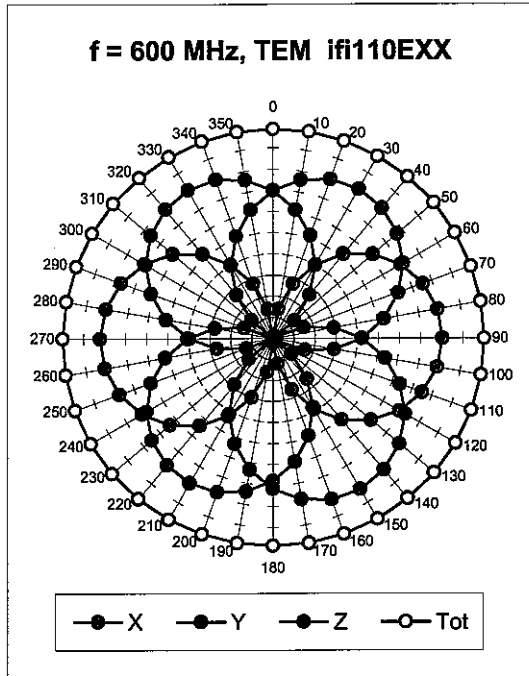

Uncertainty of Axial Isotropy Assessment: $\pm 0.5\%$ ($k=2$)

Dynamic Range f(SAR_{head}) (Waveguide R22, f = 1800 MHz)

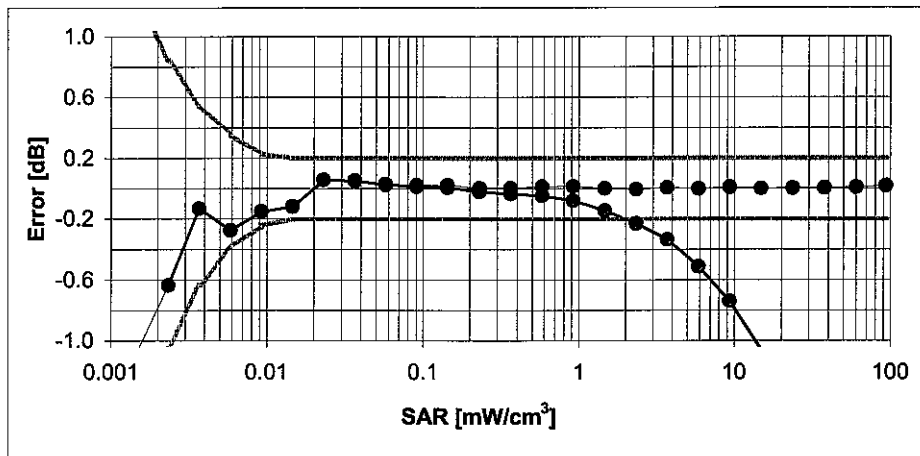
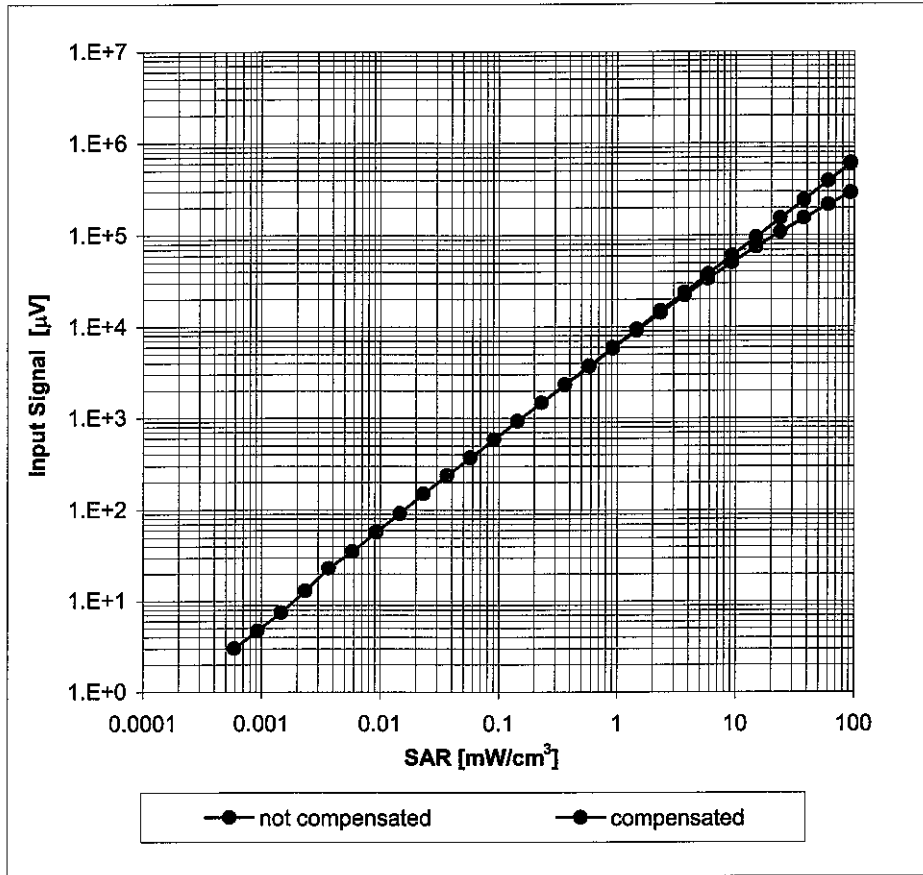

Uncertainty of Linearity Assessment: $\pm 0.6\%$ (k=2)

Conversion Factor Assessment

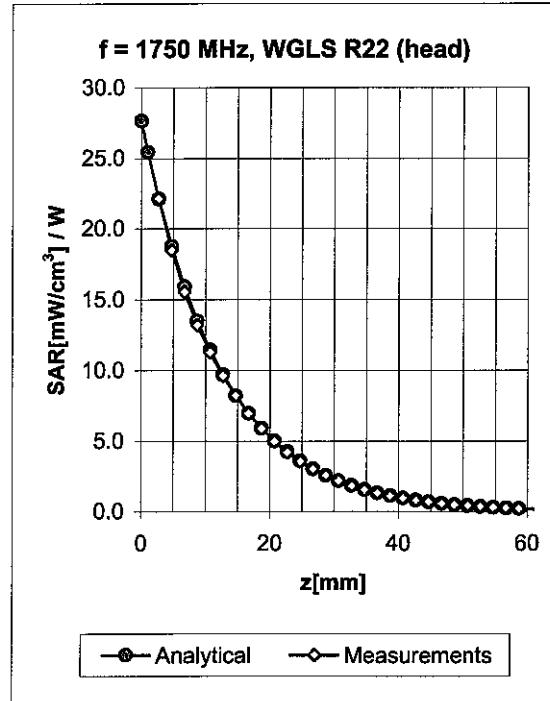
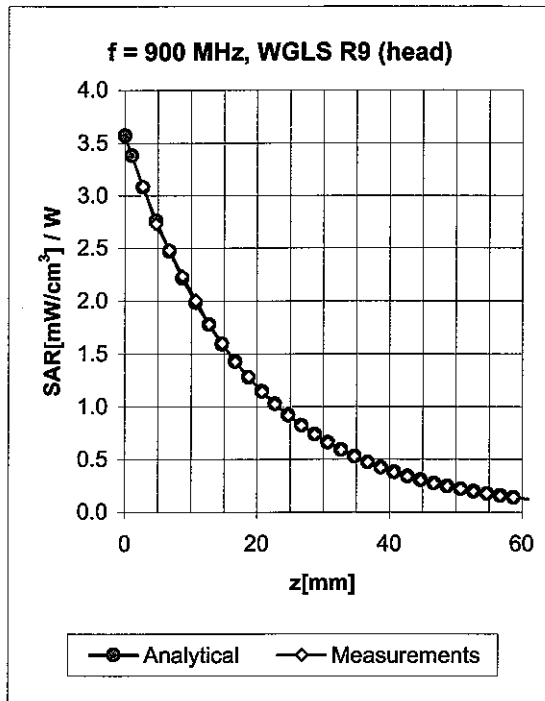

f [MHz]	Validity [MHz] ^c	TSL	Permittivity	Conductivity	Alpha	Depth	ConvF Uncertainty
900	± 50 / ± 100	Head	41.5 ± 5%	0.97 ± 5%	0.59	2.17	6.65 ± 11.0% (k=2)
1750	± 50 / ± 100	Head	40.1 ± 5%	1.37 ± 5%	0.59	2.28	5.42 ± 11.0% (k=2)
1950	± 50 / ± 100	Head	40.0 ± 5%	1.40 ± 5%	0.63	2.14	5.10 ± 11.0% (k=2)
2450	± 50 / ± 100	Head	39.2 ± 5%	1.80 ± 5%	0.74	1.94	4.74 ± 11.8% (k=2)
900	± 50 / ± 100	Body	55.0 ± 5%	1.05 ± 5%	0.67	2.06	6.15 ± 11.0% (k=2)
1750	± 50 / ± 100	Body	53.4 ± 5%	1.49 ± 5%	0.57	2.54	4.98 ± 11.0% (k=2)
1950	± 50 / ± 100	Body	53.3 ± 5%	1.52 ± 5%	0.60	2.49	4.58 ± 11.0% (k=2)
2450	± 50 / ± 100	Body	52.7 ± 5%	1.95 ± 5%	0.66	2.27	4.16 ± 11.8% (k=2)

^c The validity of ± 100 MHz only applies for DASY v4.4 and higher (see Page 2). The uncertainty is the RSS of the ConvF uncertainty at calibration frequency and the uncertainty for the indicated frequency band.

Deviation from Isotropy in HSL

Error (ϕ , ϑ), $f = 900$ MHz

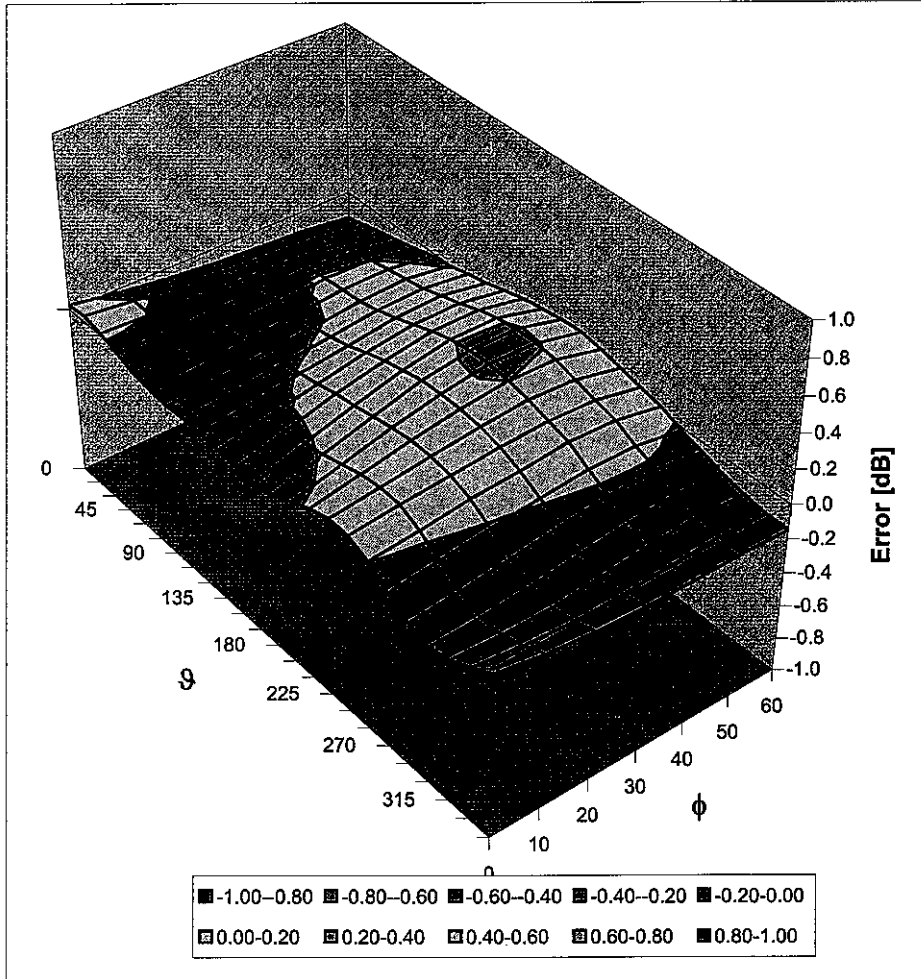

Uncertainty of Spherical Isotropy Assessment: $\pm 2.6\%$ ($k=2$)



Accredited by the Swiss Federal Office of Metrology and Accreditation
The Swiss Accreditation Service is one of the signatories to the EA
Multilateral Agreement for the recognition of calibration certificates

Accreditation No.: **SCS 108**

Client **ADT (Auden)**

Certificate No: **DAE3-510_Aug07**

CALIBRATION CERTIFICATE

Object **DAE3 - SD.000 D03 AA - SN: 510**

Calibration procedure(s) **QA CAL-06 v12
Calibration procedure for the data acquisition electronics (DAE)**

Calibration date: **August 29, 2007**

Condition of the calibrated item **In Tolerance**

This calibration certificate documents the traceability to national standards, which realize the physical units of measurements (SI).
The measurements and the uncertainties with confidence probability are given on the following pages and are part of the certificate.

All calibrations have been conducted in the closed laboratory facility: environment temperature (22 ± 3)°C and humidity < 70%.

Calibration Equipment used (M&TE critical for calibration)

Primary Standards	ID #	Cal Date (Calibrated by, Certificate No.)	Scheduled Calibration
Fluke Process Calibrator Type 702	SN: 6295803	13-Oct-06 (Elcal AG, No: 5492)	Oct-07
Keithley Multimeter Type 2001	SN: 0810278	03-Oct-06 (Elcal AG, No: 5478)	Oct-07
Secondary Standards	ID #	Check Date (in house)	Scheduled Check
Calibrator Box V1.1	SE UMS 006 AB 1004	25-Jun-07 (SPEAG, in house check)	In house check Jun-08

	Name	Function	Signature
Calibrated by:	Dominique Steffen	Technician	

	Name	Function	Signature
Approved by:	Fin Bornholt	R&D Director	

Issued: August 29, 2007

This calibration certificate shall not be reproduced except in full without written approval of the laboratory.



Glossary

DAE	data acquisition electronics
Connector angle	information used in DASY system to align probe sensor X to the robot coordinate system.

Methods Applied and Interpretation of Parameters

- *DC Voltage Measurement:* Calibration Factor assessed for use in DASY system by comparison with a calibrated instrument traceable to national standards. The figure given corresponds to the full scale range of the voltmeter in the respective range.
- *Connector angle:* The angle of the connector is assessed measuring the angle mechanically by a tool inserted. Uncertainty is not required.
- The following parameters contain technical information as a result from the performance test and require no uncertainty.
- *DC Voltage Measurement Linearity:* Verification of the Linearity at +10% and -10% of the nominal calibration voltage. Influence of offset voltage is included in this measurement.
- *Common mode sensitivity:* Influence of a positive or negative common mode voltage on the differential measurement.
- *Channel separation:* Influence of a voltage on the neighbor channels not subject to an input voltage.
- *AD Converter Values with inputs shorted:* Values on the internal AD converter corresponding to zero input voltage
- *Input Offset Measurement:* Output voltage and statistical results over a large number of zero voltage measurements.
- *Input Offset Current:* Typical value for information; Maximum channel input offset current, not considering the input resistance.
- *Input resistance:* DAE input resistance at the connector, during internal auto-zeroing and during measurement.
- *Low Battery Alarm Voltage:* Typical value for information. Below this voltage, a battery alarm signal is generated.
- *Power consumption:* Typical value for information. Supply currents in various operating modes.

DC Voltage Measurement

A/D - Converter Resolution nominal

High Range: 1LSB = 6.1 μ V, full range = -100...+300 mV

Low Range: 1LSB = 61nV, full range = -1.....+3mV

DASY measurement parameters: Auto Zero Time: 3 sec; Measuring time: 3 sec

Calibration Factors	X	Y	Z
High Range	404.150 \pm 0.1% (k=2)	404.218 \pm 0.1% (k=2)	404.585 \pm 0.1% (k=2)
Low Range	3.98817 \pm 0.7% (k=2)	3.97339 \pm 0.7% (k=2)	3.96897 \pm 0.7% (k=2)

Connector Angle

Connector Angle to be used in DASY system	42 $^{\circ}$ \pm 1 $^{\circ}$
---	----------------------------------

Appendix

1. DC Voltage Linearity

High Range		Input (μV)	Reading (μV)	Error (%)
Channel X	+ Input	200000	200000.7	0.00
Channel X	+ Input	20000	20006.63	0.03
Channel X	- Input	20000	-19999.14	0.00
Channel Y	+ Input	200000	199999.5	0.00
Channel Y	+ Input	20000	20005.23	0.03
Channel Y	- Input	20000	-20002.04	0.01
Channel Z	+ Input	200000	199999.6	0.00
Channel Z	+ Input	20000	20006.53	0.03
Channel Z	- Input	20000	-20001.38	0.01

Low Range		Input (μV)	Reading (μV)	Error (%)
Channel X	+ Input	2000	2000	0.00
Channel X	+ Input	200	199.97	-0.01
Channel X	- Input	200	-199.90	-0.05
Channel Y	+ Input	2000	2000.1	0.00
Channel Y	+ Input	200	199.64	-0.18
Channel Y	- Input	200	-200.58	0.29
Channel Z	+ Input	2000	2000	0.00
Channel Z	+ Input	200	199.20	-0.40
Channel Z	- Input	200	-200.81	0.41

2. Common mode sensitivity

DASY measurement parameters: Auto Zero Time: 3 sec; Measuring time: 3 sec

	Common mode Input Voltage (mV)	High Range Average Reading (μV)	Low Range Average Reading (μV)
Channel X	200	17.82	16.82
	- 200	-16.18	-16.83
Channel Y	200	14.68	14.20
	- 200	-15.70	-16.05
Channel Z	200	-8.25	-8.73
	- 200	8.01	8.08

3. Channel separation

DASY measurement parameters: Auto Zero Time: 3 sec; Measuring time: 3 sec

	Input Voltage (mV)	Channel X (μV)	Channel Y (μV)	Channel Z (μV)
Channel X	200	-	0.75	1.74
Channel Y	200	2.34	-	2.77
Channel Z	200	-1.43	0.25	-

4. AD-Converter Values with inputs shorted

DASY measurement parameters: Auto Zero Time: 3 sec; Measuring time: 3 sec

	High Range (LSB)	Low Range (LSB)
Channel X	15893	16120
Channel Y	16114	16051
Channel Z	16081	16196

5. Input Offset Measurement

DASY measurement parameters: Auto Zero Time: 3 sec; Measuring time: 3 sec

Input 10M Ω

	Average (μ V)	min. Offset (μ V)	max. Offset (μ V)	Std. Deviation (μ V)
Channel X	-0.67	-1.71	-0.06	0.26
Channel Y	-1.04	-3.37	0.35	0.34
Channel Z	-1.26	-3.29	0.15	0.35

6. Input Offset Current

Nominal Input circuitry offset current on all channels: <25fA

7. Input Resistance

	Zeroing (MOhm)	Measuring (MOhm)
Channel X	0.2001	198.5
Channel Y	0.2001	199.2
Channel Z	0.2000	200.3

8. Low Battery Alarm Voltage (verified during pre test)

Typical values	Alarm Level (VDC)
Supply (+ Vcc)	+7.9
Supply (- Vcc)	-7.6

9. Power Consumption (verified during pre test)

Typical values	Switched off (mA)	Stand by (mA)	Transmitting (mA)
Supply (+ Vcc)	+0.0	+6	+14
Supply (- Vcc)	-0.01	-8	-9

IMPORTANT NOTICE

USAGE OF THE DAE 3

The DAE unit is a delicate, high precision instrument and requires careful treatment by the user. There are no serviceable parts inside the DAE. Special attention shall be given to the following points:

Battery Exchange: The battery cover of the DAE3 unit is connected to a fragile 3-pin battery connector. Customer is responsible to apply utmost caution not to bend or damage the connector when changing batteries.

Shipping of the DAE: Before shipping the DAE to SPEAG for calibration Customer shall remove the batteries and pack the DAE in an antistatic bag. The packaging shall protect the DAE from impacts during transportation. The package shall be marked to indicate that a fragile instrument is inside.

E-Stop Failures: Touch detection may be malfunctioning due to broken magnets in the E-stop. Rough handling of the E-stop may lead to damage of these magnets. Touch and collision errors are often caused by dust and dirt accumulated in the E-stop. To prevent E-stop failure, Customer shall always mount the probe to the DAE carefully and keep the DAE unit in a non-dusty environment if not used for measurements.

Repair: Minor repairs are performed at no extra cost during the annual calibration. However, SPEAG reserves the right to charge for any repair especially if rough unprofessional handling caused the defect.

Important Note:

Warranty and calibration is void if the DAE unit is disassembled partly or fully by the Customer.

Important Note:

Never attempt to grease or oil the E-stop assembly. Cleaning and readjusting of the E-stop assembly is allowed by certified SPEAG personnel only and is part of the annual calibration procedure.



Accredited by the Swiss Accreditation Service (SAS)
The Swiss Accreditation Service is one of the signatories to the EA
Multilateral Agreement for the recognition of calibration certificates

Accreditation No.: **SCS 108**

Client **ADT (Auden)**

Certificate No: **DAE3-579_Mar08**

CALIBRATION CERTIFICATE

Object **DAE3 - SD 000 D03 AA - SN: 579**

Calibration procedure(s) **QA CAL-06.v12
Calibration procedure for the data acquisition electronics (DAE)**

Calibration date: **March 13, 2008**

Condition of the calibrated item **In Tolerance**

This calibration certificate documents the traceability to national standards, which realize the physical units of measurements (SI).
The measurements and the uncertainties with confidence probability are given on the following pages and are part of the certificate.

All calibrations have been conducted in the closed laboratory facility: environment temperature (22 ± 3)°C and humidity < 70%.

Calibration Equipment used (M&TE critical for calibration)

Primary Standards	ID #	Cal Date (Calibrated by, Certificate No.)	Scheduled Calibration
Fluke Process Calibrator Type 702	SN: 6295803	04-Oct-07 (Elcal AG, No: 6467)	Oct-08
Keithley Multimeter Type 2001	SN: 0810278	03-Oct-07 (Elcal AG, No: 6465)	Oct-08
Secondary Standards	ID #	Check Date (in house)	Scheduled Check
Calibrator Box V1.1	SE UMS 006 AB 1004	25-Jun-07 (SPEAG, in house check)	In house check Jun-08

Calibrated by:	Name Dominique Steffen	Function Technician	Signature
Approved by:	Fin Bornholt	R&D Director	

Issued: March 13, 2008

This calibration certificate shall not be reproduced except in full without written approval of the laboratory.



Glossary

DAE	data acquisition electronics
Connector angle	information used in DASY system to align probe sensor X to the robot coordinate system.

Methods Applied and Interpretation of Parameters

- *DC Voltage Measurement:* Calibration Factor assessed for use in DASY system by comparison with a calibrated instrument traceable to national standards. The figure given corresponds to the full scale range of the voltmeter in the respective range.
- *Connector angle:* The angle of the connector is assessed measuring the angle mechanically by a tool inserted. Uncertainty is not required.
- The following parameters as documented in the Appendix contain technical information as a result from the performance test and require no uncertainty.
 - *DC Voltage Measurement Linearity:* Verification of the Linearity at +10% and -10% of the nominal calibration voltage. Influence of offset voltage is included in this measurement.
 - *Common mode sensitivity:* Influence of a positive or negative common mode voltage on the differential measurement.
 - *Channel separation:* Influence of a voltage on the neighbor channels not subject to an input voltage.
 - *AD Converter Values with inputs shorted:* Values on the internal AD converter corresponding to zero input voltage
 - *Input Offset Measurement:* Output voltage and statistical results over a large number of zero voltage measurements.
 - *Input Offset Current:* Typical value for information; Maximum channel input offset current, not considering the input resistance.
 - *Input resistance:* DAE input resistance at the connector, during internal auto-zeroing and during measurement.
 - *Low Battery Alarm Voltage:* Typical value for information. Below this voltage, a battery alarm signal is generated.
 - *Power consumption:* Typical value for information. Supply currents in various operating modes.

DC Voltage Measurement

A/D - Converter Resolution nominal

High Range: 1LSB = 6.1 μ V, full range = -100...+300 mV

Low Range: 1LSB = 61nV, full range = -1.....+3mV

DASY measurement parameters: Auto Zero Time: 3 sec; Measuring time: 3 sec

Calibration Factors	X	Y	Z
High Range	404.417 \pm 0.1% (k=2)	404.496 \pm 0.1% (k=2)	404.250 \pm 0.1% (k=2)
Low Range	3.96392 \pm 0.7% (k=2)	3.98485 \pm 0.7% (k=2)	3.94736 \pm 0.7% (k=2)

Connector Angle

Connector Angle to be used in DASY system	0 $^{\circ}$ \pm 1 $^{\circ}$
---	---------------------------------

Appendix

1. DC Voltage Linearity

High Range		Input (μV)	Reading (μV)	Error (%)
Channel X	+ Input	200000	199999.9	0.00
Channel X	+ Input	20000	20006.39	0.03
Channel X	- Input	20000	-19997.12	-0.01
Channel Y	+ Input	200000	199999.6	0.00
Channel Y	+ Input	20000	20003.48	0.02
Channel Y	- Input	20000	-19999.40	0.00
Channel Z	+ Input	200000	200000.5	0.00
Channel Z	+ Input	20000	20005.11	0.03
Channel Z	- Input	20000	-20000.56	0.00

Low Range		Input (μV)	Reading (μV)	Error (%)
Channel X	+ Input	2000	1999.9	0.00
Channel X	+ Input	200	200.77	0.38
Channel X	- Input	200	-199.61	-0.19
Channel Y	+ Input	2000	1999.9	0.00
Channel Y	+ Input	200	199.52	-0.24
Channel Y	- Input	200	-200.01	0.00
Channel Z	+ Input	2000	2000	0.00
Channel Z	+ Input	200	200.04	0.02
Channel Z	- Input	200	-200.10	0.05

2. Common mode sensitivity

DASY measurement parameters: Auto Zero Time: 3 sec; Measuring time: 3 sec

	Common mode Input Voltage (mV)	High Range Average Reading (μV)	Low Range Average Reading (μV)
Channel X	200	7.31	7.04
	- 200	-5.43	-5.14
Channel Y	200	-4.64	3.79
	- 200	9.97	2.98
Channel Z	200	9.71	9.67
	- 200	-10.05	-10.25

3. Channel separation

DASY measurement parameters: Auto Zero Time: 3 sec; Measuring time: 3 sec

	Input Voltage (mV)	Channel X (μV)	Channel Y (μV)	Channel Z (μV)
Channel X	200	-	0.91	1.12
Channel Y	200	1.44	-	4.27
Channel Z	200	-2.15	0.74	-

4. AD-Converter Values with inputs shorted

DASY measurement parameters: Auto Zero Time: 3 sec; Measuring time: 3 sec

	High Range (LSB)	Low Range (LSB)
Channel X	16337	17475
Channel Y	16186	16655
Channel Z	15807	16761

5. Input Offset Measurement

DASY measurement parameters: Auto Zero Time: 3 sec; Measuring time: 3 sec

Input 10M Ω

	Average (μ V)	min. Offset (μ V)	max. Offset (μ V)	Std. Deviation (μ V)
Channel X	-0.02	-1.05	2.46	0.44
Channel Y	-1.99	-3.37	-0.92	0.33
Channel Z	2.37	0.38	3.81	0.43

6. Input Offset Current

Nominal Input circuitry offset current on all channels: <25fA

7. Input Resistance

	Zeroing (MOhm)	Measuring (MOhm)
Channel X	0.2001	199.5
Channel Y	0.2000	202.9
Channel Z	0.1999	204.2

8. Low Battery Alarm Voltage (verified during pre test)

Typical values	Alarm Level (VDC)
Supply (+ Vcc)	+7.9
Supply (- Vcc)	-7.6

9. Power Consumption (verified during pre test)

Typical values	Switched off (mA)	Stand by (mA)	Transmitting (mA)
Supply (+ Vcc)	+0.0	+6	+14
Supply (- Vcc)	-0.01	-8	-9



Accredited by the Swiss Federal Office of Metrology and Accreditation
The Swiss Accreditation Service is one of the signatories to the EA
Multilateral Agreement for the recognition of calibration certificates

Accreditation No.: **SCS 108**

Client **ADT (Auden)**

Certificate No: **D2450V2-716_Aug07**

CALIBRATION CERTIFICATE

Object **D2450V2 - SN: 716**

Calibration procedure(s) **QA CAL-05.v6
Calibration procedure for dipole validation kits**

Calibration date: **August 20, 2007**

Condition of the calibrated item **In Tolerance**

This calibration certificate documents the traceability to national standards, which realize the physical units of measurements (SI).
The measurements and the uncertainties with confidence probability are given on the following pages and are part of the certificate.

All calibrations have been conducted in the closed laboratory facility: environment temperature (22 ± 3)°C and humidity < 70%.

Calibration Equipment used (M&TE critical for calibration)

Primary Standards	ID #	Cal Date (Calibrated by, Certificate No.)	Scheduled Calibration
Power meter EPM-442A	GB37480704	03-Oct-06 (METAS, No. 217-00608)	Oct-07
Power sensor HP 8481A	US37292783	03-Oct-06 (METAS, No. 217-00608)	Oct-07
Reference 20 dB Attenuator	SN: 5086 (20g)	07-Aug-07 (METAS, No 217-00718)	Aug-08
Reference 10 dB Attenuator	SN: 5047.2 (10r)	07-Aug-07 (METAS, No 217-00718)	Aug-08
Reference Probe ES3DV3	SN 3025	19-Oct-06 (SPEAG, No. ES3-3025_Oct06)	Oct-07
DAE4	SN 601	30-Jan-07 (SPEAG, No. DAE4-601_Jan07)	Jan-08

Secondary Standards	ID #	Check Date (in house)	Scheduled Check
Power sensor HP 8481A	MY41092317	18-Oct-02 (SPEAG, in house check Oct-05)	In house check: Oct-07
RF generator Agilent E4421B	MY41000675	11-May-05 (SPEAG, in house check Nov-05)	In house check: Nov-07
Network Analyzer HP 8753E	US37390585 S4206	18-Oct-01 (SPEAG, in house check Oct-06)	In house check: Oct-07

Calibrated by: **Name: Mike Meili, Function: Laboratory Technician, Signature: [Handwritten]**

Approved by: **Katja Pokovic, Technical Manager, Signature: [Handwritten]**

Issued: August 21, 2007

This calibration certificate shall not be reproduced except in full without written approval of the laboratory.



Accredited by the Swiss Federal Office of Metrology and Accreditation
The Swiss Accreditation Service is one of the signatories to the EA
Multilateral Agreement for the recognition of calibration certificates

Accreditation No.: **SCS 108**

Glossary:

TSL	tissue simulating liquid
ConvF	sensitivity in TSL / NORM x,y,z
N/A	not applicable or not measured

Calibration is Performed According to the Following Standards:

- a) IEEE Std 1528-2003, "IEEE Recommended Practice for Determining the Peak Spatial-Averaged Specific Absorption Rate (SAR) in the Human Head from Wireless Communications Devices: Measurement Techniques", December 2003
- b) IEC 62209-1, "Procedure to measure the Specific Absorption Rate (SAR) for hand-held devices used in close proximity to the ear (frequency range of 300 MHz to 3 GHz)", February 2005
- c) Federal Communications Commission Office of Engineering & Technology (FCC OET), "Evaluating Compliance with FCC Guidelines for Human Exposure to Radiofrequency Electromagnetic Fields; Additional Information for Evaluating Compliance of Mobile and Portable Devices with FCC Limits for Human Exposure to Radiofrequency Emissions", Supplement C (Edition 01-01) to Bulletin 65

Additional Documentation:

- d) DASY4 System Handbook

Methods Applied and Interpretation of Parameters:

- *Measurement Conditions:* Further details are available from the Validation Report at the end of the certificate. All figures stated in the certificate are valid at the frequency indicated.
- *Antenna Parameters with TSL:* The dipole is mounted with the spacer to position its feed point exactly below the center marking of the flat phantom section, with the arms oriented parallel to the body axis.
- *Feed Point Impedance and Return Loss:* These parameters are measured with the dipole positioned under the liquid filled phantom. The impedance stated is transformed from the measurement at the SMA connector to the feed point. The Return Loss ensures low reflected power. No uncertainty required.
- *Electrical Delay:* One-way delay between the SMA connector and the antenna feed point. No uncertainty required.
- *SAR measured:* SAR measured at the stated antenna input power.
- *SAR normalized:* SAR as measured, normalized to an input power of 1 W at the antenna connector.
- *SAR for nominal TSL parameters:* The measured TSL parameters are used to calculate the nominal SAR result.

Measurement Conditions

DASY system configuration, as far as not given on page 1.

DASY Version	DASY4	V4.7
Extrapolation	Advanced Extrapolation	
Phantom	Modular Flat Phantom V5.0	
Distance Dipole Center - TSL	10 mm	with Spacer
Zoom Scan Resolution	dx, dy, dz = 5 mm	
Frequency	2450 MHz \pm 1 MHz	

Head TSL parameters

The following parameters and calculations were applied.

	Temperature	Permittivity	Conductivity
Nominal Head TSL parameters	22.0 °C	39.2	1.80 mho/m
Measured Head TSL parameters	(22.0 \pm 0.2) °C	38.7 \pm 6 %	1.81 mho/m \pm 6 %
Head TSL temperature during test	(22.3 \pm 0.2) °C	-----	-----

SAR result with Head TSL

SAR averaged over 1 cm ³ (1 g) of Head TSL	condition	
SAR measured	250 mW input power	13.2 mW / g
SAR normalized	normalized to 1W	52.8 mW / g
SAR for nominal Head TSL parameters ¹	normalized to 1W	52.4 mW / g \pm 17.0 % (k=2)

SAR averaged over 10 cm ³ (10 g) of Head TSL	condition	
SAR measured	250 mW input power	6.14 mW / g
SAR normalized	normalized to 1W	24.6 mW / g
SAR for nominal Head TSL parameters ¹	normalized to 1W	24.4 mW / g \pm 16.5 % (k=2)

¹ Correction to nominal TSL parameters according to d), chapter "SAR Sensitivities"

Body TSL parameters

The following parameters and calculations were applied.

	Temperature	Permittivity	Conductivity
Nominal Body TSL parameters	22.0 °C	52.7	1.95 mho/m
Measured Body TSL parameters	(22.0 ± 0.2) °C	53.9 ± 6 %	1.97 mho/m ± 6 %
Body TSL temperature during test	(21.5 ± 0.2) °C	----	----

SAR result with Body TSL

SAR averaged over 1 cm ³ (1 g) of Body TSL	Condition	
SAR measured	250 mW input power	13.1 mW / g
SAR normalized	normalized to 1W	52.4 mW / g
SAR for nominal Body TSL parameters ²	normalized to 1W	52.8 mW / g ± 17.0 % (k=2)

SAR averaged over 10 cm ³ (10 g) of Body TSL	Condition	
SAR measured	250 mW input power	6.09 mW / g
SAR normalized	normalized to 1W	24.4 mW / g
SAR for nominal Body TSL parameters ²	normalized to 1W	24.5 mW / g ± 16.5 % (k=2)

² Correction to nominal TSL parameters according to d), chapter "SAR Sensitivities"

Appendix

Antenna Parameters with Head TSL

Impedance, transformed to feed point	$54.2 \Omega + 2.1 j\Omega$
Return Loss	- 26.9 dB

Antenna Parameters with Body TSL

Impedance, transformed to feed point	$49.5 \Omega + 3.6 j\Omega$
Return Loss	- 28.7 dB

General Antenna Parameters and Design

Electrical Delay (one direction)	1.147 ns
----------------------------------	----------

After long term use with 100W radiated power, only a slight warming of the dipole near the feedpoint can be measured.

The dipole is made of standard semirigid coaxial cable. The center conductor of the feeding line is directly connected to the second arm of the dipole. The antenna is therefore short-circuited for DC-signals.

No excessive force must be applied to the dipole arms, because they might bend or the soldered connections near the feedpoint may be damaged.

Additional EUT Data

Manufactured by	SPEAG
Manufactured on	September 10, 2002

DASY4 Validation Report for Head TSL

Date/Time: 20.08.2007 13:03:38

Test Laboratory: SPEAG, Zurich, Switzerland

DUT: Dipole 2450 MHz; Type: D2450V2; Serial: D2450V2 - SN716

Communication System: CW-2450; Frequency: 2450 MHz; Duty Cycle: 1:1

Medium: HSL U10 BB;

Medium parameters used: $f = 2450$ MHz; $\sigma = 1.81$ mho/m; $\epsilon_r = 38.7$; $\rho = 1000$ kg/m³

Phantom section: Flat Section

Measurement Standard: DASY4 (High Precision Assessment)

DASY4 Configuration:

- Probe: ES3DV2 - SN3025 (HF); ConvF(4.5, 4.5, 4.5); Calibrated: 19.10.2006
- Sensor-Surface: 4mm (Mechanical Surface Detection)
- Electronics: DAE4 Sn601; Calibrated: 30.01.2007
- Phantom: Flat Phantom 5.0 (front); Type: QD000P50AA
- Measurement SW: DASY4, V4.7 Build 53; Postprocessing SW: SEMCAD, V1.8 Build 172

Pin = 250 mW; d = 10 mm/Zoom Scan (7x7x7)/Cube 0:

Measurement grid: dx=5mm, dy=5mm, dz=5mm

Reference Value = 90.6 V/m; Power Drift = 0.032 dB

Peak SAR (extrapolated) = 27.5 W/kg

SAR(1 g) = 13.2 mW/g; SAR(10 g) = 6.14 mW/g

Maximum value of SAR (measured) = 14.3 mW/g

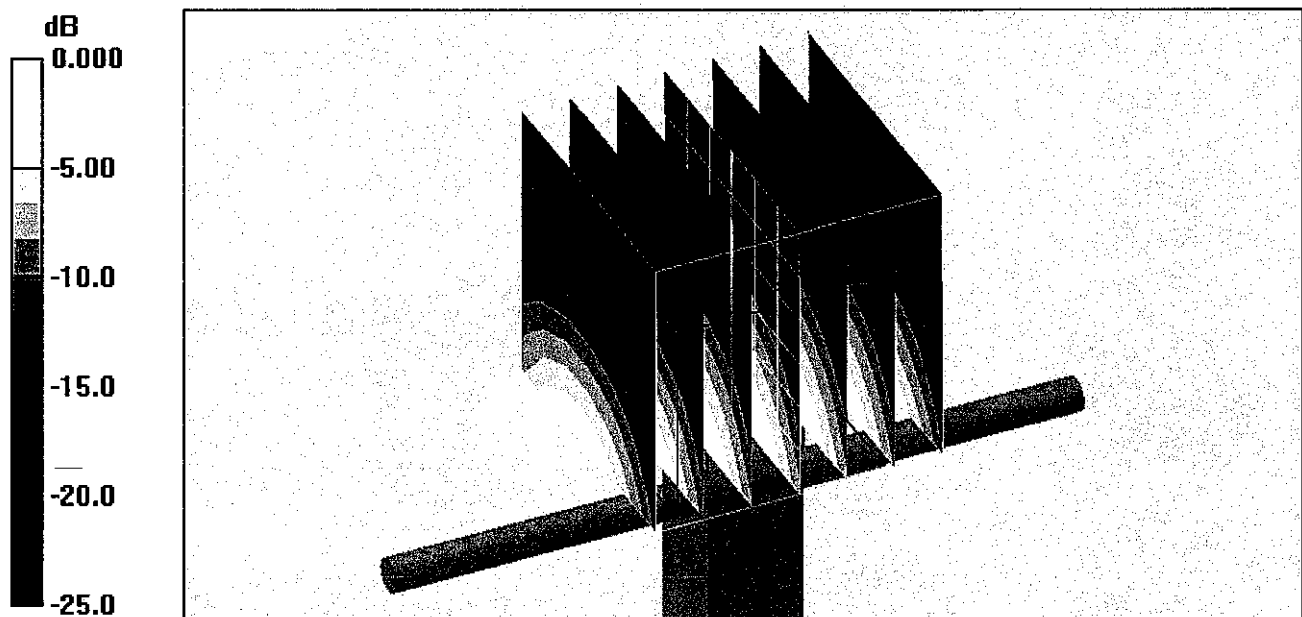

0 dB = 14.3mW/g

Impedance Measurement Plot for Head TSL

20 Aug 2007 11:53:21

CH1 S11 1 U FS 1: 54.225 Ω 2: 1.055 Ω 136.77 μH 2 450.000 000 MHz

*
Del
Cor

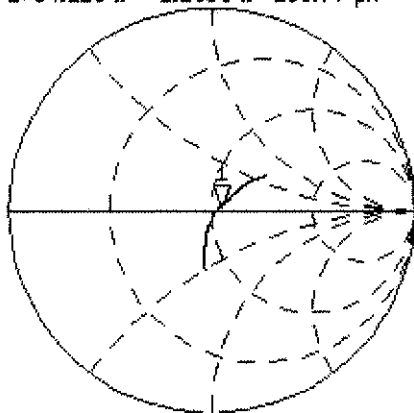

Avg
16

CH2 S11 LOG 5 dB/REF -20 dB 1: -26.879 dB 2 450.000 000 MHz

Cor

Avg
16

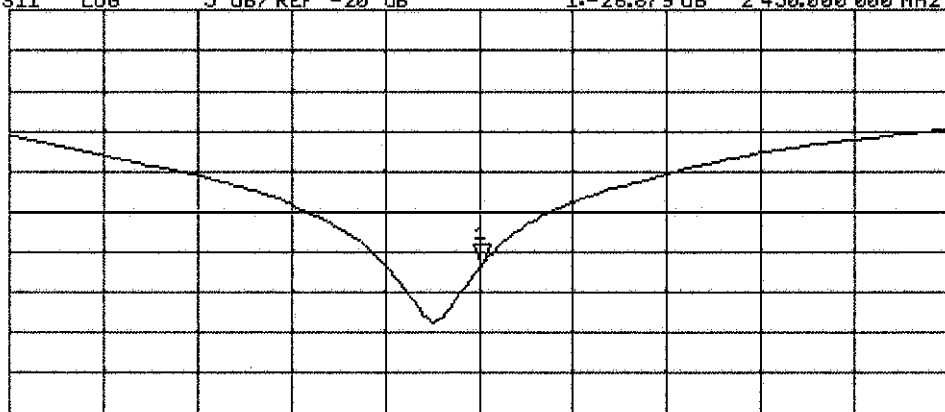

START 2 250.000 000 MHz

STOP 2 650.000 000 MHz

DASY4 Validation Report for Body TSL

Date/Time: 20.08.2007 14:23:38

Test Laboratory: SPEAG, Zurich, Switzerland

DUT: Dipole 2450 MHz; Type: D2450V2; Serial: D2450V2 - SN716

Communication System: CW-2450; Frequency: 2450 MHz; Duty Cycle: 1:1

Medium: MSL U10 BB;

Medium parameters used: $f = 2450$ MHz; $\sigma = 1.98$ mho/m; $\epsilon_r = 54$; $\rho = 1000$ kg/m³

Phantom section: Flat Section

Measurement Standard: DASY4 (High Precision Assessment)

DASY4 Configuration:

- Probe: ES3DV2 - SN3025 (HF); ConvF(4.16, 4.16, 4.16); Calibrated: 19.10.2006
- Sensor-Surface: 4mm (Mechanical Surface Detection)
- Electronics: DAE4 Sn601; Calibrated: 30.01.2007
- Phantom: Flat Phantom 5.0 (back); Type: QD000P50AA
- Measurement SW: DASY4, V4.7 Build 53; Postprocessing SW: SEMCAD, V1.8 Build 172

Pin = 250 mW; d = 10 mm/Zoom Scan (7x7x7)/Cube 0:

Measurement grid: dx=5mm, dy=5mm, dz=5mm

Reference Value = 87.6 V/m; Power Drift = 0.014 dB

Peak SAR (extrapolated) = 27.0 W/kg

SAR(1 g) = 13.1 mW/g; SAR(10 g) = 6.09 mW/g

Maximum value of SAR (measured) = 14.9 mW/g

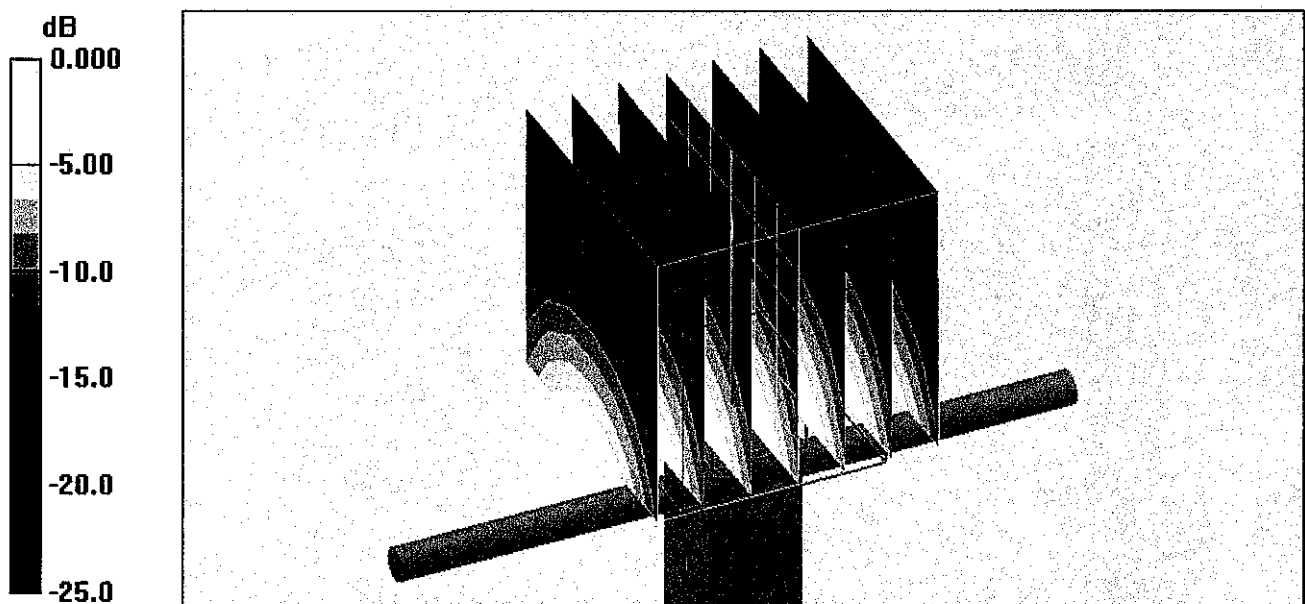

0 dB = 14.9mW/g

Impedance Measurement Plot for Body TSL

20 Aug 2007 11:53:48

CH1 S11 1 U FS 1: 49.539 Ω 3.6348 Ω 236.12 pF 2 450.000 000 MHz

*
De1
Cor

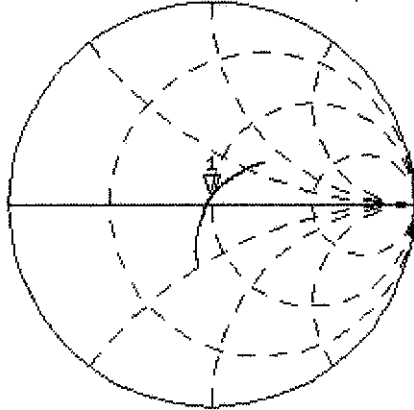

Avg
16
↑

CH2 S11 LOG 5 dB/REF -20 dB 1: -28.684 dB 2 450.000 000 MHz

Cor

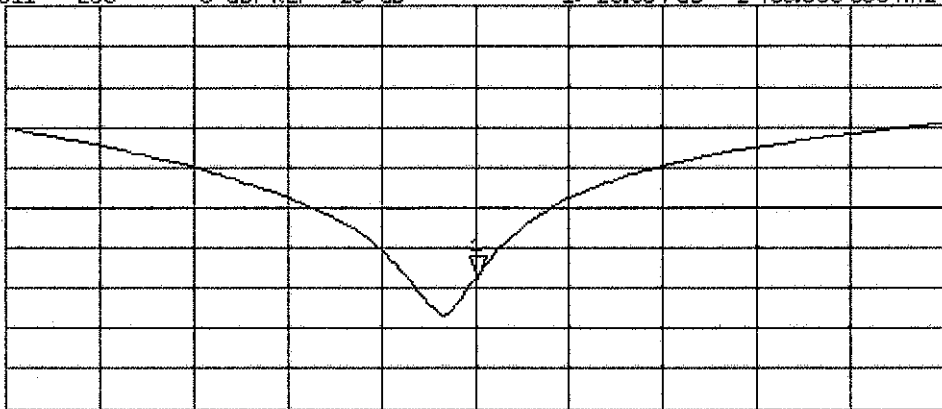

Avg
16
↑

START 2 250.000 000 MHz

STOP 2 650.000 000 MHz



Accredited by the Swiss Accreditation Service (SAS)
The Swiss Accreditation Service is one of the signatories to the EA
Multilateral Agreement for the recognition of calibration certificates

Accreditation No.: **SCS 108**

Client **ADT (Auden)**

Certificate No: **D2450V2-737_Apr08**

CALIBRATION CERTIFICATE

Object **D2450V2 - SN: 737**

Calibration procedure(s) **QA CAL-05.v7
Calibration procedure for dipole validation kits**

Calibration date: **April 22, 2008**

Condition of the calibrated item **In Tolerance**

This calibration certificate documents the traceability to national standards, which realize the physical units of measurements (SI).
The measurements and the uncertainties with confidence probability are given on the following pages and are part of the certificate.

All calibrations have been conducted in the closed laboratory facility: environment temperature (22 ± 3)°C and humidity < 70%.

Calibration Equipment used (M&TE critical for calibration)

Primary Standards	ID #	Cal Date (Certificate No.)	Scheduled Calibration
Power meter EPM-442A	GB37480704	04-Oct-07 (No. 217-00736)	Oct-08
Power sensor HP 8481A	US37292783	04-Oct-07 (No. 217-00736)	Oct-08
Reference 20 dB Attenuator	SN: 5086 (20g)	07-Aug-07 (No 217-00718)	Aug-08
Type-N mismatch combination	SN: 5047.2 / 06327	08-Aug-07 (No. 217-00721)	Aug-08
Reference Probe ES3DV2	SN: 3025	01-Mar-08 (No. ES3-3025_Mar08)	Mar-09
DAE4	SN: 601	14-Mar-08 (No. DAE4-601_Mar08)	Mar-09
Secondary Standards	ID #	Check Date (in house)	Scheduled Check
Power sensor HP 8481A	MY41092317	18-Oct-02 (in house check Oct-07)	In house check: Oct-09
RF generator R&S SMT-06	100005	4-Aug-99 (in house check Oct-07)	In house check: Oct-09
Network Analyzer HP 8753E	US37390585 S4206	18-Oct-01 (in house check Oct-07)	In house check: Oct-08

	Name	Function	Signature
Calibrated by:	Marcel Fehr	Laboratory Technician	
Approved by:	Katja Pokovic	Technical Manager	

Issued: April 23, 2008

This calibration certificate shall not be reproduced except in full without written approval of the laboratory.



Accredited by the Swiss Accreditation Service (SAS)
The Swiss Accreditation Service is one of the signatories to the EA
Multilateral Agreement for the recognition of calibration certificates

Accreditation No.: **SCS 108**

Glossary:

TSL	tissue simulating liquid
ConvF	sensitivity in TSL / NORM x,y,z
N/A	not applicable or not measured

Calibration is Performed According to the Following Standards:

- a) IEEE Std 1528-2003, "IEEE Recommended Practice for Determining the Peak Spatial-Averaged Specific Absorption Rate (SAR) in the Human Head from Wireless Communications Devices: Measurement Techniques", December 2003
- b) IEC 62209-1, "Procedure to measure the Specific Absorption Rate (SAR) for hand-held devices used in close proximity to the ear (frequency range of 300 MHz to 3 GHz)", February 2005
- c) Federal Communications Commission Office of Engineering & Technology (FCC OET), "Evaluating Compliance with FCC Guidelines for Human Exposure to Radiofrequency Electromagnetic Fields; Additional Information for Evaluating Compliance of Mobile and Portable Devices with FCC Limits for Human Exposure to Radiofrequency Emissions", Supplement C (Edition 01-01) to Bulletin 65

Additional Documentation:

- d) DASY4/5 System Handbook

Methods Applied and Interpretation of Parameters:

- *Measurement Conditions:* Further details are available from the Validation Report at the end of the certificate. All figures stated in the certificate are valid at the frequency indicated.
- *Antenna Parameters with TSL:* The dipole is mounted with the spacer to position its feed point exactly below the center marking of the flat phantom section, with the arms oriented parallel to the body axis.
- *Feed Point Impedance and Return Loss:* These parameters are measured with the dipole positioned under the liquid filled phantom. The impedance stated is transformed from the measurement at the SMA connector to the feed point. The Return Loss ensures low reflected power. No uncertainty required.
- *Electrical Delay:* One-way delay between the SMA connector and the antenna feed point. No uncertainty required.
- *SAR measured:* SAR measured at the stated antenna input power.
- *SAR normalized:* SAR as measured, normalized to an input power of 1 W at the antenna connector.
- *SAR for nominal TSL parameters:* The measured TSL parameters are used to calculate the nominal SAR result.

Measurement Conditions

DASY system configuration, as far as not given on page 1.

DASY Version	DASY4	V4.7
Extrapolation	Advanced Extrapolation	
Phantom	Modular Flat Phantom V5.0	
Distance Dipole Center - TSL	10 mm	with Spacer
Zoom Scan Resolution	dx, dy, dz = 5 mm	
Frequency	2450 MHz ± 1 MHz	

Head TSL parameters

The following parameters and calculations were applied.

	Temperature	Permittivity	Conductivity
Nominal Head TSL parameters	22.0 °C	39.2	1.80 mho/m
Measured Head TSL parameters	(22.0 ± 0.2) °C	39.4 ± 6 %	1.84 mho/m ± 6 %
Head TSL temperature during test	(21.1 ± 0.2) °C	----	----

SAR result with Head TSL

SAR averaged over 1 cm³ (1 g) of Head TSL	Condition	
SAR measured	250 mW input power	14.0 mW / g
SAR normalized	normalized to 1W	56.0 mW / g
SAR for nominal Head TSL parameters ¹	normalized to 1W	55.6 mW / g ± 17.0 % (k=2)

SAR averaged over 10 cm³ (10 g) of Head TSL	condition	
SAR measured	250 mW input power	6.46 mW / g
SAR normalized	normalized to 1W	25.8 mW / g
SAR for nominal Head TSL parameters ¹	normalized to 1W	25.8 mW / g ± 16.5 % (k=2)

¹ Correction to nominal TSL parameters according to d), chapter "SAR Sensitivities"

Body TSL parameters

The following parameters and calculations were applied.

	Temperature	Permittivity	Conductivity
Nominal Body TSL parameters	22.0 °C	52.7	1.95 mho/m
Measured Body TSL parameters	(22.0 ± 0.2) °C	50.9 ± 6 %	1.98 mho/m ± 6 %
Body TSL temperature during test	(22.0 ± 0.2) °C	----	----

SAR result with Body TSL

SAR averaged over 1 cm³ (1 g) of Body TSL	Condition	
SAR measured	250 mW input power	12.8 mW / g
SAR normalized	normalized to 1W	51.2 mW / g
SAR for nominal Body TSL parameters ²	normalized to 1W	49.9 mW / g ± 17.0 % (k=2)

SAR averaged over 10 cm³ (10 g) of Body TSL	condition	
SAR measured	250 mW input power	5.97 mW / g
SAR normalized	normalized to 1W	23.9 mW / g
SAR for nominal Body TSL parameters ²	normalized to 1W	23.5 mW / g ± 16.5 % (k=2)

² Correction to nominal TSL parameters according to d), chapter "SAR Sensitivities"

Appendix

Antenna Parameters with Head TSL

Impedance, transformed to feed point	$52.5 \Omega + 5.4 j\Omega$
Return Loss	- 24.8 dB

Antenna Parameters with Body TSL

Impedance, transformed to feed point	$49.2 \Omega + 5.5 j\Omega$
Return Loss	- 25.0 dB

General Antenna Parameters and Design

Electrical Delay (one direction)	1.162 ns
----------------------------------	----------

After long term use with 100W radiated power, only a slight warming of the dipole near the feedpoint can be measured.

The dipole is made of standard semirigid coaxial cable. The center conductor of the feeding line is directly connected to the second arm of the dipole. The antenna is therefore short-circuited for DC-signals.

No excessive force must be applied to the dipole arms, because they might bend or the soldered connections near the feedpoint may be damaged.

Additional EUT Data

Manufactured by	SPEAG
Manufactured on	August 26, 2003

DASY4 Validation Report for Head TSL

Date/Time: 22.04.2008 15:20:29

Test Laboratory: SPEAG, Zurich, Switzerland

DUT: Dipole 2450 MHz; Type: D2450V2; Serial: D2450V2 - SN737

Communication System: CW-2450; Frequency: 2450 MHz; Duty Cycle: 1:1

Medium: HSL U10 BB;

Medium parameters used: $f = 2450$ MHz; $\sigma = 1.83$ mho/m; $\epsilon_r = 39.5$; $\rho = 1000$ kg/m³

Phantom section: Flat Section

Measurement Standard: DASY4 (High Precision Assessment)

DASY4 Configuration:

- Probe: ES3DV2 - SN3025; ConvF(4.4, 4.4, 4.4); Calibrated: 01.03.2008
- Sensor-Surface: 3.4mm (Mechanical Surface Detection)
- Electronics: DAE4 Sn601; Calibrated: 14.03.2008
- Phantom: Flat Phantom 5.0 (front); Type: QD000P50AA; ;
- Measurement SW: DASY4, V4.7 Build 55; Postprocessing SW: SEMCAD, V1.8 Build 172

Pin = 250 mW; d = 10 mm/Zoom Scan (7x7x7)/Cube 0:

Measurement grid: dx=5mm, dy=5mm, dz=5mm

Reference Value = 98.6 V/m; Power Drift = 0.043 dB

Peak SAR (extrapolated) = 28.8 W/kg

SAR(1 g) = 14 mW/g; SAR(10 g) = 6.46 mW/g

Maximum value of SAR (measured) = 16.9 mW/g

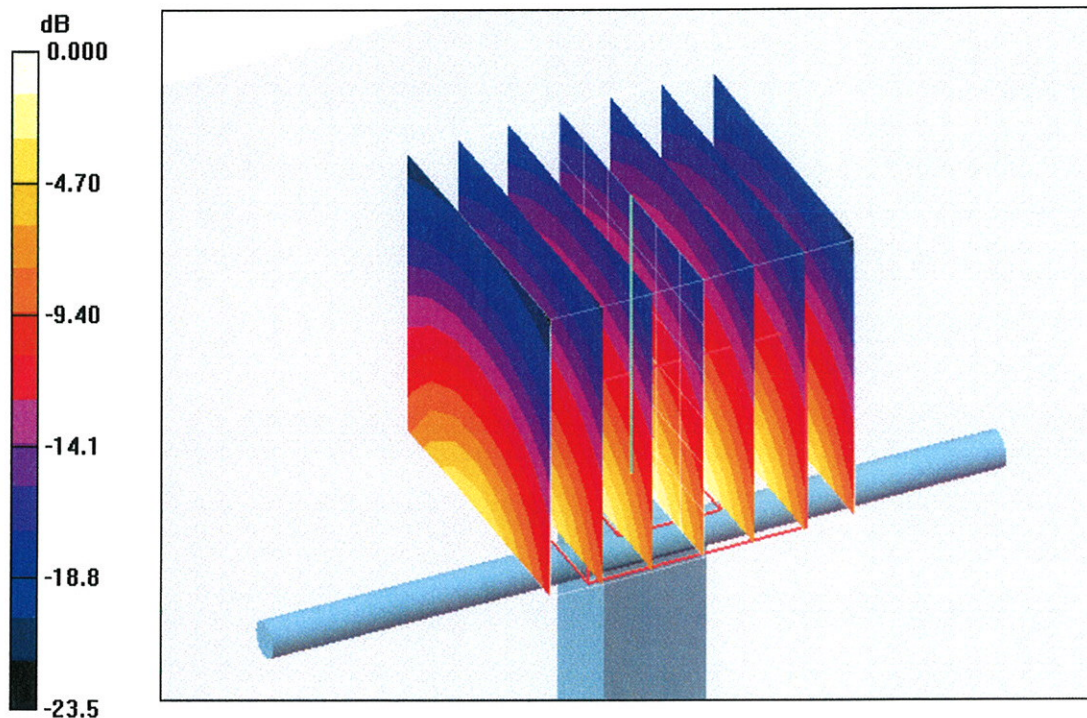

0 dB = 16.9mW/g

Impedance Measurement Plot for Head TSL

22 Apr 2008 14:28:37

CH1 S11 1 U FS 1: 52.467 Ω 5.3535 Ω 347.77 pF 2 450.000 000 MHz

*
Del
Cor

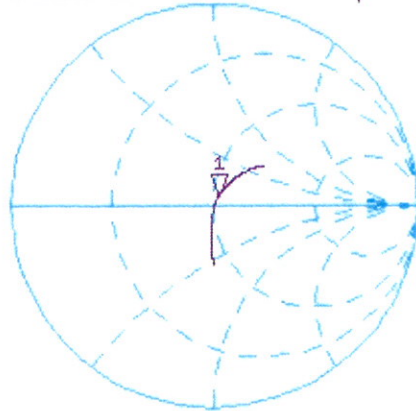

Avg
16
↑

CH2 S11 LOG 5 dB/REF -20 dB 1:-24.808 dB 2 450.000 000 MHz

Cor
Avg
16
↑

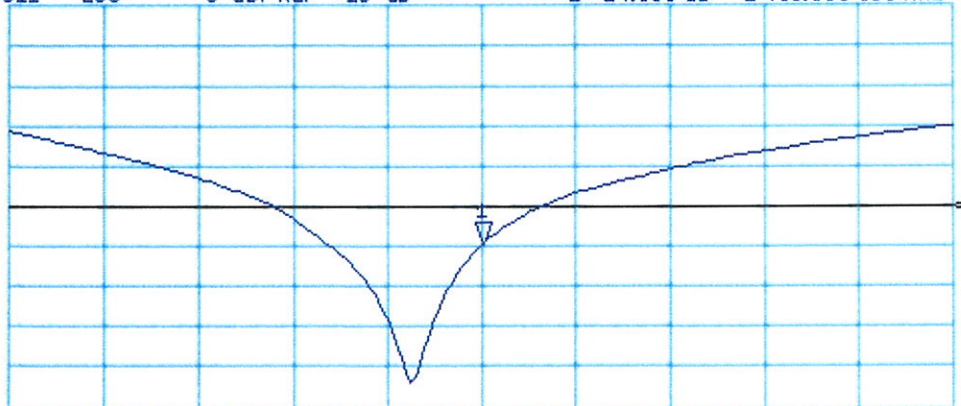

CENTER 2 450.000 000 MHz SPAN 400.000 000 MHz

DASY4 Validation Report for Body TSL

Date/Time: 14.04.2008 11:47:59

Test Laboratory: SPEAG, Zurich, Switzerland

DUT: Dipole 2450 MHz; Type: D2450V2; Serial: D2450V2 - SN737

Communication System: CW-2450; Frequency: 2450 MHz; Duty Cycle: 1:1

Medium: MSL U10;

Medium parameters used: $f = 2450$ MHz; $\sigma = 1.98$ mho/m; $\epsilon_r = 50.9$; $\rho = 1000$ kg/m³

Phantom section: Flat Section

Measurement Standard: DASY4 (High Precision Assessment)

DASY4 Configuration:

- Probe: ES3DV2 - SN3025; ConvF(4.07, 4.07, 4.07); Calibrated: 01.03.2008
- Sensor-Surface: 3.4mm (Mechanical Surface Detection)
- Electronics: DAE4 Sn601; Calibrated: 14.03.2008
- Phantom: Flat Phantom 4.9L; Type: QD000P49AA; ;
- Measurement SW: DASY4, V4.7 Build 55; Postprocessing SW: SEMCAD, V1.8 Build 172

Pin = 250 mW; d = 10 mm/Zoom Scan (7x7x7)/Cube 0:

Measurement grid: dx=5mm, dy=5mm, dz=5mm

Reference Value = 92.2 V/m; Power Drift = 0.027 dB

Peak SAR (extrapolated) = 25.5 W/kg

SAR(1 g) = 12.8 mW/g; SAR(10 g) = 5.97 mW/g

Maximum value of SAR (measured) = 15.6 mW/g

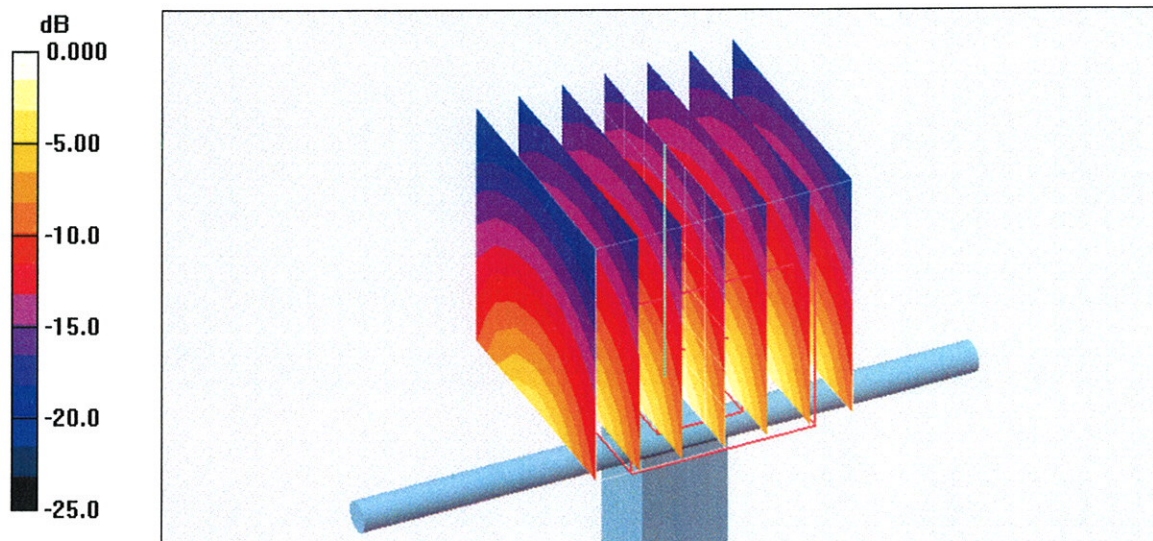

0 dB = 15.6mW/g

Impedance Measurement Plot for Body TSL

14 Apr 2008 10:59:29

CH1 S11 1 U FS 1: 49.240 Ω 5.5078 Ω 357.79 pF 2 450.000 000 MHz

*
De1
CA

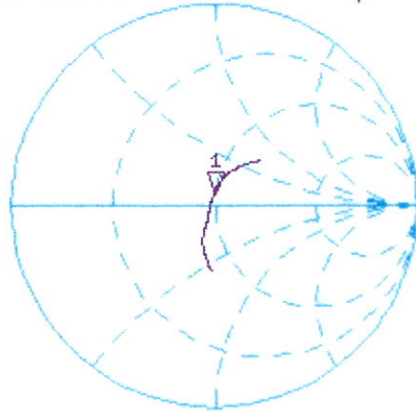

Avg
16
↑

CH2 S11 LOG 5 dB/REF -20 dB 1:-25.047 dB 2 450.000 000 MHz

CA
Avg
16
↑

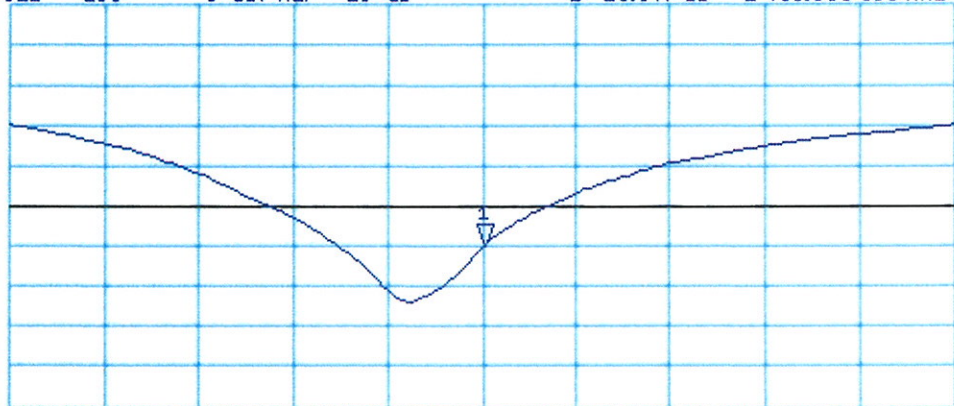

CENTER 2 450.000 000 MHz

SPAN 400.000 000 MHz