



RF TEST REPORT

REPORT NO.: RF120302C25

MODEL NO.: TL-WDN4800

FCC ID: TE7WDN4800

IC: 8853A-WDN4800

RECEIVED: Mar. 02, 2012

TESTED: Mar. 10 to 29, 2012

ISSUED: Apr. 13, 2012

APPLICANT: TP-LINK TECHNOLOGIES CO., LTD.

ADDRESS: Building 24 (floors 1,3,4,5) and 28
(floors1-4) Central Science and Technology
Park,Shennan Rd, Nanshan,
Shenzhen,China

ISSUED BY: Bureau Veritas Consumer Products Services
(H.K.) Ltd., Taoyuan Branch Hsin Chu Laboratory

LAB ADDRESS : No. 81-1, Lu Liao Keng, 9th Ling, Wu Lung Tsuen,
Chiung Lin Hsiang, Hsin Chu Hsien 307, Taiwan,
R.O.C.

TEST LOCATION (1): No. 81-1, Lu Liao Keng, 9th Ling, Wu Lung Tsuen,
Chiung Lin Hsiang, Hsin Chu Hsien 307, Taiwan,
R.O.C.

TEST LOCATION (2): No. 49, Ln. 206, Wende Rd., Shangshan Tsuen,
Chiung Lin Hsiang, Hsin Chu Hsien 307, Taiwan,
R.O.C.

This test report consists of 95 pages in total. It may be duplicated completely for legal use with the approval of the applicant. It should not be reproduced except in full, without the written approval of our laboratory. The client should not use it to claim product certification, approval, or endorsement by TAF or any government agencies. The test results in the report only apply to the tested sample.





A D T

Table of Contents

RELEASE CONTROL RECORD	6
1. CERTIFICATION	7
2. SUMMARY OF TEST RESULTS	8
2.1 MEASUREMENT UNCERTAINTY	10
3. GENERAL INFORMATION	11
3.1 GENERAL DESCRIPTION OF EUT	11
3.2 DESCRIPTION OF TEST MODES	14
3.2.1 TEST MODE APPLICABILITY AND TESTED CHANNEL DETAIL	15
3.3 GENERAL DESCRIPTION OF APPLIED STANDARDS	18
3.4 DESCRIPTION OF SUPPORT UNITS.....	19
3.5 CONFIGURATION OF SYSTEM UNDER TEST	20
4. TEST TYPES AND RESULTS (802.11b & g, 2400 ~ 2483.5MHz Band)	22
4.1 CONDUCTED EMISSION MEASUREMENT	22
4.1.1 LIMITS OF CONDUCTED EMISSION MEASUREMENT	22
4.1.2 TEST INSTRUMENTS.....	22
4.1.3 TEST PROCEDURES	23
4.1.4 DEVIATION FROM TEST STANDARD	23
4.1.5 TEST SETUP	24
4.1.6 EUT OPERATING CONDITIONS	24
4.1.7 TEST RESULTS	25
4.2 RADIATED EMISSION AND BANDEDGE MEASUREMENT	27
4.2.1 LIMITS OF RADIATED EMISSION AND BANDEDGE MEASUREMENT	27
4.2.2 TEST INSTRUMENTS.....	28
4.2.3 TEST PROCEDURES	29
4.2.4 DEVIATION FROM TEST STANDARD	29
4.2.5 TEST SETUP	30
4.2.6 EUT OPERATING CONDITIONS	30
4.2.7 TEST RESULTS	31
4.3 6dB BANDWIDTH MEASUREMENT	45
4.3.1 LIMITS OF 6dB BANDWIDTH MEASUREMENT	45
4.3.2 TEST INSTRUMENTS.....	45
4.3.3 TEST PROCEDURE.....	45
4.3.4 DEVIATION FROM TEST STANDARD	45
4.3.5 TEST SETUP	45
4.3.6 EUT OPERATING CONDITIONS	45
4.3.7 TEST RESULTS	46
4.4 OCCUPIED BANDWIDTH MEASUREMENT	48
4.4.1 TEST INSTRUMENTS.....	48
4.4.2 TEST PROCEDURE.....	48
4.4.3 DEVIATION FROM TEST STANDARD	48



A D T

4.4.4	TEST SETUP	48
4.4.5	EUT OPERATING CONDITIONS	48
4.4.6	TEST RESULTS	49
4.5	CONDUCTED OUTPUT POWER.....	50
4.5.1	LIMITS OF MAXIMUM PEAK OUTPUT POWER MEASUREMENT	50
4.5.2	INSTRUMENTS.....	50
4.5.3	TEST PROCEDURES	50
4.5.4	DEVIATION FROM TEST STANDARD	50
4.5.5	TEST SETUP	50
4.5.6	EUT OPERATING CONDITIONS	50
4.5.7	TEST RESULTS	51
4.6	POWER SPECTRAL DENSITY MEASUREMENT.....	52
4.6.1	LIMITS OF POWER SPECTRAL DENSITY MEASUREMENT	52
4.6.2	TEST INSTRUMENTS.....	52
4.6.3	TEST PROCEDURE.....	52
4.6.4	DEVIATION FROM TEST STANDARD	52
4.6.5	TEST SETUP	52
4.6.6	EUT OPERATING CONDITION.....	52
4.6.7	TEST RESULTS	53
4.7	CONDUCTED OUT-BAND EMISSION MEASUREMENT.....	55
4.7.1	LIMITS OF CONDUCTED OUT-BAND EMISSION MEASUREMENT.....	55
4.7.2	TEST INSTRUMENTS.....	55
4.7.3	TEST PROCEDURE.....	55
4.7.4	DEVIATION FROM TEST STANDARD	56
4.7.5	TEST SETUP	56
4.7.6	EUT OPERATING CONDITION.....	56
4.7.7	TEST RESULTS	56
5.	TEST TYPES AND RESULTS (802.11a, 5725~5850MHz Band).....	61
5.1	CONDUCTED EMISSION MEASUREMENT.....	61
5.1.1	LIMITS OF CONDUCTED EMISSION MEASUREMENT	61
5.1.2	TEST INSTRUMENTS.....	61
5.1.3	TEST PROCEDURES	62
5.1.4	DEVIATION FROM TEST STANDARD	62
5.1.5	TEST SETUP	63
5.1.6	EUT OPERATING CONDITIONS	63
5.1.7	TEST RESULTS	64
5.2	RADIATED AND BANDEDGE EMISSION MEASUREMENT.....	66
5.2.1	LIMITS OF RADIATED AND BANDEDGE EMISSION MEASUREMENT	66
5.2.2	TEST INSTRUMENTS.....	67
5.2.3	TEST PROCEDURES	68
5.2.4	DEVIATION FROM TEST STANDARD	68
5.2.5	TEST SETUP	69



5.2.6	EUT OPERATING CONDITIONS	69
5.2.7	TEST RESULTS	70
5.3	6dB BANDWIDTH MEASUREMENT	80
5.3.1	LIMITS OF 6dB BANDWIDTH MEASUREMENT	80
5.3.2	TEST INSTRUMENTS.....	80
5.3.3	TEST PROCEDURE.....	80
5.3.4	DEVIATION FROM TEST STANDARD	80
5.3.5	TEST SETUP	80
5.3.6	EUT OPERATING CONDITIONS	80
5.3.7	TEST RESULTS	81
5.4	OCCUPIED BANDWIDTH MEASUREMENT	82
5.4.1	TEST INSTRUMENTS.....	82
5.4.2	TEST PROCEDURE.....	82
5.4.3	DEVIATION FROM TEST STANDARD	82
5.4.4	TEST SETUP	82
5.4.5	EUT OPERATING CONDITIONS	82
5.4.6	TEST RESULTS	83
5.5	CONDUCTED OUTPUT POWER.....	84
5.5.1	LIMITS OF CONDUCTED OUTPUT POWER MEASUREMENT	84
5.5.2	INSTRUMENTS.....	84
5.5.3	TEST PROCEDURES	84
5.5.4	DEVIATION FROM TEST STANDARD	84
5.5.5	TEST SETUP	84
5.5.6	EUT OPERATING CONDITIONS	84
5.5.7	TEST RESULTS	85
5.6	POWER SPECTRAL DENSITY MEASUREMENT.....	86
5.6.1	LIMITS OF POWER SPECTRAL DENSITY MEASUREMENT	86
5.6.2	TEST INSTRUMENTS.....	86
5.6.3	TEST PROCEDURE.....	86
5.6.4	DEVIATION FROM TEST STANDARD	86
5.6.5	TEST SETUP	86
5.6.6	EUT OPERATING CONDITION.....	86
5.6.7	TEST RESULTS	87
5.7	CONDUCTED OUT-BAND EMISSION MEASUREMENT.....	88
5.7.1	LIMITS OF CONDUCTED OUT-BAND EMISSION MEASUREMENT.....	88
5.7.2	TEST INSTRUMENTS.....	88
5.7.3	TEST PROCEDURE.....	88
5.7.4	DEVIATION FROM TEST STANDARD	89
5.7.5	EUT OPERATING CONDITION.....	89
5.7.6	TEST RESULTS	89
6.	PHOTOGRAPHS OF THE TEST CONFIGURATION.....	93
7.	INFORMATION ON THE TESTING LABORATORIES	94



A D T

8. APPENDIX A - MODIFICATIONS RECORDERS FOR ENGINEERING CHANGES
THE EUT BY THE LAB..... 95



A D T

RELEASE CONTROL RECORD

ISSUE NO.	REASON FOR CHANGE	DATE ISSUED
RF120302C25	Original release	Apr. 13, 2012



A D T

1. CERTIFICATION

PRODUCT: 450Mbps Wireless N Dual Band PCI Express Adapter
BRAND NAME: TP-LINK
MODEL NO.: TL-WDN4800
TEST SAMPLE: PROTOTYPE
APPLICANT: TP-LINK TECHNOLOGIES CO., LTD.
TESTED: Mar. 10 to 29, 2012
STANDARDS: FCC Part 15, Subpart C (Section 15.247)
ANSI C63.10-2009
Canada RSS-210 Issue 8 (2010-12)
Canada RSS-Gen Issue 3 (2010-12)

The above equipment (Model: TL-WDN4800) has been tested by **Bureau Veritas Consumer Products Services (H.K.) Ltd., Taoyuan Branch**, and found compliance with the requirement of the above standards. The test record, data evaluation & Equipment Under Test (EUT) configurations represented herein are true and accurate accounts of the measurements of the sample's EMC characteristics under the conditions specified in this report.

PREPARED BY : , **DATE:** Apr. 13, 2012
(Lori Chung, Specialist)

APPROVED BY : , **DATE:** Apr. 13, 2012
(May Chen, Deputy Manager)

2. SUMMARY OF TEST RESULTS

The EUT has been tested according to the following specifications:

For 2.4GHz, 2412~2462MHz Band

APPLIED STANDARD: FCC PART 15, SUBPART C (SECTION 15.247); RSS-210; RSS-Gen				
STANDARD SECTION		TEST TYPE	RESULT	REMARK
FCC PART 15	CANADA STANDARD			
15.207	RSS-Gen 7.2.4	AC Power Conducted Emission	PASS	Meet the requirement of limit. Minimum passing margin is -8.59dB at 0.20859MHz
-	RSS-Gen 4.6	Occupied Bandwidth Measurement	PASS	Meet the requirement of limit.
15.247(d) 15.209	RSS-210 A8.5	Radiated Emissions	PASS	Meet the requirement of limit. Minimum passing margin is -0.5dB at 4824.00MHz
15.247(d)	RSS-210 A8.5	Band Edge Measurement	PASS	Meet the requirement of limit.
15.247(a)(2)	RSS-210 A8.2 (a)	6dB bandwidth	PASS	Meet the requirement of limit.
15.247(b)	RSS-210 A8.2 (4)	Maximum Peak Output Power	PASS	Meet the requirement of limit.
15.247(e)	RSS-210 A8.2 (b)	Power Spectral Density	PASS	Meet the requirement of limit.
15.203	-	Antenna Requirement	PASS	Antenna connector is SMA Reverse not a standard connector.



For 5GHz, 5745~5825MHz Band

APPLIED STANDARD: FCC PART 15, SUBPART C (SECTION 15.247); RSS-210; RSS-Gen				
STANDARD SECTION		TEST TYPE	RESULT	REMARK
FCC PART 15	CANADA STANDARD			
15.207	RSS-Gen 7.2.4	AC Power Conducted Emission	PASS	Meet the requirement of limit. Minimum passing margin is -8.24dB at 0.20859MHz
-	RSS-Gen 4.6	Occupied Bandwidth Measurement	PASS	Meet the requirement of limit.
15.247(d) 15.209	RSS-210 A8.5	Radiated Emissions	PASS	Meet the requirement of limit. Minimum passing margin is -2.0dB at 5400.00MHz
15.247(d)	RSS-210 A8.5	Band Edge Measurement	PASS	Meet the requirement of limit.
15.247(a)(2)	RSS-210 A8.2 (a)	6dB bandwidth	PASS	Meet the requirement of limit.
15.247(b)	RSS-210 A8.2 (4)	Maximum Peak Output Power	PASS	Meet the requirement of limit.
15.247(e)	RSS-210 A8.2 (b)	Power Spectral Density	PASS	Meet the requirement of limit.
15.203	-	Antenna Requirement	PASS	Antenna connector is SMA Reverse not a standard connector.

NOTE: The EUT was operating in 2400 ~ 2483.5MHz, 5.15~5.25GHz and 5.725~5.850GHz frequencies band. This report was recorded the RF parameters including 2400 ~ 2483.5MHz and 5.725~5.850GHz. For the 5.15~5.25GHz RF parameters was recorded in another test report.



A D T

2.1 MEASUREMENT UNCERTAINTY

Where relevant, the following measurement uncertainty levels have been estimated for tests performed on the EUT as specified in CISPR 16-4-2:

This uncertainty represents an expanded uncertainty expressed at approximately the 95% confidence level using a coverage factor of $k=2$.

Measurement	Value
Conducted emissions	2.45 dB
Radiated emissions (30MHz-1GHz)	3.89 dB
Radiated emissions (1GHz -18GHz)	2.19 dB
Radiated emissions (18GHz -40GHz)	2.56 dB

3. GENERAL INFORMATION

3.1 GENERAL DESCRIPTION OF EUT

PRODUCT	450Mbps Wireless N Dual Band PCI Express Adapter
MODEL NO.	TL-WDN4800
POWER SUPPLY	DC 3.3V from host equipment
MODULATION TYPE	CCK, DQPSK, DBPSK for DSSS 64QAM, 16QAM, QPSK, BPSK for OFDM
MODULATION TECHNOLOGY	DSSS, OFDM
TRANSFER RATE	802.11b: up to 11Mbps 802.11a / g: up to 54Mbps 802.11n: up to 450Mbps
OPERATING FREQUENCY	For 15.407 / Annex 9 802.11a: 5.18 ~ 5.24GHz
	For 15.247 / Annex 8 802.11b/g: 2.412 ~ 2.462GHz 802.11a: 5.745 ~ 5.825GHz
NUMBER OF CHANNEL	For 15.407 / Annex 9 4 for 802.11a, 802.11n (20MHz) 2 for 802.11n (40MHz)
	For 15.247 (2.4GHz) / Annex 8 11 for 802.11b, 802.11g, 802.11n (20MHz) 7 for 802.11n (40MHz)
	For 15.247 (5GHz) / Annex 8 5 for 802.11a, 802.11n (20MHz) 2 for 802.11n (40MHz)



A D T

MAXIMUM OUTPUT POWER	For 15.407 / Annex 9 802.11a: 13.87mW 802.11n (20MHz): 13.241mW 802.11n (40MHz): 15.303mW For 15.247 (2.4GHz) / Annex 8 802.11b: 231.149mW 802.11g: 688.102mW 802.11n (20MHz): 527.839mW 802.11n (40MHz): 219.005mW For 15.247 (5GHz) / Annex 8 802.11a: 155.431mW 802.11n (20MHz): 156.926mW 802.11n (40MHz): 169.013mW
ANTENNA TYPE	Please see NOTE
DATA CABLE	NA
I/O PORTS	Refer to user's manual
ASSOCIATED DEVICES	NA

NOTE:

1. The antennas provided to the EUT, please refer to the following table:

Transmitter Circuit	Antenna Type	Peak Gain (dBi)	Connector Type
Chain (0)	Omni	2	SMA Reverse
Chain (1)	Omni	2	SMA Reverse
Chain (2)	Omni	2	SMA Reverse

2. The EUT incorporates a MIMO function. Physically, the EUT provides three completed transmitters and three receivers.

MODULATION MODE	TX/RX FUNCTION
802.11b	3Tx/3Rx
802.11g	3Tx/3Rx
802.11a	3Tx/3Rx
802.11n (20MHz)	3Tx/3Rx
802.11n (40MHz)	3Tx/3Rx

3. The EUT is 3 * 3 spatial MIMO (3Tx & 3Rx) without beam forming function.

4. The EUT incorporates CDD function with 802.11a, 802.11b, 802.11g.

5. When the EUT operating in 802.11n, the software operation, which is defined by manufacturer, MCS (Modulation and Coding Schemes) from 0 to 23.

6. The above EUT information was declared by the manufacturer and for more detailed features description, please refer to the manufacturer's specifications or User's Manual.



A D T

3.2 DESCRIPTION OF TEST MODES

Operated in 2400 ~ 2483.5MHz band:

Eleven channels are provided for 802.11b, 802.11g, 802.11n (20MHz):

CHANNEL	FREQUENCY	CHANNEL	FREQUENCY
1	2412MHz	7	2442MHz
2	2417MHz	8	2447MHz
3	2422MHz	9	2452MHz
4	2427MHz	10	2457MHz
5	2432MHz	11	2462MHz
6	2437MHz		

Seven channels are provided for 802.11n (40MHz):

CHANNEL	FREQUENCY	CHANNEL	FREQUENCY
3	2422MHz	7	2442MHz
4	2427MHz	8	2447MHz
5	2432MHz	9	2452MHz
6	2437MHz		

Operated in 5725 ~ 5850MHz band:

Five channels are provided for 802.11a, 802.11n (20MHz):

CHANNEL	FREQUENCY	CHANNEL	FREQUENCY
149	5745 MHz	161	5805 MHz
153	5765 MHz	165	5825 MHz
157	5785 MHz		

Two channels are provided for 802.11n (40MHz):

CHANNEL	FREQUENCY
151	5755 MHz
159	5795 MHz

3.2.1 TEST MODE APPLICABILITY AND TESTED CHANNEL DETAIL

EUT CONFIGURE MODE	APPLICABLE TO					DESCRIPTION
	PLC	RE < 1G	RE [≧] 1G	APCM	OB	
-	√	√	√	√	√	-

Where **PLC**: Power Line Conducted Emission **RE < 1G**: Radiated Emission below 1GHz
RE [≧] 1G: Radiated Emission above 1GHz **APCM**: Antenna Port Conducted Measurement
OB: Conducted Out-Band Emission Measurement

POWER LINE CONDUCTED EMISSION TEST:

- Pre-Scan has been conducted to determine the worst-case mode from all possible combinations between available modulations, data rates and antenna ports (if EUT with antenna diversity architecture).
- Following channel(s) was (were) selected for the final test as listed below.

MODE	AVAILABLE CHANNEL	TESTED CHANNEL	MODULATION TECHNOLOGY	MODULATION TYPE	DATA RATE (Mbps)
802.11g	1 to 11	6	OFDM	BPSK	6
For 5 GHz 802.11n (20MHz)	149 to 165	149	OFDM	BPSK	6

RADIATED EMISSION TEST (BELOW 1 GHz):

- Pre-Scan has been conducted to determine the worst-case mode from all possible combinations between available modulations, data rates and antenna ports (if EUT with antenna diversity architecture).
- Following channel(s) was (were) selected for the final test as listed below.

MODE	AVAILABLE CHANNEL	TESTED CHANNEL	MODULATION TECHNOLOGY	MODULATION TYPE	DATA RATE (Mbps)
802.11g	1 to 11	6	OFDM	BPSK	6
For 5 GHz 802.11n (20MHz)	149 to 165	149	OFDM	BPSK	6.5



A D T

RADIATED EMISSION TEST (ABOVE 1 GHz):

- Pre-Scan has been conducted to determine the worst-case mode from all possible combinations between available modulations, data rates and antenna ports (if EUT with antenna diversity architecture).
- Following channel(s) was (were) selected for the final test as listed below.

MODE	AVAILABLE CHANNEL	TESTED CHANNEL	MODULATION TECHNOLOGY	MODULATION TYPE	DATA RATE (Mbps)
802.11b	1 to 11	1, 6, 11	DSSS	DBPSK	1
802.11g	1 to 11	1, 6, 11	OFDM	BPSK	6
For 2.4 GHz 802.11n (20MHz)	1 to 11	1, 6, 11	OFDM	BPSK	6.5
For 2.4 GHz 802.11n (40MHz)	3 to 9	3, 6, 9	OFDM	BPSK	13.5
802.11a	149 to 165	149, 157, 165	OFDM	BPSK	6
For 5 GHz 802.11n (20MHz)	149 to 165	149, 157, 165	OFDM	BPSK	6.5
For 5 GHz 802.11n (40MHz)	151 to 159	151, 159	OFDM	BPSK	13.5

ANTENNA PORT CONDUCTED MEASUREMENT:

- Pre-Scan has been conducted to determine the worst-case mode from all possible combinations between available modulations, data rates and antenna ports (if EUT with antenna diversity architecture).
- Following channel(s) was (were) selected for the final test as listed below.

MODE	AVAILABLE CHANNEL	TESTED CHANNEL	MODULATION TECHNOLOGY	MODULATION TYPE	DATA RATE (Mbps)
802.11b	1 to 11	1, 6, 11	DSSS	DBPSK	1
802.11g	1 to 11	1, 6, 11	OFDM	BPSK	6
For 2.4 GHz 802.11n (20MHz)	1 to 11	1, 6, 11	OFDM	BPSK	6.5
For 2.4 GHz 802.11n (40MHz)	3 to 9	3, 6, 9	OFDM	BPSK	13.5
802.11a	149 to 165	149, 157, 165	OFDM	BPSK	6
For 5 GHz 802.11n (20MHz)	149 to 165	149, 157, 165	OFDM	BPSK	6.5
For 5 GHz 802.11n (40MHz)	151 to 159	151, 159	OFDM	BPSK	13.5



A D T

CONDUCTED OUT-BAND EMISSION MEASUREMENT:

- Pre-Scan has been conducted to determine the worst-case mode from all possible combinations between available modulations, data rates and antenna ports (if EUT with antenna diversity architecture).
- Following channel(s) was (were) selected for the final test as listed below.

MODE	AVAILABLE CHANNEL	TESTED CHANNEL	MODULATION TECHNOLOGY	MODULATION TYPE	DATA RATE (Mbps)
802.11b	1 to 11	1, 11	DSSS	DBPSK	1
802.11g	1 to 11	1, 11	OFDM	BPSK	6
For 2.4 GHz 802.11n (20MHz)	1 to 11	1, 11	OFDM	BPSK	6.5
For 2.4 GHz 802.11n (40MHz)	3 to 9	3, 9	OFDM	BPSK	13.5
802.11a	149 to 165	149, 165	OFDM	BPSK	6
For 5 GHz 802.11n (20MHz)	149 to 165	149, 165	OFDM	BPSK	6.5
For 5 GHz 802.11n (40MHz)	151 to 159	151, 159	OFDM	BPSK	13.5

TEST CONDITION:

APPLICABLE TO	ENVIRONMENTAL CONDITIONS	INPUT POWER (SYSTEM)	TESTED BY
PLC	22deg. C, 64%RH	120Vac, 60Hz	Kyle Huang
RE<1G	23deg. C, 70%RH	120Vac, 60Hz	Amos Chuang
RE ³ 1G	23deg. C, 71%RH 24deg. C, 74%RH	120Vac, 60Hz	Amos Chuang
APCM	25deg. C, 60%RH	120Vac, 60Hz	Rex Huang
OB	25deg. C, 60%RH	120Vac, 60Hz	Rex Huang

3.3 GENERAL DESCRIPTION OF APPLIED STANDARDS

The EUT is a RF product. According to the specifications of the manufacturer, it must comply with the requirements of the following standards:

FCC Part 15, Subpart C (Section 15.247)

ANSI C63.10-2009

Canada RSS-210 Issue 8 (2010-12)

Canada RSS-Gen Issue 3 (2010-12)

All test items have been performed and recorded as per the above standards.

NOTE:

1. This device support multiple outputs in the same band, therefore test methodology will be following FCC KDB 662911 requirements.
2. The EUT is also considered as a kind of computer peripheral, because the connection to computer is necessary for typical use. It has been verified to comply with the requirements of FCC Part 15, Subpart B, Class B (DoC). The test report has been issued separately.



A D T

3.4 DESCRIPTION OF SUPPORT UNITS

The EUT has been tested as an independent unit together with other necessary accessories or support units. The following support units or accessories were used to form a representative test configuration during the tests.

NO.	PRODUCT	BRAND	MODEL NO.	SERIAL NO.	FCC ID
1	PERSONAL COMPUTER (For conducted emission test)	DELL	DCSCMF	9KKB32S	FCC DoC
	PERSONAL COMPUTER (For other test items)	DELL	DCNE	HRJB32S	FCC DoC
2	MONITOR	DELL	E2210Hc	CN-OG337R-6418 0-97S-OQDS	FCC DoC
3	PRINTER (For conducted emission test)	EPSON	LQ-300+II	G88Y074083	FCC DoC
	PRINTER (For other test items)	EPSON	LQ-300+II	G88Y074015	FCC DoC
4	MODEM	ACEEX	1414	0206026778	IFAXDM1414
5	KEYBOARD	DELL	SK-8115	MY-0DJ325-71619 -99B-0476	FCC DoC
6	MOUSE (For conducted emission test)	DELL	MOC5UO	I1401LVG	FCC DoC
	MOUSE (For other test items)	DELL	MOC5UO	I14066PS	FCC DoC
7	WIRELESS AP	Linksys	WRT160N V3	NA	NA

NO.	SIGNAL CABLE DESCRIPTION OF THE ABOVE SUPPORT UNITS
1	NA
2	VGA cable (1.4m), with 2 cores
3	USB cable (1.8m)
4	RS232 cable (1m) / RS232 cable (1.1m)
5	USB cable (1.8m), with 1 core
6	USB cable (1.5m) / USB cable (1.8m)
7	NA

NOTE: All power cords of the above support units are non shielded (1.8m).

3.5 CONFIGURATION OF SYSTEM UNDER TEST

For conducted emission test:

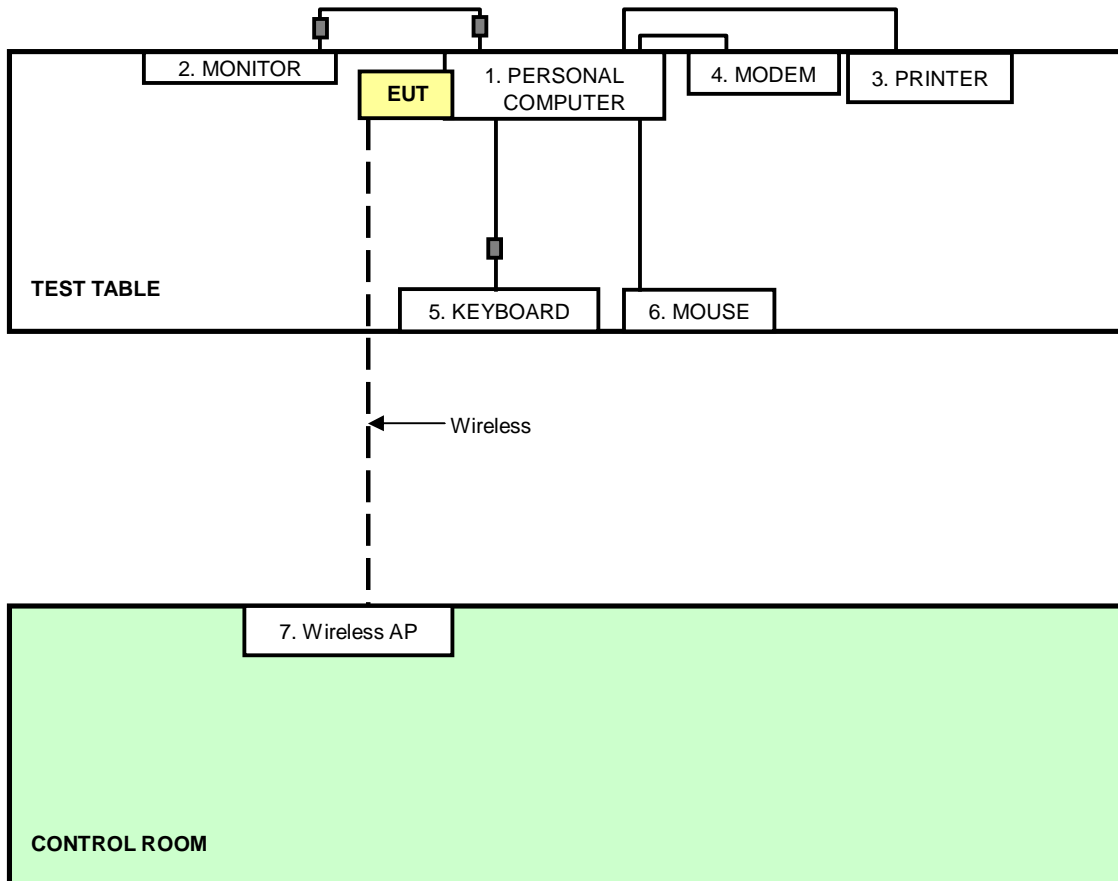

For other test items:

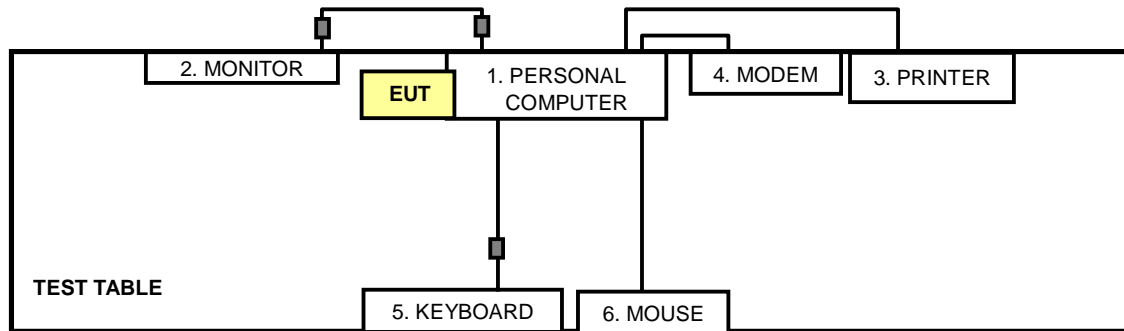



A D T

4. TEST TYPES AND RESULTS (802.11b & g, 2400 ~ 2483.5MHz Band)

4.1 CONDUCTED EMISSION MEASUREMENT

4.1.1 LIMITS OF CONDUCTED EMISSION MEASUREMENT

FREQUENCY OF EMISSION (MHz)	CONDUCTED LIMIT (dBµV)	
	Quasi-peak	Average
0.15-0.5	66 to 56	56 to 46
0.5-5	56	46
5-30	60	50

- NOTE:**
1. The lower limit shall apply at the transition frequencies.
 2. The limit decreases in line with the logarithm of the frequency in the range of 0.15 to 0.50 MHz.

4.1.2 TEST INSTRUMENTS

DESCRIPTION & MANUFACTURER	MODEL NO.	SERIAL NO.	CALIBRATED DATE	CALIBRATED UNTIL
ROHDE & SCHWARZ Test Receiver	ESCS 30	100287	Feb. 29, 2012	Feb. 28, 2013
Line-Impedance Stabilization Network (for EUT)	NSLK 8127	8127-523	Sep. 20, 2011	Sep. 19, 2012
Line-Impedance Stabilization Network (for Peripheral)	ENV-216	100072	June 10, 2011	June 09, 2012
RF Cable (JYEBAO)	5DFB	COACAB-002	Aug. 06, 2011	Aug. 05, 2012
50 ohms Terminator	50	3	Nov. 02, 2011	Nov. 01, 2012
Software	BV ADT_Cond_V7.3.7	NA	NA	NA

Note:

1. The calibration interval of the above test instruments is 12 months and the calibrations are traceable to NML/ROC and NIST/USA.
2. The test was performed in Shielded Room No. A.
3. The VCCI Con A Registration No. is C-817.
4. Tested Date: Mar. 29, 2012.

4.1.3 TEST PROCEDURES

- a. The EUT was placed 0.4 meters from the conducting wall of the shielded room with EUT being connected to the power mains through a line impedance stabilization network (LISN). Other support units were connected to the power mains through another LISN. The two LISNs provide 50 ohm/ 50uH of coupling impedance for the measuring instrument.
- b. Both lines of the power mains connected to the EUT were checked for maximum conducted interference.
- c. The frequency range from 150kHz to 30MHz was searched. Emission levels under (Limit - 20dB) were not recorded.

4.1.4 DEVIATION FROM TEST STANDARD

No deviation

4.1.5 TEST SETUP

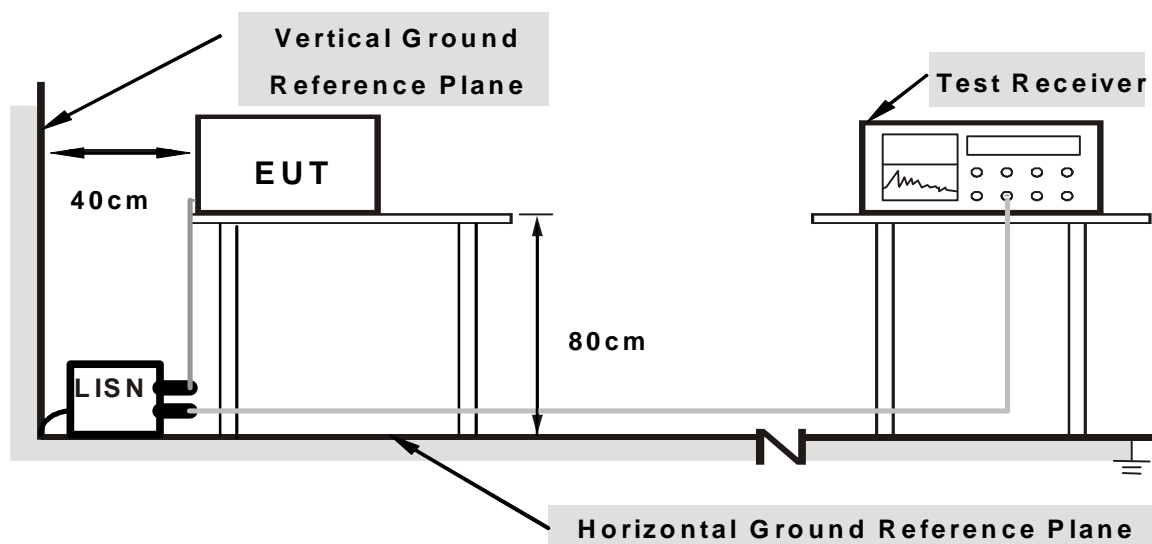

Note: 1.Support units were connected to second LISN.

2.Both of LISNs (AMN) are 80 cm from EUT and at least 80 from other units and other metal planes

For the actual test configuration, please refer to the related item – Photographs of the Test Configuration.

4.1.6 EUT OPERATING CONDITIONS

1. Connect the EUT with the support unit 1 (PC) which is placed on a testing table.
2. The support unit 1 (PC) runs a test program “Ping. exe” to enable EUT under transmission/receiving condition continuously with support unit 7 (Wireless AP) via wireless.

4.1.7 TEST RESULTS

PHASE	Line (L)	6dB BANDWIDTH	9 kHz
--------------	----------	----------------------	-------

No	Freq. [MHz]	Corr. Factor (dB)	Reading Value		Emission Level		Limit		Margin	
			[dB (uV)]		[dB (uV)]		[dB (uV)]		(dB)	
			Q.P.	AV.	Q.P.	AV.	Q.P.	AV.	Q.P.	AV.
1	0.16172	0.06	39.33	38.67	39.39	38.73	65.38	55.38	-25.99	-16.65
2	0.20469	0.06	39.35	37.27	39.41	37.33	63.42	53.42	-24.01	-16.09
3	0.46250	0.08	31.88	28.59	31.96	28.67	56.65	46.65	-24.69	-17.98
4	0.68906	0.09	31.09	30.79	31.18	30.88	56.00	46.00	-24.82	-15.12
5	1.31250	0.14	28.44	24.02	28.58	24.16	56.00	46.00	-27.42	-21.84
6	17.38672	0.57	28.29	21.77	28.86	22.34	60.00	50.00	-31.14	-27.66

- REMARKS:**
1. Q.P. and AV. are abbreviations of quasi-peak and average individually.
 2. The emission levels of other frequencies were very low against the limit.
 3. Margin value = Emission level - Limit value
 4. Correction factor = Insertion loss + Cable loss
 5. Emission Level = Correction Factor + Reading Value.

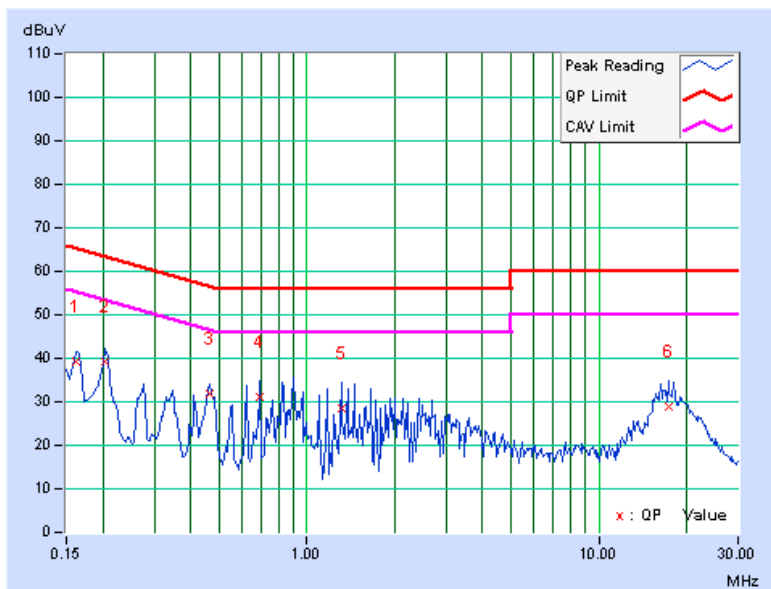

PHASE	Neutral (N)	6dB BANDWIDTH	9 kHz
--------------	-------------	----------------------	-------

No	Freq. [MHz]	Corr. Factor (dB)	Reading Value [dB (uV)]		Emission Level [dB (uV)]		Limit [dB (uV)]		Margin (dB)	
			Q.P.	AV.	Q.P.	AV.	Q.P.	AV.	Q.P.	AV.
	1	0.16562	0.07	38.89	38.10	38.96	38.17	65.18	55.18	-26.22
2	0.20859	0.07	44.97	44.60	45.04	44.67	63.26	53.26	-18.22	-8.59
3	0.27500	0.07	36.36	33.14	36.43	33.21	60.97	50.97	-24.53	-17.75
4	0.34531	0.08	36.05	35.03	36.13	35.11	59.07	49.07	-22.95	-13.97
5	4.27344	0.26	25.76	21.77	26.02	22.03	56.00	46.00	-29.98	-23.97
6	18.03284	0.56	32.60	31.74	33.16	32.30	60.00	50.00	-26.84	-17.70

- REMARKS:**
1. Q.P. and AV. are abbreviations of quasi-peak and average individually.
 2. The emission levels of other frequencies were very low against the limit.
 3. Margin value = Emission level - Limit value
 4. Correction factor = Insertion loss + Cable loss
 5. Emission Level = Correction Factor + Reading Value.

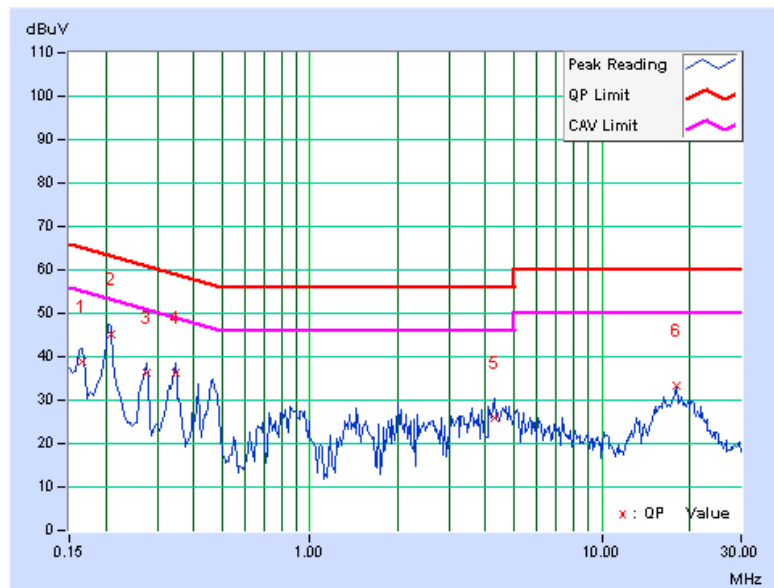

4.2 RADIATED EMISSION AND BANDEDGE MEASUREMENT

4.2.1 LIMITS OF RADIATED EMISSION AND BANDEDGE MEASUREMENT

Radiated emissions which fall in the restricted bands must comply with the radiated emission limits specified as below table. Other emissions shall be at least 20dB below the highest level of the desired power:

Frequencies (MHz)	Field strength (microvolts/meter)	Measurement distance (meters)
0.009-0.490	2400/F(kHz)	300
0.490-1.705	24000/F(kHz)	30
1.705-30.0	30	30
30-88	100	3
88-216	150	3
216-960	200	3
Above 960	500	3

NOTE:

1. The lower limit shall apply at the transition frequencies.
2. Emission level (dBuV/m) = 20 log Emission level (uV/m).
3. For frequencies above 1000MHz, the field strength limits are based on average detector, however, the peak field strength of any emission shall not exceed the maximum permitted average limits, specified above by more than 20dB under any condition of modulation.



A D T

4.2.2 TEST INSTRUMENTS

DESCRIPTION & MANUFACTURER	MODEL NO.	SERIAL NO.	CALIBRATED DATE	CALIBRATED UNTIL
Agilent Spectrum Analyzer	E4446A	MY48250253	Aug. 29, 2011	Aug. 28, 2012
Agilent Pre-Selector	N9039A	MY46520310	Aug. 29, 2011	Aug. 28, 2012
Agilent Signal Generator	N5181A	MY49060347	July 25, 2011	July 24, 2012
Mini-Circuits Pre-Amplifier	ZFL-1000VH2B	AMP-ZFL-04	Nov. 15, 2011	Nov. 14, 2012
Agilent Pre-Amplifier	8449B	3008A02465	Feb. 27, 2012	Feb. 26, 2013
SPACEK LABS	SLKKa-48-6	9K16	Nov. 15, 2011	Nov. 14, 2012
SCHWARZBECK Trilog Broadband Antenna	VULB 9168	9168-361	Apr. 14, 2011	Apr. 13, 2012
AISI Horn_Antenna	AIH.8018	0000220091110	Nov. 23, 2011	Nov. 22, 2012
SCHWARZBECK Horn_Antenna	BBHA 9170	9170-424	Oct. 07, 2011	Oct. 06, 2012
RF CABLE	NA	RF104-205 RF104-207 RF104-202	Dec. 27, 2011	Dec. 26, 2012
RF Cable	NA	CHHCAB_001	Oct. 08, 2011	Oct. 07, 2012
Software	ADT_Radiated_V8.7.05	NA	NA	NA
CT Antenna Tower & Turn Table	NA	NA	NA	NA

- Note: 1. The calibration interval of the above test instruments is 12 months and the calibrations are traceable to NML/ROC and NIST/USA.
2. The horn antenna, preamplifier (model: 8449B) are used only for the measurement of emission frequency above 1GHz if tested.
3. The test was performed in 966 Chamber No. H.
4. The FCC Site Registration No. is 797305.
5. The CANADA Site Registration No. is IC 7450H-3.
6. Tested Date: Mar. 10, 2012.

4.2.3 TEST PROCEDURES

- a. The EUT was placed on the top of a rotating table 0.8 meters above the ground at a 3 meter chamber room. The table was rotated 360 degrees to determine the position of the highest radiation.
- b. The EUT was set 3 meters away from the interference-receiving antenna, which was mounted on the top of a variable-height antenna tower.
- c. The height of antenna is varied from one meter to four meters above the ground to determine the maximum value of the field strength. Both horizontal and vertical polarizations of the antenna are set to make the measurement.
- d. For each suspected emission, the EUT was arranged to its worst case and then the antenna was tuned to heights from 1 meter to 4 meters and the rotatable table was turned from 0 degrees to 360 degrees to find the maximum reading.
- e. The test-receiver system was set to quasi-peak detect function and specified bandwidth with maximum hold mode when the test frequency is below 1 GHz.
- f. The test-receiver system was set to peak and average detect function and specified bandwidth with maximum hold mode when the test frequency is above 1 GHz. If the peak reading value also meets average limit, measurement with the average detector is unnecessary.

NOTE:

1. The resolution bandwidth and video bandwidth of test receiver/spectrum analyzer is 120kHz for Quasi-peak detection (QP) at frequency below 1GHz.
2. The resolution bandwidth of test receiver/spectrum analyzer is 1 MHz and the video bandwidth is 3 MHz for Peak detection (PK) at frequency above 1GHz.
3. The resolution bandwidth of test receiver/spectrum analyzer is 1 MHz and the video bandwidth is 10 Hz for Average detection (AV) at frequency above 1GHz.
4. All modes of operation were investigated and the worst-case emissions are reported.

4.2.4 DEVIATION FROM TEST STANDARD

No deviation

4.2.5 TEST SETUP

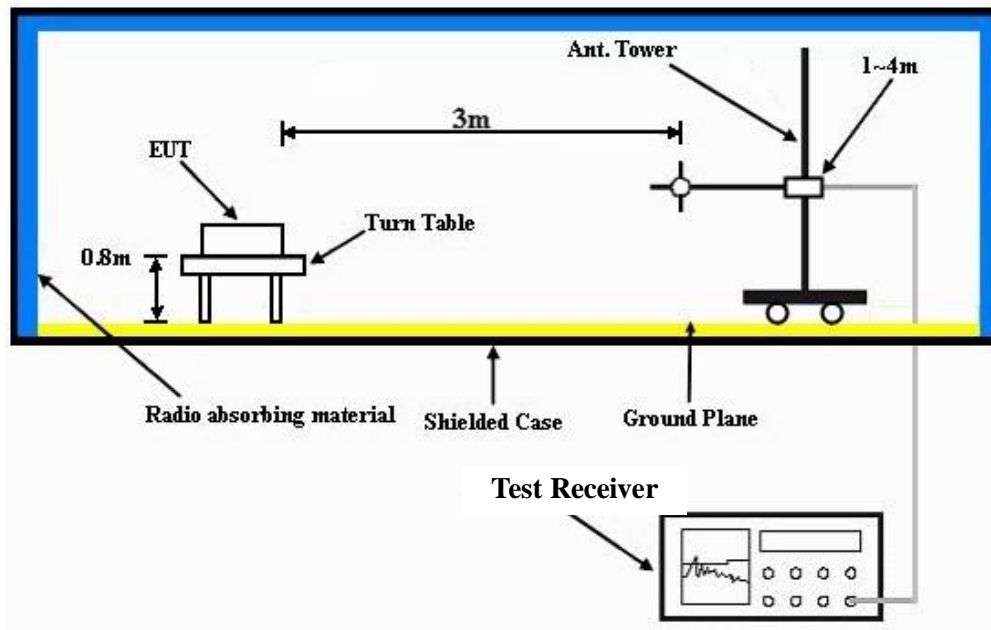

For the actual test configuration, please refer to the related item – Photographs of the Test Configuration.

4.2.6 EUT OPERATING CONDITIONS

1. Placed the EUT on testing table.
2. Prepared other computer system (support unit 1) to act as communication partners.
3. The communication partners ran test program “artgui.exe” to enable EUT under transmission/receiving condition continuously.

4.2.7 TEST RESULTS

BELOW 1GHz WORST-CASE DATA

802.11g

CHANNEL	TX Channel 6	DETECTOR FUNCTION	Quasi-Peak (QP)
FREQUENCY RANGE	Below 1GHz		

ANTENNA POLARITY & TEST DISTANCE: HORIZONTAL AT 3 M								
NO.	FREQ. (MHz)	EMISSION LEVEL (dBuV/m)	LIMIT (dBuV/m)	MARGIN (dB)	ANTENNA HEIGHT (m)	TABLE ANGLE (Degree)	RAW VALUE (dBuV)	CORRECTION FACTOR (dB/m)
1	101.17	25.9 QP	43.5	-17.6	2.00 H	89	16.21	9.65
2	329.96	21.6 QP	46.0	-24.4	1.00 H	315	5.52	16.07
3	385.98	22.8 QP	46.0	-23.2	2.00 H	360	5.44	17.37
4	696.84	27.5 QP	46.0	-18.5	1.00 H	240	4.41	23.07
5	763.15	29.4 QP	46.0	-16.6	1.00 H	221	4.76	24.60
6	940.67	29.8 QP	46.0	-16.2	2.00 H	340	2.23	27.54

REMARKS:

1. Emission level (dBuV/m) = Raw Value (dBuV) + Correction Factor (dB/m).
2. Correction Factor (dB/m) = Antenna Factor (dB/m) + Cable Factor (dB).
3. The other emission levels were very low against the limit.
4. Margin value = Emission level – Limit value.

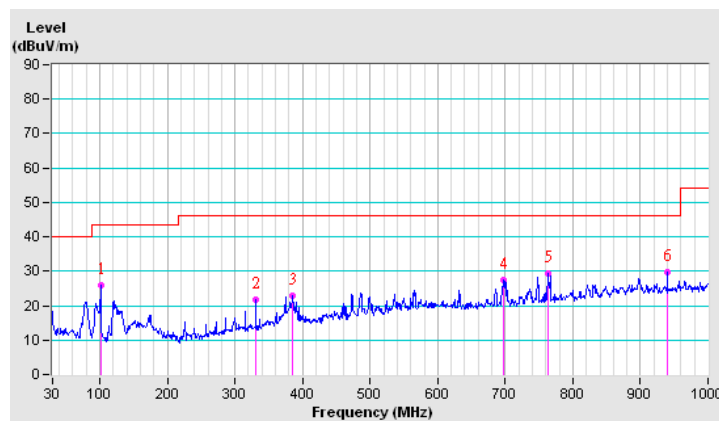



A D T

CHANNEL	TX Channel 6	DETECTOR FUNCTION	Quasi-Peak (QP)
FREQUENCY RANGE	Below 1GHz		

ANTENNA POLARITY & TEST DISTANCE: VERTICAL AT 3 M								
NO.	FREQ. (MHz)	EMISSION LEVEL (dBuV/m)	LIMIT (dBuV/m)	MARGIN (dB)	ANTENNA HEIGHT (m)	TABLE ANGLE (Degree)	RAW VALUE (dBuV)	CORRECTION FACTOR (dB/m)
1	30.00	34.8 QP	40.0	-5.2	1.00 V	124	21.73	13.08
2	101.17	22.5 QP	43.5	-21.0	1.00 V	90	12.88	9.65
3	374.97	29.9 QP	46.0	-16.1	1.00 V	110	12.81	17.10
4	384.08	31.2 QP	46.0	-14.8	1.00 V	132	13.85	17.32
5	697.55	34.8 QP	46.0	-11.2	1.50 V	140	11.74	23.08
6	899.70	30.5 QP	46.0	-15.5	1.50 V	0	3.54	26.96

REMARKS:

1. Emission level (dBuV/m) = Raw Value (dBuV) + Correction Factor (dB/m).
2. Correction Factor (dB/m) = Antenna Factor (dB/m) + Cable Factor (dB).
3. The other emission levels were very low against the limit.
4. Margin value = Emission level – Limit value.

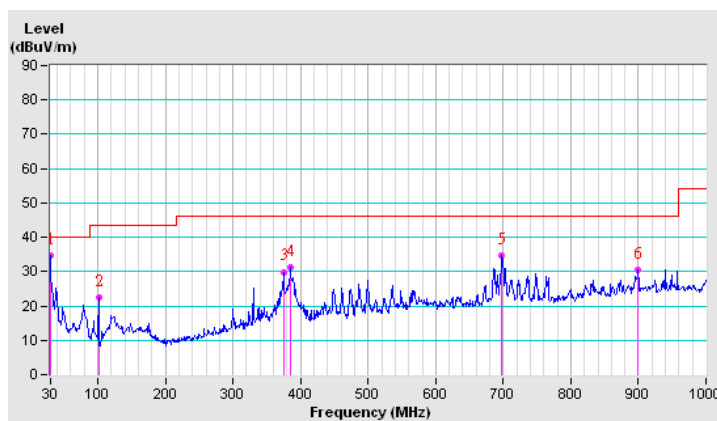



A D T

ABOVE 1GHz DATA

802.11b

CHANNEL	TX Channel 1	DETECTOR FUNCTION	Peak (PK)
FREQUENCY RANGE	1GHz ~ 25GHz		Average (AV)

ANTENNA POLARITY & TEST DISTANCE: HORIZONTAL AT 3 M								
NO.	FREQ. (MHz)	EMISSION LEVEL (dBuV/m)	LIMIT (dBuV/m)	MARGIN (dB)	ANTENNA HEIGHT (m)	TABLE ANGLE (Degree)	RAW VALUE (dBuV)	CORRECTION FACTOR (dB/m)
1	2390.00	57.2 PK	74.0	-16.8	1.00 H	23	25.88	31.32
2	2390.00	44.3 AV	54.0	-9.7	1.00 H	23	12.98	31.32
3	*2412.00	96.9 PK			1.00 H	21	65.51	31.39
4	*2412.00	94.6 AV			1.00 H	21	63.21	31.39
5	4824.00	51.5 PK	74.0	-22.5	1.14 H	313	15.33	36.17
6	4824.00	44.4 AV	54.0	-9.6	1.14 H	313	8.23	36.17

ANTENNA POLARITY & TEST DISTANCE: VERTICAL AT 3 M								
NO.	FREQ. (MHz)	EMISSION LEVEL (dBuV/m)	LIMIT (dBuV/m)	MARGIN (dB)	ANTENNA HEIGHT (m)	TABLE ANGLE (Degree)	RAW VALUE (dBuV)	CORRECTION FACTOR (dB/m)
1	2390.00	57.5 PK	74.0	-16.5	1.04 V	55	26.18	31.32
2	2390.00	46.6 AV	54.0	-7.4	1.04 V	55	15.28	31.32
3	*2412.00	110.0 PK			1.04 V	52	78.61	31.39
4	*2412.00	107.6 AV			1.04 V	52	76.21	31.39
5	4824.00	56.5 PK	74.0	-17.5	1.09 V	265	20.33	36.17
6	4824.00	53.5 AV	54.0	-0.5	1.09 V	265	17.33	36.17

REMARKS:

1. Emission level (dBuV/m) = Raw Value (dBuV) + Correction Factor (dB/m).
2. Correction Factor (dB/m) = Antenna Factor (dB/m) + Cable Factor (dB).
3. The other emission levels were very low against the limit.
4. Margin value = Emission level – Limit value.
5. " * ": Fundamental frequency.



A D T

CHANNEL	TX Channel 6	DETECTOR FUNCTION	Peak (PK)
FREQUENCY RANGE	1GHz ~ 25GHz		Average (AV)

ANTENNA POLARITY & TEST DISTANCE: HORIZONTAL AT 3 M

NO.	FREQ. (MHz)	EMISSION LEVEL (dBuV/m)	LIMIT (dBuV/m)	MARGIN (dB)	ANTENNA HEIGHT (m)	TABLE ANGLE (Degree)	RAW VALUE (dBuV)	CORRECTION FACTOR (dB/m)
1	*2437.00	98.1 PK			1.00 H	20	66.61	31.49
2	*2437.00	95.8 AV			1.00 H	20	64.31	31.49
3	4874.00	51.1 PK	74.0	-22.9	1.12 H	304	14.79	36.31
4	4874.00	44.3 AV	54.0	-9.7	1.12 H	304	7.99	36.31
5	7311.00	53.2 PK	74.0	-20.8	1.00 H	231	10.97	42.23
6	7311.00	40.9 AV	54.0	-13.1	1.00 H	231	-1.33	42.23

ANTENNA POLARITY & TEST DISTANCE: VERTICAL AT 3 M

NO.	FREQ. (MHz)	EMISSION LEVEL (dBuV/m)	LIMIT (dBuV/m)	MARGIN (dB)	ANTENNA HEIGHT (m)	TABLE ANGLE (Degree)	RAW VALUE (dBuV)	CORRECTION FACTOR (dB/m)
1	*2437.00	111.3 PK			1.04 V	51	79.81	31.49
2	*2437.00	108.2 AV			1.04 V	51	76.71	31.49
3	4874.00	56.3 PK	74.0	-17.7	1.12 V	283	19.99	36.31
4	4874.00	53.1 AV	54.0	-0.9	1.12 V	283	16.79	36.31
5	7311.00	52.4 PK	74.0	-21.6	1.00 V	152	10.17	42.23
6	7311.00	40.8 AV	54.0	-13.2	1.00 V	152	-1.43	42.23

REMARKS:

1. Emission level (dBuV/m) = Raw Value (dBuV) + Correction Factor (dB/m).
2. Correction Factor (dB/m) = Antenna Factor (dB/m) + Cable Factor (dB).
3. The other emission levels were very low against the limit.
4. Margin value = Emission level – Limit value.
5. " * ": Fundamental frequency.



A D T

CHANNEL	TX Channel 11	DETECTOR FUNCTION	Peak (PK)
FREQUENCY RANGE	1GHz ~ 25GHz		Average (AV)

ANTENNA POLARITY & TEST DISTANCE: HORIZONTAL AT 3 M

NO.	FREQ. (MHz)	EMISSION LEVEL (dBuV/m)	LIMIT (dBuV/m)	MARGIN (dB)	ANTENNA HEIGHT (m)	TABLE ANGLE (Degree)	RAW VALUE (dBuV)	CORRECTION FACTOR (dB/m)
1	*2462.00	98.5 PK			1.00 H	23	66.92	31.58
2	*2462.00	96.1 AV			1.00 H	23	64.52	31.58
3	2483.50	57.1 PK	74.0	-16.9	1.00 H	21	25.44	31.66
4	2483.50	44.6 AV	54.0	-9.4	1.00 H	21	12.94	31.66
5	4924.00	50.7 PK	74.0	-23.3	1.09 H	324	14.28	36.42
6	4924.00	43.9 AV	54.0	-10.1	1.09 H	324	7.48	36.42
7	7386.00	53.7 PK	74.0	-20.3	1.05 H	224	11.18	42.52
8	7386.00	41.2 AV	54.0	-12.8	1.05 H	224	-1.32	42.52

ANTENNA POLARITY & TEST DISTANCE: VERTICAL AT 3 M

NO.	FREQ. (MHz)	EMISSION LEVEL (dBuV/m)	LIMIT (dBuV/m)	MARGIN (dB)	ANTENNA HEIGHT (m)	TABLE ANGLE (Degree)	RAW VALUE (dBuV)	CORRECTION FACTOR (dB/m)
1	*2462.00	111.6 PK			1.05 V	53	80.02	31.58
2	*2462.00	108.4 AV			1.05 V	53	76.82	31.58
3	2483.50	58.6 PK	74.0	-15.4	1.04 V	51	26.94	31.66
4	2483.50	46.8 AV	54.0	-7.2	1.04 V	51	15.14	31.66
5	4924.00	56.3 PK	74.0	-17.7	1.43 V	318	19.88	36.42
6	4924.00	53.2 AV	54.0	-0.8	1.43 V	318	16.78	36.42
7	7386.00	52.0 PK	74.0	-22.0	1.03 V	158	9.48	42.52
8	7386.00	40.7 AV	54.0	-13.3	1.03 V	158	-1.82	42.52

REMARKS:

1. Emission level (dBuV/m) = Raw Value (dBuV) + Correction Factor (dB/m).
2. Correction Factor (dB/m) = Antenna Factor (dB/m) + Cable Factor (dB).
3. The other emission levels were very low against the limit.
4. Margin value = Emission level – Limit value.
5. " * ": Fundamental frequency.



802.11g

CHANNEL	TX Channel 1	DETECTOR FUNCTION	Peak (PK)
FREQUENCY RANGE	1GHz ~ 25GHz		Average (AV)

ANTENNA POLARITY & TEST DISTANCE: HORIZONTAL AT 3 M

NO.	FREQ. (MHz)	EMISSION LEVEL (dBuV/m)	LIMIT (dBuV/m)	MARGIN (dB)	ANTENNA HEIGHT (m)	TABLE ANGLE (Degree)	RAW VALUE (dBuV)	CORRECTION FACTOR (dB/m)
1	2390.00	58.2 PK	74.0	-15.8	1.00 H	24	26.88	31.32
2	2390.00	44.9 AV	54.0	-9.1	1.00 H	24	13.58	31.32
3	*2412.00	98.9 PK			1.00 H	27	67.51	31.39
4	*2412.00	89.8 AV			1.00 H	27	58.41	31.39
5	4824.00	47.8 PK	74.0	-26.2	1.00 H	231	11.63	36.17
6	4824.00	36.5 AV	54.0	-17.5	1.00 H	231	0.33	36.17

ANTENNA POLARITY & TEST DISTANCE: VERTICAL AT 3 M

NO.	FREQ. (MHz)	EMISSION LEVEL (dBuV/m)	LIMIT (dBuV/m)	MARGIN (dB)	ANTENNA HEIGHT (m)	TABLE ANGLE (Degree)	RAW VALUE (dBuV)	CORRECTION FACTOR (dB/m)
1	2390.00	69.4 PK	74.0	-4.6	1.60 V	304	38.08	31.32
2	2390.00	52.0 AV	54.0	-2.0	1.60 V	304	20.68	31.32
3	*2412.00	110.5 PK			1.55 V	300	79.11	31.39
4	*2412.00	101.8 AV			1.55 V	300	70.41	31.39
5	4824.00	50.5 PK	74.0	-23.5	1.00 V	343	14.33	36.17
6	4824.00	36.9 AV	54.0	-17.1	1.00 V	343	0.73	36.17

REMARKS:

1. Emission level (dBuV/m) = Raw Value (dBuV) + Correction Factor (dB/m).
2. Correction Factor (dB/m) = Antenna Factor (dB/m) + Cable Factor (dB).
3. The other emission levels were very low against the limit.
4. Margin value = Emission level – Limit value.
5. " * ": Fundamental frequency.



A D T

CHANNEL	TX Channel 6	DETECTOR FUNCTION	Peak (PK)
FREQUENCY RANGE	1GHz ~ 25GHz		Average (AV)

ANTENNA POLARITY & TEST DISTANCE: HORIZONTAL AT 3 M

NO.	FREQ. (MHz)	EMISSION LEVEL (dBuV/m)	LIMIT (dBuV/m)	MARGIN (dB)	ANTENNA HEIGHT (m)	TABLE ANGLE (Degree)	RAW VALUE (dBuV)	CORRECTION FACTOR (dB/m)
1	*2437.00	101.0 PK			1.00 H	26	69.51	31.49
2	*2437.00	91.9 AV			1.00 H	26	60.41	31.49
3	4874.00	47.9 PK	74.0	-26.1	1.00 H	233	11.59	36.31
4	4874.00	36.7 AV	54.0	-17.3	1.00 H	233	0.39	36.31
5	7311.00	52.9 PK	74.0	-21.1	1.00 H	133	10.67	42.23
6	7311.00	40.9 AV	54.0	-13.1	1.00 H	133	-1.33	42.23

ANTENNA POLARITY & TEST DISTANCE: VERTICAL AT 3 M

NO.	FREQ. (MHz)	EMISSION LEVEL (dBuV/m)	LIMIT (dBuV/m)	MARGIN (dB)	ANTENNA HEIGHT (m)	TABLE ANGLE (Degree)	RAW VALUE (dBuV)	CORRECTION FACTOR (dB/m)
1	2388.00	60.6 PK	74.0	-13.4	1.60 V	304	29.29	31.31
2	2388.00	48.5 AV	54.0	-5.5	1.60 V	304	17.19	31.31
3	*2437.00	115.3 PK			1.56 V	304	83.81	31.49
4	*2437.00	106.0 AV			1.56 V	304	74.51	31.49
5	2486.00	62.6 PK	74.0	-11.4	1.55 V	307	30.93	31.67
6	2486.00	50.1 AV	54.0	-3.9	1.55 V	307	18.43	31.67
7	4874.00	52.6 PK	74.0	-21.4	1.00 V	343	16.29	36.31
8	4874.00	38.2 AV	54.0	-15.8	1.00 V	343	1.89	36.31
9	7311.00	54.4 PK	74.0	-19.6	1.00 V	155	12.17	42.23
10	7311.00	41.9 AV	54.0	-12.1	1.00 V	155	-0.33	42.23

REMARKS:

1. Emission level (dBuV/m) = Raw Value (dBuV) + Correction Factor (dB/m).
2. Correction Factor (dB/m) = Antenna Factor (dB/m) + Cable Factor (dB).
3. The other emission levels were very low against the limit.
4. Margin value = Emission level – Limit value.
5. " * ": Fundamental frequency.



A D T

CHANNEL	TX Channel 11	DETECTOR FUNCTION	Peak (PK)
FREQUENCY RANGE	1GHz ~ 25GHz		Average (AV)

ANTENNA POLARITY & TEST DISTANCE: HORIZONTAL AT 3 M

NO.	FREQ. (MHz)	EMISSION LEVEL (dBuV/m)	LIMIT (dBuV/m)	MARGIN (dB)	ANTENNA HEIGHT (m)	TABLE ANGLE (Degree)	RAW VALUE (dBuV)	CORRECTION FACTOR (dB/m)
1	*2462.00	98.6 PK			1.00 H	21	67.02	31.58
2	*2462.00	88.4 AV			1.00 H	21	56.82	31.58
3	2483.50	59.6 PK	74.0	-14.4	1.00 H	22	27.94	31.66
4	2483.50	44.4 AV	54.0	-9.6	1.00 H	22	12.74	31.66
5	4924.00	48.3 PK	74.0	-25.7	1.00 H	231	11.88	36.42
6	4924.00	36.3 AV	54.0	-17.7	1.00 H	231	-0.12	36.42
7	7386.00	52.6 PK	74.0	-21.4	1.00 H	131	10.08	42.52
8	7386.00	40.3 AV	54.0	-13.7	1.00 H	131	-2.22	42.52

ANTENNA POLARITY & TEST DISTANCE: VERTICAL AT 3 M

NO.	FREQ. (MHz)	EMISSION LEVEL (dBuV/m)	LIMIT (dBuV/m)	MARGIN (dB)	ANTENNA HEIGHT (m)	TABLE ANGLE (Degree)	RAW VALUE (dBuV)	CORRECTION FACTOR (dB/m)
1	*2462.00	109.9 PK			1.56 V	305	78.32	31.58
2	*2462.00	100.9 AV			1.56 V	305	69.32	31.58
3	2483.50	71.8 PK	74.0	-2.2	1.54 V	38	40.14	31.66
4	2483.50	50.4 AV	54.0	-3.6	1.54 V	38	18.74	31.66
5	4924.00	50.7 PK	74.0	-23.3	1.00 V	342	14.28	36.42
6	4924.00	36.7 AV	54.0	-17.3	1.00 V	342	0.28	36.42
7	7386.00	54.6 PK	74.0	-19.4	1.00 V	159	12.08	42.52
8	7386.00	41.6 AV	54.0	-12.4	1.00 V	159	-0.92	42.52

REMARKS:

1. Emission level (dBuV/m) = Raw Value (dBuV) + Correction Factor (dB/m).
2. Correction Factor (dB/m) = Antenna Factor (dB/m) + Cable Factor (dB).
3. The other emission levels were very low against the limit.
4. Margin value = Emission level – Limit value.
5. " * ": Fundamental frequency.

802.11n (20MHz)

CHANNEL	TX Channel 1	DETECTOR FUNCTION	Peak (PK)
FREQUENCY RANGE	1GHz ~ 25GHz		Average (AV)

ANTENNA POLARITY & TEST DISTANCE: HORIZONTAL AT 3 M								
NO.	FREQ. (MHz)	EMISSION LEVEL (dBuV/m)	LIMIT (dBuV/m)	MARGIN (dB)	ANTENNA HEIGHT (m)	TABLE ANGLE (Degree)	RAW VALUE (dBuV)	CORRECTION FACTOR (dB/m)
1	2390.00	58.3 PK	74.0	-15.7	1.00 H	23	26.98	31.32
2	2390.00	44.6 AV	54.0	-9.4	1.00 H	23	13.28	31.32
3	*2412.00	98.3 PK			1.00 H	21	66.91	31.39
4	*2412.00	89.6 AV			1.00 H	21	58.21	31.39
5	4824.00	48.8 PK	74.0	-25.2	1.01 H	239	12.63	36.17
6	4824.00	36.7 AV	54.0	-17.3	1.01 H	239	0.53	36.17
ANTENNA POLARITY & TEST DISTANCE: VERTICAL AT 3 M								
NO.	FREQ. (MHz)	EMISSION LEVEL (dBuV/m)	LIMIT (dBuV/m)	MARGIN (dB)	ANTENNA HEIGHT (m)	TABLE ANGLE (Degree)	RAW VALUE (dBuV)	CORRECTION FACTOR (dB/m)
1	2390.00	67.9 PK	74.0	-6.1	1.06 V	50	36.58	31.32
2	2390.00	52.9 AV	54.0	-1.1	1.06 V	50	21.58	31.32
3	*2412.00	110.6 PK			1.00 V	47	79.21	31.39
4	*2412.00	101.5 AV			1.00 V	47	70.11	31.39
5	4824.00	49.5 PK	74.0	-24.5	1.01 V	356	13.33	36.17
6	4824.00	37.0 AV	54.0	-17.0	1.01 V	356	0.83	36.17

REMARKS:

1. Emission level (dBuV/m) = Raw Value (dBuV) + Correction Factor (dB/m).
2. Correction Factor (dB/m) = Antenna Factor (dB/m) + Cable Factor (dB).
3. The other emission levels were very low against the limit.
4. Margin value = Emission level – Limit value.
5. " * ": Fundamental frequency.



A D T

CHANNEL	TX Channel 6	DETECTOR FUNCTION	Peak (PK)
FREQUENCY RANGE	1GHz ~ 25GHz		Average (AV)

ANTENNA POLARITY & TEST DISTANCE: HORIZONTAL AT 3 M

NO.	FREQ. (MHz)	EMISSION LEVEL (dBuV/m)	LIMIT (dBuV/m)	MARGIN (dB)	ANTENNA HEIGHT (m)	TABLE ANGLE (Degree)	RAW VALUE (dBuV)	CORRECTION FACTOR (dB/m)
1	*2437.00	97.0 PK			1.02 H	32	65.51	31.49
2	*2437.00	88.1 AV			1.02 H	32	56.61	31.49
3	4874.00	48.6 PK	74.0	-25.4	1.00 H	232	12.29	36.31
4	4874.00	36.2 AV	54.0	-17.8	1.00 H	232	-0.11	36.31
5	7311.00	53.1 PK	74.0	-20.9	1.00 H	230	10.87	42.23
6	7311.00	40.9 AV	54.0	-13.1	1.00 H	230	-1.33	42.23

ANTENNA POLARITY & TEST DISTANCE: VERTICAL AT 3 M

NO.	FREQ. (MHz)	EMISSION LEVEL (dBuV/m)	LIMIT (dBuV/m)	MARGIN (dB)	ANTENNA HEIGHT (m)	TABLE ANGLE (Degree)	RAW VALUE (dBuV)	CORRECTION FACTOR (dB/m)
1	2390.00	57.4 PK	74.0	-16.6	1.59 V	101	26.08	31.32
2	2390.00	46.1 AV	54.0	-7.9	1.59 V	101	14.78	31.32
3	*2437.00	109.4 PK			1.00 V	50	77.91	31.49
4	*2437.00	99.4 AV			1.00 V	50	67.91	31.49
5	2483.50	60.5 PK	74.0	-13.5	1.57 V	103	28.84	31.66
6	2483.50	48.3 AV	54.0	-5.7	1.57 V	103	16.64	31.66
7	4874.00	48.9 PK	74.0	-25.1	1.00 V	349	12.59	36.31
8	4874.00	36.7 AV	54.0	-17.3	1.00 V	349	0.39	36.31
9	7311.00	53.5 PK	74.0	-20.5	1.00 V	160	11.27	42.23
10	7311.00	40.9 AV	54.0	-13.1	1.00 V	160	-1.33	42.23

REMARKS:

1. Emission level (dBuV/m) = Raw Value (dBuV) + Correction Factor (dB/m).
2. Correction Factor (dB/m) = Antenna Factor (dB/m) + Cable Factor (dB).
3. The other emission levels were very low against the limit.
4. Margin value = Emission level – Limit value.
5. " * " : Fundamental frequency.



A D T

CHANNEL	TX Channel 11	DETECTOR FUNCTION	Peak (PK)
FREQUENCY RANGE	1GHz ~ 25GHz		Average (AV)

ANTENNA POLARITY & TEST DISTANCE: HORIZONTAL AT 3 M

NO.	FREQ. (MHz)	EMISSION LEVEL (dBuV/m)	LIMIT (dBuV/m)	MARGIN (dB)	ANTENNA HEIGHT (m)	TABLE ANGLE (Degree)	RAW VALUE (dBuV)	CORRECTION FACTOR (dB/m)
1	*2462.00	96.4 PK			1.01 H	34	64.82	31.58
2	*2462.00	87.4 AV			1.01 H	34	55.82	31.58
3	2483.50	59.1 PK	74.0	-14.9	1.00 H	34	27.44	31.66
4	2483.50	44.2 AV	54.0	-9.8	1.00 H	34	12.54	31.66
5	4924.00	48.9 PK	74.0	-25.1	1.00 H	233	12.48	36.42
6	4924.00	36.5 AV	54.0	-17.5	1.00 H	233	0.08	36.42
7	7386.00	53.3 PK	74.0	-20.7	1.00 H	215	10.78	42.52
8	7386.00	41.1 AV	54.0	-12.9	1.00 H	215	-1.42	42.52

ANTENNA POLARITY & TEST DISTANCE: VERTICAL AT 3 M

NO.	FREQ. (MHz)	EMISSION LEVEL (dBuV/m)	LIMIT (dBuV/m)	MARGIN (dB)	ANTENNA HEIGHT (m)	TABLE ANGLE (Degree)	RAW VALUE (dBuV)	CORRECTION FACTOR (dB/m)
1	*2462.00	108.8 PK			1.00 V	49	76.79	32.01
2	*2462.00	99.2 AV			1.00 V	49	67.19	32.01
3	2483.50	73.3 PK	74.0	-0.7	1.87 V	102	41.21	32.09
4	2483.50	47.8 AV	54.0	-6.2	1.87 V	102	15.71	32.09
5	4924.00	49.5 PK	74.0	-24.5	1.00 V	342	9.83	39.67
6	4924.00	37.2 AV	54.0	-16.8	1.00 V	342	-2.47	39.67
7	7386.00	54.2 PK	74.0	-19.8	1.04 V	157	7.40	46.80
8	7386.00	41.3 AV	54.0	-12.7	1.04 V	157	-5.50	46.80

REMARKS:

1. Emission level (dBuV/m) = Raw Value (dBuV) + Correction Factor (dB/m).
2. Correction Factor (dB/m) = Antenna Factor (dB/m) + Cable Factor (dB).
3. The other emission levels were very low against the limit.
4. Margin value = Emission level – Limit value.
5. " * ": Fundamental frequency.



A D T

802.11n (40MHz)

CHANNEL	TX Channel 3	DETECTOR FUNCTION	Peak (PK)
FREQUENCY RANGE	1GHz ~ 25GHz		Average (AV)

ANTENNA POLARITY & TEST DISTANCE: HORIZONTAL AT 3 M								
NO.	FREQ. (MHz)	EMISSION LEVEL (dBuV/m)	LIMIT (dBuV/m)	MARGIN (dB)	ANTENNA HEIGHT (m)	TABLE ANGLE (Degree)	RAW VALUE (dBuV)	CORRECTION FACTOR (dB/m)
1	2390.00	56.9 PK	74.0	-17.1	1.00 H	26	25.58	31.32
2	2390.00	44.5 AV	54.0	-9.5	1.00 H	26	13.18	31.32
3	*2422.00	89.6 PK			1.00 H	33	58.17	31.43
4	*2422.00	81.0 AV			1.00 H	33	49.57	31.43
5	4844.00	49.0 PK	74.0	-25.0	1.00 H	235	12.78	36.22
6	4844.00	36.1 AV	54.0	-17.9	1.00 H	235	-0.12	36.22
7	7266.00	52.5 PK	74.0	-21.5	1.00 H	218	10.37	42.13
8	7266.00	40.4 AV	54.0	-13.6	1.00 H	218	-1.73	42.13

ANTENNA POLARITY & TEST DISTANCE: VERTICAL AT 3 M								
NO.	FREQ. (MHz)	EMISSION LEVEL (dBuV/m)	LIMIT (dBuV/m)	MARGIN (dB)	ANTENNA HEIGHT (m)	TABLE ANGLE (Degree)	RAW VALUE (dBuV)	CORRECTION FACTOR (dB/m)
1	2390.00	68.2 PK	74.0	-5.8	1.32 V	137	36.88	31.32
2	2390.00	52.1 AV	54.0	-1.9	1.32 V	137	20.78	31.32
3	*2422.00	101.6 PK			1.02 V	55	70.17	31.43
4	*2422.00	93.4 AV			1.02 V	55	61.97	31.43
5	4844.00	46.9 PK	74.0	-27.1	1.00 V	347	10.68	36.22
6	4844.00	35.7 AV	54.0	-18.3	1.00 V	347	-0.52	36.22
7	7266.00	53.4 PK	74.0	-20.6	1.00 V	162	11.27	42.13
8	7266.00	41.2 AV	54.0	-12.8	1.00 V	162	-0.93	42.13

REMARKS:

1. Emission level (dBuV/m) = Raw Value (dBuV) + Correction Factor (dB/m).
2. Correction Factor (dB/m) = Antenna Factor (dB/m) + Cable Factor (dB).
3. The other emission levels were very low against the limit.
4. Margin value = Emission level – Limit value.
5. " * ": Fundamental frequency.



A D T

CHANNEL	TX Channel 6	DETECTOR FUNCTION	Peak (PK)
FREQUENCY RANGE	1GHz ~ 25GHz		Average (AV)

ANTENNA POLARITY & TEST DISTANCE: HORIZONTAL AT 3 M

NO.	FREQ. (MHz)	EMISSION LEVEL (dBuV/m)	LIMIT (dBuV/m)	MARGIN (dB)	ANTENNA HEIGHT (m)	TABLE ANGLE (Degree)	RAW VALUE (dBuV)	CORRECTION FACTOR (dB/m)
1	*2437.00	88.6 PK			1.00 H	39	57.11	31.49
2	*2437.00	79.5 AV			1.00 H	39	48.01	31.49
3	4874.00	48.9 PK	74.0	-25.1	1.00 H	230	12.59	36.31
4	4874.00	36.2 AV	54.0	-17.8	1.00 H	230	-0.11	36.31
5	7311.00	52.5 PK	74.0	-21.5	1.00 H	209	10.27	42.23
6	7311.00	40.6 AV	54.0	-13.4	1.00 H	209	-1.63	42.23

ANTENNA POLARITY & TEST DISTANCE: VERTICAL AT 3 M

NO.	FREQ. (MHz)	EMISSION LEVEL (dBuV/m)	LIMIT (dBuV/m)	MARGIN (dB)	ANTENNA HEIGHT (m)	TABLE ANGLE (Degree)	RAW VALUE (dBuV)	CORRECTION FACTOR (dB/m)
1	*2437.00	100.1 PK			1.01 V	51	68.61	31.49
2	*2437.00	91.1 AV			1.01 V	51	59.61	31.49
3	4874.00	47.2 PK	74.0	-26.8	1.00 V	339	10.89	36.31
4	4874.00	36.2 AV	54.0	-17.8	1.00 V	339	-0.11	36.31
5	7311.00	53.1 PK	74.0	-20.9	1.00 V	161	10.87	42.23
6	7311.00	40.9 AV	54.0	-13.1	1.00 V	161	-1.33	42.23

REMARKS:

1. Emission level (dBuV/m) = Raw Value (dBuV) + Correction Factor (dB/m).
2. Correction Factor (dB/m) = Antenna Factor (dB/m) + Cable Factor (dB).
3. The other emission levels were very low against the limit.
4. Margin value = Emission level – Limit value.
5. " * ": Fundamental frequency.



A D T

CHANNEL	TX Channel 9	DETECTOR FUNCTION	Peak (PK)
FREQUENCY RANGE	1GHz ~ 25GHz		Average (AV)

ANTENNA POLARITY & TEST DISTANCE: HORIZONTAL AT 3 M

NO.	FREQ. (MHz)	EMISSION LEVEL (dBuV/m)	LIMIT (dBuV/m)	MARGIN (dB)	ANTENNA HEIGHT (m)	TABLE ANGLE (Degree)	RAW VALUE (dBuV)	CORRECTION FACTOR (dB/m)
1	*2452.00	88.2 PK			1.00 H	40	56.66	31.54
2	*2452.00	78.7 AV			1.00 H	40	47.16	31.54
3	2483.50	56.9 PK	74.0	-17.1	1.00 H	33	25.24	31.66
4	2483.50	44.4 AV	54.0	-9.6	1.00 H	33	12.74	31.66
5	4904.00	48.6 PK	74.0	-25.4	1.00 H	226	12.21	36.39
6	4904.00	35.7 AV	54.0	-18.3	1.00 H	226	-0.69	36.39
7	7356.00	52.7 PK	74.0	-21.3	1.00 H	211	10.30	42.40
8	7356.00	40.8 AV	54.0	-13.2	1.00 H	211	-1.60	42.40

ANTENNA POLARITY & TEST DISTANCE: VERTICAL AT 3 M

NO.	FREQ. (MHz)	EMISSION LEVEL (dBuV/m)	LIMIT (dBuV/m)	MARGIN (dB)	ANTENNA HEIGHT (m)	TABLE ANGLE (Degree)	RAW VALUE (dBuV)	CORRECTION FACTOR (dB/m)
1	*2452.00	99.6 PK			1.03 V	52	68.06	31.54
2	*2452.00	91.4 AV			1.03 V	52	59.86	31.54
3	2483.50	68.0 PK	74.0	-6.0	1.55 V	302	36.34	31.66
4	2483.50	50.0 AV	54.0	-4.0	1.55 V	302	18.34	31.66
5	4904.00	47.1 PK	74.0	-26.9	1.00 V	323	10.71	36.39
6	4904.00	35.8 AV	54.0	-18.2	1.00 V	323	-0.59	36.39
7	7356.00	53.1 PK	74.0	-20.9	1.01 V	158	10.70	42.40
8	7356.00	41.2 AV	54.0	-12.8	1.01 V	158	-1.20	42.40

REMARKS:

1. Emission level (dBuV/m) = Raw Value (dBuV) + Correction Factor (dB/m).
2. Correction Factor (dB/m) = Antenna Factor (dB/m) + Cable Factor (dB).
3. The other emission levels were very low against the limit.
4. Margin value = Emission level – Limit value.
5. " * ": Fundamental frequency.

4.3 6dB BANDWIDTH MEASUREMENT

4.3.1 LIMITS OF 6dB BANDWIDTH MEASUREMENT

The minimum of 6dB Bandwidth Measurement is 0.5 MHz.

4.3.2 TEST INSTRUMENTS

DESCRIPTION & MANUFACTURER	MODEL NO.	SERIAL NO.	CALIBRATED DATE	CALIBRATED UNTIL
R&S Spectrum Analyzer	FSP 40	100060	May 11, 2011	May 10, 2012

Note:

1. The calibration interval of the above test instruments is 12 months and the calibrations are traceable to NML/ROC and NIST/USA.
2. Tested date : Mar. 20, 2012

4.3.3 TEST PROCEDURE

1. Set resolution bandwidth (RBW) = approximately 1% of the emission bandwidth
2. Set the video bandwidth (VBW) $\geq 3 \times$ RBW, Detector = Peak.
3. Trace mode = max hold.
4. Sweep = auto couple.
5. Measure the maximum width of the emission that is constrained by the frequencies associated with the two amplitude points (upper and lower) that are attenuated by 6 dB relative to the maximum level measured in the fundamental emission

4.3.4 DEVIATION FROM TEST STANDARD

No deviation

4.3.5 TEST SETUP

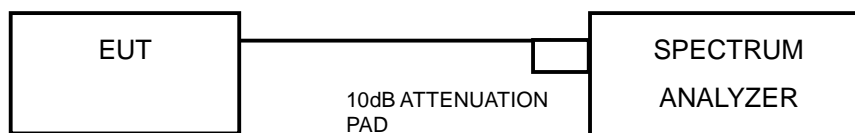

4.3.6 EUT OPERATING CONDITIONS

The software provided by client to enable the EUT under transmission condition continuously at lowest, middle and highest channel frequencies individually.



A D T

4.3.7 TEST RESULTS

802.11b

CHANNEL	CHANNEL FREQUENCY (MHz)	6dB BANDWIDTH (MHz)			MINIMUM LIMIT (MHz)	PASS / FAIL
		CHAIN(0)	CHAIN(1)	CHAIN(2)		
1	2412	10.86	10.50	10.89	0.5	PASS
6	2437	10.67	10.64	10.42	0.5	PASS
11	2462	10.36	10.60	10.43	0.5	PASS

802.11g

CHANNEL	CHANNEL FREQUENCY (MHz)	6dB BANDWIDTH (MHz)			MINIMUM LIMIT (MHz)	PASS / FAIL
		CHAIN(0)	CHAIN(1)	CHAIN(2)		
1	2412	16.64	16.61	16.57	0.5	PASS
6	2437	16.59	16.57	16.55	0.5	PASS
11	2462	16.51	16.63	16.54	0.5	PASS

802.11n (20MHz)

CHANNEL	CHANNEL FREQUENCY (MHz)	6dB BANDWIDTH (MHz)			MINIMUM LIMIT (MHz)	PASS / FAIL
		CHAIN(0)	CHAIN(1)	CHAIN(2)		
1	2412	17.73	17.81	17.82	0.5	PASS
6	2437	17.70	17.86	17.76	0.5	PASS
11	2462	17.73	17.79	17.77	0.5	PASS



A D T

802.11n (40MHz)

CHANNEL	CHANNEL FREQUENCY (MHz)	6dB BANDWIDTH (MHz)			MINIMUM LIMIT (MHz)	PASS / FAIL
		CHAIN(0)	CHAIN(1)	CHAIN(2)		
3	2422	36.63	36.93	36.78	0.5	PASS
6	2437	36.57	37.12	36.64	0.5	PASS
9	2452	36.85	36.96	36.07	0.5	PASS

4.4 OCCUPIED BANDWIDTH MEASUREMENT

4.4.1 TEST INSTRUMENTS

DESCRIPTION & MANUFACTURER	MODEL NO.	SERIAL NO.	CALIBRATED DATE	CALIBRATED UNTIL
R&S Spectrum Analyzer	FSP 40	100060	May 11, 2011	May 10, 2012

Note:

1. The calibration interval of the above test instruments is 12 months and the calibrations are traceable to NML/ROC and NIST/USA.
2. Tested date : Mar. 20, 2012

4.4.2 TEST PROCEDURE

- 1) Set RBW \geq 1% of the emission bandwidth.
- 2) Set the VBW \geq 3 x RBW.
- 3) Detector = Peak.
- 4) Trace mode = max hold.
- 5) Record the 99% emission bandwidth.

4.4.3 DEVIATION FROM TEST STANDARD

No deviation

4.4.4 TEST SETUP

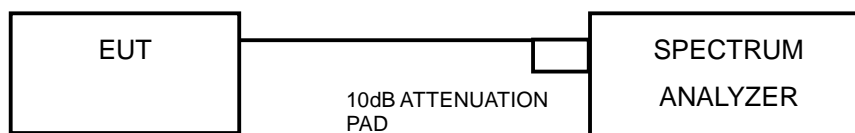

4.4.5 EUT OPERATING CONDITIONS

The software provided by client to enable the EUT under transmission condition continuously at lowest, middle and highest channel frequencies individually.



A D T

4.4.6 TEST RESULTS

802.11b

CHANNEL	CHANNEL FREQUENCY (MHz)	OCCUPIED BANDWIDTH (MHz)			PASS / FAIL
		CHAIN 0	CHAIN 1	CHAIN 2	
1	2412	13.70	13.90	13.80	PASS
6	2437	13.80	13.70	13.70	PASS
11	2462	13.70	13.80	13.70	PASS

802.11g

CHANNEL	CHANNEL FREQUENCY (MHz)	OCCUPIED BANDWIDTH (MHz)			PASS / FAIL
		CHAIN 0	CHAIN 1	CHAIN 2	
1	2412	17.00	17.00	16.90	PASS
6	2437	17.10	17.00	17.00	PASS
11	2462	17.20	16.90	16.90	PASS

802.11n (20MHz)

CHANNEL	CHANNEL FREQUENCY (MHz)	OCCUPIED BANDWIDTH (MHz)			PASS / FAIL
		CHAIN 0	CHAIN 1	CHAIN 2	
1	2412	18.20	18.10	18.00	PASS
6	2437	18.20	18.10	18.00	PASS
11	2462	18.10	18.10	18.00	PASS

802.11n (40MHz)

CHANNEL	CHANNEL FREQUENCY (MHz)	OCCUPIED BANDWIDTH (MHz)			PASS / FAIL
		CHAIN 0	CHAIN 1	CHAIN 2	
3	2422	36.60	36.40	36.60	PASS
6	2437	36.80	36.60	36.60	PASS
9	2452	36.60	36.60	36.60	PASS



A D T

4.5 CONDUCTED OUTPUT POWER

4.5.1 LIMITS OF MAXIMUM PEAK OUTPUT POWER MEASUREMENT

For systems using digital modulation in the 2400–2483.5 MHz band: 1 Watt (30dBm)

4.5.2 INSTRUMENTS

DESCRIPTION & MANUFACTURER	MODEL NO.	SERIAL NO.	CALIBRATED DATE	CALIBRATED UNTIL
Peak Power Meter	ML2495A	0824006	May 04, 2011	May 03, 2012
Power Sensor	MA2411B	0738172	May 03, 2011	May 02, 2012

Note:

1. The calibration interval of the above test instruments is 12 months and the calibrations are traceable to NML/ROC and NIST/USA.
2. Tested date : Mar. 20, 2012

4.5.3 TEST PROCEDURES

A peak power sensor was used on the output port of the EUT. A power meter was used to read the response of the peak power sensor. Record the peak power level.

4.5.4 DEVIATION FROM TEST STANDARD

No deviation

4.5.5 TEST SETUP

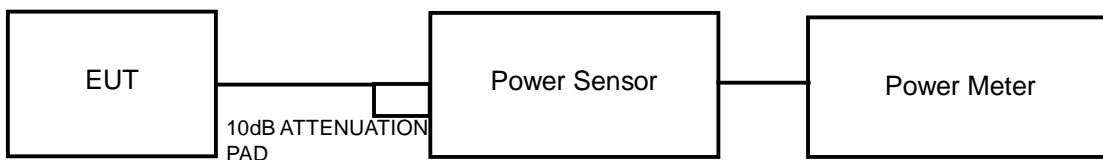

4.5.6 EUT OPERATING CONDITIONS

Same as Item 4.3.6



4.5.7 TEST RESULTS

802.11b

CHANNEL	CHANNEL FREQUENCY (MHz)	PEAK POWER OUTPUT (dBm)			TOTAL PEAK POWER (mW)	TOTAL PEAK POWER (dBm)	PEAK POWER LIMIT (dBm)	PASS / FAIL
		CHAIN(0)	CHAIN(1)	CHAIN(2)				
1	2412	18.10	17.40	18.00	182.615	22.62	29.23	PASS
6	2437	17.90	17.30	17.50	171.597	22.35	29.23	PASS
11	2462	18.80	18.80	19.00	231.149	23.64	29.23	PASS

Note: Directional gain = gain of antenna element + 10 log (# of TX antenna elements)
 Effective Legacy Gain (dBi) = 6.77
 The effective legacy gain is 6.77dBi, therefore the limit needs to reduce.

802.11g

CHANNEL	CHANNEL FREQUENCY (MHz)	PEAK POWER OUTPUT (dBm)			TOTAL PEAK POWER (mW)	TOTAL PEAK POWER (dBm)	PEAK POWER LIMIT (dBm)	PASS / FAIL
		CHAIN(0)	CHAIN(1)	CHAIN(2)				
1	2412	23.10	22.00	22.10	524.844	27.20	29.23	PASS
6	2437	23.80	23.30	23.70	688.102	28.38	29.23	PASS
11	2462	22.10	21.90	21.90	471.945	26.74	29.23	PASS

Note: Directional gain = gain of antenna element + 10 log (# of TX antenna elements)
 Effective Legacy Gain (dBi) = 6.77
 The effective legacy gain is 6.77dBi, therefore the limit needs to reduce.

802.11n (20MHz)

CHANNEL	CHANNEL FREQUENCY (MHz)	PEAK POWER OUTPUT (dBm)			TOTAL PEAK POWER (mW)	TOTAL PEAK POWER (dBm)	PEAK POWER LIMIT (dBm)	PASS / FAIL
		CHAIN(0)	CHAIN(1)	CHAIN(2)				
1	2412	23.00	22.00	22.30	527.839	27.23	30	PASS
6	2437	22.30	21.90	21.60	469.25	26.71	30	PASS
11	2462	22.00	21.30	21.80	444.741	26.48	30	PASS

802.11n (40MHz)

CHANNEL	CHANNEL FREQUENCY (MHz)	PEAK POWER OUTPUT (dBm)			TOTAL PEAK POWER (mW)	TOTAL PEAK POWER (dBm)	PEAK POWER LIMIT (dBm)	PASS / FAIL
		CHAIN(0)	CHAIN(1)	CHAIN(2)				
3	2422	19.30	18.00	18.50	219.005	23.40	30	PASS
6	2437	18.20	16.10	16.30	149.465	21.75	30	PASS
9	2452	18.50	16.00	16.10	151.344	21.80	30	PASS

4.6 POWER SPECTRAL DENSITY MEASUREMENT

4.6.1 LIMITS OF POWER SPECTRAL DENSITY MEASUREMENT

The Maximum of Power Spectral Density Measurement is 8dBm.

4.6.2 TEST INSTRUMENTS

DESCRIPTION & MANUFACTURER	MODEL NO.	SERIAL NO.	CALIBRATED DATE	CALIBRATED UNTIL
R&S Spectrum Analyzer	FSP 40	100060	May 11, 2011	May 10, 2012

Note:

1. The calibration interval of the above test instruments is 12 months and the calibrations are traceable to NML/ROC and NIST/USA.
2. Tested date : Mar. 20, 2012

4.6.3 TEST PROCEDURE

1. Set the RBW = 100 kHz, VBW =300 kHz, Detector = peak.
2. Sweep time = auto couple, Trace mode = max hold, allow trace to fully stabilize.
3. Use the peak marker function to determine the maximum power level in any 100 kHz band segment within the fundamental EBW.
4. Scale the observed power level to an equivalent value in 3 kHz by adjusting (reducing) the measured power by a bandwidth correction factor (BWCF) where $BWCF = 10\log(3 \text{ kHz}/100\text{kHz})$

4.6.4 DEVIATION FROM TEST STANDARD

No deviation

4.6.5 TEST SETUP

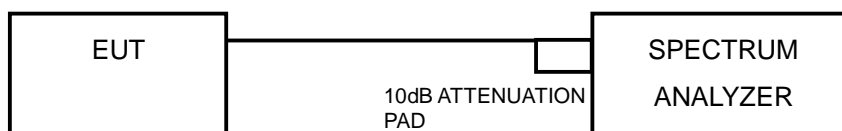

4.6.6 EUT OPERATING CONDITION

Same as Item 4.3.6



A D T

4.6.7 TEST RESULTS

802.11b

TX chain	Channel	FREQ. (MHz)	PSD (dBm/100kHz)	PSD (dBm/3kHz)	10 log (N=3) dB	Total PSD (dBm/3kHz)	Limit (dBm/3kHz)	PASS /FAIL
0	1	2412	6.48	-8.75	4.77	-3.98	7.23	PASS
	6	2437	7.45	-7.78	4.77	-3.01	7.23	PASS
	11	2462	7.73	-7.50	4.77	-2.73	7.23	PASS
1	1	2412	5.22	-10.01	4.77	-5.24	7.23	PASS
	6	2437	5.47	-9.76	4.77	-4.99	7.23	PASS
	11	2462	6.70	-8.53	4.77	-3.76	7.23	PASS
2	1	2412	5.99	-9.24	4.77	-4.47	7.23	PASS
	6	2437	6.05	-9.18	4.77	-4.41	7.23	PASS
	11	2462	7.59	-7.64	4.77	-2.87	7.23	PASS

Note: Directional gain = gain of antenna element + 10 log (# of TX antenna elements)
 Effective Legacy Gain (dBi) = 6.77
 The effective legacy gain is 6.77dBi, therefore the limit needs to reduce.

802.11g

TX chain	Channel	FREQ. (MHz)	PSD (dBm/100kHz)	PSD (dBm/3kHz)	10 log (N=3) dB	Total PSD (dBm/3kHz)	Limit (dBm/3kHz)	PASS /FAIL
0	1	2412	1.20	-14.03	4.77	-9.26	7.23	PASS
	6	2437	3.34	-11.89	4.77	-7.12	7.23	PASS
	11	2462	0.24	-14.99	4.77	-10.22	7.23	PASS
1	1	2412	-0.11	-15.34	4.77	-10.57	7.23	PASS
	6	2437	2.98	-12.25	4.77	-7.48	7.23	PASS
	11	2462	0.15	-15.08	4.77	-10.31	7.23	PASS
2	1	2412	0.60	-14.63	4.77	-9.86	7.23	PASS
	6	2437	3.07	-12.16	4.77	-7.39	7.23	PASS
	11	2462	0.59	-14.64	4.77	-9.87	7.23	PASS

Note: Directional gain = gain of antenna element + 10 log (# of TX antenna elements)
 Effective Legacy Gain (dBi) = 6.77
 The effective legacy gain is 6.77dBi, therefore the limit needs to reduce.



A D T

802.11n (20MHz)

TX chain	Channel	FREQ. (MHz)	PSD (dBm/100kHz)	PSD (dBm/3kHz)	10 log (N=3) dB	Total PSD (dBm/3kHz)	Limit (dBm/3kHz)	PASS /FAIL
0	1	2412	0.62	-14.61	4.77	-9.84	8	PASS
	6	2437	0.22	-15.01	4.77	-10.24	8	PASS
	11	2462	-1.08	-16.31	4.77	-11.54	8	PASS
1	1	2412	-0.19	-15.42	4.77	-10.65	8	PASS
	6	2437	-1.37	-16.60	4.77	-11.83	8	PASS
	11	2462	-1.08	-16.31	4.77	-11.54	8	PASS
2	1	2412	0.29	-14.94	4.77	-10.17	8	PASS
	6	2437	-0.50	-15.73	4.77	-10.96	8	PASS
	11	2462	-0.88	-16.11	4.77	-11.34	8	PASS

802.11n (40MHz)

TX chain	Channel	FREQ. (MHz)	PSD (dBm/100kHz)	PSD (dBm/3kHz)	10 log (N=3) dB	Total PSD (dBm/3kHz)	Limit (dBm/3kHz)	PASS /FAIL
0	3	2422	-5.77	-21.00	4.77	-16.23	8	PASS
	6	2437	-7.22	-22.45	4.77	-17.68	8	PASS
	9	2452	-6.52	-21.75	4.77	-16.98	8	PASS
1	3	2422	-7.54	-22.77	4.77	-18.00	8	PASS
	6	2437	-9.76	-24.99	4.77	-20.22	8	PASS
	9	2452	-10.66	-25.89	4.77	-21.12	8	PASS
2	3	2422	-6.62	-21.85	4.77	-17.08	8	PASS
	6	2437	-8.36	-23.59	4.77	-18.82	8	PASS
	9	2452	-9.12	-24.35	4.77	-19.58	8	PASS

4.7 CONDUCTED OUT-BAND EMISSION MEASUREMENT

4.7.1 LIMITS OF CONDUCTED OUT-BAND EMISSION MEASUREMENT

Below -20dB of the highest emission level of operating band (in 100kHz Resolution Bandwidth).

4.7.2 TEST INSTRUMENTS

DESCRIPTION & MANUFACTURER	MODEL NO.	SERIAL NO.	CALIBRATED DATE	CALIBRATED UNTIL
R&S Spectrum Analyzer	FSP 40	100060	May 11, 2011	May 10, 2012

Note:

1. The calibration interval of the above test instruments is 12 months and the calibrations are traceable to NML/ROC and NIST/USA.
2. Tested date : Mar. 20, 2012

4.7.3 TEST PROCEDURE

MEASUREMENT PROCEDURE REF

1. Set the RBW = 100 kHz.
2. Set the VBW \geq 300 kHz.
3. Detector = peak.
4. Sweep time = auto couple.
5. Trace mode = max hold.
6. Allow trace to fully stabilize.
7. Use the peak marker function to determine the maximum power level in any 100 kHz band segment within the fundamental EBW.

MEASUREMENT PROCEDURE OOB

1. Set RBW = 100 kHz.
2. Set VBW \geq 300 kHz.
3. Set span to encompass the spectrum to be examined
4. Detector = peak.
5. Trace Mode = max hold.
6. Sweep = auto couple.

4.7.4 DEVIATION FROM TEST STANDARD

No deviation

4.7.5 TEST SETUP

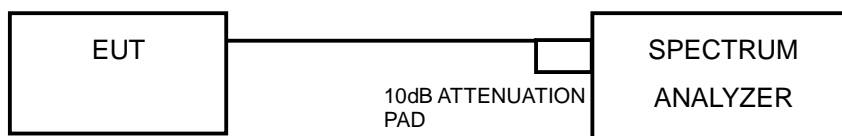

4.7.6 EUT OPERATING CONDITION

Same as Item 4.3.6

4.7.7 TEST RESULTS

The conducted emission test is performed on each TX port of operating mode without summing or adding $10\log(N)$ since the limit is relative emission limit. Only worst data of each operating mode is presented.

The spectrum plots are attached on the following pages. D1 line indicates the highest level, and D2 line indicates the 20dB offset below D1. It shows compliance with the requirement.



A D T

802.11b

CH 1

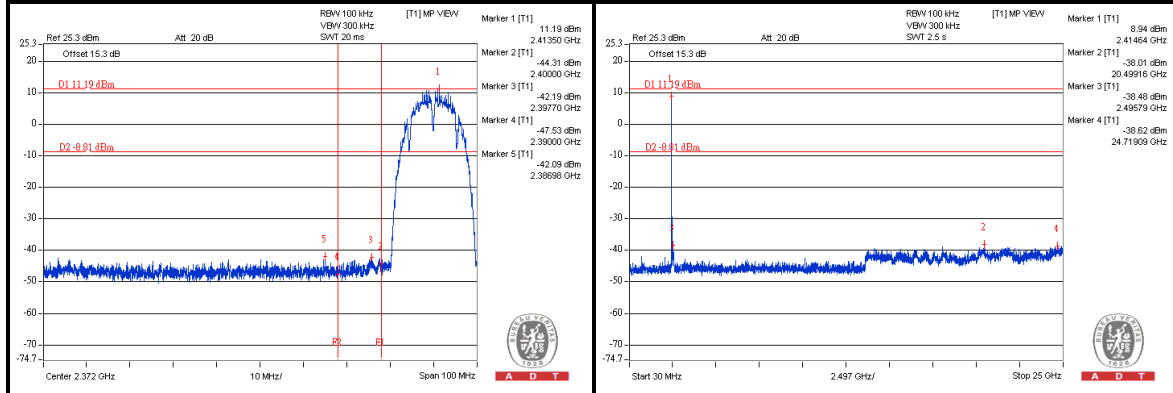

CH 11

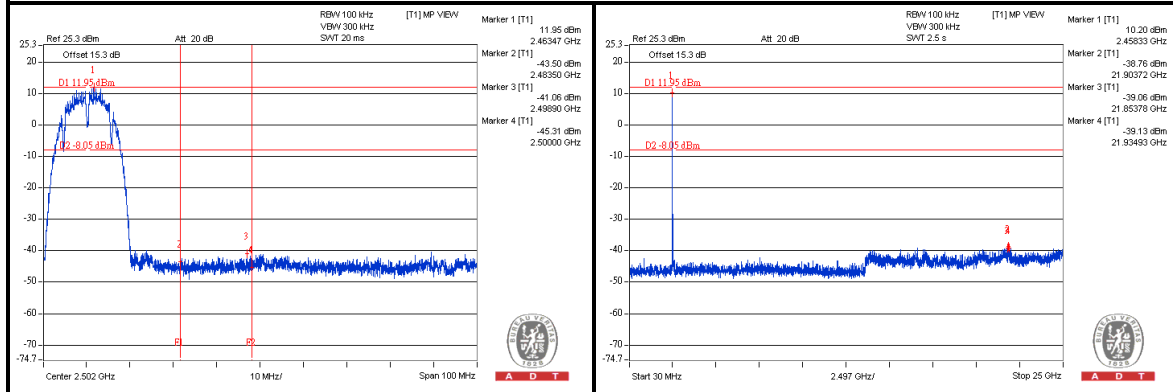



A D T

802.11g

CH 1

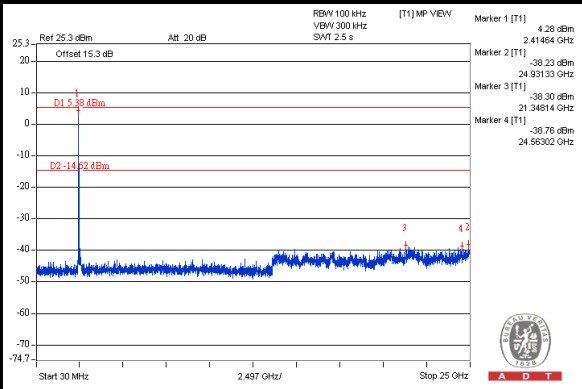
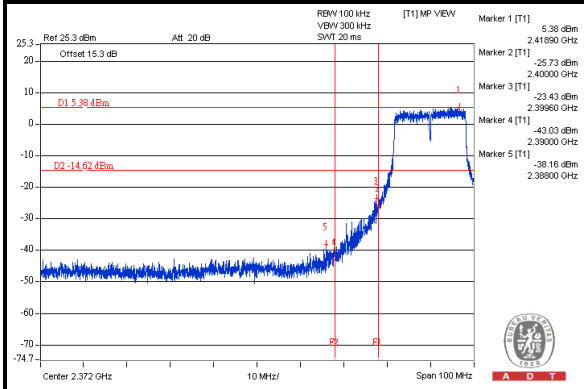

CH 11

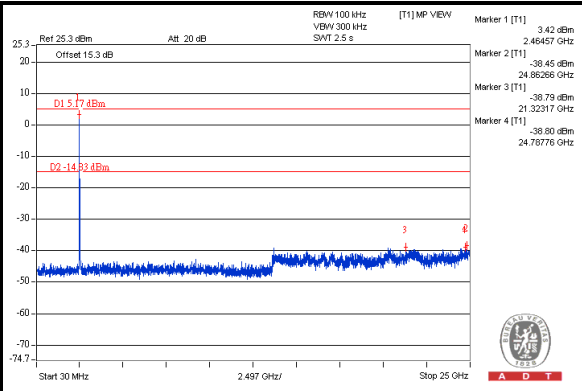
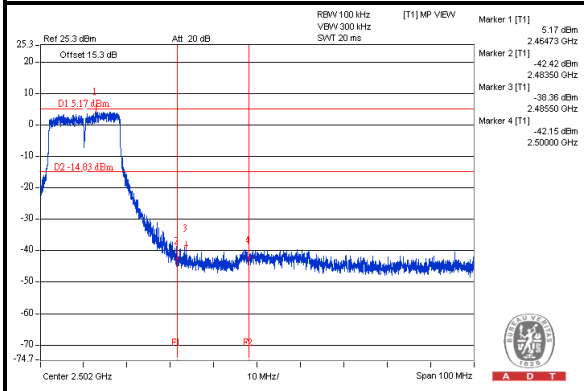



A D T

802.11n (20MHz)

CH 1

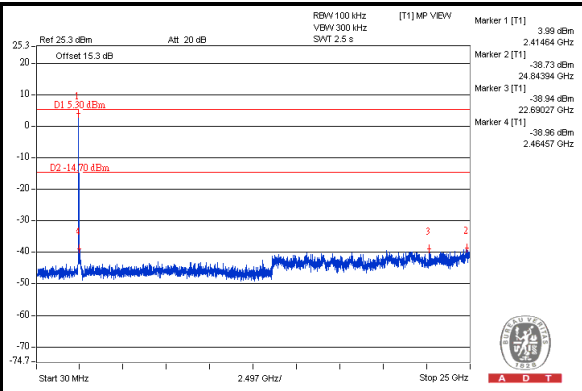
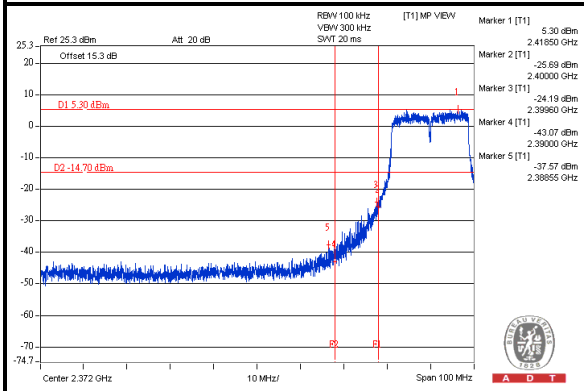

CH 11

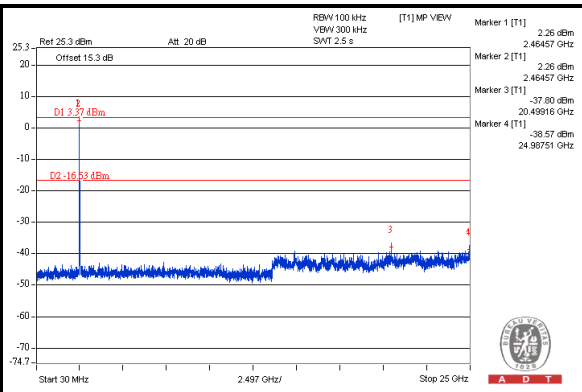
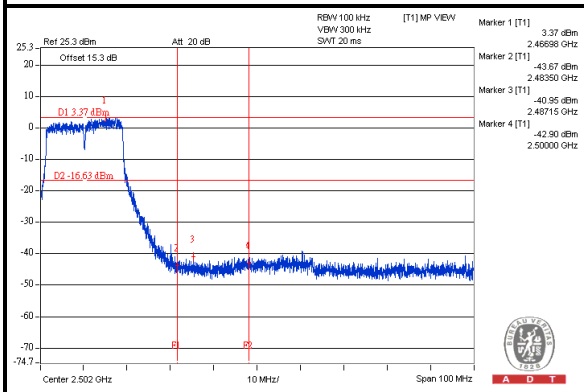



A D T

802.11n (40MHz)

CH 3

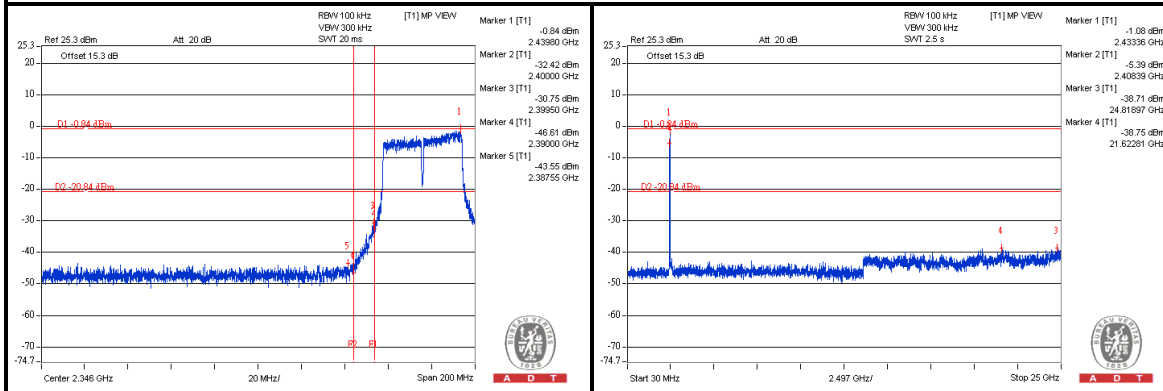

CH 9

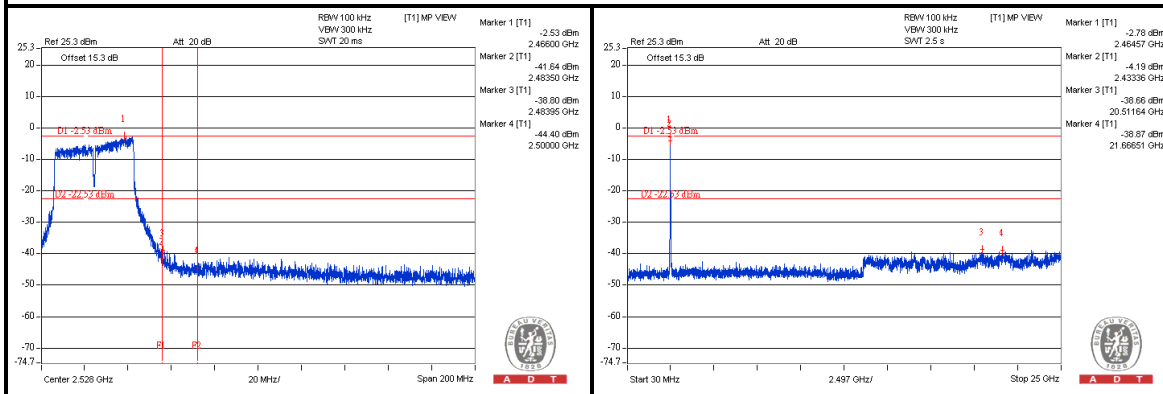

5. TEST TYPES AND RESULTS (802.11a, 5725~5850MHz Band)

5.1 CONDUCTED EMISSION MEASUREMENT

5.1.1 LIMITS OF CONDUCTED EMISSION MEASUREMENT

FREQUENCY OF EMISSION (MHz)	CONDUCTED LIMIT (dB μ V)	
	Quasi-peak	Average
0.15-0.5	66 to 56	56 to 46
0.5-5	56	46
5-30	60	50

- NOTE:**
1. The lower limit shall apply at the transition frequencies.
 2. The limit decreases in line with the logarithm of the frequency in the range of 0.15 to 0.50 MHz.

5.1.2 TEST INSTRUMENTS

DESCRIPTION & MANUFACTURER	MODEL NO.	SERIAL NO.	CALIBRATED DATE	CALIBRATED UNTIL
ROHDE & SCHWARZ Test Receiver	ESCS 30	100287	Feb. 29, 2012	Feb. 28, 2013
Line-Impedance Stabilization Network (for EUT)	NSLK 8127	8127-523	Sep. 20, 2011	Sep. 19, 2012
Line-Impedance Stabilization Network (for Peripheral)	ENV-216	100072	June 10, 2011	June 09, 2012
RF Cable (JYEBAO)	5DFB	COACAB-002	Aug. 06, 2011	Aug. 05, 2012
50 ohms Terminator	50	3	Nov. 02, 2011	Nov. 01, 2012
Software	BV ADT_Cond_V7.3.7	NA	NA	NA

Note:

1. The calibration interval of the above test instruments is 12 months and the calibrations are traceable to NML/ROC and NIST/USA.
2. The test was performed in Shielded Room No. A.
3. The VCCI Con A Registration No. is C-817.
4. Tested Date: Mar. 29, 2012.



A D T

5.1.3 TEST PROCEDURES

- a. The EUT was placed 0.4 meters from the conducting wall of the shielded room with EUT being connected to the power mains through a line impedance stabilization network (LISN). Other support units were connected to the power mains through another LISN. The two LISNs provide 50 ohm/ 50uH of coupling impedance for the measuring instrument.
- b. Both lines of the power mains connected to the EUT were checked for maximum conducted interference.
- c. The frequency range from 150kHz to 30MHz was searched. Emission levels under (Limit – 20dB) were not recorded.

5.1.4 DEVIATION FROM TEST STANDARD

No deviation

5.1.5 TEST SETUP

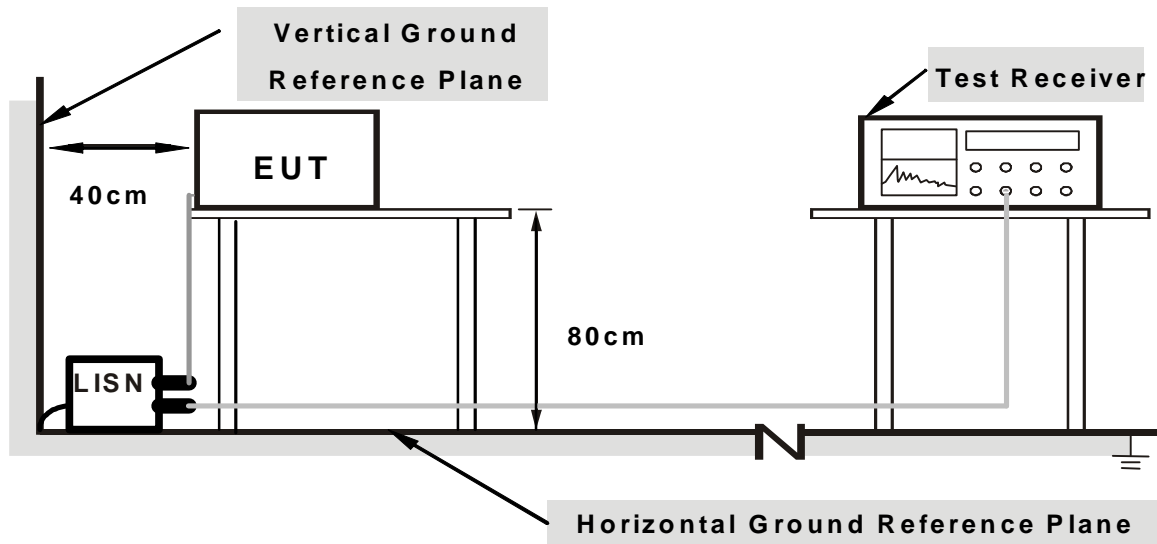

Note: 1. Support units were connected to second LISN.

2. Both of LISNs (AMN) are 80 cm from EUT and at least 80 from other units and other metal planes

For the actual test configuration, please refer to the related item – Photographs of the Test Configuration.

5.1.6 EUT OPERATING CONDITIONS

Same as the 4.1.6

5.1.7 TEST RESULTS

PHASE	Line (L)	6dB BANDWIDTH	9 kHz
--------------	----------	----------------------	-------

No	Freq. [MHz]	Corr. Factor (dB)	Reading Value [dB (uV)]		Emission Level [dB (uV)]		Limit [dB (uV)]		Margin (dB)	
			Q.P.	AV.	Q.P.	AV.	Q.P.	AV.	Q.P.	AV.
	1	0.16409	0.06	39.78	39.29	39.84	39.35	65.25	55.25	-25.41
2	0.20469	0.06	39.19	36.99	39.25	37.05	63.42	53.42	-24.17	-16.37
3	0.46250	0.08	31.88	28.69	31.96	28.77	56.65	46.65	-24.69	-17.88
4	0.82891	0.11	31.06	29.80	31.17	29.91	56.00	46.00	-24.83	-16.09
5	1.38281	0.15	32.80	31.80	32.95	31.95	56.00	46.00	-23.05	-14.05
6	18.03125	0.58	34.51	32.37	35.09	32.95	60.00	50.00	-24.91	-17.05

- REMARKS:**
1. Q.P. and AV. are abbreviations of quasi-peak and average individually.
 2. The emission levels of other frequencies were very low against the limit.
 3. Margin value = Emission level - Limit value
 4. Correction factor = Insertion loss + Cable loss
 5. Emission Level = Correction Factor + Reading Value.

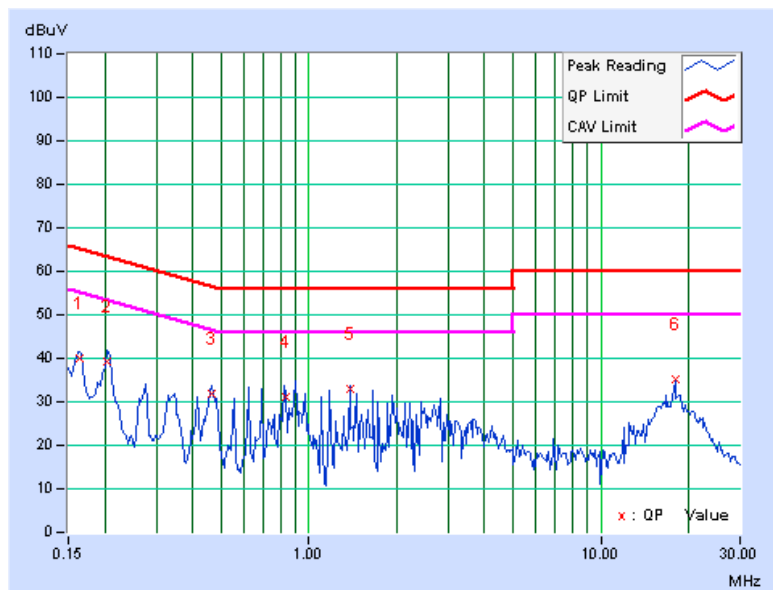

PHASE	Neutral (N)	6dB BANDWIDTH	9 kHz
--------------	-------------	----------------------	-------

No	Freq. [MHz]	Corr. Factor (dB)	Reading Value [dB (uV)]		Emission Level [dB (uV)]		Limit [dB (uV)]		Margin (dB)	
			Q.P.	AV.	Q.P.	AV.	Q.P.	AV.	Q.P.	AV.
			1	0.16172	0.07	39.98	39.33	40.05	39.40	65.38
2	0.20859	0.07	45.31	44.95	45.38	45.02	63.26	53.26	-17.88	-8.24
3	0.27500	0.07	36.50	33.23	36.57	33.30	60.97	50.97	-24.39	-17.66
4	0.34531	0.08	36.52	35.56	36.60	35.64	59.07	49.07	-22.48	-13.44
5	3.03906	0.22	25.34	21.21	25.56	21.43	56.00	46.00	-30.44	-24.57
6	18.03125	0.56	33.06	32.09	33.62	32.65	60.00	50.00	-26.38	-17.35

- REMARKS:**
1. Q.P. and AV. are abbreviations of quasi-peak and average individually.
 2. The emission levels of other frequencies were very low against the limit.
 3. Margin value = Emission level - Limit value
 4. Correction factor = Insertion loss + Cable loss
 5. Emission Level = Correction Factor + Reading Value.

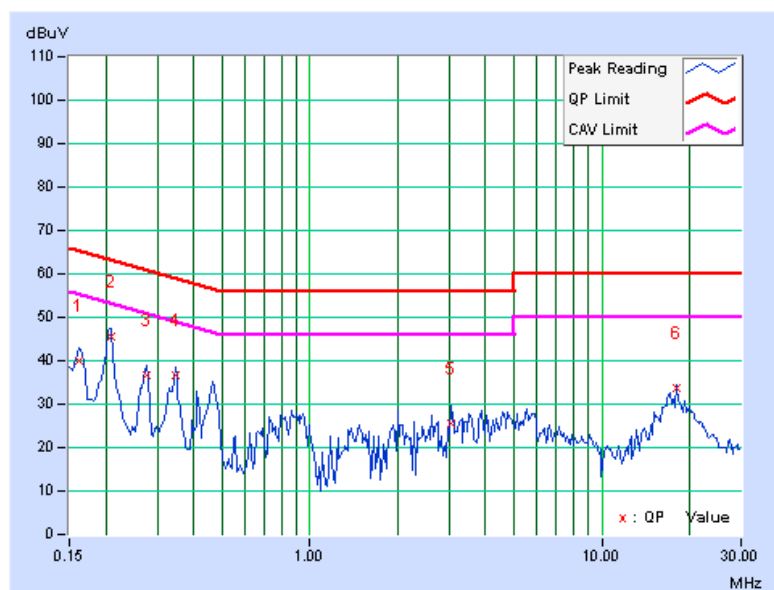

5.2 RADIATED AND BANDEDGE EMISSION MEASUREMENT

5.2.1 LIMITS OF RADIATED AND BANDEDGE EMISSION MEASUREMENT

Radiated emissions which fall in the restricted bands must comply with the radiated emission limits specified as below table. Other emissions shall be at least 20dB below the highest level of the desired power:

Frequencies (MHz)	Field strength (microvolts/meter)	Measurement distance (meters)
0.009-0.490	2400/F(kHz)	300
0.490-1.705	24000/F(kHz)	30
1.705-30.0	30	30
30-88	100	3
88-216	150	3
216-960	200	3
Above 960	500	3

NOTE:

1. The lower limit shall apply at the transition frequencies.
2. Emission level (dBuV/m) = 20 log Emission level (uV/m).
3. For frequencies above 1000MHz, the field strength limits are based on average detector, however, the peak field strength of any emission shall not exceed the maximum permitted average limits, specified above by more than 20dB under any condition of modulation.



A D T

5.2.2 TEST INSTRUMENTS

DESCRIPTION & MANUFACTURER	MODEL NO.	SERIAL NO.	CALIBRATED DATE	CALIBRATED UNTIL
Agilent Spectrum Analyzer	E4446A	MY48250253	Aug. 29, 2011	Aug. 28, 2012
Agilent Pre-Selector	N9039A	MY46520310	Aug. 29, 2011	Aug. 28, 2012
Agilent Signal Generator	N5181A	MY49060347	July 25, 2011	July 24, 2012
Mini-Circuits Pre-Amplifier	ZFL-1000VH2B	AMP-ZFL-04	Nov. 15, 2011	Nov. 14, 2012
Agilent Pre-Amplifier	8449B	3008A02465	Feb. 27, 2012	Feb. 26, 2013
SPACEK LABS	SLKKa-48-6	9K16	Nov. 15, 2011	Nov. 14, 2012
SCHWARZBECK Trilog Broadband Antenna	VULB 9168	9168-361	Apr. 14, 2011	Apr. 13, 2012
AISI Horn_Antenna	AIH.8018	0000220091110	Nov. 23, 2011	Nov. 22, 2012
SCHWARZBECK Horn_Antenna	BBHA 9170	9170-424	Oct. 07, 2011	Oct. 06, 2012
RF CABLE	NA	RF104-205 RF104-207 RF104-202	Dec. 27, 2011	Dec. 26, 2012
RF Cable	NA	CHHCAB_001	Oct. 08, 2011	Oct. 07, 2012
Software	ADT_Radiated_V8.7.05	NA	NA	NA
CT Antenna Tower & Turn Table	NA	NA	NA	NA

Note: 1. The calibration interval of the above test instruments is 12 months and the calibrations are traceable to NML/ROC and NIST/USA.

2. The horn antenna, preamplifier (model: 8449B) are used only for the measurement of emission frequency above 1GHz if tested.

3. The test was performed in 966 Chamber No. H.

4. The FCC Site Registration No. is 797305.

5. The CANADA Site Registration No. is IC 7450H-3.

6. Tested Date: Mar. 10, 2012.

5.2.3 TEST PROCEDURES

- a. The EUT was placed on the top of a rotating table 0.8 meters above the ground at a 3 meter chamber room. The table was rotated 360 degrees to determine the position of the highest radiation.
- b. The EUT was set 3 meters away from the interference-receiving antenna, which was mounted on the top of a variable-height antenna tower.
- c. The height of antenna is varied from one meter to four meters above the ground to determine the maximum value of the field strength. Both horizontal and vertical polarizations of the antenna are set to make the measurement.
- d. For each suspected emission, the EUT was arranged to its worst case and then the antenna was tuned to heights from 1 meter to 4 meters and the rotatable table was turned from 0 degrees to 360 degrees to find the maximum reading.
- e. The test-receiver system was set to quasi-peak detect function and specified bandwidth with maximum hold mode when the test frequency is below 1 GHz.
- f. The test-receiver system was set to peak and average detect function and specified bandwidth with maximum hold mode when the test frequency is above 1 GHz. If the peak reading value also meets average limit, measurement with the average detector is unnecessary.

NOTE:

1. The resolution bandwidth and video bandwidth of test receiver/spectrum analyzer is 120kHz for Quasi-peak detection (QP) at frequency below 1GHz.
2. The resolution bandwidth of test receiver/spectrum analyzer is 1 MHz and the video bandwidth is 3 MHz for Peak detection (PK) at frequency above 1GHz.
3. The resolution bandwidth of test receiver/spectrum analyzer is 1 MHz and the video bandwidth is 10 Hz for Average detection (AV) at frequency above 1GHz.
4. All modes of operation were investigated and the worst-case emissions are reported.

5.2.4 DEVIATION FROM TEST STANDARD

No deviation

5.2.5 TEST SETUP

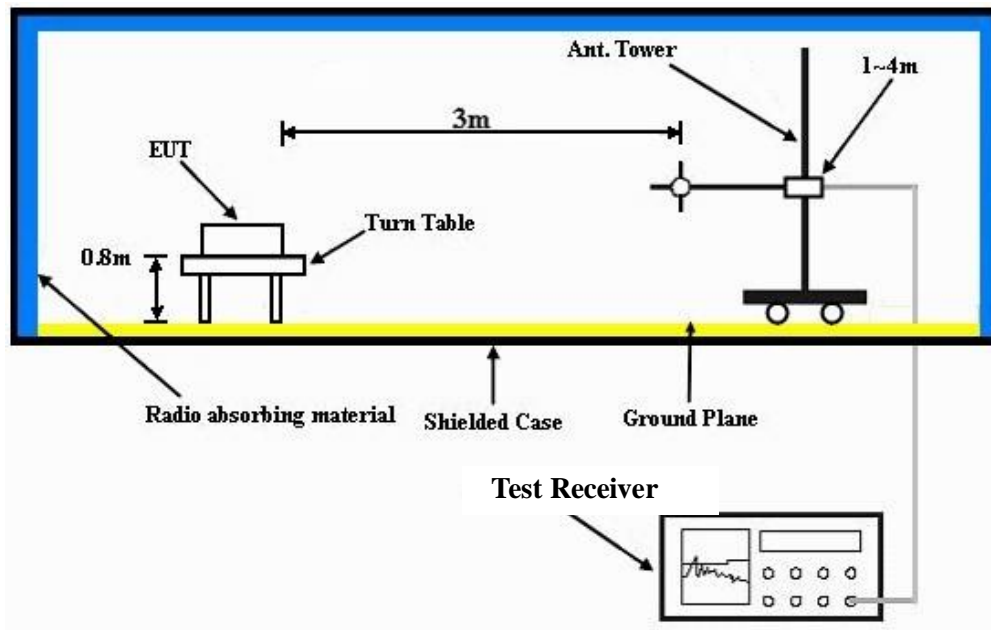

For the actual test configuration, please refer to the related item – Photographs of the Test Configuration.

5.2.6 EUT OPERATING CONDITIONS

Same as the 4.2.6

5.2.7 TEST RESULTS

BELOW 1GHz WORST-CASE DATA

802.11n (20MHz)

CHANNEL	TX Channel 149	DETECTOR FUNCTION	Quasi-Peak (QP)
FREQUENCY RANGE	Below 1GHz		

ANTENNA POLARITY & TEST DISTANCE: HORIZONTAL AT 3 M								
NO.	FREQ. (MHz)	EMISSION LEVEL (dBuV/m)	LIMIT (dBuV/m)	MARGIN (dB)	ANTENNA HEIGHT (m)	TABLE ANGLE (Degree)	RAW VALUE (dBuV)	CORRECTION FACTOR (dB/m)
1	101.17	26.1 QP	43.5	-17.5	2.00 H	88	16.40	9.65
2	329.96	21.7 QP	46.0	-24.3	2.00 H	5	5.63	16.07
3	383.14	25.4 QP	46.0	-20.6	2.00 H	246	8.11	17.30
4	450.00	23.1 QP	46.0	-22.9	1.25 H	131	4.24	18.86
5	697.55	30.2 QP	46.0	-15.8	2.00 H	73	7.16	23.08
6	763.27	31.6 QP	46.0	-14.4	1.00 H	130	7.01	24.60

REMARKS:

1. Emission level (dBuV/m) = Raw Value (dBuV) + Correction Factor (dB/m).
2. Correction Factor (dB/m) = Antenna Factor (dB/m) + Cable Factor (dB).
3. The other emission levels were very low against the limit.
4. Margin value = Emission level – Limit value.

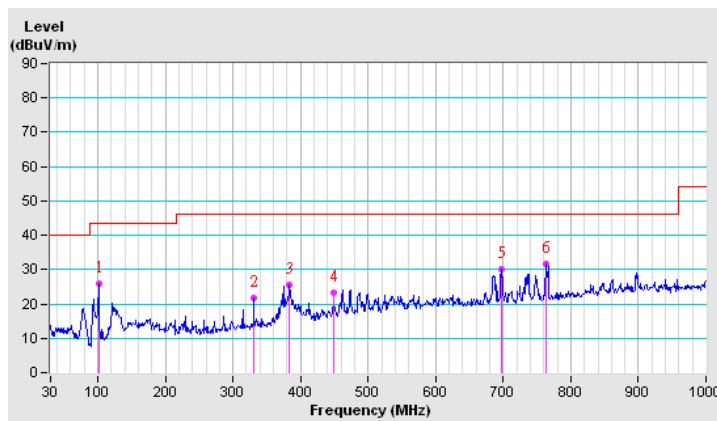

CHANNEL	TX Channel 149	DETECTOR FUNCTION	Quasi-Peak (QP)
FREQUENCY RANGE	Below 1GHz		

ANTENNA POLARITY & TEST DISTANCE: VERTICAL AT 3 M								
NO.	FREQ. (MHz)	EMISSION LEVEL (dBuV/m)	LIMIT (dBuV/m)	MARGIN (dB)	ANTENNA HEIGHT (m)	TABLE ANGLE (Degree)	RAW VALUE (dBuV)	CORRECTION FACTOR (dB/m)
1	30.00	26.9 QP	40.0	-13.1	1.00 V	228	13.83	13.08
2	329.96	25.7 QP	46.0	-20.3	1.00 V	179	9.66	16.07
3	374.97	33.5 QP	46.0	-12.5	1.50 V	156	16.41	17.10
4	487.11	29.0 QP	46.0	-17.0	1.00 V	112	9.27	19.75
5	696.48	35.4 QP	46.0	-10.6	1.50 V	152	12.31	23.06
6	940.67	33.2 QP	46.0	-12.8	1.50 V	360	5.66	27.54

REMARKS:

1. Emission level (dBuV/m) = Raw Value (dBuV) + Correction Factor (dB/m).
2. Correction Factor (dB/m) = Antenna Factor (dB/m) + Cable Factor (dB).
3. The other emission levels were very low against the limit.
4. Margin value = Emission level – Limit value.

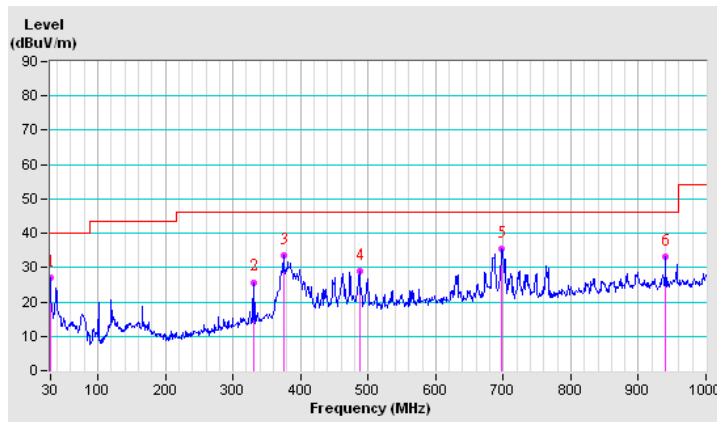



A D T

ABOVE 1GHz DATA

802.11a

CHANNEL	TX Channel 149	DETECTOR FUNCTION	Peak (PK)
FREQUENCY RANGE	1GHz ~ 40GHz		Average (AV)

ANTENNA POLARITY & TEST DISTANCE: HORIZONTAL AT 3 M

NO.	FREQ. (MHz)	EMISSION LEVEL (dBuV/m)	LIMIT (dBuV/m)	MARGIN (dB)	ANTENNA HEIGHT (m)	TABLE ANGLE (Degree)	RAW VALUE (dBuV)	CORRECTION FACTOR (dB/m)
1	*5745.00	102.1 PK			1.44 H	328	64.32	37.78
2	*5745.00	92.1 AV			1.44 H	328	54.32	37.78
3	11490.00	57.5 PK	74.0	-16.5	1.19 H	3	9.91	47.59
4	11490.00	46.8 AV	54.0	-7.2	1.19 H	3	-0.79	47.59

ANTENNA POLARITY & TEST DISTANCE: VERTICAL AT 3 M

NO.	FREQ. (MHz)	EMISSION LEVEL (dBuV/m)	LIMIT (dBuV/m)	MARGIN (dB)	ANTENNA HEIGHT (m)	TABLE ANGLE (Degree)	RAW VALUE (dBuV)	CORRECTION FACTOR (dB/m)
1	5400.00	61.6 PK	74.0	-12.4	1.26 V	60	24.58	37.02
2	5400.00	51.1 AV	54.0	-2.9	1.26 V	60	14.08	37.02
3	*5745.00	110.2 PK			1.09 V	289	72.42	37.78
4	*5745.00	101.2 AV			1.09 V	289	63.42	37.78
5	11490.00	57.9 PK	74.0	-16.1	1.00 V	166	10.31	47.59
6	11490.00	47.2 AV	54.0	-6.8	1.00 V	166	-0.39	47.59

REMARKS:

1. Emission level (dBuV/m) = Raw Value (dBuV) + Correction Factor (dB/m).
2. Correction Factor (dB/m) = Antenna Factor (dB/m) + Cable Factor (dB).
3. The other emission levels were very low against the limit.
4. Margin value = Emission level – Limit value.
5. " * ": Fundamental frequency.
6. The limit value is defined as per 15.247.



A D T

CHANNEL	TX Channel 157	DETECTOR FUNCTION	Peak (PK)
FREQUENCY RANGE	1GHz ~ 40GHz		Average (AV)

ANTENNA POLARITY & TEST DISTANCE: HORIZONTAL AT 3 M

NO.	FREQ. (MHz)	EMISSION LEVEL (dBuV/m)	LIMIT (dBuV/m)	MARGIN (dB)	ANTENNA HEIGHT (m)	TABLE ANGLE (Degree)	RAW VALUE (dBuV)	CORRECTION FACTOR (dB/m)
1	*5785.00	102.5 PK			1.42 H	331	64.62	37.88
2	*5785.00	92.3 AV			1.42 H	331	54.42	37.88
3	11570.00	57.4 PK	74.0	-16.6	1.17 H	17	9.85	47.55
4	11570.00	46.5 AV	54.0	-7.5	1.17 H	17	-1.05	47.55

ANTENNA POLARITY & TEST DISTANCE: VERTICAL AT 3 M

NO.	FREQ. (MHz)	EMISSION LEVEL (dBuV/m)	LIMIT (dBuV/m)	MARGIN (dB)	ANTENNA HEIGHT (m)	TABLE ANGLE (Degree)	RAW VALUE (dBuV)	CORRECTION FACTOR (dB/m)
1	5400.00	61.4 PK	74.0	-12.6	1.26 V	59	24.38	37.02
2	5400.00	51.3 AV	54.0	-2.7	1.26 V	59	14.28	37.02
3	*5785.00	110.5 PK			1.10 V	289	72.62	37.88
4	*5785.00	101.9 AV			1.10 V	289	64.02	37.88
5	11570.00	58.4 PK	74.0	-15.6	1.00 V	165	10.85	47.55
6	11570.00	46.1 AV	54.0	-7.9	1.00 V	165	-1.45	47.55

REMARKS:

1. Emission level (dBuV/m) = Raw Value (dBuV) + Correction Factor (dB/m).
2. Correction Factor (dB/m) = Antenna Factor (dB/m) + Cable Factor (dB).
3. The other emission levels were very low against the limit.
4. Margin value = Emission level – Limit value.
5. " * ": Fundamental frequency.
6. The limit value is defined as per 15.247.



A D T

CHANNEL	TX Channel 165	DETECTOR FUNCTION	Peak (PK)
FREQUENCY RANGE	1GHz ~ 40GHz		Average (AV)

ANTENNA POLARITY & TEST DISTANCE: HORIZONTAL AT 3 M

NO.	FREQ. (MHz)	EMISSION LEVEL (dBuV/m)	LIMIT (dBuV/m)	MARGIN (dB)	ANTENNA HEIGHT (m)	TABLE ANGLE (Degree)	RAW VALUE (dBuV)	CORRECTION FACTOR (dB/m)
1	*5825.00	103.2 PK			1.39 H	320	65.23	37.97
2	*5825.00	93.6 AV			1.39 H	320	55.63	37.97
3	11650.00	57.1 PK	74.0	-16.9	1.24 H	4	9.61	47.49
4	11650.00	46.6 AV	54.0	-7.4	1.24 H	4	-0.89	47.49

ANTENNA POLARITY & TEST DISTANCE: VERTICAL AT 3 M

NO.	FREQ. (MHz)	EMISSION LEVEL (dBuV/m)	LIMIT (dBuV/m)	MARGIN (dB)	ANTENNA HEIGHT (m)	TABLE ANGLE (Degree)	RAW VALUE (dBuV)	CORRECTION FACTOR (dB/m)
1	5400.00	61.6 PK	74.0	-12.4	1.27 V	60	24.58	37.02
2	5400.00	51.4 AV	54.0	-2.6	1.27 V	60	14.38	37.02
3	*5825.00	119.3 PK			1.19 V	283	81.33	37.97
4	*5825.00	110.7 AV			1.19 V	283	72.73	37.97
5	11650.00	57.9 PK	74.0	-16.1	1.00 V	171	10.41	47.49
6	11650.00	46.9 AV	54.0	-7.1	1.00 V	171	-0.59	47.49

REMARKS:

1. Emission level (dBuV/m) = Raw Value (dBuV) + Correction Factor (dB/m).
2. Correction Factor (dB/m) = Antenna Factor (dB/m) + Cable Factor (dB).
3. The other emission levels were very low against the limit.
4. Margin value = Emission level – Limit value.
5. " * ": Fundamental frequency.
6. The limit value is defined as per 15.247.



802.11n (20MHz)

CHANNEL	TX Channel 149	DETECTOR FUNCTION	Peak (PK)
FREQUENCY RANGE	1GHz ~ 40GHz		Average (AV)

ANTENNA POLARITY & TEST DISTANCE: HORIZONTAL AT 3 M

NO.	FREQ. (MHz)	EMISSION LEVEL (dBuV/m)	LIMIT (dBuV/m)	MARGIN (dB)	ANTENNA HEIGHT (m)	TABLE ANGLE (Degree)	RAW VALUE (dBuV)	CORRECTION FACTOR (dB/m)
1	*5745.00	101.0 PK			1.31 H	325	63.22	37.78
2	*5745.00	91.4 AV			1.31 H	325	53.62	37.78
3	11490.00	56.5 PK	74.0	-17.5	1.20 H	5	8.91	47.59
4	11490.00	46.1 AV	54.0	-7.9	1.20 H	5	-1.49	47.59

ANTENNA POLARITY & TEST DISTANCE: VERTICAL AT 3 M

NO.	FREQ. (MHz)	EMISSION LEVEL (dBuV/m)	LIMIT (dBuV/m)	MARGIN (dB)	ANTENNA HEIGHT (m)	TABLE ANGLE (Degree)	RAW VALUE (dBuV)	CORRECTION FACTOR (dB/m)
1	5400.00	61.7 PK	74.0	-12.3	1.16 V	60	24.68	37.02
2	5400.00	52.0 AV	54.0	-2.0	1.16 V	60	14.98	37.02
3	*5745.00	110.6 PK			1.10 V	287	72.82	37.78
4	*5745.00	101.7 AV			1.10 V	287	63.92	37.78
5	11490.00	56.9 PK	74.0	-17.1	1.05 V	3	9.31	47.59
6	11490.00	46.5 AV	54.0	-7.5	1.05 V	3	-1.09	47.59

REMARKS:

1. Emission level (dBuV/m) = Raw Value (dBuV) + Correction Factor (dB/m).
2. Correction Factor (dB/m) = Antenna Factor (dB/m) + Cable Factor (dB).
3. The other emission levels were very low against the limit.
4. Margin value = Emission level – Limit value.
5. " * ": Fundamental frequency.
6. The limit value is defined as per 15.247.



A D T

CHANNEL	TX Channel 157	DETECTOR FUNCTION	Peak (PK)
FREQUENCY RANGE	1GHz ~ 40GHz		Average (AV)

ANTENNA POLARITY & TEST DISTANCE: HORIZONTAL AT 3 M

NO.	FREQ. (MHz)	EMISSION LEVEL (dBuV/m)	LIMIT (dBuV/m)	MARGIN (dB)	ANTENNA HEIGHT (m)	TABLE ANGLE (Degree)	RAW VALUE (dBuV)	CORRECTION FACTOR (dB/m)
1	*5785.00	101.5 PK			1.30 H	326	63.62	37.88
2	*5785.00	92.1 AV			1.30 H	326	54.22	37.88
3	11570.00	57.0 PK	74.0	-17.0	1.19 H	3	9.45	47.55
4	11570.00	46.4 AV	54.0	-7.6	1.19 H	3	-1.15	47.55

ANTENNA POLARITY & TEST DISTANCE: VERTICAL AT 3 M

NO.	FREQ. (MHz)	EMISSION LEVEL (dBuV/m)	LIMIT (dBuV/m)	MARGIN (dB)	ANTENNA HEIGHT (m)	TABLE ANGLE (Degree)	RAW VALUE (dBuV)	CORRECTION FACTOR (dB/m)
1	5400.00	61.6 PK	74.0	-12.4	1.15 V	60	24.58	37.02
2	5400.00	51.6 AV	54.0	-2.4	1.15 V	60	14.58	37.02
3	*5785.00	110.6 PK			1.11 V	288	72.72	37.88
4	*5785.00	101.6 AV			1.11 V	288	63.72	37.88
5	11570.00	58.7 PK	74.0	-15.3	1.04 V	0	11.15	47.55
6	11570.00	47.8 AV	54.0	-6.2	1.04 V	0	0.25	47.55

REMARKS:

1. Emission level (dBuV/m) = Raw Value (dBuV) + Correction Factor (dB/m).
2. Correction Factor (dB/m) = Antenna Factor (dB/m) + Cable Factor (dB).
3. The other emission levels were very low against the limit.
4. Margin value = Emission level – Limit value.
5. " * ": Fundamental frequency.
6. The limit value is defined as per 15.247.



A D T

CHANNEL	TX Channel 165	DETECTOR FUNCTION	Peak (PK)
FREQUENCY RANGE	1GHz ~ 40GHz		Average (AV)

ANTENNA POLARITY & TEST DISTANCE: HORIZONTAL AT 3 M

NO.	FREQ. (MHz)	EMISSION LEVEL (dBuV/m)	LIMIT (dBuV/m)	MARGIN (dB)	ANTENNA HEIGHT (m)	TABLE ANGLE (Degree)	RAW VALUE (dBuV)	CORRECTION FACTOR (dB/m)
1	*5825.00	102.2 PK			1.41 H	321	64.23	37.97
2	*5825.00	93.3 AV			1.41 H	321	55.33	37.97
3	11650.00	56.7 PK	74.0	-17.3	1.14 H	0	9.21	47.49
4	11650.00	46.1 AV	54.0	-7.9	1.14 H	0	-1.39	47.49

ANTENNA POLARITY & TEST DISTANCE: VERTICAL AT 3 M

NO.	FREQ. (MHz)	EMISSION LEVEL (dBuV/m)	LIMIT (dBuV/m)	MARGIN (dB)	ANTENNA HEIGHT (m)	TABLE ANGLE (Degree)	RAW VALUE (dBuV)	CORRECTION FACTOR (dB/m)
1	5400.00	61.9 PK	74.0	-12.1	1.15 V	59	24.88	37.02
2	5400.00	51.9 AV	54.0	-2.1	1.15 V	59	14.88	37.02
3	*5825.00	111.0 PK			1.09 V	284	73.03	37.97
4	*5825.00	101.6 AV			1.09 V	284	63.63	37.97
5	11650.00	59.1 PK	74.0	-14.9	1.02 V	2	11.61	47.49
6	11650.00	47.9 AV	54.0	-6.1	1.02 V	2	0.41	47.49

REMARKS:

1. Emission level (dBuV/m) = Raw Value (dBuV) + Correction Factor (dB/m).
2. Correction Factor (dB/m) = Antenna Factor (dB/m) + Cable Factor (dB).
3. The other emission levels were very low against the limit.
4. Margin value = Emission level – Limit value.
5. " * ": Fundamental frequency.
6. The limit value is defined as per 15.247.



A D T

802.11n (40MHz)

CHANNEL	TX Channel 151	DETECTOR FUNCTION	Peak (PK)
FREQUENCY RANGE	1GHz ~ 40GHz		Average (AV)

ANTENNA POLARITY & TEST DISTANCE: HORIZONTAL AT 3 M

NO.	FREQ. (MHz)	EMISSION LEVEL (dBuV/m)	LIMIT (dBuV/m)	MARGIN (dB)	ANTENNA HEIGHT (m)	TABLE ANGLE (Degree)	RAW VALUE (dBuV)	CORRECTION FACTOR (dB/m)
1	*5755.00	99.3 PK			1.31 H	328	61.50	37.80
2	*5755.00	89.1 AV			1.31 H	328	51.30	37.80
3	11510.00	57.0 PK	74.0	-17.0	1.15 H	9	9.42	47.58
4	11510.00	46.2 AV	54.0	-7.8	1.15 H	9	-1.38	47.58

ANTENNA POLARITY & TEST DISTANCE: VERTICAL AT 3 M

NO.	FREQ. (MHz)	EMISSION LEVEL (dBuV/m)	LIMIT (dBuV/m)	MARGIN (dB)	ANTENNA HEIGHT (m)	TABLE ANGLE (Degree)	RAW VALUE (dBuV)	CORRECTION FACTOR (dB/m)
1	5400.00	61.7 PK	74.0	-12.3	1.05 V	44	24.68	37.02
2	5400.00	52.0 AV	54.0	-2.0	1.05 V	44	14.98	37.02
3	*5755.00	108.1 PK			1.08 V	302	70.30	37.80
4	*5755.00	98.7 AV			1.08 V	302	60.90	37.80
5	11510.00	56.8 PK	74.0	-17.2	1.03 V	359	9.22	47.58
6	11510.00	45.2 AV	54.0	-8.8	1.03 V	359	-2.38	47.58

REMARKS:

1. Emission level (dBuV/m) = Raw Value (dBuV) + Correction Factor (dB/m).
2. Correction Factor (dB/m) = Antenna Factor (dB/m) + Cable Factor (dB).
3. The other emission levels were very low against the limit.
4. Margin value = Emission level – Limit value.
5. " * ": Fundamental frequency.
6. The limit value is defined as per 15.247.



A D T

CHANNEL	TX Channel 159	DETECTOR FUNCTION	Peak (PK)
FREQUENCY RANGE	1GHz ~ 40GHz		Average (AV)

ANTENNA POLARITY & TEST DISTANCE: HORIZONTAL AT 3 M

NO.	FREQ. (MHz)	EMISSION LEVEL (dBuV/m)	LIMIT (dBuV/m)	MARGIN (dB)	ANTENNA HEIGHT (m)	TABLE ANGLE (Degree)	RAW VALUE (dBuV)	CORRECTION FACTOR (dB/m)
1	*5795.00	99.4 PK			1.32 H	329	61.49	37.91
2	*5795.00	89.6 AV			1.32 H	329	51.69	37.91
3	11590.00	57.5 PK	74.0	-16.5	1.21 H	1	9.97	47.53
4	11590.00	46.6 AV	54.0	-7.4	1.21 H	1	-0.93	47.53

ANTENNA POLARITY & TEST DISTANCE: VERTICAL AT 3 M

NO.	FREQ. (MHz)	EMISSION LEVEL (dBuV/m)	LIMIT (dBuV/m)	MARGIN (dB)	ANTENNA HEIGHT (m)	TABLE ANGLE (Degree)	RAW VALUE (dBuV)	CORRECTION FACTOR (dB/m)
1	5400.00	62.3 PK	74.0	-11.7	1.26 V	60	25.28	37.02
2	5400.00	51.8 AV	54.0	-2.2	1.26 V	60	14.78	37.02
3	*5795.00	108.6 PK			1.08 V	286	70.69	37.91
4	*5795.00	98.8 AV			1.08 V	286	60.89	37.91
5	11590.00	58.1 PK	74.0	-15.9	1.03 V	0	10.57	47.53
6	11590.00	46.9 AV	54.0	-7.1	1.03 V	0	-0.63	47.53

REMARKS:

1. Emission level (dBuV/m) = Raw Value (dBuV) + Correction Factor (dB/m).
2. Correction Factor (dB/m) = Antenna Factor (dB/m) + Cable Factor (dB).
3. The other emission levels were very low against the limit.
4. Margin value = Emission level – Limit value.
5. " * ": Fundamental frequency.
6. The limit value is defined as per 15.247.

5.3 6dB BANDWIDTH MEASUREMENT

5.3.1 LIMITS OF 6dB BANDWIDTH MEASUREMENT

The minimum of 6dB Bandwidth Measurement is 0.5 MHz.

5.3.2 TEST INSTRUMENTS

DESCRIPTION & MANUFACTURER	MODEL NO.	SERIAL NO.	CALIBRATED DATE	CALIBRATED UNTIL
R&S Spectrum Analyzer	FSP 40	100060	May 11, 2011	May 10, 2012

Note:

1. The calibration interval of the above test instruments is 12 months and the calibrations are traceable to NML/ROC and NIST/USA.
2. Tested date : Mar. 20, 2012

5.3.3 TEST PROCEDURE

1. Set resolution bandwidth (RBW) = approximately 1% of the emission bandwidth
2. Set the video bandwidth (VBW) $\geq 3 \times$ RBW, Detector = Peak.
3. Trace mode = max hold.
4. Sweep = auto couple.
5. Measure the maximum width of the emission that is constrained by the frequencies associated with the two amplitude points (upper and lower) that are attenuated by 6 dB relative to the maximum level measured in the fundamental emission

5.3.4 DEVIATION FROM TEST STANDARD

No deviation

5.3.5 TEST SETUP

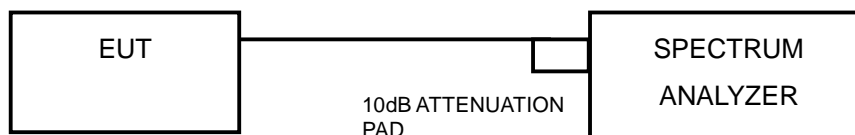

5.3.6 EUT OPERATING CONDITIONS

The software provided by client to enable the EUT under transmission condition continuously at lowest, middle and highest channel frequencies individually.



A D T

5.3.7 TEST RESULTS

802.11a

CHANNEL	CHANNEL FREQUENCY (MHz)	6dB BANDWIDTH (MHz)			MINIMUM LIMIT (MHz)	PASS / FAIL
		CHAIN 0	CHAIN 1	CHAIN 2		
149	5745	16.50	16.58	16.52	0.5	PASS
157	5785	16.46	16.57	16.50	0.5	PASS
165	5825	16.50	16.52	16.53	0.5	PASS

802.11n (20MHz)

CHANNEL	CHANNEL FREQUENCY (MHz)	6dB BANDWIDTH (MHz)			MINIMUM LIMIT (MHz)	PASS / FAIL
		CHAIN 0	CHAIN 1	CHAIN 2		
149	5745	17.66	17.76	17.81	0.5	PASS
157	5785	17.58	17.69	17.72	0.5	PASS
165	5825	17.74	17.79	17.76	0.5	PASS

802.11n (40MHz)

CHANNEL	CHANNEL FREQUENCY (MHz)	6dB BANDWIDTH (MHz)			MINIMUM LIMIT (MHz)	PASS / FAIL
		CHAIN 0	CHAIN 1	CHAIN 2		
151	5755	36.19	36.26	35.81	0.5	PASS
159	5795	36.47	36.78	36.09	0.5	PASS

5.4 OCCUPIED BANDWIDTH MEASUREMENT

5.4.1 TEST INSTRUMENTS

DESCRIPTION & MANUFACTURER	MODEL NO.	SERIAL NO.	CALIBRATED DATE	CALIBRATED UNTIL
R&S Spectrum Analyzer	FSP 40	100060	May 11, 2011	May 10, 2012

Note:

1. The calibration interval of the above test instruments is 12 months and the calibrations are traceable to NML/ROC and NIST/USA.
2. Tested date : Feb. 17, 2012

5.4.2 TEST PROCEDURE

- 1) Set RBW \geq 1% of the emission bandwidth.
- 2) Set the VBW \geq 3 x RBW.
- 3) Detector = Peak.
- 4) Trace mode = max hold.
- 5) Record the 99% emission bandwidth.

5.4.3 DEVIATION FROM TEST STANDARD

No deviation

5.4.4 TEST SETUP

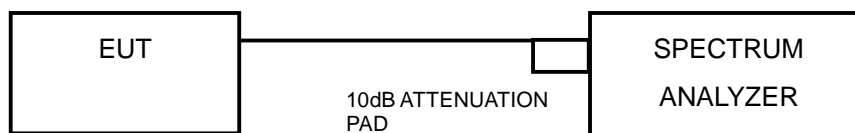

5.4.5 EUT OPERATING CONDITIONS

The software provided by client to enable the EUT under transmission condition continuously at lowest, middle and highest channel frequencies individually.



A D T

5.4.6 TEST RESULTS

802.11a

CHANNEL	CHANNEL FREQUENCY (MHz)	OCCUPIED BANDWIDTH (MHz)			PASS / FAIL
		CHAIN 0	CHAIN 1	CHAIN 2	
149	5745	16.80	16.80	16.70	PASS
157	5785	16.90	16.80	16.70	PASS
165	5825	16.70	16.80	16.80	PASS

802.11n (20MHz)

CHANNEL	CHANNEL FREQUENCY (MHz)	OCCUPIED BANDWIDTH (MHz)			PASS / FAIL
		CHAIN 0	CHAIN 1	CHAIN 2	
149	5745	18.00	17.80	17.90	PASS
157	5785	17.90	17.90	17.80	PASS
165	5825	18.00	17.80	17.90	PASS

802.11n (40MHz)

CHANNEL	CHANNEL FREQUENCY (MHz)	OCCUPIED BANDWIDTH (MHz)			PASS / FAIL
		CHAIN 0	CHAIN 1	CHAIN 2	
151	5755	36.40	36.40	36.40	PASS
159	5795	36.20	36.20	36.40	PASS

5.5 CONDUCTED OUTPUT POWER

5.5.1 LIMITS OF CONDUCTED OUTPUT POWER MEASUREMENT

For systems using digital modulation in the 5725 –5850 MHz band: 1 Watt (30dBm)

5.5.2 INSTRUMENTS

DESCRIPTION & MANUFACTURER	MODEL NO.	SERIAL NO.	CALIBRATED DATE	CALIBRATED UNTIL
Peak Power Meter	ML2495A	0824006	May 04, 2011	May 03, 2012
Power Sensor	MA2411B	0738172	May 03, 2011	May 02, 2012

Note:

1. The calibration interval of the above test instruments is 12 months and the calibrations are traceable to NML/ROC and NIST/USA.
2. Tested date : Mar. 20, 2012

5.5.3 TEST PROCEDURES

A peak power sensor was used on the output port of the EUT. A power meter was used to read the response of the peak power sensor. Record the peak power level.

5.5.4 DEVIATION FROM TEST STANDARD

No deviation

5.5.5 TEST SETUP

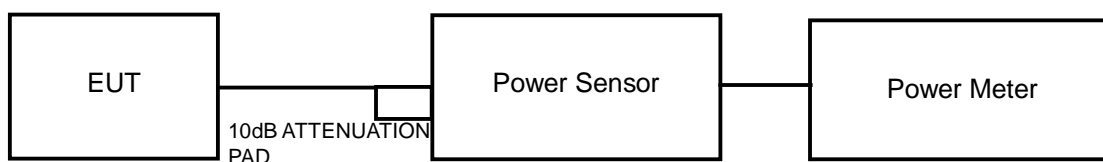

5.5.6 EUT OPERATING CONDITIONS

Same as Item 4.3.6



A D T

5.5.7 TEST RESULTS

802.11a

CHAN.	FREQUENCY (MHz)	PEAK POWER (dBm)			TOTAL POWER (mW)	TOTAL POWER (dBm)	LIMIT (dBm)	PASS / FAIL
		CHAIN 0	CHAIN 1	CHAIN 2				
149	5745	16.10	16.20	18.00	145.521	21.63	29.23	PASS
157	5785	16.40	17.00	17.90	155.431	21.92	29.23	PASS
165	5825	16.10	17.00	18.10	155.422	21.92	29.23	PASS

Note: Directional gain = gain of antenna element + 10 log (# of TX antenna elements)

Effective Legacy Gain (dBi) = 6.77

The effective legacy gain is 6.77dBi, therefore the limit needs to reduce.

802.11n (20MHz)

CHAN.	FREQUENCY (MHz)	PEAK POWER (dBm)			TOTAL POWER (mW)	TOTAL POWER (dBm)	LIMIT (dBm)	PASS / FAIL
		CHAIN 0	CHAIN 1	CHAIN 2				
149	5745	17.00	16.10	18.20	156.926	21.96	30	PASS
157	5785	16.30	16.20	18.00	147.441	21.69	30	PASS
165	5825	16.20	16.00	17.20	133.979	21.27	30	PASS

802.11n (40MHz)

CHAN.	FREQUENCY (MHz)	PEAK POWER (dBm)			TOTAL POWER (mW)	TOTAL POWER (dBm)	LIMIT (dBm)	PASS / FAIL
		CHAIN 0	CHAIN 1	CHAIN 2				
151	5755	16.00	16.20	18.60	153.942	21.87	30	PASS
159	5795	17.10	17.00	18.30	169.013	22.28	30	PASS

5.6 POWER SPECTRAL DENSITY MEASUREMENT

5.6.1 LIMITS OF POWER SPECTRAL DENSITY MEASUREMENT

The Maximum of Power Spectral Density Measurement is 8dBm.

5.6.2 TEST INSTRUMENTS

DESCRIPTION & MANUFACTURER	MODEL NO.	SERIAL NO.	CALIBRATED DATE	CALIBRATED UNTIL
R&S Spectrum Analyzer	FSP 40	100060	May 11, 2011	May 10, 2012

Note:

1. The calibration interval of the above test instruments is 12 months and the calibrations are traceable to NML/ROC and NIST/USA.
2. Tested date : Mar. 20, 2012

5.6.3 TEST PROCEDURE

1. Set the RBW = 100 kHz, VBW =300 kHz, Detector = peak.
2. Sweep time = auto couple, Trace mode = max hold, allow trace to fully stabilize.
3. Use the peak marker function to determine the maximum power level in any 100 kHz band segment within the fundamental EBW.
4. Scale the observed power level to an equivalent value in 3 kHz by adjusting (reducing) the measured power by a bandwidth correction factor (BWCF) where $BWCF = 10\log(3\text{ kHz}/100\text{kHz})$

5.6.4 DEVIATION FROM TEST STANDARD

No deviation

5.6.5 TEST SETUP

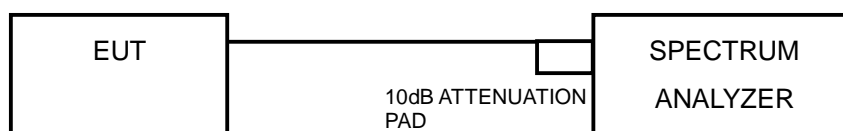

5.6.6 EUT OPERATING CONDITION

Same as Item 4.3.6



A D T

5.6.7 TEST RESULTS

802.11a

TX chain	Channel	FREQ. (MHz)	PSD (dBm/100kHz)	PSD (dBm/3kHz)	10 log (N=3) dB	Total PSD (dBm/3kHz)	Limit (dBm/3kHz)	PASS /FAIL
0	149	5745	-5.00	-20.23	4.77	-15.46	7.23	PASS
	157	5785	-5.40	-20.63	4.77	-15.86	7.23	PASS
	165	5825	-5.36	-20.59	4.77	-15.82	7.23	PASS
1	149	5745	-5.57	-20.80	4.77	-16.03	7.23	PASS
	157	5785	-5.25	-20.48	4.77	-15.71	7.23	PASS
	165	5825	-5.45	-20.68	4.77	-15.91	7.23	PASS
2	149	5745	-3.99	-19.22	4.77	-14.45	7.23	PASS
	157	5785	-4.79	-20.02	4.77	-15.25	7.23	PASS
	165	5825	-4.03	-19.26	4.77	-14.49	7.23	PASS

Note: Directional gain = gain of antenna element + 10 log (# of TX antenna elements)

Effective Legacy Gain (dBi) = 6.77

The effective legacy gain is 6.77dBi, therefore the limit needs to reduce.

802.11n (20MHz)

TX chain	Channel	FREQ. (MHz)	PSD (dBm/100kHz)	PSD (dBm/3kHz)	10 log (N=3) dB	Total PSD (dBm/3kHz)	Limit (dBm/3kHz)	PASS /FAIL
0	149	5745	-5.67	-20.90	4.77	-16.13	8	PASS
	157	5785	-6.06	-21.29	4.77	-16.52	8	PASS
	165	5825	-6.13	-21.36	4.77	-16.59	8	PASS
1	149	5745	-6.31	-21.54	4.77	-16.77	8	PASS
	157	5785	-5.93	-21.16	4.77	-16.39	8	PASS
	165	5825	-6.03	-21.26	4.77	-16.49	8	PASS
2	149	5745	-5.43	-20.66	4.77	-15.89	8	PASS
	157	5785	-5.08	-20.31	4.77	-15.54	8	PASS
	165	5825	-5.05	-20.28	4.77	-15.51	8	PASS

802.11n (40MHz)

TX chain	Channel	FREQ. (MHz)	PSD (dBm/100kHz)	PSD (dBm/3kHz)	10 log (N=3) dB	Total PSD (dBm/3kHz)	Limit (dBm/3kHz)	PASS /FAIL
0	151	5755	-9.07	-24.30	4.77	-19.53	8	PASS
	159	5795	-8.95	-24.18	4.77	-19.41	8	PASS
1	151	5755	-9.47	-24.70	4.77	-19.93	8	PASS
	159	5795	-9.67	-24.90	4.77	-20.13	8	PASS
2	151	5755	-7.95	-23.18	4.77	-18.41	8	PASS
	159	5795	-8.42	-23.65	4.77	-18.88	8	PASS

5.7 CONDUCTED OUT-BAND EMISSION MEASUREMENT

5.7.1 LIMITS OF CONDUCTED OUT-BAND EMISSION MEASUREMENT

Below -20dB of the highest emission level of operating band (in 100kHz Resolution Bandwidth).

5.7.2 TEST INSTRUMENTS

DESCRIPTION & MANUFACTURER	MODEL NO.	SERIAL NO.	CALIBRATED DATE	CALIBRATED UNTIL
R&S Spectrum Analyzer	FSP 40	100060	May 11, 2011	May 10, 2012

Note:

1. The calibration interval of the above test instruments is 12 months and the calibrations are traceable to NML/ROC and NIST/USA.
2. Tested date : Mar. 20, 2012

5.7.3 TEST PROCEDURE

MEASUREMENT PROCEDURE REF

1. Set the RBW = 100 kHz.
2. Set the VBW \geq 300 kHz.
3. Detector = peak.
4. Sweep time = auto couple.
5. Trace mode = max hold.
6. Allow trace to fully stabilize.
7. Use the peak marker function to determine the maximum power level in any 100 kHz band segment within the fundamental EBW.

MEASUREMENT PROCEDURE OOB

1. Set RBW = 100 kHz.
2. Set VBW \geq 300 kHz.
3. Set span to encompass the spectrum to be examined.
4. Detector = peak.
5. Trace Mode = max hold.
6. Sweep = auto couple.

5.7.4 DEVIATION FROM TEST STANDARD

No deviation

5.7.5 EUT OPERATING CONDITION

Same as Item 4.3.6

5.7.6 TEST RESULTS

The conducted emission test is performed on each TX port of operating mode without summing or adding $10\log(N)$ since the limit is relative emission limit. Only worst data of each operating mode is presented.

The spectrum plots are attached on the following pages. D1 line indicates the highest level, and D2 line indicates the 20dB offset below D1. It shows compliance with the requirement.



A D T

802.11a

CH 149

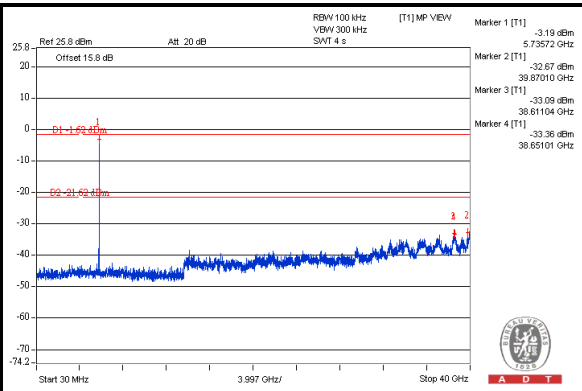
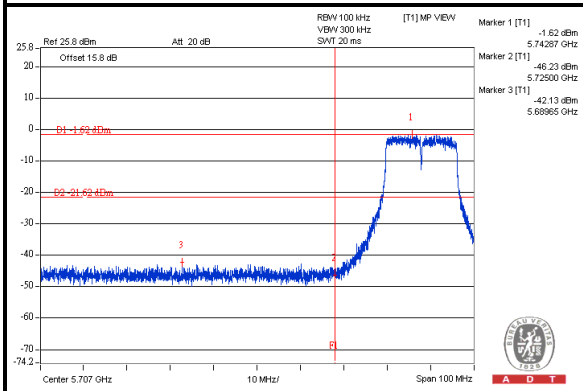

CH 165

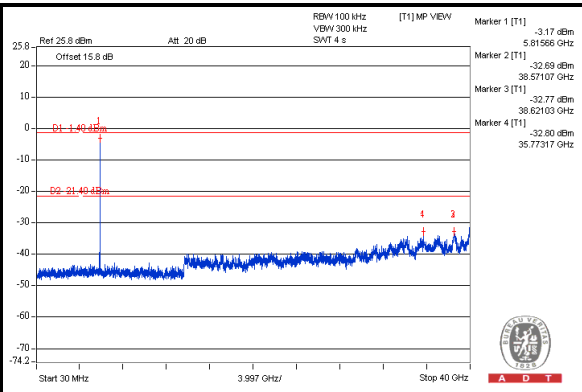
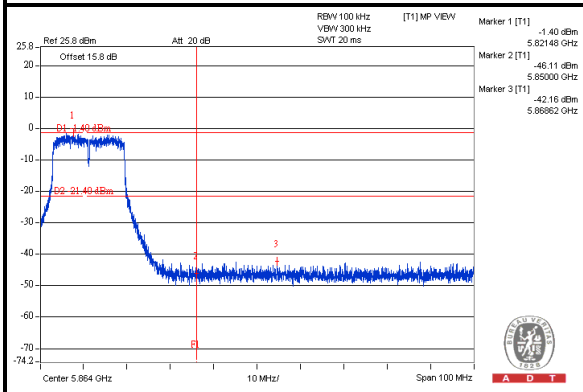



A D T

802.11n (20MHz)

CH 149

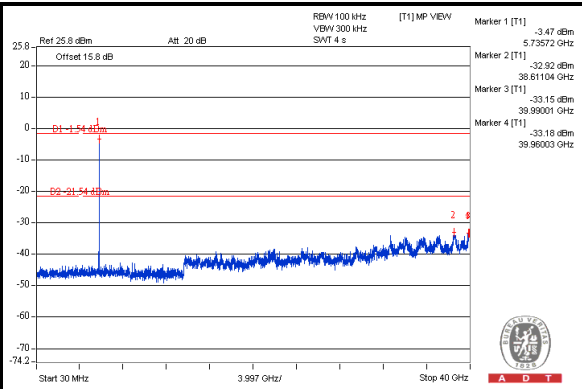
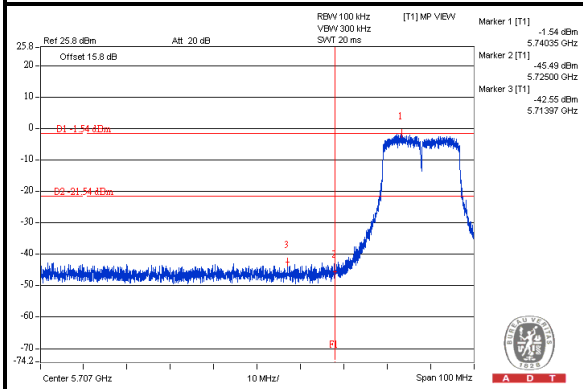

CH 165

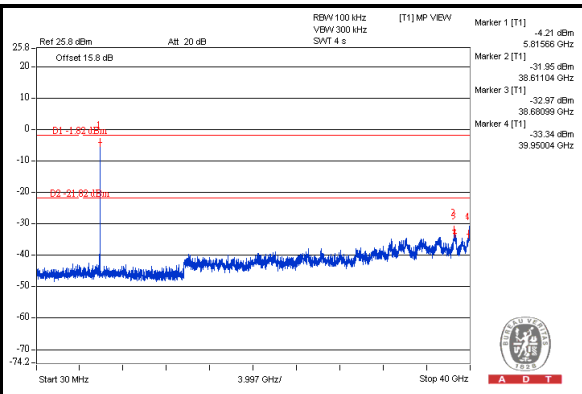
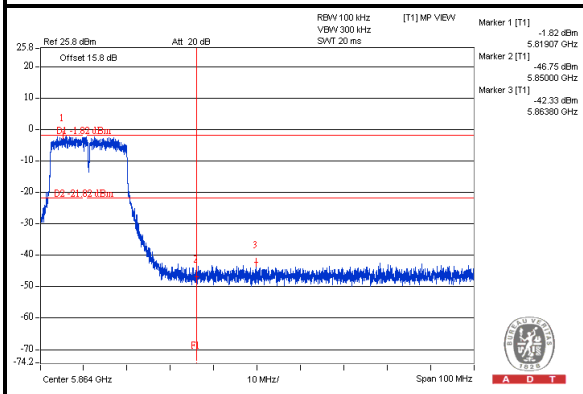



A D T

802.11n (40MHz)

CH 151

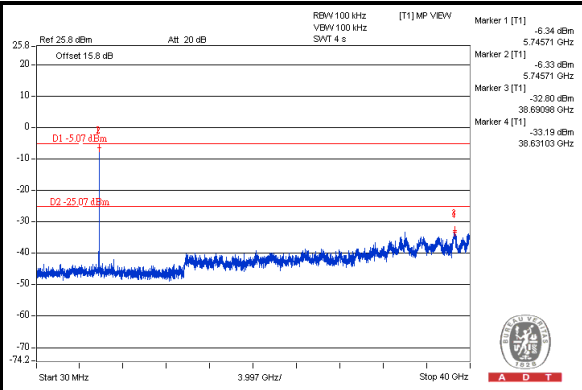
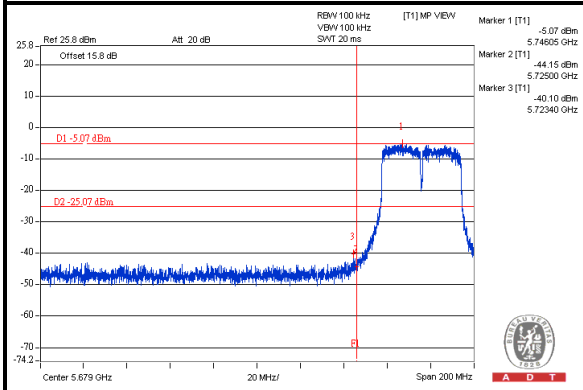

CH 159

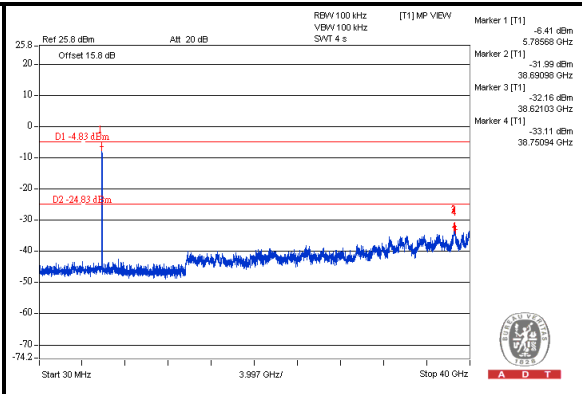
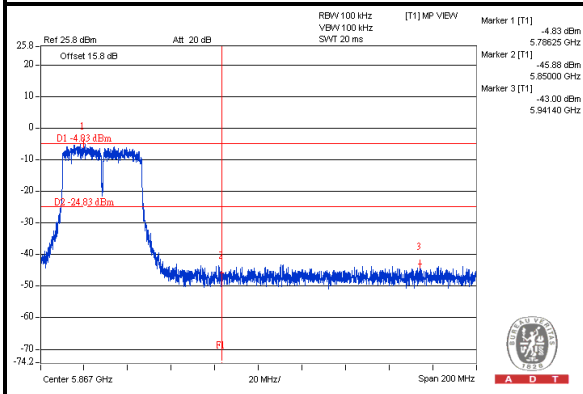



A D T

6. PHOTOGRAPHS OF THE TEST CONFIGURATION

Please refer to the attached file (Test Setup Photo).





A D T

7. INFORMATION ON THE TESTING LABORATORIES

We, Bureau Veritas Consumer Products Services (H.K.) Ltd., Taoyuan Branch, were founded in 1988 to provide our best service in EMC, Radio, Telecom and Safety consultation. Our laboratories are accredited and approved according to ISO/IEC 17025.

Copies of accreditation and authorization certificates of our laboratories obtained from approval agencies can be downloaded from our web site:

www.adt.com.tw/index.5.phtml.

If you have any comments, please feel free to contact us at the following:

Linko EMC/RF Lab:

Tel: 886-2-26052180

Fax: 886-2-26052943

Hsin Chu EMC/RF Lab:

Tel: 886-3-5935343

Fax: 886-3-5935342

Hwa Ya EMC/RF/Safety/Telecom Lab:

Tel: 886-3-3183232

Fax: 886-3-3185050

Email: service.adt@tw.bureauveritas.com

Web Site: www.adt.com.tw

The address and road map of all our labs can be found in our web site also.



A D T

8. APPENDIX A - MODIFICATIONS RECORDERS FOR ENGINEERING CHANGES TO THE EUT BY THE LAB

No modifications were made to the EUT by the lab during the test.

--- END ---