



FCC TEST REPORT (15.407)

REPORT NO.: RF121211E05-1

MODEL NO.: TL-WDN3800

FCC ID: TE7WDN3800

IC: 8853A-WDN3800

RECEIVED: Dec. 11, 2012

TESTED: Dec. 13, 2012 to Mar. 13, 2013

ISSUED: Mar. 22, 2013

APPLICANT: TP-LINK TECHNOLOGIES CO., LTD.

ADDRESS: Building 24 (floors 1,3,4,5) and 28 (floors1-4)
Central Science and Technology Park, Shennan
Rd, Nanshan, Shenzhen, China

ISSUED BY: Bureau Veritas Consumer Products Services (H.K.)
Ltd., Taoyuan Branch Hsin Chu Laboratory

LAB ADDRESS : No. 81-1, Lu Liao Keng, 9th Ling, Wu Lung Tsuen,
Chiung Lin Hsiang, Hsin Chu Hsien 307, Taiwan,
R.O.C.

TEST LOCATION (1): No. 81-1, Lu Liao Keng, 9th Ling, Wu Lung Tsuen,
Chiung Lin Hsiang, Hsin Chu Hsien 307, Taiwan,
R.O.C.

TEST LOCATION (2): No. 49, Ln. 206, Wende Rd., Shangshan Tsuen,
Chiung Lin Hsiang, Hsin Chu Hsien 307, Taiwan,
R.O.C.

This report should not be used by the client to claim product certification, approval, or endorsement by TAF or any government agencies.



This report is for your exclusive use. Any copying or replication of this report to or for any other person or entity, or use of our name or trademark, is permitted only with our prior written permission. This report sets forth our findings solely with respect to the test samples identified herein. The results set forth in this report are not indicative or representative of the quality or characteristics of the lot from which a test sample was taken or any similar or identical product unless specifically and expressly noted. Our report includes all of the tests requested by you and the results thereof based upon the information that you provided to us. You have 60 days from date of issuance of this report to notify us of any material error or omission caused by our negligence, provided, however, that such notice shall be in writing and shall specifically address the issue you wish to raise. A failure to raise such issue within the prescribed time shall constitute your unqualified acceptance of the completeness of this report, the tests conducted and the correctness of the report contents. Unless specific mention, the uncertainty of measurement has been explicitly taken into account to declare the compliance or non-compliance to the specification



A D T

Table of Contents

RELEASE CONTROL RECORD.....	4
1. CERTIFICATION.....	5
2. SUMMARY OF TEST RESULTS.....	6
2.1 MEASUREMENT UNCERTAINTY	7
3. GENERAL INFORMATION	8
3.1 GENERAL DESCRIPTION OF EUT.....	8
3.2 DESCRIPTION OF TEST MODES.....	10
3.2.1 TEST MODE APPLICABILITY AND TESTED CHANNEL DETAIL	11
3.3 GENERAL DESCRIPTION OF APPLIED STANDARDS	13
3.4 DUTY CYCLE OF TEST SIGNAL.....	14
3.5 DESCRIPTION OF SUPPORT UNITS.....	15
3.6 CONFIGURATION OF SYSTEM UNDER TEST	16
4. TEST TYPES AND RESULTS.....	17
4.1 CONDUCTED EMISSION MEASUREMENT	17
4.1.1 LIMITS OF CONDUCTED EMISSION MEASUREMENT.....	17
4.1.2 TEST INSTRUMENTS	17
4.1.3 TEST PROCEDURES.....	18
4.1.4 DEVIATION FROM TEST STANDARD	18
4.1.5 TEST SETUP	18
4.1.6 EUT OPERATING CONDITIONS.....	19
4.1.7 TEST RESULTS.....	20
4.2 RADIATED EMISSION AND BANDEDGE MEASUREMENT.....	22
4.2.1 LIMITS OF RADIATED EMISSION AND BANDEDGE MEASUREMENT	22
4.2.2 LIMITS OF UNWANTED EMISSION OUT OF THE RESTRICTED BANDS.....	22
4.2.3 TEST INSTRUMENTS	23
4.2.4 TEST PROCEDURES.....	24
4.2.5 DEVIATION FROM TEST STANDARD	24
4.2.6 TEST SETUP	25
4.2.7 EUT OPERATING CONDITION	25
4.2.8 TEST RESULTS.....	26
4.3 OCCUPIED BANDWIDTH MEASUREMENT	43
4.3.1 TEST INSTRUMENTS	43
4.3.2 TEST PROCEDURE	43
4.3.3 DEVIATION FROM TEST STANDARD	43
4.3.4 TEST SETUP	43
4.3.5 EUT OPERATING CONDITIONS.....	43
4.3.6 TEST RESULTS.....	44
4.4 TRANSMIT POWER MEASUREMENT.....	45
4.4.1 LIMITS OF TRANSMIT POWER MEASUREMENT	45
4.4.2 TEST INSTRUMENTS	46
4.4.3 TEST PROCEDURE	47
4.4.4 DEVIATION FROM TEST STANDARD	47
4.4.5 TEST SETUP	47



A D T

4.4.6	EUT OPERATING CONDITIONS	48
4.4.7	TEST RESULTS	49
4.5	PEAK POWER SPECTRAL DENSITY MEASUREMENT	58
4.5.1	LIMITS OF PEAK POWER SPECTRAL DENSITY MEASUREMENT	58
4.5.2	TEST INSTRUMENTS	58
4.5.3	TEST PROCEDURES	58
4.5.4	DEVIATION FROM TEST STANDARD	58
4.5.5	TEST SETUP	58
4.5.6	EUT OPERATING CONDITIONS	59
4.5.7	TEST RESULTS	60
4.6	PEAK POWER EXCURSION MEASUREMENT	62
4.6.1	LIMITS OF PEAK POWER EXCURSION MEASUREMENT	62
4.6.2	TEST INSTRUMENTS	62
4.6.3	TEST PROCEDURE	62
4.6.4	DEVIATION FROM TEST STANDARD	62
4.6.5	TEST SETUP	62
4.6.6	EUT OPERATING CONDITIONS	62
4.6.7	TEST RESULTS	63
4.7	FREQUENCY STABILITY	64
4.7.1	LIMITS OF FREQUENCY STABILITY MEASUREMENT	64
4.7.2	TEST INSTRUMENTS	64
4.7.3	TEST PROCEDURE	64
4.7.4	DEVIATION FROM TEST STANDARD	65
4.7.5	TEST SETUP	65
4.7.6	EUT OPERATING CONDITION	65
4.7.7	TEST RESULTS	66
5.	PHOTOGRAPHS OF THE TEST CONFIGURATION	67
6.	INFORMATION ON THE TESTING LABORATORIES	68
7.	APPENDIX A - MODIFICATIONS RECORDERS FOR ENGINEERING CHANGES TO THE EUT BY THE LAB	69



A D T

RELEASE CONTROL RECORD

ISSUE NO.	REASON FOR CHANGE	DATE ISSUED
RF121211E05-1	Original release	Mar. 22, 2013



1. CERTIFICATION

PRODUCT: N600 Wireless Dual Band PCI Express Adapter
BRAND NAME: TP-LINK
MODEL NO.: TL-WDN3800
TEST SAMPLE: PROTOTYPE
APPLICANT: TP-LINK TECHNOLOGIES CO., LTD.
TESTED: Dec. 13, 2012 to Mar. 13, 2013
STANDARDS: **FCC Part 15, Subpart E (Section 15.407)**
Canada RSS-210 Issue 8 (2010-12)
Canada RSS-Gen Issue 3 (2010-12)
ANSI C63.10-2009

The above equipment (Model: TL-WDN3800) has been tested by **Bureau Veritas Consumer Products Services (H.K.) Ltd., Taoyuan Branch**, and found compliance with the requirement of the above standards. The test record, data evaluation & Equipment Under Test (EUT) configurations represented herein are true and accurate accounts of the measurements of the sample's EMC characteristics under the conditions specified in this report.

PREPARED BY : , **DATE:** Mar. 22, 2013
(Midoli Peng, Specialist)

APPROVED BY : , **DATE:** Mar. 22, 2013
(May Chen, Manager)



A D T

2. SUMMARY OF TEST RESULTS

The EUT has been tested according to the following specifications:

For 5GHz, 5150~5350MHz

APPLIED STANDARD: FCC PART 15, SUBPART E (SECTION 15.407) ; RSS-210; RSS-Gen				
STANDARD SECTION		TEST TYPE	RESULT	REMARK
FCC Part 15	RSS-210; RSS-Gen			
15.407(b)(6)	RSS-Gen 7.2.4	AC Power Conducted Emission	PASS	Meet the requirement of limit. Minimum passing margin is -9.58dB at 0.20859MHz
15.407(b)(1/2/3) (b)(5)	RSS-210 A9.2	Spurious Emissions	PASS	Meet the requirement of limit. Minimum passing margin is -0.7dB at 5120.00MHz & 5150.00MHz
15.407(a)(1/2/3)	RSS-210 A9.2	Transmit Power	PASS	Meet the requirement of limit.
15.407(a)(6)	RSS-210 A9.2	Peak Power Excursion	PASS	Meet the requirement of limit.
15.407(a)(1/2/3)	RSS-210 A9.2 A9.4 (2)	Peak Power Spectral Density	PASS	Meet the requirement of limit.
15.407(g)	RSS-Gen 4.7	Frequency Stability	PASS	Meet the requirement of limit.
-	RSS-Gen 4.6	Occupied Bandwidth Measurement	-	Meet the requirement.
15.203	-	Antenna Requirement	PASS	Antenna connector is SMA Straight Plug Reverse not a standard connector.

NOTE: The EUT was operating in 2.400 ~ 2.4835GHz, 5.15~5.35GHz and 5.725~5.850GHz frequencies band 5.15~5.35GHz. This report was recorded the RF parameters including 5.15~5.35GHz.. For the 2.400 ~ 2.4835GHz and 5.725~5.850GHz RF parameters was recorded in another test report.



A D T

2.1 MEASUREMENT UNCERTAINTY

Where relevant, the following measurement uncertainty levels have been estimated for tests performed on the EUT as specified in CISPR 16-4-2:

This uncertainty represents an expanded uncertainty expressed at approximately the 95% confidence level using a coverage factor of $k=2$.

Measurement	Value
Conducted emissions	2.98 dB
Radiated emissions (30MHz-1GHz)	5.43 dB
Radiated emissions (1GHz -6GHz)	3.54 dB
Radiated emissions (6GHz -18GHz)	4.08 dB
Radiated emissions (18GHz -40GHz)	4.11 dB



A D T

3. GENERAL INFORMATION

3.1 GENERAL DESCRIPTION OF EUT

PRODUCT	N600 Wireless Dual Band PCI Express Adapter
MODEL NO.	TL-WDN3800
POWER SUPPLY	DC 5V from host equipment
MODULATION TYPE	CCK, DQPSK, DBPSK for DSSS 64QAM, 16QAM, QPSK, BPSK for OFDM
MODULATION TECHNOLOGY	DSSS,OFDM
TRANSFER RATE	802.11b: up to 11Mbps 802.11a / g: up to 54Mbps 802.11n: up to 300Mbps
OPERATING FREQUENCY	For 15.407 5.18 ~ 5.24GHz, 5.26 ~ 5.32GHz
	For 15.247 2.4GHz: 2.412 ~ 2.462GHz 5GHz: 5.745 ~ 5.825GHz
NUMBER OF CHANNEL	For 15.407 8 for 802.11a, 802.11n (HT20) 4 for 802.11n (HT40)
	For 15.247 (2.4GHz) 11 for 802.11b, 802.11g, 802.11n (HT20) 7 for 802.11n (HT40)
	For 15.247 (5GHz) 5 for 802.11a, 802.11n (HT20) 2 for 802.11n (HT40)
MAXIMUM OUTPUT POWER	For 15.407 802.11a: 16.784mW 802.11n (HT20): 23.016mW 802.11n (HT40): 42.428mW
	For 15.247 (2.4GHz) 802.11b: 229.874mW 802.11g: 339.739mW 802.11n (HT20): 335.961mW 802.11n (HT20): 358.015mW
	For 15.247 (5GHz) 802.11a: 292.455mW 802.11n (HT20): 286.123mW 802.11n (HT40): 276.370mW
ANTENNA TYPE	Please see NOTE



A D T

DATA CABLE	NA
I/O PORTS	Refer to user's manual
ASSOCIATED DEVICES	NA

NOTE:

1. The antenna provided to the EUT, please refer to the following table:

Transmitter Circuit	Brand	Model	Antenna Type	Antenna Gain (dBi)	Connector Type	Diversity	Frequency range (GHz to GHz)
Chain (0)	WHA YU INDUSTRIAL CO., LTD.	C636-510034-A	Dipole	1.8	SMA Straight Plug Reverse	Yes	2.4~2.5 5.15~5.825
Chain (1)	WHA YU INDUSTRIAL CO., LTD.	C636-510034-A	Dipole	1.8	SMA Straight Plug Reverse	Yes	2.4~2.5 5.15~5.825

2. The EUT incorporates a MIMO function without beam forming.

MODULATION MODE	TX/RX FUNCTION
802.11a	2TX/2RX
802.11b	2TX/2RX
802.11g	2TX/2RX
802.11n (HT20)	2TX/2RX
802.11n (HT40)	2TX/2RX

3. 2.4GHz and 5GHz technology cannot transmit at same time.

4. When the EUT operating in 802.11n, the software operation, which is defined by manufacturer, MCS (Modulation and Coding Schemes) from 0 to 15.

5. The EUT was pre-tested under following test modes:

Pre-test Mode	PC	Antenna
Mode A	Laying-flat type	90°
Mode B	Stand-up type	90°
Mode C	Laying-flat type	180°
Mode D	Stand-up type	180°

From the above modes, the worst case was found in **Mode A**. Therefore only the test data of the mode was recorded in this report individually.

6. The above EUT information was declared by the manufacturer and for more detailed features description, please refer to the manufacturer's specifications or User's Manual.



A D T

3.2 DESCRIPTION OF TEST MODES

Operated in 5150 ~ 5350MHz band:

8 channels are provided for 802.11a, 802.11n (HT20):

CHANNEL	FREQUENCY
36	5180 MHz
40	5200 MHz
44	5220 MHz
48	5240 MHz
52	5260 MHz
56	5280 MHz
60	5300 MHz
64	5320 MHz

4 channels are provided for 802.11n (HT40):

CHANNEL	FREQUENCY
38	5190 MHz
46	5230 MHz
54	5270 MHz
62	5310 MHz

3.2.1 TEST MODE APPLICABILITY AND TESTED CHANNEL DETAIL

EUT CONFIGURE MODE	APPLICABLE TO				DESCRIPTION
	PLC	RE < 1G	RE ≥ 1G	APCM	
-	√	√	√	√	-

Where **PLC**: Power Line Conducted Emission **RE < 1G**: Radiated Emission below 1GHz
RE ≥ 1G: Radiated Emission above 1GHz **APCM**: Antenna Port Conducted Measurement

POWER LINE CONDUCTED EMISSION TEST:

- Pre-Scan has been conducted to determine the worst-case mode from all possible combinations between available modulations, data rates and antenna ports (if EUT with antenna diversity architecture).
- Following channel(s) was (were) selected for the final test as listed below.

MODE	AVAILABLE CHANNEL	TESTED CHANNEL	MODULATION TECHNOLOGY	MODULATION TYPE	DATA RATE (MBPS)
802.11n (HT20)	36 to 64	48	OFDM	BPSK	6.5

RADIATED EMISSION TEST (BELOW 1 GHz):

- Pre-Scan has been conducted to determine the worst-case mode from all possible combinations between available modulations, data rates and antenna ports (if EUT with antenna diversity architecture).
- Following channel(s) was (were) selected for the final test as listed below.

MODE	AVAILABLE CHANNEL	TESTED CHANNEL	MODULATION TECHNOLOGY	MODULATION TYPE	DATA RATE (Mbps)
802.11n (HT20)	36 to 64	48	OFDM	BPSK	6.5



A D T

RADIATED EMISSION TEST (ABOVE 1 GHz):

- Pre-Scan has been conducted to determine the worst-case mode from all possible combinations between available modulations, data rates and antenna ports (if EUT with antenna diversity architecture).
- Following channel(s) was (were) selected for the final test as listed below.

MODE	AVAILABLE CHANNEL	TESTED CHANNEL	MODULATION TECHNOLOGY	MODULATION TYPE	DATA RATE (Mbps)
802.11a	36 to 64	36, 40, 48, 52, 60, 64	OFDM	BPSK	6
802.11n (HT20)	36 to 64	36, 40, 48, 52, 60, 64	OFDM	BPSK	6.5
802.11n (HT40)	38 to 62	38, 46, 54, 62	OFDM	BPSK	13.5

ANTENNA PORT CONDUCTED MEASUREMENT:

- Pre-Scan has been conducted to determine the worst-case mode from all possible combinations between available modulations, data rates and antenna ports (if EUT with antenna diversity architecture).
- Following channel(s) was (were) selected for the final test as listed below.

MODE	AVAILABLE CHANNEL	TESTED CHANNEL	MODULATION TECHNOLOGY	MODULATION TYPE	DATA RATE (Mbps)
802.11a	36 to 64	36, 40, 48, 52, 60, 64	OFDM	BPSK	6
802.11n (HT20)	36 to 64	36, 40, 48, 52, 60, 64	OFDM	BPSK	6.5
802.11n (HT40)	38 to 62	38, 46, 54, 62	OFDM	BPSK	13.5

TEST CONDITION:

APPLICABLE TO	ENVIRONMENTAL CONDITIONS	INPUT POWER (SYSTEM)	TESTED BY
PLC	25deg. C, 62%RH	120Vac, 60Hz	Jason Huang
RE<1G	23deg. C, 67%RH	120Vac, 60Hz	Robert Cheng
RE ³ 1G	23deg. C, 67%RH	120Vac, 60Hz	Robert Cheng
APCM	25deg. C, 60%RH	120Vac, 60Hz	Nelson Teng

3.3 GENERAL DESCRIPTION OF APPLIED STANDARDS

The EUT is a RF product. According to the specifications of the manufacturer, it must comply with the requirements of the following standards:

FCC Part 15, Subpart E (15.407)

Canada RSS-210 Issue 8 (2010-12)

Canada RSS-Gen Issue 3 (2010-12)

789033 D01 General UNII Test Procedures v01 r02

662911 D01 Multiple Transmitter Output v01 r02

ANSI C63.10-2009

All test items have been performed and recorded as per the above standards.

Note: The EUT has been verified to comply with the requirements of FCC Part 15, Subpart B, Class B (DoC). The test report has been issued separately.



A D T

3.4 DUTY CYCLE OF TEST SIGNAL

Duty cycle of test signal is 100 %, duty factor is not required.

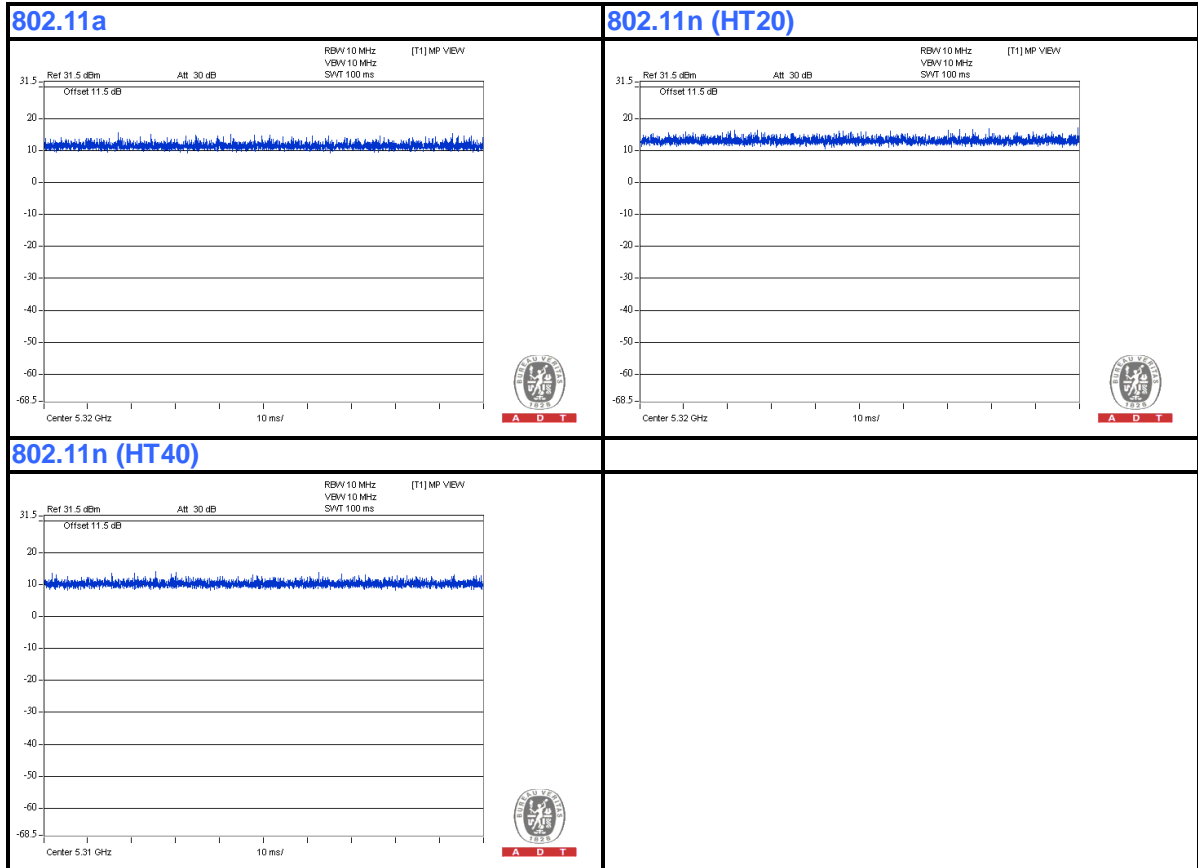



3.5 DESCRIPTION OF SUPPORT UNITS

The EUT has been tested as an independent unit together with other necessary accessories or support units. The following support units or accessories were used to form a representative test configuration during the tests.

For conducted emission test					
NO.	PRODUCT	BRAND	MODEL NO.	SERIAL NO.	FCC ID
1	PERSONAL COMPUTER	DELL	DCSM	394QL1S	FCC DoC
2	MONITOR	DELL	2007FPb	CN-0DC2144663363 V-12WS	FCC DoC
3	PRINTER	EPSON	LQ-300+II	G88Y074083	FCC DoC
4	MODEM	ACEEX	1414	0206026779	IFAXDM1414
5	KEYBOARD	DELL	SK-8115	MY-0J4635-71619-67 V-0354	FCC DoC
6	MOUSE	DELL	MO56UO	516045397	NA
For other test items					
NO.	PRODUCT	BRAND	MODEL NO.	SERIAL NO.	FCC ID
1	PERSONAL COMPUTER	IBM	A65	L3B4724	FCC DoC
2	MONITOR	ADI	G1000	240058T00100081	NA
3	PRINTER	EPSON	LQ-300+II	G88Y074015	FCC DoC
4	MODEM	ACEEX	1414	0206026779	IFAXDM1414
5	KEYBOARD	BTC	KB-5200T	F24800406	E5XKB5122WTH0 110
6	MOUSE	BTC	M851	G00347024440	FCC DoC

NO.	SIGNAL CABLE DESCRIPTION OF THE ABOVE SUPPORT UNITS
1	NA
2	VGA cable (1.4m, with 2 cores)
3	Printer cable (1.8m)
4	Modem cable (1m)
5	USB cable (2m)
6	USB cable (2m)

NOTE: All power cords of the above support units are non shielded (1.8m).



A D T

3.6 CONFIGURATION OF SYSTEM UNDER TEST

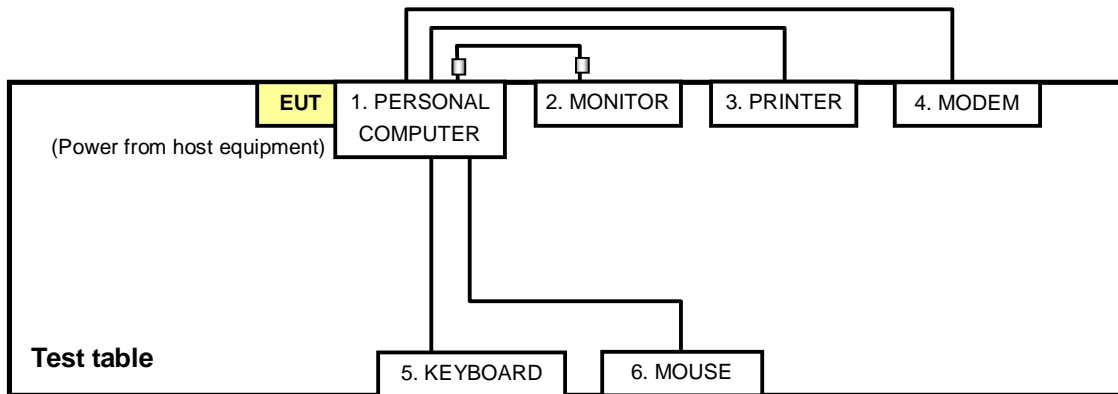



A D T

4. TEST TYPES AND RESULTS

4.1 CONDUCTED EMISSION MEASUREMENT

4.1.1 LIMITS OF CONDUCTED EMISSION MEASUREMENT

FREQUENCY OF EMISSION (MHz)	CONDUCTED LIMIT (dB μ V)	
	Quasi-peak	Average
0.15-0.5	66 to 56	56 to 46
0.5-5	56	46
5-30	60	50

- NOTE:**
1. The lower limit shall apply at the transition frequencies.
 2. The limit decreases in line with the logarithm of the frequency in the range of 0.15 to 0.50 MHz.

4.1.2 TEST INSTRUMENTS

DESCRIPTION & MANUFACTURER	MODEL NO.	SERIAL NO.	CALIBRATED DATE	CALIBRATED UNTIL
Test Receiver ROHDE & SCHWARZ	ESCS 30	100287	Feb. 29, 2012	Feb. 28, 2013
Line-Impedance Stabilization Network (for EUT) SCHWARZBECK	NSLK 8127	8127-523	Sep. 19, 2012	Sep. 20, 2013
Line-Impedance Stabilization Network (for Peripheral) ROHDE & SCHWARZ	ESH3-Z5	848773/004	Oct. 29, 2012	Oct. 28, 2013
RF Cable (JYEBAO)	5DFB	COACAB-002	Aug. 05, 2012	Aug. 04, 2013
50 ohms Terminator	50	3	Oct. 23, 2012	Oct. 22, 2013
Software ADT	BV ADT_Cond_V7.3.7 .3	NA	NA	NA

Note:

1. The calibration interval of the above test instruments is 12 months and the calibrations are traceable to NML/ROC and NIST/USA.
2. The test was performed in Shielded Room No. A.
3. The VCCI Con A Registration No. is C-817.
4. Tested Date: Dec. 13, 2012

4.1.3 TEST PROCEDURES

- a. The EUT was placed 0.4 meters from the conducting wall of the shielded room with EUT being connected to the power mains through a line impedance stabilization network (LISN). Other support units were connected to the power mains through another LISN.
- b. The two LISNs provide 50 ohm/ 50uH of coupling impedance for the measuring instrument.
- c. Both lines of the power mains connected to the EUT were checked for maximum conducted interference.
- d. The frequency range from 150kHz to 30MHz was searched. Emission level under (Limit – 20dB) was not recorded.

NOTE:

1. The resolution bandwidth of test receiver is 9kHz for Quasi-peak detection (QP) & Average detection (AV).

4.1.4 DEVIATION FROM TEST STANDARD

No deviation

4.1.5 TEST SETUP

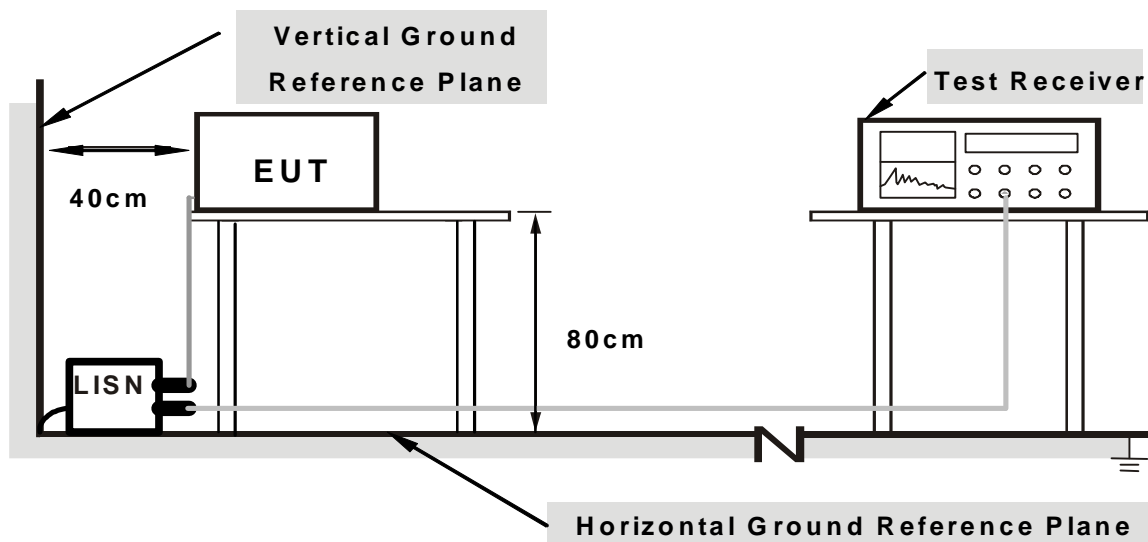

Note: 1.Support units were connected to second LISN.

For the actual test configuration, please refer to the related item – Photographs of the Test Configuration.



A D T

4.1.6 EUT OPERATING CONDITIONS

1. Connect the EUT with the support unit 1 (PC) which is placed on a testing table.
2. The communication partner run test program “art.exe” to enable EUT under transmission/receiving condition continuously at specific channel frequency.

4.1.7 TEST RESULTS

PHASE	Line (L)	DETECTOR FUNCTION	Quasi-Peak (QP) / Average (AV)
-------	----------	-------------------	--------------------------------

No	Freq. [MHz]	Corr. Factor [dB]	Reading Value [dB (uV)]		Emission Level [dB (uV)]		Limit [dB (uV)]		Margin [dB]	
			Q.P.	AV.	Q.P.	AV.	Q.P.	AV.	Q.P.	AV.
1	0.16452	0.10	41.58	40.71	41.68	40.81	65.23	55.23	-23.55	-14.42
2	0.20859	0.11	44.01	43.57	44.12	43.68	63.26	53.26	-19.14	-9.58
3	0.27700	0.13	36.41	33.67	36.54	33.80	60.91	50.91	-24.37	-17.11
4	0.34756	0.15	35.10	33.96	35.25	34.11	59.02	49.02	-23.77	-14.91
5	0.41563	0.16	30.83	29.33	30.99	29.49	57.54	47.54	-26.54	-18.04
6	0.46480	0.16	31.36	28.42	31.52	28.58	56.61	46.61	-25.08	-18.02

REMARKS:

1. Q.P. and AV. are abbreviations of quasi-peak and average individually.
2. The emission levels of other frequencies were very low against the limit.
3. Margin value = Emission level - Limit value
4. Correction factor = Insertion loss + Cable loss
5. Emission Level = Correction Factor + Reading Value.

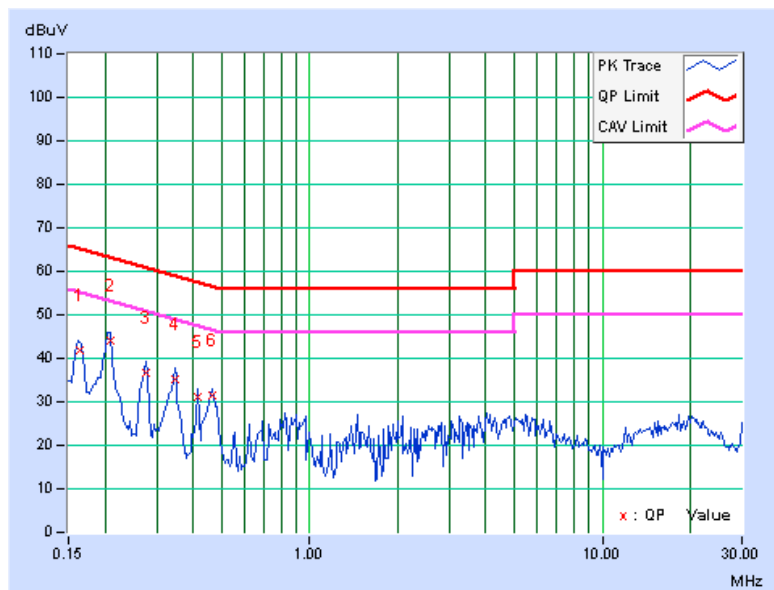

PHASE	Neutral (N)	DETECTOR FUNCTION	Quasi-Peak (QP) / Average (AV)
--------------	-------------	--------------------------	--------------------------------

No	Freq.	Corr.	Reading Value		Emission Level		Limit		Margin	
	[MHz]	[dB]	Q.P.	AV.	Q.P.	AV.	Q.P.	AV.	Q.P.	AV.
			[dB (uV)]	[dB (uV)]	[dB (uV)]	[dB (uV)]	[dB (uV)]	[dB (uV)]	[dB (uV)]	[dB (uV)]
1	0.16597	0.15	40.91	40.06	41.06	40.21	65.16	55.16	-24.10	-14.95
2	0.20884	0.15	37.38	36.07	37.53	36.22	63.25	53.25	-25.72	-17.03
3	0.27530	0.17	31.69	27.77	31.86	27.94	60.96	50.96	-29.10	-23.02
4	0.62266	0.20	30.54	29.60	30.74	29.80	56.00	46.00	-25.26	-16.20
5	0.82863	0.21	30.93	28.73	31.14	28.94	56.00	46.00	-24.86	-17.06
6	1.37931	0.24	31.81	30.73	32.05	30.97	56.00	46.00	-23.95	-15.03

REMARKS:

1. Q.P. and AV. are abbreviations of quasi-peak and average individually.
2. The emission levels of other frequencies were very low against the limit.
3. Margin value = Emission level - Limit value
4. Correction factor = Insertion loss + Cable loss
5. Emission Level = Correction Factor + Reading Value.

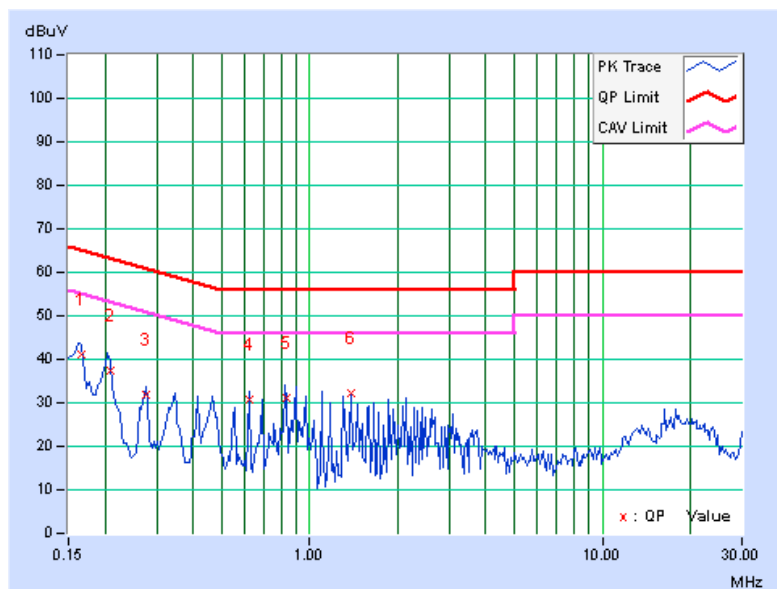



A D T

4.2 RADIATED EMISSION AND BANDEGE MEASUREMENT

4.2.1 LIMITS OF RADIATED EMISSION AND BANDEGE MEASUREMENT

Radiated emissions which fall in the restricted bands must comply with the radiated emission limits specified as below table:

Frequencies (MHz)	Field strength (microvolts/meter)	Measurement distance (meters)
0.009-0.490	2400/F(kHz)	300
0.490-1.705	24000/F(kHz)	30
1.705-30.0	30	30
30-88	100	3
88-216	150	3
216-960	200	3
Above 960	500	3

NOTE:

1. The lower limit shall apply at the transition frequencies.
2. Emission level (dBuV/m) = 20 log Emission level (uV/m).
3. For frequencies above 1000MHz, the field strength limits are based on average detector, however, the peak field strength of any emission shall not exceed the maximum permitted average limits, specified above by more than 20dB.

4.2.2 LIMITS OF UNWANTED EMISSION OUT OF THE RESTRICTED BANDS

APPLICABLE TO	LIMIT	
√	FIELD STRENGTH AT 3m (dBμV/m)	
	PK	AV
	74	54
	EIRP LIMIT (dBm)	EQUIVALENT FIELD STRENGTH AT 3m (dBμV/m)
	PK	PK
	-27	68.3

NOTE:

1. The following formula is used to convert the equipment isotropic radiated power (eirp) to field strength:

$$E = \frac{1000000\sqrt{30P}}{3} \mu\text{V/m, where P is the eirp (Watts).}$$



A D T

4.2.3 TEST INSTRUMENTS

DESCRIPTION & MANUFACTURER	MODEL NO.	SERIAL NO.	CALIBRATED DATE	CALIBRATED UNTIL
Spectrum Analyzer Agilent	E4446A	MY48250253	Sep. 03, 2012	Sep. 02, 2013
Pre-Selector Agilent	N9039A	MY46520310	Sep. 03, 2012	Sep. 02, 2013
Signal Generator Agilent	N5181A	MY49060347	July 24, 2012	July 23, 2013
Pre-Amplifier Mini-Circuits	ZFL-1000VH2 B	AMP-ZFL-04	Nov. 14, 2012	Nov. 13, 2013
Pre-Amplifier Agilent	8449B	3008A02465	Feb. 26, 2013	Feb. 25, 2014
SPACEK LABS	SLKKa-48-6	9K16	Nov. 14, 2012	Nov. 13, 2013
Trilog Broadband Antenna SCHWARZBECK	VULB 9168	9168-361	Apr. 06, 2012	Apr. 05, 2013
Horn_Antenna AISI	AIH.8018	0000220091110	Nov. 27, 2012	Nov. 26, 2013
Horn_Antenna SCHWARZBECK	BBHA 9170	9170-424	Oct. 12, 2012	Oct. 11, 2013
RF Cable	NA	RF104-205 RF104-207 RF104-202	Dec. 26, 2012	Dec. 25, 2013
RF Cable	NA	CHHCAB_001	Oct. 07, 2012	Oct. 06, 2013
Software	ADT_Radiated _V8.7.05	NA	NA	NA
Antenna Tower & Turn Table CT	NA	NA	NA	NA

Note:

1. The calibration interval of the above test instruments is 12 months and the calibrations are traceable to NML/ROC and NIST/USA.
2. The horn antenna, preamplifier (model: 8449B) are used only for the measurement of emission frequency above 1GHz if tested.
- 3 The test was performed in 966 Chamber No. H.
4. The FCC Site Registration No. is 797305.
- 5 The CANADA Site Registration No. is IC 7450H-3.
- 6 Tested Date: Feb. 27 to 28, 2013

4.2.4 TEST PROCEDURES

- a. The EUT was placed on the top of a rotating table 0.8 meters above the ground at 3 meter chamber room for test. The table was rotated 360 degrees to determine the position of the highest radiation.
- b. The EUT was set 3 meters away from the interference-receiving antenna, which was mounted on the top of a variable-height antenna tower.
- c. The height of antenna is varied from one meter to four meters above the ground to determine the maximum value of the field strength. Both horizontal and vertical polarizations of the antenna are set to make the measurement.
- d. For each suspected emission, the EUT was arranged to its worst case and then the antenna was tuned to heights from 1 meter to 4 meters and the rotatable table was turned from 0 degrees to 360 degrees to find the maximum reading.
- e. The test-receiver system was set to quasi-peak detect function and specified bandwidth with maximum hold mode when the test frequency is below 1 GHz.
- f. The test-receiver system was set to peak and average detect function and specified bandwidth with maximum hold mode when the test frequency is above 1 GHz. If the peak reading value also meets average limit, measurement with the average detector is unnecessary.

NOTE:

1. The resolution bandwidth and video bandwidth of test receiver/spectrum analyzer is 120kHz for Quasi-peak detection (QP) at frequency below 1GHz.
2. The resolution bandwidth of test receiver/spectrum analyzer is 1 MHz and the video bandwidth is 3 MHz for Peak detection (PK) at frequency above 1GHz.
3. The resolution bandwidth of test receiver/spectrum analyzer is 1 MHz and the video bandwidth is 10 Hz for Average detection (AV) at frequency above 1GHz.
4. All modes of operation were investigated and the worst-case emissions are reported.

4.2.5 DEVIATION FROM TEST STANDARD

No deviation

4.2.6 TEST SETUP

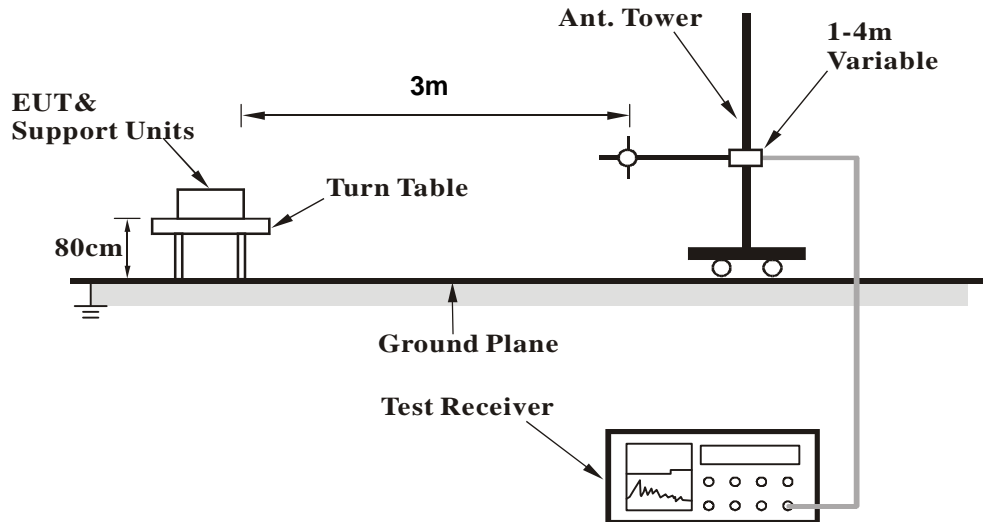

For the actual test configuration, please refer to the related item – Photographs of the Test Configuration.

4.2.7 EUT OPERATING CONDITION

Same as 4.1.6

4.2.8 TEST RESULTS

BELOW 1GHz WORST-CASE DATA

802.11n (HT20)

CHANNEL	TX Channel 48	DETECTOR FUNCTION	Quasi-Peak (QP)
FREQUENCY RANGE	Below 1GHz		

ANTENNA POLARITY & TEST DISTANCE: HORIZONTAL AT 3 M

NO.	FREQ. (MHz)	EMISSION LEVEL (dBuV/m)	LIMIT (dBuV/m)	MARGIN (dB)	ANTENNA HEIGHT (m)	TABLE ANGLE (Degree)	RAW VALUE (dBuV)	CORRECTION FACTOR (dB/m)
1	87.07	31.7 QP	40.0	-8.3	1.45 H	67	23.04	8.67
2	162.10	28.0 QP	43.5	-15.5	1.41 H	241	13.83	14.15
3	298.90	34.8 QP	46.0	-11.3	1.24 H	34	19.48	15.27
4	432.01	36.8 QP	46.0	-9.3	1.40 H	21	18.27	18.48
5	632.84	35.5 QP	46.0	-10.6	1.24 H	65	12.73	22.72
6	799.50	35.6 QP	46.0	-10.4	1.04 H	68	9.90	25.67

ANTENNA POLARITY & TEST DISTANCE: VERTICAL AT 3 M

NO.	FREQ. (MHz)	EMISSION LEVEL (dBuV/m)	LIMIT (dBuV/m)	MARGIN (dB)	ANTENNA HEIGHT (m)	TABLE ANGLE (Degree)	RAW VALUE (dBuV)	CORRECTION FACTOR (dB/m)
1	162.06	31.4 QP	43.5	-12.1	1.07 V	65	17.26	14.16
2	333.20	31.6 QP	46.0	-14.4	1.47 V	21	15.47	16.13
3	528.00	36.8 QP	46.0	-9.2	1.11 V	21	16.07	20.70
4	566.37	36.7 QP	46.0	-9.3	1.32 V	65	15.21	21.52
5	698.76	33.0 QP	46.0	-13.0	1.10 V	22	9.28	23.69
6	799.53	35.3 QP	46.0	-10.7	1.47 V	65	9.61	25.67

REMARKS:

1. Emission level (dBuV/m) = Raw Value (dBuV) + Correction Factor (dB/m).
2. Correction Factor (dB/m) = Antenna Factor (dB/m) + Cable Factor (dB).
3. The other emission levels were very low against the limit.
4. Margin value = Emission level – Limit value.

ABOVE 1GHz DATA

802.11a

CHANNEL	TX Channel 36	DETECTOR FUNCTION	Peak (PK)
FREQUENCY RANGE	1GHz ~ 40GHz		Average (AV)

ANTENNA POLARITY & TEST DISTANCE: HORIZONTAL AT 3 M

NO.	FREQ. (MHz)	EMISSION LEVEL (dBuV/m)	LIMIT (dBuV/m)	MARGIN (dB)	ANTENNA HEIGHT (m)	TABLE ANGLE (Degree)	RAW VALUE (dBuV)	CORRECTION FACTOR (dB/m)
1	5150.00	59.9 PK	74.0	-14.1	1.26 H	161	17.33	42.57
2	5150.00	48.4 AV	54.0	-5.6	1.26 H	161	5.83	42.57
3	*5180.00	95.1 PK			1.26 H	161	52.43	42.67
4	*5180.00	87.8 AV			1.26 H	161	45.13	42.67
5	#10360.00	62.9 PK	74.0	-11.1	1.10 H	241	13.49	49.41
6	#10360.00	49.7 AV	54.0	-4.3	1.10 H	241	0.29	49.41
7	15540.00	64.2 PK	74.0	-9.8	1.01 H	113	8.75	55.45
8	15540.00	50.1 AV	54.0	-3.9	1.01 H	113	-5.35	55.45

ANTENNA POLARITY & TEST DISTANCE: VERTICAL AT 3 M

NO.	FREQ. (MHz)	EMISSION LEVEL (dBuV/m)	LIMIT (dBuV/m)	MARGIN (dB)	ANTENNA HEIGHT (m)	TABLE ANGLE (Degree)	RAW VALUE (dBuV)	CORRECTION FACTOR (dB/m)
1	5080.00	60.2 PK	74.0	-13.8	1.10 V	356	17.82	42.38
2	5080.00	49.4 AV	54.0	-4.6	1.10 V	356	7.02	42.38
3	5120.00	60.2 PK	74.0	-13.8	1.10 V	354	17.73	42.47
4	5120.00	51.4 AV	54.0	-2.6	1.10 V	354	8.93	42.47
5	5150.00	60.7 PK	74.0	-13.3	1.08 V	360	18.13	42.57
6	5150.00	49.8 AV	54.0	-4.2	1.08 V	360	7.23	42.57
7	*5180.00	108.6 PK			1.09 V	356	65.93	42.67
8	*5180.00	100.0 AV			1.09 V	356	57.33	42.67
9	#10360.00	62.5 PK	74.0	-11.5	1.01 V	226	13.09	49.41
10	#10360.00	49.0 AV	54.0	-5.0	1.01 V	226	-0.41	49.41
11	15540.00	64.5 PK	74.0	-9.5	1.01 V	124	9.05	55.45
12	15540.00	50.5 AV	54.0	-3.5	1.01 V	124	-4.95	55.45

REMARKS:

1. Emission level (dBuV/m) = Raw Value (dBuV) + Correction Factor (dB/m).
2. Correction Factor (dB/m) = Antenna Factor (dB/m) + Cable Factor (dB).
3. The other emission levels were very low against the limit.
4. Margin value = Emission level – Limit value.
5. " * ": Fundamental frequency.
6. " # ": The radiated frequency is out of the restricted band.



A D T

CHANNEL	TX Channel 40	DETECTOR FUNCTION	Peak (PK)
FREQUENCY RANGE	1GHz ~ 40GHz		Average (AV)

ANTENNA POLARITY & TEST DISTANCE: HORIZONTAL AT 3 M

NO.	FREQ. (MHz)	EMISSION LEVEL (dBuV/m)	LIMIT (dBuV/m)	MARGIN (dB)	ANTENNA HEIGHT (m)	TABLE ANGLE (Degree)	RAW VALUE (dBuV)	CORRECTION FACTOR (dB/m)
1	*5200.00	94.8 PK			1.31 H	171	52.07	42.73
2	*5200.00	87.4 AV			1.31 H	171	44.67	42.73
3	#10400.00	63.4 PK	74.0	-10.6	1.06 H	243	14.37	49.03
4	#10400.00	50.2 AV	54.0	-3.8	1.06 H	243	1.17	49.03
5	15600.00	63.8 PK	74.0	-10.2	1.00 H	118	8.55	55.25
6	15600.00	49.6 AV	54.0	-4.4	1.00 H	118	-5.65	55.25

ANTENNA POLARITY & TEST DISTANCE: VERTICAL AT 3 M

NO.	FREQ. (MHz)	EMISSION LEVEL (dBuV/m)	LIMIT (dBuV/m)	MARGIN (dB)	ANTENNA HEIGHT (m)	TABLE ANGLE (Degree)	RAW VALUE (dBuV)	CORRECTION FACTOR (dB/m)
1	5120.00	61.5 PK	74.0	-12.5	1.11 V	353	19.03	42.47
2	5120.00	51.6 AV	54.0	-2.4	1.11 V	353	9.13	42.47
3	*5200.00	108.9 PK			1.09 V	352	66.17	42.73
4	*5200.00	100.3 AV			1.09 V	352	57.57	42.73
5	#10400.00	62.5 PK	74.0	-11.5	1.04 V	219	13.47	49.03
6	#10400.00	49.2 AV	54.0	-4.8	1.04 V	219	0.17	49.03
7	15600.00	64.8 PK	74.0	-9.2	1.00 V	137	9.55	55.25
8	15600.00	50.6 AV	54.0	-3.4	1.00 V	137	-4.65	55.25

REMARKS:

1. Emission level (dBuV/m) = Raw Value (dBuV) + Correction Factor (dB/m).
2. Correction Factor (dB/m) = Antenna Factor (dB/m) + Cable Factor (dB).
3. The other emission levels were very low against the limit.
4. Margin value = Emission level – Limit value.
5. " * ": Fundamental frequency.
6. " # ": The radiated frequency is out of the restricted band.



A D T

CHANNEL	TX Channel 48	DETECTOR FUNCTION	Peak (PK)
FREQUENCY RANGE	1GHz ~ 40GHz		Average (AV)

ANTENNA POLARITY & TEST DISTANCE: HORIZONTAL AT 3 M

NO.	FREQ. (MHz)	EMISSION LEVEL (dBuV/m)	LIMIT (dBuV/m)	MARGIN (dB)	ANTENNA HEIGHT (m)	TABLE ANGLE (Degree)	RAW VALUE (dBuV)	CORRECTION FACTOR (dB/m)
1	*5240.00	95.7 PK			1.33 H	170	52.93	42.77
2	*5240.00	88.9 AV			1.33 H	170	46.13	42.77
3	#10480.00	62.9 PK	74.0	-11.1	1.06 H	244	13.31	49.59
4	#10480.00	49.8 AV	54.0	-4.2	1.06 H	244	0.21	49.59
5	15720.00	63.9 PK	74.0	-10.1	1.00 H	112	9.06	54.84
6	15720.00	49.5 AV	54.0	-4.5	1.00 H	112	-5.34	54.84

ANTENNA POLARITY & TEST DISTANCE: VERTICAL AT 3 M

NO.	FREQ. (MHz)	EMISSION LEVEL (dBuV/m)	LIMIT (dBuV/m)	MARGIN (dB)	ANTENNA HEIGHT (m)	TABLE ANGLE (Degree)	RAW VALUE (dBuV)	CORRECTION FACTOR (dB/m)
1	5080.00	60.6 PK	74.0	-13.4	1.11 V	353	18.22	42.38
2	5080.00	49.5 AV	54.0	-4.5	1.11 V	353	7.12	42.38
3	5120.00	62.1 PK	74.0	-11.9	1.11 V	353	19.63	42.47
4	5120.00	51.4 AV	54.0	-2.6	1.11 V	353	8.93	42.47
5	*5240.00	110.1 PK			1.08 V	354	67.33	42.77
6	*5240.00	101.1 AV			1.08 V	354	58.33	42.77
7	#10480.00	62.8 PK	74.0	-11.2	1.02 V	215	13.21	49.59
8	#10480.00	49.4 AV	54.0	-4.6	1.02 V	215	-0.19	49.59
9	15720.00	64.8 PK	74.0	-9.2	1.00 V	140	9.96	54.84
10	15720.00	50.9 AV	54.0	-3.1	1.00 V	140	-3.94	54.84

REMARKS:

1. Emission level (dBuV/m) = Raw Value (dBuV) + Correction Factor (dB/m).
2. Correction Factor (dB/m) = Antenna Factor (dB/m) + Cable Factor (dB).
3. The other emission levels were very low against the limit.
4. Margin value = Emission level – Limit value.
5. " * ": Fundamental frequency.
6. " # ": The radiated frequency is out of the restricted band.



A D T

CHANNEL	TX Channel 52	DETECTOR FUNCTION	Peak (PK)
FREQUENCY RANGE	1GHz ~ 40GHz		Average (AV)

ANTENNA POLARITY & TEST DISTANCE: HORIZONTAL AT 3 M

NO.	FREQ. (MHz)	EMISSION LEVEL (dBuV/m)	LIMIT (dBuV/m)	MARGIN (dB)	ANTENNA HEIGHT (m)	TABLE ANGLE (Degree)	RAW VALUE (dBuV)	CORRECTION FACTOR (dB/m)
1	*5260.00	91.1 PK			1.33 H	170	48.32	42.78
2	*5260.00	84.5 AV			1.33 H	170	41.72	42.78
3	#10520.00	63.2 PK	74.0	-10.8	1.11 H	251	13.51	49.69
4	#10520.00	50.0 AV	54.0	-4.0	1.11 H	251	0.31	49.69
5	15780.00	63.5 PK	74.0	-10.5	1.00 H	109	8.55	54.95
6	15780.00	49.0 AV	54.0	-5.0	1.00 H	109	-5.95	54.95

ANTENNA POLARITY & TEST DISTANCE: VERTICAL AT 3 M

NO.	FREQ. (MHz)	EMISSION LEVEL (dBuV/m)	LIMIT (dBuV/m)	MARGIN (dB)	ANTENNA HEIGHT (m)	TABLE ANGLE (Degree)	RAW VALUE (dBuV)	CORRECTION FACTOR (dB/m)
1	5120.00	61.1 PK	74.0	-12.9	1.56 V	180	18.63	42.47
2	5120.00	53.0 AV	54.0	-1.0	1.56 V	180	10.53	42.47
3	*5260.00	105.9 PK			1.52 V	180	63.12	42.78
4	*5260.00	96.8 AV			1.52 V	180	54.02	42.78
5	#10520.00	63.0 PK	74.0	-11.0	1.01 V	200	13.31	49.69
6	#10520.00	49.3 AV	54.0	-4.7	1.01 V	200	-0.39	49.69
7	15780.00	65.3 PK	74.0	-8.7	1.00 V	125	10.35	54.95
8	15780.00	51.2 AV	54.0	-2.8	1.00 V	125	-3.75	54.95

REMARKS:

1. Emission level (dBuV/m) = Raw Value (dBuV) + Correction Factor (dB/m).
2. Correction Factor (dB/m) = Antenna Factor (dB/m) + Cable Factor (dB).
3. The other emission levels were very low against the limit.
4. Margin value = Emission level – Limit value.
5. " * ": Fundamental frequency.
6. " # ": The radiated frequency is out of the restricted band.



A D T

CHANNEL	TX Channel 60	DETECTOR FUNCTION	Peak (PK)
FREQUENCY RANGE	1GHz ~ 40GHz		Average (AV)

ANTENNA POLARITY & TEST DISTANCE: HORIZONTAL AT 3 M

NO.	FREQ. (MHz)	EMISSION LEVEL (dBuV/m)	LIMIT (dBuV/m)	MARGIN (dB)	ANTENNA HEIGHT (m)	TABLE ANGLE (Degree)	RAW VALUE (dBuV)	CORRECTION FACTOR (dB/m)
1	*5300.00	91.7 PK			1.28 H	181	48.88	42.82
2	*5300.00	85.2 AV			1.28 H	181	42.38	42.82
3	10600.00	62.2 PK	74.0	-11.8	1.14 H	259	12.65	49.55
4	10600.00	49.3 AV	54.0	-4.7	1.14 H	259	-0.25	49.55
5	15900.00	63.4 PK	74.0	-10.6	1.00 H	117	8.39	55.01
6	15900.00	49.0 AV	54.0	-5.0	1.00 H	117	-6.01	55.01

ANTENNA POLARITY & TEST DISTANCE: VERTICAL AT 3 M

NO.	FREQ. (MHz)	EMISSION LEVEL (dBuV/m)	LIMIT (dBuV/m)	MARGIN (dB)	ANTENNA HEIGHT (m)	TABLE ANGLE (Degree)	RAW VALUE (dBuV)	CORRECTION FACTOR (dB/m)
1	5120.00	61.3 PK	74.0	-12.7	1.54 V	190	18.83	42.47
2	5120.00	53.1 AV	54.0	-0.9	1.54 V	190	10.63	42.47
3	*5300.00	106.3 PK			1.55 V	169	63.48	42.82
4	*5300.00	97.0 AV			1.55 V	169	54.18	42.82
5	10600.00	63.1 PK	74.0	-10.9	1.04 V	188	13.55	49.55
6	10600.00	49.3 AV	54.0	-4.7	1.04 V	188	-0.25	49.55
7	15900.00	65.3 PK	74.0	-8.7	1.00 V	113	10.29	55.01
8	15900.00	50.9 AV	54.0	-3.1	1.00 V	113	-4.11	55.01

REMARKS:

1. Emission level (dBuV/m) = Raw Value (dBuV) + Correction Factor (dB/m).
2. Correction Factor (dB/m) = Antenna Factor (dB/m) + Cable Factor (dB).
3. The other emission levels were very low against the limit.
4. Margin value = Emission level – Limit value.
5. " * ": Fundamental frequency.



CHANNEL	TX Channel 64	DETECTOR FUNCTION	Peak (PK)
FREQUENCY RANGE	1GHz ~ 40GHz		Average (AV)

ANTENNA POLARITY & TEST DISTANCE: HORIZONTAL AT 3 M								
NO.	FREQ. (MHz)	EMISSION LEVEL (dBuV/m)	LIMIT (dBuV/m)	MARGIN (dB)	ANTENNA HEIGHT (m)	TABLE ANGLE (Degree)	RAW VALUE (dBuV)	CORRECTION FACTOR (dB/m)
1	*5320.00	91.7 PK			1.32 H	175	48.88	42.82
2	*5320.00	85.3 AV			1.32 H	175	42.48	42.82
3	5350.00	59.7 PK	74.0	-14.3	1.25 H	152	16.87	42.83
4	5350.00	48.4 AV	54.0	-5.6	1.25 H	152	5.57	42.83
5	10640.00	62.0 PK	74.0	-12.0	1.19 H	260	12.34	49.66
6	10640.00	49.3 AV	54.0	-4.7	1.19 H	260	-0.36	49.66
7	15960.00	62.9 PK	74.0	-11.1	1.00 H	121	8.22	54.68
8	15960.00	48.7 AV	54.0	-5.3	1.00 H	121	-5.98	54.68

ANTENNA POLARITY & TEST DISTANCE: VERTICAL AT 3 M								
NO.	FREQ. (MHz)	EMISSION LEVEL (dBuV/m)	LIMIT (dBuV/m)	MARGIN (dB)	ANTENNA HEIGHT (m)	TABLE ANGLE (Degree)	RAW VALUE (dBuV)	CORRECTION FACTOR (dB/m)
1	*5320.00	106.7 PK			1.50 V	160	63.88	42.82
2	*5320.00	97.4 AV			1.50 V	160	54.58	42.82
3	5350.00	63.0 PK	74.0	-11.0	1.50 V	160	20.17	42.83
4	5350.00	50.0 AV	54.0	-4.0	1.50 V	160	7.17	42.83
5	10640.00	63.0 PK	74.0	-11.0	1.01 V	180	13.34	49.66
6	10640.00	49.3 AV	54.0	-4.7	1.01 V	180	-0.36	49.66
7	15960.00	65.2 PK	74.0	-8.8	1.00 V	97	10.52	54.68
8	15960.00	51.3 AV	54.0	-2.7	1.00 V	97	-3.38	54.68

REMARKS:

1. Emission level (dBuV/m) = Raw Value (dBuV) + Correction Factor (dB/m).
2. Correction Factor (dB/m) = Antenna Factor (dB/m) + Cable Factor (dB).
3. The other emission levels were very low against the limit.
4. Margin value = Emission level – Limit value.
5. " * ": Fundamental frequency.



A D T

802.11n (HT20)

CHANNEL	TX Channel 36	DETECTOR FUNCTION	Peak (PK)
FREQUENCY RANGE	1GHz ~ 40GHz		Average (AV)

ANTENNA POLARITY & TEST DISTANCE: HORIZONTAL AT 3 M

NO.	FREQ. (MHz)	EMISSION LEVEL (dBuV/m)	LIMIT (dBuV/m)	MARGIN (dB)	ANTENNA HEIGHT (m)	TABLE ANGLE (Degree)	RAW VALUE (dBuV)	CORRECTION FACTOR (dB/m)
1	5150.00	59.4 PK	74.0	-14.6	1.34 H	195	16.83	42.57
2	5150.00	47.6 AV	54.0	-6.4	1.34 H	195	5.03	42.57
3	*5180.00	99.9 PK			1.43 H	188	57.23	42.67
4	*5180.00	94.1 AV			1.43 H	188	51.43	42.67
5	#10360.00	60.3 PK	74.0	-13.7	1.19 H	216	10.89	49.41
6	#10360.00	48.2 AV	54.0	-5.8	1.19 H	216	-1.21	49.41
7	15540.00	60.7 PK	74.0	-13.3	1.00 H	88	5.25	55.45
8	15540.00	47.6 AV	54.0	-6.4	1.00 H	88	-7.85	55.45

ANTENNA POLARITY & TEST DISTANCE: VERTICAL AT 3 M

NO.	FREQ. (MHz)	EMISSION LEVEL (dBuV/m)	LIMIT (dBuV/m)	MARGIN (dB)	ANTENNA HEIGHT (m)	TABLE ANGLE (Degree)	RAW VALUE (dBuV)	CORRECTION FACTOR (dB/m)
1	5080.00	60.1 PK	74.0	-13.9	1.07 V	350	17.72	42.38
2	5080.00	49.4 AV	54.0	-4.6	1.07 V	350	7.02	42.38
3	5120.00	59.8 PK	74.0	-14.2	1.12 V	351	17.33	42.47
4	5120.00	52.4 AV	54.0	-1.6	1.12 V	351	9.93	42.47
5	5150.00	60.2 PK	74.0	-13.8	1.10 V	356	17.63	42.57
6	5150.00	49.4 AV	54.0	-4.6	1.10 V	356	6.83	42.57
7	*5180.00	112.5 PK			1.12 V	351	69.83	42.67
8	*5180.00	104.2 AV			1.12 V	351	61.53	42.67
9	#10360.00	62.2 PK	74.0	-11.8	1.00 V	142	12.79	49.41
10	#10360.00	48.3 AV	54.0	-5.7	1.00 V	142	-1.11	49.41
11	15540.00	63.9 PK	74.0	-10.1	1.00 V	65	8.45	55.45
12	15540.00	50.1 AV	54.0	-3.9	1.00 V	65	-5.35	55.45

REMARKS:

1. Emission level (dBuV/m) = Raw Value (dBuV) + Correction Factor (dB/m).
2. Correction Factor (dB/m) = Antenna Factor (dB/m) + Cable Factor (dB).
3. The other emission levels were very low against the limit.
4. Margin value = Emission level – Limit value.
5. " * ": Fundamental frequency.
6. " # ": The radiated frequency is out of the restricted band.



A D T

CHANNEL	TX Channel 40	DETECTOR FUNCTION	Peak (PK)
FREQUENCY RANGE	1GHz ~ 40GHz		Average (AV)

ANTENNA POLARITY & TEST DISTANCE: HORIZONTAL AT 3 M

NO.	FREQ. (MHz)	EMISSION LEVEL (dBuV/m)	LIMIT (dBuV/m)	MARGIN (dB)	ANTENNA HEIGHT (m)	TABLE ANGLE (Degree)	RAW VALUE (dBuV)	CORRECTION FACTOR (dB/m)
1	*5200.00	99.6 PK			1.43 H	184	56.87	42.73
2	*5200.00	94.1 AV			1.43 H	184	51.37	42.73
3	#10400.00	60.4 PK	74.0	-13.6	1.19 H	209	11.37	49.03
4	#10400.00	48.0 AV	54.0	-6.0	1.19 H	209	-1.03	49.03
5	15600.00	60.3 PK	74.0	-13.7	1.00 H	81	5.05	55.25
6	15600.00	47.6 AV	54.0	-6.4	1.00 H	81	-7.65	55.25

ANTENNA POLARITY & TEST DISTANCE: VERTICAL AT 3 M

NO.	FREQ. (MHz)	EMISSION LEVEL (dBuV/m)	LIMIT (dBuV/m)	MARGIN (dB)	ANTENNA HEIGHT (m)	TABLE ANGLE (Degree)	RAW VALUE (dBuV)	CORRECTION FACTOR (dB/m)
1	5080.00	60.2 PK	74.0	-13.8	1.06 V	347	17.82	42.38
2	5080.00	49.3 AV	54.0	-4.7	1.06 V	347	6.92	42.38
3	5120.00	60.2 PK	74.0	-13.8	1.10 V	360	17.73	42.47
4	5120.00	52.7 AV	54.0	-1.3	1.10 V	360	10.23	42.47
5	*5200.00	112.3 PK			1.17 V	349	69.57	42.73
6	*5200.00	104.0 AV			1.17 V	349	61.27	42.73
7	#10400.00	62.1 PK	74.0	-11.9	1.00 V	142	13.07	49.03
8	#10400.00	48.1 AV	54.0	-5.9	1.00 V	142	-0.93	49.03
9	15600.00	63.6 PK	74.0	-10.4	1.00 V	75	8.35	55.25
10	15600.00	50.0 AV	54.0	-4.0	1.00 V	75	-5.25	55.25

REMARKS:

1. Emission level (dBuV/m) = Raw Value (dBuV) + Correction Factor (dB/m).
2. Correction Factor (dB/m) = Antenna Factor (dB/m) + Cable Factor (dB).
3. The other emission levels were very low against the limit.
4. Margin value = Emission level – Limit value.
5. " * ": Fundamental frequency.
6. " # ": The radiated frequency is out of the restricted band.



A D T

CHANNEL	TX Channel 48	DETECTOR FUNCTION	Peak (PK)
FREQUENCY RANGE	1GHz ~ 40GHz		Average (AV)

ANTENNA POLARITY & TEST DISTANCE: HORIZONTAL AT 3 M

NO.	FREQ. (MHz)	EMISSION LEVEL (dBuV/m)	LIMIT (dBuV/m)	MARGIN (dB)	ANTENNA HEIGHT (m)	TABLE ANGLE (Degree)	RAW VALUE (dBuV)	CORRECTION FACTOR (dB/m)
1	*5240.00	99.2 PK			1.37 H	171	56.43	42.77
2	*5240.00	94.0 AV			1.37 H	171	51.23	42.77
3	#10480.00	60.9 PK	74.0	-13.1	1.14 H	185	11.31	49.59
4	#10480.00	48.5 AV	54.0	-5.5	1.14 H	185	-1.09	49.59
5	15720.00	60.6 PK	74.0	-13.4	1.00 H	80	5.76	54.84
6	15720.00	48.1 AV	54.0	-5.9	1.00 H	80	-6.74	54.84

ANTENNA POLARITY & TEST DISTANCE: VERTICAL AT 3 M

NO.	FREQ. (MHz)	EMISSION LEVEL (dBuV/m)	LIMIT (dBuV/m)	MARGIN (dB)	ANTENNA HEIGHT (m)	TABLE ANGLE (Degree)	RAW VALUE (dBuV)	CORRECTION FACTOR (dB/m)
1	5080.00	59.9 PK	74.0	-14.1	1.10 V	345	17.52	42.38
2	5080.00	48.9 AV	54.0	-5.1	1.10 V	345	6.52	42.38
3	5120.00	60.8 PK	74.0	-13.2	1.08 V	360	18.33	42.47
4	5120.00	53.1 AV	54.0	-0.9	1.08 V	360	10.63	42.47
5	*5240.00	112.5 PK			1.12 V	346	69.73	42.77
6	*5240.00	104.3 AV			1.12 V	346	61.53	42.77
7	#10480.00	60.9 PK	74.0	-13.1	1.00 V	140	11.31	49.59
8	#10480.00	47.0 AV	54.0	-7.0	1.00 V	140	-2.59	49.59
9	15720.00	63.2 PK	74.0	-10.8	1.00 V	80	8.36	54.84
10	15720.00	50.0 AV	54.0	-4.0	1.00 V	80	-4.84	54.84

REMARKS:

1. Emission level (dBuV/m) = Raw Value (dBuV) + Correction Factor (dB/m).
2. Correction Factor (dB/m) = Antenna Factor (dB/m) + Cable Factor (dB).
3. The other emission levels were very low against the limit.
4. Margin value = Emission level – Limit value.
5. " * ": Fundamental frequency.
6. " # ": The radiated frequency is out of the restricted band.



A D T

CHANNEL	TX Channel 52	DETECTOR FUNCTION	Peak (PK)
FREQUENCY RANGE	1GHz ~ 40GHz		Average (AV)

ANTENNA POLARITY & TEST DISTANCE: HORIZONTAL AT 3 M

NO.	FREQ. (MHz)	EMISSION LEVEL (dBuV/m)	LIMIT (dBuV/m)	MARGIN (dB)	ANTENNA HEIGHT (m)	TABLE ANGLE (Degree)	RAW VALUE (dBuV)	CORRECTION FACTOR (dB/m)
1	*5260.00	94.2 PK			1.37 H	171	51.42	42.78
2	*5260.00	89.4 AV			1.37 H	171	46.62	42.78
3	#10520.00	60.4 PK	74.0	-13.6	1.17 H	181	10.71	49.69
4	#10520.00	48.0 AV	54.0	-6.0	1.17 H	181	-1.69	49.69
5	15780.00	60.5 PK	74.0	-13.5	1.00 H	73	5.55	54.95
6	15780.00	47.9 AV	54.0	-6.1	1.00 H	73	-7.05	54.95

ANTENNA POLARITY & TEST DISTANCE: VERTICAL AT 3 M

NO.	FREQ. (MHz)	EMISSION LEVEL (dBuV/m)	LIMIT (dBuV/m)	MARGIN (dB)	ANTENNA HEIGHT (m)	TABLE ANGLE (Degree)	RAW VALUE (dBuV)	CORRECTION FACTOR (dB/m)
1	5080.00	60.0 PK	74.0	-14.0	1.12 V	351	17.62	42.38
2	5080.00	49.1 AV	54.0	-4.9	1.12 V	351	6.72	42.38
3	5120.00	60.5 PK	74.0	-13.5	1.08 V	360	18.03	42.47
4	5120.00	53.1 AV	54.0	-0.9	1.08 V	360	10.63	42.47
5	*5260.00	107.4 PK			1.12 V	346	64.62	42.78
6	*5260.00	99.2 AV			1.12 V	346	56.42	42.78
7	#10520.00	60.7 PK	74.0	-13.3	1.00 V	131	11.01	49.69
8	#10520.00	46.6 AV	54.0	-7.4	1.00 V	131	-3.09	49.69
9	15780.00	62.6 PK	74.0	-11.4	1.00 V	62	7.65	54.95
10	15780.00	49.2 AV	54.0	-4.8	1.00 V	62	-5.75	54.95

REMARKS:

1. Emission level (dBuV/m) = Raw Value (dBuV) + Correction Factor (dB/m).
2. Correction Factor (dB/m) = Antenna Factor (dB/m) + Cable Factor (dB).
3. The other emission levels were very low against the limit.
4. Margin value = Emission level – Limit value.
5. " * ": Fundamental frequency.
6. " # ": The radiated frequency is out of the restricted band.



A D T

CHANNEL	TX Channel 60	DETECTOR FUNCTION	Peak (PK)
FREQUENCY RANGE	1GHz ~ 40GHz		Average (AV)

ANTENNA POLARITY & TEST DISTANCE: HORIZONTAL AT 3 M

NO.	FREQ. (MHz)	EMISSION LEVEL (dBuV/m)	LIMIT (dBuV/m)	MARGIN (dB)	ANTENNA HEIGHT (m)	TABLE ANGLE (Degree)	RAW VALUE (dBuV)	CORRECTION FACTOR (dB/m)
1	*5300.00	93.9 PK			1.34 H	172	51.08	42.82
2	*5300.00	88.9 AV			1.34 H	172	46.08	42.82
3	10600.00	59.8 PK	74.0	-14.2	1.12 H	184	10.25	49.55
4	10600.00	47.5 AV	54.0	-6.5	1.12 H	184	-2.05	49.55
5	15900.00	61.1 PK	74.0	-12.9	1.00 H	75	6.09	55.01
6	15900.00	48.3 AV	54.0	-5.7	1.00 H	75	-6.71	55.01

ANTENNA POLARITY & TEST DISTANCE: VERTICAL AT 3 M

NO.	FREQ. (MHz)	EMISSION LEVEL (dBuV/m)	LIMIT (dBuV/m)	MARGIN (dB)	ANTENNA HEIGHT (m)	TABLE ANGLE (Degree)	RAW VALUE (dBuV)	CORRECTION FACTOR (dB/m)
1	5080.00	59.9 PK	74.0	-14.1	1.10 V	344	17.52	42.38
2	5080.00	48.7 AV	54.0	-5.3	1.10 V	344	6.32	42.38
3	5120.00	61.1 PK	74.0	-12.9	1.07 V	360	18.63	42.47
4	5120.00	53.2 AV	54.0	-0.8	1.07 V	360	10.73	42.47
5	*5300.00	106.8 PK			1.12 V	346	63.98	42.82
6	*5300.00	98.6 AV			1.12 V	346	55.78	42.82
7	10600.00	60.5 PK	74.0	-13.5	1.00 V	137	10.95	49.55
8	10600.00	46.9 AV	54.0	-7.1	1.00 V	137	-2.65	49.55
9	15900.00	62.9 PK	74.0	-11.1	1.00 V	73	7.89	55.01
10	15900.00	49.6 AV	54.0	-4.4	1.00 V	73	-5.41	55.01

REMARKS:

1. Emission level (dBuV/m) = Raw Value (dBuV) + Correction Factor (dB/m).
2. Correction Factor (dB/m) = Antenna Factor (dB/m) + Cable Factor (dB).
3. The other emission levels were very low against the limit.
4. Margin value = Emission level – Limit value.
5. " * ": Fundamental frequency.



A D T

CHANNEL	TX Channel 64	DETECTOR FUNCTION	Peak (PK)
FREQUENCY RANGE	1GHz ~ 40GHz		Average (AV)

ANTENNA POLARITY & TEST DISTANCE: HORIZONTAL AT 3 M

NO.	FREQ. (MHz)	EMISSION LEVEL (dBuV/m)	LIMIT (dBuV/m)	MARGIN (dB)	ANTENNA HEIGHT (m)	TABLE ANGLE (Degree)	RAW VALUE (dBuV)	CORRECTION FACTOR (dB/m)
1	*5320.00	93.8 PK			1.33 H	165	50.98	42.82
2	*5320.00	88.9 AV			1.33 H	165	46.08	42.82
3	5350.00	59.8 PK	74.0	-14.2	1.33 H	186	16.97	42.83
4	5350.00	47.7 AV	54.0	-6.3	1.33 H	186	4.87	42.83
5	10640.00	59.6 PK	74.0	-14.4	1.10 H	179	9.94	49.66
6	10640.00	47.1 AV	54.0	-6.9	1.10 H	179	-2.56	49.66
7	15960.00	59.8 PK	74.0	-14.2	1.00 H	91	5.12	54.68
8	15960.00	47.1 AV	54.0	-6.9	1.00 H	91	-7.58	54.68

ANTENNA POLARITY & TEST DISTANCE: VERTICAL AT 3 M

NO.	FREQ. (MHz)	EMISSION LEVEL (dBuV/m)	LIMIT (dBuV/m)	MARGIN (dB)	ANTENNA HEIGHT (m)	TABLE ANGLE (Degree)	RAW VALUE (dBuV)	CORRECTION FACTOR (dB/m)
1	5080.00	60.4 PK	74.0	-13.6	1.11 V	341	18.02	42.38
2	5080.00	49.0 AV	54.0	-5.0	1.11 V	341	6.62	42.38
3	5120.00	61.4 PK	74.0	-12.6	1.01 V	360	18.93	42.47
4	5120.00	53.3 AV	54.0	-0.7	1.01 V	360	10.83	42.47
5	*5320.00	107.3 PK			1.12 V	346	64.48	42.82
6	*5320.00	99.1 AV			1.12 V	346	56.28	42.82
7	5350.00	59.9 PK	74.0	-14.1	1.04 V	340	17.07	42.83
8	5350.00	49.3 AV	54.0	-4.7	1.04 V	340	6.47	42.83
9	10640.00	60.6 PK	74.0	-13.4	1.00 V	131	10.94	49.66
10	10640.00	47.1 AV	54.0	-6.9	1.00 V	131	-2.56	49.66
11	15960.00	62.8 PK	74.0	-11.2	1.00 V	65	8.12	54.68
12	15960.00	49.5 AV	54.0	-4.5	1.00 V	65	-5.18	54.68

REMARKS:

1. Emission level (dBuV/m) = Raw Value (dBuV) + Correction Factor (dB/m).
2. Correction Factor (dB/m) = Antenna Factor (dB/m) + Cable Factor (dB).
3. The other emission levels were very low against the limit.
4. Margin value = Emission level – Limit value.
5. " * ": Fundamental frequency.



A D T

802.11n (HT40)

CHANNEL	TX Channel 38	DETECTOR FUNCTION	Peak (PK)
FREQUENCY RANGE	1GHz ~ 40GHz		Average (AV)

ANTENNA POLARITY & TEST DISTANCE: HORIZONTAL AT 3 M

NO.	FREQ. (MHz)	EMISSION LEVEL (dBuV/m)	LIMIT (dBuV/m)	MARGIN (dB)	ANTENNA HEIGHT (m)	TABLE ANGLE (Degree)	RAW VALUE (dBuV)	CORRECTION FACTOR (dB/m)
1	5150.00	60.1 PK	74.0	-13.9	1.36 H	191	17.53	42.57
2	5150.00	47.5 AV	54.0	-6.5	1.36 H	191	4.93	42.57
3	*5190.00	92.8 PK			1.32 H	187	50.10	42.70
4	*5190.00	88.1 AV			1.32 H	187	45.40	42.70
5	#10380.00	59.3 PK	74.0	-14.7	1.00 H	175	10.08	49.22
6	#10380.00	46.9 AV	54.0	-7.1	1.00 H	175	-2.32	49.22
7	15570.00	58.5 PK	74.0	-15.5	1.00 H	90	3.15	55.35
8	15570.00	45.6 AV	54.0	-8.4	1.00 H	90	-9.75	55.35

ANTENNA POLARITY & TEST DISTANCE: VERTICAL AT 3 M

NO.	FREQ. (MHz)	EMISSION LEVEL (dBuV/m)	LIMIT (dBuV/m)	MARGIN (dB)	ANTENNA HEIGHT (m)	TABLE ANGLE (Degree)	RAW VALUE (dBuV)	CORRECTION FACTOR (dB/m)
1	5080.00	60.1 PK	74.0	-13.9	1.16 V	340	17.72	42.38
2	5080.00	48.5 AV	54.0	-5.5	1.16 V	340	6.12	42.38
3	5120.00	61.1 PK	74.0	-12.9	1.00 V	360	18.63	42.47
4	5120.00	53.1 AV	54.0	-0.9	1.00 V	360	10.63	42.47
5	5150.00	64.8 PK	74.0	-9.2	1.64 V	202	22.23	42.57
6	5150.00	53.3 AV	54.0	-0.7	1.64 V	202	10.73	42.57
7	*5190.00	107.5 PK			1.64 V	201	64.80	42.70
8	*5190.00	98.2 AV			1.64 V	201	55.50	42.70
9	#10380.00	59.3 PK	74.0	-14.7	1.00 V	104	10.08	49.22
10	#10380.00	46.5 AV	54.0	-7.5	1.00 V	104	-2.72	49.22
11	15570.00	61.7 PK	74.0	-12.3	1.00 V	47	6.35	55.35
12	15570.00	49.4 AV	54.0	-4.6	1.00 V	47	-5.95	55.35

REMARKS:

1. Emission level (dBuV/m) = Raw Value (dBuV) + Correction Factor (dB/m).
2. Correction Factor (dB/m) = Antenna Factor (dB/m) + Cable Factor (dB).
3. The other emission levels were very low against the limit.
4. Margin value = Emission level – Limit value.
5. " * ": Fundamental frequency.
6. " # ": The radiated frequency is out of the restricted band.



A D T

CHANNEL	TX Channel 46	DETECTOR FUNCTION	Peak (PK)
FREQUENCY RANGE	1GHz ~ 40GHz		Average (AV)

ANTENNA POLARITY & TEST DISTANCE: HORIZONTAL AT 3 M

NO.	FREQ. (MHz)	EMISSION LEVEL (dBuV/m)	LIMIT (dBuV/m)	MARGIN (dB)	ANTENNA HEIGHT (m)	TABLE ANGLE (Degree)	RAW VALUE (dBuV)	CORRECTION FACTOR (dB/m)
1	*5230.00	96.2 PK			1.33 H	189	53.44	42.76
2	*5230.00	91.7 AV			1.33 H	189	48.94	42.76
3	#10460.00	58.9 PK	74.0	-15.1	1.00 H	171	9.45	49.45
4	#10460.00	46.5 AV	54.0	-7.5	1.00 H	171	-2.95	49.45
5	15690.00	58.4 PK	74.0	-15.6	1.00 H	87	3.56	54.84
6	15690.00	45.5 AV	54.0	-8.5	1.00 H	87	-9.34	54.84

ANTENNA POLARITY & TEST DISTANCE: VERTICAL AT 3 M

NO.	FREQ. (MHz)	EMISSION LEVEL (dBuV/m)	LIMIT (dBuV/m)	MARGIN (dB)	ANTENNA HEIGHT (m)	TABLE ANGLE (Degree)	RAW VALUE (dBuV)	CORRECTION FACTOR (dB/m)
1	5080.00	59.8 PK	74.0	-14.2	1.22 V	333	17.42	42.38
2	5080.00	48.3 AV	54.0	-5.7	1.22 V	333	5.92	42.38
3	5120.00	61.0 PK	74.0	-13.0	1.00 V	360	18.53	42.47
4	5120.00	53.2 AV	54.0	-0.8	1.00 V	360	10.73	42.47
5	*5230.00	110.4 PK			1.64 V	201	67.64	42.76
6	*5230.00	101.1 AV			1.64 V	201	58.34	42.76
7	#10460.00	58.7 PK	74.0	-15.3	1.00 V	86	9.25	49.45
8	#10460.00	46.1 AV	54.0	-7.9	1.00 V	86	-3.35	49.45
9	15690.00	61.7 PK	74.0	-12.3	1.00 V	24	6.86	54.84
10	15690.00	49.5 AV	54.0	-4.5	1.00 V	24	-5.34	54.84

REMARKS:

1. Emission level (dBuV/m) = Raw Value (dBuV) + Correction Factor (dB/m).
2. Correction Factor (dB/m) = Antenna Factor (dB/m) + Cable Factor (dB).
3. The other emission levels were very low against the limit.
4. Margin value = Emission level – Limit value.
5. " * ": Fundamental frequency.
6. " # ": The radiated frequency is out of the restricted band.



A D T

CHANNEL	TX Channel 54	DETECTOR FUNCTION	Peak (PK)
FREQUENCY RANGE	1GHz ~ 40GHz		Average (AV)

ANTENNA POLARITY & TEST DISTANCE: HORIZONTAL AT 3 M

NO.	FREQ. (MHz)	EMISSION LEVEL (dBuV/m)	LIMIT (dBuV/m)	MARGIN (dB)	ANTENNA HEIGHT (m)	TABLE ANGLE (Degree)	RAW VALUE (dBuV)	CORRECTION FACTOR (dB/m)
1	*5270.00	99.1 PK			1.33 H	188	56.31	42.79
2	*5270.00	88.2 AV			1.33 H	188	45.41	42.79
3	#10540.00	58.8 PK	74.0	-15.2	1.00 H	180	9.14	49.66
4	#10540.00	46.6 AV	54.0	-7.4	1.00 H	180	-3.06	49.66
5	15810.00	57.4 PK	74.0	-16.6	1.00 H	84	2.41	54.99
6	15810.00	45.2 AV	54.0	-8.8	1.00 H	84	-9.79	54.99

ANTENNA POLARITY & TEST DISTANCE: VERTICAL AT 3 M

NO.	FREQ. (MHz)	EMISSION LEVEL (dBuV/m)	LIMIT (dBuV/m)	MARGIN (dB)	ANTENNA HEIGHT (m)	TABLE ANGLE (Degree)	RAW VALUE (dBuV)	CORRECTION FACTOR (dB/m)
1	5080.00	59.4 PK	74.0	-14.6	1.18 V	339	17.02	42.38
2	5080.00	48.1 AV	54.0	-5.9	1.18 V	339	5.72	42.38
3	5120.00	60.4 PK	74.0	-13.6	1.00 V	360	17.93	42.47
4	5120.00	52.8 AV	54.0	-1.2	1.00 V	360	10.33	42.47
5	*5270.00	107.7 PK			1.64 V	202	64.91	42.79
6	*5270.00	98.4 AV			1.64 V	202	55.61	42.79
7	#10540.00	58.6 PK	74.0	-15.4	1.00 V	85	8.94	49.66
8	#10540.00	46.0 AV	54.0	-8.0	1.00 V	85	-3.66	49.66
9	15810.00	60.8 PK	74.0	-13.2	1.00 V	22	5.81	54.99
10	15810.00	48.8 AV	54.0	-5.2	1.00 V	22	-6.19	54.99

REMARKS:

1. Emission level (dBuV/m) = Raw Value (dBuV) + Correction Factor (dB/m).
2. Correction Factor (dB/m) = Antenna Factor (dB/m) + Cable Factor (dB).
3. The other emission levels were very low against the limit.
4. Margin value = Emission level – Limit value.
5. " * ": Fundamental frequency.
6. " # ": The radiated frequency is out of the restricted band.



A D T

CHANNEL	TX Channel 62	DETECTOR FUNCTION	Peak (PK)
FREQUENCY RANGE	1GHz ~ 40GHz		Average (AV)

ANTENNA POLARITY & TEST DISTANCE: HORIZONTAL AT 3 M

NO.	FREQ. (MHz)	EMISSION LEVEL (dBuV/m)	LIMIT (dBuV/m)	MARGIN (dB)	ANTENNA HEIGHT (m)	TABLE ANGLE (Degree)	RAW VALUE (dBuV)	CORRECTION FACTOR (dB/m)
1	*5310.00	100.2 PK			1.33 H	188	57.38	42.82
2	*5310.00	89.5 AV			1.33 H	188	46.68	42.82
3	5350.00	59.7 PK	74.0	-14.3	1.39 H	206	16.87	42.83
4	5350.00	47.1 AV	54.0	-6.9	1.39 H	206	4.27	42.83
5	10620.00	58.3 PK	74.0	-15.7	1.00 H	168	8.70	49.60
6	10620.00	46.5 AV	54.0	-7.5	1.00 H	168	-3.10	49.60
7	15930.00	56.6 PK	74.0	-17.4	1.00 H	86	1.76	54.84
8	15930.00	44.9 AV	54.0	-9.1	1.00 H	86	-9.94	54.84

ANTENNA POLARITY & TEST DISTANCE: VERTICAL AT 3 M

NO.	FREQ. (MHz)	EMISSION LEVEL (dBuV/m)	LIMIT (dBuV/m)	MARGIN (dB)	ANTENNA HEIGHT (m)	TABLE ANGLE (Degree)	RAW VALUE (dBuV)	CORRECTION FACTOR (dB/m)
1	5120.00	59.8 PK	74.0	-14.2	1.54 V	202	17.33	42.47
2	5120.00	51.6 AV	54.0	-2.4	1.54 V	202	9.13	42.47
3	*5310.00	109.2 PK			1.54 V	202	66.38	42.82
4	*5310.00	99.9 AV			1.54 V	202	57.08	42.82
5	5350.00	62.2 PK	74.0	-11.8	1.54 V	202	19.37	42.83
6	5350.00	50.4 AV	54.0	-3.6	1.54 V	202	7.57	42.83
7	10620.00	58.6 PK	74.0	-15.4	1.00 V	91	9.00	49.60
8	10620.00	46.3 AV	54.0	-7.7	1.00 V	91	-3.30	49.60
9	15930.00	60.7 PK	74.0	-13.3	1.00 V	37	5.86	54.84
10	15930.00	48.9 AV	54.0	-5.1	1.00 V	37	-5.94	54.84

REMARKS:

1. Emission level (dBuV/m) = Raw Value (dBuV) + Correction Factor (dB/m).
2. Correction Factor (dB/m) = Antenna Factor (dB/m) + Cable Factor (dB).
3. The other emission levels were very low against the limit.
4. Margin value = Emission level – Limit value.
5. " * ": Fundamental frequency.

4.3 OCCUPIED BANDWIDTH MEASUREMENT

4.3.1 TEST INSTRUMENTS

DESCRIPTION & MANUFACTURER	MODEL NO.	SERIAL NO.	CALIBRATED DATE	CALIBRATED UNTIL
R&S Spectrum Analyzer	FSP40	100037	Nov. 01, 2012	Oct. 31, 2013

Note:

1. The calibration interval of the above test instruments is 12 months and the calibrations are traceable to NML/ROC and NIST/USA.
2. Tested date : Mar. 13, 2013

4.3.2 TEST PROCEDURE

1. Set RBW \geq 1% of the emission bandwidth.
2. Set the VBW \geq 3 \times RBW.
3. Detector = Peak.
4. Trace mode = max hold.
5. Record the 99% emission bandwidth.

4.3.3 DEVIATION FROM TEST STANDARD

No deviation

4.3.4 TEST SETUP

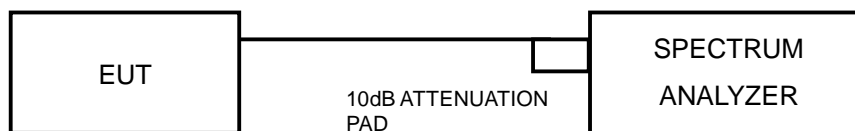

4.3.5 EUT OPERATING CONDITIONS

The software provided by client to enable the EUT under transmission condition continuously at lowest, middle and highest channel frequencies individually.



A D T

4.3.6 TEST RESULTS

802.11a

CHANNEL	CHANNEL FREQUENCY (MHz)	OCCUPIED BANDWIDTH (MHz)	
		CHAIN 0	CHAIN 1
36	5180	16.44	16.44
40	5200	16.44	16.44
48	5240	16.44	16.44
52	5260	16.44	16.44
60	5300	16.56	16.44
64	5320	16.56	16.56

802.11n (HT20)

CHANNEL	CHANNEL FREQUENCY (MHz)	OCCUPIED BANDWIDTH (MHz)	
		CHAIN 0	CHAIN 1
36	5180	17.76	17.64
40	5200	17.64	17.64
48	5240	17.76	17.64
52	5260	17.64	17.76
60	5300	17.88	17.76
64	5320	17.64	17.64

802.11n (HT40)

CHANNEL	CHANNEL FREQUENCY (MHz)	OCCUPIED BANDWIDTH (MHz)	
		CHAIN 0	CHAIN 1
38	5190	36.60	37.00
46	5230	37.00	36.80
54	5270	37.00	37.00
62	5310	36.80	37.00

4.4 TRANSMIT POWER MEASUREMENT

4.4.1 LIMITS OF TRANSMIT POWER MEASUREMENT

Frequency Band	Limit
5.15 – 5.25GHz	The lesser of 50mW (17dBm) or 4dBm + 10logB
5.25 – 5.35GHz	The lesser of 250mW (24dBm) or 11dBm + 10logB
5.47 – 5.725GHz	The lesser of 250mW (24dBm) or 11dBm + 10logB
5.725 – 5.825GHz	The lesser of 1W (30dBm) or 17dBm + 10logB

NOTE: Where B is the 26dB emission bandwidth in MHz.

Per KDB 662911 D01 Multiple Transmitter Output v01r02 Method of conducted output power measurement on IEEE 802.11 devices,

Array Gain = 0 dB (i.e., no array gain) for NANT ≤ 4;

Array Gain = 0 dB (i.e., no array gain) for channel widths ≥ 40 MHz for any NANT;

Array Gain = 5 log(NANT/NSS) dB or 3 dB, whichever is less for 20-MHz channel widths with NANT ≥ 5.

For power measurements on all other devices: Array Gain = 10 log(NANT/NSS) dB.



A D T

4.4.2 TEST INSTRUMENTS

FOR POWER OUTPUT MEASUREMENT

DESCRIPTION & MANUFACTURER	MODEL NO.	SERIAL NO.	CALIBRATED DATE	CALIBRATED UNTIL
Power Meter	ML2495A	0824006	May 10, 2012	May 09, 2013
Power Sensor	MA2411B	0738172	May 10, 2012	May 09, 2013

Note:

1. The calibration interval of the above test instruments is 12 months and the calibrations are traceable to NML/ROC and NIST/USA.
2. Tested date : Mar. 13, 2013

FOR 26dB EMISSION BANDWIDTH MEASUREMENT

DESCRIPTION & MANUFACTURER	MODEL NO.	SERIAL NO.	CALIBRATED DATE	CALIBRATED UNTIL
R&S Spectrum Analyzer	FSP40	100037	Nov. 01, 2012	Oct. 31, 2013

Note:

1. The calibration interval of the above test instruments is 12 months and the calibrations are traceable to NML/ROC and NIST/USA.
2. Tested date : Mar. 13, 2013

4.4.3 TEST PROCEDURE

FOR POWER OUTPUT MEASUREMENT

An average power sensor was used on the output port of the EUT. A power meter was used to read the response of the average power sensor. Record the power level.

FOR 26dB EMISSION BANDWIDTH MEASUREMENT

1. Set RBW = approximately 1% of the emission bandwidth.
2. Set the VBW > RBW.
3. Detector = Peak.
4. Trace mode = max hold.
5. Measure the maximum width of the emission that is 26 dB down from the peak of the emission. Compare this with the RBW setting of the analyzer. Readjust RBW and repeat measurement as needed until the RBW/EBW ratio is approximately 1%.

4.4.4 DEVIATION FROM TEST STANDARD

No deviation

4.4.5 TEST SETUP

FOR POWER OUTPUT MEASUREMENT

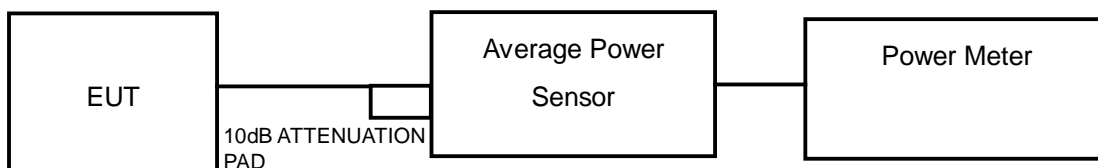

FOR 99% OCCUPIED BANDWIDTH

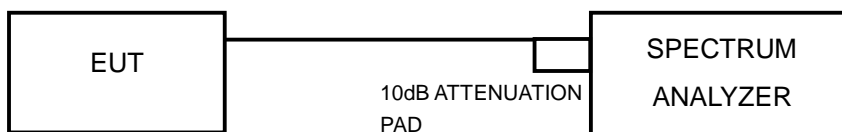



A D T

4.4.6 EUT OPERATING CONDITIONS

The software provided by client to enable the EUT under transmission condition continuously at specific channel frequencies individually.



A D T

4.4.7 TEST RESULTS

POWER OUTPUT:

802.11a

CHAN.	CHAN. FREQ. (MHz)	AVERAGE POWER (dBm)		TOTAL POWER (mW)	TOTAL POWER (dBm)	POWER LIMIT (dBm)	PASS / FAIL
		CHAIN 0	CHAIN 1				
36	5180	8.27	7.23	11.998	10.79	17	PASS
40	5200	8.21	7.65	12.443	10.95	17	PASS
48	5240	8.77	8.26	14.233	11.53	17	PASS
52	5260	8.40	8.01	13.242	11.22	24	PASS
60	5300	9.71	8.71	16.784	12.25	24	PASS
64	5320	9.54	8.05	15.378	11.87	24	PASS

26dB EMISSION BANDWIDTH MEASUREMENT

802.11a

CHANNEL	CHANNEL FREQUENCY (MHz)	OCCUPIED BANDWIDTH (MHz)	
		CHAIN 0	CHAIN 1
36	5180	22.71	21.72
40	5200	22.78	22.10
48	5240	23.19	22.13
52	5260	22.13	21.68
60	5300	22.71	21.79
64	5320	22.73	21.82



A D T

Chain(0) : CH36

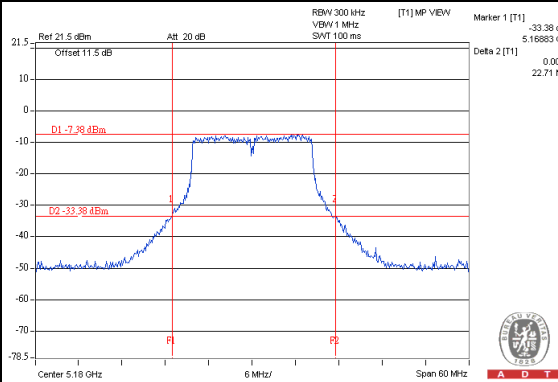

Chain(0) : CH40

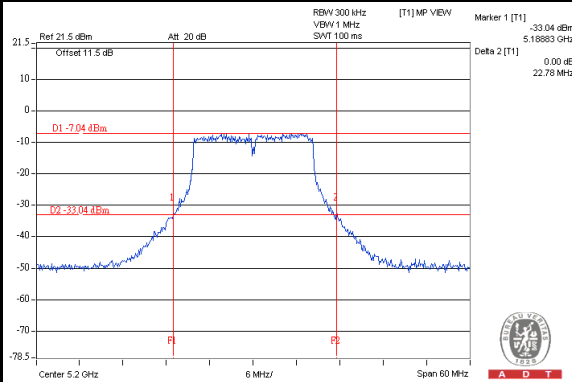

Chain(0) : CH48

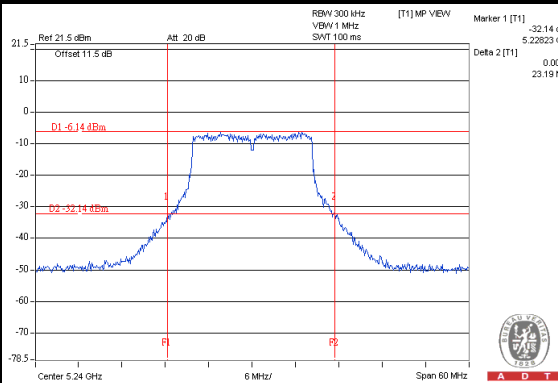

Chain(0) : CH52

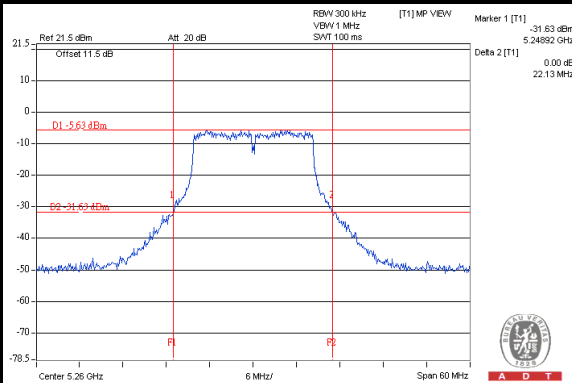

Chain(0) : CH60

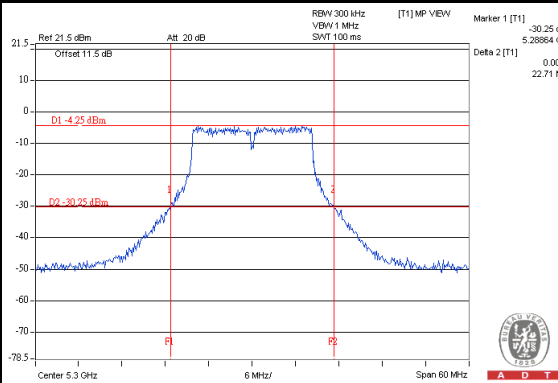

Chain(0) : CH64

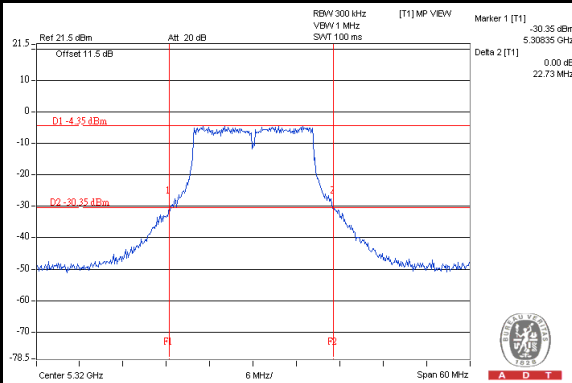



A D T

Chain(1) : CH36

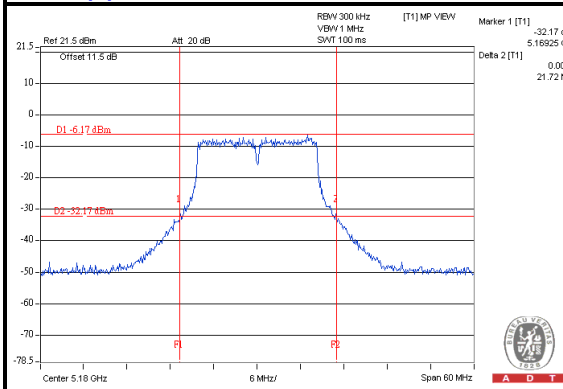

Chain(1) : CH40

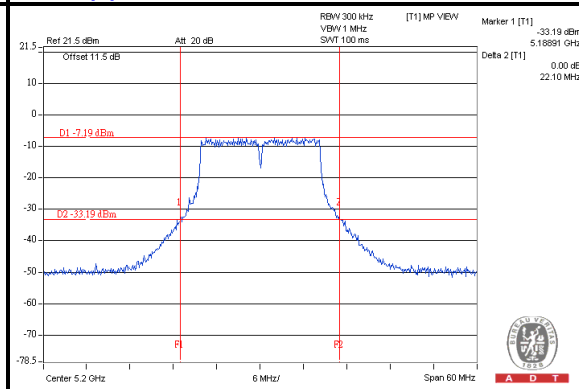

Chain(1) : CH48

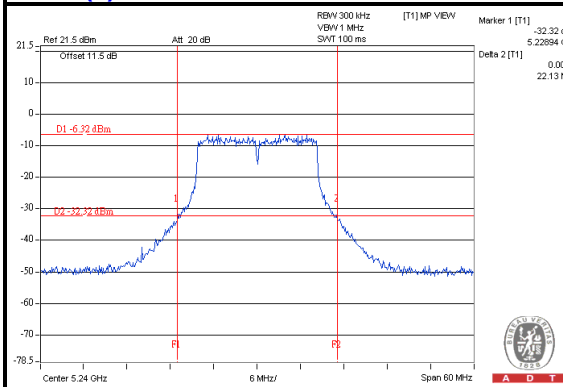

Chain(1) : CH52

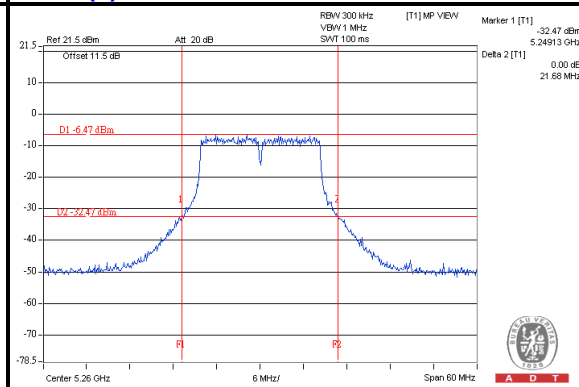

Chain(1) : CH60

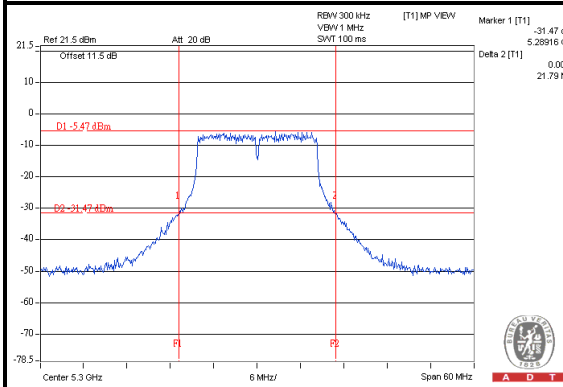

Chain(1) : CH64

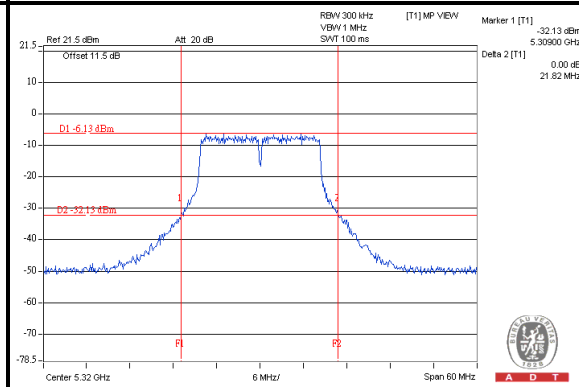



A D T

POWER OUTPUT:

802.11n (HT20)

CHAN.	CHAN. FREQ. (MHz)	AVERAGE POWER (dBm)		TOTAL POWER (mW)	TOTAL POWER (dBm)	POWER LIMIT (dBm)	PASS / FAIL
		CHAIN 0	CHAIN 1				
36	5180	9.97	9.97	19.862	12.98	17	PASS
40	5200	10.24	10.24	21.136	13.25	17	PASS
48	5240	10.61	10.61	23.016	13.62	17	PASS
52	5260	9.31	8.21	15.153	11.80	24	PASS
60	5300	9.89	8.31	16.526	12.18	24	PASS
64	5320	10.01	8.21	16.645	12.21	24	PASS

26dB EMISSION BANDWIDTH MEASUREMENT

802.11n (HT20)

CHANNEL	CHANNEL FREQUENCY (MHz)	OCCUPIED BANDWIDTH (MHz)	
		CHAIN 0	CHAIN 1
36	5180	23.99	23.50
40	5200	23.41	23.35
48	5240	23.92	23.82
52	5260	23.68	23.08
60	5300	23.17	22.92
64	5320	23.37	23.30



A D T

Chain(0) : CH36

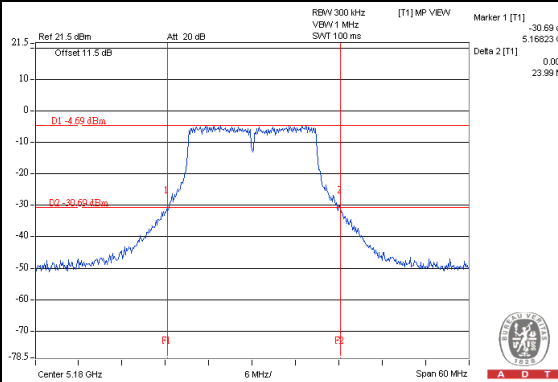

Chain(0) : CH40

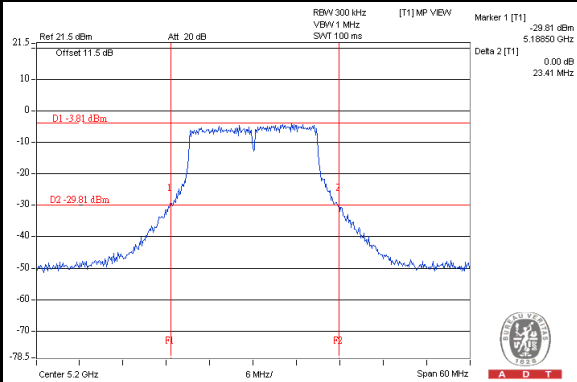

Chain(0) : CH48

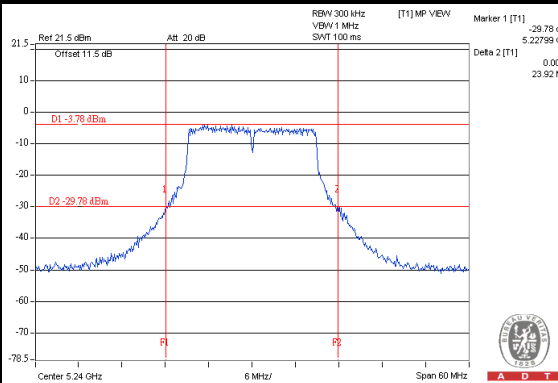

Chain(0) : CH52

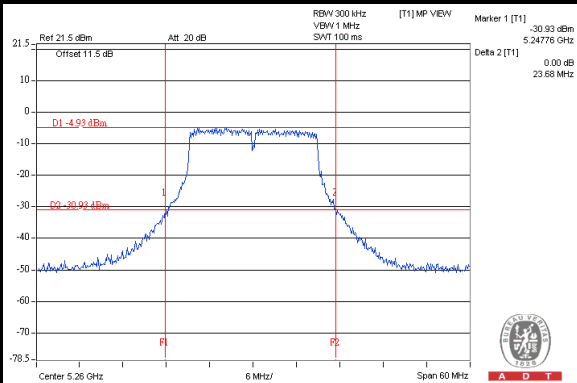

Chain(0) : CH60

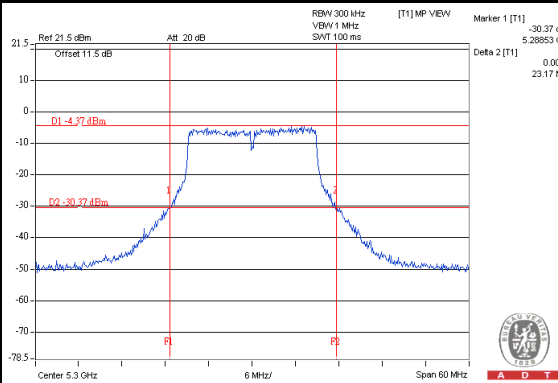

Chain(0) : CH64

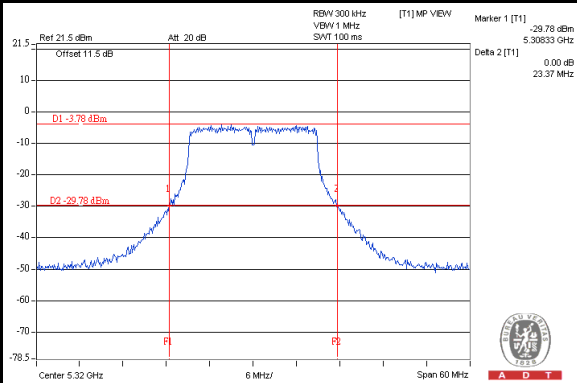



A D T

Chain(1) : CH36

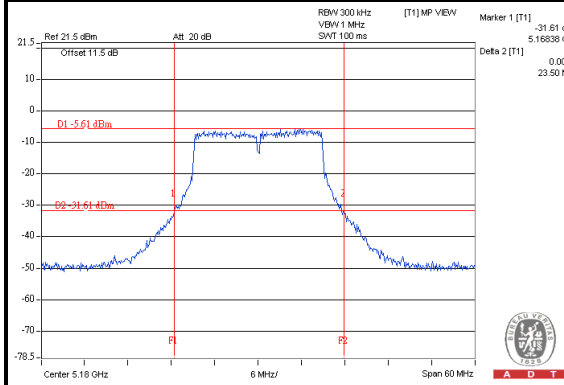

Chain(1) : CH40

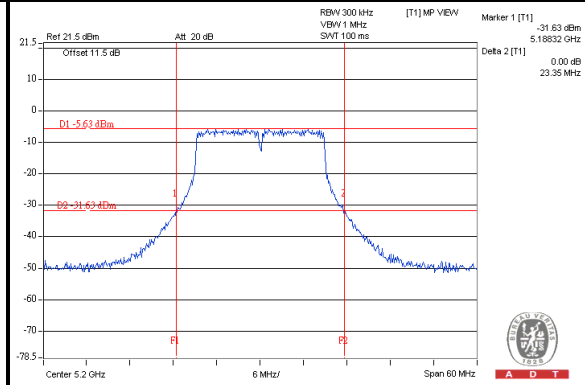

Chain(1) : CH48

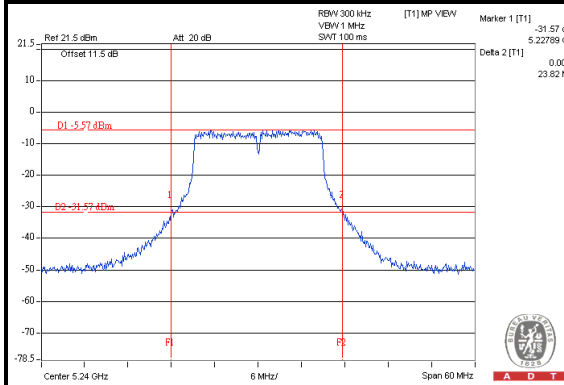

Chain(1) : CH52

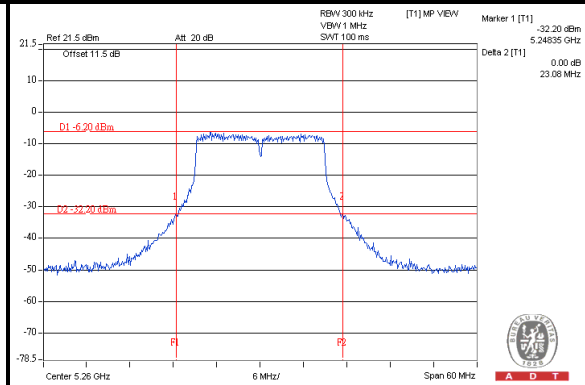

Chain(1) : CH60

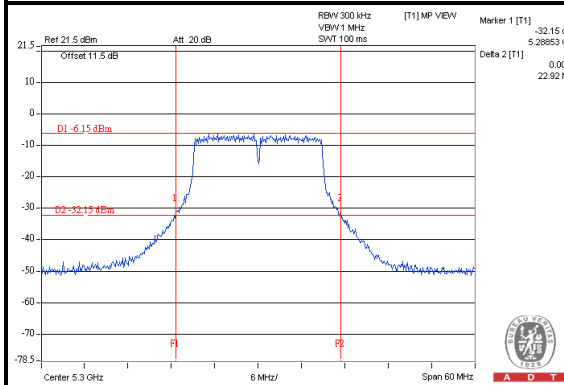

Chain(1) : CH64

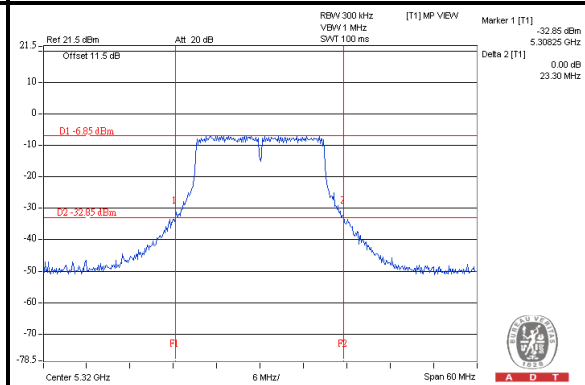



A D T

POWER OUTPUT:

802.11n (HT40)

CHAN.	CHAN. FREQ. (MHz)	AVERAGE POWER (dBm)		TOTAL POWER (mW)	TOTAL POWER (dBm)	POWER LIMIT (dBm)	PASS / FAIL
		CHAIN 0	CHAIN 1				
38	5190	9.81	9.32	18.123	12.58	17	PASS
46	5230	13.91	12.51	42.428	16.28	17	PASS
54	5270	9.81	8.68	16.951	12.29	24	PASS
62	5310	10.78	8.77	19.501	12.90	24	PASS

26dB EMISSION BANDWIDTH MEASUREMENT

802.11n (HT40)

CHANNEL	CHANNEL FREQUENCY (MHz)	OCCUPIED BANDWIDTH (MHz)	
		CHAIN 0	CHAIN 1
38	5190	53.56	51.75
46	5230	51.87	50.42
54	5270	52.62	52.23
62	5310	51.76	53.19



A D T

Chain(0) : CH38

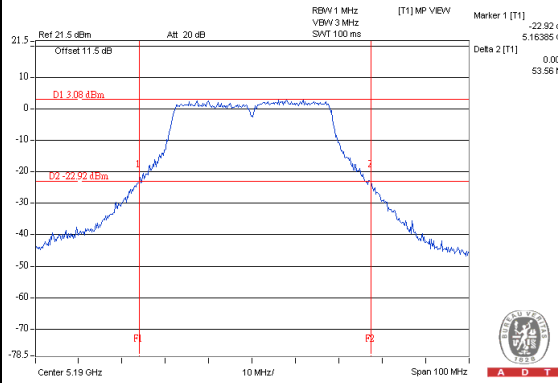

Chain(0) : CH46

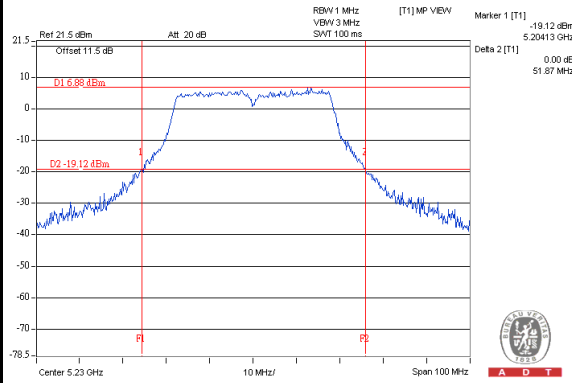

Chain(0) : CH54

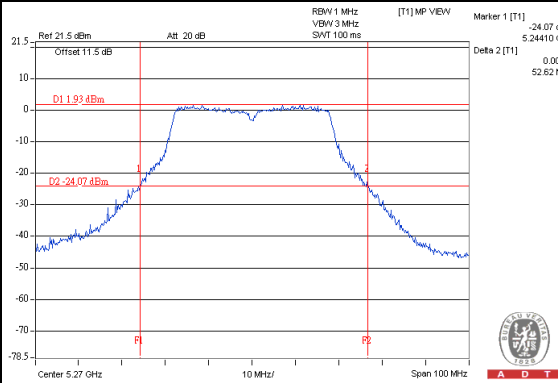

Chain(0) : CH62

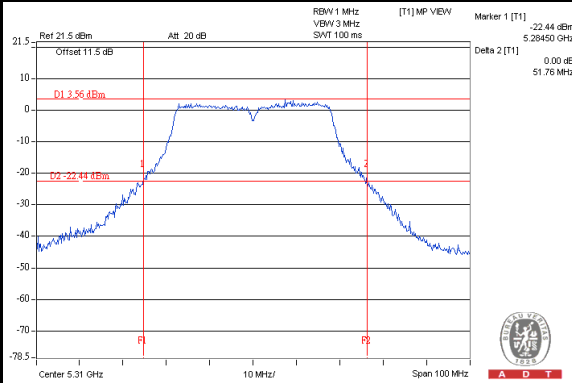



A D T

Chain(1) : CH38

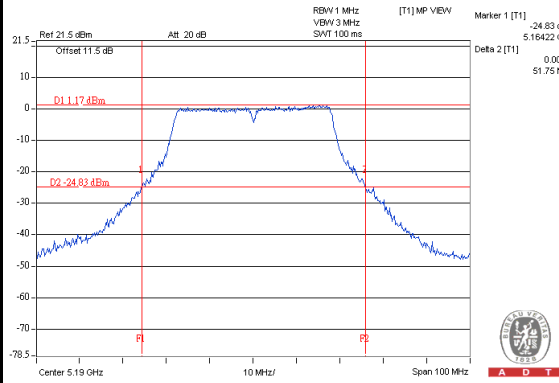

Chain(1) : CH46

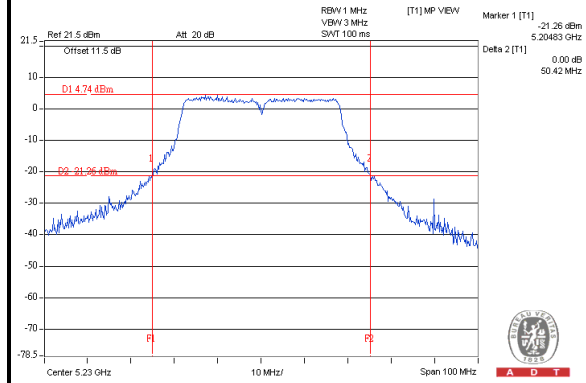

Chain(1) : CH54

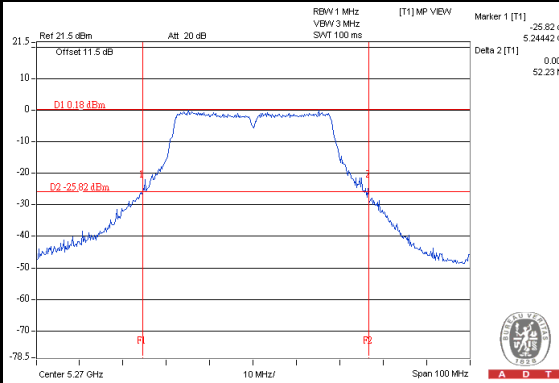

Chain(1) : CH62

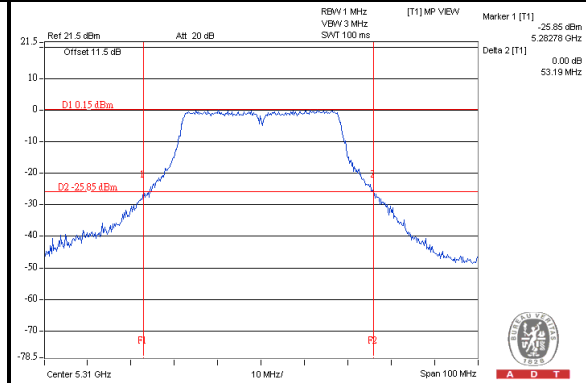



A D T

4.5 PEAK POWER SPECTRAL DENSITY MEASUREMENT

4.5.1 LIMITS OF PEAK POWER SPECTRAL DENSITY MEASUREMENT

Frequency Band	Limit
5.15 ~ 5.25GHz	4dBm
5.25 ~ 5.35GHz	11dBm
5.47 ~ 5.725GHz	11dBm
5.725 ~ 5.825GHz	17dBm

4.5.2 TEST INSTRUMENTS

DESCRIPTION & MANUFACTURER	MODEL NO.	SERIAL NO.	CALIBRATED DATE	CALIBRATED UNTIL
R&S Spectrum Analyzer	FSP40	100037	Nov. 01, 2012	Oct. 31, 2013

Note:

1. The calibration interval of the above test instruments is 12 months and the calibrations are traceable to NML/ROC and NIST/USA.
2. Tested date : Mar. 13, 2013

4.5.3 TEST PROCEDURES

Using method SA-1

Set span to encompass the entire emission bandwidth (EBW) of the signal.

1. Set RBW = 30 KHz, Set VBW \geq 1 MHz, Detector = RMS
2. Set Channel power measure = 1MHz
3. Sweep time = auto, trigger set to "free run".
4. Trace average at least 100 traces in power averaging mode.
5. Record the max value

4.5.4 DEVIATION FROM TEST STANDARD

No deviation

4.5.5 TEST SETUP

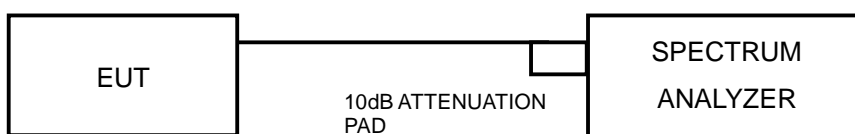

4.5.6 EUT OPERATING CONDITIONS

Same as 4.3.6



4.5.7 TEST RESULTS

802.11a

CHAN.	CHAN. FREQ. (MHz)	PSD (dBm)		TOTAL POWER DENSITY (dBm)	MAX. LIMIT (dBm)	PASS / FAIL
		CHAIN 0	CHAIN 1			
36	5180	-6.40	-6.33	-3.35	4	PASS
40	5200	-5.89	-6.32	-3.09	4	PASS
48	5240	-5.29	-6.59	-2.88	4	PASS
52	5260	-4.67	-6.16	-2.34	11	PASS
60	5300	-3.32	-5.64	-1.32	11	PASS
64	5320	-3.26	-5.98	-1.40	11	PASS

- NOTE:**
- Method 1 of power density measurement of KDB 662911 is using for calculating total power density. Total power density is summing entire spectra across corresponding frequency bins on the various outputs by computer.
 - Directional gain = $1.8\text{dBi} + 10\log(2) = 4.81\text{dBi} < 6\text{dBi}$, so the power density limit shall not be reduced.

802.11n (HT20)

CHAN.	CHAN. FREQ. (MHz)	PSD (dBm)		TOTAL POWER DENSITY (dBm)	MAX. LIMIT (dBm)	PASS / FAIL
		CHAIN 0	CHAIN 1			
36	5180	-3.58	-4.84	-1.15	4	PASS
40	5200	-3.22	-4.96	-0.99	4	PASS
48	5240	-3.27	-5.31	-1.16	4	PASS
52	5260	-4.01	-5.64	-1.74	11	PASS
60	5300	-3.62	-6.04	-1.65	11	PASS
64	5320	-3.51	-5.89	-1.53	11	PASS

- NOTE:**
- Method 1 of power density measurement of KDB 662911 is using for calculating total power density. Total power density is summing entire spectra across corresponding frequency bins on the various outputs by computer.
 - Directional gain = $1.8\text{dBi} + 10\log(2) = 4.81\text{dBi} < 6\text{dBi}$, so the power density limit shall not be reduced.



A D T

802.11n (HT40)

CHAN.	CHAN. FREQ. (MHz)	PSD (dBm)		TOTAL POWER DENSITY (dBm)	MAX. LIMIT (dBm)	PASS / FAIL
		CHAIN 0	CHAIN 1			
38	5190	-5.71	-6.99	-3.29	4	PASS
46	5230	-2.14	-4.84	-0.27	4	PASS
54	5270	-6.90	-8.68	-4.69	11	PASS
62	5310	-5.89	-8.33	-3.93	11	PASS

- NOTE:**
1. Method 1 of power density measurement of KDB 662911 is using for calculating total power density. Total power density is summing entire spectra across corresponding frequency bins on the various outputs by computer.
 2. Directional gain = $1.8\text{dBi} + 10\log(2) = 4.81\text{dBi} < 6\text{dBi}$, so the power density limit shall not be reduced.

4.6 PEAK POWER EXCURSION MEASUREMENT

4.6.1 LIMITS OF PEAK POWER EXCURSION MEASUREMENT

Shall not exceed 13 dB

4.6.2 TEST INSTRUMENTS

DESCRIPTION & MANUFACTURER	MODEL NO.	SERIAL NO.	CALIBRATED DATE	CALIBRATED UNTIL
R&S Spectrum Analyzer	FSP40	100037	Nov. 01, 2012	Oct. 31, 2013

Note:

1. The calibration interval of the above test instruments is 12 months and the calibrations are traceable to NML/ROC and NIST/USA.
2. Tested date : Mar. 13, 2013

4.6.3 TEST PROCEDURE

1. Set RBW = 1 MHz, VBW \geq 3 MHz, Detector = peak.
2. Trace mode = max-hold. Allow the sweeps to continue until the trace stabilizes.
3. Use the peak search function to find the peak of the spectrum.
4. Measure the PPSD.
5. Compute the ratio of the maximum of the peak-max-hold spectrum to the PPSD.

4.6.4 DEVIATION FROM TEST STANDARD

No deviation

4.6.5 TEST SETUP

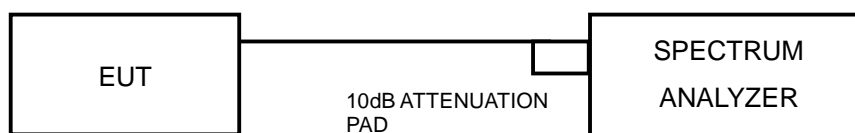

4.6.6 EUT OPERATING CONDITIONS

The software provided by client to enable the EUT under transmission condition continuously at specific channel frequencies individually.



A D T

4.6.7 TEST RESULTS

802.11a

CHAN.	CHAN. FREQ. (MHz)	PEAK VALUE (dBm)		PPSD (dBm)		PEAK EXCURSION (dB)		LIMIT (dB)	PASS/ FAIL
		CHAIN 0	CHAIN 1	CHAIN 0	CHAIN 1	CHAIN 0	CHAIN 1		
36	5180	2.24	3.24	-6.40	-6.33	8.64	9.57	13	PASS
40	5200	3.53	3.21	-5.89	-6.32	9.42	9.53	13	PASS
48	5240	3.43	3.68	-5.29	-6.59	8.72	10.27	13	PASS
52	5260	4.49	3.65	-4.67	-6.16	9.16	9.81	13	PASS
60	5300	5.31	4.52	-3.32	-5.64	8.63	10.16	13	PASS
64	5320	4.99	4.09	-3.26	-5.98	8.25	10.07	13	PASS

802.11n (HT20)

CHAN.	CHAN. FREQ. (MHz)	PEAK VALUE (dBm)		PPSD (dBm)		PEAK EXCURSION (dB)		LIMIT (dB)	PASS/ FAIL
		CHAIN 0	CHAIN 1	CHAIN 0	CHAIN 1	CHAIN 0	CHAIN 1		
36	5180	5.66	3.87	-3.58	-4.84	9.24	8.71	13	PASS
40	5200	5.92	3.92	-3.22	-4.96	9.14	8.88	13	PASS
48	5240	6.06	4.11	-3.27	-5.31	9.33	9.42	13	PASS
52	5260	5.50	3.36	-4.01	-5.64	9.51	9.00	13	PASS
60	5300	5.21	3.02	-3.62	-6.04	8.83	9.06	13	PASS
64	5320	5.97	3.08	-3.51	-5.89	9.48	8.97	13	PASS

802.11n (HT40)

CHAN.	CHAN. FREQ. (MHz)	PEAK VALUE (dBm)		PPSD (dBm)		PEAK EXCURSION (dB)		LIMIT (dB)	PASS/ FAIL
		CHAIN 0	CHAIN 1	CHAIN 0	CHAIN 1	CHAIN 0	CHAIN 1		
38	5190	3.56	2.14	-5.71	-6.99	9.27	9.13	13	PASS
46	5230	6.75	4.59	-2.14	-4.84	8.89	9.43	13	PASS
54	5270	2.16	0.26	-6.90	-8.68	9.06	8.94	13	PASS
62	5310	3.65	0.84	-5.89	-8.33	9.54	9.17	13	PASS

4.7 FREQUENCY STABILITY

4.7.1 LIMITS OF FREQUENCY STABILITY MEASUREMENT

The frequency of the carrier signal shall be maintained within band of operation

4.7.2 TEST INSTRUMENTS

DESCRIPTION & MANUFACTURER	MODEL NO.	SERIAL NO.	CALIBRATED DATE	CALIBRATED UNTIL
R&S Spectrum Analyzer	FSP40	100037	Nov. 01, 2012	Oct. 31, 2013

Note:

1. The calibration interval of the above test instruments is 12 months and the calibrations are traceable to NML/ROC and NIST/USA.
2. Tested date : Mar. 13, 2013

4.7.3 TEST PROCEDURE

1. The EUT was placed inside the environmental test chamber and powered by nominal AC voltage.
2. Turn the EUT on and couple its output to a spectrum analyzer.
3. Turn the EUT off and set the chamber to the highest temperature specified.
4. Allow sufficient time (approximately 30 min) for the temperature of the chamber to stabilize, turn the EUT on and measure the operating frequency after 2, 5, and 10 minutes.
5. Repeat step 2 and 3 with the temperature chamber set to the lowest temperature.
6. The test chamber was allowed to stabilize at +20 degree C for a minimum of 30 minutes. The supply voltage was then adjusted on the EUT from 85% to 115% and the frequency record.

4.7.4 DEVIATION FROM TEST STANDARD

No deviation

4.7.5 TEST SETUP

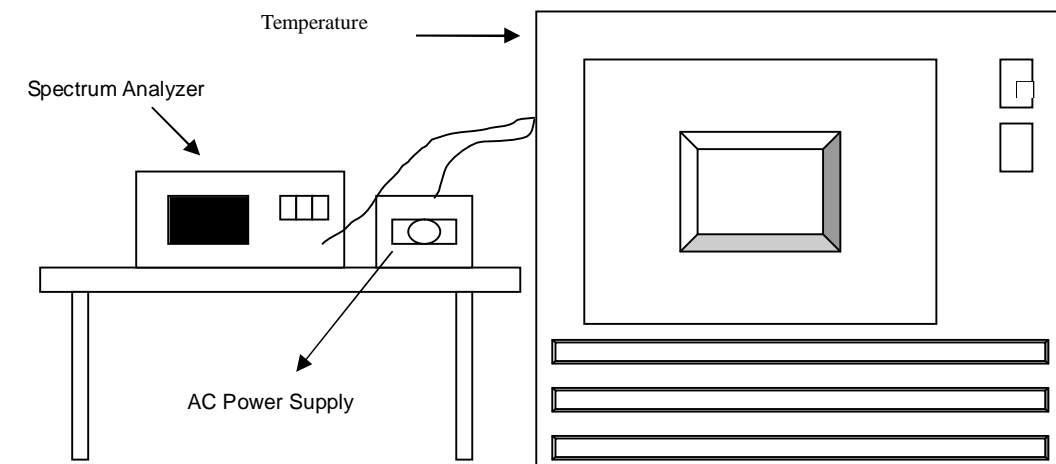

4.7.6 EUT OPERATING CONDITION

Set the EUT transmit at un-modulation mode to test frequency stability.



A D T

4.7.7 TEST RESULTS

FREQUENCY STABILITY VERSUS TEMP.									
OPERATING FREQUENCY: 5320MHz									
TEMP. (°C)	POWER SUPPLY (Vac)	0 MINUTE		2 MINUTE		5 MINUTE		10 MINUTE	
		Measured Frequency	Frequency Drift	Measured Frequency	Frequency Drift	Measured Frequency	Frequency Drift	Measured Frequency	Frequency Drift
		(MHz)	ppm	(MHz)	ppm	(MHz)	ppm	(MHz)	ppm
50	120	5320.0052	0.9774	5320.0047	0.8835	5320.0053	0.9962	5320.0032	0.6015
40	120	5319.9951	-0.9211	5319.9956	-0.8271	5319.9991	-0.1692	5320.0046	0.8647
30	120	5320.0094	1.7669	5320.0022	0.4135	5320.0112	2.1053	5320.0068	1.2782
20	120	5320.0158	2.9699	5320.0159	2.9887	5320.022	4.1353	5320.0248	4.6617
10	120	5319.9939	-1.1466	5319.9966	-0.6391	5319.9951	-0.9211	5319.993	-1.3158
0	120	5320.0185	3.4774	5320.0174	3.2707	5320.0195	3.6654	5320.0151	2.8383
-10	120	5319.9783	-4.0789	5319.9787	-4.0038	5319.9768	-4.3609	5319.9759	-4.5301
-20	120	5320.0087	1.6353	5320.0048	0.9023	5320.0035	0.6579	5320.0061	1.1466
-30	120	5319.9795	-3.8534	5319.9871	-2.4248	5319.9889	-2.0865	5319.9876	-2.3308

FREQUENCY STABILITY VERSUS VOLTAGE									
OPERATING FREQUENCY: 5320MHz									
TEMP. (°C)	POWER SUPPLY (Vac)	0 MINUTE		2 MINUTE		5 MINUTE		10 MINUTE	
		Measured Frequency	Frequency Drift	Measured Frequency	Frequency Drift	Measured Frequency	Frequency Drift	Measured Frequency	Frequency Drift
		(MHz)	ppm	(MHz)	ppm	(MHz)	ppm	(MHz)	ppm
20	138	5320.0158	2.9699	5320.0155	2.9135	5320.0233	4.3797	5320.0241	4.5301
	120	5320.0158	2.9699	5320.0159	2.9887	5320.022	4.1353	5320.0248	4.6617
	102	5320.0154	2.8947	5320.0138	2.5940	5320.0225	4.2293	5320.0234	4.3985



A D T

5. PHOTOGRAPHS OF THE TEST CONFIGURATION

Please refer to the attached file (Test Setup Photo).





6. INFORMATION ON THE TESTING LABORATORIES

We, Bureau Veritas Consumer Products Services (H.K.) Ltd., Taoyuan Branch, were founded in 1988 to provide our best service in EMC, Radio, Telecom and Safety consultation. Our laboratories are accredited and approved according to ISO/IEC 17025.

If you have any comments, please feel free to contact us at the following:

Linko EMC/RF Lab:

Tel: 886-2-26052180

Fax: 886-2-26052943

Hsin Chu EMC/RF Lab:

Tel: 886-3-5935343

Fax: 886-3-5935342

Hwa Ya EMC/RF/Safety/Telecom Lab:

Tel: 886-3-3183232

Fax: 886-3-3270892

Email: service.adt@tw.bureauveritas.com

Web Site: www.bureauveritas-adt.com

The address and road map of all our labs can be found in our web site also.



A D T

7.APPENDIX A - MODIFICATIONS RECORDERS FOR ENGINEERING CHANGES TO THE EUT BY THE LAB

No modifications were made to the EUT by the lab during the test.

--- END ---