



FCC PART 15C TEST REPORT FOR CERTIFICATION
On Behalf of

TP-LINK TECHNOLOGIES CO., LTD.

300Mbps Wireless N Range Extender

Model No.: TL-WA830RE

FCC ID: TE7WA830RE

Prepared for : TP-LINK TECHNOLOGIES CO., LTD.

Building 24(floors 1,3,4,5) and 28 (floors1-4) Central Science
and Technology Park, Shennan Rd, Nanshan, Shenzhen,
China

Prepared By : Audix Technology (Shenzhen) Co., Ltd.

No. 6, Ke Feng Rd., 52 Block,
Shenzhen Science & Industrial Park,
Nantou, Shenzhen, Guangdong, China

Tel: (0755) 26639496

Report Number : ACS-F11264

Date of Test : Nov.17~18, 2011

Date of Report : Nov.23, 2011

TABLE OF CONTENTS

<u>Description</u>	<u>Page</u>
1. SUMMARY OF STANDARDS AND RESULTS	1-1
1.1. Description of Standards and Results.....	1-1
2. GENERAL INFORMATION.....	2-1
2.1. Description of Device (EUT)	2-1
2.2. Test Information.....	2-2
2.3. Tested Supporting System Details	2-3
2.4. Block Diagram of Test Setup	2-3
2.5. Test Facility.....	2-4
2.6. Measurement Uncertainty (95% confidence levels, k=2)	2-4
3. POWER LINE CONDUCTED EMISSION TEST	3-1
3.1. Test Equipments.....	3-1
3.2. Block Diagram of Test Setup	3-1
3.3. Power Line Conducted Emission Test Limits	3-1
3.4. Configuration of EUT on Test	3-2
3.5. Operating Condition of EUT.....	3-2
3.6. Test Procedure.....	3-2
3.7. Power Line Conducted Emission Test Results.....	3-2
4. RADIATED EMISSION TEST.....	4-1
4.1. Test Equipment	4-1
4.2. Block Diagram of Test Setup	4-1
4.3. Radiated Emission Limit.....	4-2
4.4. EUT Configuration on Test.....	4-3
4.5. Operating Condition of EUT.....	4-3
4.6. Test Procedure.....	4-3
4.7. Radiated Emission Test Results	4-4
5. CONDUCTED SPURIOUS EMISSIONS	5-1
5.1. Test Equipment	5-1
5.2. Limit.....	5-1
5.3. Test Procedure.....	5-1
5.4. Test result	5-1
6. BAND EDGE COMPLIANCE TEST.....	6-1
6.1. Test Equipment	6-1
6.2. Limit.....	6-1
6.3. Test Produce	6-1
6.4. Test Results	6-1
7. 6dB Bandwidth Test	7-1
7.1. Test Equipment	7-1
7.2. Limit.....	7-1
7.3. Test Procedure.....	7-1
7.4. Test Results	7-1
8. OUTPUT POWER TEST	8-1
8.1. Test Equipment	8-1
8.2. Limit (FCC Part 15C 15.247 b(3))	8-1
8.3. Test Procedure.....	8-1
8.4. Test Results	8-2
9. POWER SPECTRAL DENSITY TEST.....	9-3
9.1. Test Equipment	9-3



FCC ID:TE7WA830RE

9.2.	Limit.....	9-3
9.3.	Test Procedure.....	9-3
9.4.	Test Results	9-4
10.	ANTENNA REQUIREMENT.....	10-1
10.1.	STANDARD APPLICABLE.....	10-1
10.2.	ANTENNA CONNECTED CONSTRUCTION	10-1
11.	MPE ESTIMATION	11-1
11.1.	Limit for General Population/ Uncontrolled Exposures.....	11-1
11.2.	Estimation Result	11-1
12.	DEVIATION TO TEST SPECIFICATIONS	12-1
13.	PHOTOGRAPH OF TEST.....	13-1
13.1.	Photos of Power Line Conducted Emission Test	13-1
13.2.	Photos of Radiated Emission Test.....	13-2
14.	PHOTOS OF THE EUT	14-1

TEST REPORT CERTIFICATION

Applicant : TP-LINK TECHNOLOGIES CO., LTD.
Manufacturer : TP-LINK TECHNOLOGIES CO., LTD.
EUT Description : 300Mbps Wireless N Range Extender
FCC ID : TE7WA830RE
(A) MODEL NO. : TL-WA830RE
(B) SERIAL NO. : N/A
(C) POWER SUPPLY : DC 12V
(D) TEST VOLTAGE : DC 12V From Adapter Input AC 120V/60Hz

Tested for comply with:
FCC Rules and Regulations Part 15 Subpart C: 2008

Test procedure used:
ANSI C63.10:2009

The device described above is tested by AUDIX TECHNOLOGY (SHENZHEN) CO., LTD. to confirm comply with all the FCC Part 15 Subpart C requirements.

The test results are contained in this test report and AUDIX TECHNOLOGY (SHENZHEN) CO., LTD. is assumed full responsibility for the accuracy and completeness of these tests. Also, this report shows that the Equipment Under Test (EUT) is to be technically compliant with the FCC and IC requirements. This report contains data that are not covered by the NVLAP accreditation.

This Report is made under FCC Part 2.1075. No modifications were required during testing to bring this product into compliance.

This report applies to above tested sample only. This report shall not be reproduced in part without written approval of AUDIX TECHNOLOGY (SHENZHEN) CO., LTD.

The report must not be used by the client to claim product certification, approval, or endorsement by NVLAP, NIST, or any agency of the federal government.

Date of Test : Nov.17- 21, 2011 Report of date: Nov.22, 2011

Prepared by : Sala Yang Reviewer by : Sunny Lu
Sala Yang/ Supervisor Sunny Lu / Supervisor



Approved & Authorized Signer : Ken Lu
Ken Lu / Manager

1. SUMMARY OF STANDARDS AND RESULTS

1.1. Description of Standards and Results

The EUT have been tested according to the applicable standards as referenced below.

EMISSION		
Description of Test Item	Standard	Results
Power Line Conducted Emission	FCC Part 15: 15.207 ANSI C63.10: 2009	PASS
Radiated Emission	FCC Part 15: 15.209 ANSI C63.10: 2009	PASS
Band Edge Compliance	FCC Part 15: 15.247 ANSI C63.10: 2009	PASS
Conducted spurious emissions	FCC Part 15: 15.247 ANSI C63.10: 2009	PASS
6dB Bandwidth	FCC Part 15: 15.247 ANSI C63.10: 2009	PASS
Peak Output Power	FCC Part 15: 15.247 ANSI C63.10: 2009	PASS
Power Spectral Density	FCC Part 15: 15.247 ANSI C63.10: 2009	PASS
Antenna requirement	FCC Part 15: 15.203	PASS

2. GENERAL INFORMATION

2.1. Description of Device (EUT)

Product Name	:	300Mbps Wireless N Range Extender
Model Number	:	TL-WA830RE
Test Model	:	TL-WA830RE
FCC ID	:	TE7WA830RE
Operation Frequency	:	IEEE 802.11b: 2412MHz—2462MHz IEEE 802.11g: 2412MHz—2462MHz IEEE802.11n HT20: 2412MHz—2462MHz IEEE802.11n HT40: 2422MHz—2452MHz
Channel Number	:	IEEE 802.11b/g, IEEE 802.11n HT20: 11 Channels IEEE 802.11n HT40: 7 Channels
Modulation Technology	:	IEEE 802.11b: DSSS(CCK,DQPSK,DBPSK) IEEE 802.11g: OFDM(64QAM, 16QAM, QPSK, BPSK) IEEE 802.11n HT20, HT40: OFDM (64QAM, 16QAM, QPSK,BPSK)
Antenna Assembly Gain	:	MIMO 2X2 Dipole antenna, 4dBi PK gain
Applicant	:	TP-LINK TECHNOLOGIES CO., LTD. Building 24(floors 1,3,4,5) and 28 (floors1-4) Central Science and Technology Park, Shennan Rd, Nanshan, Shenzhen, China
Manufacturer	:	TP-LINK TECHNOLOGIES CO., LTD. Building 24(floors 1,3,4,5) and 28 (floors1-4) Central Science and Technology Park, Shennan Rd, Nanshan, Shenzhen, China
Power Adapter	:	Manufacturer: LEADER ELECTRONICS INC., M/N: MU12-S120100-A1 Cable: Unshielded, Undetachable, 1.5m
Remark	:	Add POE mode have the worst case emission, so reported this mode in the report
Date of Test	:	Nov.17~18, 2011
Date of Receipt	:	Nov.06, 2011
Sample Type	:	Prototype production

2.2. Test Information

A special test software was used to control EUT work in Continuous TX mode(100% duty cycle), and select test channel, wireless mode and data rate.

Tested mode, channel, and data rate information			
Mode	data rate (Mbps)(see Note)	Channel	Frequency (MHz)
IEEE 802.11b	11	Low :CH1	2412
	11	Middle: CH6	2437
	11	High: CH11	2462
IEEE 802.11g	54	Low :CH1	2412
	54	Middle: CH6	2437
	54	High: CH11	2462
IEEE 802.11n HT20	6.5	Low :CH1	2412
	6.5	Middle: CH6	2437
	6.5	High: CH11	2462
IEEE 802.11n HT40	13.5	Low :CH1	2422
	13.5	Middle: CH4	2437
	13.5	High: CH7	2452
Note1: According exploratory test, EUT will have maximum PK output power in those data rate, so those data rate were used for all test.			

2.3. Tested Supporting System Details

No.	Description	ACS No.	Manufacturer	Model	Serial Number	Approved type
1	Personal Computer	Test PC M	DELL	Studio 540	224XK2X	<input checked="" type="checkbox"/> FCC DoC <input checked="" type="checkbox"/> BSMI ID:R33002
		Power Cord: Unshielded, Detachable, 1.8m Display Card: HD3450 (DVI+VGA+HDMI)				
2	Monitor	ACS-EMC-LM04R	DELL	1907FPt	CN-009759-7161 8-6AP-ACPP	<input checked="" type="checkbox"/> FCC DoC <input checked="" type="checkbox"/> BSMI ID: R3A002
		Power Cord: Unshielded, Detachable, 1.8m VGA Cable: Shielded, Detachable, 2.0m (with two cores) DVI Cable: Shielded, Detachable, 2.0m (with two cores)				
3	USB Keyboard	ACS-EMC- K04R	DELL	SK-8115	CN-ODJ313-716 16-6BB-049J	<input checked="" type="checkbox"/> FCC DoC <input checked="" type="checkbox"/> BSMI ID: T3A002
		Power Cord: shielded, Undetachable, 2.0m				
4	USB Mouse	ACS-EMC-M04R	DELL	M056UO	512024282	<input checked="" type="checkbox"/> FCC DoC <input checked="" type="checkbox"/> BSMI ID: R41108
		Power Cord: shielded, Undetachable, 1.8m				

2.4. Block Diagram of Test Setup

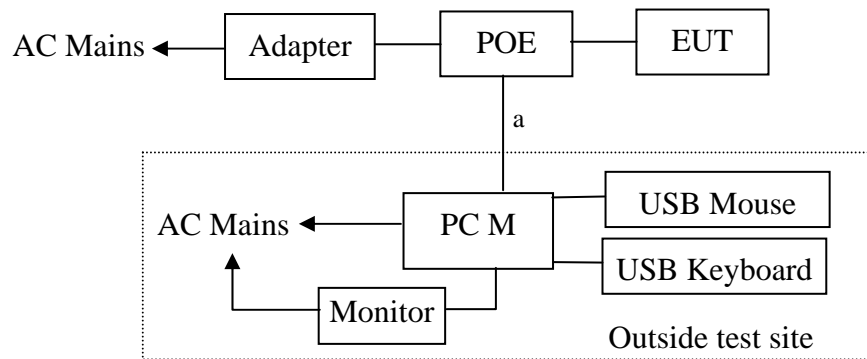

(EUT: 300Mbps Wireless N Range Extender)

a: LAN port

2.5. Test Facility

Site Description

Name of Firm : Audix Technology (Shenzhen) Co., Ltd.
No. 6, Ke Feng Rd., 52 Block, Shenzhen
Science & Industrial Park, Nantou, Shenzhen,
Guangdong, China

3m Anechoic Chamber : Certificated by FCC, USA
Registration Number: 90454
Valid Date: Mar.31, 2012

3m & 10m Anechoic Chamber : Certificated by FCC, USA
Registration Number: 794232
Valid Date: Dec.30, 2012

EMC Lab. : Certificated by Industry Canada
Registration Number: IC 5183A-1
Valid Date: Jun.13, 2014

: Certificated by DAkkS, Germany
Registration No: D-PL-12151-01-01
Valid Date: Feb.01, 2014

Accredited by NVLAP, USA
NVLAP Code: 200372-0
Valid Date: Mar.31, 2012

2.6.Measurement Uncertainty (95% confidence levels, k=2)

Test Item	Uncertainty
Uncertainty for Conduction emission test in No. 1 Conduction	3.2 dB (150KHz to 30MHz)
Uncertainty for Radiation Emission test in 3m chamber	3.6 dB(30~200MHz, Polarize: H)
	3.7 dB(30~200MHz, Polarize: V)
	4.0 dB(200M~1GHz, Polarize: H)
	3.7 dB(200M~1GHz, Polarize: V)
Uncertainty for Radiation Emission test in 3m chamber (1GHz-18GHz)	3.1dB (Distance: 3m Polarize: V)
	3.7 dB (Distance: 3m Polarize: H)
Uncertainty for Radiated Spurious Emission test in RF chamber	3.57 dB
Uncertainty for Conduction Spurious emission test	2.00 dB
Uncertainty for Output power test	0.73 dB
Uncertainty for Power density test	2.00 dB
Uncertainty for Frequency range test	7×10^{-8}
Uncertainty for Bandwidth test	83 kHz
Uncertainty for DC power test	0.038 %
Uncertainty for test site temperature and humidity	0.6°C
	3%

3. POWER LINE CONDUCTED EMISSION TEST

3.1. Test Equipments

Item	Equipment	Manufacturer	Model No.	Serial No.	Last Cal.	Cal. Interval
1.	Test Receiver	Rohde & Schwarz	ESHS10	838693/001	Oct.31, 11	1 Year
2.	L.I.S.N.#1	Rohde & Schwarz	ESH2-Z5	834066/011	Oct.31, 11	1 Year
3.	L.I.S.N.#3	Kyoritsu	KNW-242C	8-1920-1	May.08, 11	1 Year
4.	Terminator	Hubersuhner	50Ω	No. 1	May.08, 11	1 Year
5.	RF Cable	Fujikura	3D-2W	No.1	May.08, 11	1 Year
6.	Coaxial Switch	Anritsu	MP59B	M50564	May.08, 11	1 Year
7.	Passive Probe	Rohde & Schwarz	ESH2-Z3	299.7810.52	May.08, 11	1 Year
8.	Pulse Limiter	Rohde & Schwarz	ESH3-Z2	100341	May.08, 11	1 Year

3.2. Block Diagram of Test Setup

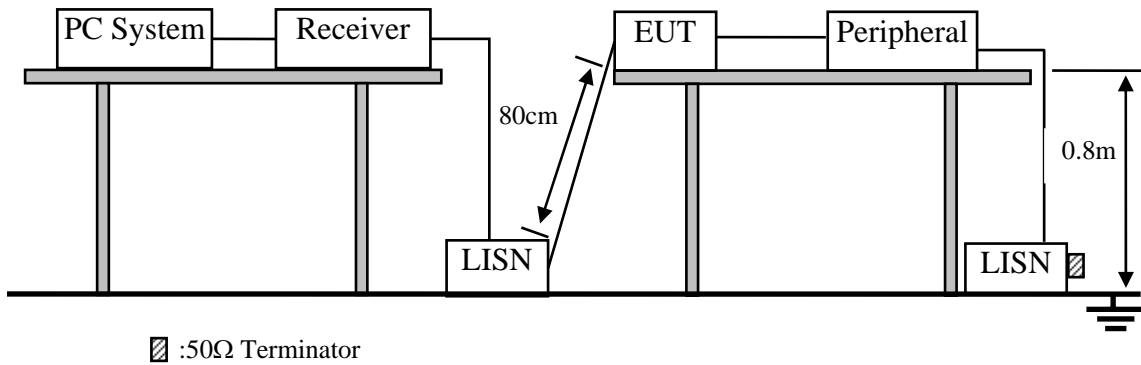

3.3. Power Line Conducted Emission Test Limits

Frequency	Maximum RF Line Voltage	
	Quasi-Peak Level dB(μV)	Average Level dB(μV)
150kHz ~ 500kHz	66 ~ 56*	56 ~ 46*
500kHz ~ 5MHz	56	46
5MHz ~ 30MHz	60	50

Notes: 1. * Decreasing linearly with logarithm of frequency.
 2. The lower limit shall apply at the transition frequencies.

3.4. Configuration of EUT on Test

The following equipment are installed on Power Line Conducted Emission Test to meet the commission requirement and operating regulations in a manner which tends to maximize its emission characteristics in a normal application.

3.4.1. 300Mbps Wireless N Range Extender (EUT)

Model Number: TL-WA830RE

Serial Number : N/A

3.4.2. Support Equipment : As Tested Supporting System Details, in Section 2.3.

3.5. Operating Condition of EUT

3.5.1. Setup the EUT and simulator as shown as Section 2.4.

3.5.2. Turned on the power of all equipment.

3.5.3. PC run test software to control EUT work in Tx mode.

3.6. Test Procedure

The EUT was placed on a non-metallic table, 80cm above the ground plane. The EUT Power connected to the power mains through a line impedance stabilization network (L.I.S.N. 1#). This provides a 50 ohm coupling impedance for the EUT (Please refer the block diagram of the test setup and photographs). The AC line are checked to find out the maximum conducted emission. In order to find the maximum emission levels, the relative positions of equipment and all of the interface cables shall be changed according to ANSI C63.10: 2009 on Conducted Emission Test.

The bandwidth of test receiver (R & S ESHS10) is set at 10kHz.

The frequency range from 150kHz to 30MHz is checked.

3.7. Power Line Conducted Emission Test Results

PASS. (All emissions not reported below are too low against the prescribed limits.)

Data: 2 File: D:\DATA\2011 Report data\T\TP-LINK\ACS11Q2305R1.EM6 (2) Date: 2011-11-18

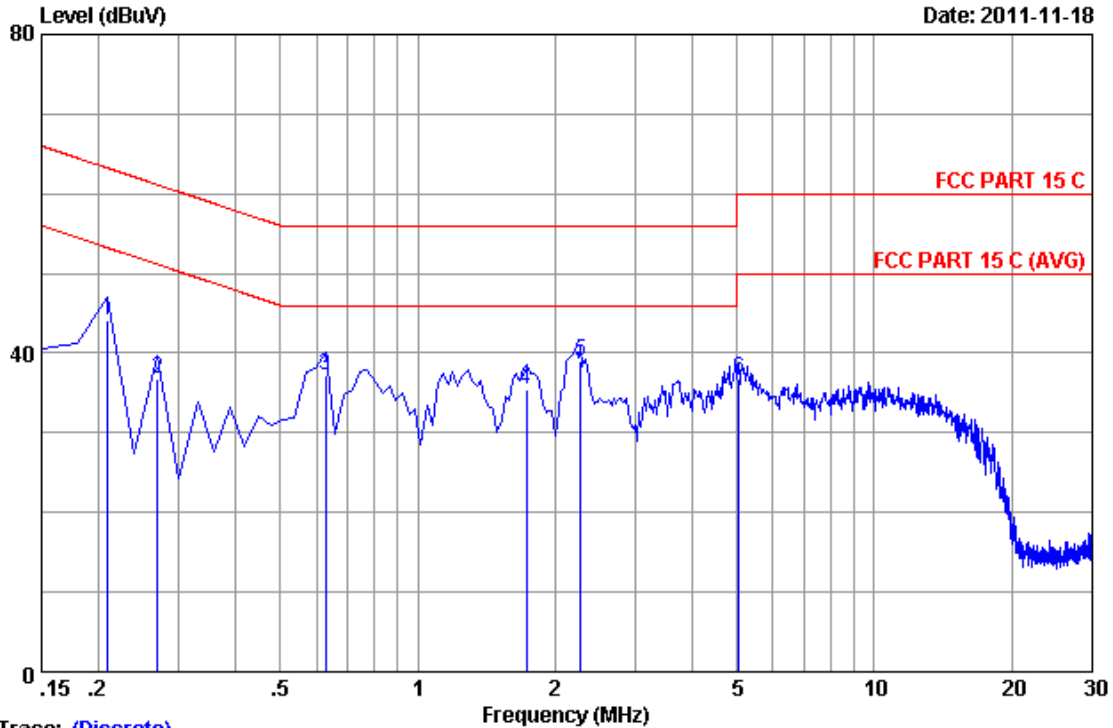

Trace: (Discrete)
 Site no :1#conduction Data No :2
 Dis./Ant. :** 2011 ESH2-25 LINE
 Limit :FCC PART 15 C
 Env./Ins. :29.5*C/55% Engineer :Leo_Li
 EUT :300Mbps Wireless N Range Extender
 Power Rating :DC 12V Adapter Input AC 120V/60Hz
 Test Mode :Tx Mode
 :M/N:TL-WA830RE

No	Freq (MHz)	LISN Factor (dB)	Cable Loss (dB)	Reading (dBuV)	Emission Level (dBuV)	Limits (dBuV)	Margin (dB)	Remark
1	0.20970	0.17	9.86	33.99	44.02	63.22	19.20	QP
2	0.26940	0.18	9.86	26.71	36.75	61.14	24.39	QP
3	0.62760	0.19	9.87	27.07	37.13	56.00	18.87	QP
4	1.732	0.29	9.91	25.25	35.45	56.00	20.55	QP
5	2.269	0.32	9.93	28.72	38.97	56.00	17.03	QP
6	5.045	0.37	10.02	26.44	36.83	60.00	23.17	QP

Remarks: 1.Emission Level=LISN Factor+Cable Loss(Include 10dB pulse limit)+Reading.
 2.If the average limit is met when using a quasi-peak detector, the EUT shall be deemed to meet both limits and measurement with average detector is unnecessary.

Data: 1 File: D:\DATA\2011 Report data\T\TP-LINK\ACS11Q2305R1.EM6 (2) Date: 2011-11-18

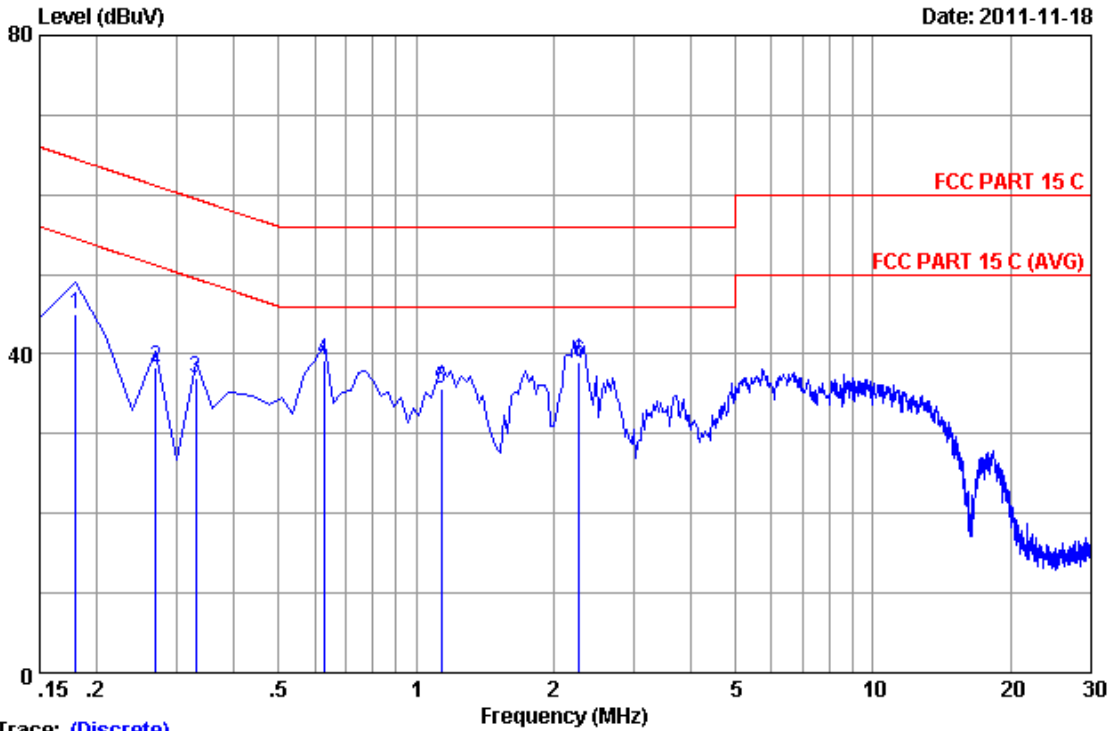

Trace: (Discrete)
 Site no :1#conduction Data No :1
 Dis./Ant. :** 2011 ESH2-Z5 NEUTRAL
 Limit :FCC PART 15 C
 Env./Ins. :29.5°C/55% Engineer :Leo_Li
 EUT :300Mbps Wireless N Range Extender
 Power Rating :DC 12V Adapter Input AC 120V/60Hz
 Test Mode :Tx Mode
 :M/N:TL-WA830RE

No	Freq (MHz)	LISN Factor (dB)	Cable Loss (dB)	Reading (dBuV)	Emission Level (dBuV)	Limits (dBuV)	Margin (dB)	Remark
1	0.17985	0.21	9.86	34.98	45.05	64.49	19.44	QP
2	0.26940	0.21	9.86	28.29	38.36	61.14	22.78	QP
3	0.32910	0.22	9.86	26.85	36.93	59.47	22.54	QP
4	0.62760	0.23	9.87	29.10	39.20	56.00	16.80	QP
5	1.135	0.24	9.89	25.44	35.57	56.00	20.43	QP
6	2.269	0.28	9.93	28.77	38.98	56.00	17.02	QP

Remarks: 1.Emission Level=LISN Factor+Cable Loss(Include 10dB pulse limit)+Reading.
 2.If the average limit is met when using a quasi-peak detector. the EUT shall be deemed to meet both limits and measurement with average detector is unnecessary.

4. RADIATED EMISSION TEST

4.1. Test Equipment

4.1.1. For frequency range 30MHz~1000MHz (At Anechoic Chamber)

Item	Equipment	Manufacturer	Model No.	Serial No.	Last Cal.	Cal. Interval
1	3#Chamber	AUDIX	N/A	N/A	Dec.05,10	1 Year
2	EMI Spectrum	Agilent	E4407B	MY41440292	May.08, 11	1 Year
3	Test Receiver	Rohde & Schwarz	ESVS10	834468/011	May.08, 11	1 Year
4	Amplifier	HP	8447D	2648A04738	May.08, 11	1 Year
5	Bilog Antenna	Schaffner	CBL6111C	2597	May.25, 11	1 Year
6	RF Cable	MIYAZAKI	JB Y400	3# Chamber No.1	May.08, 11	1 Year
7	Coaxial Switch	Anritsu	MP59B	M74389	May.08, 11	1 Year

4.1.2. For frequency range 1GHz~18GHz (At Anechoic Chamber)

Item	Equipment	Manufacturer	Model No.	Serial No.	Last Cal.	Cal. Interval
1	Spectrum Analyzer	Agilent	E4407B	MY41440292	May.08, 11	1 Year
2	Horn Antenna	EMCO	3115	9607-4877	July.01, 11	1 Year
3	Amplifier	Agilent	8449B	3008A00863	May.08, 11	1 Year
4	RF Cable	Hubersuhner	SUCOFLEX102	28620/2	May.08, 11	1 Year
5	RF Cable	Hubersuhner	SUCOFLEX102	29091/2	May.08, 11	1 Year

4.2. Block Diagram of Test Setup

For frequency range 30MHz-1000MHz

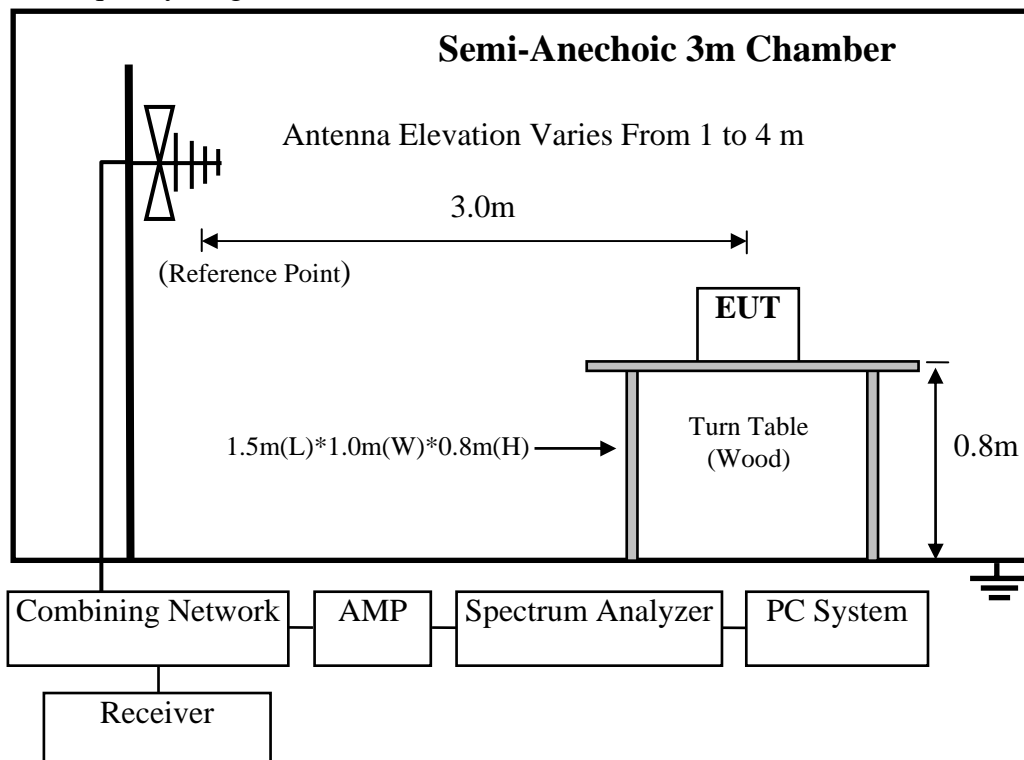

For frequency range 1GHz-18GHz

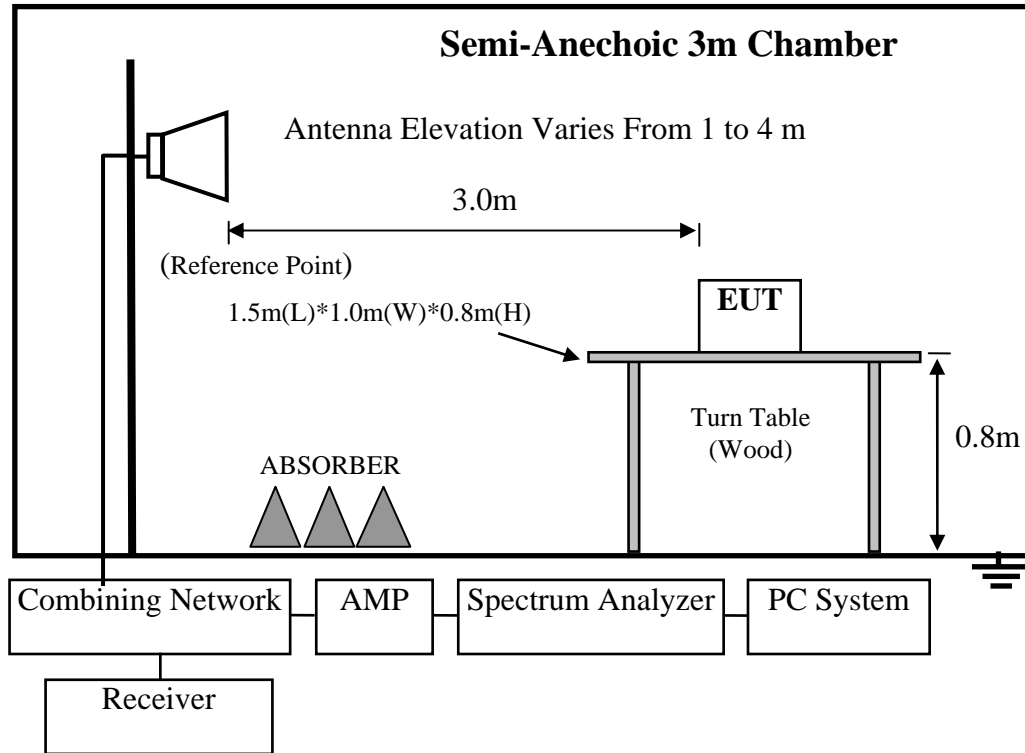

4.3. Radiated Emission Limit

4.3.1. 15.209 limits

FREQUENCY MHz	DISTANCE Meters	FIELD STRENGTHS LIMIT	
		$\mu\text{V}/\text{m}$	$\text{dB}(\mu\text{V})/\text{m}$
30 ~ 88	3	100	40.0
88 ~ 216	3	150	43.5
216 ~ 960	3	200	46.0
960 ~ 1000	3	500	54.0
Above 1000	3	74.0 $\text{dB}(\mu\text{V})/\text{m}$ (Peak) 54.0 $\text{dB}(\mu\text{V})/\text{m}$ (Average)	

Remark : (1) Emission level $\text{dB}\mu\text{V} = 20 \log$ Emission level $\mu\text{V}/\text{m}$

(2) The smaller limit shall apply at the cross point between two frequency bands.

(3) Distance is the distance in meters between the measuring instrument, antenna and the closest point of any part of the device or system.

4.3.2. 15.205 Restricted bands of operation

MHz	MHz	MHz	GHz
0.090 - 0.110	16.42 - 16.423	399.9 - 410	4.5 - 5.15
¹ 0.495 - 0.505	16.69475 - 16.69525	608 - 614	5.35 - 5.46
2.1735 - 2.1905	16.80425 - 16.80475	960 - 1240	7.25 - 7.75
4.125 - 4.128	25.5 - 25.67	1300 - 1427	8.025 - 8.5
4.17725 - 4.17775	37.5 - 38.25	1435 - 1626.5	9.0 - 9.2
4.20725 - 4.20775	73 - 74.6	1645.5 - 1646.5	9.3 - 9.5
6.215 - 6.218	74.8 - 75.2	1660 - 1710	10.6 - 12.7
6.26775 - 6.26825	108 - 121.94	1718.8 - 1722.2	13.25 - 13.4
6.31175 - 6.31225	123 - 138	2200 - 2300	14.47 - 14.5
8.291 - 8.294	149.9 - 150.05	2310 - 2390	15.35 - 16.2
8.362 - 8.366	156.52475 - 156.52525	2483.5 - 2500	17.7 - 21.4
8.37625 - 8.38675	156.7 - 156.9	2690 - 2900	22.01 - 23.12
8.41425 - 8.41475	162.0125 - 167.17	3260 - 3267	23.6 - 24.0
12.29 - 12.293	167.72 - 173.2	3332 - 3339	31.2 - 31.8
12.51975 - 12.52025	240 - 285	3345.8 - 3358	36.43 - 36.5
12.57675 - 12.57725	322 - 335.4	3600 - 4400	(²)

All the emissions appearing within 15.205 restricted frequency bands shall not exceed the limits shown in 15.209, all the other emissions shall be at least 20dB below the fundamental emissions, or comply with 15.209 limits.

4.4.EUT Configuration on Test

The configurations of EUT are listed in Section 3.5.

4.5.Operating Condition of EUT

Same as Conducted Emission test that is listed in Section 3.6. except the test set up replaced by Section 4.2.

4.6.Test Procedure

EUT and its simulators are placed on a turn table, which is 0.8 meter high above ground. The turn table can rotate 360 degrees to determine the position of the maximum emission level. Power on the EUT and let it working in test mode, then test it. EUT is set 3 meters away from the receiving antenna, which is mounted on a antenna tower. The antenna can be moved up and down between 1 meter and 4 meters to find out the maximum emission level. Broadband antenna (calibrated bilog antenna) is used as receiving antenna. Both horizontal and vertical polarization of the antenna are set on test.

The bandwidth of the EMI test receiver (R&S ESVS10) is set at 120kHz for frequency range from 30MHz to 1000 MHz.

The bandwidth of the Spectrum's VBW is set at 3MHz and RBW is set at 1MHz for peak emissions measurement above 1GHz and 1MHz RBW, 10Hz VBW for average emissions measure above 1GHz

The frequency range from 30MHz to 10th harmonic (25GHz) are checked. and no any emissions were found from 18GHz to 25 GHz, So the radiated emissions from 18GHz to 25GHz were not record.



4.7. Radiated Emission Test Results

PASS.

All the emissions from 30MHz to 25 GHz were comply with 15.209 limits.

Note: For emissions above 1GHz, if peak level comply with average limit, then the average level is deemed to comply with average limit.

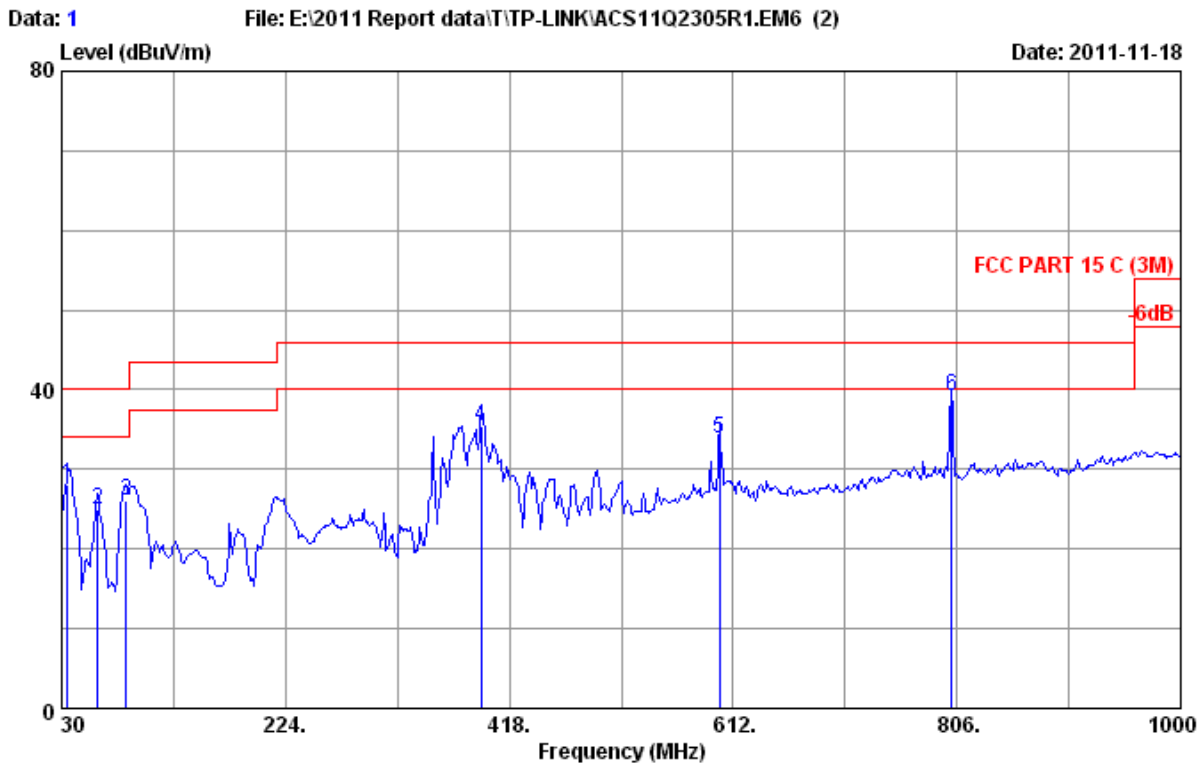

Site no. : 3m Chamber Data no. : 1
 Dis. / Ant. : 3m 2010 CBL6111C 2598 Ant. pol. : VERTICAL
 Limit : FCC PART 15 C (3M)
 Env. / Ins. : 24°C/56% Engineer : Leo_Li
 EUT : 300Mbps Wireless N Range Extender
 Power rating : DC 12V From Adapter Input AC 120V/60Hz
 Test Mode : Tx Mode
 M/N:TL-WA830RE

No.	Freq. (MHz)	Ant. Factor (dB/m)	Cable Loss (dB)	Emission Reading (dBuV)	Emission Level (dBuV/m)	Limits (dBuV/m)	Margin (dB)	Remark
1	34.850	17.20	0.65	10.29	28.14	40.00	11.86	QP
2	61.040	6.00	0.90	17.97	24.87	40.00	15.13	QP
3	86.260	8.54	1.07	16.44	26.05	40.00	13.95	QP
4	393.750	16.34	3.31	15.79	35.44	46.00	10.56	QP
5	600.360	19.90	4.50	9.49	33.89	46.00	12.11	QP
6	801.150	22.00	5.50	11.67	39.17	46.00	6.83	QP

Remarks: 1. Emission Level= Antenna Factor + Cable Loss + Reading.
 2. The emission levels that are 20dB below the official limit are not reported.

Frequency: 1GHz~18GHz

Data: 1 File: E:\2011 report data\TTP-LINK\ACS11Q2305R1.EM6 (108) Date: 2011-11-17

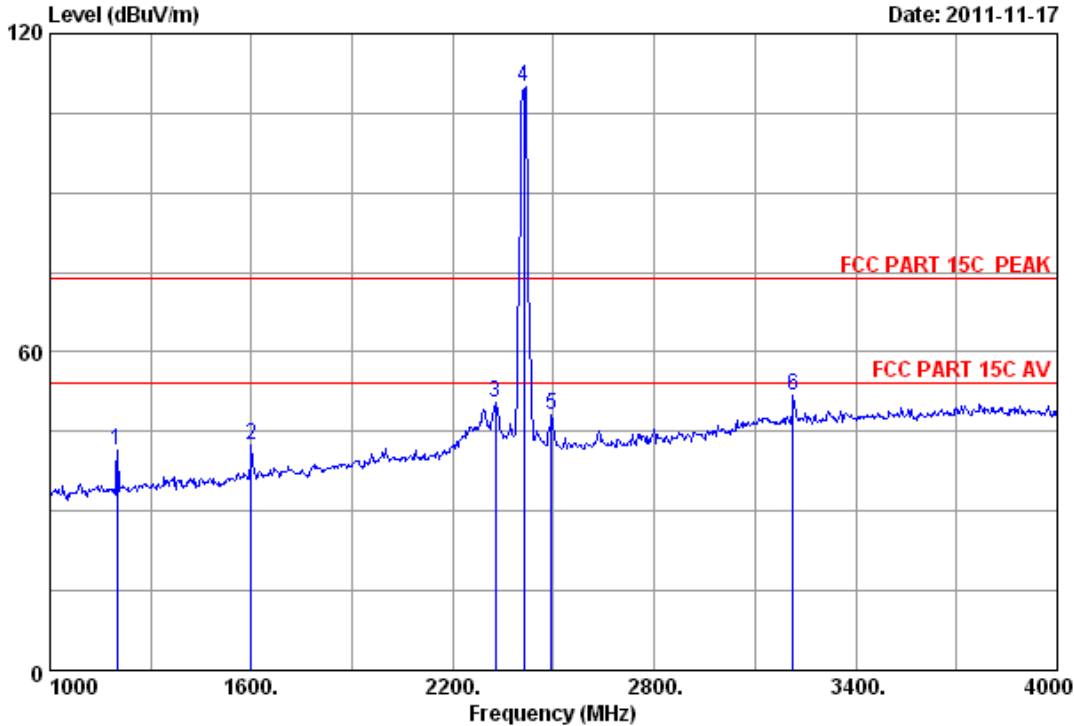

Site no. : 3m Chamber Data no. : 1
 Dis. / Ant. : 3m 3115(0911) Ant. pol. : VERTICAL
 Limit : FCC PART 15C PEAK
 Env. / Ins. : 23*C/54% Engineer : Leo-Li
 EUT : 300Mbps Wireless N Range Extender
 Power : DC 12V From Adapter input AC 120V/60Hz
 Test mode : IEEE802.11b CH1 2412MHz Tx
 M/N : TL-WA830RE

	Freq. (MHz)	Ant. Factor (dB/m)	Cable loss (dB)	Amp. Factor (dB)	Reading (dBuV)	Emission			Remark
						Level (dBuV/m)	Limits (dBuV/m)	Margin (dB)	
1	1201.000	25.81	5.98	36.97	46.68	41.50	74.00	32.50	Peak
2	1600.000	26.96	6.98	36.43	45.02	42.53	74.00	31.47	Peak
3	2326.000	29.40	8.57	36.06	48.47	50.38	74.00	23.62	Peak
4	2412.000	29.45	8.72	35.95	107.77	109.99	74.00	-35.99	Peak
5	2494.000	29.50	8.87	36.00	45.71	48.08	74.00	25.92	Peak
6	3214.000	32.54	10.21	35.86	44.83	51.72	74.00	22.28	Peak

Remarks:

1. Emission Level= Antenna Factor + Cable Loss -Amp Factor + Reading.
2. The emission levels that are 20dB below the official limit are not reported.

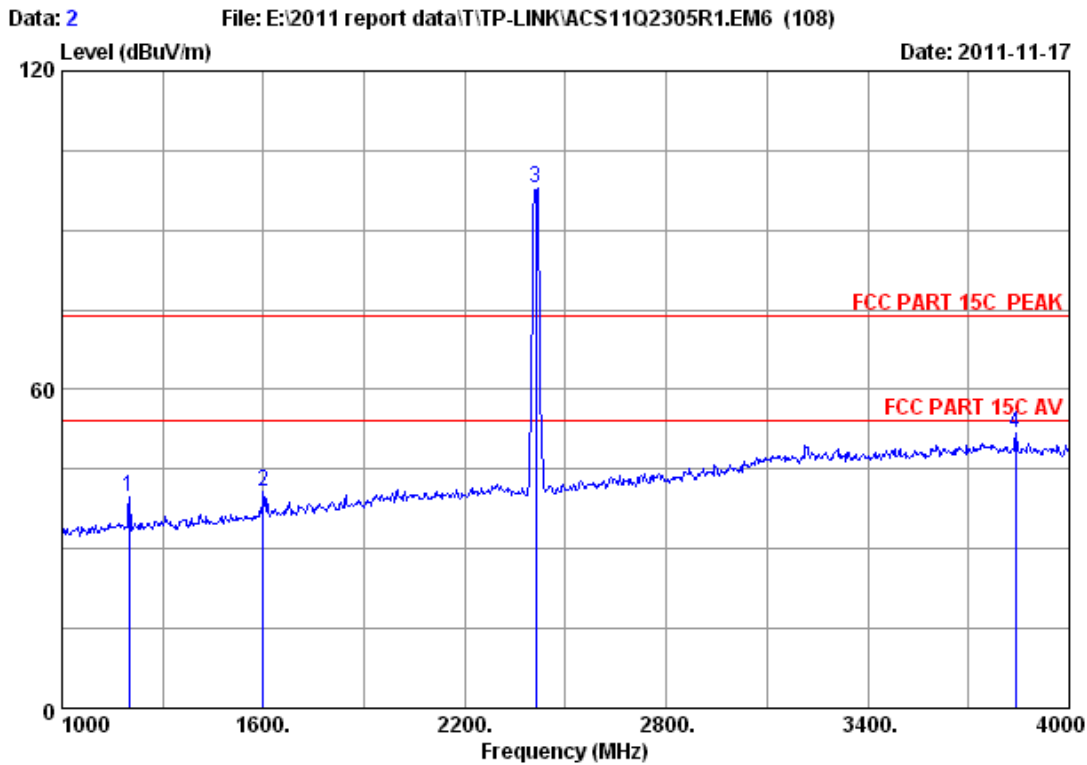

Site no. : 3m Chamber Data no. : 2
 Dis. / Ant. : 3m 3115(0911) Ant. pol. : HORIZONTAL
 Limit : FCC PART 15C PEAK
 Env. / Ins. : 23°C/54% Engineer : Leo-Li
 EUT : 300Mbps Wireless N Range Extender
 Power : DC 12V From Adapter input AC 120V/60Hz
 Test mode : IEEE802.11b CH1 2412MHz Tx
 M/N : TL-WA830RE

	Ant. Freq. (MHz)	Ant. Factor (dB/m)	Cable loss (dB)	Amp. Factor (dB)	Reading (dBuV)	Emission Level (dBuV/m)	Limits (dBuV/m)	Margin (dB)	Remark
1	1201.000	25.81	5.98	36.97	45.08	39.90	74.00	34.10	Peak
2	1600.000	26.96	6.98	36.43	43.43	40.94	74.00	33.06	Peak
3	2412.000	29.45	8.72	35.95	95.56	97.78	74.00	-23.78	Peak
4	3841.000	33.78	11.14	35.46	42.19	51.65	74.00	22.35	Peak

Remarks:

1. Emission Level= Antenna Factor + Cable Loss -Amp Factor + Reading.
2. The emission levels that are 20dB below the official limit are not reported.

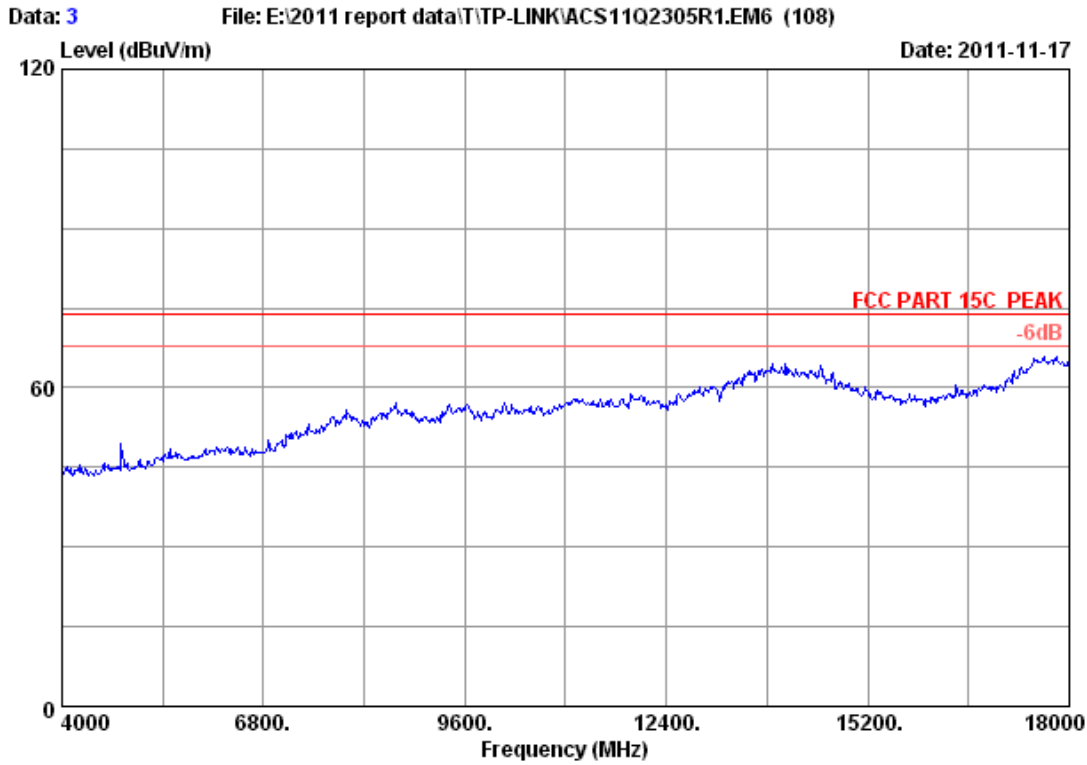

Site no. : 3m Chamber Data no. : 3
Dis. / Ant. : 3m 3115(0911) Ant. pol. : VERTICAL
Limit : FCC PART 15C PEAK
Env. / Ins. : 23°C/54% Engineer : Leo-Li
EUT : 300Mbps Wireless N Range Extender
Power : DC 12V From Adapter input AC 120V/60Hz
Test mode : IEEE802.11b CH1 2412MHz Tx
M/N : TL-WA830RE

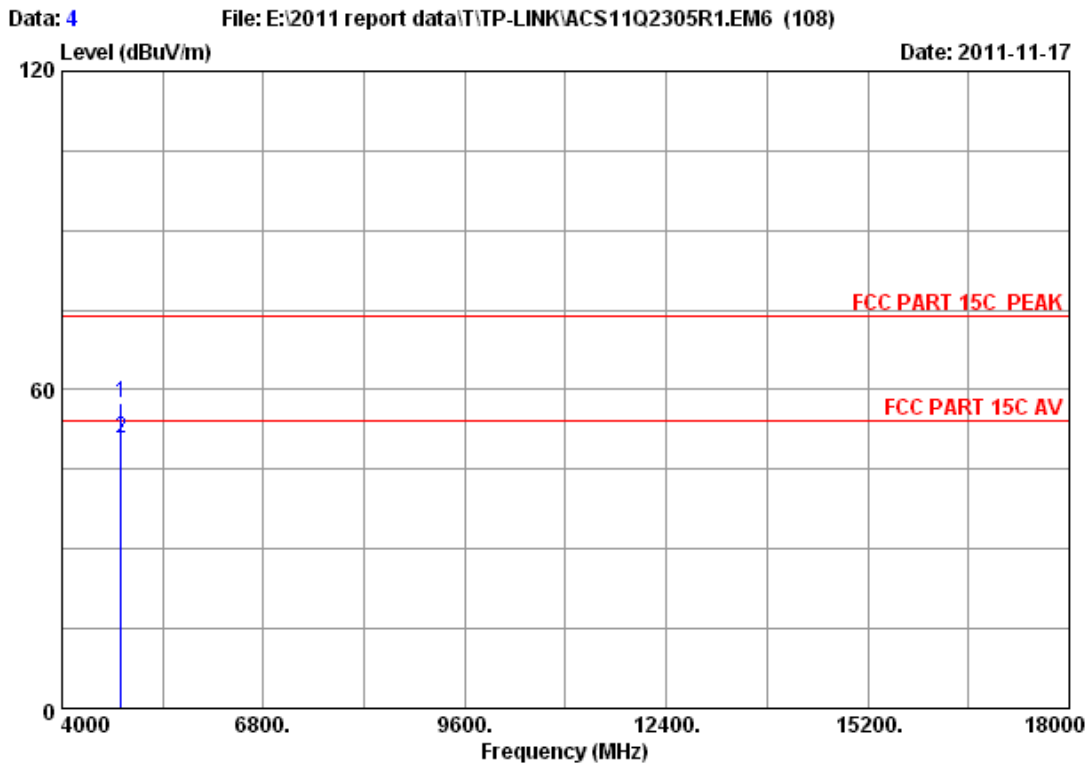

Site no. : 3m Chamber Data no. : 4
 Dis. / Ant. : 3m 3115(0911) Ant. pol. : VERTICAL
 Limit : FCC PART 15C PEAK
 Env. / Ins. : 23°C/54% Engineer : Leo-Li
 EUT : 300Mbps Wireless N Range Extender
 Power : DC 12V From Adapter input AC 120V/60Hz
 Test mode : IEEE802.11b CH1 2412MHz Tx
 M/N : TL-WA830RE

	Ant. Freq. (MHz)	Ant. Factor (dB/m)	Cable loss (dB)	Amp. Factor (dB)	Reading (dBuV)	Emission Level (dBuV/m)	Limits (dBuV/m)	Margin (dB)	Remark
1	4824.000	34.32	12.38	35.25	46.06	57.51	74.00	16.49	Peak
2	4824.000	34.32	12.38	35.25	39.23	50.68	54.00	3.32	Average

Remarks:

1. Emission Level= Antenna Factor + Cable Loss -Amp Factor + Reading.
2. The emission levels that are 20dB below the official limit are not reported.

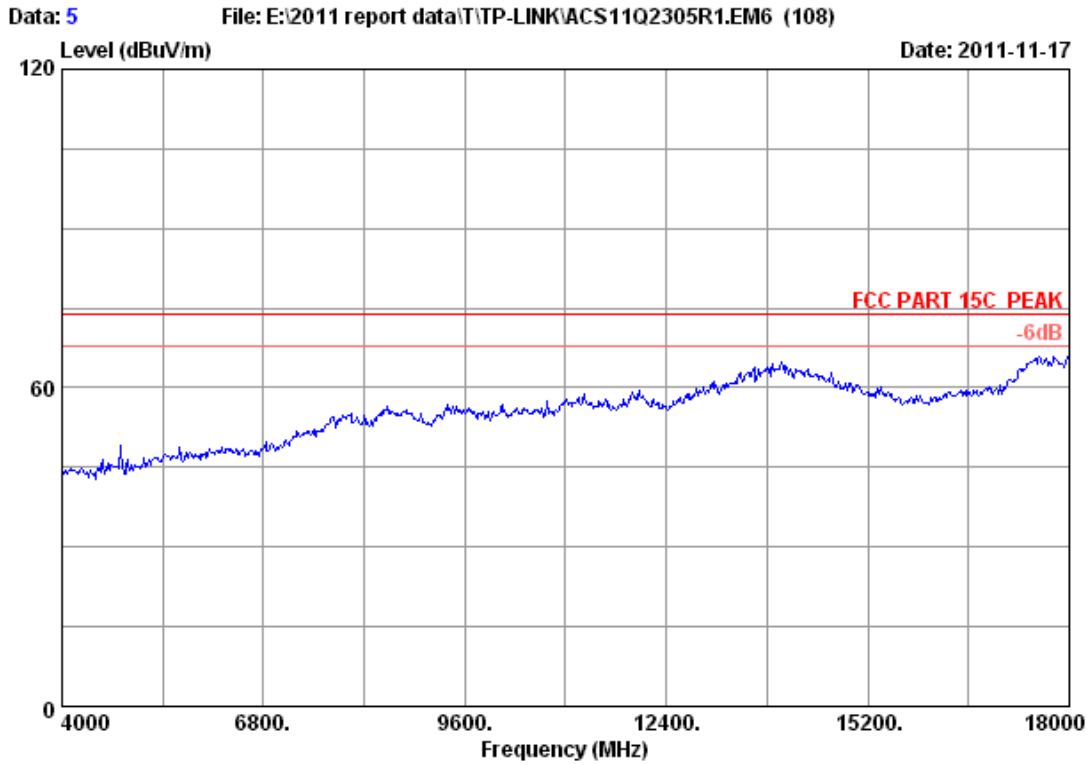

Site no. : 3m Chamber Data no. : 5
Dis. / Ant. : 3m 3115(0911) Ant. pol. : HORIZONTAL
Limit : FCC PART 15C PEAK
Env. / Ins. : 23°C/54% Engineer : Leo-Li
EUT : 300Mbps Wireless N Range Extender
Power : DC 12V From Adapter input AC 120V/60Hz
Test mode : IEEE802.11b CH1 2412MHz Tx
M/N : TL-WA830RE

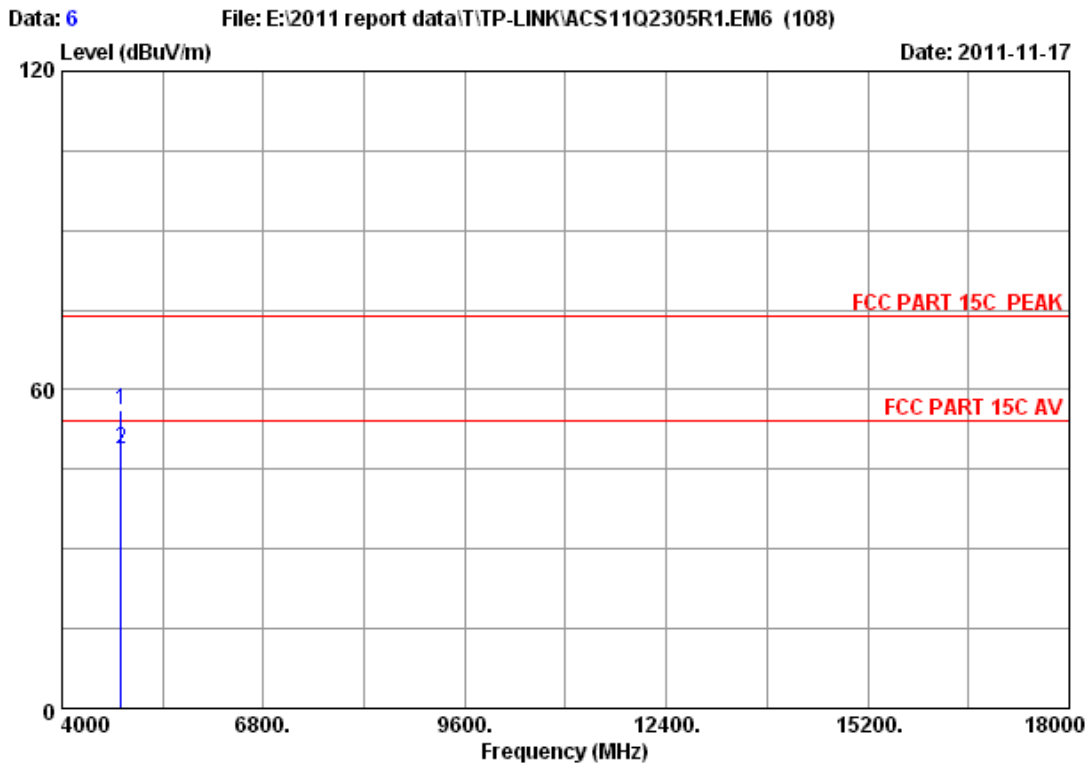

Site no. : 3m Chamber Data no. : 6
 Dis. / Ant. : 3m 3115(0911) Ant. pol. : HORIZONTAL
 Limit : FCC PART 15C PEAK
 Env. / Ins. : 23°C/54% Engineer : Leo-Li
 EUT : 300Mbps Wireless N Range Extender
 Power : DC 12V From Adapter input AC 120V/60Hz
 Test mode : IEEE802.11b CH1 2412MHz Tx
 M/N : TL-WA830RE

	Ant. Factor	Cable loss	Amp. Factor	Reading	Emission Level	Limits	Margin	Remark
Freq. (MHz)	(dB/m)	(dB)	(dB)	(dBuV)	(dBuV/m)	(dBuV/m)	(dB)	
1 4824.000	34.32	12.38	35.25	44.57	56.02	74.00	17.98	Peak
2 4824.000	34.32	12.38	35.25	37.27	48.72	54.00	5.28	Average

Remarks:

1. Emission Level= Antenna Factor + Cable Loss -Amp Factor + Reading.
2. The emission levels that are 20dB below the official limit are not reported.

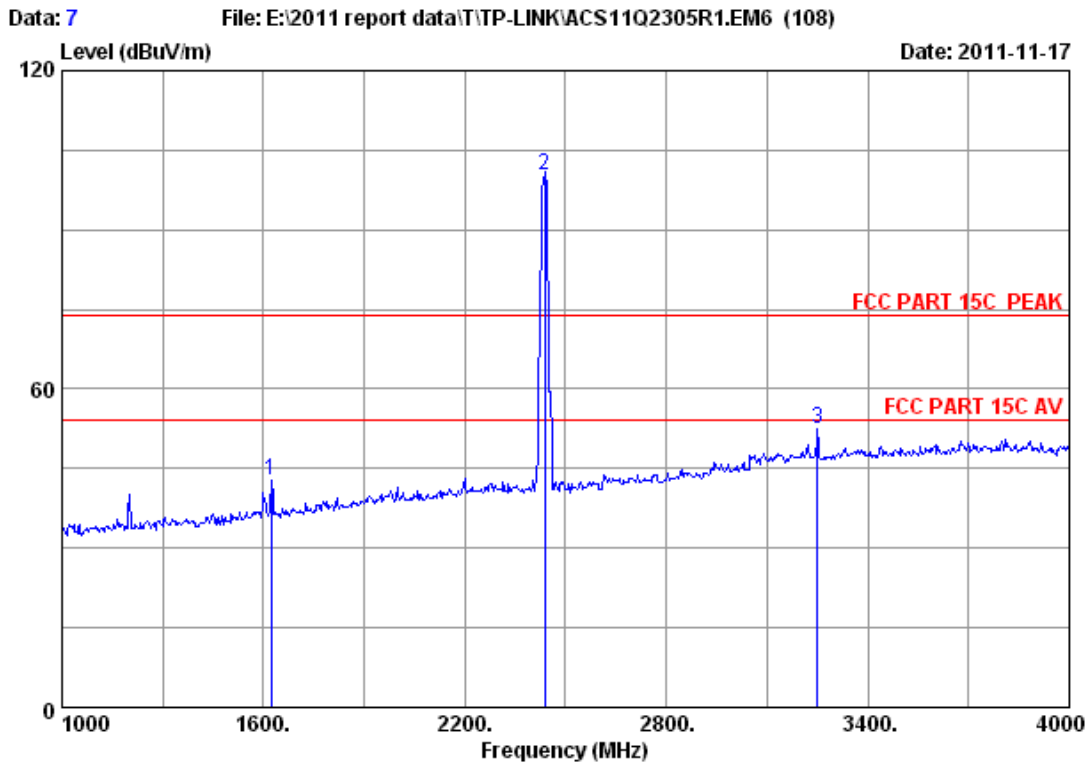

Site no. : 3m Chamber Data no. : 7
 Dis. / Ant. : 3m 3115(0911) Ant. pol. : HORIZONTAL
 Limit : FCC PART 15C PEAK
 Env. / Ins. : 23°C/54% Engineer : Leo-Li
 EUT : 300Mbps Wireless N Range Extender
 Power : DC 12V From Adapter input AC 120V/60Hz
 Test mode : IEEE802.11b CH6 2437MHz Tx
 M/N : TL-WA830RE

	Ant. Freq. (MHz)	Ant. Factor (dB/m)	Cable loss (dB)	Amp. Factor (dB)	Reading (dBuV)	Emission Level (dBuV/m)	Limits (dBuV/m)	Margin (dB)	Remark
1	1624.000	27.15	7.04	36.26	44.97	42.90	74.00	31.10	Peak
2	2437.000	29.47	8.77	36.06	97.98	100.16	74.00	-26.16	Peak
3	3250.000	32.63	10.28	35.68	45.37	52.60	74.00	21.40	Peak

Remarks:

1. Emission Level= Antenna Factor + Cable Loss -Amp Factor + Reading.
2. The emission levels that are 20dB below the official limit are not reported.

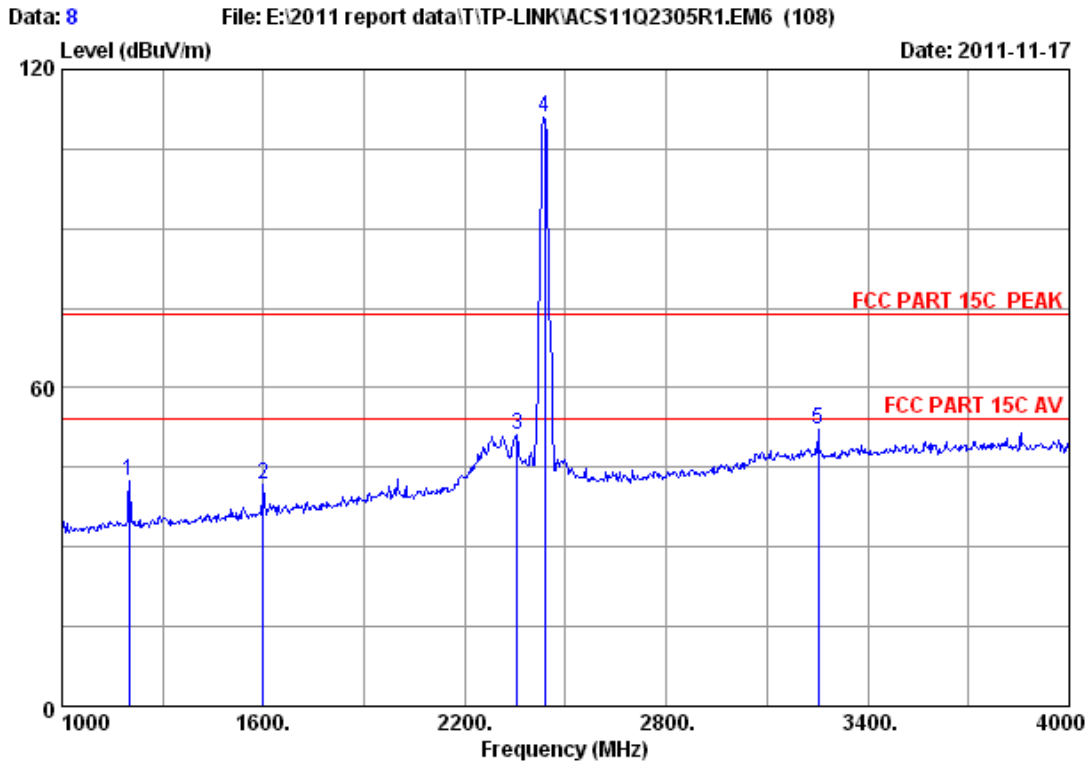

Site no. : 3m Chamber Data no. : 8
 Dis. / Ant. : 3m 3115(0911) Ant. pol. : VERTICAL
 Limit : FCC PART 15C PEAK
 Env. / Ins. : 23°C/54% Engineer : Leo-Li
 EUT : 300Mbps Wireless N Range Extender
 Power : DC 12V From Adapter input AC 120V/60Hz
 Test mode : IEEE802.11b CH6 2437MHz Tx
 M/N : TL-WA830RE

	Ant. Freq. (MHz)	Ant. Factor (dB/m)	Cable loss (dB)	Amp. Factor (dB)	Reading (dBuV)	Emission Level (dBuV/m)	Limits (dBuV/m)	Margin (dB)	Remark
1	1201.000	25.81	5.98	36.97	47.60	42.42	74.00	31.58	Peak
2	1600.000	26.96	6.98	36.43	44.22	41.73	74.00	32.27	Peak
3	2356.000	29.42	8.62	35.91	49.12	51.25	74.00	22.75	Peak
4	2437.000	29.47	8.77	36.06	108.89	111.07	74.00	-37.07	Peak
5	3253.000	32.67	10.28	35.79	45.09	52.25	74.00	21.75	Peak

Remarks:

1. Emission Level= Antenna Factor + Cable Loss -Amp Factor + Reading.
2. The emission levels that are 20dB below the official limit are not reported.

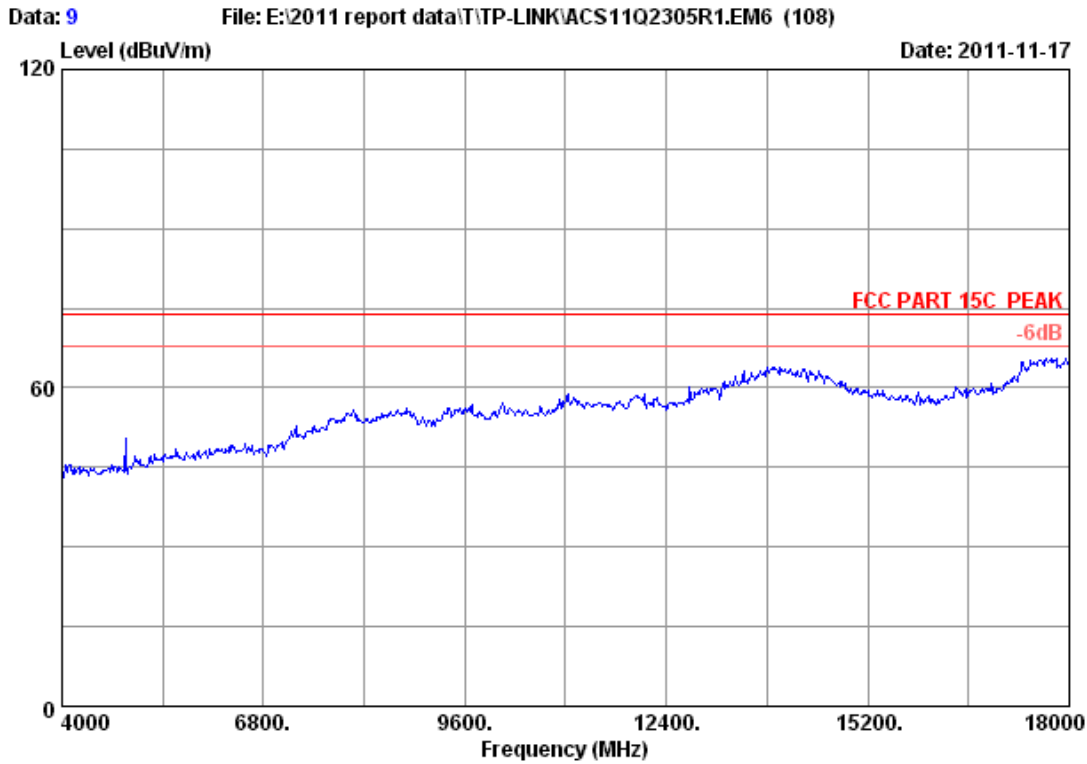

Site no.	: 3m Chamber	Data no. :	9
Dis. / Ant.	: 3m 3115(0911)	Ant. pol. :	VERTICAL
Limit	: FCC PART 15C PEAK		
Env. / Ins.	: 23°C/54%	Engineer :	Leo-Li
EUT	: 300Mbps Wireless N Range Extender		
Power	: DC 12V From Adapter input AC 120V/60Hz		
Test mode	: IEEE802.11b CH6 2437MHz Tx		
M/N	: TL-WA830RE		

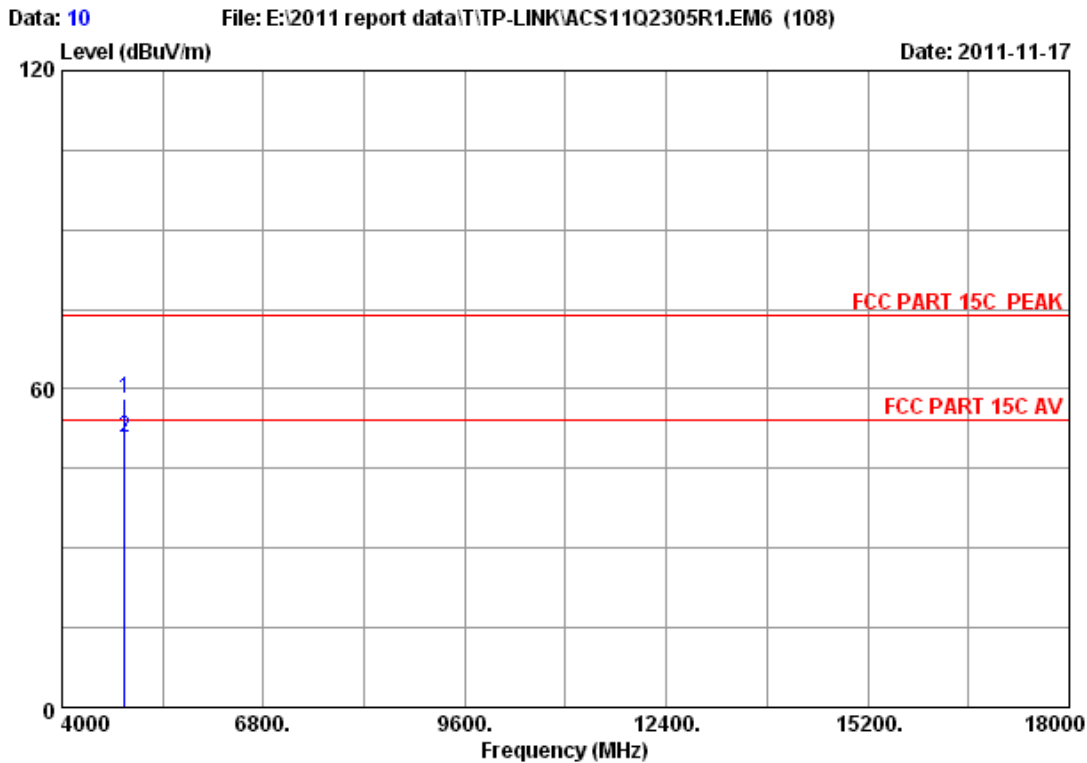

Site no. : 3m Chamber Data no. : 10
 Dis. / Ant. : 3m 3115(0911) Ant. pol. : VERTICAL
 Limit : FCC PART 15C PEAK
 Env. / Ins. : 23°C/54% Engineer : Leo-Li
 EUT : 300Mbps Wireless N Range Extender
 Power : DC 12V From Adapter input AC 120V/60Hz
 Test mode : IEEE802.11b CH6 2437MHz Tx
 M/N : TL-WA830RE

	Ant. Freq. (MHz)	Ant. Factor (dB/m)	Cable loss (dB)	Amp. Factor (dB)	Reading (dBuV)	Emission Level (dBuV/m)	Limits (dBuV/m)	Margin (dB)	Remark
1	4874.000	34.41	12.44	35.36	46.78	58.27	74.00	15.73	Peak
2	4874.000	34.41	12.44	35.36	39.15	50.64	54.00	3.36	Average

Remarks:
 1. Emission Level= Antenna Factor + Cable Loss -Amp Factor + Reading.
 2. The emission levels that are 20dB below the official limit are not reported.

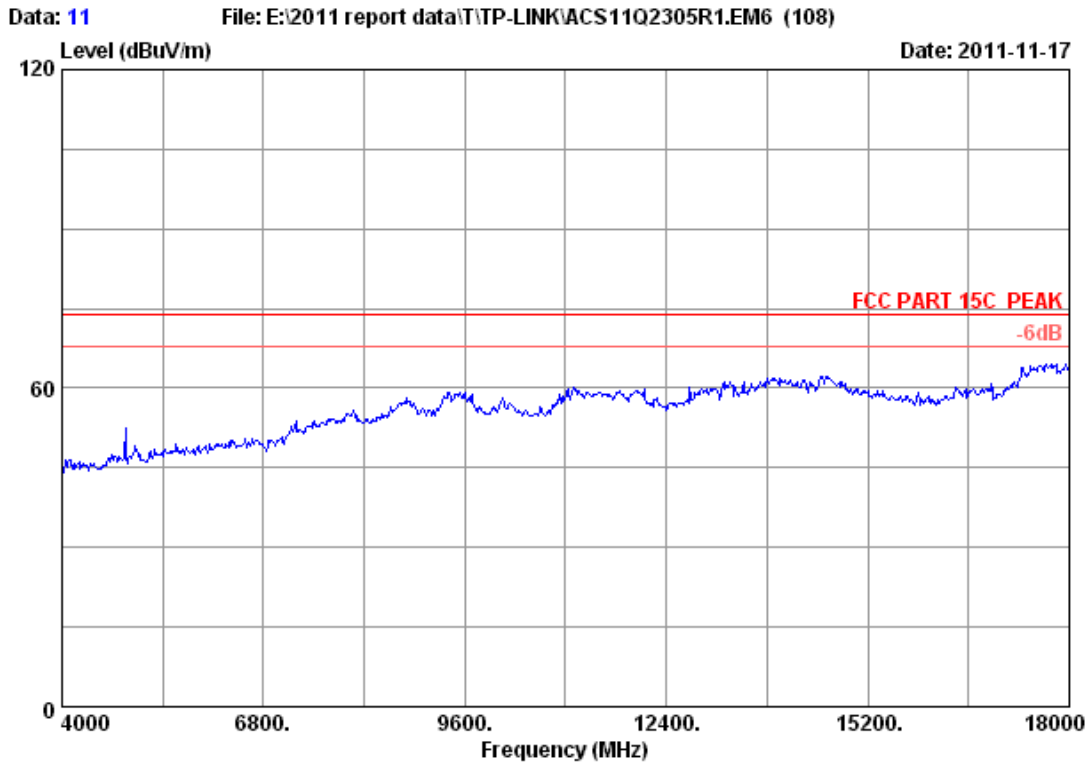

Site no.	: 3m Chamber	Data no. :	11
Dis. / Ant.	: 3m 3115(0911)	Ant. pol. :	HORIZONTAL
Limit	: FCC PART 15C PEAK		
Env. / Ins.	: 23°C/54%	Engineer :	Leo-Li
EUT	: 300Mbps Wireless N Range Extender		
Power	: DC 12V From Adapter input AC 120V/60Hz		
Test mode	: IEEE802.11b CH6 2437MHz Tx		
M/N	: TL-WA830RE		

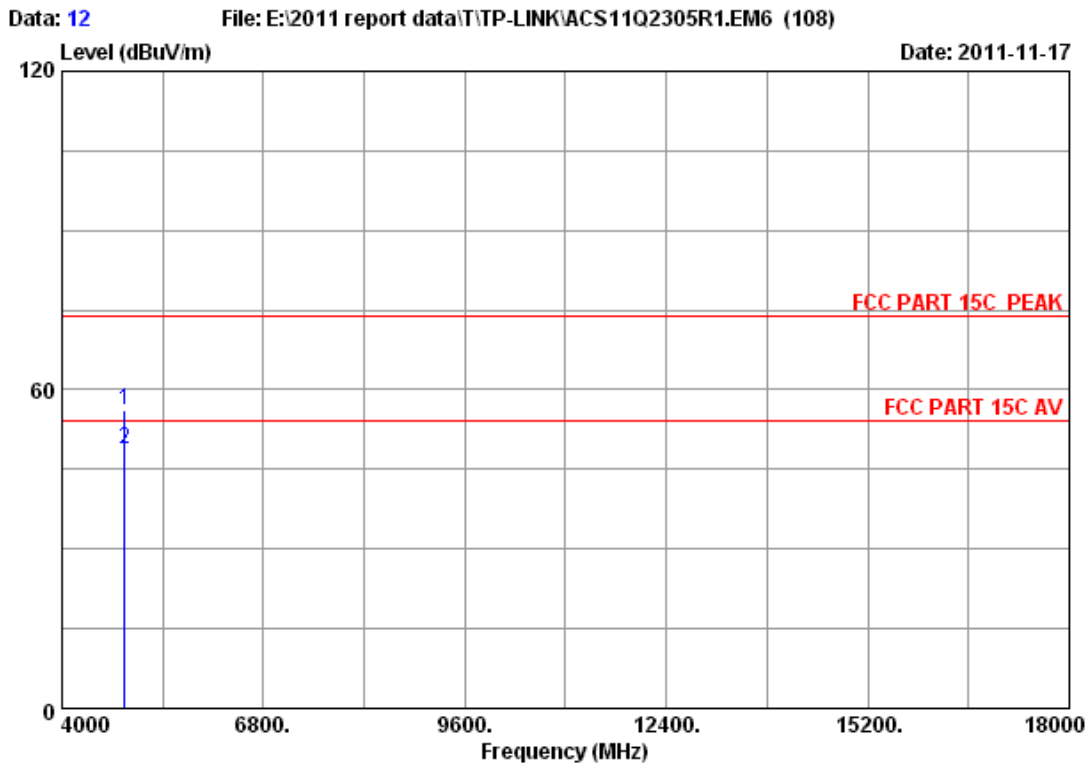

Site no. : 3m Chamber Data no. : 12
 Dis. / Ant. : 3m 3115(0911) Ant. pol. : HORIZONTAL
 Limit : FCC PART 15C PEAK
 Env. / Ins. : 23°C/54% Engineer : Leo-Li
 EUT : 300Mbps Wireless N Range Extender
 Power : DC 12V From Adapter input AC 120V/60Hz
 Test mode : IEEE802.11b CH6 2437MHz Tx
 M/N : TL-WA830RE

	Ant. Freq. (MHz)	Ant. Factor (dB/m)	Cable loss (dB)	Amp. Factor (dB)	Reading (dBuV)	Emission Level (dBuV/m)	Limits (dBuV/m)	Margin (dB)	Remark
1	4874.000	34.41	12.44	35.36	44.78	56.27	74.00	17.73	Peak
2	4874.000	34.41	12.44	35.36	37.28	48.77	54.00	5.23	Average

Remarks:

1. Emission Level= Antenna Factor + Cable Loss -Amp Factor + Reading.
2. The emission levels that are 20dB below the official limit are not reported.

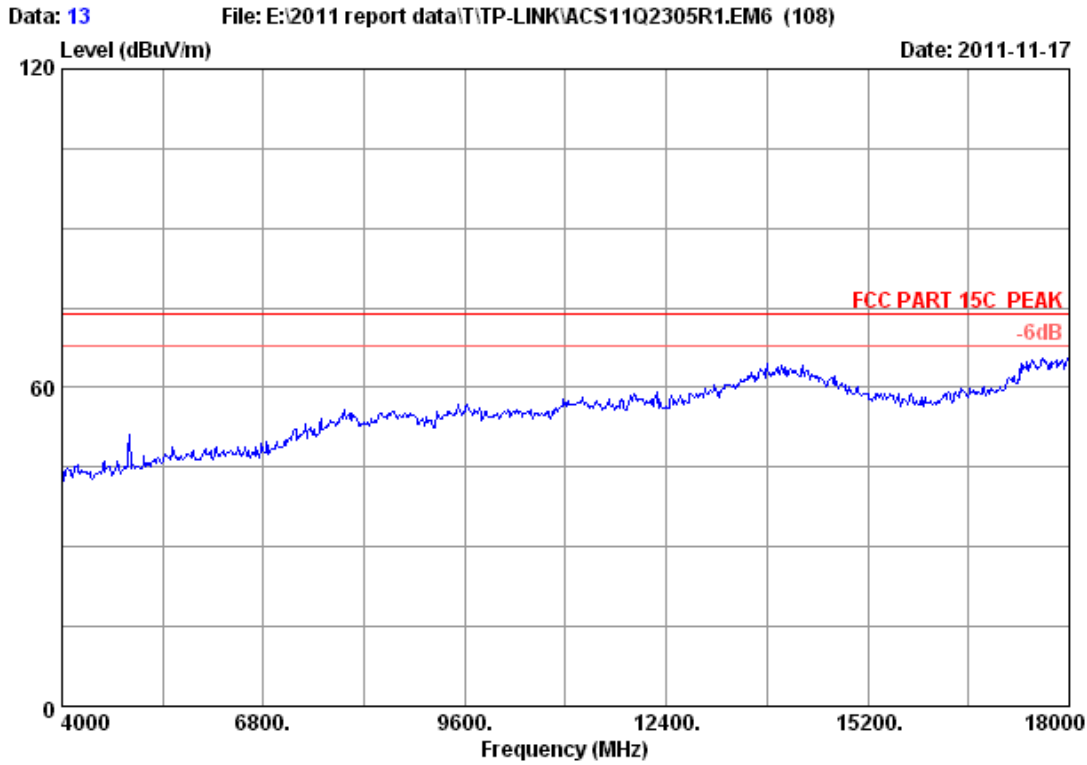

Site no. : 3m Chamber Data no. : 13
Dis. / Ant. : 3m 3115(0911) Ant. pol. : HORIZONTAL
Limit : FCC PART 15C PEAK
Env. / Ins. : 23°C/54% Engineer : Leo-Li
EUT : 300Mbps Wireless N Range Extender
Power : DC 12V From Adapter input AC 120V/60Hz
Test mode : IEEE802.11b CH11 2462MHz Tx
M/N : TL-WA830RE

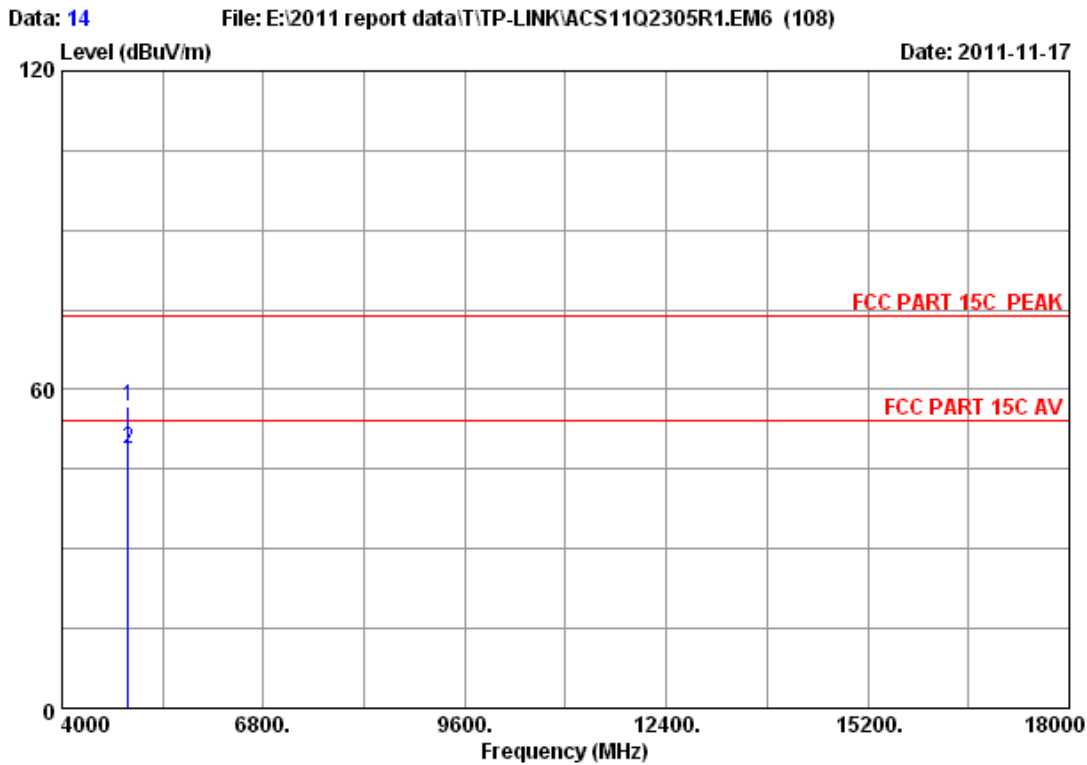

Site no. : 3m Chamber Data no. : 14
 Dis. / Ant. : 3m 3115(0911) Ant. pol. : HORIZONTAL
 Limit : FCC PART 15C PEAK
 Env. / Ins. : 23°C/54% Engineer : Leo-Li
 EUT : 300Mbps Wireless N Range Extender
 Power : DC 12V From Adapter input AC 120V/60Hz
 Test mode : IEEE802.11b CH11 2462MHz Tx
 M/N : TL-WA830RE

	Ant. Freq. (MHz)	Ant. Factor (dB/m)	Cable loss (dB)	Amp. Factor (dB)	Reading (dBUV)	Emission Level (dBUV/m)	Limits (dBUV/m)	Margin (dB)	Remark
1	4924.000	34.49	12.50	35.34	45.28	56.93	74.00	17.07	Peak
2	4924.000	34.49	12.50	35.34	37.28	48.93	54.00	5.07	Average

Remarks:
 1. Emission Level= Antenna Factor + Cable Loss -Amp Factor + Reading.
 2. The emission levels that are 20dB below the official limit are not reported.

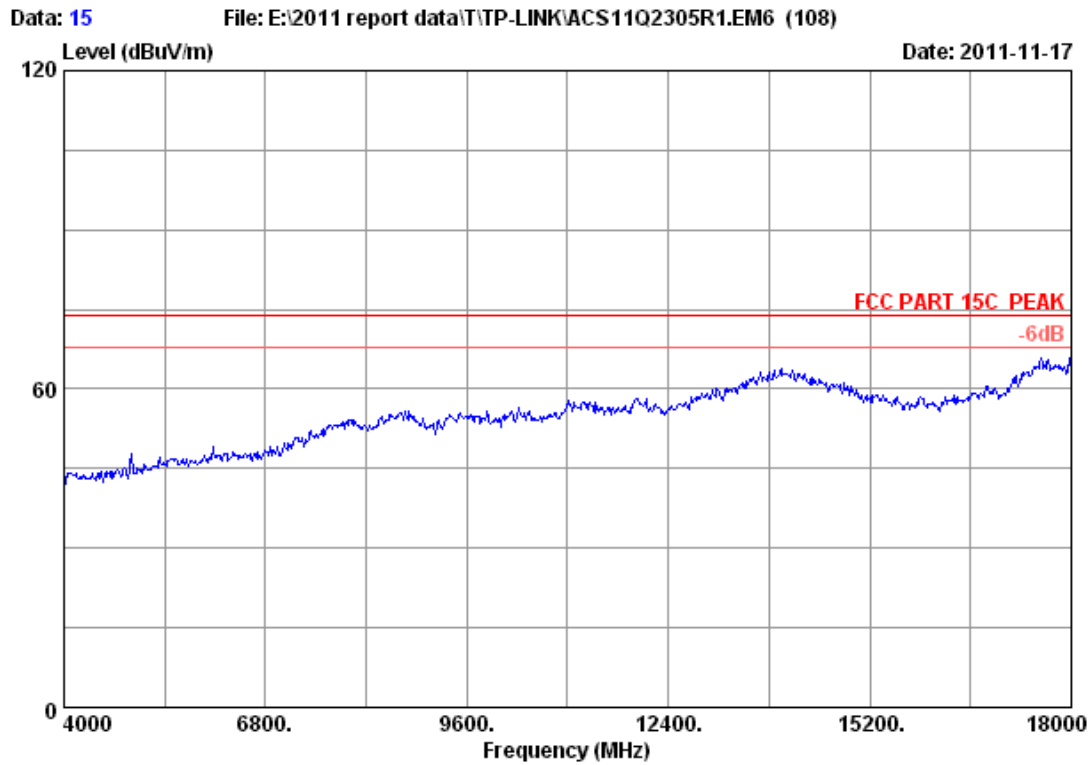

Site no. : 3m Chamber Data no. : 15
Dis. / Ant. : 3m 3115(0911) Ant. pol. : VERTICAL
Limit : FCC PART 15C PEAK
Env. / Ins. : 23°C/54% Engineer : Leo-Li
EUT : 300Mbps Wireless N Range Extender
Power : DC 12V From Adapter input AC 120V/60Hz
Test mode : IEEE802.11b CH11 2462MHz Tx
M/N : TL-WA830RE

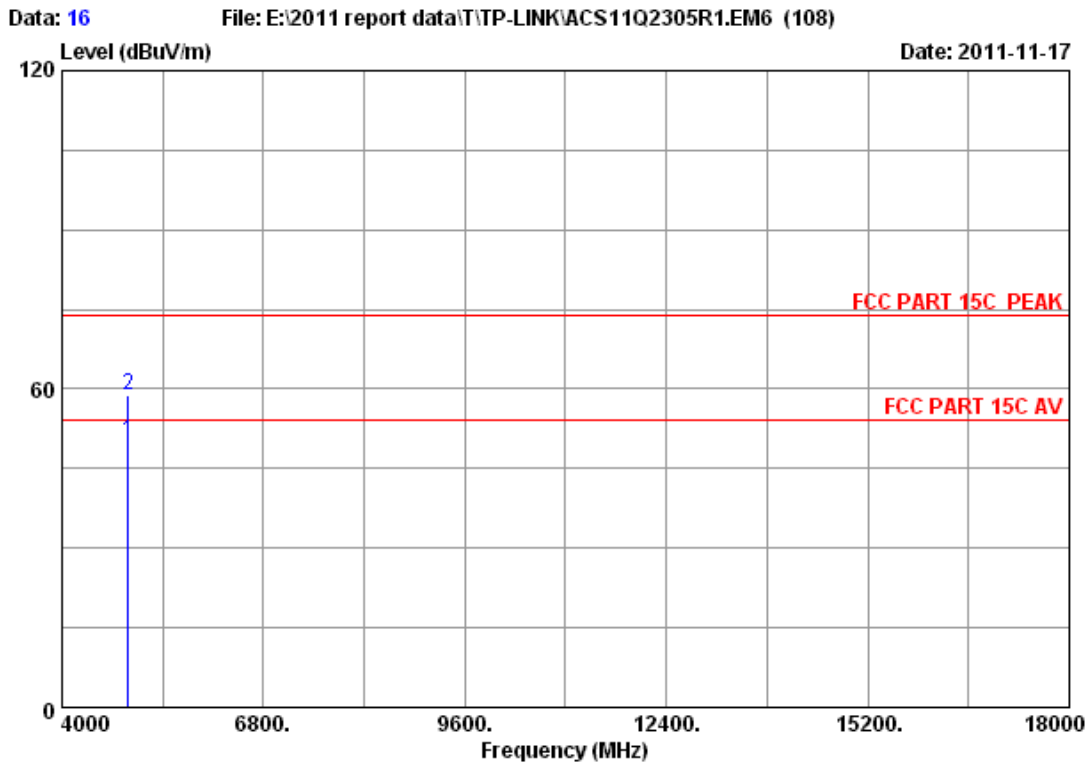

Site no. : 3m Chamber Data no. : 16
 Dis. / Ant. : 3m 3115(0911) Ant. pol. : VERTICAL
 Limit : FCC PART 15C PEAK
 Env. / Ins. : 23°C/54% Engineer : Leo-Li
 EUT : 300Mbps Wireless N Range Extender
 Power : DC 12V From Adapter input AC 120V/60Hz
 Test mode : IEEE802.11b CH11 2462MHz Tx
 M/N : TL-WA830RE

	Ant. Freq. (MHz)	Ant. Factor (dB/m)	Cable loss (dB)	Amp. Factor (dB)	Reading (dBuV)	Emission Level (dBuV/m)	Limits (dBuV/m)	Margin (dB)	Remark
1	4924.000	34.49	12.50	35.34	38.63	50.28	54.00	3.72	Average
2	4924.000	34.49	12.50	35.34	47.31	58.96	74.00	15.04	Peak

Remarks:

1. Emission Level= Antenna Factor + Cable Loss -Amp Factor + Reading.
2. The emission levels that are 20dB below the official limit are not reported.

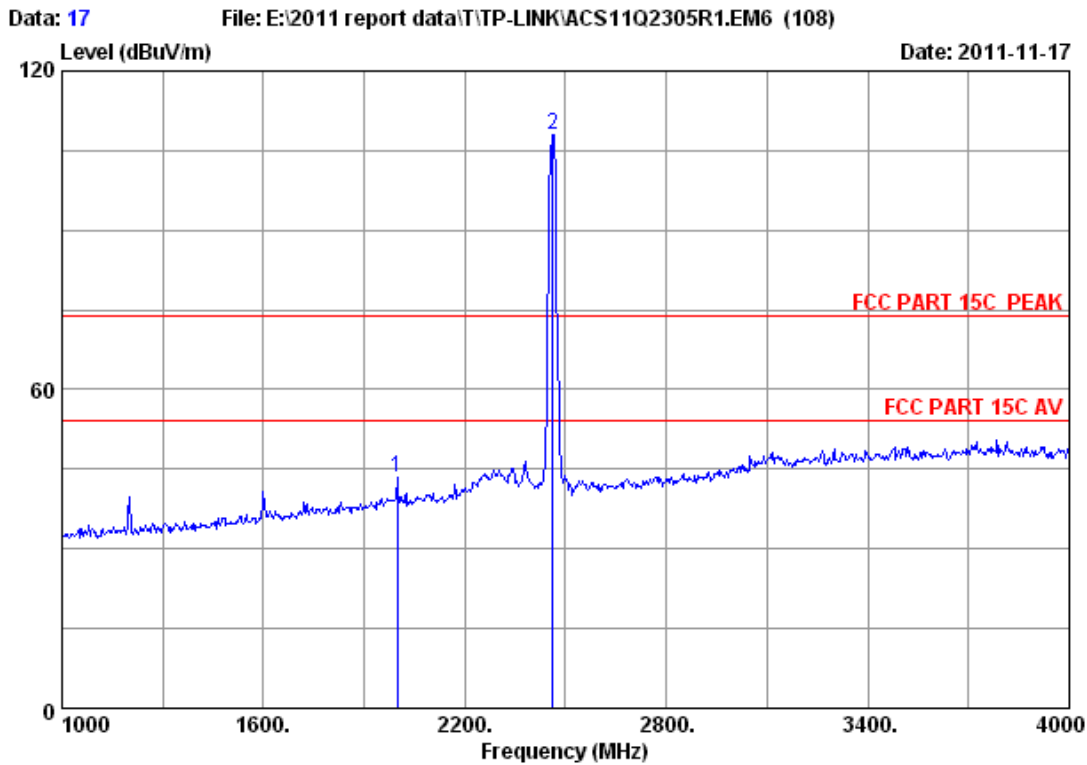

```

Site no.      : 3m Chamber           Data no. : 17
Dis. / Ant.  : 3m 3115(0911)       Ant. pol.: VERTICAL
Limit        : FCC PART 15C PEAK
Env. / Ins.  : 23*C/54%           Engineer : Leo-Li
EUT          : 300Mbps Wireless N Range Extender
Power        : DC 12V From Adapter input AC 120V/60Hz
Test mode    : IEEE802.11b CH11 2462MHz Tx
M/N          : TL-WA830RE
    
```

	Ant. Freq. (MHz)	Ant. Factor (dB/m)	Cable loss (dB)	Amp. Factor (dB)	Reading (dBuV)	Emission Level (dBuV/m)	Limits (dBuV/m)	Margin (dB)	Remark
1	1999.000	29.20	7.93	36.09	42.43	43.47	74.00	30.53	Peak
2	2462.000	29.48	8.82	36.02	105.59	107.87	74.00	-33.87	Peak

Remarks:

1. Emission Level= Antenna Factor + Cable Loss -Amp Factor + Reading.
2. The emission levels that are 20dB below the official limit are not reported.

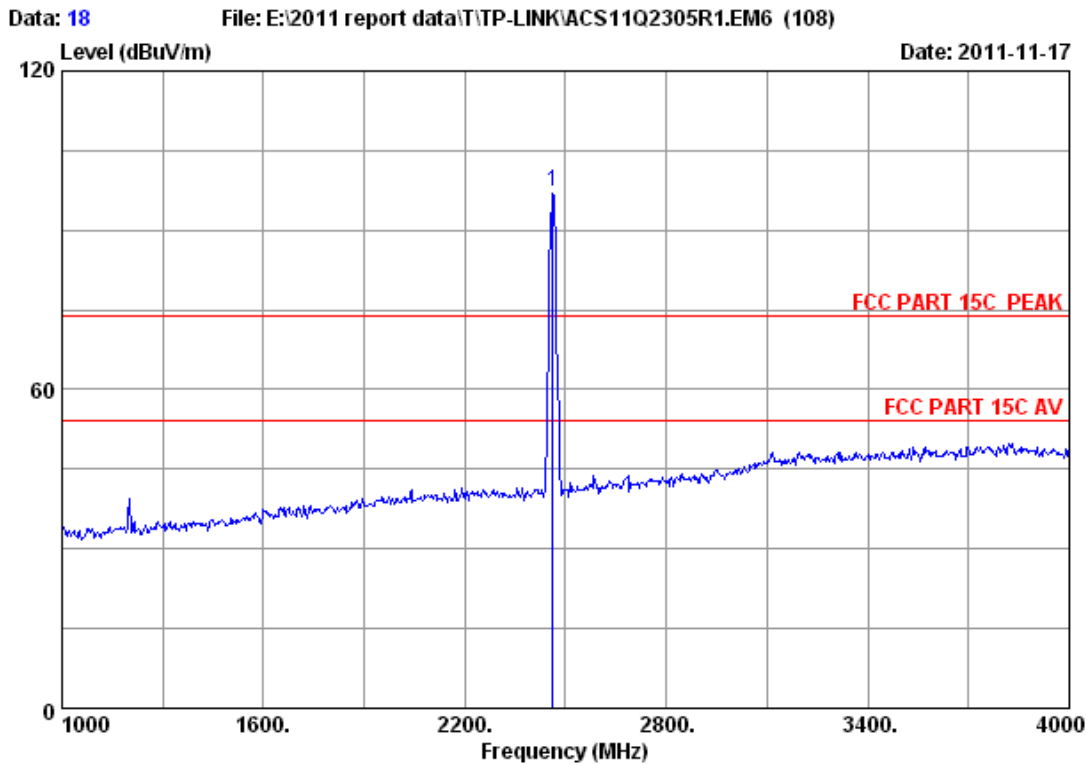

```

Site no.      : 3m Chamber           Data no. : 18
Dis. / Ant.  : 3m 3115(0911)       Ant. pol.: HORIZONTAL
Limit        : FCC PART 15C PEAK
Env. / Ins.  : 23*C/54%           Engineer : Leo-Li
EUT          : 300Mbps Wireless N Range Extender
Power        : DC 12V From Adapter input AC 120V/60Hz
Test mode    : IEEE802.11b CH11 2462MHz Tx
M/N         : TL-WA830RE
    
```

	Freq. (MHz)	Ant. Factor (dB/m)	Cable loss (dB)	Amp. Factor (dB)	Reading (dBUV)	Emission			Remark
						Level (dBUV/m)	Limits (dBUV/m)	Margin (dB)	
1	2462.000	29.48	8.82	36.02	95.03	97.31	74.00	-23.31	Peak

Remarks:

- Emission Level= Antenna Factor + Cable Loss -Amp Factor + Reading.
- The emission levels that are 20dB below the official limit are not reported.

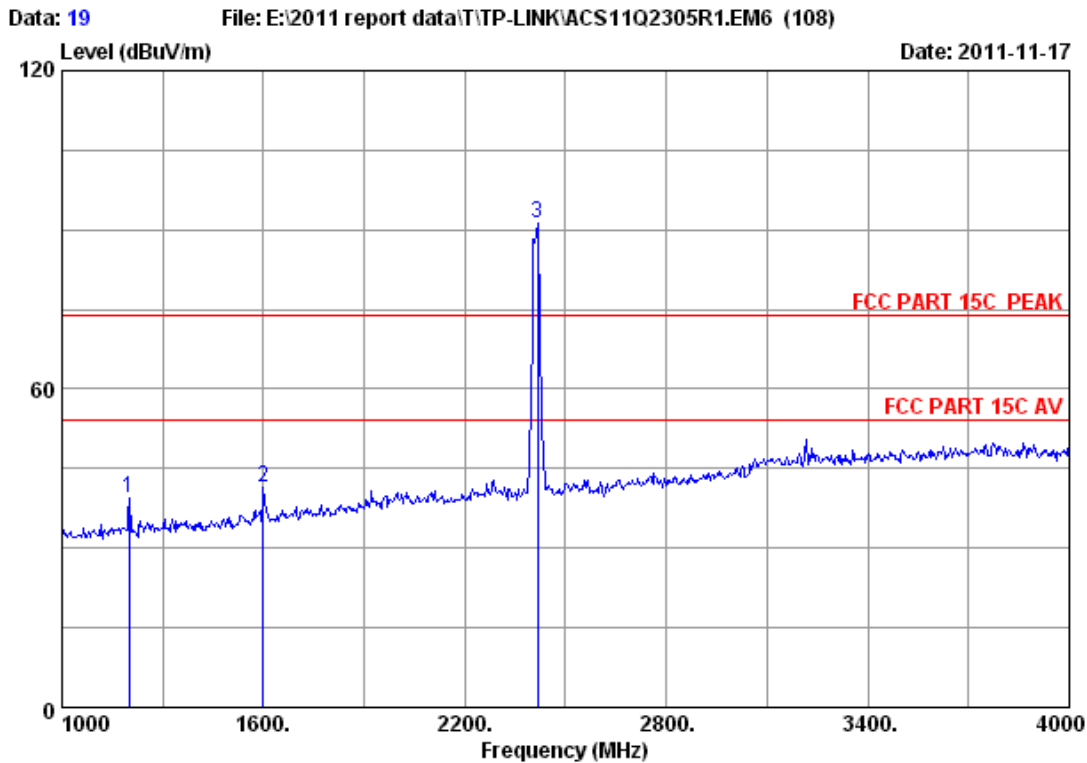

```

Site no.      : 3m Chamber           Data no. : 19
Dis. / Ant.  : 3m 3115(0911)       Ant. pol.: HORIZONTAL
Limit        : FCC PART 15C PEAK
Env. / Ins.  : 23°C/54%           Engineer : Leo-Li
EUT          : 300Mbps Wireless N Range Extender
Power        : DC 12V From Adapter input AC 120V/60Hz
Test mode    : IEEE802.11g CH1 2412MHz Tx
M/N         : TL-WA830RE
    
```

	Ant. Freq. (MHz)	Ant. Factor (dB/m)	Cable loss (dB)	Amp. Factor (dB)	Reading (dBuV)	Emission Level (dBuV/m)	Limits (dBuV/m)	Margin (dB)	Remark
1	1201.000	25.81	5.98	36.97	44.52	39.34	74.00	34.66	Peak
2	1600.000	26.96	6.98	36.43	43.89	41.40	74.00	32.60	Peak
3	2416.000	29.45	8.72	35.95	88.92	91.14	74.00	-17.14	Peak

Remarks:

1. Emission Level= Antenna Factor + Cable Loss -Amp Factor + Reading.
2. The emission levels that are 20dB below the official limit are not reported.

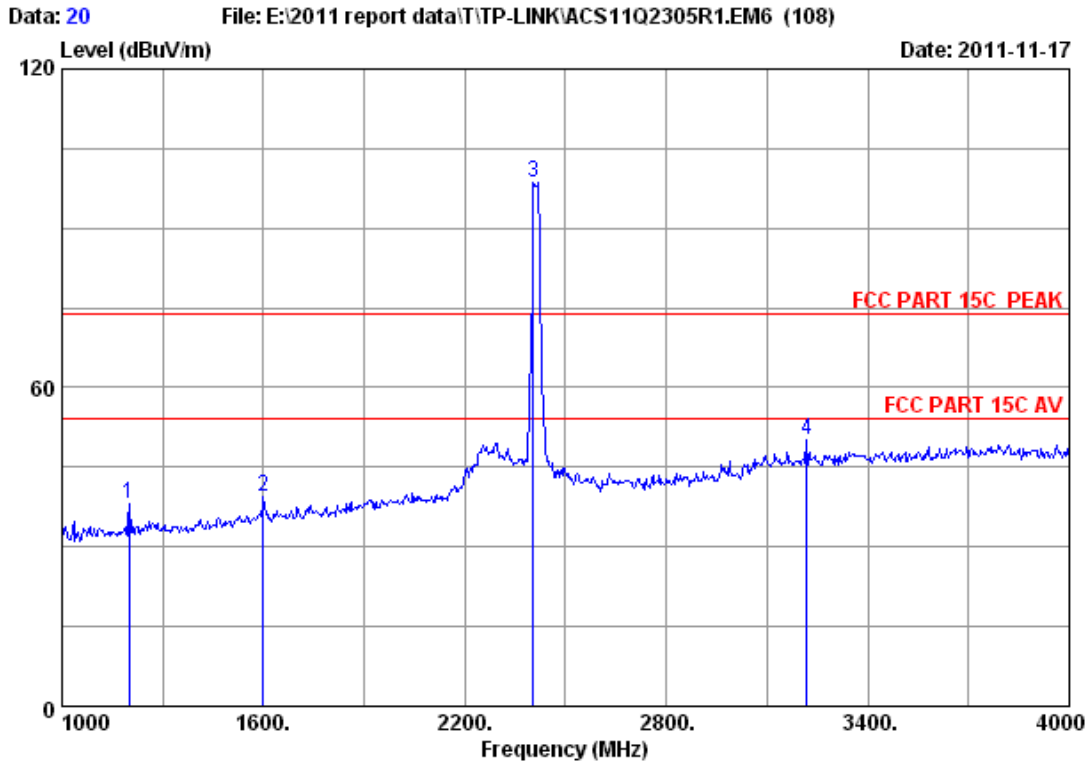

Site no. : 3m Chamber Data no. : 20
 Dis. / Ant. : 3m 3115(0911) Ant. pol. : VERTICAL
 Limit : FCC PART 15C PEAK
 Env. / Ins. : 23°C/54% Engineer : Leo-Li
 EUT : 300Mbps Wireless N Range Extender
 Power : DC 12V From Adapter input AC 120V/60Hz
 Test mode : IEEE802.11g CH1 2412MHz Tx
 M/N : TL-WA830RE

	Ant.	Cable	Amp.	Emission					
Freq.	Factor	loss	Factor	Reading	Level	Limits	Margin	Remark	
(MHz)	(dB/m)	(dB)	(dB)	(dBUV)	(dBUV/m)	dBUV/m)	(dB)		
1	1201.000	25.81	5.98	36.97	43.35	38.17	74.00	35.83	Peak
2	1600.000	26.96	6.98	36.43	42.02	39.53	74.00	34.47	Peak
3	2404.000	29.45	8.72	35.95	96.51	98.73	74.00	-24.73	Peak
4	3217.000	32.54	10.21	35.86	43.26	50.15	74.00	23.85	Peak

Remarks:

1. Emission Level= Antenna Factor + Cable Loss -Amp Factor + Reading.
2. The emission levels that are 20dB below the official limit are not reported.

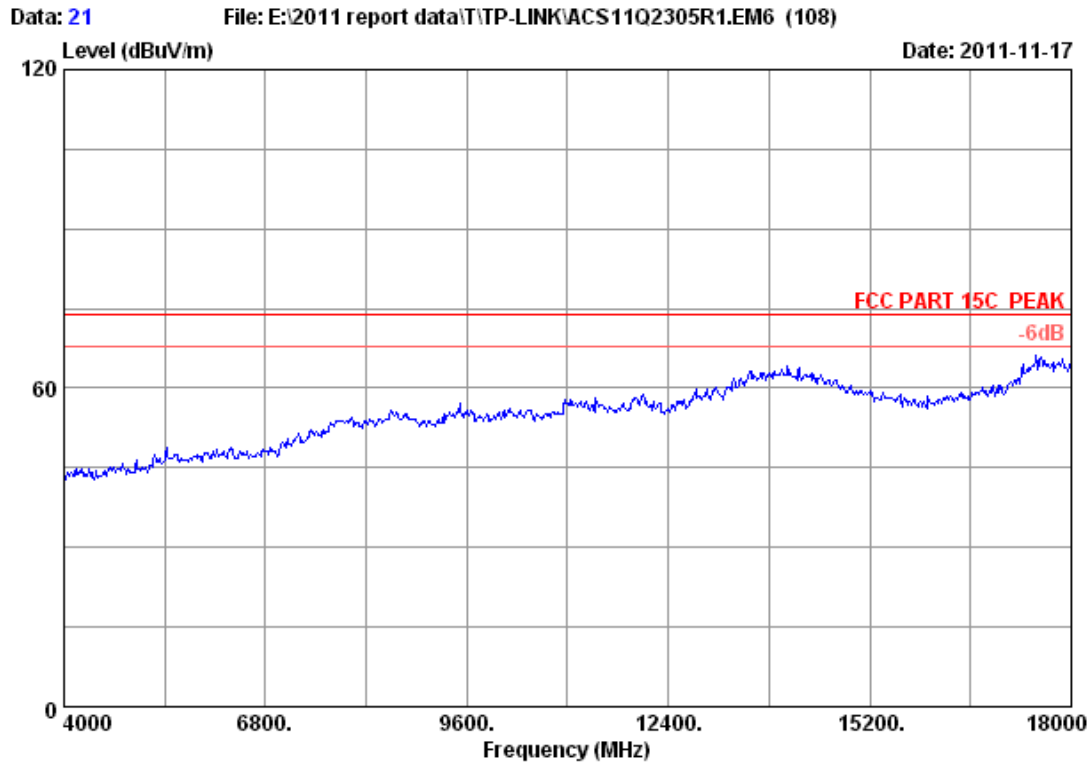

Site no. : 3m Chamber Data no. : 21
Dis. / Ant. : 3m 3115(0911) Ant. pol. : VERTICAL
Limit : FCC PART 15C PEAK
Env. / Ins. : 23°C/54% Engineer : Leo-Li
EUT : 300Mbps Wireless N Range Extender
Power : DC 12V From Adapter input AC 120V/60Hz
Test mode : IEEE802.11g CH1 2412MHz Tx
M/N : TL-WA830RE

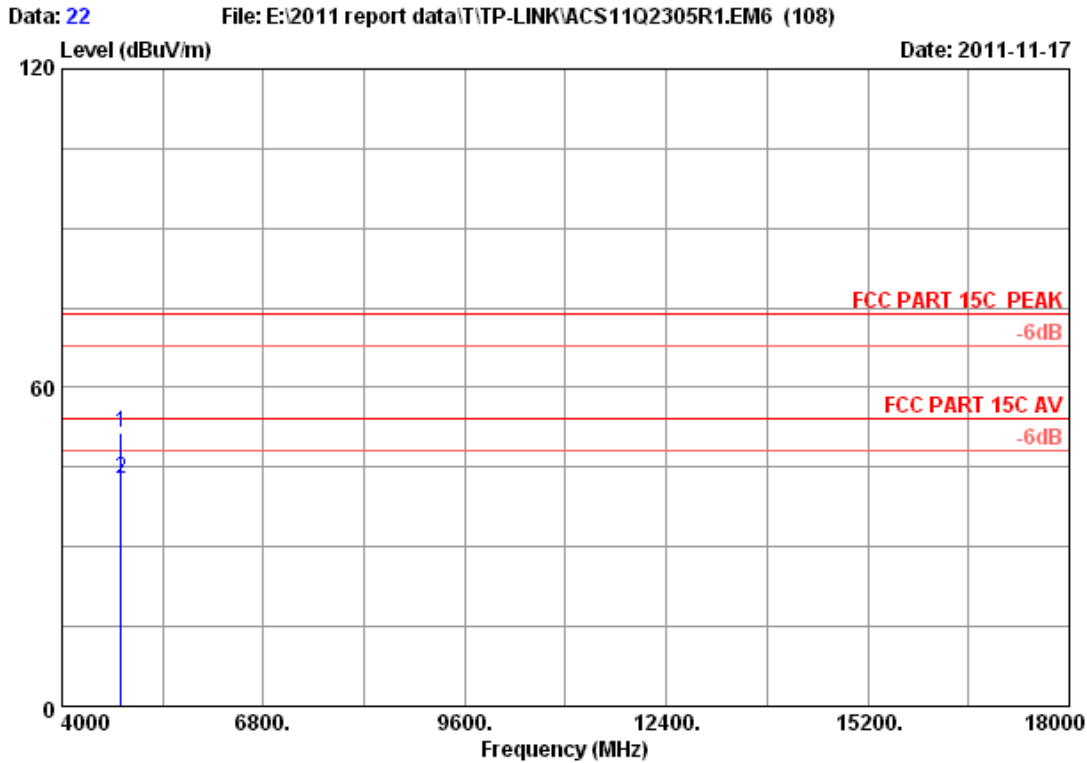

Site no. : 3m Chamber Data no. : 22
 Dis. / Ant. : 3m 3115(0911) Ant. pol. : VERTICAL
 Limit : FCC PART 15C PEAK
 Env. / Ins. : 23*C/54% Engineer : Leo-Li
 EUT : 300Mbps Wireless N Range Extender
 Power : DC 12V From Adapter input AC 120V/60Hz
 Test mode : IEEE802.11g CH1 2412MHz Tx
 M/N : TL-WA830RE

	Ant. Factor	Cable loss	Amp. Factor	Reading	Emission Level	Limits	Margin	Remark
Freq. (MHz)	(dB/m)	(dB)	(dB)	(dBUV)	(dBUV/m)	dBUV/m)	(dB)	
1 4824.000	34.32	12.38	35.25	39.90	51.35	74.00	22.65	Peak
2 4824.000	34.32	12.38	35.25	31.38	42.83	54.00	11.17	Average

Remarks:
 1. Emission Level= Antenna Factor + Cable Loss -Amp Factor + Reading.
 2. The emission levels that are 20dB below the official limit are not reported.

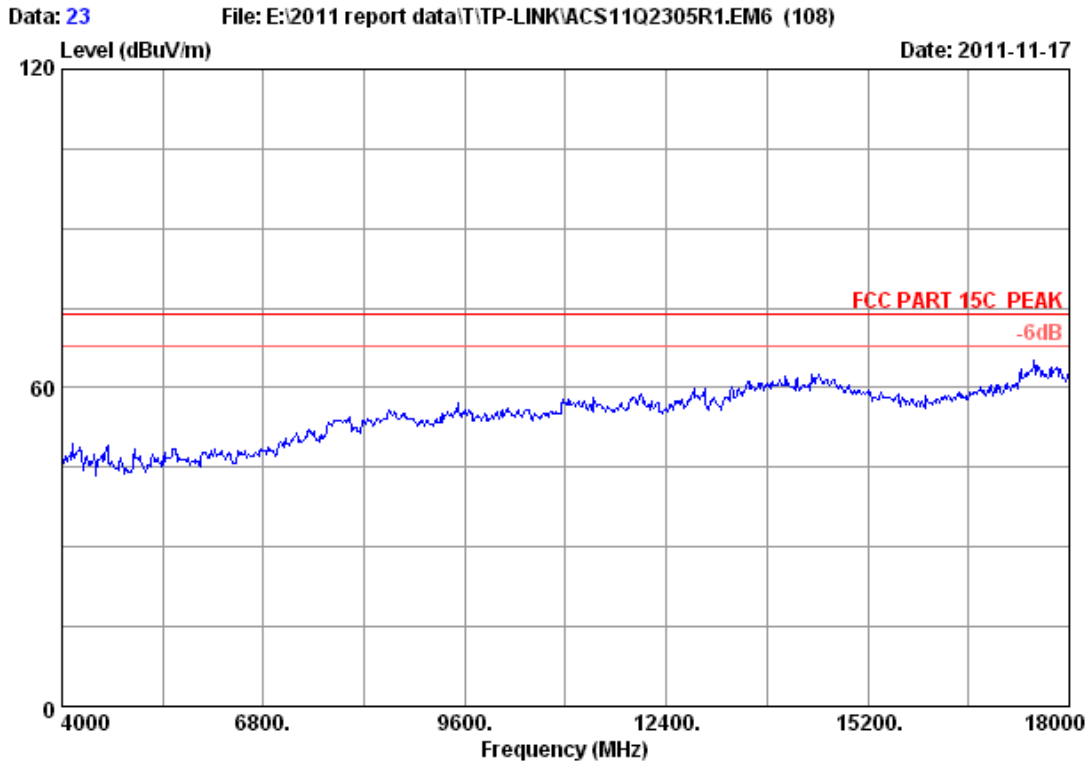

Site no.	: 3m Chamber	Data no. :	23
Dis. / Ant.	: 3m 3115(0911)	Ant. pol. :	HORIZONTAL
Limit	: FCC PART 15C PEAK		
Env. / Ins.	: 23°C/54%	Engineer :	Leo-Li
EUT	: 300Mbps Wireless N Range Extender		
Power	: DC 12V From Adapter input AC 120V/60Hz		
Test mode	: IEEE802.11g CH1 2412MHz Tx		
M/N	: TL-WA830RE		

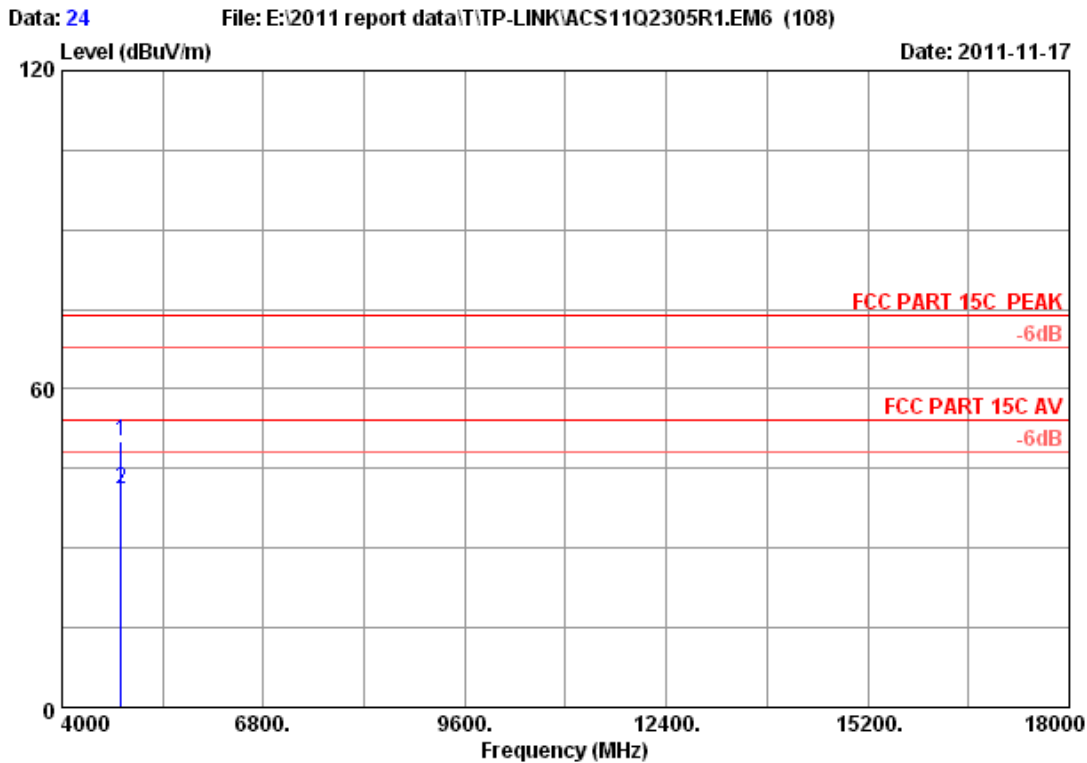

Site no. : 3m Chamber Data no. : 24
 Dis. / Ant. : 3m 3115(0911) Ant. pol. : HORIZONTAL
 Limit : FCC PART 15C PEAK
 Env. / Ins. : 23°C/54% Engineer : Leo-Li
 EUT : 300Mbps Wireless N Range Extender
 Power : DC 12V From Adapter input AC 120V/60Hz
 Test mode : IEEE802.11g CH1 2412MHz Tx
 M/N : TL-WA830RE

	Ant. Freq. (MHz)	Ant. Factor (dB/m)	Cable loss (dB)	Amp. Factor (dB)	Reading (dBuV)	Emission Level (dBuV/m)	Limits (dBuV/m)	Margin (dB)	Remark
1	4824.000	34.32	12.38	35.25	38.69	50.14	74.00	23.86	Peak
2	4824.000	34.32	12.38	35.25	29.79	41.24	54.00	12.76	Average

Remarks:

1. Emission Level= Antenna Factor + Cable Loss -Amp Factor + Reading.
2. The emission levels that are 20dB below the official limit are not reported.

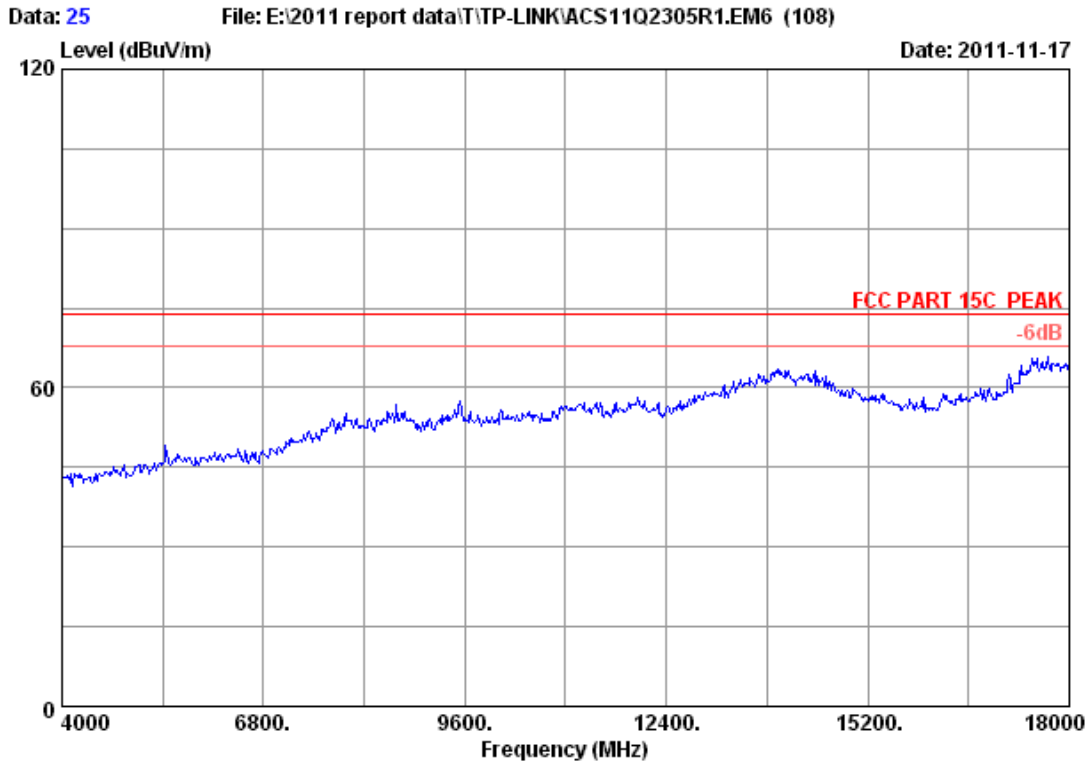

Site no. : 3m Chamber Data no. : 25
Dis. / Ant. : 3m 3115(0911) Ant. pol. : HORIZONTAL
Limit : FCC PART 15C PEAK
Env. / Ins. : 23°C/54% Engineer : Leo-Li
EUT : 300Mbps Wireless N Range Extender
Power : DC 12V From Adapter input AC 120V/60Hz
Test mode : IEEE802.11g CH6 2437MHz Tx
M/N : TL-WA830RE

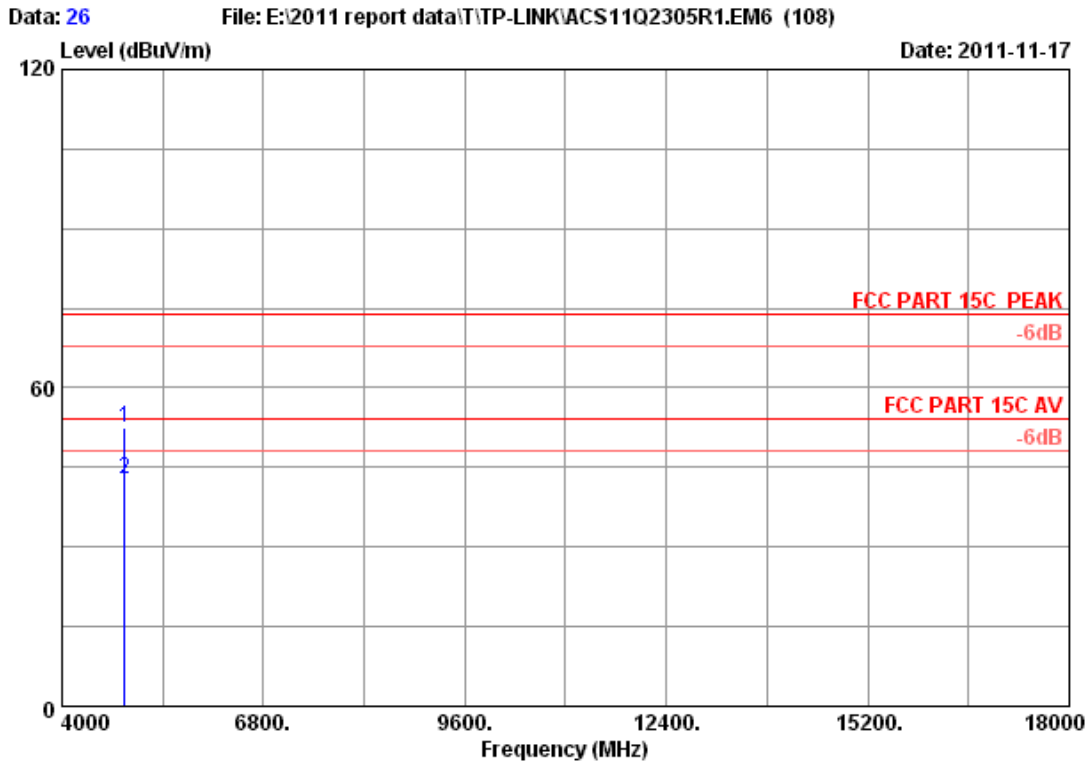

Site no. : 3m Chamber Data no. : 26
 Dis. / Ant. : 3m 3115(0911) Ant. pol. : HORIZONTAL
 Limit : FCC PART 15C PEAK
 Env. / Ins. : 23°C/54% Engineer : Leo-Li
 EUT : 300Mbps Wireless N Range Extender
 Power : DC 12V From Adapter input AC 120V/60Hz
 Test mode : IEEE802.11g CH6 2437MHz Tx
 M/N : TL-WA830RE

	Freq. (MHz)	Ant. Cable Amp.			Emission				Remark
		Factor (dB/m)	loss (dB)	Factor (dB)	Reading (dBuV)	Level (dBuV/m)	Limits (dBuV/m)	Margin (dB)	
1	4874.000	34.41	12.44	35.36	40.95	52.44	74.00	21.56	Peak
2	4874.000	34.41	12.44	35.36	31.27	42.76	54.00	11.24	Average

- Remarks:
1. Emission Level= Antenna Factor + Cable Loss -Amp Factor + Reading.
 2. The emission levels that are 20dB below the official limit are not reported.

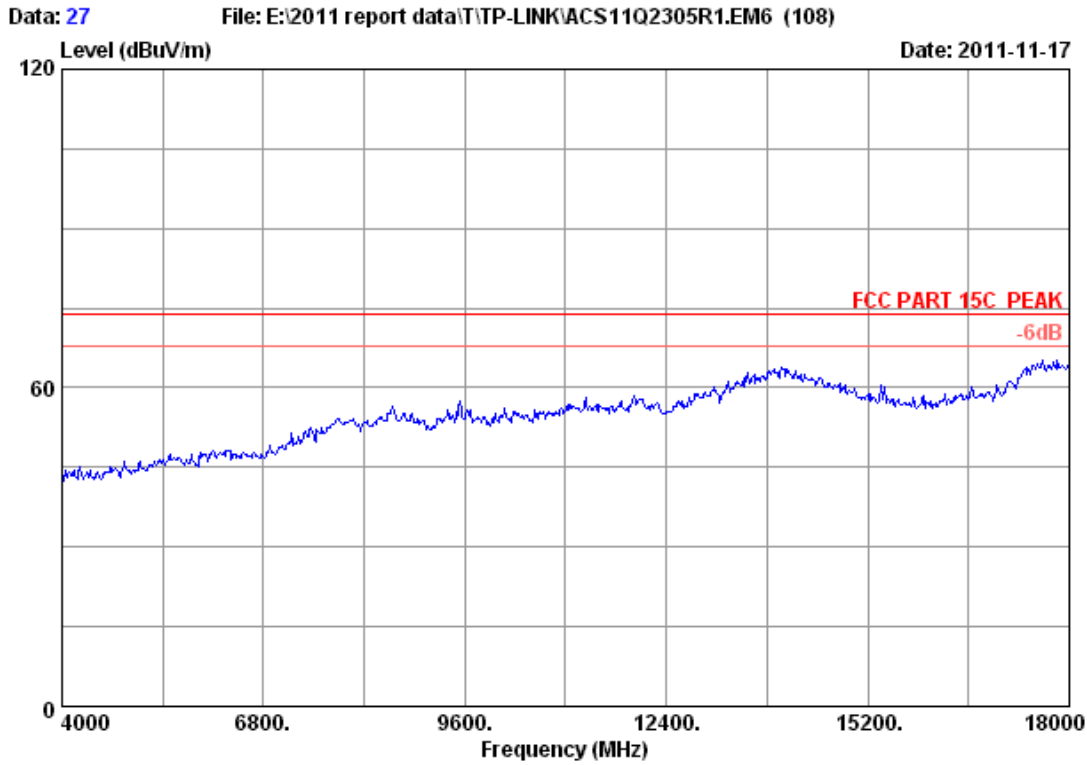

Site no. : 3m Chamber Data no. : 27
Dis. / Ant. : 3m 3115(0911) Ant. pol. : VERTICAL
Limit : FCC PART 15C PEAK
Env. / Ins. : 23°C/54% Engineer : Leo-Li
EUT : 300Mbps Wireless N Range Extender
Power : DC 12V From Adapter input AC 120V/60Hz
Test mode : IEEE802.11g CH6 2437MHz Tx
M/N : TL-WA830RE

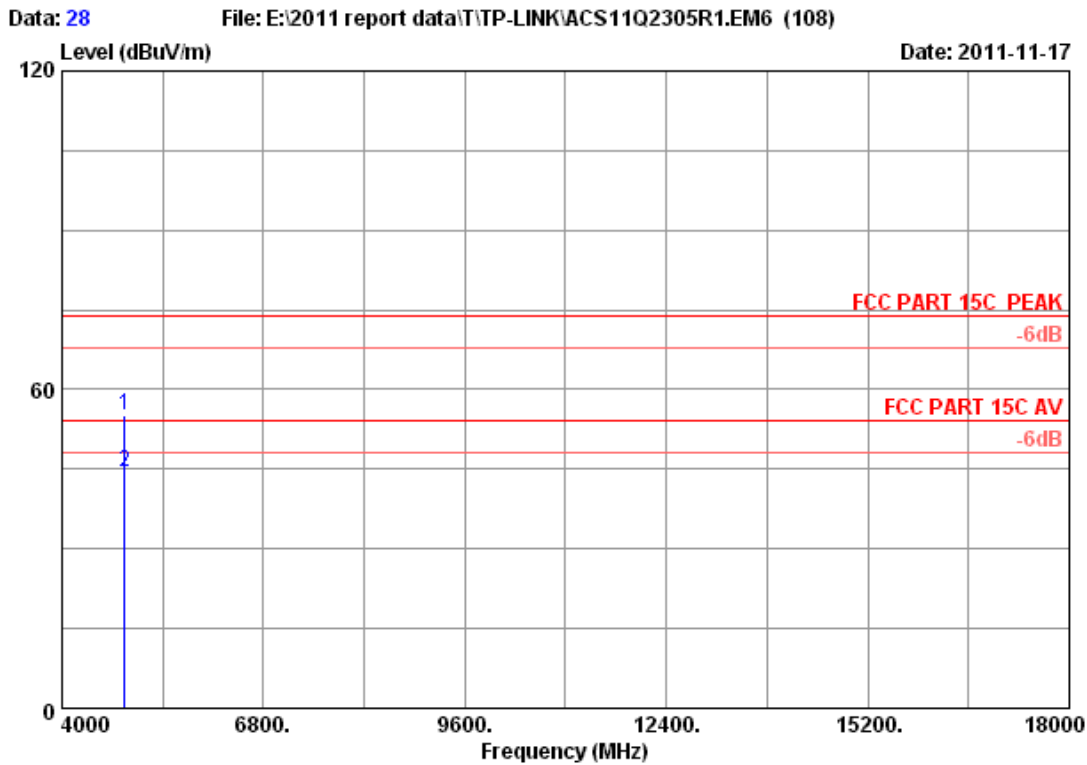

Site no. : 3m Chamber Data no. : 28
 Dis. / Ant. : 3m 3115(0911) Ant. pol. : VERTICAL
 Limit : FCC PART 15C PEAK
 Env. / Ins. : 23°C/54% Engineer : Leo-Li
 EUT : 300Mbps Wireless N Range Extender
 Power : DC 12V From Adapter input AC 120V/60Hz
 Test mode : IEEE802.11g CH6 2437MHz Tx
 M/N : TL-WA830RE

	Ant. Factor	Cable loss	Amp. Factor	Reading	Emission Level	Limits	Margin	Remark
Freq. (MHz)	(dB/m)	(dB)	(dB)	(dBUV)	(dBUV/m)	dBUV/m)	(dB)	
1 4874.000	34.41	12.44	35.36	43.61	55.10	74.00	18.90	Peak
2 4874.000	34.41	12.44	35.36	32.95	44.44	54.00	9.56	Average

Remarks:
 1. Emission Level= Antenna Factor + Cable Loss -Amp Factor + Reading.
 2. The emission levels that are 20dB below the official limit are not reported.

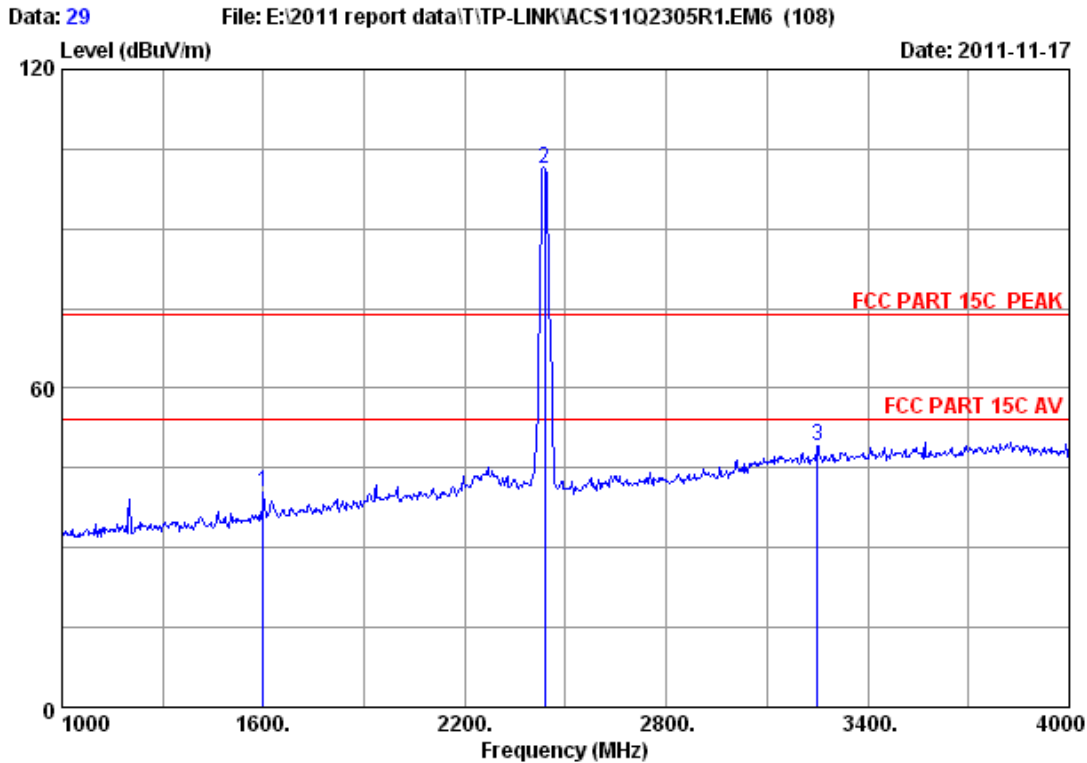

Site no. : 3m Chamber Data no. : 29
 Dis. / Ant. : 3m 3115(0911) Ant. pol. : HORIZONTAL
 Limit : FCC PART 15C PEAK
 Env. / Ins. : 23°C/54% Engineer : Leo-Li
 EUT : 300Mbps Wireless N Range Extender
 Power : DC 12V From Adapter input AC 120V/60Hz
 Test mode : IEEE802.11g CH6 2437MHz Tx
 M/N : TL-WA830RE

	Ant.	Cable	Amp.	Emission					
Freq. (MHz)	Factor (dB/m)	loss (dB)	Factor (dB)	Reading (dBuV)	Level (dBuV/m)	Limits (dBuV/m)	Margin (dB)	Remark	
1	1600.000	26.96	6.98	36.43	42.97	40.48	74.00	33.52	Peak
2	2437.000	29.47	8.77	36.06	99.26	101.44	74.00	-27.44	Peak
3	3250.000	32.63	10.28	35.68	42.07	49.30	74.00	24.70	Peak

Remarks:

1. Emission Level= Antenna Factor + Cable Loss -Amp Factor + Reading.
2. The emission levels that are 20dB below the official limit are not reported.

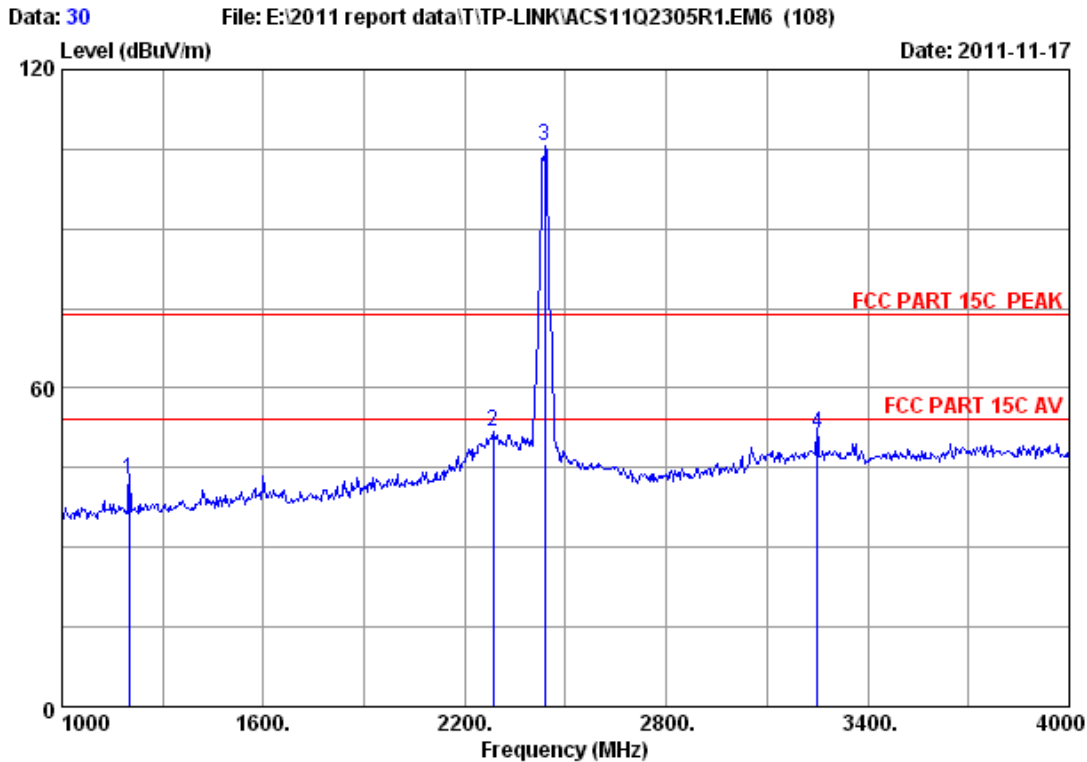

```

Site no.      : 3m Chamber           Data no. : 30
Dis. / Ant.  : 3m 3115(0911)        Ant. pol.: VERTICAL
Limit        : FCC PART 15C PEAK
Env. / Ins.  : 23°C/54%             Engineer : Leo-Li
EUT          : 300Mbps Wireless N Range Extender
Power        : DC 12V From Adapter input AC 120V/60Hz
Test mode    : IEEE802.11g CH6 2437MHz Tx
M/N         : TL-WA830RE
    
```

	Freq. (MHz)	Ant. Factor (dB/m)	Cable loss (dB)	Amp. Factor (dB)	Reading (dBuV)	Emission			Remark
						Level (dBuV/m)	Limits (dBuV/m)	Margin (dB)	
1	1201.000	25.81	5.98	36.97	47.88	42.70	74.00	31.30	Peak
2	2284.000	29.38	8.47	35.92	50.01	51.94	74.00	22.06	Peak
3	2437.000	29.47	8.77	36.06	103.33	105.51	74.00	-31.51	Peak
4	3250.000	32.63	10.28	35.68	44.40	51.63	74.00	22.37	Peak

Remarks:

1. Emission Level= Antenna Factor + Cable Loss -Amp Factor + Reading.
2. The emission levels that are 20dB below the official limit are not reported.

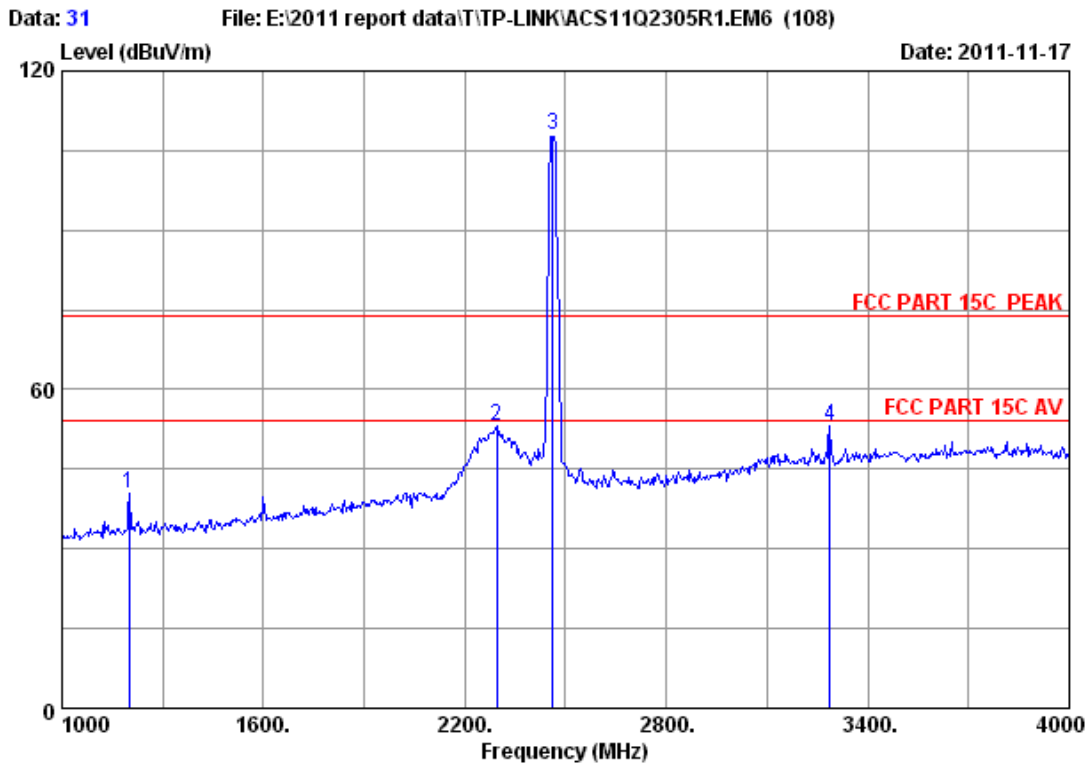

Site no. : 3m Chamber Data no. : 31
 Dis. / Ant. : 3m 3115(0911) Ant. pol. : VERTICAL
 Limit : FCC PART 15C PEAK
 Env. / Ins. : 23°C/54% Engineer : Leo-Li
 EUT : 300Mbps Wireless N Range Extender
 Power : DC 12V From Adapter input AC 120V/60Hz
 Test mode : IEEE802.11g CH11 2462MHz Tx
 M/N : TL-WA830RE

	Ant.	Cable	Amp.	Emission					
Freq. (MHz)	Factor (dB/m)	loss (dB)	Factor (dB)	Reading (dBuV)	Level (dBuV/m)	Limits (dBuV/m)	Margin (dB)	Remark	
1	1201.000	25.81	5.98	36.97	45.70	40.52	74.00	33.48	Peak
2	2296.000	29.38	8.47	35.92	51.05	52.98	74.00	21.02	Peak
3	2462.000	29.48	8.82	36.02	105.52	107.80	74.00	-33.80	Peak
4	3286.000	32.72	10.32	35.79	45.87	53.12	74.00	20.88	Peak

Remarks:

1. Emission Level= Antenna Factor + Cable Loss -Amp Factor + Reading.
2. The emission levels that are 20dB below the official limit are not reported.

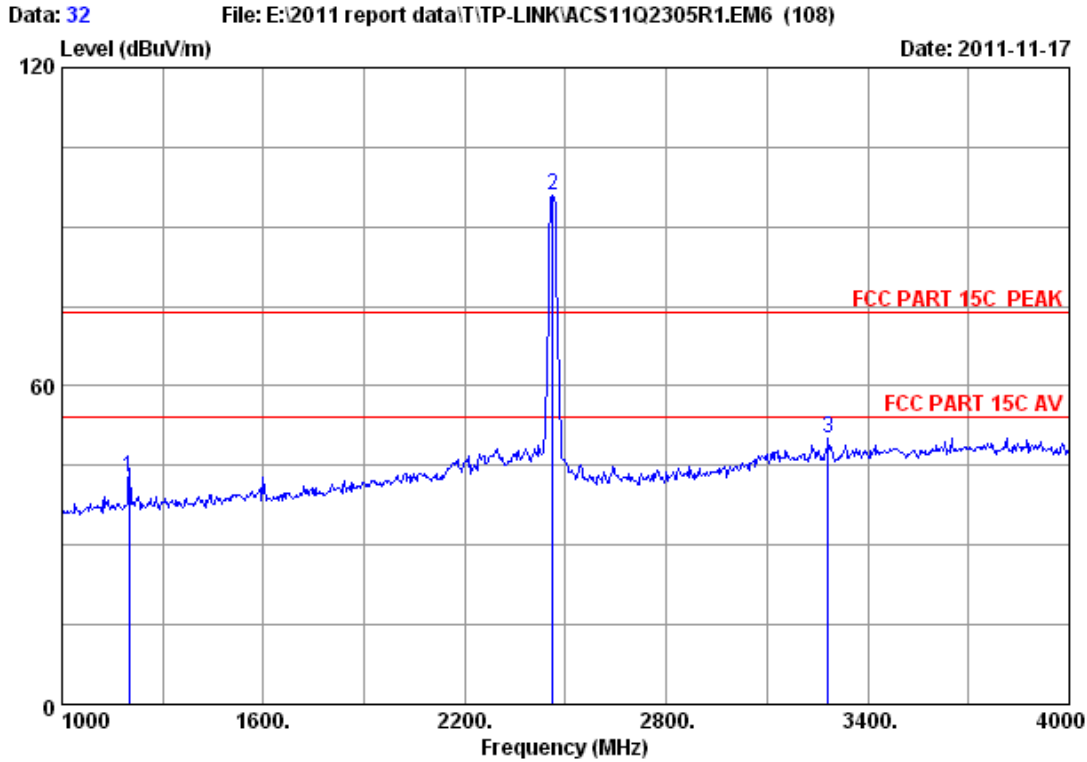

Site no. : 3m Chamber Data no. : 32
 Dis. / Ant. : 3m 3115(0911) Ant. pol. : HORIZONTAL
 Limit : FCC PART 15C PEAK
 Env. / Ins. : 23°C/54% Engineer : Leo-Li
 EUT : 300Mbps Wireless N Range Extender
 Power : DC 12V From Adapter input AC 120V/60Hz
 Test mode : IEEE802.11g CH11 2462MHz Tx
 M/N : TL-WA830RE

	Ant. Freq. (MHz)	Ant. Factor (dB/m)	Cable loss (dB)	Amp. Factor (dB)	Reading (dBuV)	Emission Level (dBuV/m)	Limits (dBuV/m)	Margin (dB)	Remark
1	1201.000	25.81	5.98	36.97	47.95	42.77	74.00	31.23	Peak
2	2462.000	29.48	8.82	36.02	93.52	95.80	74.00	-21.80	Peak
3	3283.000	32.72	10.32	35.79	42.83	50.08	74.00	23.92	Peak

Remarks:
 1. Emission Level= Antenna Factor + Cable Loss -Amp Factor + Reading.
 2. The emission levels that are 20dB below the official limit are not reported.

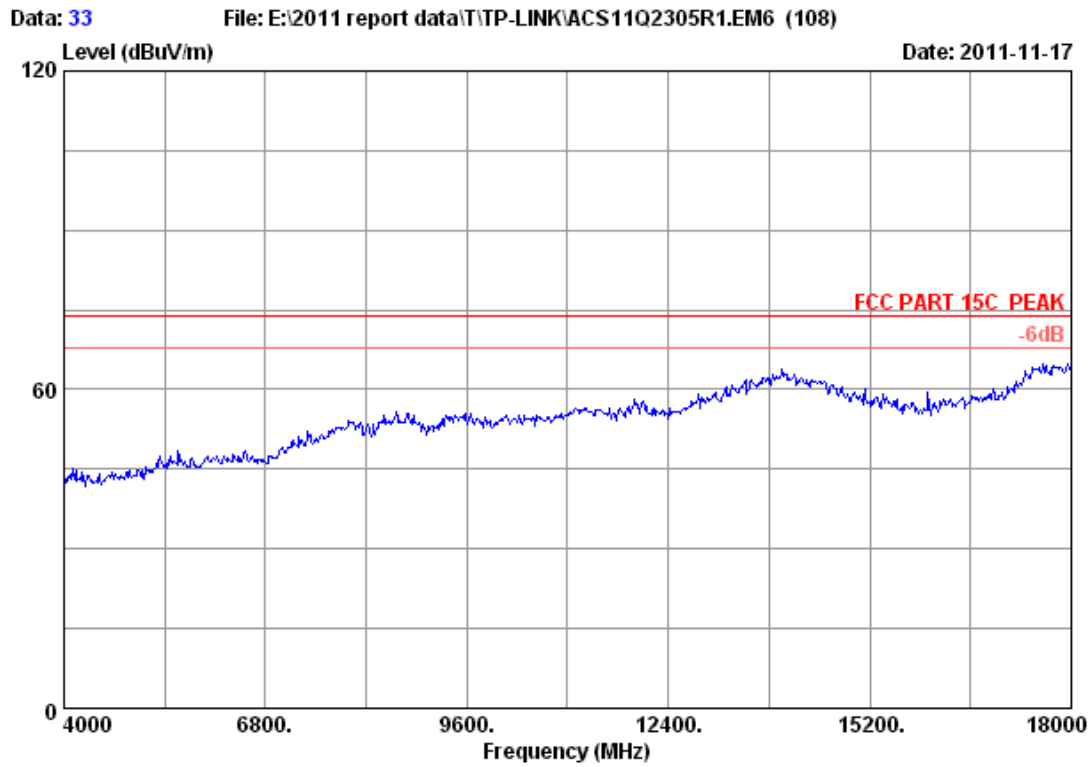

```

Site no.      : 3m Chamber           Data no. : 33
Dis. / Ant.  : 3m 3115(0911)       Ant. pol.: VERTICAL
Limit        : FCC PART 15C PEAK
Env. / Ins.  : 23*C/54%           Engineer : Leo-Li
EUT          : 300Mbps Wireless N Range Extender
Power        : DC 12V From Adapter input AC 120V/60Hz
Test mode    : IEEE802.11g CH11 2462MHz Tx
M/N          : TL-WA830RE
    
```

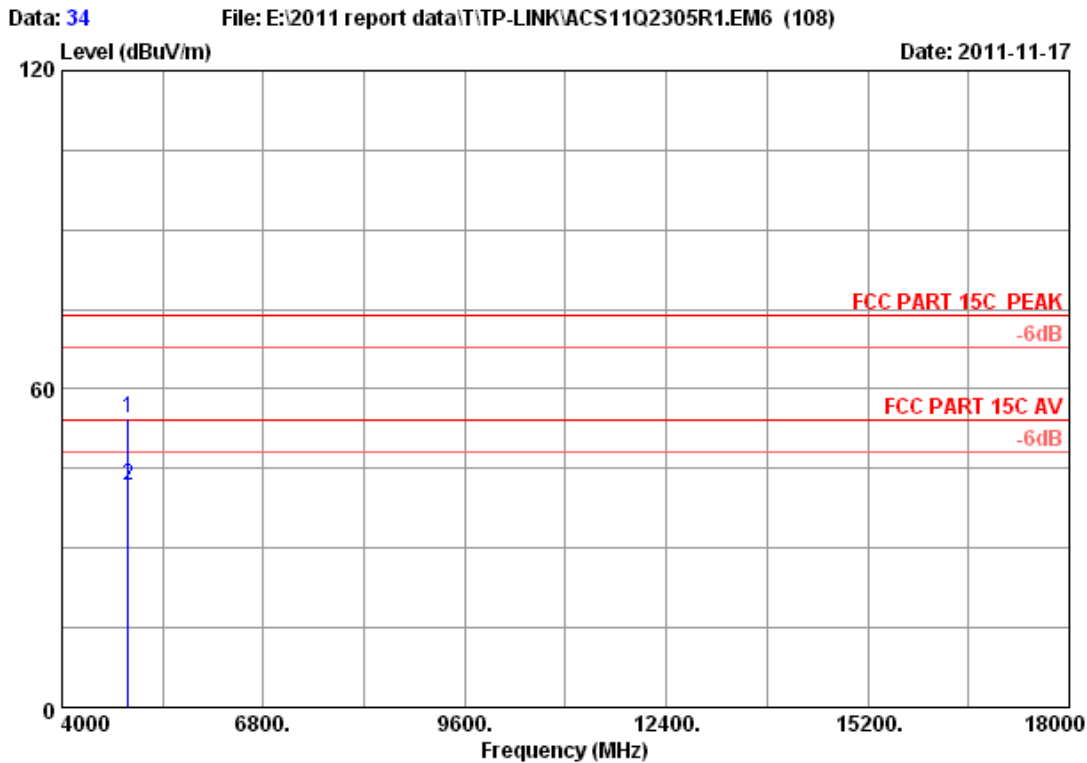

Site no. : 3m Chamber Data no. : 34
 Dis. / Ant. : 3m 3115(0911) Ant. pol. : VERTICAL
 Limit : FCC PART 15C PEAK
 Env. / Ins. : 23°C/54% Engineer : Leo-Li
 EUT : 300Mbps Wireless N Range Extender
 Power : DC 12V From Adapter input AC 120V/60Hz
 Test mode : IEEE802.11g CH11 2462MHz Tx
 M/N : TL-WA830RE

	Ant. Freq. (MHz)	Ant. Factor (dB/m)	Cable loss (dB)	Amp. Factor (dB)	Reading (dBuV)	Emission Level (dBuV/m)	Limits (dBuV/m)	Margin (dB)	Remark
1	4924.000	34.49	12.50	35.34	42.96	54.61	74.00	19.39	Peak
2	4924.000	34.49	12.50	35.34	30.16	41.81	54.00	12.19	Average

Remarks:
 1. Emission Level= Antenna Factor + Cable Loss -Amp Factor + Reading.
 2. The emission levels that are 20dB below the official limit are not reported.

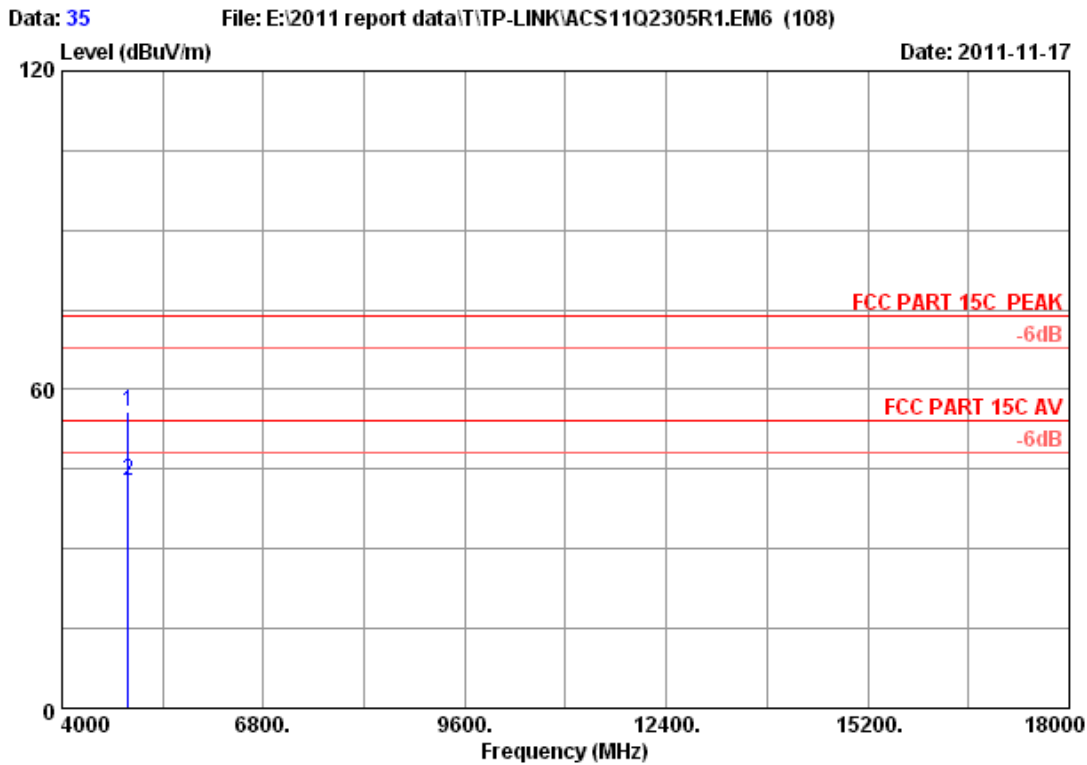

Site no. : 3m Chamber Data no. : 35
 Dis. / Ant. : 3m 3115(0911) Ant. pol. : HORIZONTAL
 Limit : FCC PART 15C PEAK
 Env. / Ins. : 23°C/54% Engineer : Leo-Li
 EUT : 300Mbps Wireless N Range Extender
 Power : DC 12V From Adapter input AC 120V/60Hz
 Test mode : IEEE802.11g CH11 2462MHz Tx
 M/N : TL-WA830RE

	Ant. Freq. (MHz)	Ant. Factor (dB/m)	Cable loss (dB)	Amp. Factor (dB)	Reading (dBUV)	Emission Level (dBUV/m)	Limits (dBUV/m)	Margin (dB)	Remark
1	4924.000	34.49	12.50	35.34	44.18	55.83	74.00	18.17	Peak
2	4924.000	34.49	12.50	35.34	31.21	42.86	54.00	11.14	Average

Remarks:

1. Emission Level= Antenna Factor + Cable Loss -Amp Factor + Reading.
2. The emission levels that are 20dB below the official limit are not reported.

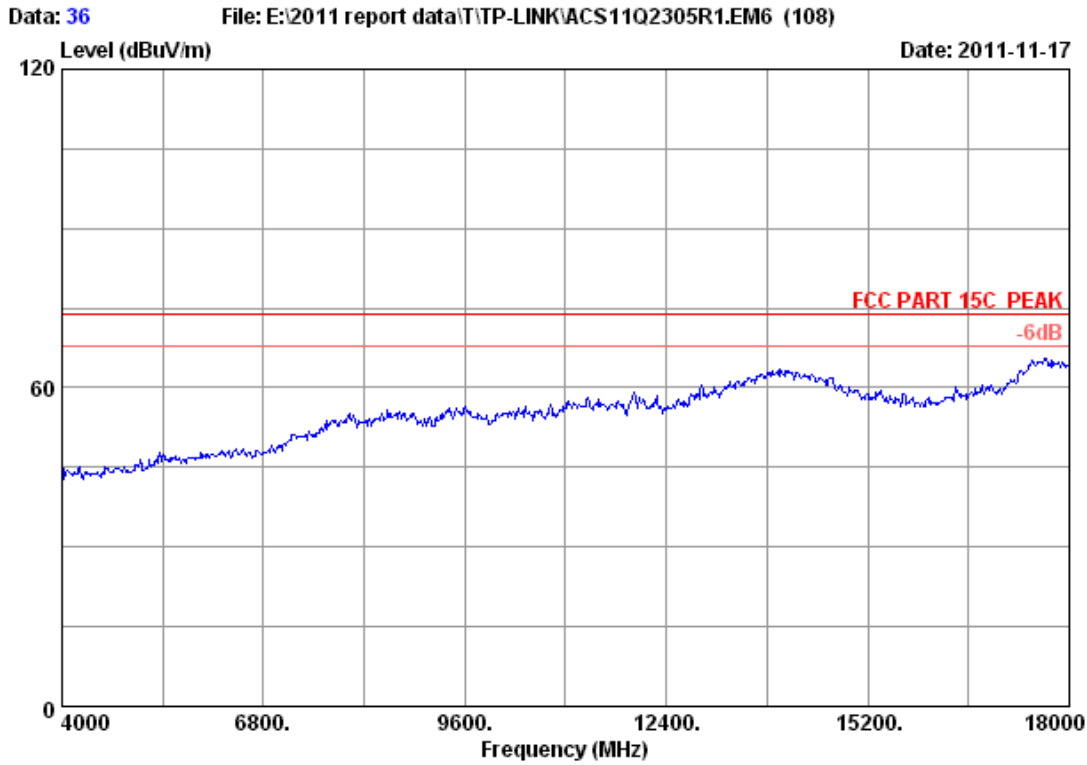

Site no. : 3m Chamber Data no. : 36
Dis. / Ant. : 3m 3115(0911) Ant. pol. : HORIZONTAL
Limit : FCC PART 15C PEAK
Env. / Ins. : 23°C/54% Engineer : Leo-Li
EUT : 300Mbps Wireless N Range Extender
Power : DC 12V From Adapter input AC 120V/60Hz
Test mode : IEEE802.11g CH11 2462MHz Tx
M/N : TL-WA830RE

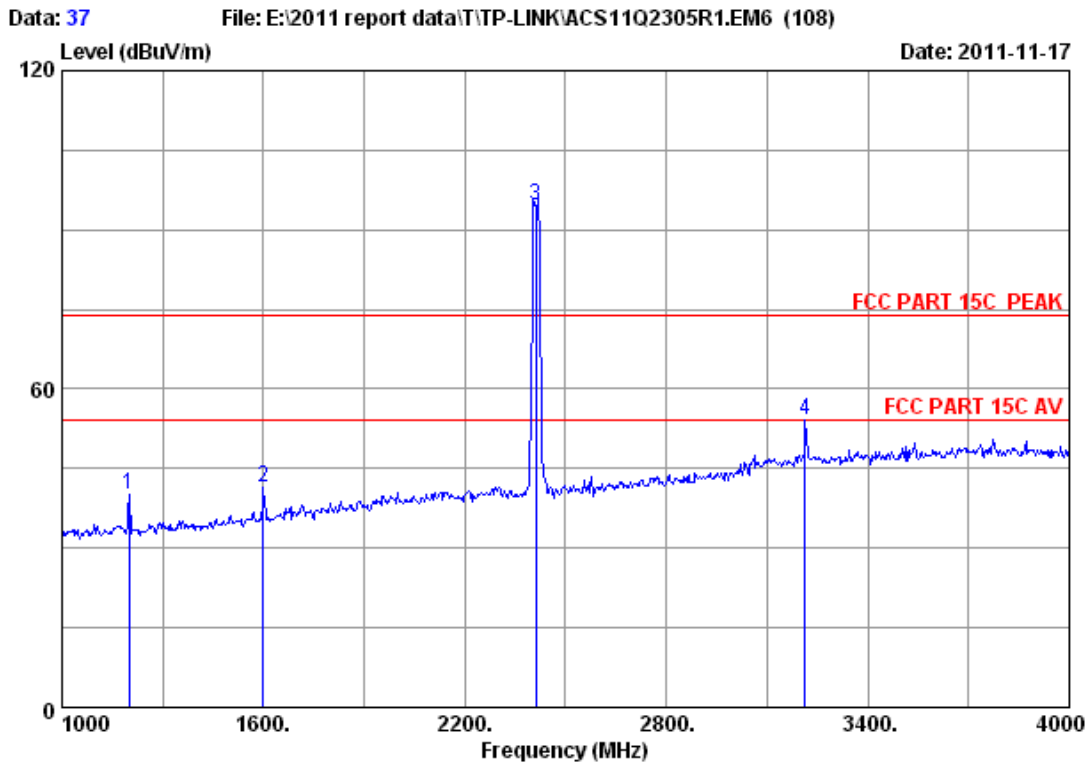

Site no. : 3m Chamber Data no. : 37
 Dis. / Ant. : 3m 3115(0911) Ant. pol. : HORIZONTAL
 Limit : FCC PART 15C PEAK
 Env. / Ins. : 23°C/54% Engineer : Leo-Li
 EUT : 300Mbps Wireless N Range Extender
 Power : DC 12V From Adapter input AC 120V/60Hz
 Test mode : IEEE802.11nHT20 CH1 2412MHz Tx
 M/N : TL-WA830RE

	Ant. Freq. (MHz)	Ant. Factor (dB/m)	Cable loss (dB)	Amp. Factor (dB)	Reading (dBuV)	Emission Level (dBuV/m)	Limits (dBuV/m)	Margin (dB)	Remark
1	1201.000	25.81	5.98	36.97	45.42	40.24	74.00	33.76	Peak
2	1600.000	26.96	6.98	36.43	43.80	41.31	74.00	32.69	Peak
3	2412.000	29.45	8.72	35.95	92.35	94.57	74.00	-20.57	Peak
4	3214.000	32.54	10.21	35.86	47.32	54.21	74.00	19.79	Peak

Remarks:

1. Emission Level= Antenna Factor + Cable Loss -Amp Factor + Reading.
2. The emission levels that are 20dB below the official limit are not reported.

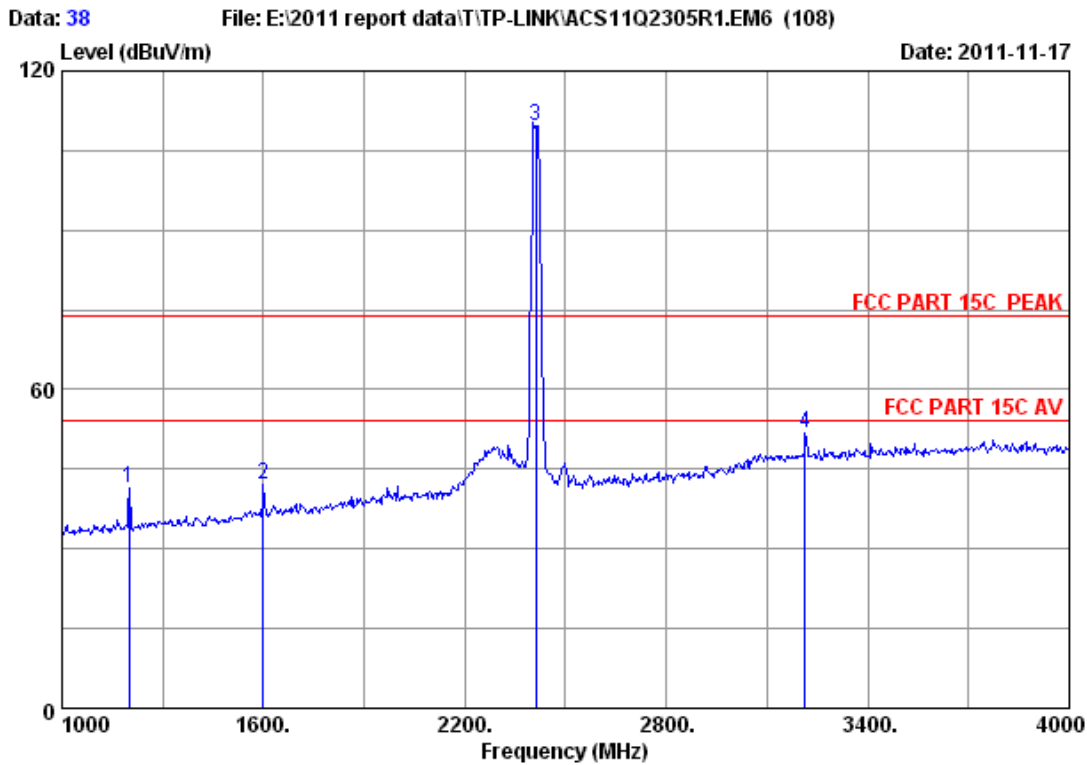

Site no. : 3m Chamber Data no. : 38
 Dis. / Ant. : 3m 3115(0911) Ant. pol. : VERTICAL
 Limit : FCC PART 15C PEAK
 Env. / Ins. : 23°C/54% Engineer : Leo-Li
 EUT : 300Mbps Wireless N Range Extender
 Power : DC 12V From Adapter input AC 120V/60Hz
 Test mode : IEEE802.11nHT20 CH1 2412MHz Tx
 M/N : TL-WA830RE

	Ant.	Cable	Amp.	Emission					
Freq.	Factor	loss	Factor	Reading	Level	Limits	Margin	Remark	
(MHz)	(dB/m)	(dB)	(dB)	(dBUV)	(dBUV/m)	dBUV/m)	(dB)		
1	1201.000	25.81	5.98	36.97	46.61	41.43	74.00	32.57	Peak
2	1600.000	26.96	6.98	36.43	44.47	41.98	74.00	32.02	Peak
3	2412.000	29.45	8.72	35.95	107.31	109.53	74.00	-35.53	Peak
4	3214.000	32.54	10.21	35.86	44.81	51.70	74.00	22.30	Peak

Remarks:

1. Emission Level= Antenna Factor + Cable Loss -Amp Factor + Reading.
2. The emission levels that are 20dB below the official limit are not reported.

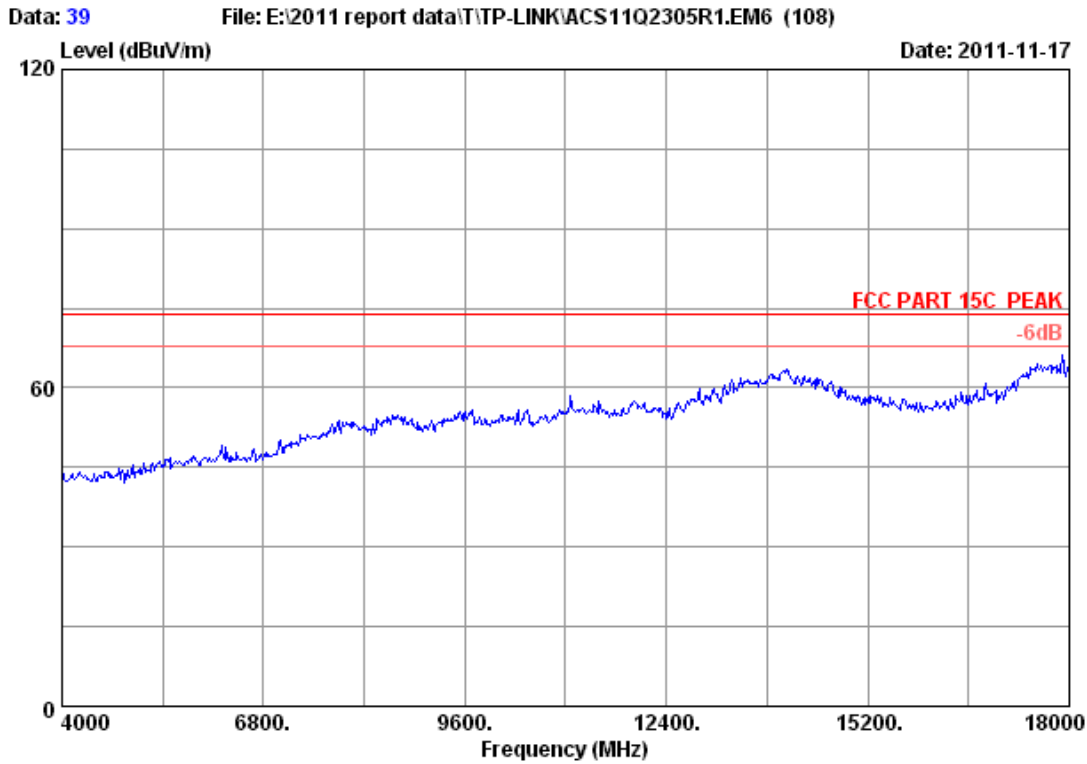

Site no. : 3m Chamber Data no. : 39
Dis. / Ant. : 3m 3115(0911) Ant. pol. : VERTICAL
Limit : FCC PART 15C PEAK
Env. / Ins. : 23°C/54% Engineer : Leo-Li
EUT : 300Mbps Wireless N Range Extender
Power : DC 12V From Adapter input AC 120V/60Hz
Test mode : IEEE802.11nHT20 CH1 2412MHz Tx
M/N : TL-WA830RE

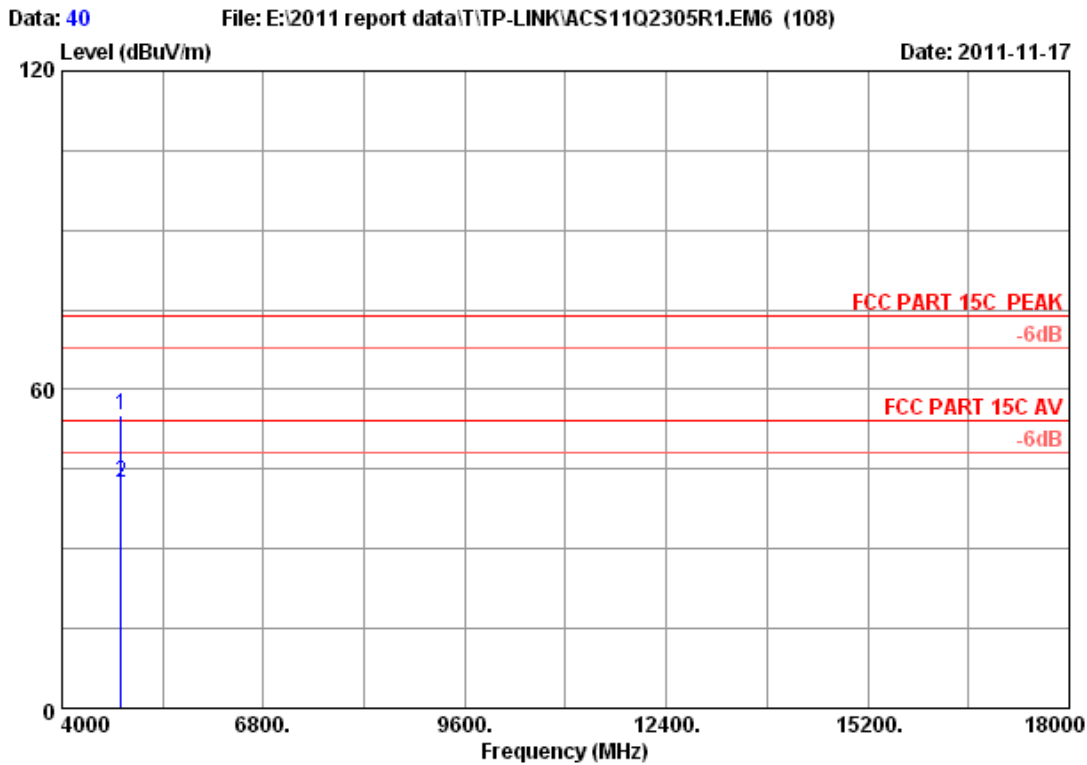

Site no. : 3m Chamber Data no. : 40
 Dis. / Ant. : 3m 3115(0911) Ant. pol. : VERTICAL
 Limit : FCC PART 15C PEAK
 Env. / Ins. : 23°C/54% Engineer : Leo-Li
 EUT : 300Mbps Wireless N Range Extender
 Power : DC 12V From Adapter input AC 120V/60Hz
 Test mode : IEEE802.11nHT20 CH1 2412MHz Tx
 M/N : TL-WA830RE

	Ant. Freq. (MHz)	Ant. Factor (dB/m)	Cable loss (dB)	Amp. Factor (dB)	Reading (dBUV)	Emission Level (dBUV/m)	Limits (dBUV/m)	Margin (dB)	Remark
1	4824.000	34.32	12.38	35.25	43.72	55.17	74.00	18.83	Peak
2	4824.000	34.32	12.38	35.25	30.96	42.41	54.00	11.59	Average

Remarks:
 1. Emission Level= Antenna Factor + Cable Loss -Amp Factor + Reading.
 2. The emission levels that are 20dB below the official limit are not reported.

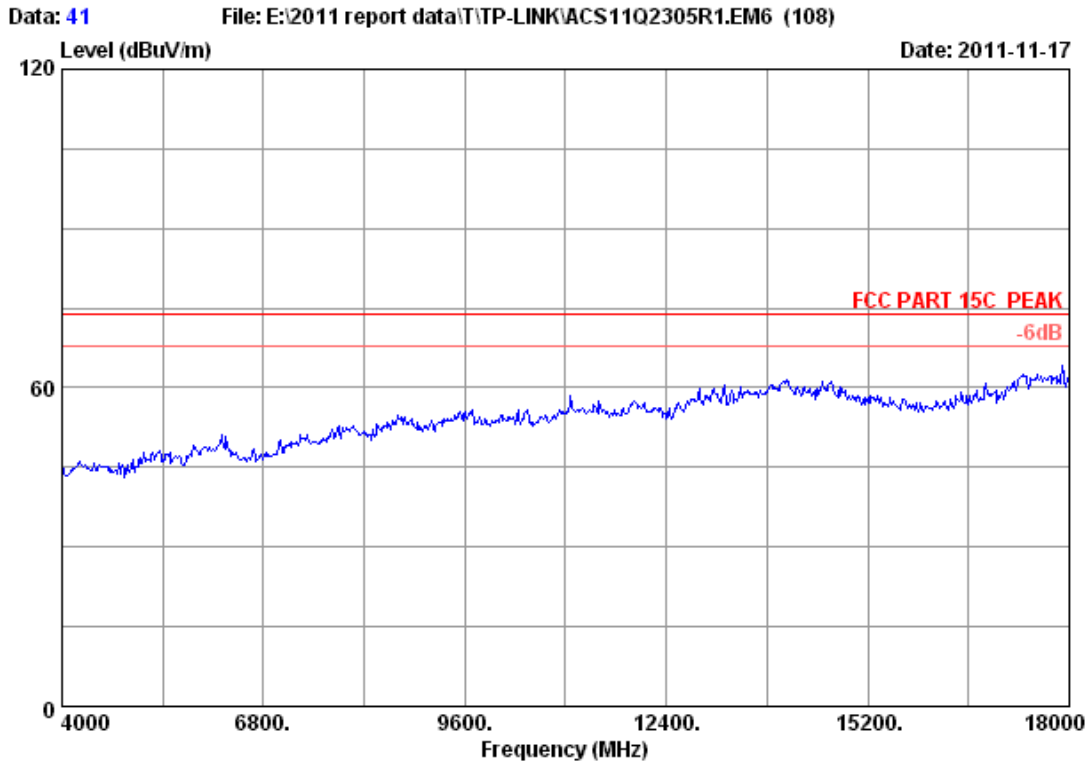

Site no.	: 3m Chamber	Data no. :	41
Dis. / Ant.	: 3m 3115(0911)	Ant. pol. :	HORIZONTAL
Limit	: FCC PART 15C PEAK		
Env. / Ins.	: 23°C/54%	Engineer :	Leo-Li
EUT	: 300Mbps Wireless N Range Extender		
Power	: DC 12V From Adapter input AC 120V/60Hz		
Test mode	: IEEE802.11nHT20 CH1 2412MHz Tx		
M/N	: TL-WA830RE		

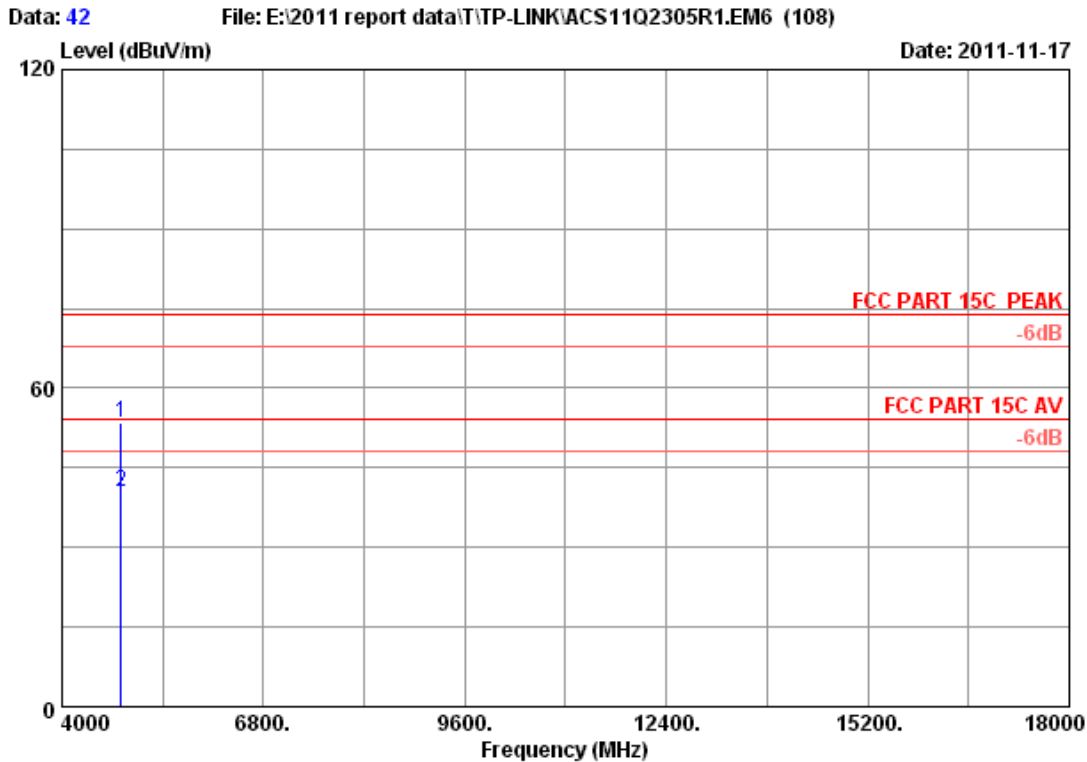

Site no. : 3m Chamber Data no. : 42
 Dis. / Ant. : 3m 3115(0911) Ant. pol. : HORIZONTAL
 Limit : FCC PART 15C PEAK
 Env. / Ins. : 23°C/54% Engineer : Leo-Li
 EUT : 300Mbps Wireless N Range Extender
 Power : DC 12V From Adapter input AC 120V/60Hz
 Test mode : IEEE802.11nHT20 CH1 2412MHz Tx
 M/N : TL-WA830RE

	Freq. (MHz)	Ant. Factor (dB/m)	Cable loss (dB)	Amp. Factor (dB)	Reading (dBuV)	Emission			Remark
						Level (dBuV/m)	Limits (dBuV/m)	Margin (dB)	
1	4824.000	34.32	12.38	35.25	42.14	53.59	74.00	20.41	Peak
2	4824.000	34.32	12.38	35.25	29.05	40.50	54.00	13.50	Average

Remarks:

1. Emission Level= Antenna Factor + Cable Loss -Amp Factor + Reading.
2. The emission levels that are 20dB below the official limit are not reported.

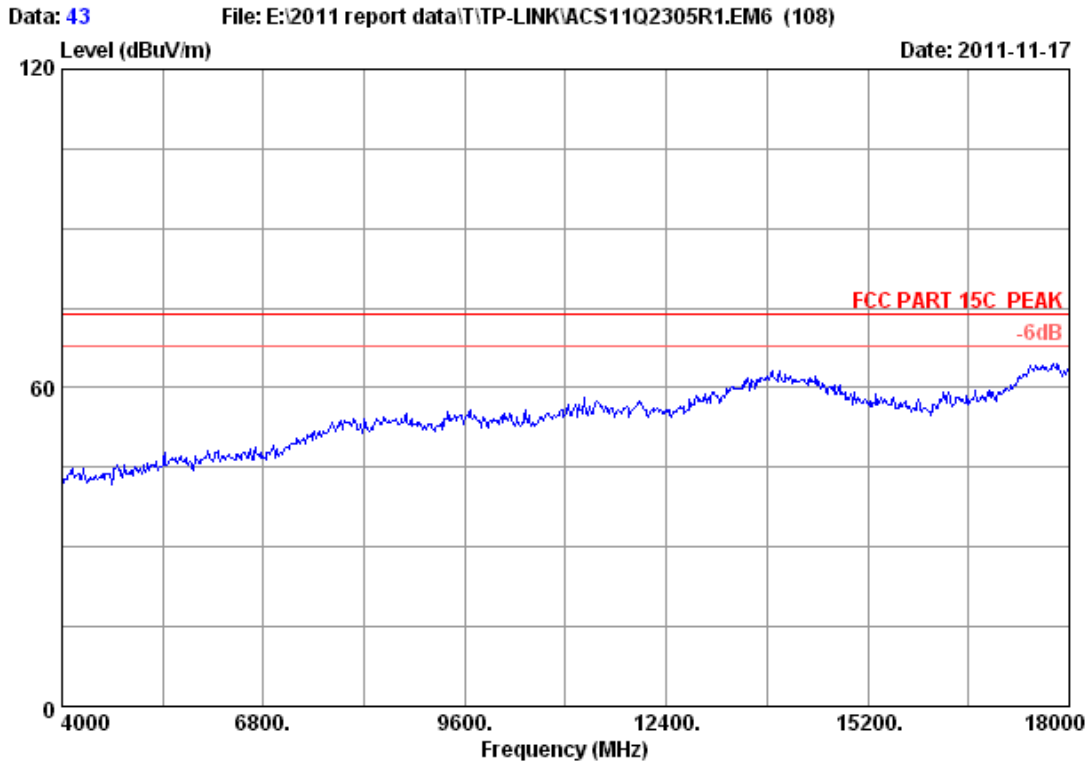

Site no. : 3m Chamber Data no. : 43
Dis. / Ant. : 3m 3115(0911) Ant. pol. : VERTICAL
Limit : FCC PART 15C PEAK
Env. / Ins. : 23°C/54% Engineer : Leo-Li
EUT : 300Mbps Wireless N Range Extender
Power : DC 12V From Adapter input AC 120V/60Hz
Test mode : IEEE802.11nHT20 CH6 2437MHz Tx
M/N : TL-WA830RE

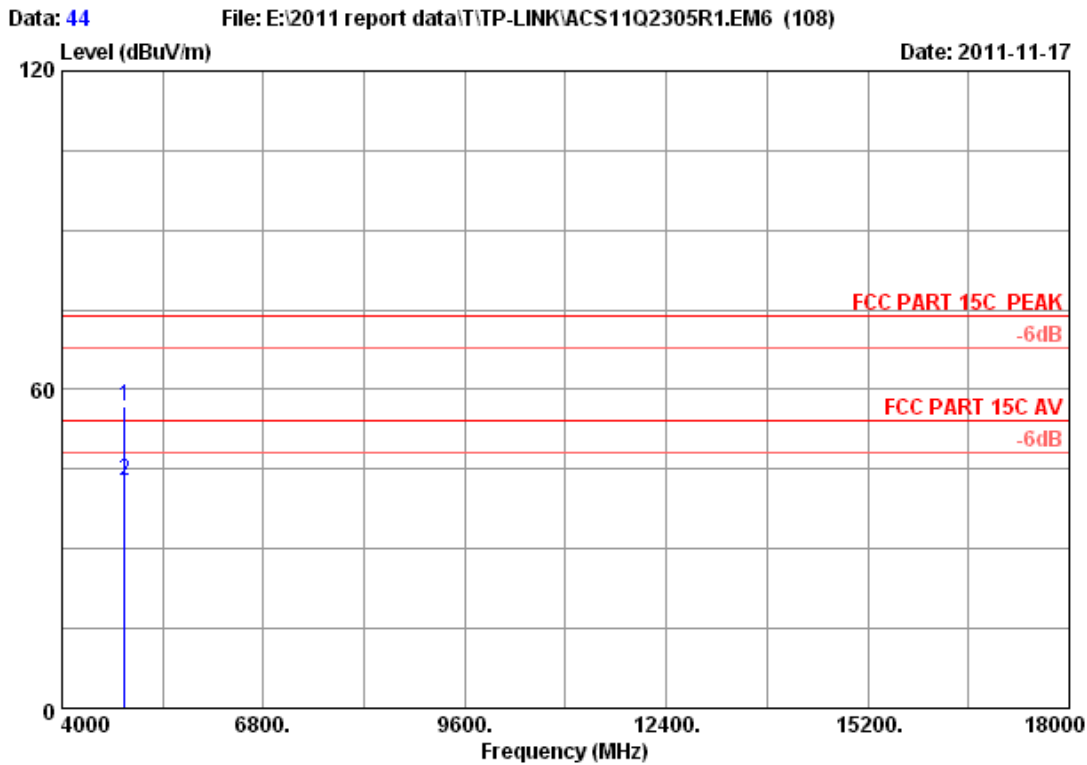

Site no. : 3m Chamber Data no. : 44
 Dis. / Ant. : 3m 3115(0911) Ant. pol. : VERTICAL
 Limit : FCC PART 15C PEAK
 Env. / Ins. : 23°C/54% Engineer : Leo-Li
 EUT : 300Mbps Wireless N Range Extender
 Power : DC 12V From Adapter input AC 120V/60Hz
 Test mode : IEEE802.11nHT20 CH6 2437MHz Tx
 M/N : TL-WA830RE

	Ant. Factor	Cable loss	Amp. Factor	Reading	Emission Level	Limits	Margin	Remark	
1	(dB/m)	(dB)	(dB)	(dBUV)	(dBUV/m)	dBUV/m)	(dB)		
1	4874.000	34.41	12.44	35.36	45.20	56.69	74.00	17.31	Peak
2	4874.000	34.41	12.44	35.36	31.24	42.73	54.00	11.27	Average

Remarks:
 1. Emission Level= Antenna Factor + Cable Loss -Amp Factor + Reading.
 2. The emission levels that are 20dB below the official limit are not reported.

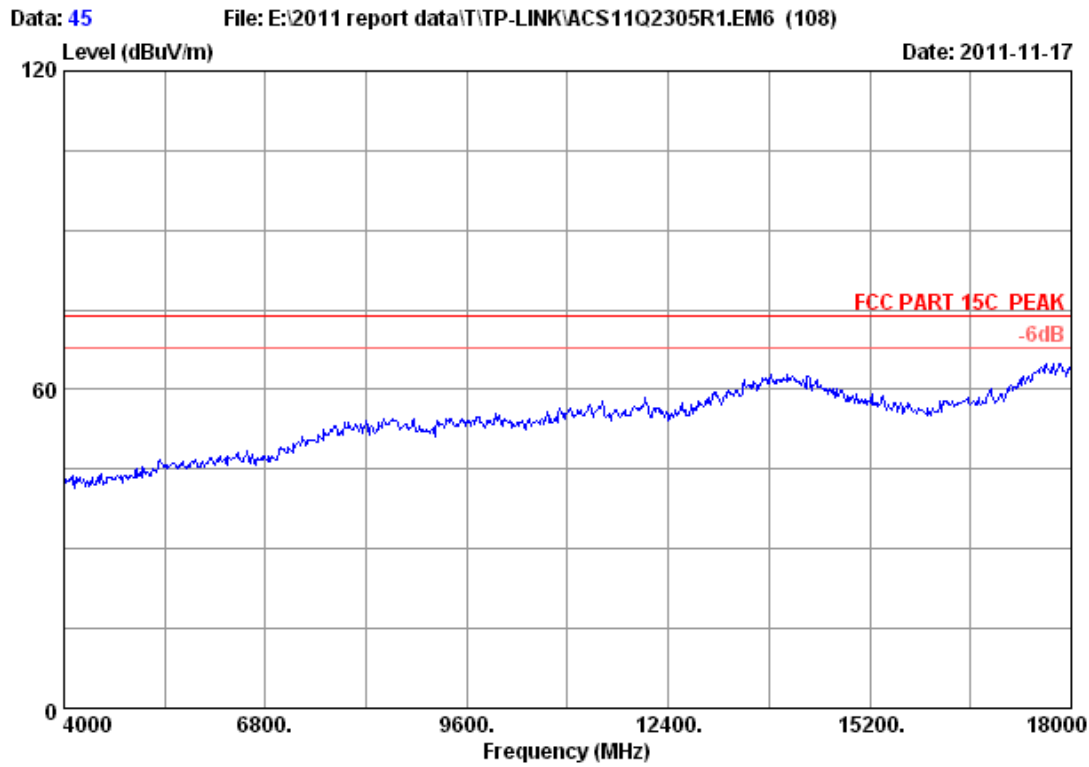

Site no. : 3m Chamber Data no. : 45
Dis. / Ant. : 3m 3115(0911) Ant. pol. : HORIZONTAL
Limit : FCC PART 15C PEAK
Env. / Ins. : 23°C/54% Engineer : Leo-Li
EUT : 300Mbps Wireless N Range Extender
Power : DC 12V From Adapter input AC 120V/60Hz
Test mode : IEEE802.11nHT20 CH6 2437MHz Tx
M/N : TL-WA830RE

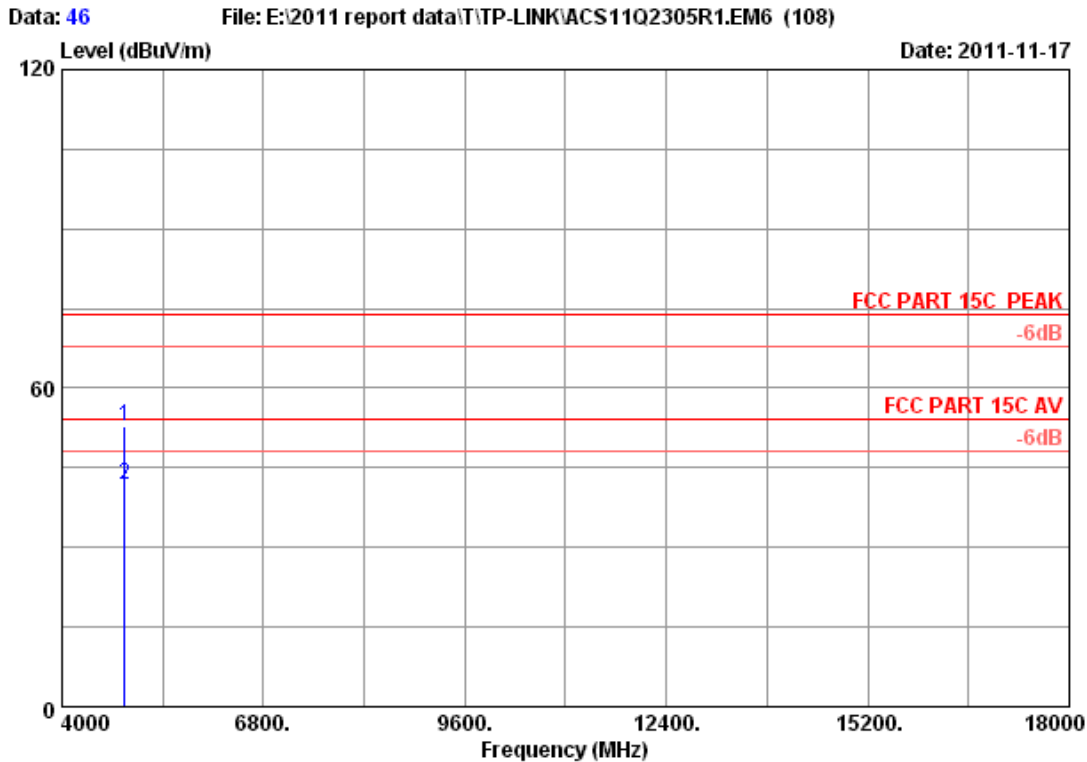

Site no. : 3m Chamber Data no. : 46
 Dis. / Ant. : 3m 3115(0911) Ant. pol. : HORIZONTAL
 Limit : FCC PART 15C PEAK
 Env. / Ins. : 23°C/54% Engineer : Leo-Li
 EUT : 300Mbps Wireless N Range Extender
 Power : DC 12V From Adapter input AC 120V/60Hz
 Test mode : IEEE802.11nHT20 CH6 2437MHz Tx
 M/N : TL-WA830RE

	Freq. (MHz)	Ant. Factor (dB/m)	Cable loss (dB)	Amp. Factor (dB)	Reading (dBuV)	Emission			Remark
						Level (dBuV/m)	Limits (dBuV/m)	Margin (dB)	
1	4874.000	34.41	12.44	35.36	41.34	52.83	74.00	21.17	Peak
2	4874.000	34.41	12.44	35.36	30.28	41.77	54.00	12.23	Average

Remarks:

1. Emission Level= Antenna Factor + Cable Loss -Amp Factor + Reading.
2. The emission levels that are 20dB below the official limit are not reported.

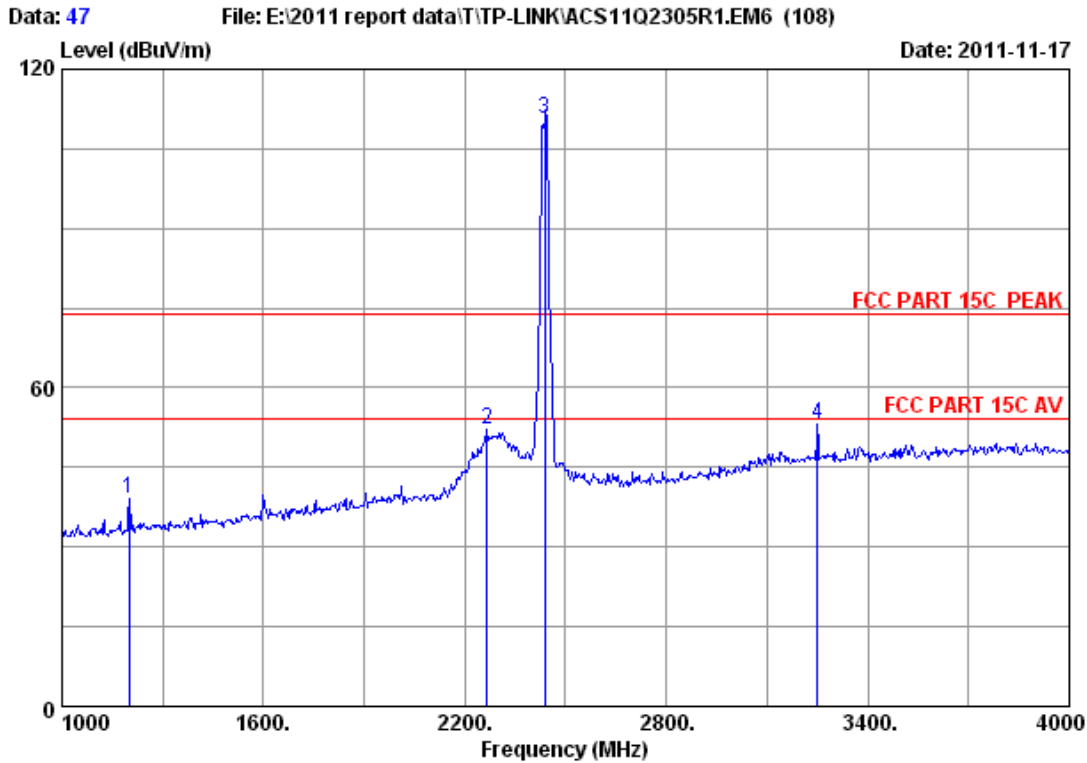

```

Site no.      : 3m Chamber           Data no. : 47
Dis. / Ant.  : 3m 3115(0911)       Ant. pol.: VERTICAL
Limit        : FCC PART 15C PEAK
Env. / Ins.  : 23°C/54%           Engineer : Leo-Li
EUT          : 300Mbps Wireless N Range Extender
Power        : DC 12V From Adapter input AC 120V/60Hz
Test mode    : IEEE802.11nHT20 CH6 2437MHz Tx
M/N         : TL-WA830RE
    
```

	Ant. Freq. (MHz)	Ant. Factor (dB/m)	Cable loss (dB)	Amp. Factor (dB)	Reading (dBuV)	Emission Level (dBuV/m)	Limits (dBuV/m)	Margin (dB)	Remark
1	1201.000	25.81	5.98	36.97	44.44	39.26	74.00	34.74	Peak
2	2266.000	29.36	8.42	35.85	50.24	52.17	74.00	21.83	Peak
3	2437.000	29.47	8.77	36.06	108.46	110.64	74.00	-36.64	Peak
4	3250.000	32.63	10.28	35.68	46.06	53.29	74.00	20.71	Peak

Remarks:

1. Emission Level= Antenna Factor + Cable Loss -Amp Factor + Reading.
2. The emission levels that are 20dB below the official limit are not reported.

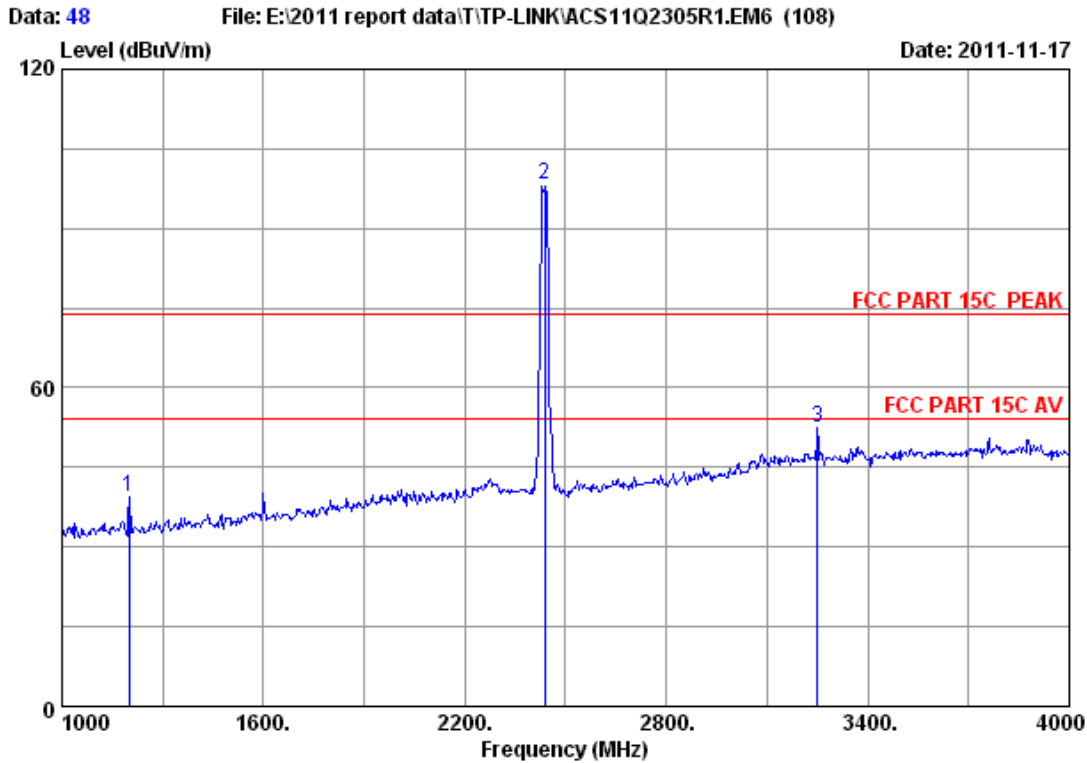

```

Site no.      : 3m Chamber           Data no. : 48
Dis. / Ant.  : 3m 3115(0911)        Ant. pol.: HORIZONTAL
Limit        : FCC PART 15C PEAK
Env. / Ins.  : 23°C/54%             Engineer : Leo-Li
EUT         : 300Mbps Wireless N Range Extender
Power       : DC 12V From Adapter input AC 120V/60Hz
Test mode   : IEEE802.11nHT20 CH6 2437MHz Tx
M/N        : TL-WA830RE
    
```

	Ant. Freq. (MHz)	Ant. Factor (dB/m)	Cable loss (dB)	Amp. Factor (dB)	Reading (dBuV)	Emission Level (dBuV/m)	Limits (dBuV/m)	Margin (dB)	Remark
1	1201.000	25.81	5.98	36.97	44.76	39.58	74.00	34.42	Peak
2	2437.000	29.47	8.77	36.06	96.19	98.37	74.00	-24.37	Peak
3	3250.000	32.63	10.28	35.68	45.36	52.59	74.00	21.41	Peak

Remarks:

1. Emission Level= Antenna Factor + Cable Loss -Amp Factor + Reading.
2. The emission levels that are 20dB below the official limit are not reported.

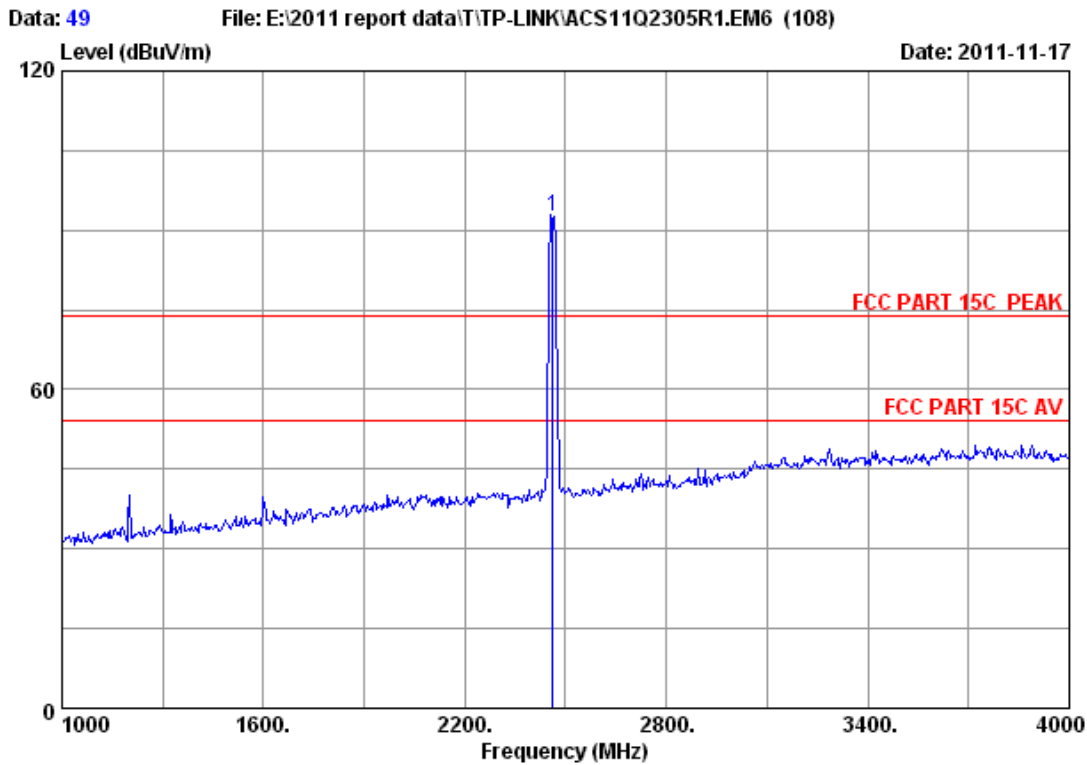

```

Site no.      : 3m Chamber           Data no. : 49
Dis. / Ant.  : 3m 3115(0911)       Ant. pol. : HORIZONTAL
Limit        : FCC PART 15C PEAK
Env. / Ins.  : 23*C/54%           Engineer  : Leo-Li
EUT         : 300Mbps Wireless N Range Extender
Power       : DC 12V From Adapter input AC 120V/60Hz
Test mode   : IEEE802.11nHT20 CH11 2462MHz Tx
M/N        : TL-WA830RE
    
```

	Ant.	Cable	Amp.	Emission				
Freq.	Factor	loss	Factor	Reading	Level	Limits	Margin	Remark
(MHz)	(dB/m)	(dB)	(dB)	(dBuV)	(dBuV/m)	(dBuV/m)	(dB)	
1 2462.000	29.48	8.82	36.02	90.36	92.64	74.00	-18.64	Peak

Remarks:

1. Emission Level= Antenna Factor + Cable Loss -Amp Factor + Reading.
2. The emission levels that are 20dB below the official limit are not reported.

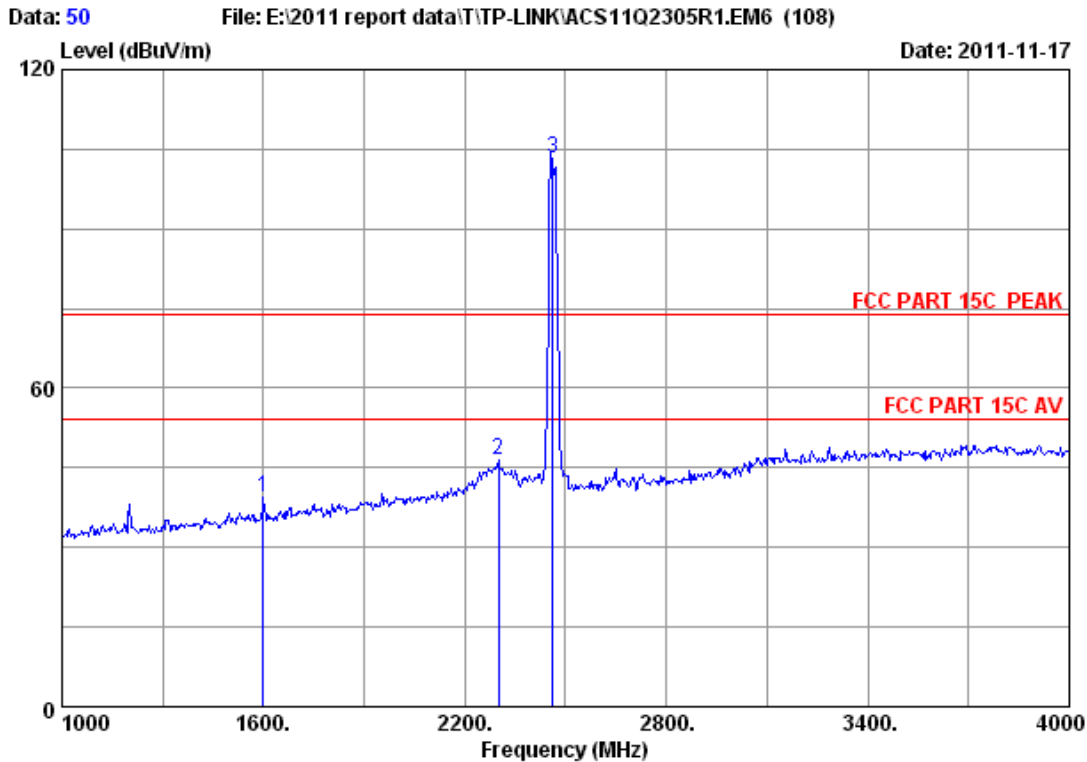

Site no. : 3m Chamber Data no. : 50
 Dis. / Ant. : 3m 3115(0911) Ant. pol. : VERTICAL
 Limit : FCC PART 15C PEAK
 Env. / Ins. : 23°C/54% Engineer : Leo-Li
 EUT : 300Mbps Wireless N Range Extender
 Power : DC 12V From Adapter input AC 120V/60Hz
 Test mode : IEEE802.11nHT20 CH11 2462MHz Tx
 M/N : TL-WA830RE

No.	Freq. (MHz)	Ant. Factor (dB/m)	Cable loss (dB)	Amp. Factor (dB)	Reading (dBuV)	Emission			Remark
						Level (dBuV/m)	Limits (dBuV/m)	Margin (dB)	
1	1600.000	26.96	6.98	36.43	41.79	39.30	74.00	34.70	Peak
2	2299.000	29.38	8.52	35.92	44.32	46.30	74.00	27.70	Peak
3	2462.000	29.48	8.82	36.02	100.96	103.24	74.00	-29.24	Peak

Remarks:

1. Emission Level= Antenna Factor + Cable Loss -Amp Factor + Reading.
2. The emission levels that are 20dB below the official limit are not reported.

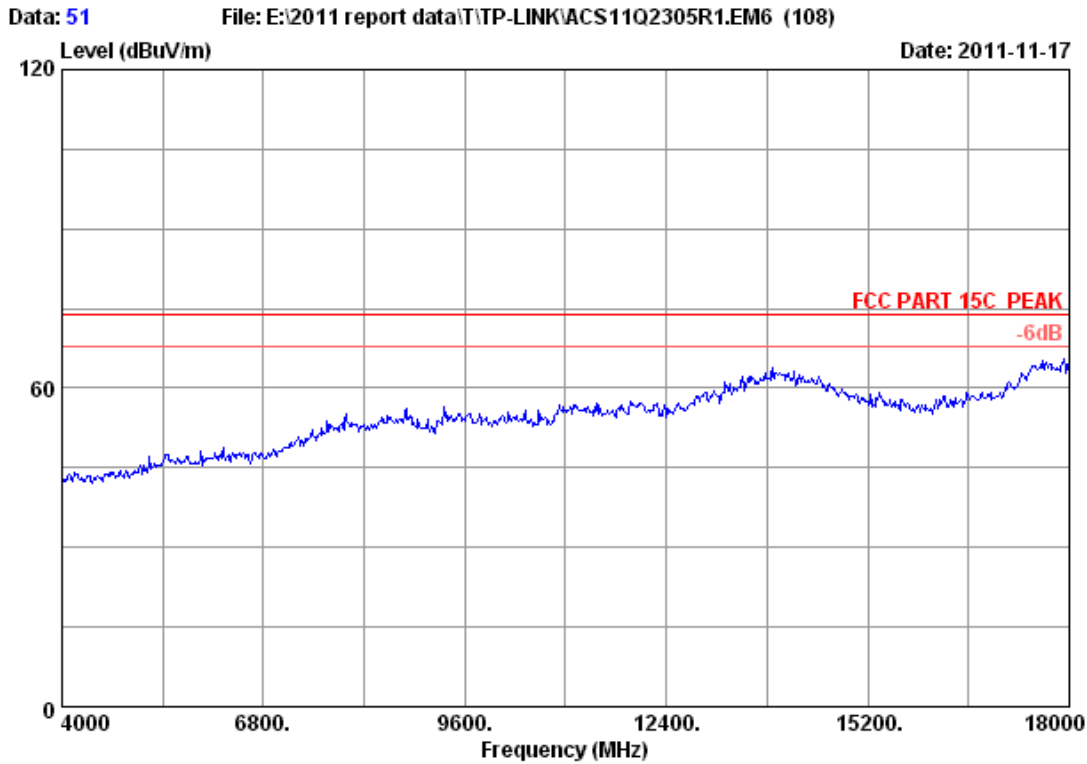

Site no. : 3m Chamber Data no. : 51
Dis. / Ant. : 3m 3115(0911) Ant. pol. : VERTICAL
Limit : FCC PART 15C PEAK
Env. / Ins. : 23°C/54% Engineer : Leo-Li
EUT : 300Mbps Wireless N Range Extender
Power : DC 12V From Adapter input AC 120V/60Hz
Test mode : IEEE802.11nHT20 CH11 2462MHz Tx
M/N : TL-WA830RE

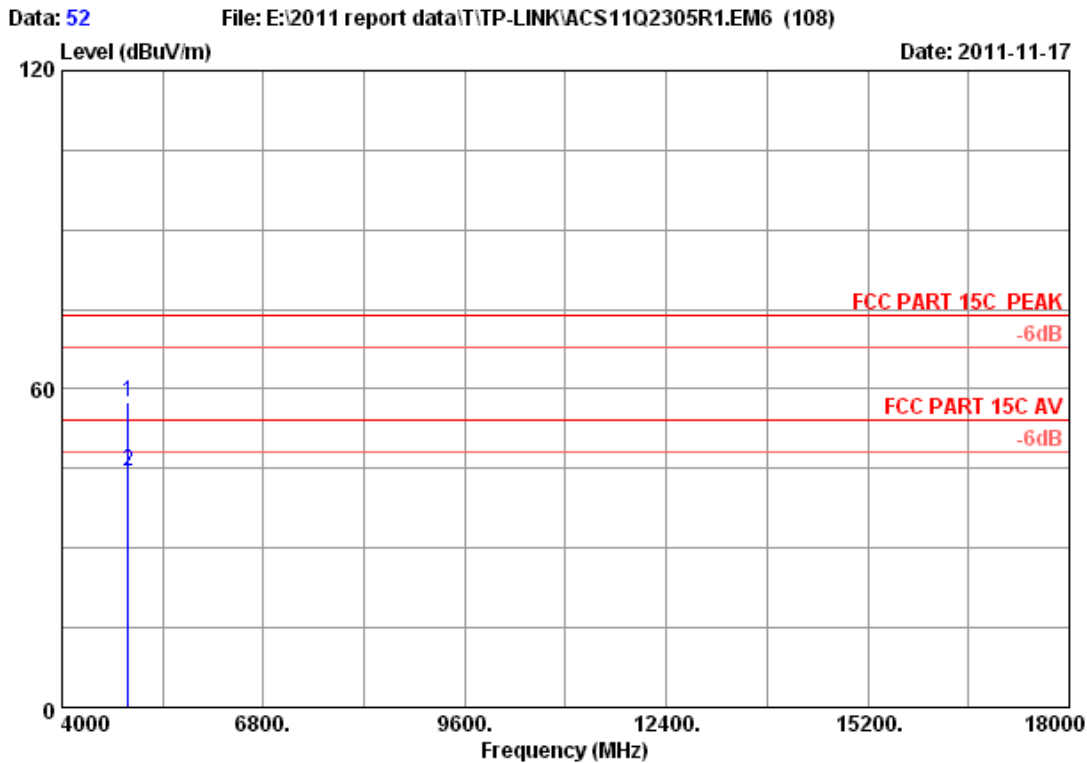

Site no. : 3m Chamber Data no. : 52
 Dis. / Ant. : 3m 3115(0911) Ant. pol. : VERTICAL
 Limit : FCC PART 15C PEAK
 Env. / Ins. : 23°C/54% Engineer : Leo-Li
 EUT : 300Mbps Wireless N Range Extender
 Power : DC 12V From Adapter input AC 120V/60Hz
 Test mode : IEEE802.11nHT20 CH11 2462MHz Tx
 M/N : TL-WA830RE

	Ant. Freq. (MHz)	Ant. Factor (dB/m)	Cable loss (dB)	Amp. Factor (dB)	Reading (dBuV)	Emission Level (dBuV/m)	Limits (dBuV/m)	Margin (dB)	Remark
1	4924.000	34.49	12.50	35.34	45.91	57.56	74.00	16.44	Peak
2	4924.000	34.49	12.50	35.34	32.73	44.38	54.00	9.62	Average

Remarks:
 1. Emission Level= Antenna Factor + Cable Loss -Amp Factor + Reading.
 2. The emission levels that are 20dB below the official limit are not reported.

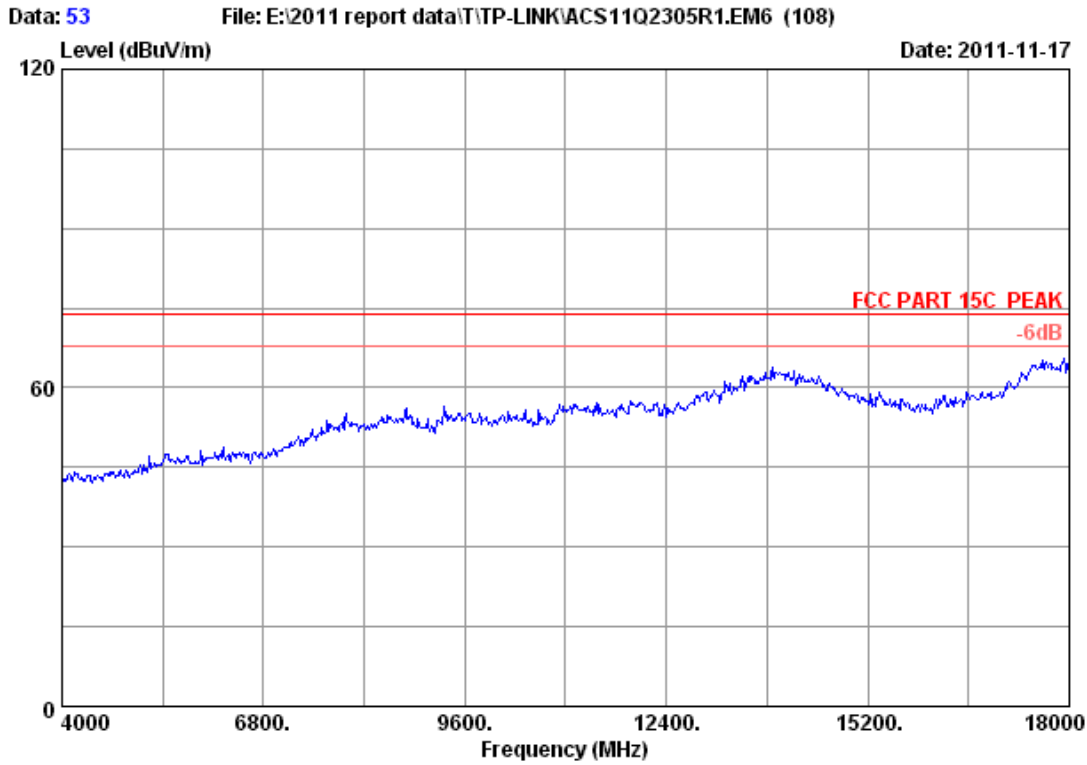

Site no. : 3m Chamber Data no. : 53
Dis. / Ant. : 3m 3115(0911) Ant. pol. : HORIZONTAL
Limit : FCC PART 15C PEAK
Env. / Ins. : 23°C/54% Engineer : Leo-Li
EUT : 300Mbps Wireless N Range Extender
Power : DC 12V From Adapter input AC 120V/60Hz
Test mode : IEEE802.11nHT20 CH11 2462MHz Tx
M/N : TL-WA830RE

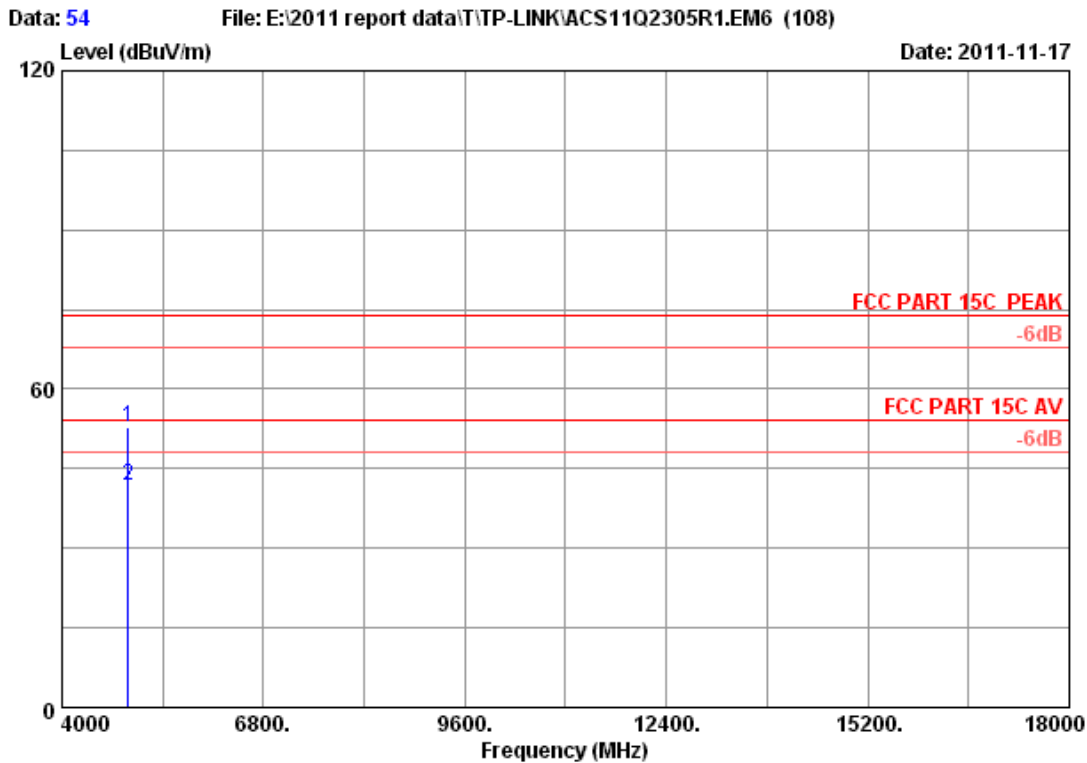

Site no. : 3m Chamber Data no. : 54
 Dis. / Ant. : 3m 3115(0911) Ant. pol. : HORIZONTAL
 Limit : FCC PART 15C PEAK
 Env. / Ins. : 23°C/54% Engineer : Leo-Li
 EUT : 300Mbps Wireless N Range Extender
 Power : DC 12V From Adapter input AC 120V/60Hz
 Test mode : IEEE802.11nHT20 CH11 2462MHz Tx
 M/N : TL-WA830RE

	Ant.	Cable	Amp.	Emission				
Freq. (MHz)	Factor (dB/m)	loss (dB)	Factor (dB)	Reading (dBuV)	Level (dBuV/m)	Limits (dBuV/m)	Margin (dB)	Remark
1 4924.000	34.49	12.50	35.34	41.26	52.91	74.00	21.09	Peak
2 4924.000	34.49	12.50	35.34	30.15	41.80	54.00	12.20	Average

Remarks:
 1. Emission Level= Antenna Factor + Cable Loss -Amp Factor + Reading.
 2. The emission levels that are 20dB below the official limit are not reported.

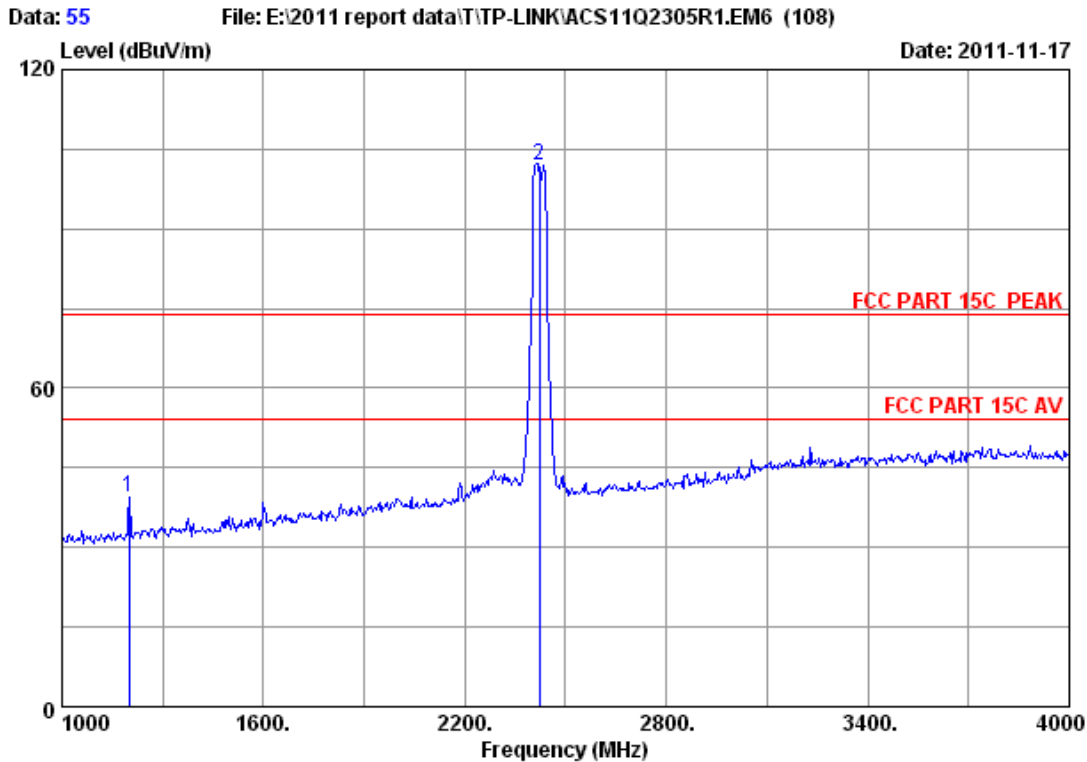

```

Site no.      : 3m Chamber           Data no. : 55
Dis. / Ant.  : 3m 3115(0911)        Ant. pol.: VERTICAL
Limit        : FCC PART 15C PEAK
Env. / Ins.  : 23°C/54%             Engineer : Leo-Li
EUT          : 300Mbps Wireless N Range Extender
Power        : DC 12V From Adapter input AC 120V/60Hz
Test mode    : IEEE802.11nHT40 CH1 2422MHz Tx
M/N          : TL-WA830RE
    
```

	Ant.	Cable	Amp.	Emission					
Freq. (MHz)	Factor (dB/m)	loss (dB)	Factor (dB)	Reading (dBuV)	Level (dBuV/m)	Limits (dBuV/m)	Margin (dB)	Remark	
1	1201.000	25.81	5.98	36.97	44.61	39.43	74.00	34.57	Peak
2	2422.000	29.46	8.77	36.01	99.68	101.90	74.00	-27.90	Peak

Remarks:

1. Emission Level= Antenna Factor + Cable Loss -Amp Factor + Reading.
2. The emission levels that are 20dB below the official limit are not reported.

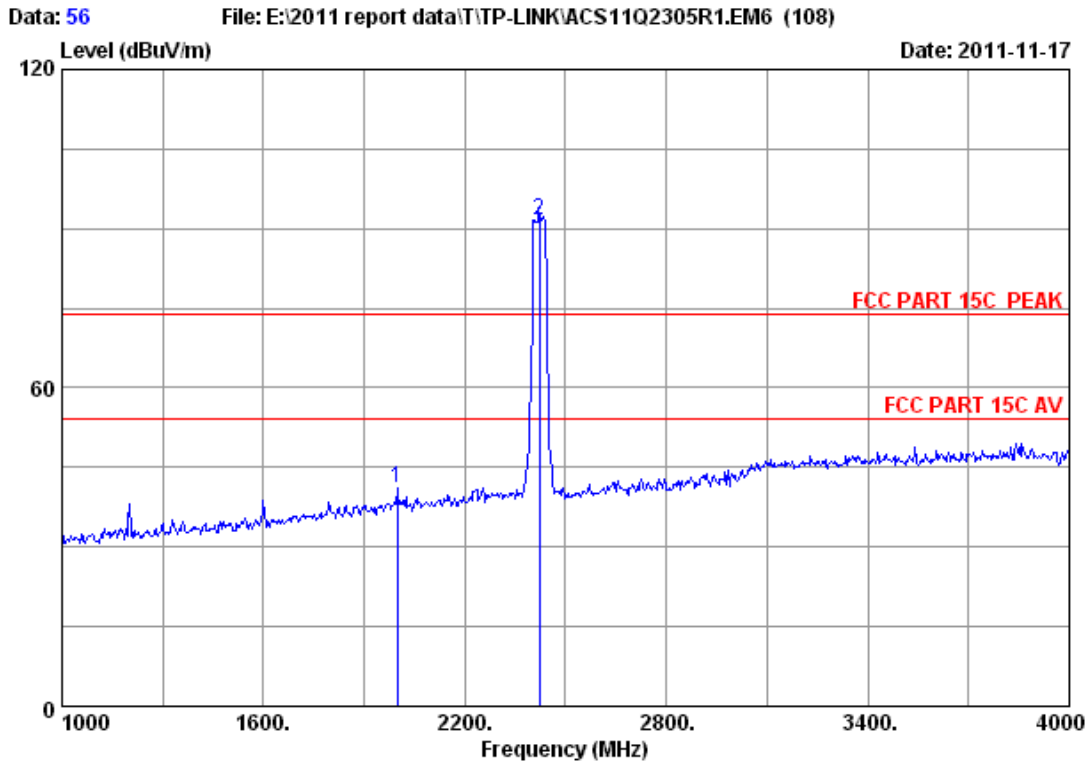

Site no. : 3m Chamber Data no. : 56
 Dis. / Ant. : 3m 3115(0911) Ant. pol. : HORIZONTAL
 Limit : FCC PART 15C PEAK
 Env. / Ins. : 23°C/54% Engineer : Leo-Li
 EUT : 300Mbps Wireless N Range Extender
 Power : DC 12V From Adapter input AC 120V/60Hz
 Test mode : IEEE802.11nHT40 CH1 2422MHz Tx
 M/N : TL-WA830RE

	Ant. Freq. (MHz)	Ant. Factor (dB/m)	Cable loss (dB)	Amp. Factor (dB)	Reading (dBuV)	Emission Level (dBuV/m)	Limits (dBuV/m)	Margin (dB)	Remark
1	1999.000	29.20	7.93	36.09	40.12	41.16	74.00	32.84	Peak
2	2422.000	29.46	8.77	36.01	89.34	91.56	74.00	-17.56	Peak

Remarks:

- Emission Level= Antenna Factor + Cable Loss -Amp Factor + Reading.
- The emission levels that are 20dB below the official limit are not reported.

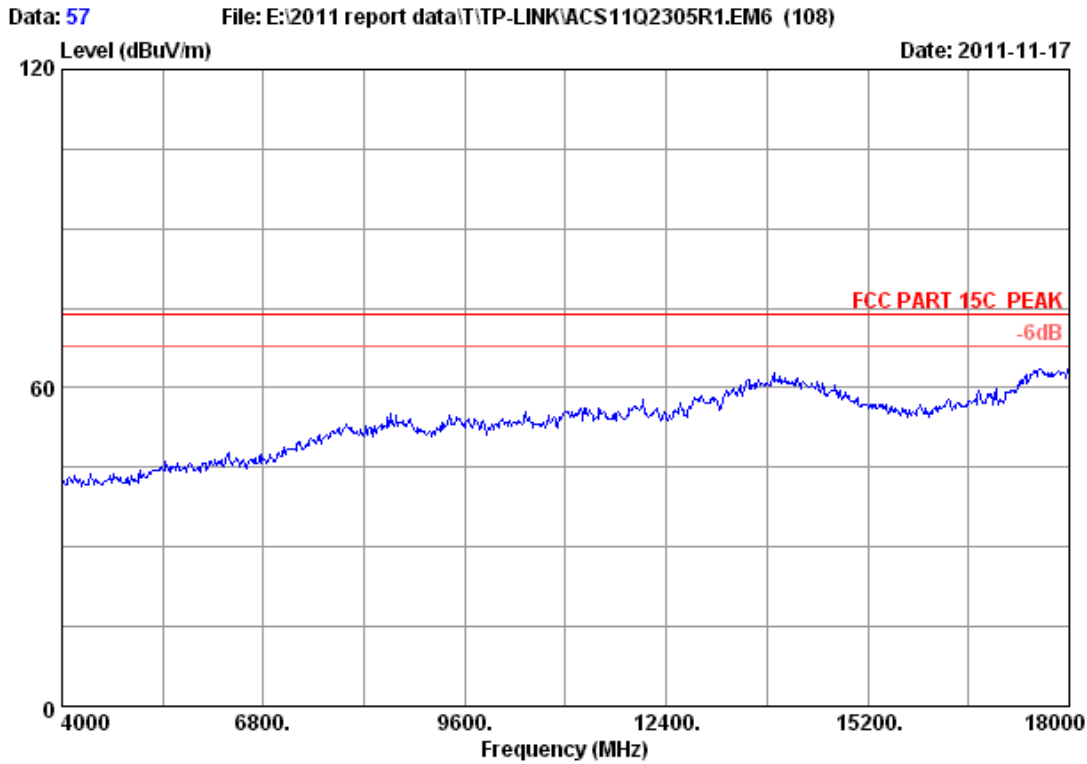

Site no. : 3m Chamber Data no. : 57
Dis. / Ant. : 3m 3115(0911) Ant. pol. : HORIZONTAL
Limit : FCC PART 15C PEAK
Env. / Ins. : 23°C/54% Engineer : Leo-Li
EUT : 300Mbps Wireless N Range Extender
Power : DC 12V From Adapter input AC 120V/60Hz
Test mode : IEEE802.11nHT40 CH1 2422MHz Tx
M/N : TL-WA830RE

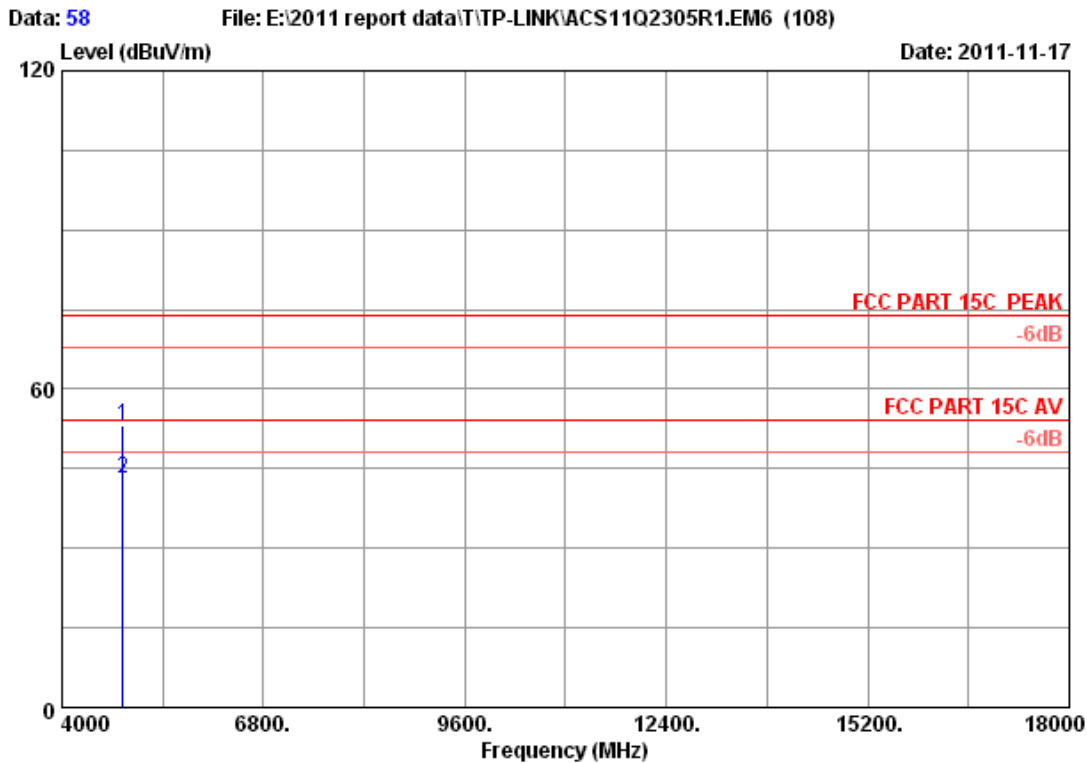

Site no. : 3m Chamber Data no. : 58
 Dis. / Ant. : 3m 3115(0911) Ant. pol. : HORIZONTAL
 Limit : FCC PART 15C PEAK
 Env. / Ins. : 23°C/54% Engineer : Leo-Li
 EUT : 300Mbps Wireless N Range Extender
 Power : DC 12V From Adapter input AC 120V/60Hz
 Test mode : IEEE802.11nHT40 CH1 2422MHz Tx
 M/N : TL-WA830RE

	Ant.	Cable	Amp.	Emission				
Freq. (MHz)	Factor (dB/m)	loss (dB)	Factor (dB)	Reading (dBuV)	Level (dBuV/m)	Limits (dBuV/m)	Margin (dB)	Remark
1 4844.000	34.35	12.38	35.25	41.57	53.05	74.00	20.95	Peak
2 4844.000	34.35	12.38	35.25	31.65	43.13	54.00	10.87	Average

Remarks:
 1. Emission Level= Antenna Factor + Cable Loss -Amp Factor + Reading.
 2. The emission levels that are 20dB below the official limit are not reported.

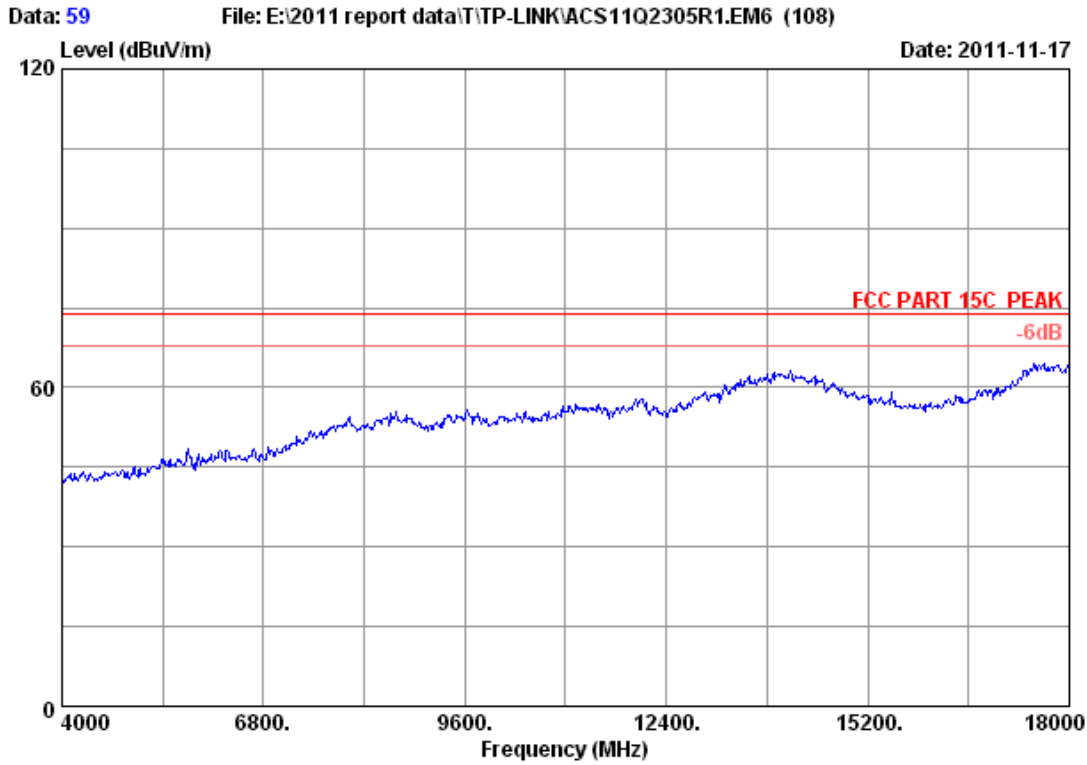

Site no. : 3m Chamber Data no. : 59
Dis. / Ant. : 3m 3115(0911) Ant. pol. : VERTICAL
Limit : FCC PART 15C PEAK
Env. / Ins. : 23°C/54% Engineer : Leo-Li
EUT : 300Mbps Wireless N Range Extender
Power : DC 12V From Adapter input AC 120V/60Hz
Test mode : IEEE802.11nHT40 CH1 2422MHz Tx
M/N : TL-WA830RE

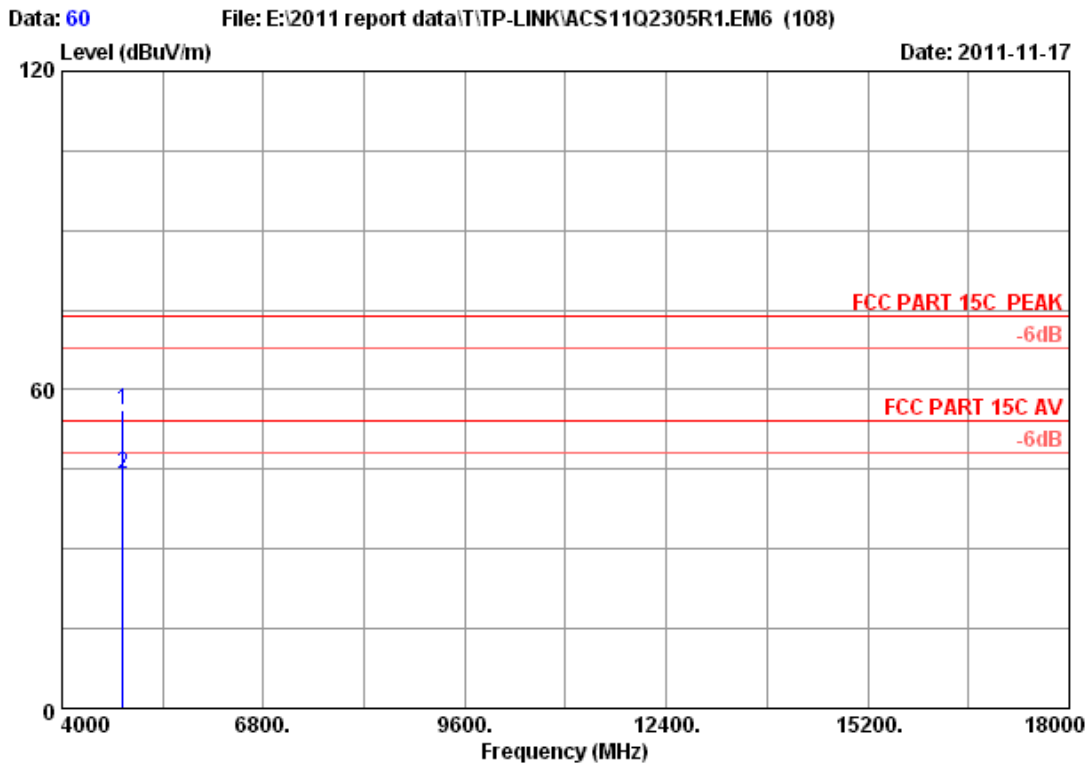

Site no. : 3m Chamber Data no. : 60
 Dis. / Ant. : 3m 3115(0911) Ant. pol. : VERTICAL
 Limit : FCC PART 15C PEAK
 Env. / Ins. : 23°C/54% Engineer : Leo-Li
 EUT : 300Mbps Wireless N Range Extender
 Power : DC 12V From Adapter input AC 120V/60Hz
 Test mode : IEEE802.11nHT40 CH1 2422MHz Tx
 M/N : TL-WA830RE

	Ant. Factor (dB/m)	Cable loss (dB)	Amp. Factor (dB)	Reading (dBuV)	Emission Level (dBuV/m)	Limits (dBuV/m)	Margin (dB)	Remark
1	34.35	12.38	35.25	44.81	56.29	74.00	17.71	Peak
2	34.35	12.38	35.25	32.71	44.19	54.00	9.81	Average

Remarks:

1. Emission Level= Antenna Factor + Cable Loss -Amp Factor + Reading.
2. The emission levels that are 20dB below the official limit are not reported.

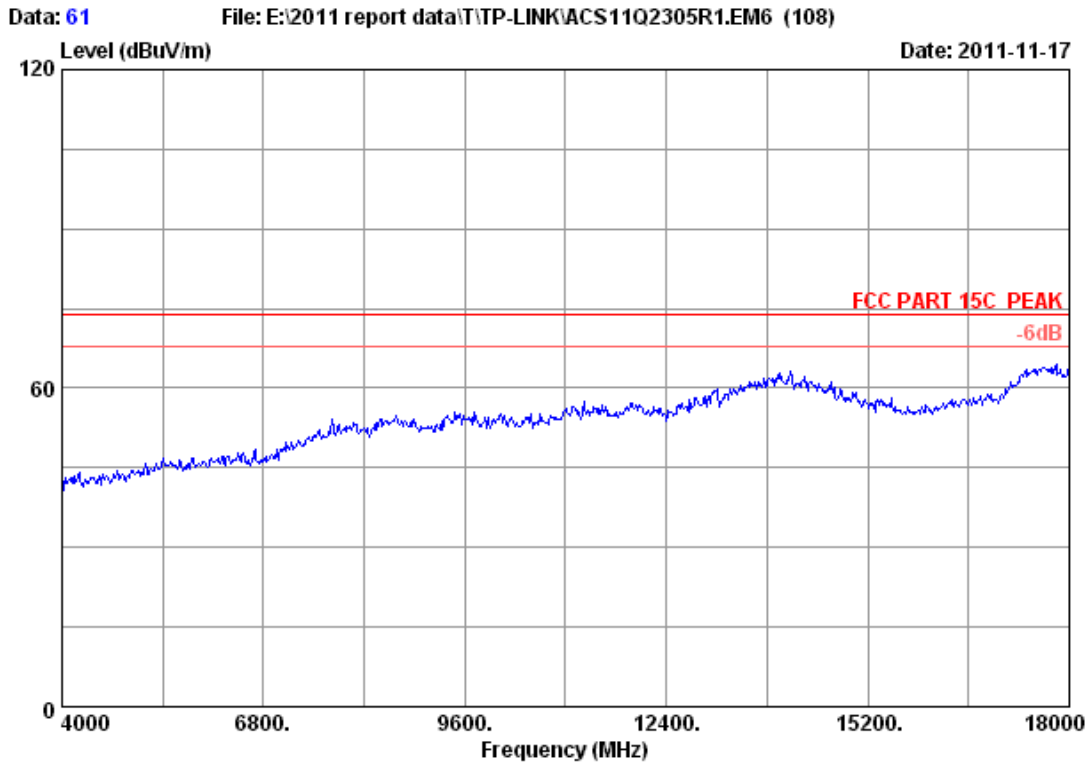

Site no. : 3m Chamber Data no. : 61
Dis. / Ant. : 3m 3115(0911) Ant. pol. : HORIZONTAL
Limit : FCC PART 15C PEAK
Env. / Ins. : 23°C/54% Engineer : Leo-Li
EUT : 300Mbps Wireless N Range Extender
Power : DC 12V From Adapter input AC 120V/60Hz
Test mode : IEEE802.11nHT40 CH4 2437MHz Tx
M/N : TL-WA830RE

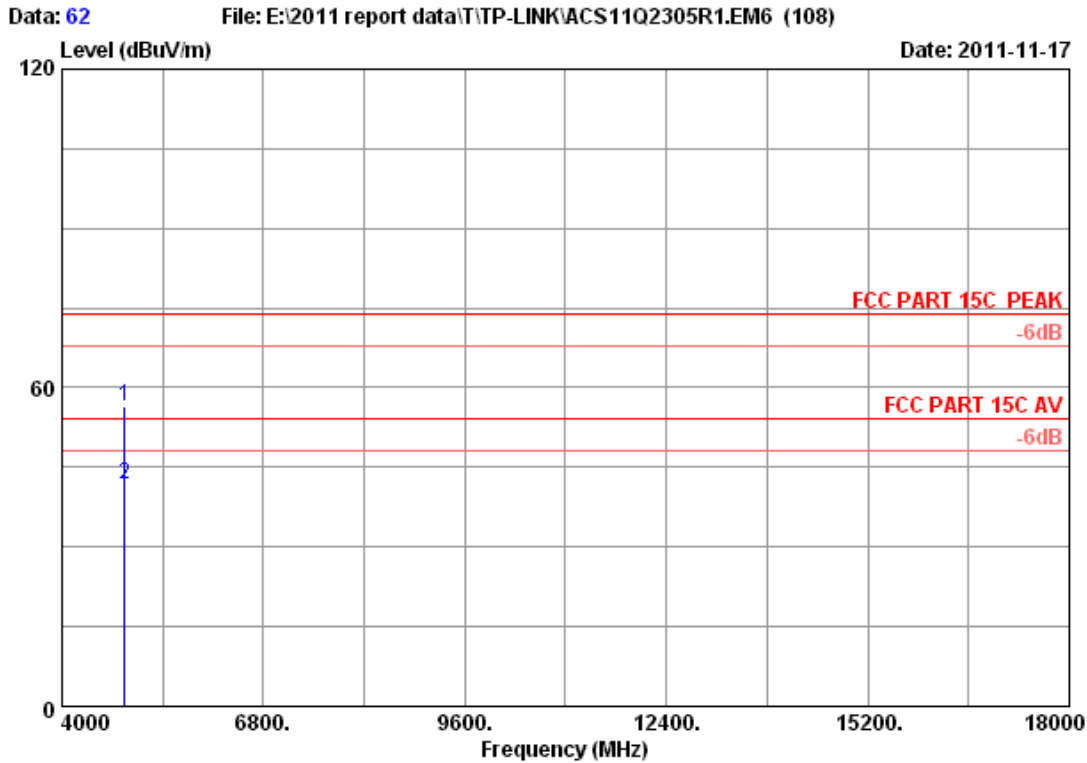

Site no. : 3m Chamber Data no. : 62
 Dis. / Ant. : 3m 3115(0911) Ant. pol. : HORIZONTAL
 Limit : FCC PART 15C PEAK
 Env. / Ins. : 23°C/54% Engineer : Leo-Li
 EUT : 300Mbps Wireless N Range Extender
 Power : DC 12V From Adapter input AC 120V/60Hz
 Test mode : IEEE802.11nHT40 CH4 2437MHz Tx
 M/N : TL-WA830RE

	Ant.	Cable	Amp.	Emission				
Freq. (MHz)	Factor (dB/m)	loss (dB)	Factor (dB)	Reading (dBuV)	Level (dBuV/m)	Limits (dBuV/m)	Margin (dB)	Remark
1 4874.000	34.41	12.44	35.36	44.94	56.43	74.00	17.57	Peak
2 4874.000	34.41	12.44	35.36	30.38	41.87	54.00	12.13	Average

- Remarks:
1. Emission Level= Antenna Factor + Cable Loss -Amp Factor + Reading.
 2. The emission levels that are 20dB below the official limit are not reported.

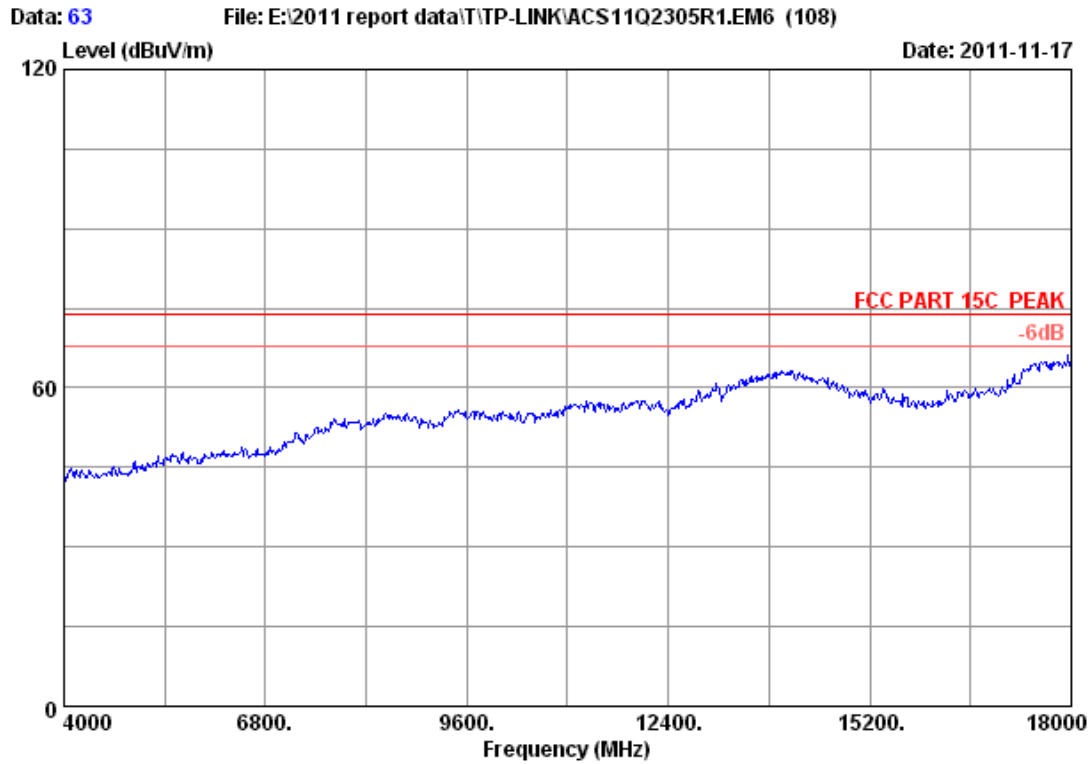

Site no. : 3m Chamber Data no. : 63
Dis. / Ant. : 3m 3115(0911) Ant. pol. : VERTICAL
Limit : FCC PART 15C PEAK
Env. / Ins. : 23°C/54% Engineer : Leo-Li
EUT : 300Mbps Wireless N Range Extender
Power : DC 12V From Adapter input AC 120V/60Hz
Test mode : IEEE802.11nHT40 CH4 2437MHz Tx
M/N : TL-WA830RE

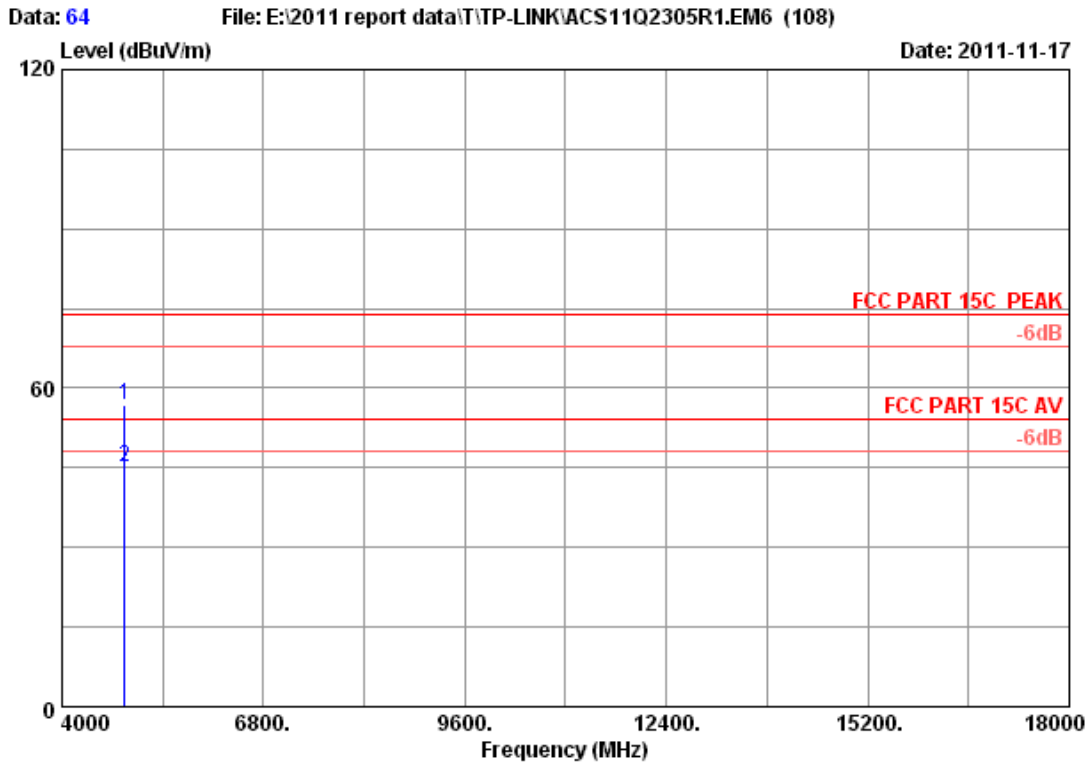

Site no. : 3m Chamber Data no. : 64
 Dis. / Ant. : 3m 3115(0911) Ant. pol. : VERTICAL
 Limit : FCC PART 15C PEAK
 Env. / Ins. : 23°C/54% Engineer : Leo-Li
 EUT : 300Mbps Wireless N Range Extender
 Power : DC 12V From Adapter input AC 120V/60Hz
 Test mode : IEEE802.11nHT40 CH4 2437MHz Tx
 M/N : TL-WA830RE

	Freq. (MHz)	Ant. Factor (dB/m)	Cable loss (dB)	Amp. Factor (dB)	Reading (dBuV)	Emission			Remark
						Level (dBuV/m)	Limits (dBuV/m)	Margin (dB)	
1	4874.000	34.41	12.44	35.36	45.45	56.94	74.00	17.06	Peak
2	4874.000	34.41	12.44	35.36	33.64	45.13	54.00	8.87	Average

Remarks:

1. Emission Level= Antenna Factor + Cable Loss -Amp Factor + Reading.
2. The emission levels that are 20dB below the official limit are not reported.

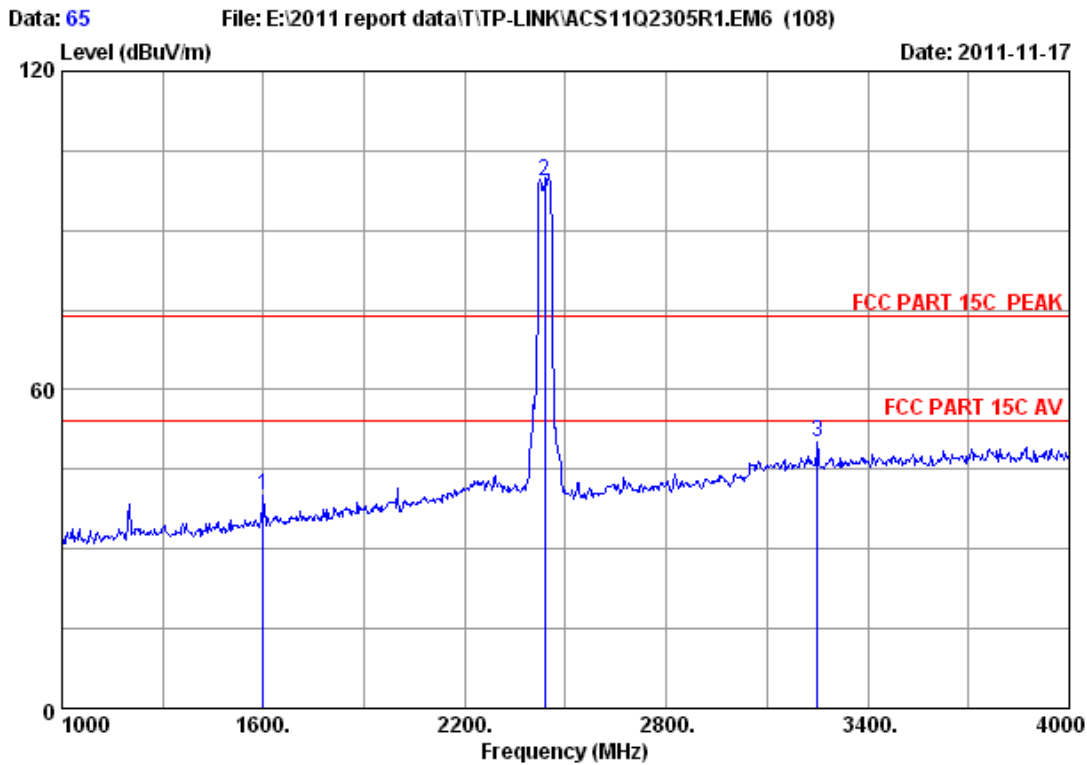

```

Site no.      : 3m Chamber           Data no. : 65
Dis. / Ant.  : 3m 3115(0911)       Ant. pol.: HORIZONTAL
Limit        : FCC PART 15C PEAK
Env. / Ins.  : 23°C/54%           Engineer : Leo-Li
EUT          : 300Mbps Wireless N Range Extender
Power        : DC 12V From Adapter input AC 120V/60Hz
Test mode    : IEEE802.11nHT40 CH4 2437MHz Tx
M/N          : TL-WA830RE
    
```

	Ant. Freq. (MHz)	Ant. Factor (dB/m)	Cable loss (dB)	Amp. Factor (dB)	Reading (dBuV)	Emission Level (dBuV/m)	Limits (dBuV/m)	Margin (dB)	Remark
1	1600.000	26.96	6.98	36.43	42.67	40.18	74.00	33.82	Peak
2	2437.000	29.47	8.77	36.06	97.05	99.23	74.00	-25.23	Peak
3	3250.000	32.63	10.28	35.68	42.92	50.15	74.00	23.85	Peak

Remarks:

1. Emission Level= Antenna Factor + Cable Loss -Amp Factor + Reading.
2. The emission levels that are 20dB below the official limit are not reported.

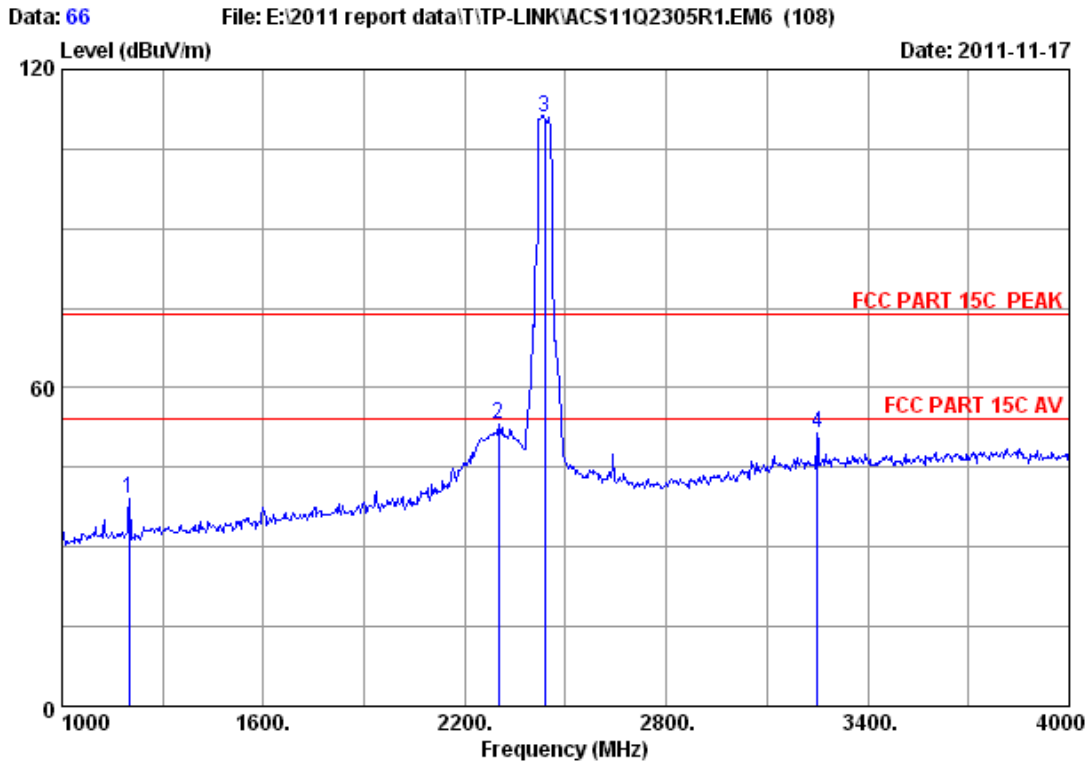

```

Site no.      : 3m Chamber           Data no. : 66
Dis. / Ant.  : 3m 3115(0911)       Ant. pol. : VERTICAL
Limit        : FCC PART 15C PEAK
Env. / Ins.  : 23°C/54%           Engineer  : Leo-Li
EUT          : 300Mbps Wireless N Range Extender
Power        : DC 12V From Adapter input AC 120V/60Hz
Test mode    : IEEE802.11nHT40 CH4 2437MHz Tx
M/N          : TL-WA830RE
    
```

	Ant. Freq. (MHz)	Ant. Factor (dB/m)	Cable loss (dB)	Amp. Factor (dB)	Reading (dBuV)	Emission Level (dBuV/m)	Limits (dBuV/m)	Margin (dB)	Remark
1	1201.000	25.81	5.98	36.97	44.32	39.14	74.00	34.86	Peak
2	2299.000	29.38	8.52	35.92	51.26	53.24	74.00	20.76	Peak
3	2437.000	29.47	8.77	36.06	108.74	110.92	74.00	-36.92	Peak
4	3250.000	32.63	10.28	35.68	44.12	51.35	74.00	22.65	Peak

Remarks:

1. Emission Level= Antenna Factor + Cable Loss -Amp Factor + Reading.
2. The emission levels that are 20dB below the official limit are not reported.

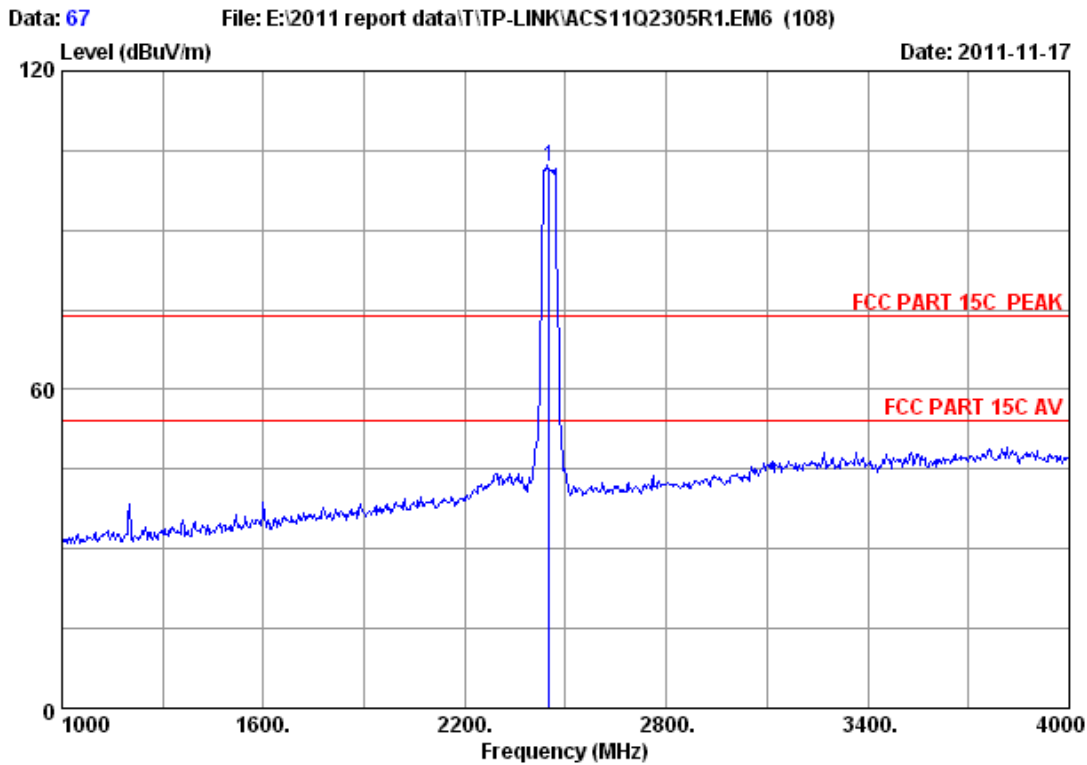

Site no. : 3m Chamber Data no. : 67
 Dis. / Ant. : 3m 3115(0911) Ant. pol. : VERTICAL
 Limit : FCC PART 15C PEAK
 Env. / Ins. : 23°C/54% Engineer : Leo-Li
 EUT : 300Mbps Wireless N Range Extender
 Power : DC 12V From Adapter input AC 120V/60Hz
 Test mode : IEEE802.11nHT40 CH7 2452MHz Tx
 M/N : TL-WA830RE

	Freq. (MHz)	Ant. Cable Amp.			Emission				Remark
		Factor (dB/m)	loss (dB)	Factor (dB)	Reading (dBUV)	Level (dBUV/m)	Limits (dBUV/m)	Margin (dB)	
1	2452.000	29.47	8.82	36.06	99.78	102.01	74.00	-28.01	Peak

Remarks:

1. Emission Level= Antenna Factor + Cable Loss -Amp Factor + Reading.
2. The emission levels that are 20dB below the official limit are not reported.

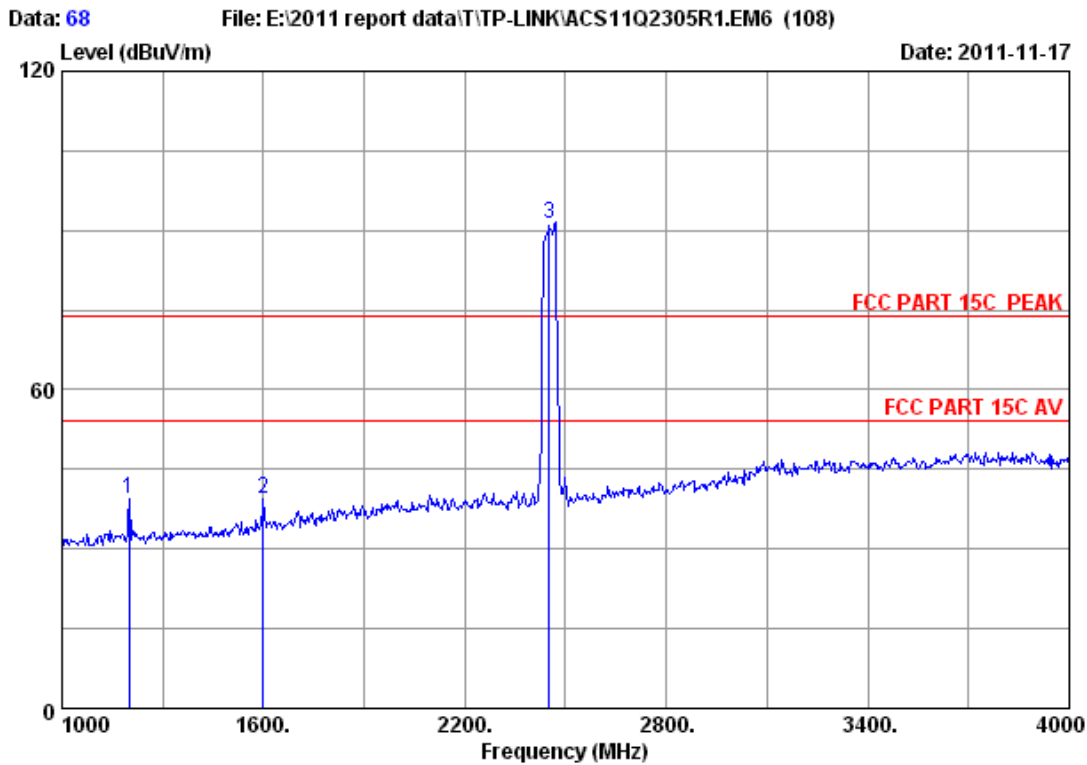

```

Site no.      : 3m Chamber           Data no. : 68
Dis. / Ant.  : 3m 3115(0911)       Ant. pol.: HORIZONTAL
Limit        : FCC PART 15C PEAK
Env. / Ins.  : 23°C/54%           Engineer : Leo-Li
EUT          : 300Mbps Wireless N Range Extender
Power        : DC 12V From Adapter input AC 120V/60Hz
Test mode    : IEEE802.11nHT40 CH7 2452MHz Tx
M/N          : TL-WA830RE
    
```

	Ant. Freq. (MHz)	Ant. Factor (dB/m)	Cable loss (dB)	Amp. Factor (dB)	Reading (dBuV)	Emission Level (dBuV/m)	Limits (dBuV/m)	Margin (dB)	Remark
1	1201.000	25.81	5.98	36.97	44.65	39.47	74.00	34.53	Peak
2	1600.000	26.96	6.98	36.43	41.90	39.41	74.00	34.59	Peak
3	2452.000	29.47	8.82	36.06	88.97	91.20	74.00	-17.20	Peak

Remarks:

1. Emission Level= Antenna Factor + Cable Loss -Amp Factor + Reading.
2. The emission levels that are 20dB below the official limit are not reported.

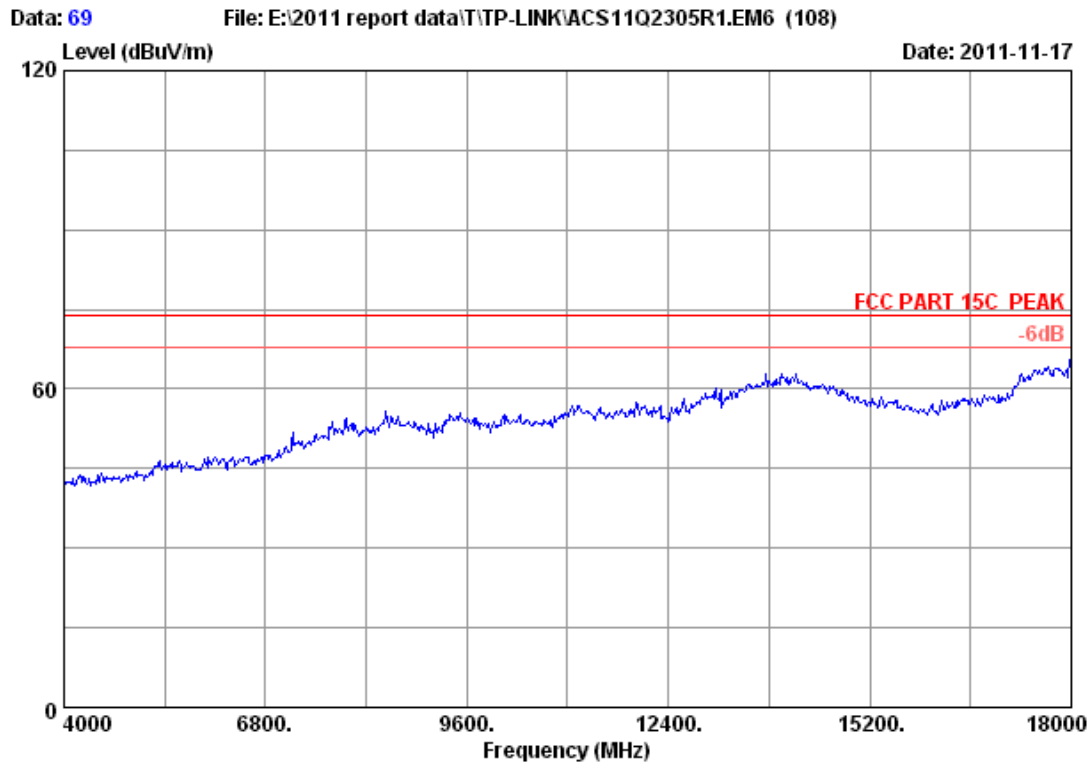

Site no. : 3m Chamber Data no. : 69
Dis. / Ant. : 3m 3115(0911) Ant. pol. : HORIZONTAL
Limit : FCC PART 15C PEAK
Env. / Ins. : 23°C/54% Engineer : Leo-Li
EUT : 300Mbps Wireless N Range Extender
Power : DC 12V From Adapter input AC 120V/60Hz
Test mode : IEEE802.11nHT40 CH7 2452MHz Tx
M/N : TL-WA830RE

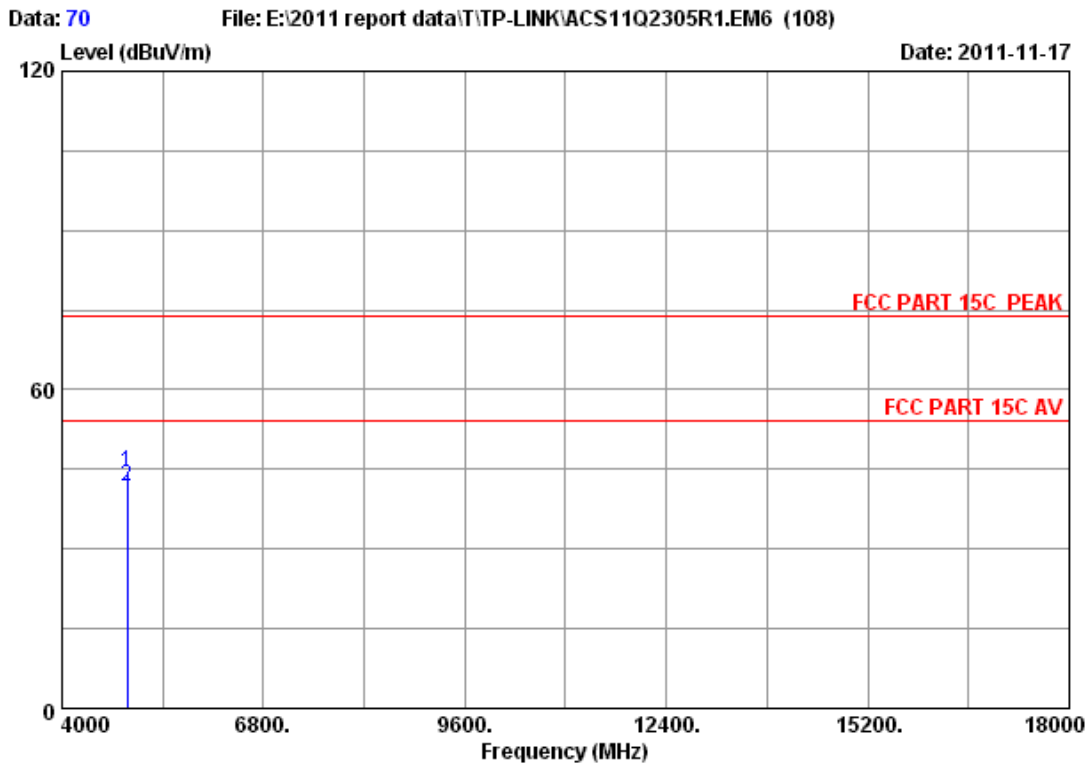

Site no. : 3m Chamber Data no. : 70
 Dis. / Ant. : 3m 3115(0911) Ant. pol. : HORIZONTAL
 Limit : FCC PART 15C PEAK
 Env. / Ins. : 23°C/54% Engineer : Leo-Li
 EUT : 300Mbps Wireless N Range Extender
 Power : DC 12V From Adapter input AC 120V/60Hz
 Test mode : IEEE802.11nHT40 CH7 2452MHz Tx
 M/N : TL-WA830RE

	Ant. Freq. (MHz)	Ant. Factor (dB/m)	Cable loss (dB)	Amp. Factor (dB)	Reading (dBuV)	Emission Level (dBuV/m)	Limits (dBuV/m)	Margin (dB)	Remark
1	4904.000	34.46	12.47	35.27	32.81	44.47	74.00	29.53	Peak
2	4904.000	34.46	12.47	35.27	30.25	41.91	54.00	12.09	Average

Remarks:

1. Emission Level= Antenna Factor + Cable Loss -Amp Factor + Reading.
2. The emission levels that are 20dB below the official limit are not reported.

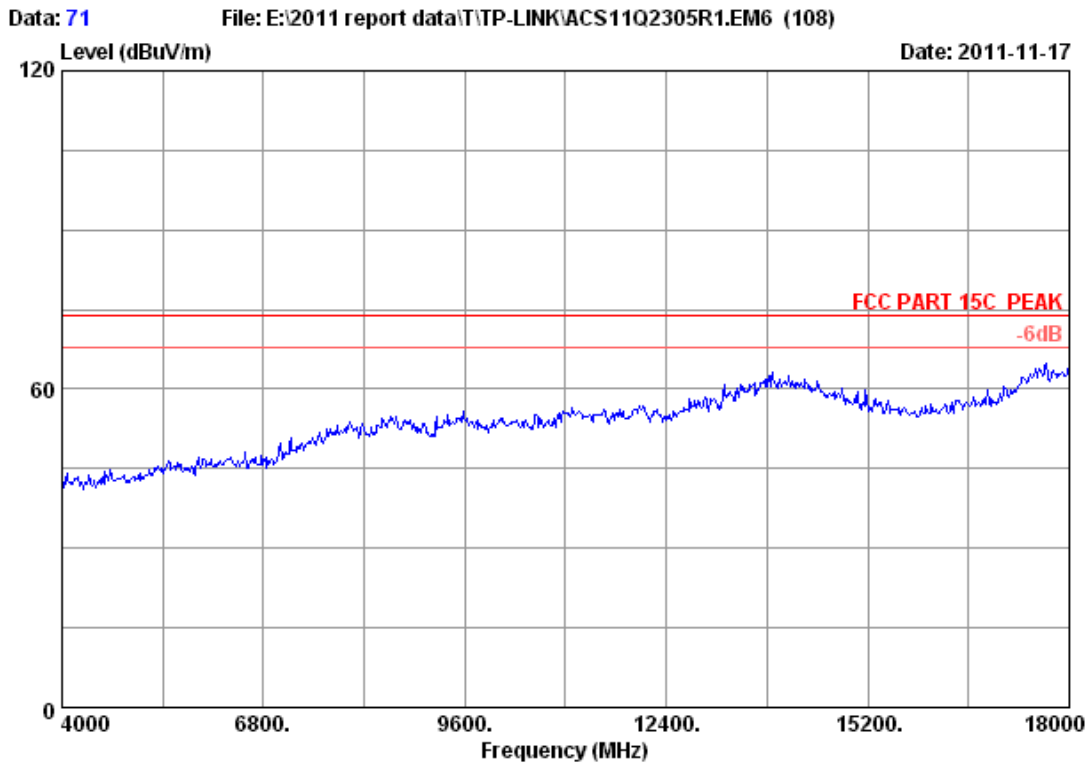

Site no. : 3m Chamber Data no. : 71
Dis. / Ant. : 3m 3115(0911) Ant. pol. : VERTICAL
Limit : FCC PART 15C PEAK
Env. / Ins. : 23°C/54% Engineer : Leo-Li
EUT : 300Mbps Wireless N Range Extender
Power : DC 12V From Adapter input AC 120V/60Hz
Test mode : IEEE802.11nHT40 CH7 2452MHz Tx
M/N : TL-WA830RE

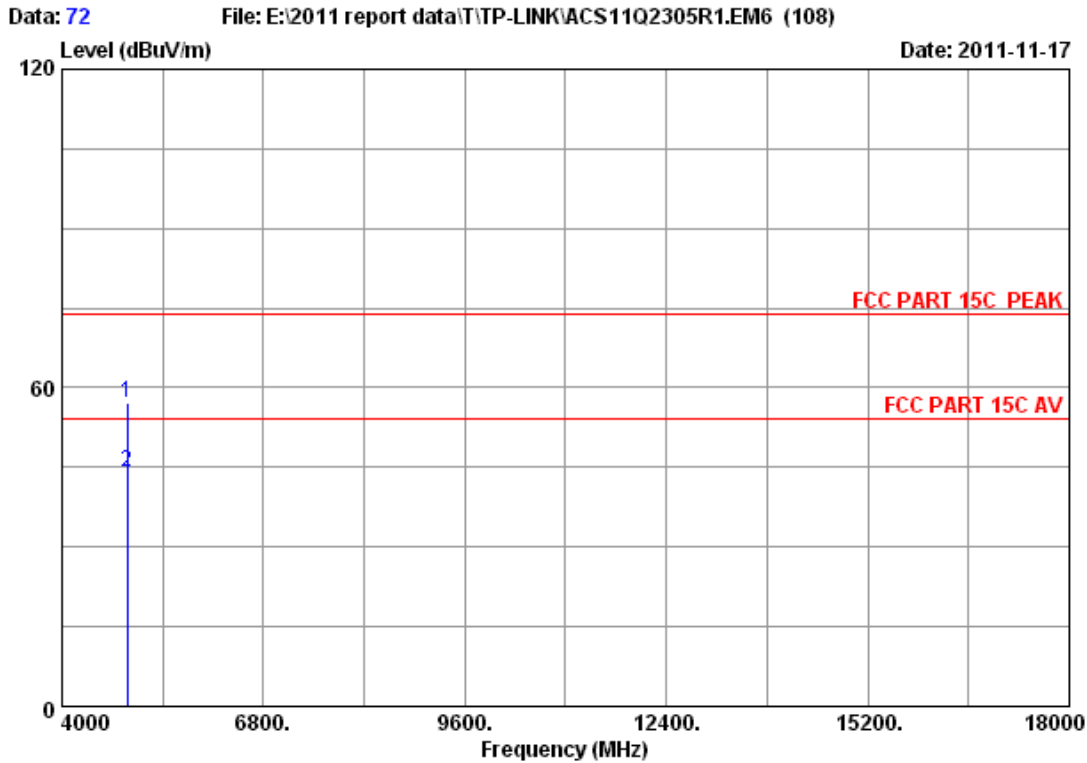

Site no. : 3m Chamber Data no. : 72
 Dis. / Ant. : 3m 3115(0911) Ant. pol. : VERTICAL
 Limit : FCC PART 15C PEAK
 Env. / Ins. : 23°C/54% Engineer : Leo-Li
 EUT : 300Mbps Wireless N Range Extender
 Power : DC 12V From Adapter input AC 120V/60Hz
 Test mode : IEEE802.11nHT40 CH7 2452MHz Tx
 M/N : TL-WA830RE

	Ant. Freq. (MHz)	Ant. Factor (dB/m)	Cable loss (dB)	Amp. Factor (dB)	Reading (dBuV)	Emission Level (dBuV/m)	Limits (dBuV/m)	Margin (dB)	Remark
1	4904.000	34.46	12.47	35.27	45.48	57.14	74.00	16.86	Peak
2	4904.000	34.46	12.47	35.27	32.58	44.24	54.00	9.76	Average

Remarks:

1. Emission Level= Antenna Factor + Cable Loss -Amp Factor + Reading.
2. The emission levels that are 20dB below the official limit are not reported.

5. CONDUCTED SPURIOUS EMISSIONS

5.1. Test Equipment

Item	Equipment	Manufacturer	Model No.	Serial No.	Last Cal.	Cal. Interval
1.	Spectrum Analyzer	Agilent	E4446A	US44300459	May.08,11	1 Year
2.	Attenuator	Agilent	8491B	MY39262165	May.08,11	1 Year
3.	RF Cable	Hubersuhner	SUCOFLEX102	28618/2	May.08,11	1Year

5.2. Limit

In any 100kHz bandwidth outside the frequency bands in which the spread spectrum intentional radiator is operating, the radio frequency power that is produced by the intentional radiator shall be at least 20dB below that in the 100kHz bandwidth within the band that contains the highest level of the desired power.

5.3. Test Procedure

The transmitter output was connected to a spectrum analyzer, The resolution bandwidth is set to 100 kHz, The video bandwidth is set to 300 kHz and measure all the emissions detected.

5.4. Test result

PASS (The testing data was attached in the next pages.)

Chain 0:

Test Mode: IEEE 802.11b TX

Test CH1: 2412MHz

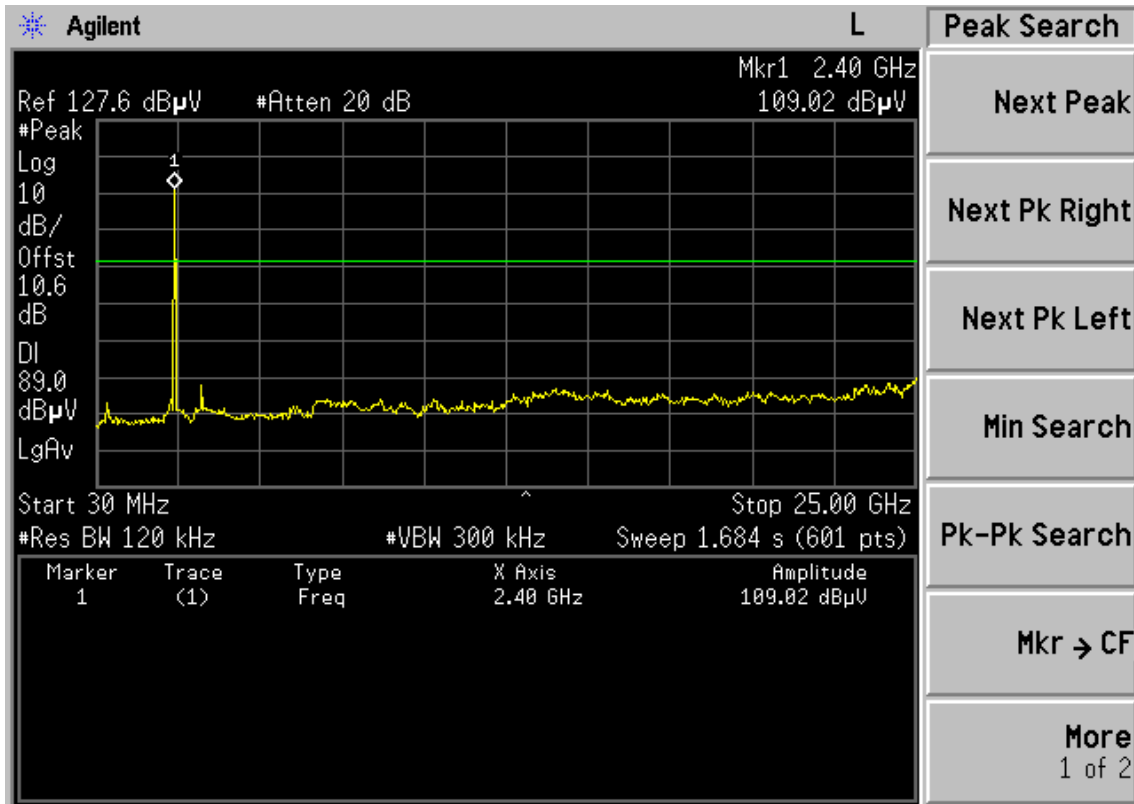

Copyright 2000-2005 Agilent Technologies

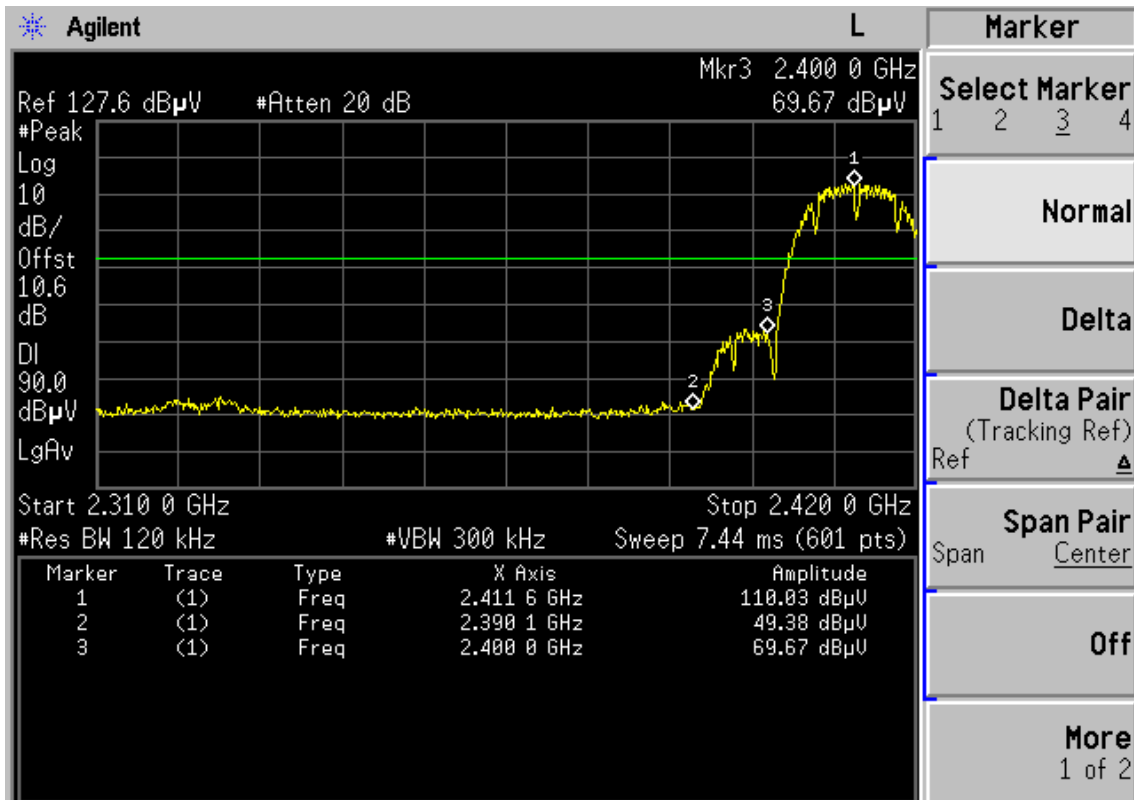

Copyright 2000-2005 Agilent Technologies

Test CH6: 2437MHz

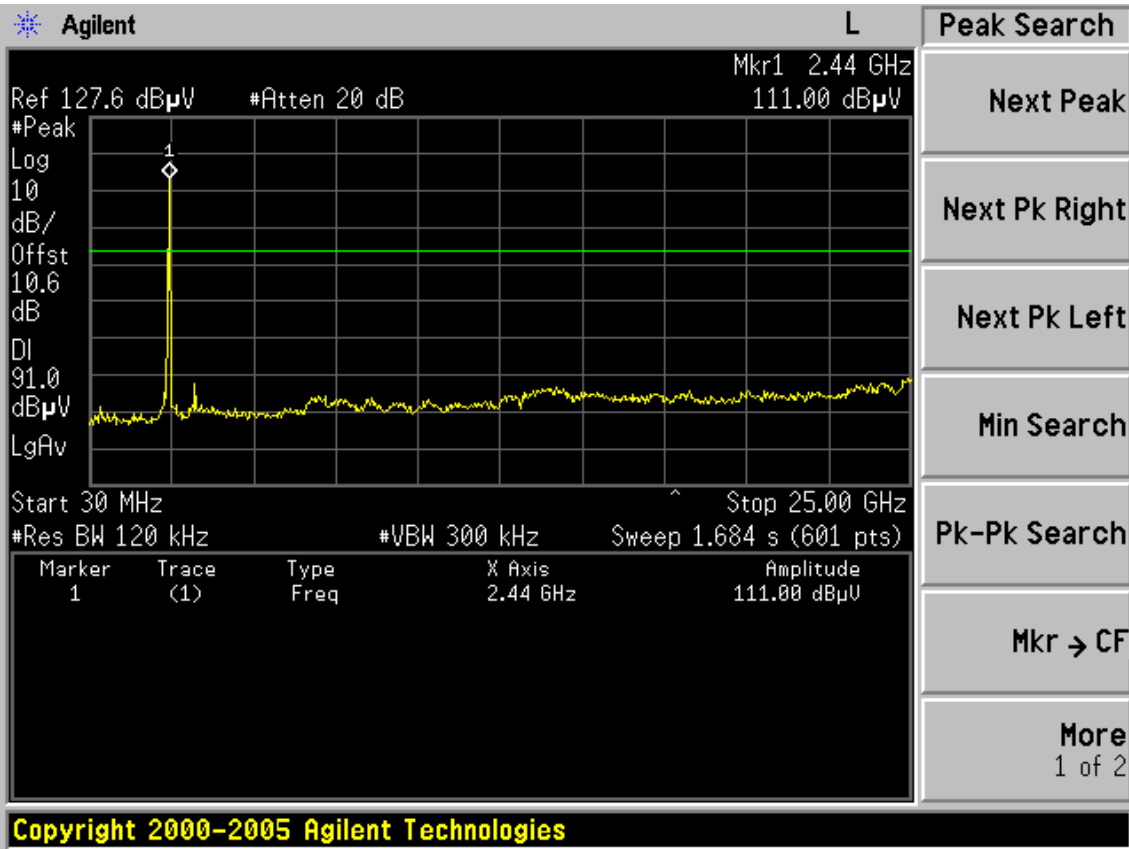

Test CH11: 2462MHz

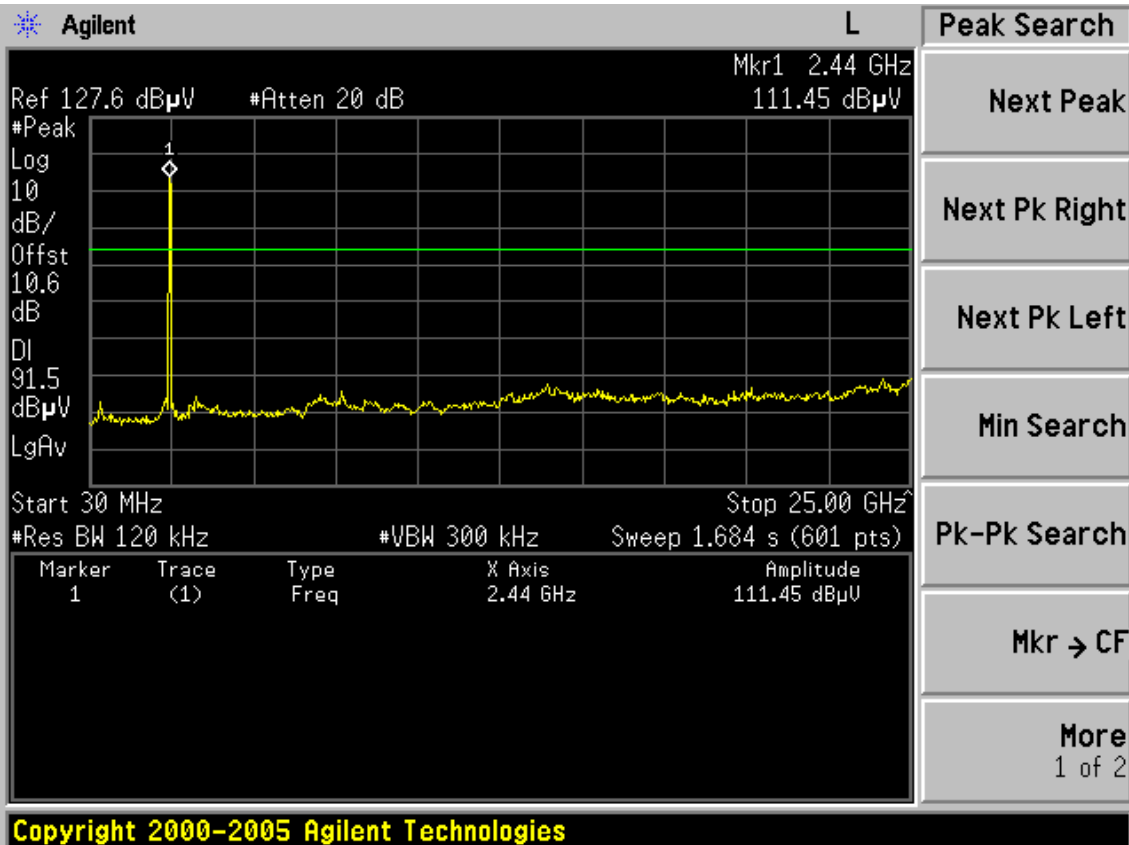

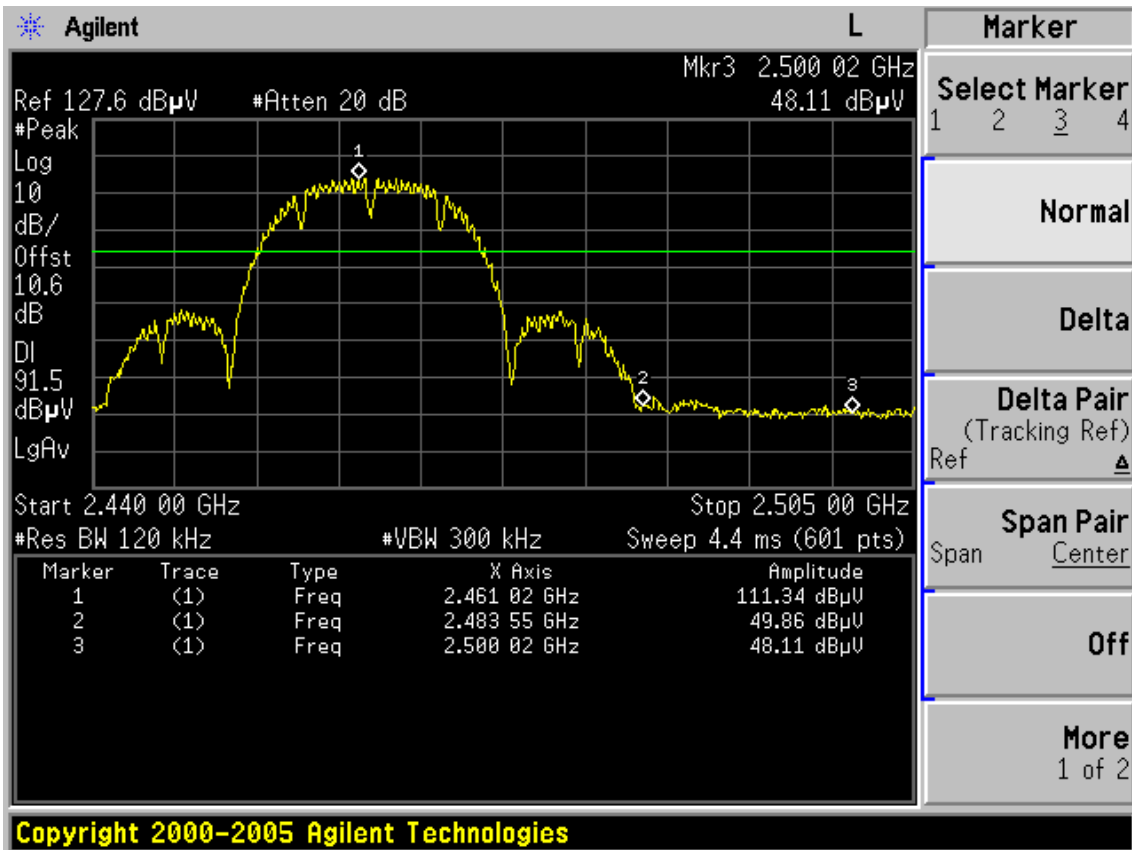

Test Mode: IEEE 802.11g TX
 Test CH1: 2412MHz

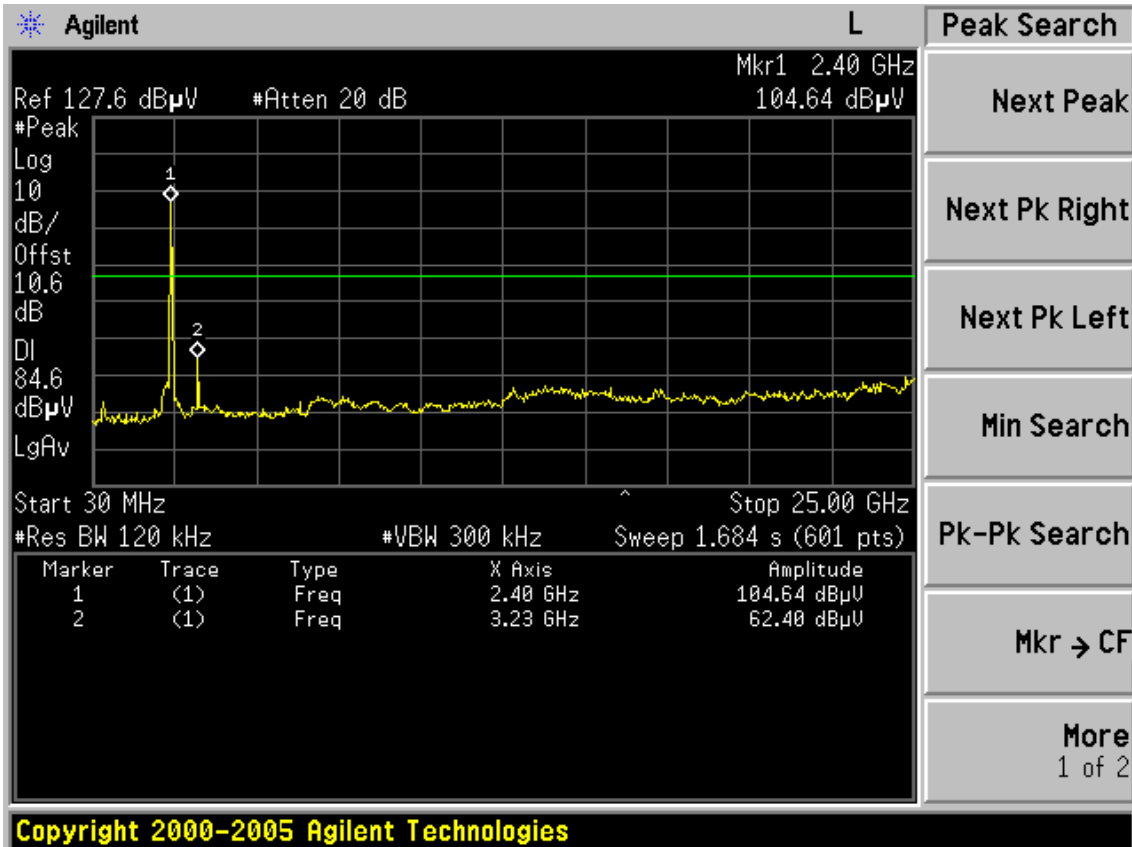

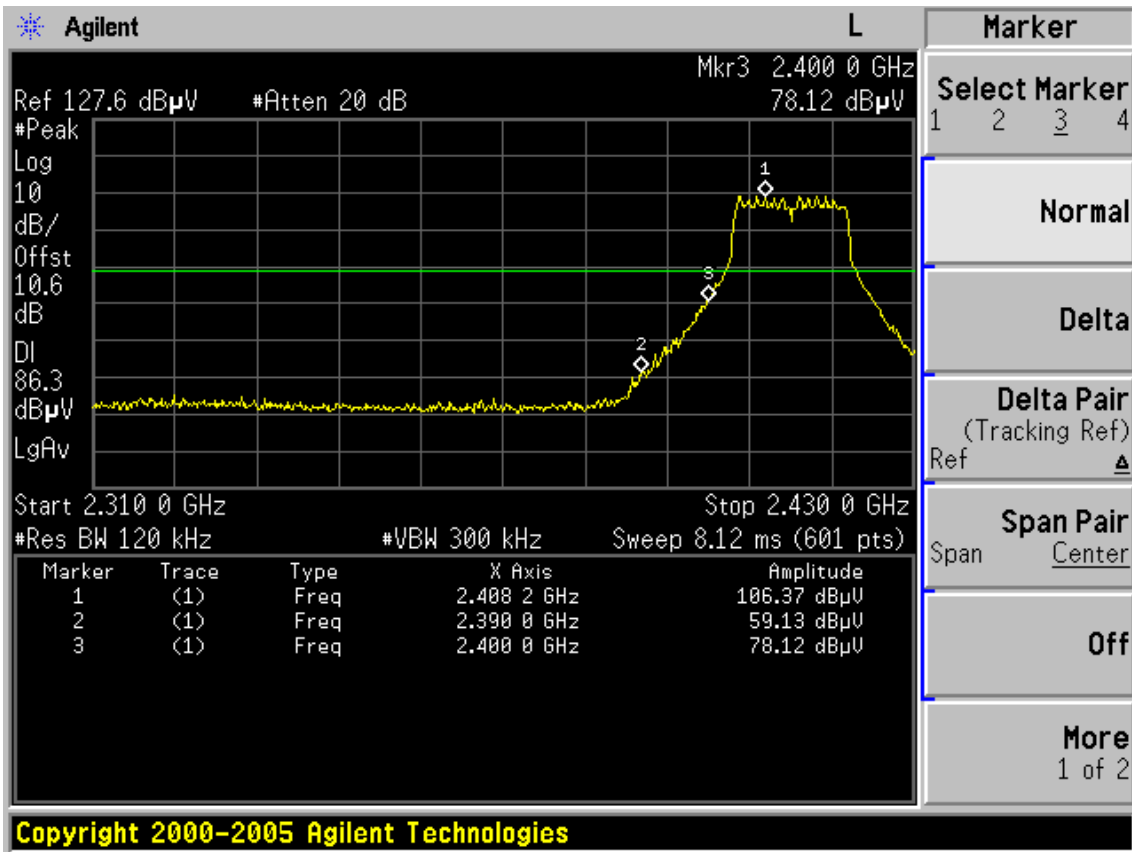

Test CH6: 2437MHz

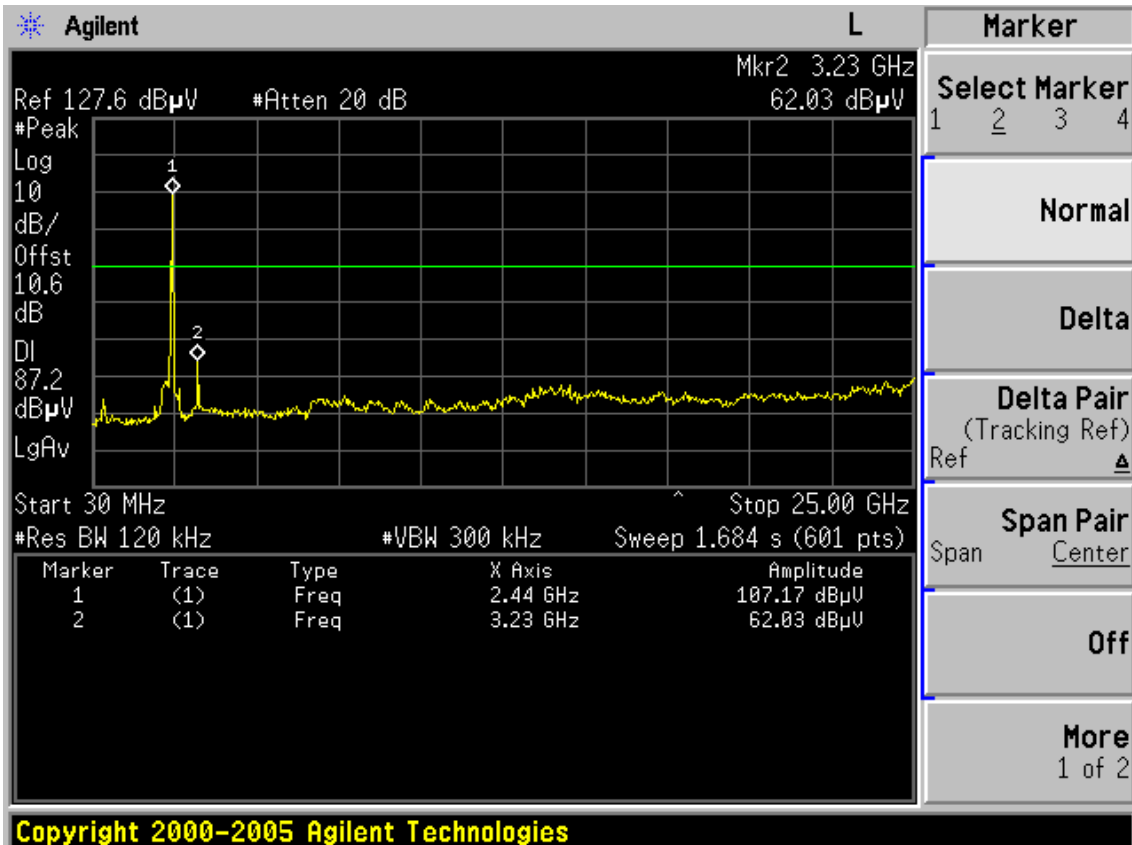

Test CH11: 2462MHz

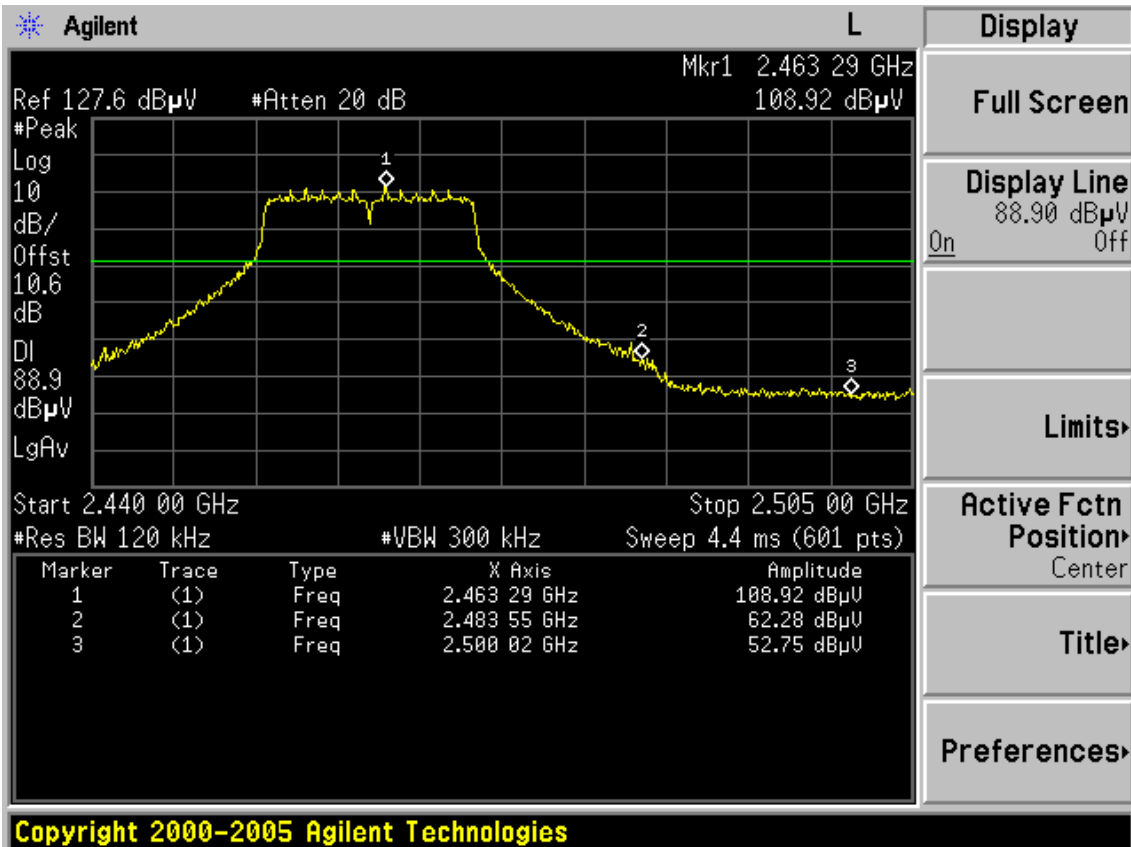
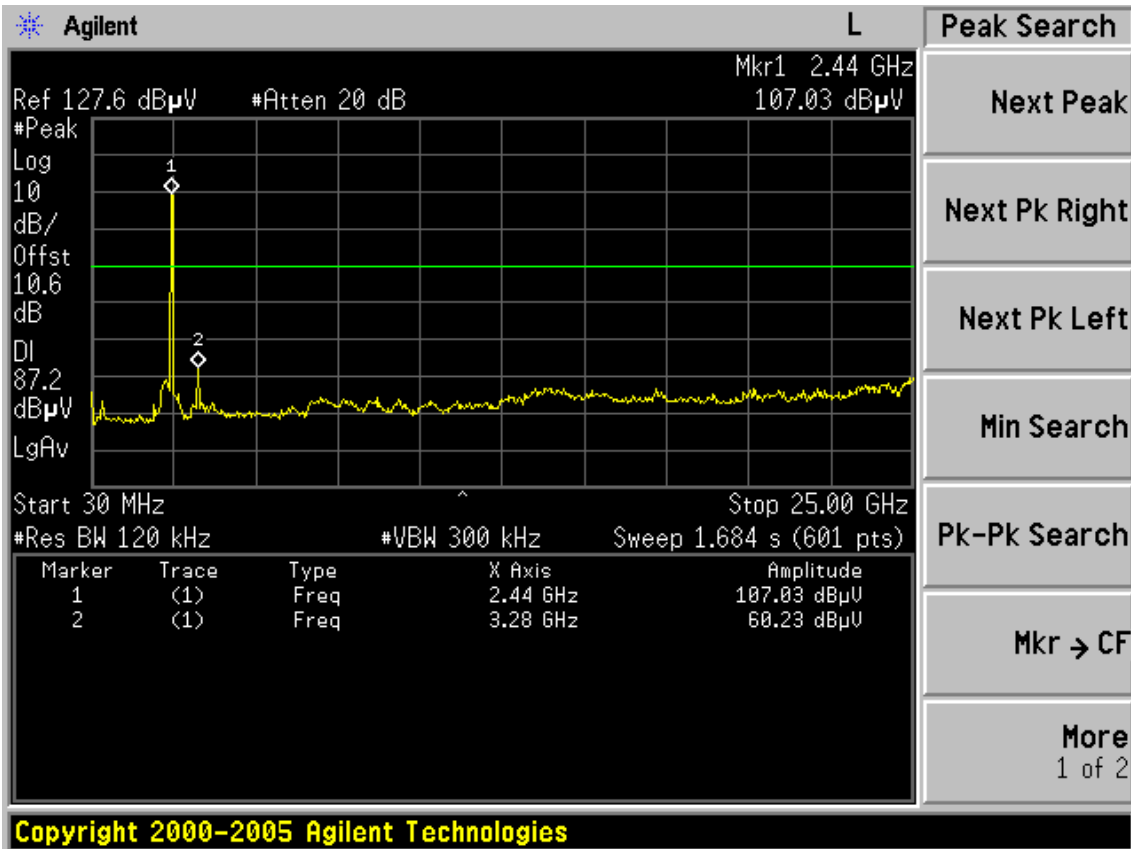

Test Mode: IEEE 802.11n HT20 TX

Test CH1: 2412MHz

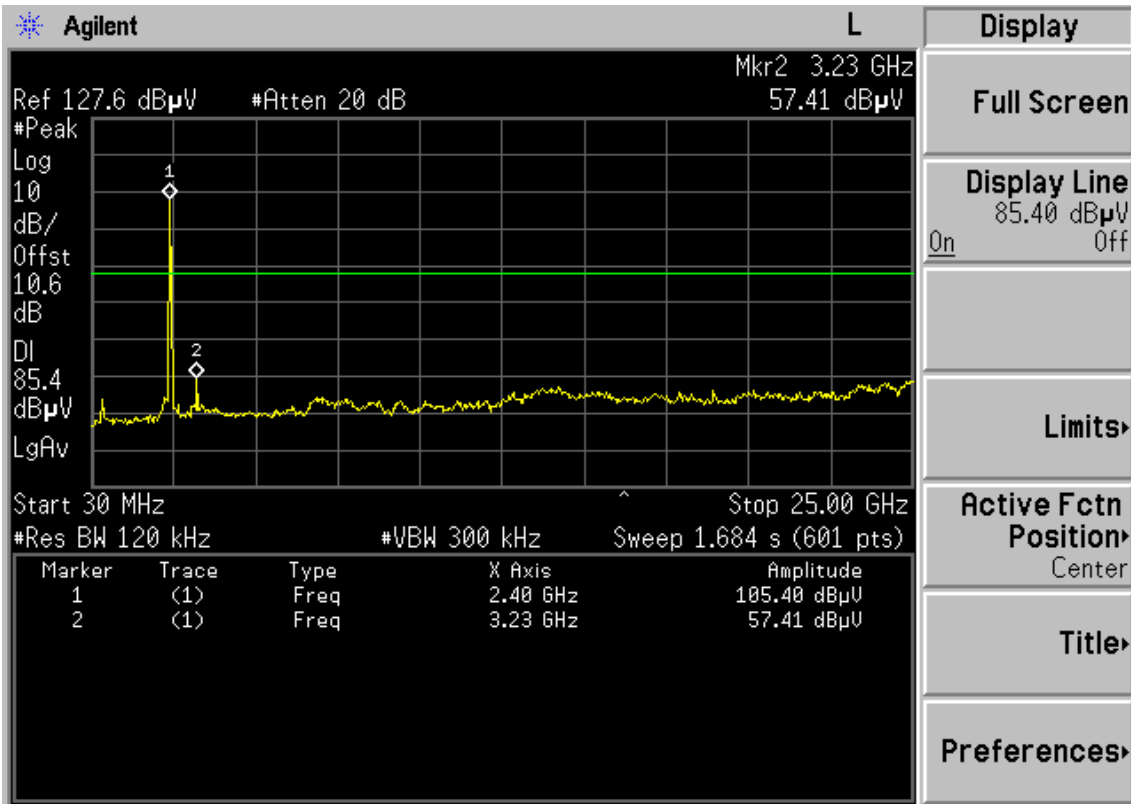

Copyright 2000-2005 Agilent Technologies

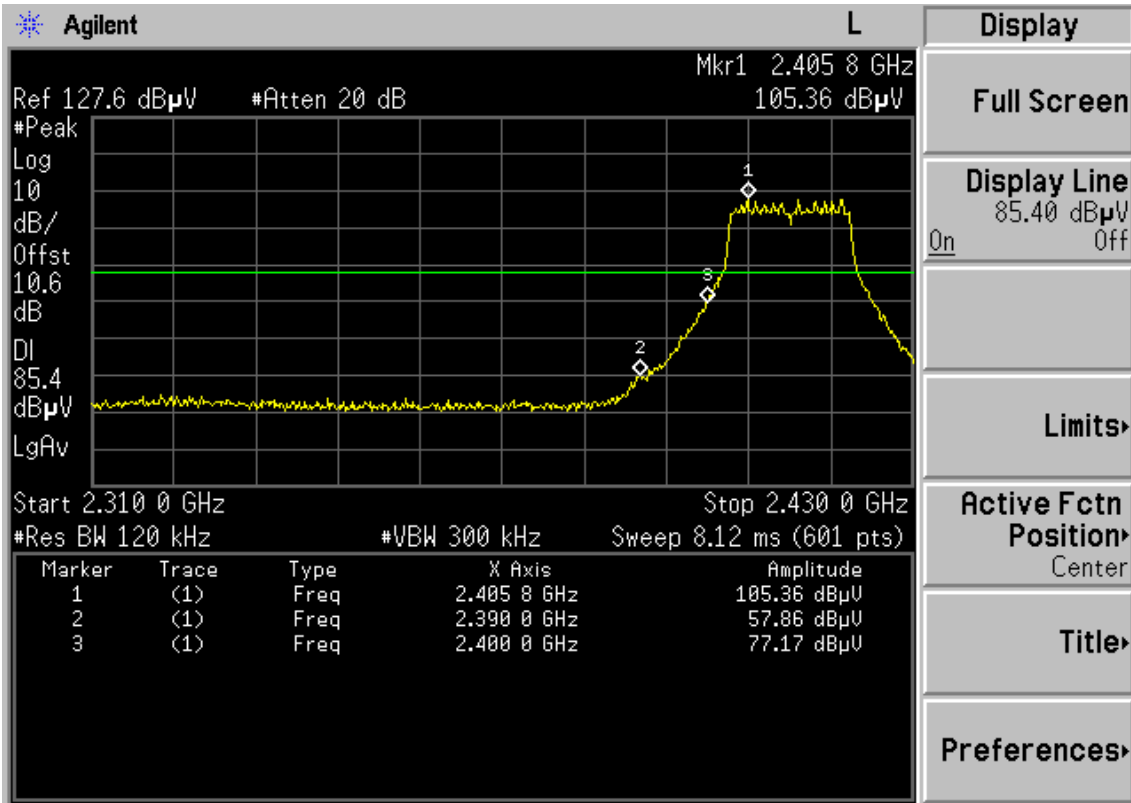

Copyright 2000-2005 Agilent Technologies

Test CH6: 2437MHz

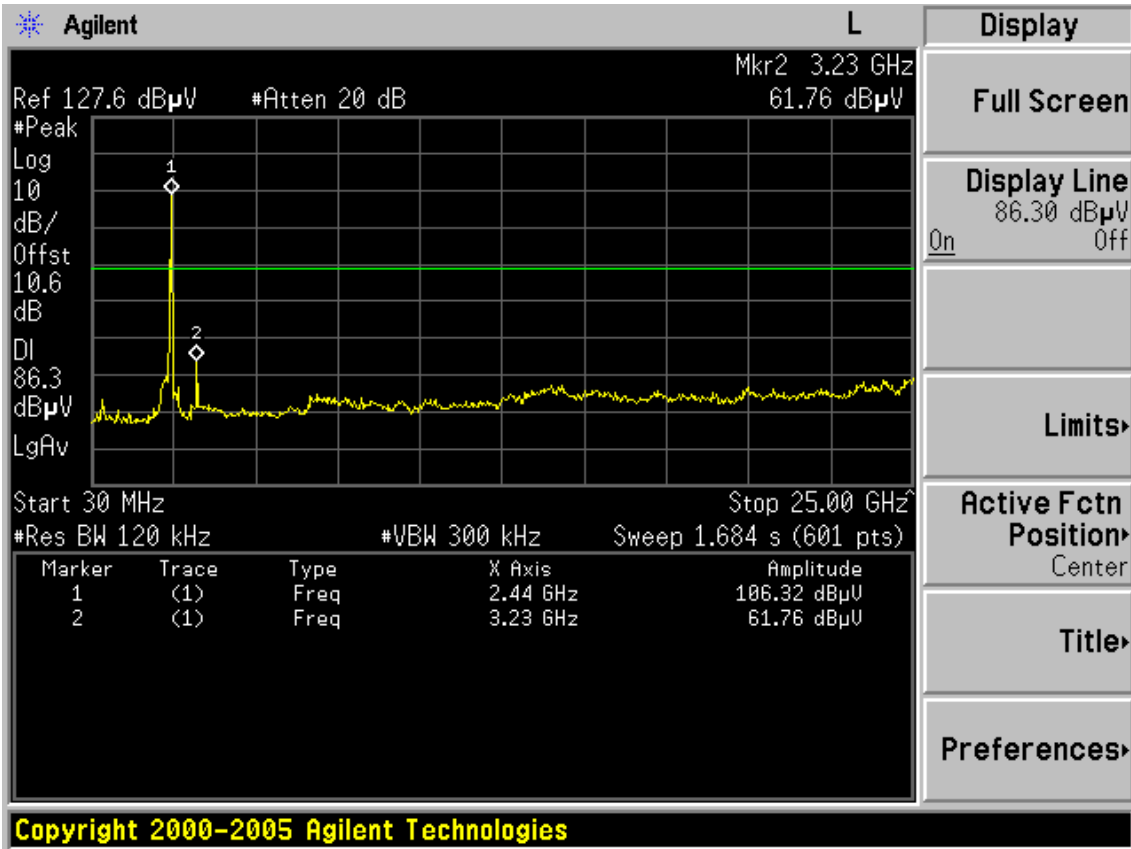

Test CH11: 2462MHz

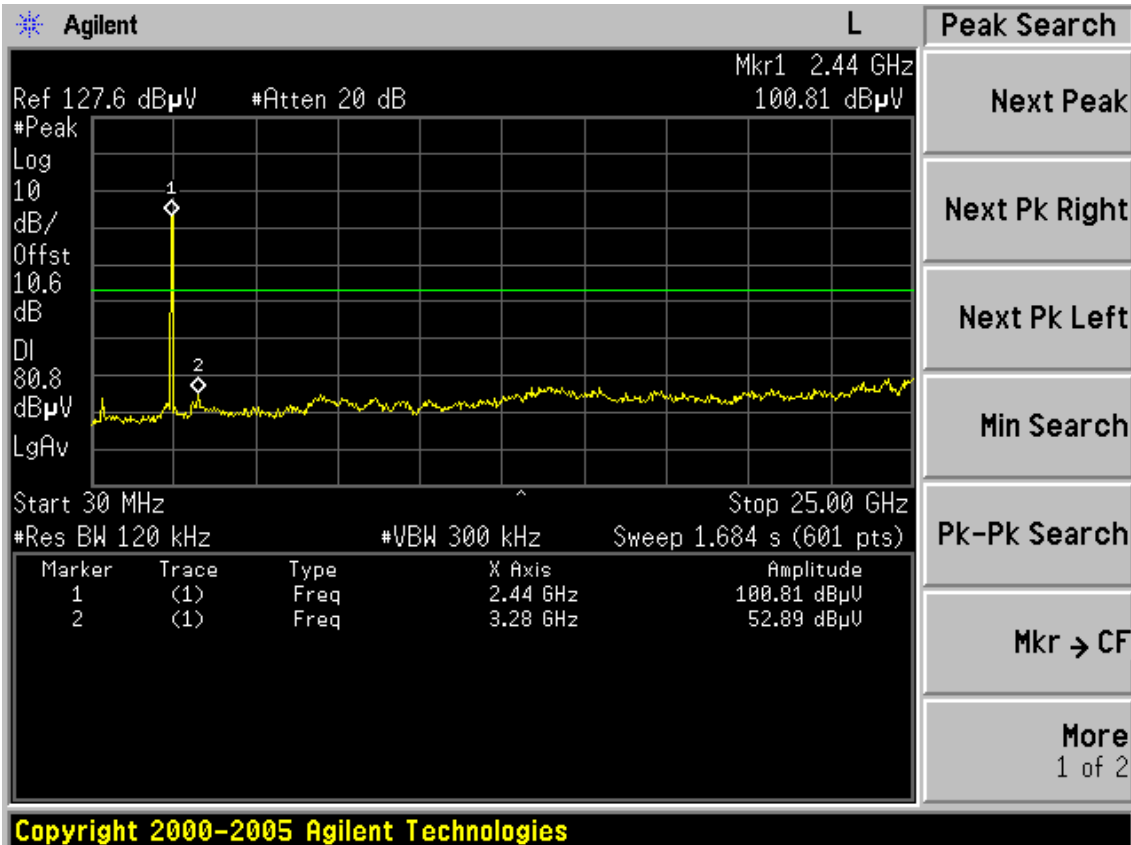

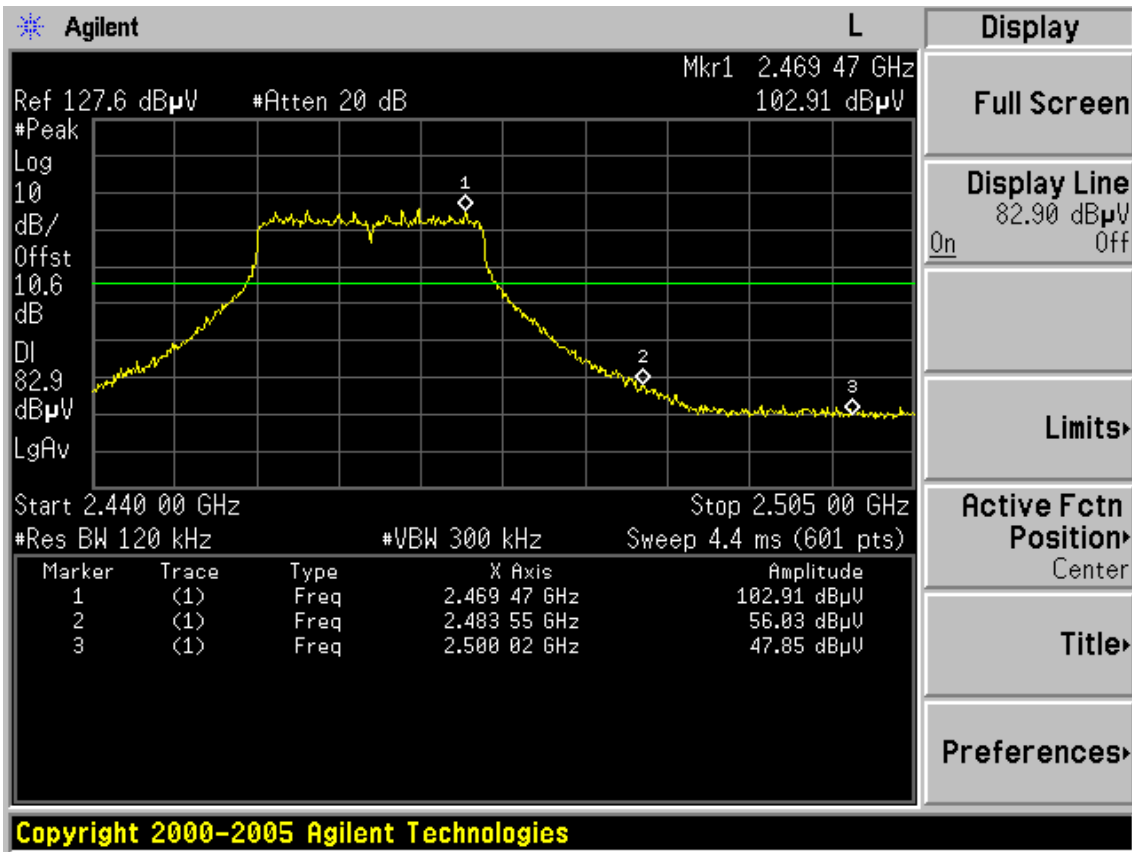

Test Mode: IEEE 802.11n HT40 TX
 Test CH1: 2422MHz

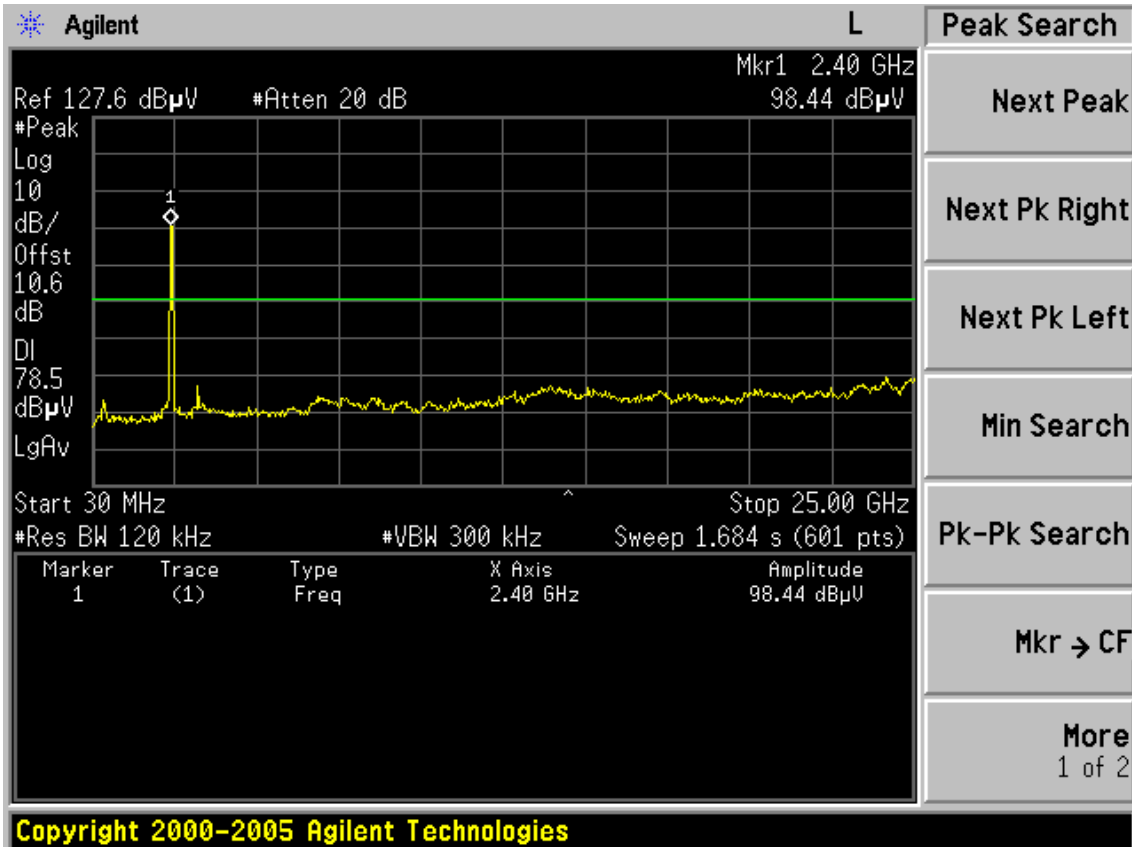

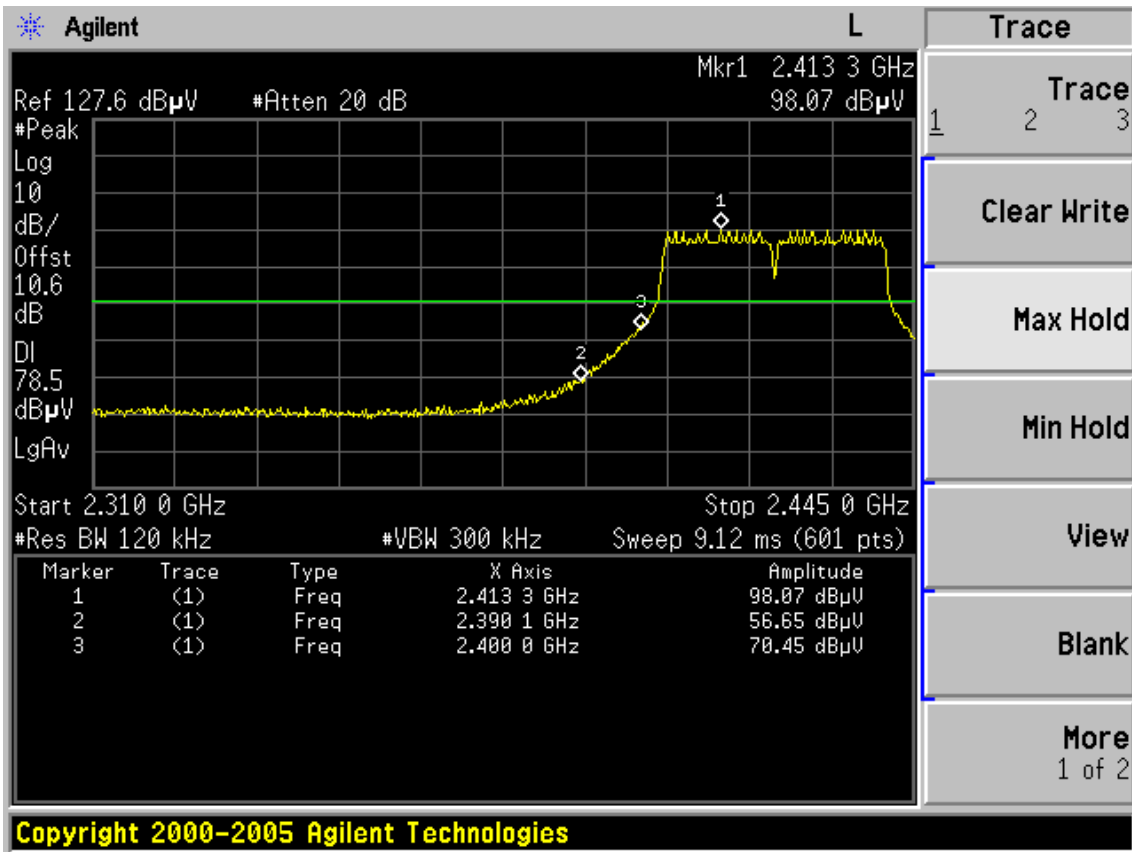

Test CH4: 2437MHz

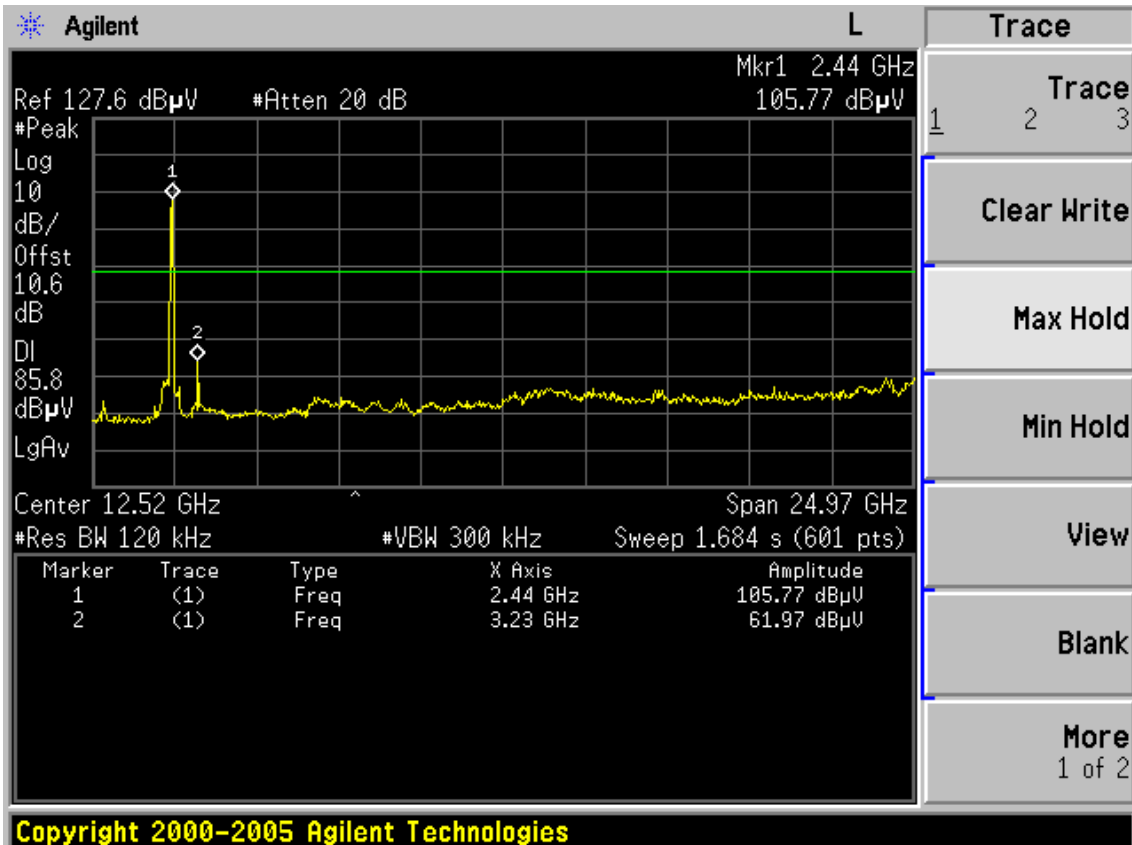

Test CH7: 2452MHz

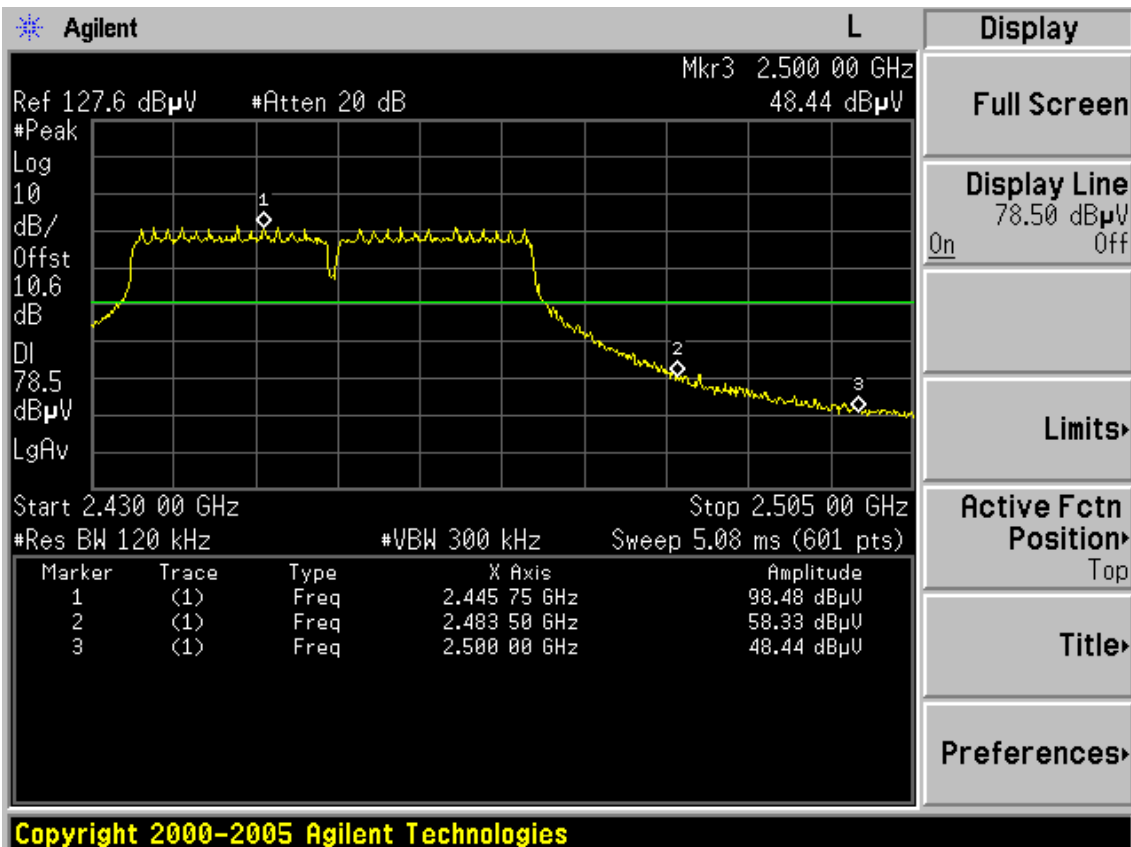
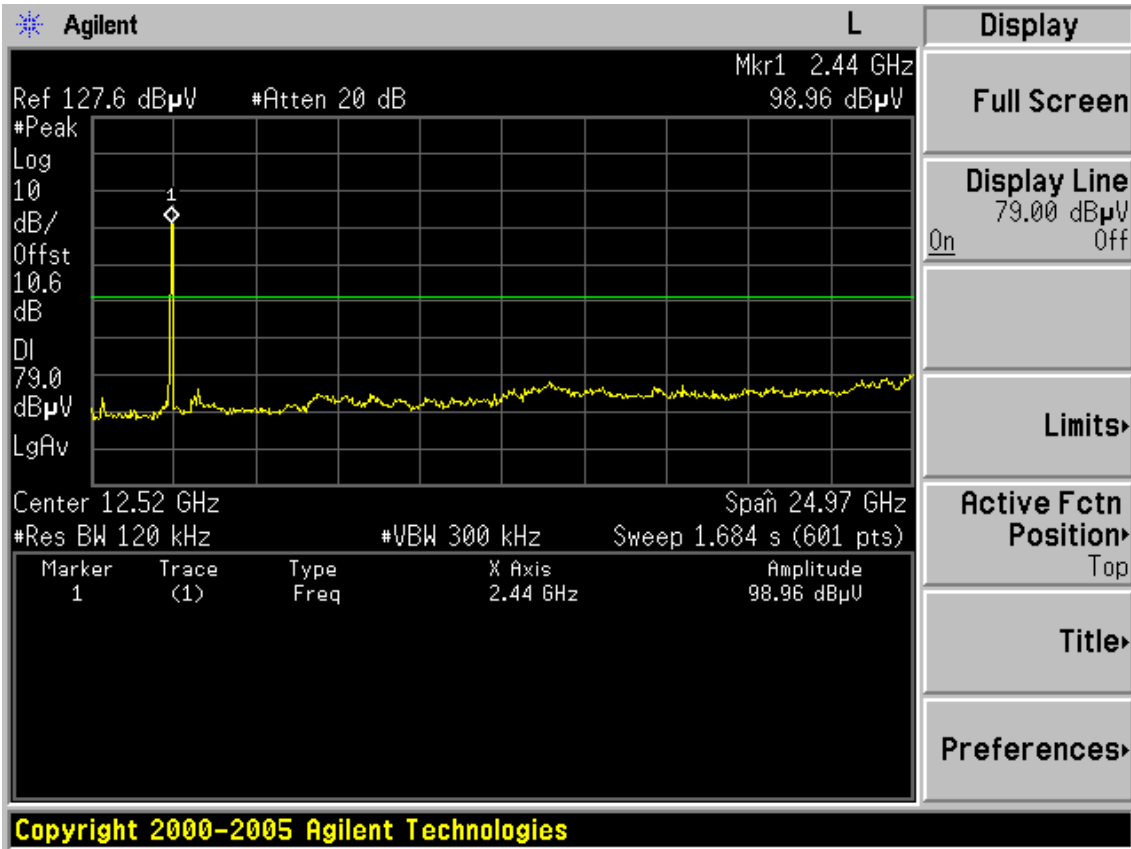

Chain 1:

Test Mode: IEEE 802.11b TX

Test CH1: 2412MHz

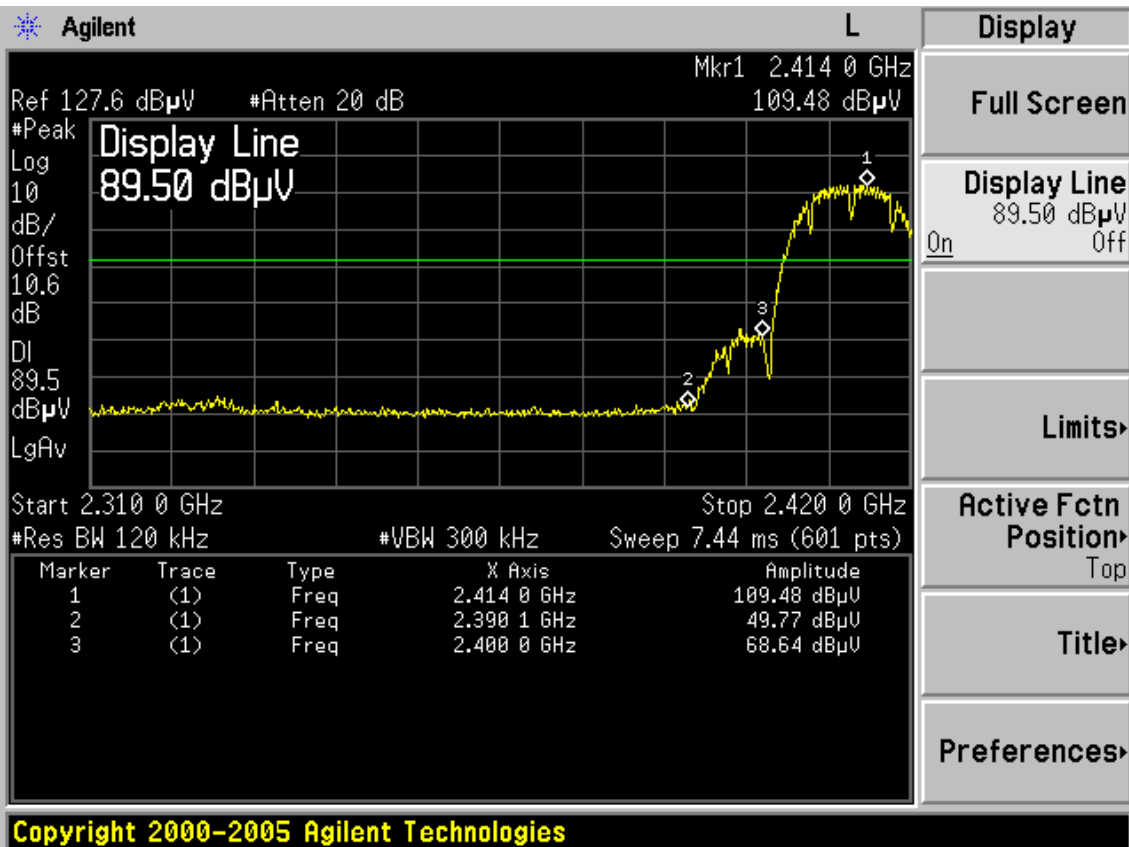
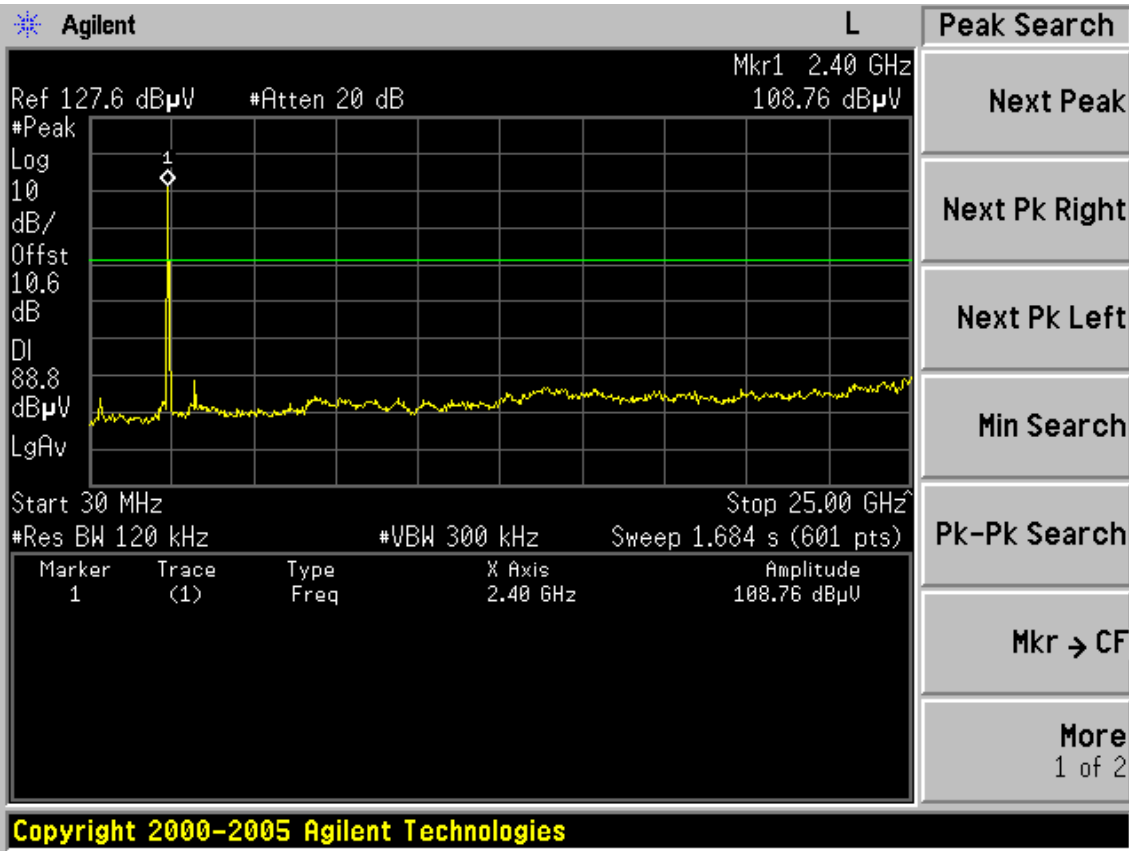

Test CH6: 2437MHz

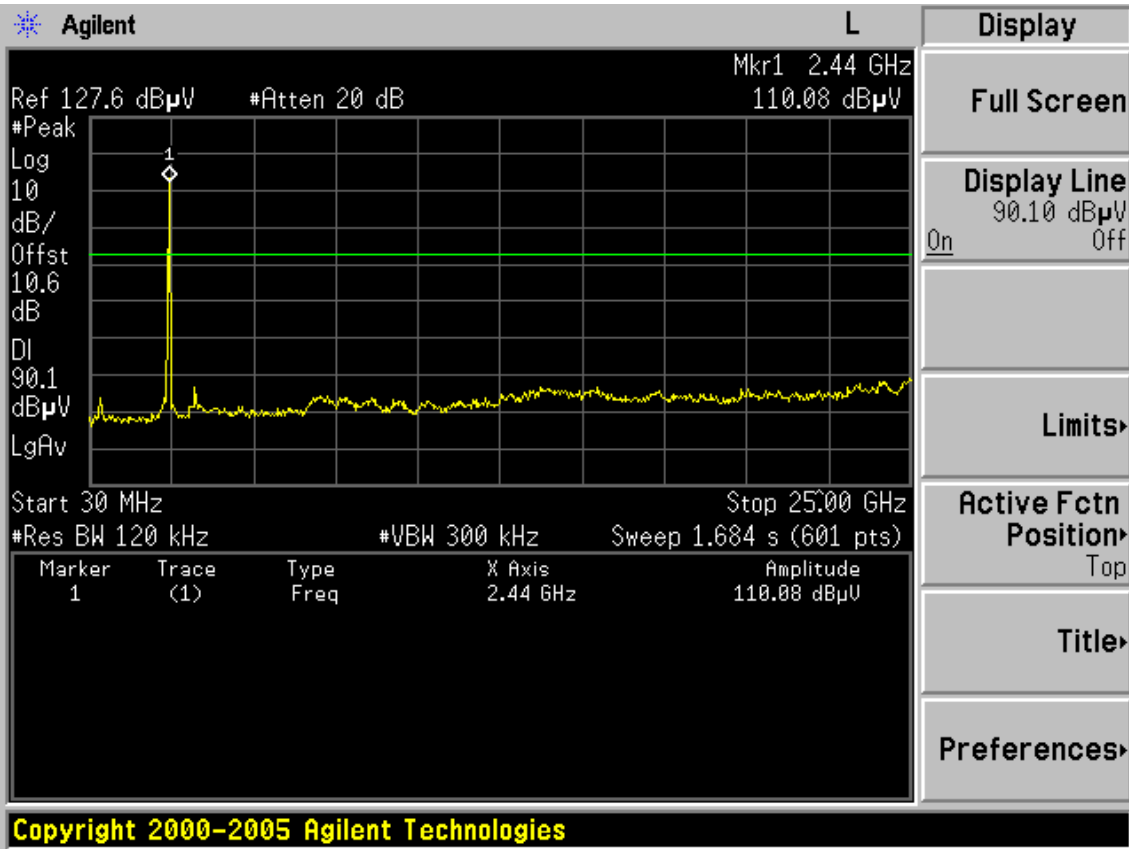

Test CH11: 2462MHz

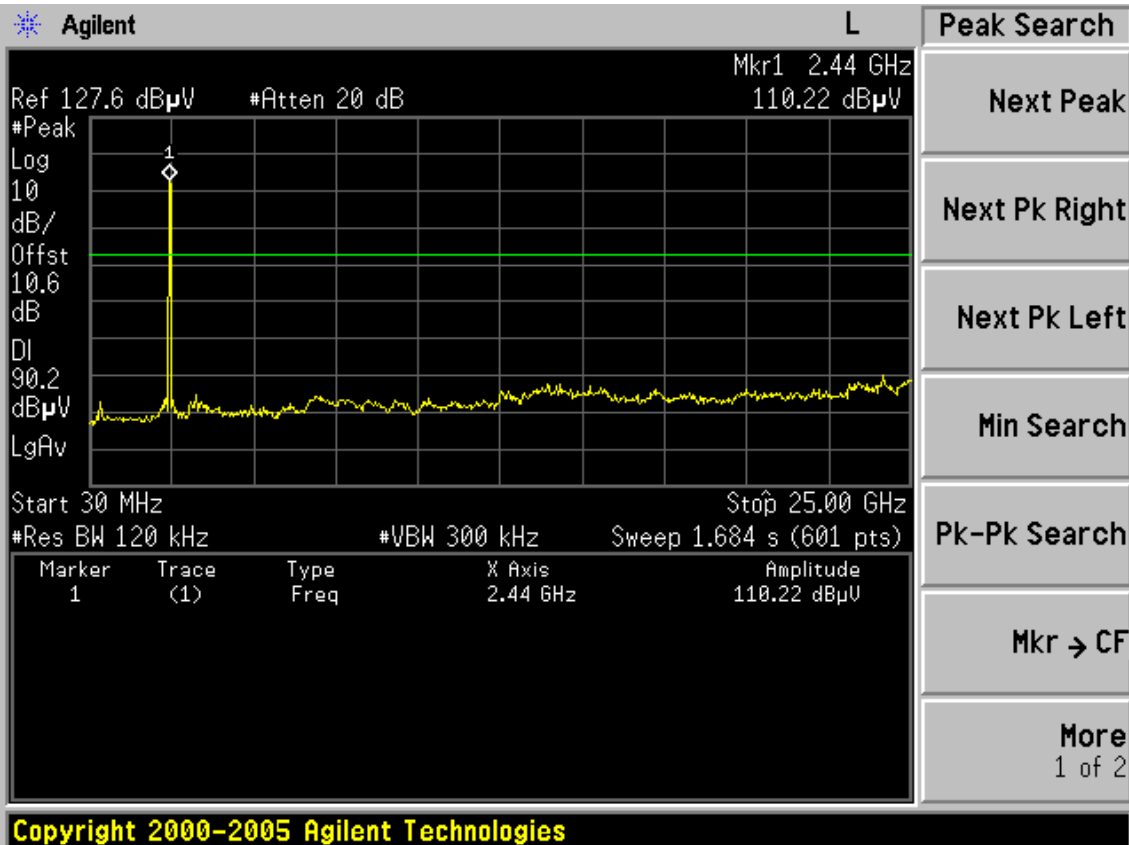

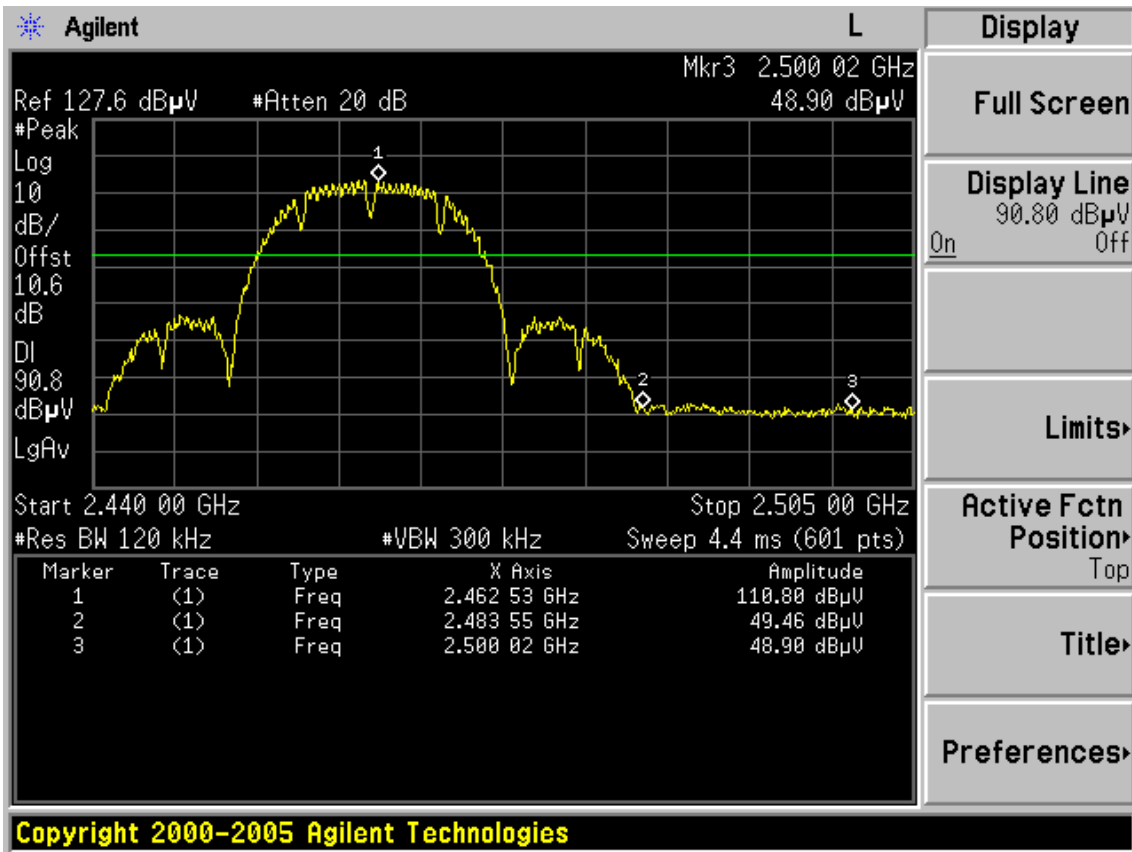

Test Mode: IEEE 802.11g TX
 Test CH1: 2412MHz

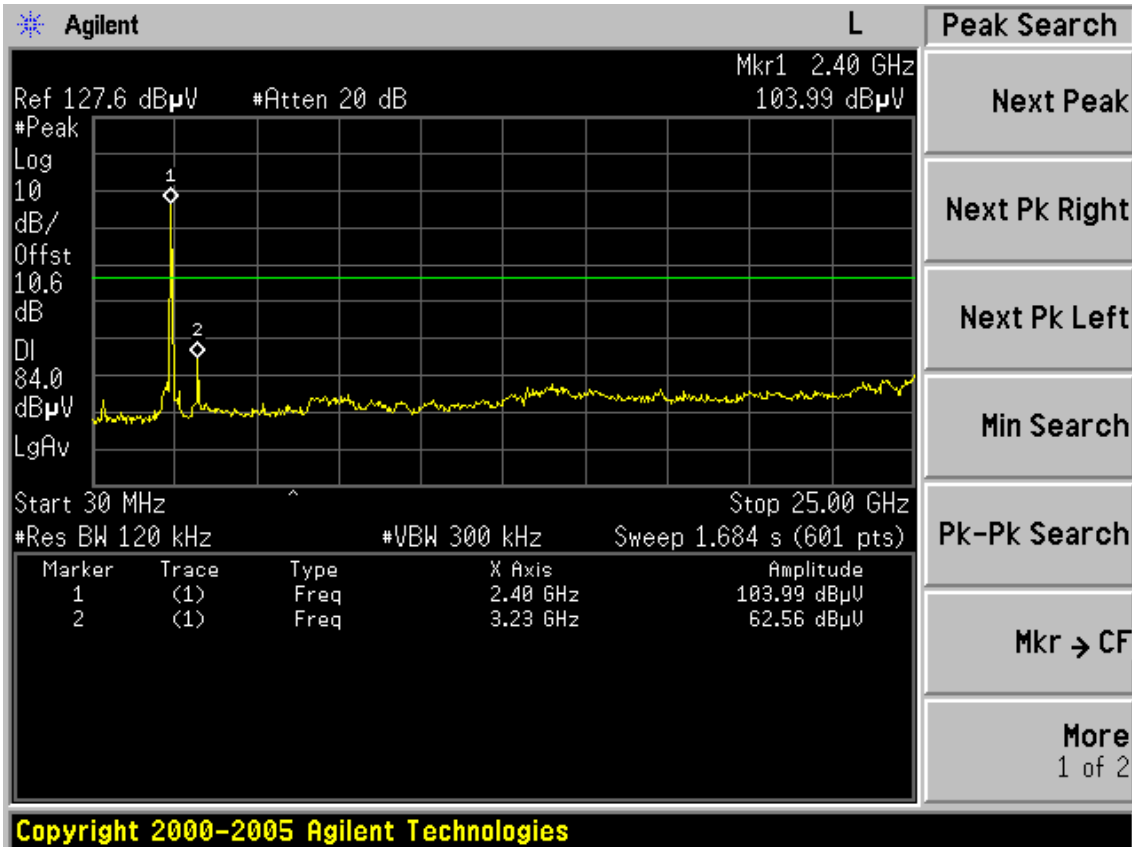

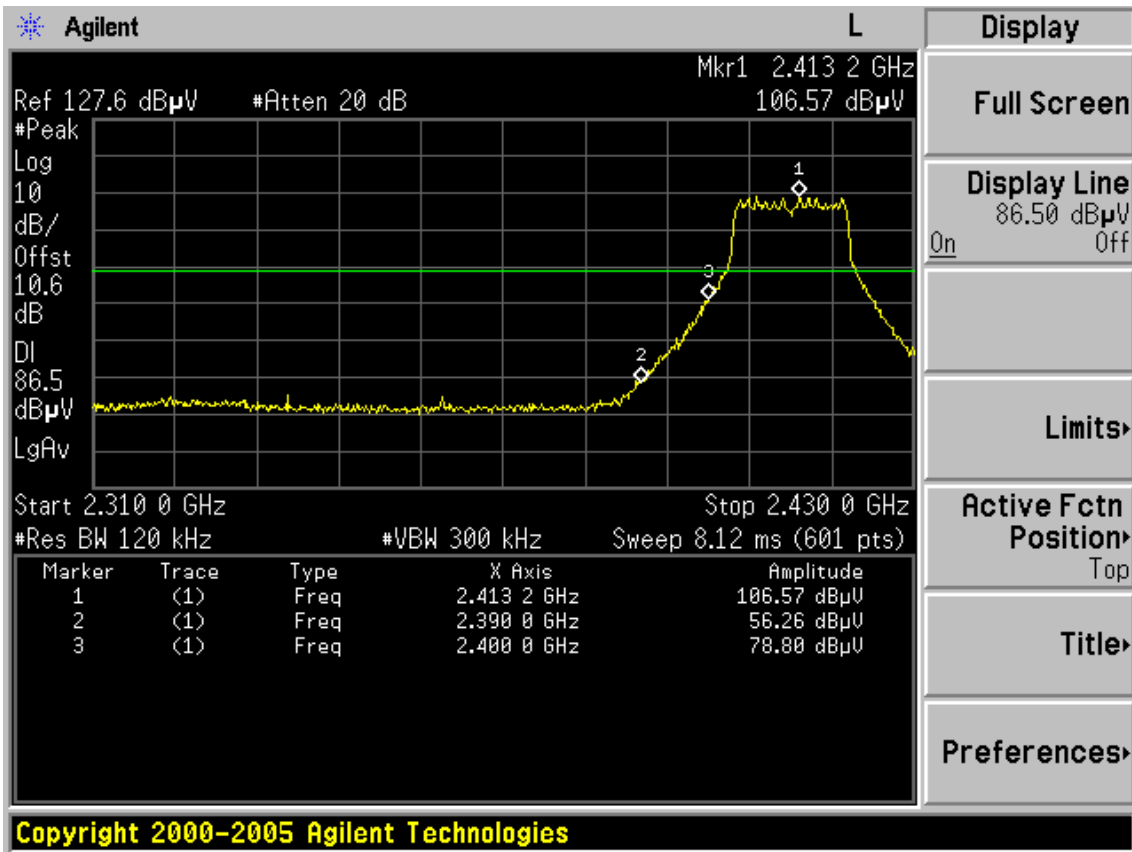

Test CH6: 2437MHz

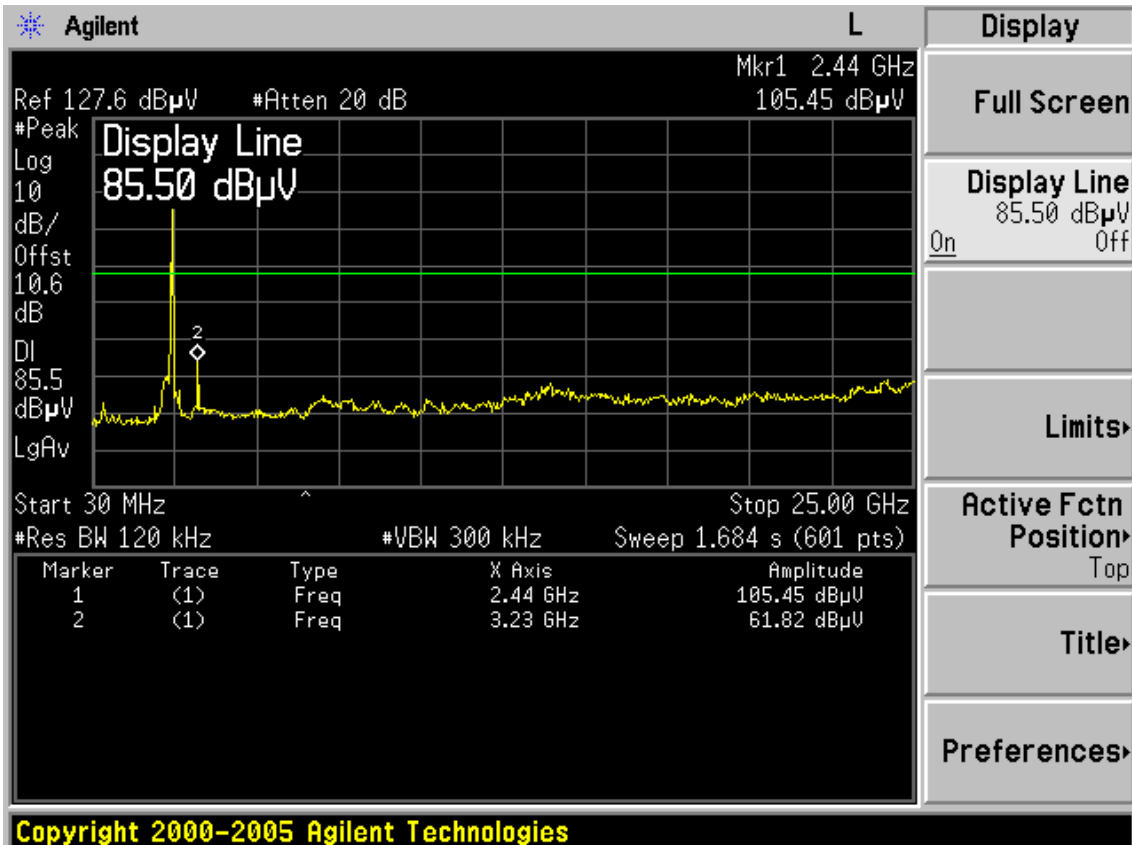

Test CH11: 2462MHz

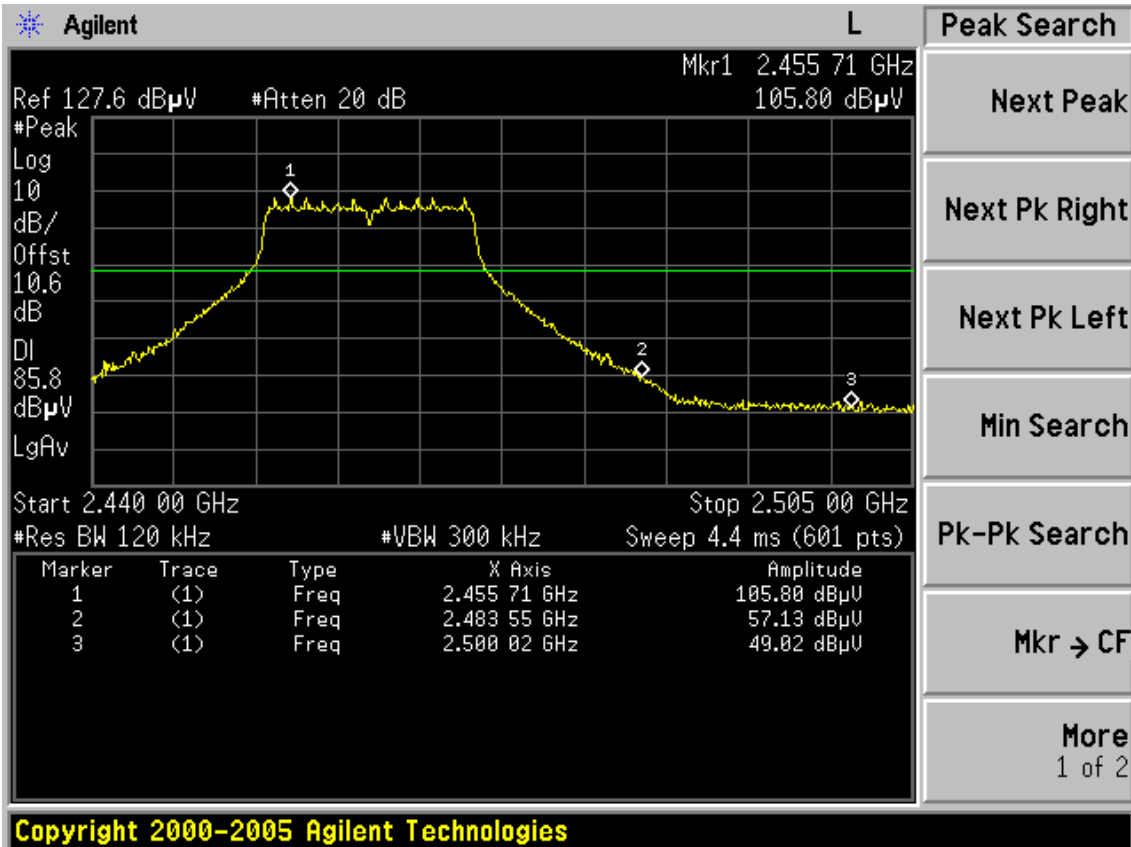
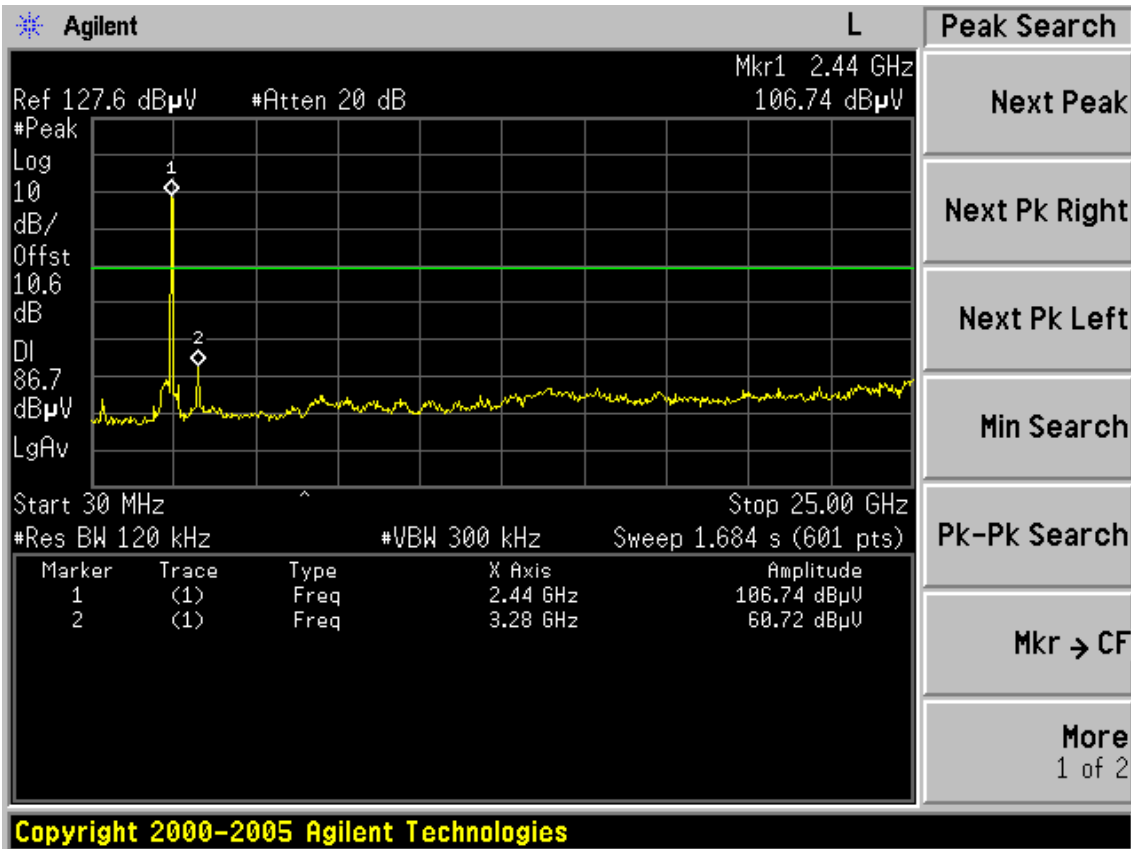

Test Mode: IEEE 802.11n HT20 TX

Test CH1: 2412MHz

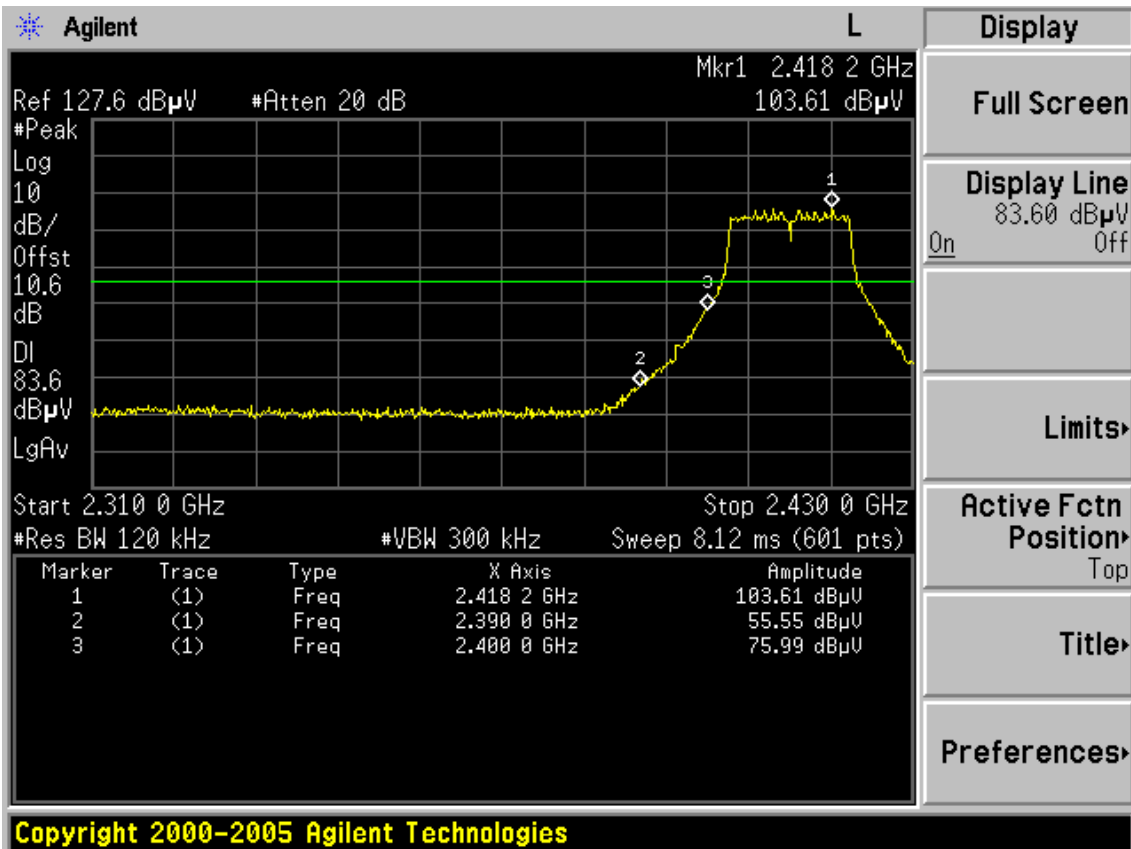
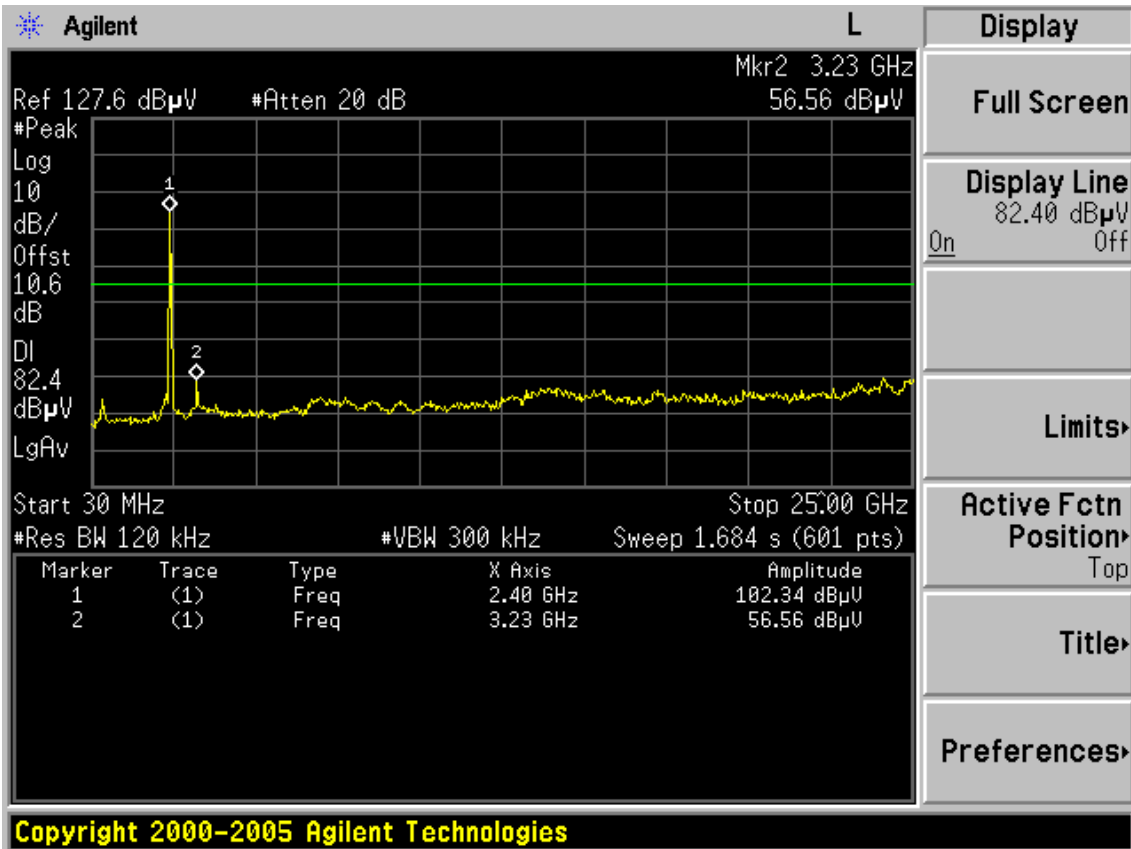

Test CH6: 2437MHz

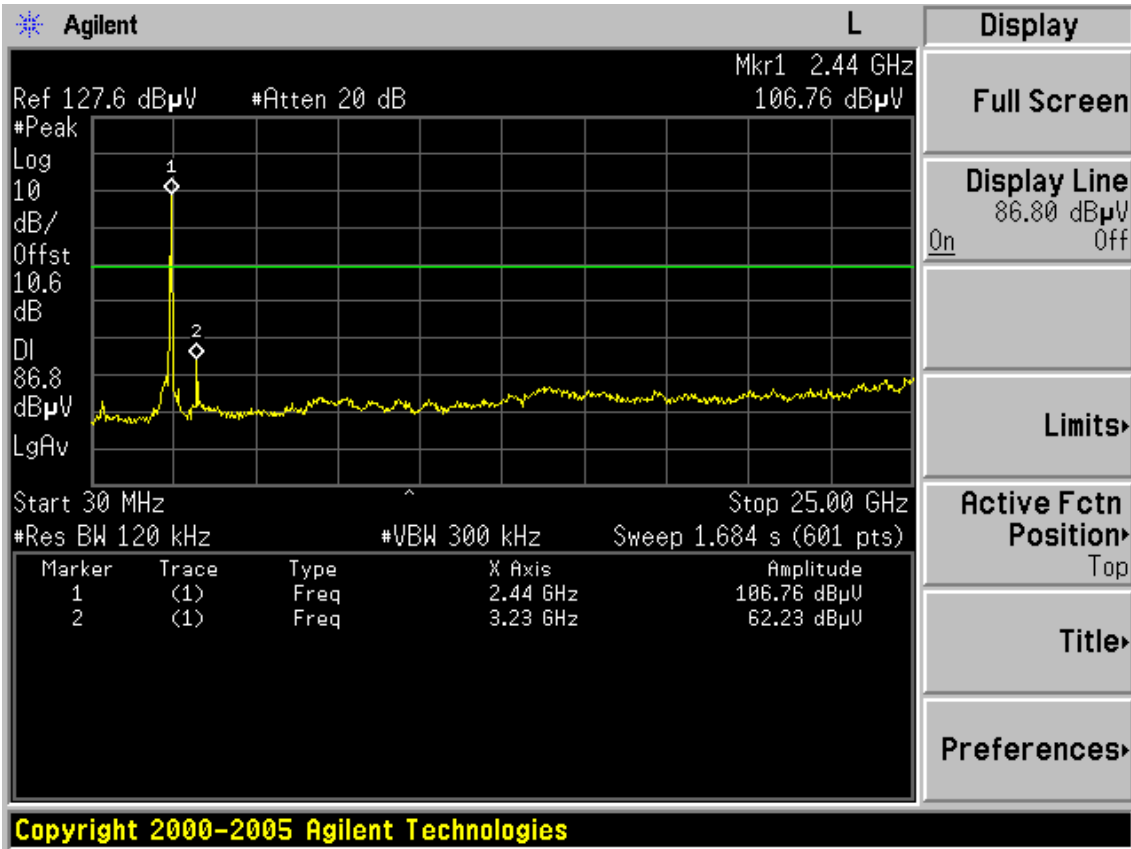

Test CH11: 2462MHz

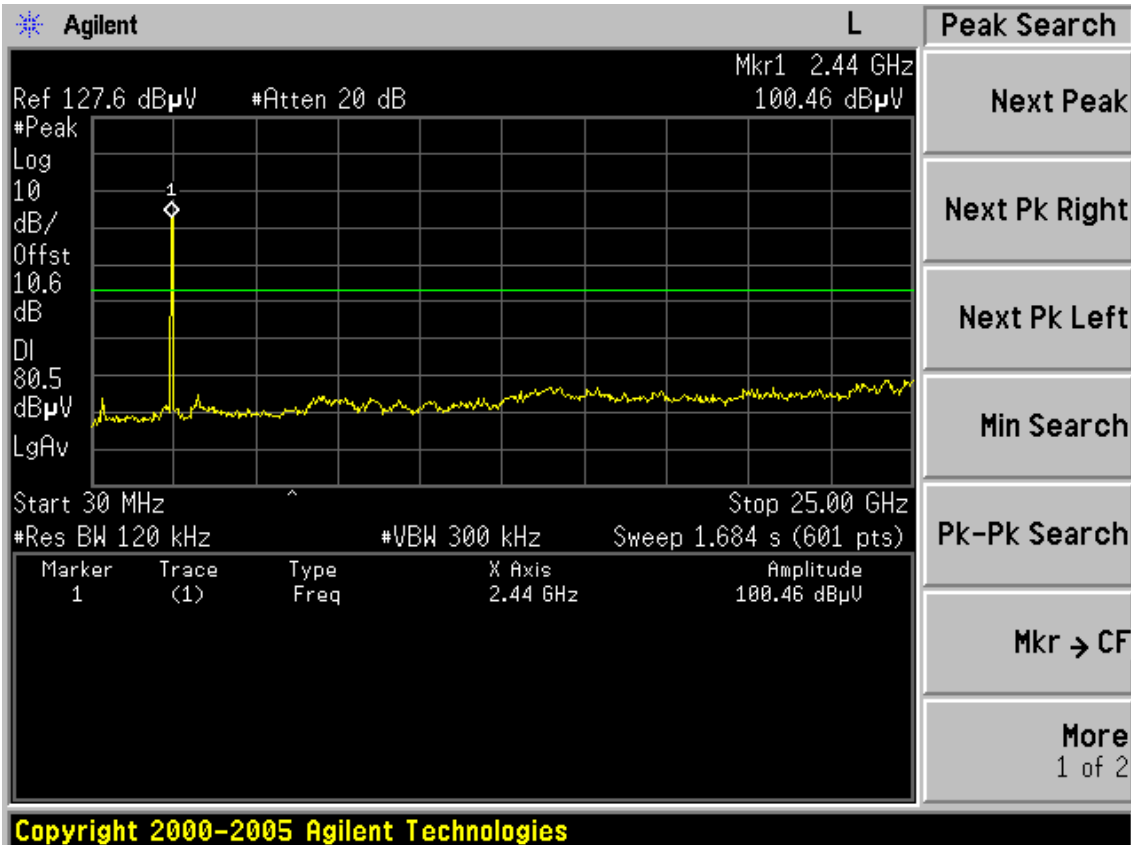

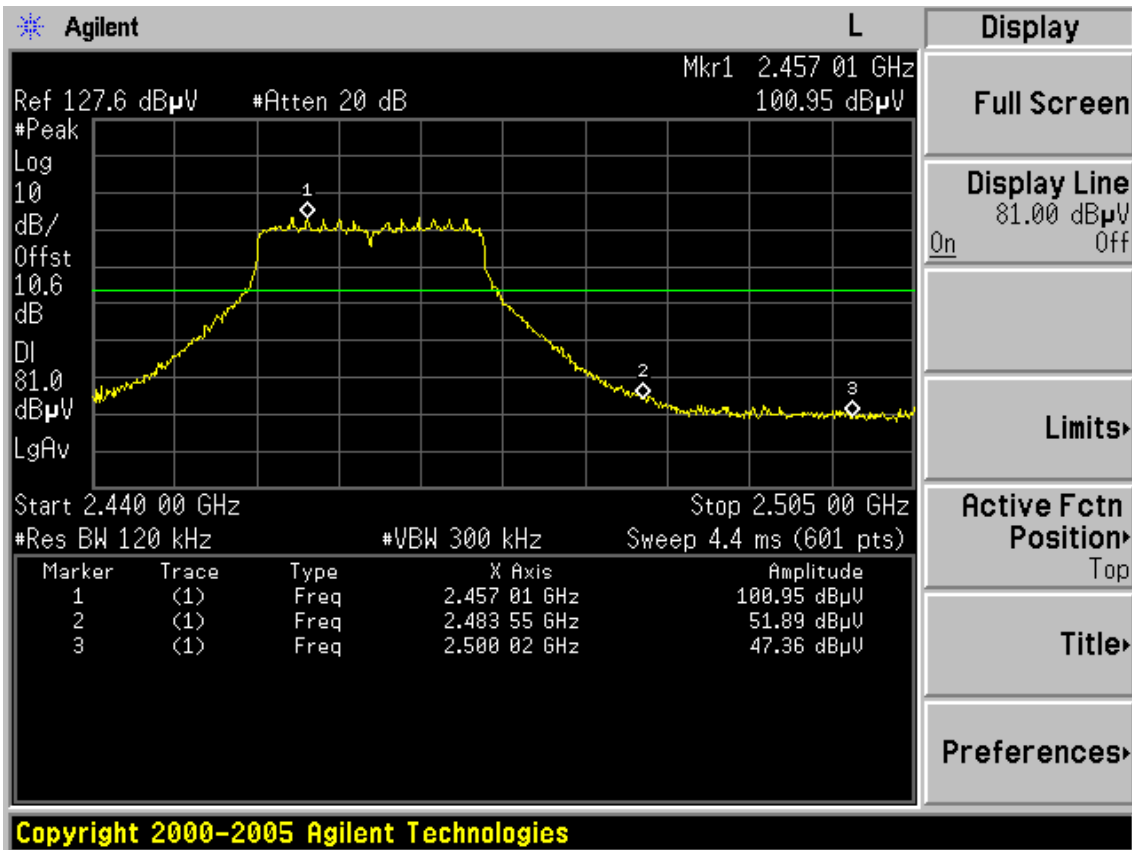

Test Mode: IEEE 802.11n HT40 TX
 Test CH1: 2422MHz

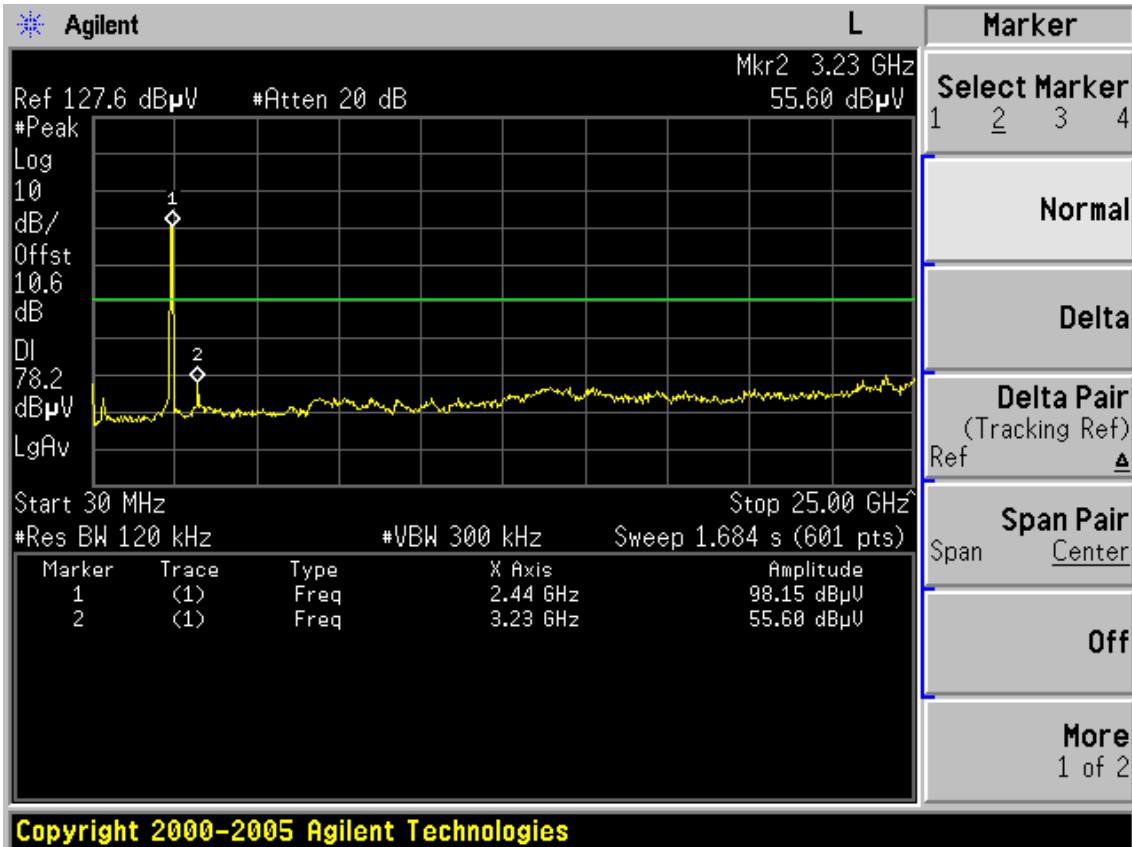

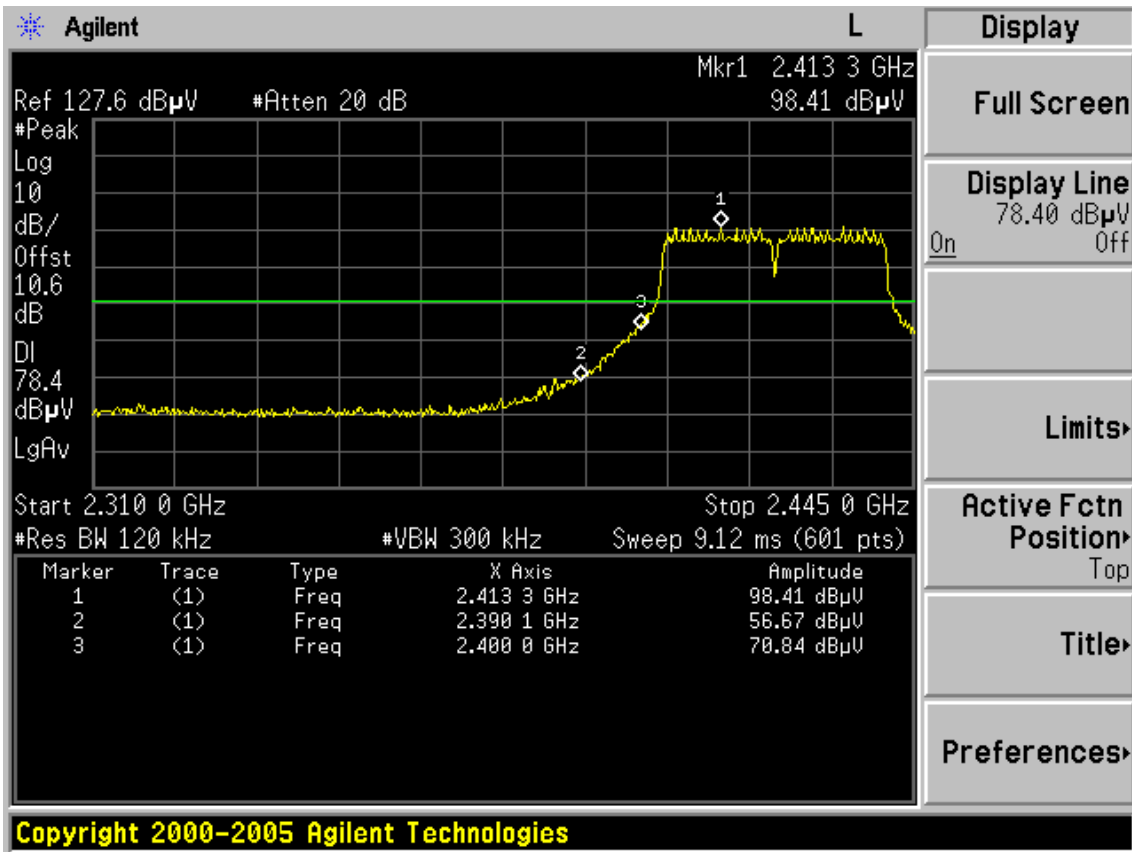

Test CH4: 2437MHz

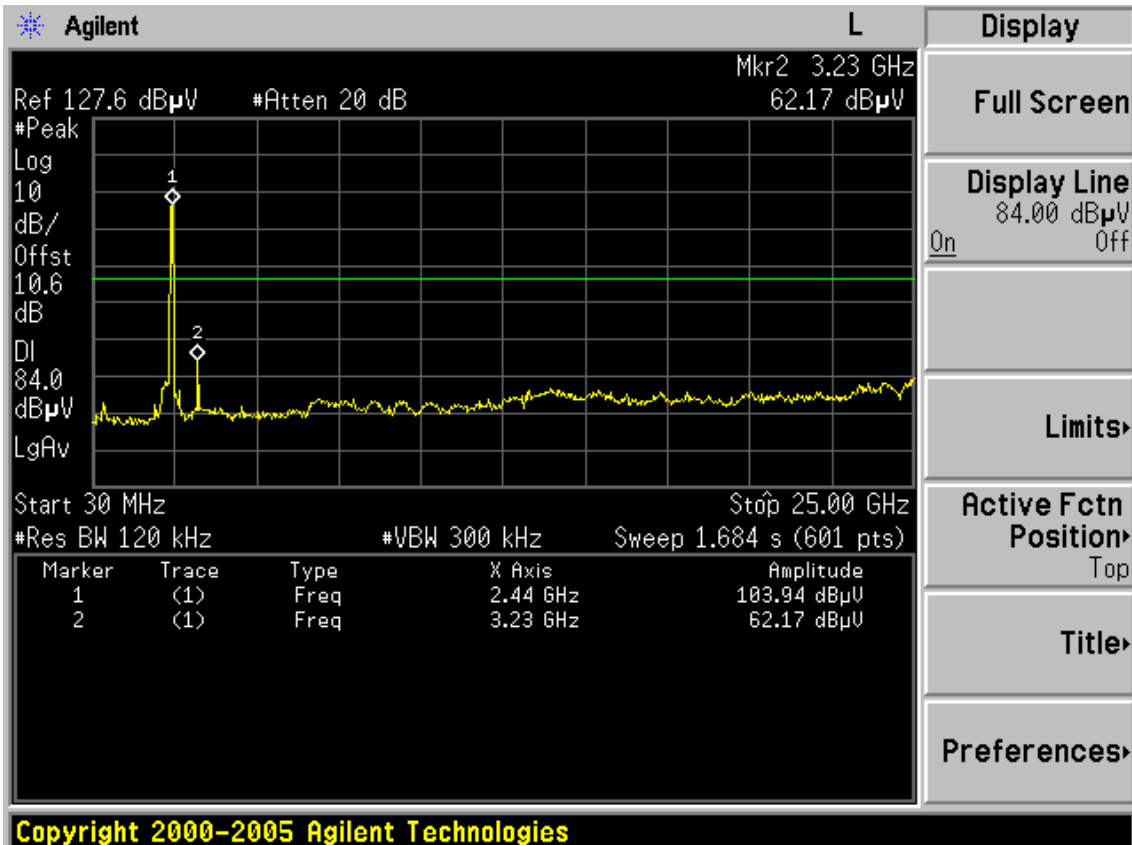

Test CH7: 2452MHz

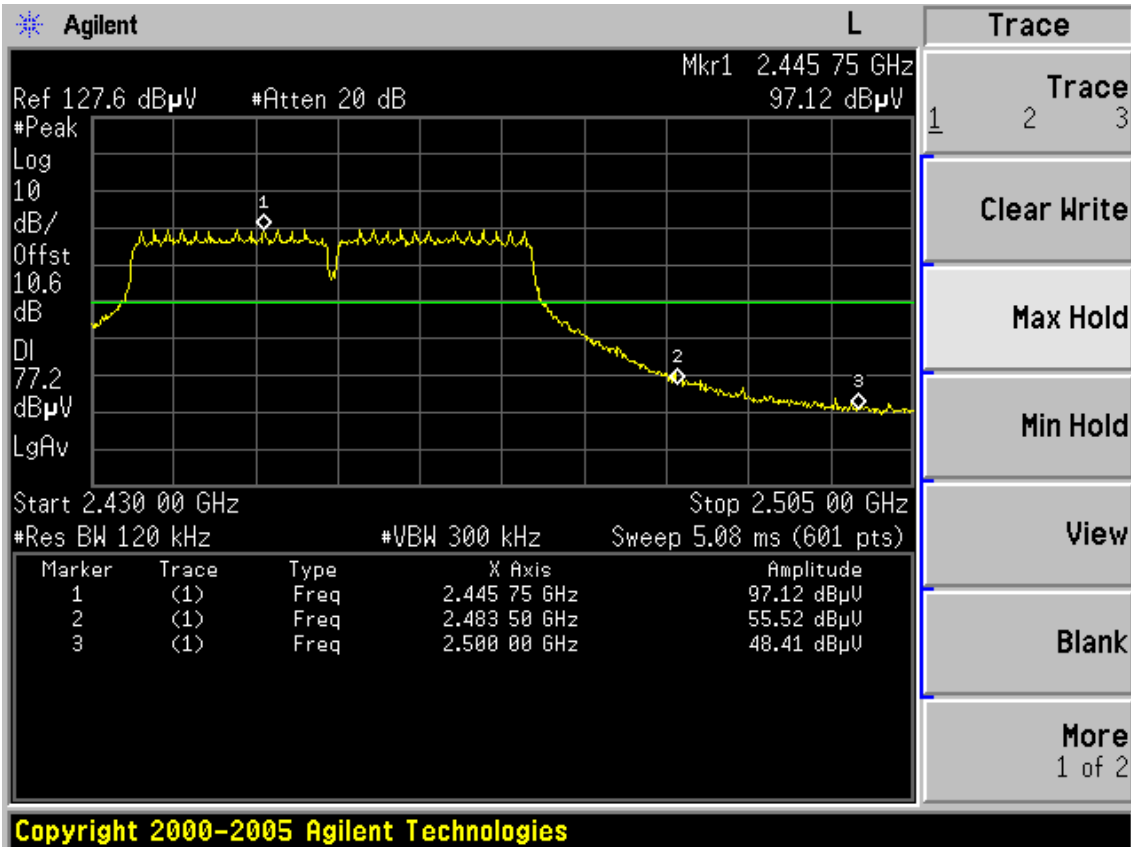
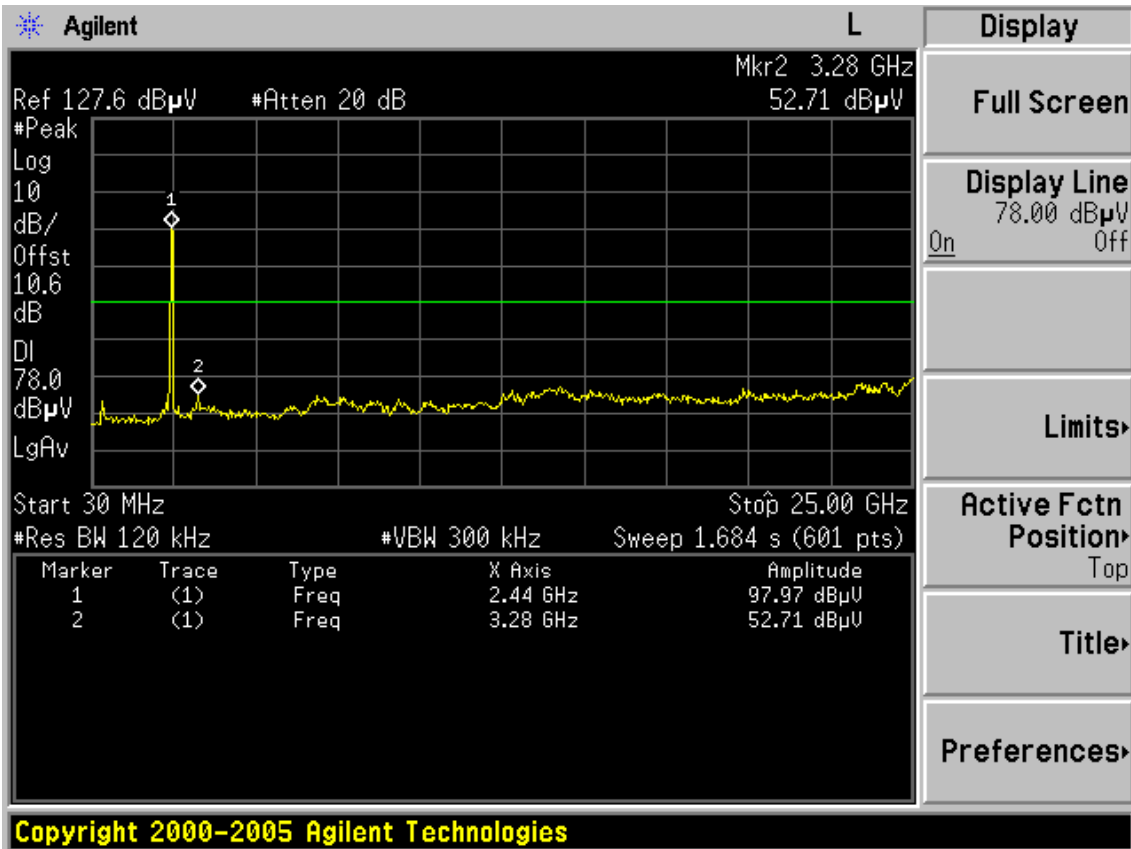

6. BAND EDGE COMPLIANCE TEST

6.1. Test Equipment

Item	Equipment	Manufacturer	Model No.	Serial No.	Last Cal.	Cal. Interval
1.	Spectrum Analyzer	Agilent	E4446A	US44300459	May.08,11	1 Year
2.	Horn Antenna	EMCO	3115	9607-4877	May.25, 11	1.5 Year
3.	Amplifier	Agilent	8449B	3008A02495	May.08, 11	1 Year
4.	RF Cable	Hubersuhner	SUCOFLEX102	28620/2	May.08,11	1 Year
5.	RF Cable	Hubersuhner	SUCOFLEX102	28618/2	May.08,11	1 Year
6.	RF Cable	Hubersuhner	SUCOFLEX102	28610/2	May.08,11	1 Year

6.2. Limit

All the lower and upper band-edges emissions appearing within 2310MHz to 2390MHz and 2483.5MHz to 2500MHz restricted frequency bands shall not exceed the limits shown in 15.209, all the other emissions outside operation frequency band 2400MHz to 2483.5MHz shall be at least 20dB below the fundamental emissions, or comply with 15.209 limits.

6.3. Test Produce

1. The EUT is placed on a turntable, which is 0.8m above the ground plane and worked at highest radiated power.
2. The turntable was rotated for 360 degrees to determine the position of maximum emission level.
3. EUT is set 3m away from the receiving antenna, which is varied from 1m to 4m to find out the highest emission.
4. Set the spectrum analyzer in the following setting in order to capture the lower and upper band-edges of the emission:
 - (a) PEAK: RBW=1MHz; VBW=3MHz; Sweep=AUTO
 - (b) AVERAGE: RBW=1MHz; VBW=10Hz; Sweep=AUTO

6.4. Test Results

Pass (The testing data was attached in the next pages.)

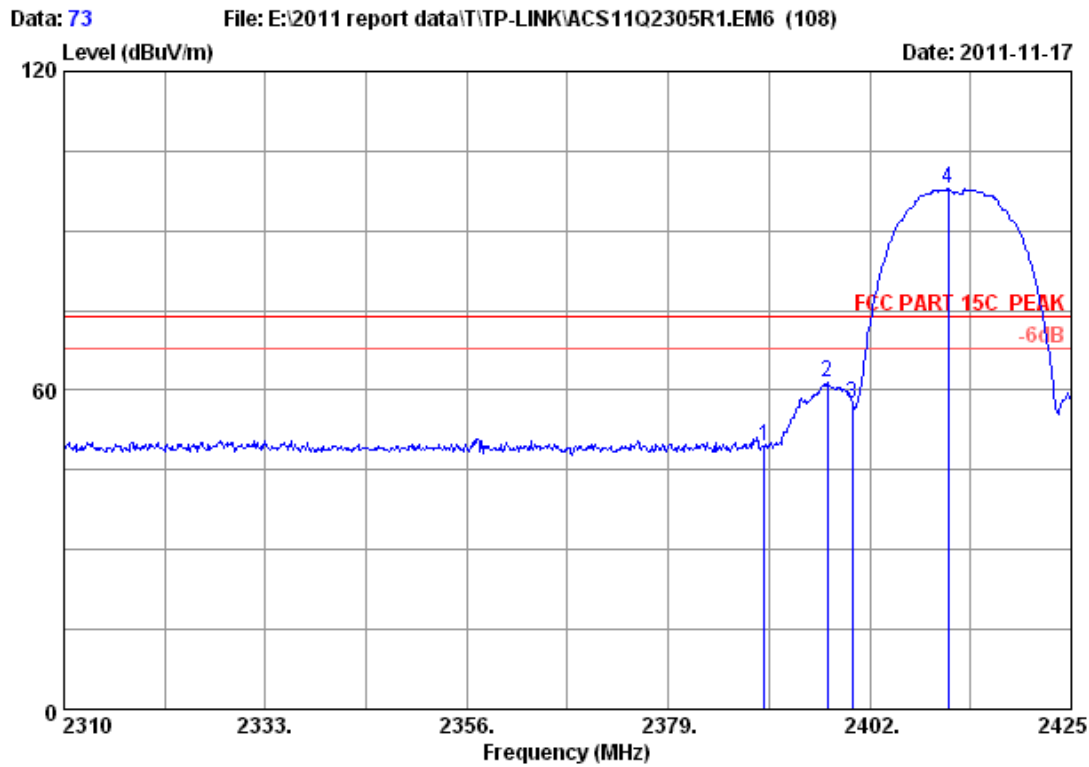

Site no. : 3m Chamber Data no. : 73
 Dis. / Ant. : 3m 3115(0911) Ant. pol. : HORIZONTAL
 Limit : FCC PART 15C PEAK
 Env. / Ins. : 23°C/54% Engineer : Leo-Li
 EUT : 300Mbps Wireless N Range Extender
 Power : DC 12V From Adapter input AC 120V/60Hz
 Test mode : IEEE802.11b CH1 2412MHz Tx
 M/N : TL-WA830RE

	Freq. (MHz)	Ant. Factor (dB/m)	Cable loss (dB)	Amp. Factor (dB)	Reading (dBuV)	Emission			Remark
						Level (dBuV/m)	Limits (dBuV/m)	Margin (dB)	
1	2390.000	29.44	8.67	36.09	47.59	49.61	74.00	24.39	Peak
2	2397.170	29.44	8.72	36.09	59.35	61.42	74.00	12.58	Peak
3	2400.000	29.44	8.72	36.09	55.40	57.47	74.00	16.53	Peak
4	2410.970	29.45	8.72	35.95	95.60	97.82	74.00	-23.82	Peak

Remarks:

1. Emission Level= Antenna Factor + Cable Loss -Amp Factor + Reading.
2. The emission levels that are 20dB below the official limit are not reported.

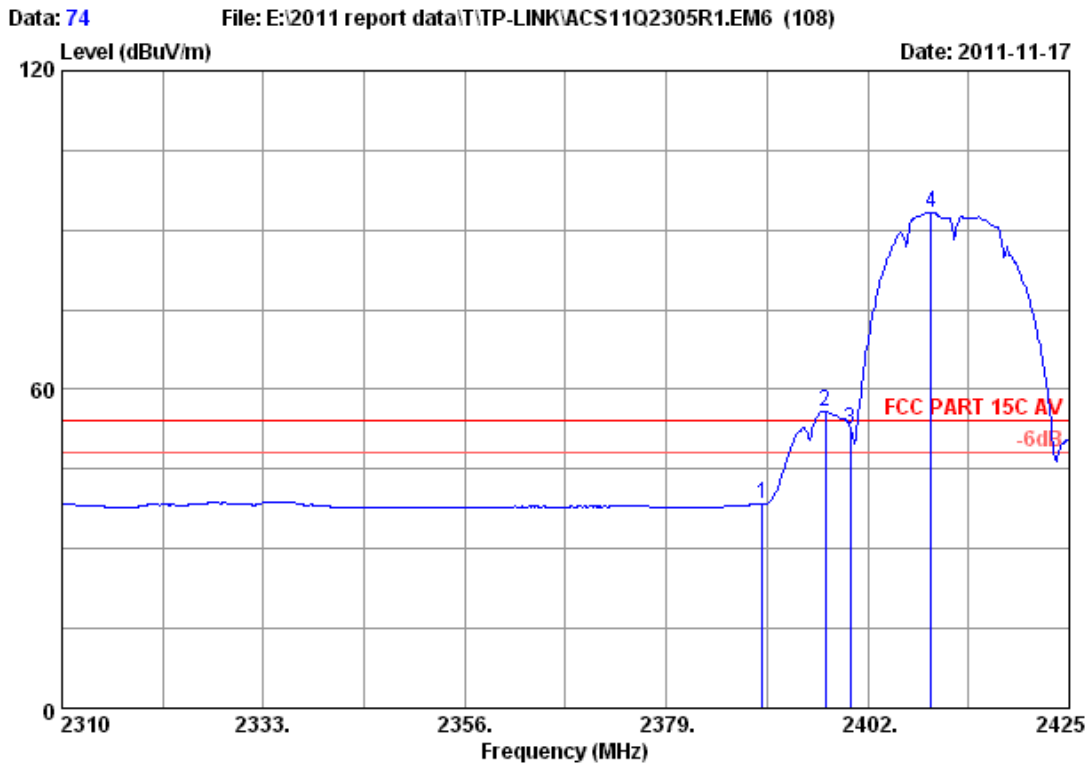

Site no. : 3m Chamber Data no. : 74
 Dis. / Ant. : 3m 3115(0911) Ant. pol. : HORIZONTAL
 Limit : FCC PART 15C AV
 Env. / Ins. : 23°C/54% Engineer : Leo-Li
 EUT : 300Mbps Wireless N Range Extender
 Power : DC 12V From Adapter input AC 120V/60Hz
 Test mode : IEEE802.11b CH1 2412MHz Tx
 M/N : TL-WA830RE

	Freq. (MHz)	Ant. Factor (dB/m)	Cable loss (dB)	Amp. Factor (dB)	Reading (dBuV)	Emission			Remark
						Level (dBuV/m)	Limits (dBuV/m)	Margin (dB)	
1	2390.000	29.44	8.67	36.09	36.44	38.46	54.00	15.54	Average
2	2397.170	29.44	8.72	36.09	53.78	55.85	54.00	-1.85	Average
3	2400.000	29.44	8.72	36.09	50.52	52.59	54.00	1.41	Average
4	2409.245	29.45	8.72	35.95	91.19	93.41	54.00	-39.41	Average

Remarks:

1. Emission Level= Antenna Factor + Cable Loss -Amp Factor + Reading.
2. The emission levels that are 20dB below the official limit are not reported.

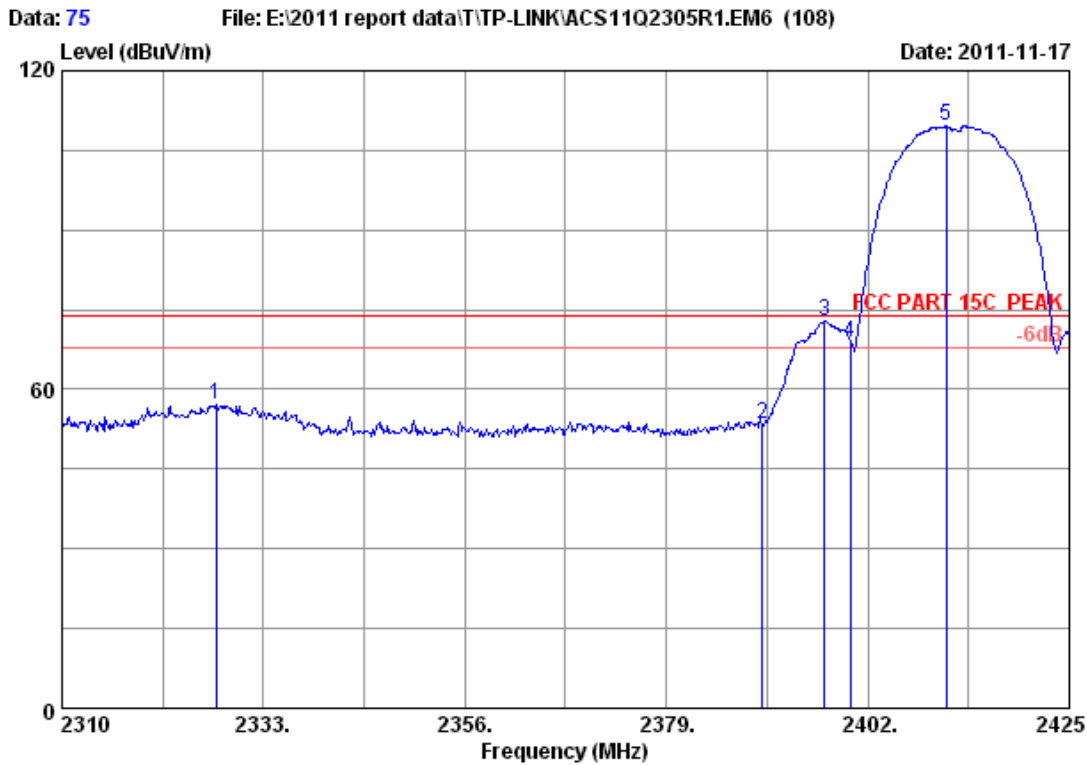

Site no. : 3m Chamber Data no. : 75
 Dis. / Ant. : 3m 3115(0911) Ant. pol. : VERTICAL
 Limit : FCC PART 15C PEAK
 Env. / Ins. : 23°C/54% Engineer : Leo-Li
 EUT : 300Mbps Wireless N Range Extender
 Power : DC 12V From Adapter input AC 120V/60Hz
 Test mode : IEEE802.11b CH1 2412MHz Tx
 M/N : TL-WA830RE

	Ant. Freq. (MHz)	Ant. Factor (dB/m)	Cable loss (dB)	Amp. Factor (dB)	Reading (dBUV)	Emission Level (dBUV/m)	Limits (dBUV/m)	Margin (dB)	Remark
1	2327.595	29.40	8.57	36.06	55.15	57.06	74.00	16.94	Peak
2	2390.000	29.44	8.67	36.09	51.37	53.39	74.00	20.61	Peak
3	2397.055	29.44	8.72	36.09	70.90	72.97	74.00	1.03	Peak
4	2400.000	29.44	8.72	36.09	66.79	68.86	74.00	5.14	Peak
5	2410.970	29.45	8.72	35.95	107.33	109.55	74.00	-35.55	Peak

Remarks:

1. Emission Level= Antenna Factor + Cable Loss -Amp Factor + Reading.
2. The emission levels that are 20dB below the official limit are not reported.

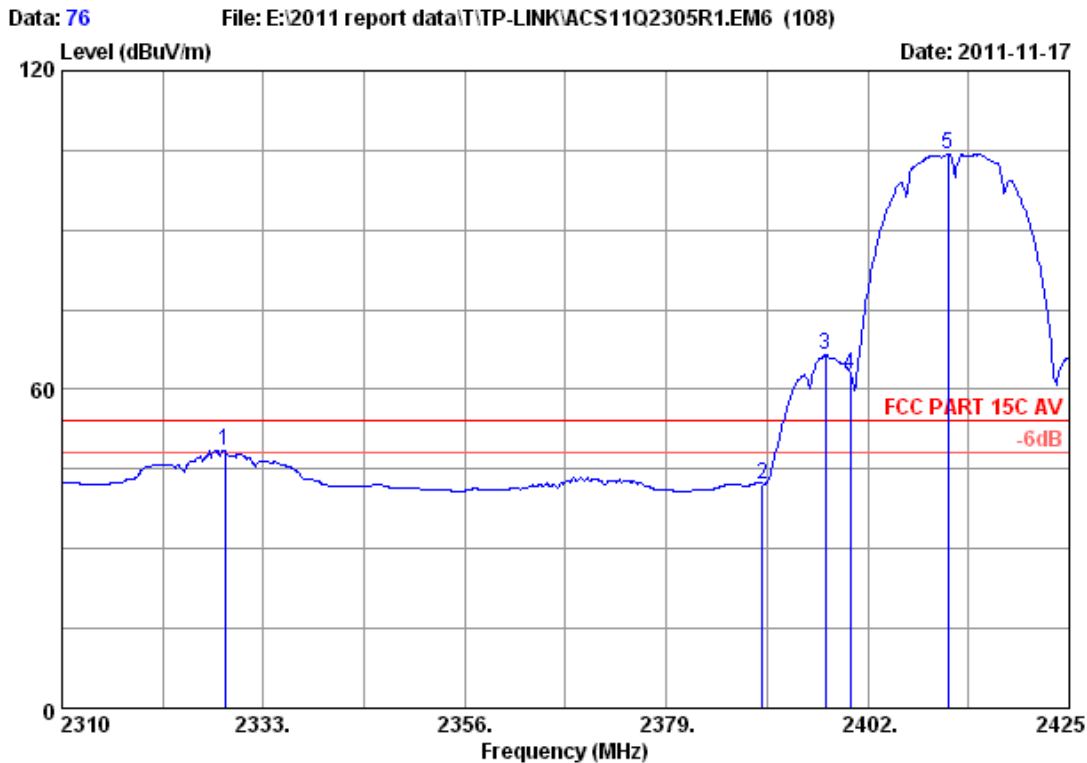

Site no. : 3m Chamber Data no. : 76
 Dis. / Ant. : 3m 3115(0911) Ant. pol. : VERTICAL
 Limit : FCC PART 15C AV
 Env. / Ins. : 23°C/54% Engineer : Leo-Li
 EUT : 300Mbps Wireless N Range Extender
 Power : DC 12V From Adapter input AC 120V/60Hz
 Test mode : IEEE802.11b CH1 2412MHz Tx
 M/N : TL-WA830RE

	Ant. Freq. (MHz)	Ant. Factor (dB/m)	Cable loss (dB)	Amp. Factor (dB)	Reading (dBuV)	Emission Level (dBuV/m)	Limits (dBuV/m)	Margin (dB)	Remark
1	2328.630	29.40	8.57	36.06	46.63	48.54	54.00	5.46	Average
2	2390.000	29.44	8.67	36.09	40.21	42.23	54.00	11.77	Average
3	2397.170	29.44	8.72	36.09	64.38	66.45	54.00	-12.45	Average
4	2400.000	29.44	8.72	36.09	60.91	62.98	54.00	-8.98	Average
5	2411.200	29.45	8.72	35.95	102.10	104.32	54.00	-50.32	Average

Remarks:

1. Emission Level= Antenna Factor + Cable Loss -Amp Factor + Reading.
2. The emission levels that are 20dB below the official limit are not reported.

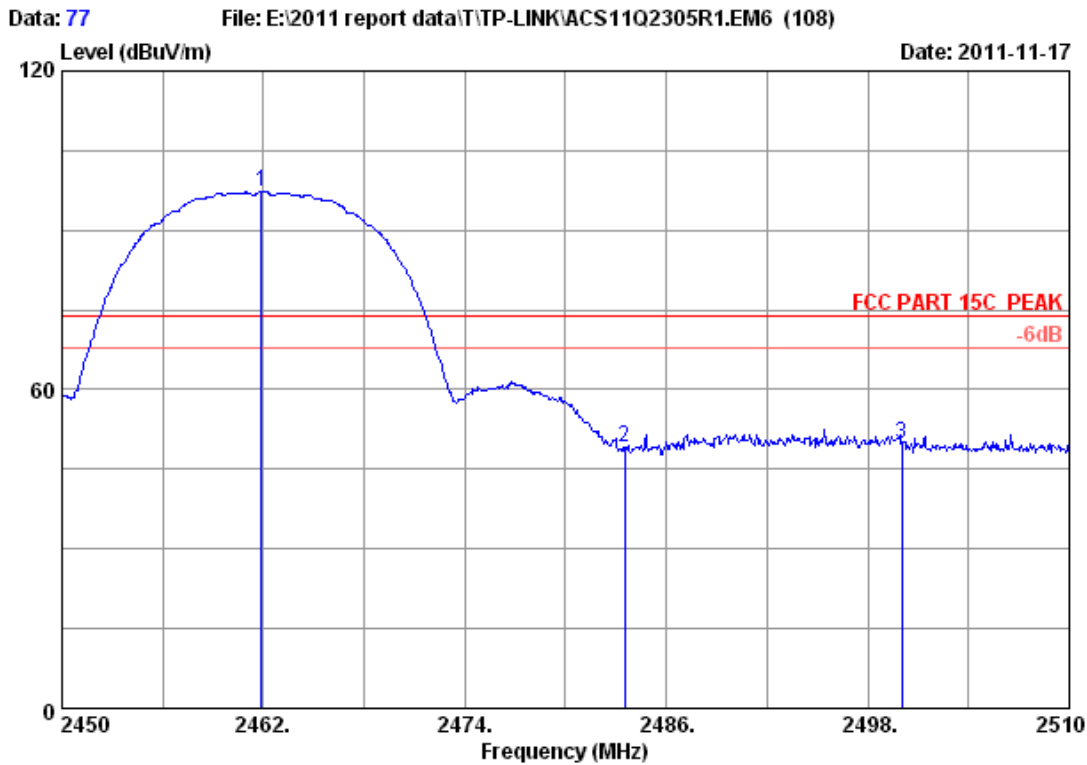

Site no. : 3m Chamber Data no. : 77
 Dis. / Ant. : 3m 3115(0911) Ant. pol. : HORIZONTAL
 Limit : FCC PART 15C PEAK
 Env. / Ins. : 23°C/54% Engineer : Leo-Li
 EUT : 300Mbps Wireless N Range Extender
 Power : DC 12V From Adapter input AC 120V/60Hz
 Test mode : IEEE802.11b CH11 2462MHz Tx
 M/N : TL-WA830RE

	Ant. Freq. (MHz)	Ant. Factor (dB/m)	Cable loss (dB)	Amp. Factor (dB)	Reading (dBuV)	Emission Level (dBuV/m)	Limits (dBuV/m)	Margin (dB)	Remark
1	2461.880	29.48	8.82	36.02	95.09	97.37	74.00	-23.37	Peak
2	2483.500	29.49	8.87	35.97	46.73	49.12	74.00	24.88	Peak
3	2500.000	29.50	8.92	36.00	47.45	49.87	74.00	24.13	Peak

Remarks:

1. Emission Level= Antenna Factor + Cable Loss -Amp Factor + Reading.
2. The emission levels that are 20dB below the official limit are not reported.

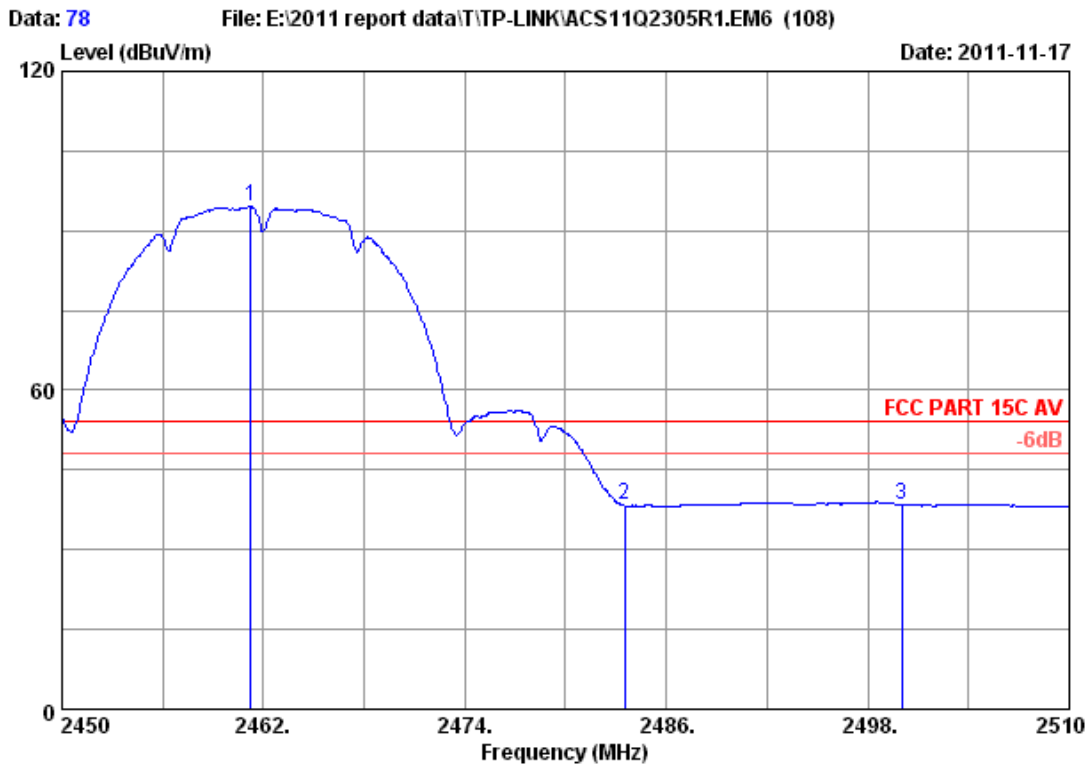

Site no. : 3m Chamber Data no. : 78
 Dis. / Ant. : 3m 3115(0911) Ant. pol. : HORIZONTAL
 Limit : FCC PART 15C AV
 Env. / Ins. : 23°C/54% Engineer : Leo-Li
 EUT : 300Mbps Wireless N Range Extender
 Power : DC 12V From Adapter input AC 120V/60Hz
 Test mode : IEEE802.11b CH11 2462MHz Tx
 M/N : TL-WA830RE

	Ant. Freq. (MHz)	Ant. Factor (dB/m)	Cable loss (dB)	Amp. Factor (dB)	Reading (dBuV)	Emission Level (dBuV/m)	Limits (dBuV/m)	Margin (dB)	Remark
1	2461.220	29.48	8.82	36.02	92.21	94.49	54.00	-40.49	Average
2	2483.500	29.49	8.87	35.97	35.91	38.30	54.00	15.70	Average
3	2500.000	29.50	8.92	36.00	36.16	38.58	54.00	15.42	Average

Remarks:

1. Emission Level= Antenna Factor + Cable Loss -Amp Factor + Reading.
2. The emission levels that are 20dB below the official limit are not reported.

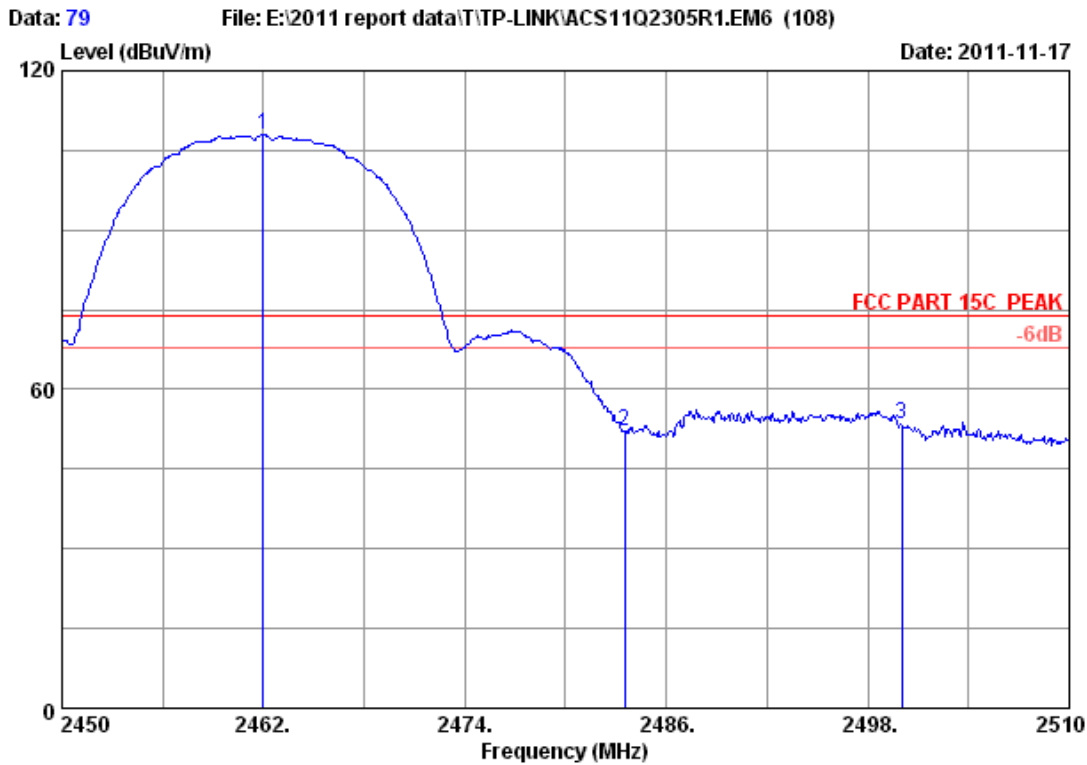

Site no. : 3m Chamber Data no. : 79
 Dis. / Ant. : 3m 3115(0911) Ant. pol. : VERTICAL
 Limit : FCC PART 15C PEAK
 Env. / Ins. : 23°C/54% Engineer : Leo-Li
 EUT : 300Mbps Wireless N Range Extender
 Power : DC 12V From Adapter input AC 120V/60Hz
 Test mode : IEEE802.11b CH11 2462MHz Tx
 M/N : TL-WA830RE

	Ant. Freq. (MHz)	Ant. Factor (dB/m)	Cable loss (dB)	Amp. Factor (dB)	Reading (dBUV)	Emission Level (dBUV/m)	Limits (dBUV/m)	Margin (dB)	Remark
1	2462.000	29.48	8.82	36.02	105.60	107.88	74.00	-33.88	Peak
2	2483.500	29.49	8.87	35.97	49.85	52.24	74.00	21.76	Peak
3	2500.000	29.50	8.92	36.00	51.04	53.46	74.00	20.54	Peak

Remarks:

1. Emission Level= Antenna Factor + Cable Loss -Amp Factor + Reading.
2. The emission levels that are 20dB below the official limit are not reported.

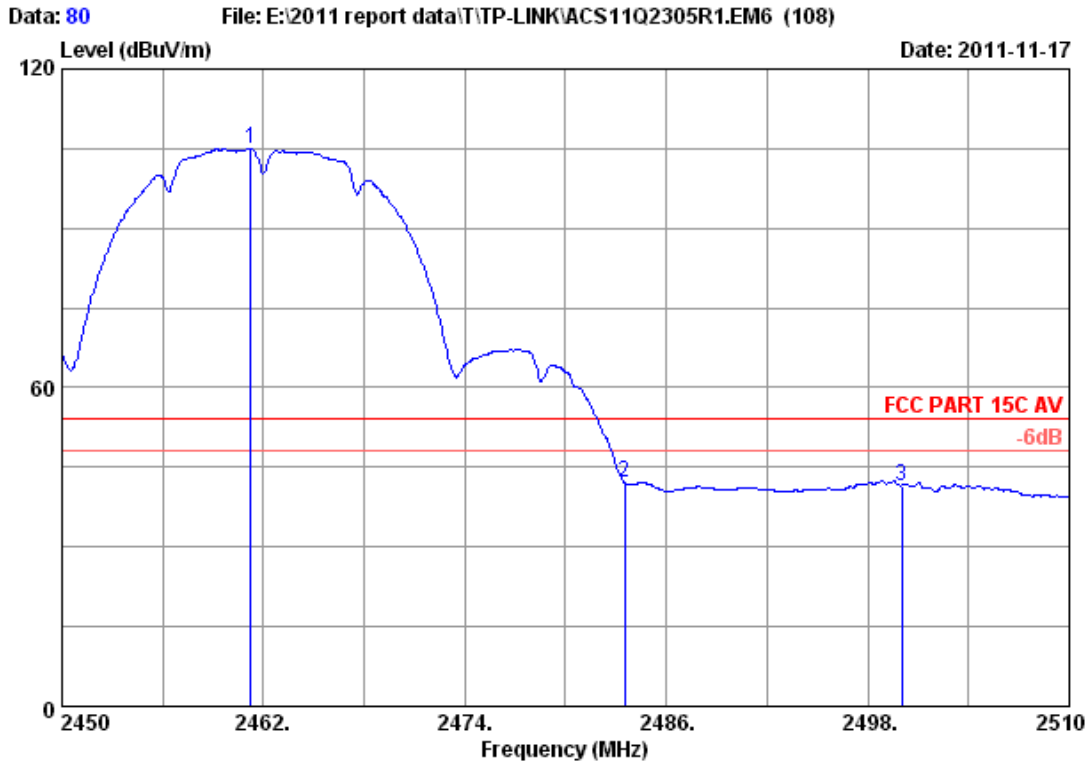

Site no. : 3m Chamber Data no. : 80
 Dis. / Ant. : 3m 3115(0911) Ant. pol. : VERTICAL
 Limit : FCC PART 15C AV
 Env. / Ins. : 23°C/54% Engineer : Leo-Li
 EUT : 300Mbps Wireless N Range Extender
 Power : DC 12V From Adapter input AC 120V/60Hz
 Test mode : IEEE802.11b CH11 2462MHz Tx
 M/N : TL-WA830RE

	Ant. Freq. (MHz)	Ant. Factor (dB/m)	Cable loss (dB)	Amp. Factor (dB)	Reading (dBuV)	Emission Level (dBuV/m)	Limits (dBuV/m)	Margin (dB)	Remark
1	2461.220	29.48	8.82	36.02	102.68	104.96	54.00	-50.96	Average
2	2483.500	29.49	8.87	35.97	39.76	42.15	54.00	11.85	Average
3	2500.000	29.50	8.92	36.00	39.15	41.57	54.00	12.43	Average

Remarks:

1. Emission Level= Antenna Factor + Cable Loss -Amp Factor + Reading.
2. The emission levels that are 20dB below the official limit are not reported.

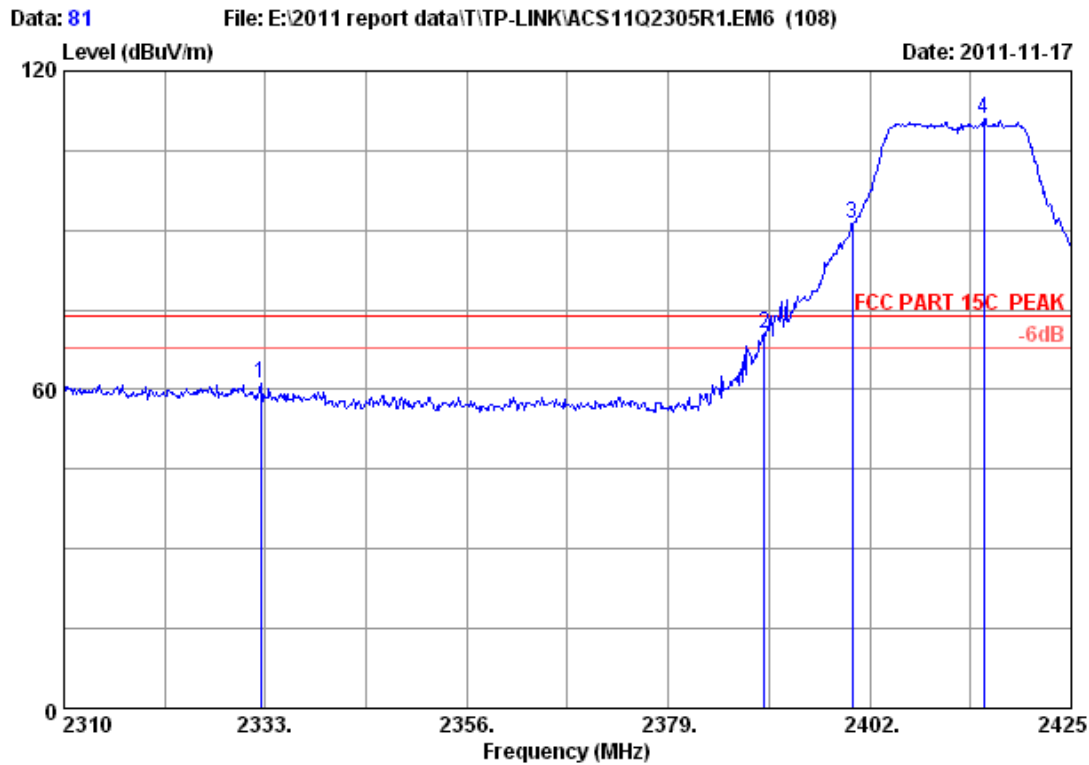

Site no. : 3m Chamber Data no. : 81
 Dis. / Ant. : 3m 3115(0911) Ant. pol. : VERTICAL
 Limit : FCC PART 15C PEAK
 Env. / Ins. : 23°C/54% Engineer : Leo-Li
 EUT : 300Mbps Wireless N Range Extender
 Power : DC 12V From Adapter input AC 120V/60Hz
 Test mode : IEEE802.11g CH1 2412MHz Tx
 M/N : TL-WA830RE

	Ant. Freq. (MHz)	Ant. Factor (dB/m)	Cable loss (dB)	Amp. Factor (dB)	Reading (dBuV)	Emission Level (dBuV/m)	Limits (dBuV/m)	Margin (dB)	Remark
1	2332.425	29.40	8.57	36.06	59.11	61.02	74.00	12.98	Peak
2	2390.000	29.44	8.67	36.09	68.37	70.39	74.00	3.61	Peak
3	2400.000	29.44	8.72	36.09	89.33	91.40	74.00	-17.40	Peak
4	2414.995	29.45	8.72	35.95	108.61	110.83	74.00	-36.83	Peak

Remarks:

1. Emission Level= Antenna Factor + Cable Loss -Amp Factor + Reading.
2. The emission levels that are 20dB below the official limit are not reported.

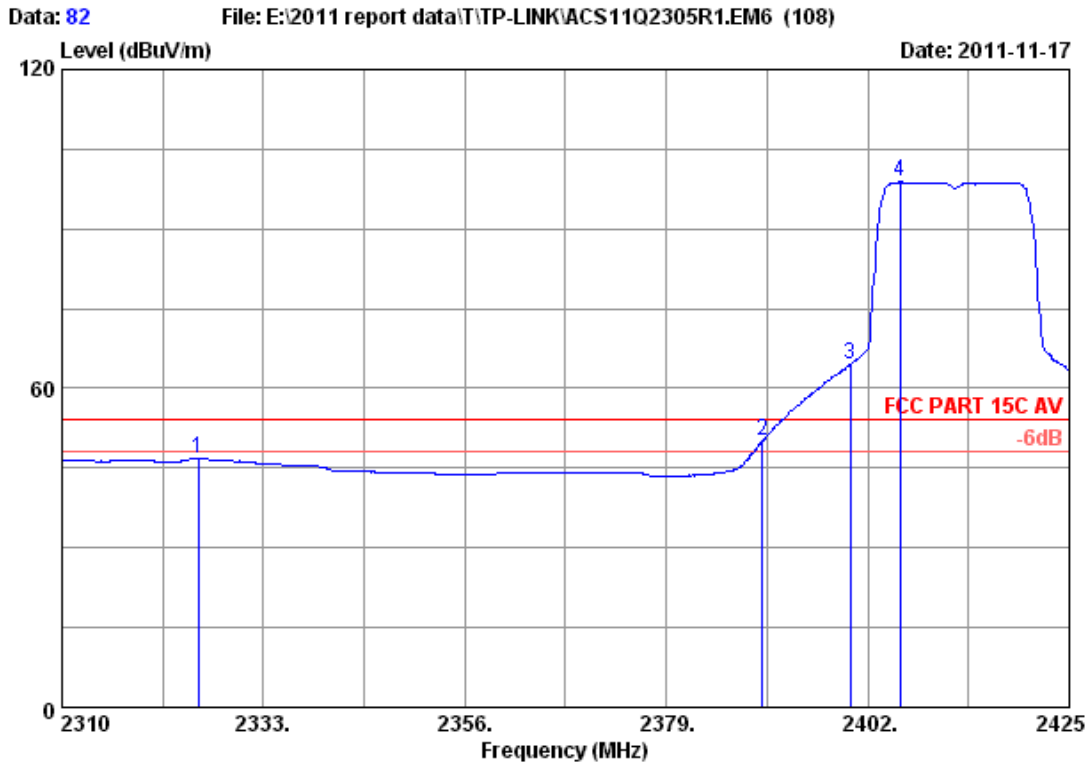

Site no. : 3m Chamber Data no. : 82
 Dis. / Ant. : 3m 3115(0911) Ant. pol. : VERTICAL
 Limit : FCC PART 15C AV
 Env. / Ins. : 23°C/54% Engineer : Leo-Li
 EUT : 300Mbps Wireless N Range Extender
 Power : DC 12V From Adapter input AC 120V/60Hz
 Test mode : IEEE802.11g CH1 2412MHz Tx
 M/N : TL-WA830RE

	Freq. (MHz)	Ant. Factor (dB/m)	Cable loss (dB)	Amp. Factor (dB)	Reading (dBuV)	Emission			Remark
						Level (dBuV/m)	Limits (dBuV/m)	Margin (dB)	
1	2325.525	29.40	8.57	36.06	44.78	46.69	54.00	7.31	Average
2	2390.000	29.44	8.67	36.09	48.15	50.17	54.00	3.83	Average
3	2400.000	29.44	8.72	36.09	62.59	64.66	54.00	-10.66	Average
4	2405.680	29.45	8.72	35.95	96.63	98.85	54.00	-44.85	Average

Remarks:

- Emission Level= Antenna Factor + Cable Loss -Amp Factor + Reading.
- The emission levels that are 20dB below the official limit are not reported.

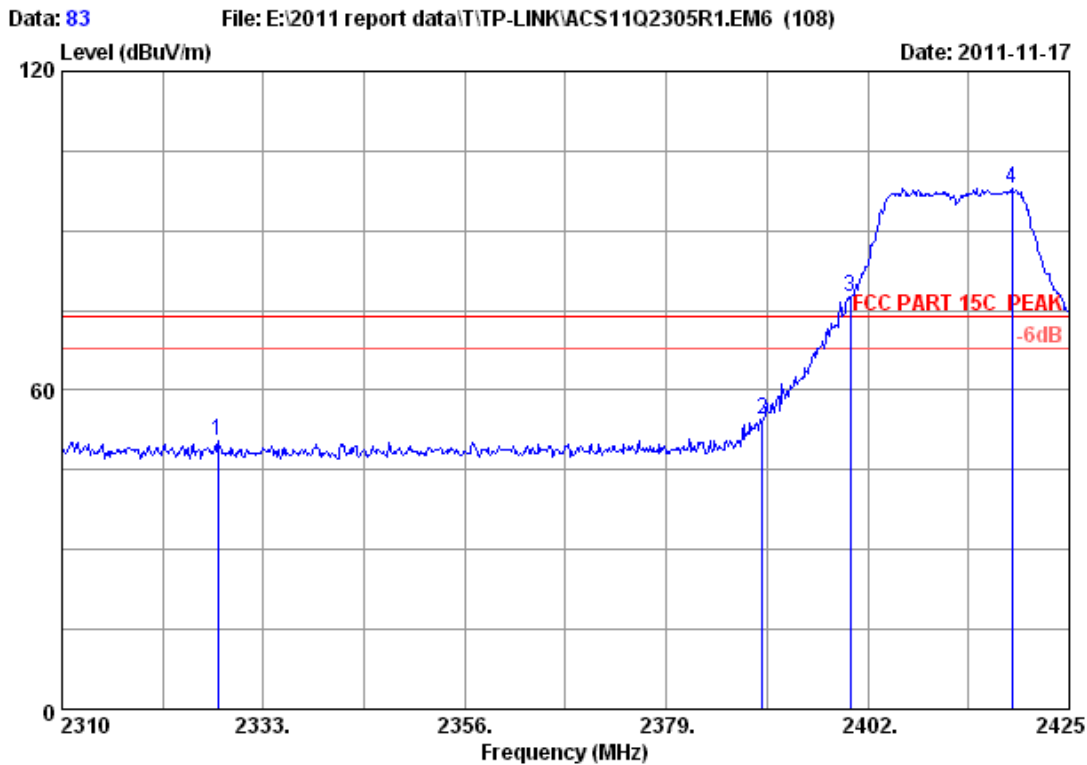

Site no. : 3m Chamber Data no. : 83
 Dis. / Ant. : 3m 3115(0911) Ant. pol. : HORIZONTAL
 Limit : FCC PART 15C PEAK
 Env. / Ins. : 23°C/54% Engineer : Leo-Li
 EUT : 300Mbps Wireless N Range Extender
 Power : DC 12V From Adapter input AC 120V/60Hz
 Test mode : IEEE802.11g CH1 2412MHz Tx
 M/N : TL-WA830RE

	Ant. Freq. (MHz)	Ant. Factor (dB/m)	Cable loss (dB)	Amp. Factor (dB)	Reading (dBuV)	Emission Level (dBuV/m)	Limits (dBuV/m)	Margin (dB)	Remark
1	2327.825	29.40	8.57	36.06	48.50	50.41	74.00	23.59	Peak
2	2390.000	29.44	8.67	36.09	52.38	54.40	74.00	19.60	Peak
3	2400.000	29.44	8.72	36.09	75.52	77.59	74.00	-3.59	Peak
4	2418.445	29.45	8.72	35.95	95.77	97.99	74.00	-23.99	Peak

Remarks:

1. Emission Level= Antenna Factor + Cable Loss -Amp Factor + Reading.
2. The emission levels that are 20dB below the official limit are not reported.

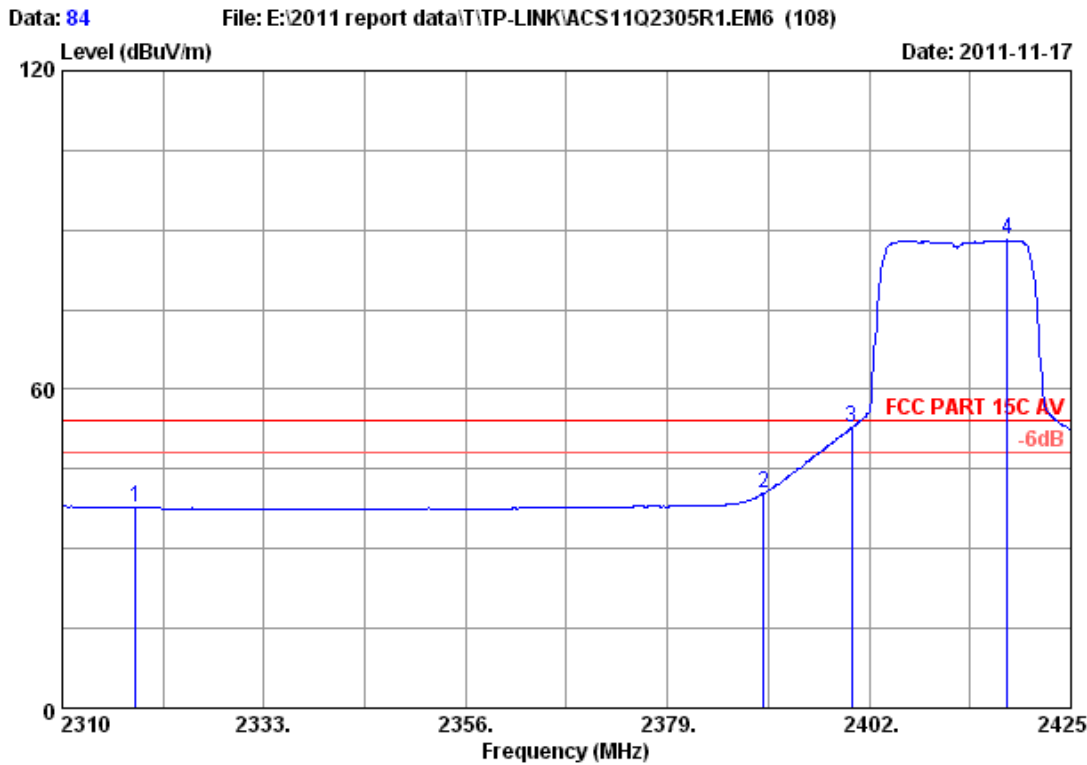

Site no. : 3m Chamber Data no. : 84
 Dis. / Ant. : 3m 3115(0911) Ant. pol. : HORIZONTAL
 Limit : FCC PART 15C AV
 Env. / Ins. : 23°C/54% Engineer : Leo-Li
 EUT : 300Mbps Wireless N Range Extender
 Power : DC 12V From Adapter input AC 120V/60Hz
 Test mode : IEEE802.11g CH1 2412MHz Tx
 M/N : TL-WA830RE

	Ant. Freq. (MHz)	Ant. Factor (dB/m)	Cable loss (dB)	Amp. Factor (dB)	Reading (dBuV)	Emission Level (dBuV/m)	Limits (dBuV/m)	Margin (dB)	Remark
1	2318.395	29.40	8.52	36.06	35.84	37.70	54.00	16.30	Average
2	2390.000	29.44	8.67	36.09	38.48	40.50	54.00	13.50	Average
3	2400.000	29.44	8.72	36.09	50.82	52.89	54.00	1.11	Average
4	2417.755	29.45	8.72	35.95	85.86	88.08	54.00	-34.08	Average

Remarks:

1. Emission Level= Antenna Factor + Cable Loss -Amp Factor + Reading.
2. The emission levels that are 20dB below the official limit are not reported.

Data: 85 File: E:\2011 report data\T\TP-LINK\ACS11Q2305R1.EM6 (108) Date: 2011-11-17

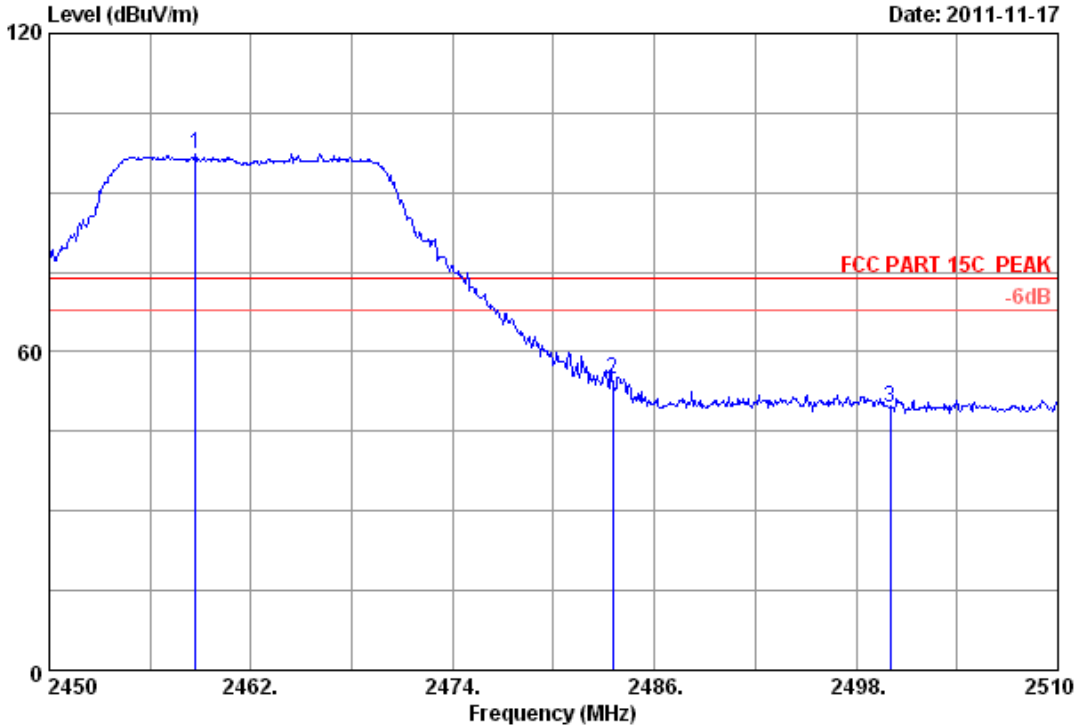

Site no. : 3m Chamber Data no. : 85
 Dis. / Ant. : 3m 3115(0911) Ant. pol. : HORIZONTAL
 Limit : FCC PART 15C PEAK
 Env. / Ins. : 23°C/54% Engineer : Leo-Li
 EUT : 300Mbps Wireless N Range Extender
 Power : DC 12V From Adapter input AC 120V/60Hz
 Test mode : IEEE802.11g CH11 2462MHz Tx
 M/N : TL-WA830RE

	Ant. Freq. (MHz)	Ant. Factor (dB/m)	Cable loss (dB)	Amp. Factor (dB)	Reading (dBuV)	Emission Level (dBuV/m)	Limits (dBuV/m)	Margin (dB)	Remark
1	2458.700	29.48	8.82	36.02	95.03	97.31	74.00	-23.31	Peak
2	2483.500	29.49	8.87	35.97	52.34	54.73	74.00	19.27	Peak
3	2500.000	29.50	8.92	36.00	47.12	49.54	74.00	24.46	Peak

Remarks:

1. Emission Level= Antenna Factor + Cable Loss -Amp Factor + Reading.
2. The emission levels that are 20dB below the official limit are not reported.

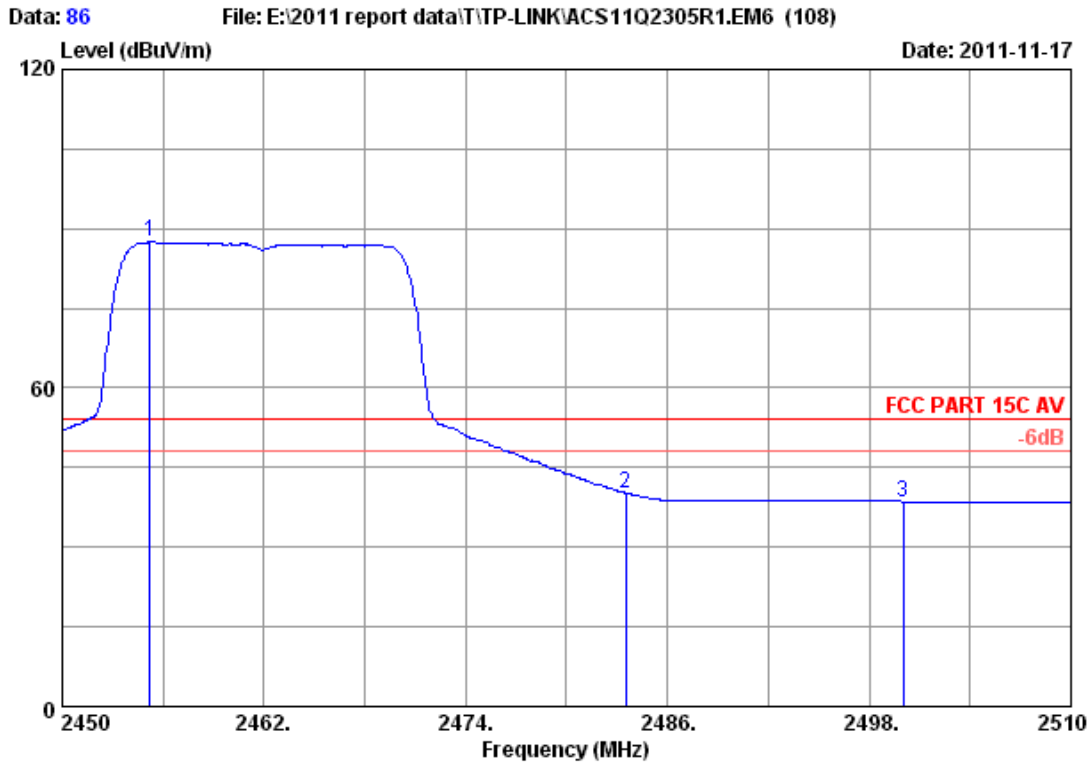

Site no. : 3m Chamber Data no. : 86
 Dis. / Ant. : 3m 3115(0911) Ant. pol. : HORIZONTAL
 Limit : FCC PART 15C AV
 Env. / Ins. : 23°C/54% Engineer : Leo-Li
 EUT : 300Mbps Wireless N Range Extender
 Power : DC 12V From Adapter input AC 120V/60Hz
 Test mode : IEEE802.11g CH11 2462MHz Tx
 M/N : TL-WA830RE

	Freq. (MHz)	Ant. Factor (dB/m)	Cable loss (dB)	Amp. Factor (dB)	Reading (dBuV)	Emission			Remark
						Level (dBuV/m)	Limits (dBuV/m)	Margin (dB)	
1	2455.220	29.48	8.82	36.02	85.22	87.50	54.00	-33.50	Average
2	2483.500	29.49	8.87	35.97	37.86	40.25	54.00	13.75	Average
3	2500.000	29.50	8.92	36.00	36.11	38.53	54.00	15.47	Average

Remarks:

1. Emission Level= Antenna Factor + Cable Loss -Amp Factor + Reading.
2. The emission levels that are 20dB below the official limit are not reported.

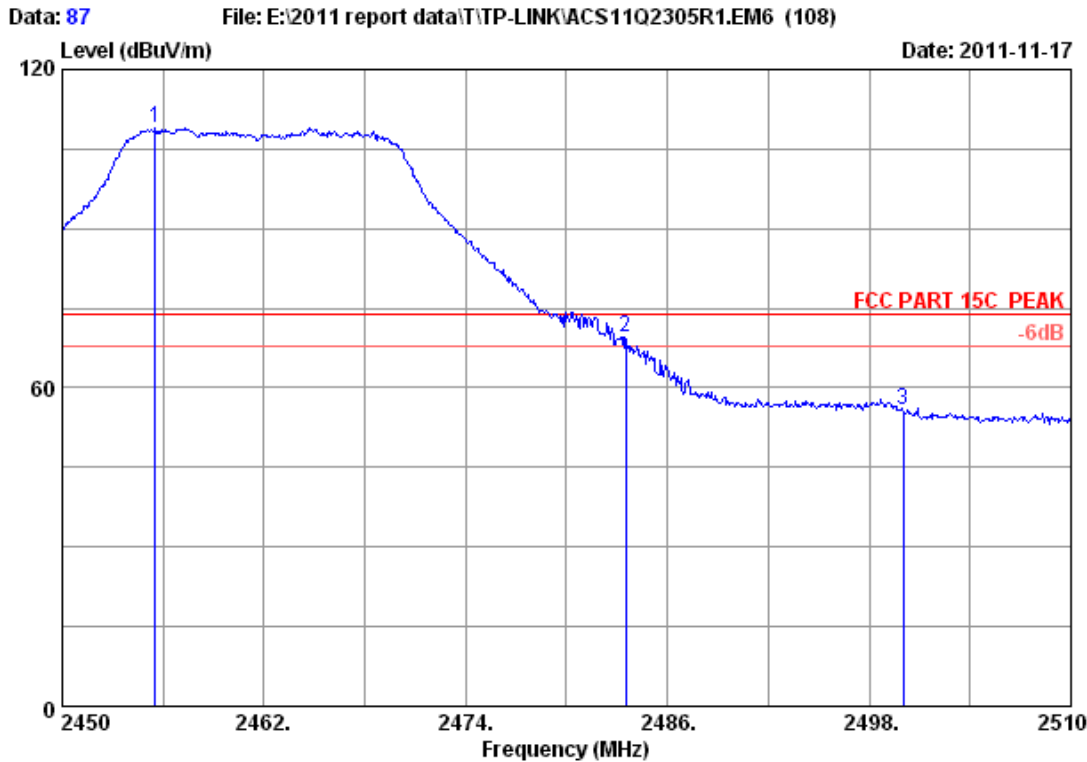

Site no. : 3m Chamber Data no. : 87
 Dis. / Ant. : 3m 3115(0911) Ant. pol. : VERTICAL
 Limit : FCC PART 15C PEAK
 Env. / Ins. : 23°C/54% Engineer : Leo-Li
 EUT : 300Mbps Wireless N Range Extender
 Power : DC 12V From Adapter input AC 120V/60Hz
 Test mode : IEEE802.11g CH11 2462MHz Tx
 M/N : TL-WA830RE

	Ant. Freq. (MHz)	Ant. Factor (dB/m)	Cable loss (dB)	Amp. Factor (dB)	Reading (dBuV)	Emission Level (dBuV/m)	Limits (dBuV/m)	Margin (dB)	Remark
1	2455.520	29.48	8.82	36.02	106.66	108.94	74.00	-34.94	Peak
2	2483.500	29.49	8.87	35.97	67.07	69.46	74.00	4.54	Peak
3	2500.000	29.50	8.92	36.00	53.55	55.97	74.00	18.03	Peak

Remarks:

1. Emission Level= Antenna Factor + Cable Loss -Amp Factor + Reading.
2. The emission levels that are 20dB below the official limit are not reported.

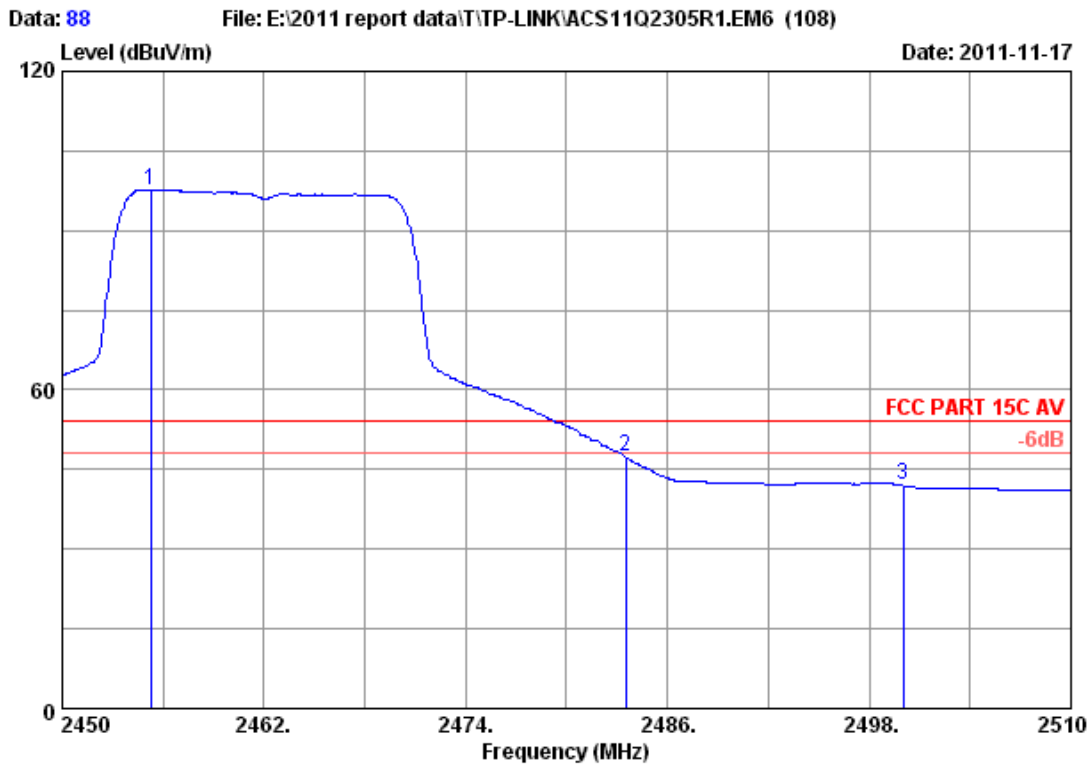

Site no. : 3m Chamber Data no. : 88
 Dis. / Ant. : 3m 3115(0911) Ant. pol. : VERTICAL
 Limit : FCC PART 15C AV
 Env. / Ins. : 23°C/54% Engineer : Leo-Li
 EUT : 300Mbps Wireless N Range Extender
 Power : DC 12V From Adapter input AC 120V/60Hz
 Test mode : IEEE802.11g CH11 2462MHz Tx
 M/N : TL-WA830RE

	Freq. (MHz)	Ant. Factor (dB/m)	Cable loss (dB)	Amp. Factor (dB)	Reading (dBuV)	Emission			Remark
						Level (dBuV/m)	Limits (dBuV/m)	Margin (dB)	
1	2455.280	29.48	8.82	36.02	95.43	97.71	54.00	-43.71	Average
2	2483.500	29.49	8.87	35.97	44.93	47.32	54.00	6.68	Average
3	2500.000	29.50	8.92	36.00	39.54	41.96	54.00	12.04	Average

Remarks:

1. Emission Level= Antenna Factor + Cable Loss -Amp Factor + Reading.
2. The emission levels that are 20dB below the official limit are not reported.

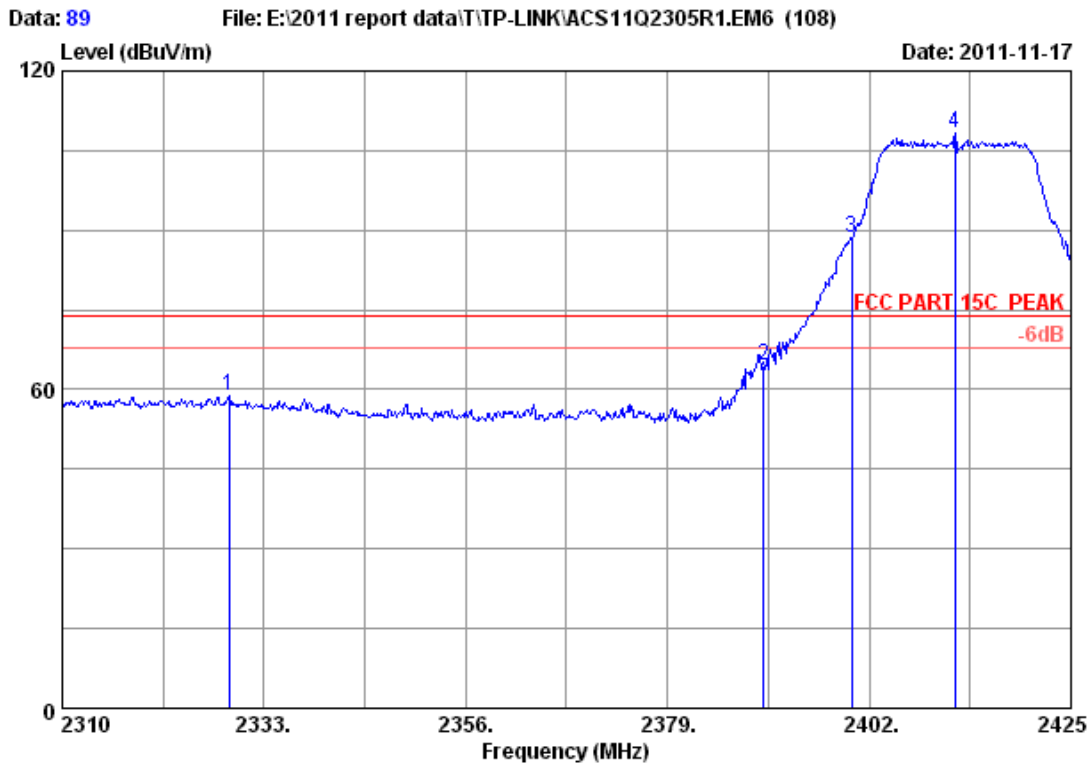

Site no. : 3m Chamber Data no. : 89
 Dis. / Ant. : 3m 3115(0911) Ant. pol. : VERTICAL
 Limit : FCC PART 15C PEAK
 Env. / Ins. : 23°C/54% Engineer : Leo-Li
 EUT : 300Mbps Wireless N Range Extender
 Power : DC 12V From Adapter input AC 120V/60Hz
 Test mode : IEEE802.11nHT20 CH1 2412MHz Tx
 M/N : TL-WA830RE

	Ant. Freq. (MHz)	Ant. Factor (dB/m)	Cable loss (dB)	Amp. Factor (dB)	Reading (dBuV)	Emission Level (dBuV/m)	Limits (dBuV/m)	Margin (dB)	Remark
1	2328.975	29.40	8.57	36.06	57.03	58.94	74.00	15.06	Peak
2	2390.000	29.44	8.67	36.09	62.55	64.57	74.00	9.43	Peak
3	2400.000	29.44	8.72	36.09	86.57	88.64	74.00	-14.64	Peak
4	2411.775	29.45	8.72	35.95	106.07	108.29	74.00	-34.29	Peak

Remarks:

1. Emission Level= Antenna Factor + Cable Loss -Amp Factor + Reading.
2. The emission levels that are 20dB below the official limit are not reported.

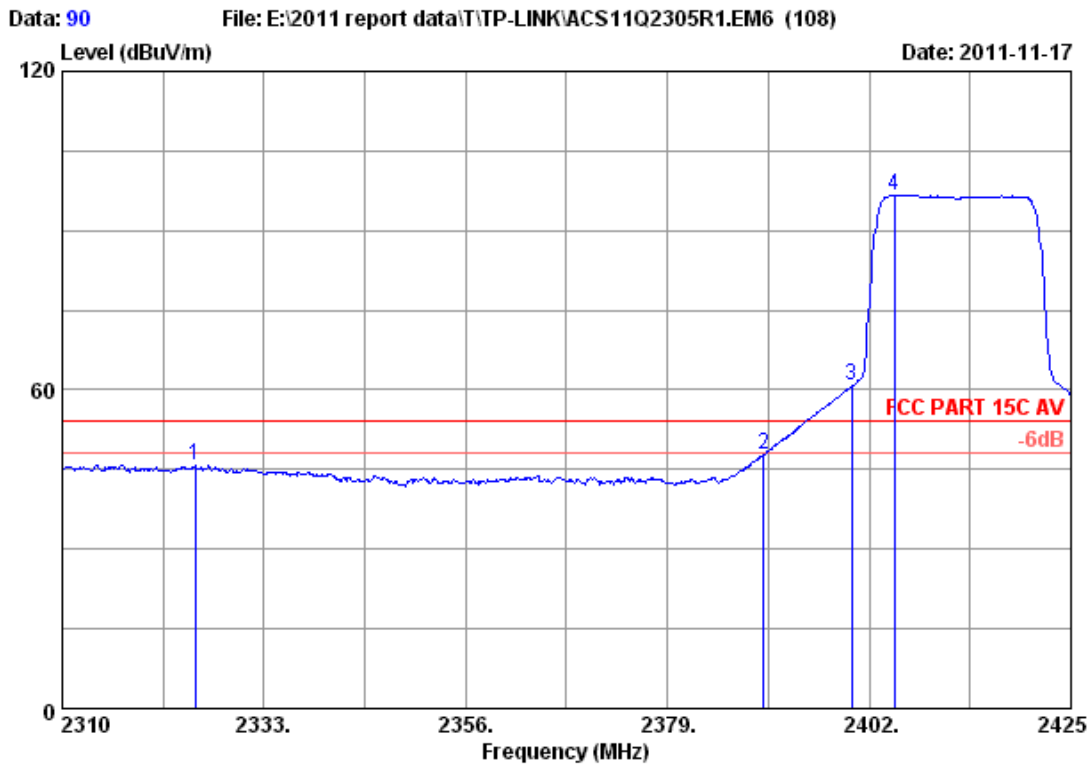

Site no. : 3m Chamber Data no. : 90
 Dis. / Ant. : 3m 3115(0911) Ant. pol. : VERTICAL
 Limit : FCC PART 15C AV
 Env. / Ins. : 23°C/54% Engineer : Leo-Li
 EUT : 300Mbps Wireless N Range Extender
 Power : DC 12V From Adapter input AC 120V/60Hz
 Test mode : IEEE802.11nHT20 CH1 2412MHz Tx
 M/N : TL-WA830RE

	Freq. (MHz)	Ant. Factor (dB/m)	Cable loss (dB)	Amp. Factor (dB)	Reading (dBuV)	Emission			Remark
						Level (dBuV/m)	Limits (dBuV/m)	Margin (dB)	
1	2325.180	29.40	8.57	36.06	43.80	45.71	54.00	8.29	Average
2	2390.000	29.44	8.67	36.09	45.77	47.79	54.00	6.21	Average
3	2400.000	29.44	8.72	36.09	58.71	60.78	54.00	-6.78	Average
4	2404.875	29.45	8.72	35.95	94.53	96.75	54.00	-42.75	Average

Remarks:

1. Emission Level= Antenna Factor + Cable Loss -Amp Factor + Reading.
2. The emission levels that are 20dB below the official limit are not reported.

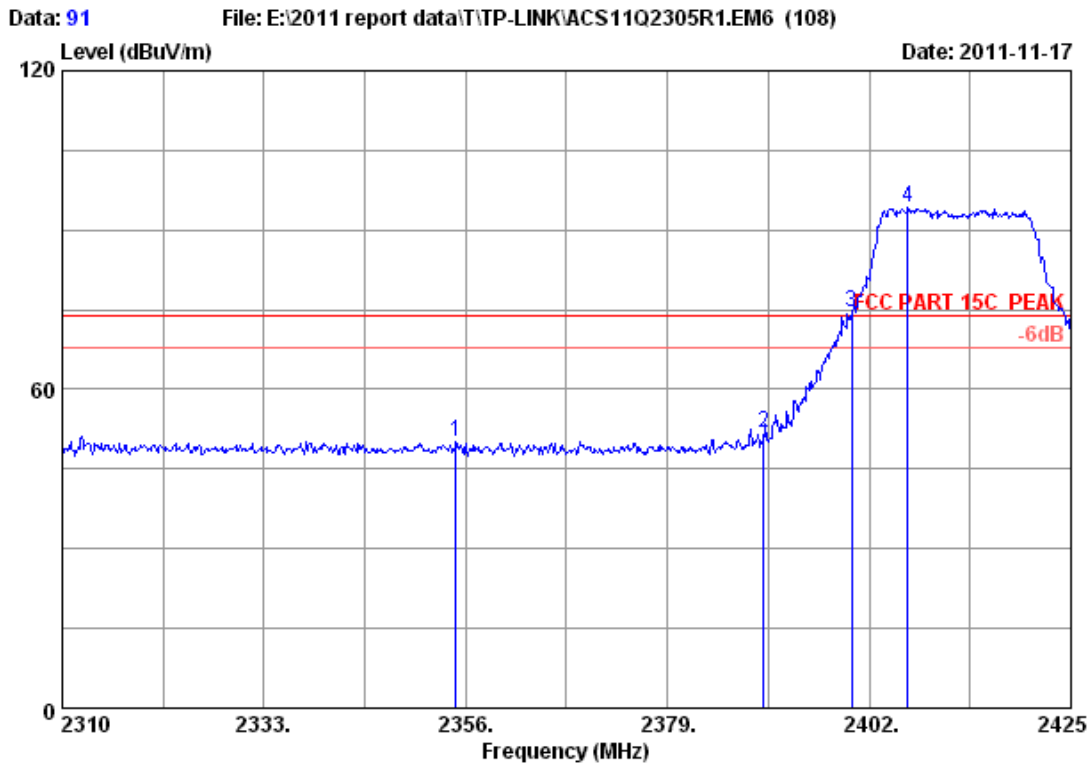

Site no. : 3m Chamber Data no. : 91
 Dis. / Ant. : 3m 3115(0911) Ant. pol. : HORIZONTAL
 Limit : FCC PART 15C PEAK
 Env. / Ins. : 23°C/54% Engineer : Leo-Li
 EUT : 300Mbps Wireless N Range Extender
 Power : DC 12V From Adapter input AC 120V/60Hz
 Test mode : IEEE802.11nHT20 CH1 2412MHz Tx
 M/N : TL-WA830RE

	Ant. Freq. (MHz)	Ant. Factor (dB/m)	Cable loss (dB)	Amp. Factor (dB)	Reading (dBuV)	Emission Level (dBuV/m)	Limits (dBuV/m)	Margin (dB)	Remark
1	2354.850	29.42	8.62	35.91	48.02	50.15	74.00	23.85	Peak
2	2390.000	29.44	8.67	36.09	49.84	51.86	74.00	22.14	Peak
3	2400.000	29.44	8.72	36.09	72.40	74.47	74.00	-0.47	Peak
4	2406.370	29.45	8.72	35.95	91.91	94.13	74.00	-20.13	Peak

Remarks:

1. Emission Level= Antenna Factor + Cable Loss -Amp Factor + Reading.
2. The emission levels that are 20dB below the official limit are not reported.

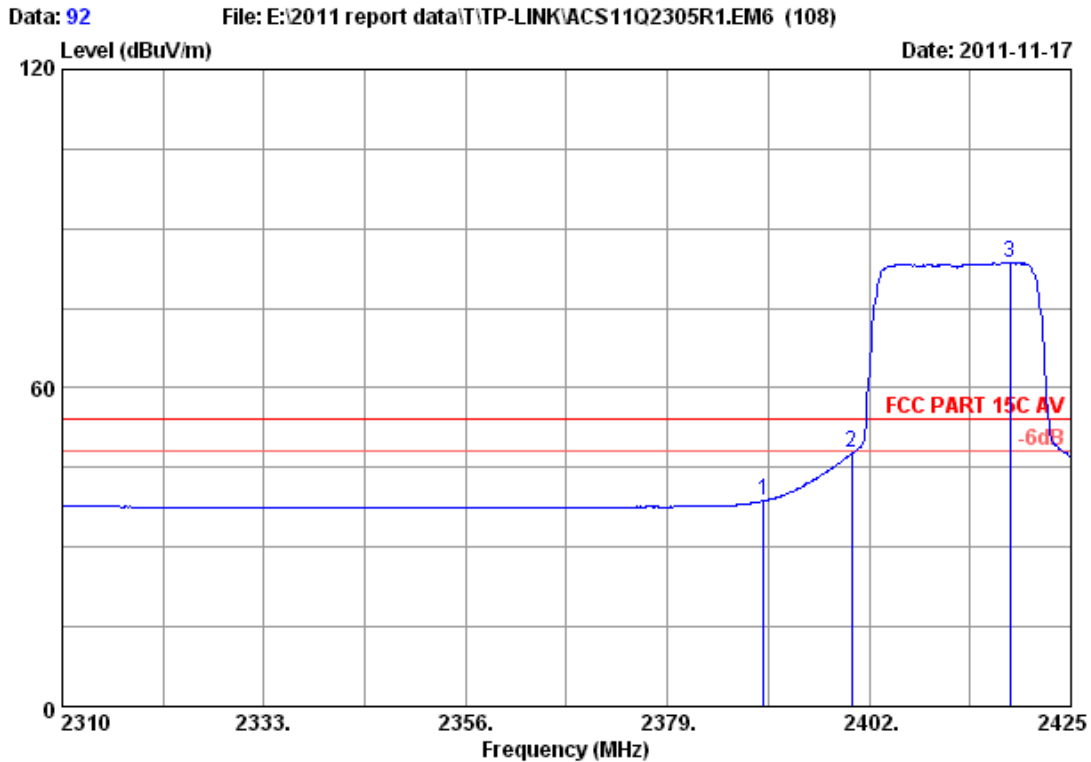

Site no. : 3m Chamber Data no. : 92
 Dis. / Ant. : 3m 3115(0911) Ant. pol. : HORIZONTAL
 Limit : FCC PART 15C AV
 Env. / Ins. : 23°C/54% Engineer : Leo-Li
 EUT : 300Mbps Wireless N Range Extender
 Power : DC 12V From Adapter input AC 120V/60Hz
 Test mode : IEEE802.11nHT20 CH1 2412MHz Tx
 M/N : TL-WA830RE

	Freq. (MHz)	Ant. Factor (dB/m)	Cable loss (dB)	Amp. Factor (dB)	Reading (dBuV)	Emission			Remark
						Level (dBuV/m)	Limits (dBuV/m)	Margin (dB)	
1	2390.000	29.44	8.67	36.09	36.72	38.74	54.00	15.26	Average
2	2400.000	29.44	8.72	36.09	45.64	47.71	54.00	6.29	Average
3	2418.100	29.45	8.72	35.95	81.37	83.59	54.00	-29.59	Average

Remarks:

1. Emission Level= Antenna Factor + Cable Loss -Amp Factor + Reading.
2. The emission levels that are 20dB below the official limit are not reported.

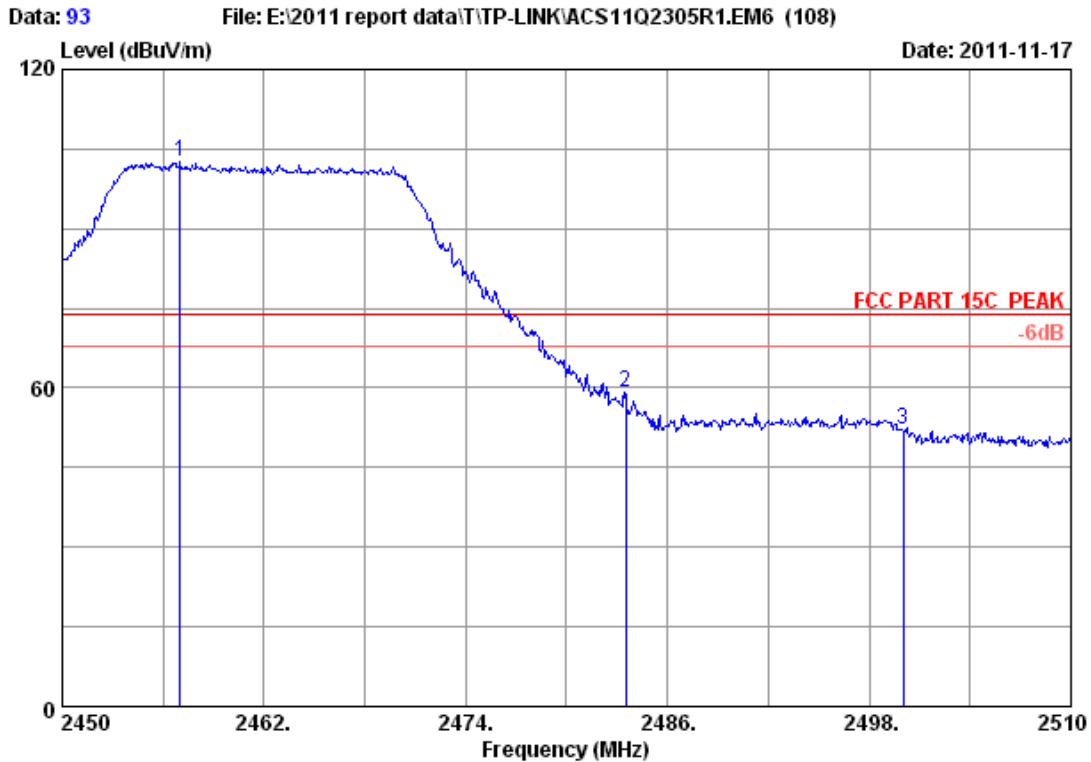

Site no. : 3m Chamber Data no. : 93
 Dis. / Ant. : 3m 3115(0911) Ant. pol. : VERTICAL
 Limit : FCC PART 15C PEAK
 Env. / Ins. : 23*C/54% Engineer : Leo-Li
 EUT : 300Mbps Wireless N Range Extender
 Power : DC 12V From Adapter input AC 120V/60Hz
 Test mode : IEEE802.11nHT20 CH11 2462MHz Tx
 M/N : TL-WA830RE

	Ant.			Emission			Margin	Remark	
	Freq. (MHz)	Factor (dB/m)	Cable loss (dB)	Amp. Factor (dB)	Reading (dBuV)	Level (dBuV/m)			Limits (dBuV/m)
1	2457.020	29.48	8.82	36.02	100.27	102.55	74.00	-28.55	Peak
2	2483.500	29.49	8.87	35.97	56.92	59.31	74.00	14.69	Peak
3	2500.000	29.50	8.92	36.00	49.64	52.06	74.00	21.94	Peak

Remarks:

1. Emission Level= Antenna Factor + Cable Loss -Amp Factor + Reading.
2. The emission levels that are 20dB below the official limit are not reported.

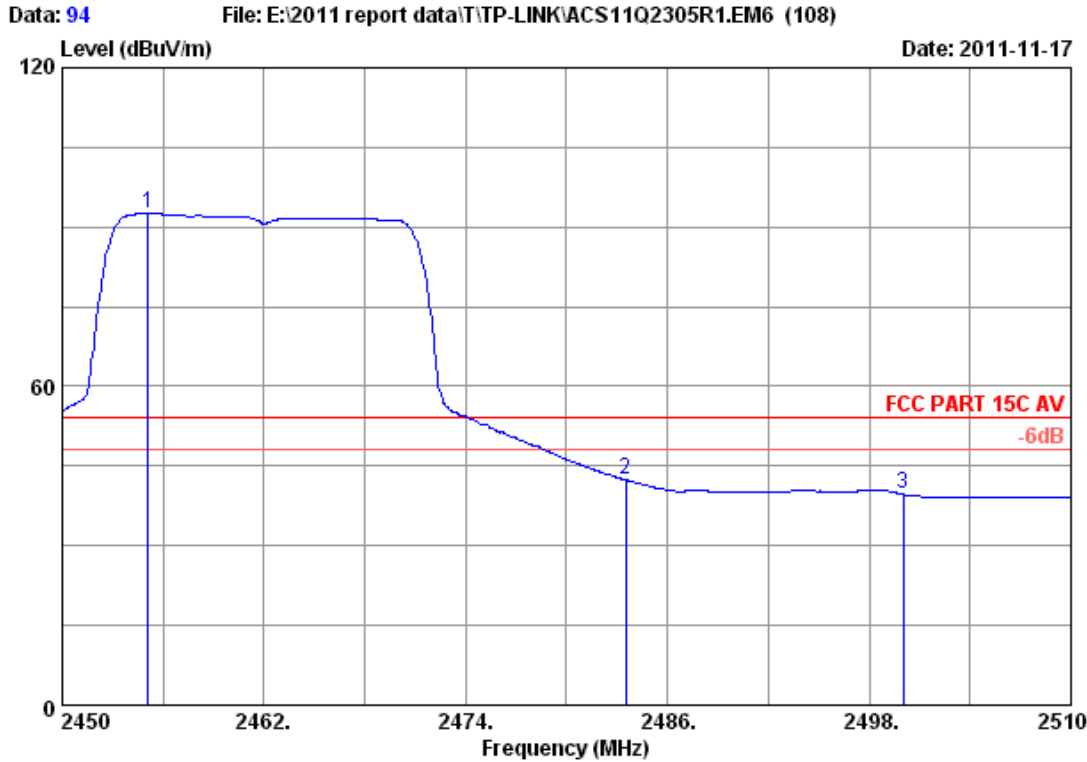

Site no. : 3m Chamber Data no. : 94
 Dis. / Ant. : 3m 3115(0911) Ant. pol. : VERTICAL
 Limit : FCC PART 15C AV
 Env. / Ins. : 23°C/54% Engineer : Leo-Li
 EUT : 300Mbps Wireless N Range Extender
 Power : DC 12V From Adapter input AC 120V/60Hz
 Test mode : IEEE802.11nHT20 CH11 2462MHz Tx
 M/N : TL-WA830RE

	Freq. (MHz)	Ant. Factor (dB/m)	Cable loss (dB)	Amp. Factor (dB)	Reading (dBuV)	Emission			Remark
						Level (dBuV/m)	Limits (dBuV/m)	Margin (dB)	
1	2455.100	29.48	8.82	36.02	90.29	92.57	54.00	-38.57	Average
2	2483.500	29.49	8.87	35.97	40.00	42.39	54.00	11.61	Average
3	2500.000	29.50	8.92	36.00	37.26	39.68	54.00	14.32	Average

Remarks:

- Emission Level= Antenna Factor + Cable Loss -Amp Factor + Reading.
- The emission levels that are 20dB below the official limit are not reported.

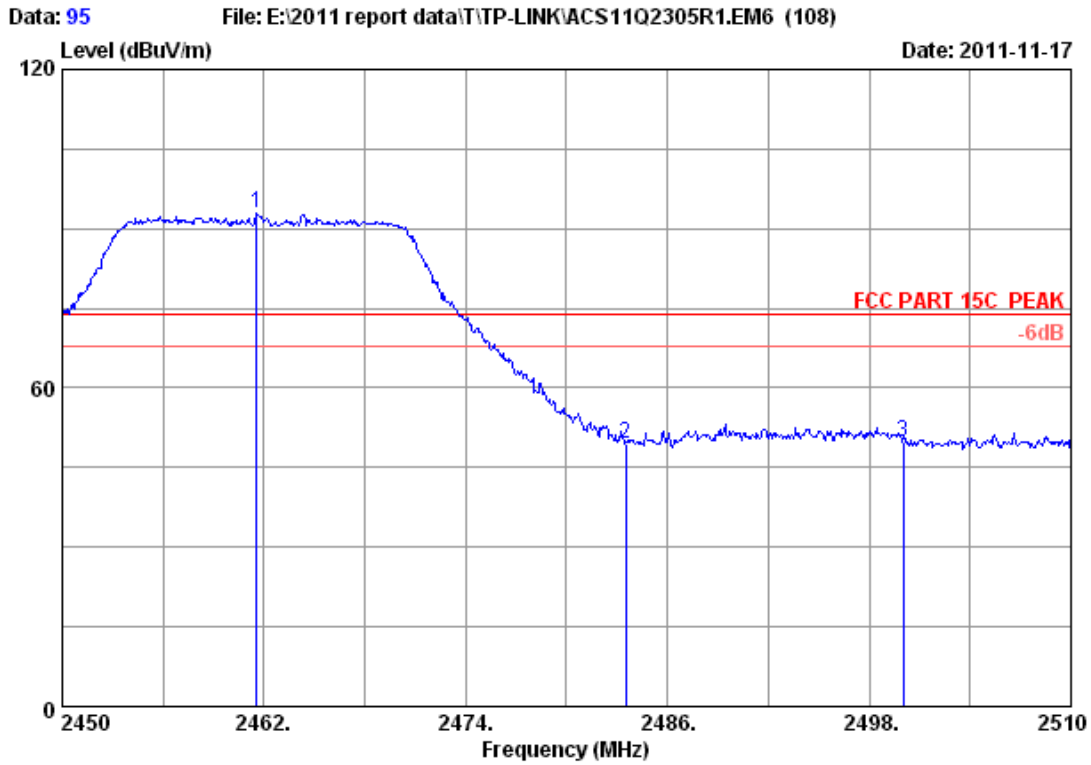

Site no. : 3m Chamber Data no. : 95
 Dis. / Ant. : 3m 3115(0911) Ant. pol. : HORIZONTAL
 Limit : FCC PART 15C PEAK
 Env. / Ins. : 23°C/54% Engineer : Leo-Li
 EUT : 300Mbps Wireless N Range Extender
 Power : DC 12V From Adapter input AC 120V/60Hz
 Test mode : IEEE802.11nHT20 CH11 2462MHz Tx
 M/N : TL-WA830RE

	Freq. (MHz)	Ant. Factor (dB/m)	Cable loss (dB)	Amp. Factor (dB)	Reading (dBuV)	Emission			Remark
						Level (dBuV/m)	Limits (dBuV/m)	Margin (dB)	
1	2461.580	29.48	8.82	36.02	90.50	92.78	74.00	-18.78	Peak
2	2483.500	29.49	8.87	35.97	47.11	49.50	74.00	24.50	Peak
3	2500.000	29.50	8.92	36.00	47.44	49.86	74.00	24.14	Peak

Remarks:

1. Emission Level= Antenna Factor + Cable Loss -Amp Factor + Reading.
2. The emission levels that are 20dB below the official limit are not reported.

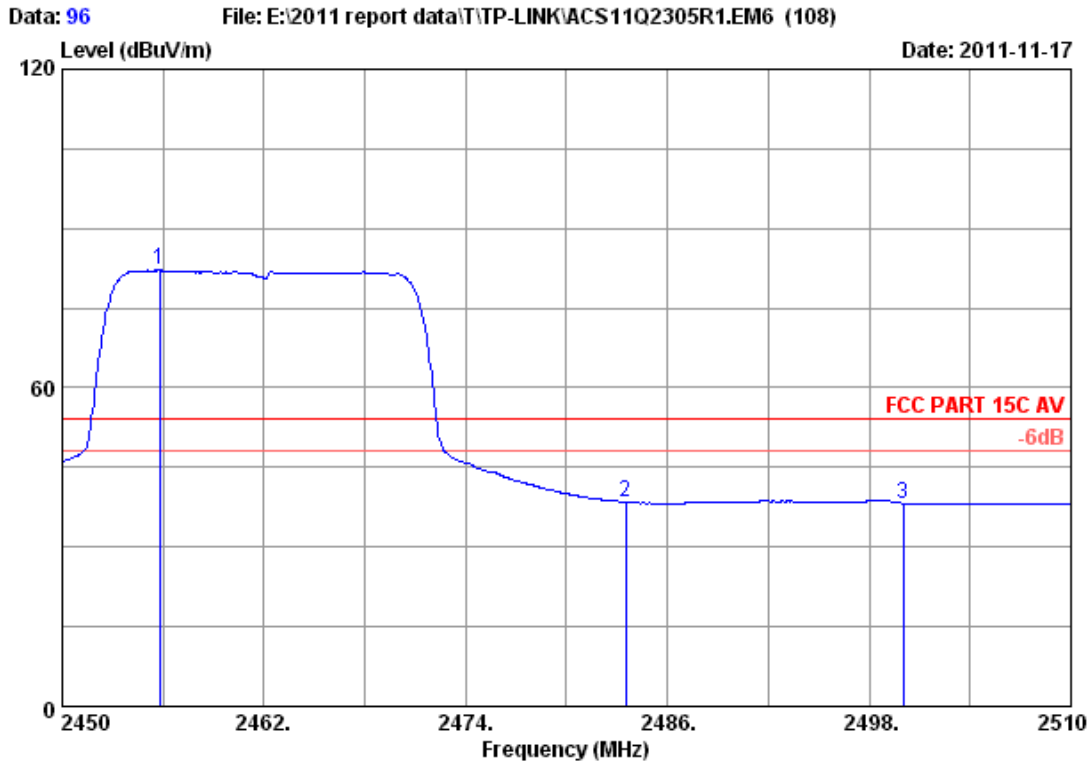

Site no. : 3m Chamber Data no. : 96
 Dis. / Ant. : 3m 3115(0911) Ant. pol. : HORIZONTAL
 Limit : FCC PART 15C AV
 Env. / Ins. : 23°C/54% Engineer : Leo-Li
 EUT : 300Mbps Wireless N Range Extender
 Power : DC 12V From Adapter input AC 120V/60Hz
 Test mode : IEEE802.11nHT20 CH11 2462MHz Tx
 M/N : TL-WA830RE

	Ant.	Cable	Amp.	Emission				
Freq. (MHz)	Factor (dB/m)	loss (dB)	Factor (dB)	Reading (dBuV)	Level (dBuV/m)	Limits (dBuV/m)	Margin (dB)	Remark
1 2455.820	29.48	8.82	36.02	79.86	82.14	54.00	-28.14	Average
2 2483.500	29.49	8.87	35.97	36.10	38.49	54.00	15.51	Average
3 2500.000	29.50	8.92	36.00	35.84	38.26	54.00	15.74	Average

Remarks:

1. Emission Level= Antenna Factor + Cable Loss -Amp Factor + Reading.
2. The emission levels that are 20dB below the official limit are not reported.

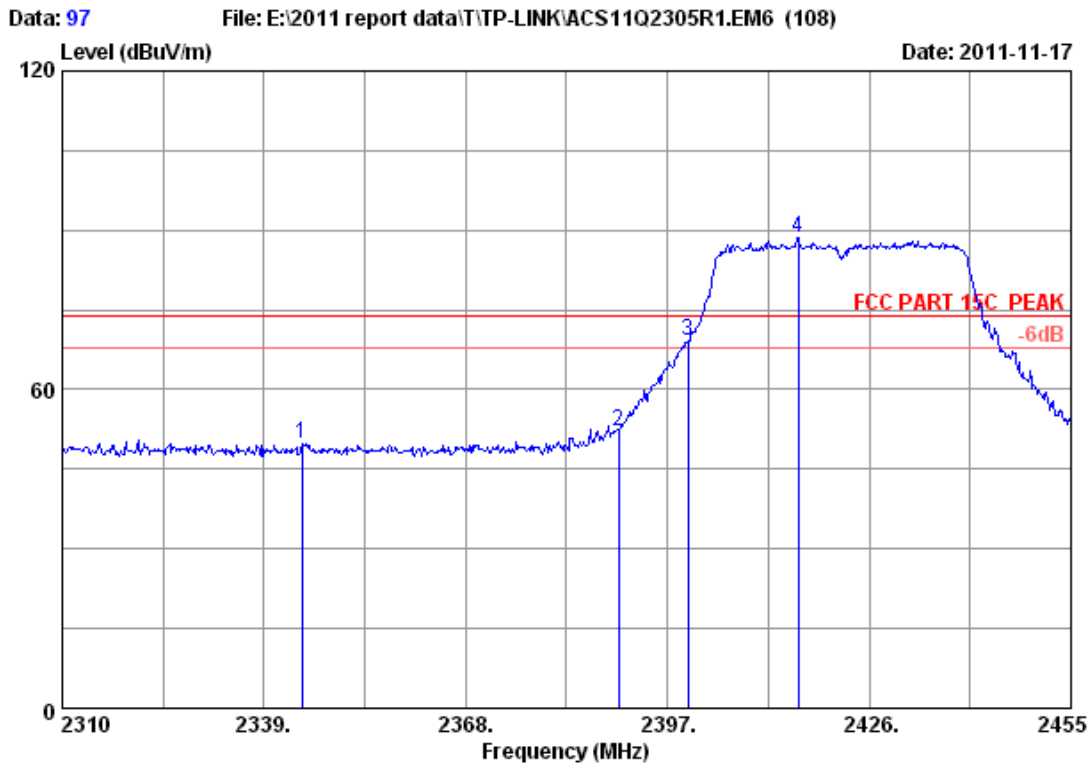

Site no. : 3m Chamber Data no. : 97
 Dis. / Ant. : 3m 3115(0911) Ant. pol. : HORIZONTAL
 Limit : FCC PART 15C PEAK
 Env. / Ins. : 23°C/54% Engineer : Leo-Li
 EUT : 300Mbps Wireless N Range Extender
 Power : DC 12V From Adapter input AC 120V/60Hz
 Test mode : IEEE802.11nHT40 CH1 2422MHz Tx
 M/N : TL-WA830RE

	Ant. Freq. (MHz)	Ant. Factor (dB/m)	Cable loss (dB)	Amp. Factor (dB)	Reading (dBuV)	Emission Level (dBuV/m)	Limits (dBuV/m)	Margin (dB)	Remark
1	2344.510	29.41	8.57	35.99	47.69	49.68	74.00	24.32	Peak
2	2390.000	29.44	8.67	36.09	50.21	52.23	74.00	21.77	Peak
3	2400.000	29.44	8.72	36.09	67.00	69.07	74.00	4.93	Peak
4	2415.850	29.45	8.72	35.95	86.32	88.54	74.00	-14.54	Peak

Remarks:

1. Emission Level= Antenna Factor + Cable Loss -Amp Factor + Reading.
2. The emission levels that are 20dB below the official limit are not reported.

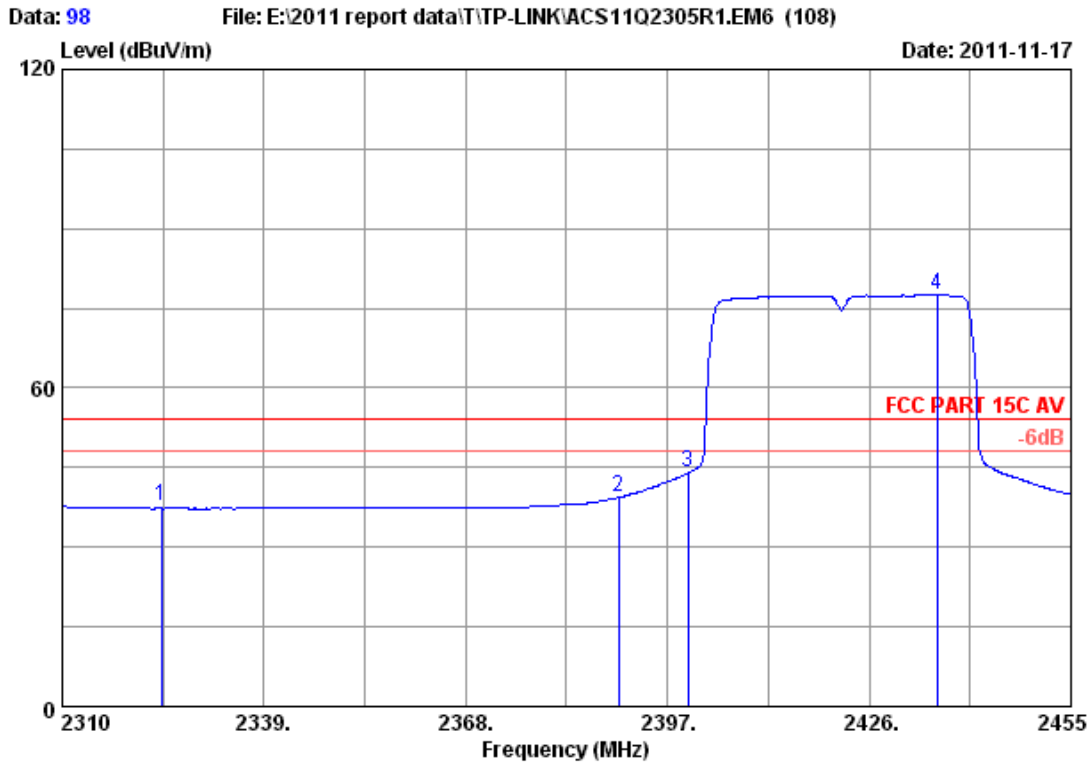

Site no. : 3m Chamber Data no. : 98
 Dis. / Ant. : 3m 3115(0911) Ant. pol. : HORIZONTAL
 Limit : FCC PART 15C AV
 Env. / Ins. : 23°C/54% Engineer : Leo-Li
 EUT : 300Mbps Wireless N Range Extender
 Power : DC 12V From Adapter input AC 120V/60Hz
 Test mode : IEEE802.11nHT40 CH1 2422MHz Tx
 M/N : TL-WA830RE

	Ant.	Cable	Amp.	Emission					
Freq. (MHz)	Factor (dB/m)	loss (dB)	Factor (dB)	Reading (dBuV)	Level (dBuV/m)	Limits (dBuV/m)	Margin (dB)	Remark	
1 2324.210	29.40	8.57	36.06	35.95	37.86	54.00	16.14	Average	
2 2390.000	29.44	8.67	36.09	37.32	39.34	54.00	14.66	Average	
3 2400.000	29.44	8.72	36.09	41.99	44.06	54.00	9.94	Average	
4 2435.715	29.46	8.77	36.01	75.33	77.55	54.00	-23.55	Average	

Remarks:

1. Emission Level= Antenna Factor + Cable Loss -Amp Factor + Reading.
2. The emission levels that are 20dB below the official limit are not reported.

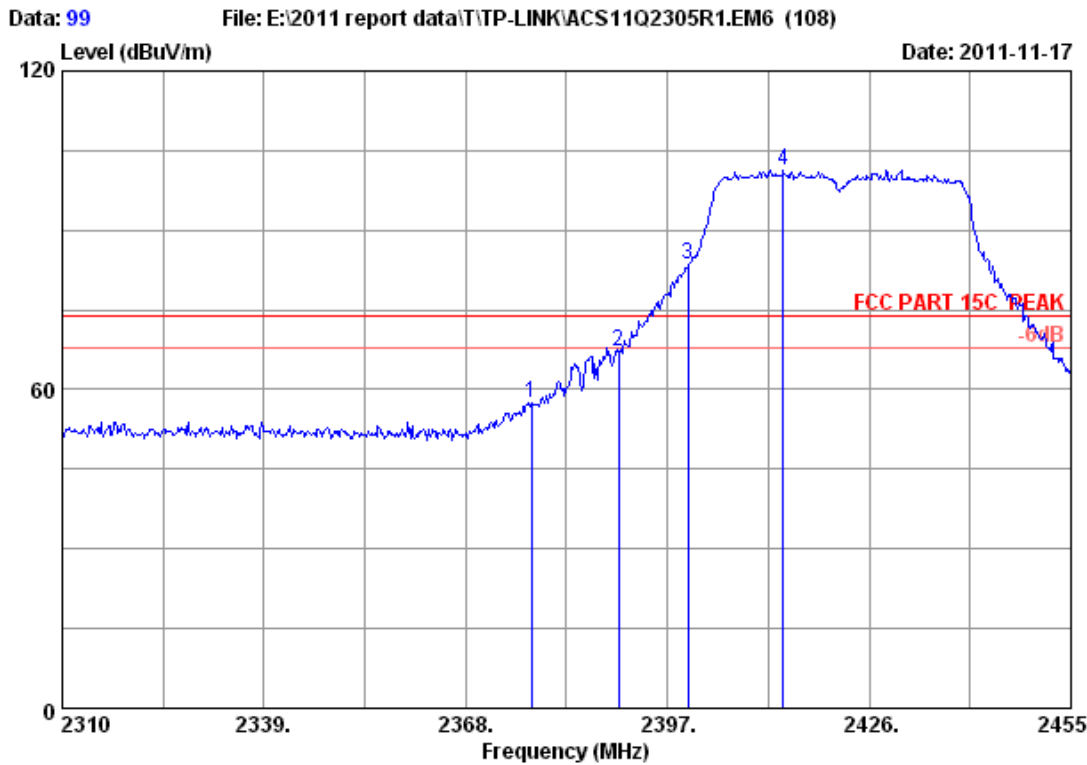

Site no. : 3m Chamber Data no. : 99
 Dis. / Ant. : 3m 3115(0911) Ant. pol. : VERTICAL
 Limit : FCC PART 15C PEAK
 Env. / Ins. : 23°C/54% Engineer : Leo-Li
 EUT : 300Mbps Wireless N Range Extender
 Power : DC 12V From Adapter input AC 120V/60Hz
 Test mode : IEEE802.11nHT40 CH1 2422MHz Tx
 M/N : TL-WA830RE

	Ant. Freq. (MHz)	Ant. Factor (dB/m)	Cable loss (dB)	Amp. Factor (dB)	Reading (dBuV)	Emission Level (dBuV/m)	Limits (dBuV/m)	Margin (dB)	Remark
1	2377.425	29.43	8.67	36.00	55.49	57.59	74.00	16.41	Peak
2	2390.000	29.44	8.67	36.09	65.02	67.04	74.00	6.96	Peak
3	2400.000	29.44	8.72	36.09	81.42	83.49	74.00	-9.49	Peak
4	2413.675	29.45	8.72	35.95	98.99	101.21	74.00	-27.21	Peak

Remarks:

1. Emission Level= Antenna Factor + Cable Loss -Amp Factor + Reading.
2. The emission levels that are 20dB below the official limit are not reported.

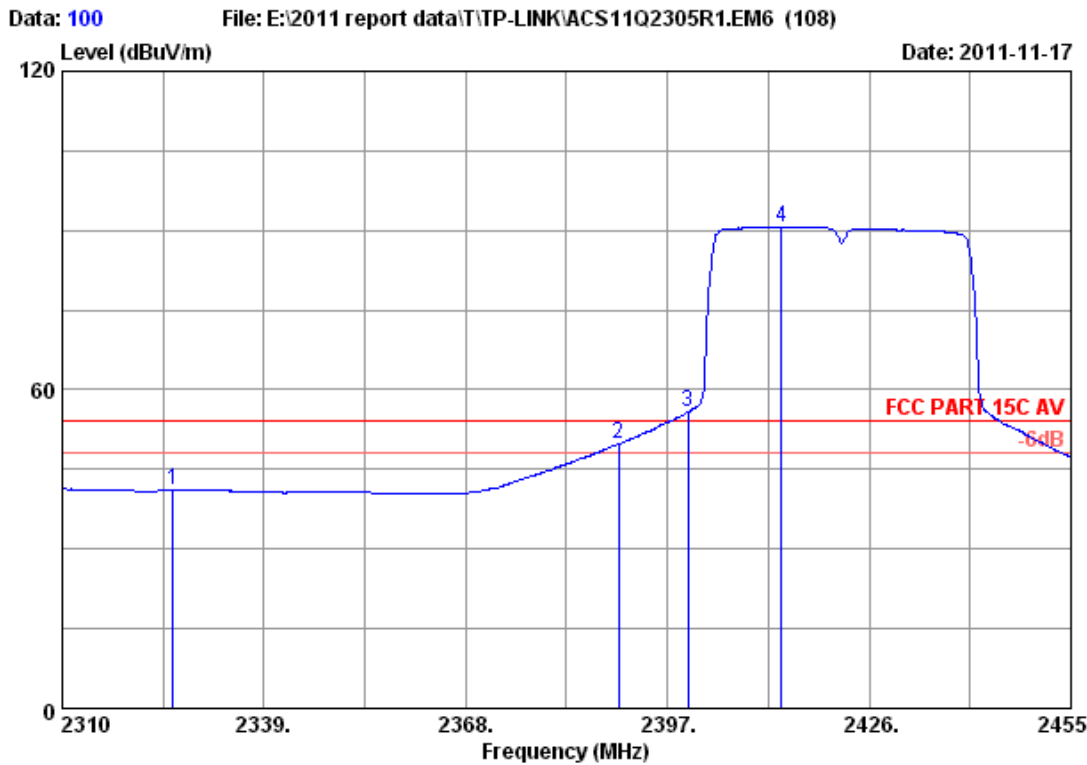

Site no. : 3m Chamber Data no. : 100
 Dis. / Ant. : 3m 3115(0911) Ant. pol. : VERTICAL
 Limit : FCC PART 15C AV
 Env. / Ins. : 23°C/54% Engineer : Leo-Li
 EUT : 300Mbps Wireless N Range Extender
 Power : DC 12V From Adapter input AC 120V/60Hz
 Test mode : IEEE802.11nHT40 CH1 2422MHz Tx
 M/N : TL-WA830RE

	Ant. Freq. (MHz)	Ant. Factor (dB/m)	Cable loss (dB)	Amp. Factor (dB)	Reading (dBUV)	Emission Level (dBUV/m)	Limits (dBUV/m)	Margin (dB)	Remark
1	2325.950	29.40	8.57	36.06	39.23	41.14	54.00	12.86	Average
2	2390.000	29.44	8.67	36.09	47.75	49.77	54.00	4.23	Average
3	2400.000	29.44	8.72	36.09	53.79	55.86	54.00	-1.86	Average
4	2413.385	29.45	8.72	35.95	88.45	90.67	54.00	-36.67	Average

Remarks:

- Emission Level= Antenna Factor + Cable Loss -Amp Factor + Reading.
- The emission levels that are 20dB below the official limit are not reported.

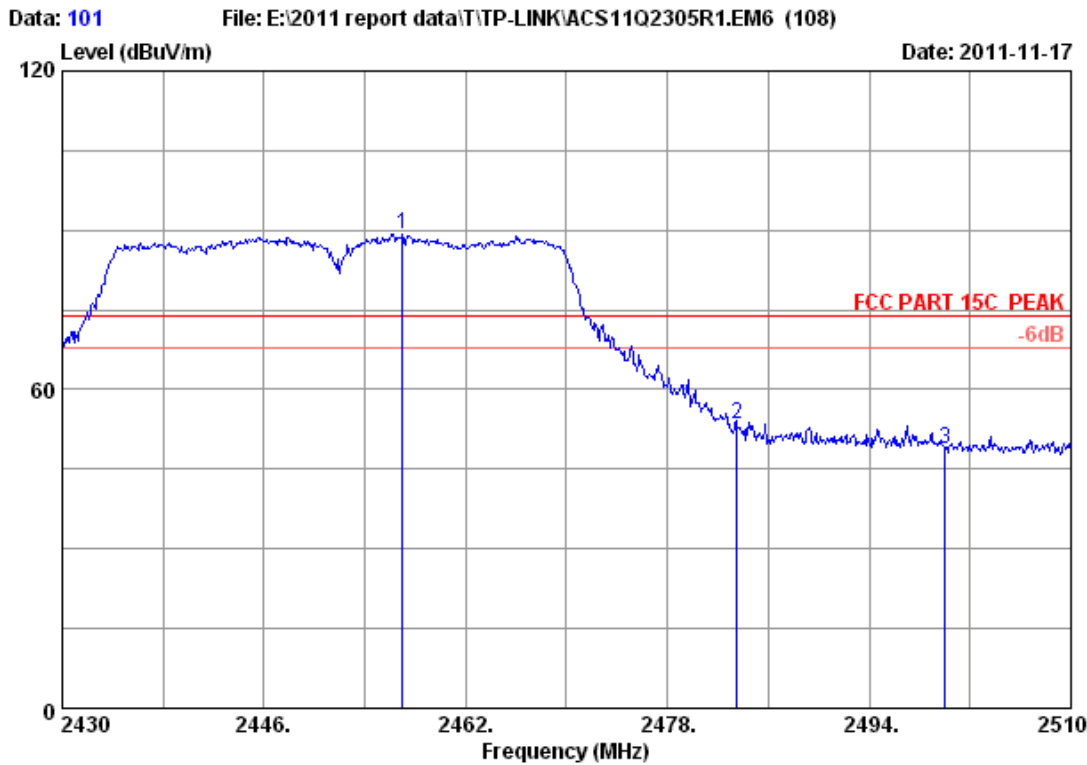

Site no. : 3m Chamber Data no. : 101
 Dis. / Ant. : 3m 3115(0911) Ant. pol. : HORIZONTAL
 Limit : FCC PART 15C PEAK
 Env. / Ins. : 23°C/54% Engineer : Leo-Li
 EUT : 300Mbps Wireless N Range Extender
 Power : DC 12V From Adapter input AC 120V/60Hz
 Test mode : IEEE802.11nHT40 CH7 2452MHz Tx
 M/N : TL-WA830RE

	Ant. Freq. (MHz)	Ant. Factor (dB/m)	Cable loss (dB)	Amp. Factor (dB)	Reading (dBuV)	Emission Level (dBuV/m)	Limits (dBuV/m)	Margin (dB)	Remark
1	2456.960	29.48	8.82	36.02	87.11	89.39	74.00	-15.39	Peak
2	2483.500	29.49	8.87	35.97	51.06	53.45	74.00	20.55	Peak
3	2500.000	29.50	8.92	36.00	46.53	48.95	74.00	25.05	Peak

Remarks:

1. Emission Level= Antenna Factor + Cable Loss -Amp Factor + Reading.
2. The emission levels that are 20dB below the official limit are not reported.

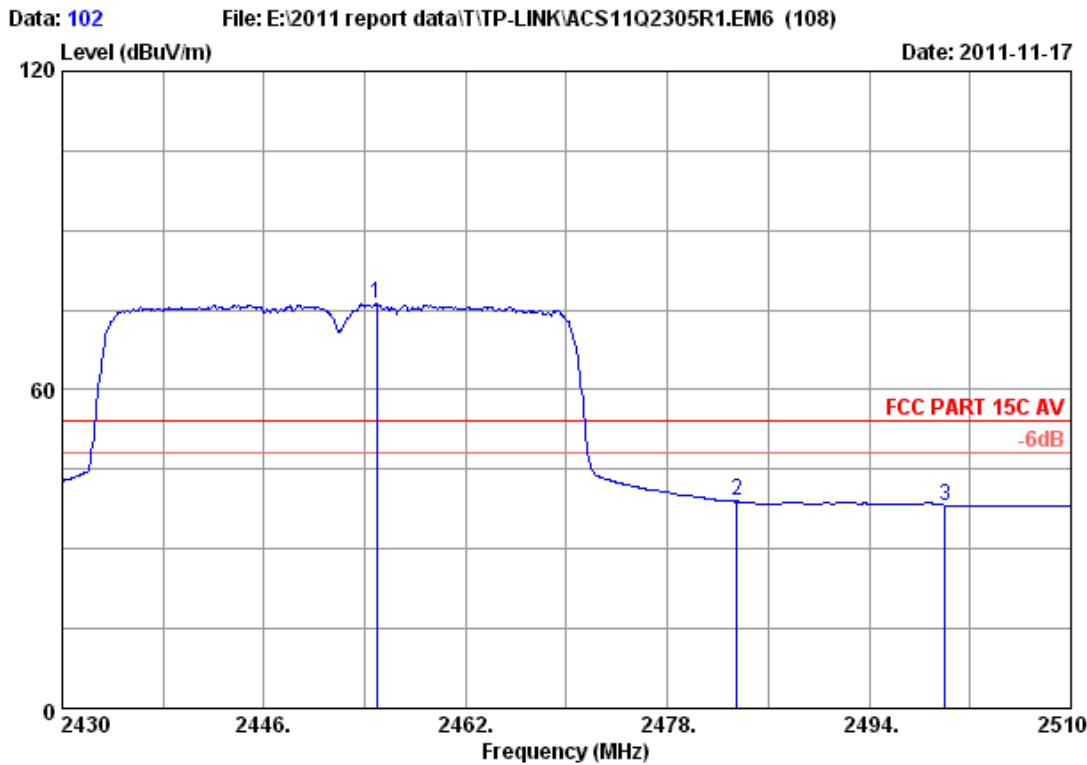

Site no. : 3m Chamber Data no. : 102
 Dis. / Ant. : 3m 3115(0911) Ant. pol. : HORIZONTAL
 Limit : FCC PART 15C AV
 Env. / Ins. : 23°C/54% Engineer : Leo-Li
 EUT : 300Mbps Wireless N Range Extender
 Power : DC 12V From Adapter input AC 120V/60Hz
 Test mode : IEEE802.11nHT40 CH7 2452MHz Tx
 M/N : TL-WA830RE

	Ant. Freq. (MHz)	Ant. Factor (dB/m)	Cable loss (dB)	Amp. Factor (dB)	Reading (dBuV)	Emission Level (dBuV/m)	Limits (dBuV/m)	Margin (dB)	Remark
1	2454.960	29.48	8.82	36.02	74.01	76.29	54.00	-22.29	Average
2	2483.500	29.49	8.87	35.97	36.55	38.94	54.00	15.06	Average
3	2500.000	29.50	8.92	36.00	35.84	38.26	54.00	15.74	Average

Remarks:

1. Emission Level= Antenna Factor + Cable Loss -Amp Factor + Reading.
2. The emission levels that are 20dB below the official limit are not reported.

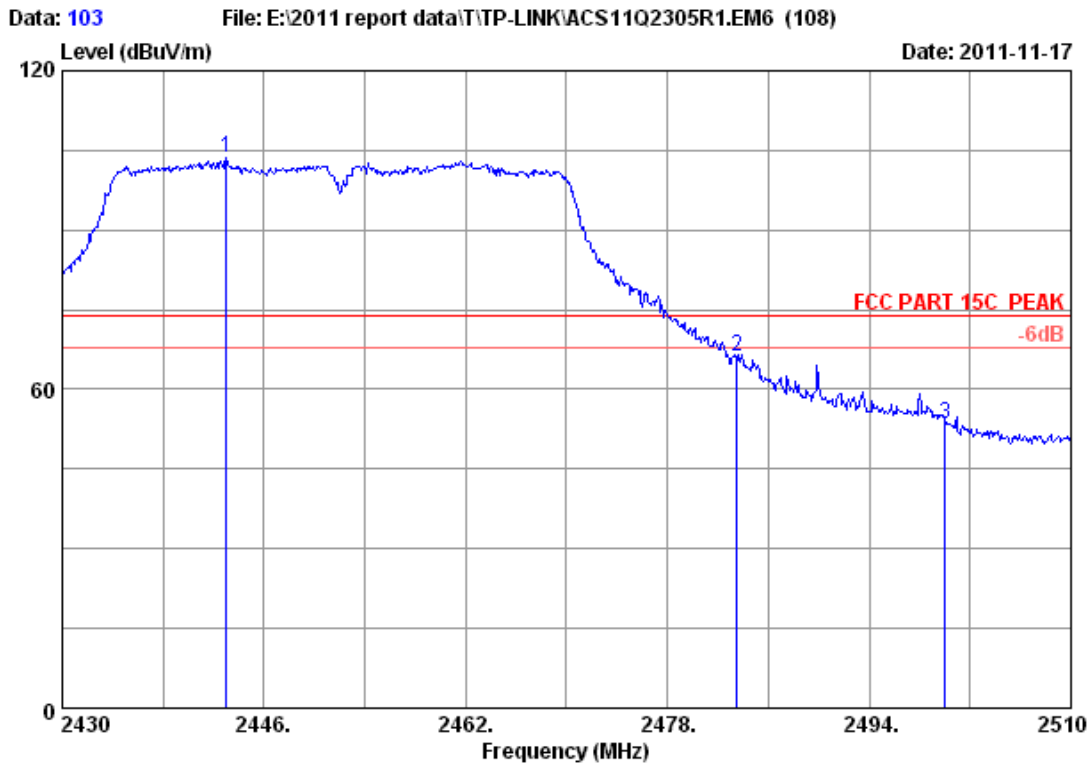

Site no. : 3m Chamber Data no. : 103
 Dis. / Ant. : 3m 3115(0911) Ant. pol. : VERTICAL
 Limit : FCC PART 15C PEAK
 Env. / Ins. : 23°C/54% Engineer : Leo-Li
 EUT : 300Mbps Wireless N Range Extender
 Power : DC 12V From Adapter input AC 120V/60Hz
 Test mode : IEEE802.11nHT40 CH7 2452MHz Tx
 M/N : TL-WA830RE

	Ant. Freq. (MHz)	Ant. Factor (dB/m)	Cable loss (dB)	Amp. Factor (dB)	Reading (dBuV)	Emission Level (dBuV/m)	Limits (dBuV/m)	Margin (dB)	Remark
1	2443.040	29.47	8.77	36.06	101.45	103.63	74.00	-29.63	Peak
2	2483.500	29.49	8.87	35.97	63.78	66.17	74.00	7.83	Peak
3	2500.000	29.50	8.92	36.00	51.16	53.58	74.00	20.42	Peak

Remarks:

1. Emission Level= Antenna Factor + Cable Loss -Amp Factor + Reading.
2. The emission levels that are 20dB below the official limit are not reported.

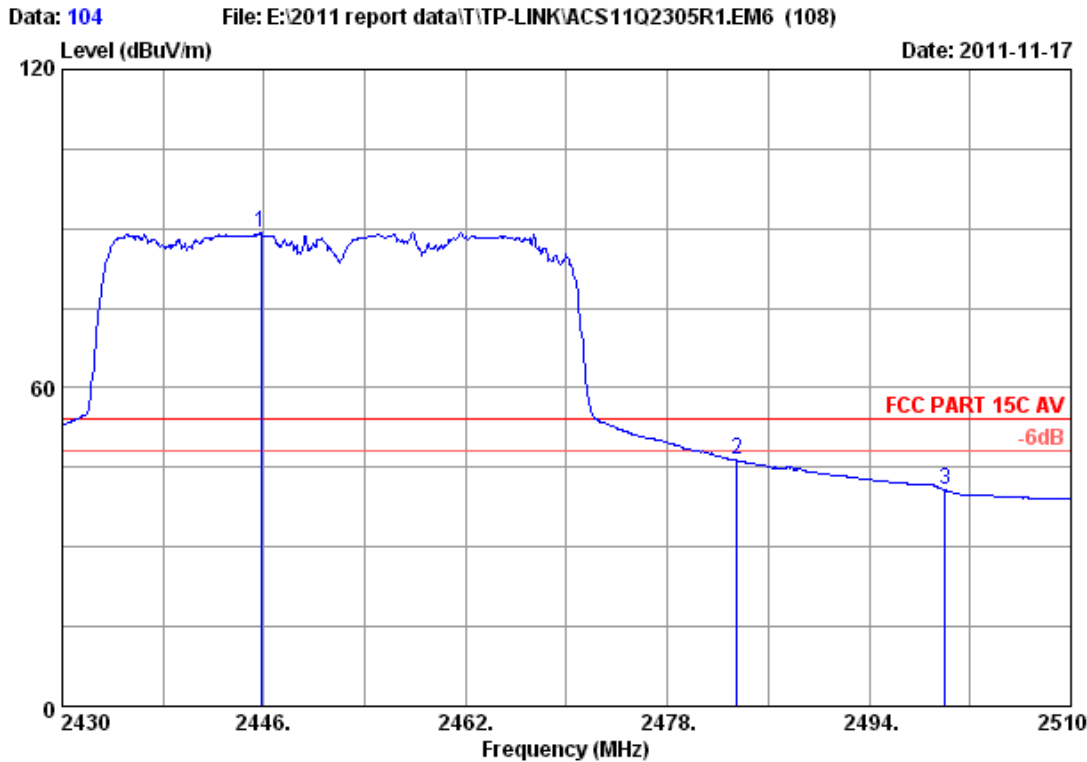

Site no. : 3m Chamber Data no. : 104
 Dis. / Ant. : 3m 3115(0911) Ant. pol. : VERTICAL
 Limit : FCC PART 15C AV
 Env. / Ins. : 23°C/54% Engineer : Leo-Li
 EUT : 300Mbps Wireless N Range Extender
 Power : DC 12V From Adapter input AC 120V/60Hz
 Test mode : IEEE802.11nHT40 CH7 2452MHz Tx
 M/N : TL-WA830RE

	Ant. Freq. (MHz)	Ant. Factor (dB/m)	Cable loss (dB)	Amp. Factor (dB)	Reading (dBuV)	Emission Level (dBuV/m)	Limits (dBuV/m)	Margin (dB)	Remark
1	2445.760	29.47	8.77	36.06	87.15	89.33	54.00	-35.33	Average
2	2483.500	29.49	8.87	35.97	43.91	46.30	54.00	7.70	Average
3	2500.000	29.50	8.92	36.00	38.25	40.67	54.00	13.33	Average

Remarks:

1. Emission Level= Antenna Factor + Cable Loss -Amp Factor + Reading.
2. The emission levels that are 20dB below the official limit are not reported.

7. 6dB Bandwidth Test

7.1. Test Equipment

Item	Equipment	Manufacturer	Model No.	Serial No.	Last Cal.	Cal. Interval
1.	Spectrum Analyzer	Agilent	E4446A	US44300459	May.08,11	1 Year
2.	Attenuator	Agilent	8491B	MY39262165	May.08,11	1 Year
3.	RF Cable	Hubersuhner	SUCOFLEX102	28618/2	May.08,11	1Year

7.2. Limit

For direct sequence systems, the minimum 6dB bandwidth shall be at least 500kHz

7.3. Test Procedure

The transmitter output was connected to a spectrum analyzer, The bandwidth of the fundamental frequency was measured by spectrum analyzer with 100kHz RBW and 300 kHz VBW. The 6dB bandwidth is defined as the total spectrum the power of which is higher than peak power minus 6dB.

7.4. Test Results

EUT: 300Mbps Wireless N Range Extender		
M/N: TL-WA830RE		
Test date: 2011-11-18	Pressure: 101.6 kpa	Humidity: 54.2%
Tested by: Leo-Li	Test site: RF Site	Temperature : 25.8 °C

Test Mode	CH	Result		Limit (KHz)
		Chain0 6dB bandwidth (MHz)	Chain1 6dB bandwidth (MHz)	
11b	CH1	12.603	12.618	>500
	CH6	12.629	12.590	>500
	CH11	12.597	12.625	>500
11g	CH1	16.507	16.512	>500
	CH6	16.518	16.439	>500
	CH11	16.483	16.473	>500
11n HT20	CH1	17.706	17.703	>500
	CH6	17.657	17.669	>500
	CH11	17.685	17.797	>500
11n HT40	CH1	36.392	36.402	>500
	CH4	36.346	36.211	>500
	CH7	36.207	36.148	>500
Conclusion : PASS				

Chain 0:

Test Mode: IEEE 802.11b TX

Test CH1: 2412MHz

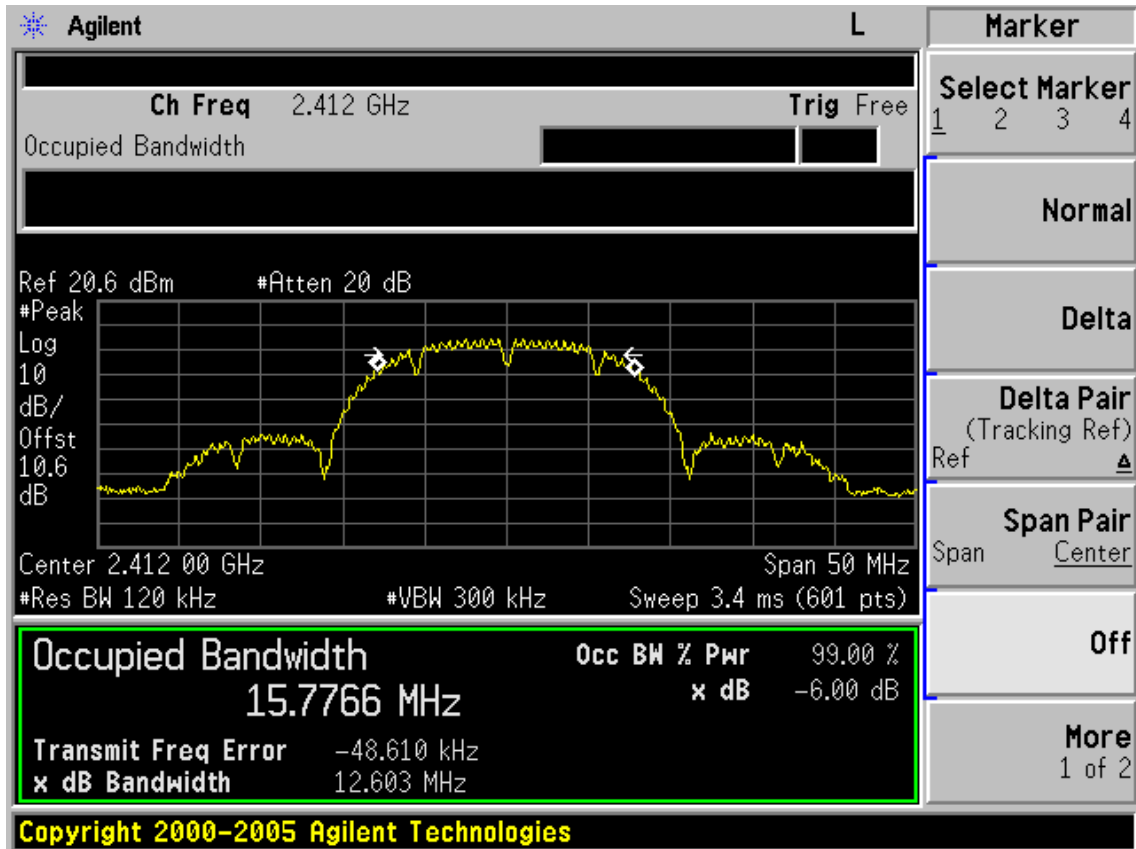

Test CH6: 2437MHz

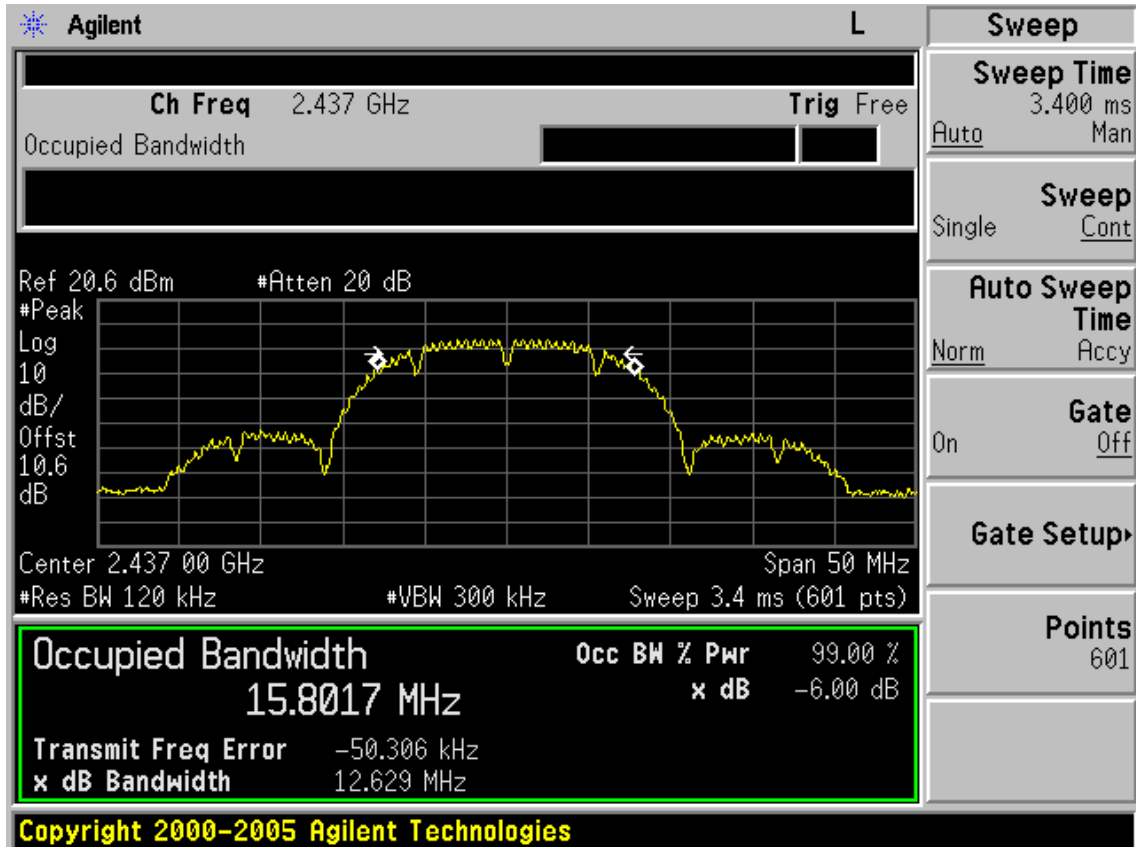

Test CH11: 2462MHz

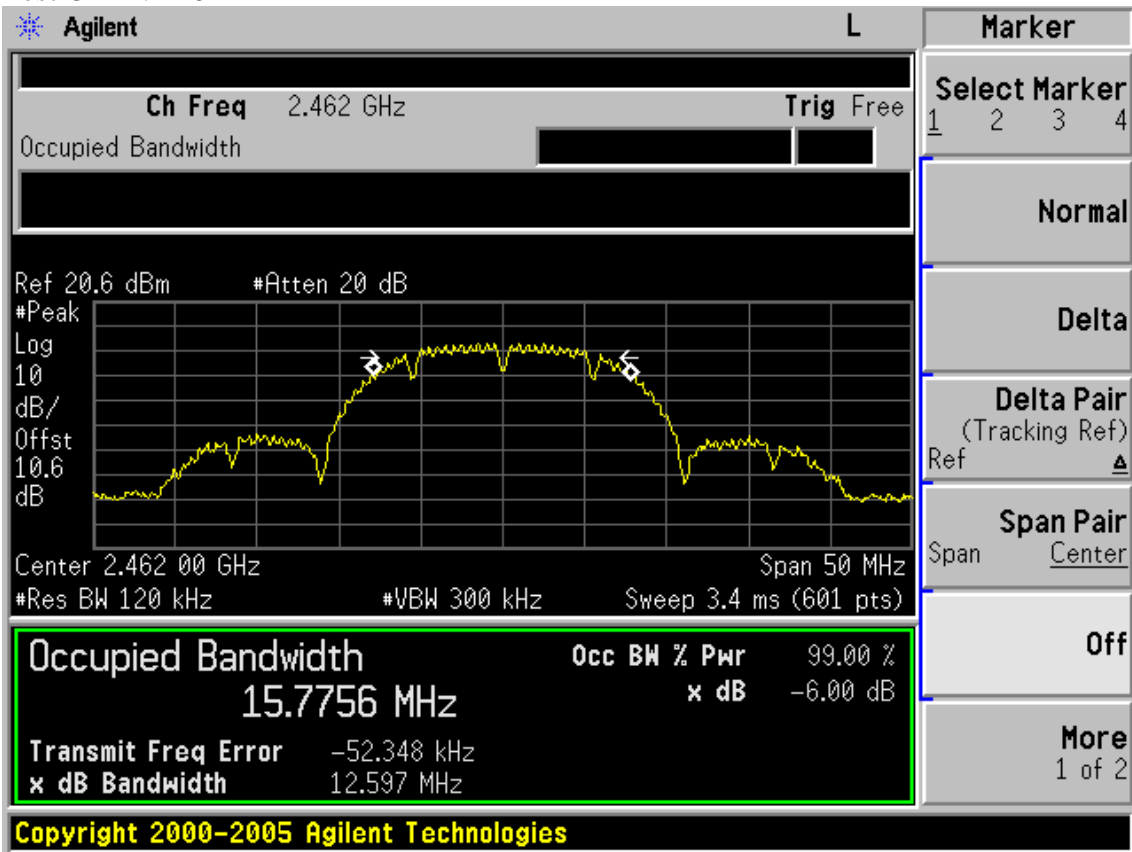

Test Mode: IEEE 802.11g TX

Test CH1: 2412MHz

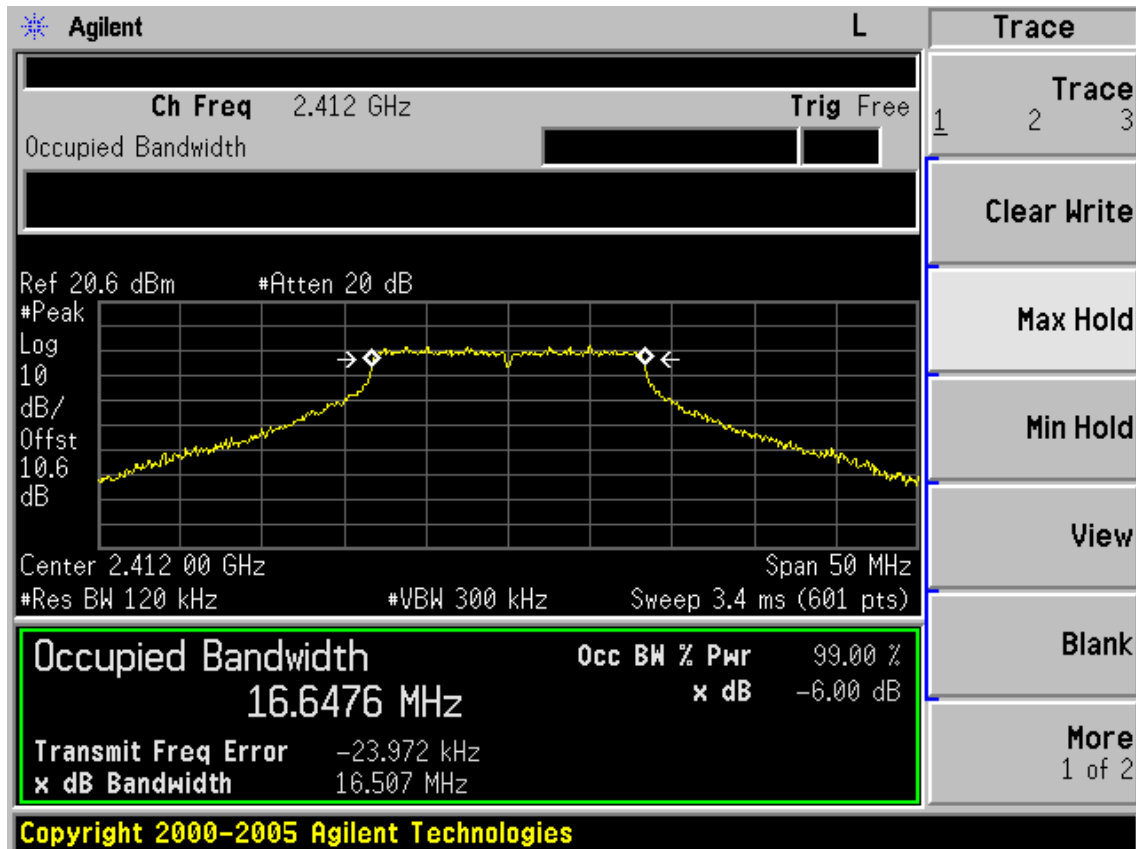

Test CH6: 2437MHz

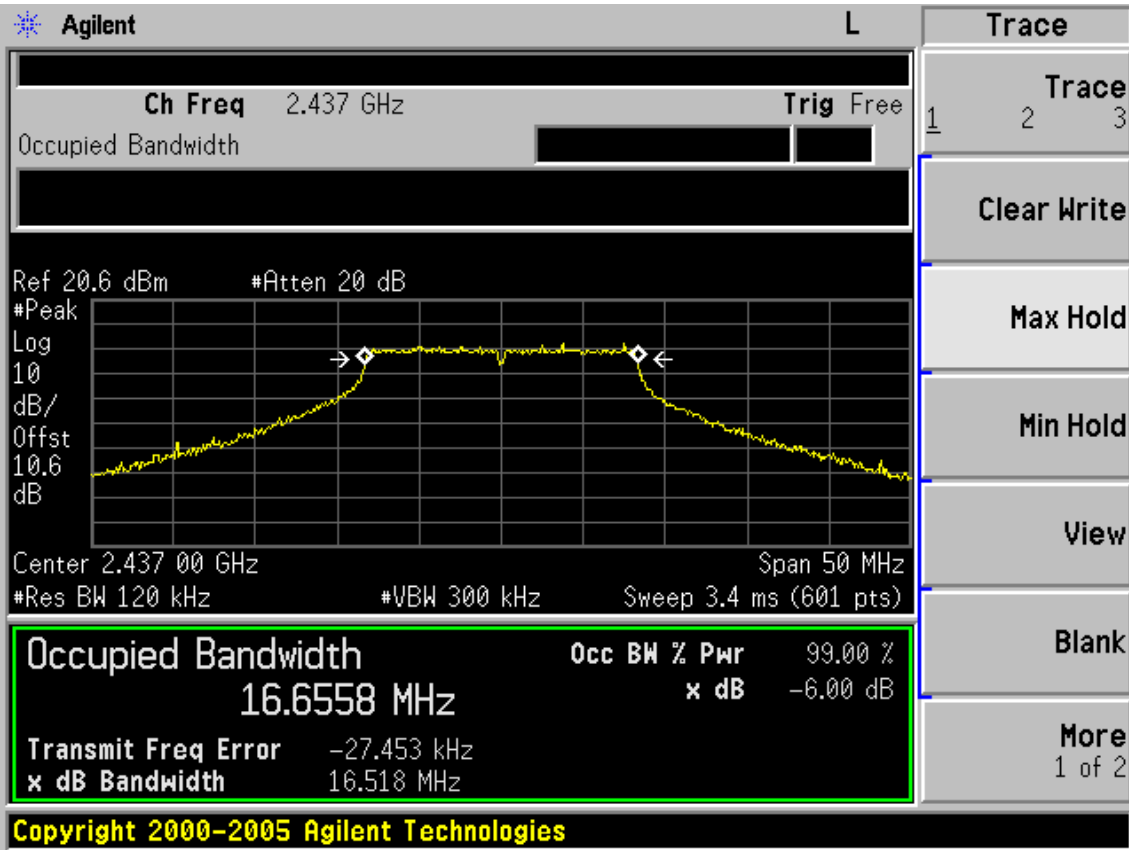

Test CH11: 2462MHz

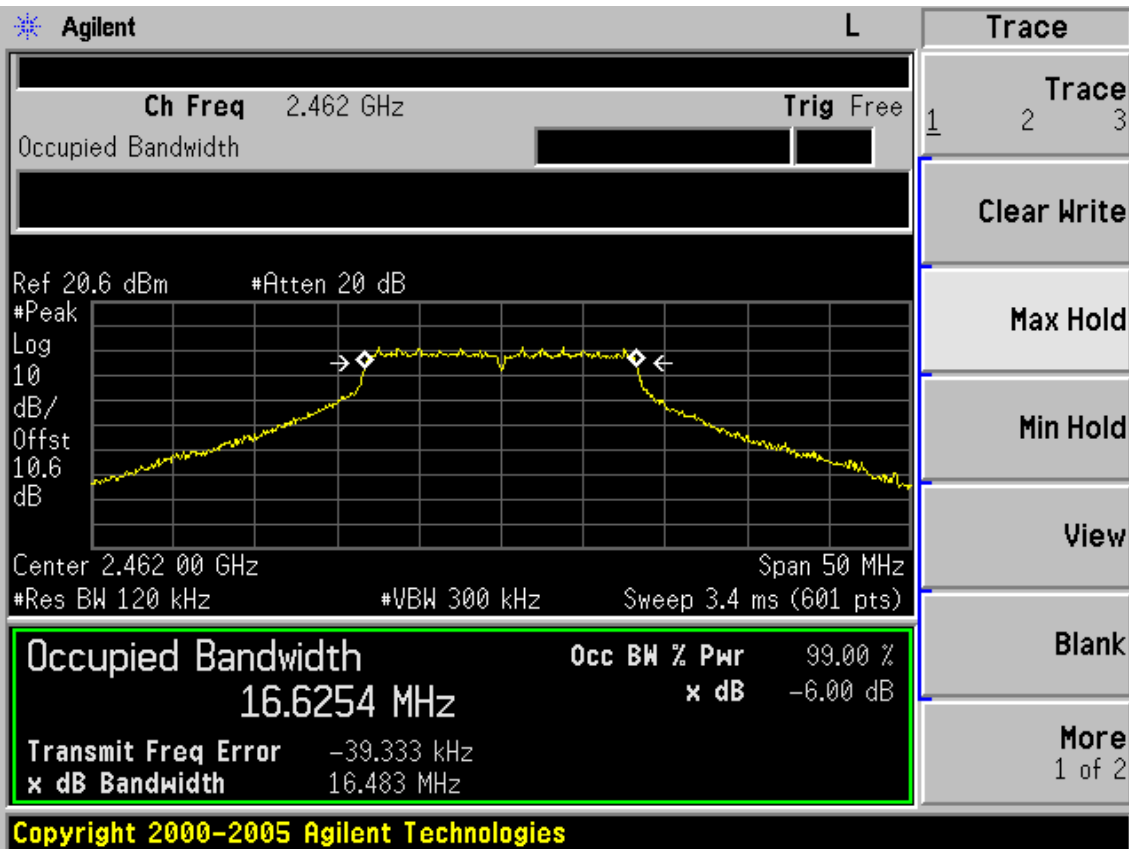

Test Mode: IEEE 802.11n HT20 TX
 Test CH1: 2412MHz

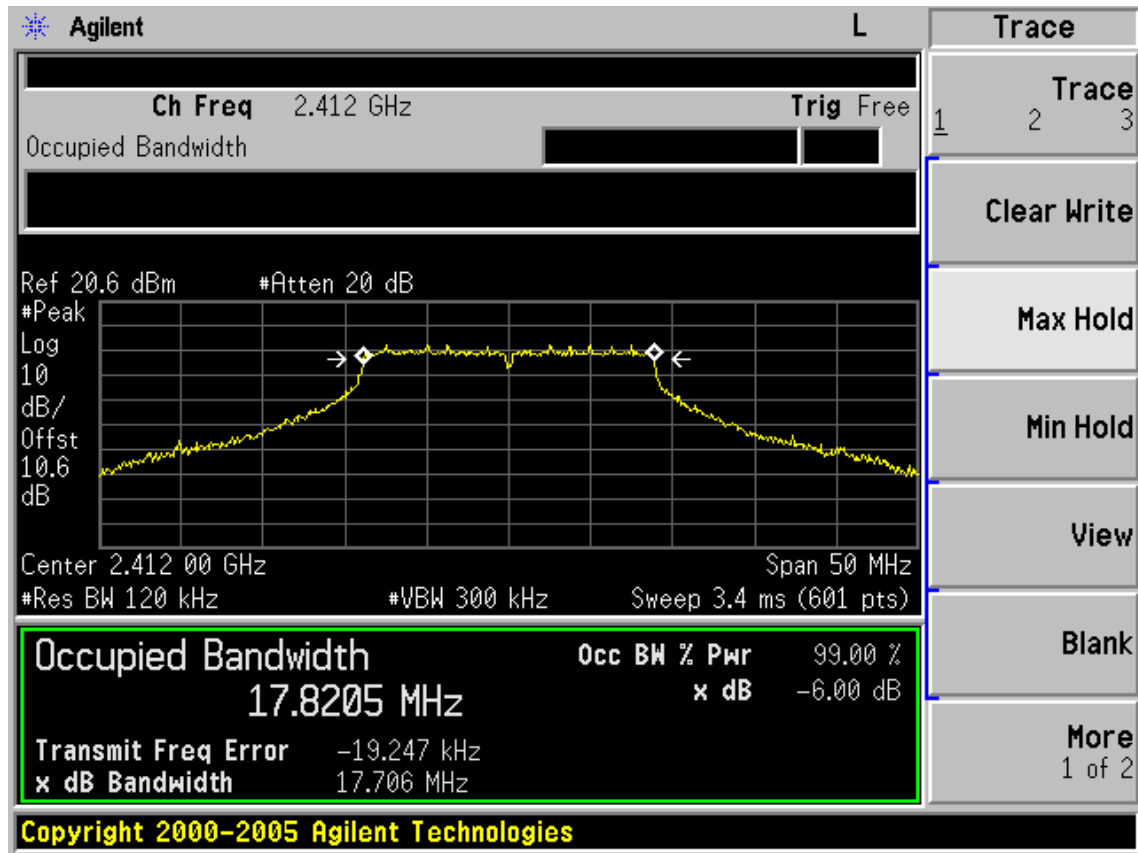

Test CH6: 2437MHz

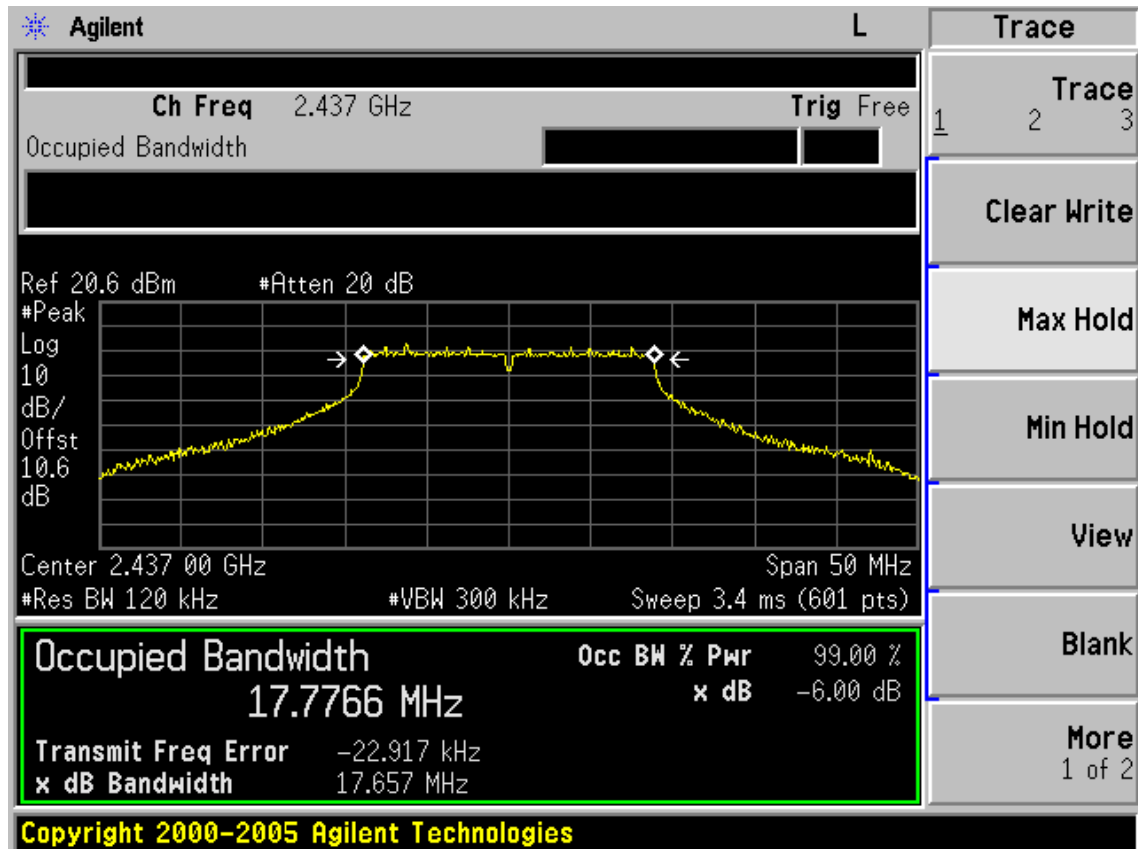

Test CH11: 2462MHz

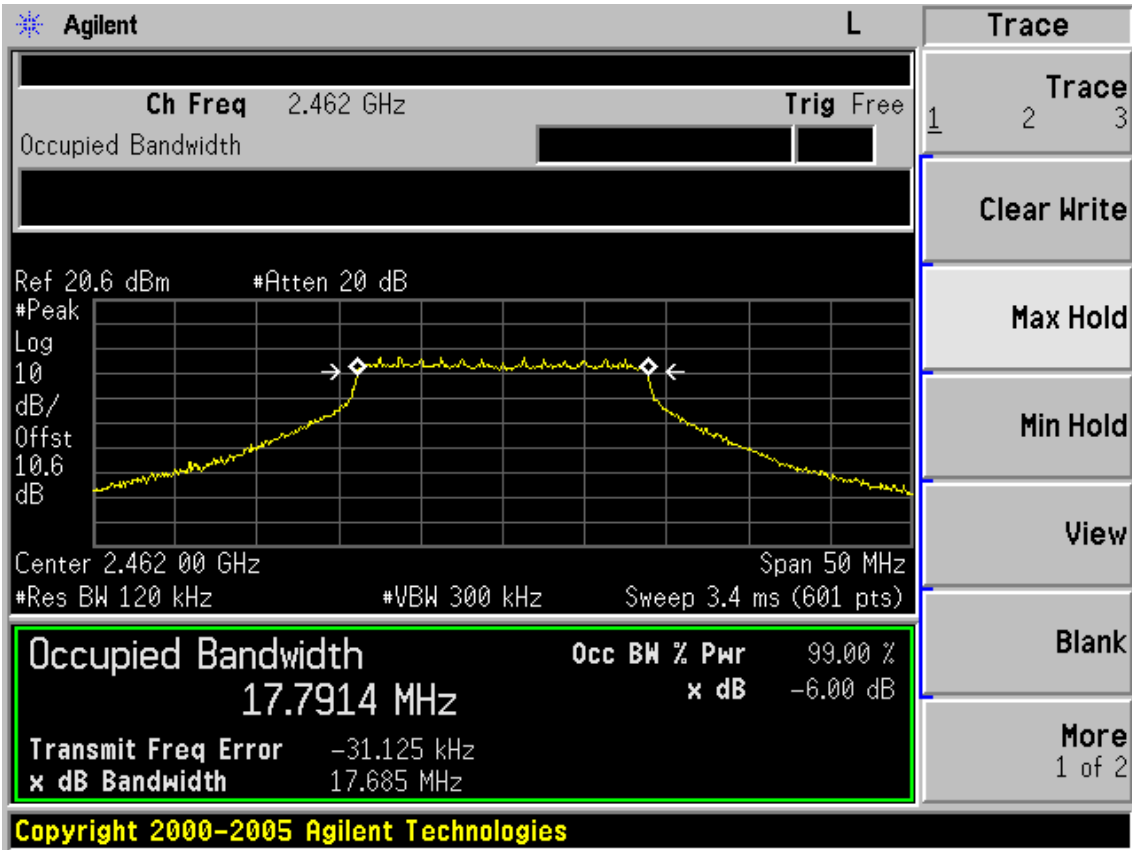

Test Mode: IEEE 802.11n HT40 TX

Test CH1: 2422MHz

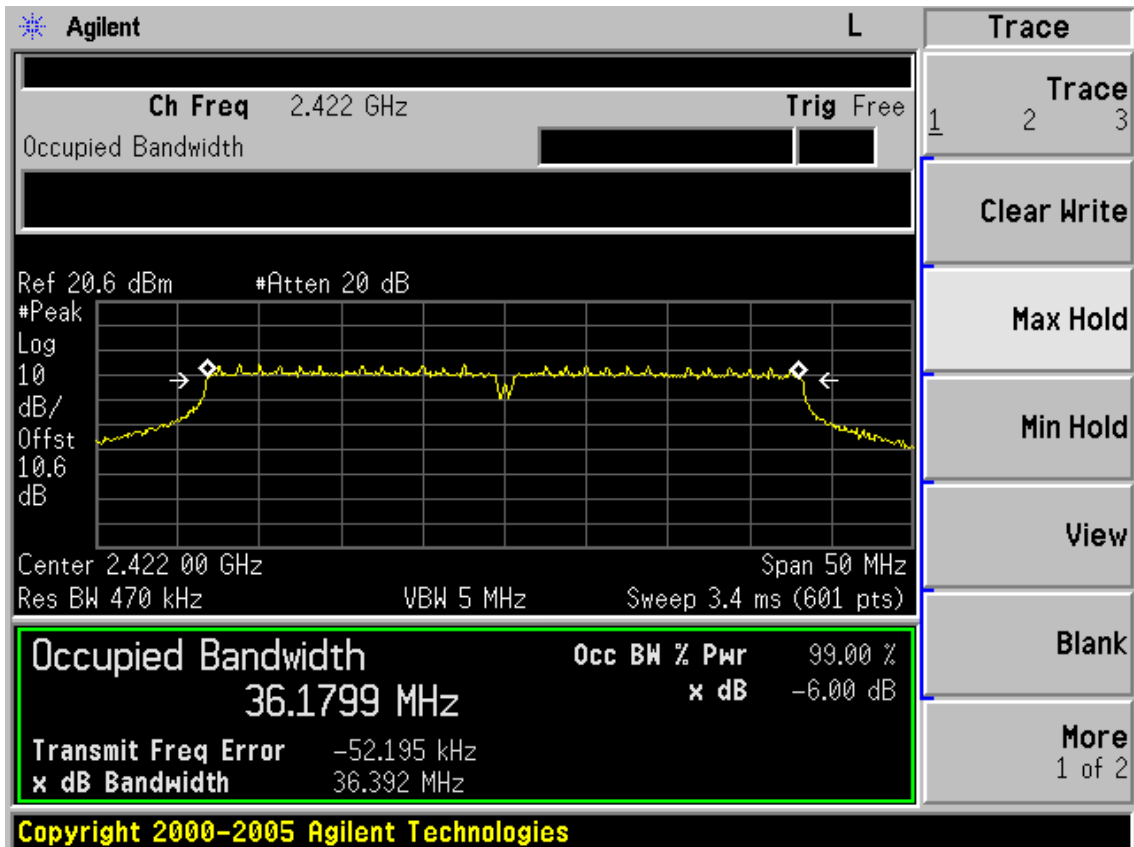

Test CH4: 2437MHz

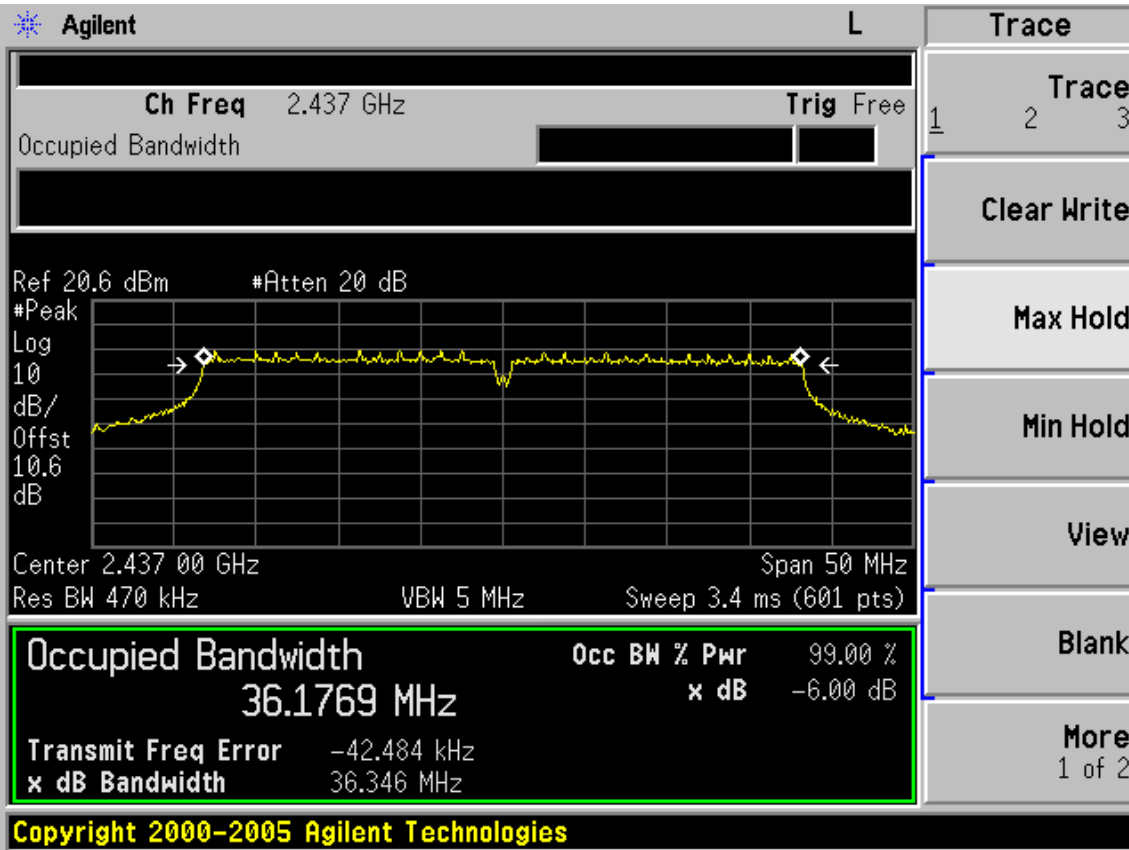

Test CH7: 2452MHz

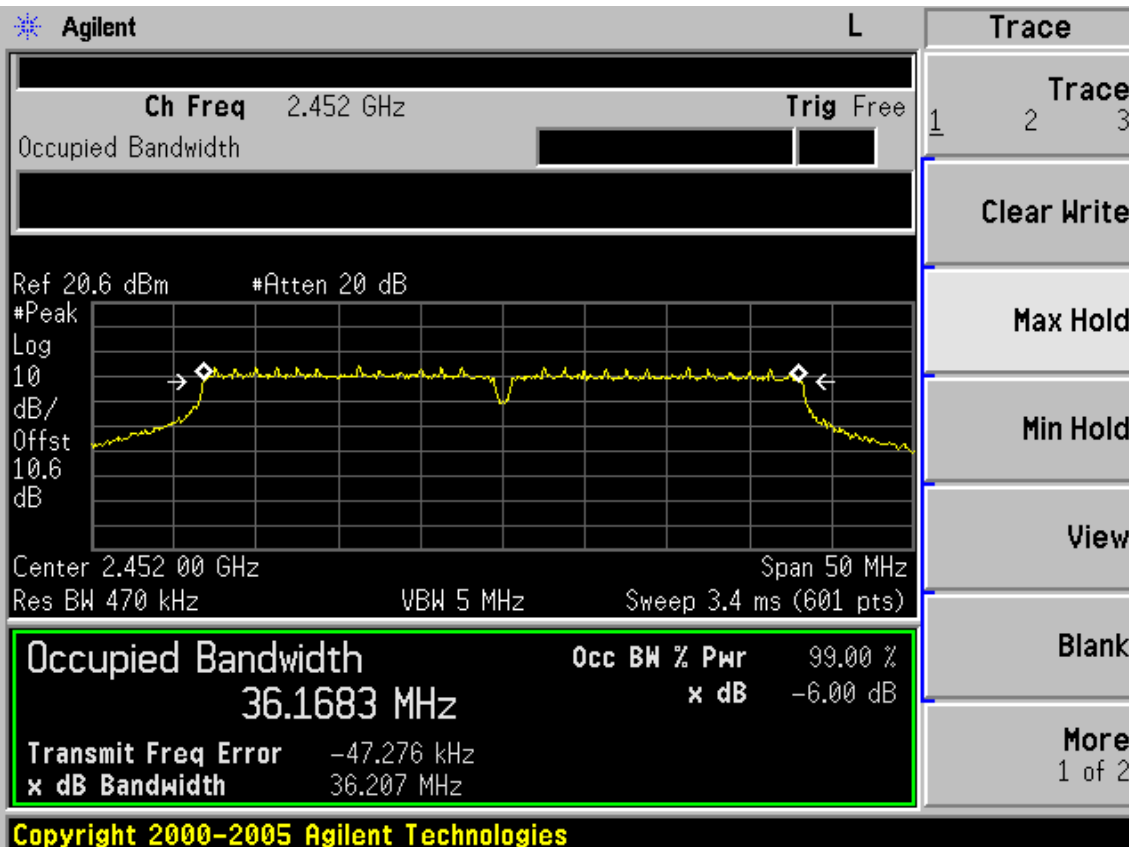

Chain 1:

Test Mode: IEEE 802.11b TX
 Test CH1: 2412MHz

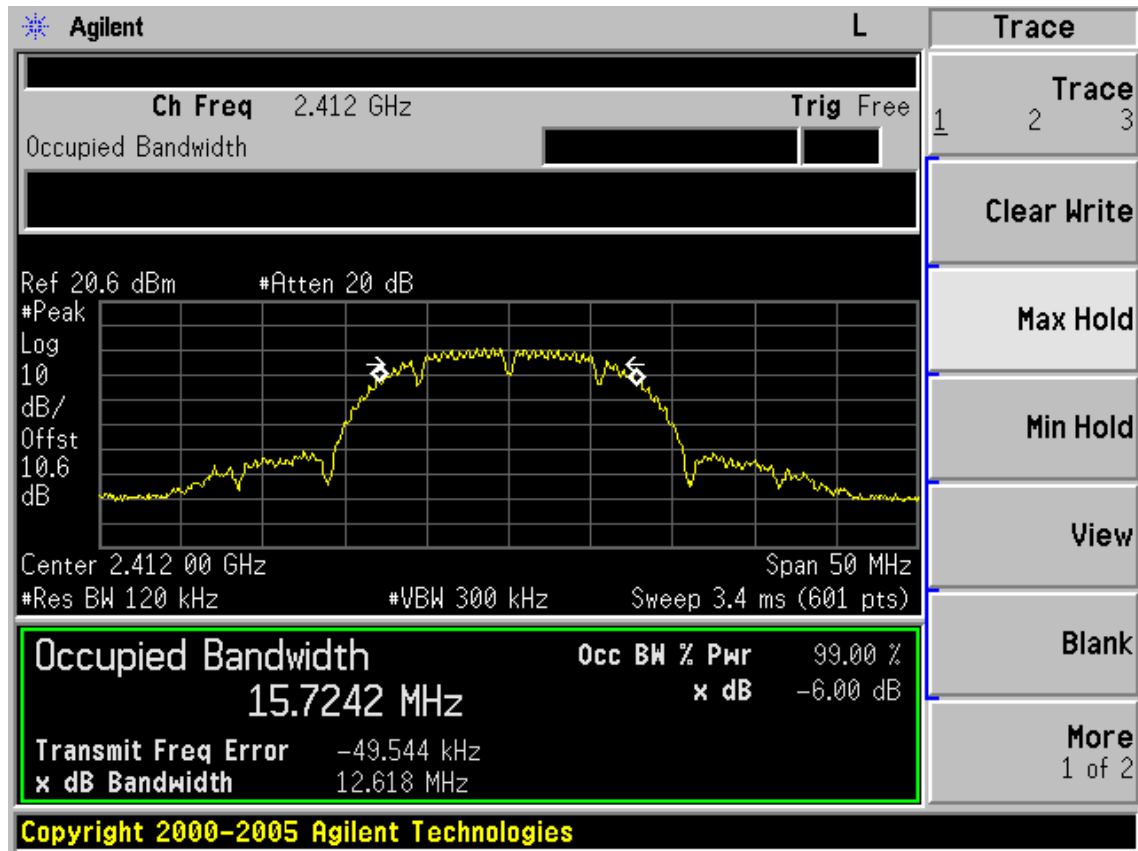

Test CH6: 2437MHz

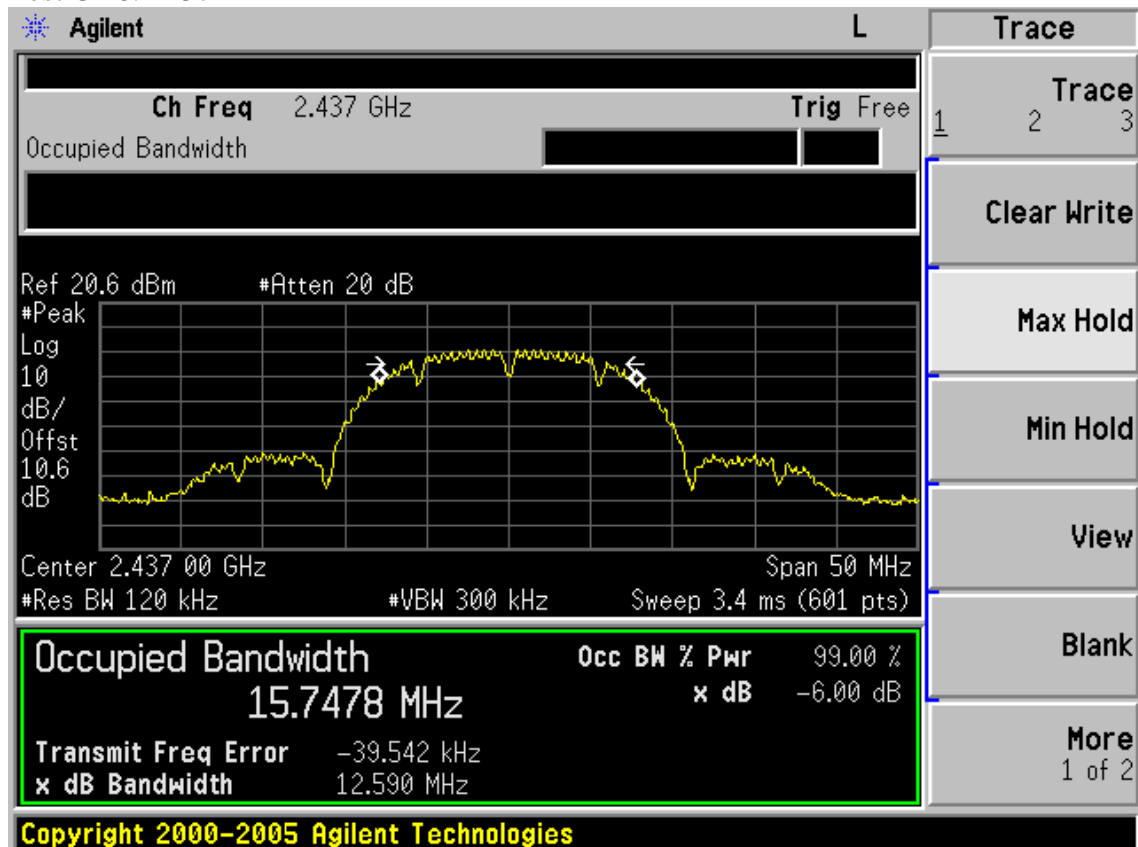

Test CH11: 2462MHz

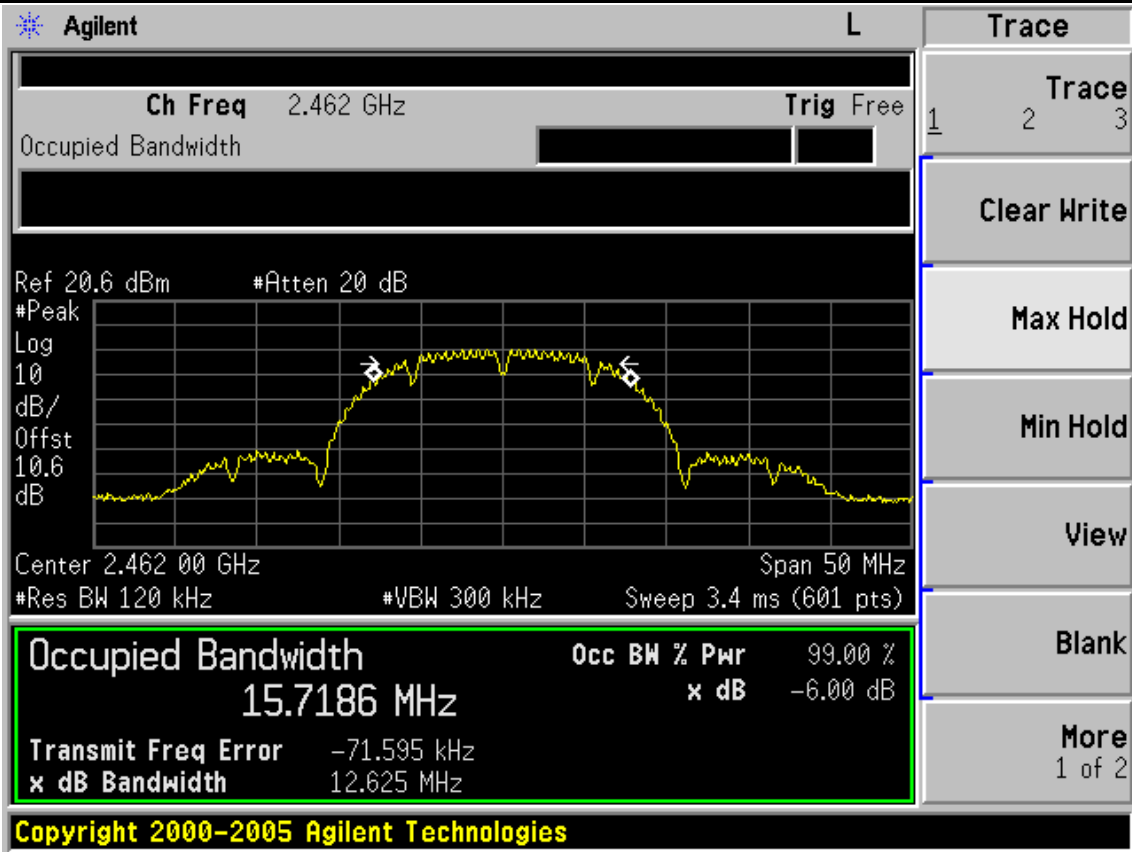

Test Mode: IEEE 802.11g TX

Test CH1: 2412MHz

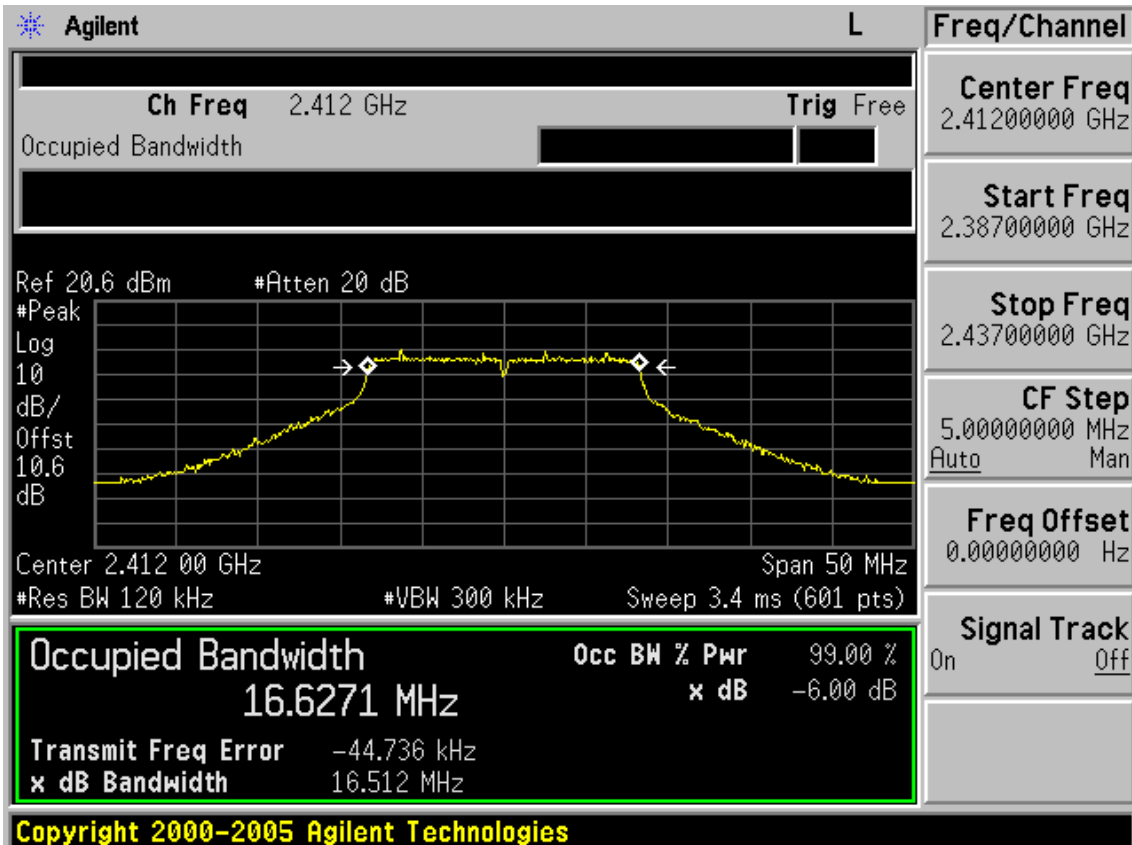

Test CH6: 2437MHz

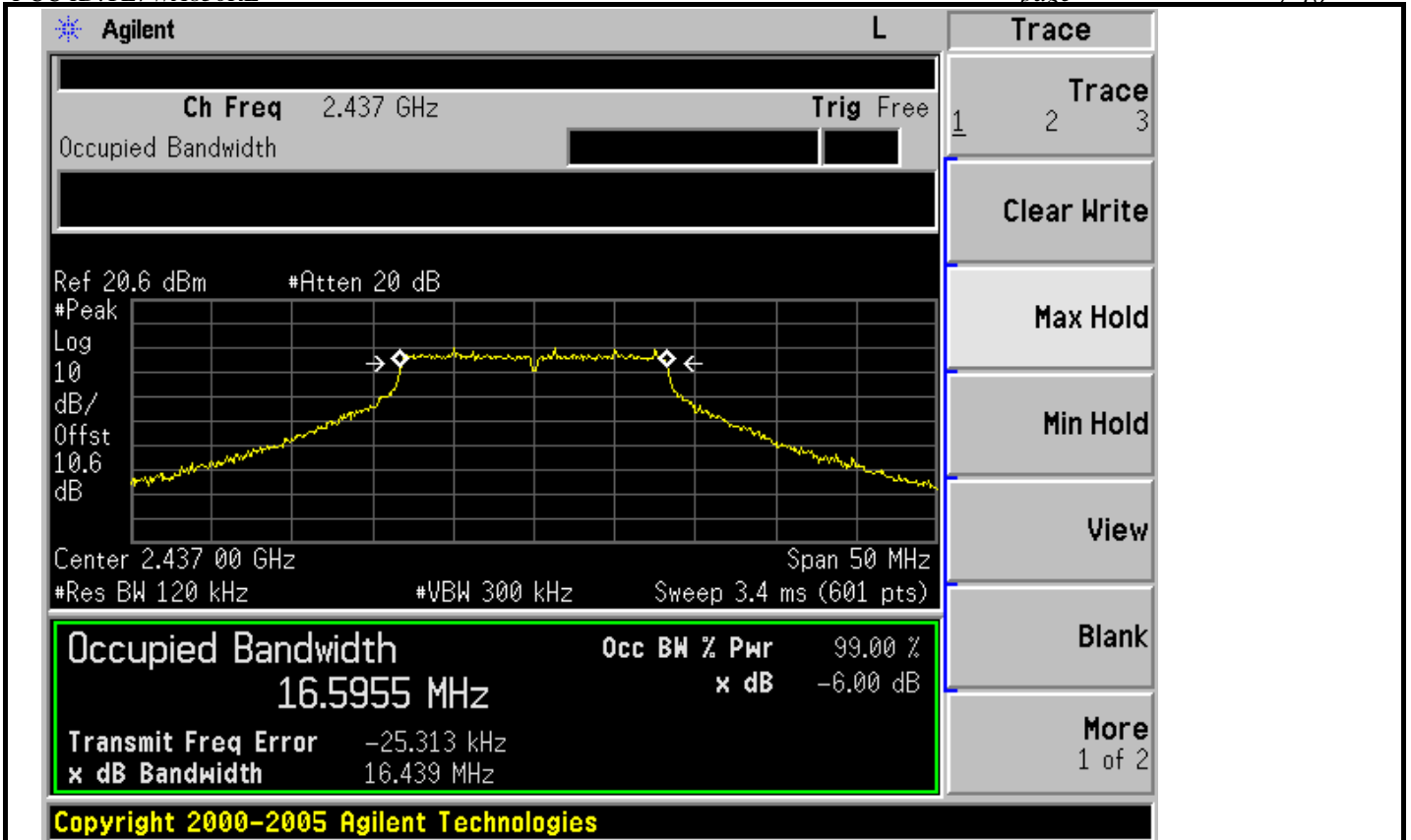

Test CH11: 2462MHz

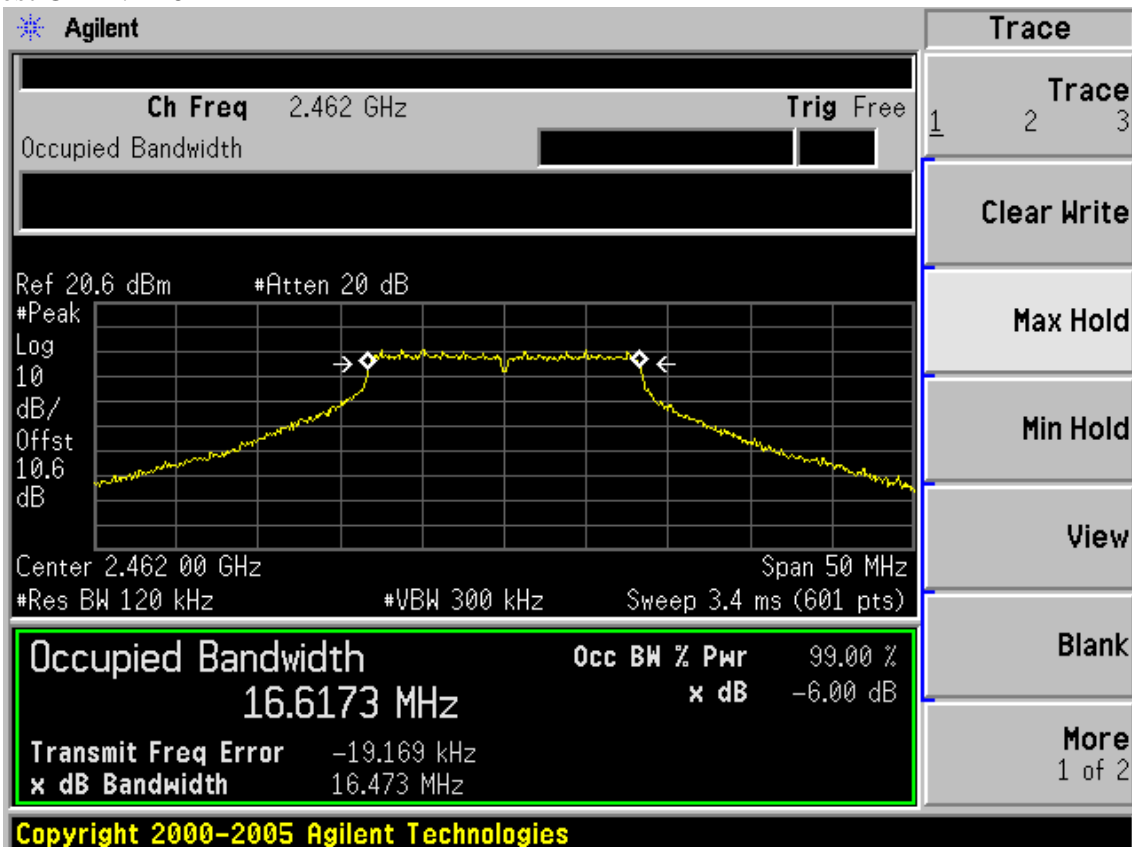

Test Mode: IEEE 802.11n HT20 TX

Test CH1: 2412MHz

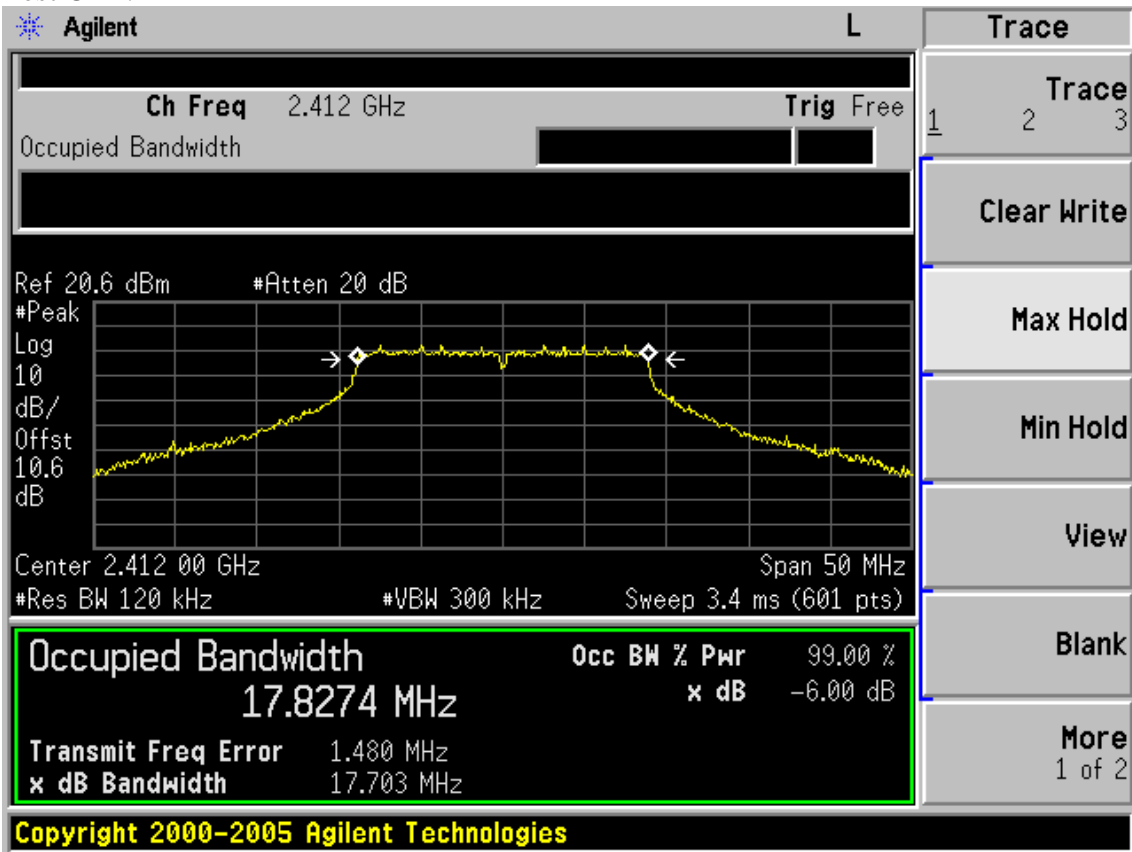

Test CH6: 2437MHz

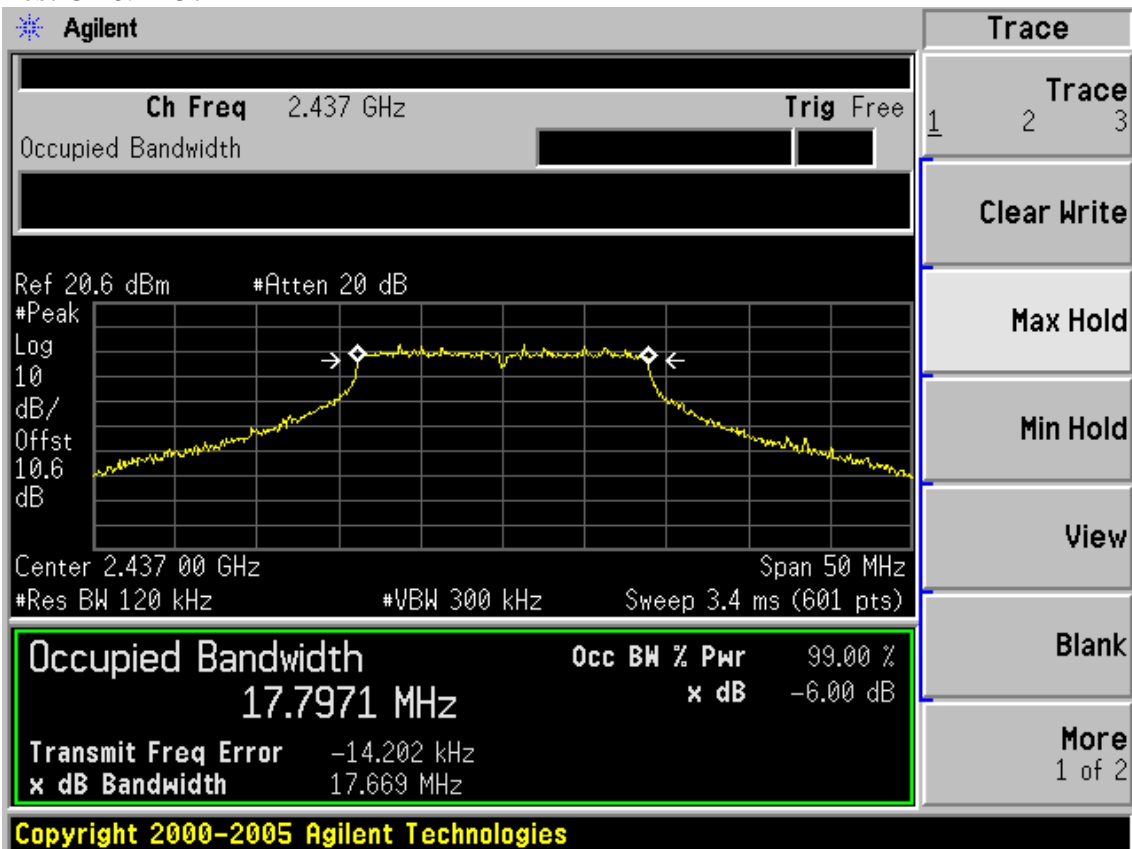

Test CH11: 2462MHz

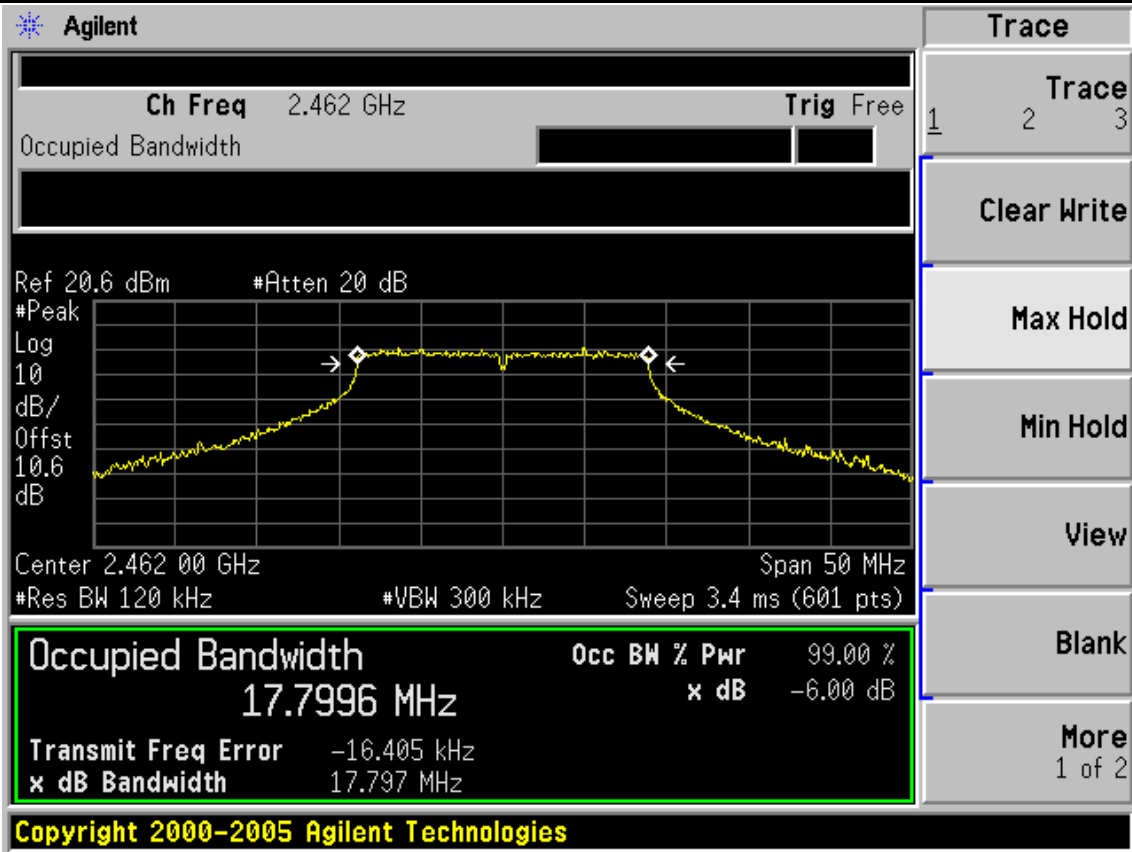

Test Mode: IEEE 802.11n HT40 TX

Test CH1: 2422MHz

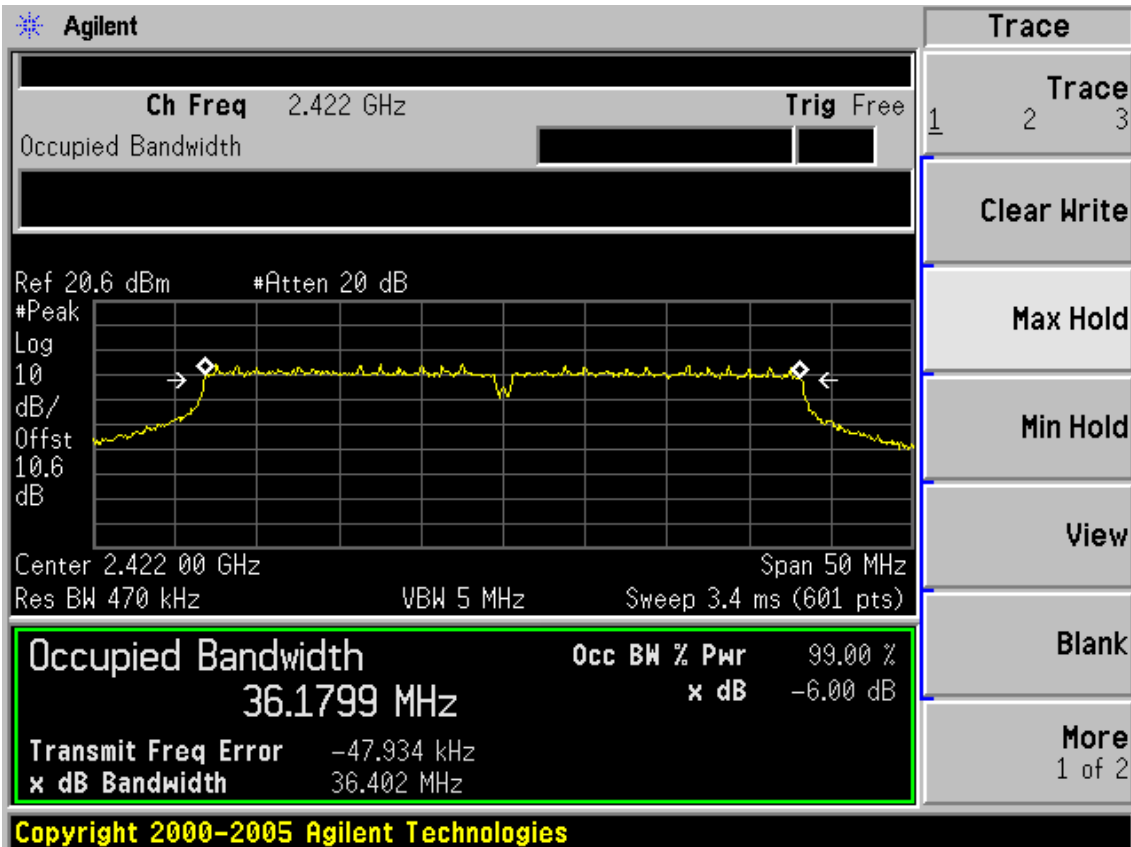

Test CH4: 2437MHz

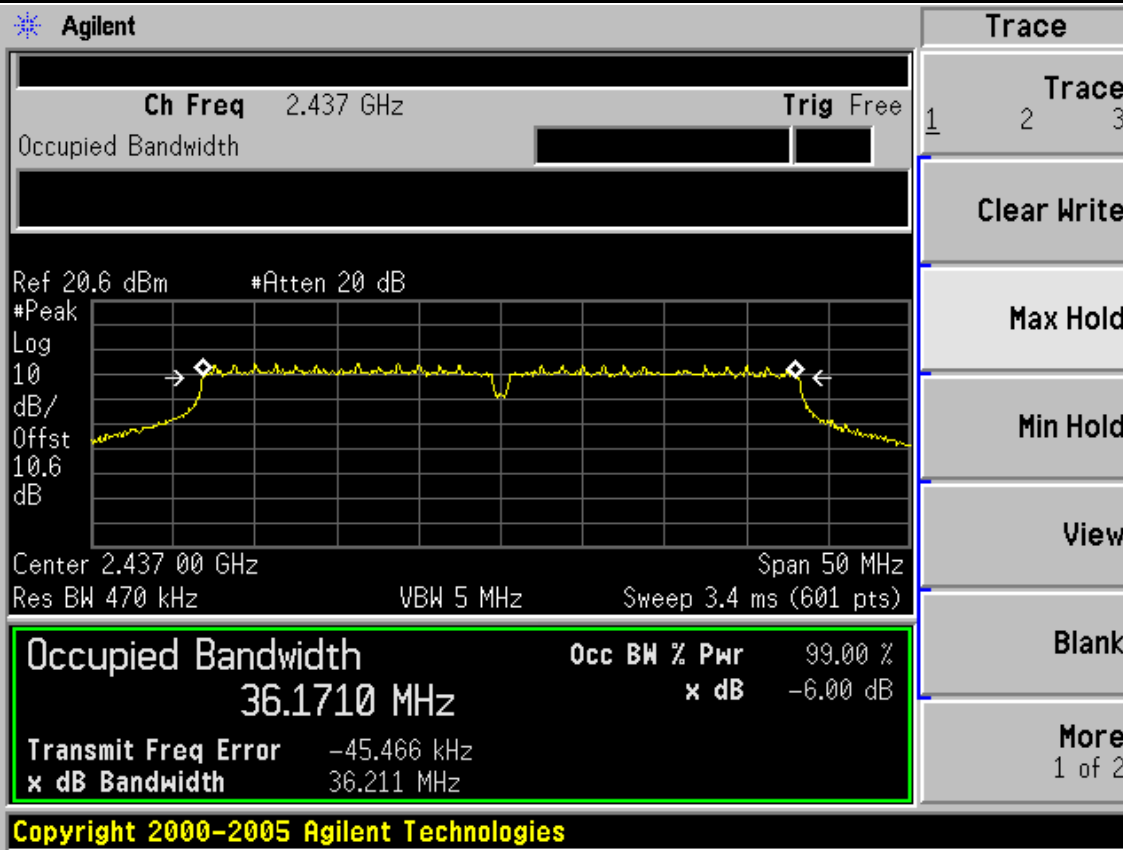

Test CH7: 2452MHz

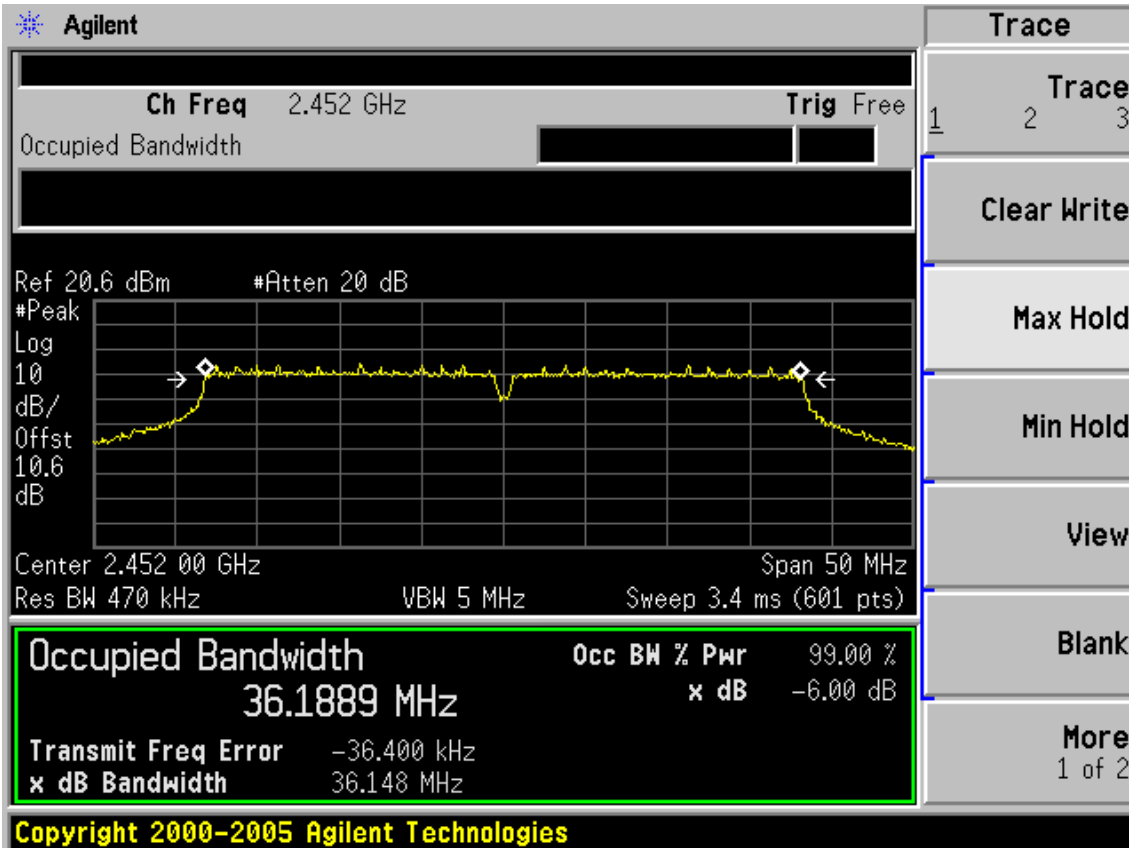

8. OUTPUT POWER TEST

8.1. Test Equipment

Item	Equipment	Manufacturer	Model No.	Serial No.	Last Cal.	Cal. Interval
1.	Power meter	Anritsu	ML2487A	6K00002472	May.08,11	1Year
2.	Power sensor	Anritsu	MA2491A	0033005	May.08,11	1Year
3	Attenuator	Agilent	8491B	MY39262165	May.08,11	1 Year
4	Spectrum Analyzer	Agilent	E4446A	US44300459	May.08, 11	1 Year
5	RF Cable	Hubersuhner	SUCOFLEX102	28618/2	May.08,11	1Year

8.2.Limit (FCC Part 15C 15.247 b(3))

For systems using digital modulation in the 2400—2483.5MHz, The Peak out put Power shall not exceed 1W(30dBm)

8.3. Test Procedure

- 1, Connected the EUT's antenna port to measure device by 20dB attenuator.
- 2, For IEEE 802.11b/g and IEEE802.11n HT20 mode, use a PK power meter which's bandwidth is 20MHz and above 26dB bandwidth of signal to measure out each test modes' PK output power.
- 3, For IEEE802.11n HT40 mode, because the signal's bandwidth is about 40MHz and above 20MHz bandwidth of power sensor ML2491A. So Bandwidth correction method according to ANSI C63.10 clause 6.10.2.1 part (c) was used:
 - 1) Set the RBW=3MHz and VBW =8MHz
 - 2) Turn averaging off
 - 3) Set sweep to automatic
 - 4) Set the span just large enough to capture the emission
 - 5) Use a peak detector on max hold
 - 6) Record the measured power
 - 7) Calculate Output power of EUT use the formula:

$$\text{Peak output power} = \text{measured power} + 10\log[(26\text{dB bandwidth of emission})/(\text{analyzer RBW})]$$

Note: The cable loss and attenuator loss were offset into measure device as an amplitude offset.

8.4.Test Results

EUT: 300Mbps Wireless N Range Extender					
M/N: TL-WA830RE					
Test date: 2011-11-17		Pressure: 101.3 kpa			Humidity: 53.6 %
Tested by: Leo-Li		Test site: RF site			Temperature: 25.7 °C
Cable loss: 1 dB			Attenuator loss: 20 dB		
Test Mode	CH (MHz)	Peak output Power (dBm)			Limit (dBm)
		Chain0	Chain1	Total	
11b	CH1	17.49	15.62	N/A	30
	CH6	17.87	16.51	N/A	30
	CH11	16.55	16.38	N/A	30
11g	CH1	20.71	19.56	N/A	30
	CH6	21.77	20.45	N/A	30
	CH11	20.53	19.84	N/A	30
11n HT20	CH1	18.73	17.64	21.23	30
	CH6	21.69	21.18	24.45	30
	CH11	15.43	15.37	18.41	30

Test Mode	CH	Result					Limit (dBm)
		Measured power(dBm)/3MHz		PK Output power (dBm)			
		Chain0	Chain1	Chain0	Chain1	Total	
11n HT40	CH1	4.88	4.53	17.15	16.83	20.00	30
	CH4	11.10	10.51	23.37	22.81	26.11	30
	CH7	2.83	2.33	15.10	14.63	17.88	30
Chain 0		26dB Bandwidth for 11n HT40: 50.631MHz					
Chain 1		26dB Bandwidth for 11n HT40: 50.943MHz					
Chain 0		BW correction factor = $10\log[(50.631\text{MHz})/(3\text{MHz})] = 12.27\text{dB}$					
Chain 1		BW correction factor = $10\log[(50.943\text{MHz})/(3\text{MHz})] = 12.30\text{dB}$					
Conclusion: PASS							

IEEE 802.11n HT40

Chain 0

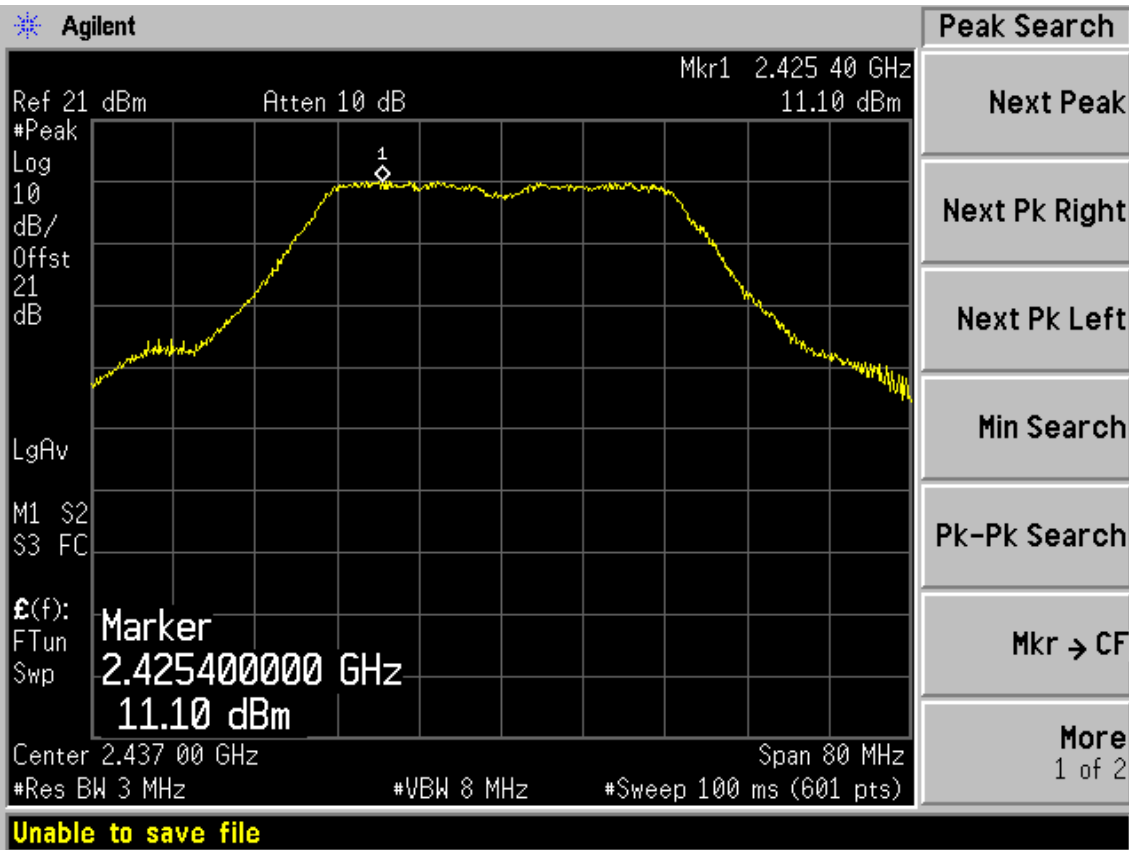
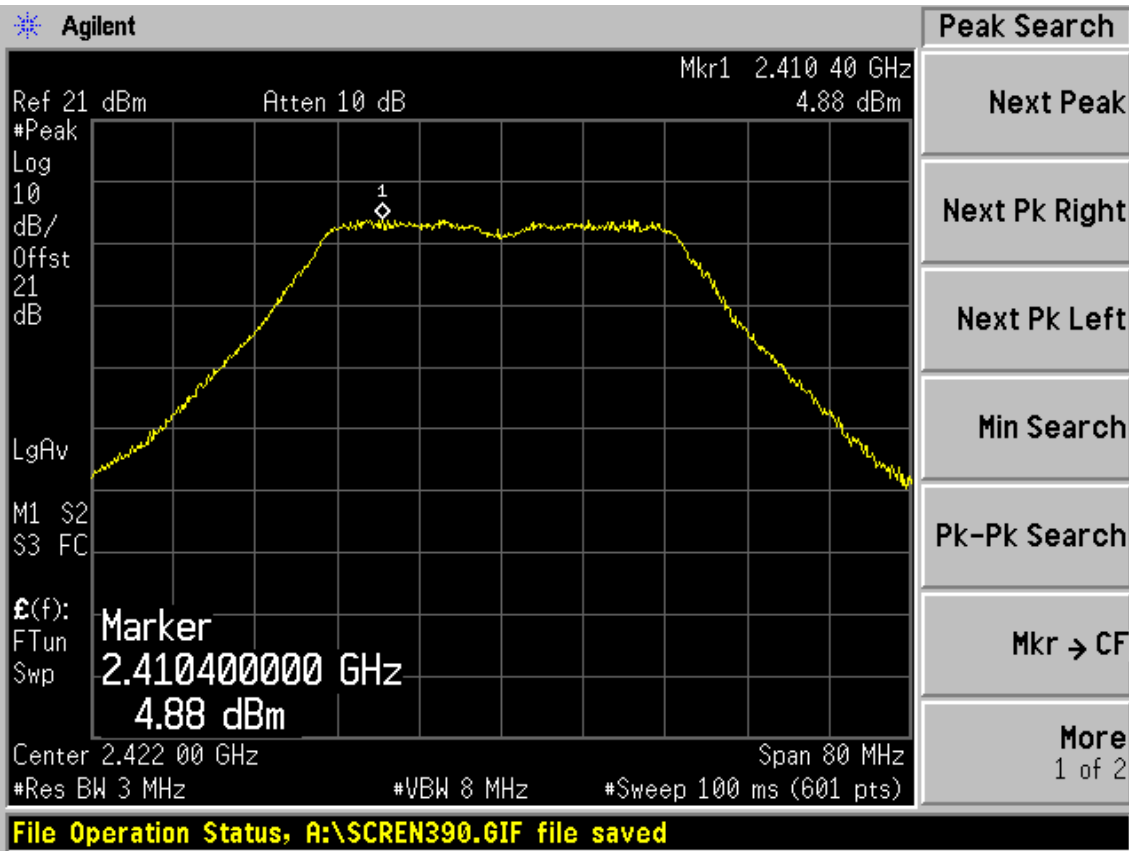

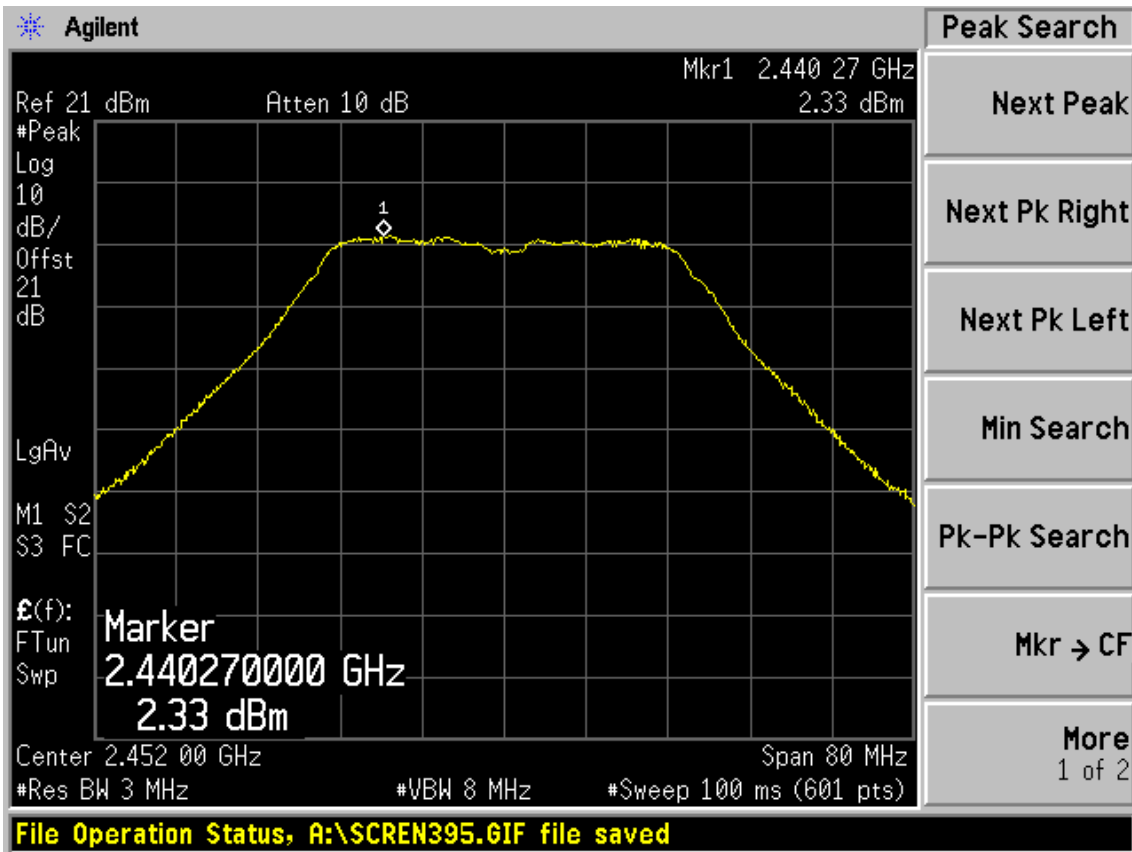
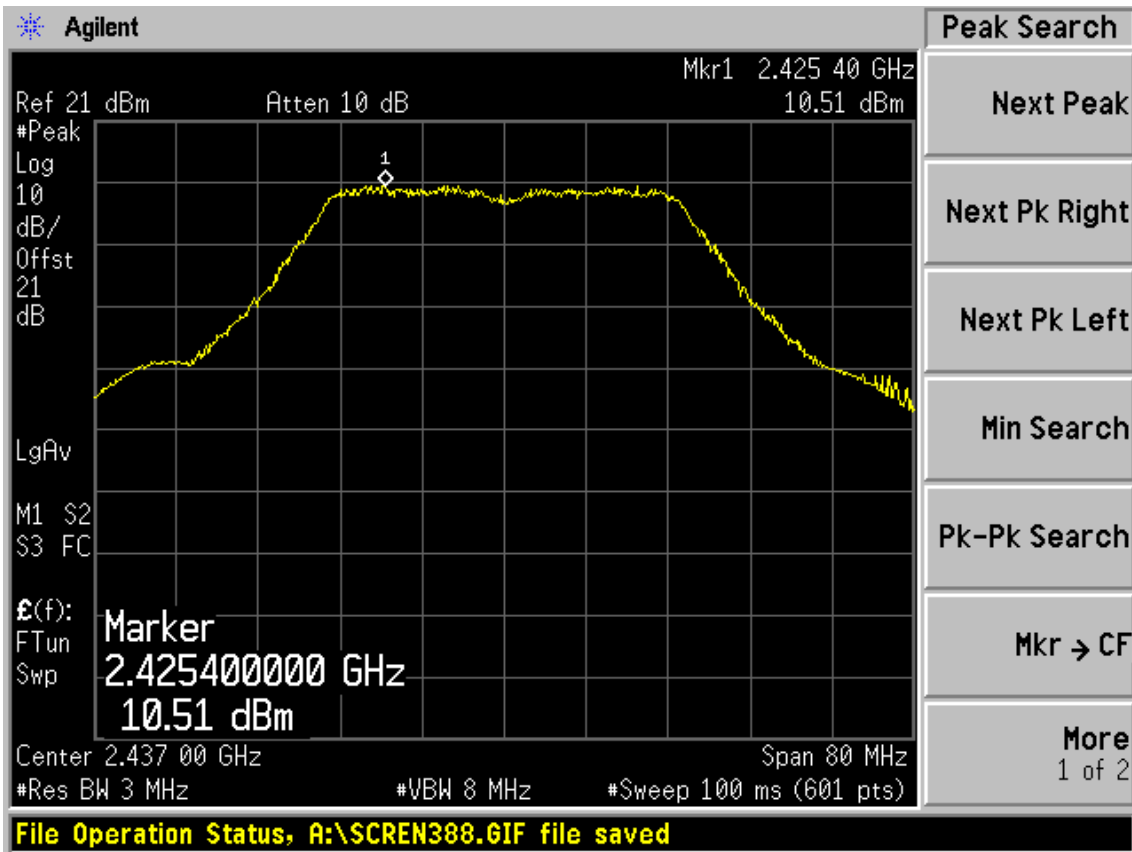

26dB Bandwidth

Chain 0

Agilent

Ch Freq 2.437 GHz Trig Free

Occupied Bandwidth

Ref 21 dBm Atten 10 dB

#Peak Log 10 dB/ Offst 21 dB

Start 2.407 00 GHz Stop 2.467 00 GHz

#Res BW 470 kHz #VBW 3 MHz Sweep 1 ms (601 pts)

Occupied Bandwidth	Occ BW % Pwr	99.00 %
37.1990 MHz	x dB	-26.00 dB
Transmit Freq Error	-57.514 kHz	
x dB Bandwidth	51.468 MHz	

File Operation Status, A:\SCREN794.GIF file saved

Trace

Trace 1 2 3

Clear Write

Max Hold

Min Hold

View

Blank

More
1 of 2

Agilent

Ch Freq 2.452 GHz Trig Free

Occupied Bandwidth

Ref 21 dBm Atten 10 dB

#Peak Log 10 dB/ Offst 21 dB

Center 2.452 00 GHz Span 60 MHz

#Res BW 470 kHz #VBW 3 MHz Sweep 1 ms (601 pts)

Occupied Bandwidth	Occ BW % Pwr	99.00 %
37.1225 MHz	x dB	-26.00 dB
Transmit Freq Error	-92.546 kHz	
x dB Bandwidth	50.632 MHz	

Copyright 2000-2005 Agilent Technologies

Trace

Trace 1 2 3

Clear Write

Max Hold

Min Hold

View

Blank

More
1 of 2

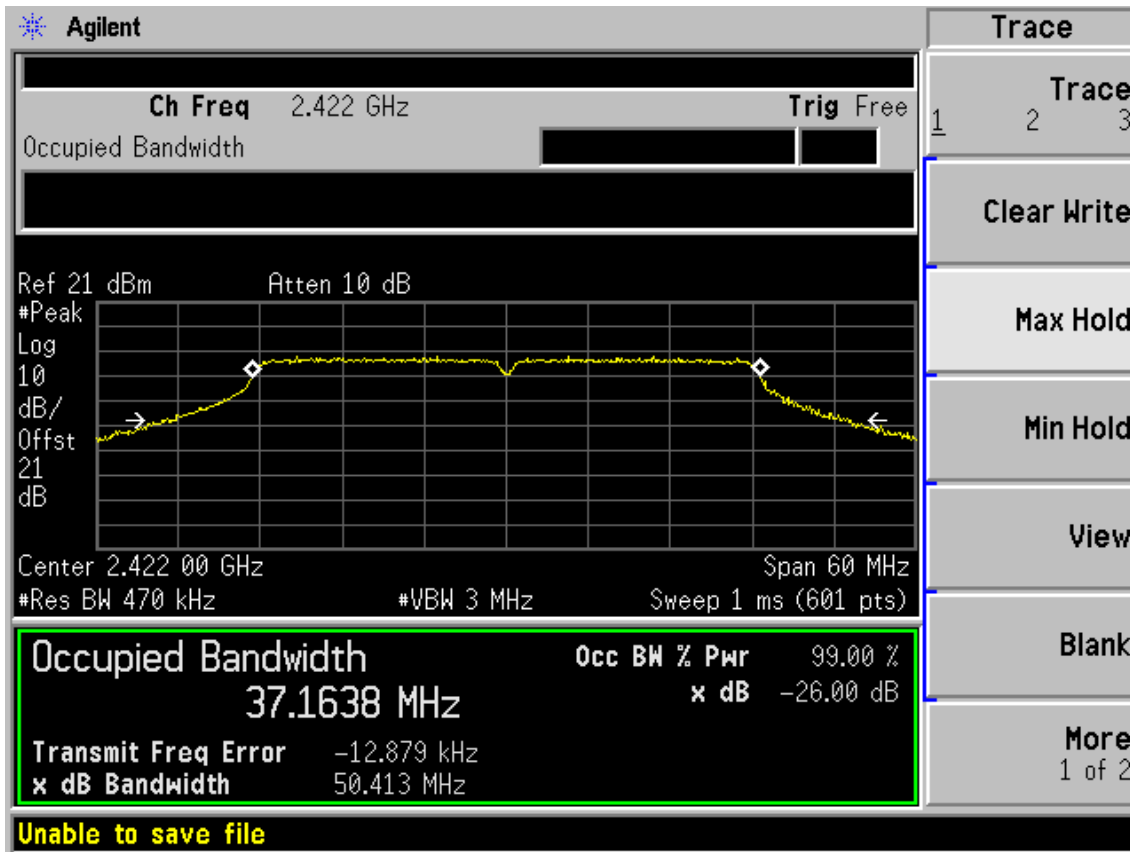

Chain 1

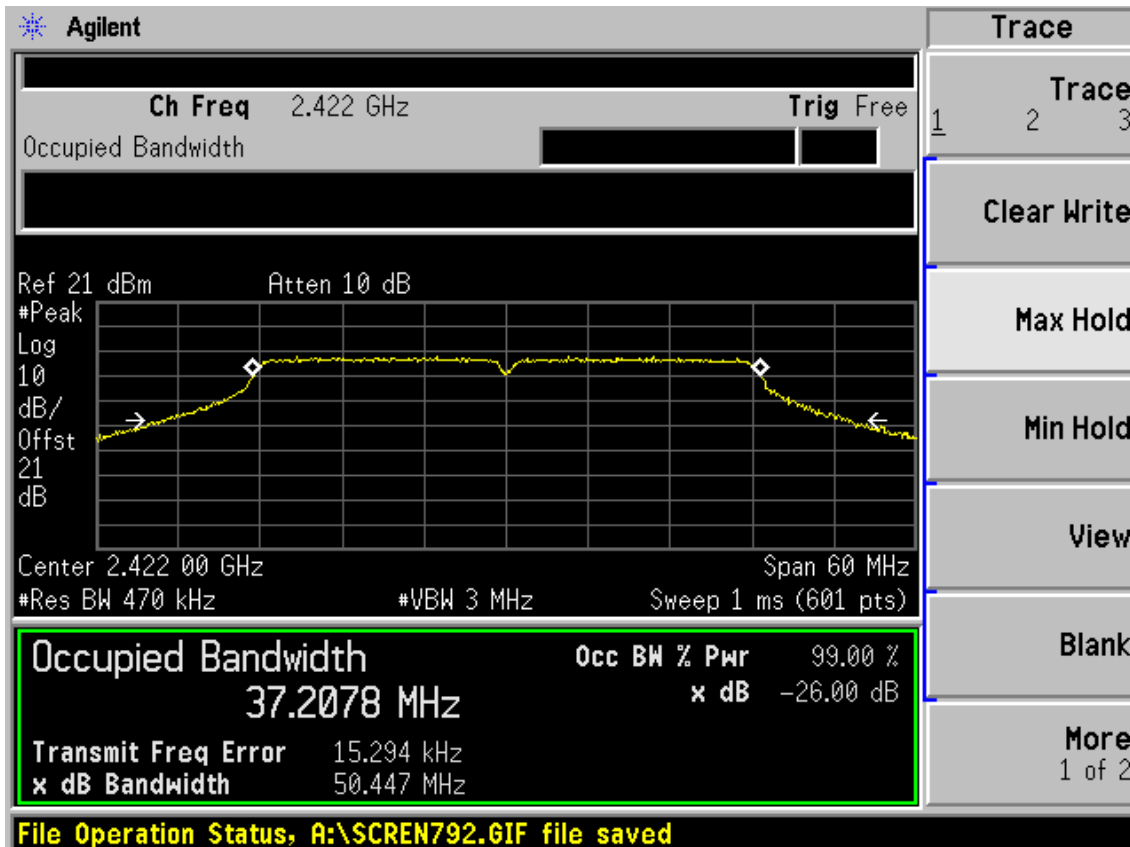

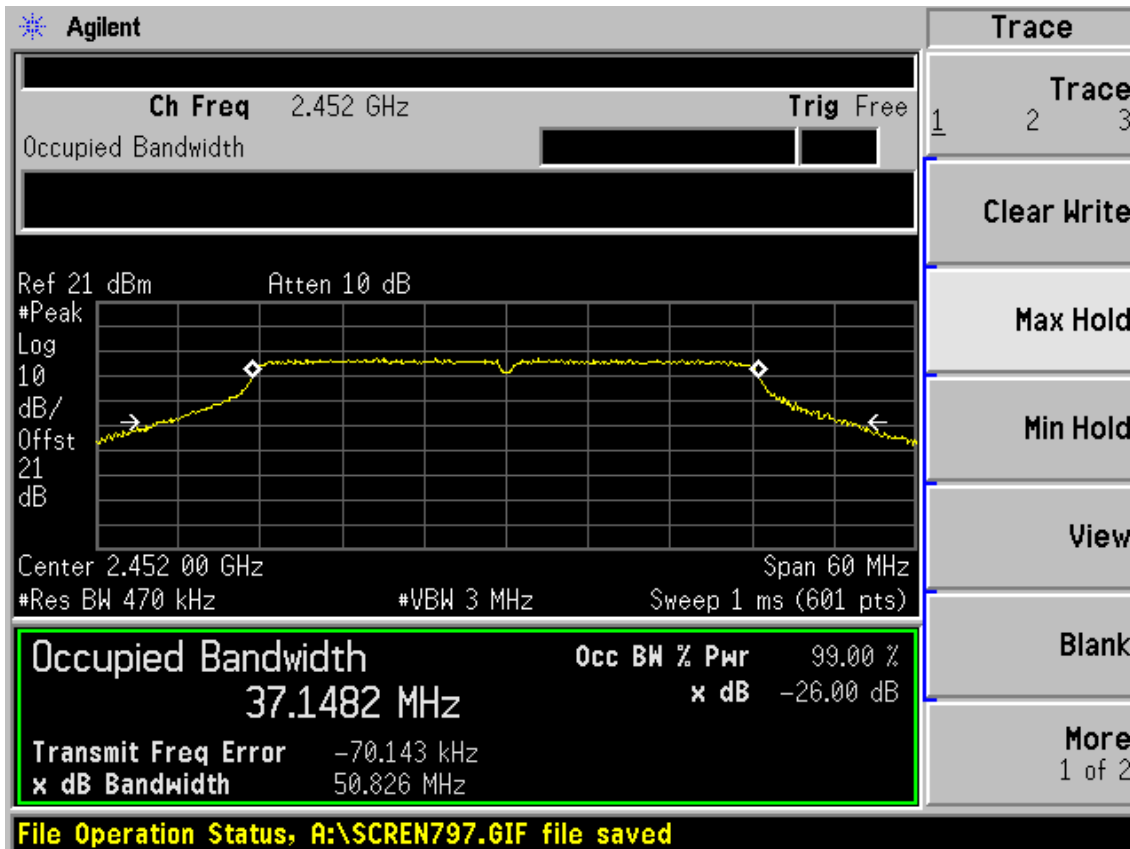
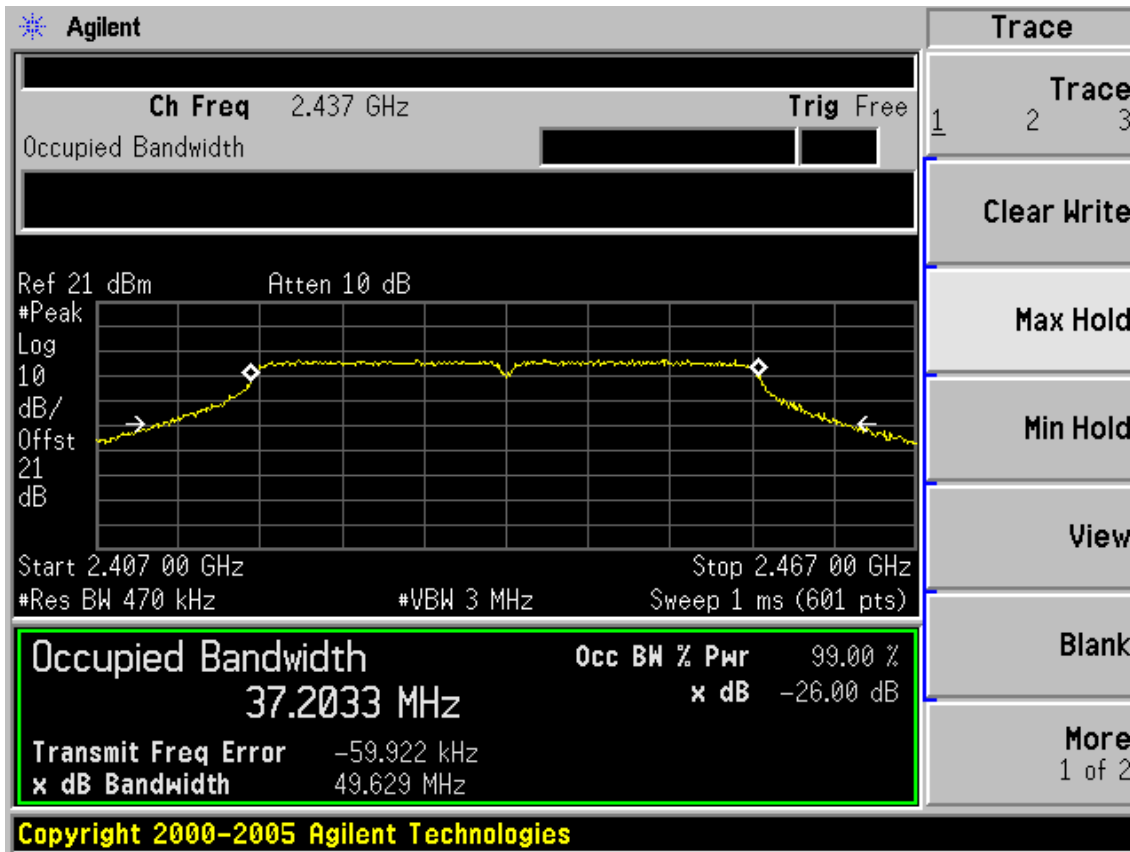

9. POWER SPECTRAL DENSITY TEST

9.1. Test Equipment

Item	Equipment	Manufacturer	Model No.	Serial No.	Last Cal.	Cal. Interval
1.	Spectrum Analyzer	Agilent	E4446A	US44300459	May.08, 11	1 Year
2.	Attenuator	Agilent	8491B	MY39262165	May.08, 11	1 Year
3.	RF Cable	Hubersuhner	SUCOFLEX102	28618/2	May.08, 11	1Year

9.2. Limit

For digitally modulated systems, the power spectral density conducted from the intentional radiator to the antenna shall not be greater than 8dBm in any 3kHz band during any time interval of continuous transmission.

9.3. Test Procedure

1. Connected the EUT's antenna port to spectrum analyzer device by 20dB attenuator.
- 2 , Set the test frequency as center frequency, Set RBW=3KHz, VBW=10KHz, Span large enough capture the entire frequency, Read out maximum peak level frequency
- 3, Set the frequency read from produce 2 as center frequency, then set the span= 300KHz, Sweep time=Span/RBW, Then Max hold, read out each mode and each chain's Power density.

Note: The cable loss and attenuator loss were offset into measure device as an amplitude

9.4. Test Results

EUT: 300Mbps Wireless N Range Extender		
M/N: TL-WA830RE		
Test date: 2011-11-18	Pressure: 100.9kpa	Humidity: 53.6 %
Tested by: Leo-Li	Test site: RF Site	Temperature : 25.7°C

Cable loss:0.6dB		Attenuator loss: 10dB		Antenna Gain: 4.0dBi	
Mode	CH	Result (Power density)			Limit (dBm/3KHz)
		Chain0 (dBm/3KHz)	Chain1 (dBm/3KHz)	Total (dBm/3KHz)	
11b	CH1	-9.71	-10.76	N/A	8
	CH6	-9.40	-9.67	N/A	8
	CH11	-10.00	-10.63	N/A	8
11g	CH1	-11.55	-11.90	N/A	8
	CH6	-11.53	-12.17	N/A	8
	CH11	-12.61	-13.11	N/A	8
11n HT20	CH1	-8.03	-10.34	-6.02	8
	CH6	-10.65	-12.19	-8.34	8
	CH11	-16.86	-17.36	-14.09	8
11n HT40	CH1	-20.01	-20.51	-17.24	8
	CH4	-13.17	-13.85	-10.49	8
	CH7	-20.75	-20.56	-17.64	8
Conclusion: PASS					

Chain 0:

Test Mode: IEEE 802.11b TX

Test CH1: 2412MHz

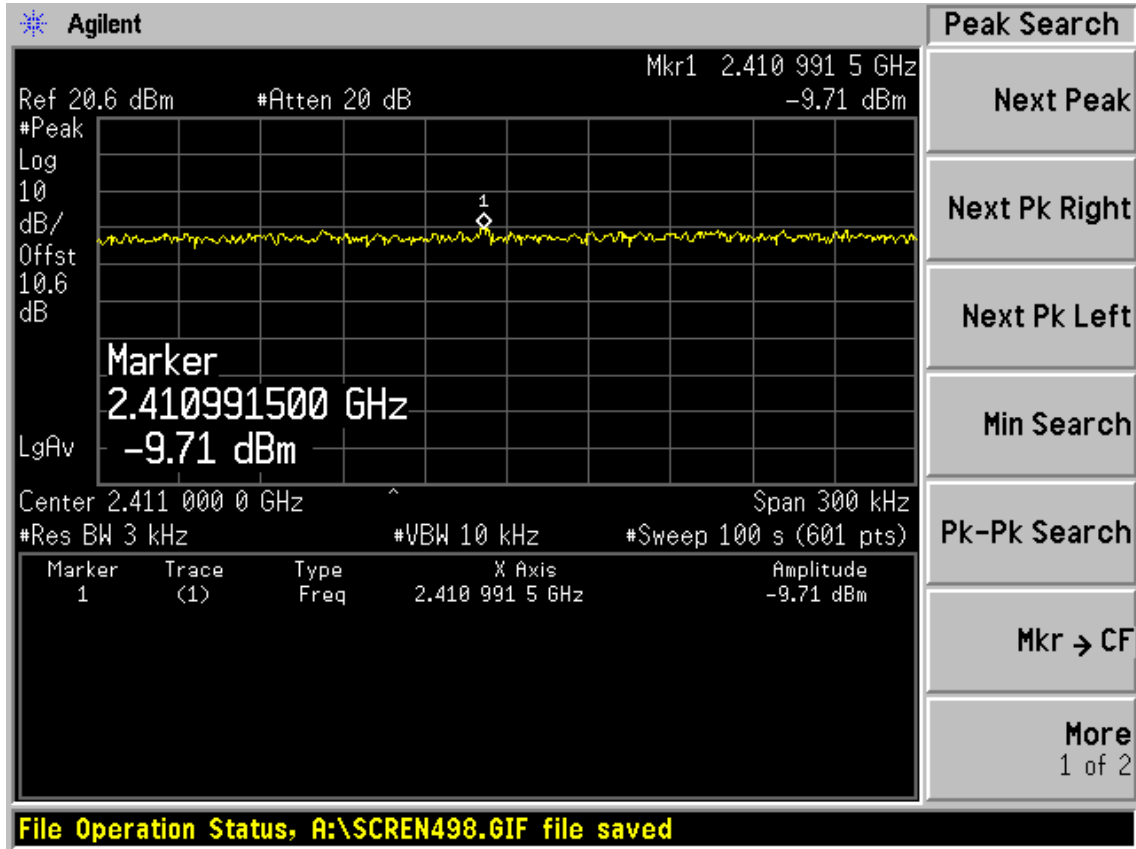

Test CH6: 2437MHz

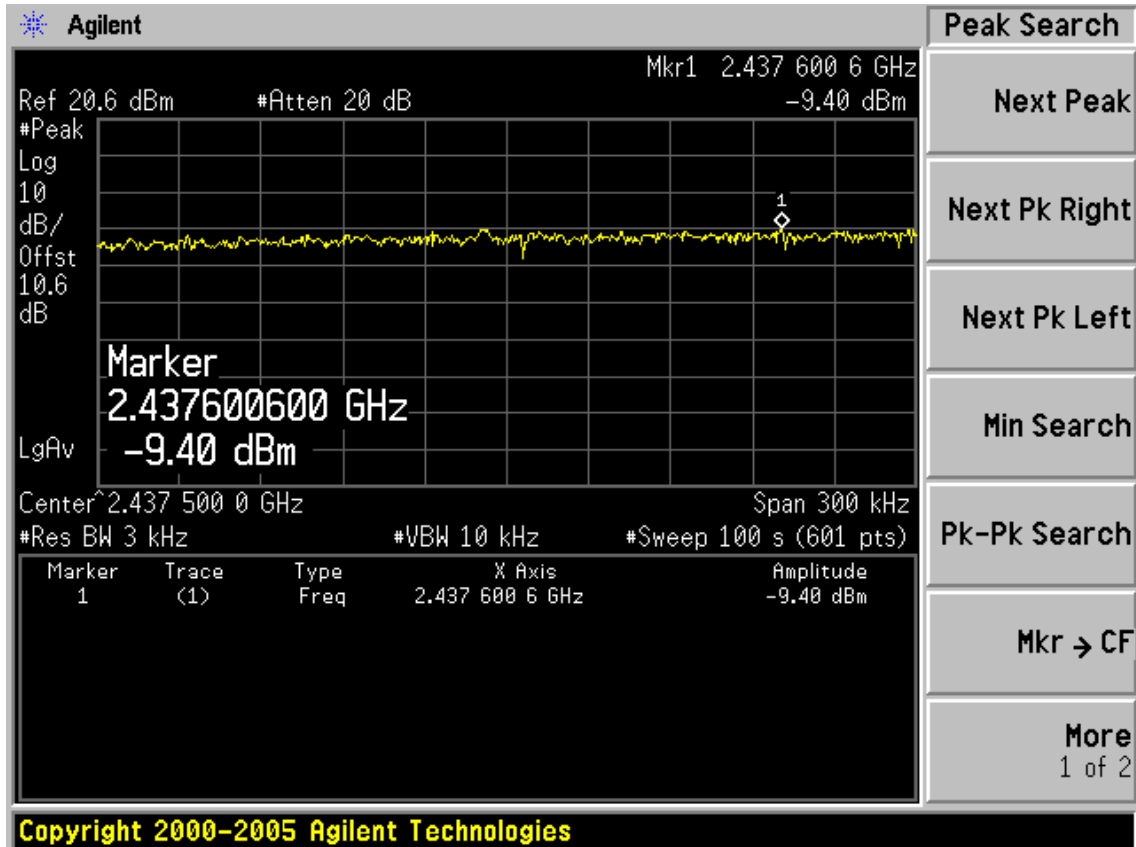

Test CH11: 2462MHz

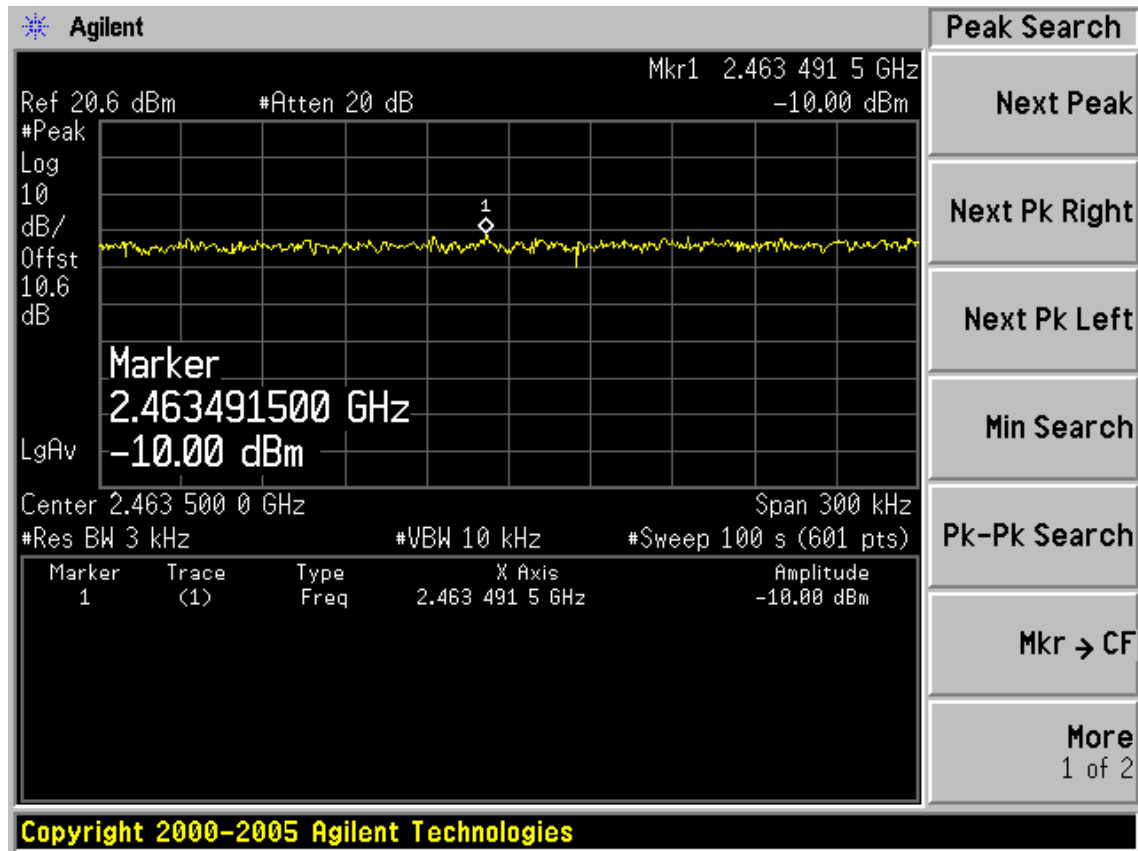

Test Mode: IEEE 802.11g TX

Test CH1: 2412MHz

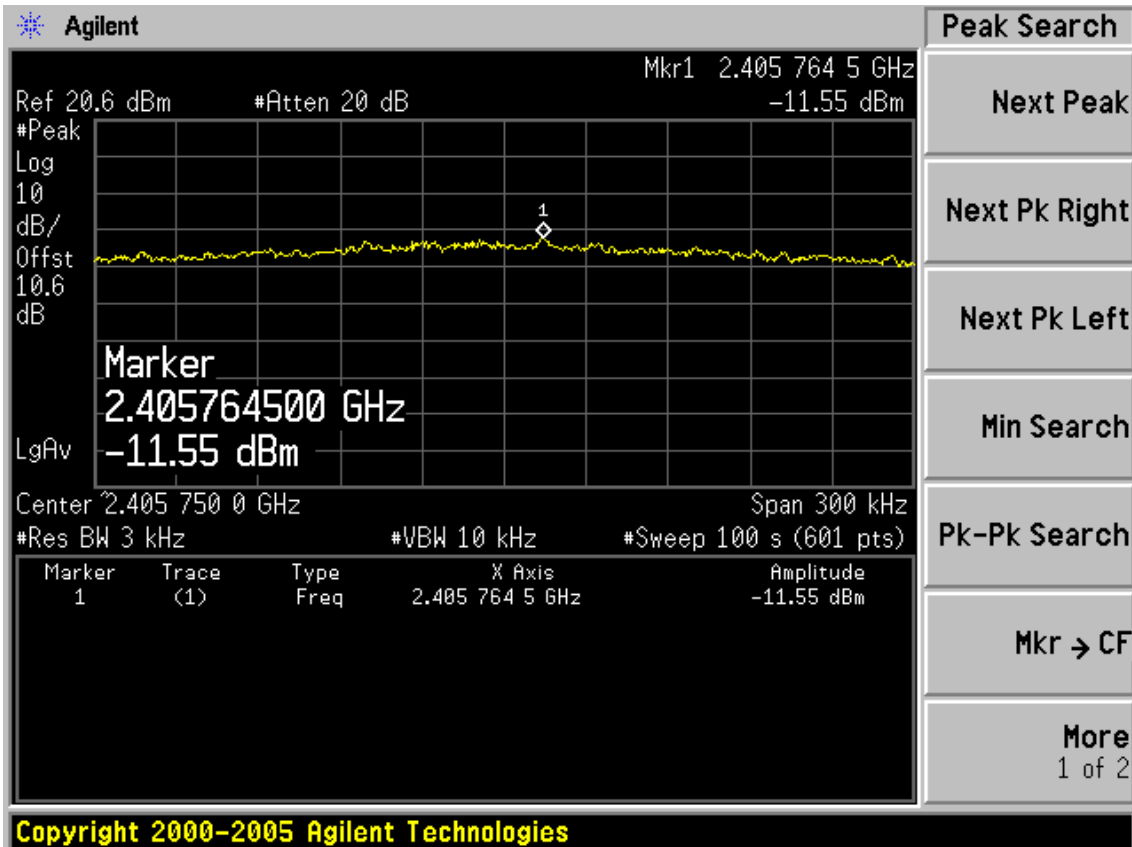

Test CH6: 2437MHz

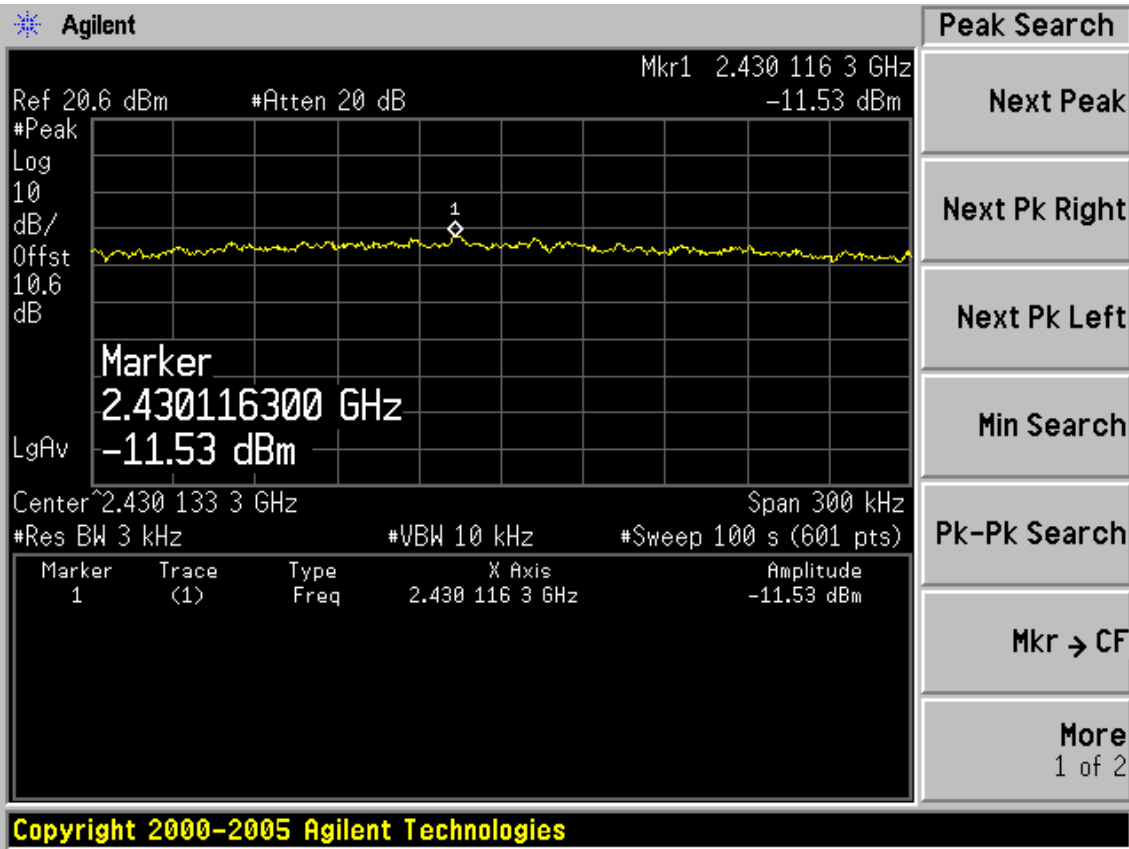

Test CH11: 2462MHz

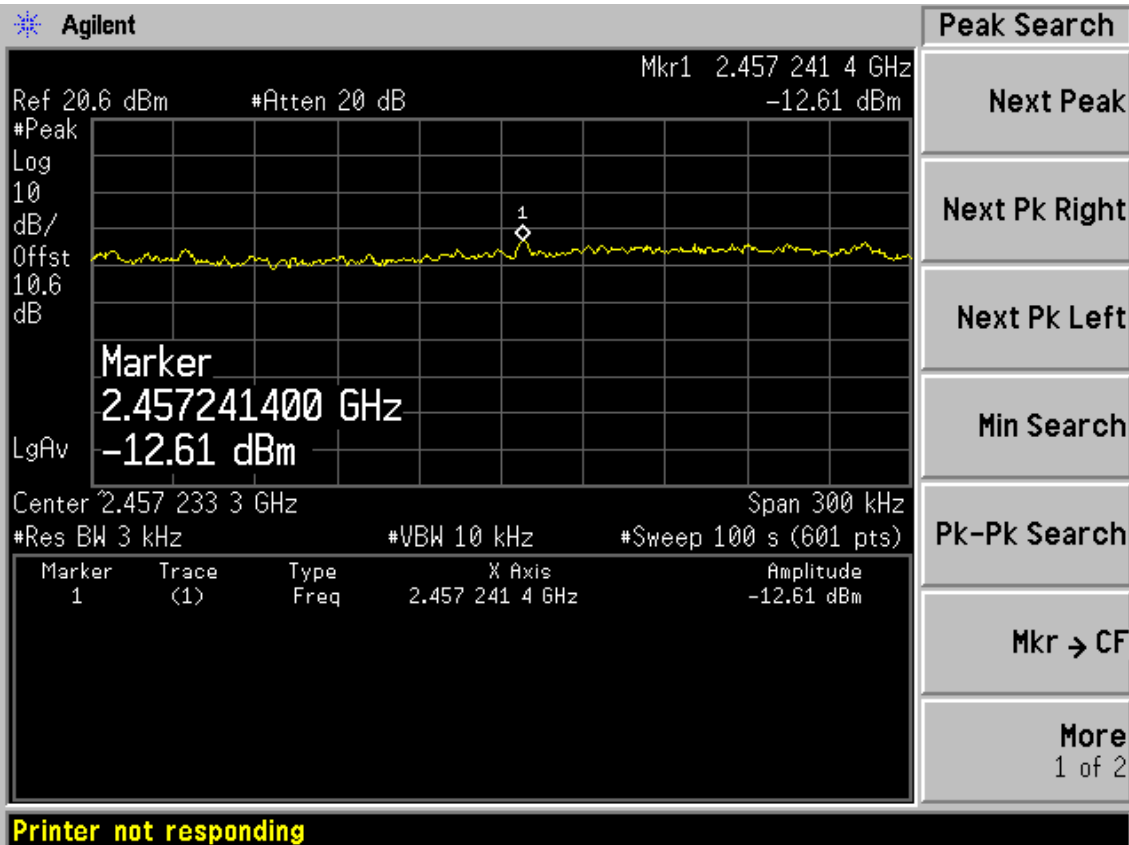

Test Mode: IEEE 802.11n HT20 TX

Test CH1: 2412MHz

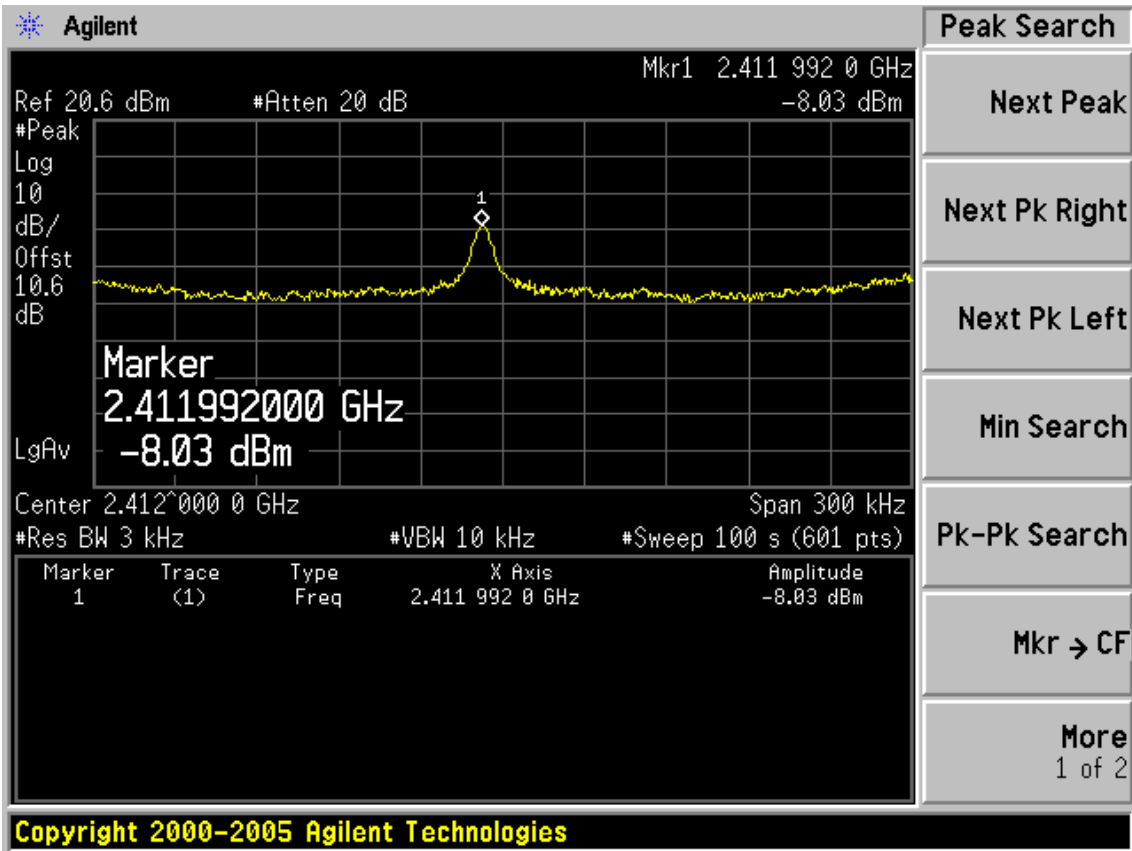

Test CH6: 2437MHz

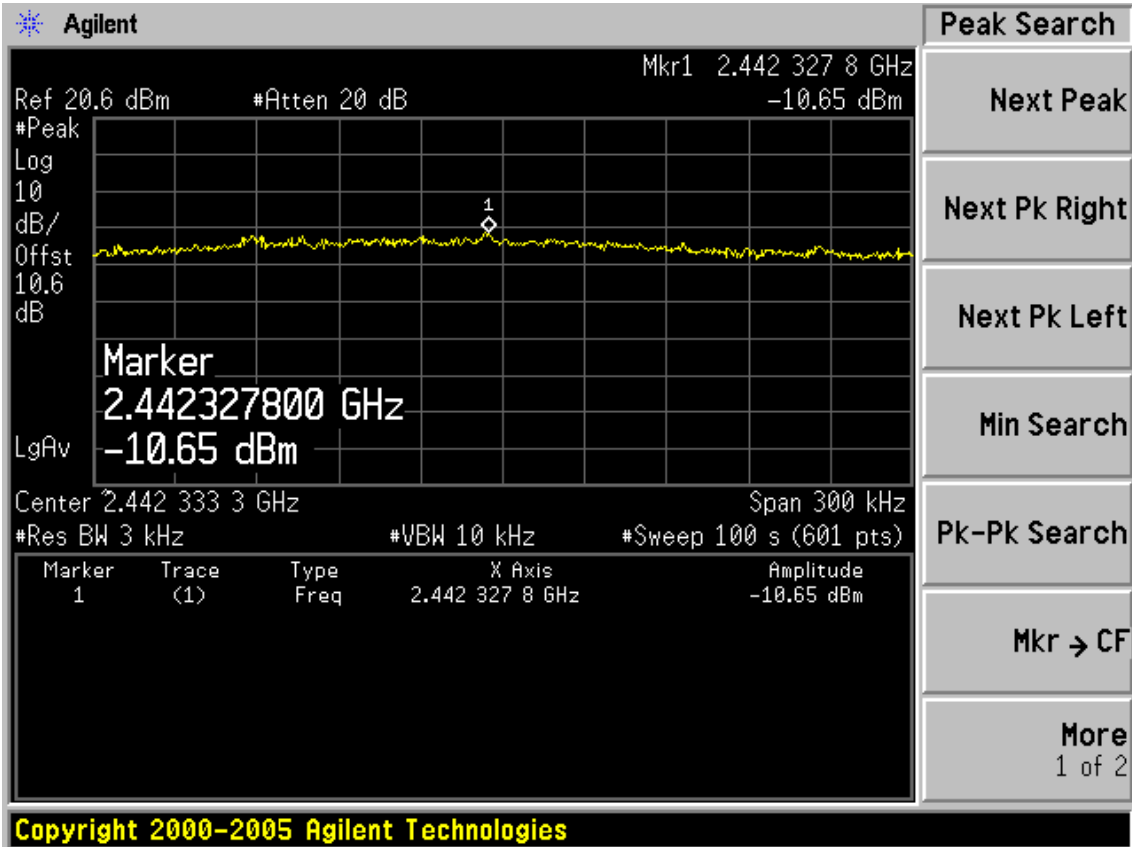

Test CH11: 2462MHz

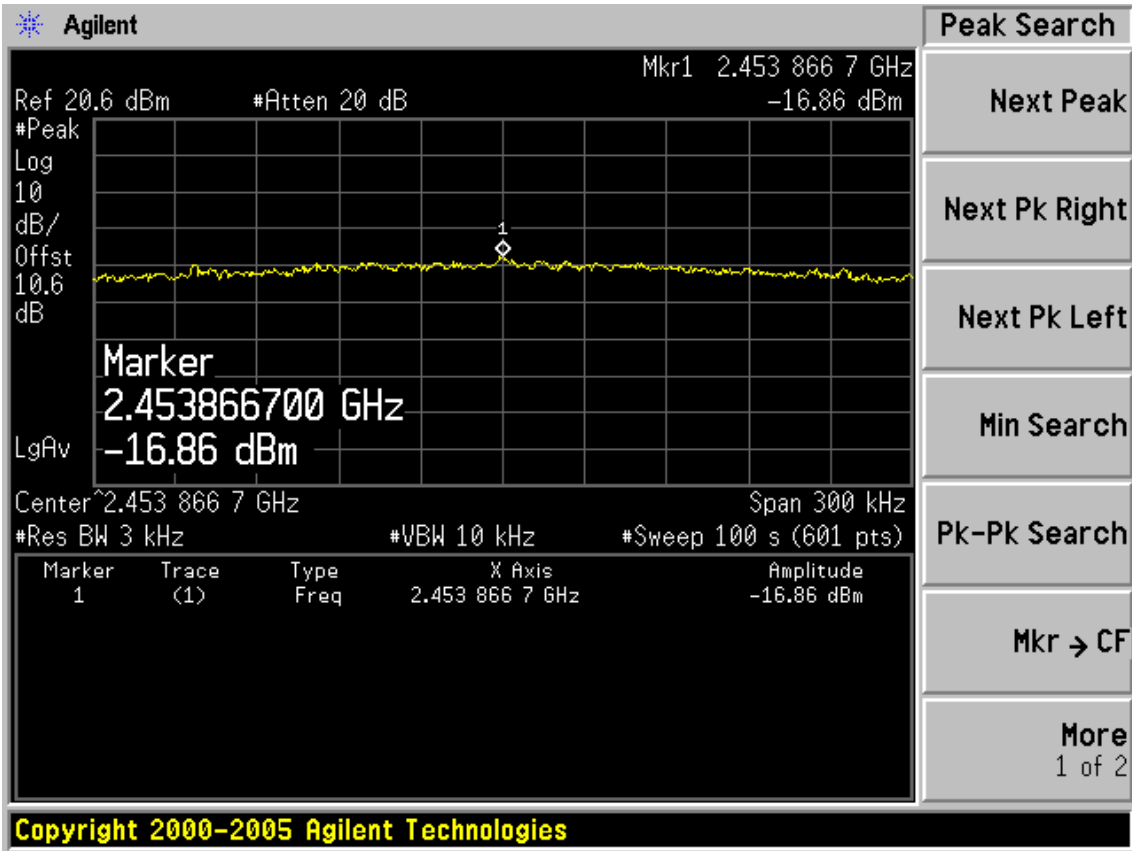

Test Mode: IEEE 802.11n HT40 TX

Test CH1: 2422MHz

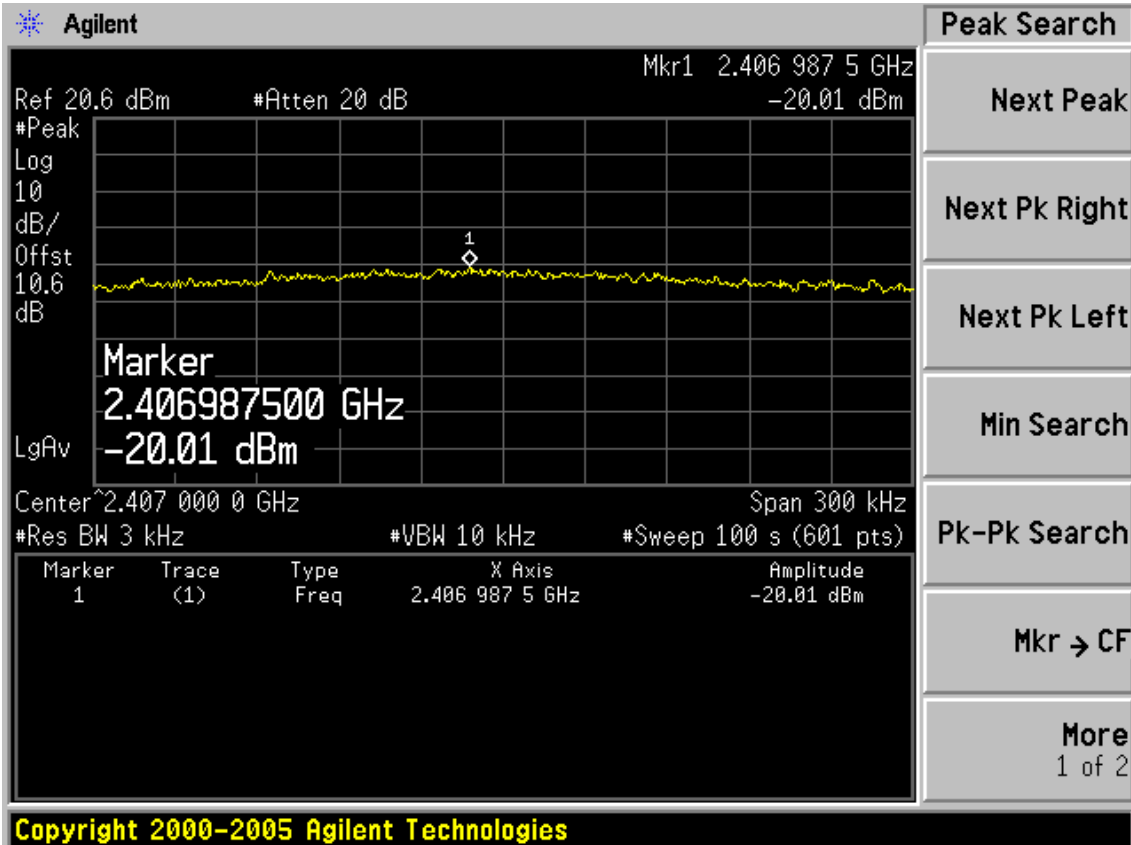

Test CH4: 2437MHz

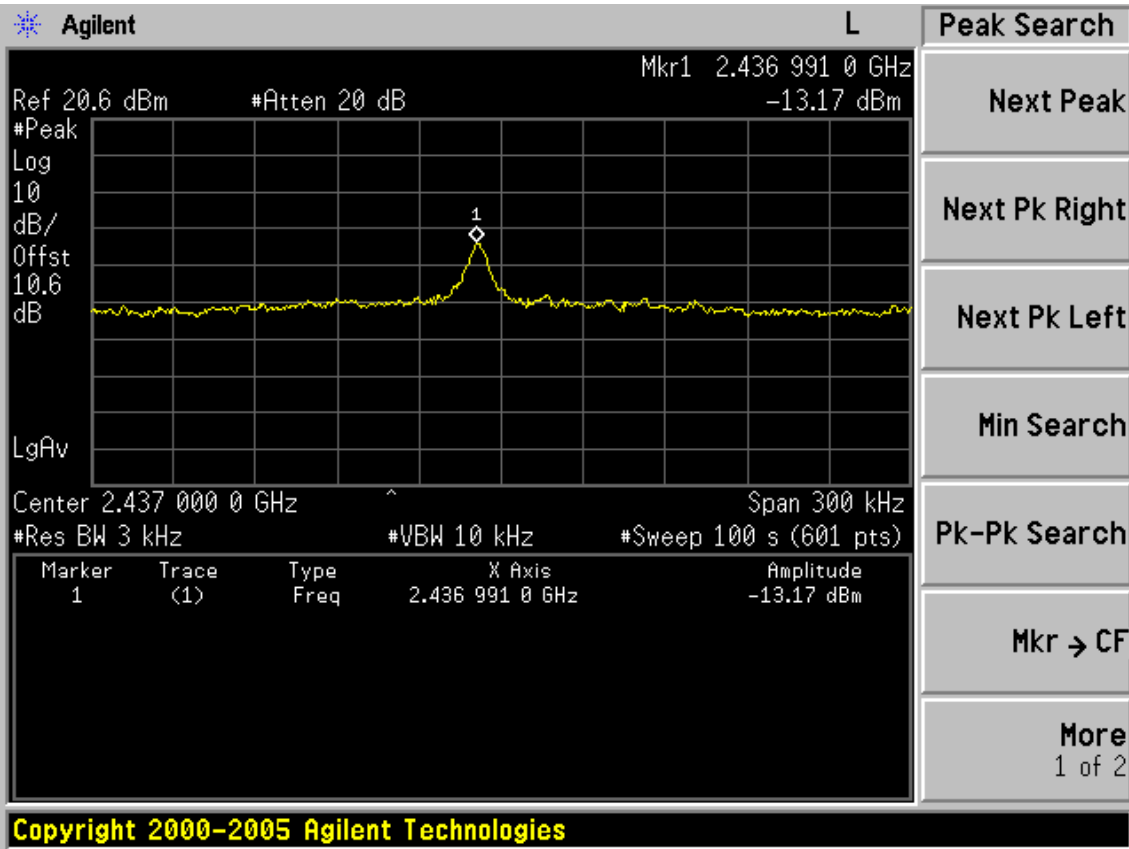

Test CH7: 2452MHz

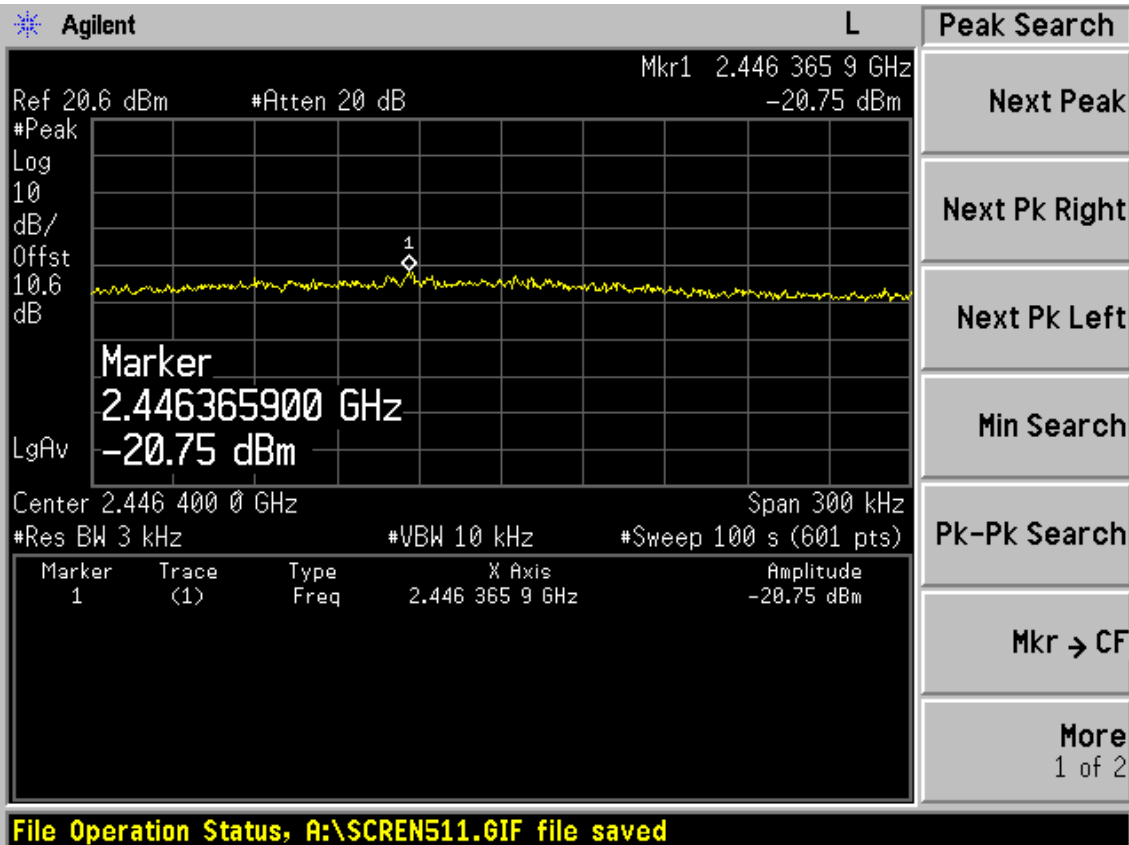

Chain 1:

Test Mode: IEEE 802.11b TX

Test CH1: 2412MHz

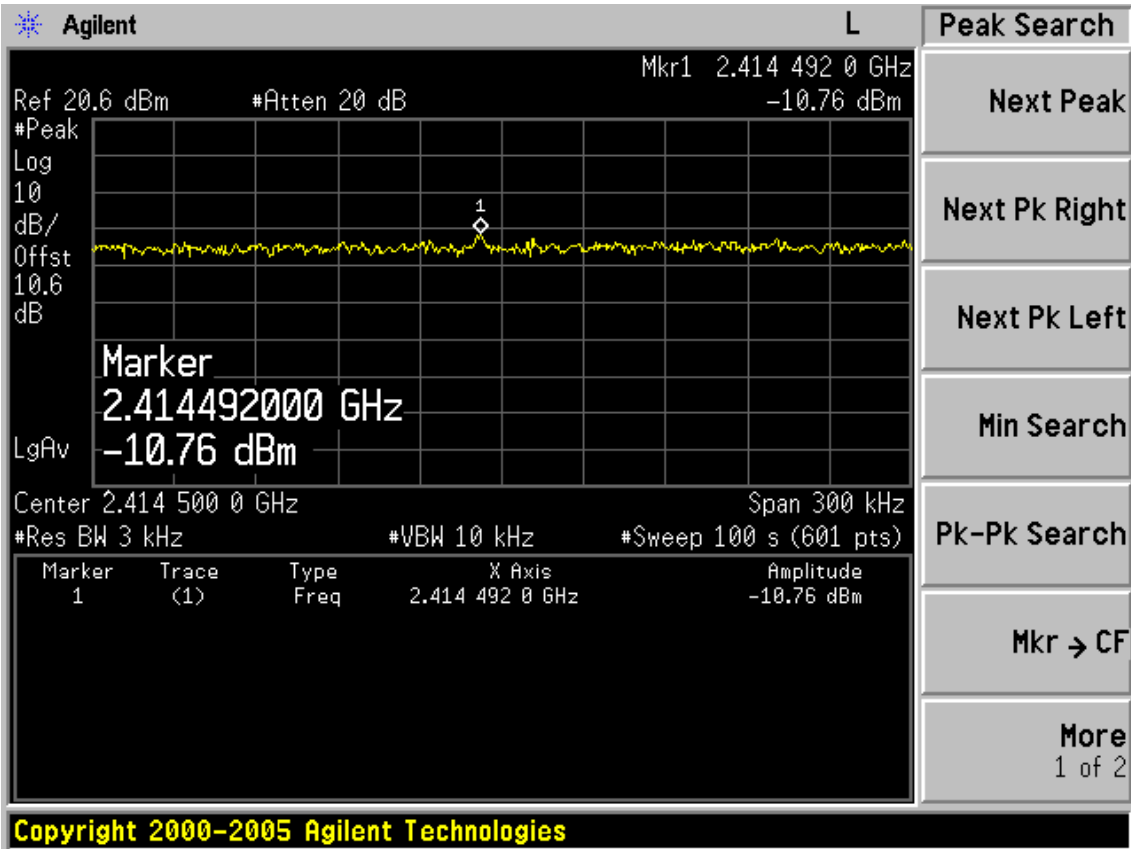

Test CH6: 2437MHz

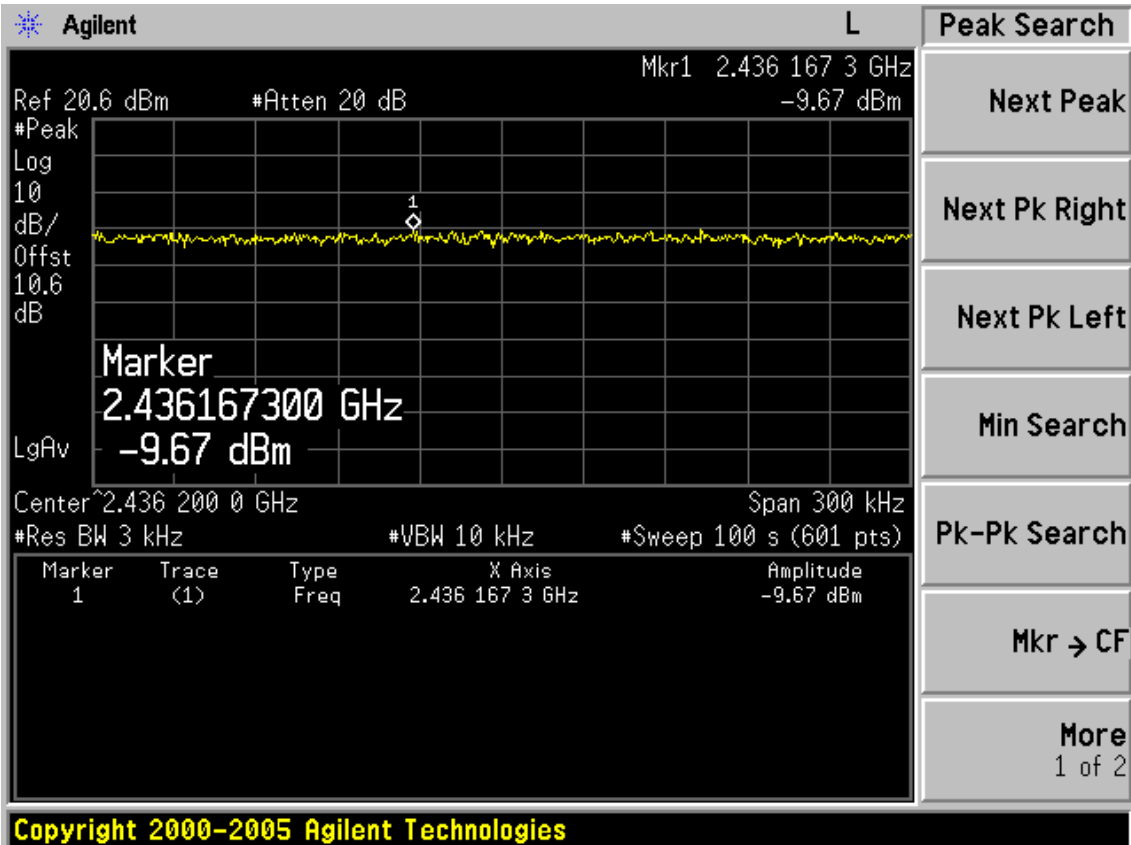

Test CH11: 2462MHz

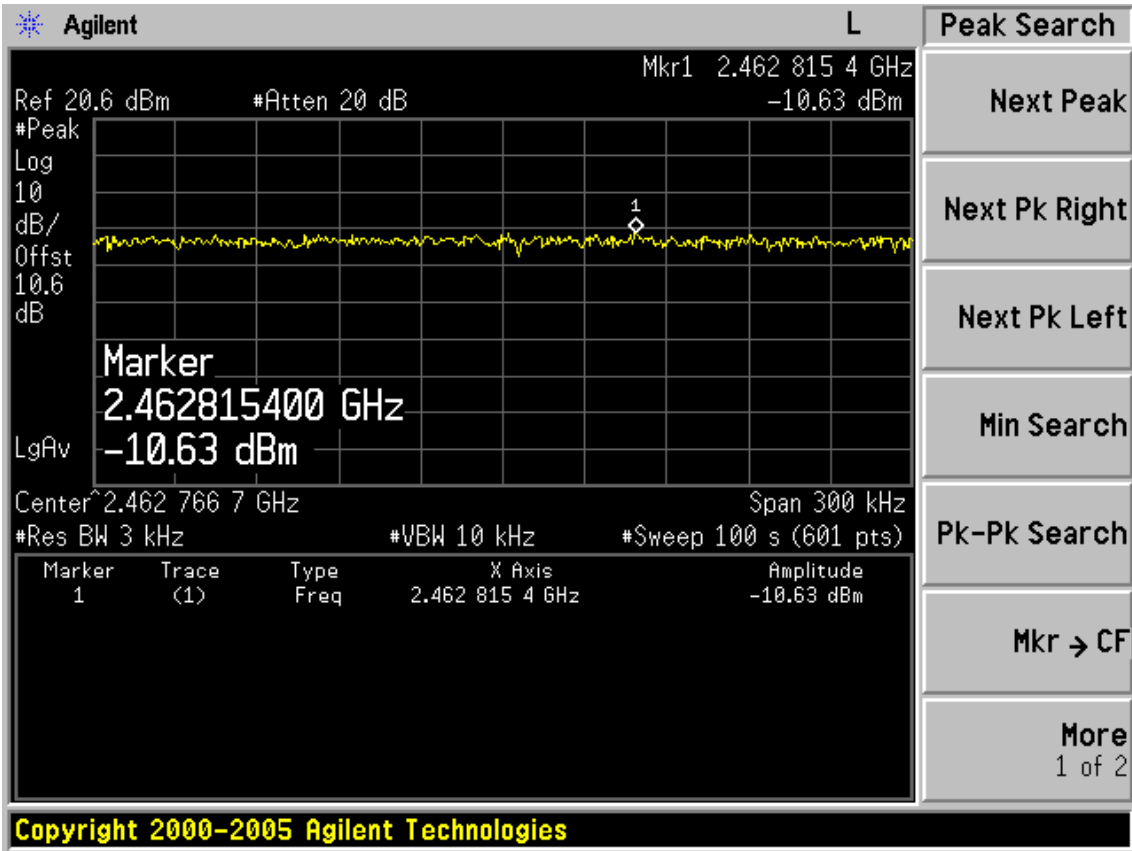

Test Mode: IEEE 802.11g TX

Test CH1: 2412MHz

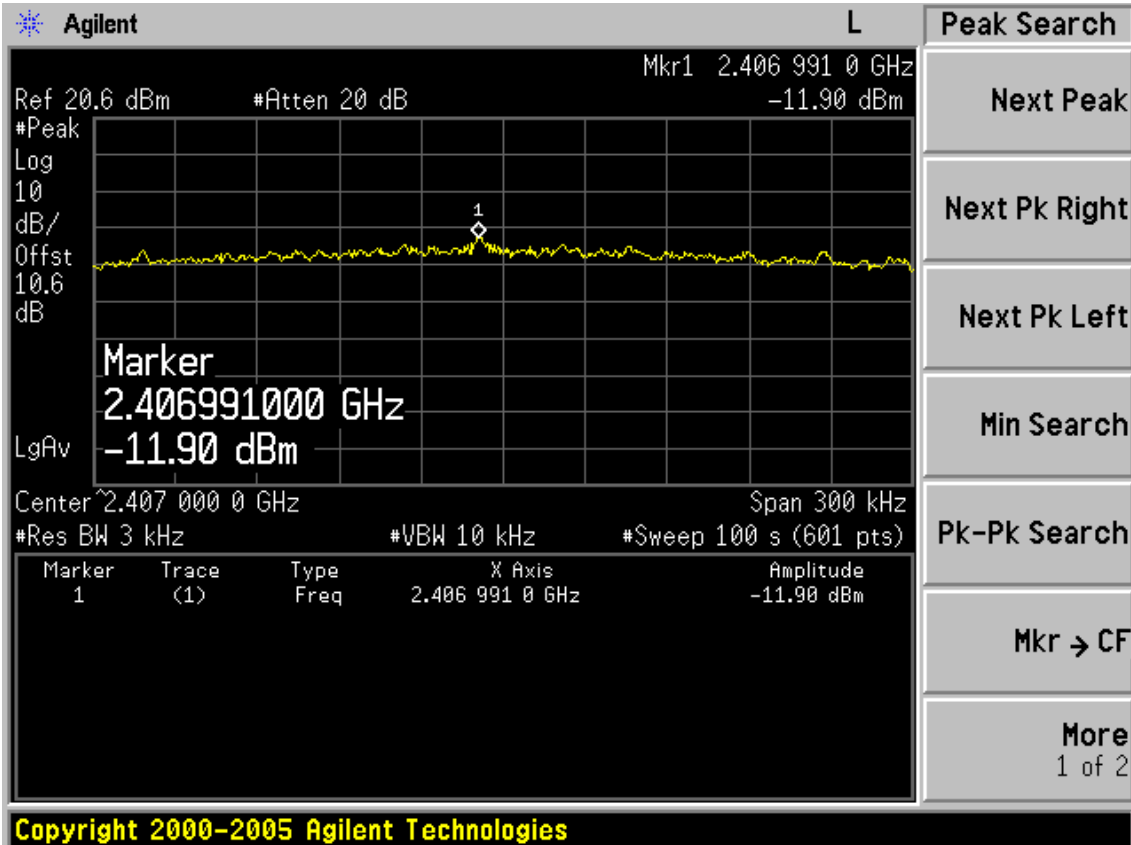

Test CH6: 2437MHz

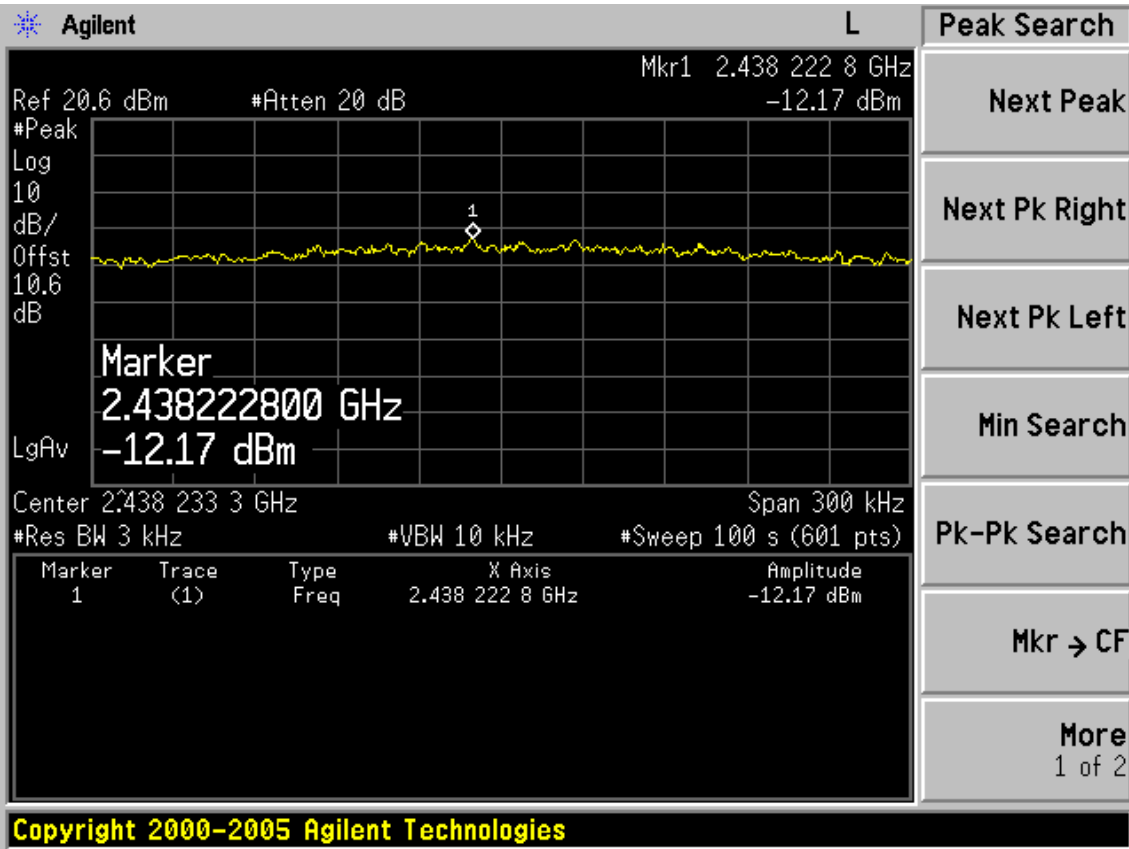

Test CH11: 2462MHz

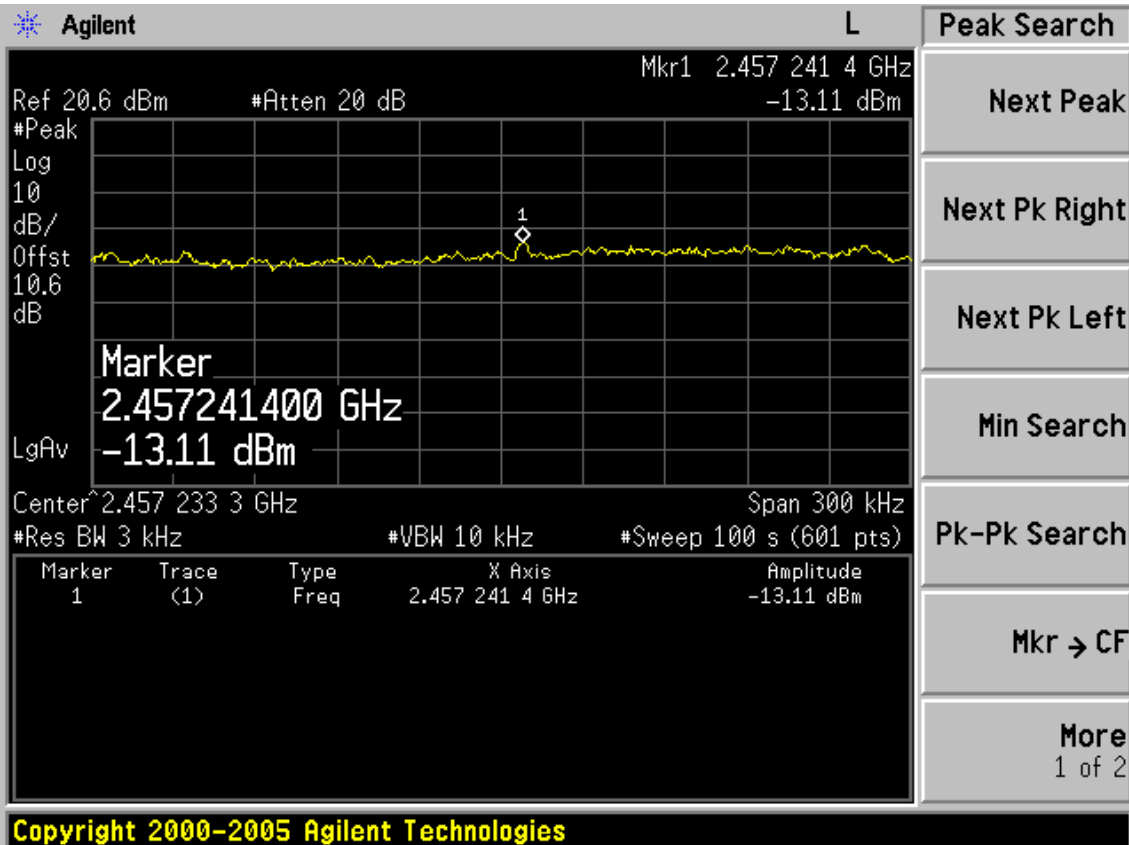

Test Mode: IEEE 802.11n HT20 TX

Test CH1: 2412MHz

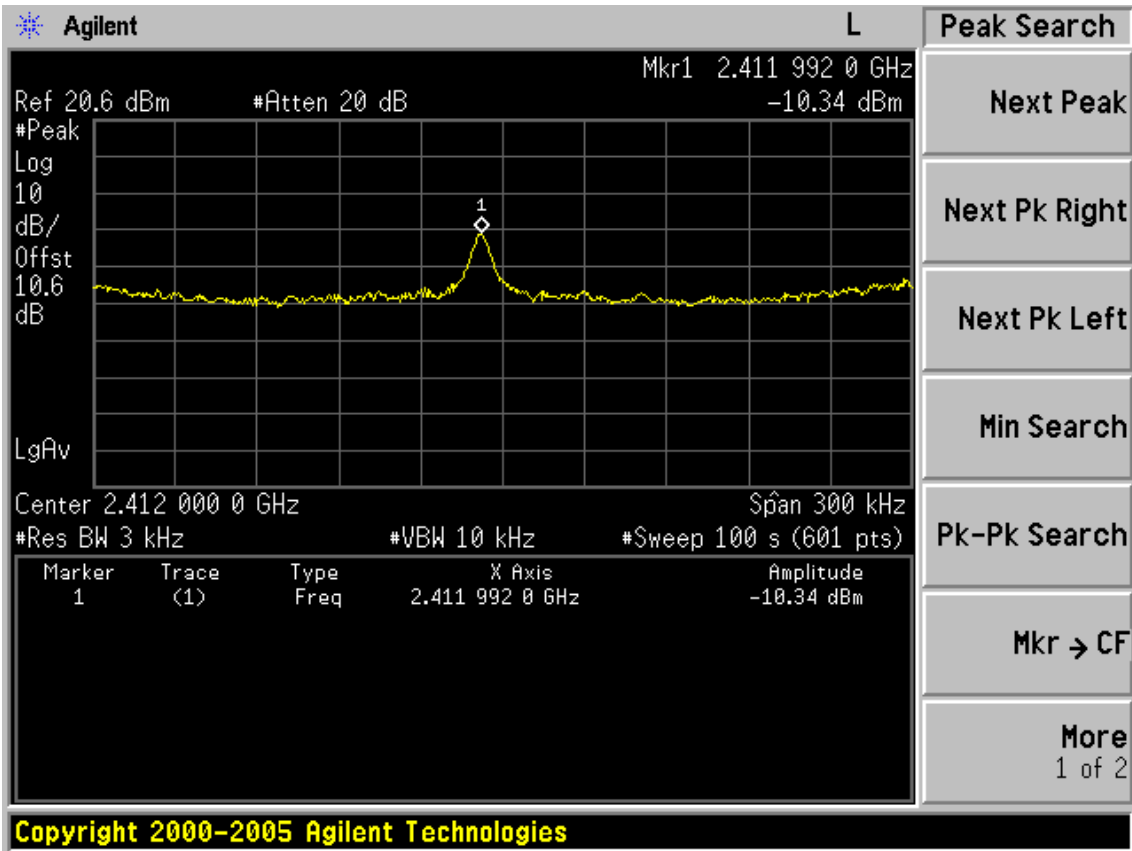

Test CH6: 2437MHz

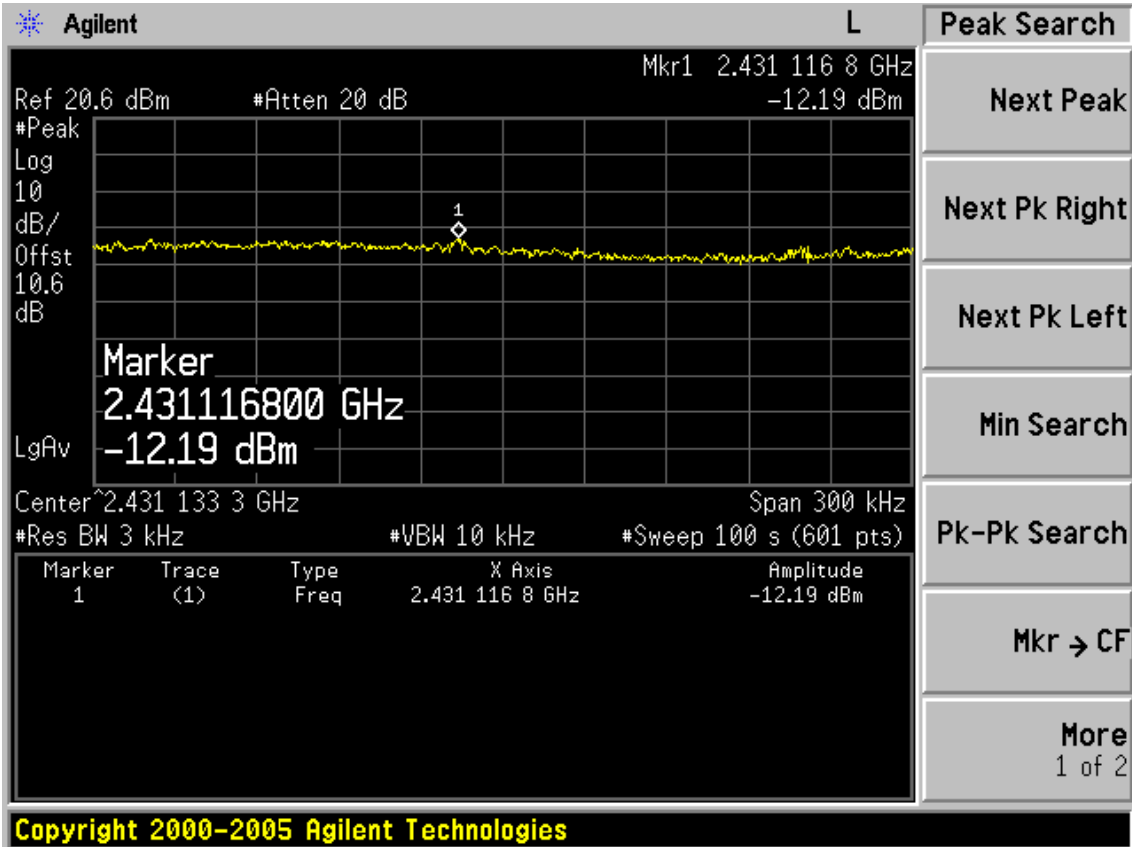

Test CH11: 2462MHz

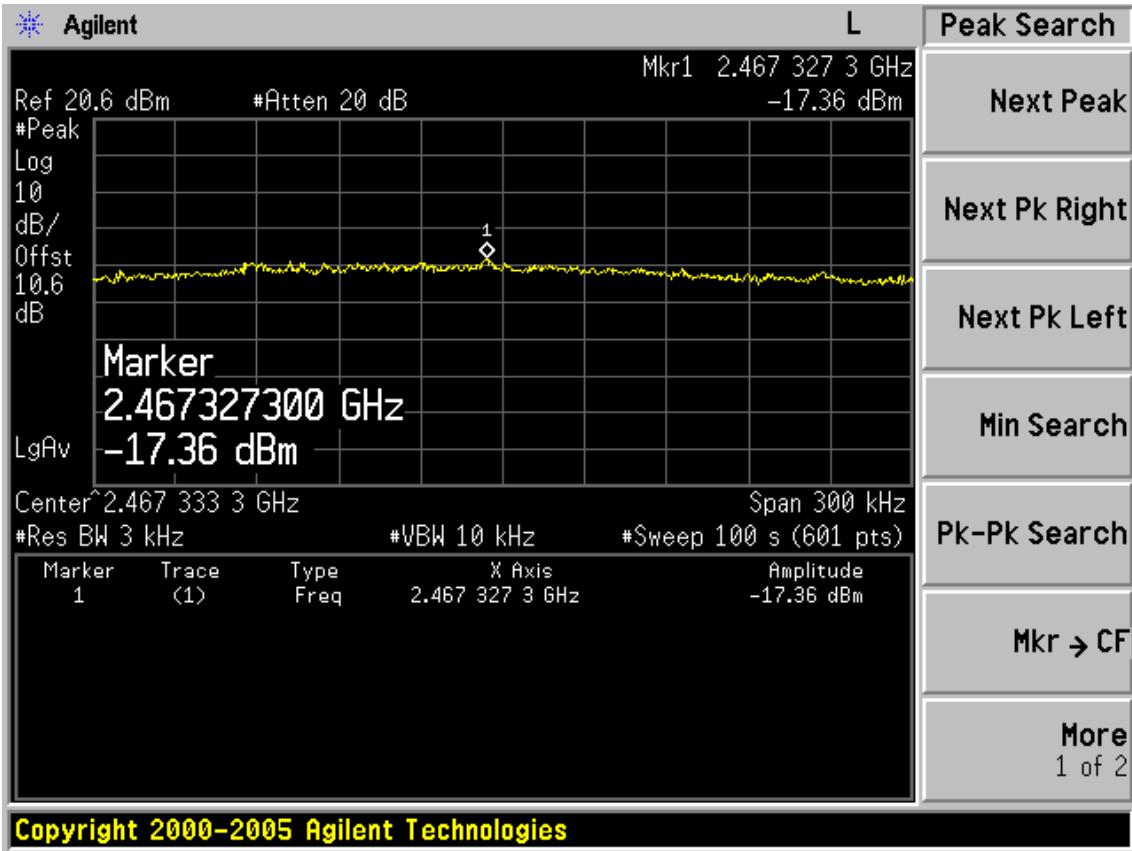

Test Mode: IEEE 802.11n HT40 TX

Test CH1: 2422MHz

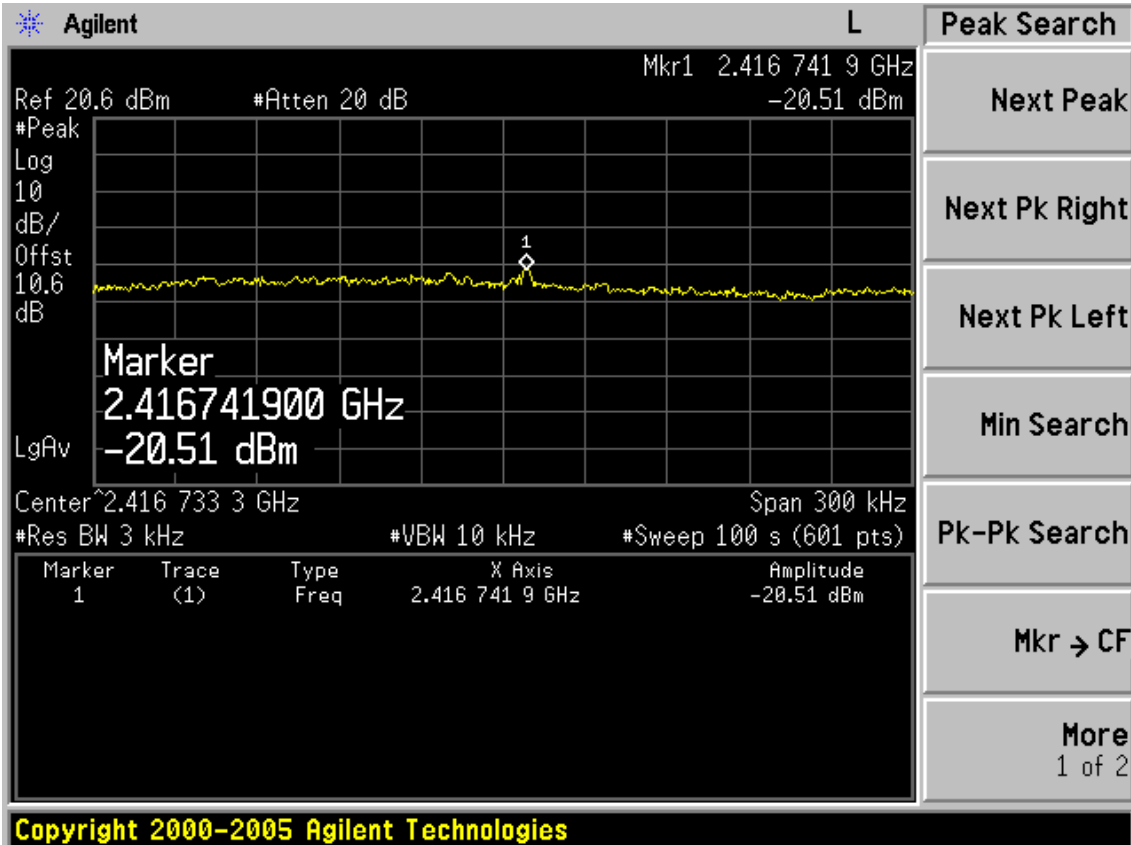

Test CH4: 2437MHz

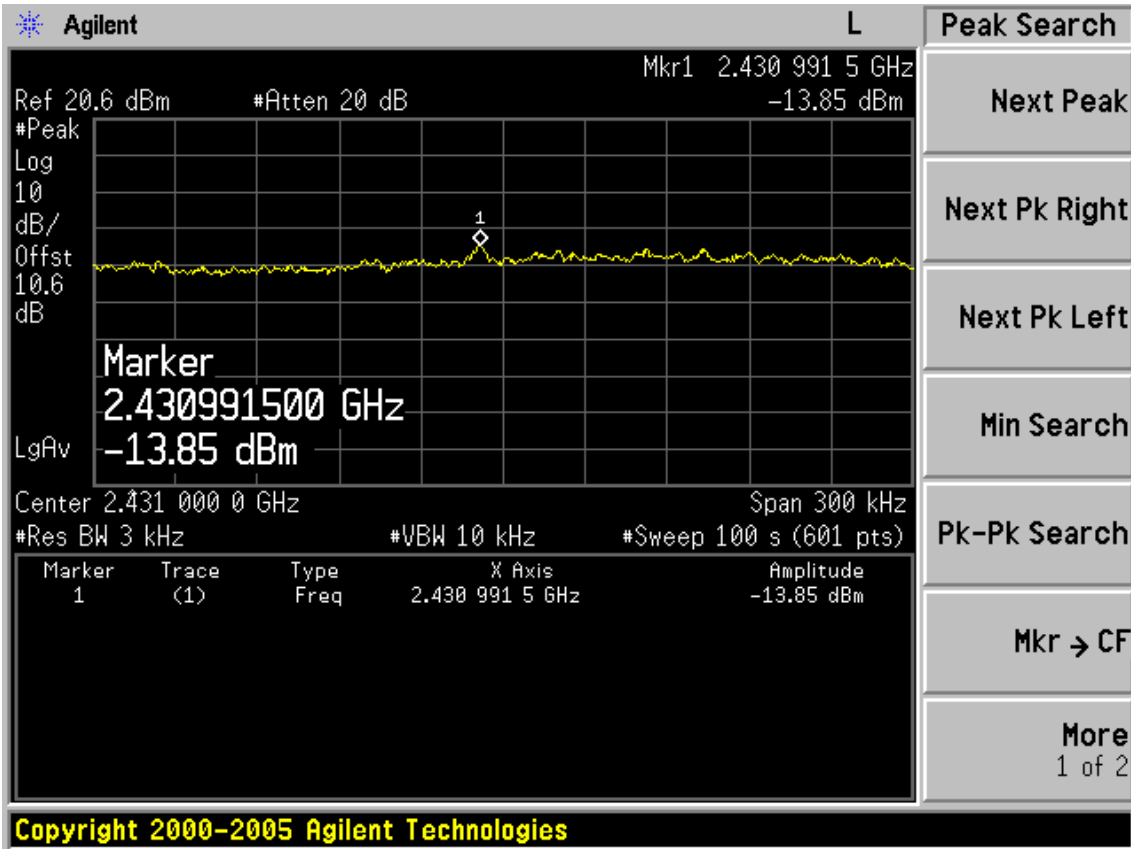

Copyright 2000-2005 Agilent Technologies

Test CH7: 2452MHz

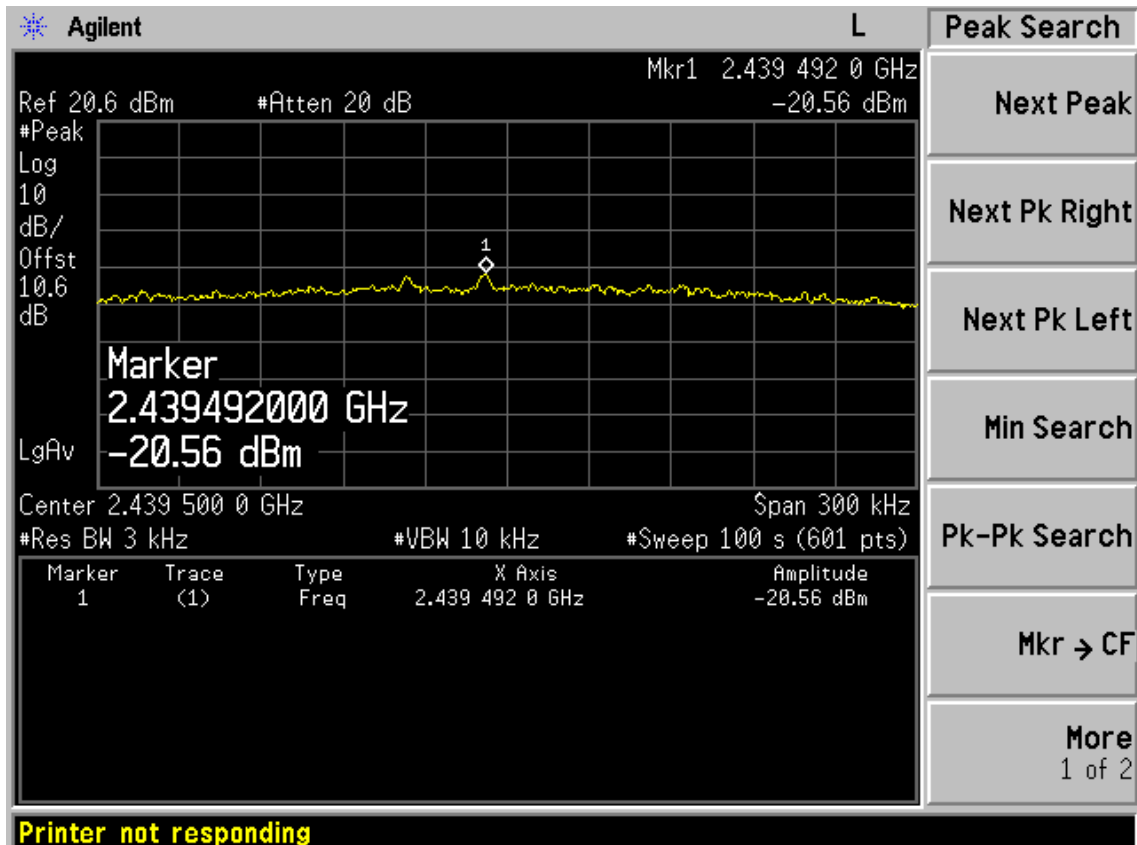

Printer not responding

10. ANTENNA REQUIREMENT

10.1. STANDARD APPLICABLE

For intentional device, according to FCC 47 CFR Section 15.203, an intentional radiator shall be designed to ensure that no antenna other than that furnished by the responsible party shall be used with the device. And according to FCC 47 CFR Section 15.247 (b), if transmitting antennas of directional gain greater than 6dBi are used, the power shall be reduced by the amount in dB that the directional gain of the antenna exceeds 6dBi.

10.2. ANTENNA CONNECTED CONSTRUCTION

The antennas used for this product are one Patch PCB antenna that no antenna other than that furnished by the responsible party shall be used with the device, the maximum peak gain of the transmit antenna is 4.0dBi.