

# FCC Radio Test Report

## FCC ID: TE7UB400

This report concerns: **Original Grant**

**Project No.** : 1812C107  
**Equipment** : Bluetooth 4.0 Nano USB Adapter  
**Test Model** : UB400  
**Series Model** : N/A  
**Applicant** : TP-Link Technologies Co., Ltd.  
**Address** : Building 24(floors 1,3,4,5) and 28(floors 1-4) Central  
Science and Technology Park, Shennan Rd,  
Nanshan, Shenzhen, China

**Date of Receipt** : Dec. 19, 2018  
**Date of Test** : Dec. 19, 2018~Apr. 23, 2019  
**Issued Date** : Apr. 28, 2019  
**Tested by** : BTL Inc.

**Testing Engineer** :   
(Rose Liu)

**Technical Manager** :   
(Steven Lu)

**Authorized Signatory** :   
(Ethan Ma)

# **B T L I N C .**

No.3, Jinshagang 1st Road, Shixia, Dalang Town, Dongguan,  
Guangdong, China.

TEL: +86-769-8318-3000 FAX: +86-769-8319-6000



Certificate #5123.02

**Declaration**

**BTL** represents to the client that testing is done in accordance with standard procedures as applicable and that test instruments used has been calibrated with standards traceable to international standard(s) and/or national standard(s).

**BTL's** reports apply only to the specific samples tested under conditions. It is manufacture's responsibility to ensure that additional production units of this model are manufactured with the identical electrical and mechanical components. **BTL** shall have no liability for any declarations, inferences or generalizations drawn by the client or others from **BTL** issued reports.

The report must not be used by the client to claim product certification, approval, or endorsement by NVLAP, NIST, A2LA, or any agency of the U.S. Government.

This report is the confidential property of the client. As a mutual protection to the clients, the public and ourselves, the test report shall not be reproduced, except in full, without our written approval.

**BTL's** laboratory quality assurance procedures are in compliance with the **ISO/IEC 17025** requirements, and accredited by the conformity assessment authorities listed in this test report.

**BTL** is not responsible for the sampling stage, so the results only apply to the sample as received.

The information, data and test plan are provided by manufacturer which may affect the validity of results, so it is manufacturer's responsibility to ensure that the apparatus meets the essential requirements of applied standards and in all the possible configurations as representative of its intended use.

**Limitation**

For the use of the authority's logo is limited unless the Test Standard(s)/Scope(s)/Item(s) mentioned in this test report is (are) included in the conformity assessment authorities acceptance respective.

Please note that the measurement uncertainty is provided for informational purpose only and are not use in determining the Pass/Fail results.

Table of Contents	Page
<b>REPORT ISSUED HISTORY</b>	<b>6</b>
<b>1 . GENERAL SUMMARY</b>	<b>7</b>
<b>2 . SUMMARY OF TEST RESULTS</b>	<b>8</b>
2.1 TEST FACILITY	9
2.2 MEASUREMENT UNCERTAINTY	9
<b>3 . GENERAL INFORMATION</b>	<b>10</b>
3.1 GENERAL DESCRIPTION OF EUT	10
3.2 DESCRIPTION OF TEST MODES	12
3.3 PARAMETERS OF TEST SOFTWARE	12
3.4 BLOCK DIAGRAM SHOWING THE CONFIGURATION OF SYSTEM TESTED	13
3.5 SUPPORT UNITS	13
<b>4 . AC POWER LINE CONDUCTED EMISSIONS TEST</b>	<b>14</b>
4.1 LIMIT	14
4.2 TEST PROCEDURE	14
4.3 DEVIATION FROM TEST STANDARD	14
4.4 TEST SETUP	15
4.5 EUT OPERATING CONDITIONS	15
4.6 EUT TEST CONDITIONS	15
4.7 TEST RESULTS	15
<b>5 . RADIATED EMISSION TEST</b>	<b>16</b>
5.1 LIMIT	16
5.2 TEST PROCEDURE	17
5.3 DEVIATION FROM TEST STANDARD	17
5.4 TEST SETUP	18
5.5 EUT OPERATING CONDITIONS	20
5.6 EUT TEST CONDITIONS	20
5.7 TEST RESULTS - 9 KHZ TO 30 MHZ	20
5.8 TEST RESULTS - 30 MHZ TO 1000 MHZ	20
5.9 TEST RESULTS - ABOVE 1000 MHZ	20
<b>6 . NUMBER OF HOPPING FREQUENCY</b>	<b>21</b>
6.1 LIMIT	21
6.2 TEST PROCEDURE	21
6.3 DEVIATION FROM STANDARD	21

<b>Table of Contents</b>	<b>Page</b>
6.4 TEST SETUP	21
6.5 EUT OPERATION CONDITIONS	21
6.6 EUT TEST CONDITIONS	21
6.7 TEST RESULTS	21
<b>7 . AVERAGE TIME OF OCCUPANCY</b>	<b>22</b>
7.1 LIMIT	22
7.2 TEST PROCEDURE	22
7.3 DEVIATION FROM STANDARD	22
7.4 TEST SETUP	22
7.5 EUT OPERATION CONDITIONS	22
7.6 EUT TEST CONDITIONS	22
7.7 TEST RESULTS	22
<b>8 . HOPPING CHANNEL SEPARATION MEASUREMENT</b>	<b>23</b>
8.1 LIMIT	23
8.2 TEST PROCEDURE	23
8.3 DEVIATION FROM STANDARD	23
8.4 TEST SETUP	23
8.5 EUT OPERATION CONDITIONS	23
8.6 EUT TEST CONDITIONS	23
8.7 TEST RESULTS	23
<b>9 . BANDWIDTH TEST</b>	<b>24</b>
9.1 LIMIT	24
9.2 TEST PROCEDURE	24
9.3 DEVIATION FROM STANDARD	24
9.4 TEST SETUP	24
9.5 EUT OPERATION CONDITIONS	24
9.6 EUT TEST CONDITIONS	24
9.7 TEST RESULTS	24
<b>10 . MAXIMUM OUTPUT POWER</b>	<b>25</b>
10.1 LIMIT	25
10.2 TEST PROCEDURE	25
10.3 DEVIATION FROM STANDARD	25
10.4 TEST SETUP	25
10.5 EUT OPERATION CONDITIONS	25

<b>Table of Contents</b>	<b>Page</b>
<b>10.6 EUT TEST CONDITIONS</b>	<b>25</b>
<b>10.7 TEST RESULTS</b>	<b>25</b>
<b>11 . CONDUCTED SPURIOUS EMISSION</b>	<b>26</b>
<b>11.1 LIMIT</b>	<b>26</b>
<b>11.2 TEST PROCEDURE</b>	<b>26</b>
<b>11.3 DEVIATION FROM STANDARD</b>	<b>26</b>
<b>11.4 TEST SETUP</b>	<b>26</b>
<b>11.5 EUT OPERATION CONDITIONS</b>	<b>26</b>
<b>11.6 EUT TEST CONDITIONS</b>	<b>26</b>
<b>11.7 TEST RESULTS</b>	<b>26</b>
<b>12 . MEASUREMENT INSTRUMENTS LIST</b>	<b>27</b>
<b>13 . EUT TEST PHOTO</b>	<b>29</b>
<b>APPENDIX A - AC POWER LINE CONDUCTED EMISSIONS</b>	<b>34</b>
<b>APPENDIX B - RADIATED EMISSION - 9 KHZ-30 MHZ</b>	<b>37</b>
<b>APPENDIX C - RADIATED EMISSION - 30 MHZ TO 1000 MHZ</b>	<b>42</b>
<b>APPENDIX D - RADIATED EMISSION - ABOVE 1000 MHZ</b>	<b>45</b>
<b>APPENDIX E - NUMBER OF HOPPING FREQUENCY</b>	<b>70</b>
<b>APPENDIX F - AVERAGE TIME OF OCCUPANCY</b>	<b>72</b>
<b>APPENDIX G - HOPPING CHANNEL SEPARATION MEASUREMENT</b>	<b>77</b>
<b>APPENDIX H - BANDWIDTH</b>	<b>80</b>
<b>APPENDIX I - MAXIMUM OUTPUT POWER</b>	<b>83</b>
<b>APPENDIX J - CONDUCTED SPURIOUS EMISSION</b>	<b>86</b>

### REPORT ISSUED HISTORY

Report Version	Description	Issued Date
R00	Original Issue.	Apr. 28, 2019

## 1. GENERAL SUMMARY

Equipment : Bluetooth 4.0 Nano USB Adapter  
Brand Name : tp-link  
Test Model : UB400  
Series Model : N/A  
Applicant : TP-Link Technologies Co., Ltd.  
Manufacturer : TP-Link Technologies Co., Ltd.  
Address : Building 24(floors1,3,4,5) and 28(floors1-4) Central Science and Technology Park, Shennan Rd, Nanshan, Shenzhen, China  
Factory : TP-Link Technologies Co., Ltd.  
Address : Building 24(floors1,3,4,5) and 28(floors1-4) Central Science and Technology Park, Shennan Rd, Nanshan, Shenzhen, China  
Date of Test : Dec. 19, 2018~Apr. 23, 2019  
Test Sample : Engineering Sample No.:D181211642 for conducted; D181211643 for radiated.  
Standard(s) : FCC Part15, Subpart C (15.247)  
ANSI C63.10-2013

The above equipment has been tested and found compliance with the requirement of the relative standards by BTL Inc.

The test data, data evaluation, and equipment configuration contained in our test report (Ref No. BTL-FCCP-1-1812C107) were obtained utilizing the test procedures, test instruments, test sites that has been accredited by the Authority of A2LA according to the ISO/IEC 17025 quality assessment standard and technical standard(s).

**Test results included in this report are only for the Bluetooth EDR part.**

## 2. SUMMARY OF TEST RESULTS

Test procedures according to the technical standard(s):

Applied Standard(s): FCC Part15, Subpart C (15.247)				
Standard(s) Section	Test Item	Test Result	Judgment	Remark
15.207	AC Power Line Conducted Emissions	APPENDIX A	PASS	-----
15.247(d) 15.205(a) 15.209(a)	Radiated Emission	APPENDIX B APPENDIX C APPENDIX D	PASS	-----
15.247 (a)(1)(iii)	Number of Hopping Frequency	APPENDIX E	PASS	-----
15.247 (a)(1)(iii)	Average Time Of Occupancy	APPENDIX F	PASS	-----
15.247(a)(1)	Hopping Channel Separation	APPENDIX G	PASS	-----
15.247(a)(1)	Bandwidth	APPENDIX H	PASS	-----
15.247(a)(1)	Maximum Output Power	APPENDIX I	PASS	-----
15.247(d)	Conducted Spurious Emission	APPENDIX J	PASS	-----
15.203	Antenna Requirement	-----	PASS	-----

Note:

(1) "N/A" denotes test is not applicable in this test report



## 2.1 TEST FACILITY

The test facilities used to collect the test data in this report is at the location of No.3, Jinshagang 1st Road, Shixia, Dalang Town, Dongguan, Guangdong, China  
 BTL's Test Firm Registration Number for FCC: 357015  
 BTL's Designation Number for FCC: CN1240

## 2.2 MEASUREMENT UNCERTAINTY

ISO/IEC 17025 requires that an estimate of the measurement uncertainties associated with the emissions test results be included in the report. The measurement uncertainties given below are based on a 95% confidence level (based on a coverage factor (k=2))  
 The BTL measurement uncertainty as below table:

### A. AC power line conducted emissions test:

Test Site	Method	Measurement Frequency Range	U, (dB)
DG-C02	CISPR	150 kHz ~ 30 MHz	2.32

### B. Radiated emissions test:

Test Site	Method	Measurement Frequency Range	Ant. H / V	U, (dB)
DG-CB03	CISPR	9 kHz~30 MHz	V	3.79
		9 kHz~30 MHz	H	3.57
		30 MHz~200 MHz	V	3.82
		30 MHz~200 MHz	H	3.78
		200 MHz~1,000 MHz	V	4.10
		200 MHz~1,000 MHz	H	4.06
		1 GHz~18 GHz	V	3.12
		1 GHz~18 GHz	H	3.68
		18 GHz~40 GHz	V	4.15
		18 GHz~40 GHz	H	4.14

### C. Other Measurement:

Test Item	Uncertainty
Conducted Spurious Emission	2.67 dB
Hopping Channel Separation	53.46 MHz
Output Power	0.95 dB
Number of Hopping Frequency	53.46 MHz
Temperature	0.08 °C
Humidity	1.5%

Note: Unless specifically mentioned, the uncertainty of measurement has not been taken into account to declare the compliance or non-compliance to the specification.

### 3. GENERAL INFORMATION

#### 3.1 GENERAL DESCRIPTION OF EUT

Equipment	Bluetooth 4.0 Nano USB Adapter
Brand Name	tp-link
Test Model	UB400
Series Model	N/A
Model Difference(s)	N/A
Software Version	1.0
Hardware Version	1.0
Power Source	Supplied from PC USB port.
Power Rating	DC 5V
Operation Frequency	2402 MHz ~ 2480 MHz
Modulation Technology	GFSK, $\pi/4$ -DQPSK, 8-DPSK
Bit Rate of Transmitter	1/2/3Mbps
Output Power Max.	9.99 dBm (0.0100 W) For 1Mbps 8.72 dBm (0.0074 W) For 3Mbps

**Note:**

1. For a more detailed features description, please refer to the manufacturer's specifications or the user's manual.

2. Channel List:

Channel	Frequency (MHz)	Channel	Frequency (MHz)	Channel	Frequency (MHz)
00	2402	27	2429	54	2456
01	2403	28	2430	55	2457
02	2404	29	2431	56	2458
03	2405	30	2432	57	2459
04	2406	31	2433	58	2460
05	2407	32	2434	59	2461
06	2408	33	2435	60	2462
07	2409	34	2436	61	2463
08	2410	35	2437	62	2464
09	2411	36	2438	63	2465
10	2412	37	2439	64	2466
11	2413	38	2440	65	2467
12	2414	39	2441	66	2468
13	2415	40	2442	67	2469
14	2416	41	2443	68	2470
15	2417	42	2444	69	2471
16	2418	43	2445	70	2472
17	2419	44	2446	71	2473
18	2420	45	2447	72	2474
19	2421	46	2448	73	2475
20	2422	47	2449	74	2476
21	2423	48	2450	75	2477
22	2424	49	2451	76	2478
23	2425	50	2452	77	2479
24	2426	51	2453	78	2480
25	2427	52	2454		
26	2428	53	2455		

3 Table for Filed Antenna:

Ant.	Brand	Model Name	Antenna Type	Connector	Gain (dBi)
1	N/A	N/A	Internal	N/A	0.58

### 3.2 DESCRIPTION OF TEST MODES

The test system was pre-tested based on the consideration of all possible combinations of EUT operation mode.

Pretest Mode	Description
Mode 1	TX Mode <b>NOTE (1)</b>

Following mode(s) as (were) found to be the worst case(s) and selected for the final test.

<b>AC power line conducted emissions test</b>	
Final Test Mode	Description
Mode 1	TX Mode

<b>Radiated emissions test</b>	
Final Test Mode	Description
Mode 1	TX Mode <b>NOTE (1)</b>

<b>Conducted test</b>	
Final Test Mode	Description
Mode 1	TX Mode <b>NOTE (1)</b>

Note:

- (1) The measurements are performed at the high, middle, low available channels.
- (2) The measurements for Hopping Channel Separation, Bandwidth and Maximum Output Power were tested during 1Mbps, 2Mbps and 3Mbps, the worst case are 1Mbps and 3Mbps, only worst case was documented.
- (3) For radiated emission above 1 GHz test, 1GHz~26.5GHz have been pre-tested and in this report only recorded the worst case. The remaining spurious points are all below the limit value of 20dB.

### 3.3 PARAMETERS OF TEST SOFTWARE

During testing, channel & power controlling software provided by the customer was used to control the operating channel as well as the output power level. The RF output power selection is for the setting of RF output power expected by the customer and is going to be fixed on the firmware of the final end product power parameters of FHSS

Test Software	Bluetest3_2.6.4		
Frequency (MHz)	2402	2441	2480
Parameters(1Mbps)	255,50	255,50	255,50
Parameters(3Mbps)	255,50	255,50	255,50

**3.4 BLOCK DIAGRAM SHOWING THE CONFIGURATION OF SYSTEM TESTED**

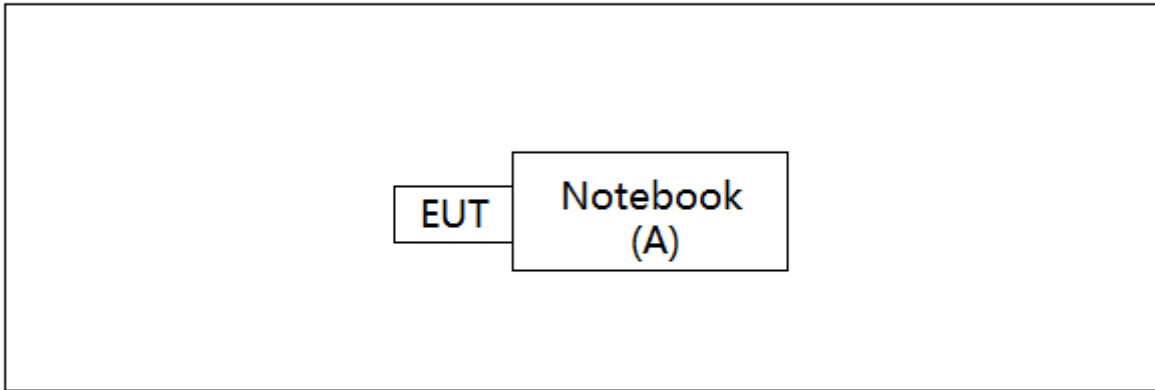

**3.5 SUPPORT UNITS**

Item	Equipment	Mfr/Brand	Model/Type No.	Series No.	Note
A	Notebook	DELL	INSPIRON 1420	N/A	N/A

Item	Shielded Type	Ferrite Core	Length	Note
-	-	-	-	-

## 4. AC POWER LINE CONDUCTED EMISSIONS TEST

### 4.1 LIMIT

Frequency of Emission (MHz)	Limit (dB $\mu$ V)	
	Quasi-peak	Average
0.15 - 0.5	66 to 56*	56 to 46*
0.50 - 5.0	56	46
5.0 - 30.0	60	50

Note:

- (1) The tighter limit applies at the band edges.
- (2) The limit of " \* " marked band means the limitation decreases linearly with the logarithm of the frequency in the range.

The following table is the setting of the receiver

Receiver Parameters	Setting
Attenuation	10 dB
Start Frequency	0.15 MHz
Stop Frequency	30 MHz
IF Bandwidth	9 kHz

### 4.2 TEST PROCEDURE

- a. The EUT was placed 0.8 meters from the horizontal ground plane with EUT being connected to the power mains through a line impedance stabilization network (LISN). All other support equipment powered from additional LISN(s). The LISN provide 50 Ohm/ 50uH of coupling impedance for the measuring instrument.
- b. Interconnecting cables that hang closer than 40 cm to the ground plane shall be folded back and forth in the center forming a bundle 30 to 40 cm long.
- c. I/O cables that are not connected to a peripheral shall be bundled in the center. The end of the cable may be terminated, if required, using the correct terminating impedance. The overall length shall not exceed 1 m.
- d. LISN at least 80 cm from nearest part of EUT chassis.
- e. For the actual test configuration, please refer to the related Item –EUT Test Photos.

### 4.3 DEVIATION FROM TEST STANDARD

No deviation

#### 4.4 TEST SETUP

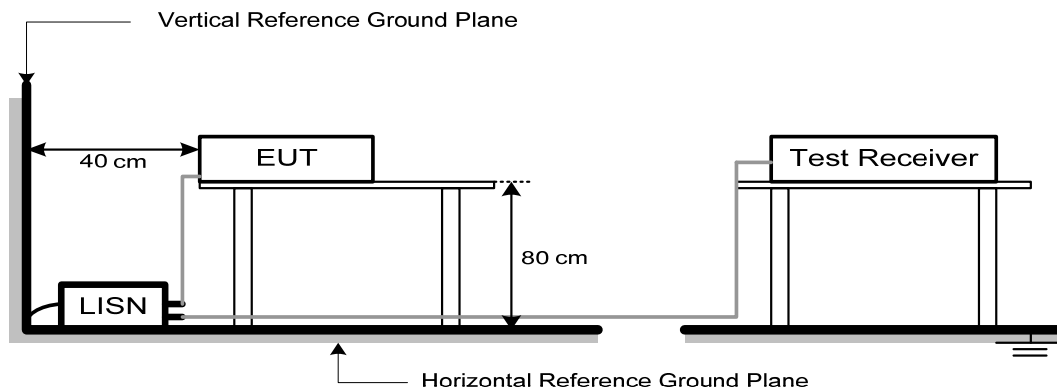

#### 4.5 EUT OPERATING CONDITIONS

The EUT was configured for testing in a typical function (as a customer would normally use it), EUT was programmed to be in continuously transmitting data or hopping on mode.

#### 4.6 EUT TEST CONDITIONS

Temperature: 25°C    Relative Humidity: 53%    Test Voltage: DC 5V

#### 4.7 TEST RESULTS

Please refer to the APPENDIX A.

Remark:

- (1) All readings are QP Mode value unless otherwise stated AVG in column of 『Note 』. If the QP Mode Measured value compliance with the QP Limits and lower than AVG Limits, the EUT shall be deemed to meet both QP & AVG Limits and then only QP Mode was measured, but AVG Mode didn't perform in this case, a "\*" marked in AVG Mode column of Interference Voltage Measured.
- (2) Measuring frequency range from 150 kHz to 30 MHz.

## 5. RADIATED EMISSION TEST

### 5.1 LIMIT

In case the emission fall within the restricted band specified on 15.205(a), then the 15.209(a) limit in the table below has to be followed.

#### LIMITS OF RADIATED EMISSION MEASUREMENT (9 kHz-1000 MHz)

Frequency (MHz)	Field Strength (microvolts/meter)	Measurement Distance (meters)
0.009-0.490	2400/F(kHz)	300
0.490-1.705	24000/F(kHz)	30
1.705-30.0	30	30
30-88	100	3
88-216	150	3
216-960	200	3
Above 960	500	3

#### LIMITS OF RADIATED EMISSION MEASUREMENT (Above 1000 MHz)

Frequency (MHz)	(dBuV/m at 3 m)	
	Peak	Average
Above 1000	74	54

**Note:**

- (1) The limit for radiated test was performed according to FCC PART 15C.
- (2) The tighter limit applies at the band edges.
- (3) Emission level (dBuV/m)=20log Emission level (uV/m).
- (4) The test result calculated as following:  
 Measurement Value = Reading Level + Correct Factor  
 Correct Factor = Antenna Factor + Cable Loss - Amplifier Gain(if use)  
 Margin Level = Measurement Value - Limit Value



Spectrum Parameter	Setting
Attenuation	Auto
Start Frequency	1000 MHz
Stop Frequency	10th carrier harmonic
RBW / VBW (Emission in restricted band)	RBW 1 MHz VBW 3 MHz peak detector for Pk value RMS detector for AV value

Receiver Parameter	Setting
Attenuation	Auto
Start ~ Stop Frequency	9 kHz~90 kHz for PK/AVG detector
Start ~ Stop Frequency	90 kHz~110 kHz for QP detector
Start ~ Stop Frequency	110 kHz~490 kHz for PK/AVG detector
Start ~ Stop Frequency	490 kHz~30 MHz for QP detector
Start ~ Stop Frequency	30 MHz~1000 MHz for QP detector

## 5.2 TEST PROCEDURE

- a. The measuring distance of 3 m shall be used for measurements. The EUT was placed on the top of a rotating table 0.8 meter above the ground at a 3 meter semi-anechoic chamber. The table was rotated 360 degrees to determine the position of the highest radiation.(below 1 GHz)
- b. The measuring distance of 3 m shall be used for measurements. The EUT was placed on the top of a rotating table 1.5 meter above the ground at a 3 meter semi-anechoic chamber. The table was rotated 360 degrees to determine the position of the highest radiation.(above 1 GHz)
- c. The height of the equipment or of the substitution antenna shall be 0.8m or 1.5m; the height of the test antenna shall vary between 1 m to 4 m. Both horizontal and vertical polarizations of the antenna are set to make the measurement.
- d. For each suspected emission, the EUT was arranged to its worst case and then the antenna was tuned to heights find the maximum reading (used Bore sight function).
- e. The receiver system was set to peak and average detect function and specified bandwidth with maximum hold mode when the test frequency is above 1 GHz.
- f. The initial step in collecting radiated emission data is a receiver peak detector mode pre-scanning the measurement frequency range. Significant peaks are then marked and then Quasi Peak detector mode re-measured.
- g. All readings are Peak unless otherwise stated QP in column of Note. Peak denotes that the Peak reading compliance with the QP Limits and then QP Mode measurement didn't perform. (below 1 GHz)
- h. All readings are Peak Mode value unless otherwise stated AVG in column of Note. If the Peak Mode Measured value compliance with the Peak Limits and lower than AVG Limits, the EUT shall be deemed to meet both Peak & AVG Limits and then only Peak Mode was measured, but AVG Mode didn't perform. (above 1 GHz)
- i. For the actual test configuration, please refer to the related Item –EUT Test Photos.

## 5.3 DEVIATION FROM TEST STANDARD

No deviation

**5.4 TEST SETUP**

**9 kHz-30 MHz**

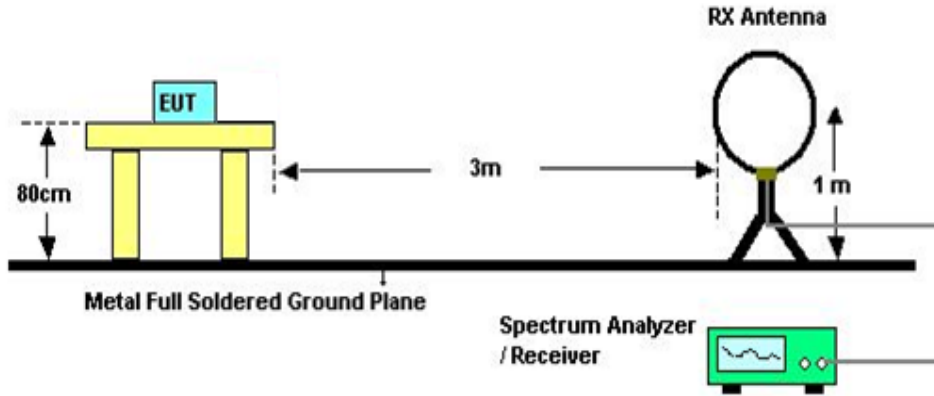

**30 MHz to 1 GHz**

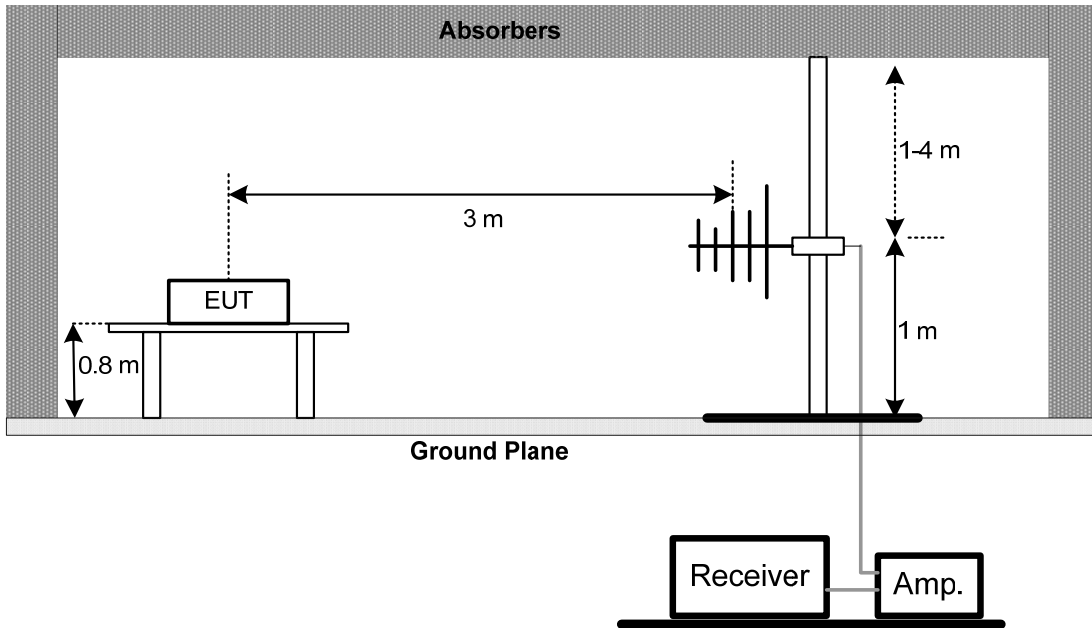

**Above 1 GHz**

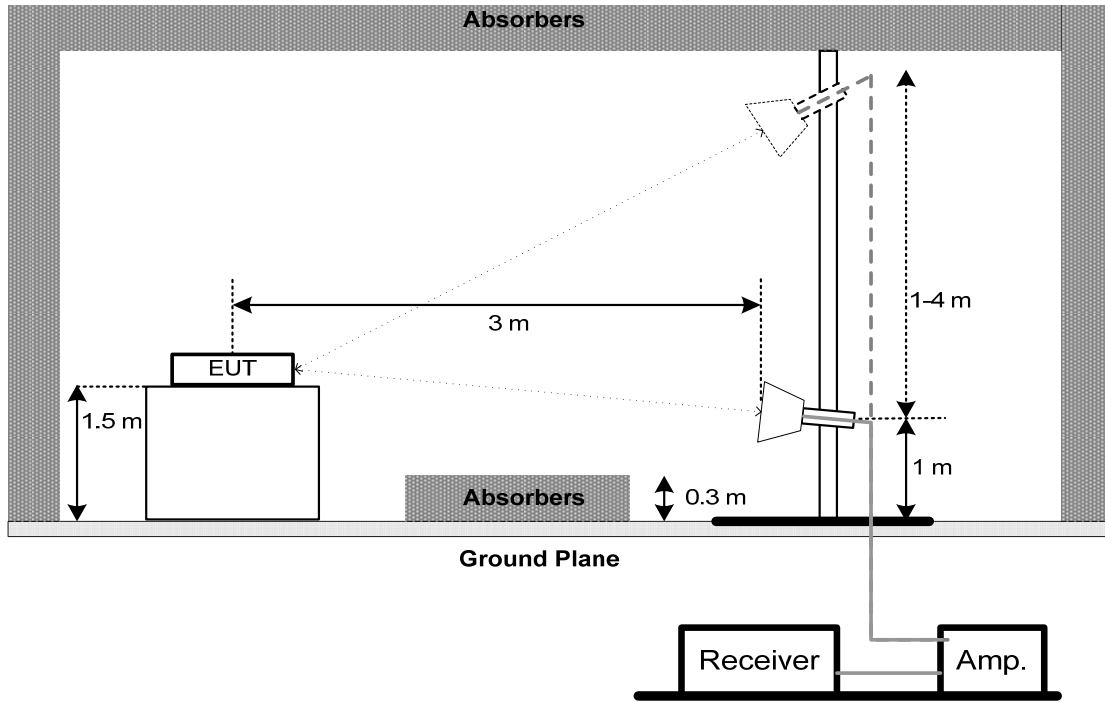

### 5.5 EUT OPERATING CONDITIONS

The EUT was programmed to be in continuously transmitting mode.

### 5.6 EUT TEST CONDITIONS

Temperature: 25°C    Relative Humidity: 60%    Test Voltage: DC 5V

### 5.7 TEST RESULTS - 9 kHz TO 30 MHz

Please refer to the APPENDIX B

Remark:

- (1) Distance extrapolation factor =  $40 \log$  (specific distance / test distance) (dB).
- (2) Limit line = specific limits (dBuV) + distance extrapolation factor.

### 5.8 TEST RESULTS - 30 MHz TO 1000 MHz

Please refer to the APPENDIX C.

### 5.9 TEST RESULTS - ABOVE 1000 MHz

Please refer to the APPENDIX D.

Remark:

- (1) No limit: This is fundamental signal, the judgment is not applicable.  
For fundamental signal judgment was referred to Peak output test.

## 6. NUMBER OF HOPPING FREQUENCY

### 6.1 LIMIT

FCC Part15, Subpart C (15.247)	
Section	Test Item
15.247(a)(1)(iii)	Number of Hopping Frequency

Spectrum Parameters	Setting
Attenuation	Auto
Span Frequency	> Operating Frequency Range
RBW	100 kHz
VBW	100 kHz
Detector	Peak
Trace	Max Hold
Sweep Time	Auto

### 6.2 TEST PROCEDURE

- The EUT was directly connected to the spectrum analyzer and antenna output port as show in the block diagram below.
- Spectrum Setting: RBW=100 kHz, VBW=100 kHz, Sweep time = Auto.

### 6.3 DEVIATION FROM STANDARD

No deviation.

### 6.4 TEST SETUP



### 6.5 EUT OPERATION CONDITIONS

The EUT tested system was configured as the statements of 4.5 unless otherwise a special operating condition is specified in the follows during the testing.

### 6.6 EUT TEST CONDITIONS

Temperature: 26°C    Relative Humidity: 63%    Test Voltage: DC 5V

### 6.7 TEST RESULTS

Please refer to the APPENDIX E

## 7. AVERAGE TIME OF OCCUPANCY

### 7.1 LIMIT

FCC Part15, Subpart C (15.247)		
Section	Test Item	Limit
15.247(a)(1)(iii)	Average Time of Occupancy	0.4sec

### 7.2 TEST PROCEDURE

- a. The transmitter output (antenna port) was connected to the spectrum analyzer
- b. Set RBW of spectrum analyzer to 1 MHz and VBW to 1 MHz
- c. Use a video trigger with the trigger level set to enable triggering only on full pulses
- d. Sweep Time is more than once pulse time
- e. Set the center frequency on any frequency would be measure and set the frequency span to zero span
- f. Measure the maximum time duration of one single pulse
- g. Set the EUT for DH5, DH3 and DH1 packet transmitting
- h. Measure the maximum time duration of one single pulse
- i. DH5 Packet permit maximum  $1600 / 79 / 6 = 3.37$  hops per second in each channel (5 time slots TX, 1 time slot RX). So, the dwell time is the time duration of the pulse times  $3.37 \times 31.6 = 106.6$  within 31.6 seconds
- j. DH3 Packet permit maximum  $1600 / 79 / 4 = 5.06$  hops per second in each channel (3 time slots TX, 1 time slot RX). So, the dwell time is the time duration of the pulse times  $5.06 \times 31.6 = 160$  within 31.6 seconds
- k. DH1 Packet permit maximum  $1600 / 79 / 2 = 10.12$  hops per second in each channel (1 time slot TX, 1 time slot RX). So, the dwell time is the time duration of the pulse times  $10.12 \times 31.6 = 320$  within 31.6 seconds

### 7.3 DEVIATION FROM STANDARD

No deviation.

### 7.4 TEST SETUP

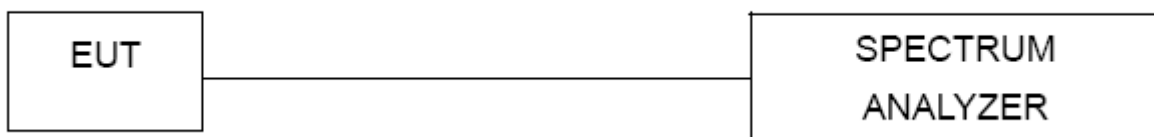

### 7.5 EUT OPERATION CONDITIONS

The EUT tested system was configured as the statements of 4.5 unless otherwise a special operating condition is specified in the follows during the testing.

### 7.6 EUT TEST CONDITIONS

Temperature: 26°C    Relative Humidity: 63%    Test Voltage: DC 5V

### 7.7 TEST RESULTS

Please refer to the APPENDIX F

## 8. HOPPING CHANNEL SEPARATION MEASUREMENT

### 8.1 LIMIT

Frequency hopping systems operating in the 2400-2483.5 MHz band may have hopping channel carrier frequencies that are separated by 25 kHz or two-thirds of the 20 dB bandwidth of the hopping channel, whichever is greater, provided the systems operate with an output power no greater than 125 mW.

Spectrum Parameter	Setting
Attenuation	Auto
Span Frequency	> Measurement Bandwidth or Channel Separation
RBW	30 kHz
VBW	100 kHz
Detector	Peak
Trace	Max Hold
Sweep Time	Auto

### 8.2 TEST PROCEDURE

- a. The EUT was directly connected to the spectrum analyzer and antenna output port as show in the block diagram below.
- b. Span = wide enough to capture the peaks of two adjacent channels  
 Resolution (or IF) Bandwidth (RBW)  $\geq$  1% of the span  
 Video (or Average) Bandwidth (VBW)  $\geq$  RBW  
 Sweep = Auto  
 Detector function = Peak  
 Trace = Max Hold

### 8.3 DEVIATION FROM STANDARD

No deviation.

### 8.4 TEST SETUP

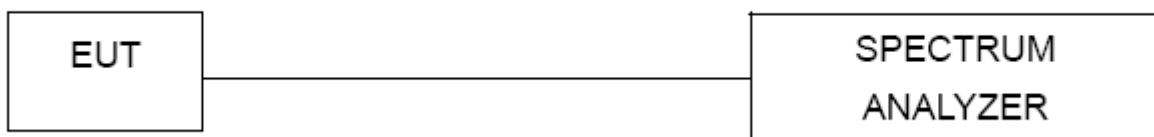

### 8.5 EUT OPERATION CONDITIONS

The EUT tested system was configured as the statements of 4.5 unless otherwise a special operating condition is specified in the follows during the testing.

### 8.6 EUT TEST CONDITIONS

Temperature: 26°C    Relative Humidity: 63%    Test Voltage: DC 5V

### 8.7 TEST RESULTS

Please refer to the APPENDIX G

## 9. BANDWIDTH TEST

### 9.1 LIMIT

FCC Part15, Subpart C (15.247)	
Section	Test Item
15.247(a)(1)	Bandwidth

Spectrum Parameter	Setting
Attenuation	Auto
Span Frequency	> Measurement Bandwidth
RBW	30 kHz
VBW	100 kHz
Detector	Peak
Trace	Max Hold
Sweep Time	Auto

### 9.2 TEST PROCEDURE

- The EUT was directly connected to the spectrum analyzer and antenna output port as show in the block diagram below.
- Spectrum Setting: RBW= 30 kHz, VBW=100 kHz, Sweep Time = Auto.

### 9.3 DEVIATION FROM STANDARD

No deviation.

### 9.4 TEST SETUP



### 9.5 EUT OPERATION CONDITIONS

The EUT tested system was configured as the statements of 4.5 unless otherwise a special operating condition is specified in the follows during the testing.

### 9.6 EUT TEST CONDITIONS

Temperature: 26°C    Relative Humidity: 63%    Test Voltage: DC 5V

### 9.7 TEST RESULTS

Please refer to the APPENDIX H



## 10. MAXIMUM OUTPUT POWER

### 10.1 LIMIT

FCC Part15 , Subpart C (15.247)		
Section	Test Item	Limit
15.247(a)(1)	Maximum Output Power	0.125Watt or 21dBm

Note: Frequency hopping systems shall have hopping channel carrier frequencies separated by a minimum of 25 kHz or the 20 dB bandwidth of the hopping channel, whichever is greater. Alternatively, frequency hopping systems operating in the 2400-2483.5 MHz band may have hopping channel carrier frequencies that are separated by 25 kHz or two-thirds of the 20 dB bandwidth of the hopping channel, whichever is greater, provided the systems operate with an output power no greater than 125 mW.

### 10.2 TEST PROCEDURE

- a. The EUT was directly connected to the spectrum analyzer and antenna output port as show in the block diagram below.
- b. Spectrum Setting: RBW= 1 MHz/3 MHz, VBW= 1 MHz/3 MHz, Sweep time = Auto.

### 10.3 DEVIATION FROM STANDARD

No deviation.

### 10.4 TEST SETUP



### 10.5 EUT OPERATION CONDITIONS

The EUT tested system was configured as the statements of 4.5 unless otherwise a special operating condition is specified in the follows during the testing.

### 10.6 EUT TEST CONDITIONS

Temperature: 26°C    Relative Humidity: 63%    Test Voltage: DC 5V

### 10.7 TEST RESULTS

Please refer to the APPENDIX I

## 11. CONDUCTED SPURIOUS EMISSION

### 11.1 LIMIT

In any 100 kHz bandwidth outside the frequency band in which the spread spectrum or digitally modulated intentional radiator is operating, the radio frequency power that is produced by the intentional radiator shall be at least 20 dB below that in the 100 kHz bandwidth within the band that contains the highest level of the desired power, based on either an RF conducted or a radiated measurement, provided the transmitter demonstrates compliance with the peak Output Power limits. If the transmitter complies with the Output Power limits based on the use of RMS averaging over a time interval, as permitted under paragraph (b)(3) of this section, the attenuation required under this paragraph shall be 30 dB instead of 20 dB. Attenuation below the general limits specified in Section 15.209(a) is not required. In addition, radiated emissions which fall in the restricted bands, as defined in Section 15.205(a), must also comply with the radiated emission limits specified in Section 15.209(a) (see Section 15.205(c)).

### 11.2 TEST PROCEDURE

- a. The EUT was directly connected to the spectrum analyzer and antenna output port as show in the block diagram below.
- b. Spectrum Setting: RBW= 100 kHz, VBW=100 kHz, Sweep time = Auto.

### 11.3 DEVIATION FROM STANDARD

No deviation.

### 11.4 TEST SETUP



### 11.5 EUT OPERATION CONDITIONS

The EUT tested system was configured as the statements of 4.5 unless otherwise a special operating condition is specified in the follows during the testing.

### 11.6 EUT TEST CONDITIONS

Temperature: 26°C    Relative Humidity: 63%    Test Voltage: DC 5V

### 11.7 TEST RESULTS

Please refer to the APPENDIX J

## 12. MEASUREMENT INSTRUMENTS LIST

AC Power Line Conducted Emissions					
Item	Kind of Equipment	Manufacturer	Type No.	Serial No.	Calibrated until
1	EMI Test Receiver	R&S	ESCI	100382	Mar. 10, 2020
2	LISN	EMCO	3816/2	52765	Mar. 10, 2020
3	50ohm Terminator	SHX	TF5-3	15041305	Mar. 10, 2020
4	Artificial-Mains Network	SCHWARZBECK	NSLK 8127	8127685	Mar. 10, 2020
5	TRANSIENT LIMITER	EM	EM-7600	772	Mar. 10, 2020
6	Measurement Software	Farad	EZ-EMC Ver.NB-03A1-01	N/A	N/A
7	Cable	N/A	RG223	12m	Mar. 12, 2020

Radiated Emissions - 9 kHz to 30 MHz					
Item	Kind of Equipment	Manufacturer	Type No.	Serial No.	Calibrated until
1	Loop Antenna	EM	EM-6876-1	230	Jan. 15, 2020
2	Cable	N/A	RG 213/U	C-102	Jun. 01, 2019
3	EMI Test Receiver	R&S	ESCI	100895	Mar. 10, 2020
4	Measurement Software	Farad	EZ-EMC Ver.NB-03A1-01	N/A	N/A

Radiated Emissions - 30 MHz to 1 GHz					
Item	Kind of Equipment	Manufacturer	Type No.	Serial No.	Calibrated until
1	Antenna	Schwarzbeck	VULB9160	9160-3232	Mar. 09, 2020
2	Amplifier	HP	8447D	2944A09673	Aug. 11, 2019
3	Receiver	Agilent	N9038A	MY52130039	Aug. 11, 2019
4	Cable	emci	LMR-400(30MHz-1GHz)(8m+5m)	N/A	May 25, 2019
5	Controller	CT	SC100	N/A	N/A
6	Controller	MF	MF-7802	MF780208416	N/A
7	Measurement Software	Farad	EZ-EMC Ver.NB-03A1-01	N/A	N/A

Radiated Emissions - Above 1 GHz					
Item	Kind of Equipment	Manufacturer	Type No.	Serial No.	Calibrated until
1	Double Ridged Guide Antenna	ETS	3115	75789	Mar. 09, 2020
2	Broad-Band Horn Antenna	Schwarzbeck	BBHA 9170	9170319	Jun. 30, 2019
3	Amplifier	Agilent	8449B	3008A02333	Mar. 10, 2020
4	Microwave Preamplifier With Adaptor	EMC INSTRUMENT	EMC2654045	980039 & HA01	Mar. 10, 2020
5	Receiver	Agilent	N9038A	MY52130039	Aug. 11, 2019
6	Controller	CT	SC100	N/A	N/A
7	Controller	MF	MF-7802	MF780208416	N/A
8	Cable	mitron	B10-01-01-12M	18072744	Jul. 30, 2019
9	Measurement Software	Farad	EZ-EMC Ver.NB-03A1-01	N/A	N/A

**Number of Hopping Frequency**

Item	Kind of Equipment	Manufacturer	Type No.	Serial No.	Calibrated until
1	Spectrum Analyzer	R&S	FSP40	100185	Aug. 11, 2019

**Average Time of Occupancy**

Item	Kind of Equipment	Manufacturer	Type No.	Serial No.	Calibrated until
1	Spectrum Analyzer	R&S	FSP40	100185	Aug. 11, 2019

**Hopping Channel Separation Measurement**

Item	Kind of Equipment	Manufacturer	Type No.	Serial No.	Calibrated until
1	Spectrum Analyzer	R&S	FSP40	100185	Aug. 11, 2019

**Bandwidth**

Item	Kind of Equipment	Manufacturer	Type No.	Serial No.	Calibrated until
1	Spectrum Analyzer	R&S	FSP40	100185	Aug. 11, 2019

**Maximum Output Power**

Item	Kind of Equipment	Manufacturer	Type No.	Serial No.	Calibrated until
1	Spectrum Analyzer	R&S	FSP40	100185	Aug. 11, 2019

**Antenna Conducted Spurious Emission**

Item	Kind of Equipment	Manufacturer	Type No.	Serial No.	Calibrated until
1	Spectrum Analyzer	R&S	FSP40	100185	Aug. 11, 2019

Remark "N/A" denotes no model name, serial no. or calibration specified.  
 All calibration period of equipment list is one year.

### 13. EUT TEST PHOTO

#### AC Power Line Conducted Emissions Test Photos





## Radiated Measurement Photos

9 kHz to 30 MHz



**Radiated Emissions Test Photos**

**30 MHz to 1000 MHz**

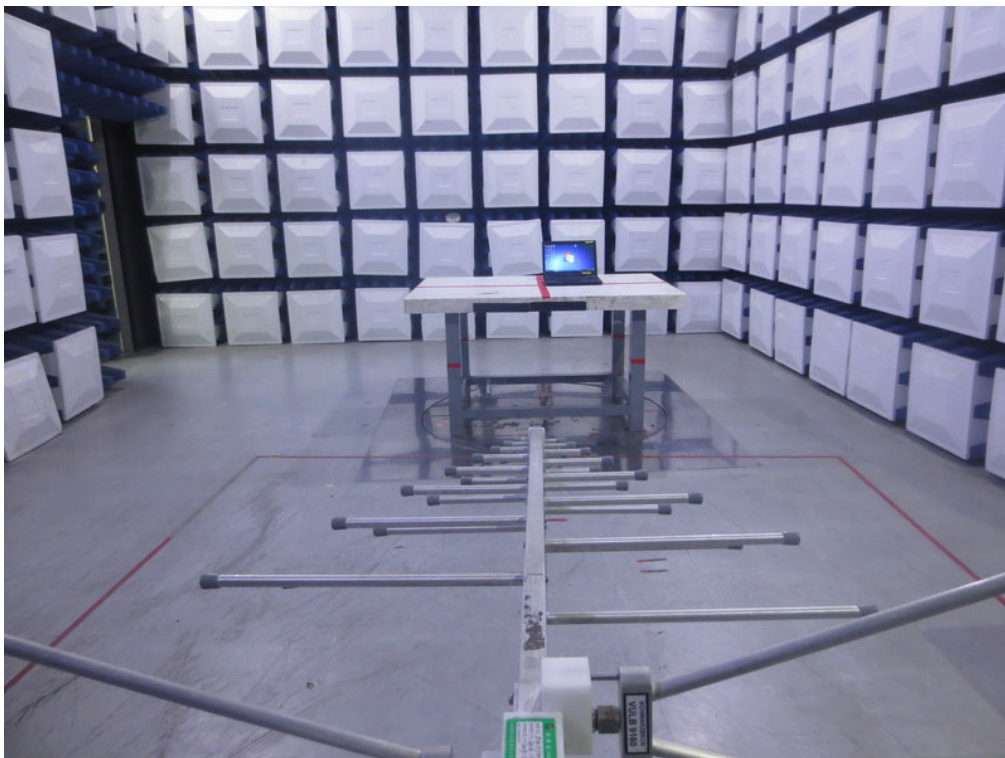
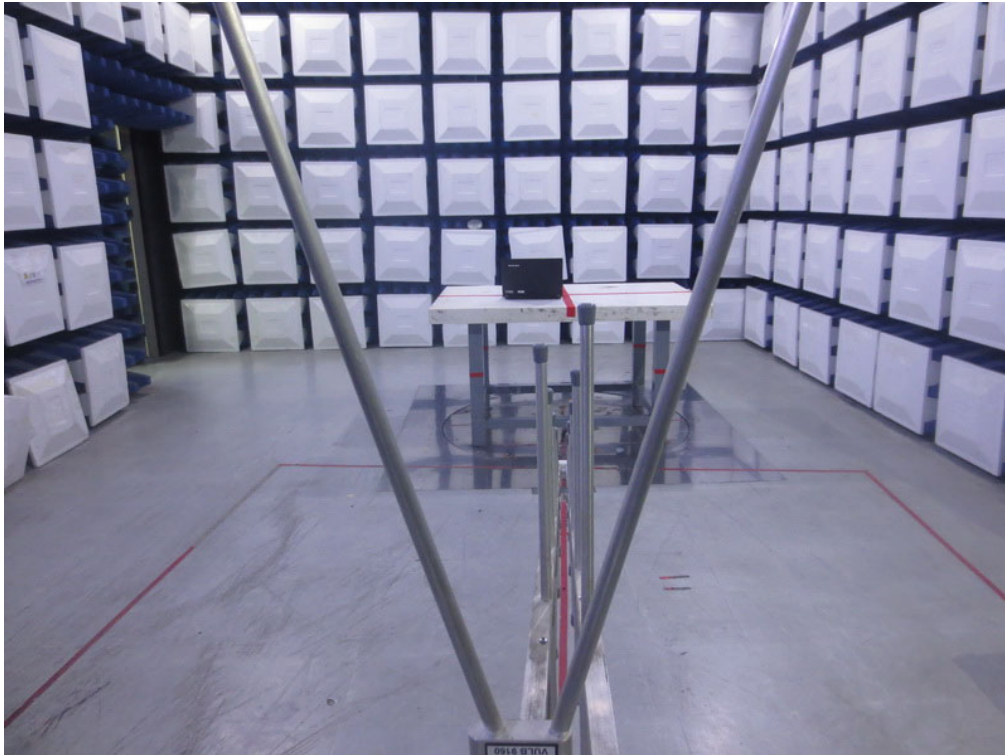



**Radiated Emissions Test Photos**  
**Above 1 GHz**

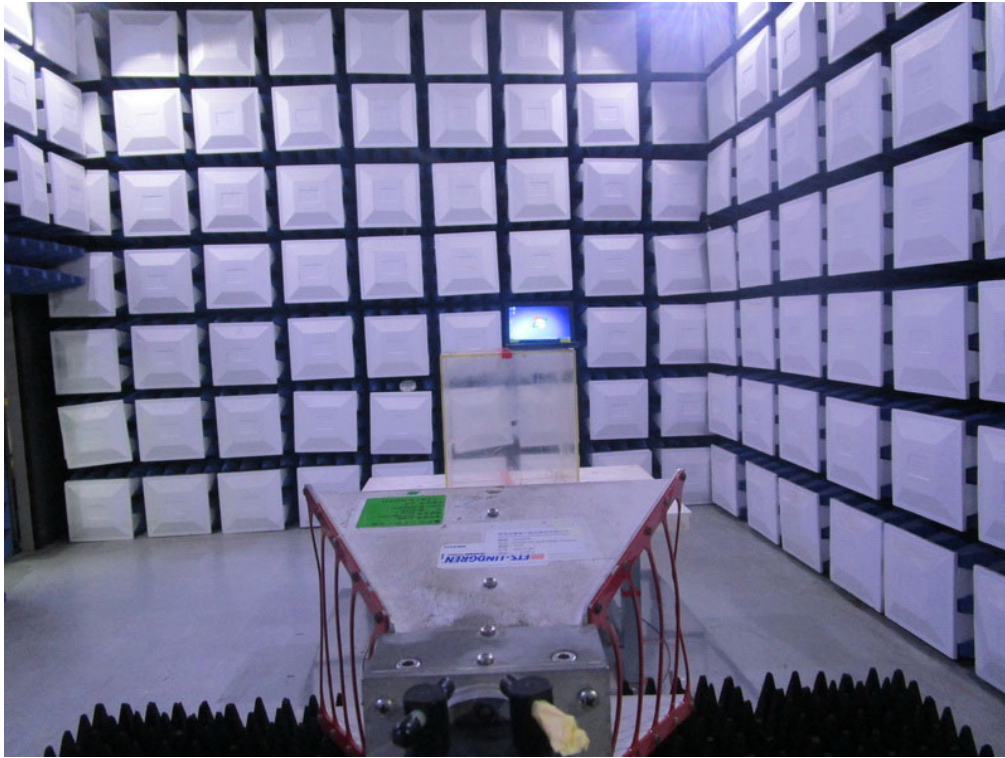





## APPENDIX A - AC POWER LINE CONDUCTED EMISSIONS

Test Mode: TX Mode Channel 78 \_1Mbps (USB Support)

Line

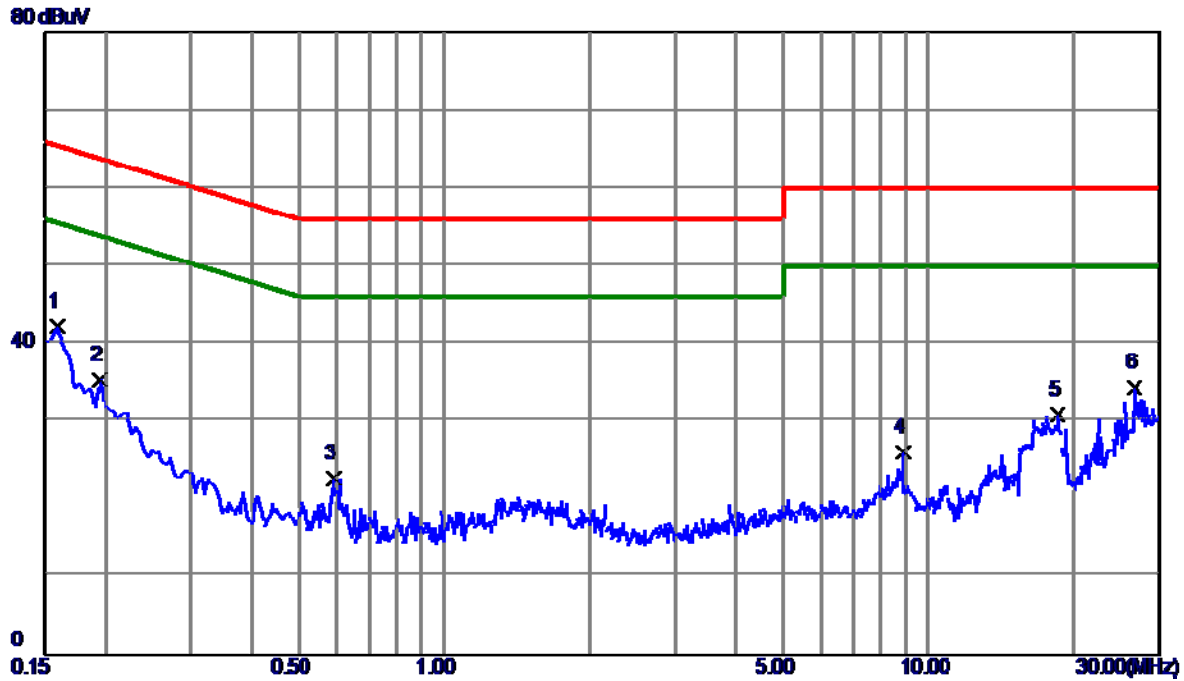

No.	Freq. MHz	Reading Level dBuV	Correct Factor dB	Measure ment dBuV	Limit dBuV	Margin dB	Detector	Comment
1 *	0.1590	32.46	9.82	42.28	65.52	-23.24	Peak	
2	0.1949	25.50	9.82	35.32	63.83	-28.51	Peak	
3	0.5910	12.88	9.83	22.71	56.00	-33.29	Peak	
4	8.8440	15.59	10.43	26.02	60.00	-33.98	Peak	
5	18.5145	19.86	11.06	30.92	60.00	-29.08	Peak	
6	26.6235	23.35	11.11	34.46	60.00	-25.54	Peak	

REMARKS:

- (1) Measurement Value = Reading Level + Correct Factor.
- (2) Margin Level = Measurement Value - Limit Value.

Test Mode: TX Mode Channel 78 \_1Mbps (USB Support)

Neutral

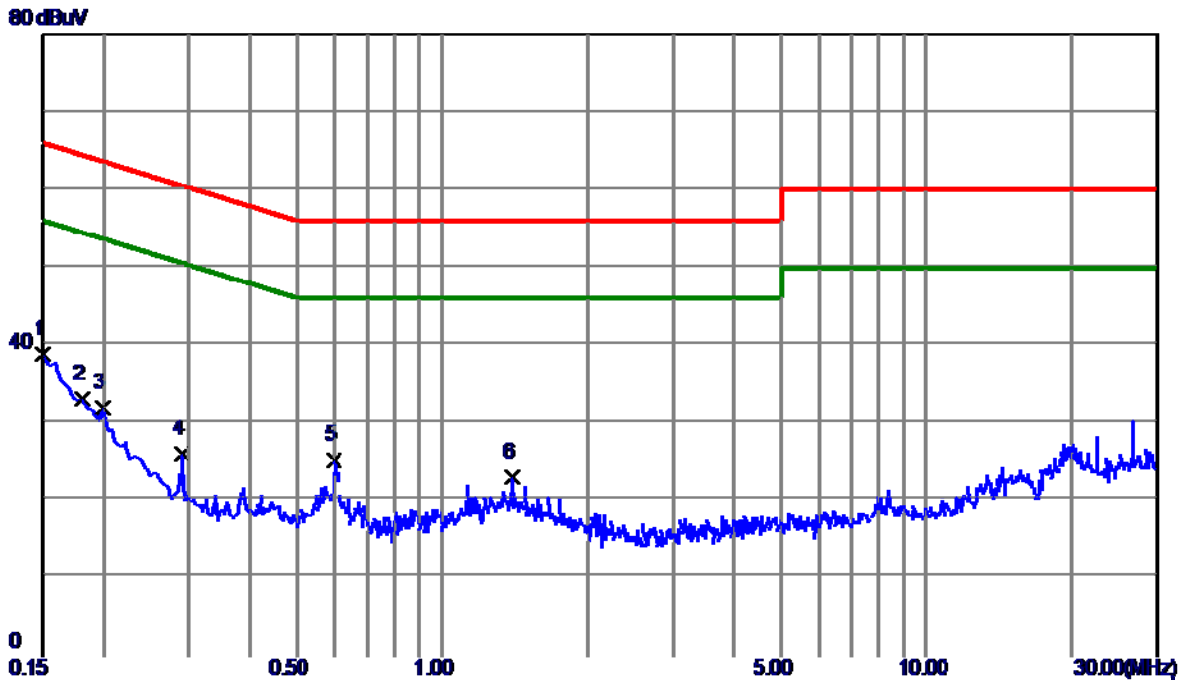

No.	Freq. MHz	Reading Level dBuV	Correct Factor dB	Measure ment dBuV	Limit dBuV	Margin dB	Detector	Comment
1 *	0.1500	28.96	9.91	38.87	66.00	-27.13	Peak	
2	0.1815	23.15	9.91	33.06	64.42	-31.36	Peak	
3	0.1995	22.09	9.91	32.00	63.63	-31.63	Peak	
4	0.2895	16.20	9.93	26.13	60.54	-34.41	Peak	
5	0.6000	15.26	9.98	25.24	56.00	30.76	Peak	
6	1.3965	12.86	10.15	23.01	56.00	-32.99	Peak	

REMARKS:

- (1) Measurement Value = Reading Level + Correct Factor.
- (2) Margin Level = Measurement Value - Limit Value.

## APPENDIX B - RADIATED EMISSION - 9 KHZ-30 MHZ

Test Mode: TX Mode Channel 78 \_1Mbps

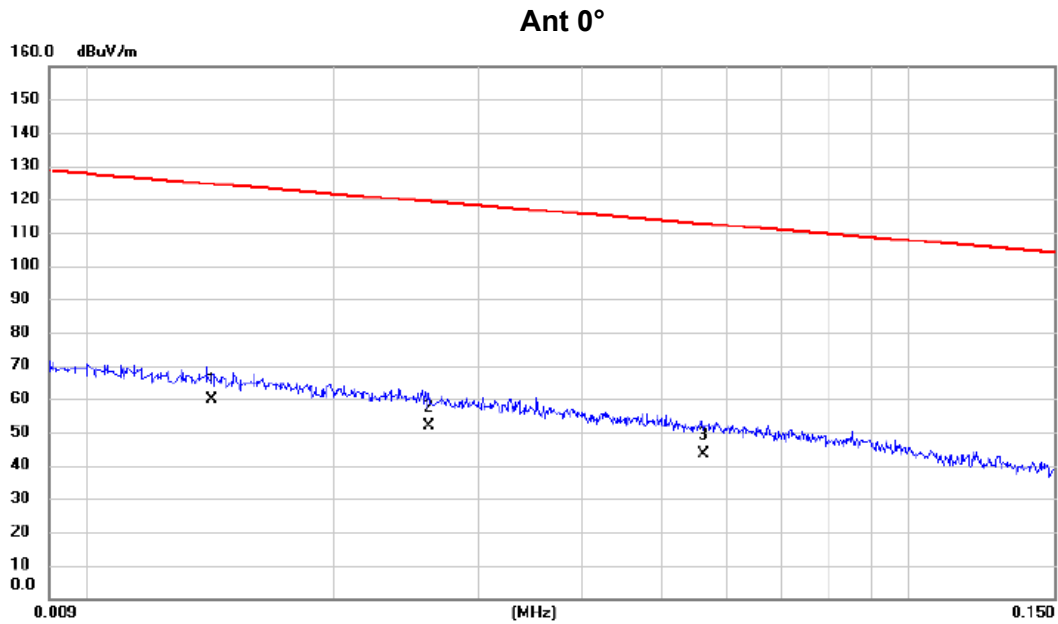

No.	Mk.	Freq. MHz	Reading Level dBuV	Correct Factor dB	Measure- ment dBuV/m	Limit dBuV/m	Margin dB	Detector	Comment
1	*	0.0142	38.90	20.83	59.73	124.56	-64.83	AVG	
2		0.0261	31.80	19.92	51.72	119.27	-67.55	AVG	
3		0.0562	24.10	19.41	43.51	112.61	-69.10	AVG	

**REMARKS:**

(1) Measurement Value = Reading Level + Correct Factor.

(2) Margin Level = Measurement Value - Limit Value.

Test Mode: TX Mode Channel 78 \_1Mbps

Ant 0°

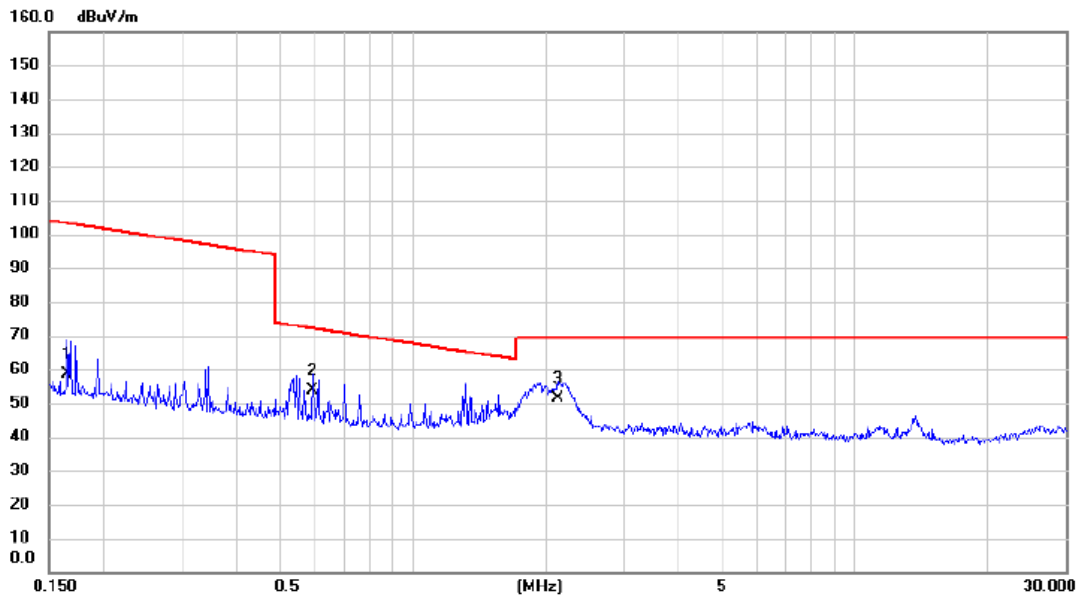

No.	Mk.	Freq. MHz	Reading Level dBuV	Correct Factor dB	Measure- ment dBuV/m	Limit dBuV/m	Margin dB	Detector	Comment
1		0.1654	41.30	17.23	58.53	103.24	-44.71	AVG	
2		0.5932	36.70	16.93	53.63	72.14	-18.51	QP	
3	*	2.1270	34.50	17.04	51.54	69.54	-18.00	QP	

REMARKS:

- (1) Measurement Value = Reading Level + Correct Factor.
- (2) Margin Level = Measurement Value - Limit Value.

Test Mode: TX Mode Channel 78 \_1Mbps

**Ant 90°**

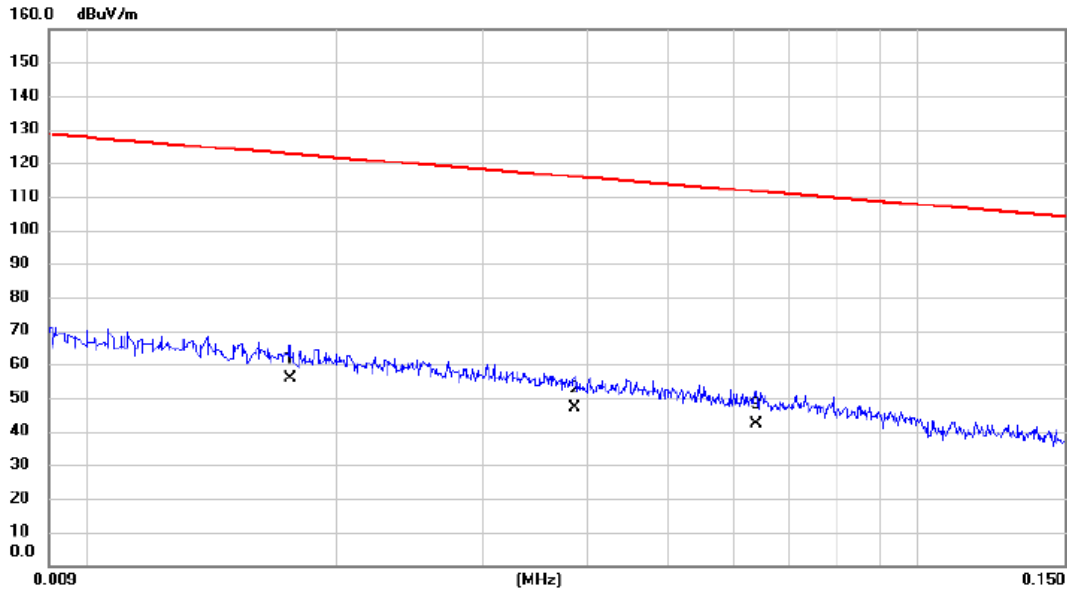

No.	Mk.	Freq.	Reading Level	Correct Factor	Measurement	Limit	Margin		
		MHz	dBuV	dB	dBuV/m	dBuV/m	dB	Detector	Comment
1	*	0.0176	35.60	20.36	55.96	122.69	-66.73	AVG	
2		0.0387	27.10	19.72	46.82	115.85	-69.03	AVG	
3		0.0640	23.10	19.25	42.35	111.48	-69.13	AVG	

**REMARKS:**

- (1) Measurement Value = Reading Level + Correct Factor.
- (2) Margin Level = Measurement Value - Limit Value.



Test Mode: TX Mode Channel 78 \_1Mbps

**Ant 90°**

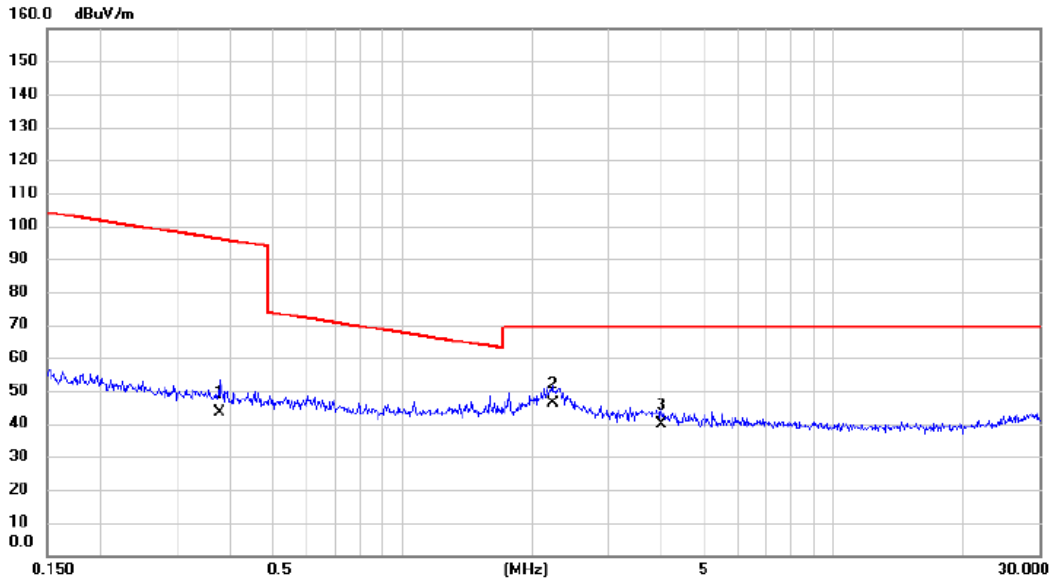

No.	Mk.	Freq. MHz	Reading Level dBuV	Correct Factor dB	Measure- ment dBuV/m	Limit dBuV/m	Margin dB	Detector	Comment
1		0.3781	26.20	17.01	43.21	96.05	-52.84	AVG	
2	*	2.2308	29.30	16.98	46.28	69.54	-23.26	QP	
3		3.9956	23.90	15.74	39.64	69.54	-29.90	QP	

**REMARKS:**

(1) Measurement Value = Reading Level + Correct Factor.

(2) Margin Level = Measurement Value - Limit Value.

# APPENDIX C - RADIATED EMISSION - 30 MHZ TO 1000 MHZ

Test Mode: TX Mode Channel 78 \_1Mbps

Vertical

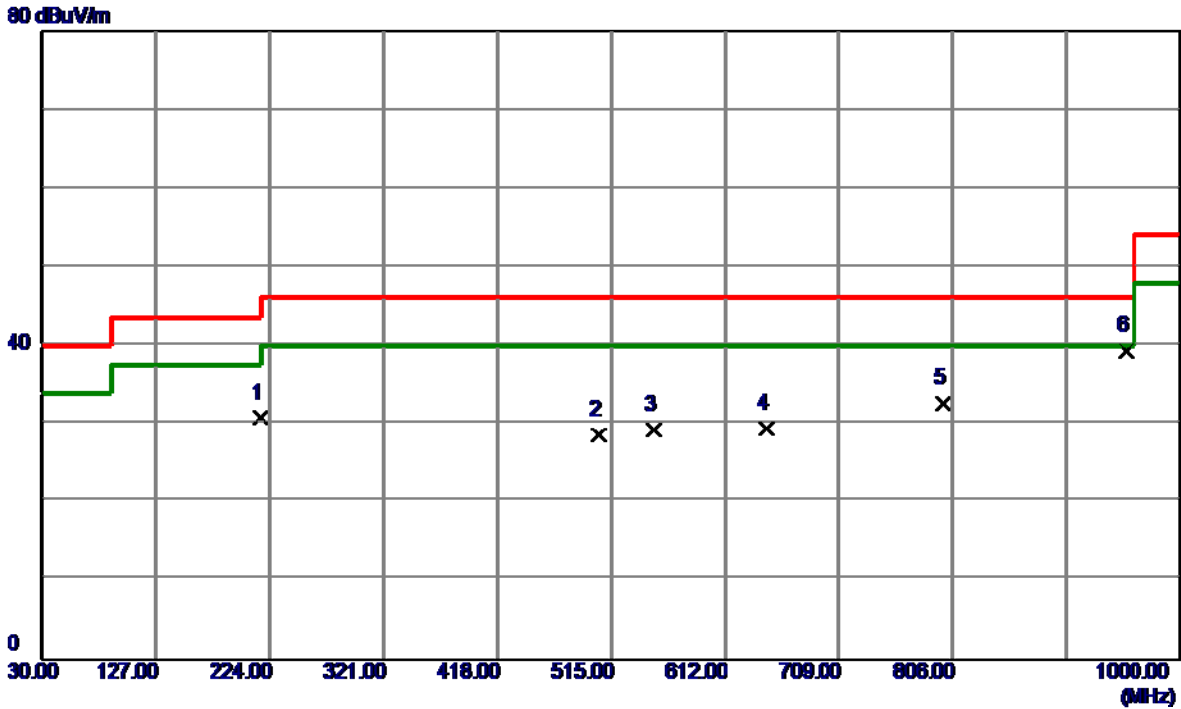

No.	Freq. MHz	Reading Level dBuV/m	Correct Factor dB	Measure ment dBuV/m	Limit dBuV/m	Margin dB	Detector	Comment
1	216.2400	45.79	-14.99	30.80	46.00	-15.20	Peak	
2	504.3300	36.90	-8.26	28.64	46.00	-17.36	Peak	
3	551.8600	34.74	-5.49	29.25	46.00	-16.75	Peak	
4	647.8900	34.61	-5.22	29.39	46.00	-16.61	Peak	
5	798.2400	33.83	-1.15	32.68	46.00	-13.32	Peak	
6 *	953.4400	38.07	1.33	39.40	46.00	-6.60	Peak	

REMARKS:

- (1) Measurement Value = Reading Level + Correct Factor.
- (2) Margin Level = Measurement Value - Limit Value.

Test Mode: TX Mode Channel 78 \_1Mbps

Horizontal

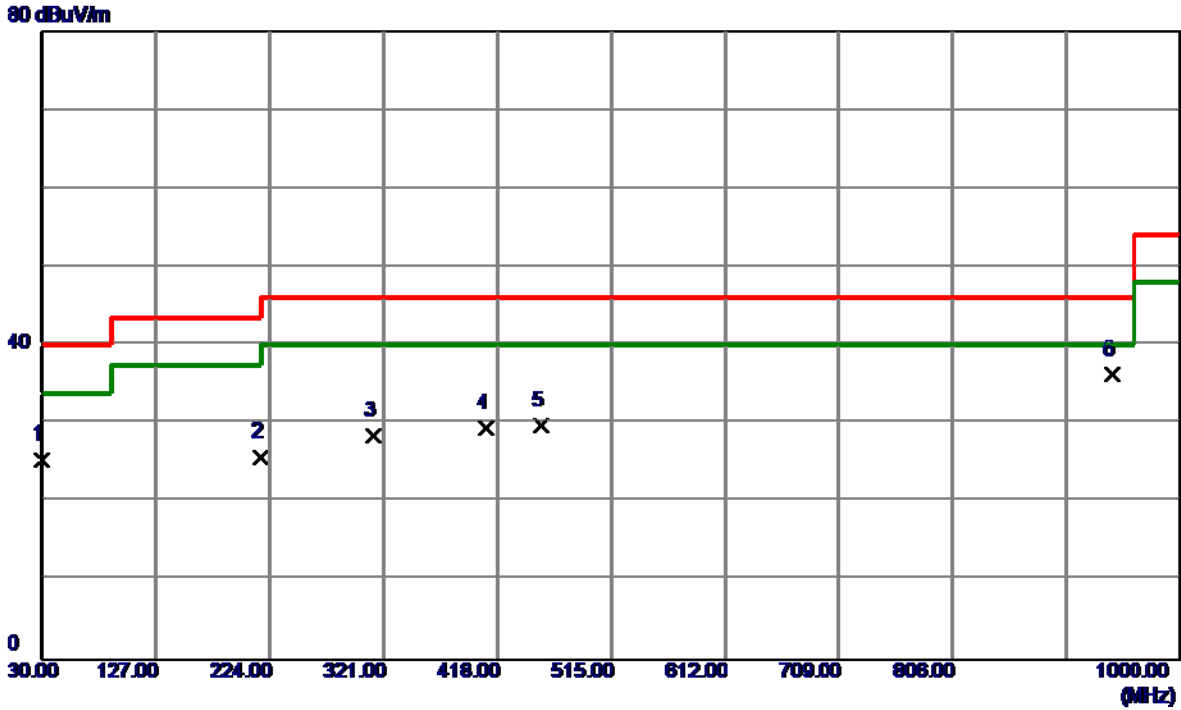

No.	Freq. MHz	Reading Level dBuV/m	Correct Factor dB	Measurement dBuV/m	Limit dBuV/m	Margin dB	Detector	Comment
1	30.0000	40.40	-14.97	25.43	40.00	-14.57	Peak	
2	216.2400	40.70	-14.99	25.71	46.00	-20.29	Peak	
3	312.2700	39.02	-10.54	28.48	46.00	-17.52	Peak	
4	408.3000	38.46	-9.06	29.40	46.00	-16.60	Peak	
5	455.8300	37.26	-7.54	29.72	46.00	-16.28	Peak	
6 *	941.8000	35.16	1.08	36.24	46.00	-9.76	Peak	

REMARKS:

- (1) Measurement Value = Reading Level + Correct Factor.
- (2) Margin Level = Measurement Value - Limit Value.

## APPENDIX D - RADIATED EMISSION - ABOVE 1000 MHZ

Test Mode: TX 2402 MHz \_CH00\_1Mbps

Vertical

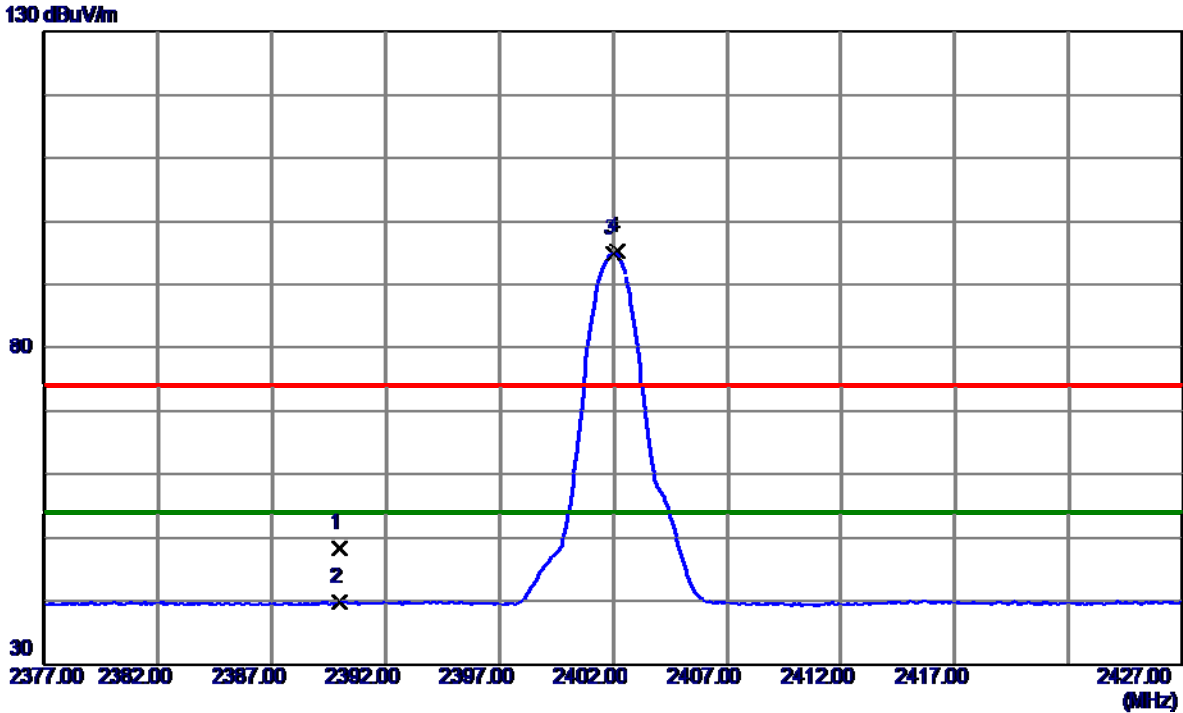

No.	Freq. MHz	Reading Level dBuV/m	Correct Factor dB	Measure ment dBuV/m	Limit dBuV/m	Margin dB	Detector	Comment
1	2390.0000	41.73	6.62	48.35	74.00	-25.65	Peak	
2	2390.0000	33.09	6.62	39.71	54.00	-14.29	AVG	
3 *	2402.0250	88.23	6.62	94.85	54.00	40.85	AVG	No Limit
4	2402.1500	88.57	6.62	95.19	74.00	21.19	Peak	No Limit

REMARKS:

- (1) Measurement Value = Reading Level + Correct Factor.
- (2) Margin Level = Measurement Value - Limit Value.

Test Mode: TX 2402 MHz \_CH00\_1Mbps

**Vertical**

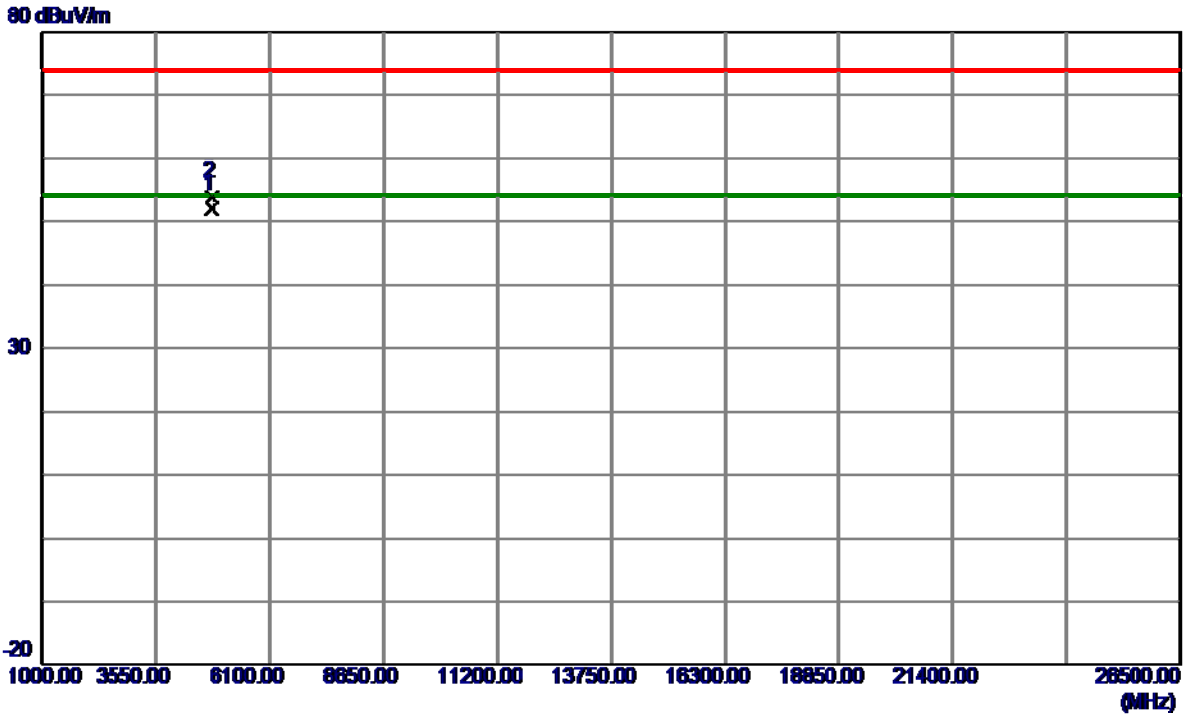

No.	Freq. MHz	Reading Level dBuV/m	Correct Factor dB	Measure ment dBuV/m	Limit dBuV/m	Margin dB	Detector	Comment
1 *	4803.9550	48.44	3.53	51.97	54.00	-2.03	AVG	
2	4804.1980	50.37	3.53	53.90	74.00	-20.10	Peak	

**REMARKS:**

(1) Measurement Value = Reading Level + Correct Factor.

(2) Margin Level = Measurement Value - Limit Value.

Test Mode: TX 2402 MHz \_CH00\_1Mbps

Horizontal

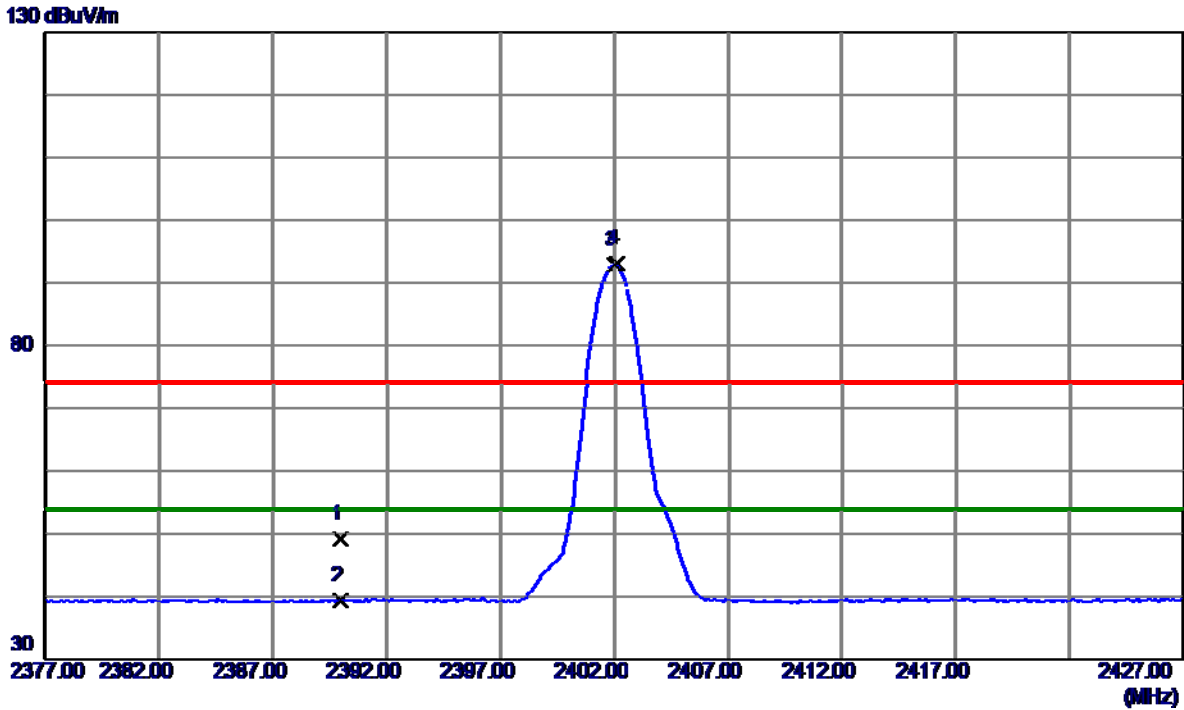

No.	Freq. MHz	Reading Level dBuV/m	Correct Factor dB	Measure ment dBuV/m	Limit dBuV/m	Margin dB	Detector	Comment
1	2390.0000	42.66	6.62	49.28	74.00	-24.72	Peak	
2	2390.0000	32.74	6.62	39.36	54.00	-14.64	AVG	
3 *	2402.0250	86.11	6.62	92.73	54.00	38.73	AVG	No Limit
4	2402.1250	86.44	6.62	93.06	74.00	19.06	Peak	No Limit

REMARKS:

- (1) Measurement Value = Reading Level + Correct Factor.
- (2) Margin Level = Measurement Value - Limit Value.



Test Mode: TX 2402 MHz \_CH00\_1Mbps

Horizontal

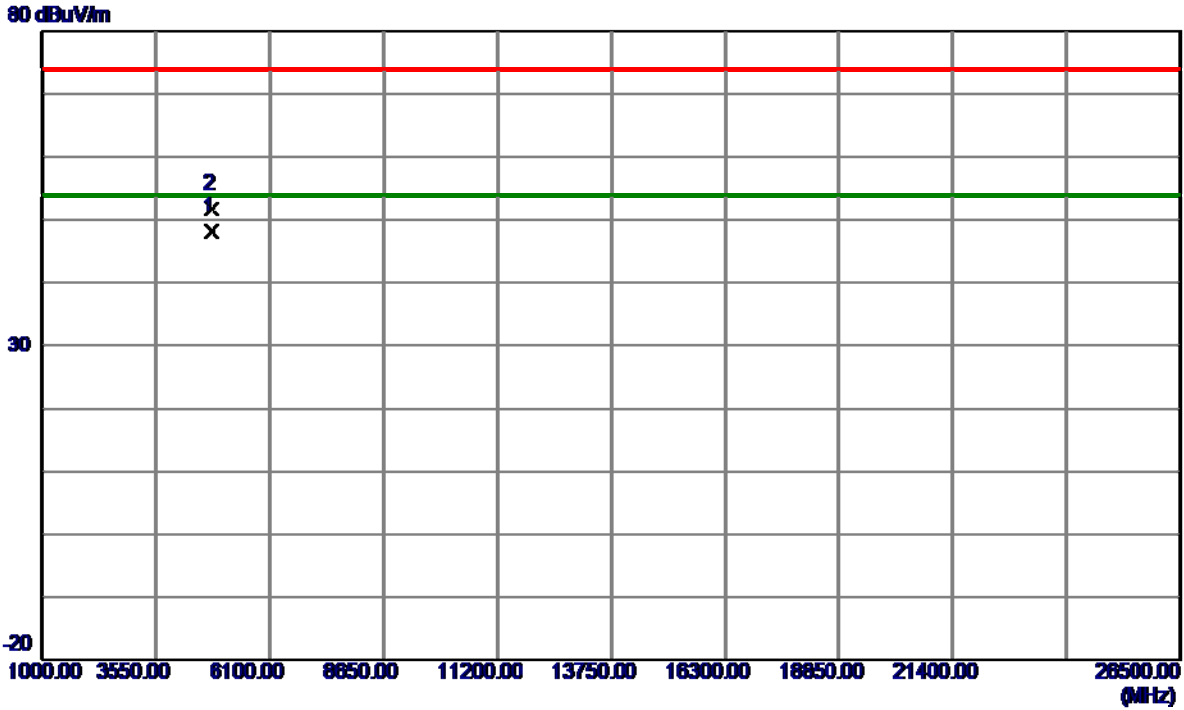

No.	Freq. MHz	Reading Level dBuV/m	Correct Factor dB	Measure ment dBuV/m	Limit dBuV/m	Margin dB	Detector	Comment
1 *	4803.9670	44.71	3.53	48.24	54.00	-5.76	AVC	
2	4804.2000	48.20	3.53	51.73	74.00	-22.27	Peak	

REMARKS:

- (1) Measurement Value = Reading Level + Correct Factor.
- (2) Margin Level = Measurement Value - Limit Value.

Test Mode: TX 2441 MHz \_CH39\_1Mbps

**Vertical**

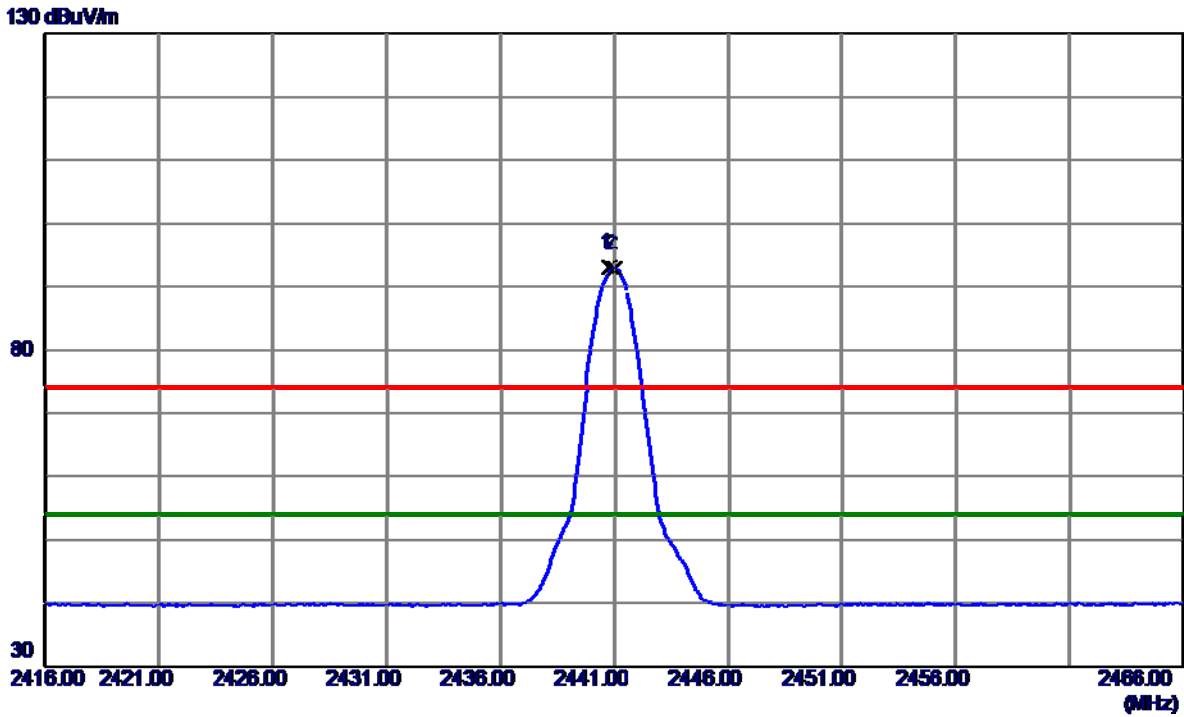

No.	Freq. MHz	Reading Level dBuV/m	Correct Factor dB	Measure ment dBuV/m	Limit dBuV/m	Margin dB	Detector	Comment
1	2440.7750	86.47	6.61	93.08	74.00	19.08	Peak	No Limit
2 *	2441.0250	86.15	6.61	92.76	54.00	38.76	AVG	No Limit

**REMARKS:**

- (1) Measurement Value = Reading Level + Correct Factor.
- (2) Margin Level = Measurement Value - Limit Value.

Test Mode: TX 2441 MHz \_CH39\_1Mbps

Vertical

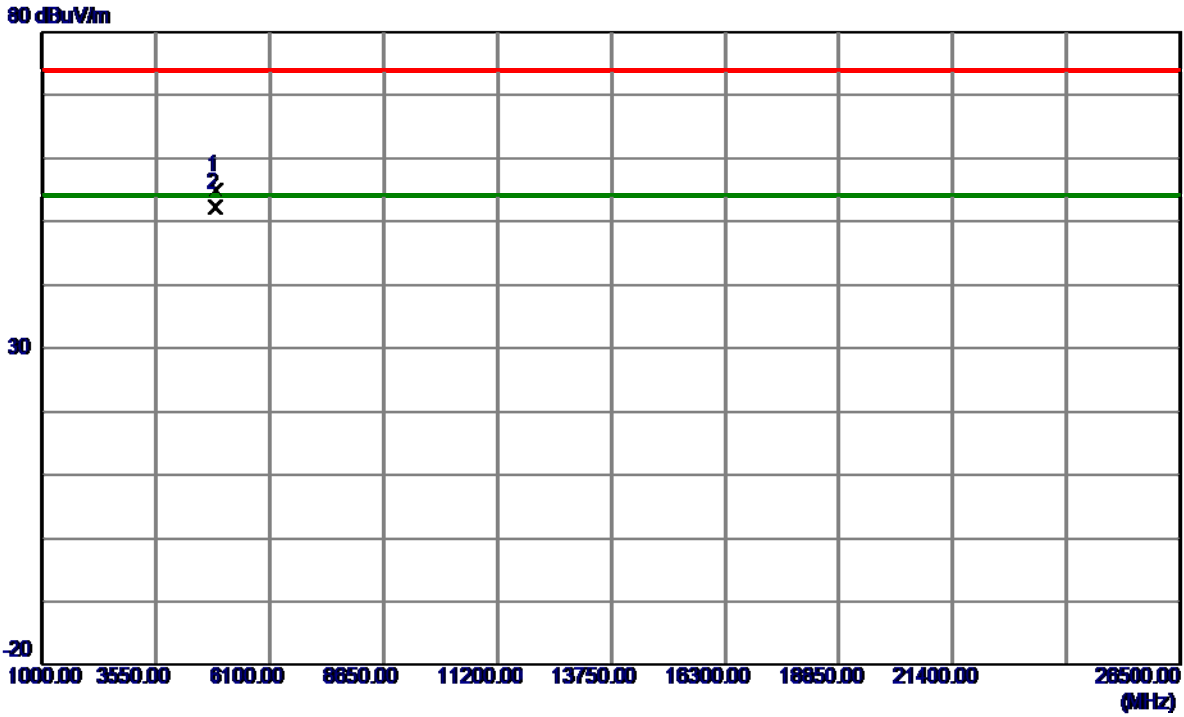

No.	Freq. MHz	Reading Level dBuV/m	Correct Factor dB	Measure ment dBuV/m	Limit dBuV/m	Margin dB	Detector	Comment
1	4881.6800	51.23	3.70	54.93	74.00	-19.07	Peak	
2 *	4881.8980	48.44	3.70	52.14	54.00	-1.86	AVG	

REMARKS:

(1) Measurement Value = Reading Level + Correct Factor.

(2) Margin Level = Measurement Value - Limit Value.

Test Mode: TX 2441 MHz \_CH39\_1Mbps

Horizontal

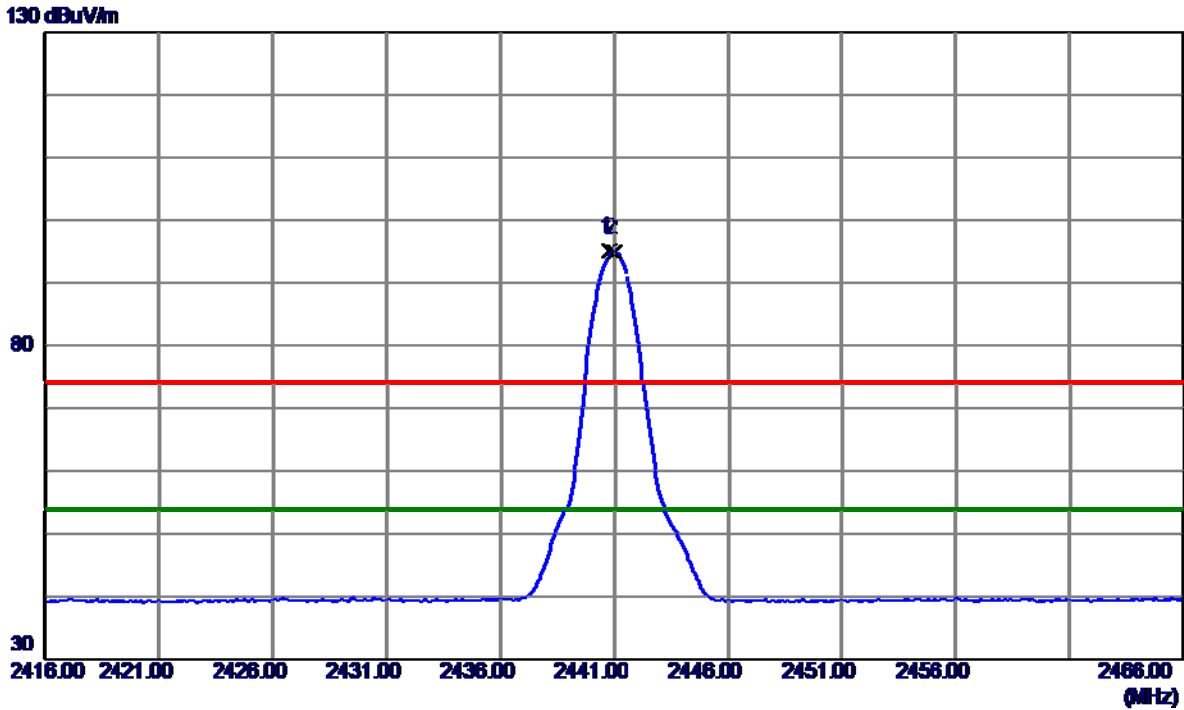

No.	Freq. MHz	Reading Level dBuV/m	Correct Factor dB	Measure ment dBuV/m	Limit dBuV/m	Margin dB	Detector	Comment
1	2440.8000	88.44	6.61	95.05	74.00	21.05	Peak	No Limit
2 *	2441.0250	88.15	6.61	94.76	54.00	40.76	AVG	No Limit

REMARKS:

- (1) Measurement Value = Reading Level + Correct Factor.
- (2) Margin Level = Measurement Value - Limit Value.

Test Mode: TX 2441 MHz \_CH39\_1Mbps

Horizontal

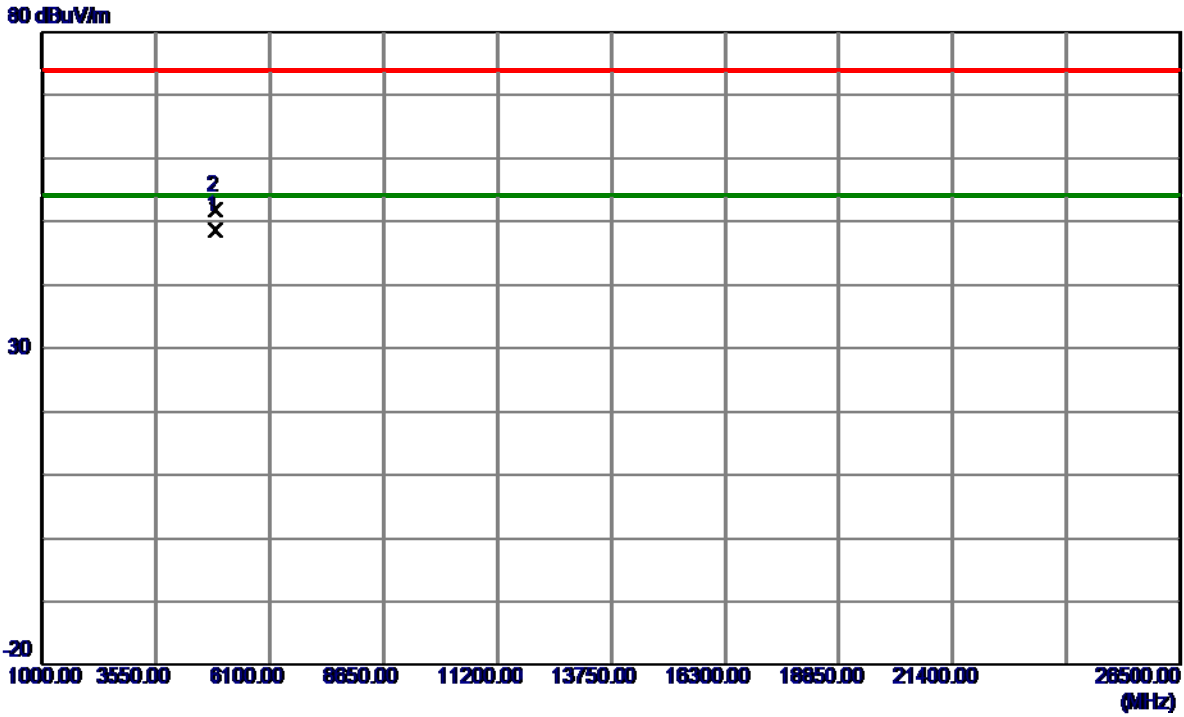

No.	Freq. MHz	Reading Level dBuV/m	Correct Factor dB	Measure ment dBuV/m	Limit dBuV/m	Margin dB	Detector	Comment
1 *	4881.8870	44.91	3.70	48.61	54.00	-5.39	AVG	
2	4881.9900	48.11	3.70	51.81	74.00	-22.19	Peak	

REMARKS:

(1) Measurement Value = Reading Level + Correct Factor.

(2) Margin Level = Measurement Value - Limit Value.

Test Mode: TX 2480 MHz \_CH78\_1Mbps

Vertical

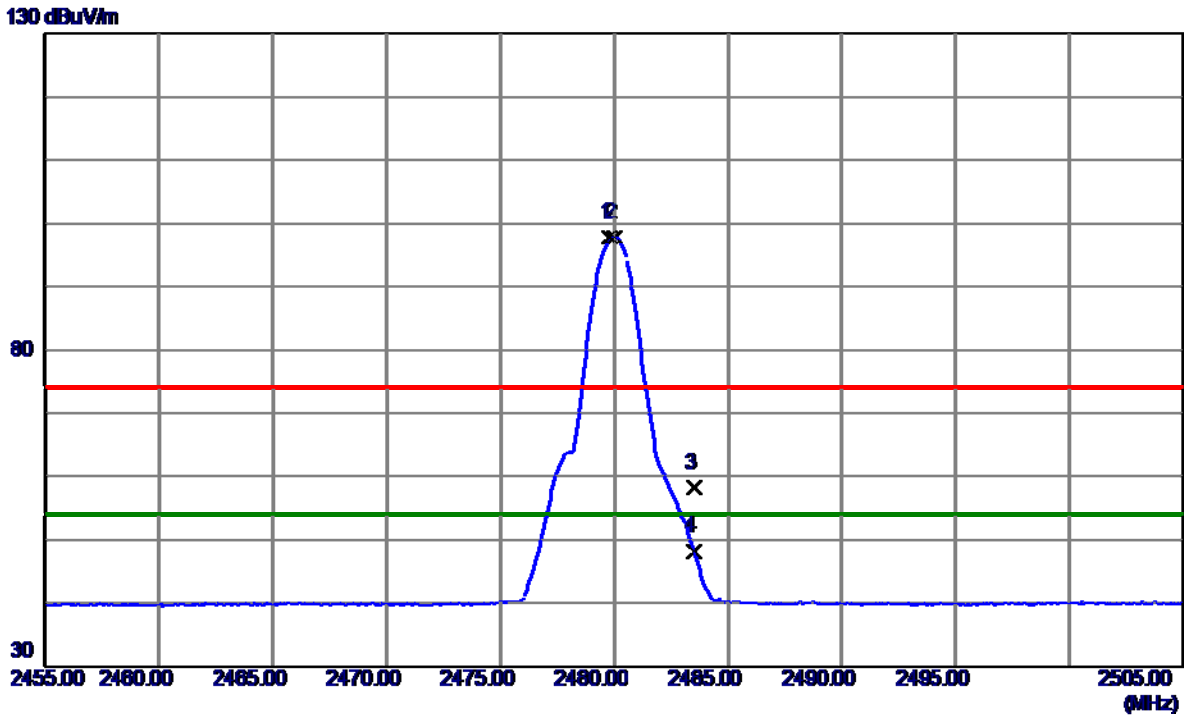

No.	Freq. MHz	Reading Level dBuV/m	Correct Factor dB	Measure ment dBuV/m	Limit dBuV/m	Margin dB	Detector	Comment
1	2479.7750	91.12	6.61	97.73	74.00	23.73	Peak	No Limit
2 *	2480.0000	91.22	6.61	97.83	54.00	43.83	AVG	No Limit
3	2483.5000	51.63	6.61	58.24	74.00	-15.76	Peak	
4	2483.5000	41.55	6.61	48.16	54.00	-5.84	AVG	

REMARKS:

(1) Measurement Value = Reading Level + Correct Factor.

(2) Margin Level = Measurement Value - Limit Value.

Test Mode: TX 2480 MHz \_CH78\_1Mbps

Vertical

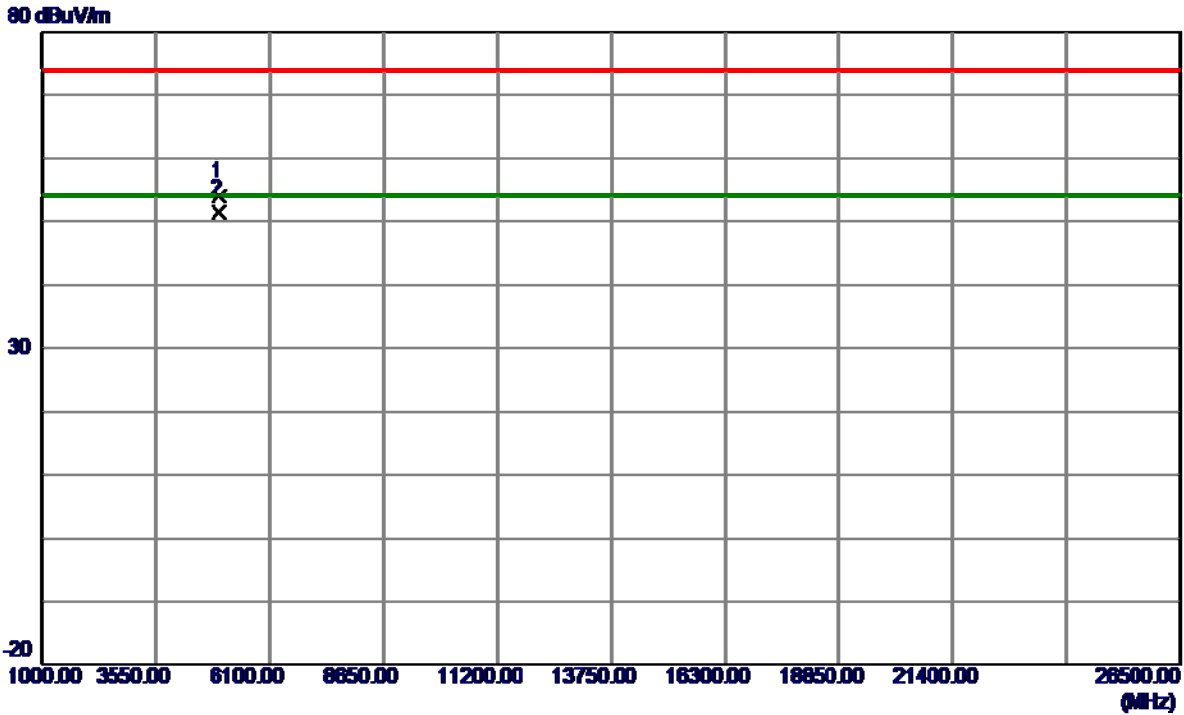

No.	Freq. MHz	Reading Level dBuV/m	Correct Factor dB	Measure ment dBuV/m	Limit dBuV/m	Margin dB	Detector	Comment
1	4959.5099	50.19	3.87	54.06	74.00	-19.94	Peak	
2 *	4959.9450	47.43	3.87	51.30	54.00	-2.70	AVG	

REMARKS:

(1) Measurement Value = Reading Level + Correct Factor.

(2) Margin Level = Measurement Value - Limit Value.

Test Mode: TX 2480 MHz \_CH78\_1Mbps

Horizontal

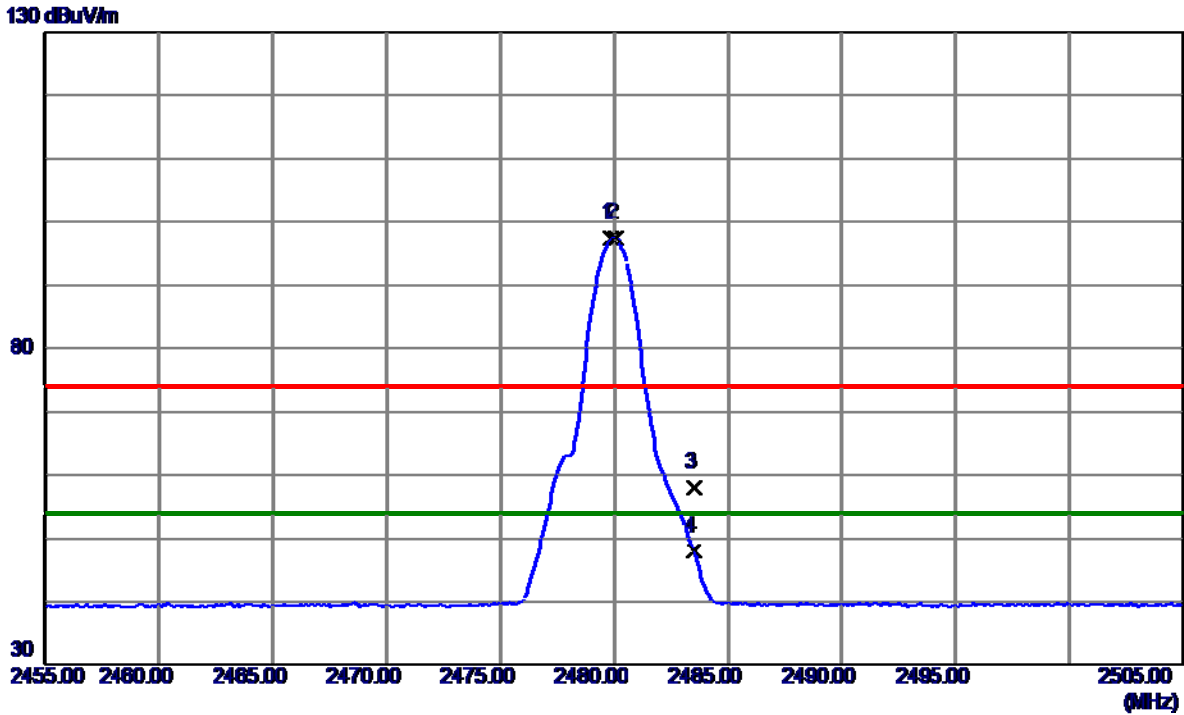

No.	Freq. MHz	Reading Level dBuV/m	Correct Factor dB	Measure ment dBuV/m	Limit dBuV/m	Margin dB	Detector	Comment
1	2479.8250	90.85	6.61	97.46	74.00	23.46	Peak	No Limit
2 *	2480.0500	90.79	6.61	97.40	54.00	43.40	AVG	No Limit
3	2483.5000	51.36	6.61	57.97	74.00	-16.03	Peak	
4	2483.5000	41.35	6.61	47.96	54.00	-6.04	AVG	

REMARKS:

(1) Measurement Value = Reading Level + Correct Factor.

(2) Margin Level = Measurement Value - Limit Value.



Test Mode: TX 2480 MHz \_CH78\_1Mbps

Horizontal

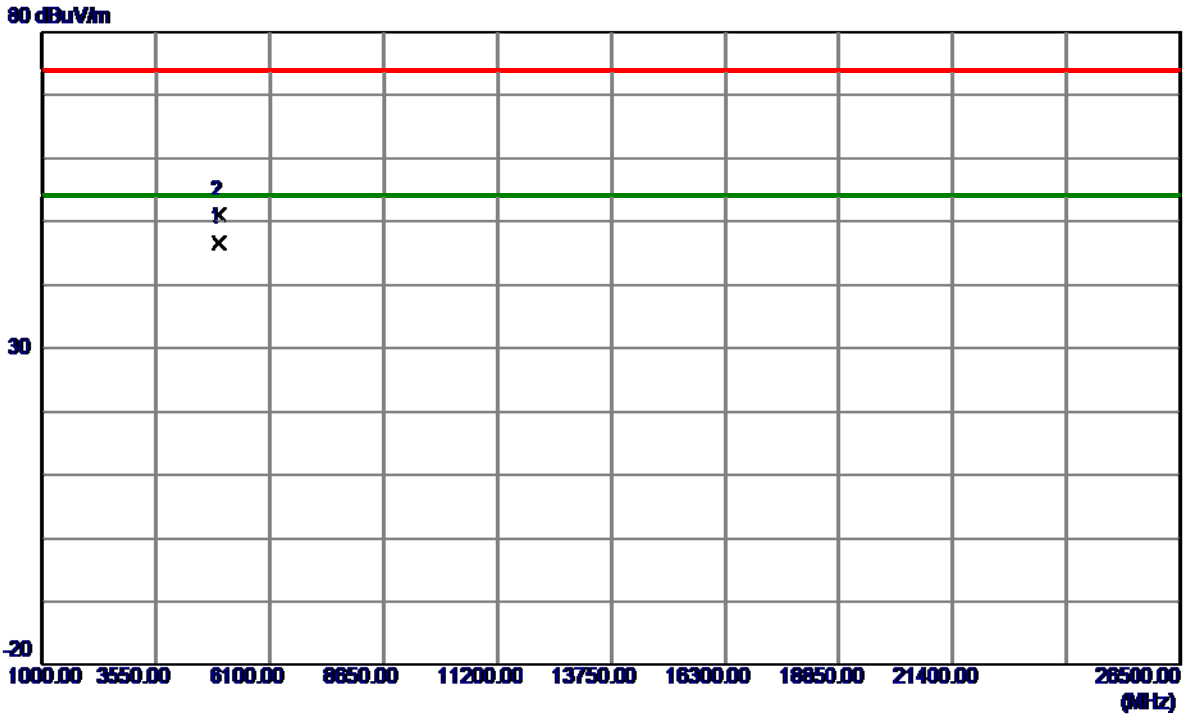

No.	Freq. MHz	Reading Level dBuV/m	Correct Factor dB	Measure ment dBuV/m	Limit dBuV/m	Margin dB	Detector	Comment
1 *	4959.9250	42.76	3.87	46.63	54.00	-7.37	AVG	
2	4960.3580	47.05	3.87	50.92	74.00	-23.08	Peak	

REMARKS:

(1) Measurement Value = Reading Level + Correct Factor.

(2) Margin Level = Measurement Value - Limit Value.

Test Mode: TX 2402 MHz \_CH00\_3Mbps

Vertical

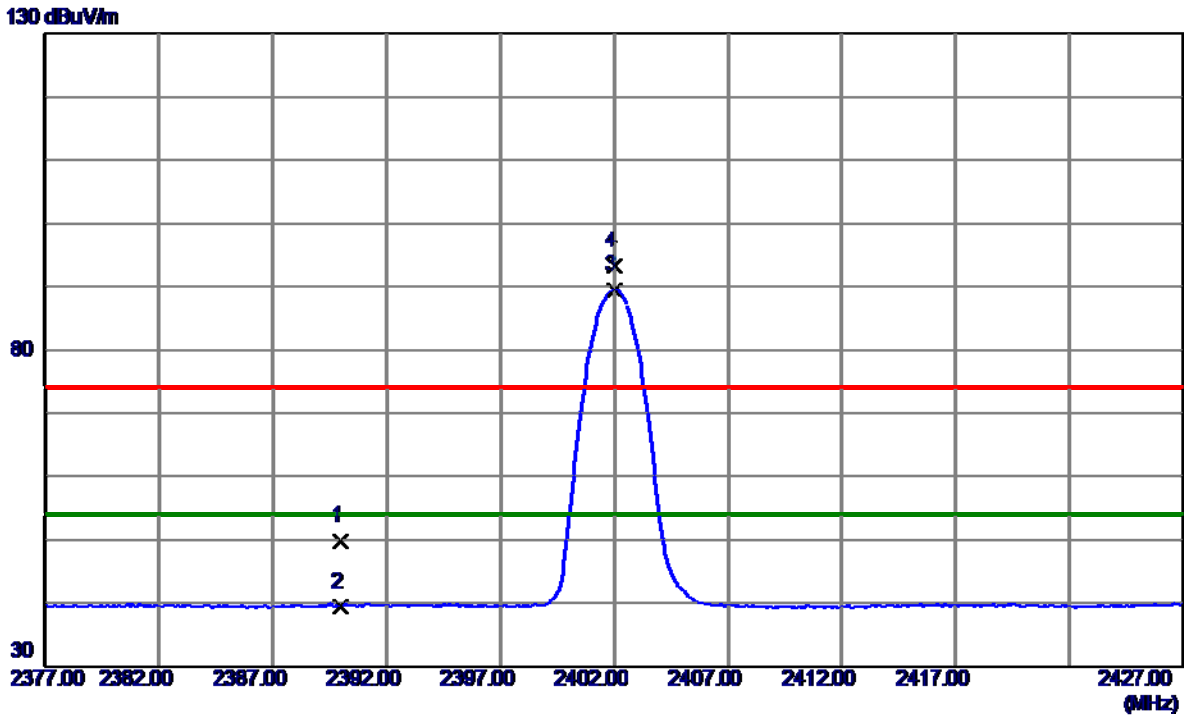

No.	Freq. MHz	Reading Level dBuV/m	Correct Factor dB	Measure ment dBuV/m	Limit dBuV/m	Margin dB	Detector	Comment
1	2390.0000	43.19	6.62	49.81	74.00	-24.19	Peak	
2	2390.0000	32.87	6.62	39.49	54.00	-14.51	AVG	
3 *	2401.9750	82.82	6.62	89.44	54.00	35.44	AVG	No Limit
4	2402.0250	86.49	6.62	93.11	74.00	19.11	Peak	No Limit

REMARKS:

(1) Measurement Value = Reading Level + Correct Factor.

(2) Margin Level = Measurement Value - Limit Value.

Test Mode: TX 2402 MHz \_CH00\_3Mbps

Vertical

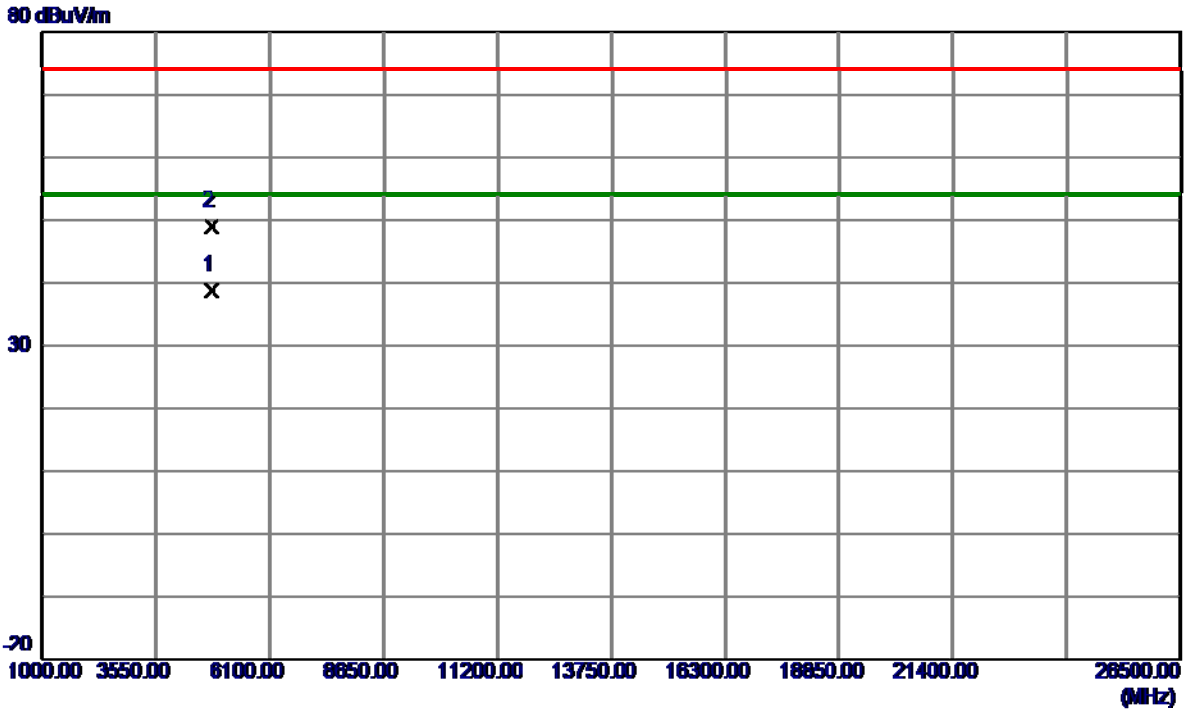

No.	Freq. MHz	Reading Level dBuV/m	Correct Factor dB	Measure ment dBuV/m	Limit dBuV/m	Margin dB	Detector	Comment
1 *	4803.8769	35.29	3.53	38.82	54.00	-15.18	AVG	
2	4803.9220	45.46	3.53	48.99	74.00	-25.01	Peak	

REMARKS:

- (1) Measurement Value = Reading Level + Correct Factor.
- (2) Margin Level = Measurement Value - Limit Value.

Test Mode: TX 2402 MHz \_CH00\_3Mbps

Horizontal

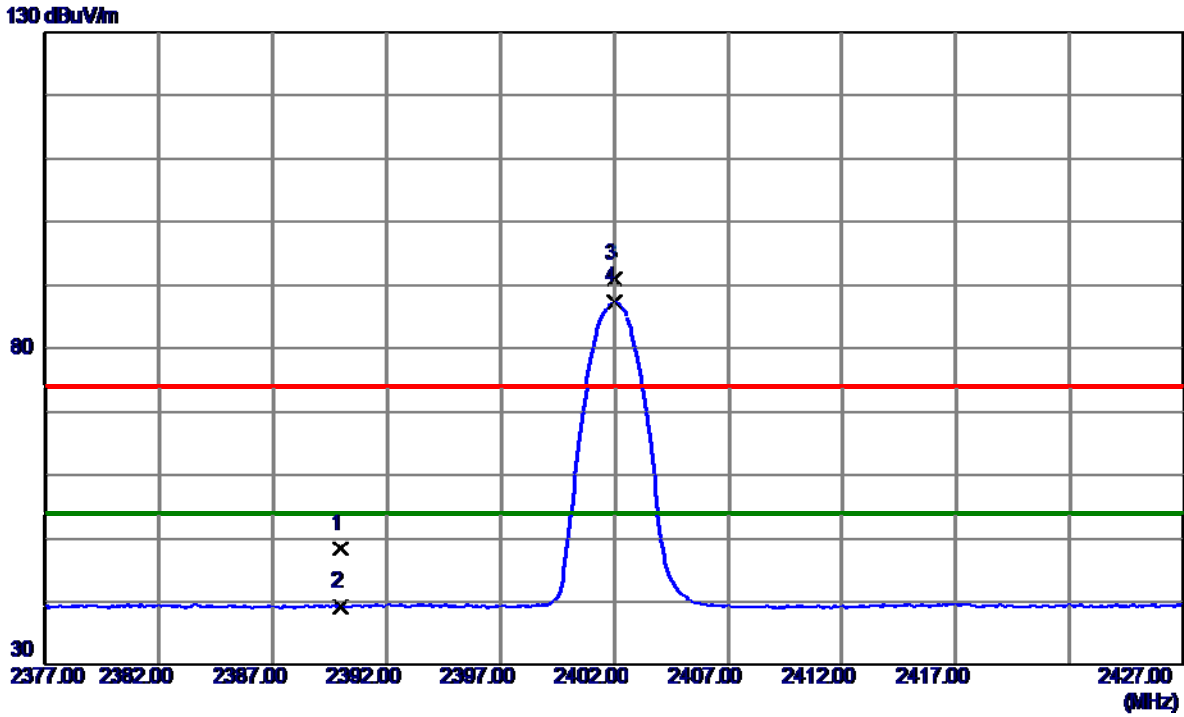

No.	Freq. MHz	Reading Level dBuV/m	Correct Factor dB	Measure ment dBuV/m	Limit dBuV/m	Margin dB	Detector	Comment
1	2390.0000	41.79	6.62	48.41	74.00	-25.59	Peak	
2	2390.0000	32.65	6.62	39.27	54.00	-14.73	AVG	
3	2402.0000	84.35	6.62	90.97	74.00	16.97	Peak	No Limit
4 *	2402.0250	80.72	6.62	87.34	54.00	33.34	AVG	No Limit

REMARKS:

(1) Measurement Value = Reading Level + Correct Factor.

(2) Margin Level = Measurement Value - Limit Value.

Test Mode: TX 2402 MHz \_CH00\_3Mbps

Horizontal

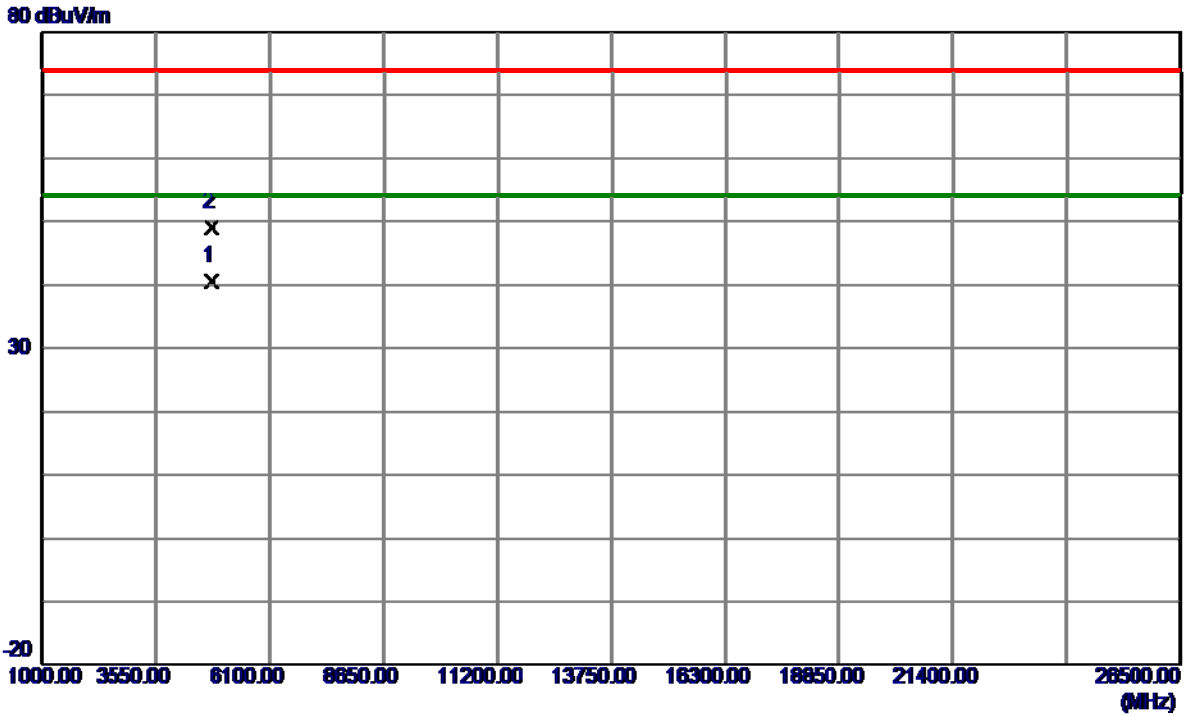

No.	Freq. MHz	Reading Level dBuV/m	Correct Factor dB	Measure ment dBuV/m	Limit dBuV/m	Margin dB	Detector	Comment
1 *	4803.9000	37.02	3.53	40.55	54.00	-13.45	AVG	
2	4804.5280	45.44	3.53	48.97	74.00	-25.03	Peak	

REMARKS:

(1) Measurement Value = Reading Level + Correct Factor.

(2) Margin Level = Measurement Value - Limit Value.

Test Mode: TX 2441 MHz \_CH39\_3Mbps

**Vertical**

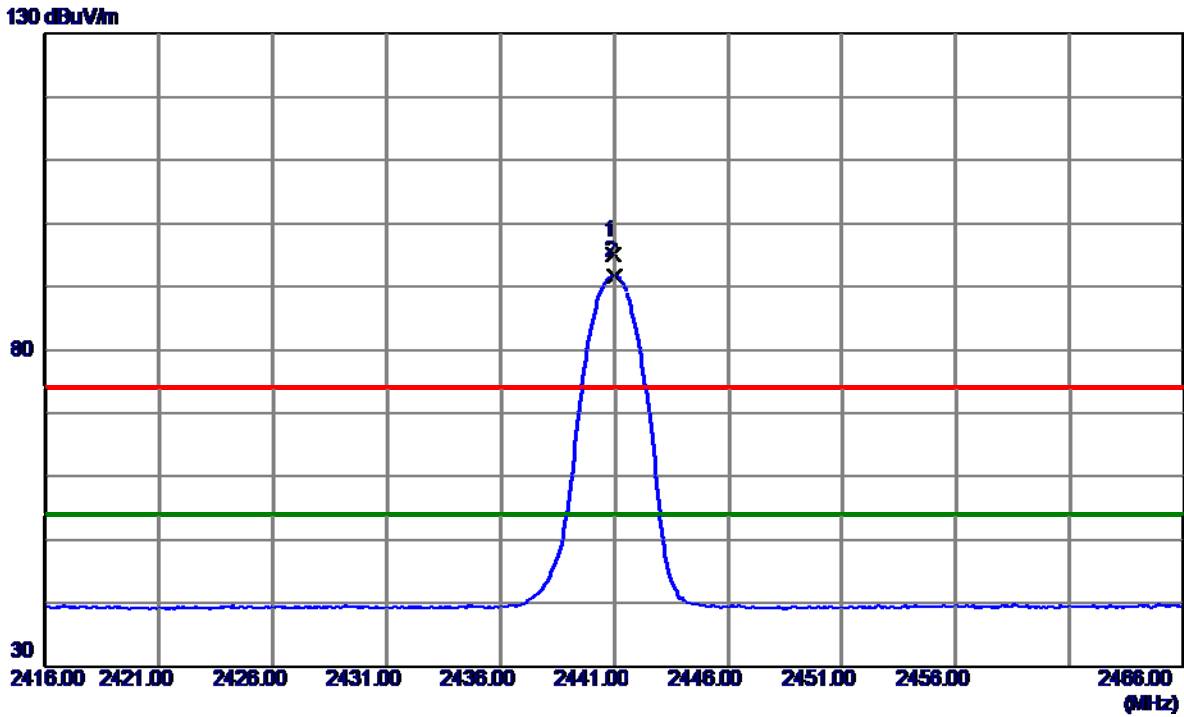

No.	Freq. MHz	Reading Level dBuV/m	Correct Factor dB	Measure ment dBuV/m	Limit dBuV/m	Margin dB	Detector	Comment
1	2440.9500	88.41	6.61	95.02	74.00	21.02	Peak	No Limit
2 *	2441.0000	85.08	6.61	91.69	54.00	37.69	AVG	No Limit

**REMARKS:**

(1) Measurement Value = Reading Level + Correct Factor.

(2) Margin Level = Measurement Value - Limit Value.

Test Mode: TX 2441 MHz \_CH39\_3Mbps

Vertical

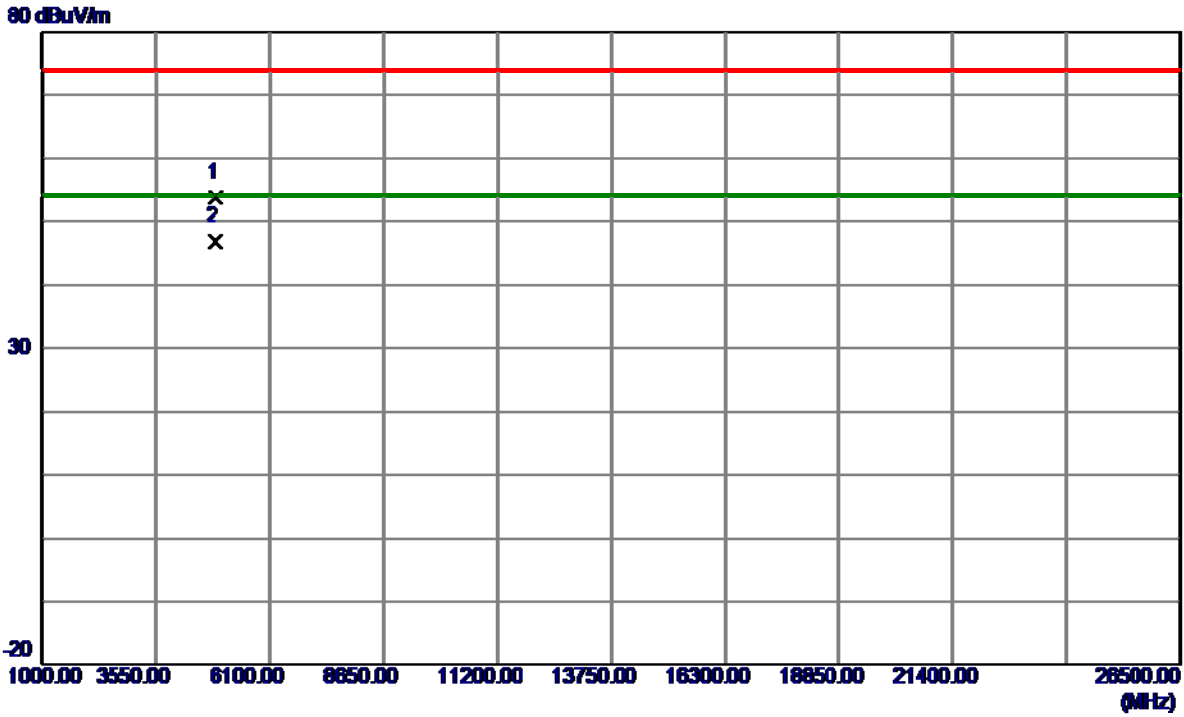

No.	Freq. MHz	Reading Level dBuV/m	Correct Factor dB	Measure ment dBuV/m	Limit dBuV/m	Margin dB	Detector	Comment
1	4881.7200	50.18	3.70	53.88	74.00	-20.12	Peak	
2 *	4881.8200	43.03	3.70	46.73	54.00	-7.27	AVG	

REMARKS:

(1) Measurement Value = Reading Level + Correct Factor.

(2) Margin Level = Measurement Value - Limit Value.

Test Mode: TX 2441 MHz \_CH39\_3Mbps

**Horizontal**

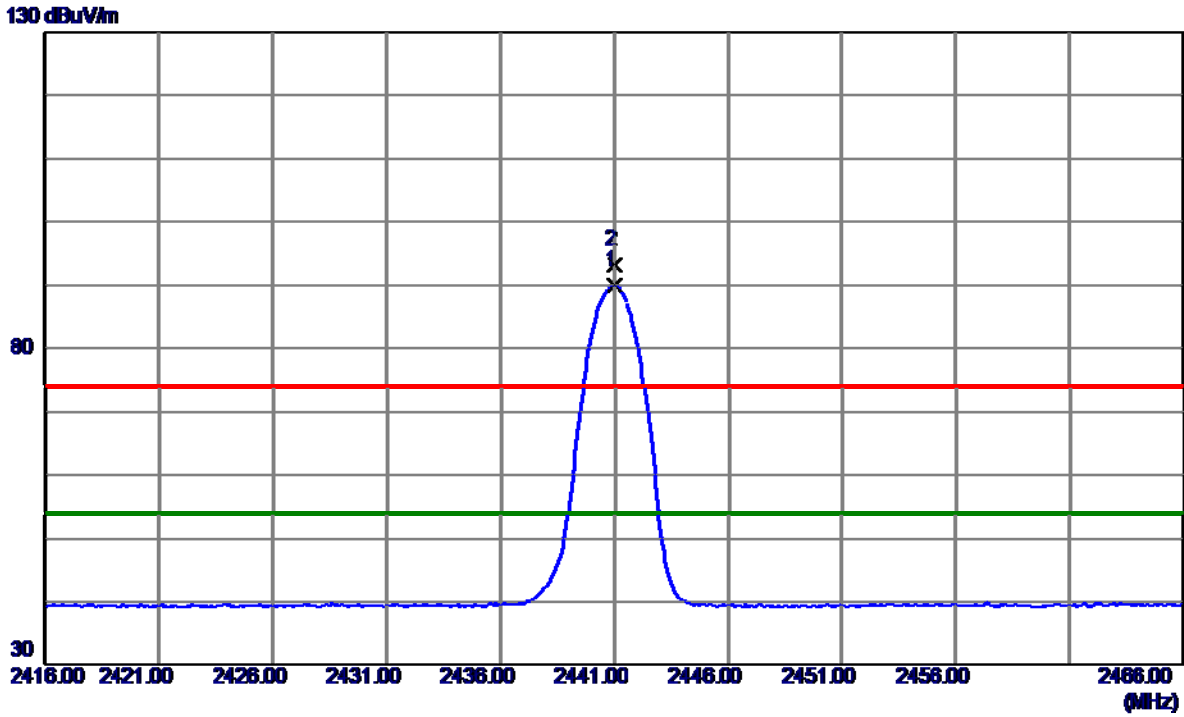

No.	Freq. MHz	Reading Level dBuV/m	Correct Factor dB	Measure ment dBuV/m	Limit dBuV/m	Margin dB	Detector	Comment
1 *	2440.9750	83.29	6.61	89.90	54.00	35.90	AVG	No Limit
2	2441.0250	86.59	6.61	93.20	74.00	19.20	Peak	No Limit

**REMARKS:**

(1) Measurement Value = Reading Level + Correct Factor.

(2) Margin Level = Measurement Value - Limit Value.



Test Mode: TX 2441 MHz \_CH39\_3Mbps

Horizontal

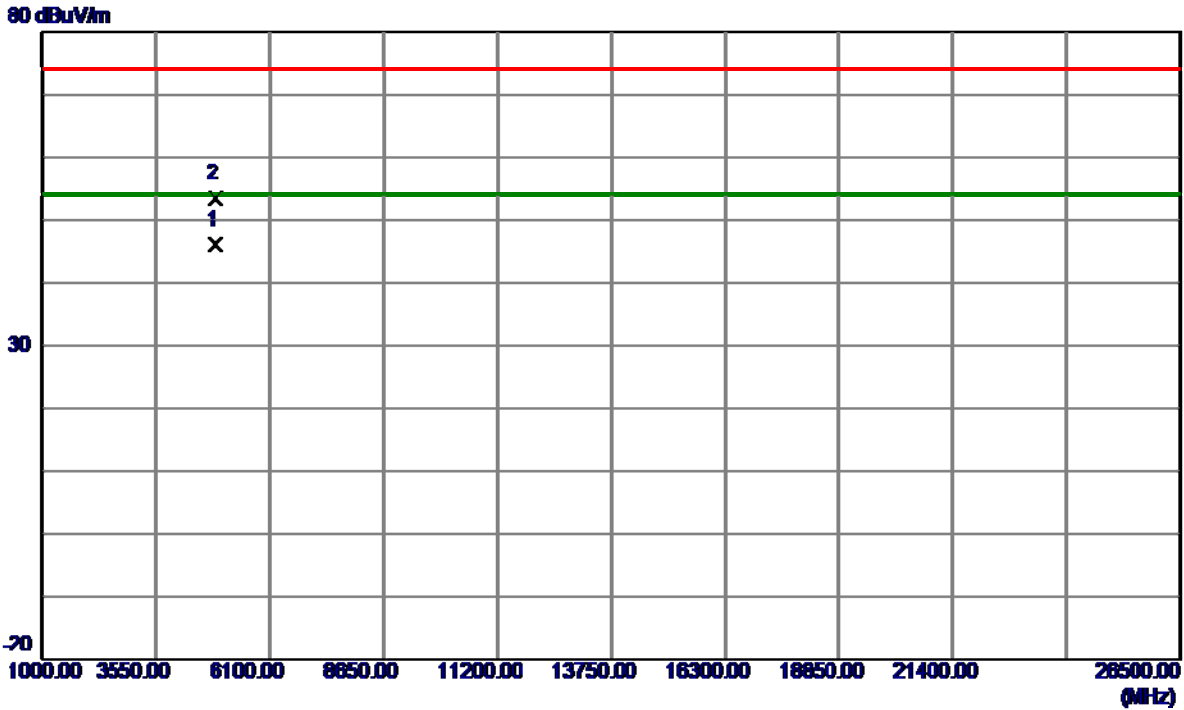

No.	Freq. MHz	Reading Level dBuV/m	Correct Factor dB	Measure ment dBuV/m	Limit dBuV/m	Margin dB	Detector	Comment
1 *	4881.8550	42.25	3.70	45.95	54.00	-8.05	AVG	
2	4882.3000	49.62	3.70	53.32	74.00	-20.68	Peak	

REMARKS:

- (1) Measurement Value = Reading Level + Correct Factor.
- (2) Margin Level = Measurement Value - Limit Value.

Test Mode: TX 2480 MHz \_CH78\_ 3Mbps

Vertical

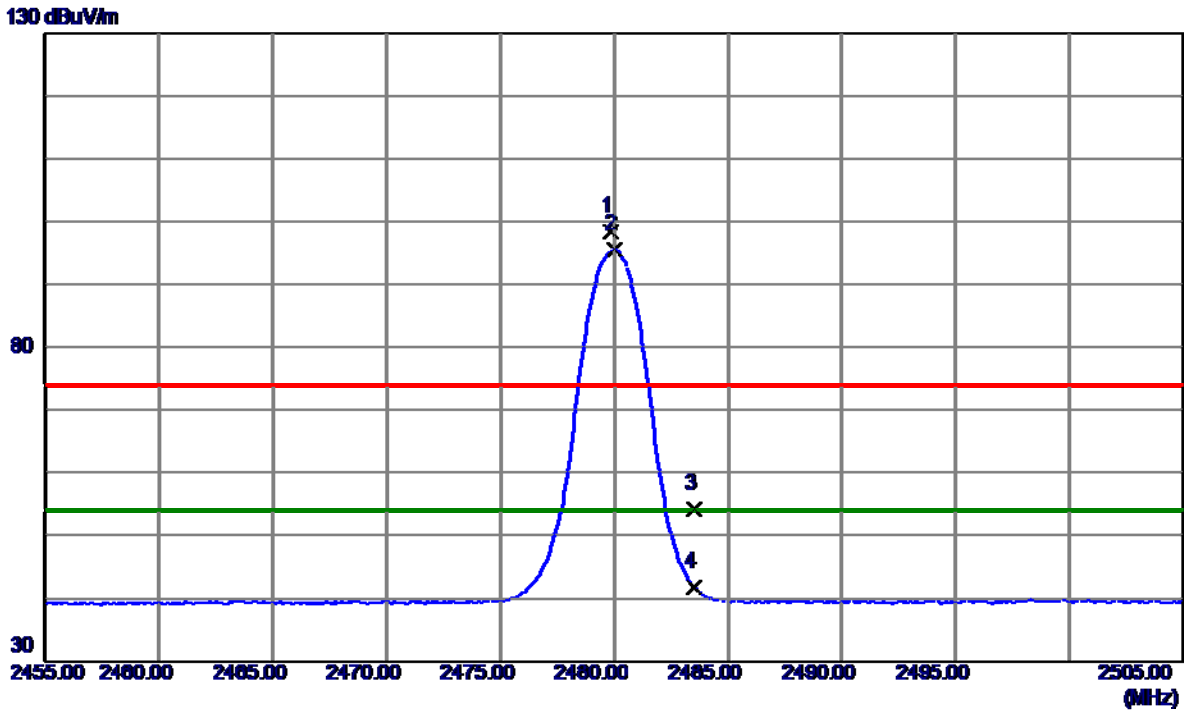

No.	Freq. MHz	Reading Level dBuV/m	Correct Factor dB	Measure ment dBuV/m	Limit dBuV/m	Margin dB	Detector	Comment
1	2479.8250	91.75	6.61	98.36	74.00	24.36	Peak	No Limit
2 *	2480.0000	88.92	6.61	95.53	54.00	41.53	AVG	No Limit
3	2483.5000	47.59	6.61	54.20	74.00	-19.80	Peak	
4	2483.5000	35.22	6.61	41.83	54.00	-12.17	AVG	

REMARKS:

- (1) Measurement Value = Reading Level + Correct Factor.
- (2) Margin Level = Measurement Value - Limit Value.

Test Mode: TX 2480 MHz \_CH78\_3Mbps

Vertical

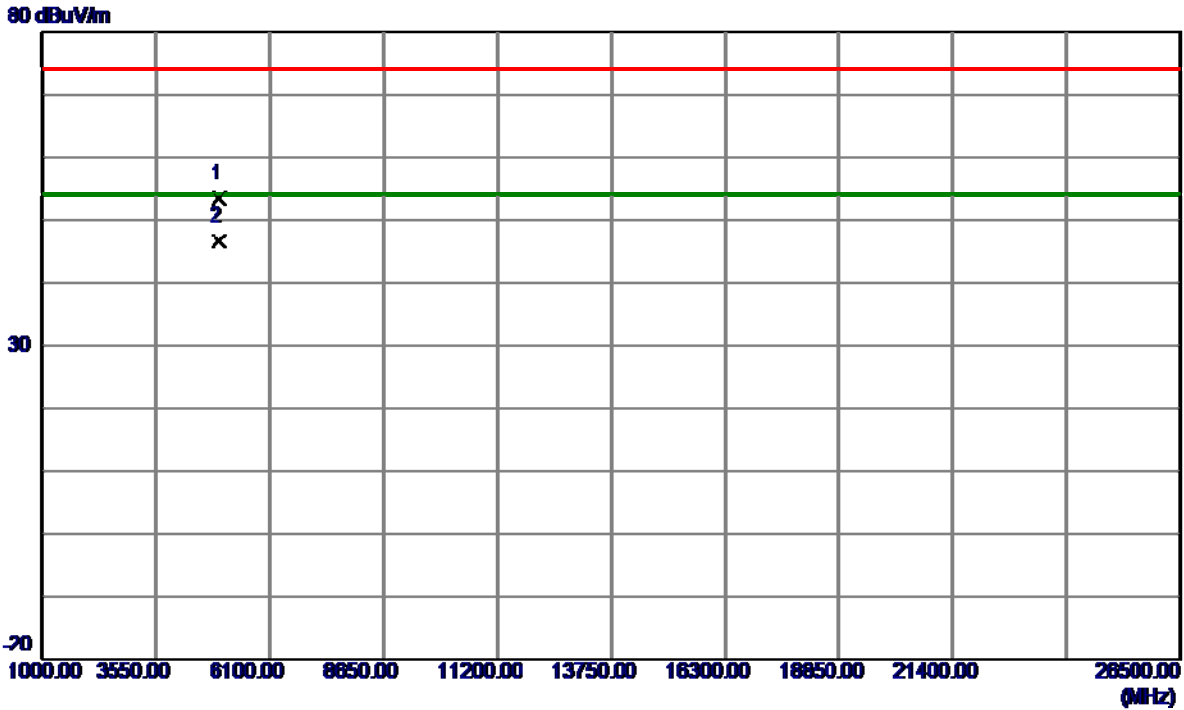

No.	Freq. MHz	Reading Level dBuV/m	Correct Factor dB	Measure ment dBuV/m	Limit dBuV/m	Margin dB	Detector	Comment
1	4959.3900	49.44	3.87	53.31	74.00	-20.69	Peak	
2 *	4959.9450	42.79	3.87	46.66	54.00	-7.34	AVG	

REMARKS:

- (1) Measurement Value = Reading Level + Correct Factor.
- (2) Margin Level = Measurement Value - Limit Value.

Test Mode: TX 2480 MHz \_CH78\_ 3Mbps

**Horizontal**

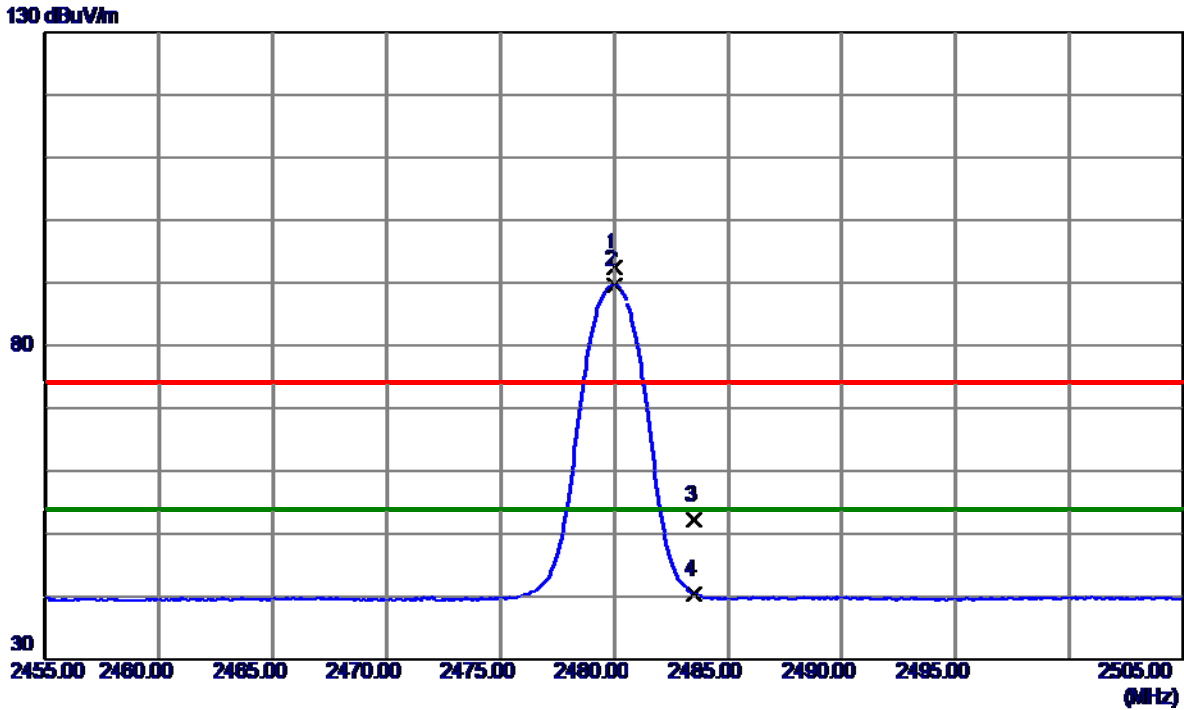

No.	Freq. MHz	Reading Level dBuV/m	Correct Factor dB	Measure ment dBuV/m	Limit dBuV/m	Margin dB	Detector	Comment
1	2480.0250	85.80	6.61	92.41	74.00	18.41	Peak	No Limit
2 *	2480.0250	83.04	6.61	89.65	54.00	35.65	AVG	No Limit
3	2483.5000	45.66	6.61	52.27	74.00	-21.73	Peak	
4	2483.5000	33.82	6.61	40.43	54.00	-13.57	AVG	

**REMARKS:**

- (1) Measurement Value = Reading Level + Correct Factor.
- (2) Margin Level = Measurement Value - Limit Value.

Test Mode: TX 2480 MHz \_CH78\_3Mbps

Horizontal

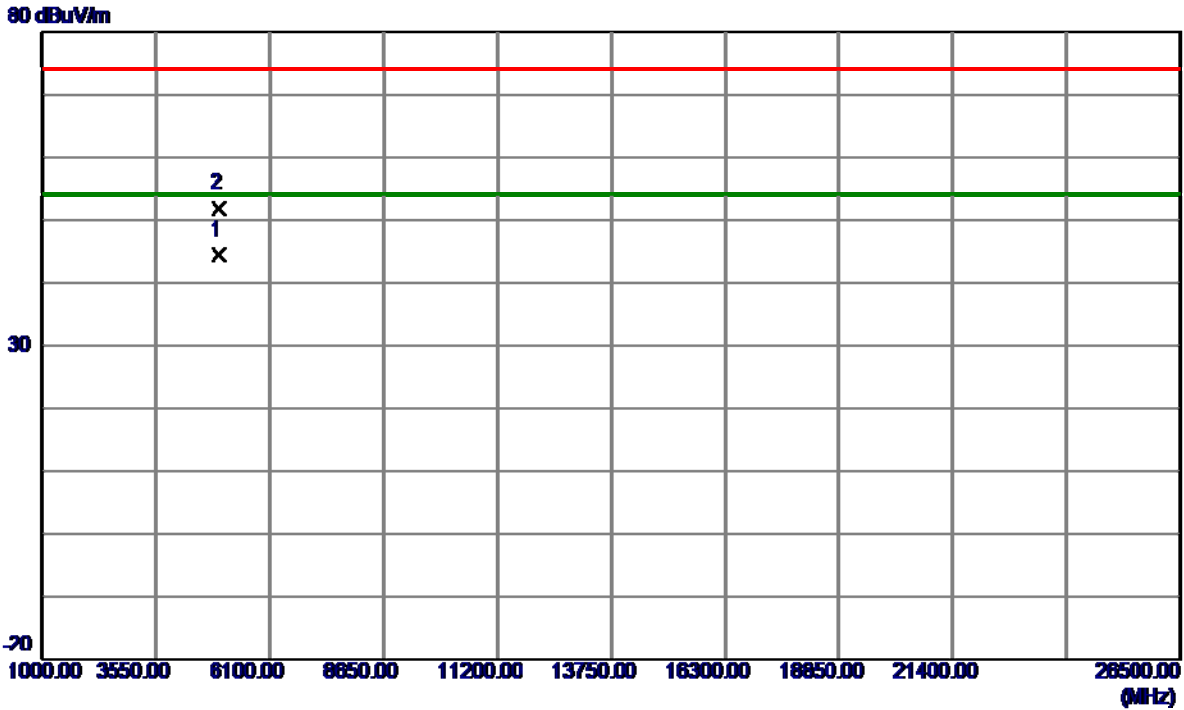

No.	Freq. MHz	Reading Level dBuV/m	Correct Factor dB	Measure ment dBuV/m	Limit dBuV/m	Margin dB	Detector	Comment
1 *	4959.8400	40.57	3.87	44.44	54.00	-9.56	AVG	
2	4960.1530	48.01	3.87	51.88	74.00	-22.12	Peak	

REMARKS:

- (1) Measurement Value = Reading Level + Correct Factor.
- (2) Margin Level = Measurement Value - Limit Value.

## APPENDIX E - NUMBER OF HOPPING FREQUENCY

Test Mode	Hopping Mode_1Mbps
Number of Hopping Frequency	79

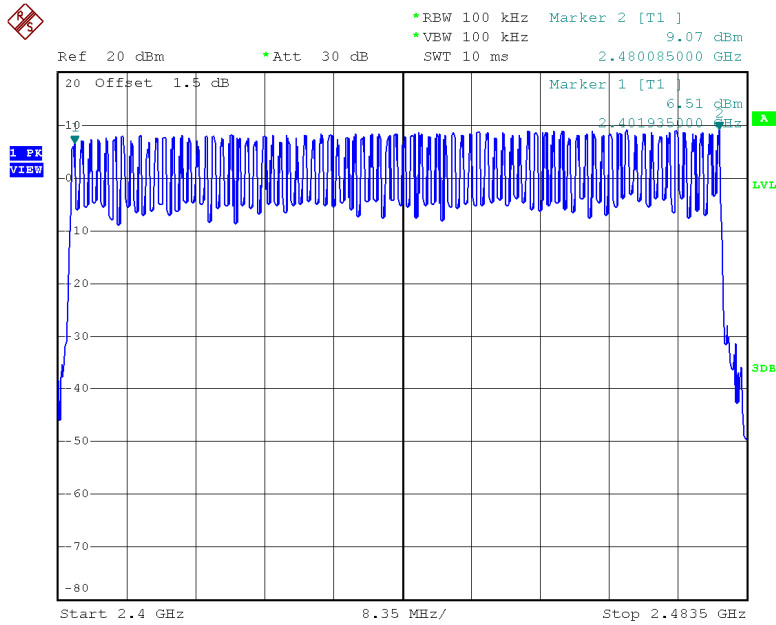

Date: 21.DEC.2018 09:58:34

Test Mode	Hopping Mode_3Mbps
Number of Hopping Frequency	79

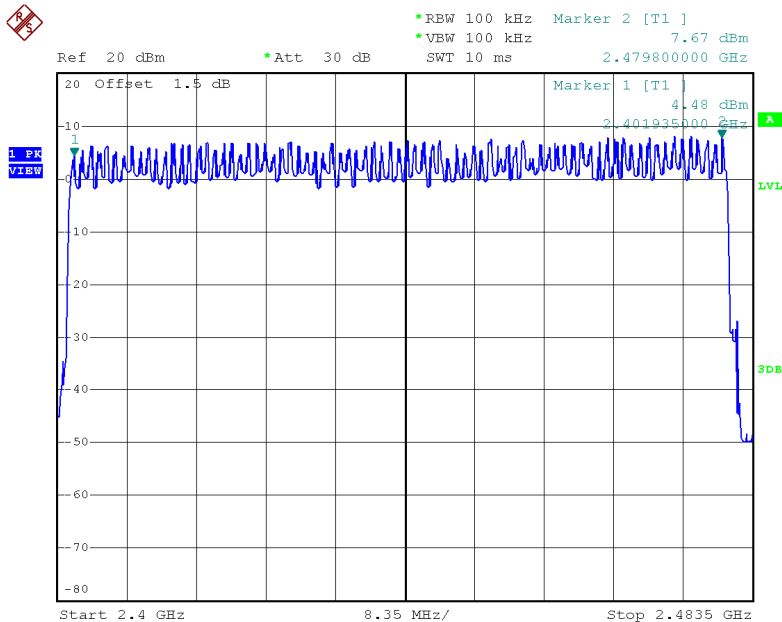

Date: 21.DEC.2018 09:11:20

## APPENDIX F - AVERAGE TIME OF OCCUPANCY



Test Mode:	TX Mode_1Mbps
------------	---------------

Data Packet	Frequency (MHz)	Pulse Duration (ms)	Dwell Time (s)	Limits (s)	Test Result
DH5	2402	2.9200	0.3115	0.4000	Pass
DH3	2402	1.6600	0.2656	0.4000	Pass
DH1	2402	0.3900	0.1248	0.4000	Pass
DH5	2441	2.9200	0.3115	0.4000	Pass
DH3	2441	1.6600	0.2656	0.4000	Pass
DH1	2441	0.3900	0.1248	0.4000	Pass
DH5	2480	2.9200	0.3115	0.4000	Pass
DH3	2480	1.6600	0.2656	0.4000	Pass
DH1	2480	0.3850	0.1232	0.4000	Pass

### CH00-DH1

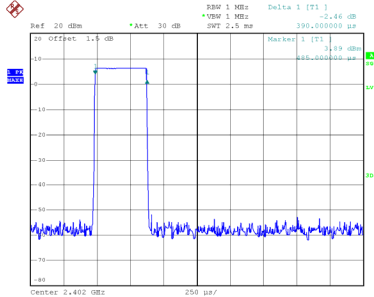

Date: 21.DEC.2018 09:39:46

### CH39-DH1

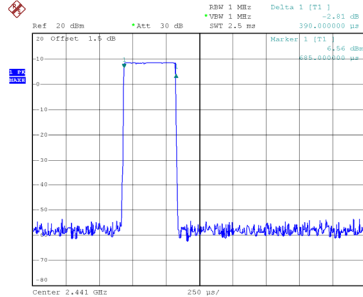

Date: 21.DEC.2018 09:47:36

### CH78-DH1

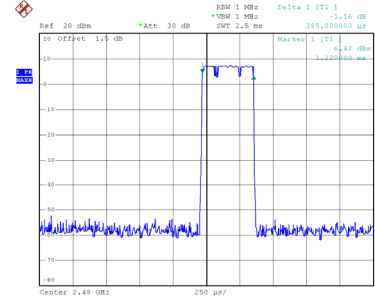

Date: 21.DEC.2018 09:53:19

### CH00-DH3

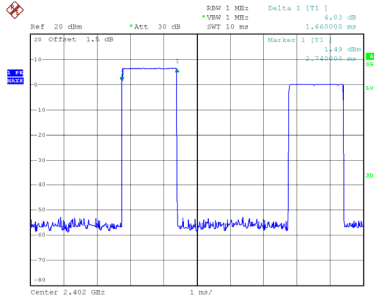

Date: 21.DEC.2018 10:03:19

### CH39-DH3

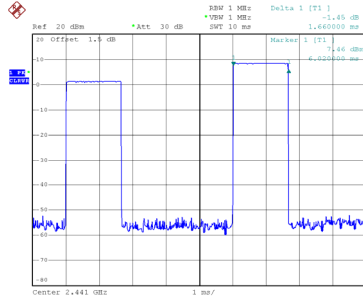

Date: 21.DEC.2018 10:06:01

### CH78-DH3

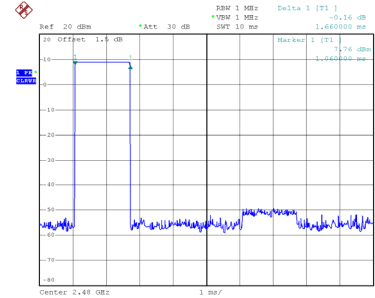

Date: 21.DEC.2018 10:06:08

### CH00-DH5

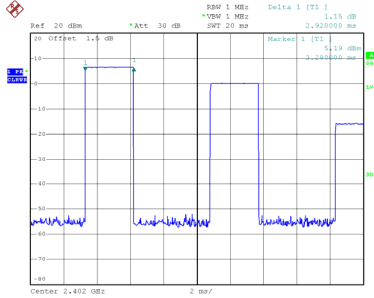

Date: 21.DEC.2018 10:07:18

### CH39-DH5

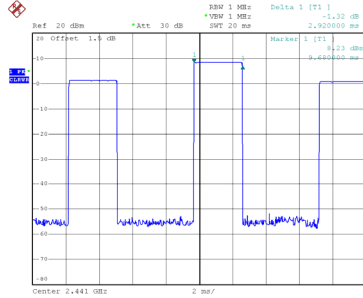

Date: 21.DEC.2018 10:07:23

### CH78-DH5

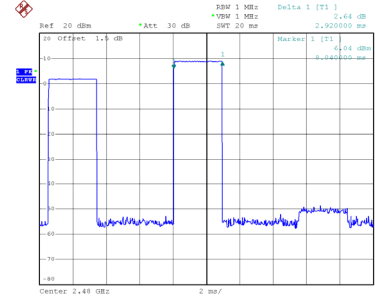

Date: 21.DEC.2018 10:13:02

Test Mode:	TX Mode_3Mbps
------------	---------------

Data Packet	Frequency	Pulse Duration(ms)	Dwell Time(s)	Limits(s)	Test Result
DH5	2402	2.8800	0.3072	0.4000	Pass
DH3	2402	1.6400	0.2624	0.4000	Pass
DH1	2402	0.3850	0.1232	0.4000	Pass
DH5	2441	2.8800	0.3072	0.4000	Pass
DH3	2441	1.6400	0.2624	0.4000	Pass
DH1	2441	0.3900	0.1248	0.4000	Pass
DH5	2480	2.9200	0.3115	0.4000	Pass
DH3	2480	1.6400	0.2624	0.4000	Pass
DH1	2480	0.3950	0.1264	0.4000	Pass

### CH00-DH1

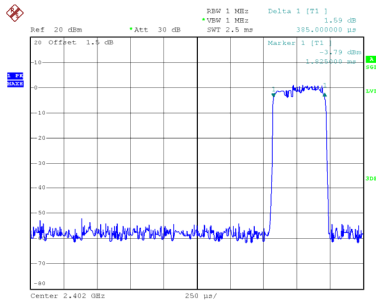

Date: 21.DEC.2018 09:02:40

### CH39-DH1

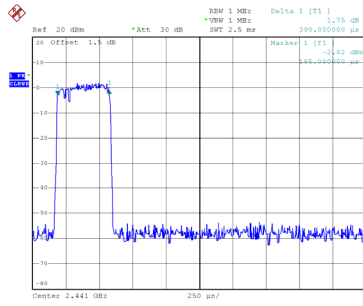

Date: 21.DEC.2018 09:02:50

### CH78-DH1

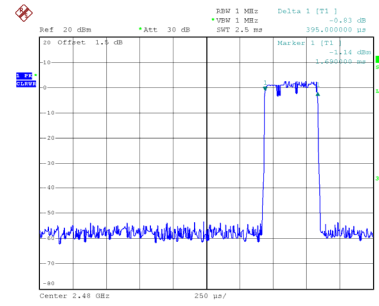

Date: 21.DEC.2018 09:02:57

### CH00-DH3

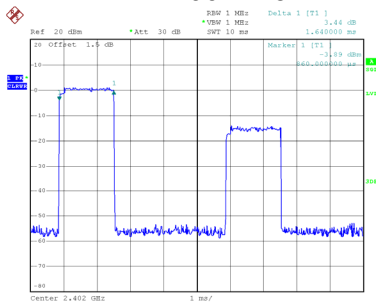

Date: 21.DEC.2018 09:19:31

### CH39-DH3

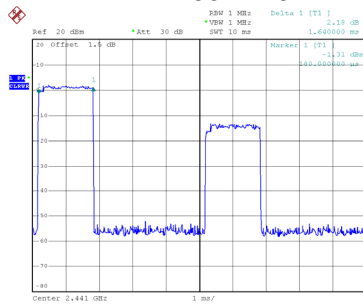

Date: 21.DEC.2018 09:19:38

### CH78-DH3

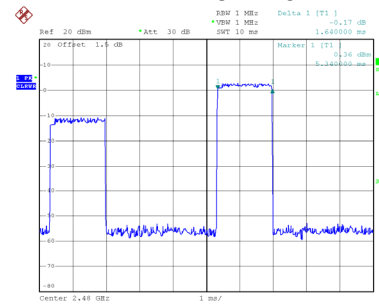

Date: 21.DEC.2018 09:19:43

### CH00-DH5

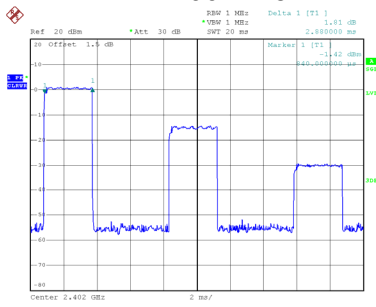

Date: 21.DEC.2018 09:21:24

### CH39-DH5

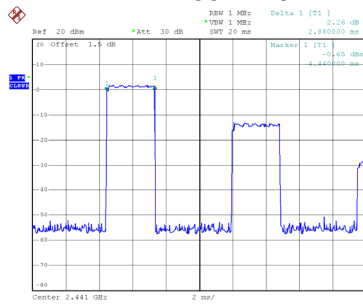

Date: 21.DEC.2018 09:21:29

### CH78-DH5

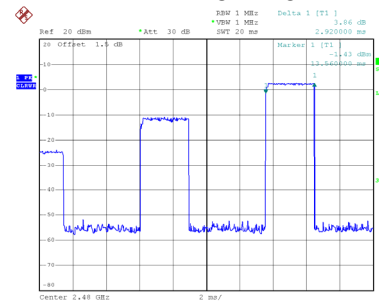

Date: 21.DEC.2018 09:23:03

# APPENDIX G - HOPPING CHANNEL SEPARATION MEASUREMENT

Test Mode: Hopping on \_1Mbps

Channel	Frequency (MHz)	Channel Separation (MHz)	2/3 of 20 dB Bandwidth (MHz)	Test Result
00	2402	1.161	0.639	Pass
39	2441	0.996	0.660	Pass
78	2480	1.161	0.672	Pass

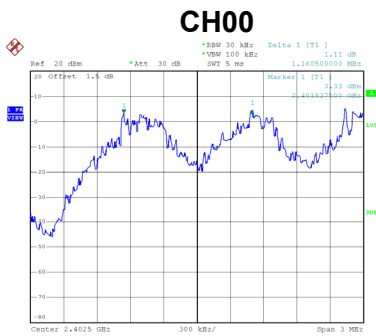

Date: 21.Dec.2018 09:54:29

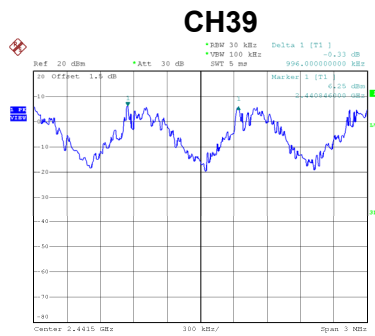

Date: 21.Dec.2018 09:55:34

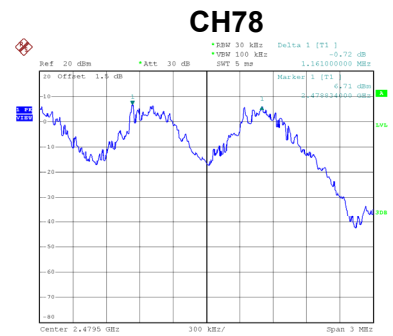

Date: 21.Dec.2018 09:56:44

Test Mode: Hopping on \_3Mbps

Channel	Frequency (MHz)	Channel Separation (MHz)	2/3 of 20 dB Bandwidth (MHz)	Test Result
00	2402	0.993	0.871	Pass
39	2441	1.002	0.859	Pass
78	2480	0.993	0.861	Pass

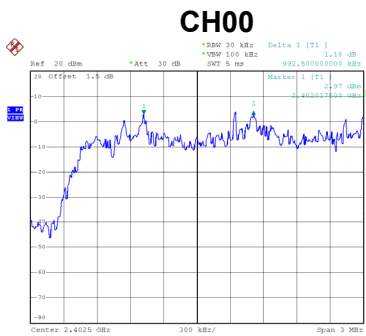

Date: 21.DEC.2018 09:04:07

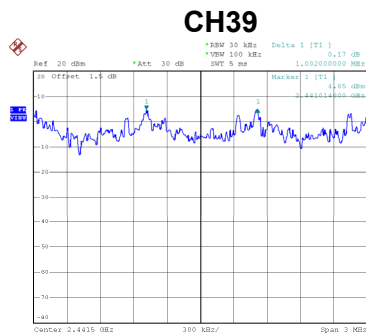

Date: 21.DEC.2018 09:05:12

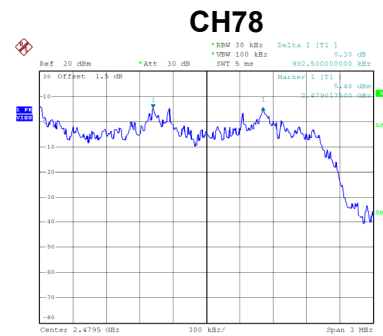

Date: 21.DEC.2018 09:09:30

# APPENDIX H - BANDWIDTH



Test Mode: TX Mode \_1Mbps

Channel	Frequency (MHz)	20 dB Bandwidth (MHz)	99 % Emission Bandwidth (MHz)
00	2402	0.958	0.864
39	2441	0.990	0.864
78	2480	1.008	0.876

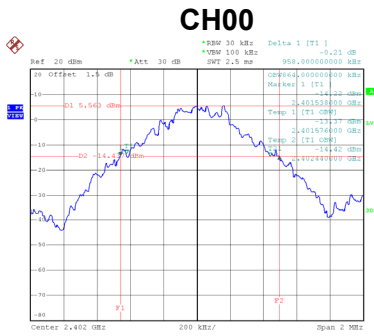

Date: 21.DEC.2018 09:28:40

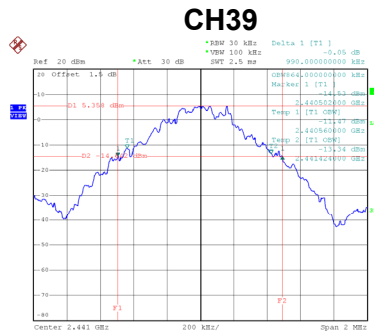

Date: 21.DEC.2018 09:33:34

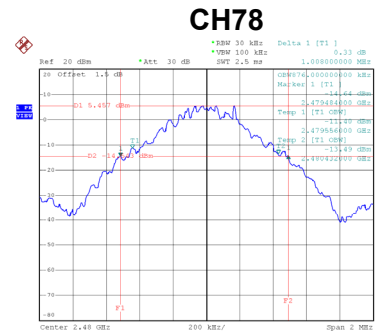

Date: 21.DEC.2018 09:37:17

Test Mode: TX Mode \_3Mbps

Channel	Frequency (MHz)	20 dB Bandwidth (MHz)	99 % Emission Bandwidth (MHz)
00	2402	1.306	1.188
39	2441	1.288	1.192
78	2480	1.292	1.196

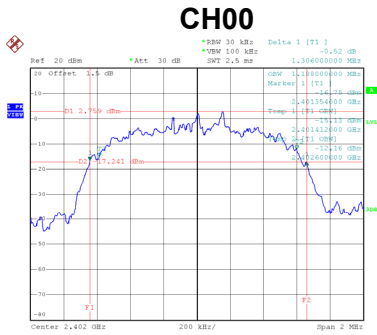

Date: 21.DEC.2018 08:48:28

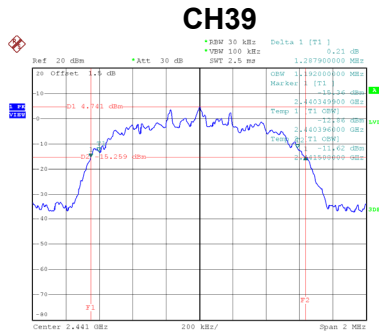

Date: 21.DEC.2018 08:57:08

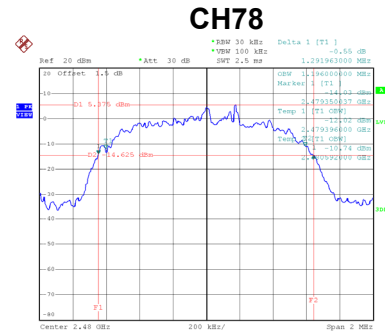

Date: 21.DEC.2018 09:00:27

## APPENDIX I - MAXIMUM OUTPUT POWER

Test Mode: TX Mode \_1Mbps

Channel	Frequency (MHz)	Output Power (dBm)	Output Power (W)	Max. Limit (dBm)	Max. Limit (W)	Test Result
00	2402	7.28	0.0053	21.00	0.125	Pass
39	2441	9.14	0.0082	21.00	0.125	Pass
78	2480	9.99	0.0100	21.00	0.125	Pass

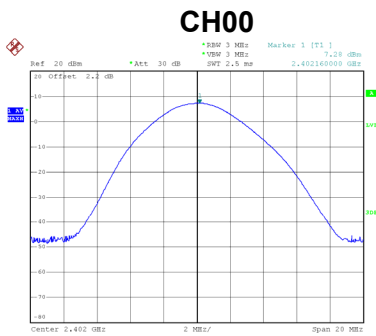

Date: 16.APR.2019 12:54:58

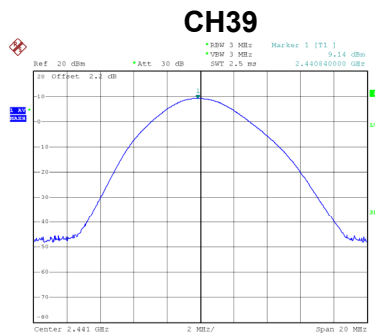

Date: 16.APR.2019 12:55:21

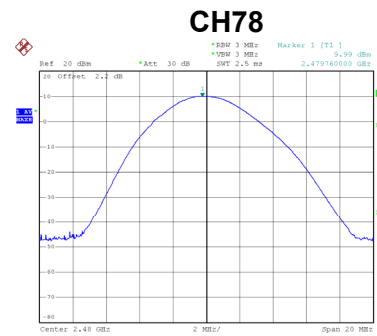

Date: 16.APR.2019 12:55:35

Test Mode: TX Mode \_3Mbps

Channel	Frequency (MHz)	Output Power (dBm)	Output Power (W)	Max. Limit (dBm)	Max. Limit (W)	Test Result
00	2402	5.38	0.0035	21.00	0.125	Pass
39	2441	7.60	0.0058	21.00	0.125	Pass
78	2480	8.72	0.0074	21.00	0.125	Pass

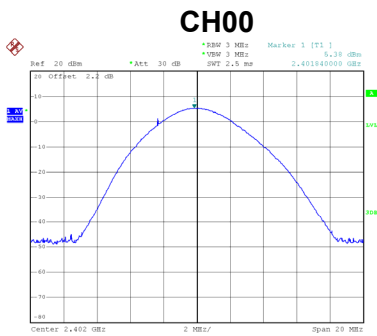

Date: 16.APR.2019 12:56:56

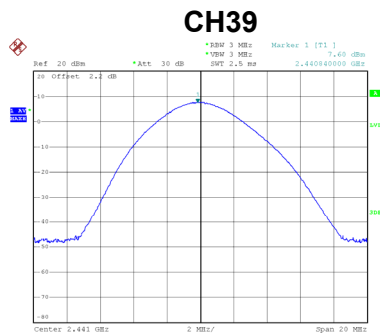

Date: 16.APR.2019 12:57:12

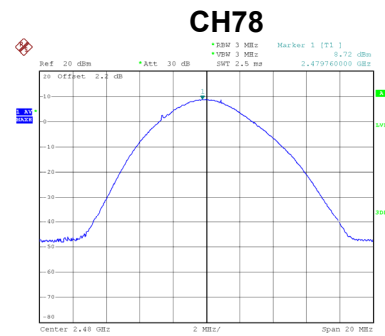

Date: 16.APR.2019 12:57:48

## APPENDIX J - CONDUCTED SPURIOUS EMISSION

Test Mode : TX Mode \_1Mbps

Bandedge- CH00 (Lower)

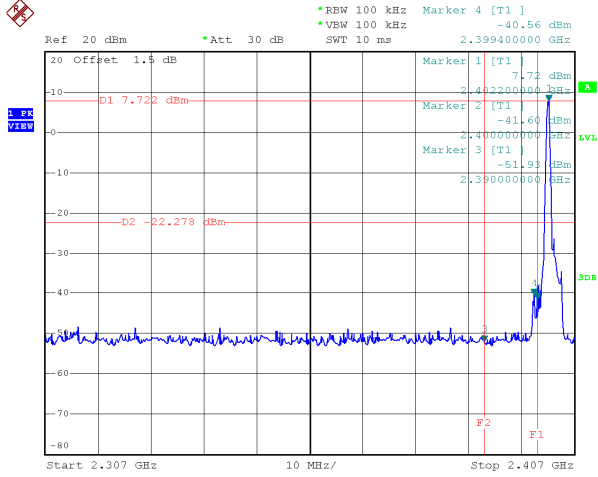

Bandedge CH78 (Upper)

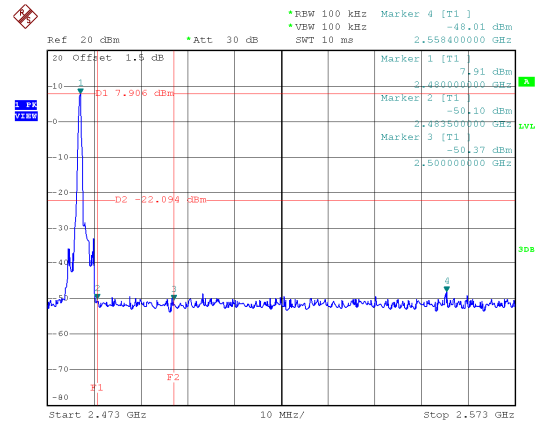

Date: 21.DEC.2018 09:34:49

Date: 21.DEC.2018 09:24:45

Hopping on mode (Lower)

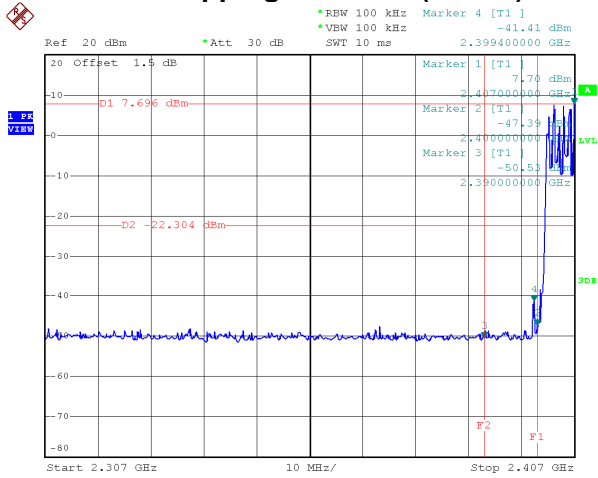

Hopping on mode (Upper)

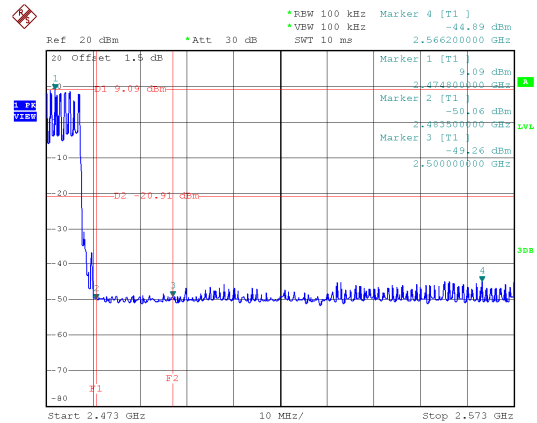

Date: 21.DEC.2018 10:02:42

Date: 21.DEC.2018 09:59:41

CH00 – 10th Harmonic of the fundamental frequency

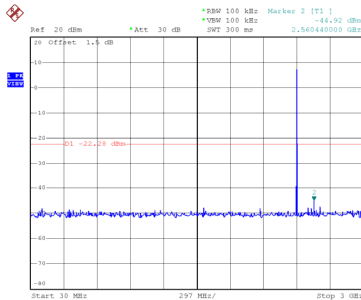

Date: 21.DEC.2018 09:28:55

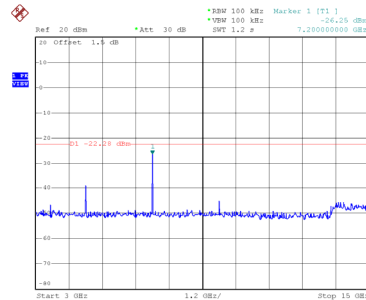

Date: 21.DEC.2018 09:29:04

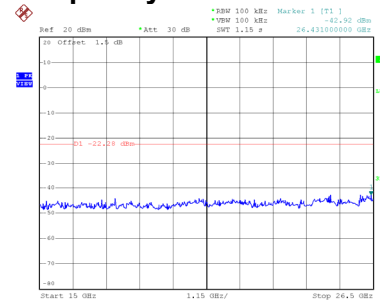

Date: 21.DEC.2018 09:29:13

### CH39 – 10th Harmonic of the fundamental frequency

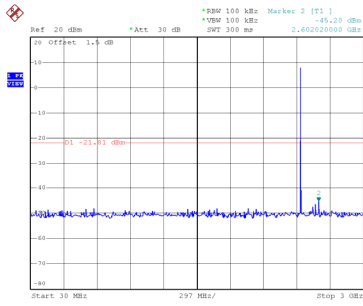

Date: 21.DEC.2018 09:32:41

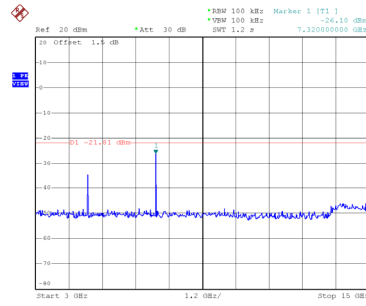

Date: 21.DEC.2018 09:32:51

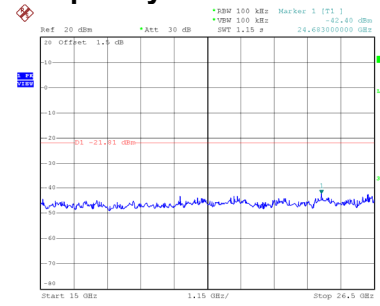

Date: 21.DEC.2018 09:33:00

### CH78 – 10th Harmonic of the fundamental frequency

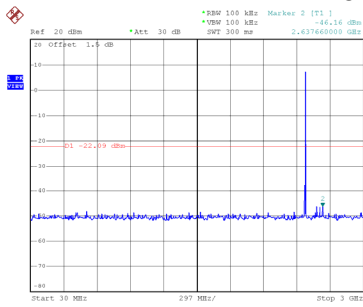

Date: 21.DEC.2018 09:37:32

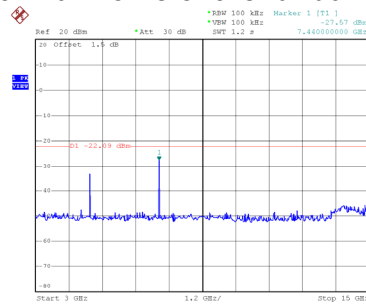

Date: 21.DEC.2018 09:37:41

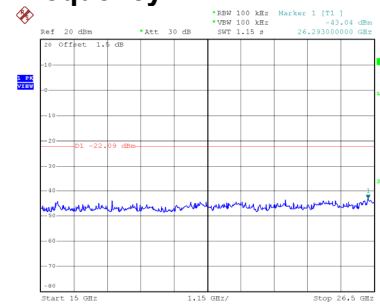

Date: 21.DEC.2018 09:37:50



**Test Mode : TX Mode \_3Mbps**

**Bandedge- CH00 (Lower)**

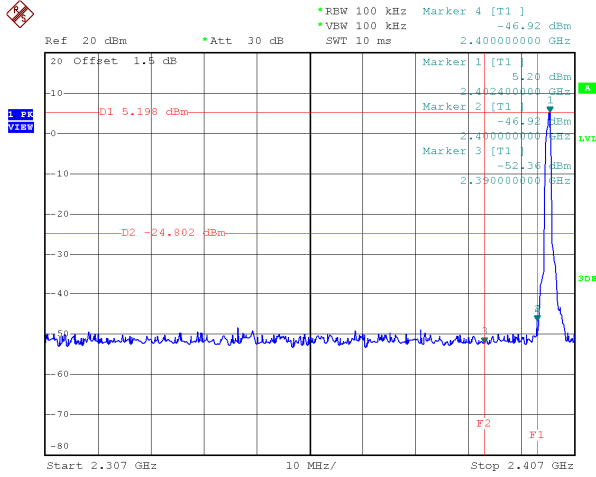

Date: 21.DEC.2018 08:50:39

**Bandedge CH78 (Upper)**

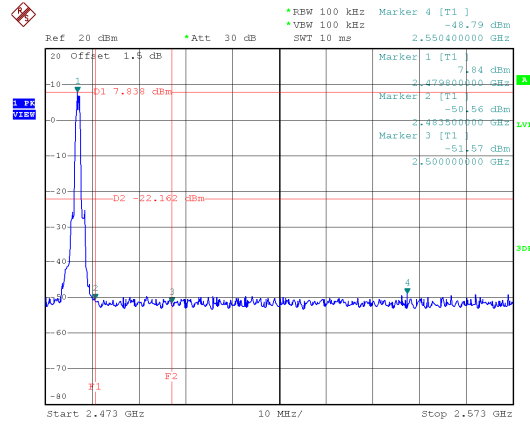

Date: 21.DEC.2018 08:58:32

**Hopping on mode (Lower)**

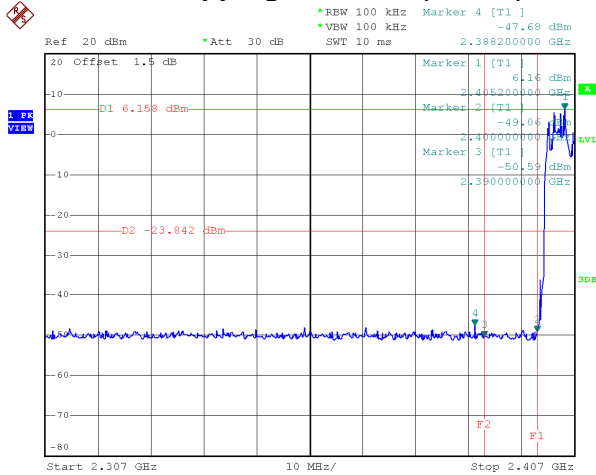

Date: 21.DEC.2018 09:14:01

**Hopping on mode (Upper)**

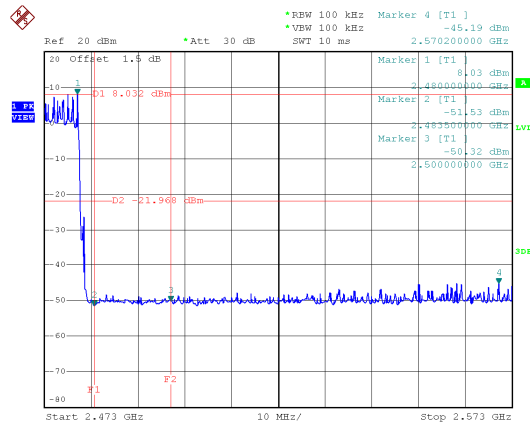

Date: 21.DEC.2018 09:17:04

**CH00 – 10th Harmonic of the fundamental frequency**

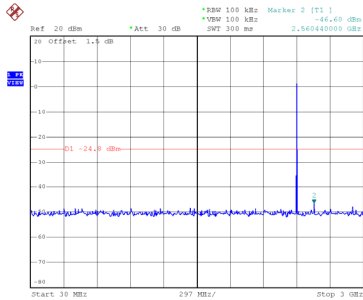

Date: 21.DEC.2018 08:52:25

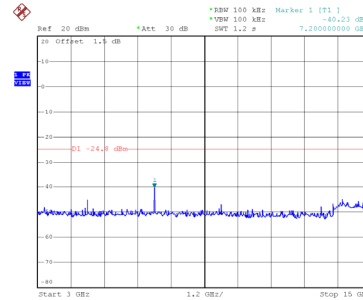

Date: 21.DEC.2018 08:52:34

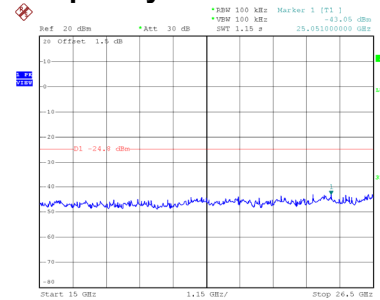

Date: 21.DEC.2018 08:52:43

### CH39 – 10th Harmonic of the fundamental frequency

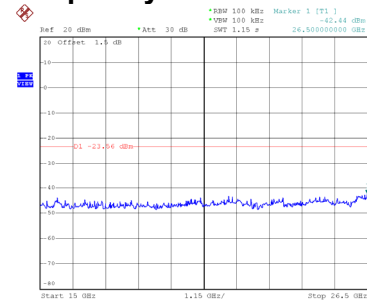
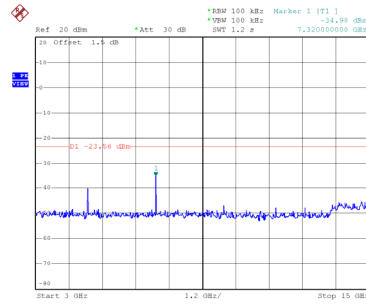
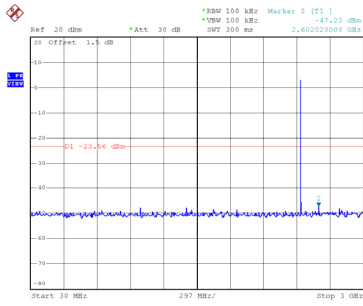

Date: 21.DEC.2018 08:56:21

Date: 21.DEC.2018 08:56:31

Date: 21.DEC.2018 08:56:40

### CH78 – 10th Harmonic of the fundamental frequency

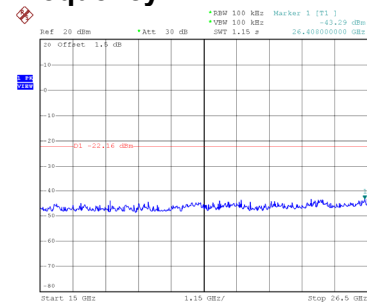
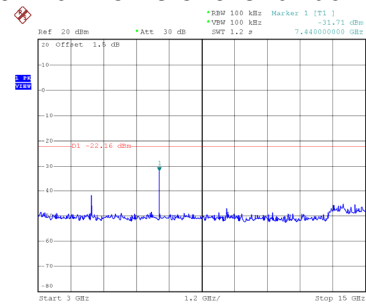
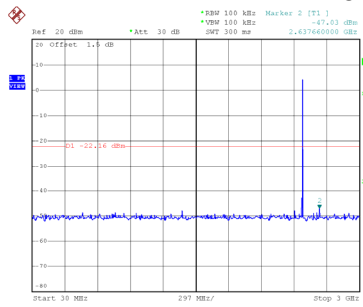

Date: 21.DEC.2018 09:00:42

Date: 21.DEC.2018 09:00:51

Date: 21.DEC.2018 09:01:00

End of Test Report