

FCC Test Report

Report No.: RF150326C16B

FCC ID: TE7T9E

Test Model: Archer T9E

Received Date: Mar. 26, 2015

Test Date: Apr. 25 ~ May 11, 2015

Issued Date: Aug. 10, 2015

Applicant: TP-LINK TECHNOLOGIES CO., LTD.

Address: Building 24 (floors 1,3,4,5) and 28 (floors1-4) Central Science and Technology Park, Shennan Rd, Nanshan, Shenzhen, China

Issued By: Bureau Veritas Consumer Products Services (H.K.) Ltd., Taoyuan Branch

Lab Address: No. 47-2, 14th Ling, Chia Pau Vil., Lin Kou Dist., New Taipei City, Taiwan, R.O.C.

Test Location: No. 19, Hwa Ya 2nd Rd., Wen Hwa Vil., Kwei Shan Dist., Taoyuan City 33383, TAIWAN (R.O.C.)



This report is for your exclusive use. Any copying or replication of this report to or for any other person or entity, or use of our name or trademark, is permitted only with our prior written permission. This report sets forth our findings solely with respect to the test samples identified herein. The results set forth in this report are not indicative or representative of the quality or characteristics of the lot from which a test sample was taken or any similar or identical product unless specifically and expressly noted. Our report includes all of the tests requested by you and the results thereof based upon the information that you provided to us. You have 60 days from date of issuance of this report to notify us of any material error or omission caused by our negligence, provided, however, that such notice shall be in writing and shall specifically address the issue you wish to raise. A failure to raise such issue within the prescribed time shall constitute your unqualified acceptance of the completeness of this report, the tests conducted and the correctness of the report contents. Unless specific mention, the uncertainty of measurement has been explicitly taken into account to declare the compliance or non-compliance to the specification. The report must not be used by the client to claim product certification, approval, or endorsement by TAF or any government agencies.



Table of Contents

Release Control Record	4
1 Certificate of Conformity	5
2 Summary of Test Results	6
2.1 Measurement Uncertainty	6
2.2 Modification Record	6
3 General Information	7
3.1 General Description of EUT	7
3.2 Description of Test Modes	8
3.2.1 Test Mode Applicability and Tested Channel Detail.....	9
3.3 Duty Cycle of Test Signal	11
3.4 Description of Support Units	12
3.4.1 Configuration of System under Test	12
3.5 General Description of Applied Standards	13
4 Test Types and Results	14
4.1 Radiated Emission and Bandedge Measurement.....	14
4.1.1 Limits of Radiated Emission and Bandedge Measurement	14
4.1.2 Test Instruments	15
4.1.3 Test Procedures.....	16
4.1.4 Deviation from Test Standard	16
4.1.5 Test Set Up	17
4.1.6 EUT Operating Conditions.....	17
4.1.7 Test Results	18
4.2 Conducted Emission Measurement	38
4.2.1 Limits of Conducted Emission Measurement	38
4.2.2 Test Instruments	38
4.2.3 Test Procedures.....	39
4.2.4 Deviation from Test Standard	39
4.2.5 Test Setup.....	39
4.2.6 EUT Operating Conditions.....	39
4.2.7 Test Results	40
4.3 Transmit Power Measurement	42
4.3.1 Limits of Transmit Power Measurement	42
4.3.2 Test Setup.....	42
4.3.3 Test Instruments	42
4.3.4 Test Procedure	43
4.3.5 Deviation from Test Standard	43
4.3.6 EUT Operating Conditions.....	43
4.3.7 Test Result.....	44
4.4 Peak Power Spectral Density Measurement	52
4.4.1 Limits of Peak Power Spectral Density Measurement	52
4.4.2 Test Setup.....	52
4.4.3 Test Instruments	52
4.4.4 Test Procedures.....	52
4.4.5 Deviation from Test Standard	52
4.4.6 EUT Operating Conditions.....	52
4.4.7 Test Results	53
4.5 Frequency Stability.....	56
4.5.1 Limits of Frequency Stability Measurement	56
4.5.2 Test Setup.....	56
4.5.3 Test Instruments	56
4.5.4 Test Procedure	56
4.5.5 Deviation from Test Standard	56
4.5.6 EUT Operating Condition	56



4.5.7 Test Results	57
5 Pictures of Test Arrangements.....	58
Appendix – Information on the Testing Laboratories	59



A D T

Release Control Record

Issue No.	Description	Date Issued
RF150326C16B	Original release.	Aug. 10, 2015

1 Certificate of Conformity

Product: AC1900 Wireless Dual Band PCI Express Adapter

Brand: TP-LINK

Test Model: Archer T9E

Sample Status: Prototype

Applicant: TP-LINK TECHNOLOGIES CO., LTD.

Test Date: Apr. 25 ~ May 11, 2015

Standards: 47 CFR FCC Part 15, Subpart E (Section 15.407)
ANSI C63.10:2013

The above equipment has been tested by **Bureau Veritas Consumer Products Services (H.K.) Ltd., Taoyuan Branch**, and found compliance with the requirement of the above standards. The test record, data evaluation & Equipment Under Test (EUT) configurations represented herein are true and accurate accounts of the measurements of the sample's EMC characteristics under the conditions specified in this report.

Prepared by : Celine Chou , **Date:** Aug. 10, 2015
Celine Chou / Specialist

Approved by : Ken Liu , **Date:** Aug. 10, 2015
Ken Liu / Senior Manager

2 Summary of Test Results

47 CFR FCC Part 15, Subpart E (section 15.407)			
FCC Clause	Test Item	Result	Remarks
15.207 15.407(b)(6)	AC Power Conducted Emissions	Pass	Meet the requirement of limit. Minimum passing margin is -10.43dB at 23.90716MHz.
15.407(b) (1/2/3/4/6)	Radiated Emissions & Band Edge Measurement	Pass	Meet the requirement of limit. Minimum passing margin is -0.1dB at 5660.00MHz.
15.407(a)(1/2 /3)	Max Average Transmit Power	Pass	Meet the requirement of limit.
15.407(a)(1/2 /3)	Peak Power Spectral Density	Pass	Meet the requirement of limit.
15.407(g)	Frequency Stability	Pass	Meet the requirement of limit.
15.203	Antenna Requirement	Pass	Antenna connector is SMA Male Reverse not a standard connector.

2.1 Measurement Uncertainty

Where relevant, the following measurement uncertainty levels have been estimated for tests performed on the EUT as specified in CISPR 16-4-2:

Measurement	Frequency	Expanded Uncertainty (k=2) (\pm)
Conducted Emissions at mains ports	150kHz ~ 30MHz	2.44 dB
Radiated Emissions up to 1 GHz	30MHz ~ 200MHz	3.63 dB
	200MHz ~ 1000MHz	3.64 dB
Radiated Emissions above 1 GHz	1GHz ~ 18GHz	2.29 dB
	18GHz ~ 40GHz	2.29 dB

2.2 Modification Record

There were no modifications required for compliance.

3 General Information

3.1 General Description of EUT

Product	AC1900 Wireless Dual Band PCI Express Adapter
Brand	TP-LINK
Test Model	Archer T9E
Status of EUT	Prototype
Power Supply Rating	12Vdc or 3.3Vdc from host equipment
Modulation Type	256QAM, 64QAM, 16QAM, QPSK, BPSK
Modulation Technology	OFDM
Transfer Rate	802.11a: 54.0/ 48.0/ 36.0/ 24.0/ 18.0/ 12.0/ 9.0/ 6.0Mbps 802.11n: up to 450.0Mbps 802.11ac: up to 1300Mbps
Operating Frequency	5260 ~ 5320MHz, 5500 ~ 5700MHz
Number of Channel	5260 ~ 5320MHz: 4 for 802.11a, 802.11n (20MHz) , 802.11ac (20MHz) 2 for 802.11n (40MHz), 802.11ac (40MHz) 1 for 802.11ac (80MHz) 5500 ~ 5700MHz: 8 for 802.11a, 802.11n (20MHz), 802.11ac (20MHz) 3 for 802.11n (40MHz), 802.11ac (40MHz) 1 for 802.11ac (80MHz)
Output Power	5260 ~ 5320MHz: 240.343mW 5500 ~ 5700MHz: 232.420mW
Antenna Type	Dipole antenna with 2dBi gain
Antenna Connector	SMA Male Reverse
Accessory Device	NA
Data Cable Supplied	NA

Note:

1. This report is prepared for FCC class II permissive change. The difference compared with the original report (AUDIX report no.: ACS-F14406) is adding 5.26GHz to 5.32GHz and 5.50GHz to 5.70GHz by software.
2. The EUT incorporates a MIMO function. Physically, the EUT provides 3 completed transmitters and 3 receivers.

Modulation Mode	TX FUNCTION
802.11a	3TX
802.11n (20MHz)	3TX
802.11n (40MHz)	3TX
802.11ac (20MHz)	3TX
802.11ac (40MHz)	3TX
802.11ac (80MHz)	3TX

* The modulation and bandwidth are similar for 802.11n mode for 20MHz / 40MHz and 802.11ac mode for 20MHz / 40MHz, therefore investigated worst case to representative mode in test report. (Final test mode refer section 3.2.1)

3. The above EUT information is declared by manufacturer and for more detailed features description, please refer to the manufacturer's specifications or user's manual.

3.2 Description of Test Modes

FOR 5260 ~ 5320MHz

4 channels are provided for 802.11a, 802.11n (20MHz), 802.11ac (20MHz):

Channel	Frequency	Channel	Frequency
52	5260 MHz	60	5300 MHz
56	5280 MHz	64	5320 MHz

2 channels are provided for 802.11n (40MHz), 802.11ac (40MHz):

Channel	Frequency	Channel	Frequency
54	5270 MHz	62	5310 MHz

1 channel is provided for 802.11ac (80MHz):

Channel	Frequency
58	5290 MHz

FOR 5500 ~ 5700MHz

8 channels are provided for 802.11a, 802.11n (20MHz), 802.11ac (20MHz):

Channel	Frequency	Channel	Frequency
100	5500 MHz	116	5580 MHz
104	5520 MHz	132	5660 MHz
108	5540 MHz	136	5680 MHz
112	5560 MHz	140	5700 MHz

3 channels are provided for 802.11n (40MHz), 802.11ac (40MHz):

Channel	Frequency	Channel	Frequency
102	5510 MHz	134	5670 MHz
110	5550 MHz		

1 channel is provided for 802.11ac (80MHz):

Channel	Frequency
106	5530MHz

3.2.1 Test Mode Applicability and Tested Channel Detail

EUT CONFIGURE MODE	APPLICABLE TO				DESCRIPTION
	RE≥1G	RE<1G	PLC	APCM	
-	√	√	√	√	-

Where **RE≥1G**: Radiated Emission above 1GHz & Bandedge Measurement
RE<1G: Radiated Emission below 1GHz
PLC: Power Line Conducted Emission
APCM: Antenna Port Conducted Measurement

NOTE: The EUT had been pre-tested on the positioned of each 3 axis. The worst case was found when positioned on **Z-plane**.

Radiated Emission Test (Above 1GHz):

- Pre-Scan has been conducted to determine the worst-case mode from all possible combinations between available modulations, data rates and antenna ports (if EUT with antenna diversity architecture).
- Following channel(s) was (were) selected for the final test as listed below.

EUT CONFIGURE MODE	MODE	FREQ. BAND (MHz)	AVAILABLE CHANNEL	TESTED CHANNEL	MODULATION TECHNOLOGY	MODULATION TYPE	DATA RATE (Mbps)
-	802.11a	5260-5320	52 to 64	52, 60, 64	OFDM	BPSK	6.0
-	802.11n (20MHz)		52 to 64	52, 60, 64	OFDM	BPSK	7.2
-	802.11n (40MHz)		54 to 62	54, 62	OFDM	BPSK	15.0
-	802.11ac (80MHz)		58	58	OFDM	BPSK	87.8
-	802.11a	5500-5700	100 to 140	100, 116, 140	OFDM	BPSK	6.0
-	802.11n (20MHz)		100 to 140	100, 116, 140	OFDM	BPSK	7.2
-	802.11n (40MHz)		102 to 134	102, 110, 134	OFDM	BPSK	15.0
-	802.11ac (80MHz)		106	106	OFDM	BPSK	87.8

Radiated Emission Test (Below 1GHz):

- Pre-Scan has been conducted to determine the worst-case mode from all possible combinations between available modulations, data rates and antenna ports (if EUT with antenna diversity architecture).
- Following channel(s) was (were) selected for the final test as listed below.

EUT CONFIGURE MODE	MODE	FREQ. BAND (MHz)	AVAILABLE CHANNEL	TESTED CHANNEL	MODULATION TECHNOLOGY	MODULATION TYPE	DATA RATE (Mbps)
-	802.11a	5260-5320	52 to 64	52	OFDM	BPSK	6.0
		5500-5700	100 to 140		OFDM	BPSK	6.0

Power Line Conducted Emission Test:

- Pre-Scan has been conducted to determine the worst-case mode from all possible combinations between available modulations, data rates and antenna ports (if EUT with antenna diversity architecture).
- Following channel(s) was (were) selected for the final test as listed below.

EUT CONFIGURE MODE	MODE	FREQ. BAND (MHz)	AVAILABLE CHANNEL	TESTED CHANNEL	MODULATION TECHNOLOGY	MODULATION TYPE	DATA RATE (Mbps)
-	802.11a	5260-5320	52 to 64	52	OFDM	BPSK	6.0
		5500-5700	100 to 140		OFDM	BPSK	6.0

Antenna Port Conducted Measurement:

- This item includes all test value of each mode, but only includes spectrum plot of worst value of each mode.
- Pre-Scan has been conducted to determine the worst-case mode from all possible combinations between available modulations, data rates and antenna ports (if EUT with antenna diversity architecture).
- Following channel(s) was (were) selected for the final test as listed below.

EUT CONFIGURE MODE	MODE	FREQ. BAND (MHz)	AVAILABLE CHANNEL	TESTED CHANNEL	MODULATION TECHNOLOGY	MODULATION TYPE	DATA RATE (Mbps)
-	802.11a	5260-5320	52 to 64	52, 60, 64	OFDM	BPSK	6.0
-	802.11n (20MHz)		52 to 64	52, 60, 64	OFDM	BPSK	7.2
-	802.11n (40MHz)		54 to 62	54, 62	OFDM	BPSK	15.0
-	802.11ac (80MHz)		58	58	OFDM	BPSK	87.8
-	802.11a	5500-5700	100 to 140	100, 116, 140	OFDM	BPSK	6.0
-	802.11n (20MHz)		100 to 140	100, 116, 140	OFDM	BPSK	7.2
-	802.11n (40MHz)		102 to 134	102, 110, 134	OFDM	BPSK	15.0
-	802.11ac (80MHz)		106	106	OFDM	BPSK	87.8

Test Condition:

APPLICABLE TO	ENVIRONMENTAL CONDITIONS	INPUT POWER (SYSTEM)	TESTED BY
RE \geq 1G	25deg. C, 65%RH	120Vac, 60Hz	Ted Chang
RE $<$ 1G	25deg. C, 65%RH	120Vac, 60Hz	Match Tsui
PLC	25deg. C, 65%RH	120Vac, 60Hz	Chirs Lin
APCM	25deg. C, 60%RH	120Vac, 60Hz	Antony Lee

3.3 Duty Cycle of Test Signal

Duty cycle of test signal is < 98 %, duty factor is required

802.11a: Duty cycle = $2.038/2.175 = 0.937$, Duty factor = $10 * \log(1/0.937) = 0.28$

802.11n (20MHz): Duty cycle = $1.875/2.062 = 0.909$, Duty factor = $10 * \log(1/0.909) = 0.41$

802.11n (40MHz): Duty cycle = $0.900/1.037 = 0.868$, Duty factor = $10 * \log(1/0.868) = 0.62$

802.11ac (80MHz): Duty cycle = $0.425/0.525 = 0.810$, Duty factor = $10 * \log(1/0.810) = 0.92$

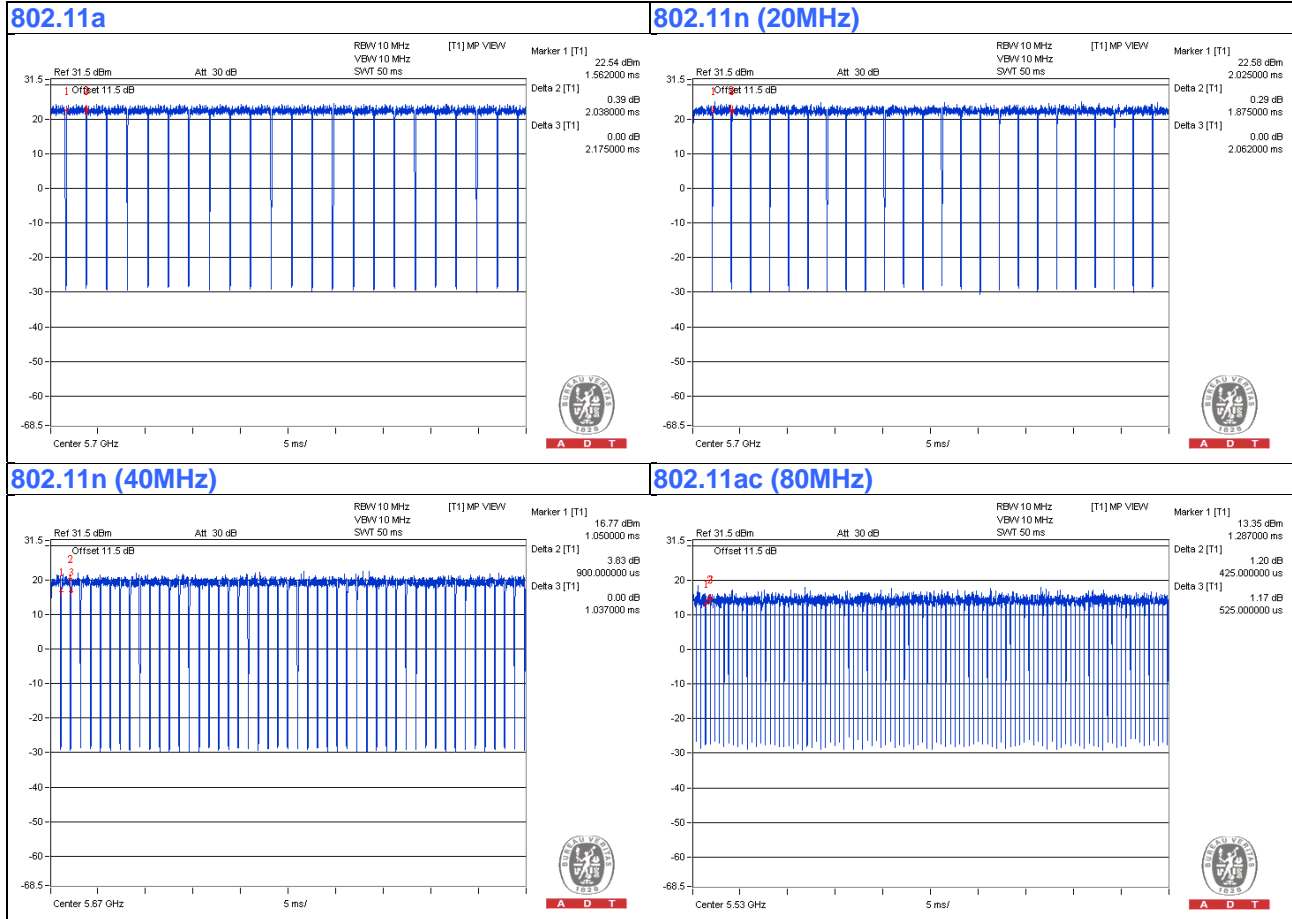

3.4 Description of Support Units

The EUT has been tested as an independent unit together with other necessary accessories or support units. The following support units or accessories were used to form a representative test configuration during the tests.

ID	Product	Brand	Model No.	Serial No.	FCC ID	Remarks
A.	PC	DELL	optiplex 390	74QKYBX	NA	-
B.	Monitor	DELL	U2410f	CN-082WXD-72872-2 B7-A3VL	FCC DoC Approved	-
C.	Keyboard	DELL	KB4021	CN-05V23T-71581-1A K-01S8-A01	FCC DoC Approved	-
D.	Mouse	DELL	MS111-P	CN-011D3V-71581-1C J-0195	FCC DoC Approved	-

Note: All power cords of the above support units are non-shielded (1.8m).

ID	Descriptions	Qty.	Length (m)	Shielding (Yes/No)	Cores (Qty.)	Remarks
1.	D-Sub	1	1.8	Y	2	-
2.	USB	1	1.8	N	0	-
3.	USB	1	1.8	N	0	-

Note: The core(s) is(are) originally attached to the cable(s).

3.4.1 Configuration of System under Test

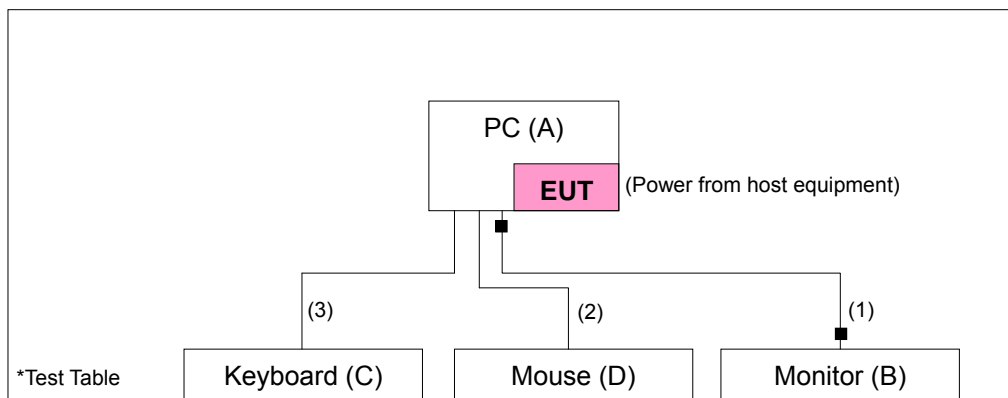

3.5 General Description of Applied Standards

The EUT is a RF Product. According to the specifications of the manufacturer, it must comply with the requirements of the following standards:

FCC Part 15, Subpart E (15.407)

789033 D02 General UNII Test Procedure New Rules v01

662911 D01 Multiple Transmitter Output v02r01

ANSI C63.10-2013

All test items have been performed and recorded as per the above standards.

NOTE: The EUT is also considered as a kind of computer peripheral, because the connection to computer is necessary for typical use. It has been verified to comply with the requirements of FCC Part 15, Subpart B, Class B (DoC). The test report has been issued separately.

4 Test Types and Results

4.1 Radiated Emission and Bandedge Measurement

4.1.1 Limits of Radiated Emission and Bandedge Measurement

Radiated emissions which fall in the restricted bands must comply with the radiated emission limits specified as below table. Other emissions shall be at least 20dB below the highest level of the desired power:

Frequencies (MHz)	Field Strength (microvolts/meter)	Measurement Distance (meters)
0.009 ~ 0.490	2400/F(kHz)	300
0.490 ~ 1.705	24000/F(kHz)	30
1.705 ~ 30.0	30	30
30 ~ 88	100	3
88 ~ 216	150	3
216 ~ 960	200	3
Above 960	500	3

NOTE:

1. The lower limit shall apply at the transition frequencies.
2. Emission level (dBuV/m) = 20 log Emission level (uV/m).
3. For frequencies above 1000MHz, the field strength limits are based on average detector, however, the peak field strength of any emission shall not exceed the maximum permitted average limits, specified above by more than 20dB under any condition of modulation.

LIMITS OF UNWANTED EMISSION OUT OF THE RESTRICTED BANDS

APPLICABLE TO	LIMIT	
789033 D02 General UNII Test Procedures New Rules v01	FIELD STRENGTH AT 3m	
	PK:74 (dBuV/m)	AV:54 (dBuV/m)
APPLICABLE TO	EIRP LIMIT	EQUIVALENT FIELD STRENGTH AT 3m
15.407(b)(1)	PK:-27 (dBm/MHz)	PK:68.2(dBuV/m)
15.407(b)(2)		
15.407(b)(3)		
15.407(b)(4)	PK:-27 (dBm/MHz) ^{*1} PK:-17 (dBm/MHz) ^{*2}	PK: 68.2(dBuV/m) ^{*1} PK:78.2 (dBuV/m) ^{*2}

NOTE: ^{*1} beyond 10MHz of the band edge ^{*2} within 10 MHz of band edge

The following formula is used to convert the equipment isotropic radiated power (eirp) to field strength:

$$E = \frac{1000000\sqrt{30P}}{3} \mu\text{V/m, where P is the eirp (Watts).}$$

4.1.2 Test Instruments

Description & Manufacturer	Model No.	Serial No.	Date Of Calibration	Due Date Of Calibration
Test Receiver ROHDE & SCHWARZ	ESCS30	100289	Dec. 01, 2014	Nov. 30, 2015
Spectrum Analyzer ROHDE & SCHWARZ	FSP40	100269	Mar. 30, 2015	Mar. 29, 2016
BILOG Antenna SCHWARZBECK	VULB9168	9168-156	Feb. 06, 2015	Feb. 05, 2016
HORN Antenna SCHWARZBECK	BBHA 9120 D	9120D-1169	Feb. 09, 2015	Feb. 08, 2016
HORN Antenna SCHWARZBECK	BBHA 9170	BBHA9170241	Feb. 09, 2015	Feb. 08, 2016
Preamplifier Agilent	8449B	3008A01911	Aug. 09, 2014	Aug. 08, 2015
Preamplifier Agilent	8447D	2944A10638	Aug. 09, 2014	Aug. 08, 2015
RF signal cable HUBER+SUHNNER	SUCOFLEX 104	248780/4 309222/4 274092/4	Aug. 09, 2014	Aug. 08, 2015
RF signal cable Worken	8D-FB	Cable-CH9-01	Aug. 11, 2014	Aug. 10, 2015
Software BV ADT	ADT_Radiated_ V7.6.15.9.4	NA	NA	NA
Antenna Tower EMCO	2070/2080	512.835.4684	NA	NA
Turn Table EMCO	2087-2.03	NA	NA	NA
Antenna Tower & Turn BV ADT	AT100	AT93021705	NA	NA
Turn Table BV ADT	TT100	TT93021705	NA	NA
Turn Table Controller BV ADT	SC100	SC93021705	NA	NA
26GHz ~ 40GHz Amplifier	EM26400	815221	Oct. 18, 2014	Oct. 17, 2015
High Speed Peak Power Meter	ML2495A	0824011	Jul. 26, 2014	Jul. 25, 2015
Power Sensor	MA2411B	0738171	Jul. 26, 2014	Jul. 25, 2015
WIT Standard Temperature And Humidity Chamber	TH-4S-C	W981030	Jun. 09, 2014	Jun. 08, 2015

- NOTE:**
1. The calibration interval of the above test instruments is 12 months and the calibrations are traceable to NML/ROC and NIST/USA.
 2. The test was performed in HwaYa Chamber 9.
 3. The horn antenna and HP preamplifier (model: 8449B) are used only for the measurement of emission frequency above 1GHz if tested.
 4. The FCC Site Registration No. is 215374.
 5. The IC Site Registration No. is IC 7450F-9.

4.1.3 Test Procedures

- a. The EUT was placed on the top of a rotating table 0.8 meters (for below 1GHz) / 1.5 meters (for above 1GHz) above the ground at 3 meter chamber room for test. The table was rotated 360 degrees to determine the position of the highest radiation.
- b. The EUT was set 3 meters away from the interference-receiving antenna, which was mounted on the top of a variable-height antenna tower.
- c. The height of antenna is varied from one meter to four meters above the ground to determine the maximum value of the field strength. Both horizontal and vertical polarizations of the antenna are set to make the measurement.
- d. For each suspected emission, the EUT was arranged to its worst case and then the antenna was tuned to heights from 1 meter to 4 meters and the rotatable table was turned from 0 degrees to 360 degrees to find the maximum reading.
- e. The test-receiver system was set to quasi-peak detect function and specified bandwidth with maximum hold mode when the test frequency is below 1 GHz.
- f. The test-receiver system was set to peak and average detect function and specified bandwidth with maximum hold mode when the test frequency is above 1 GHz. If the peak reading value also meets average limit, measurement with the average detector is unnecessary.

Note:

1. The resolution bandwidth and video bandwidth of test receiver/spectrum analyzer is 120kHz for Quasi-peak detection (QP) at frequency below 1GHz.
2. The resolution bandwidth of test receiver/spectrum analyzer is 1 MHz and the video bandwidth is 3 MHz for Peak detection (PK) at frequency above 1GHz.
3. The resolution bandwidth of test receiver/spectrum analyzer is 1MHz and the video bandwidth is 3MHz for RMS Average (Duty cycle < 98%) for Average detection (AV) at frequency above 1GHz, then the measurement results was added to a correction factor ($10 \log(1/\text{duty cycle})$).
4. The resolution bandwidth of test receiver/spectrum analyzer is 1MHz and the video bandwidth is 10Hz (Duty cycle $\geq 98\%$) for Average detection (AV) at frequency above 1GHz.
5. All modes of operation were investigated and the worst-case emissions are reported.

4.1.4 Deviation from Test Standard

No deviation.

4.1.5 Test Set Up

<Frequency Range below 1GHz>

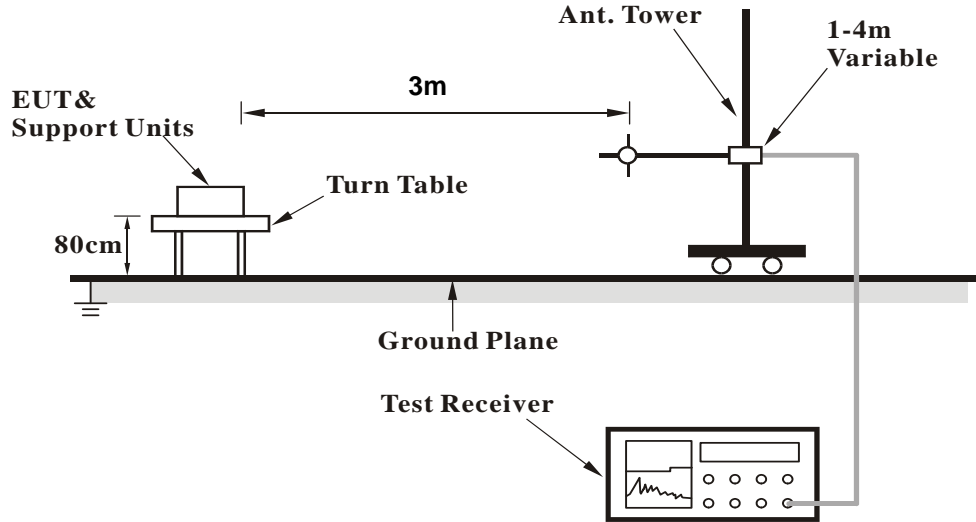

<Frequency Range above 1GHz>

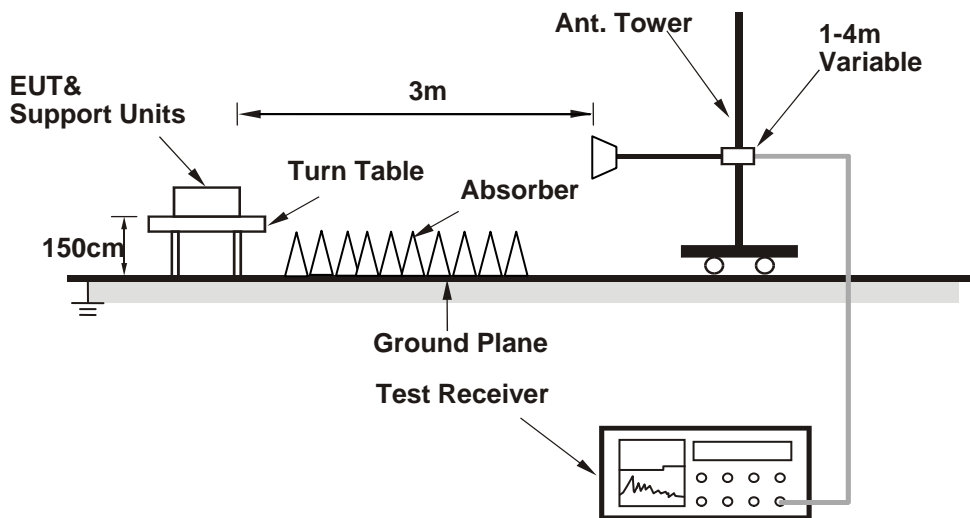

For the actual test configuration, please refer to the attached file (Test Setup Photo)

4.1.6 EUT Operating Conditions

Installed the EUT in the PC and set the EUT under transmission condition continuously at specific channel frequency.

4.1.7 Test Results

Above 1GHz Data

802.11a

CHANNEL	TX Channel 52	DETECTOR	Peak (PK)
FREQUENCY RANGE	1GHz ~ 40GHz	FUNCTION	Average (AV)

ANTENNA POLARITY & TEST DISTANCE: HORIZONTAL AT 3 M

NO.	FREQ. (MHz)	EMISSION LEVEL (dBuV/m)	LIMIT (dBuV/m)	MARGIN (dB)	ANTENNA HEIGHT (m)	TABLE ANGLE (Degree)	RAW VALUE (dBuV)	CORRECTION FACTOR (dB/m)
1	5100.00	56.9 PK	74.0	-17.1	1.70 H	133	55.00	1.90
2	5100.00	43.6 AV	54.0	-10.4	1.70 H	133	41.70	1.90
3	5150.00	46.6 PK	74.0	-27.4	1.04 H	99	44.60	2.00
4	5150.00	43.2 AV	54.0	-10.8	1.04 H	99	41.20	2.00
5	*5260.00	108.1 PK			1.70 H	133	68.00	40.10
6	*5260.00	98.1 AV			1.70 H	133	58.00	40.10
7	5420.00	59.0 PK	74.0	-15.0	1.04 H	88	56.90	2.10
8	5420.00	45.6 AV	54.0	-8.4	1.04 H	88	43.50	2.10
9	#10520.00	58.9 PK	74.0	-15.1	1.04 H	99	43.60	15.30
10	#10520.00	46.8 AV	54.0	-7.2	1.04 H	99	31.50	15.30

ANTENNA POLARITY & TEST DISTANCE: VERTICAL AT 3 M

NO.	FREQ. (MHz)	EMISSION LEVEL (dBuV/m)	LIMIT (dBuV/m)	MARGIN (dB)	ANTENNA HEIGHT (m)	TABLE ANGLE (Degree)	RAW VALUE (dBuV)	CORRECTION FACTOR (dB/m)
1	5100.00	61.9 PK	74.0	-12.1	1.65 V	133	60.00	1.90
2	5100.00	52.0 AV	54.0	-2.0	1.65 V	133	50.10	1.90
3	5150.00	58.3 PK	74.0	-15.7	1.65 V	133	56.30	2.00
4	5150.00	44.2 AV	54.0	-9.8	1.65 V	133	42.20	2.00
5	*5260.00	115.0 PK			1.53 V	130	74.90	40.10
6	*5260.00	105.2 AV			1.53 V	130	65.10	40.10
7	5420.00	64.3 PK	74.0	-9.7	1.61 V	133	62.20	2.10
8	5420.00	52.8 AV	54.0	-1.2	1.61 V	133	50.70	2.10
9	#10520.00	59.4 PK	74.0	-14.6	1.04 V	155	44.10	15.30
10	#10520.00	46.6 AV	54.0	-7.4	1.04 V	155	31.30	15.30

Remark:

1. Emission Level(dBuV/m) = Raw Value(dBuV) + Correction Factor(dB/m)
2. Correction Factor(dB/m) = Antenna Factor(dB/m) + Cable Factor(dB)
3. The other emission levels were very low against the limit.
4. Margin value = Emission Level – Limit value
5. " * ": Fundamental frequency.
6. " # ": The radiated frequency is out of the restricted band.

CHANNEL	TX Channel 60	DETECTOR FUNCTION	Peak (PK)
FREQUENCY RANGE	1GHz ~ 40GHz		Average (AV)

ANTENNA POLARITY & TEST DISTANCE: HORIZONTAL AT 3 M

NO.	FREQ. (MHz)	EMISSION LEVEL (dBuV/m)	LIMIT (dBuV/m)	MARGIN (dB)	ANTENNA HEIGHT (m)	TABLE ANGLE (Degree)	RAW VALUE (dBuV)	CORRECTION FACTOR (dB/m)
1	5150.00	56.9 PK	74.0	-17.1	1.87 H	99	54.90	2.00
2	5150.00	45.6 AV	54.0	-8.4	1.87 H	99	43.60	2.00
3	*5300.00	109.3 PK			1.54 H	141	69.20	40.10
4	*5300.00	99.5 AV			1.54 H	141	59.40	40.10
5	5380.00	58.6 PK	74.0	-15.4	1.05 H	88	56.60	2.00
6	5380.00	47.9 AV	54.0	-6.1	1.05 H	88	45.90	2.00
7	5460.00	57.7 PK	74.0	-16.3	1.59 H	66	55.60	2.10
8	5460.00	45.8 AV	54.0	-8.2	1.59 H	66	43.70	2.10
9	10600.00	60.8 PK	74.0	-13.2	1.02 H	55	44.60	16.20
10	10600.00	47.7 AV	54.0	-6.3	1.02 H	55	31.50	16.20

ANTENNA POLARITY & TEST DISTANCE: VERTICAL AT 3 M

NO.	FREQ. (MHz)	EMISSION LEVEL (dBuV/m)	LIMIT (dBuV/m)	MARGIN (dB)	ANTENNA HEIGHT (m)	TABLE ANGLE (Degree)	RAW VALUE (dBuV)	CORRECTION FACTOR (dB/m)
1	5150.00	62.1 PK	74.0	-11.9	1.64 V	139	60.10	2.00
2	5150.00	51.1 AV	54.0	-2.9	1.64 V	139	49.10	2.00
3	*5300.00	114.4 PK			1.63 V	151	74.30	40.10
4	*5300.00	104.9 AV			1.63 V	151	64.80	40.10
5	5380.00	64.2 PK	74.0	-9.8	1.70 V	133	62.20	2.00
6	5380.00	53.5 AV	54.0	-0.5	1.70 V	133	51.50	2.00
7	5460.00	65.1 PK	74.0	-8.9	1.67 V	131	63.00	2.10
8	5460.00	53.7 AV	54.0	-0.3	1.67 V	131	51.60	2.10
9	10600.00	62.9 PK	74.0	-11.1	1.05 V	34	46.70	16.20
10	10600.00	47.8 AV	54.0	-6.2	1.05 V	34	31.60	16.20

Remark:

1. Emission Level(dBuV/m) = Raw Value(dBuV) + Correction Factor(dB/m)
2. Correction Factor(dB/m) = Antenna Factor(dB/m) + Cable Factor(dB)
3. The other emission levels were very low against the limit.
4. Margin value = Emission Level – Limit value
5. " * ": Fundamental frequency.
6. " # ": The radiated frequency is out of the restricted band.

CHANNEL	TX Channel 64	DETECTOR FUNCTION	Peak (PK)
FREQUENCY RANGE	1GHz ~ 40GHz		Average (AV)

ANTENNA POLARITY & TEST DISTANCE: HORIZONTAL AT 3 M

NO.	FREQ. (MHz)	EMISSION LEVEL (dBuV/m)	LIMIT (dBuV/m)	MARGIN (dB)	ANTENNA HEIGHT (m)	TABLE ANGLE (Degree)	RAW VALUE (dBuV)	CORRECTION FACTOR (dB/m)
1	5100.00	56.9 PK	74.0	-17.1	1.61 H	139	55.00	1.90
2	5100.00	44.9 AV	54.0	-9.1	1.61 H	139	43.00	1.90
3	*5320.00	108.2 PK			1.34 H	142	68.00	40.20
4	*5320.00	97.8 AV			1.34 H	142	57.60	40.20
5	5350.00	56.6 PK	74.0	-17.4	1.54 H	99	54.60	2.00
6	5350.00	43.6 AV	54.0	-10.4	1.54 H	99	41.60	2.00
7	5400.00	57.7 PK	74.0	-16.3	1.67 H	136	55.60	2.10
8	5400.00	46.1 AV	54.0	-7.9	1.67 H	136	44.00	2.10
9	#5480.00	58.0 PK	74.0	-16.0	1.74 H	105	55.80	2.20
10	#5480.00	45.7 AV	54.0	-8.3	1.74 H	105	43.50	2.20
11	10640.00	60.9 PK	74.0	-13.1	1.32 H	68	44.60	16.30
12	10640.00	47.6 AV	54.0	-6.4	1.32 H	68	31.30	16.30

ANTENNA POLARITY & TEST DISTANCE: VERTICAL AT 3 M

NO.	FREQ. (MHz)	EMISSION LEVEL (dBuV/m)	LIMIT (dBuV/m)	MARGIN (dB)	ANTENNA HEIGHT (m)	TABLE ANGLE (Degree)	RAW VALUE (dBuV)	CORRECTION FACTOR (dB/m)
1	5100.00	60.9 PK	74.0	-13.1	1.66 V	131	59.00	1.90
2	5100.00	50.9 AV	54.0	-3.1	1.66 V	131	49.00	1.90
3	*5320.00	115.6 PK			1.72 V	137	75.40	40.20
4	*5320.00	106.6 AV			1.72 V	137	66.40	40.20
5	5350.00	61.6 PK	74.0	-12.4	1.77 V	132	59.60	2.00
6	5350.00	47.1 AV	54.0	-6.9	1.77 V	132	45.10	2.00
7	5400.00	65.4 PK	74.0	-8.6	1.77 V	131	63.30	2.10
8	5400.00	53.6 AV	54.0	-0.4	1.77 V	131	51.50	2.10
9	#5480.00	64.5 PK	74.0	-9.5	1.74 V	130	62.30	2.20
10	#5480.00	52.8 AV	54.0	-1.2	1.74 V	130	50.60	2.20
11	10640.00	63.0 PK	74.0	-11.0	1.00 V	48	46.70	16.30
12	10640.00	48.9 AV	54.0	-5.1	1.00 V	48	32.60	16.30

Remark:

1. Emission Level(dBuV/m) = Raw Value(dBuV) + Correction Factor(dB/m)
2. Correction Factor(dB/m) = Antenna Factor(dB/m) + Cable Factor(dB)
3. The other emission levels were very low against the limit.
4. Margin value = Emission Level – Limit value
5. " * ": Fundamental frequency.
6. " # ": The radiated frequency is out of the restricted band.



CHANNEL	TX Channel 100	DETECTOR FUNCTION	Peak (PK)
FREQUENCY RANGE	1GHz ~ 40GHz		Average (AV)

ANTENNA POLARITY & TEST DISTANCE: HORIZONTAL AT 3 M

NO.	FREQ. (MHz)	EMISSION LEVEL (dBuV/m)	LIMIT (dBuV/m)	MARGIN (dB)	ANTENNA HEIGHT (m)	TABLE ANGLE (Degree)	RAW VALUE (dBuV)	CORRECTION FACTOR (dB/m)
1	5420.00	58.5 PK	74.0	-15.5	1.66 H	135	56.40	2.10
2	5420.00	47.3 AV	54.0	-6.7	1.66 H	135	45.20	2.10
3	5460.00	56.8 PK	74.0	-17.2	1.72 H	135	54.70	2.10
4	5460.00	43.3 AV	54.0	-10.7	1.72 H	135	41.20	2.10
5	#5470.00	57.9 PK	74.0	-16.1	1.72 H	135	55.70	2.20
6	#5470.00	44.7 AV	54.0	-9.3	1.72 H	135	42.50	2.20
7	*5500.00	107.8 PK			1.65 H	134	67.50	40.30
8	*5500.00	98.4 AV			1.65 H	134	58.10	40.30
9	#5660.00	60.7 PK	74.0	-13.3	1.65 H	101	58.20	2.50
10	#5660.00	48.8 AV	54.0	-5.2	1.65 H	101	46.30	2.50
11	11000.00	63.0 PK	74.0	-11.0	1.67 H	94	45.30	17.70
12	11000.00	49.2 AV	54.0	-4.8	1.67 H	94	31.50	17.70

ANTENNA POLARITY & TEST DISTANCE: VERTICAL AT 3 M

NO.	FREQ. (MHz)	EMISSION LEVEL (dBuV/m)	LIMIT (dBuV/m)	MARGIN (dB)	ANTENNA HEIGHT (m)	TABLE ANGLE (Degree)	RAW VALUE (dBuV)	CORRECTION FACTOR (dB/m)
1	5420.00	64.3 PK	74.0	-9.7	1.64 V	133	62.20	2.10
2	5420.00	53.1 AV	54.0	-0.9	1.64 V	133	51.00	2.10
3	5460.00	57.7 PK	74.0	-16.3	1.54 V	131	55.60	2.10
4	5460.00	44.6 AV	54.0	-9.4	1.54 V	131	42.50	2.10
5	#5470.00	64.5 PK	74.0	-9.5	1.54 V	131	62.30	2.20
6	#5470.00	48.7 AV	54.0	-5.3	1.54 V	131	46.50	2.20
7	*5500.00	116.8 PK			1.53 V	125	76.50	40.30
8	*5500.00	107.3 AV			1.53 V	125	67.00	40.30
9	#5660.00	65.7 PK	74.0	-8.3	1.64 V	107	63.20	2.50
10	#5660.00	53.9 AV	54.0	-0.1	1.64 V	107	51.40	2.50
11	11000.00	63.4 PK	74.0	-10.6	1.52 V	335	45.70	17.70
12	11000.00	49.3 AV	54.0	-4.7	1.52 V	335	31.60	17.70

Remark:

1. Emission Level(dBuV/m) = Raw Value(dBuV) + Correction Factor(dB/m)
2. Correction Factor(dB/m) = Antenna Factor(dB/m) + Cable Factor(dB)
3. The other emission levels were very low against the limit.
4. Margin value = Emission Level – Limit value
5. " * ": Fundamental frequency.
6. " # ": The radiated frequency is out of the restricted band.

CHANNEL	TX Channel 116	DETECTOR FUNCTION	Peak (PK)
FREQUENCY RANGE	1GHz ~ 40GHz		Average (AV)

ANTENNA POLARITY & TEST DISTANCE: HORIZONTAL AT 3 M

NO.	FREQ. (MHz)	EMISSION LEVEL (dBuV/m)	LIMIT (dBuV/m)	MARGIN (dB)	ANTENNA HEIGHT (m)	TABLE ANGLE (Degree)	RAW VALUE (dBuV)	CORRECTION FACTOR (dB/m)
1	5420.00	58.9 PK	74.0	-15.1	1.00 H	96	56.80	2.10
2	5420.00	45.6 AV	54.0	-8.4	1.00 H	96	43.50	2.10
3	*5580.00	106.4 PK			1.76 H	360	65.90	40.50
4	*5580.00	96.8 AV			1.76 H	360	56.30	40.50
5	#5740.00	59.4 PK	74.0	-14.6	1.55 H	118	56.70	2.70
6	#5740.00	45.8 AV	54.0	-8.2	1.55 H	118	43.10	2.70
7	11160.00	62.1 PK	74.0	-11.9	1.05 H	95	45.70	16.40
8	11160.00	47.9 AV	54.0	-6.1	1.05 H	95	31.50	16.40

ANTENNA POLARITY & TEST DISTANCE: VERTICAL AT 3 M

NO.	FREQ. (MHz)	EMISSION LEVEL (dBuV/m)	LIMIT (dBuV/m)	MARGIN (dB)	ANTENNA HEIGHT (m)	TABLE ANGLE (Degree)	RAW VALUE (dBuV)	CORRECTION FACTOR (dB/m)
1	5420.00	60.3 PK	74.0	-13.7	1.64 V	128	58.20	2.10
2	5420.00	48.6 AV	54.0	-5.4	1.64 V	128	46.50	2.10
3	*5580.00	114.4 PK			1.81 V	116	73.90	40.50
4	*5580.00	105.0 AV			1.81 V	116	64.50	40.50
5	#5740.00	65.5 PK	74.0	-8.5	1.54 V	116	62.80	2.70
6	#5740.00	53.6 AV	54.0	-0.4	1.54 V	116	50.90	2.70
7	11160.00	62.1 PK	74.0	-11.9	1.05 V	94	45.70	16.40
8	11160.00	48.0 AV	54.0	-6.0	1.05 V	94	31.60	16.40

Remark:

1. Emission Level(dBuV/m) = Raw Value(dBuV) + Correction Factor(dB/m)
2. Correction Factor(dB/m) = Antenna Factor(dB/m) + Cable Factor(dB)
3. The other emission levels were very low against the limit.
4. Margin value = Emission Level – Limit value
5. " * ": Fundamental frequency.
6. " # ": The radiated frequency is out of the restricted band.

CHANNEL	TX Channel 140	DETECTOR FUNCTION	Peak (PK)
FREQUENCY RANGE	1GHz ~ 40GHz		Average (AV)

ANTENNA POLARITY & TEST DISTANCE: HORIZONTAL AT 3 M

NO.	FREQ. (MHz)	EMISSION LEVEL (dBuV/m)	LIMIT (dBuV/m)	MARGIN (dB)	ANTENNA HEIGHT (m)	TABLE ANGLE (Degree)	RAW VALUE (dBuV)	CORRECTION FACTOR (dB/m)
1	5460.00	57.0 PK	74.0	-17.0	1.09 H	52	54.90	2.10
2	5460.00	43.6 AV	54.0	-10.4	1.09 H	52	41.50	2.10
3	*5700.00	103.6 PK			1.10 H	164	62.80	40.80
4	*5700.00	94.1 AV			1.10 H	164	53.30	40.80
5	#5780.00	58.6 PK	74.0	-15.4	1.78 H	148	55.90	2.70
6	#5780.00	46.3 AV	54.0	-7.7	1.78 H	148	43.60	2.70
7	11400.00	61.8 PK	74.0	-12.2	1.05 H	63	45.60	16.20
8	11400.00	47.7 AV	54.0	-6.3	1.05 H	63	31.50	16.20

ANTENNA POLARITY & TEST DISTANCE: VERTICAL AT 3 M

NO.	FREQ. (MHz)	EMISSION LEVEL (dBuV/m)	LIMIT (dBuV/m)	MARGIN (dB)	ANTENNA HEIGHT (m)	TABLE ANGLE (Degree)	RAW VALUE (dBuV)	CORRECTION FACTOR (dB/m)
1	5460.00	60.3 PK	74.0	-13.7	2.11 V	138	58.20	2.10
2	5460.00	48.3 AV	54.0	-5.7	2.11 V	138	46.20	2.10
3	*5700.00	116.9 PK			2.06 V	187	76.10	40.80
4	*5700.00	107.3 AV			2.06 V	187	66.50	40.80
5	#5780.00	65.3 PK	74.0	-8.7	2.14 V	242	62.60	2.70
6	#5780.00	53.2 AV	54.0	-0.8	2.14 V	242	50.50	2.70
7	11400.00	61.8 PK	74.0	-12.2	1.52 V	195	45.60	16.20
8	11400.00	47.7 AV	54.0	-6.3	1.52 V	195	31.50	16.20

Remark:

1. Emission Level(dBuV/m) = Raw Value(dBuV) + Correction Factor(dB/m)
2. Correction Factor(dB/m) = Antenna Factor(dB/m) + Cable Factor(dB)
3. The other emission levels were very low against the limit.
4. Margin value = Emission Level – Limit value
5. " * ": Fundamental frequency.
6. " # ": The radiated frequency is out of the restricted band.

802.11n (20MHz)

CHANNEL	TX Channel 52	DETECTOR FUNCTION	Peak (PK)
FREQUENCY RANGE	1GHz ~ 40GHz		Average (AV)

ANTENNA POLARITY & TEST DISTANCE: HORIZONTAL AT 3 M

NO.	FREQ. (MHz)	EMISSION LEVEL (dBuV/m)	LIMIT (dBuV/m)	MARGIN (dB)	ANTENNA HEIGHT (m)	TABLE ANGLE (Degree)	RAW VALUE (dBuV)	CORRECTION FACTOR (dB/m)
1	5100.00	57.4 PK	74.0	-16.6	1.95 H	36	55.50	1.90
2	5100.00	44.1 AV	54.0	-9.9	1.95 H	36	42.20	1.90
3	5150.00	56.3 PK	74.0	-17.7	1.12 H	335	54.30	2.00
4	5150.00	43.2 AV	54.0	-10.8	1.12 H	335	41.20	2.00
5	*5260.00	108.9 PK			1.25 H	142	68.80	40.10
6	*5260.00	98.7 AV			1.25 H	142	58.60	40.10
7	5420.00	57.8 PK	74.0	-16.2	1.36 H	66	55.70	2.10
8	5420.00	44.5 AV	54.0	-9.5	1.36 H	66	42.40	2.10
9	#10520.00	60.9 PK	74.0	-13.1	1.04 H	88	45.60	15.30
10	#10520.00	46.6 AV	54.0	-7.4	1.04 H	88	31.30	15.30

ANTENNA POLARITY & TEST DISTANCE: VERTICAL AT 3 M

NO.	FREQ. (MHz)	EMISSION LEVEL (dBuV/m)	LIMIT (dBuV/m)	MARGIN (dB)	ANTENNA HEIGHT (m)	TABLE ANGLE (Degree)	RAW VALUE (dBuV)	CORRECTION FACTOR (dB/m)
1	5100.00	62.5 PK	74.0	-11.5	1.66 V	144	60.60	1.90
2	5100.00	50.9 AV	54.0	-3.1	1.66 V	144	49.00	1.90
3	5150.00	57.0 PK	74.0	-17.0	1.66 V	144	55.00	2.00
4	5150.00	43.1 AV	54.0	-10.9	1.66 V	144	41.10	2.00
5	*5260.00	115.7 PK			1.40 V	233	75.60	40.10
6	*5260.00	105.0 AV			1.40 V	233	64.90	40.10
7	5420.00	63.7 PK	74.0	-10.3	1.56 V	131	61.60	2.10
8	5420.00	52.0 AV	54.0	-2.0	1.56 V	131	49.90	2.10
9	#10520.00	60.9 PK	74.0	-13.1	1.65 V	152	45.60	15.30
10	#10520.00	47.2 AV	54.0	-6.8	1.65 V	152	31.90	15.30

Remark:

1. Emission Level(dBuV/m) = Raw Value(dBuV) + Correction Factor(dB/m)
2. Correction Factor(dB/m) = Antenna Factor(dB/m) + Cable Factor(dB)
3. The other emission levels were very low against the limit.
4. Margin value = Emission Level – Limit value
5. " * ": Fundamental frequency.
6. " # ": The radiated frequency is out of the restricted band.

CHANNEL	TX Channel 60	DETECTOR FUNCTION	Peak (PK)
FREQUENCY RANGE	1GHz ~ 40GHz		Average (AV)

ANTENNA POLARITY & TEST DISTANCE: HORIZONTAL AT 3 M

NO.	FREQ. (MHz)	EMISSION LEVEL (dBuV/m)	LIMIT (dBuV/m)	MARGIN (dB)	ANTENNA HEIGHT (m)	TABLE ANGLE (Degree)	RAW VALUE (dBuV)	CORRECTION FACTOR (dB/m)
1	5150.00	57.7 PK	74.0	-16.3	1.52 H	99	55.70	2.00
2	5150.00	44.6 AV	54.0	-9.4	1.52 H	99	42.60	2.00
3	*5300.00	108.0 PK			1.31 H	138	67.90	40.10
4	*5300.00	97.9 AV			1.31 H	138	57.80	40.10
5	5380.00	58.8 PK	74.0	-15.2	1.05 H	96	56.80	2.00
6	5380.00	47.9 AV	54.0	-6.1	1.05 H	96	45.90	2.00
7	5460.00	58.8 PK	74.0	-15.2	1.04 H	88	56.70	2.10
8	5460.00	45.6 AV	54.0	-8.4	1.04 H	88	43.50	2.10
9	10600.00	61.8 PK	74.0	-12.2	1.45 H	88	45.60	16.20
10	10600.00	47.8 AV	54.0	-6.2	1.45 H	88	31.60	16.20

ANTENNA POLARITY & TEST DISTANCE: VERTICAL AT 3 M

NO.	FREQ. (MHz)	EMISSION LEVEL (dBuV/m)	LIMIT (dBuV/m)	MARGIN (dB)	ANTENNA HEIGHT (m)	TABLE ANGLE (Degree)	RAW VALUE (dBuV)	CORRECTION FACTOR (dB/m)
1	5150.00	61.5 PK	74.0	-12.5	1.66 V	115	59.50	2.00
2	5150.00	51.2 AV	54.0	-2.8	1.66 V	115	49.20	2.00
3	*5300.00	115.0 PK			1.67 V	143	74.90	40.10
4	*5300.00	105.0 AV			1.67 V	143	64.90	40.10
5	5380.00	64.1 PK	74.0	-9.9	1.57 V	141	62.10	2.00
6	5380.00	53.0 AV	54.0	-1.0	1.57 V	141	51.00	2.00
7	5460.00	63.6 PK	74.0	-10.4	1.69 V	116	61.50	2.10
8	5460.00	52.7 AV	54.0	-1.3	1.69 V	116	50.60	2.10
9	10600.00	61.9 PK	74.0	-12.1	1.08 V	96	45.70	16.20
10	10600.00	47.8 AV	54.0	-6.2	1.08 V	96	31.60	16.20

Remark:

1. Emission Level(dBuV/m) = Raw Value(dBuV) + Correction Factor(dB/m)
2. Correction Factor(dB/m) = Antenna Factor(dB/m) + Cable Factor(dB)
3. The other emission levels were very low against the limit.
4. Margin value = Emission Level – Limit value
5. " * ": Fundamental frequency.
6. " # ": The radiated frequency is out of the restricted band.

CHANNEL	TX Channel 64	DETECTOR FUNCTION	Peak (PK)
FREQUENCY RANGE	1GHz ~ 40GHz		Average (AV)

ANTENNA POLARITY & TEST DISTANCE: HORIZONTAL AT 3 M

NO.	FREQ. (MHz)	EMISSION LEVEL (dBuV/m)	LIMIT (dBuV/m)	MARGIN (dB)	ANTENNA HEIGHT (m)	TABLE ANGLE (Degree)	RAW VALUE (dBuV)	CORRECTION FACTOR (dB/m)
1	5100.00	57.1 PK	74.0	-16.9	1.05 H	96	55.20	1.90
2	5100.00	45.0 AV	54.0	-9.0	1.05 H	96	43.10	1.90
3	*5320.00	107.6 PK			1.30 H	140	67.40	40.20
4	*5320.00	97.4 AV			1.30 H	140	57.20	40.20
5	5350.00	57.2 PK	74.0	-16.8	1.59 H	66	55.20	2.00
6	5350.00	44.5 AV	54.0	-9.5	1.59 H	66	42.50	2.00
7	5400.00	58.7 PK	74.0	-15.3	1.06 H	332	56.60	2.10
8	5400.00	45.9 AV	54.0	-8.1	1.06 H	332	43.80	2.10
9	#5480.00	58.8 PK	74.0	-15.2	1.02 H	88	56.60	2.20
10	#5480.00	46.8 AV	54.0	-7.2	1.02 H	88	44.60	2.20
11	10640.00	62.0 PK	74.0	-12.0	1.52 H	99	45.70	16.30
12	10640.00	47.5 AV	54.0	-6.5	1.52 H	99	31.20	16.30

ANTENNA POLARITY & TEST DISTANCE: VERTICAL AT 3 M

NO.	FREQ. (MHz)	EMISSION LEVEL (dBuV/m)	LIMIT (dBuV/m)	MARGIN (dB)	ANTENNA HEIGHT (m)	TABLE ANGLE (Degree)	RAW VALUE (dBuV)	CORRECTION FACTOR (dB/m)
1	5100.00	60.6 PK	74.0	-13.4	1.67 V	138	58.70	1.90
2	5100.00	49.7 AV	54.0	-4.3	1.67 V	138	47.80	1.90
3	*5320.00	114.6 PK			1.82 V	134	74.40	40.20
4	*5320.00	104.5 AV			1.82 V	134	64.30	40.20
5	5350.00	62.6 PK	74.0	-11.4	1.67 V	138	60.60	2.00
6	5350.00	49.6 AV	54.0	-4.4	1.67 V	138	47.60	2.00
7	5400.00	64.5 PK	74.0	-9.5	1.72 V	138	62.40	2.10
8	5400.00	53.5 AV	54.0	-0.5	1.72 V	138	51.40	2.10
9	#5480.00	63.5 PK	74.0	-10.5	1.62 V	113	61.30	2.20
10	#5480.00	52.9 AV	54.0	-1.1	1.62 V	113	50.70	2.20
11	10640.00	62.9 PK	74.0	-11.1	1.08 V	55	46.60	16.30
12	10640.00	48.8 AV	54.0	-5.2	1.08 V	55	32.50	16.30

Remark:

1. Emission Level(dBuV/m) = Raw Value(dBuV) + Correction Factor(dB/m)
2. Correction Factor(dB/m) = Antenna Factor(dB/m) + Cable Factor(dB)
3. The other emission levels were very low against the limit.
4. Margin value = Emission Level – Limit value
5. " * ": Fundamental frequency.
6. " # ": The radiated frequency is out of the restricted band.

CHANNEL	TX Channel 100	DETECTOR FUNCTION	Peak (PK)
FREQUENCY RANGE	1GHz ~ 40GHz		Average (AV)

ANTENNA POLARITY & TEST DISTANCE: HORIZONTAL AT 3 M

NO.	FREQ. (MHz)	EMISSION LEVEL (dBuV/m)	LIMIT (dBuV/m)	MARGIN (dB)	ANTENNA HEIGHT (m)	TABLE ANGLE (Degree)	RAW VALUE (dBuV)	CORRECTION FACTOR (dB/m)
1	5420.00	57.4 PK	74.0	-16.6	1.09 H	65	55.30	2.10
2	5420.00	46.9 AV	54.0	-7.1	1.09 H	65	44.80	2.10
3	5460.00	55.7 PK	74.0	-18.3	1.36 H	225	53.60	2.10
4	5460.00	43.7 AV	54.0	-10.3	1.36 H	225	41.60	2.10
5	#5470.00	57.2 PK	74.0	-16.8	1.02 H	84	55.00	2.20
6	#5470.00	44.1 AV	54.0	-9.9	1.02 H	84	41.90	2.20
7	*5500.00	106.6 PK			1.05 H	69	66.30	40.30
8	*5500.00	97.4 AV			1.05 H	69	57.10	40.30
9	#5660.00	59.8 PK	74.0	-14.2	1.07 H	78	57.30	2.50
10	#5660.00	47.6 AV	54.0	-6.4	1.07 H	78	45.10	2.50
11	11000.00	63.2 PK	74.0	-10.8	1.52 H	360	45.50	17.70
12	11000.00	49.2 AV	54.0	-4.8	1.52 H	360	31.50	17.70

ANTENNA POLARITY & TEST DISTANCE: VERTICAL AT 3 M

NO.	FREQ. (MHz)	EMISSION LEVEL (dBuV/m)	LIMIT (dBuV/m)	MARGIN (dB)	ANTENNA HEIGHT (m)	TABLE ANGLE (Degree)	RAW VALUE (dBuV)	CORRECTION FACTOR (dB/m)
1	5420.00	63.9 PK	74.0	-10.1	2.14 V	140	61.80	2.10
2	5420.00	52.4 AV	54.0	-1.6	2.14 V	140	50.30	2.10
3	5460.00	58.6 PK	74.0	-15.4	1.87 V	141	56.50	2.10
4	5460.00	45.6 AV	54.0	-8.4	1.87 V	141	43.50	2.10
5	#5470.00	67.2 PK	74.0	-6.8	1.87 V	141	65.00	2.20
6	#5470.00	50.0 AV	54.0	-4.0	1.87 V	141	47.80	2.20
7	*5500.00	115.5 PK			1.91 V	122	75.20	40.30
8	*5500.00	105.8 AV			1.91 V	122	65.50	40.30
9	#5660.00	64.0 PK	74.0	-10.0	1.88 V	105	61.50	2.50
10	#5660.00	53.1 AV	54.0	-0.9	1.88 V	105	50.60	2.50
11	11000.00	63.2 PK	74.0	-10.8	1.08 V	84	45.50	17.70
12	11000.00	49.2 AV	54.0	-4.8	1.08 V	84	31.50	17.70

Remark:

1. Emission Level(dBuV/m) = Raw Value(dBuV) + Correction Factor(dB/m)
2. Correction Factor(dB/m) = Antenna Factor(dB/m) + Cable Factor(dB)
3. The other emission levels were very low against the limit.
4. Margin value = Emission Level – Limit value
5. " * ": Fundamental frequency.
6. " # ": The radiated frequency is out of the restricted band.

CHANNEL	TX Channel 116	DETECTOR FUNCTION	Peak (PK)
FREQUENCY RANGE	1GHz ~ 40GHz		Average (AV)

ANTENNA POLARITY & TEST DISTANCE: HORIZONTAL AT 3 M

NO.	FREQ. (MHz)	EMISSION LEVEL (dBuV/m)	LIMIT (dBuV/m)	MARGIN (dB)	ANTENNA HEIGHT (m)	TABLE ANGLE (Degree)	RAW VALUE (dBuV)	CORRECTION FACTOR (dB/m)
1	5420.00	58.2 PK	74.0	-15.8	1.52 H	33	56.10	2.10
2	5420.00	44.9 AV	54.0	-9.1	1.52 H	33	42.80	2.10
3	*5580.00	105.6 PK			1.54 H	84	65.10	40.50
4	*5580.00	96.3 AV			1.54 H	84	55.80	40.50
5	#5740.00	58.6 PK	74.0	-15.4	1.62 H	154	55.90	2.70
6	#5740.00	45.5 AV	54.0	-8.5	1.62 H	154	42.80	2.70
7	11160.00	60.1 PK	74.0	-13.9	1.02 H	332	43.70	16.40
8	11160.00	47.6 AV	54.0	-6.4	1.02 H	332	31.20	16.40

ANTENNA POLARITY & TEST DISTANCE: VERTICAL AT 3 M

NO.	FREQ. (MHz)	EMISSION LEVEL (dBuV/m)	LIMIT (dBuV/m)	MARGIN (dB)	ANTENNA HEIGHT (m)	TABLE ANGLE (Degree)	RAW VALUE (dBuV)	CORRECTION FACTOR (dB/m)
1	5420.00	59.2 PK	74.0	-14.8	1.63 V	96	57.10	2.10
2	5420.00	47.8 AV	54.0	-6.2	1.63 V	96	45.70	2.10
3	*5580.00	113.3 PK			1.45 V	85	72.80	40.50
4	*5580.00	103.9 AV			1.45 V	85	63.40	40.50
5	#5740.00	64.6 PK	74.0	-9.4	1.53 V	66	61.90	2.70
6	#5740.00	52.8 AV	54.0	-1.2	1.53 V	66	50.10	2.70
7	11160.00	62.1 PK	74.0	-11.9	1.04 V	56	45.70	16.40
8	11160.00	47.9 AV	54.0	-6.1	1.04 V	56	31.50	16.40

Remark:

1. Emission Level(dBuV/m) = Raw Value(dBuV) + Correction Factor(dB/m)
2. Correction Factor(dB/m) = Antenna Factor(dB/m) + Cable Factor(dB)
3. The other emission levels were very low against the limit.
4. Margin value = Emission Level – Limit value
5. " * ": Fundamental frequency.
6. " # ": The radiated frequency is out of the restricted band.

CHANNEL	TX Channel 140	DETECTOR FUNCTION	Peak (PK)
FREQUENCY RANGE	1GHz ~ 40GHz		Average (AV)

ANTENNA POLARITY & TEST DISTANCE: HORIZONTAL AT 3 M

NO.	FREQ. (MHz)	EMISSION LEVEL (dBuV/m)	LIMIT (dBuV/m)	MARGIN (dB)	ANTENNA HEIGHT (m)	TABLE ANGLE (Degree)	RAW VALUE (dBuV)	CORRECTION FACTOR (dB/m)
1	5460.00	56.3 PK	74.0	-17.7	1.09 H	63	54.20	2.10
2	5460.00	43.3 AV	54.0	-10.7	1.09 H	63	41.20	2.10
3	*5700.00	102.9 PK			1.52 H	196	62.10	40.80
4	*5700.00	93.0 AV			1.52 H	196	52.20	40.80
5	#5780.00	57.8 PK	74.0	-16.2	1.08 H	214	55.10	2.70
6	#5780.00	45.4 AV	54.0	-8.6	1.08 H	214	42.70	2.70
7	11400.00	60.7 PK	74.0	-13.3	1.23 H	335	44.50	16.20
8	11400.00	47.8 AV	54.0	-6.2	1.23 H	335	31.60	16.20

ANTENNA POLARITY & TEST DISTANCE: VERTICAL AT 3 M

NO.	FREQ. (MHz)	EMISSION LEVEL (dBuV/m)	LIMIT (dBuV/m)	MARGIN (dB)	ANTENNA HEIGHT (m)	TABLE ANGLE (Degree)	RAW VALUE (dBuV)	CORRECTION FACTOR (dB/m)
1	5460.00	59.3 PK	74.0	-14.7	1.96 V	66	57.20	2.10
2	5460.00	48.0 AV	54.0	-6.0	1.96 V	66	45.90	2.10
3	*5700.00	115.8 PK			1.11 V	52	75.00	40.80
4	*5700.00	105.9 AV			1.11 V	52	65.10	40.80
5	#5780.00	61.7 PK	74.0	-12.3	1.06 V	65	59.00	2.70
6	#5780.00	49.8 AV	54.0	-4.2	1.06 V	65	47.10	2.70
7	11400.00	61.9 PK	74.0	-12.1	1.53 V	63	45.70	16.20
8	11400.00	47.5 AV	54.0	-6.5	1.53 V	63	31.30	16.20

Remark:

1. Emission Level(dBuV/m) = Raw Value(dBuV) + Correction Factor(dB/m)
2. Correction Factor(dB/m) = Antenna Factor(dB/m) + Cable Factor(dB)
3. The other emission levels were very low against the limit.
4. Margin value = Emission Level – Limit value
5. " * ": Fundamental frequency.
6. " # ": The radiated frequency is out of the restricted band.

802.11n (40MHz)

CHANNEL	TX Channel 54	DETECTOR FUNCTION	Peak (PK)
FREQUENCY RANGE	1GHz ~ 40GHz		Average (AV)

ANTENNA POLARITY & TEST DISTANCE: HORIZONTAL AT 3 M

NO.	FREQ. (MHz)	EMISSION LEVEL (dBuV/m)	LIMIT (dBuV/m)	MARGIN (dB)	ANTENNA HEIGHT (m)	TABLE ANGLE (Degree)	RAW VALUE (dBuV)	CORRECTION FACTOR (dB/m)
1	5100.00	57.4 PK	74.0	-16.6	1.05 H	58	55.50	1.90
2	5100.00	43.5 AV	54.0	-10.5	1.05 H	58	41.60	1.90
3	5150.00	57.6 PK	74.0	-16.4	1.59 H	64	55.60	2.00
4	5150.00	43.5 AV	54.0	-10.5	1.59 H	64	41.50	2.00
5	*5270.00	106.7 PK			1.47 H	144	66.60	40.10
6	*5270.00	96.2 AV			1.47 H	144	56.10	40.10
7	5430.00	60.1 PK	74.0	-13.9	1.36 H	66	58.00	2.10
8	5430.00	44.2 AV	54.0	-9.8	1.36 H	66	42.10	2.10
9	#10540.00	61.6 PK	74.0	-12.4	1.00 H	96	46.00	15.60
10	#10540.00	47.7 AV	54.0	-6.3	1.00 H	96	32.10	15.60

ANTENNA POLARITY & TEST DISTANCE: VERTICAL AT 3 M

NO.	FREQ. (MHz)	EMISSION LEVEL (dBuV/m)	LIMIT (dBuV/m)	MARGIN (dB)	ANTENNA HEIGHT (m)	TABLE ANGLE (Degree)	RAW VALUE (dBuV)	CORRECTION FACTOR (dB/m)
1	5100.00	58.7 PK	74.0	-15.3	1.00 V	118	56.80	1.90
2	5100.00	47.3 AV	54.0	-6.7	1.00 V	118	45.40	1.90
3	5150.00	55.4 PK	74.0	-18.6	1.00 V	118	53.40	2.00
4	5150.00	42.9 AV	54.0	-11.1	1.00 V	118	40.90	2.00
5	*5270.00	112.4 PK			1.39 V	234	72.30	40.10
6	*5270.00	101.4 AV			1.39 V	234	61.30	40.10
7	5430.00	60.2 PK	74.0	-13.8	1.86 V	124	58.10	2.10
8	5430.00	48.5 AV	54.0	-5.5	1.86 V	124	46.40	2.10
9	#10540.00	60.5 PK	74.0	-13.5	1.52 V	99	44.90	15.60
10	#10540.00	48.1 AV	54.0	-5.9	1.52 V	99	32.50	15.60

Remark:

1. Emission Level(dBuV/m) = Raw Value(dBuV) + Correction Factor(dB/m)
2. Correction Factor(dB/m) = Antenna Factor(dB/m) + Cable Factor(dB)
3. The other emission levels were very low against the limit.
4. Margin value = Emission Level – Limit value
5. " * ": Fundamental frequency.
6. " # ": The radiated frequency is out of the restricted band.

CHANNEL	TX Channel 62	DETECTOR FUNCTION	Peak (PK)
FREQUENCY RANGE	1GHz ~ 40GHz		Average (AV)

ANTENNA POLARITY & TEST DISTANCE: HORIZONTAL AT 3 M

NO.	FREQ. (MHz)	EMISSION LEVEL (dBuV/m)	LIMIT (dBuV/m)	MARGIN (dB)	ANTENNA HEIGHT (m)	TABLE ANGLE (Degree)	RAW VALUE (dBuV)	CORRECTION FACTOR (dB/m)
1	5150.00	57.2 PK	74.0	-16.8	1.05 H	96	55.20	2.00
2	5150.00	44.2 AV	54.0	-9.8	1.05 H	96	42.20	2.00
3	*5310.00	104.8 PK			1.51 H	141	64.70	40.10
4	*5310.00	93.5 AV			1.51 H	141	53.40	40.10
5	5350.00	60.6 PK	74.0	-13.4	1.62 H	145	58.60	2.00
6	5350.00	46.9 AV	54.0	-7.1	1.62 H	145	44.90	2.00
7	#5753.00	57.0 PK	74.0	-17.0	1.02 H	64	54.30	2.70
8	#5753.00	45.3 AV	54.0	-8.7	1.02 H	64	42.60	2.70
9	10620.00	60.8 PK	74.0	-13.2	1.20 H	200	44.60	16.20
10	10620.00	47.3 AV	54.0	-6.7	1.20 H	200	31.10	16.20

ANTENNA POLARITY & TEST DISTANCE: VERTICAL AT 3 M

NO.	FREQ. (MHz)	EMISSION LEVEL (dBuV/m)	LIMIT (dBuV/m)	MARGIN (dB)	ANTENNA HEIGHT (m)	TABLE ANGLE (Degree)	RAW VALUE (dBuV)	CORRECTION FACTOR (dB/m)
1	5150.00	58.1 PK	74.0	-15.9	1.66 V	137	56.10	2.00
2	5150.00	46.6 AV	54.0	-7.4	1.66 V	137	44.60	2.00
3	*5310.00	108.7 PK			1.49 V	188	68.60	40.10
4	*5310.00	98.1 AV			1.49 V	188	58.00	40.10
5	5350.00	68.4 PK	74.0	-5.6	1.74 V	137	66.40	2.00
6	5350.00	53.5 AV	54.0	-0.5	1.74 V	137	51.50	2.00
7	#5753.00	56.6 PK	74.0	-17.4	1.79 V	138	53.90	2.70
8	#5753.00	47.5 AV	54.0	-6.5	1.79 V	138	44.80	2.70
9	10620.00	62.7 PK	74.0	-11.3	1.51 V	99	46.50	16.20
10	10620.00	47.7 AV	54.0	-6.3	1.51 V	99	31.50	16.20

Remark:

1. Emission Level(dBuV/m) = Raw Value(dBuV) + Correction Factor(dB/m)
2. Correction Factor(dB/m) = Antenna Factor(dB/m) + Cable Factor(dB)
3. The other emission levels were very low against the limit.
4. Margin value = Emission Level – Limit value
5. " * ": Fundamental frequency.
6. " # ": The radiated frequency is out of the restricted band.

CHANNEL	TX Channel 102	DETECTOR FUNCTION	Peak (PK)
FREQUENCY RANGE	1GHz ~ 40GHz		Average (AV)

ANTENNA POLARITY & TEST DISTANCE: HORIZONTAL AT 3 M

NO.	FREQ. (MHz)	EMISSION LEVEL (dBuV/m)	LIMIT (dBuV/m)	MARGIN (dB)	ANTENNA HEIGHT (m)	TABLE ANGLE (Degree)	RAW VALUE (dBuV)	CORRECTION FACTOR (dB/m)
1	5460.00	60.0 PK	74.0	-14.0	1.00 H	214	57.90	2.10
2	5460.00	43.7 AV	54.0	-10.3	1.00 H	214	41.60	2.10
3	#5470.00	59.8 PK	74.0	-14.2	1.00 H	214	57.60	2.20
4	#5470.00	46.1 AV	54.0	-7.9	1.00 H	214	43.90	2.20
5	*5510.00	101.1 PK			2.18 H	161	60.80	40.30
6	*5510.00	91.3 AV			2.18 H	161	51.00	40.30
7	11020.00	62.1 PK	74.0	-11.9	1.04 H	84	44.70	17.40
8	11020.00	48.9 AV	54.0	-5.1	1.04 H	84	31.50	17.40

ANTENNA POLARITY & TEST DISTANCE: VERTICAL AT 3 M

NO.	FREQ. (MHz)	EMISSION LEVEL (dBuV/m)	LIMIT (dBuV/m)	MARGIN (dB)	ANTENNA HEIGHT (m)	TABLE ANGLE (Degree)	RAW VALUE (dBuV)	CORRECTION FACTOR (dB/m)
1	5460.00	63.7 PK	74.0	-10.3	1.54 V	124	61.60	2.10
2	5460.00	49.2 AV	54.0	-4.8	1.54 V	124	47.10	2.10
3	#5470.00	70.0 PK	74.0	-4.0	1.54 V	124	67.80	2.20
4	#5470.00	53.7 AV	54.0	-0.3	1.54 V	124	51.50	2.20
5	*5510.00	110.3 PK			2.00 V	141	70.00	40.30
6	*5510.00	99.9 AV			2.00 V	141	59.60	40.30
7	11020.00	63.1 PK	74.0	-10.9	1.05 V	94	45.70	17.40
8	11020.00	49.9 AV	54.0	-4.1	1.05 V	94	32.50	17.40

Remark:

1. Emission Level(dBuV/m) = Raw Value(dBuV) + Correction Factor(dB/m)
2. Correction Factor(dB/m) = Antenna Factor(dB/m) + Cable Factor(dB)
3. The other emission levels were very low against the limit.
4. Margin value = Emission Level – Limit value
5. " * ": Fundamental frequency.
6. " # ": The radiated frequency is out of the restricted band.

CHANNEL	TX Channel 110	DETECTOR FUNCTION	Peak (PK)
FREQUENCY RANGE	1GHz ~ 40GHz		Average (AV)

ANTENNA POLARITY & TEST DISTANCE: HORIZONTAL AT 3 M

NO.	FREQ. (MHz)	EMISSION LEVEL (dBuV/m)	LIMIT (dBuV/m)	MARGIN (dB)	ANTENNA HEIGHT (m)	TABLE ANGLE (Degree)	RAW VALUE (dBuV)	CORRECTION FACTOR (dB/m)
1	5460.00	56.7 PK	74.0	-17.3	2.08 H	161	54.60	2.10
2	5460.00	43.6 AV	54.0	-10.4	2.08 H	161	41.50	2.10
3	#5470.00	57.9 PK	74.0	-16.1	2.08 H	161	55.70	2.20
4	#5470.00	44.6 AV	54.0	-9.4	2.08 H	161	42.40	2.20
5	*5550.00	103.6 PK			2.21 H	162	63.20	40.40
6	*5550.00	93.4 AV			2.21 H	162	53.00	40.40
7	#5725.00	56.7 PK	74.0	-17.3	2.12 H	168	54.10	2.60
8	#5725.00	45.9 AV	54.0	-8.1	2.12 H	168	43.30	2.60
9	11100.00	61.6 PK	74.0	-12.4	1.02 H	34	45.00	16.60
10	11100.00	48.1 AV	54.0	-5.9	1.02 H	34	31.50	16.60

ANTENNA POLARITY & TEST DISTANCE: VERTICAL AT 3 M

NO.	FREQ. (MHz)	EMISSION LEVEL (dBuV/m)	LIMIT (dBuV/m)	MARGIN (dB)	ANTENNA HEIGHT (m)	TABLE ANGLE (Degree)	RAW VALUE (dBuV)	CORRECTION FACTOR (dB/m)
1	5460.00	61.6 PK	74.0	-12.4	1.87 V	133	59.50	2.10
2	5460.00	50.2 AV	54.0	-3.8	1.87 V	133	48.10	2.10
3	#5470.00	63.4 PK	74.0	-10.6	1.77 V	139	61.20	2.20
4	#5470.00	51.5 AV	54.0	-2.5	1.77 V	139	49.30	2.20
5	*5550.00	111.8 PK			1.46 V	124	71.40	40.40
6	*5550.00	101.8 AV			1.46 V	124	61.40	40.40
7	#5725.00	61.3 PK	74.0	-12.7	1.69 V	112	58.70	2.60
8	#5725.00	50.7 AV	54.0	-3.3	1.69 V	112	48.10	2.60
9	11100.00	63.2 PK	74.0	-10.8	1.54 V	96	46.60	16.60
10	11100.00	48.2 AV	54.0	-5.8	1.54 V	96	31.60	16.60

Remark:

1. Emission Level(dBuV/m) = Raw Value(dBuV) + Correction Factor(dB/m)
2. Correction Factor(dB/m) = Antenna Factor(dB/m) + Cable Factor(dB)
3. The other emission levels were very low against the limit.
4. Margin value = Emission Level – Limit value
5. " * ": Fundamental frequency.
6. " # ": The radiated frequency is out of the restricted band.

CHANNEL	TX Channel 134	DETECTOR FUNCTION	Peak (PK)
FREQUENCY RANGE	1GHz ~ 40GHz		Average (AV)

ANTENNA POLARITY & TEST DISTANCE: HORIZONTAL AT 3 M

NO.	FREQ. (MHz)	EMISSION LEVEL (dBuV/m)	LIMIT (dBuV/m)	MARGIN (dB)	ANTENNA HEIGHT (m)	TABLE ANGLE (Degree)	RAW VALUE (dBuV)	CORRECTION FACTOR (dB/m)
1	*5670.00	101.5 PK			1.11 H	163	60.80	40.70
2	*5670.00	91.6 AV			1.11 H	163	50.90	40.70
3	#5725.00	58.3 PK	74.0	-15.7	1.11 H	159	55.70	2.60
4	#5725.00	45.1 AV	54.0	-8.9	1.11 H	159	42.50	2.60
5	11340.00	62.0 PK	74.0	-12.0	1.00 H	95	45.50	16.50
6	11340.00	48.0 AV	54.0	-6.0	1.00 H	95	31.50	16.50

ANTENNA POLARITY & TEST DISTANCE: VERTICAL AT 3 M

NO.	FREQ. (MHz)	EMISSION LEVEL (dBuV/m)	LIMIT (dBuV/m)	MARGIN (dB)	ANTENNA HEIGHT (m)	TABLE ANGLE (Degree)	RAW VALUE (dBuV)	CORRECTION FACTOR (dB/m)
1	*5670.00	112.5 PK			1.91 V	187	71.80	40.70
2	*5670.00	102.4 AV			1.91 V	187	61.70	40.70
3	#5725.00	68.4 PK	74.0	-5.6	1.97 V	186	65.80	2.60
4	#5725.00	52.8 AV	54.0	-1.2	1.97 V	186	50.20	2.60
5	11340.00	62.2 PK	74.0	-11.8	1.54 V	96	45.70	16.50
6	11340.00	48.1 AV	54.0	-5.9	1.54 V	96	31.60	16.50

Remark:

1. Emission Level(dBuV/m) = Raw Value(dBuV) + Correction Factor(dB/m)
2. Correction Factor(dB/m) = Antenna Factor(dB/m) + Cable Factor(dB)
3. The other emission levels were very low against the limit.
4. Margin value = Emission Level – Limit value
5. " * ": Fundamental frequency.
6. " # ": The radiated frequency is out of the restricted band.

802.11ac (80MHz)

CHANNEL	TX Channel 58	DETECTOR FUNCTION	Peak (PK) Average (AV)
FREQUENCY RANGE	1GHz ~ 40GHz		

ANTENNA POLARITY & TEST DISTANCE: HORIZONTAL AT 3 M

NO.	FREQ. (MHz)	EMISSION LEVEL (dBuV/m)	LIMIT (dBuV/m)	MARGIN (dB)	ANTENNA HEIGHT (m)	TABLE ANGLE (Degree)	RAW VALUE (dBuV)	CORRECTION FACTOR (dB/m)
1	5150.00	56.9 PK	74.0	-17.1	1.20 H	55	54.90	2.00
2	5150.00	43.9 AV	54.0	-10.1	1.20 H	55	41.90	2.00
3	*5290.00	99.8 PK			1.15 H	137	59.70	40.10
4	*5290.00	89.1 AV			1.15 H	137	49.00	40.10
5	5350.00	61.0 PK	74.0	-13.0	1.56 H	142	59.00	2.00
6	5350.00	46.4 AV	54.0	-7.6	1.56 H	142	44.40	2.00
7	#5878.00	55.7 PK	74.0	-18.3	1.32 H	147	52.70	3.00
8	#5878.00	45.5 AV	54.0	-8.5	1.32 H	147	42.50	3.00
9	#10580.00	61.5 PK	74.0	-12.5	1.52 H	66	45.60	15.90
10	#10580.00	47.4 AV	54.0	-6.6	1.52 H	66	31.50	15.90

ANTENNA POLARITY & TEST DISTANCE: VERTICAL AT 3 M

NO.	FREQ. (MHz)	EMISSION LEVEL (dBuV/m)	LIMIT (dBuV/m)	MARGIN (dB)	ANTENNA HEIGHT (m)	TABLE ANGLE (Degree)	RAW VALUE (dBuV)	CORRECTION FACTOR (dB/m)
1	5150.00	57.0 PK	74.0	-17.0	1.83 V	239	55.00	2.00
2	5150.00	44.6 AV	54.0	-9.4	1.83 V	239	42.60	2.00
3	*5290.00	104.6 PK			1.42 V	189	64.50	40.10
4	*5290.00	94.0 AV			1.42 V	189	53.90	40.10
5	5350.00	68.5 PK	74.0	-5.5	1.37 V	234	66.50	2.00
6	5350.00	53.4 AV	54.0	-0.6	1.37 V	234	51.40	2.00
7	#5878.00	58.9 PK	74.0	-15.1	2.27 V	239	55.90	3.00
8	#5878.00	51.9 AV	54.0	-2.1	2.27 V	239	48.90	3.00
9	#10580.00	61.6 PK	74.0	-12.4	1.52 V	34	45.70	15.90
10	#10580.00	47.4 AV	54.0	-6.6	1.52 V	34	31.50	15.90

Remark:

1. Emission Level(dBuV/m) = Raw Value(dBuV) + Correction Factor(dB/m)
2. Correction Factor(dB/m) = Antenna Factor(dB/m) + Cable Factor(dB)
3. The other emission levels were very low against the limit.
4. Margin value = Emission Level – Limit value
5. " * ": Fundamental frequency.
6. " # ": The radiated frequency is out of the restricted band.

CHANNEL	TX Channel 106	DETECTOR FUNCTION	Peak (PK)
FREQUENCY RANGE	1GHz ~ 40GHz		Average (AV)

ANTENNA POLARITY & TEST DISTANCE: HORIZONTAL AT 3 M

NO.	FREQ. (MHz)	EMISSION LEVEL (dBuV/m)	LIMIT (dBuV/m)	MARGIN (dB)	ANTENNA HEIGHT (m)	TABLE ANGLE (Degree)	RAW VALUE (dBuV)	CORRECTION FACTOR (dB/m)
1	5460.00	59.9 PK	74.0	-14.1	1.84 H	140	57.80	2.10
2	5460.00	47.4 AV	54.0	-6.6	1.84 H	140	45.30	2.10
3	#5470.00	64.2 PK	74.0	-9.8	1.84 H	141	62.00	2.20
4	#5470.00	48.7 AV	54.0	-5.3	1.84 H	141	46.50	2.20
5	*5530.00	96.7 PK			2.11 H	164	56.30	40.40
6	*5530.00	86.5 AV			2.11 H	164	46.10	40.40
7	#6144.00	59.7 PK	74.0	-14.3	1.72 H	153	54.90	4.80
8	#6144.00	49.4 AV	54.0	-4.6	1.72 H	153	44.60	4.80
9	11060.00	61.8 PK	74.0	-12.2	1.54 H	96	44.70	17.10
10	11060.00	49.1 AV	54.0	-4.9	1.54 H	96	32.00	17.10

ANTENNA POLARITY & TEST DISTANCE: VERTICAL AT 3 M

NO.	FREQ. (MHz)	EMISSION LEVEL (dBuV/m)	LIMIT (dBuV/m)	MARGIN (dB)	ANTENNA HEIGHT (m)	TABLE ANGLE (Degree)	RAW VALUE (dBuV)	CORRECTION FACTOR (dB/m)
1	5460.00	66.4 PK	74.0	-7.6	1.78 V	143	64.30	2.10
2	5460.00	52.2 AV	54.0	-1.8	1.78 V	143	50.10	2.10
3	#5470.00	71.0 PK	74.0	-3.0	1.78 V	143	68.80	2.20
4	#5470.00	53.4 AV	54.0	-0.6	1.78 V	143	51.20	2.20
5	*5530.00	105.9 PK			1.92 V	121	65.50	40.40
6	*5530.00	94.9 AV			1.92 V	121	54.50	40.40
7	#6144.00	61.3 PK	74.0	-12.7	2.26 V	124	56.50	4.80
8	#6144.00	53.4 AV	54.0	-0.6	2.26 V	124	48.60	4.80
9	11060.00	64.0 PK	74.0	-10.0	1.87 V	34	46.90	17.10
10	11060.00	48.6 AV	54.0	-5.4	1.87 V	34	31.50	17.10

Remark:

1. Emission Level(dBuV/m) = Raw Value(dBuV) + Correction Factor(dB/m)
2. Correction Factor(dB/m) = Antenna Factor(dB/m) + Cable Factor(dB)
3. The other emission levels were very low against the limit.
4. Margin value = Emission Level – Limit value
5. " * ": Fundamental frequency.
6. " # ": The radiated frequency is out of the restricted band.

Below 1GHz worst-case data
802.11a

CHANNEL	TX Channel 52	DETECTOR FUNCTION	Quasi-Peak (QP)
FREQUENCY RANGE	30MHz ~ 1GHz		

ANTENNA POLARITY & TEST DISTANCE: HORIZONTAL AT 3 M

NO.	FREQ. (MHz)	EMISSION LEVEL (dBuV/m)	LIMIT (dBuV/m)	MARGIN (dB)	ANTENNA HEIGHT (m)	TABLE ANGLE (Degree)	RAW VALUE (dBuV)	CORRECTION FACTOR (dB/m)
1	92.08	25.8 QP	43.5	-17.7	1.49 H	250	36.90	-11.10
2	115.36	30.3 QP	43.5	-13.2	1.24 H	9	41.40	-11.10
3	128.94	29.0 QP	43.5	-14.5	1.99 H	12	40.10	-11.10
4	163.86	25.9 QP	43.5	-17.6	1.49 H	215	37.00	-11.10
5	291.90	30.4 QP	46.0	-15.6	1.00 H	302	41.50	-11.10
6	317.12	30.5 QP	46.0	-15.5	1.00 H	314	41.60	-11.10

ANTENNA POLARITY & TEST DISTANCE: VERTICAL AT 3 M

NO.	FREQ. (MHz)	EMISSION LEVEL (dBuV/m)	LIMIT (dBuV/m)	MARGIN (dB)	ANTENNA HEIGHT (m)	TABLE ANGLE (Degree)	RAW VALUE (dBuV)	CORRECTION FACTOR (dB/m)
1	94.02	29.0 QP	43.5	-14.5	1.00 V	261	40.10	-11.10
2	125.06	34.0 QP	43.5	-9.5	1.00 V	249	45.10	-11.10
3	128.94	32.3 QP	43.5	-11.2	1.24 V	270	43.40	-11.10
4	317.12	25.2 QP	46.0	-20.8	1.49 V	156	36.30	-11.10
5	518.88	24.6 QP	46.0	-21.4	1.00 V	193	35.70	-11.10
6	837.04	24.4 QP	46.0	-21.6	1.00 V	85	35.50	-11.10

Remark:

1. Emission Level(dBuV/m) = Raw Value(dBuV) + Correction Factor(dB/m)
2. Correction Factor(dB/m) = Antenna Factor(dB/m) + Cable Factor(dB)
3. The other emission levels were very low against the limit.
4. Margin value = Emission Level – Limit value

4.2 Conducted Emission Measurement

4.2.1 Limits of Conducted Emission Measurement

Frequency (MHz)	Conducted Limit (dBuV)	
	Quasi-peak	Average
0.15 - 0.5	66 - 56	56 - 46
0.50 - 5.0	56	46
5.0 - 30.0	60	50

- Note:**
1. The lower limit shall apply at the transition frequencies.
 2. The limit decreases in line with the logarithm of the frequency in the range of 0.15 to 0.50MHz.

4.2.2 Test Instruments

Description & Manufacturer	Model No.	Serial No.	Date Of Calibration	Due Date Of Calibration
Test Receiver ROHDE & SCHWARZ	ESCI	100612	Sep. 30, 2014	Sep. 29, 2015
RF signal cable Woken	5D-FB	Cable-HYC01-01	Dec. 26, 2014	Dec. 25, 2015
LISN ROHDE & SCHWARZ (EUT)	ESH3-Z5	847265/023	Oct. 21, 2014	Oct. 20, 2015
LISN ROHDE & SCHWARZ (Peripheral)	ESH3-Z5	100311	Jul. 21, 2014	Jul. 20, 2015
Software ADT	BV ADT_Cond_ V7.3.7.3	NA	NA	NA

- Note:**
1. The calibration interval of the above test instruments is 12 months and the calibrations are traceable to NML/ROC and NIST/USA.
 2. The test was performed in HwaYa Shielded Room 1.
 3. The VCCI Site Registration No. is C-2040.

4.2.3 Test Procedures

- The EUT was placed 0.4 meters from the conducting wall of the shielded room with EUT being connected to the power mains through a line impedance stabilization network (LISN). Other support units were connected to the power mains through another LISN. The two LISNs provide 50 ohm/ 50uH of coupling impedance for the measuring instrument.
- Both lines of the power mains connected to the EUT were checked for maximum conducted interference.
- The frequency range from 150kHz to 30MHz was searched. Emission levels under (Limit - 20dB) was not recorded.

NOTE: The resolution bandwidth and video bandwidth of test receiver is 9kHz for quasi-peak detection (QP) and average detection (AV) at frequency 0.15MHz-30MHz.

4.2.4 Deviation from Test Standard

No deviation.

4.2.5 Test Setup

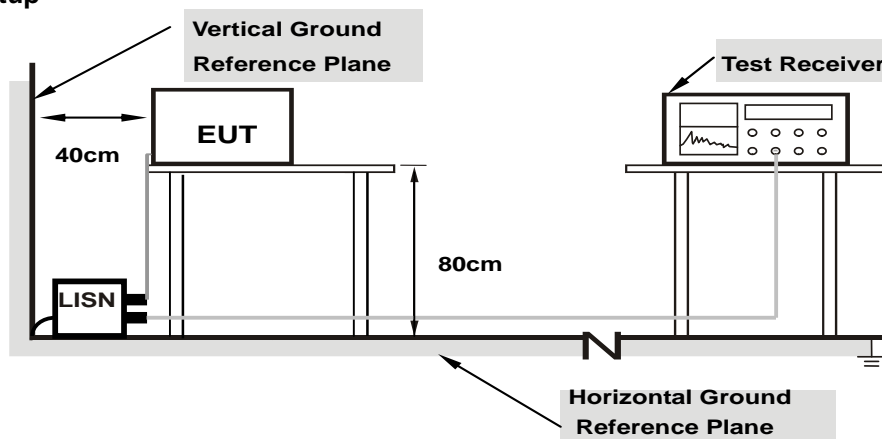

Note: 1.Support units were connected to second LISN.

For the actual test configuration, please refer to the attached file (Test Setup Photo).

4.2.6 EUT Operating Conditions

Same as 4.1.6.

4.2.7 Test Results

Phase	Line (L)	Detector Function	Quasi-Peak (QP) / Average (AV)
-------	----------	-------------------	--------------------------------

No	Freq. [MHz]	Corr. Factor (dB)	Reading Value [dB (uV)]		Emission Level [dB (uV)]		Limit [dB (uV)]		Margin (dB)	
			Q.P.	AV.	Q.P.	AV.	Q.P.	AV.	Q.P.	AV.
			1	0.19692	0.08	34.10	29.82	34.18	29.90	63.74
2	0.54089	0.09	28.59	12.36	28.68	12.45	56.00	46.00	-27.32	-33.55
3	1.52241	0.13	24.37	15.47	24.50	15.60	56.00	46.00	-31.50	-30.40
4	3.60253	0.19	26.24	19.28	26.43	19.47	56.00	46.00	-29.57	-26.53
5	16.79878	0.84	33.17	27.42	34.01	28.26	60.00	50.00	-25.99	-21.74
6	23.90716	1.05	38.81	38.52	39.86	39.57	60.00	50.00	-20.14	-10.43

Remarks:

1. Q.P. and AV. are abbreviations of quasi-peak and average individually.
2. The emission levels of other frequencies were very low against the limit.
3. Margin value = Emission level - Limit value
4. Correction factor = Insertion loss + Cable loss
5. Emission Level = Correction Factor + Reading Value.

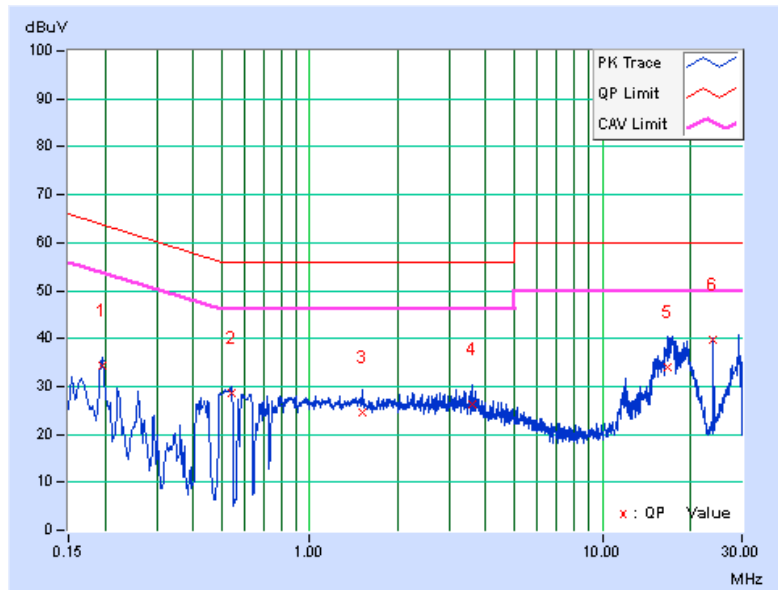

Phase	Neutral (N)	Detector Function	Quasi-Peak (QP) / Average (AV)
-------	-------------	-------------------	--------------------------------

No	Freq. [MHz]	Corr. Factor (dB)	Reading Value [dB (uV)]		Emission Level [dB (uV)]		Limit [dB (uV)]		Margin (dB)	
			Q.P.	AV.	Q.P.	AV.	Q.P.	AV.	Q.P.	AV.
			1	0.16967	0.12	33.38	28.23	33.50	28.35	64.98
2	0.53709	0.17	27.97	14.93	28.14	15.10	56.00	46.00	-27.86	-30.90
3	1.44030	0.20	27.27	13.91	27.47	14.11	56.00	46.00	-28.53	-31.89
4	3.61035	0.27	26.24	19.28	26.51	19.55	56.00	46.00	-29.49	-26.45
5	19.47322	0.87	31.44	25.09	32.31	25.96	60.00	50.00	-27.69	-24.04
6	23.90716	0.94	38.74	38.49	39.68	39.43	60.00	50.00	-20.32	-10.57

Remarks:

1. Q.P. and AV. are abbreviations of quasi-peak and average individually.
2. The emission levels of other frequencies were very low against the limit.
3. Margin value = Emission level - Limit value
4. Correction factor = Insertion loss + Cable loss
5. Emission Level = Correction Factor + Reading Value.

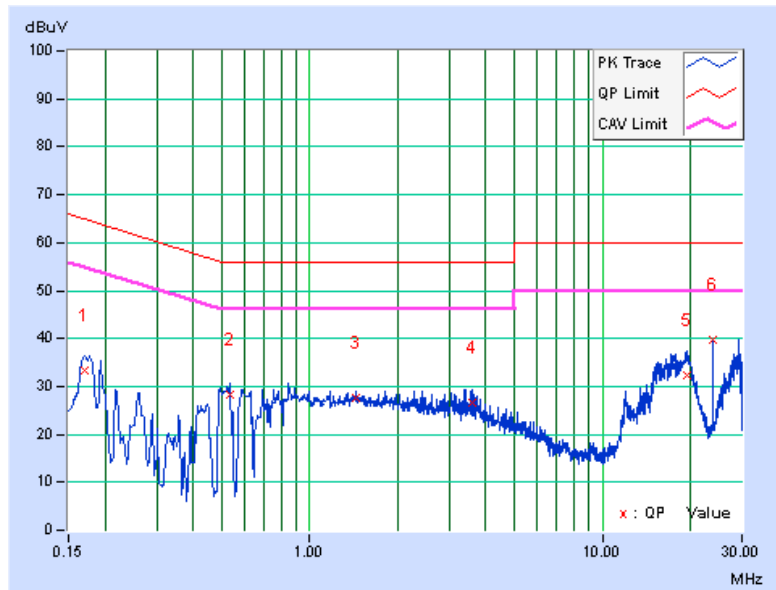

4.3 Transmit Power Measurement

4.3.1 Limits of Transmit Power Measurement

Operation Band	EUT Category		LIMIT
U-NII-1	---	Outdoor Access Point	1 Watt (30 dBm) (Max. e.i.r.p \leq 125mW(21 dBm) at any elevation angle above 30 degrees as measured from the horizon)
	---	Fixed point-to-point Access Point	1 Watt (30 dBm)
	---	Indoor Access Point	1 Watt (30 dBm)
	---	Mobile and Portable client device	250mW (24 dBm)
U-NII-2A	√		250mW (24 dBm) or 11 dBm+10 log B*
U-NII-2C	√		250mW (24 dBm) or 11 dBm+10 log B*
U-NII-3	---		1 Watt (30 dBm)

*B is the 26 dB emission bandwidth in megahertz

Per KDB 662911 Method of conducted output power measurement on IEEE 802.11 devices,

Array Gain = 0 dB (i.e., no array gain) for $N_{ANT} \leq 4$;

Array Gain = 0 dB (i.e., no array gain) for channel widths ≥ 40 MHz for any N_{ANT} ;

Array Gain = $5 \log(N_{ANT}/N_{SS})$ dB or 3 dB, whichever is less for 20-MHz channel widths with $N_{ANT} \geq 5$.

For power measurements on all other devices: Array Gain = $10 \log(N_{ANT}/N_{SS})$ dB.

4.3.2 Test Setup

For 802.11a, 802.11n (20MHz), 802.11n (40MHz), 802.11ac (20MHz), 802.11ac (40MHz)

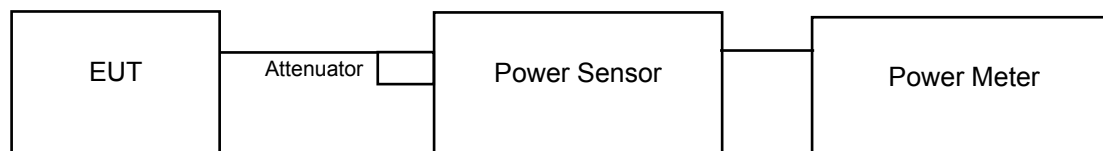

For 802.11ac (80MHz)

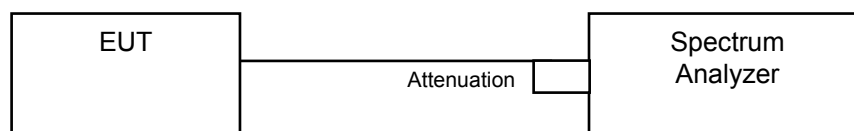

4.3.3 Test Instruments

Refer to section 4.1.2 to get information of above instrument.

4.3.4 Test Procedure

FOR AVERAGE POWER MEASUREMENT

For 802.11a, 802.11n (20MHz), 802.11n (40MHz)

Method PM is used to perform output power measurement, trigger and gating function of wide band power meter is enabled to measure max output power of TX on burst. Duty factor is not added to measured value.

For 802.11ac (80MHz)

- a. Set span to encompass the entire 26 dB EBW (or, alternatively, the entire 99% occupied bandwidth) of the signal.
- b. Set sweep trigger to "free run".
- c. Set RBW = 1 MHz.
- d. Set VBW \geq 3 MHz
- e. Number of points in sweep \geq 2 Span / RBW.
- f. Sweep time \leq (number of points in sweep) * T
- g. Detector = RMS.
- h. Trace mode = max hold.
- i. Allow max hold to run for at least 60 seconds, or longer as needed to allow the trace to stabilize.

4.3.5 Deviation from Test Standard

No deviation.

4.3.6 EUT Operating Conditions

The software provided by client to enable the EUT under transmission condition continuously at lowest, middle and highest channel frequencies individually.

4.3.7 Test Result

Power Output:

802.11a

Channel	Frequency (MHz)	Maximum Conducted Power (dBm)			Total Power (mW)	Total Power (dBm)	Power Limit (dBm)	Pass / Fail
		Chain 0	Chain 1	Chain 2				
52	5260	18.94	18.99	19.10	238.876	23.78	24.00	Pass
60	5300	18.97	19.02	19.12	240.343	23.81	24.00	Pass
64	5320	18.61	18.82	18.70	222.950	23.48	24.00	Pass
100	5500	18.65	18.58	18.51	216.351	23.35	24.00	Pass
116	5580	18.83	18.51	18.62	220.120	23.43	24.00	Pass
140	5700	18.94	19.15	18.20	226.636	23.55	24.00	Pass

Note:

Chain 0

1. $11\text{dBm} + 10\log(20.61) = 24.14\text{ dBm} > 24\text{dBm}$.
2. $11\text{dBm} + 10\log(20.65) = 24.15\text{ dBm} > 24\text{dBm}$.
3. $11\text{dBm} + 10\log(20.76) = 24.17\text{ dBm} > 24\text{dBm}$.
4. $11\text{dBm} + 10\log(20.41) = 24.10\text{ dBm} > 24\text{dBm}$.
5. $11\text{dBm} + 10\log(20.48) = 24.11\text{ dBm} > 24\text{dBm}$.
6. $11\text{dBm} + 10\log(20.58) = 24.13\text{ dBm} > 24\text{dBm}$.

Chain 1

1. $11\text{dBm} + 10\log(20.34) = 24.08\text{ dBm} > 24\text{dBm}$.
2. $11\text{dBm} + 10\log(20.37) = 24.09\text{ dBm} > 24\text{dBm}$.
3. $11\text{dBm} + 10\log(20.41) = 24.10\text{ dBm} > 24\text{dBm}$.
4. $11\text{dBm} + 10\log(21.20) = 24.26\text{ dBm} > 24\text{dBm}$.
5. $11\text{dBm} + 10\log(20.53) = 24.12\text{ dBm} > 24\text{dBm}$.
6. $11\text{dBm} + 10\log(20.51) = 24.12\text{ dBm} > 24\text{dBm}$.

Chain 2

1. $11\text{dBm} + 10\log(20.42) = 24.10\text{ dBm} > 24\text{dBm}$.
2. $11\text{dBm} + 10\log(20.42) = 24.10\text{ dBm} > 24\text{dBm}$.
3. $11\text{dBm} + 10\log(20.60) = 24.14\text{ dBm} > 24\text{dBm}$.
4. $11\text{dBm} + 10\log(20.89) = 24.20\text{ dBm} > 24\text{dBm}$.
5. $11\text{dBm} + 10\log(20.98) = 24.22\text{ dBm} > 24\text{dBm}$.
6. $11\text{dBm} + 10\log(22.98) = 24.61\text{ dBm} > 24\text{dBm}$.

802.11n (20MHz)

Channel	Frequency (MHz)	Maximum Conducted Power (dBm)			Total Power (mW)	Total Power (dBm)	Power Limit (dBm)	Pass / Fail
		Chain 0	Chain 1	Chain 2				
52	5260	18.81	19.13	19.08	238.789	23.78	24.00	Pass
60	5300	18.83	18.90	18.98	233.077	23.67	24.00	Pass
64	5320	18.64	18.80	18.71	223.274	23.49	24.00	Pass
100	5500	18.67	18.61	18.54	217.682	23.38	24.00	Pass
116	5580	18.88	18.55	18.64	221.996	23.46	24.00	Pass
140	5700	18.91	19.02	18.74	232.420	23.66	24.00	Pass

Note:
Chain 0

1. $11\text{dBm} + 10\log(20.58) = 24.13\text{ dBm} > 24\text{dBm}$.
2. $11\text{dBm} + 10\log(20.70) = 24.16\text{ dBm} > 24\text{dBm}$.
3. $11\text{dBm} + 10\log(20.85) = 24.19\text{ dBm} > 24\text{dBm}$.
4. $11\text{dBm} + 10\log(20.69) = 24.16\text{ dBm} > 24\text{dBm}$.
5. $11\text{dBm} + 10\log(21.00) = 24.22\text{ dBm} > 24\text{dBm}$.
6. $11\text{dBm} + 10\log(23.49) = 24.71\text{ dBm} > 24\text{dBm}$.

Chain 1

1. $11\text{dBm} + 10\log(20.51) = 24.12\text{ dBm} > 24\text{dBm}$.
2. $11\text{dBm} + 10\log(20.71) = 24.16\text{ dBm} > 24\text{dBm}$.
3. $11\text{dBm} + 10\log(20.58) = 24.13\text{ dBm} > 24\text{dBm}$.
4. $11\text{dBm} + 10\log(21.01) = 24.22\text{ dBm} > 24\text{dBm}$.
5. $11\text{dBm} + 10\log(20.57) = 24.13\text{ dBm} > 24\text{dBm}$.
6. $11\text{dBm} + 10\log(22.10) = 24.44\text{ dBm} > 24\text{dBm}$.

Chain 2

1. $11\text{dBm} + 10\log(20.82) = 24.18\text{ dBm} > 24\text{dBm}$.
2. $11\text{dBm} + 10\log(21.07) = 24.24\text{ dBm} > 24\text{dBm}$.
3. $11\text{dBm} + 10\log(20.76) = 24.17\text{ dBm} > 24\text{dBm}$.
4. $11\text{dBm} + 10\log(20.91) = 24.20\text{ dBm} > 24\text{dBm}$.
5. $11\text{dBm} + 10\log(24.42) = 24.88\text{ dBm} > 24\text{dBm}$.
6. $11\text{dBm} + 10\log(24.08) = 24.82\text{ dBm} > 24\text{dBm}$.

802.11n (40MHz)

Channel	Frequency (MHz)	Maximum Conducted Power (dBm)			Total Power (mW)	Total Power (dBm)	Power Limit (dBm)	Pass / Fail
		Chain 0	Chain 1	Chain 2				
54	5270	18.72	18.91	18.71	226.579	23.55	24.00	Pass
62	5310	17.25	17.24	17.37	160.630	22.06	24.00	Pass
102	5510	17.93	17.76	17.88	183.167	22.63	24.00	Pass
110	5550	18.80	18.35	18.58	216.360	23.35	24.00	Pass
134	5670	18.62	18.88	18.68	223.836	23.50	24.00	Pass

Note:
Chain 0

1. $11\text{dBm} + 10\log(41.03) = 27.13\text{ dBm} > 24\text{dBm}$.
2. $11\text{dBm} + 10\log(40.78) = 27.10\text{ dBm} > 24\text{dBm}$.
3. $11\text{dBm} + 10\log(40.80) = 27.11\text{ dBm} > 24\text{dBm}$.
4. $11\text{dBm} + 10\log(40.64) = 27.09\text{ dBm} > 24\text{dBm}$.
5. $11\text{dBm} + 10\log(42.72) = 27.31\text{ dBm} > 24\text{dBm}$.

Chain 1

1. $11\text{dBm} + 10\log(40.84) = 27.11\text{ dBm} > 24\text{dBm}$.
2. $11\text{dBm} + 10\log(40.77) = 27.10\text{ dBm} > 24\text{dBm}$.
3. $11\text{dBm} + 10\log(40.87) = 27.11\text{ dBm} > 24\text{dBm}$.
4. $11\text{dBm} + 10\log(40.92) = 27.12\text{ dBm} > 24\text{dBm}$.
5. $11\text{dBm} + 10\log(47.02) = 27.72\text{ dBm} > 24\text{dBm}$.

Chain 2

1. $11\text{dBm} + 10\log(41.23) = 27.15\text{ dBm} > 24\text{dBm}$.
2. $11\text{dBm} + 10\log(41.34) = 27.16\text{ dBm} > 24\text{dBm}$.
3. $11\text{dBm} + 10\log(41.55) = 27.19\text{ dBm} > 24\text{dBm}$.
4. $11\text{dBm} + 10\log(56.28) = 28.50\text{ dBm} > 24\text{dBm}$.
5. $11\text{dBm} + 10\log(60.98) = 28.85\text{ dBm} > 24\text{dBm}$.

802.11ac (80MHz)

Channel	Frequency (MHz)	Maximum Conducted Power (dBm)			Total Power (mW)	Total Power (dBm)	Power Limit (dBm)	Pass / Fail
		Chain 0	Chain 1	Chain 2				
58	5290	16.54	16.76	16.95	142.051	21.52	24.00	Pass
106	5530	16.38	16.15	16.68	131.220	21.18	24.00	Pass

Note:
Chain 0

1. $11\text{dBm} + 10\log(82.78) = 30.18\text{ dBm} > 24\text{dBm}$.
2. $11\text{dBm} + 10\log(81.87) = 30.13\text{ dBm} > 24\text{dBm}$.

Chain 1

1. $11\text{dBm} + 10\log(82.66) = 30.17\text{ dBm} > 24\text{dBm}$.
2. $11\text{dBm} + 10\log(82.77) = 30.18\text{ dBm} > 24\text{dBm}$.

Chain 2

1. $11\text{dBm} + 10\log(83.37) = 30.21\text{ dBm} > 24\text{dBm}$.
2. $11\text{dBm} + 10\log(83.16) = 30.20\text{ dBm} > 24\text{dBm}$.

26dB Bandwidth:
802.11a

Channel	Frequency (MHz)	26dBc Bandwidth (MHz)			Pass / Fail
		Chain 0	Chain 1	Chain 2	
52	5260	20.61	20.34	20.42	Pass
60	5300	20.65	20.37	20.42	Pass
64	5320	20.76	20.41	20.60	Pass
100	5500	20.41	21.20	20.89	Pass
116	5580	20.48	20.53	20.98	Pass
140	5700	20.58	20.51	22.98	Pass

802.11n (20MHz)

Channel	Frequency (MHz)	26dBc Bandwidth (MHz)			Pass / Fail
		Chain 0	Chain 1	Chain 2	
52	5260	20.58	20.51	20.82	Pass
60	5300	20.70	20.71	21.07	Pass
64	5320	20.85	20.58	20.76	Pass
100	5500	20.69	21.01	20.91	Pass
116	5580	21.00	20.57	24.42	Pass
140	5700	23.49	22.10	24.08	Pass

802.11n (40MHz)

Channel	Frequency (MHz)	26dBc Bandwidth (MHz)			Pass / Fail
		Chain 0	Chain 1	Chain 2	
54	5270	41.03	40.84	41.23	Pass
62	5310	40.78	40.77	41.34	Pass
102	5510	40.80	40.87	41.55	Pass
110	5550	40.64	40.92	56.28	Pass
134	5670	42.72	47.02	60.98	Pass

802.11ac (80MHz)

Channel	Frequency (MHz)	26dBc Bandwidth (MHz)			Pass / Fail
		Chain 0	Chain 1	Chain 2	
58	5290	82.78	82.66	83.37	Pass
106	5530	81.87	82.77	83.16	Pass

Spectrum Plot of Worst Value

802.11a

802.11n (20MHz)

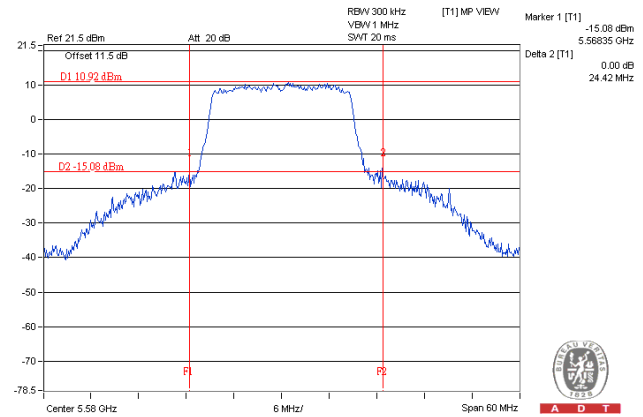
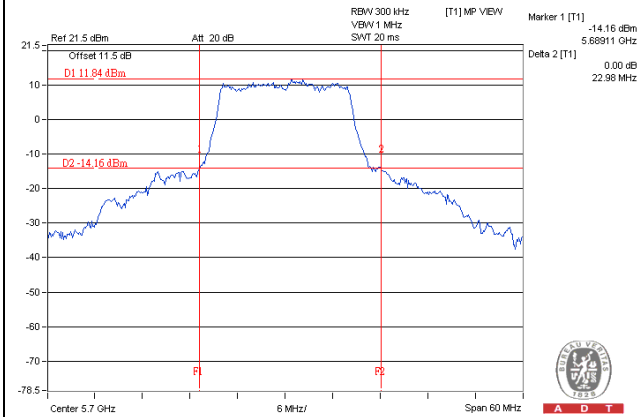

802.11n (40MHz)

802.11ac (80MHz)

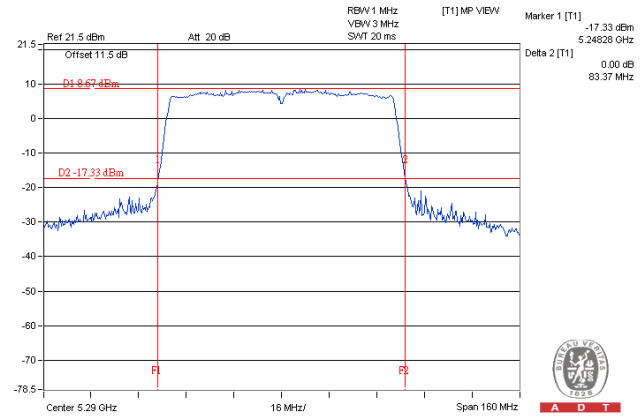
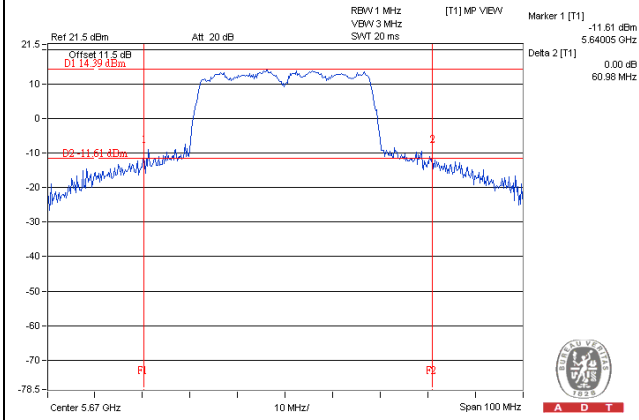

Occupied Bandwidth:
802.11a

Channel	Frequency (MHz)	Occupied Bandwidth (MHz)			Pass / Fail
		Chain 0	Chain 1	Chain 2	
52	5260	16.80	16.92	16.92	Pass
60	5300	16.92	16.92	16.92	Pass
64	5320	16.92	16.92	16.92	Pass
100	5500	16.80	16.92	16.80	Pass
116	5580	16.80	16.80	16.92	Pass
140	5700	17.04	16.80	17.16	Pass

802.11n (20MHz)

Channel	Frequency (MHz)	Occupied Bandwidth (MHz)			Pass / Fail
		Chain 0	Chain 1	Chain 2	
52	5260	16.80	17.76	17.88	Pass
60	5300	16.80	17.88	18.00	Pass
64	5320	17.88	17.76	17.88	Pass
100	5500	17.88	18.00	18.00	Pass
116	5580	17.88	17.88	18.00	Pass
140	5700	18.00	17.88	18.12	Pass

802.11n (40MHz)

Channel	Frequency (MHz)	Occupied Bandwidth (MHz)			Pass / Fail
		Chain 0	Chain 1	Chain 2	
54	5270	36.60	36.60	36.60	Pass
62	5310	36.60	36.72	36.72	Pass
102	5510	36.60	36.48	36.48	Pass
110	5550	36.60	36.60	36.72	Pass
134	5670	36.72	36.60	36.96	Pass

802.11ac (80MHz)

Channel	Frequency (MHz)	Occupied Bandwidth (MHz)			Pass / Fail
		Chain 0	Chain 1	Chain 2	
58	5290	75.84	75.84	75.84	Pass
106	5530	75.84	75.84	75.60	Pass

Spectrum Plot of Worst Value

802.11a

802.11n (20MHz)

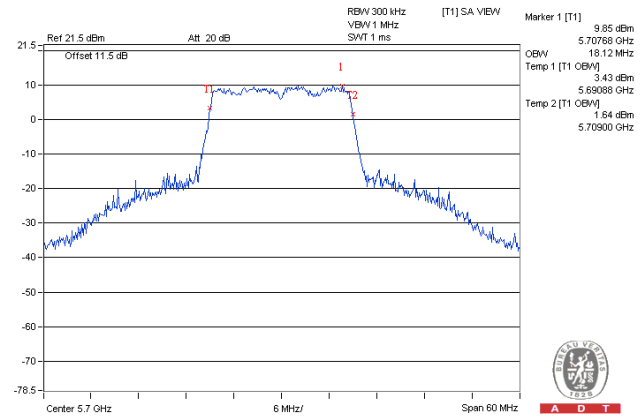
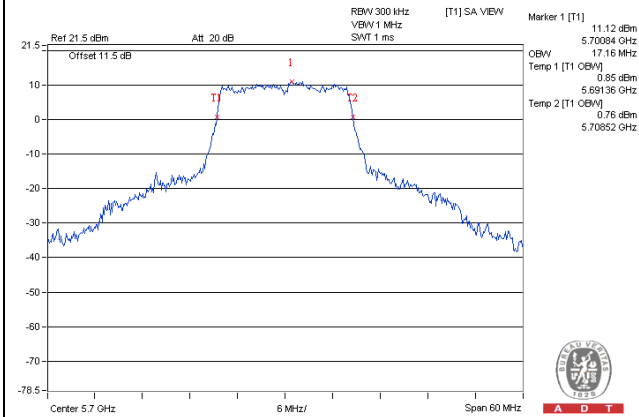

802.11n (40MHz)

802.11ac (80MHz)

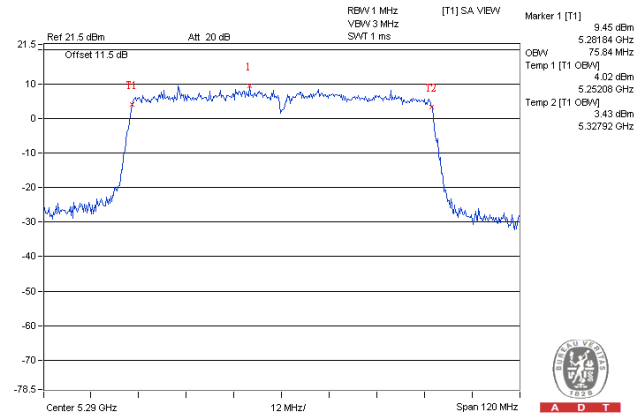
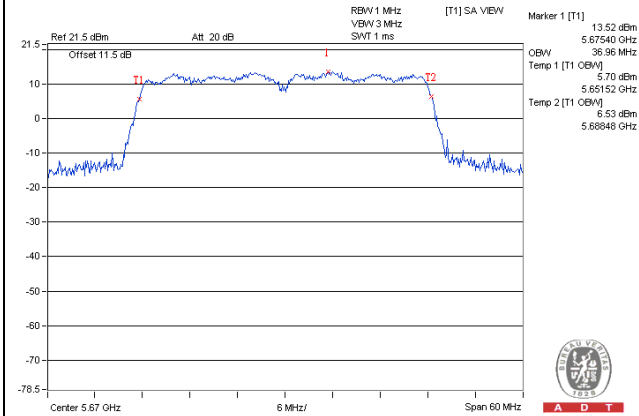

EUT MAXIMUM CONDUCTED POWER

802.11a

Frequency Band (MHz)	Max. Power	
	Output Power (mW)	Output Power (dBm)
5250~5350	240.343	23.81
5470~5725	226.636	23.55

NOTE: Manufacturer provides Transmit Power Control description to meet this requirement.

802.11n (20MHz)

Frequency Band (MHz)	Max. Power	
	Output Power (mW)	Output Power (dBm)
5250~5350	238.789	23.78
5470~5725	232.420	23.66

NOTE: Manufacturer provides Transmit Power Control description to meet this requirement.

802.11n (40MHz)

Frequency Band (MHz)	Max. Power	
	Output Power (mW)	Output Power (dBm)
5250~5350	226.579	23.55
5470~5725	223.836	23.50

NOTE: Manufacturer provides Transmit Power Control description to meet this requirement.

802.11ac (80MHz)

Frequency Band (MHz)	Max. Power	
	Output Power (mW)	Output Power (dBm)
5250~5350	142.051	21.52
5470~5725	131.220	21.18

NOTE: Manufacturer provides Transmit Power Control description to meet this requirement.

4.4 Peak Power Spectral Density Measurement

4.4.1 Limits of Peak Power Spectral Density Measurement

Operation Band	EUT Category		LIMIT
U-NII-1	---	Outdoor Access Point	17dBm/ MHz
	---	Fixed point-to-point Access Point	
	---	Indoor Access Point	
	---	Mobile and Portable client device	11dBm/ MHz
U-NII-2A	√		11dBm/ MHz
U-NII-2C	√		11dBm/ MHz
U-NII-3	---		30dBm/ 500kHz

4.4.2 Test Setup



4.4.3 Test Instruments

Refer to section 4.1.2 to get information of above instrument.

4.4.4 Test Procedures

- Set span to encompass the entire emission bandwidth (EBW) of the signal.
- Set RBW = 30 kHz, Set VBW ≥ 1 MHz, Detector = RMS
- Set Channel power measure = 1MHz
- Sweep time = auto, trigger set to “free run”.
- Trace average at least 100 traces in power averaging mode.
- Record the max value and add 10 log (1/duty cycle)

4.4.5 Deviation from Test Standard

No deviation.

4.4.6 EUT Operating Conditions

Same as Item 4.3.6.

4.4.7 Test Results

802.11a

Channel	Frequency (MHz)	PSD (dBm)			Total Psd W/O Duty Factor (dBm)	Duty Factor	Total Psd With Duty Factor (dBm)	Max. Limit (dBm)	Pass / Fail
		Chain 0	Chain 1	Chain 2					
52	5260	4.78	5.36	5.23	9.90	0.28	10.18	10.23	Pass
60	5300	4.90	5.33	5.16	9.91	0.28	10.19	10.23	Pass
64	5320	5.02	4.92	5.06	9.77	0.28	10.05	10.23	Pass
100	5500	3.93	4.67	5.84	9.66	0.28	9.94	10.23	Pass
116	5580	3.68	5.13	5.62	9.66	0.28	9.94	10.23	Pass
140	5700	3.87	4.52	6.04	9.68	0.28	9.96	10.23	Pass

- Note:**
- Method 1 of power density measurement of KDB 662911 is using for calculating total power density. Total power density is summing entire spectra across corresponding frequency bins on the various outputs by computer.
 - Directional gain = $2\text{dBi} + 10\log(3) = 6.77\text{dBi} > 6\text{dBi}$, so the power density limit shall be reduced to $11-(6.77-6) = 10.23\text{dBm}$.
 - Refer to section 3.3 for duty cycle spectrum plot.

802.11n (20MHz)

Channel	Frequency (MHz)	PSD (dBm)			Total Psd W/O Duty Factor (dBm)	Duty Factor	Total Psd With Duty Factor (dBm)	Max. Limit (dBm)	Pass / Fail
		Chain 0	Chain 1	Chain 2					
52	5260	5.02	5.06	5.01	9.81	0.41	10.22	10.23	Pass
60	5300	5.01	5.09	5.01	9.81	0.41	10.22	10.23	Pass
64	5320	3.97	5.21	5.08	9.56	0.41	9.97	10.23	Pass
100	5500	3.12	5.16	5.58	9.52	0.41	9.93	10.23	Pass
116	5580	3.22	4.19	5.70	9.27	0.41	9.68	10.23	Pass
140	5700	3.06	4.55	4.85	9.00	0.41	9.41	10.23	Pass

- Note:**
- Method 1 of power density measurement of KDB 662911 is using for calculating total power density. Total power density is summing entire spectra across corresponding frequency bins on the various outputs by computer.
 - Directional gain = $2\text{dBi} + 10\log(3) = 6.77\text{dBi} > 6\text{dBi}$, so the power density limit shall be reduced to $11-(6.77-6) = 10.23\text{dBm}$.
 - Refer to section 3.3 for duty cycle spectrum plot.

802.11n (40MHz)

Channel	Frequency (MHz)	PSD (dBm)			Total Psd W/O Duty Factor (dBm)	Duty Factor	Total Psd With Duty Factor (dBm)	Max. Limit (dBm)	Pass / Fail
		Chain 0	Chain 1	Chain 2					
54	5270	1.14	1.84	1.27	6.19	0.62	6.81	10.23	Pass
62	5310	-0.04	0.08	-0.65	4.57	0.62	5.19	10.23	Pass
102	5510	-0.17	1.08	1.03	5.45	0.62	6.07	10.23	Pass
110	5550	0.13	1.83	2.25	6.26	0.62	6.88	10.23	Pass
134	5670	-0.01	0.85	2.31	5.92	0.62	6.54	10.23	Pass

- Note:** 1. Method 1 of power density measurement of KDB 662911 is using for calculating total power density. Total power density is summing entire spectra across corresponding frequency bins on the various outputs by computer.
2. Directional gain = $2\text{dBi} + 10\log(3) = 6.77\text{dBi} > 6\text{dBi}$, so the power density limit shall be reduced to $11 - (6.77 - 6) = 10.23\text{dBm}$.
3. Refer to section 3.3 for duty cycle spectrum plot.

802.11ac (80MHz)

Channel	Frequency (MHz)	PSD (dBm)			Total Psd W/O Duty Factor (dBm)	Duty Factor	Total Psd With Duty Factor (dBm)	Max. Limit (dBm)	Pass / Fail
		Chain 0	Chain 1	Chain 2					
58	5290	-3.50	-3.03	-3.30	1.49	0.92	2.41	10.23	Pass
106	5530	-4.78	-3.69	-3.20	0.93	0.92	1.85	10.23	Pass

- Note:** 1. Method 1 of power density measurement of KDB 662911 is using for calculating total power density. Total power density is summing entire spectra across corresponding frequency bins on the various outputs by computer.
2. Directional gain = $2\text{dBi} + 10\log(3) = 6.77\text{dBi} > 6\text{dBi}$, so the power density limit shall be reduced to $11 - (6.77 - 6) = 10.23\text{dBm}$.
3. Refer to section 3.3 for duty cycle spectrum plot.

Spectrum Plot of Worst Value

802.11a

802.11n (20MHz)

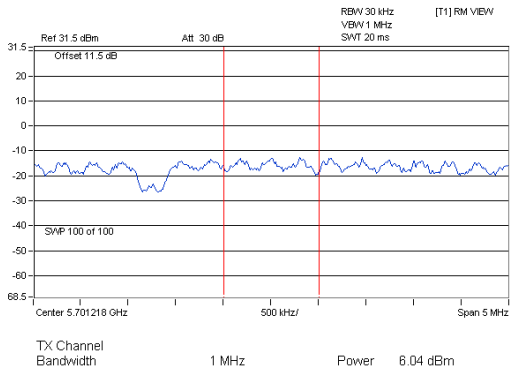

A D T

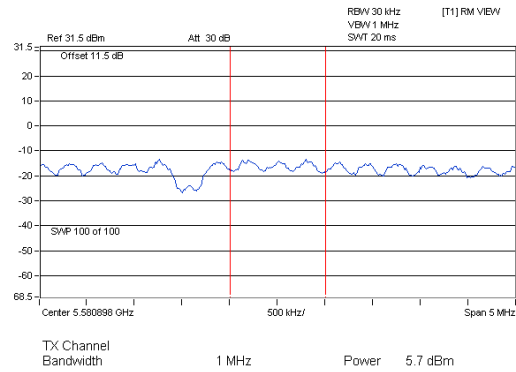

A D T

802.11n (40MHz)

802.11ac (80MHz)

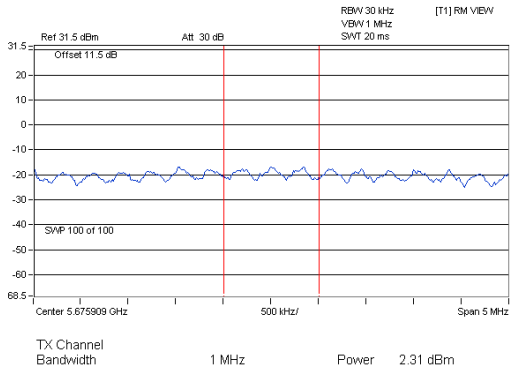

A D T

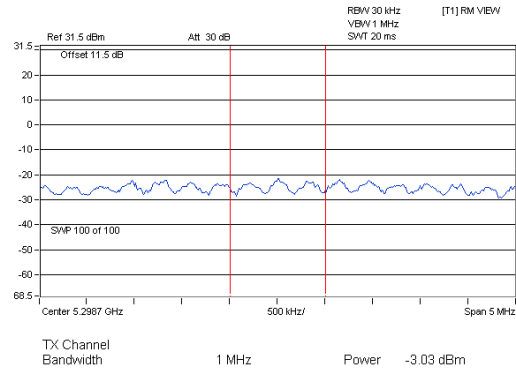

A D T

4.5 Frequency Stability

4.5.1 Limits of Frequency Stability Measurement

The frequency of the carrier signal shall be maintained within band of operation

4.5.2 Test Setup

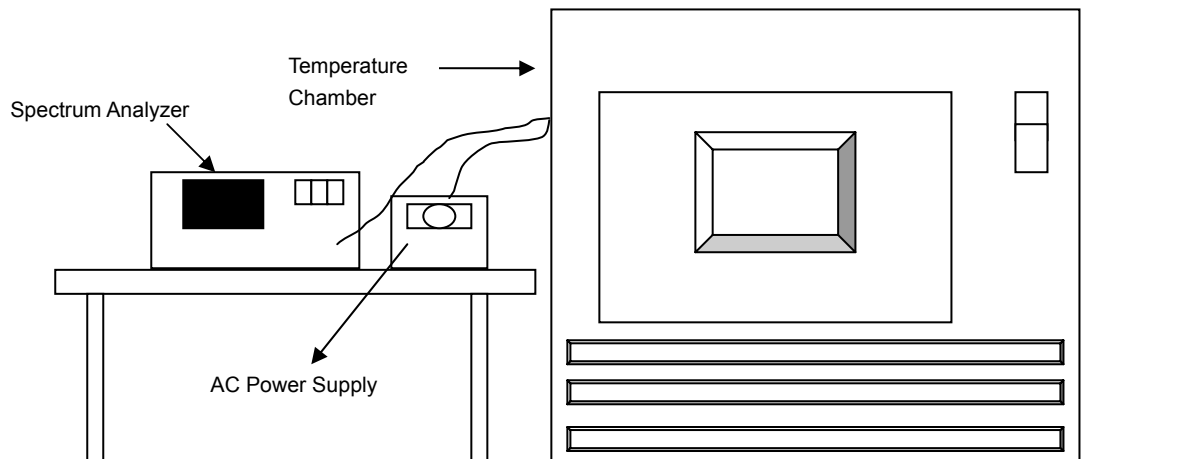

4.5.3 Test Instruments

Refer to section 4.1.2 to get information of above instrument.

4.5.4 Test Procedure

- a. The EUT was placed inside the environmental test chamber and powered by nominal AC voltage.
- b. Turn the EUT on and couple its output to a spectrum analyzer.
- c. Turn the EUT off and set the chamber to the highest temperature specified.
- d. Allow sufficient time (approximately 30 min) for the temperature of the chamber to stabilize, turn the EUT on and measure the operating frequency after 2, 5, and 10 minutes.
- e. Repeat step 2 and 3 with the temperature chamber set to the lowest temperature.
- f. The test chamber was allowed to stabilize at +20 degree C for a minimum of 30 minutes. The supply voltage was then adjusted on the EUT from 85% to 115% and the frequency record.

4.5.5 Deviation from Test Standard

No deviation.

4.5.6 EUT Operating Condition

Set the EUT transmit at un-modulation mode to test frequency stability.

4.5.7 Test Results

Frequency Stability Versus Temp.									
Operating Frequency: 5320MHz									
Temp. (°C)	Power Supply (Vac)	0 Minute		2 Minute		5 Minute		10 Minute	
		Measured Frequency (MHz)	Frequency Drift (%)	Measured Frequency (MHz)	Frequency Drift (%)	Measured Frequency (MHz)	Frequency Drift (%)	Measured Frequency (MHz)	Frequency Drift (%)
40	120	5319.9817	-0.00034	5319.985	-0.00028	5319.9843	-0.00030	5319.9839	-0.00030
30	120	5319.9885	-0.00022	5319.9865	-0.00025	5319.9908	-0.00017	5319.988	-0.00023
20	120	5319.9965	-0.00007	5319.9967	-0.00006	5319.997	-0.00006	5319.9948	-0.00010
10	120	5320.0172	0.00032	5320.0143	0.00027	5320.0169	0.00032	5320.0142	0.00027
0	120	5319.9878	-0.00023	5319.9888	-0.00021	5319.9926	-0.00014	5319.9911	-0.00017

Frequency Stability Versus Temp.									
Operating Frequency: 5320MHz									
Temp. (°C)	Power Supply (Vac)	0 Minute		2 Minute		5 Minute		10 Minute	
		Measured Frequency (MHz)	Frequency Drift (%)	Measured Frequency (MHz)	Frequency Drift (%)	Measured Frequency (MHz)	Frequency Drift (%)	Measured Frequency (MHz)	Frequency Drift (%)
20	138	5319.9972	-0.00005	5319.9961	-0.00007	5319.9973	-0.00005	5319.9953	-0.00009
	120	5319.9965	-0.00007	5319.9967	-0.00006	5319.997	-0.00006	5319.9948	-0.00010
	102	5319.9967	-0.00006	5319.9964	-0.00007	5319.9977	-0.00004	5319.9941	-0.00011



5 Pictures of Test Arrangements

Please refer to the attached file (Test Setup Photo).

Appendix – Information on the Testing Laboratories

We, Bureau Veritas Consumer Products Services (H.K.) Ltd., Taoyuan Branch, were founded in 1988 to provide our best service in EMC, Radio, Telecom and Safety consultation. Our laboratories are accredited and approved according to ISO/IEC 17025.

If you have any comments, please feel free to contact us at the following:

Linko EMC/RF Lab

Tel: 886-2-26052180

Fax: 886-2-26051924

Hsin Chu EMC/RF Lab/Telecom Lab

Tel: 886-3-5935343

Fax: 886-3-5935342

Hwa Ya EMC/RF/Safety

Tel: 886-3-3183232

Fax: 886-3-3270892

Email: service.adt@tw.bureauveritas.com

Web Site: www.bureauveritas-adt.com

The address and road map of all our labs can be found in our web site also.

--- END ---