



A D T

FCC TEST REPORT (15.247)

REPORT NO.: RF130924C01

MODEL NO.: T4U

FCC ID: TE7T4U

RECEIVED: Sep. 24, 2013

TESTED: Oct. 17 ~ Nov. 22, 2013

ISSUED: Dec. 05, 2013

APPLICANT: TP-LINK TECHNOLOGIES CO., LTD.

ADDRESS: Building 24 (floors 1,3,4,5) and 28 (floors1-4)
Central Science and Technology Park, Shennan
Rd, Nanshan, Shenzhen, China

ISSUED BY: Bureau Veritas Consumer Products Services
(H.K.) Ltd., Taoyuan Branch

LAB ADDRESS: No. 47, 14th Ling, Chia Pau Vil., Lin Kou Dist.,
New Taipei City, Taiwan, R.O.C.

TEST LOCATION: No. 19, Hwa Ya 2nd Rd, Wen Hwa Tsuen, Kwei
Shan Hsiang, Taoyuan Hsien 333, Taiwan, R.O.C.

This report should not be used by the client to claim product certification, approval, or endorsement by TAF or any government agencies.



This report is for your exclusive use. Any copying or replication of this report to or for any other person or entity, or use of our name or trademark, is permitted only with our prior written permission. This report sets forth our findings solely with respect to the test samples identified herein. The results set forth in this report are not indicative or representative of the quality or characteristics of the lot from which a test sample was taken or any similar or identical product unless specifically and expressly noted. Our report includes all of the tests requested by you and the results thereof based upon the information that you provided to us. You have 60 days from date of issuance of this report to notify us of any material error or omission caused by our negligence, provided, however, that such notice shall be in writing and shall specifically address the issue you wish to raise. A failure to raise such issue within the prescribed time shall constitute your unqualified acceptance of the completeness of this report, the tests conducted and the correctness of the report contents. Unless specific mention, the uncertainty of measurement has been explicitly taken into account to declare the compliance or non-compliance to the specification.



A D T

TABLE OF CONTENTS

RELEASE CONTROL RECORD.....	5
1. CERTIFICATION.....	6
2. SUMMARY OF TEST RESULTS	7
2.1 MEASUREMENT UNCERTAINTY.....	7
3. GENERAL INFORMATION.....	8
3.1 GENERAL DESCRIPTION OF EUT	8
3.2 DESCRIPTION OF TEST MODES	10
3.2.1 TEST MODE APPLICABILITY AND TESTED CHANNEL DETAIL	11
3.3 DESCRIPTION OF SUPPORT UNITS	17
3.3.1 CONFIGURATION OF SYSTEM UNDER TEST	17
3.4 GENERAL DESCRIPTION OF APPLIED STANDARDS	18
4. TEST TYPES AND RESULTS (FOR 2.4GHz BAND)	19
4.1 RADIATED EMISSION AND BANDEDGE MEASUREMENT	19
4.1.1 LIMITS OF RADIATED EMISSION AND BANDEDGE MEASUREMENT	19
4.1.2 TEST INSTRUMENTS.....	20
4.1.3 TEST PROCEDURES	21
4.1.4 DEVIATION FROM TEST STANDARD.....	21
4.1.5 TEST SETUP.....	22
4.1.6 EUT OPERATING CONDITIONS	23
4.1.7 TEST RESULTS	24
4.2 CONDUCTED EMISSION MEASUREMENT	37
4.2.1 LIMITS OF CONDUCTED EMISSION MEASUREMENT	37
4.2.2 TEST INSTRUMENTS.....	37
4.2.3 TEST PROCEDURES	38
4.2.4 DEVIATION FROM TEST STANDARD.....	38
4.2.5 TEST SETUP.....	38
4.2.6 EUT OPERATING CONDITIONS	38
4.2.7 TEST RESULTS	39
4.3 6dB BANDWIDTH MEASUREMENT.....	41
4.3.1 LIMITS OF 6dB BANDWIDTH MEASUREMENT	41
4.3.2 TEST SETUP.....	41
4.3.3 TEST INSTRUMENTS.....	41
4.3.4 TEST PROCEDURE.....	41
4.3.5 DEVIATION FROM TEST STANDARD.....	41
4.3.6 EUT OPERATING CONDITIONS	41
4.3.7 TEST RESULTS	42



4.4	CONDUCTED OUTPUT POWER.....	44
4.4.1	LIMITS OF CONDUCTED OUTPUT POWER MEASUREMENT	44
4.4.2	TEST SETUP	44
4.4.3	TEST INSTRUMENTS.....	44
4.4.4	TEST PROCEDURES	44
4.4.5	DEVIATION FROM TEST STANDARD.....	45
4.4.6	EUT OPERATING CONDITIONS	45
4.4.7	TEST RESULTS	46
4.5	POWER SPECTRAL DENSITY MEASUREMENT	48
4.5.1	LIMITS OF POWER SPECTRAL DENSITY MEASUREMENT	48
4.5.2	TEST SETUP.....	48
4.5.3	TEST INSTRUMENTS.....	48
4.5.4	TEST PROCEDURE.....	48
4.5.5	DEVIATION FROM TEST STANDARD.....	48
4.5.6	EUT OPERATING CONDITION.....	48
4.5.7	TEST RESULTS	49
4.6	CONDUCTED OUT OF BAND EMISSION MEASUREMENT.....	51
4.6.1	LIMITS OF CONDUCTED OUT OF BAND EMISSION MEASUREMENT	51
4.6.2	TEST SETUP.....	51
4.6.3	TEST INSTRUMENTS.....	51
4.6.4	TEST PROCEDURE.....	51
4.6.5	DEVIATION FROM TEST STANDARD.....	52
4.6.6	EUT OPERATING CONDITION.....	52
4.6.7	TEST RESULTS	52
5.	TEST TYPES AND RESULTS (FOR 5.0GHz BAND).....	59
5.1	RADIATED EMISSION MEASUREMENT	59
5.1.1	LIMITS OF RADIATED EMISSION MEASUREMENT	59
5.1.2	TEST INSTRUMENTS.....	60
5.1.3	TEST PROCEDURES	60
5.1.4	DEVIATION FROM TEST STANDARD.....	60
5.1.5	TEST SETUP.....	60
5.1.6	EUT OPERATING CONDITIONS	60
5.1.7	TEST RESULTS	61
5.2	CONDUCTED EMISSION MEASUREMENT	71
5.2.1	LIMITS OF CONDUCTED EMISSION MEASUREMENT	71
5.2.2	TEST INSTRUMENTS.....	71
5.2.3	TEST PROCEDURES	71
5.2.4	DEVIATION FROM TEST STANDARD.....	71
5.2.5	TEST SETUP.....	71



A D T

5.2.6	EUT OPERATING CONDITIONS	71
5.2.7	TEST RESULTS	72
5.3	6dB BANDWIDTH MEASUREMENT	74
5.3.1	LIMITS OF 6dB BANDWIDTH MEASUREMENT	74
5.3.2	TEST SETUP	74
5.3.3	TEST INSTRUMENTS.....	74
5.3.4	TEST PROCEDURE.....	74
5.3.5	DEVIATION FROM TEST STANDARD.....	74
5.3.6	EUT OPERATING CONDITIONS	74
5.3.7	TEST RESULTS	75
5.4	CONDUCTED OUTPUT POWER.....	77
5.4.1	LIMITS OF CONDUCTED OUTPUT POWER MEASUREMENT	77
5.4.2	TEST SETUP	77
5.4.3	INSTRUMENTS.....	77
5.4.4	TEST PROCEDURES	78
5.4.5	DEVIATION FROM TEST STANDARD.....	78
5.4.6	EUT OPERATING CONDITIONS	78
5.4.7	TEST RESULTS	79
5.5	POWER SPECTRAL DENSITY MEASUREMENT	81
5.5.1	LIMITS OF POWER SPECTRAL DENSITY MEASUREMENT	81
5.5.2	TEST SETUP.....	81
5.5.3	TEST INSTRUMENTS.....	81
5.5.4	TEST PROCEDURE.....	81
5.5.5	DEVIATION FROM TEST STANDARD.....	81
5.5.6	EUT OPERATING CONDITION.....	81
5.5.7	TEST RESULTS	82
5.6	CONDUCTED OUT OF BAND EMISSION MEASUREMENT	84
5.6.1	LIMITS OF CONDUCTED OUT OF BAND EMISSION MEASUREMENT	84
5.6.2	TEST SETUP	84
5.6.3	TEST INSTRUMENTS.....	84
5.6.4	TEST PROCEDURE.....	84
5.6.5	DEVIATION FROM TEST STANDARD.....	84
5.6.6	EUT OPERATING CONDITION.....	84
5.6.7	TEST RESULTS	84
6.	PHOTOGRAPHS OF THE TEST CONFIGURATION	92
7.	INFORMATION ON THE TESTING LABORATORIES	93
8.	APPENDIX A – MODIFICATIONS RECORDERS FOR ENGINEERING CHANGES TO THE EUT BY THE LAB.....	94



A D T

RELEASE CONTROL RECORD

ISSUE NO.	REASON FOR CHANGE	DATE ISSUED
RF130924C01	Original release	Dec. 05, 2013



A D T

1. CERTIFICATION

PRODUCT: AC1200 Wireless Dual Band USB Adapter
MODEL NO.: T4U
BRAND: TP-LINK
APPLICANT: TP-LINK TECHNOLOGIES CO., LTD.
TESTED: Oct. 17 ~ Nov. 22, 2013
TEST SAMPLE: PRODUCTION SAMPLE
STANDARDS: **FCC Part 15, Subpart C (Section 15.247)**
ANSI C63.10-2009

The above equipment (model: T4U) has been tested by **Bureau Veritas Consumer Products Services (H.K.) Ltd., Taoyuan Branch**, and found compliance with the requirement of the above standards. The test record, data evaluation & Equipment Under Test (EUT) configurations represented herein are true and accurate accounts of the measurements of the sample's EMC characteristics under the conditions specified in this report.

PREPARED BY : Celine Chou , **DATE :** Dec. 05, 2013
Celine Chou / Specialist

APPROVED BY : Ken Liu , **DATE :** Dec. 05, 2013
Ken Liu / Senior Manager



2. SUMMARY OF TEST RESULTS

The EUT has been tested according to the following specifications:

APPLIED STANDARD: FCC PART 15, SUBPART C (SECTION 15.247)			
STANDARD SECTION	TEST TYPE	RESULT	REMARK
15.207	AC Power Conducted Emission	PASS	Meet the requirement of limit. Minimum passing margin is -8.09dB at 20.87300MHz.
15.247(d) 15.209	Radiated Emissions	PASS	Meet the requirement of limit. Minimum passing margin is -1.0dB at 2390.00MHz.
15.247(d)	Band Edge Measurement	PASS	Meet the requirement of limit.
15.247(a)(2)	6dB bandwidth	PASS	Meet the requirement of limit.
15.247(b)	Conducted power	PASS	Meet the requirement of limit.
15.247(e)	Power Spectral Density	PASS	Meet the requirement of limit.
15.203	Antenna Requirement	PASS	No antenna connector is used.

2.1 MEASUREMENT UNCERTAINTY

Where relevant, the following measurement uncertainty levels have been estimated for tests performed on the EUT as specified in CISPR 16-4-2:

MEASUREMENT	FREQUENCY	UNCERTAINTY
Conducted emissions	9kHz~30MHz	2.44 dB
Radiated emissions	30MHz ~ 200MHz	3.19 dB
	200MHz ~1000MHz	3.21 dB
	1GHz ~ 18GHz	2.26 dB
	18GHz ~ 40GHz	1.94 dB

This uncertainty represents an expanded uncertainty expressed at approximately the 95% confidence level using a coverage factor of $k = 2$.



3. GENERAL INFORMATION

3.1 GENERAL DESCRIPTION OF EUT

EUT	AC1200 Wireless Dual Band USB Adapter
MODEL NO.	T4U
POWER SUPPLY	5Vdc (host equipment)
MODULATION TYPE	CCK, DQPSK, DBPSK for DSSS 256QAM, 64QAM, 16QAM, QPSK, BPSK for OFDM
MODULATION TECHNOLOGY	DSSS, OFDM
TRANSFER RATE	802.11b:11.0/ 5.5/ 2.0/ 1.0Mbps 802.11g: 54.0/ 48.0/ 36.0/ 24.0/ 18.0/ 12.0/ 9.0/ 6.0Mbps 802.11a: 54.0/ 48.0/ 36.0/ 24.0/ 18.0/ 12.0/ 9.0/ 6.0Mbps 802.11n: up to 300Mbps 802.11ac: up to 867Mbps
OPERATING FREQUENCY	2.4GHz: 2412 ~ 2462MHz 5.0GHz: 5745 ~ 5825MHz
NUMBER OF CHANNEL	2.4GHz: 11 for 802.11b, 802.11g, 802.11n (20MHz) 7 for 802.11n (40MHz) 5.0GHz: 5 for 802.11a, 802.11n (20MHz) 2 for 802.11n (40MHz) 1 for 802.11ac (80MHz)
OUTPUT POWER	509.388mW for 2412 ~ 2462MHz 336.147mW for 5745 ~ 5825MHz
ANTENNA TYPE	Refer to Note as below
ANTENNA CONNECTOR	Refer to Note as below
DATA CABLE	N/A
I/O PORTS	Refer to user's manual
ACCESSORY DEVICES	N/A

NOTE:

1. The EUT incorporates a MIMO function. Physically, the EUT provides two completed transmitters and two receivers.

MODULATION MODE	TX FUNCTION
802.11b	1TX
802.11g	1TX
802.11a	1TX
802.11n (20MHz)	2TX
802.11n (40MHz)	2TX
802.11ac (80MHz)	2TX



A D T

2. The EUT uses following antennas.

Frequency (GHz)	Antenna Type	Gain (dBi)		Antenna Connector
		Ant. 1	Ant. 2	
2.4~2.4835	PCB	1.41	-0.03	NA
5.15~5.25	PCB	3.27	3.45	NA
5.25~5.35	PCB	3.15	3.59	NA
5.47~5.725	PCB	3.29	4.24	NA
5.725~5.85	PCB	3.49	4.13	NA

3. The above EUT information is declared by manufacturer and for more detailed features description, please refer to the manufacturer's specifications or user's manual.



3.2 DESCRIPTION OF TEST MODES

FOR 2.4GHz:

11 channels are provided for 802.11b, 802.11g and 802.11n (20MHz):

CHANNEL	FREQUENCY	CHANNEL	FREQUENCY
1	2412MHz	7	2442MHz
2	2417MHz	8	2447MHz
3	2422MHz	9	2452MHz
4	2427MHz	10	2457MHz
5	2432MHz	11	2462MHz
6	2437MHz		

7 channels are provided for 802.11n (40MHz):

CHANNEL	FREQUENCY	CHANNEL	FREQUENCY
3	2422MHz	7	2442MHz
4	2427MHz	8	2447MHz
5	2432MHz	9	2452MHz
6	2437MHz		

FOR 5.0GHz (5745 ~ 5825MHz):

5 channels are provided for 802.11a, 802.11n (20MHz):

CHANNEL	FREQUENCY	CHANNEL	FREQUENCY
149	5745MHz	161	5805MHz
153	5765MHz	165	5825MHz
157	5785MHz		

2 channels are provided for 802.11n (40MHz):

CHANNEL	FREQUENCY	CHANNEL	FREQUENCY
151	5755MHz	159	5795MHz

1 channel is provided for 802.11ac (80MHz):

CHANNEL	FREQUENCY
155	5775MHz



3.2.1 TEST MODE APPLICABILITY AND TESTED CHANNEL DETAIL

FOR 2.4GHz:

EUT CONFIGURE MODE	APPLICABLE TO				DESCRIPTION
	RE≥1G	RE<1G	PLC	APCM	
-	√	√	√	√	-

Where **RE≥1G**: Radiated Emission above 1GHz **RE<1G**: Radiated Emission below 1GHz
PLC: Power Line Conducted Emission **APCM**: Antenna Port Conducted Measurement

NOTE:

1. 802.11b, 802.11g:

The EUT had been pre-tested on the positioned of each 3 axis. The worst case was found when positioned on **X-plane**.

2. 802.11n (20MHz), 802.11n (40MHz):

The EUT had been pre-tested on the positioned of each 3 axis. The worst case was found when positioned on **Y-plane**.

RADIATED EMISSION TEST (ABOVE 1GHz):

- Pre-Scan has been conducted to determine the worst-case mode from all possible combinations between available modulations, data rates and antenna ports (if EUT with antenna diversity architecture).
- Following channel(s) was (were) selected for the final test as listed below.

EUT CONFIGURE MODE	MODE	AVAILABLE CHANNEL	TESTED CHANNEL	MODULATION TECHNOLOGY	MODULATION TYPE	DATA RATE (Mbps)
-	802.11b	1 to 11	1, 6, 11	DSSS	DBPSK	1.0
-	802.11g	1 to 11	1, 6, 11	OFDM	BPSK	6.0
-	802.11n (20MHz)	1 to 11	1, 6, 11	OFDM	BPSK	7.2
-	802.11n (40MHz)	3 to 9	3, 6, 9	OFDM	BPSK	15.0

RADIATED EMISSION TEST (BELOW 1GHz):

- Pre-Scan has been conducted to determine the worst-case mode from all possible combinations between available modulations, data rates and antenna ports (if EUT with antenna diversity architecture).
- Following channel(s) was (were) selected for the final test as listed below.

EUT CONFIGURE MODE	MODE	AVAILABLE CHANNEL	TESTED CHANNEL	MODULATION TECHNOLOGY	MODULATION TYPE	DATA RATE (Mbps)
-	802.11n (20MHz)	1 to 11	1	OFDM	BPSK	7.2

POWER LINE CONDUCTED EMISSION TEST:

- Pre-Scan has been conducted to determine the worst-case mode from all possible combinations between available modulations, data rates and antenna ports (if EUT with antenna diversity architecture).
- Following channel(s) was (were) selected for the final test as listed below.

EUT CONFIGURE MODE	MODE	AVAILABLE CHANNEL	TESTED CHANNEL	MODULATION TECHNOLOGY	MODULATION TYPE	DATA RATE (Mbps)
-	802.11n (20MHz)	1 to 11	1	OFDM	BPSK	7.2



BANDEDGE MEASUREMENT:

- Pre-Scan has been conducted to determine the worst-case mode from all possible combinations between available modulations, data rates and antenna ports (if EUT with antenna diversity architecture).
- Following channel(s) was (were) selected for the final test as listed below.

EUT CONFIGURE MODE	MODE	AVAILABLE CHANNEL	TESTED CHANNEL	MODULATION TECHNOLOGY	MODULATION TYPE	DATA RATE (Mbps)
-	802.11b	1 to 11	1, 11	DSSS	DBPSK	1.0
-	802.11g	1 to 11	1, 11	OFDM	BPSK	6.0
-	802.11n (20MHz)	1 to 11	1, 11	OFDM	BPSK	7.2
-	802.11n (40MHz)	3 to 9	3, 9	OFDM	BPSK	15.0

ANTENNA PORT CONDUCTED MEASUREMENT:

- This item includes all test value of each mode, but only includes spectrum plot of worst value of each mode.
- Pre-Scan has been conducted to determine the worst-case mode from all possible combinations between available modulations, data rates and antenna ports (if EUT with antenna diversity architecture).
- Following channel(s) was (were) selected for the final test as listed below.

EUT CONFIGURE MODE	MODE	AVAILABLE CHANNEL	TESTED CHANNEL	MODULATION TECHNOLOGY	MODULATION TYPE	DATA RATE (Mbps)
-	802.11b	1 to 11	1, 6, 11	DSSS	DBPSK	1.0
-	802.11g	1 to 11	1, 6, 11	OFDM	BPSK	6.0
-	802.11n (20MHz)	1 to 11	1, 6, 11	OFDM	BPSK	7.2
-	802.11n (40MHz)	3 to 9	3, 6, 9	OFDM	BPSK	15.0

TEST CONDITION:

APPLICABLE TO	ENVIRONMENTAL CONDITIONS	INPUT POWER (SYSTEM)	TESTED BY
RE≥1G	23deg. C, 65%RH	120Vac, 60Hz	Alan Wu
RE<1G	25deg. C, 68%RH	120Vac, 60Hz	Brad Tung
PLC	21deg. C, 68%RH	120Vac, 60Hz	Brad Tung
APCM	25deg. C, 60%RH	120Vac, 60Hz	Cedric Wu



FOR 5.0GHz (5745 ~ 5825MHz):

EUT CONFIGURE MODE	APPLICABLE TO				DESCRIPTION
	RE≥1G	RE<1G	PLC	APCM	
-	√	√	√	√	-

Where **RE≥1G**: Radiated Emission above 1GHz **RE<1G**: Radiated Emission below 1GHz
PLC: Power Line Conducted Emission **APCM**: Antenna Port Conducted Measurement

NOTE:

1. 802.11a:

The EUT had been pre-tested on the positioned of each 3 axis. The worst case was found when positioned on **Y-plane**.

2. 802.11n (20MHz), 802.11n (40MHz), 802.11ac (80MHz):

The EUT had been pre-tested on the positioned of each 3 axis. The worst case was found when positioned on **X-plane**.

RADIATED EMISSION TEST (ABOVE 1GHz):

- Pre-Scan has been conducted to determine the worst-case mode from all possible combinations between available modulations, data rates and antenna ports (if EUT with antenna diversity architecture).
- Following channel(s) was (were) selected for the final test as listed below.

EUT CONFIGURE MODE	MODE	AVAILABLE CHANNEL	TESTED CHANNEL	MODULATION TECHNOLOGY	MODULATION TYPE	DATA RATE (Mbps)
-	802.11a	149 to 165	149, 157, 165	OFDM	BPSK	6.0
-	802.11n (20MHz)	149 to 165	149, 157, 165	OFDM	BPSK	7.2
-	802.11n (40MHz)	151 to 159	151, 159	OFDM	BPSK	15.0
-	802.11ac (80MHz)	155	155	OFDM	BPSK	65.0

RADIATED EMISSION TEST (BELOW 1GHz):

- Pre-Scan has been conducted to determine the worst-case mode from all possible combinations between available modulations, data rates and antenna ports (if EUT with antenna diversity architecture).
- Following channel(s) was (were) selected for the final test as listed below.

EUT CONFIGURE MODE	MODE	AVAILABLE CHANNEL	TESTED CHANNEL	MODULATION TECHNOLOGY	MODULATION TYPE	DATA RATE (Mbps)
-	802.11n (20MHz)	149 to 165	157	OFDM	BPSK	7.2

POWER LINE CONDUCTED EMISSION TEST:

- Pre-Scan has been conducted to determine the worst-case mode from all possible combinations between available modulations, data rates and antenna ports (if EUT with antenna diversity architecture).
- Following channel(s) was (were) selected for the final test as listed below.

EUT CONFIGURE MODE	MODE	AVAILABLE CHANNEL	TESTED CHANNEL	MODULATION TECHNOLOGY	MODULATION TYPE	DATA RATE (Mbps)
-	802.11n (20MHz)	149 to 165	157	OFDM	BPSK	7.2



BANDEDGE MEASUREMENT:

- Pre-Scan has been conducted to determine the worst-case mode from all possible combinations between available modulations, data rates and antenna ports (if EUT with antenna diversity architecture).
- Following channel(s) was (were) selected for the final test as listed below.

EUT CONFIGURE MODE	MODE	AVAILABLE CHANNEL	TESTED CHANNEL	MODULATION TECHNOLOGY	MODULATION TYPE	DATA RATE (Mbps)
-	802.11a	149 to 165	149, 165	OFDM	BPSK	6.0
-	802.11n (20MHz)	149 to 165	149, 165	OFDM	BPSK	7.2
-	802.11n (40MHz)	151 to 159	151, 159	OFDM	BPSK	15.0
-	802.11ac (80MHz)	155	155	OFDM	BPSK	65.0

ANTENNA PORT CONDUCTED MEASUREMENT:

- This item includes all test value of each mode, but only includes spectrum plot of worst value of each mode.
- Pre-Scan has been conducted to determine the worst-case mode from all possible combinations between available modulations, data rates and antenna ports (if EUT with antenna diversity architecture).
- Following channel(s) was (were) selected for the final test as listed below.

EUT CONFIGURE MODE	MODE	AVAILABLE CHANNEL	TESTED CHANNEL	MODULATION TECHNOLOGY	MODULATION TYPE	DATA RATE (Mbps)
-	802.11a	149 to 165	149, 157, 165	OFDM	BPSK	6.0
-	802.11n (20MHz)	149 to 165	149, 157, 165	OFDM	BPSK	7.2
-	802.11n (40MHz)	151 to 159	151, 159	OFDM	BPSK	15.0
-	802.11ac (80MHz)	155	155	OFDM	BPSK	65.0

TEST CONDITION:

APPLICABLE TO	ENVIRONMENTAL CONDITIONS	INPUT POWER (SYSTEM)	TESTED BY
RE≥1G	24deg. C, 67%RH	120Vac, 60Hz	Alan Wu
RE<1G	25deg. C, 68%RH	120Vac, 60Hz	Brad Tung
PLC	21deg. C, 68%RH	120Vac, 60Hz	Brad Tung
APCM	25deg. C, 60%RH	120Vac, 60Hz	Cedric Wu



A D T

3.3 DUTY CYCLE OF TEST SIGNAL

2.4GHz Band:

Duty cycle of test signal is > 98 %, duty factor is not required.

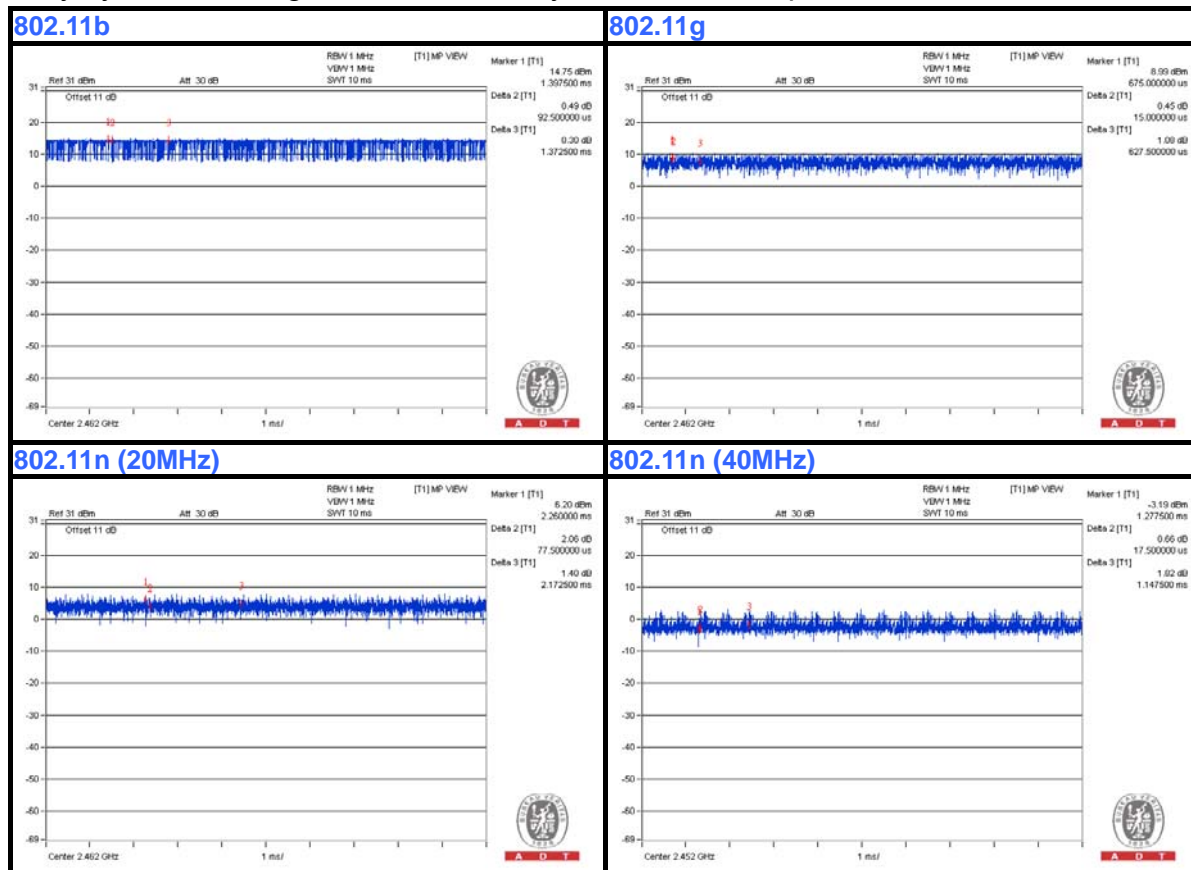



A D T

5GHz Band:

Duty cycle of test signal is > 98 %, duty factor is not required.

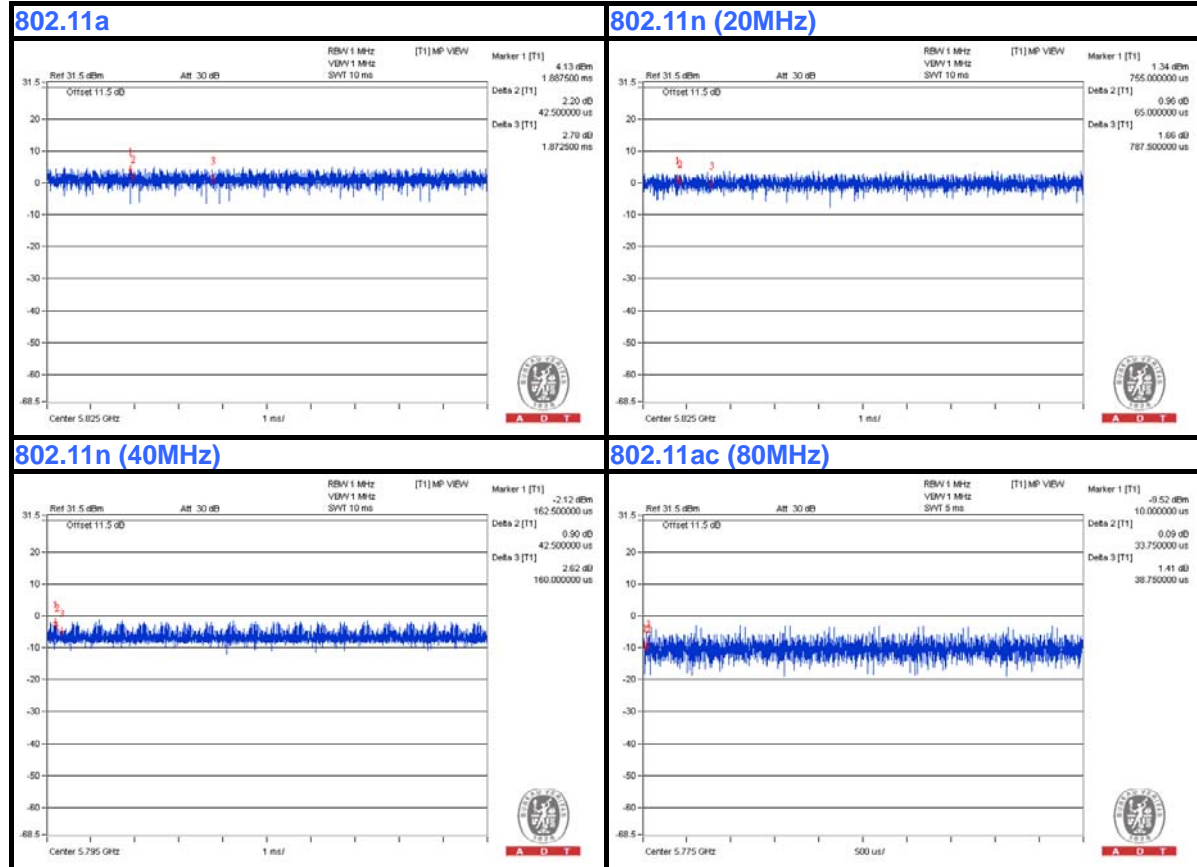

3.4 DESCRIPTION OF SUPPORT UNITS

The EUT has been tested as an independent unit together with other necessary accessories or support units. The following support units or accessories were used to form a representative test configuration during the tests.

NO.	PRODUCT	BRAND	MODEL NO.	SERIAL NO.	FCC ID
1	Notebook	DELL	E5420	BPQ7MQ1	FCC DoC Approved

NO.	SIGNAL CABLE DESCRIPTION OF THE ABOVE SUPPORT UNITS
1	0.5m USB cable

NOTE: All power cords of the above support units are non-shielded (1.8m).

3.4.1 CONFIGURATION OF SYSTEM UNDER TEST

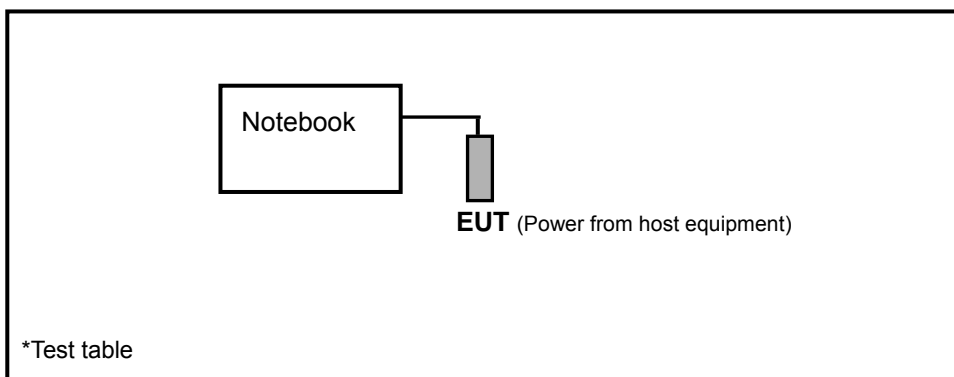



A D T

3.5 GENERAL DESCRIPTION OF APPLIED STANDARDS

The EUT is a RF Product. According to the specifications of the manufacturer, it must comply with the requirements of the following standards:

FCC Part 15, Subpart C (15.247)

558074 D01 DTS Meas Guidance v03r01

662911 D01 Multiple Transmitter Output v02

ANSI C63.10-2009

All test items have been performed and recorded as per the above standards.

NOTE: The EUT is also considered as a kind of computer peripheral, because the connection to computer is necessary for typical use. It has been verified to comply with the requirements of FCC Part 15, Subpart B, Class B (DoC). The test report has been issued separately.



4. TEST TYPES AND RESULTS (FOR 2.4GHz BAND)

4.1 RADIATED EMISSION AND BANDEDGE MEASUREMENT

4.1.1 LIMITS OF RADIATED EMISSION AND BANDEDGE MEASUREMENT

Radiated emissions which fall in the restricted bands must comply with the radiated emission limits specified as below table. Other emissions shall be at least 20dB below the highest level of the desired power:

FREQUENCIES (MHz)	FIELD STRENGTH (microvolts/meter)	MEASUREMENT DISTANCE (meters)
0.009 ~ 0.490	2400/F(kHz)	300
0.490 ~ 1.705	24000/F(kHz)	30
1.705 ~ 30.0	30	30
30 ~ 88	100	3
88 ~ 216	150	3
216 ~ 960	200	3
Above 960	500	3

NOTE:

1. The lower limit shall apply at the transition frequencies.
2. Emission level (dBuV/m) = 20 log Emission level (uV/m).
3. For frequencies above 1000MHz, the field strength limits are based on average detector, however, the peak field strength of any emission shall not exceed the maximum permitted average limits, specified above by more than 20dB under any condition of modulation.



A D T

4.1.2 TEST INSTRUMENTS

DESCRIPTION & MANUFACTURER	MODEL NO.	SERIAL NO.	DATE OF CALIBRATION	DUE DATE OF CALIBRATION
Test Receiver ROHDE & SCHWARZ	ESCI	100424	Sep. 09, 2013	Sep. 08, 2014
Spectrum Analyzer ROHDE & SCHWARZ	FSU 43	100115	Oct. 24, 2013	Oct. 23, 2014
BILOG Antenna SCHWARZBECK	VULB9168	9168-155	Mar. 25, 2013	Mar. 24, 2014
HORN Antenna SCHWARZBECK	BBHA 9120D	9120D-404	Dec. 22, 2012	Dec. 21, 2013
HORN Antenna SCHWARZBECK	BBHA 9170	148	Jul. 15, 2013	Jul. 14, 2014
Preamplifier Agilent	8449B	3008A01961	Oct. 28, 2013	Oct. 27, 2014
Preamplifier Agilent	8447D	2944A10738	Oct. 18, 2013	Oct. 17, 2014
RF signal cable HUBER+SUHNNER	SUCOFLEX 104	309220/4	Aug. 26, 2013	Aug. 25, 2014
RF signal cable HUBER+SUHNNER	SUCOFLEX 104	250724/4	Aug. 26, 2013	Aug. 25, 2014
RF signal cable HUBER+SUHNNER	SUCOFLEX 104	295012/4	Aug. 26, 2013	Aug. 25, 2014
Software BV ADT	ADT_Radiated_ V7.6.15.9.4	NA	NA	NA
Antenna Tower inn-co GmbH	MA 4000	010303	NA	NA
Antenna Tower Controller inn-co GmbH	CO2000	019303	NA	NA
Turn Table BV ADT	TT100.	TT93021704	NA	NA
Turn Table Controller BV ADT	SC100.	SC93021704	NA	NA
High Speed Peak Power Meter	ML2495A	0824012	Aug. 22, 2013	Aug. 21, 2014
Power Sensor	MA2411B	0738171	Jul. 30, 2013	Jul. 29, 2014

- NOTE:**
1. The calibration interval of the above test instruments is 12 months and the calibrations are traceable to NML/ROC and NIST/USA.
 2. The test was performed in HwaYa Chamber 4.
 3. The horn antenna and HP preamplifier (model: 8449B) are used only for the measurement of emission frequency above 1GHz if tested.
 4. The FCC Site Registration No. is 460141.
 5. The IC Site Registration No. is IC7450F-4.



A D T

4.1.3 TEST PROCEDURES

- a. The EUT was placed on the top of a rotating table 0.8 meters above the ground at a 3 meters semi-anechoic chamber. The table was rotated 360 degrees to determine the position of the highest radiation.
- b. The EUT was set 3 meters away from the interference-receiving antenna, which was mounted on the top of a variable-height antenna tower.
- c. The antenna is a broadband antenna, and its height is varied from one meter to four meters above the ground to determine the maximum value of the field strength. Both horizontal and vertical polarizations of the antenna are set to make the measurement.
- d. For each suspected emission, the EUT was arranged to its worst case and then the antenna was tuned to heights from 1 meter to 4 meters and the rotatable table was turned from 0 degrees to 360 degrees to find the maximum reading.
- e. The test-receiver system was set to Peak Detect Function and Specified Bandwidth with Maximum Hold Mode.
- f. If the emission level of the EUT in peak mode was lower than the limit specified, then testing could be stopped and the peak values of the EUT would be reported. Otherwise the emissions would be re-tested one by one using peak, quasi-peak or average method as specified and then reported in a data sheet.

NOTE:

1. The resolution bandwidth and video bandwidth of test receiver/spectrum analyzer is 120kHz for Quasi-peak detection at frequency below 1GHz.
2. The resolution bandwidth of test receiver/spectrum analyzer is 1MHz and video bandwidth is 3MHz for Peak detection at frequency above 1GHz.
3. The resolution bandwidth of test receiver/spectrum analyzer is 1MHz and the video bandwidth is 1kHz(Duty cycle < 98%) or 10Hz(Duty cycle > 98%) for Average detection (AV) at frequency above 1GHz.
4. All modes of operation were investigated and the worst-case emissions are reported.

4.1.4 DEVIATION FROM TEST STANDARD

No deviation.

4.1.5 TEST SETUP

Frequency range 30MHz~1GHz

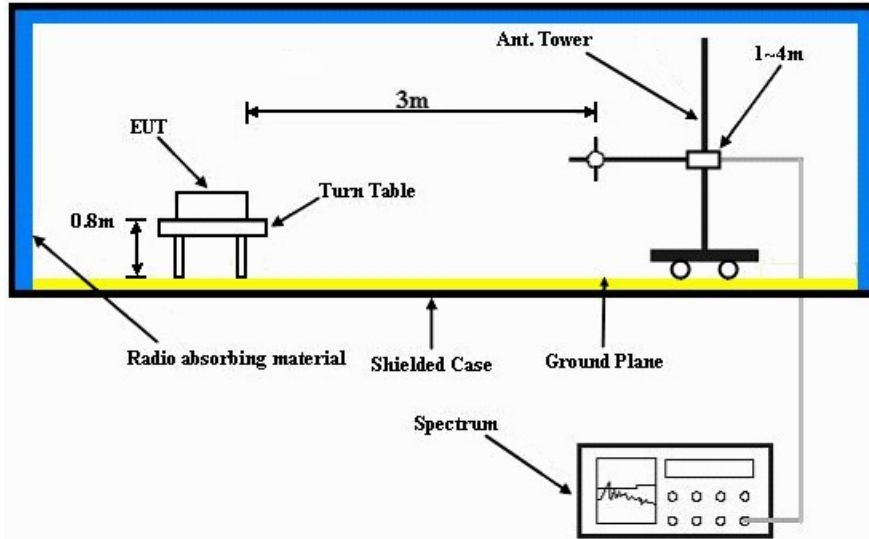

Frequency range above 1GHz

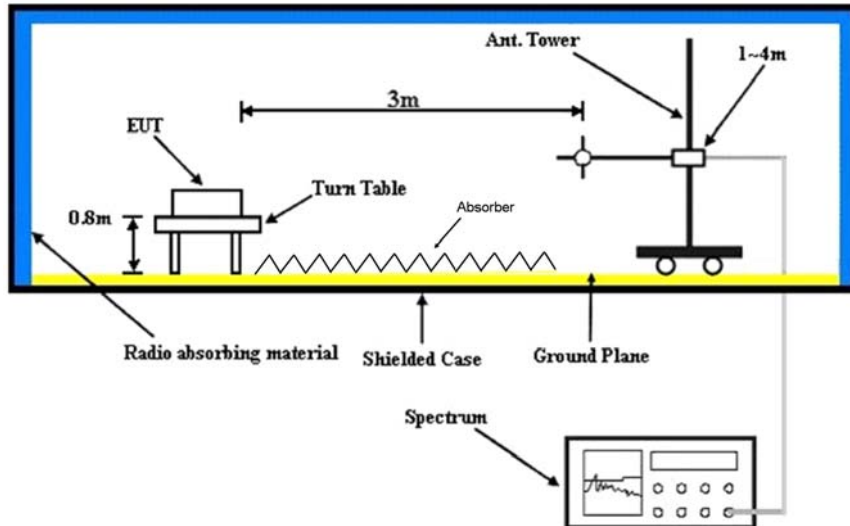

For the actual test configuration, please refer to the attached file (Test Setup Photo).



A D T

4.1.6 EUT OPERATING CONDITIONS

- a. The EUT was connected to the notebook with USB cable
- b. The notebook ran a test program (provided by manufacturer) to enable EUT under transmission condition continuously at specific channel frequency.



A D T

4.1.7 TEST RESULTS

ABOVE 1GHz DATA :

802.11b

EUT TEST CONDITION		MEASUREMENT DETAIL	
CHANNEL	Channel 1	FREQUENCY RANGE	1 ~ 25GHz
INPUT POWER (SYSTEM)	120Vac, 60Hz	DETECTOR FUNCTION	Peak (PK) Average (AV)
ENVIRONMENTAL CONDITIONS	23deg. C, 65%RH	TESTED BY	Alan Wu

ANTENNA POLARITY & TEST DISTANCE: HORIZONTAL AT 3 M								
NO.	FREQ. (MHz)	EMISSION LEVEL (dBuV/m)	LIMIT (dBuV/m)	MARGIN (dB)	ANTENNA HEIGHT (m)	TABLE ANGLE (Degree)	RAW VALUE (dBuV)	CORRECTION FACTOR (dB/m)
1	2386.00	58.8 PK	74.0	-15.2	1.00 H	226	26.90	31.90
2	2386.00	50.6 AV	54.0	-3.4	1.00 H	226	18.70	31.90
3	*2412.00	109.3 PK			1.00 H	221	77.30	32.00
4	*2412.00	105.3 AV			1.00 H	221	73.30	32.00
5	4824.00	55.2 PK	74.0	-18.8	1.07 H	198	50.40	4.80
6	4824.00	52.6 AV	54.0	-1.4	1.07 H	198	47.80	4.80

ANTENNA POLARITY & TEST DISTANCE: VERTICAL AT 3 M								
NO.	FREQ. (MHz)	EMISSION LEVEL (dBuV/m)	LIMIT (dBuV/m)	MARGIN (dB)	ANTENNA HEIGHT (m)	TABLE ANGLE (Degree)	RAW VALUE (dBuV)	CORRECTION FACTOR (dB/m)
1	2386.00	57.5 PK	74.0	-16.5	1.00 V	284	25.60	31.90
2	2386.00	48.3 AV	54.0	-5.7	1.00 V	284	16.40	31.90
3	*2412.00	106.4 PK			1.00 V	288	74.40	32.00
4	*2412.00	102.8 AV			1.00 V	288	70.80	32.00
5	4824.00	53.7 PK	74.0	-20.3	1.00 V	172	48.90	4.80
6	4824.00	49.8 AV	54.0	-4.2	1.00 V	172	45.00	4.80

REMARKS:

- Emission Level(dBuV/m) = Raw Value(dBuV) + Correction Factor(dB/m)
- Correction Factor(dB/m) = Antenna Factor(dB/m) + Cable Factor(dB) – Pre-Amplifier Factor(dB)
- The other emission levels were very low against the limit.
- Margin value = Emission Level – Limit value
- " * ": Fundamental frequency.



A D T

EUT TEST CONDITION		MEASUREMENT DETAIL	
CHANNEL	Channel 6	FREQUENCY RANGE	1 ~ 25GHz
INPUT POWER (SYSTEM)	120Vac, 60Hz	DETECTOR FUNCTION	Peak (PK) Average (AV)
ENVIRONMENTAL CONDITIONS	23deg. C, 65%RH	TESTED BY	Alan Wu

ANTENNA POLARITY & TEST DISTANCE: HORIZONTAL AT 3 M								
NO.	FREQ. (MHz)	EMISSION LEVEL (dBuV/m)	LIMIT (dBuV/m)	MARGIN (dB)	ANTENNA HEIGHT (m)	TABLE ANGLE (Degree)	RAW VALUE (dBuV)	CORRECTION FACTOR (dB/m)
1	*2437.00	109.4 PK			1.00 H	223	77.40	32.00
2	*2437.00	105.6 AV			1.00 H	223	73.60	32.00
3	4874.00	55.7 PK	74.0	-18.3	1.08 H	202	50.70	5.00
4	4874.00	52.6 AV	54.0	-1.4	1.08 H	202	47.60	5.00
ANTENNA POLARITY & TEST DISTANCE: VERTICAL AT 3 M								
NO.	FREQ. (MHz)	EMISSION LEVEL (dBuV/m)	LIMIT (dBuV/m)	MARGIN (dB)	ANTENNA HEIGHT (m)	TABLE ANGLE (Degree)	RAW VALUE (dBuV)	CORRECTION FACTOR (dB/m)
1	*2437.00	106.5 PK			1.00 V	248	74.50	32.00
2	*2437.00	102.6 AV			1.00 V	248	70.60	32.00
3	4874.00	54.1 PK	74.0	-19.9	1.00 V	175	49.10	5.00
4	4874.00	50.3 AV	54.0	-3.7	1.00 V	175	45.30	5.00

REMARKS:

1. Emission Level(dBuV/m) = Raw Value(dBuV) + Correction Factor(dB/m)
2. Correction Factor(dB/m) = Antenna Factor(dB/m) + Cable Factor(dB) – Pre-Amplifier Factor(dB)
3. The other emission levels were very low against the limit.
4. Margin value = Emission Level – Limit value
5. “ * “: Fundamental frequency.



A D T

EUT TEST CONDITION		MEASUREMENT DETAIL	
CHANNEL	Channel 11	FREQUENCY RANGE	1 ~ 25GHz
INPUT POWER (SYSTEM)	120Vac, 60Hz	DETECTOR FUNCTION	Peak (PK) Average (AV)
ENVIRONMENTAL CONDITIONS	23deg. C, 65%RH	TESTED BY	Alan Wu

ANTENNA POLARITY & TEST DISTANCE: HORIZONTAL AT 3 M								
NO.	FREQ. (MHz)	EMISSION LEVEL (dBuV/m)	LIMIT (dBuV/m)	MARGIN (dB)	ANTENNA HEIGHT (m)	TABLE ANGLE (Degree)	RAW VALUE (dBuV)	CORRECTION FACTOR (dB/m)
1	*2462.00	107.4 PK			1.00 H	223	75.20	32.20
2	*2462.00	103.4 AV			1.00 H	223	71.20	32.20
3	2488.00	60.6 PK	74.0	-13.4	1.00 H	222	28.30	32.30
4	2488.00	52.7 AV	54.0	-1.3	1.00 H	222	20.40	32.30
5	4924.00	55.0 PK	74.0	-19.0	1.07 H	202	50.00	5.00
6	4924.00	51.8 AV	54.0	-2.2	1.07 H	202	46.80	5.00
ANTENNA POLARITY & TEST DISTANCE: VERTICAL AT 3 M								
NO.	FREQ. (MHz)	EMISSION LEVEL (dBuV/m)	LIMIT (dBuV/m)	MARGIN (dB)	ANTENNA HEIGHT (m)	TABLE ANGLE (Degree)	RAW VALUE (dBuV)	CORRECTION FACTOR (dB/m)
1	*2462.00	105.0 PK			1.00 V	250	72.80	32.20
2	*2462.00	101.0 AV			1.00 V	250	68.80	32.20
3	2488.00	58.5 PK	74.0	-15.5	1.00 V	253	26.20	32.30
4	2488.00	50.1 AV	54.0	-3.9	1.00 V	253	17.80	32.30
5	4924.00	53.0 PK	74.0	-21.0	1.00 V	176	48.00	5.00
6	4924.00	48.9 AV	54.0	-5.1	1.00 V	176	43.90	5.00

REMARKS:

1. Emission Level(dBuV/m) = Raw Value(dBuV) + Correction Factor(dB/m)
2. Correction Factor(dB/m) = Antenna Factor(dB/m) + Cable Factor(dB)
– Pre-Amplifier Factor(dB)
3. The other emission levels were very low against the limit.
4. Margin value = Emission Level – Limit value
5. “ * “: Fundamental frequency.



A D T

802.11g

EUT TEST CONDITION		MEASUREMENT DETAIL	
CHANNEL	Channel 1	FREQUENCY RANGE	1 ~ 25GHz
INPUT POWER (SYSTEM)	120Vac, 60Hz	DETECTOR FUNCTION	Peak (PK) Average (AV)
ENVIRONMENTAL CONDITIONS	23deg. C, 65%RH	TESTED BY	Alan Wu

ANTENNA POLARITY & TEST DISTANCE: HORIZONTAL AT 3 M								
NO.	FREQ. (MHz)	EMISSION LEVEL (dBuV/m)	LIMIT (dBuV/m)	MARGIN (dB)	ANTENNA HEIGHT (m)	TABLE ANGLE (Degree)	RAW VALUE (dBuV)	CORRECTION FACTOR (dB/m)
1	2390.00	72.6 PK	74.0	-1.4	1.00 H	213	40.70	31.90
2	2390.00	53.0 AV	54.0	-1.0	1.00 H	213	21.10	31.90
3	*2412.00	106.9 PK			1.00 H	219	74.90	32.00
4	*2412.00	97.5 AV			1.00 H	219	65.50	32.00
5	4824.00	46.8 PK	74.0	-27.2	1.09 H	183	42.00	4.80
6	4824.00	34.6 AV	54.0	-19.4	1.09 H	183	29.80	4.80
ANTENNA POLARITY & TEST DISTANCE: VERTICAL AT 3 M								
NO.	FREQ. (MHz)	EMISSION LEVEL (dBuV/m)	LIMIT (dBuV/m)	MARGIN (dB)	ANTENNA HEIGHT (m)	TABLE ANGLE (Degree)	RAW VALUE (dBuV)	CORRECTION FACTOR (dB/m)
1	2390.00	69.7 PK	74.0	-4.3	1.00 V	281	37.80	31.90
2	2390.00	50.8 AV	54.0	-3.2	1.00 V	281	18.90	31.90
3	*2412.00	104.1 PK			1.00 V	288	72.10	32.00
4	*2412.00	94.9 AV			1.00 V	288	62.90	32.00
5	4824.00	45.4 PK	74.0	-28.6	1.00 V	178	40.60	4.80
6	4824.00	33.0 AV	54.0	-21.0	1.00 V	178	28.20	4.80

REMARKS:

1. Emission Level(dBuV/m) = Raw Value(dBuV) + Correction Factor(dB/m)
2. Correction Factor(dB/m) = Antenna Factor(dB/m) + Cable Factor(dB)
– Pre-Amplifier Factor(dB)
3. The other emission levels were very low against the limit.
4. Margin value = Emission Level – Limit value
5. “ * “: Fundamental frequency.



A D T

EUT TEST CONDITION		MEASUREMENT DETAIL	
CHANNEL	Channel 6	FREQUENCY RANGE	1 ~ 25GHz
INPUT POWER (SYSTEM)	120Vac, 60Hz	DETECTOR FUNCTION	Peak (PK) Average (AV)
ENVIRONMENTAL CONDITIONS	23deg. C, 65%RH	TESTED BY	Alan Wu

ANTENNA POLARITY & TEST DISTANCE: HORIZONTAL AT 3 M								
NO.	FREQ. (MHz)	EMISSION LEVEL (dBuV/m)	LIMIT (dBuV/m)	MARGIN (dB)	ANTENNA HEIGHT (m)	TABLE ANGLE (Degree)	RAW VALUE (dBuV)	CORRECTION FACTOR (dB/m)
1	*2437.00	106.6 PK			1.00 H	222	74.60	32.00
2	*2437.00	97.2 AV			1.00 H	222	65.20	32.00
3	4874.00	47.2 PK	74.0	-26.8	1.03 H	183	42.20	5.00
4	4874.00	34.7 AV	54.0	-19.3	1.03 H	183	29.70	5.00

ANTENNA POLARITY & TEST DISTANCE: VERTICAL AT 3 M								
NO.	FREQ. (MHz)	EMISSION LEVEL (dBuV/m)	LIMIT (dBuV/m)	MARGIN (dB)	ANTENNA HEIGHT (m)	TABLE ANGLE (Degree)	RAW VALUE (dBuV)	CORRECTION FACTOR (dB/m)
1	*2437.00	103.8 PK			1.00 V	248	71.80	32.00
2	*2437.00	94.5 AV			1.00 V	248	62.50	32.00
3	4874.00	45.9 PK	74.0	-28.1	1.00 V	177	40.90	5.00
4	4874.00	33.2 AV	54.0	-20.8	1.00 V	177	28.20	5.00

REMARKS:

1. Emission Level(dBuV/m) = Raw Value(dBuV) + Correction Factor(dB/m)
2. Correction Factor(dB/m) = Antenna Factor(dB/m) + Cable Factor(dB) – Pre-Amplifier Factor(dB)
3. The other emission levels were very low against the limit.
4. Margin value = Emission Level – Limit value
5. “ * “: Fundamental frequency.



A D T

EUT TEST CONDITION		MEASUREMENT DETAIL	
CHANNEL	Channel 11	FREQUENCY RANGE	1 ~ 25GHz
INPUT POWER (SYSTEM)	120Vac, 60Hz	DETECTOR FUNCTION	Peak (PK) Average (AV)
ENVIRONMENTAL CONDITIONS	23deg. C, 65%RH	TESTED BY	Alan Wu

ANTENNA POLARITY & TEST DISTANCE: HORIZONTAL AT 3 M								
NO.	FREQ. (MHz)	EMISSION LEVEL (dBuV/m)	LIMIT (dBuV/m)	MARGIN (dB)	ANTENNA HEIGHT (m)	TABLE ANGLE (Degree)	RAW VALUE (dBuV)	CORRECTION FACTOR (dB/m)
1	*2462.00	106.5 PK			1.00 H	223	74.30	32.20
2	*2462.00	96.6 AV			1.00 H	223	64.40	32.20
3	2483.50	68.4 PK	74.0	-5.6	1.00 H	226	36.10	32.30
4	2483.50	52.9 AV	54.0	-1.1	1.00 H	226	20.60	32.30
5	4924.00	45.9 PK	74.0	-28.1	1.05 H	183	40.90	5.00
6	4924.00	34.0 AV	54.0	-20.0	1.05 H	183	29.00	5.00
ANTENNA POLARITY & TEST DISTANCE: VERTICAL AT 3 M								
NO.	FREQ. (MHz)	EMISSION LEVEL (dBuV/m)	LIMIT (dBuV/m)	MARGIN (dB)	ANTENNA HEIGHT (m)	TABLE ANGLE (Degree)	RAW VALUE (dBuV)	CORRECTION FACTOR (dB/m)
1	*2462.00	103.4 PK			1.00 V	250	71.20	32.20
2	*2462.00	93.7 AV			1.00 V	250	61.50	32.20
3	2483.50	66.2 PK	74.0	-7.8	1.00 V	253	33.90	32.30
4	2483.50	50.7 AV	54.0	-3.3	1.00 V	253	18.40	32.30
5	4924.00	45.3 PK	74.0	-28.7	1.00 V	173	40.30	5.00
6	4924.00	32.5 AV	54.0	-21.5	1.00 V	173	27.50	5.00

REMARKS:

1. Emission Level(dBuV/m) = Raw Value(dBuV) + Correction Factor(dB/m)
2. Correction Factor(dB/m) = Antenna Factor(dB/m) + Cable Factor(dB)
– Pre-Amplifier Factor(dB)
3. The other emission levels were very low against the limit.
4. Margin value = Emission Level – Limit value
5. “ * “: Fundamental frequency.



A D T

802.11n (20MHz)

EUT TEST CONDITION		MEASUREMENT DETAIL	
CHANNEL	Channel 1	FREQUENCY RANGE	1 ~ 25GHz
INPUT POWER (SYSTEM)	120Vac, 60Hz	DETECTOR FUNCTION	Peak (PK) Average (AV)
ENVIRONMENTAL CONDITIONS	23deg. C, 65%RH	TESTED BY	Alan Wu

ANTENNA POLARITY & TEST DISTANCE: HORIZONTAL AT 3 M								
NO.	FREQ. (MHz)	EMISSION LEVEL (dBuV/m)	LIMIT (dBuV/m)	MARGIN (dB)	ANTENNA HEIGHT (m)	TABLE ANGLE (Degree)	RAW VALUE (dBuV)	CORRECTION FACTOR (dB/m)
1	2390.00	67.0 PK	74.0	-7.0	1.29 H	241	35.10	31.90
2	2390.00	52.1 AV	54.0	-1.9	1.29 H	241	20.20	31.90
3	*2412.00	108.8 PK			1.30 H	246	76.80	32.00
4	*2412.00	98.1 AV			1.30 H	246	66.10	32.00
5	4824.00	47.4 PK	74.0	-26.6	1.02 H	184	42.60	4.80
6	4824.00	35.5 AV	54.0	-18.5	1.02 H	184	30.70	4.80
ANTENNA POLARITY & TEST DISTANCE: VERTICAL AT 3 M								
NO.	FREQ. (MHz)	EMISSION LEVEL (dBuV/m)	LIMIT (dBuV/m)	MARGIN (dB)	ANTENNA HEIGHT (m)	TABLE ANGLE (Degree)	RAW VALUE (dBuV)	CORRECTION FACTOR (dB/m)
1	2390.00	66.5 PK	74.0	-7.5	1.00 V	287	34.60	31.90
2	2390.00	51.6 AV	54.0	-2.4	1.00 V	287	19.70	31.90
3	*2412.00	107.5 PK			1.00 V	285	75.50	32.00
4	*2412.00	96.4 AV			1.00 V	285	64.40	32.00
5	4824.00	46.1 PK	74.0	-27.9	1.00 V	177	41.30	4.80
6	4824.00	34.0 AV	54.0	-20.0	1.00 V	177	29.20	4.80

REMARKS:

1. Emission Level(dBuV/m) = Raw Value(dBuV) + Correction Factor(dB/m)
2. Correction Factor(dB/m) = Antenna Factor(dB/m) + Cable Factor(dB)
– Pre-Amplifier Factor(dB)
3. The other emission levels were very low against the limit.
4. Margin value = Emission Level – Limit value
5. “ * “: Fundamental frequency.



A D T

EUT TEST CONDITION		MEASUREMENT DETAIL	
CHANNEL	Channel 6	FREQUENCY RANGE	1 ~ 25GHz
INPUT POWER (SYSTEM)	120Vac, 60Hz	DETECTOR FUNCTION	Peak (PK) Average (AV)
ENVIRONMENTAL CONDITIONS	23deg. C, 65%RH	TESTED BY	Alan Wu

ANTENNA POLARITY & TEST DISTANCE: HORIZONTAL AT 3 M								
NO.	FREQ. (MHz)	EMISSION LEVEL (dBuV/m)	LIMIT (dBuV/m)	MARGIN (dB)	ANTENNA HEIGHT (m)	TABLE ANGLE (Degree)	RAW VALUE (dBuV)	CORRECTION FACTOR (dB/m)
1	*2437.00	109.6 PK			1.31 H	238	77.60	32.00
2	*2437.00	98.7 AV			1.31 H	238	66.70	32.00
3	4874.00	47.9 PK	74.0	-26.1	1.07 H	187	42.90	5.00
4	4874.00	36.1 AV	54.0	-17.9	1.07 H	187	31.10	5.00

ANTENNA POLARITY & TEST DISTANCE: VERTICAL AT 3 M								
NO.	FREQ. (MHz)	EMISSION LEVEL (dBuV/m)	LIMIT (dBuV/m)	MARGIN (dB)	ANTENNA HEIGHT (m)	TABLE ANGLE (Degree)	RAW VALUE (dBuV)	CORRECTION FACTOR (dB/m)
1	*2437.00	106.6 PK			1.00 V	284	74.60	32.00
2	*2437.00	95.5 AV			1.00 V	284	63.50	32.00
3	4874.00	47.6 PK	74.0	-26.4	1.00 V	175	42.60	5.00
4	4874.00	34.8 AV	54.0	-19.2	1.00 V	175	29.80	5.00

REMARKS:

1. Emission Level(dBuV/m) = Raw Value(dBuV) + Correction Factor(dB/m)
2. Correction Factor(dB/m) = Antenna Factor(dB/m) + Cable Factor(dB) – Pre-Amplifier Factor(dB)
3. The other emission levels were very low against the limit.
4. Margin value = Emission Level – Limit value
5. “ * “: Fundamental frequency.



A D T

EUT TEST CONDITION		MEASUREMENT DETAIL	
CHANNEL	Channel 11	FREQUENCY RANGE	1 ~ 25GHz
INPUT POWER (SYSTEM)	120Vac, 60Hz	DETECTOR FUNCTION	Peak (PK) Average (AV)
ENVIRONMENTAL CONDITIONS	23deg. C, 65%RH	TESTED BY	Alan Wu

ANTENNA POLARITY & TEST DISTANCE: HORIZONTAL AT 3 M								
NO.	FREQ. (MHz)	EMISSION LEVEL (dBuV/m)	LIMIT (dBuV/m)	MARGIN (dB)	ANTENNA HEIGHT (m)	TABLE ANGLE (Degree)	RAW VALUE (dBuV)	CORRECTION FACTOR (dB/m)
1	*2462.00	109.6 PK			1.28 H	238	77.40	32.20
2	*2462.00	98.6 AV			1.28 H	238	66.40	32.20
3	2483.50	67.0 PK	74.0	-7.0	1.28 H	232	34.70	32.30
4	2483.50	52.7 AV	54.0	-1.3	1.28 H	232	20.40	32.30
5	4924.00	46.7 PK	74.0	-27.3	1.03 H	183	41.70	5.00
6	4924.00	34.5 AV	54.0	-19.5	1.03 H	183	29.50	5.00
ANTENNA POLARITY & TEST DISTANCE: VERTICAL AT 3 M								
NO.	FREQ. (MHz)	EMISSION LEVEL (dBuV/m)	LIMIT (dBuV/m)	MARGIN (dB)	ANTENNA HEIGHT (m)	TABLE ANGLE (Degree)	RAW VALUE (dBuV)	CORRECTION FACTOR (dB/m)
1	*2462.00	106.6 PK			1.00 V	251	74.40	32.20
2	*2462.00	95.2 AV			1.00 V	251	63.00	32.20
3	2483.50	62.5 PK	74.0	-11.5	1.00 V	252	30.20	32.30
4	2483.50	48.6 AV	54.0	-5.4	1.00 V	252	16.30	32.30
5	4924.00	45.4 PK	74.0	-28.6	1.00 V	171	40.40	5.00
6	4924.00	32.9 AV	54.0	-21.1	1.00 V	171	27.90	5.00

REMARKS:

1. Emission Level(dBuV/m) = Raw Value(dBuV) + Correction Factor(dB/m)
2. Correction Factor(dB/m) = Antenna Factor(dB/m) + Cable Factor(dB)
– Pre-Amplifier Factor(dB)
3. The other emission levels were very low against the limit.
4. Margin value = Emission Level – Limit value
5. “ * “: Fundamental frequency.



A D T

802.11n (40MHz)

EUT TEST CONDITION		MEASUREMENT DETAIL	
CHANNEL	Channel 3	FREQUENCY RANGE	1 ~ 25GHz
INPUT POWER (SYSTEM)	120Vac, 60Hz	DETECTOR FUNCTION	Peak (PK) Average (AV)
ENVIRONMENTAL CONDITIONS	23deg. C, 65%RH	TESTED BY	Alan Wu

ANTENNA POLARITY & TEST DISTANCE: HORIZONTAL AT 3 M								
NO.	FREQ. (MHz)	EMISSION LEVEL (dBuV/m)	LIMIT (dBuV/m)	MARGIN (dB)	ANTENNA HEIGHT (m)	TABLE ANGLE (Degree)	RAW VALUE (dBuV)	CORRECTION FACTOR (dB/m)
1	2390.00	66.0 PK	74.0	-8.0	1.34 H	253	34.10	31.90
2	2390.00	52.8 AV	54.0	-1.2	1.34 H	253	20.90	31.90
3	*2422.00	106.4 PK			1.37 H	256	74.40	32.00
4	*2422.00	95.1 AV			1.37 H	256	63.10	32.00
5	4844.00	46.3 PK	74.0	-27.7	1.01 H	187	41.50	4.80
6	4844.00	34.2 AV	54.0	-19.8	1.01 H	187	29.40	4.80
ANTENNA POLARITY & TEST DISTANCE: VERTICAL AT 3 M								
NO.	FREQ. (MHz)	EMISSION LEVEL (dBuV/m)	LIMIT (dBuV/m)	MARGIN (dB)	ANTENNA HEIGHT (m)	TABLE ANGLE (Degree)	RAW VALUE (dBuV)	CORRECTION FACTOR (dB/m)
1	2390.00	65.2 PK	74.0	-8.8	1.00 V	283	33.30	31.90
2	2390.00	51.3 AV	54.0	-2.7	1.00 V	283	19.40	31.90
3	*2422.00	102.9 PK			1.00 V	285	70.90	32.00
4	*2422.00	92.1 AV			1.00 V	285	60.10	32.00
5	4844.00	44.9 PK	74.0	-29.1	1.00 V	172	40.10	4.80
6	4844.00	32.6 AV	54.0	-21.4	1.00 V	172	27.80	4.80

REMARKS:

1. Emission Level(dBuV/m) = Raw Value(dBuV) + Correction Factor(dB/m)
2. Correction Factor(dB/m) = Antenna Factor(dB/m) + Cable Factor(dB)
– Pre-Amplifier Factor(dB)
3. The other emission levels were very low against the limit.
4. Margin value = Emission Level – Limit value
5. “ * “: Fundamental frequency.



A D T

EUT TEST CONDITION		MEASUREMENT DETAIL	
CHANNEL	Channel 6	FREQUENCY RANGE	1 ~ 25GHz
INPUT POWER (SYSTEM)	120Vac, 60Hz	DETECTOR FUNCTION	Peak (PK) Average (AV)
ENVIRONMENTAL CONDITIONS	23deg. C, 65%RH	TESTED BY	Alan Wu

ANTENNA POLARITY & TEST DISTANCE: HORIZONTAL AT 3 M								
NO.	FREQ. (MHz)	EMISSION LEVEL (dBuV/m)	LIMIT (dBuV/m)	MARGIN (dB)	ANTENNA HEIGHT (m)	TABLE ANGLE (Degree)	RAW VALUE (dBuV)	CORRECTION FACTOR (dB/m)
1	*2437.00	105.7 PK			1.29 H	239	73.70	32.00
2	*2437.00	95.3 AV			1.29 H	239	63.30	32.00
3	4874.00	47.1 PK	74.0	-26.9	1.01 H	183	42.10	5.00
4	4874.00	34.3 AV	54.0	-19.7	1.01 H	183	29.30	5.00
ANTENNA POLARITY & TEST DISTANCE: VERTICAL AT 3 M								
NO.	FREQ. (MHz)	EMISSION LEVEL (dBuV/m)	LIMIT (dBuV/m)	MARGIN (dB)	ANTENNA HEIGHT (m)	TABLE ANGLE (Degree)	RAW VALUE (dBuV)	CORRECTION FACTOR (dB/m)
1	*2437.00	102.0 PK			1.00 V	285	70.00	32.00
2	*2437.00	91.6 AV			1.00 V	285	59.60	32.00
3	4874.00	45.8 PK	74.0	-28.2	1.00 V	175	40.80	5.00
4	4874.00	32.7 AV	54.0	-21.3	1.00 V	175	27.70	5.00

REMARKS:

1. Emission Level(dBuV/m) = Raw Value(dBuV) + Correction Factor(dB/m)
2. Correction Factor(dB/m) = Antenna Factor(dB/m) + Cable Factor(dB) – Pre-Amplifier Factor(dB)
3. The other emission levels were very low against the limit.
4. Margin value = Emission Level – Limit value
5. “ * “: Fundamental frequency.



A D T

EUT TEST CONDITION		MEASUREMENT DETAIL	
CHANNEL	Channel 9	FREQUENCY RANGE	1 ~ 25GHz
INPUT POWER (SYSTEM)	120Vac, 60Hz	DETECTOR FUNCTION	Peak (PK) Average (AV)
ENVIRONMENTAL CONDITIONS	23deg. C, 65%RH	TESTED BY	Alan Wu

ANTENNA POLARITY & TEST DISTANCE: HORIZONTAL AT 3 M								
NO.	FREQ. (MHz)	EMISSION LEVEL (dBuV/m)	LIMIT (dBuV/m)	MARGIN (dB)	ANTENNA HEIGHT (m)	TABLE ANGLE (Degree)	RAW VALUE (dBuV)	CORRECTION FACTOR (dB/m)
1	*2452.00	105.7 PK			1.29 H	238	73.50	32.20
2	*2452.00	95.0 AV			1.29 H	238	62.80	32.20
3	2483.50	66.2 PK	74.0	-7.8	1.28 H	232	33.90	32.30
4	2483.50	52.6 AV	54.0	-1.4	1.28 H	232	20.30	32.30
5	4904.00	45.3 PK	74.0	-28.7	1.00 H	186	40.30	5.00
6	4904.00	33.8 AV	54.0	-20.2	1.00 H	186	28.80	5.00
ANTENNA POLARITY & TEST DISTANCE: VERTICAL AT 3 M								
NO.	FREQ. (MHz)	EMISSION LEVEL (dBuV/m)	LIMIT (dBuV/m)	MARGIN (dB)	ANTENNA HEIGHT (m)	TABLE ANGLE (Degree)	RAW VALUE (dBuV)	CORRECTION FACTOR (dB/m)
1	*2452.00	101.1 PK			1.00 V	285	68.90	32.20
2	*2452.00	90.7 AV			1.00 V	285	58.50	32.20
3	2483.50	61.3 PK	74.0	-12.7	1.00 V	287	29.00	32.30
4	2483.50	47.5 AV	54.0	-6.5	1.00 V	287	15.20	32.30
5	4904.00	44.8 PK	74.0	-29.2	1.00 V	176	39.80	5.00
6	4904.00	32.1 AV	54.0	-21.9	1.00 V	176	27.10	5.00

REMARKS:

1. Emission Level(dBuV/m) = Raw Value(dBuV) + Correction Factor(dB/m)
2. Correction Factor(dB/m) = Antenna Factor(dB/m) + Cable Factor(dB)
– Pre-Amplifier Factor(dB)
3. The other emission levels were very low against the limit.
4. Margin value = Emission Level – Limit value
5. “ * “: Fundamental frequency.



A D T

BELOW 1GHz WORST-CASE DATA : 802.11n (20MHz)

EUT TEST CONDITION		MEASUREMENT DETAIL	
CHANNEL	Channel 1	FREQUENCY RANGE	Below 1000MHz
INPUT POWER (SYSTEM)	120Vac, 60Hz	DETECTOR FUNCTION	Quasi-Peak
ENVIRONMENTAL CONDITIONS	25deg. C, 68%RH	TESTED BY	Brad Tung

ANTENNA POLARITY & TEST DISTANCE: HORIZONTAL AT 3 M								
NO.	FREQ. (MHz)	EMISSION LEVEL (dBuV/m)	LIMIT (dBuV/m)	MARGIN (dB)	ANTENNA HEIGHT (m)	TABLE ANGLE (Degree)	RAW VALUE (dBuV)	CORRECTION FACTOR (dB/m)
1	173.49	32.4 QP	43.5	-11.1	1.25 H	241	47.00	-14.60
2	192.89	34.0 QP	43.5	-9.5	1.50 H	267	50.60	-16.60
3	239.46	38.2 QP	46.0	-7.8	2.00 H	104	53.10	-14.90
4	334.54	32.3 QP	46.0	-13.7	1.00 H	126	44.20	-11.90
5	480.07	39.6 QP	46.0	-6.4	1.00 H	139	49.00	-9.40
6	960.20	40.3 QP	54.0	-13.7	1.25 H	178	40.90	-0.60

ANTENNA POLARITY & TEST DISTANCE: VERTICAL AT 3 M								
NO.	FREQ. (MHz)	EMISSION LEVEL (dBuV/m)	LIMIT (dBuV/m)	MARGIN (dB)	ANTENNA HEIGHT (m)	TABLE ANGLE (Degree)	RAW VALUE (dBuV)	CORRECTION FACTOR (dB/m)
1	99.75	31.4 QP	43.5	-12.1	1.25 V	232	50.00	-18.60
2	142.44	32.6 QP	43.5	-10.9	1.00 V	251	46.80	-14.20
3	239.46	38.1 QP	46.0	-7.9	1.00 V	283	53.00	-14.90
4	431.56	30.7 QP	46.0	-15.3	2.00 V	231	40.70	-10.00
5	480.07	40.5 QP	46.0	-5.5	1.25 V	106	49.90	-9.40
6	961.29	36.3 QP	54.0	-17.7	1.00 V	268	36.80	-0.50

REMARKS:

1. Emission Level(dBuV/m) = Raw Value(dBuV) + Correction Factor(dB/m)
2. Correction Factor(dB/m) = Antenna Factor(dB/m) + Cable Factor(dB)
 - Pre-Amplifier Factor (dB)
3. The other emission levels were very low against the limit.
4. Margin value = Emission Level – Limit value



4.2 CONDUCTED EMISSION MEASUREMENT

4.2.1 LIMITS OF CONDUCTED EMISSION MEASUREMENT

FREQUENCY OF EMISSION (MHz)	CONDUCTED LIMIT (dBµV)	
	Quasi-peak	Average
0.15 ~ 0.5	66 to 56	56 to 46
0.5 ~ 5	56	46
5 ~ 30	60	50

- NOTE:**
1. The lower limit shall apply at the transition frequencies.
 2. The limit decreases in line with the logarithm of the frequency in the range of 0.15 to 0.50MHz.
 3. All emanations from a class A/B digital device or system, including any network of conductors and apparatus connected thereto, shall not exceed the level of field strengths specified above.

4.2.2 TEST INSTRUMENTS

DESCRIPTION & MANUFACTURER	MODEL NO.	SERIAL NO.	DATE OF CALIBRATION	DUE DATE OF CALIBRATION
Test Receiver ROHDE & SCHWARZ	ESCS30	100289	Nov. 29, 2013	Nov. 28, 2014
RF signal cable Woken	5D-FB	Cable-HYC01-01	Dec. 28, 2012	Dec. 27, 2013
LISN ROHDE & SCHWARZ (Peripheral)	ESH3-Z5	100311	Jul. 17, 2013	Jul. 16, 2014
LISN ROHDE & SCHWARZ (EUT)	ESH3-Z5	835239/001	Feb. 04, 2013	Feb. 03, 2014
Software ADT	BV ADT_Cond_ V7.3.7.3	NA	NA	NA

- NOTE:**
1. The calibration interval of the above test instruments is 12 months and the calibrations are traceable to NML/ROC and NIST/USA.
 2. The test was performed in HwaYa Shielded Room 1.
 3. The VCCI Site Registration No. is C-2040.

4.2.3 TEST PROCEDURES

- a. The EUT was placed 0.4 meters from the conducting wall of the shielded room with EUT being connected to the power mains through a line impedance stabilization network (LISN). Other support units were connected to the power mains through another LISN. The two LISNs provide 50 ohm/ 50uH of coupling impedance for the measuring instrument.
- b. Both lines of the power mains connected to the EUT were checked for maximum conducted interference.
- c. The frequency range from 150kHz to 30MHz was searched. Emission levels under (Limit - 20dB) was not recorded.

NOTE: All modes of operation were investigated and the worst-case emissions are reported.

4.2.4 DEVIATION FROM TEST STANDARD

No deviation.

4.2.5 TEST SETUP

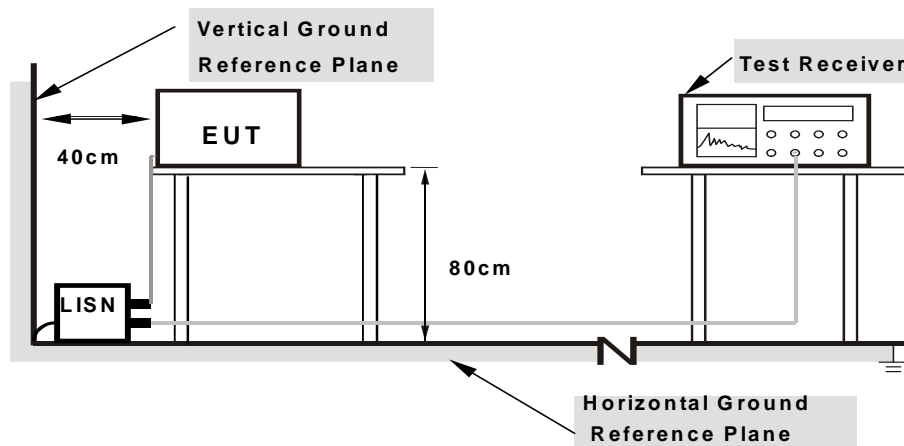

- Note:**
- 1.Support units were connected to second LISN.
 - 2.Both of LISNs (AMN) are 80 cm from EUT and at least 80 from other units and other metal planes

For the actual test configuration, please refer to the attached file (Test Setup Photo).

4.2.6 EUT OPERATING CONDITIONS

Same as 4.1.6.

4.2.7 TEST RESULTS

CONDUCTED WORST-CASE DATA : 802.11n (20MHz)

PHASE	Line 1	6dB BANDWIDTH	9kHz
--------------	--------	----------------------	------

No	Freq. [MHz]	Corr. Factor (dB)	Reading Value		Emission Level		Limit		Margin	
			[dB (uV)]		[dB (uV)]		[dB (uV)]		(dB)	
			Q.P.	AV.	Q.P.	AV.	Q.P.	AV.	Q.P.	AV.
1	0.18557	0.16	47.69	31.90	47.85	32.06	64.23	54.23	-16.38	-22.17
2	0.21565	0.17	46.70	36.15	46.87	36.32	62.98	52.98	-16.12	-16.67
3	0.50000	0.23	39.20	36.13	39.43	36.36	56.00	46.00	-16.57	-9.64
4	0.88531	0.25	33.72	24.45	33.97	24.70	56.00	46.00	-22.03	-21.30
5	1.44421	0.27	29.51	20.47	29.78	20.74	56.00	46.00	-26.22	-25.26
6	21.06068	1.28	41.33	35.35	42.61	36.63	60.00	50.00	-17.39	-13.37

REMARKS:

1. Q.P. and AV. are abbreviations of quasi-peak and average individually.
2. The emission levels of other frequencies were very low against the limit.
3. Margin value = Emission level - Limit value
4. Correction factor = Insertion loss + Cable loss
5. Emission Level = Correction Factor + Reading Value

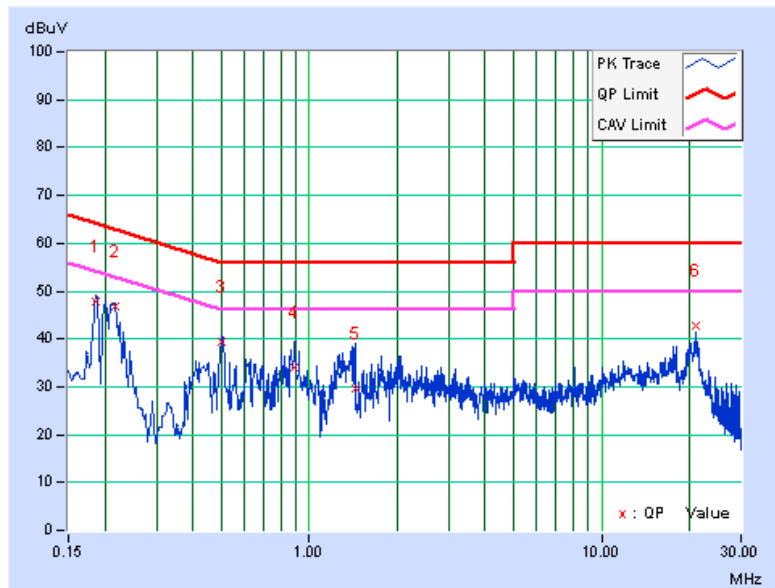

PHASE	Line 2	6dB BANDWIDTH	9kHz
-------	--------	---------------	------

No	Freq.	Corr. Factor	Reading Value		Emission Level		Limit		Margin	
	[MHz]		[dB (uV)]	[dB (uV)]	[dB (uV)]	[dB (uV)]	[dB (uV)]	[dB (uV)]	[dB (uV)]	
			Q.P.	AV.	Q.P.	AV.	Q.P.	AV.	Q.P.	AV.
1	0.19305	0.17	48.01	33.45	48.18	33.62	63.90	53.90	-15.73	-20.29
2	0.21966	0.18	46.16	35.48	46.34	35.66	62.83	52.83	-16.49	-17.17
3	0.50000	0.24	38.24	31.34	38.48	31.58	56.00	46.00	-17.52	-14.42
4	0.90854	0.25	33.54	23.74	33.79	23.99	56.00	46.00	-22.21	-22.01
5	2.11282	0.29	29.38	20.84	29.67	21.13	56.00	46.00	-26.33	-24.87
6	20.92383	0.96	36.21	30.40	37.17	31.36	60.00	50.00	-22.83	-18.64

REMARKS:

1. Q.P. and AV. are abbreviations of quasi-peak and average individually.
2. The emission levels of other frequencies were very low against the limit.
3. Margin value = Emission level - Limit value
4. Correction factor = Insertion loss + Cable loss
5. Emission Level = Correction Factor + Reading Value

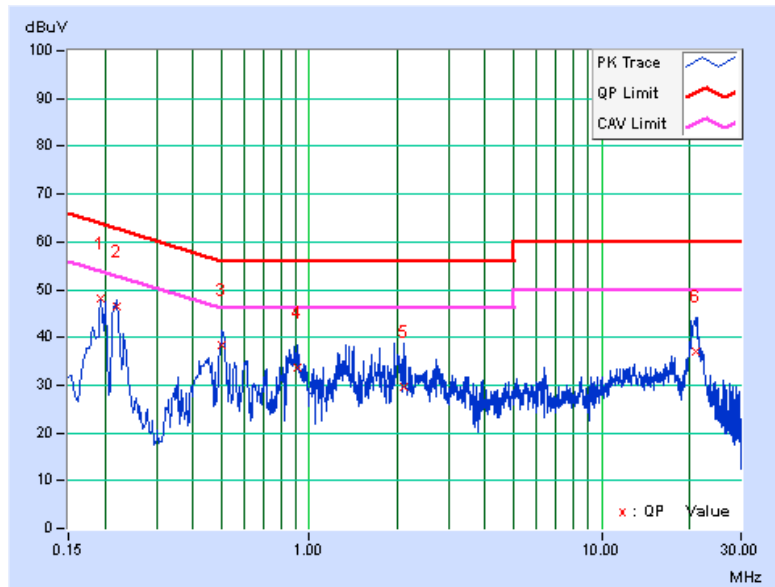

4.3 6dB BANDWIDTH MEASUREMENT

4.3.1 LIMITS OF 6dB BANDWIDTH MEASUREMENT

The minimum of 6dB Bandwidth Measurement is 0.5 MHz.

4.3.2 TEST SETUP

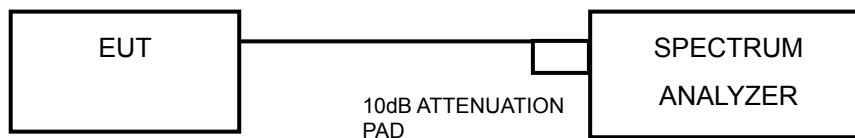

4.3.3 TEST INSTRUMENTS

Refer to section 4.1.2 to get information of above instrument.

4.3.4 TEST PROCEDURE

- a. Set resolution bandwidth (RBW) = 100kHz
- b. Set the video bandwidth (VBW) $\geq 3 \times$ RBW, Detector = Peak.
- c. Trace mode = max hold.
- d. Sweep = auto couple.
- e. Measure the maximum width of the emission that is constrained by the frequencies associated with the two amplitude points (upper and lower) that are attenuated by 6 dB relative to the maximum level measured in the fundamental emission

4.3.5 DEVIATION FROM TEST STANDARD

No deviation.

4.3.6 EUT OPERATING CONDITIONS

The software provided by client to enable the EUT under transmission condition continuously at lowest, middle and highest channel frequencies individually.



4.3.7 TEST RESULTS

802.11b

CHANNEL	FREQUENCY (MHz)	6dB BANDWIDTH (MHz)	MINIMUM LIMIT (MHz)	PASS / FAIL
1	2412	10.16	0.5	PASS
6	2437	10.16	0.5	PASS
11	2462	10.15	0.5	PASS

802.11g

CHANNEL	FREQUENCY (MHz)	6dB BANDWIDTH (MHz)	MINIMUM LIMIT (MHz)	PASS / FAIL
1	2412	16.59	0.5	PASS
6	2437	16.59	0.5	PASS
11	2462	16.57	0.5	PASS

802.11n (20MHz)

CHANNEL	FREQUENCY (MHz)	6dB BANDWIDTH (MHz)		MINIMUM LIMIT (MHz)	PASS / FAIL
		CHAIN 0	CHAIN 1		
1	2412	17.74	17.70	0.5	PASS
6	2437	17.76	17.72	0.5	PASS
11	2462	17.84	17.71	0.5	PASS

802.11n (40MHz)

CHANNEL	FREQUENCY (MHz)	6dB BANDWIDTH (MHz)		MINIMUM LIMIT (MHz)	PASS / FAIL
		CHAIN 0	CHAIN 1		
3	2422	36.61	36.57	0.5	PASS
6	2437	36.62	36.61	0.5	PASS
9	2452	36.63	36.60	0.5	PASS



A D T

SPECTRUM PLOT OF WORST VALUE

802.11b

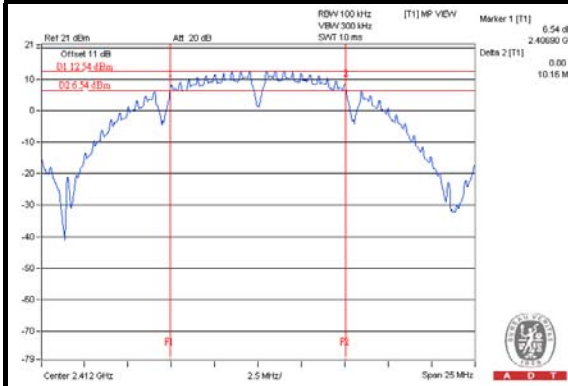

802.11g

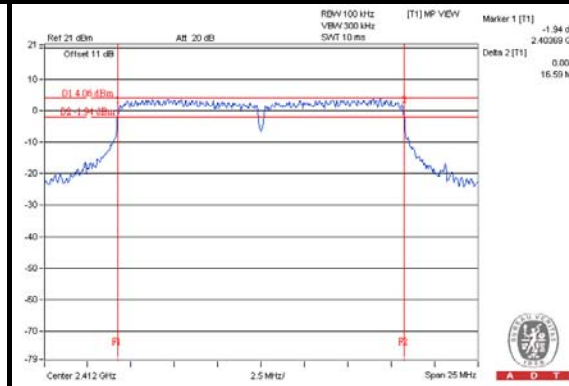

802.11n (20MHz)

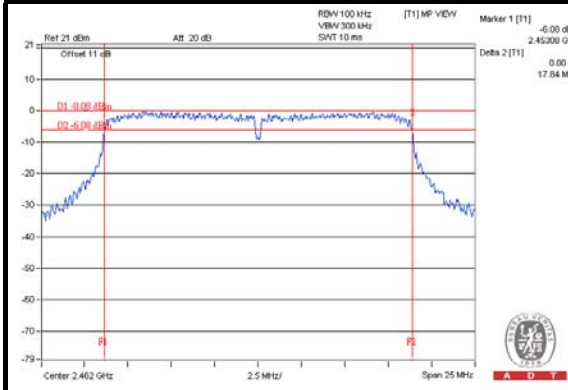

802.11n (40MHz)

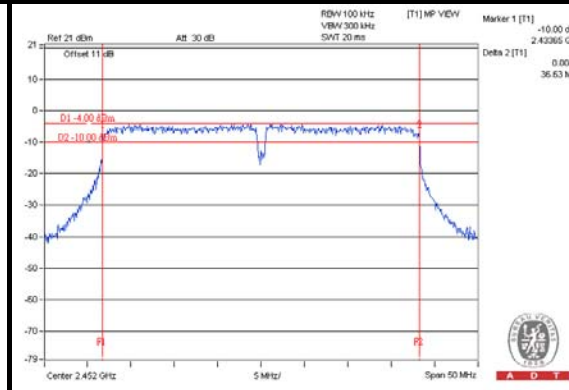

4.4 CONDUCTED OUTPUT POWER

4.4.1 LIMITS OF CONDUCTED OUTPUT POWER MEASUREMENT

For systems using digital modulation in the 2400–2483.5 MHz bands: 1 Watt (30dBm)

Per KDB 662911 D01 Multiple Transmitter Output v02 Method of conducted output power measurement on IEEE 802.11 devices,

Array Gain = 0 dB (i.e., no array gain) for $NANT \leq 4$;

Array Gain = 0 dB (i.e., no array gain) for channel widths ≥ 40 MHz for any NANT;

Array Gain = $5 \log(NANT/NSS)$ dB or 3 dB, whichever is less for 20-MHz channel widths with $NANT \geq 5$.

For power measurements on all other devices: Array Gain = $10 \log(NANT/NSS)$ dB.

4.4.2 TEST SETUP

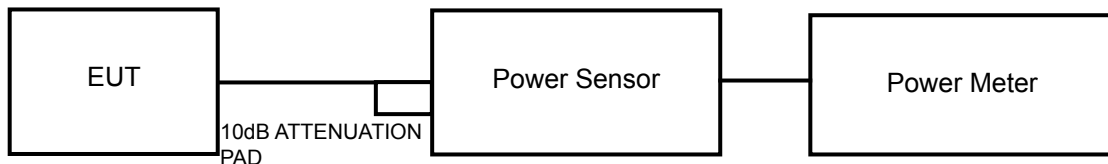

4.4.3 TEST INSTRUMENTS

Refer to section 4.1.2 to get information of above instrument.

4.4.4 TEST PROCEDURES

Follow KDB 558074 D01 DTS Meas Guidance v03r01 section 9.1.3

A peak / average power sensor was used on the output port of the EUT. A power meter was used to read the response of the peak / average power sensor. Record the peak power level.



A D T

4.4.5 DEVIATION FROM TEST STANDARD

No deviation.

4.4.6 EUT OPERATING CONDITIONS

Same as Item 4.3.6.



4.4.7 TEST RESULTS

FOR PEAK POWER

802.11b

CHANNEL	FREQUENCY (MHz)	PEAK POWER (mW)	PEAK POWER (dBm)	LIMIT (dBm)	PASS/FAIL
1	2412	185.353	22.68	30	PASS
6	2437	184.502	22.66	30	PASS
11	2462	164.816	22.17	30	PASS

802.11g

CHANNEL	FREQUENCY (MHz)	PEAK POWER (mW)	PEAK POWER (dBm)	LIMIT (dBm)	PASS/FAIL
1	2412	295.801	24.71	30	PASS
6	2437	263.633	24.21	30	PASS
11	2462	233.884	23.69	30	PASS

802.11n (20MHz)

CHAN.	FREQ. (MHz)	PEAK POWER (dBm)		TOTAL POWER (mW)	TOTAL POWER (dBm)	LIMIT (dBm)	PASS / FAIL
		CHAIN 0	CHAIN 1				
1	2412	24.10	24.02	509.388	27.07	30	PASS
6	2437	23.52	23.60	453.992	26.57	30	PASS
11	2462	22.87	23.65	425.381	26.29	30	PASS

802.11n (40MHz)

CHAN.	FREQ. (MHz)	PEAK POWER (dBm)		TOTAL POWER (mW)	TOTAL POWER (dBm)	LIMIT (dBm)	PASS / FAIL
		CHAIN 0	CHAIN 1				
3	2422	22.54	23.21	388.884	25.90	30	PASS
6	2437	22.43	22.63	358.216	25.54	30	PASS
9	2452	22.13	22.25	331.185	25.20	30	PASS



A D T

FOR AVERAGE POWER

802.11b

CHANNEL	FREQUENCY (MHz)	AVERAGE POWER (mW)	AVERAGE POWER (dBm)
1	2412	115.611	20.63
6	2437	116.145	20.65
11	2462	105.196	20.22

802.11g

CHANNEL	FREQUENCY (MHz)	AVERAGE POWER (mW)	AVERAGE POWER (dBm)
1	2412	66.069	18.20
6	2437	69.984	18.45
11	2462	60.674	17.83

802.11n (20MHz)

CHAN.	FREQUENCY (MHz)	AVG. POWER (dBm)		TOTAL POWER (mW)	TOTAL POWER (dBm)
		CHAIN 0	CHAIN 1		
1	2412	18.09	17.33	118.492	20.74
6	2437	17.27	17.62	111.143	20.46
11	2462	16.49	16.57	89.960	19.54

802.11n (40MHz)

CHAN.	FREQUENCY (MHz)	AVG. POWER (dBm)		TOTAL POWER (mW)	TOTAL POWER (dBm)
		CHAIN 0	CHAIN 1		
3	2422	15.71	15.27	70.890	18.51
6	2437	15.39	15.14	67.253	18.28
9	2452	14.76	14.81	60.192	17.80

4.5 POWER SPECTRAL DENSITY MEASUREMENT

4.5.1 LIMITS OF POWER SPECTRAL DENSITY MEASUREMENT

The Maximum of Power Spectral Density Measurement is 8dBm.

4.5.2 TEST SETUP

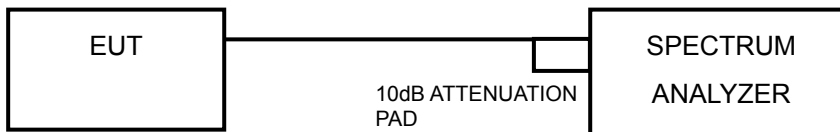

4.5.3 TEST INSTRUMENTS

Refer to section 4.1.2 to get information of above instrument.

4.5.4 TEST PROCEDURE

Follow 558074 D01 DTS Meas Guidance v03r01 section 10.2

- Set the RBW = 3 kHz, VBW =10 kHz, Detector = peak.
- Sweep time = auto couple, Trace mode = max hold, allow trace to fully stabilize.
- Use the peak marker function to determine the maximum power level in any 100 kHz band segment within the fundamental EBW.

4.5.5 DEVIATION FROM TEST STANDARD

No deviation.

4.5.6 EUT OPERATING CONDITION

Same as Item 4.3.6



A D T

4.5.7 TEST RESULTS

802.11b

Channel	Freq. (MHz)	PSD (dBm/3kHz)	Limit (dBm/3kHz)	PASS /FAIL
1	2412	-7.55	8	PASS
6	2437	-8.12	8	PASS
11	2462	-9.70	8	PASS

802.11g

Channel	Freq. (MHz)	PSD (dBm/3kHz)	Limit (dBm/3kHz)	PASS /FAIL
1	2412	-10.33	8	PASS
6	2437	-10.85	8	PASS
11	2462	-11.37	8	PASS

802.11n (20MHz)

TX chain	Channel	Freq. (MHz)	PSD (dBm/3kHz)	10 log (N=3) dB	Total PSD (dBm/3kHz)	Limit (dBm/3kHz)	PASS /FAIL
0	1	2412	-11.76	3.01	-8.75	8	PASS
	6	2437	-12.99	3.01	-9.98	8	PASS
	11	2462	-13.07	3.01	-10.06	8	PASS
1	1	2412	-11.98	3.01	-8.97	8	PASS
	6	2437	-12.63	3.01	-9.62	8	PASS
	11	2462	-14.68	3.01	-11.67	8	PASS

NOTE: Directional gain = $10 \log[(10^{G1/20} + 10^{G2/20} + \dots + 10^{GN/20})^2 / N_{ANT}] = 3.73 < 6\text{dBi}$, so the power density limit no need to reduced.

802.11n (40MHz)

TX chain	Channel	Freq. (MHz)	PSD (dBm/3kHz)	10 log (N=3) dB	Total PSD (dBm/3kHz)	Limit (dBm/3kHz)	PASS /FAIL
0	3	2422	-16.83	3.01	-13.82	8	PASS
	6	2437	-16.13	3.01	-13.12	8	PASS
	9	2452	-17.51	3.01	-14.50	8	PASS
1	3	2422	-16.29	3.01	-13.28	8	PASS
	6	2437	-15.30	3.01	-12.29	8	PASS
	9	2452	-18.72	3.01	-15.71	8	PASS

NOTE: Directional gain = $10 \log[(10^{G1/20} + 10^{G2/20} + \dots + 10^{GN/20})^2 / N_{ANT}] = 3.73 < 6\text{dBi}$, so the power density limit no need to reduced.



A D T

SPECTRUM PLOT OF WORST VALUE

802.11b

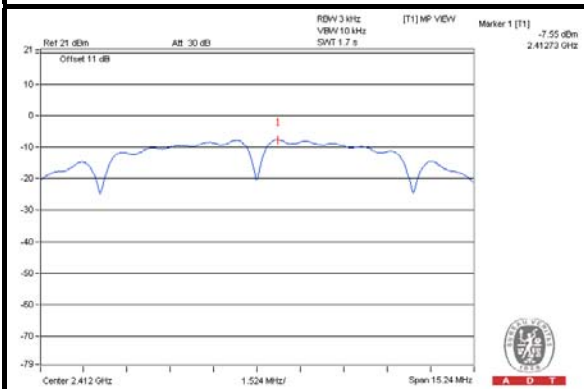

802.11g

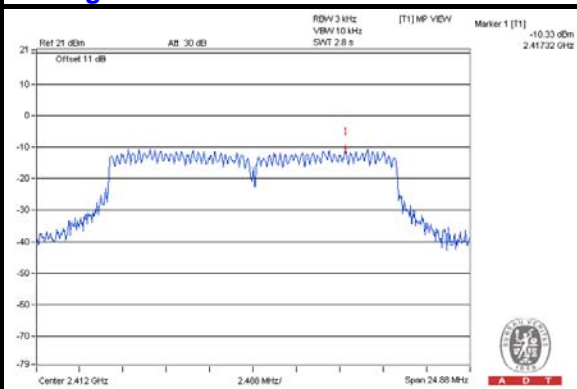

802.11n (20MHz)

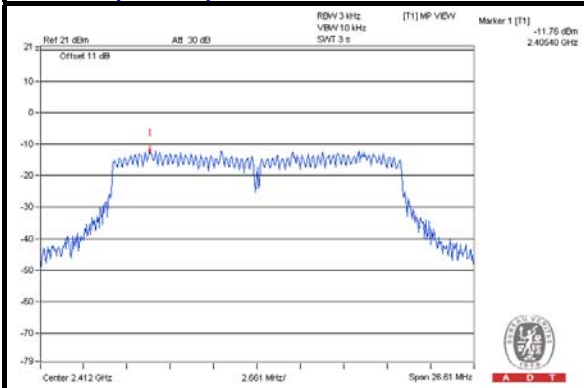

802.11n (40MHz)

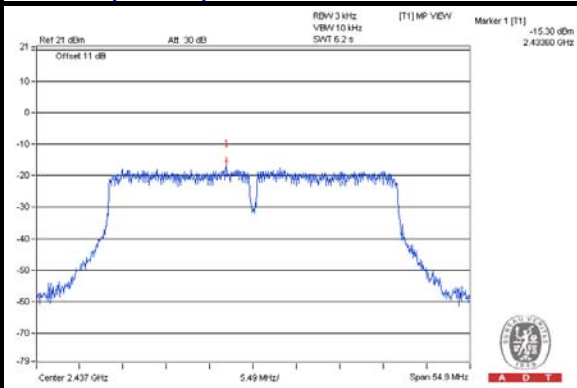

4.6 CONDUCTED OUT OF BAND EMISSION MEASUREMENT

4.6.1 LIMITS OF CONDUCTED OUT OF BAND EMISSION MEASUREMENT

Below -20dB of the highest emission level of operating band (in 100kHz Resolution Bandwidth).

4.6.2 TEST SETUP

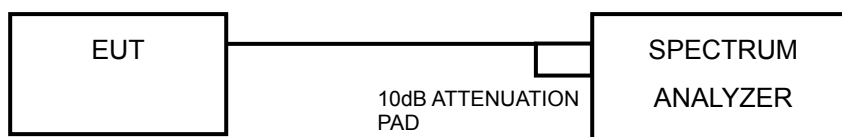

4.6.3 TEST INSTRUMENTS

Refer to section 4.1.2 to get information of above instrument.

4.6.4 TEST PROCEDURE

MEASUREMENT PROCEDURE REF

1. Set the RBW = 100 kHz.
2. Set the VBW \geq 300 kHz.
3. Detector = peak.
4. Sweep time = auto couple.
5. Trace mode = max hold.
6. Allow trace to fully stabilize.
7. Use the peak marker function to determine the maximum power level in any 100 kHz band segment within the fundamental EBW.



A D T

MEASUREMENT PROCEDURE OOB

1. Set RBW = 100 kHz.
2. Set VBW \geq 300 kHz.
3. Ensure that the number of measurement points \geq span/RBW
4. According to measurement points to set differ measurement span.
5. Detector = peak.
6. Trace Mode = max hold.
7. Sweep = auto couple.

4.6.5 DEVIATION FROM TEST STANDARD

No deviation.

4.6.6 EUT OPERATING CONDITION

Same as Item 4.3.6

4.6.7 TEST RESULTS

The conducted emission test is performed on each TX port of operating mode without summing or adding $10\log(N)$ since the limit is relative emission limit.

The spectrum plots are attached on the following pages. D1 line indicates the highest level, and D2 line indicates the 20dB offset below D1. It shows compliance with the requirement.



A D T

802.11b

CH 1

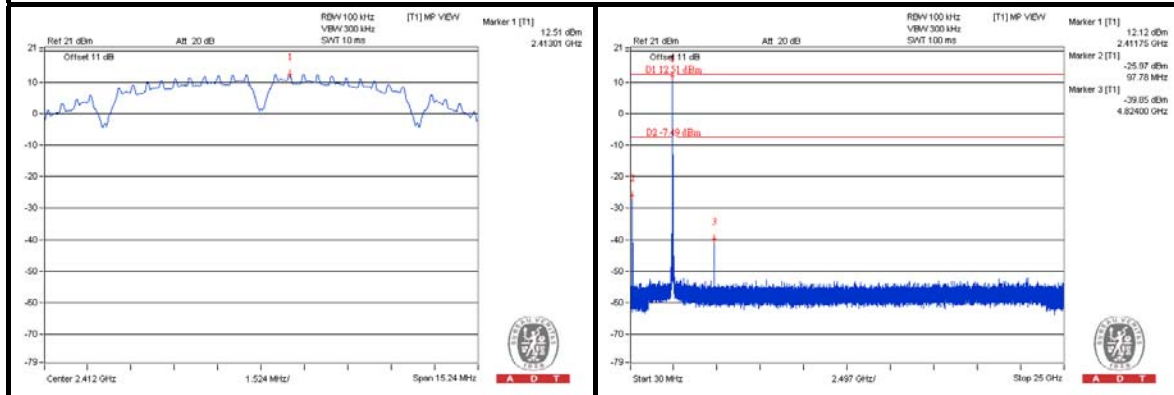

CH 6

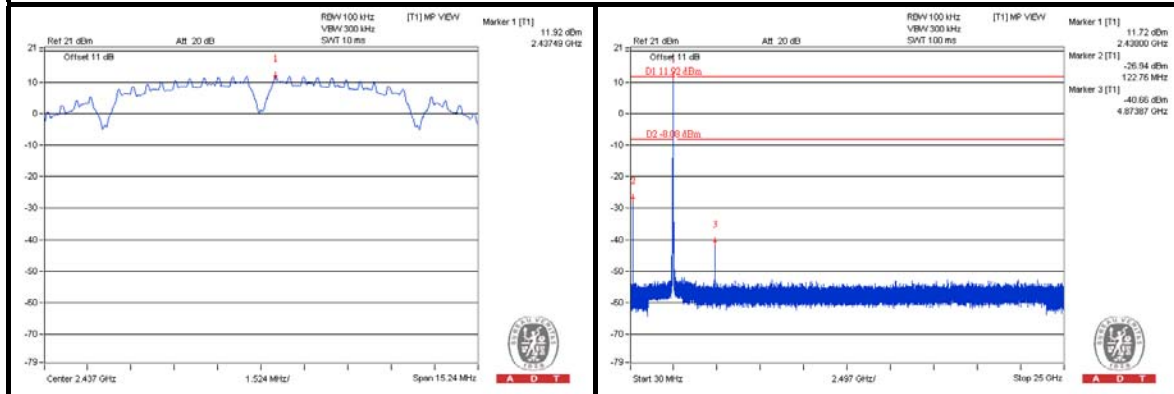

CH 11

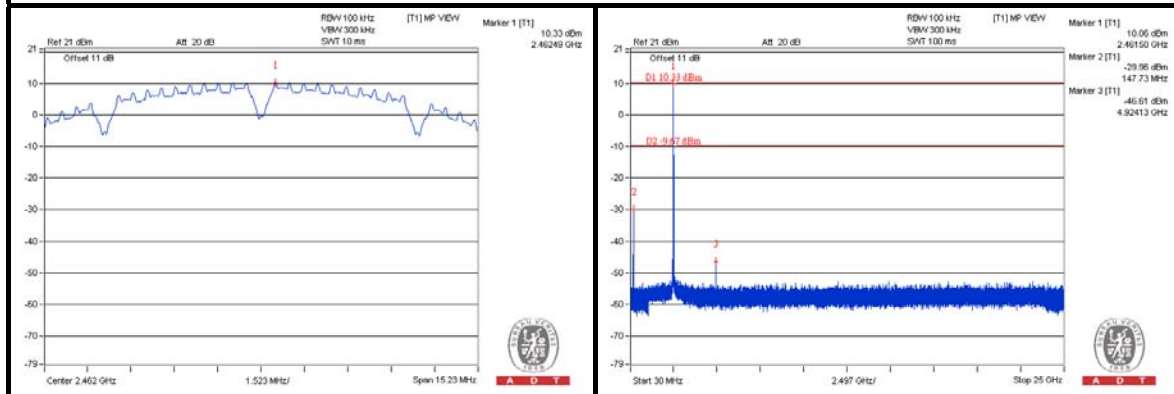

CH 1 Band edge

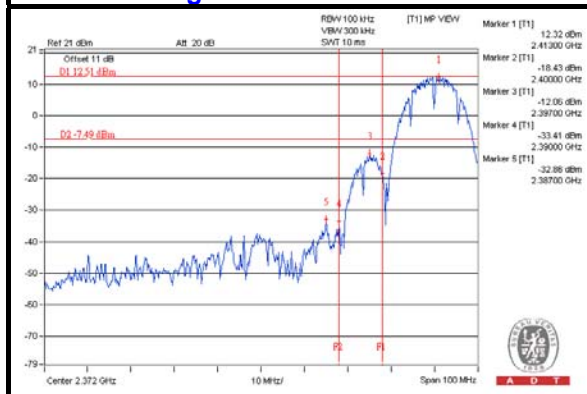

CH 11 Band edge

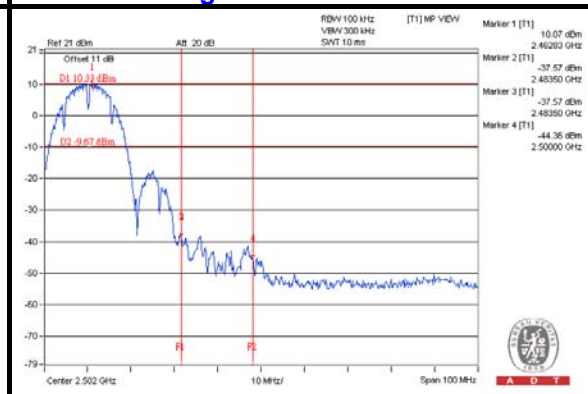



A D T

802.11g

CH 1

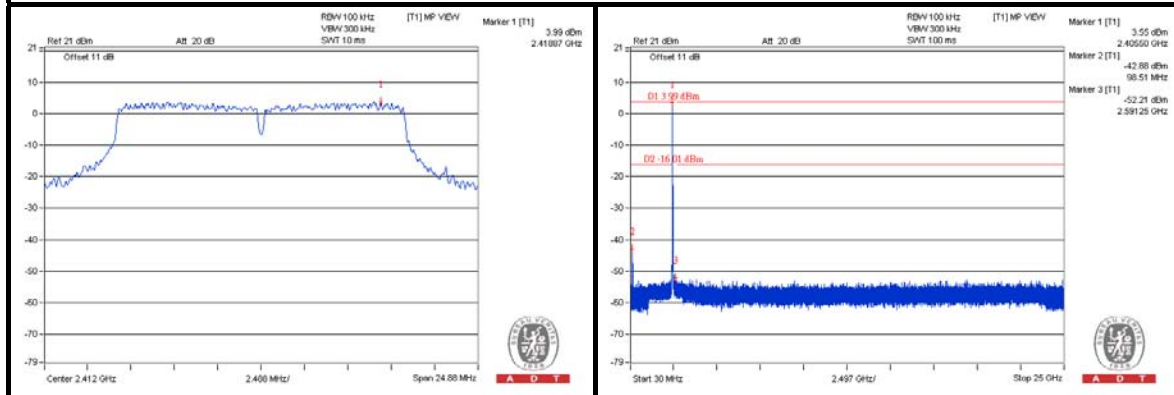

CH 6

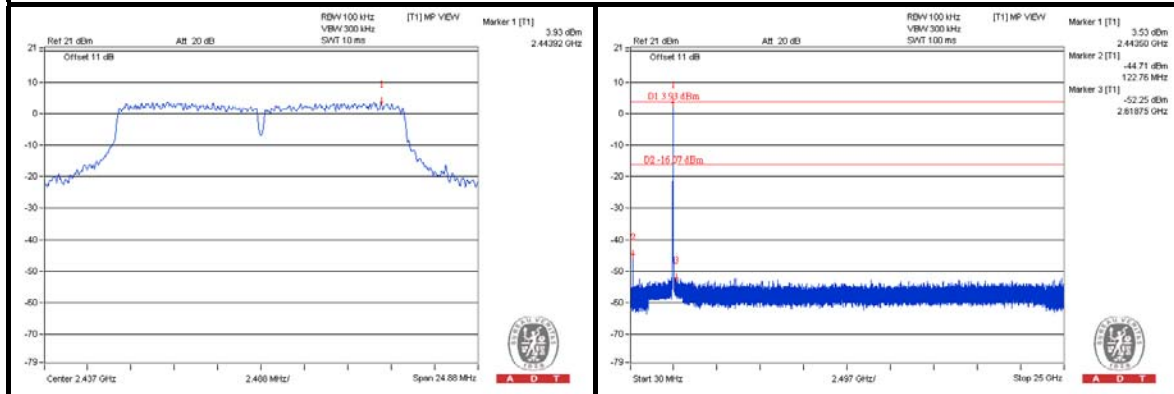

CH 11

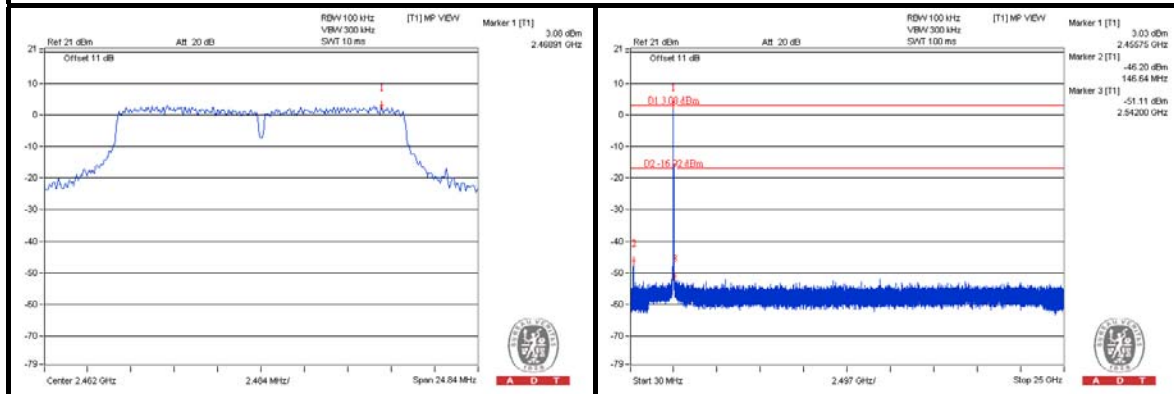

CH 1 Band edge

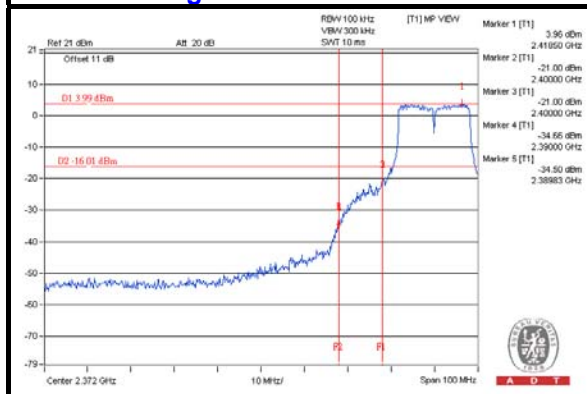

CH 11 Band edge

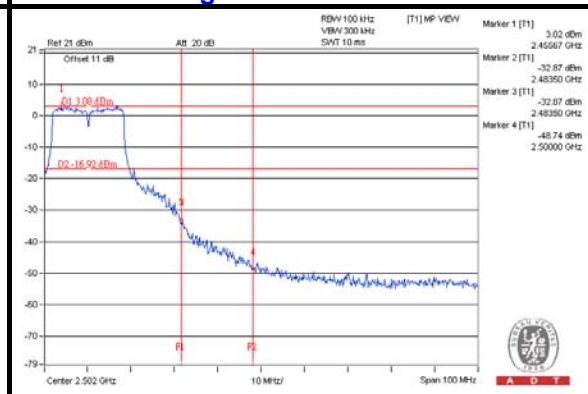

802.11n (20MHz)
CHAIN 0

CH 1

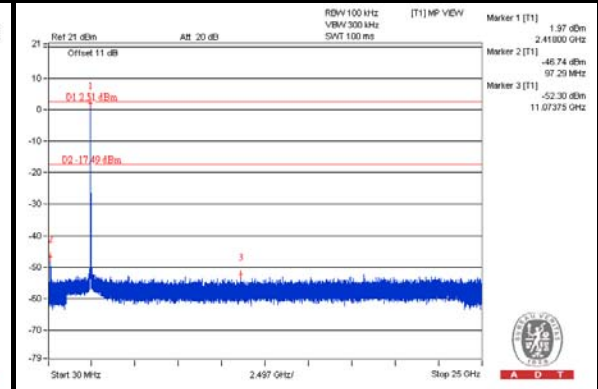
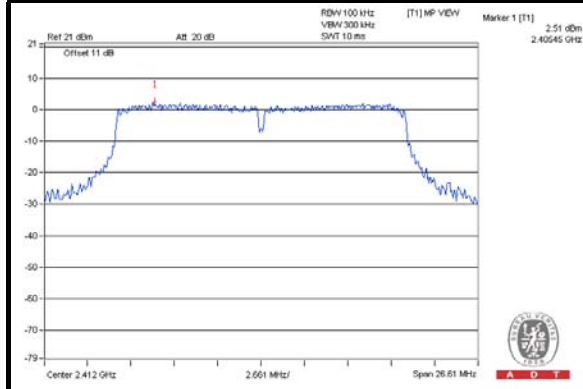

CH 6

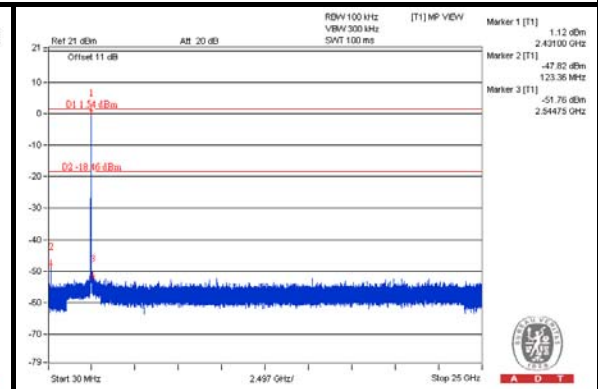
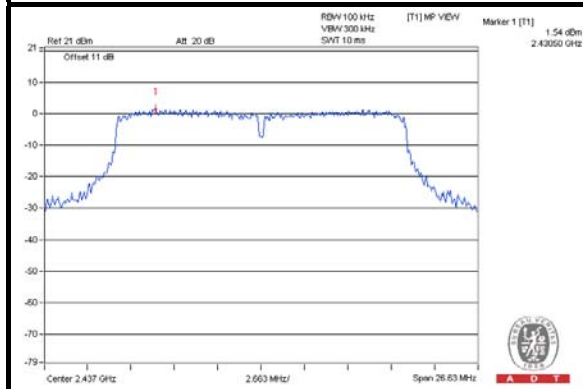

CH 11

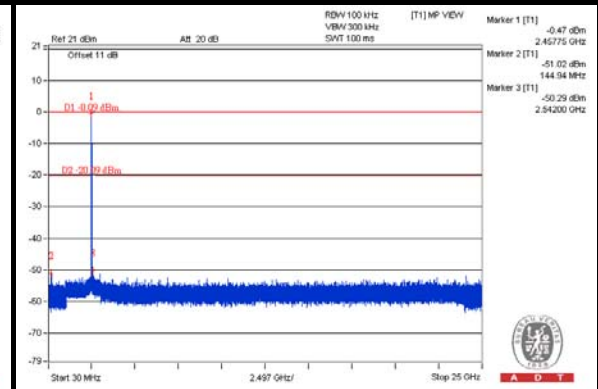
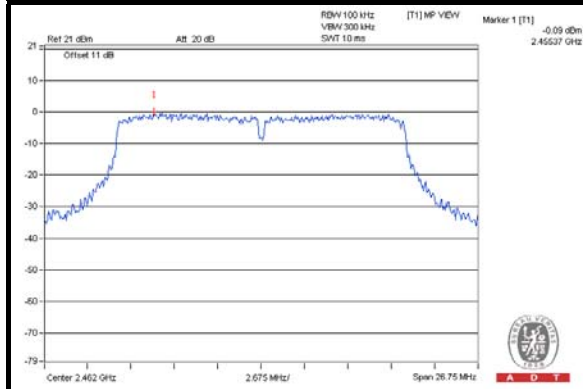

CH 1 Band edge

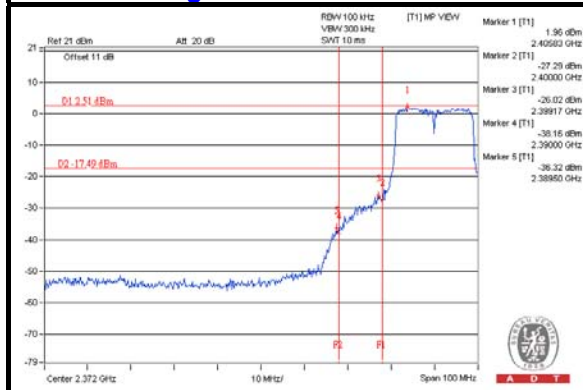

CH 11 Band edge

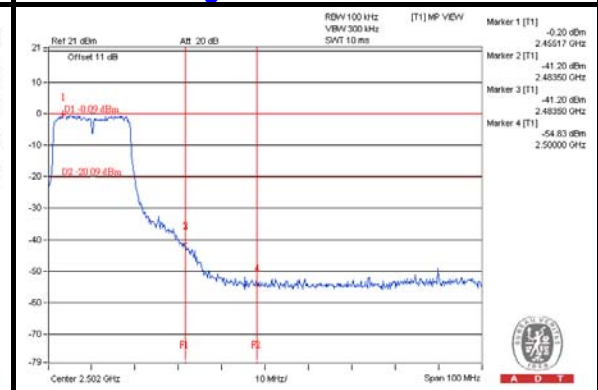



A D T

CHAIN 1

CH 1

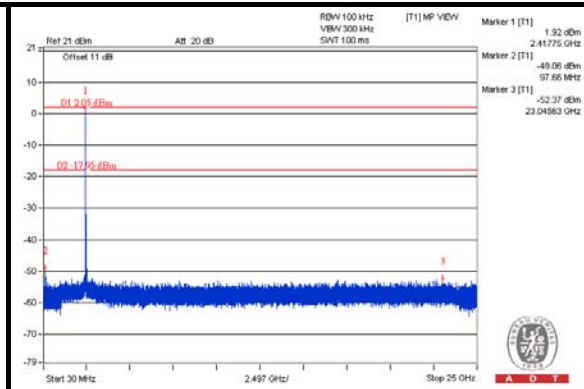
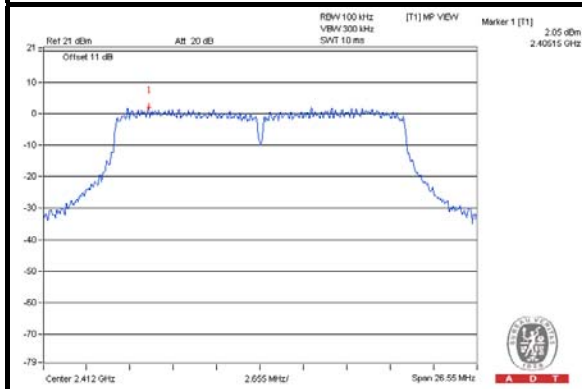

CH 6

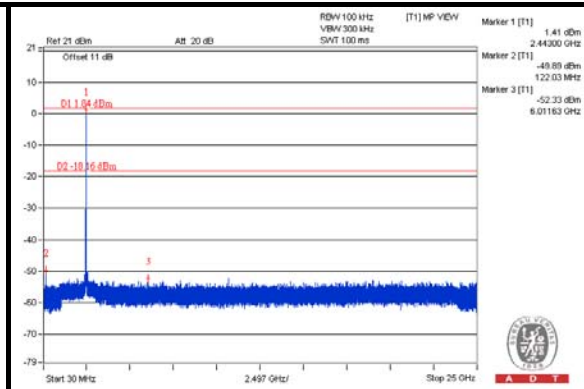
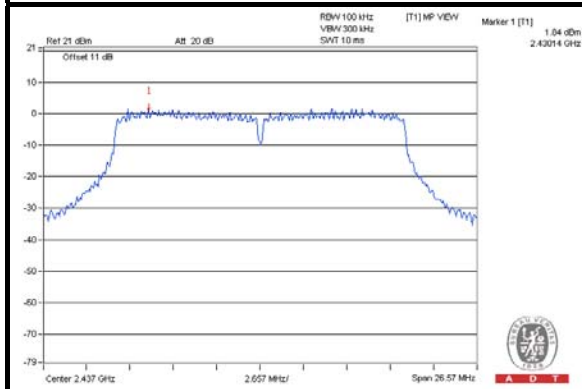

CH 11

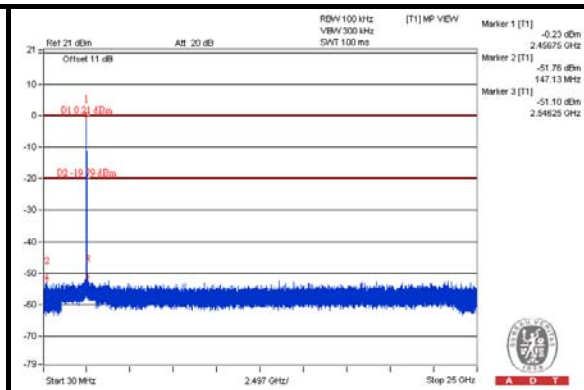
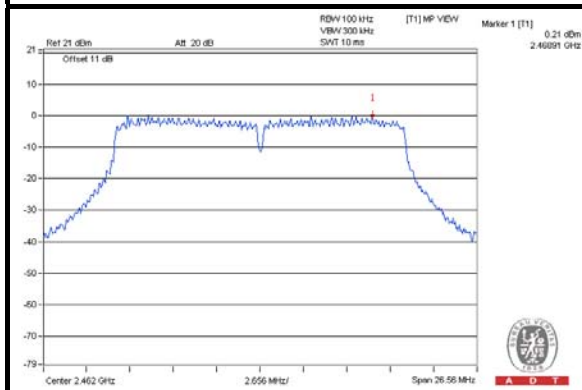

CH 1 Band edge

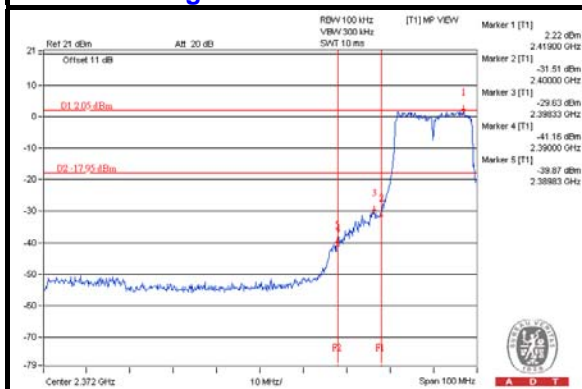

CH 11 Band edge

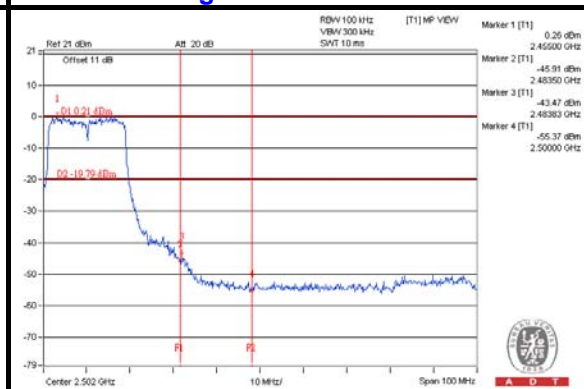



A D T

802.11n (40MHz) CHAIN 0

CH 3

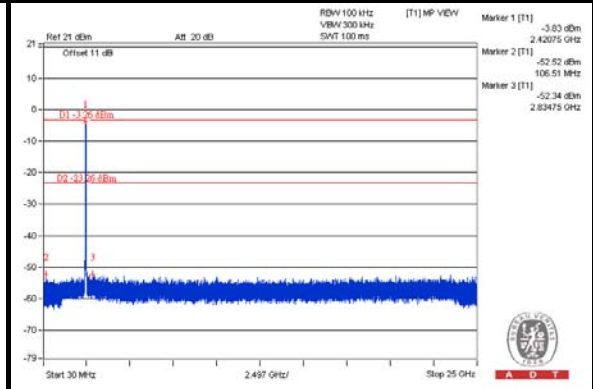
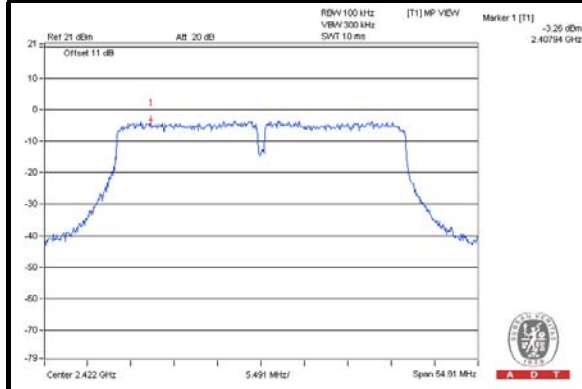

CH 6

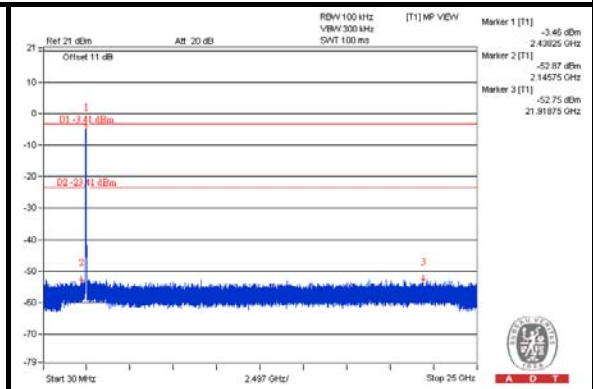
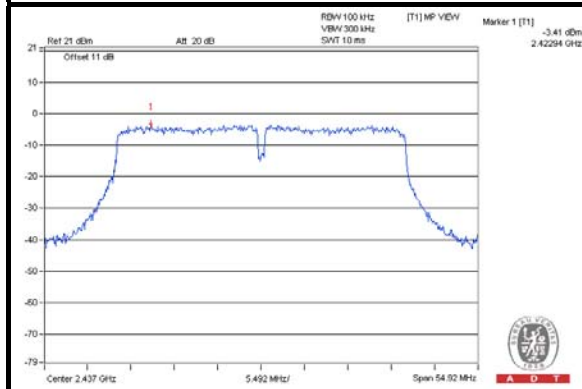

CH 9

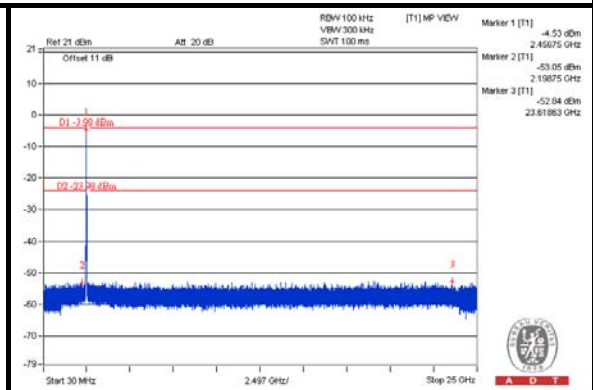
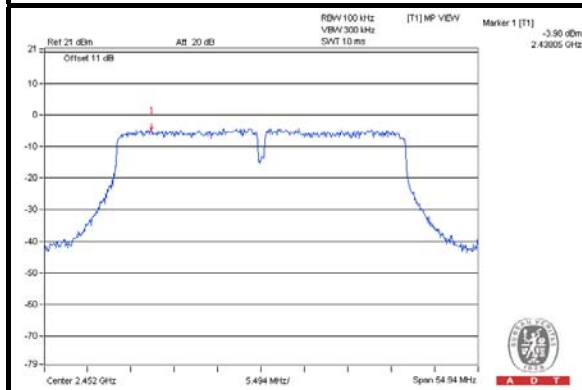

CH 1 Band edge

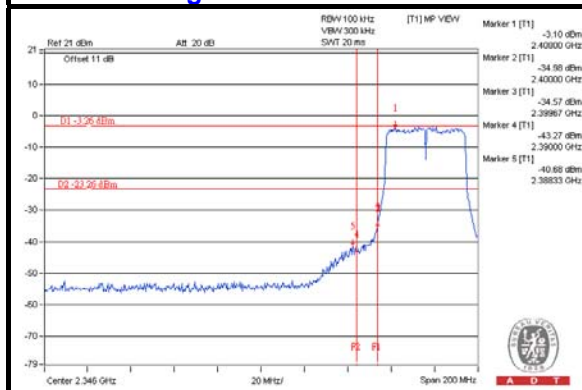

CH 11 Band edge

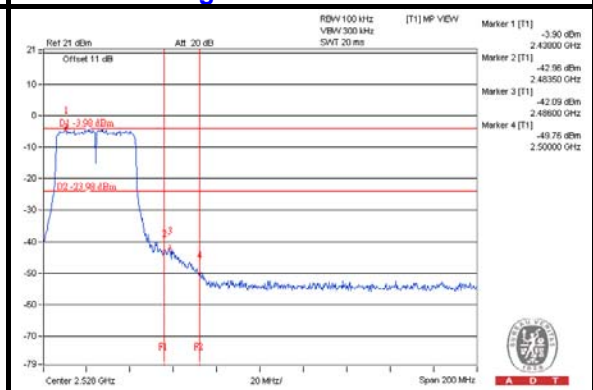



A D T

CHAIN 1

CH 3

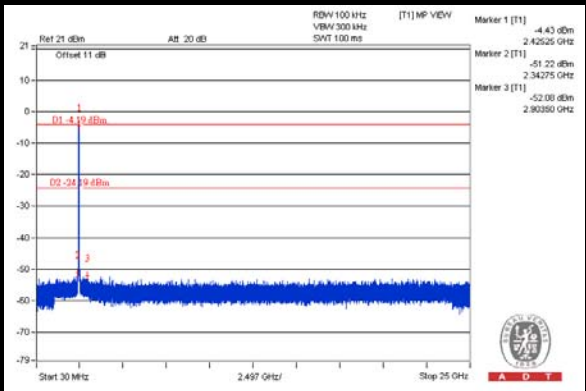
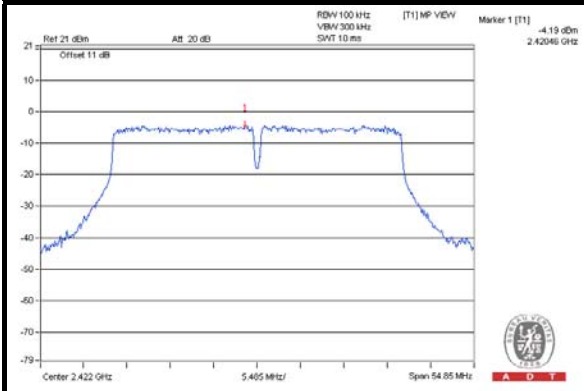

CH 6

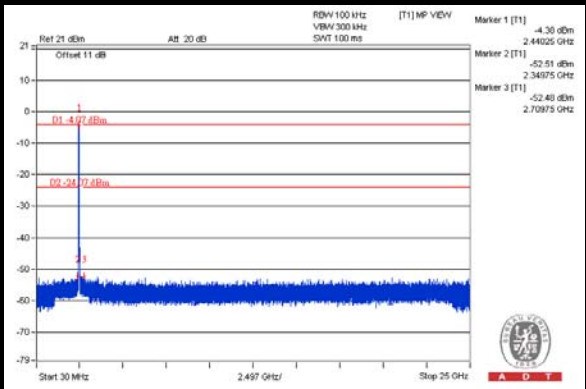
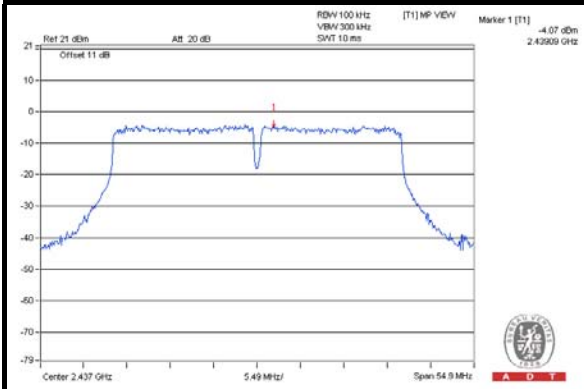

CH 9

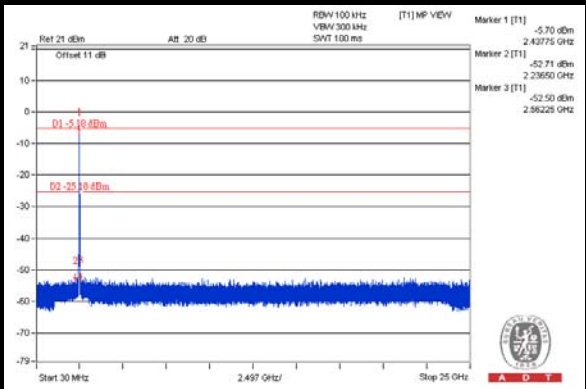
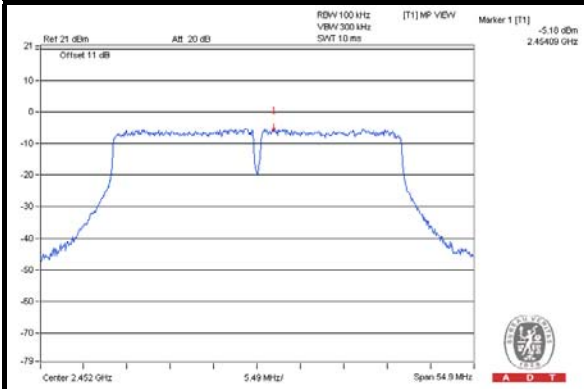

CH 1 Band edge

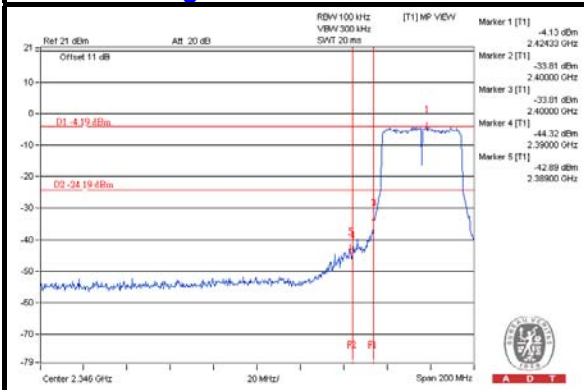

CH 11 Band edge

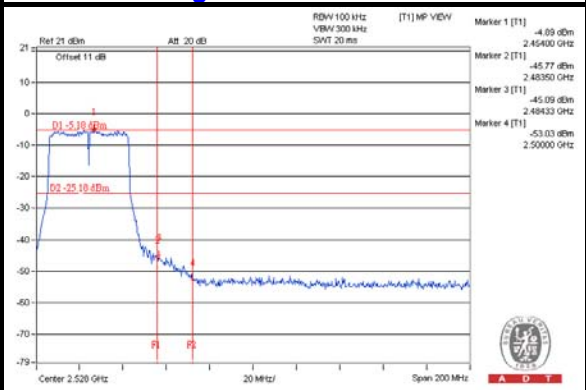



5. TEST TYPES AND RESULTS (FOR 5.0GHz BAND)

5.1 RADIATED EMISSION MEASUREMENT

5.1.1 LIMITS OF RADIATED EMISSION MEASUREMENT

Radiated emissions which fall in the restricted bands must comply with the radiated emission limits specified as below table. Other emissions shall be at least 20dB below the highest level of the desired power:

FREQUENCIES (MHz)	FIELD STRENGTH (microvolts/meter)	MEASUREMENT DISTANCE (meters)
0.009 ~ 0.490	2400/F(kHz)	300
0.490 ~ 1.705	24000/F(kHz)	30
1.705 ~ 30.0	30	30
30 ~ 88	100	3
88 ~ 216	150	3
216 ~ 960	200	3
Above 960	500	3

NOTE:

1. The lower limit shall apply at the transition frequencies.
2. Emission level (dBuV/m) = 20 log Emission level (uV/m).
3. For frequencies above 1000MHz, the field strength limits are based on average detector, however, the peak field strength of any emission shall not exceed the maximum permitted average limits, specified above by more than 20dB under any condition of modulation.



A D T

5.1.2 TEST INSTRUMENTS

Same as item 4.1.2.

5.1.3 TEST PROCEDURES

Same as item 4.1.3.

5.1.4 DEVIATION FROM TEST STANDARD

No deviation.

5.1.5 TEST SETUP

Same as item 4.1.5.

5.1.6 EUT OPERATING CONDITIONS

Same as item 4.1.6.



A D T

5.1.7 TEST RESULTS

ABOVE 1GHz DATA :

802.11a

EUT TEST CONDITION		MEASUREMENT DETAIL	
CHANNEL	Channel 149	FREQUENCY RANGE	1 ~ 40GHz
INPUT POWER (SYSTEM)	120Vac, 60Hz	DETECTOR FUNCTION	Peak (PK) Average (AV)
ENVIRONMENTAL CONDITIONS	24deg. C, 67%RH	TESTED BY	Alan Wu

ANTENNA POLARITY & TEST DISTANCE: HORIZONTAL AT 3 M								
NO.	FREQ. (MHz)	EMISSION LEVEL (dBuV/m)	LIMIT (dBuV/m)	MARGIN (dB)	ANTENNA HEIGHT (m)	TABLE ANGLE (Degree)	RAW VALUE (dBuV)	CORRECTION FACTOR (dB/m)
1	#5725.00	67.1 PK	84.6	-17.5	1.00 H	182	60.80	6.30
2	#5725.00	57.4 AV	74.9	-17.5	1.00 H	182	51.10	6.30
3	*5745.00	104.6 PK			1.00 H	184	64.40	40.20
4	*5745.00	94.9 AV			1.00 H	184	54.70	40.20
5	11490.00	56.8 PK	74.0	-17.2	1.00 H	172	38.70	18.10
6	11490.00	44.2 AV	54.0	-9.8	1.00 H	172	26.10	18.10

ANTENNA POLARITY & TEST DISTANCE: VERTICAL AT 3 M								
NO.	FREQ. (MHz)	EMISSION LEVEL (dBuV/m)	LIMIT (dBuV/m)	MARGIN (dB)	ANTENNA HEIGHT (m)	TABLE ANGLE (Degree)	RAW VALUE (dBuV)	CORRECTION FACTOR (dB/m)
1	#5725.00	69.2 PK	86.7	-17.5	1.00 V	188	62.90	6.30
2	#5725.00	59.7 AV	77.2	-17.5	1.00 V	188	53.40	6.30
3	*5745.00	106.7 PK			1.06 V	185	66.50	40.20
4	*5745.00	97.2 AV			1.06 V	185	57.00	40.20
5	11490.00	57.1 PK	74.0	-16.9	1.00 V	198	39.00	18.10
6	11490.00	44.8 AV	54.0	-9.2	1.00 V	198	26.70	18.10

REMARKS:

- Emission Level(dBuV/m) = Raw Value(dBuV) + Correction Factor(dB/m)
- Correction Factor(dB/m) = Antenna Factor(dB/m) + Cable Factor(dB) – Pre-Amplifier Factor(dB)
- The other emission levels were very low against the limit.
- Margin value = Emission Level – Limit value
- " * ": Fundamental frequency.
- The limit value is defined as per 15.247.
- "#":The radiated frequency is out the restricted band.



A D T

EUT TEST CONDITION		MEASUREMENT DETAIL	
CHANNEL	Channel 157	FREQUENCY RANGE	1 ~ 40GHz
INPUT POWER (SYSTEM)	120Vac, 60Hz	DETECTOR FUNCTION	Peak (PK) Average (AV)
ENVIRONMENTAL CONDITIONS	24deg. C, 67%RH	TESTED BY	Alan Wu

ANTENNA POLARITY & TEST DISTANCE: HORIZONTAL AT 3 M								
NO.	FREQ. (MHz)	EMISSION LEVEL (dBuV/m)	LIMIT (dBuV/m)	MARGIN (dB)	ANTENNA HEIGHT (m)	TABLE ANGLE (Degree)	RAW VALUE (dBuV)	CORRECTION FACTOR (dB/m)
1	*5785.00	104.4 PK			1.00 H	192	64.10	40.30
2	*5785.00	94.6 AV			1.00 H	192	54.30	40.30
3	11570.00	56.7 PK	74.0	-17.3	1.00 H	170	38.50	18.20
4	11570.00	44.9 AV	54.0	-9.1	1.00 H	170	26.70	18.20
ANTENNA POLARITY & TEST DISTANCE: VERTICAL AT 3 M								
NO.	FREQ. (MHz)	EMISSION LEVEL (dBuV/m)	LIMIT (dBuV/m)	MARGIN (dB)	ANTENNA HEIGHT (m)	TABLE ANGLE (Degree)	RAW VALUE (dBuV)	CORRECTION FACTOR (dB/m)
1	*5785.00	106.4 PK			1.00 V	175	66.10	40.30
2	*5785.00	96.9 AV			1.00 V	175	56.60	40.30
3	11570.00	56.9 PK	74.0	-17.1	1.00 V	193	38.70	18.20
4	11570.00	45.1 AV	54.0	-8.9	1.00 V	193	26.90	18.20

REMARKS:

1. Emission Level(dBuV/m) = Raw Value(dBuV) + Correction Factor(dB/m)
2. Correction Factor(dB/m) = Antenna Factor(dB/m) + Cable Factor(dB) – Pre-Amplifier Factor(dB)
3. The other emission levels were very low against the limit.
4. Margin value = Emission Level – Limit value
5. “ * “: Fundamental frequency.
6. The limit value is defined as per 15.247.



A D T

EUT TEST CONDITION		MEASUREMENT DETAIL	
CHANNEL	Channel 165	FREQUENCY RANGE	1 ~ 40GHz
INPUT POWER (SYSTEM)	120Vac, 60Hz	DETECTOR FUNCTION	Peak (PK) Average (AV)
ENVIRONMENTAL CONDITIONS	24deg. C, 67%RH	TESTED BY	Alan Wu

ANTENNA POLARITY & TEST DISTANCE: HORIZONTAL AT 3 M								
NO.	FREQ. (MHz)	EMISSION LEVEL (dBuV/m)	LIMIT (dBuV/m)	MARGIN (dB)	ANTENNA HEIGHT (m)	TABLE ANGLE (Degree)	RAW VALUE (dBuV)	CORRECTION FACTOR (dB/m)
1	*5825.00	104.4 PK			1.00 H	175	64.10	40.30
2	*5825.00	94.8 AV			1.00 H	175	54.50	40.30
3	#5850.00	62.4 PK	84.4	-22.0	1.00 H	175	55.80	6.60
4	#5850.00	52.8 AV	74.8	-22.0	1.00 H	175	46.20	6.60
5	11650.00	57.3 PK	74.0	-16.7	1.00 H	203	39.20	18.10
6	11650.00	45.2 AV	54.0	-8.8	1.00 H	203	27.10	18.10
ANTENNA POLARITY & TEST DISTANCE: VERTICAL AT 3 M								
NO.	FREQ. (MHz)	EMISSION LEVEL (dBuV/m)	LIMIT (dBuV/m)	MARGIN (dB)	ANTENNA HEIGHT (m)	TABLE ANGLE (Degree)	RAW VALUE (dBuV)	CORRECTION FACTOR (dB/m)
1	*5825.00	106.4 PK			1.00 V	195	66.10	40.30
2	*5825.00	96.8 AV			1.00 V	195	56.50	40.30
3	#5850.00	64.4 PK	86.4	-22.0	1.00 V	195	57.80	6.60
4	#5850.00	54.8 AV	76.8	-22.0	1.00 V	195	48.20	6.60
5	11650.00	57.0 PK	74.0	-17.0	1.09 V	242	38.90	18.10
6	11650.00	45.0 AV	54.0	-9.0	1.09 V	242	26.90	18.10

REMARKS:

1. Emission Level(dBuV/m) = Raw Value(dBuV) + Correction Factor(dB/m)
2. Correction Factor(dB/m) = Antenna Factor(dB/m) + Cable Factor(dB)
– Pre-Amplifier Factor(dB)
3. The other emission levels were very low against the limit.
4. Margin value = Emission Level – Limit value
5. “ * “: Fundamental frequency.
6. The limit value is defined as per 15.247.
7. “#”:The radiated frequency is out the restricted band.



A D T

802.11n (20MHz)

EUT TEST CONDITION		MEASUREMENT DETAIL	
CHANNEL	Channel 149	FREQUENCY RANGE	1 ~ 40GHz
INPUT POWER (SYSTEM)	120Vac, 60Hz	DETECTOR FUNCTION	Peak (PK) Average (AV)
ENVIRONMENTAL CONDITIONS	24deg. C, 67%RH	TESTED BY	Alan Wu

ANTENNA POLARITY & TEST DISTANCE: HORIZONTAL AT 3 M								
NO.	FREQ. (MHz)	EMISSION LEVEL (dBuV/m)	LIMIT (dBuV/m)	MARGIN (dB)	ANTENNA HEIGHT (m)	TABLE ANGLE (Degree)	RAW VALUE (dBuV)	CORRECTION FACTOR (dB/m)
1	#5725.00	67.0 PK	85.8	-18.8	1.09 H	197	60.70	6.30
2	#5725.00	56.5 AV	75.3	-18.8	1.09 H	197	50.20	6.30
3	*5745.00	105.8 PK			1.04 H	193	65.60	40.20
4	*5745.00	95.3 AV			1.04 H	193	55.10	40.20
5	11490.00	56.9 PK	74.0	-17.1	1.00 H	179	38.80	18.10
6	11490.00	44.5 AV	54.0	-9.5	1.00 H	179	26.40	18.10
ANTENNA POLARITY & TEST DISTANCE: VERTICAL AT 3 M								
NO.	FREQ. (MHz)	EMISSION LEVEL (dBuV/m)	LIMIT (dBuV/m)	MARGIN (dB)	ANTENNA HEIGHT (m)	TABLE ANGLE (Degree)	RAW VALUE (dBuV)	CORRECTION FACTOR (dB/m)
1	#5725.00	62.1 PK	80.9	-18.8	1.00 V	190	55.80	6.30
2	#5725.00	51.5 AV	70.3	-18.8	1.00 V	190	45.20	6.30
3	*5745.00	100.9 PK			1.00 V	192	60.70	40.20
4	*5745.00	90.3 AV			1.00 V	192	50.10	40.20
5	11490.00	56.5 PK	74.0	-17.5	1.00 V	190	38.40	18.10
6	11490.00	43.9 AV	54.0	-10.1	1.00 V	190	25.80	18.10

REMARKS:

1. Emission Level(dBuV/m) = Raw Value(dBuV) + Correction Factor(dB/m)
2. Correction Factor(dB/m) = Antenna Factor(dB/m) + Cable Factor(dB) – Pre-Amplifier Factor(dB)
3. The other emission levels were very low against the limit.
4. Margin value = Emission Level – Limit value
5. “ * “: Fundamental frequency.
6. The limit value is defined as per 15.247.
7. "#":The radiated frequency is out the restricted band.



A D T

EUT TEST CONDITION		MEASUREMENT DETAIL	
CHANNEL	Channel 157	FREQUENCY RANGE	1 ~ 40GHz
INPUT POWER (SYSTEM)	120Vac, 60Hz	DETECTOR FUNCTION	Peak (PK) Average (AV)
ENVIRONMENTAL CONDITIONS	24deg. C, 67%RH	TESTED BY	Alan Wu

ANTENNA POLARITY & TEST DISTANCE: HORIZONTAL AT 3 M								
NO.	FREQ. (MHz)	EMISSION LEVEL (dBuV/m)	LIMIT (dBuV/m)	MARGIN (dB)	ANTENNA HEIGHT (m)	TABLE ANGLE (Degree)	RAW VALUE (dBuV)	CORRECTION FACTOR (dB/m)
1	*5785.00	106.0 PK			1.05 H	180	65.70	40.30
2	*5785.00	95.6 AV			1.05 H	180	55.30	40.30
3	11570.00	57.0 PK	74.0	-17.0	1.00 H	185	38.80	18.20
4	11570.00	44.6 AV	54.0	-9.4	1.00 H	185	26.40	18.20
ANTENNA POLARITY & TEST DISTANCE: VERTICAL AT 3 M								
NO.	FREQ. (MHz)	EMISSION LEVEL (dBuV/m)	LIMIT (dBuV/m)	MARGIN (dB)	ANTENNA HEIGHT (m)	TABLE ANGLE (Degree)	RAW VALUE (dBuV)	CORRECTION FACTOR (dB/m)
1	*5785.00	101.2 PK			1.00 V	196	60.90	40.30
2	*5785.00	90.5 AV			1.00 V	196	50.20	40.30
3	11570.00	56.9 PK	74.0	-17.1	1.00 V	213	38.70	18.20
4	11570.00	44.0 AV	54.0	-10.0	1.00 V	213	25.80	18.20

REMARKS:

1. Emission Level(dBuV/m) = Raw Value(dBuV) + Correction Factor(dB/m)
2. Correction Factor(dB/m) = Antenna Factor(dB/m) + Cable Factor(dB) – Pre-Amplifier Factor(dB)
3. The other emission levels were very low against the limit.
4. Margin value = Emission Level – Limit value
5. “ * “: Fundamental frequency.
6. The limit value is defined as per 15.247.



A D T

EUT TEST CONDITION		MEASUREMENT DETAIL	
CHANNEL	Channel 165	FREQUENCY RANGE	1 ~ 40GHz
INPUT POWER (SYSTEM)	120Vac, 60Hz	DETECTOR FUNCTION	Peak (PK) Average (AV)
ENVIRONMENTAL CONDITIONS	24deg. C, 67%RH	TESTED BY	Alan Wu

ANTENNA POLARITY & TEST DISTANCE: HORIZONTAL AT 3 M								
NO.	FREQ. (MHz)	EMISSION LEVEL (dBuV/m)	LIMIT (dBuV/m)	MARGIN (dB)	ANTENNA HEIGHT (m)	TABLE ANGLE (Degree)	RAW VALUE (dBuV)	CORRECTION FACTOR (dB/m)
1	*5825.00	106.0 PK			1.05 H	199	65.70	40.30
2	*5825.00	95.5 AV			1.05 H	199	55.20	40.30
3	#5850.00	64.0 PK	86.0	-22.0	1.05 H	199	57.40	6.60
4	#5850.00	53.5 AV	75.5	-22.0	1.05 H	199	46.90	6.60
5	11650.00	57.0 PK	74.0	-17.0	1.00 H	170	38.90	18.10
6	11650.00	44.7 AV	54.0	-9.3	1.00 H	170	26.60	18.10
ANTENNA POLARITY & TEST DISTANCE: VERTICAL AT 3 M								
NO.	FREQ. (MHz)	EMISSION LEVEL (dBuV/m)	LIMIT (dBuV/m)	MARGIN (dB)	ANTENNA HEIGHT (m)	TABLE ANGLE (Degree)	RAW VALUE (dBuV)	CORRECTION FACTOR (dB/m)
1	*5825.00	101.0 PK			1.02 V	205	60.70	40.30
2	*5825.00	90.5 AV			1.02 V	205	50.20	40.30
3	#5850.00	59.0 PK	81.0	-22.0	1.02 V	205	52.40	6.60
4	#5850.00	48.5 AV	70.5	-22.0	1.02 V	205	41.90	6.60
5	11650.00	56.8 PK	74.0	-17.2	1.00 V	182	38.70	18.10
6	11650.00	44.4 AV	54.0	-9.6	1.00 V	182	26.30	18.10

REMARKS:

1. Emission Level(dBuV/m) = Raw Value(dBuV) + Correction Factor(dB/m)
2. Correction Factor(dB/m) = Antenna Factor(dB/m) + Cable Factor(dB)
– Pre-Amplifier Factor(dB)
3. The other emission levels were very low against the limit.
4. Margin value = Emission Level – Limit value
5. “ * “: Fundamental frequency.
6. The limit value is defined as per 15.247.
7. “#”:The radiated frequency is out the restricted band.



A D T

802.11n (40MHz)

EUT TEST CONDITION		MEASUREMENT DETAIL	
CHANNEL	Channel 151	FREQUENCY RANGE	1 ~ 40GHz
INPUT POWER (SYSTEM)	120Vac, 60Hz	DETECTOR FUNCTION	Peak (PK) Average (AV)
ENVIRONMENTAL CONDITIONS	24deg. C, 67%RH	TESTED BY	Alan Wu

ANTENNA POLARITY & TEST DISTANCE: HORIZONTAL AT 3 M								
NO.	FREQ. (MHz)	EMISSION LEVEL (dBuV/m)	LIMIT (dBuV/m)	MARGIN (dB)	ANTENNA HEIGHT (m)	TABLE ANGLE (Degree)	RAW VALUE (dBuV)	CORRECTION FACTOR (dB/m)
1	#5725.00	68.3 PK	84.0	-15.7	1.00 H	197	62.00	6.30
2	#5725.00	57.5 AV	73.2	-15.7	1.00 H	197	51.20	6.30
3	*5755.00	104.0 PK			1.00 H	198	63.80	40.20
4	*5755.00	93.2 AV			1.00 H	198	53.00	40.20
5	11510.00	56.1 PK	74.0	-17.9	1.00 H	176	38.00	18.10
6	11510.00	44.4 AV	54.0	-9.6	1.00 H	176	26.30	18.10
ANTENNA POLARITY & TEST DISTANCE: VERTICAL AT 3 M								
NO.	FREQ. (MHz)	EMISSION LEVEL (dBuV/m)	LIMIT (dBuV/m)	MARGIN (dB)	ANTENNA HEIGHT (m)	TABLE ANGLE (Degree)	RAW VALUE (dBuV)	CORRECTION FACTOR (dB/m)
1	#5725.00	63.1 PK	78.8	-15.7	1.35 V	195	56.80	6.30
2	#5725.00	52.6 AV	68.3	-15.7	1.35 V	195	46.30	6.30
3	*5755.00	98.8 PK			1.35 V	192	58.60	40.20
4	*5755.00	88.3 AV			1.35 V	192	48.10	40.20
5	11510.00	55.7 PK	74.0	-18.3	1.00 V	190	37.60	18.10
6	11510.00	43.7 AV	54.0	-10.3	1.00 V	190	25.60	18.10

REMARKS:

1. Emission Level(dBuV/m) = Raw Value(dBuV) + Correction Factor(dB/m)
2. Correction Factor(dB/m) = Antenna Factor(dB/m) + Cable Factor(dB)
– Pre-Amplifier Factor(dB)
3. The other emission levels were very low against the limit.
4. Margin value = Emission Level – Limit value
5. “ * “: Fundamental frequency.
6. The limit value is defined as per 15.247.
7. “#”:The radiated frequency is out the restricted band.



A D T

EUT TEST CONDITION		MEASUREMENT DETAIL	
CHANNEL	Channel 159	FREQUENCY RANGE	1 ~ 40GHz
INPUT POWER (SYSTEM)	120Vac, 60Hz	DETECTOR FUNCTION	Peak (PK) Average (AV)
ENVIRONMENTAL CONDITIONS	24deg. C, 67%RH	TESTED BY	Alan Wu

ANTENNA POLARITY & TEST DISTANCE: HORIZONTAL AT 3 M								
NO.	FREQ. (MHz)	EMISSION LEVEL (dBuV/m)	LIMIT (dBuV/m)	MARGIN (dB)	ANTENNA HEIGHT (m)	TABLE ANGLE (Degree)	RAW VALUE (dBuV)	CORRECTION FACTOR (dB/m)
1	*5795.00	103.8 PK			1.05 H	194	63.50	40.30
2	*5795.00	93.3 AV			1.05 H	194	53.00	40.30
3	#5850.00	68.8 PK	83.8	-15.0	1.05 H	194	62.20	6.60
4	#5850.00	58.3 AV	73.3	-15.0	1.05 H	194	51.70	6.60
5	11590.00	56.3 PK	74.0	-17.7	1.00 H	167	38.20	18.10
6	11590.00	44.8 AV	54.0	-9.2	1.00 H	167	26.70	18.10
ANTENNA POLARITY & TEST DISTANCE: VERTICAL AT 3 M								
NO.	FREQ. (MHz)	EMISSION LEVEL (dBuV/m)	LIMIT (dBuV/m)	MARGIN (dB)	ANTENNA HEIGHT (m)	TABLE ANGLE (Degree)	RAW VALUE (dBuV)	CORRECTION FACTOR (dB/m)
1	*5795.00	98.8 PK			1.30 V	196	58.50	40.30
2	*5795.00	88.3 AV			1.30 V	196	48.00	40.30
3	#5850.00	63.8 PK	78.8	-15.0	1.30 V	196	57.20	6.60
4	#5850.00	53.3 AV	68.3	-15.0	1.30 V	196	46.70	6.60
5	11590.00	56.1 PK	74.0	-17.9	1.00 V	126	38.00	18.10
6	11590.00	44.6 AV	54.0	-9.4	1.00 V	126	26.50	18.10

REMARKS:

1. Emission Level(dBuV/m) = Raw Value(dBuV) + Correction Factor(dB/m)
2. Correction Factor(dB/m) = Antenna Factor(dB/m) + Cable Factor(dB)
– Pre-Amplifier Factor(dB)
3. The other emission levels were very low against the limit.
4. Margin value = Emission Level – Limit value
5. “ * “: Fundamental frequency.
6. The limit value is defined as per 15.247.
7. “#”:The radiated frequency is out the restricted band.



A D T

802.11ac (80MHz)

EUT TEST CONDITION		MEASUREMENT DETAIL	
CHANNEL	Channel 155	FREQUENCY RANGE	1 ~ 40GHz
INPUT POWER (SYSTEM)	120Vac, 60Hz	DETECTOR FUNCTION	Peak (PK) Average (AV)
ENVIRONMENTAL CONDITIONS	24deg. C, 67%RH	TESTED BY	Alan Wu

ANTENNA POLARITY & TEST DISTANCE: HORIZONTAL AT 3 M								
NO.	FREQ. (MHz)	EMISSION LEVEL (dBuV/m)	LIMIT (dBuV/m)	MARGIN (dB)	ANTENNA HEIGHT (m)	TABLE ANGLE (Degree)	RAW VALUE (dBuV)	CORRECTION FACTOR (dB/m)
1	#5725.00	69.1 PK	80.3	-11.2	1.03 H	193	62.80	6.30
2	#5725.00	59.9 AV	71.1	-11.2	1.03 H	193	53.60	6.30
3	*5775.00	100.3 PK			1.02 H	196	60.10	40.20
4	*5775.00	91.1 AV			1.02 H	196	50.90	40.20
5	11550.00	55.7 PK	74.0	-18.3	1.00 H	170	37.60	18.10
6	11550.00	44.0 AV	54.0	-10.0	1.00 H	170	25.90	18.10

ANTENNA POLARITY & TEST DISTANCE: VERTICAL AT 3 M								
NO.	FREQ. (MHz)	EMISSION LEVEL (dBuV/m)	LIMIT (dBuV/m)	MARGIN (dB)	ANTENNA HEIGHT (m)	TABLE ANGLE (Degree)	RAW VALUE (dBuV)	CORRECTION FACTOR (dB/m)
1	#5725.00	62.9 PK	74.1	-11.2	1.00 V	180	56.60	6.30
2	#5725.00	52.4 AV	64.5	-12.1	1.00 V	180	46.10	6.30
3	*5775.00	94.1 PK			1.00 V	186	53.90	40.20
4	*5775.00	84.5 AV			1.00 V	186	44.30	40.20
5	11550.00	55.2 PK	74.0	-18.8	1.00 V	198	37.10	18.10
6	11550.00	43.5 AV	54.0	-10.5	1.00 V	198	25.40	18.10

REMARKS:

1. Emission Level(dBuV/m) = Raw Value(dBuV) + Correction Factor(dB/m)
2. Correction Factor(dB/m) = Antenna Factor(dB/m) + Cable Factor(dB)
– Pre-Amplifier Factor (dB)
3. The other emission levels were very low against the limit.
7. "#":The radiated frequency is out the restricted band.
4. Margin value = Emission Level – Limit value



A D T

BELOW 1GHz WORST-CASE DATA : 802.11n (20MHz)

EUT TEST CONDITION		MEASUREMENT DETAIL	
CHANNEL	Channel 157	FREQUENCY RANGE	Below 1000MHz
INPUT POWER (SYSTEM)	120Vac, 60Hz	DETECTOR FUNCTION	Quasi-Peak
ENVIRONMENTAL CONDITIONS	25deg. C, 68%RH	TESTED BY	Brad Tung

ANTENNA POLARITY & TEST DISTANCE: HORIZONTAL AT 3 M								
NO.	FREQ. (MHz)	EMISSION LEVEL (dBuV/m)	LIMIT (dBuV/m)	MARGIN (dB)	ANTENNA HEIGHT (m)	TABLE ANGLE (Degree)	RAW VALUE (dBuV)	CORRECTION FACTOR (dB/m)
1	190.95	37.5 QP	43.5	-6.0	1.50 H	273	54.00	-16.50
2	239.46	38.5 QP	46.0	-7.5	1.00 H	85	53.40	-14.90
3	330.66	32.1 QP	46.0	-13.9	1.50 H	130	43.90	-11.80
4	357.83	31.8 QP	46.0	-14.2	1.25 H	232	43.40	-11.60
5	480.07	39.2 QP	46.0	-6.8	1.25 H	257	48.60	-9.40
6	961.29	42.5 QP	54.0	-11.5	1.50 H	179	43.00	-0.50

ANTENNA POLARITY & TEST DISTANCE: VERTICAL AT 3 M								
NO.	FREQ. (MHz)	EMISSION LEVEL (dBuV/m)	LIMIT (dBuV/m)	MARGIN (dB)	ANTENNA HEIGHT (m)	TABLE ANGLE (Degree)	RAW VALUE (dBuV)	CORRECTION FACTOR (dB/m)
1	31.84	34.3 QP	40.0	-5.7	1.25 V	1	50.50	-16.20
2	66.77	31.8 QP	40.0	-8.2	1.00 V	7	47.80	-16.00
3	142.44	32.9 QP	43.5	-10.6	1.50 V	249	47.10	-14.20
4	239.46	38.5 QP	46.0	-7.5	1.00 V	298	53.40	-14.90
5	480.07	40.3 QP	46.0	-5.7	1.25 V	185	49.70	-9.40
6	960.00	36.9 QP	46.0	-9.1	2.00 V	165	37.50	-0.60

REMARKS:

1. Emission Level(dBuV/m) = Raw Value(dBuV) + Correction Factor(dB/m)
2. Correction Factor(dB/m) = Antenna Factor(dB/m) + Cable Factor(dB) – Pre-Amplifier Factor (dB)
3. The other emission levels were very low against the limit.
4. Margin value = Emission Level – Limit value



A D T

5.2 CONDUCTED EMISSION MEASUREMENT

5.2.1 LIMITS OF CONDUCTED EMISSION MEASUREMENT

FREQUENCY OF EMISSION (MHz)	CONDUCTED LIMIT (dB μ V)	
	Quasi-peak	Average
0.15 ~ 0.5	66 to 56	56 to 46
0.5 ~ 5	56	46
5 ~ 30	60	50

- NOTE:**
1. The lower limit shall apply at the transition frequencies.
 2. The limit decreases in line with the logarithm of the frequency in the range of 0.15 to 0.50MHz.
 3. All emanations from a class A/B digital device or system, including any network of conductors and apparatus connected thereto, shall not exceed the level of field strengths specified above.

5.2.2 TEST INSTRUMENTS

Same as item 4.2.2.

5.2.3 TEST PROCEDURES

Same as item 4.2.3.

5.2.4 DEVIATION FROM TEST STANDARD

No deviation.

5.2.5 TEST SETUP

Same as item 4.2.5.

5.2.6 EUT OPERATING CONDITIONS

Same as item 4.1.6.

5.2.7 TEST RESULTS

CONDUCTED WORST-CASE DATA : 802.11n (20MHz)

PHASE	Line 1	6dB BANDWIDTH	9kHz
--------------	--------	----------------------	------

No	Freq. [MHz]	Corr. Factor (dB)	Reading Value		Emission Level		Limit		Margin	
			[dB (uV)]		[dB (uV)]		[dB (uV)]		(dB)	
			Q.P.	AV.	Q.P.	AV.	Q.P.	AV.	Q.P.	AV.
1	0.17346	0.16	47.53	27.81	47.69	27.97	64.79	54.79	-17.11	-26.83
2	0.19255	0.16	48.27	33.55	48.43	33.71	63.93	53.93	-15.50	-20.22
3	0.50000	0.23	38.51	31.70	38.74	31.93	56.00	46.00	-17.26	-14.07
4	1.43248	0.27	28.50	20.80	28.77	21.07	56.00	46.00	-27.23	-24.93
5	1.94469	0.29	30.15	23.57	30.44	23.86	56.00	46.00	-25.56	-22.14
6	20.70096	1.27	45.52	39.70	46.79	40.97	60.00	50.00	-13.21	-9.03

REMARKS:

1. Q.P. and AV. are abbreviations of quasi-peak and average individually.
2. The emission levels of other frequencies were very low against the limit.
3. Margin value = Emission level - Limit value
4. Correction factor = Insertion loss + Cable loss
5. Emission Level = Correction Factor + Reading Value

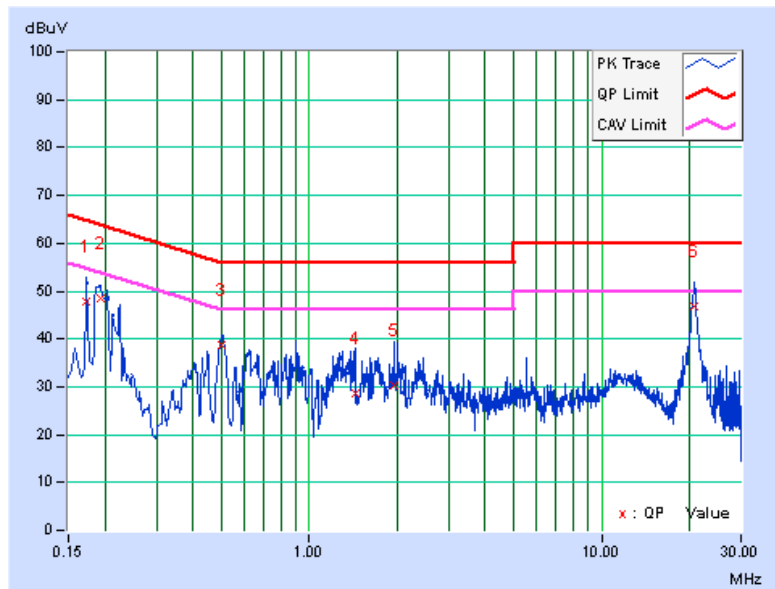

PHASE	Line 2	6dB BANDWIDTH	9kHz
--------------	--------	----------------------	------

No	Freq.	Corr. Factor	Reading Value		Emission Level		Limit		Margin	
	[MHz]		[dB (uV)]		[dB (uV)]		[dB (uV)]		(dB)	
			Q.P.	AV.	Q.P.	AV.	Q.P.	AV.	Q.P.	AV.
1	0.20084	0.17	47.22	33.64	47.39	33.81	63.58	53.58	-16.19	-19.77
2	0.22024	0.18	46.15	34.71	46.33	34.89	62.81	52.81	-16.48	-17.92
3	0.50000	0.24	38.08	32.43	38.32	32.67	56.00	46.00	-17.68	-13.33
4	0.89290	0.25	33.73	24.18	33.98	24.43	56.00	46.00	-22.02	-21.57
5	1.68272	0.27	31.82	25.60	32.09	25.87	56.00	46.00	-23.91	-20.13
6	20.87300	0.96	46.88	40.95	47.84	41.91	60.00	50.00	-12.16	-8.09

REMARKS:

1. Q.P. and AV. are abbreviations of quasi-peak and average individually.
2. The emission levels of other frequencies were very low against the limit.
3. Margin value = Emission level - Limit value
4. Correction factor = Insertion loss + Cable loss
5. Emission Level = Correction Factor + Reading Value

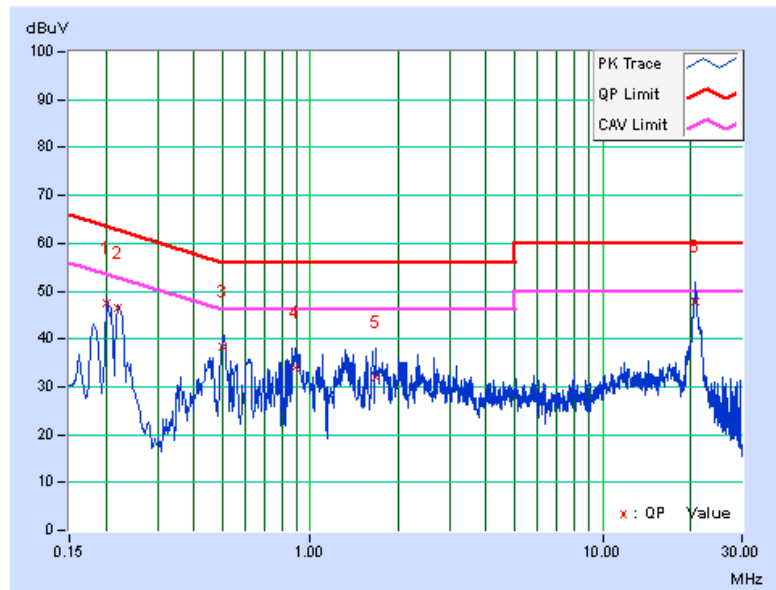



A D T

5.3 6dB BANDWIDTH MEASUREMENT

5.3.1 LIMITS OF 6dB BANDWIDTH MEASUREMENT

The minimum of 6dB Bandwidth Measurement is 0.5MHz.

5.3.2 TEST SETUP

Same as item 4.3.2.

5.3.3 TEST INSTRUMENTS

Refer to section 4.1.2 to get information of above instrument.

5.3.4 TEST PROCEDURE

Same as item 4.3.4.

5.3.5 DEVIATION FROM TEST STANDARD

No deviation.

5.3.6 EUT OPERATING CONDITIONS

Same as item 4.3.6.



5.3.7 TEST RESULTS

802.11a

CHANNEL	FREQUENCY (MHz)	6dB BANDWIDTH (MHz)	MINIMUM LIMIT (MHz)	PASS / FAIL
149	5745	17.75	0.5	PASS
157	5785	17.71	0.5	PASS
165	5825	17.73	0.5	PASS

802.11n (20MHz)

CHANNEL	FREQUENCY (MHz)	6dB BANDWIDTH (MHz)		MINIMUM LIMIT (MHz)	PASS / FAIL
		CHAIN 0	CHAIN 1		
149	5745	17.84	17.71	0.5	PASS
157	5785	17.82	17.70	0.5	PASS
165	5825	17.81	17.71	0.5	PASS

802.11n (40MHz)

CHANNEL	FREQUENCY (MHz)	6dB BANDWIDTH (MHz)		MINIMUM LIMIT (MHz)	PASS / FAIL
		CHAIN 0	CHAIN 1		
151	5755	36.60	36.46	0.5	PASS
159	5795	36.58	36.45	0.5	PASS

802.11ac (80MHz)

CHANNEL	FREQUENCY (MHz)	6dB BANDWIDTH (MHz)		MINIMUM LIMIT (MHz)	PASS / FAIL
		CHAIN 0	CHAIN 1		
155	5775	76.70	76.68	0.5	PASS



A D T

SPECTRUM PLOT OF WORST VALUE

802.11a

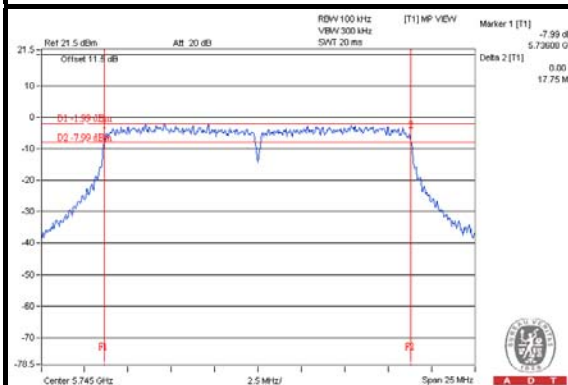

802.11n (20MHz)

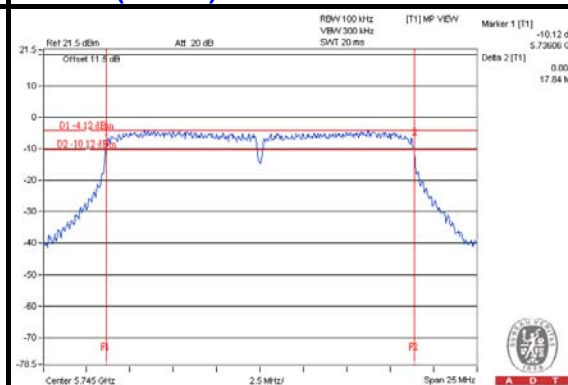

802.11n (40MHz)

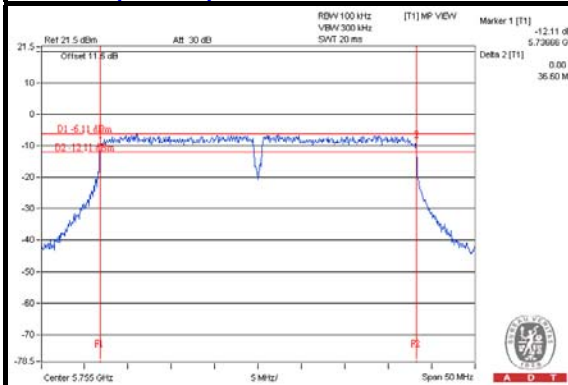

802.11ac (80MHz)

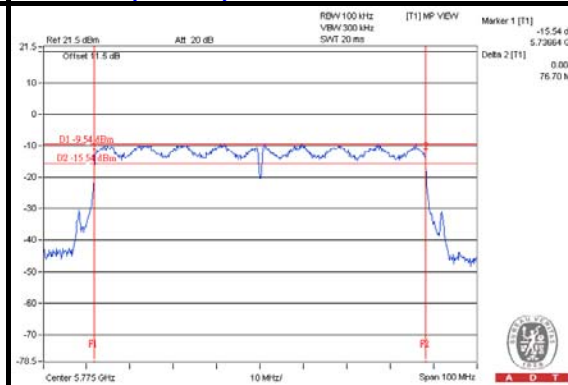

5.4 CONDUCTED OUTPUT POWER

5.4.1 LIMITS OF CONDUCTED OUTPUT POWER MEASUREMENT

For systems using digital modulation in the 5725 –5850 MHz bands: 1 Watt (30dBm)

Per KDB 662911 D01 Multiple Transmitter Output v02 Method of conducted output power measurement on IEEE 802.11 devices,

Array Gain = 0 dB (i.e., no array gain) for $NANT \leq 4$;

Array Gain = 0 dB (i.e., no array gain) for channel widths ≥ 40 MHz for any NANT;

Array Gain = $5 \log(NANT/NSS)$ dB or 3 dB, whichever is less for 20-MHz channel widths with $NANT \geq 5$.

For power measurements on all other devices: Array Gain = $10 \log(NANT/NSS)$ dB.

5.4.2 TEST SETUP

For 802.11a, 802.11n (20MHz), 802.11n (40MHz)

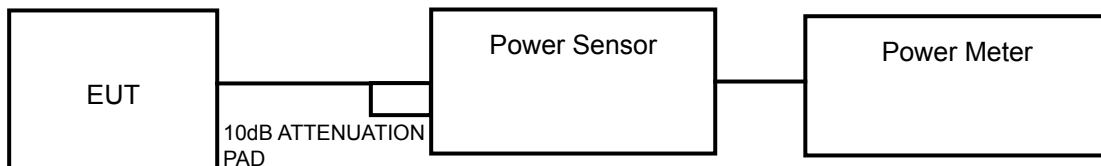

For 802.11ac (80MHz)

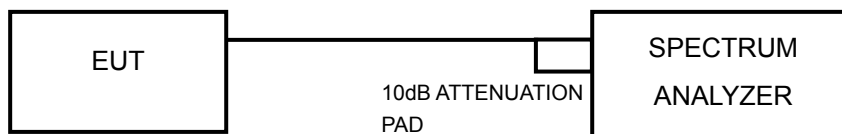

5.4.3 INSTRUMENTS

Refer to section 4.1.2 to get information of above instrument.



A D T

5.4.4 TEST PROCEDURES

Follow KDB 558074 D01 DTS Meas Guidance v03r01 section 9.1.3

For 802.11a, 802.11n (20MHz), 802.11n (40MHz)

Method PM is used to perform output power measurement, trigger and gating function of wide band power meter is enabled to measure max output power of TX on burst. Duty factor is not added to measured value.

Follow KDB 558074 D01 DTS Meas Guidance v03r01 section 9.1.2

For 802.11ac (80MHz)

Integrated band power method

This procedure may be used when the maximum available RBW of the measurement instrument is less than the DTS bandwidth.

- 1) Set the RBW = 1 MHz.
- 2) Set the VBW \geq 3 RBW
- 3) Set the span \geq 1.5 x DTS bandwidth.
- 4) Detector = peak.
- 5) Sweep time = auto couple.
- 6) Trace mode = max hold.
- 7) Allow trace to fully stabilize.
- 8) Use the instrument's band/channel power measurement function with the band limits set equal to the DTS bandwidth edges (for some instruments, this may require a manual override to select peak detector). If the instrument does not have a band power function, sum the spectrum levels (in linear power units) at intervals equal to the RBW extending across the DTS bandwidth.

5.4.5 DEVIATION FROM TEST STANDARD

No deviation.

5.4.6 EUT OPERATING CONDITIONS

Same as Item 4.3.6.



5.4.7 TEST RESULTS

FOR PEAK POWER

802.11a

CHANNEL	FREQUENCY (MHz)	PEAK POWER (mW)	PEAK POWER (dBm)	LIMIT (dBm)	PASS/FAIL
149	5745	204.174	23.10	30	PASS
157	5785	183.231	22.63	30	PASS
165	5825	195.434	22.91	30	PASS

802.11n (20MHz)

CHAN.	FREQ. (MHz)	PEAK POWER (dBm)		TOTAL POWER (mW)	TOTAL POWER (dBm)	LIMIT (dBm)	PASS / FAIL
		CHAIN 0	CHAIN 1				
149	5745	22.10	21.95	318.856	25.04	30	PASS
157	5785	22.26	22.25	336.147	25.27	30	PASS
165	5825	22.56	21.70	328.213	25.16	30	PASS

802.11n (40MHz)

CHAN.	FREQ. (MHz)	PEAK POWER (dBm)		TOTAL POWER (mW)	TOTAL POWER (dBm)	LIMIT (dBm)	PASS / FAIL
		CHAIN 0	CHAIN 1				
151	5755	22.12	21.86	316.392	25.00	30	PASS
159	5795	22.26	21.65	314.485	24.98	30	PASS

802.11ac (80MHz)

CHAN.	FREQ. (MHz)	PEAK POWER (dBm)		TOTAL POWER (mW)	TOTAL POWER (dBm)	LIMIT (dBm)	PASS / FAIL
		CHAIN 0	CHAIN 1				
155	5775	22.36	22.02	331.408	25.20	30	PASS

**FOR AVERAGE POWER****802.11a**

CHANNEL	FREQUENCY (MHz)	AVERAGE POWER (mW)	AVERAGE POWER (dBm)
149	5745	39.174	15.93
157	5785	37.670	15.76
165	5825	40.365	16.06

802.11n (20MHz)

CHANNEL	FREQUENCY (MHz)	AVG. POWER (dBm)		TOTAL POWER (mW)	TOTAL POWER (dBm)
		CHAIN 0	CHAIN 1		
149	5745	15.95	15.96	78.801	18.97
157	5785	16.01	15.95	79.257	18.99
165	5825	16.03	15.69	77.155	18.87

802.11n (40MHz)

CHANNEL	FREQUENCY (MHz)	AVG. POWER (dBm)		TOTAL POWER (mW)	TOTAL POWER (dBm)
		CHAIN 0	CHAIN 1		
151	5755	15.56	15.89	74.790	18.74
159	5795	16.00	15.92	78.895	18.97

802.11ac (80MHz)

CHANNEL	FREQUENCY (MHz)	AVG. POWER (dBm)		TOTAL POWER (mW)	TOTAL POWER (dBm)
		CHAIN 0	CHAIN 1		
155	5775	15.56	15.93	75.149	18.76



A D T

5.5 POWER SPECTRAL DENSITY MEASUREMENT

5.5.1 LIMITS OF POWER SPECTRAL DENSITY MEASUREMENT

The Maximum of Power Spectral Density Measurement is 8dBm.

5.5.2 TEST SETUP

Same as item 4.5.2.

5.5.3 TEST INSTRUMENTS

Refer to section 4.1.2 to get information of above instrument.

5.5.4 TEST PROCEDURE.

Same as item 4.5.4.

5.5.5 DEVIATION FROM TEST STANDARD

No deviation.

5.5.6 EUT OPERATING CONDITION

Same as item 4.3.6.



5.5.7 TEST RESULTS

802.11a

Channel	Freq. (MHz)	PSD (dBm/3kHz)	Limit (dBm/3kHz)	PASS /FAIL
149	5745	-15.99	8	PASS
157	5785	-16.45	8	PASS
165	5825	-15.96	8	PASS

802.11n (20MHz)

TX chain	Channel	Freq. (MHz)	PSD (dBm/3kHz)	10 log (N=3) dB	Total PSD (dBm/3kHz)	Limit (dBm/3kHz)	PASS /FAIL
0	149	5745	-18.51	3.01	-15.50	7.17	PASS
	157	5785	-17.40	3.01	-14.39	7.17	PASS
	165	5825	-16.98	3.01	-13.97	7.17	PASS
1	149	5745	-16.74	3.01	-13.73	7.17	PASS
	157	5785	-16.37	3.01	-13.36	7.17	PASS
	165	5825	-16.51	3.01	-13.50	7.17	PASS

NOTE: Directional gain = $10 \log[(10^{G1/20} + 10^{G2/20} + \dots + 10^{GN/20})^2 / N_{ANT}] = 6.83 > 6\text{dBi}$, so the power density limit shall be reduced to $8 - (6.83 - 6) = 7.17\text{dBm}$.

802.11n (40MHz)

TX chain	Channel	Freq. (MHz)	PSD (dBm/3kHz)	10 log (N=3) dB	Total PSD (dBm/3kHz)	Limit (dBm/3kHz)	PASS /FAIL
0	151	5755	-20.62	3.01	-17.61	7.17	PASS
	159	5795	-20.18	3.01	-17.17	7.17	PASS
1	151	5755	-19.65	3.01	-16.64	7.17	PASS
	159	5795	-19.66	3.01	-16.65	7.17	PASS

NOTE: Directional gain = $10 \log[(10^{G1/20} + 10^{G2/20} + \dots + 10^{GN/20})^2 / N_{ANT}] = 6.83 > 6\text{dBi}$, so the power density limit shall be reduced to $8 - (6.83 - 6) = 7.17\text{dBm}$.

802.11ac (80MHz)

TX chain	Channel	Freq. (MHz)	PSD (dBm/3kHz)	10 log (N=3) dB	Total PSD (dBm/3kHz)	Limit (dBm/3kHz)	PASS /FAIL
0	155	5775	-23.11	3.01	-20.10	7.17	PASS
1	155	5775	-22.56	3.01	-19.55	7.17	PASS

NOTE: Directional gain = $10 \log[(10^{G1/20} + 10^{G2/20} + \dots + 10^{GN/20})^2 / N_{ANT}] = 6.83 > 6\text{dBi}$, so the power density limit shall be reduced to $8 - (6.83 - 6) = 7.17\text{dBm}$.



A D T

SPECTRUM PLOT OF WORST VALUE

802.11a

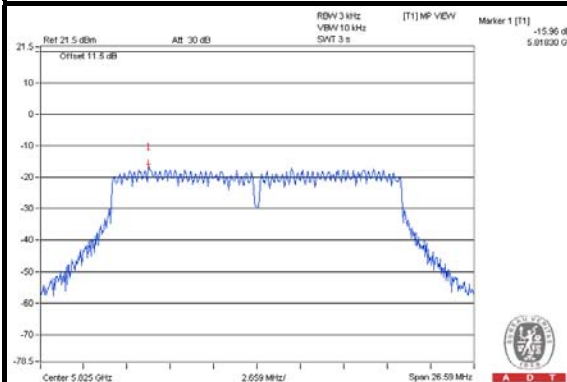

802.11n (20MHz)

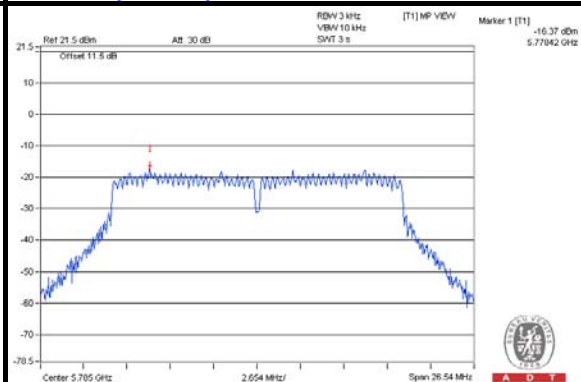

802.11n (40MHz)

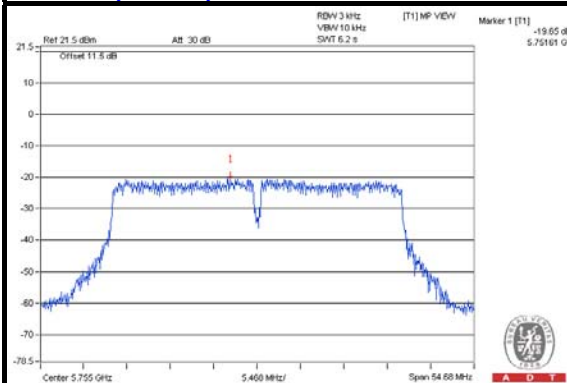

802.11ac (80MHz)

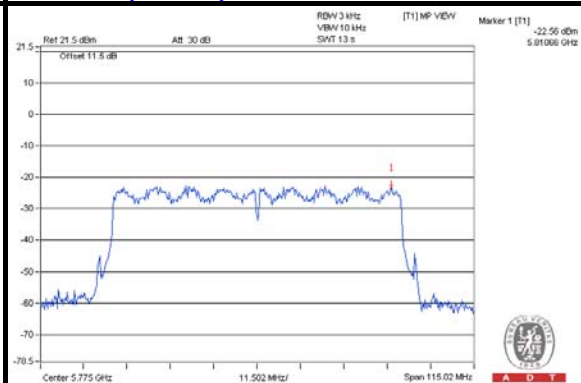



A D T

5.6 CONDUCTED OUT OF BAND EMISSION MEASUREMENT

5.6.1 LIMITS OF CONDUCTED OUT OF BAND EMISSION MEASUREMENT

Below -20dB of the highest emission level of operating band (in 100kHz Resolution Bandwidth).

5.6.2 TEST SETUP

Same as Item 4.6.2

5.6.3 TEST INSTRUMENTS

Refer to section 4.1.2 to get information of above instrument.

5.6.4 TEST PROCEDURE

Same as Item 4.6.4

5.6.5 DEVIATION FROM TEST STANDARD

No deviation.

5.6.6 EUT OPERATING CONDITION

Same as Item 4.3.6

5.6.7 TEST RESULTS

The conducted emission test is performed on each TX port of operating mode without summing or adding $10\log(N)$ since the limit is relative emission limit.

The spectrum plots are attached on the following pages. D1 line indicates the highest level, and D2 line indicates the 20dB offset below D1. It shows compliance with the requirement.



A D T

802.11a

CH 149

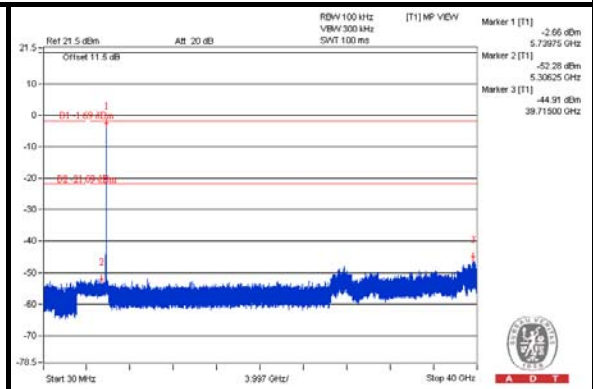
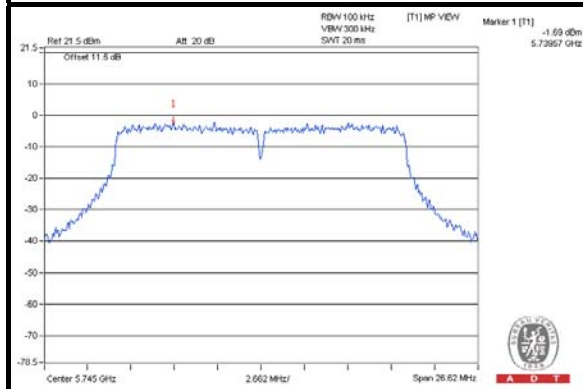

CH 157

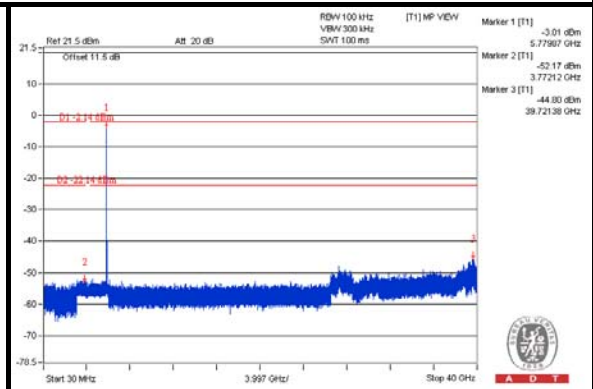
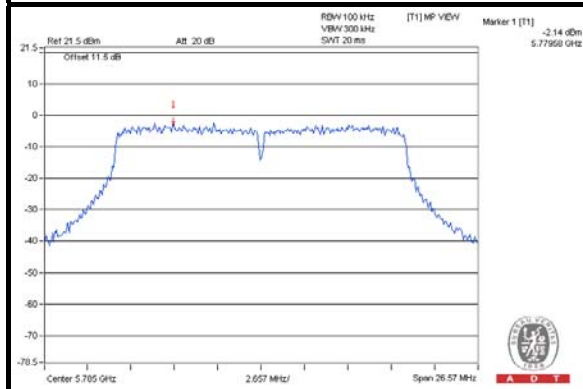

CH 165

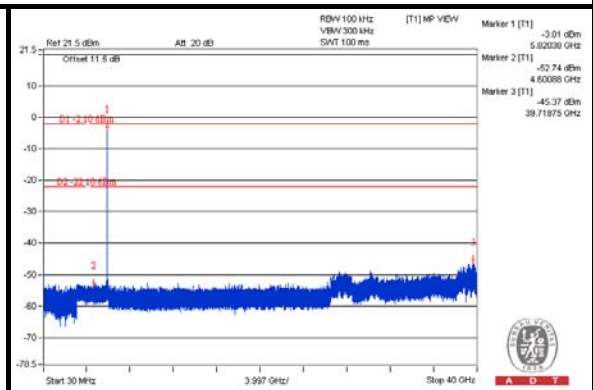
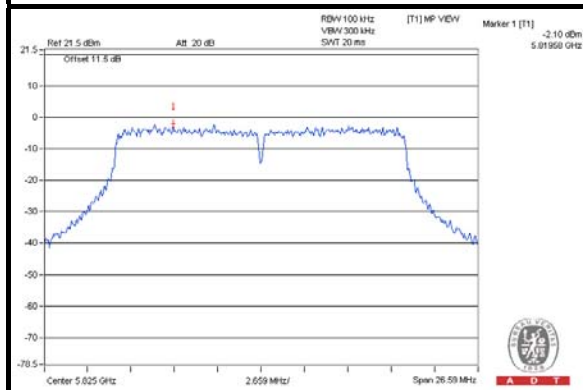

CH 149 Band edge

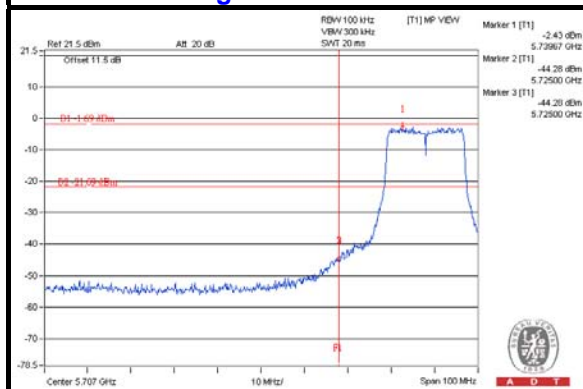

CH 165 Band edge

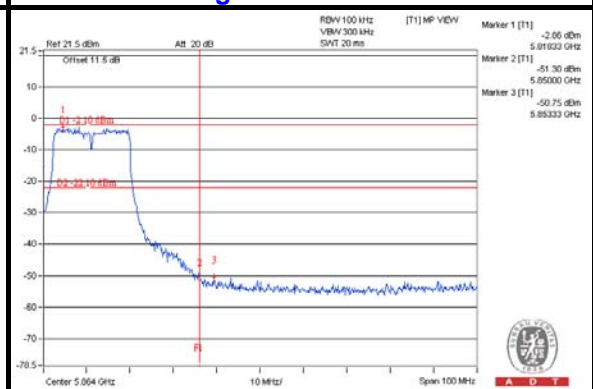



A D T

802.11n (20MHz) CHAIN 0

CH 149

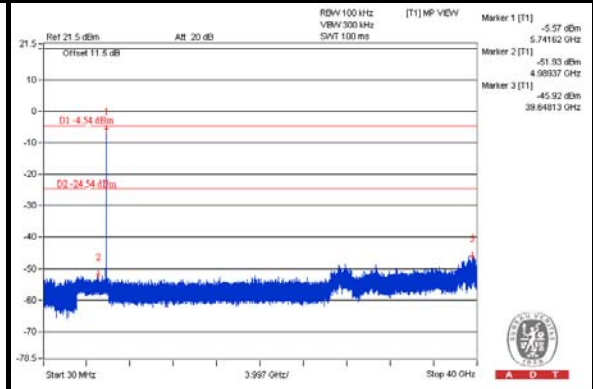
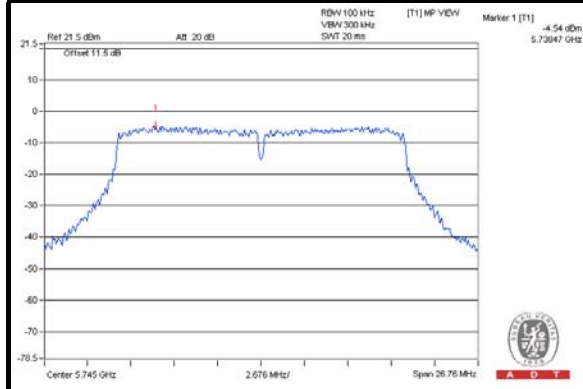

CH 157

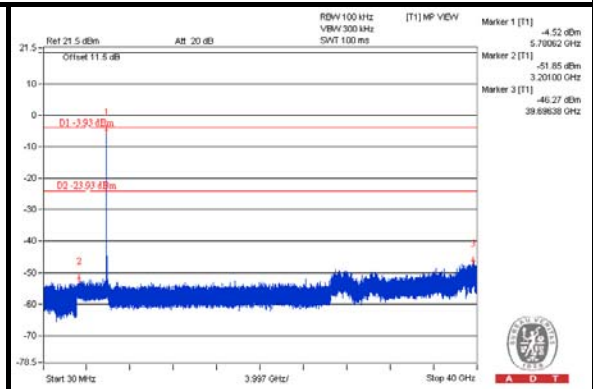
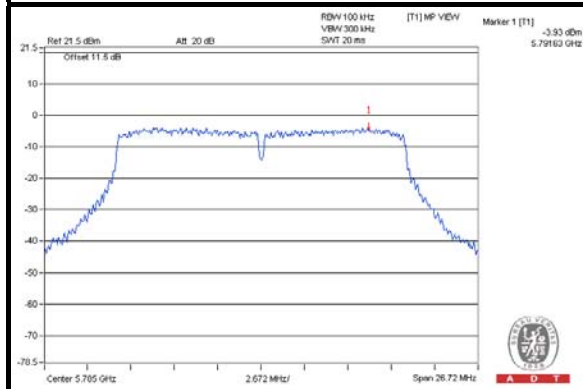

CH 165

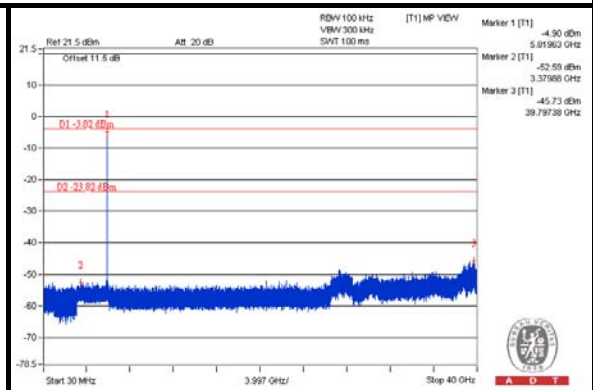
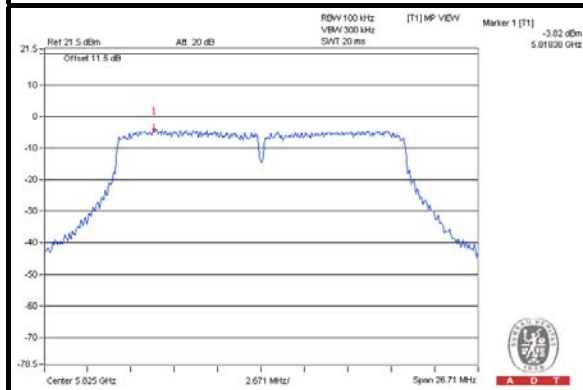

CH 149 Band edge

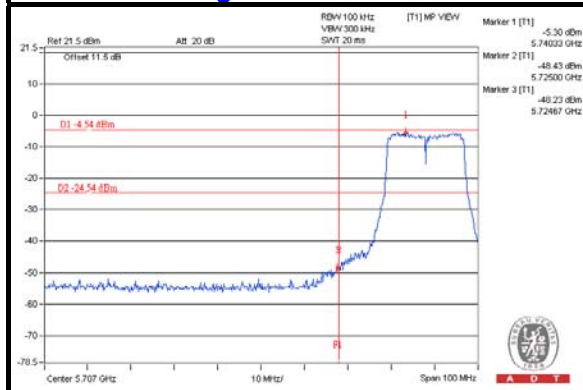

CH 165 Band edge

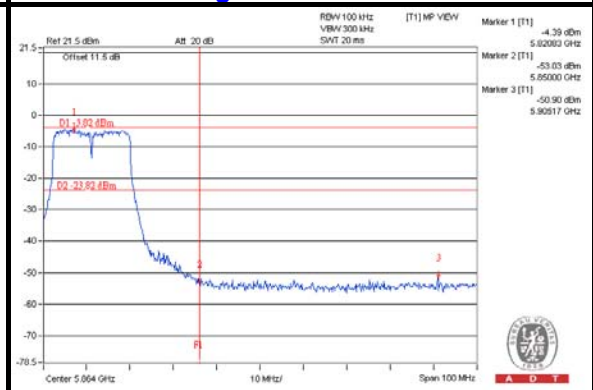



A D T

CHAIN 1

CH 149

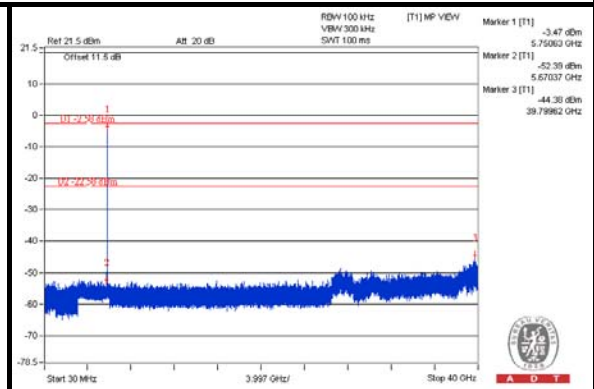
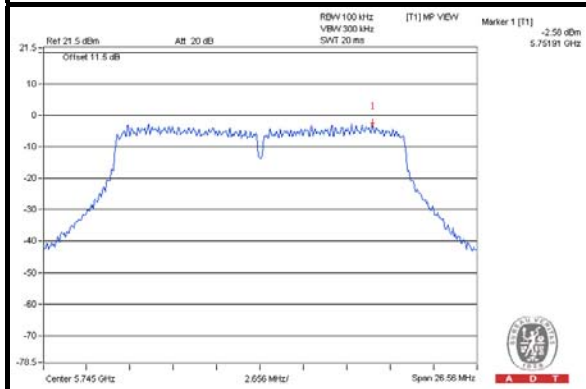

CH 157

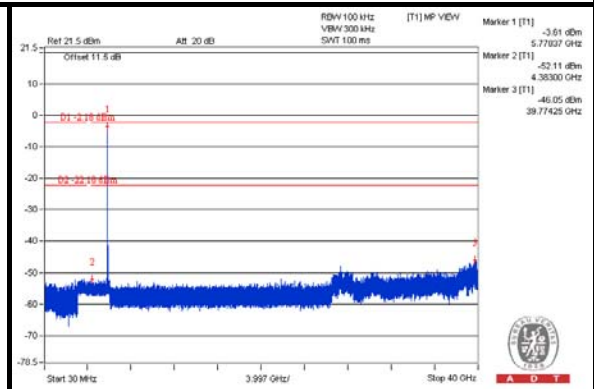
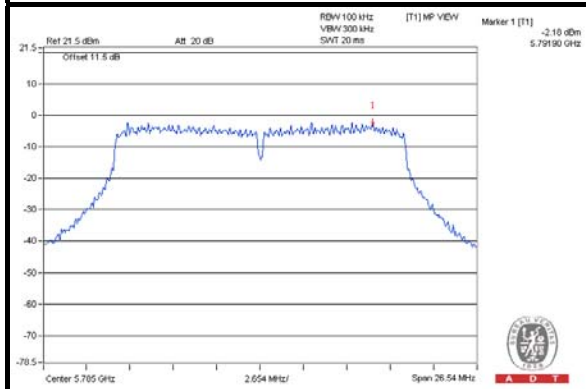

CH 165

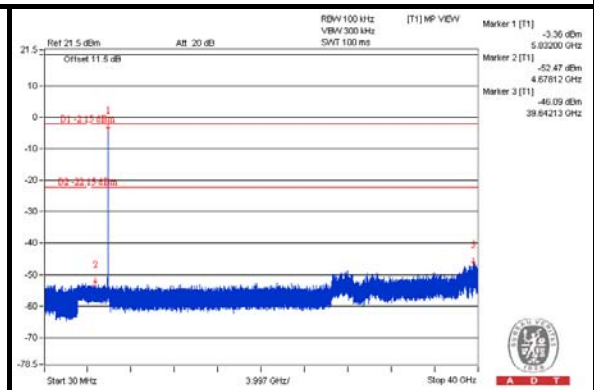
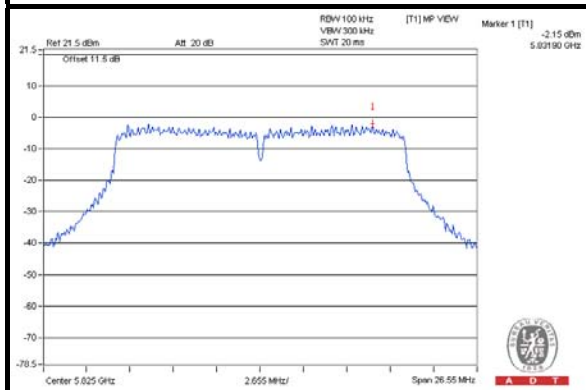

CH 149 Band edge

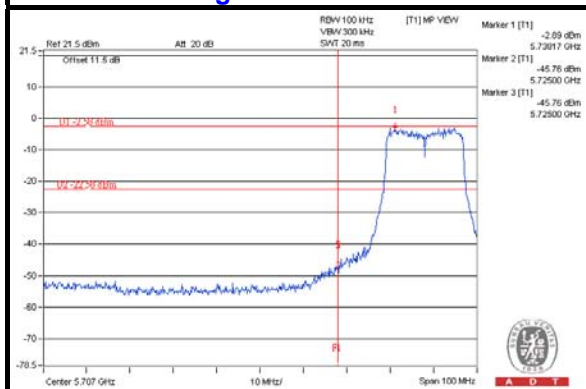

CH 165 Band edge

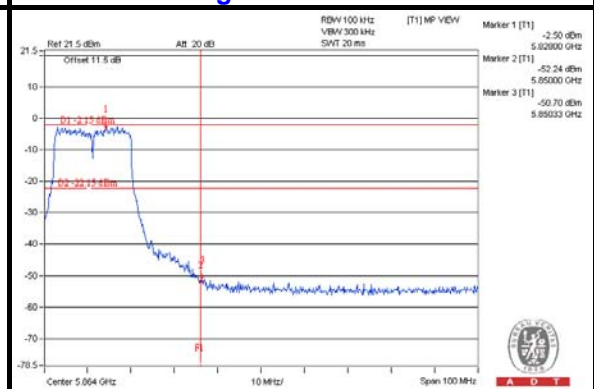



A D T

802.11n (40MHz) CHAIN 0

CH 151

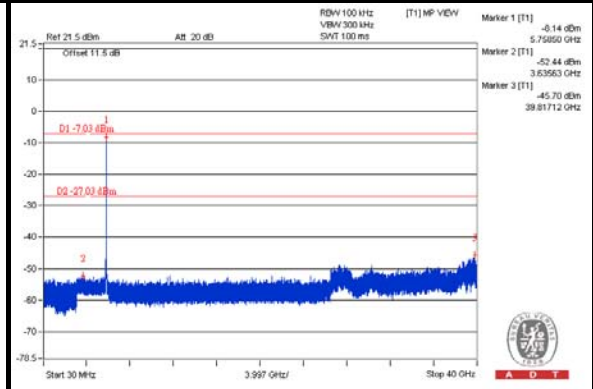
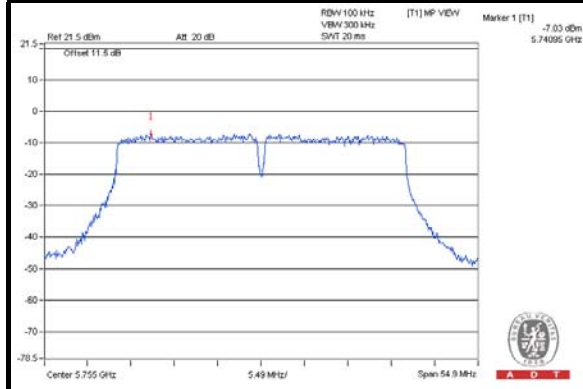

CH 159

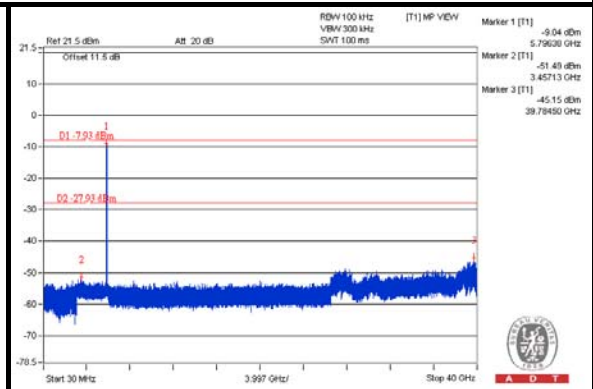
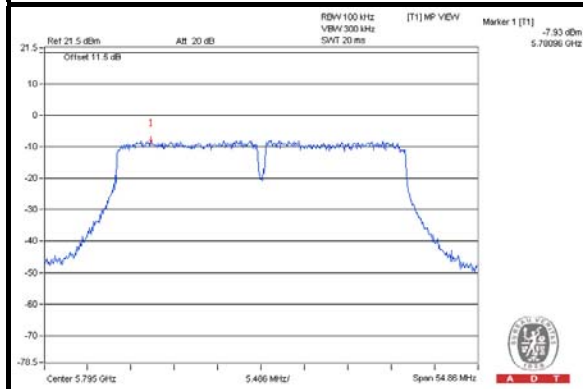

CH 151 Band edge

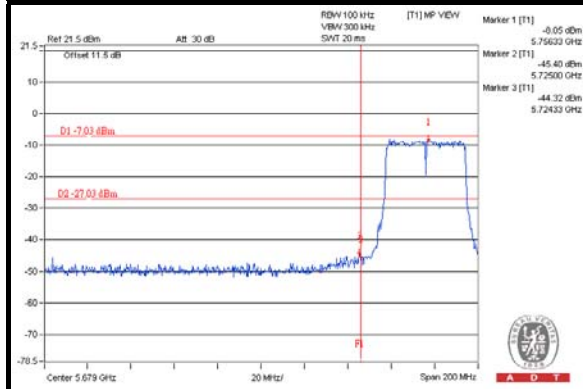

CH 159 Band edge

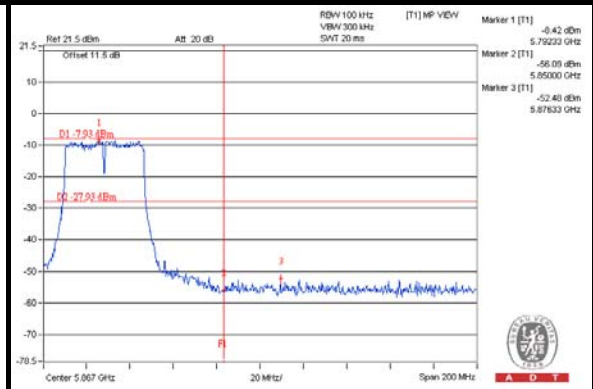



A D T

CHAIN 1

CH 151

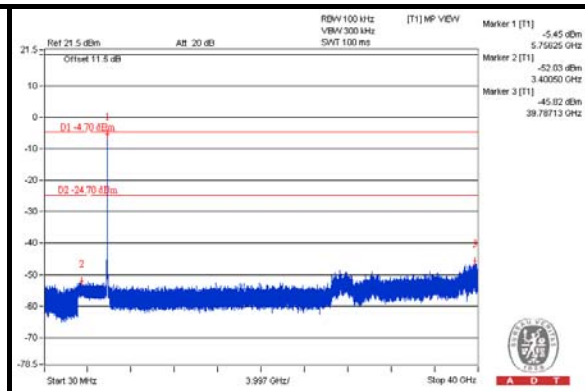
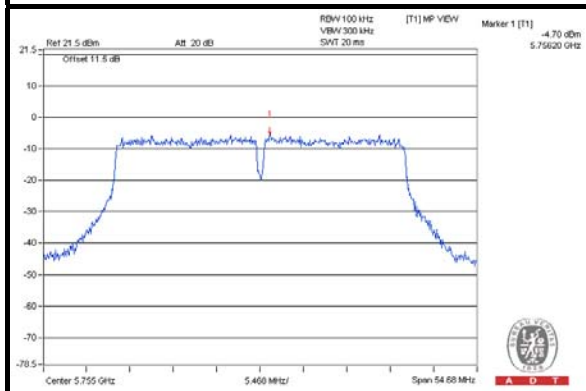

CH 159

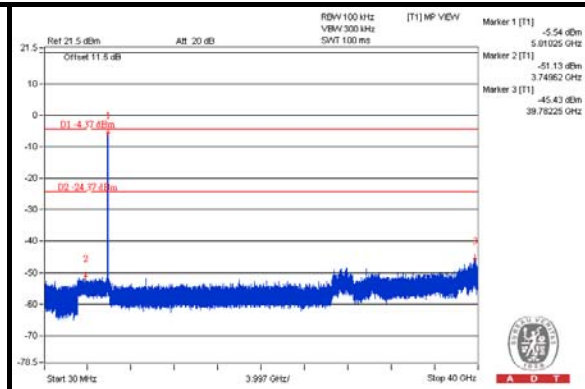
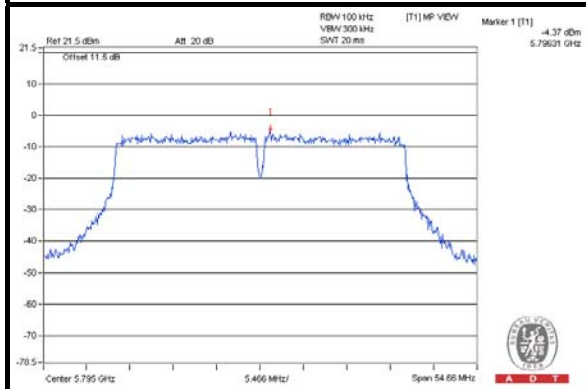

CH 151 Band edge

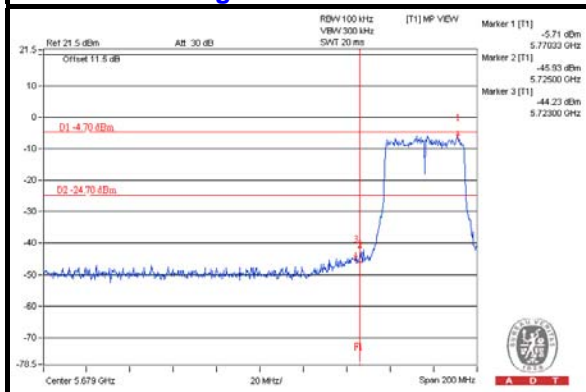

CH 159 Band edge

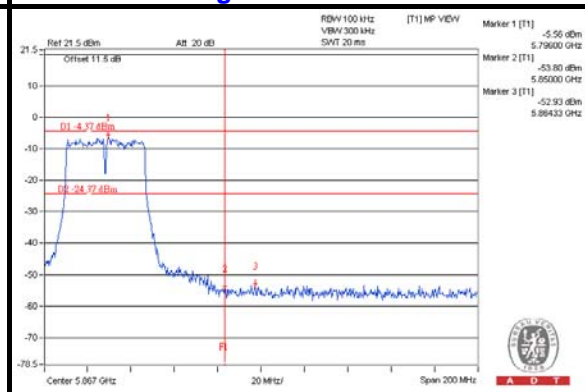



A D T

802.11ac (80MHz)
CHAIN 0

CH 155

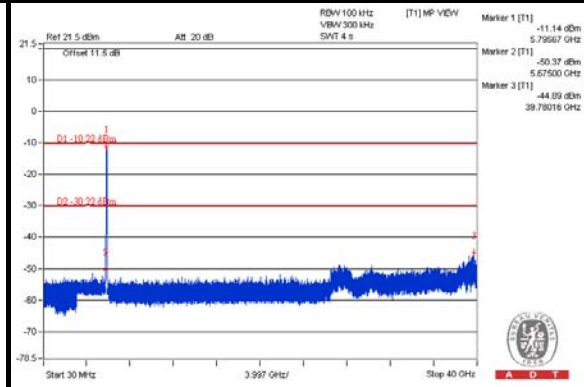
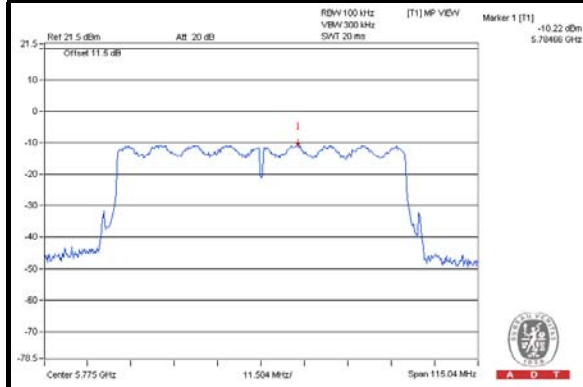

CH 155 Band edge

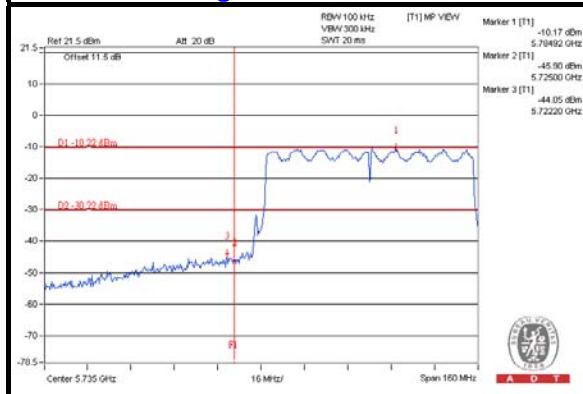

CH 155 Band edge

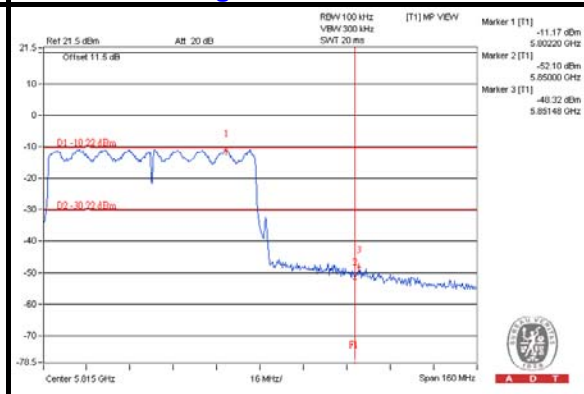



A D T

CHAIN 1

CH 155

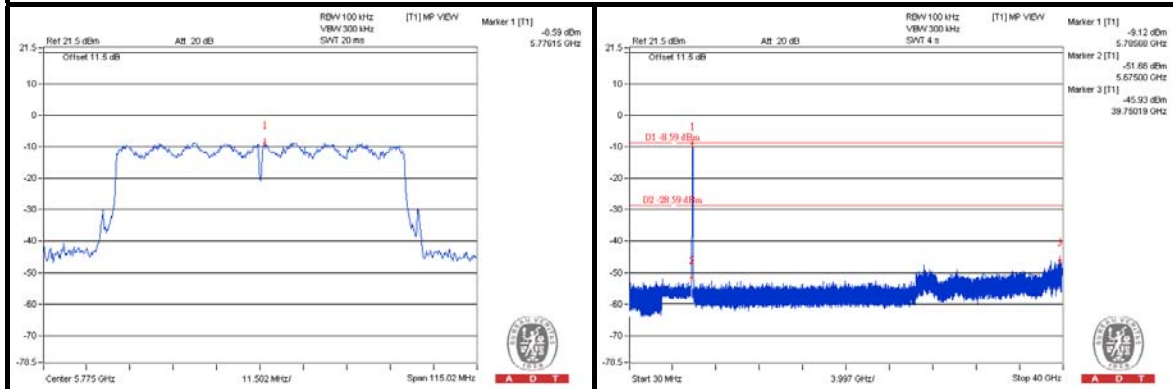

CH 155 Band edge

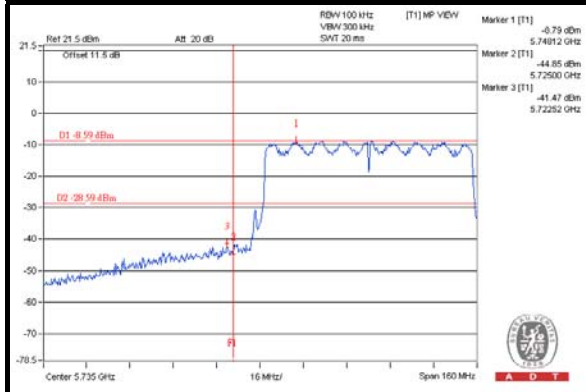

CH 155 Band edge

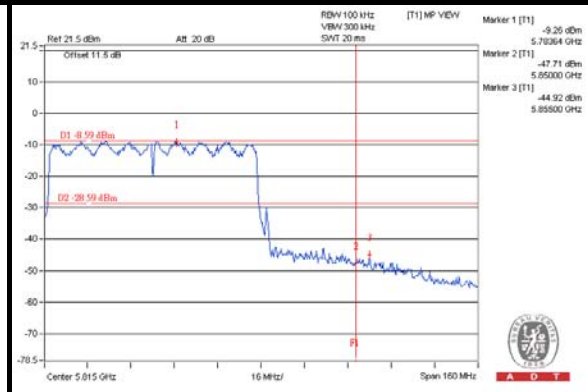



A D T

6. PHOTOGRAPHS OF THE TEST CONFIGURATION

Please refer to the attached file (Test Setup Photo).



A D T

7. INFORMATION ON THE TESTING LABORATORIES

We, Bureau Veritas Consumer Products Services (H.K.) Ltd., Taoyuan Branch, were founded in 1988 to provide our best service in EMC, Radio, Telecom and Safety consultation. Our laboratories are accredited and approved according to ISO/IEC 17025.

If you have any comments, please feel free to contact us at the following:

Linko EMC/RF Lab

Tel: 886-2-26052180

Fax: 886-2-26051924

Hsin Chu EMC/RF Lab

Tel: 886-3-5935343

Fax: 886-3-5935342

Hwa Ya EMC/RF/Safety/Telecom Lab

Tel: 886-3-3183232

Fax: 886-3-3270892

Email: service.adt@tw.bureauveritas.com

Web Site: www.bureauveritas-adt.com

The address and road map of all our labs can be found in our web site also.



A D T

8. APPENDIX A – MODIFICATIONS RECORDERS FOR ENGINEERING CHANGES TO THE EUT BY THE LAB

No modifications were made to the EUT by the lab during the test.

---END---