



# FCC RF Test Report

**APPLICANT** : TP-Link Technologies Co., Ltd.  
**EQUIPMENT** : AC1200 Wi-Fi Range Extender with Smart Plug  
**BRAND NAME** : TP-Link  
**MODEL NAME** : RE370K  
**FCC ID** : TE7RE370K  
**STANDARD** : FCC Part 15 Subpart C §15.247  
**CLASSIFICATION** : (DTS) Digital Transmission System

The product was received on Sep. 28, 2016 and testing was completed on Oct. 27, 2016. We, SPORTON INTERNATIONAL (SHENZHEN) INC., would like to declare that the tested sample has been evaluated in accordance with the test procedures and has been in compliance with the applicable technical standards.

The test results in this report apply exclusively to the tested model / sample. Without written approval of SPORTON INTERNATIONAL (SHENZHEN) INC., the test report shall not be reproduced except in full.

Prepared by: Ken Chen / Manager

Approved by: Jones Tsai / Manager



**SPORTON INTERNATIONAL (SHENZHEN) INC.**

**1F & 2F, Building A, Morning Business Center, No. 4003 ShiGu Rd., Xili Town,  
Nanshan District, Shenzhen, Guangdong, P. R. China**



# TABLE OF CONTENTS

**REVISION HISTORY..... 3**

**SUMMARY OF TEST RESULT ..... 4**

**1 GENERAL DESCRIPTION ..... 5**

    1.1 Applicant ..... 5

    1.2 Manufacturer ..... 5

    1.3 Product Feature of Equipment Under Test..... 5

    1.4 Product Specification of Equipment Under Test..... 6

    1.5 Modification of EUT ..... 7

    1.6 Testing Location ..... 7

    1.7 Applicable Standards ..... 8

**2 TEST CONFIGURATION OF EQUIPMENT UNDER TEST ..... 9**

    2.1 Carrier Frequency and Channel ..... 9

    2.2 Test Mode ..... 10

    2.3 Connection Diagram of Test System ..... 11

    2.4 Support Unit used in test configuration and system ..... 12

    2.5 EUT Operation Test Setup ..... 12

    2.6 Measurement Results Explanation Example ..... 13

**3 TEST RESULT ..... 14**

    3.1 6dB and 99% Bandwidth Measurement ..... 14

    3.2 Output Power Measurement..... 16

    3.3 Power Spectral Density Measurement ..... 18

    3.4 Conducted Band Edges and Spurious Emission Measurement ..... 20

    3.5 Radiated Band Edges and Spurious Emission Measurement ..... 45

    3.6 AC Conducted Emission Measurement..... 49

    3.7 Antenna Requirements ..... 53

**4 LIST OF MEASURING EQUIPMENT ..... 54**

**5 UNCERTAINTY OF EVALUATION ..... 55**

**APPENDIX A. CONDUCTED TEST RESULTS**

**APPENDIX B. RADIATED SPURIOUS EMISSION**

**APPENDIX C. DUTY CYCLE PLOTS**

**APPENDIX D. SETUP PHOTOGRAPHS**





### SUMMARY OF TEST RESULT

Report Section	FCC Rule	IC Rule	Description	Limit	Result	Remark
3.1	15.247(a)(2)	RSS-247 5.2(1)	6dB Bandwidth	$\geq 0.5\text{MHz}$	Pass	-
3.1	-	RSS-Gen 6.6	99% Bandwidth	-	Pass	-
3.2	15.247(b)	RSS-247 A5.4(4)	Power Output Measurement	$\leq 30\text{dBm}$	Pass	-
3.3	15.247(e)	RSS-247 5.2(2)	Power Spectral Density	$\leq 8\text{dBm}/3\text{kHz}$	Pass	-
3.4	15.247(d)	RSS-247 5.5	Conducted Band Edges	$\leq 30\text{dBc}$	Pass	-
			Conducted Spurious Emission		Pass	-
3.5	15.247(d)	RSS-247 5.5	Radiated Band Edges and Radiated Spurious Emission	15.209(a) & 15.247(d)	Pass	Under limit 0.17 dB at 2390.000 MHz
3.6	15.207	RSS-GEN 8.8	AC Conducted Emission	15.207(a)	Pass	Under limit 16.21 dB at 0.630 MHz
3.7	15.203 & 15.247(b)	N/A	Antenna Requirement	N/A	Pass	-



# 1 General Description

## 1.1 Applicant

**TP-Link Technologies Co., Ltd.**

Building 24 (floors 1,3,4,5) and 28 (floors1-4) Central Science and Technology Park, Shennan Rd., Nanshan, Shenzhen, China

## 1.2 Manufacturer

**TP-Link Technologies Co., Ltd.**

Building 24 (floors 1,3,4,5) and 28 (floors1-4) Central Science and Technology Park, Shennan Rd., Nanshan, Shenzhen, China

## 1.3 Product Feature of Equipment Under Test

Product Feature	
<b>Equipment</b>	AC1200 Wi-Fi Range Extender with Smart Plug
<b>Brand Name</b>	TP-Link
<b>Model Name</b>	RE370K
<b>FCC ID</b>	TE7RE370K
<b>EUT supports Radios application</b>	WLAN2.4GHz 802.11b/g/n HT20/HT40 WLAN5GHz 802.11a/n HT20/HT40 WLAN5GHz 80211ac VHT20/VHT40/VHT80
<b>EUT Stage</b>	Production Unit

**Remark:** The above EUT's information was declared by manufacturer. Please refer to the specifications or user's manual for more detailed description.



### 1.4 Product Specification of Equipment Under Test

Standards-related Product Specification										
<b>Tx/Rx Channel Frequency Range</b>	802.11b/g/n : 2412 MHz ~ 2462 MHz									
<b>Maximum (Average) Output Power to antenna</b>	802.11b : 23.06 dBm (0.2023 W) 802.11g : 22.30 dBm (0.1698 W) 802.11n HT20 : 22.48 dBm (0.1770 W) 802.11n HT40 : 20.42 dBm (0.1102 W)									
<b>99% Occupied Bandwidth</b>	802.11b : 13.84MHz 802.11g : 27.92MHz 802.11n HT20 : 28.17MHz 802.11n HT40 : 37.86MHz									
<b>Antenna Type / Gain</b>	<Ant 1> Dipole Antenna with gain 1.91 dBi <Ant 2> Dipole Antenna with gain 1.94 dBi									
<b>Type of Modulation</b>	802.11b : DSSS (DBPSK / DQPSK / CCK) 802.11g/n : OFDM (BPSK / QPSK / 16QAM / 64QAM)									
<b>Antenna Function for Transmitter</b>	<table border="1"> <thead> <tr> <th></th> <th>Ant. 1</th> <th>Ant. 2</th> </tr> </thead> <tbody> <tr> <td>802.11 b/g/n SISO</td> <td>V</td> <td>V</td> </tr> <tr> <td>802.11 b/g/n MIMO</td> <td>V</td> <td>V</td> </tr> </tbody> </table>		Ant. 1	Ant. 2	802.11 b/g/n SISO	V	V	802.11 b/g/n MIMO	V	V
		Ant. 1	Ant. 2							
	802.11 b/g/n SISO	V	V							
802.11 b/g/n MIMO	V	V								

Note: MIMO Ant. 1+2 is a calculated result from sum of the power MIMO Ant. 1 and MIMO Ant. 2.



### 1.5 Modification of EUT

No modifications are made to the EUT during all test items.

### 1.6 Testing Location

<b>Test Site</b>	SPORTON INTERNATIONAL (SHENZHEN) INC.	
<b>Test Site Location</b>	1F & 2F, Building A, Morning Business Center, No. 4003 ShiGu Rd., Xili Town, Nanshan District, Shenzhen, Guangdong, P. R. China TEL: +86-755-8637-9589 FAX: +86-755-8637-9595	
<b>Test Site No.</b>	<b>Sporton Site No.</b>	
	TH01-SZ	CO01-SZ

<b>Test Site</b>	SPORTON INTERNATIONAL (SHENZHEN) INC.	
<b>Test Site Location</b>	No. 3 Building, the third floor of south, Shahe River west, Fengzeyuan warehouse, Nanshan District, Shenzhen, Guangdong, P. R. China TEL: +86-755- 3320-2398	
<b>Test Site No.</b>	<b>Sporton Site No.</b>	<b>FCC Registration No.</b>
	03CH03-SZ	565805

**Note:** The test site complies with ANSI C63.4 2014 requirement.



## 1.7 Applicable Standards

According to the specifications of the manufacturer, the EUT must comply with the requirements of the following standards:

- ♦ FCC Part 15 Subpart C §15.247
- ♦ FCC KDB Publication No. 558074 D01 DTS Meas. Guidance v03r05
- ♦ FCC KDB 662911 D01 Multiple Transmitter Output v02r01.
- ♦ ANSI C63.10-2013
- ♦ IC RSS-247 Issue 1
- ♦ IC RSS-Gen Issue 4

**Remark:**

1. All test items were verified and recorded according to the standards and without any deviation during the test.
2. This EUT has also been tested and complied with the requirements of FCC Part 15, Subpart B, recorded in a separate test report.





## 2 Test Configuration of Equipment Under Test

The EUT has been associated with peripherals and configuration operated in a manner tended to maximize its emission characteristics in a typical application. Frequency range investigated: conducted emission (150 kHz to 30 MHz) and radiated emission (9 kHz to the 10th harmonic of the highest fundamental frequency or to 40 GHz, whichever is lower). For radiated measurement, pre-scanned in three orthogonal panels, X, Y, Z. The worst cases (Z plane) were recorded in this report.

### 2.1 Carrier Frequency and Channel

Frequency Band	Channel	Freq. (MHz)	Channel	Freq. (MHz)
2400-2483.5 MHz	1	2412	7	2442
	2	2417	8	2447
	3	2422	9	2452
	4	2427	10	2457
	5	2432	11	2462
	6	2437		



## 2.2 Test Mode

Final test mode of conducted test items and radiated spurious emissions are considering the modulation and worse data rates as below table.

### MIMO Antenna

Modulation	Data Rate
802.11b	1 Mbps
802.11g	6 Mbps
802.11n HT20	MCS0
802.11n HT40	MCS0

Test Cases	
AC Conducted Emission	Mode 1 : WLAN 2.4G Link (Client) + WLAN 2.4G Link (Master) + AC Load + RJ45 Link

## 2.3 Connection Diagram of Test System

### <WLAN Tx Mode>

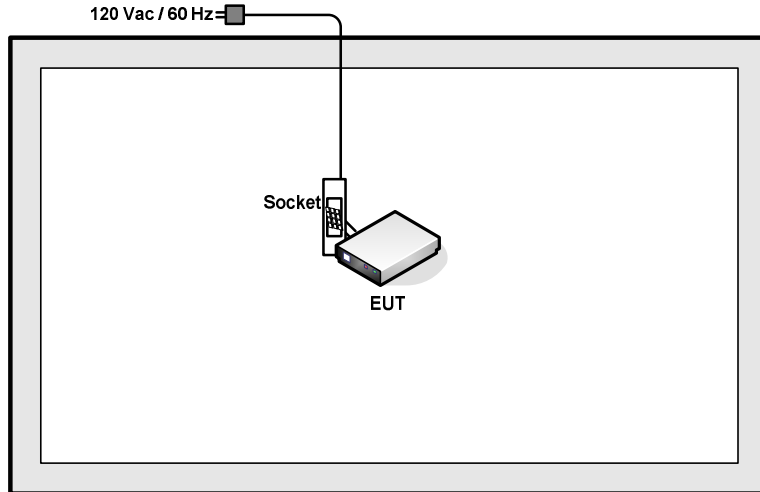

### <AC Conducted Emission Mode>

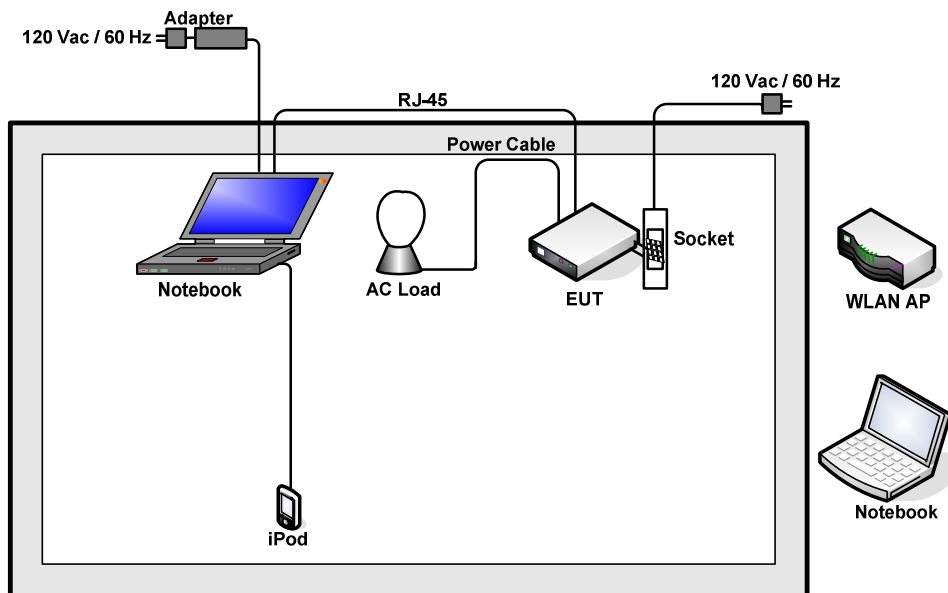



## 2.4 Support Unit used in test configuration and system

Item	Equipment	Trade Name	Model Name	FCC ID	Data Cable	Power Cord
1.	WLAN AP	D-Link	DIR-820L	KA2IR820LA1	N/A	Unshielded, 1.8 m
2.	Notebook	Lenovo	E450	FCC DoC	N/A	AC I/P: Unshielded, 1.2 m DC O/P: Shielded, 1.8 m
3.	Notebook	Lenovo	E540	FCC DoC	N/A	AC I/P: Unshielded, 1.2 m DC O/P: Shielded, 1.8 m
4.	iPod nano 8GB	Apple	MC690ZP/A	FCC DoC	Shielded, 1.2m	N/A
5.	MicroSD Card	SanDisk	8G class 4	FCC DoC	N/A	N/A
6.	AC Load	N/A	N/A	N/A	N/A	N/A
7.	Socket	N/A	N/A	N/A	N/A	N/A
8.	Power Cable	N/A	N/A	N/A	N/A	N/A

## 2.5 EUT Operation Test Setup

For WLAN function, the engineering test program was provided and enabled to make EUT continuous transmit/receive.

For AC power line conducted emissions, the EUT was set to connect with the notebook under large package sizes transmission.



## 2.6 Measurement Results Explanation Example

For all conducted test items:

The offset level is set in the spectrum analyzer to compensate the RF cable loss and attenuator factor between EUT conducted output port and spectrum analyzer. With the offset compensation, the spectrum analyzer reading level is exactly the EUT RF output level.

Example:

The spectrum analyzer offset is derived from RF cable loss and attenuator factor.

*Offset = RF cable loss + attenuator factor.*

Following shows an offset computation example with cable loss 5.0 dB and 10dB attenuator.

$$\begin{aligned} \text{Offset(dB)} &= \text{RF cable loss(dB)} + \text{attenuator factor(dB)}. \\ &= 5.0 + 10 = 15.0 \text{ (dB)} \end{aligned}$$

### 3 Test Result

#### 3.1 6dB and 99% Bandwidth Measurement

##### 3.1.1 Limit of 6dB and 99% Bandwidth

The minimum 6 dB bandwidth shall be at least 500 kHz.

##### 3.1.2 Measuring Instruments

The measuring equipment is listed in the section 4 of this test report.

##### 3.1.3 Test Procedures

1. The testing follows FCC KDB Publication No. 558074 DTS D01 Meas. Guidance v03r05.
2. The RF output of EUT was connected to the spectrum analyzer by RF cable and attenuator. The path loss was compensated to the results for each measurement.
3. Set to the maximum power setting and enable the EUT transmit continuously.
4. Make the measurement with the spectrum analyzer's resolution bandwidth (RBW) = 100 kHz. Set the Video bandwidth (VBW) = 300 kHz. In order to make an accurate measurement. The 6 dB bandwidth must be greater than 500 kHz.
5. For 99% Bandwidth Measurement, the spectrum analyzer's resolution bandwidth (RBW) = 1MHz and set the Video bandwidth (VBW) = 3MHz.
6. Measure and record the results in the test report.

##### 3.1.4 Test Setup

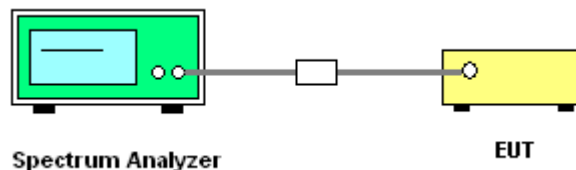



### 3.1.5 Test Result of 6dB and 99% Occupied Bandwidth

Please refer to Appendix A.

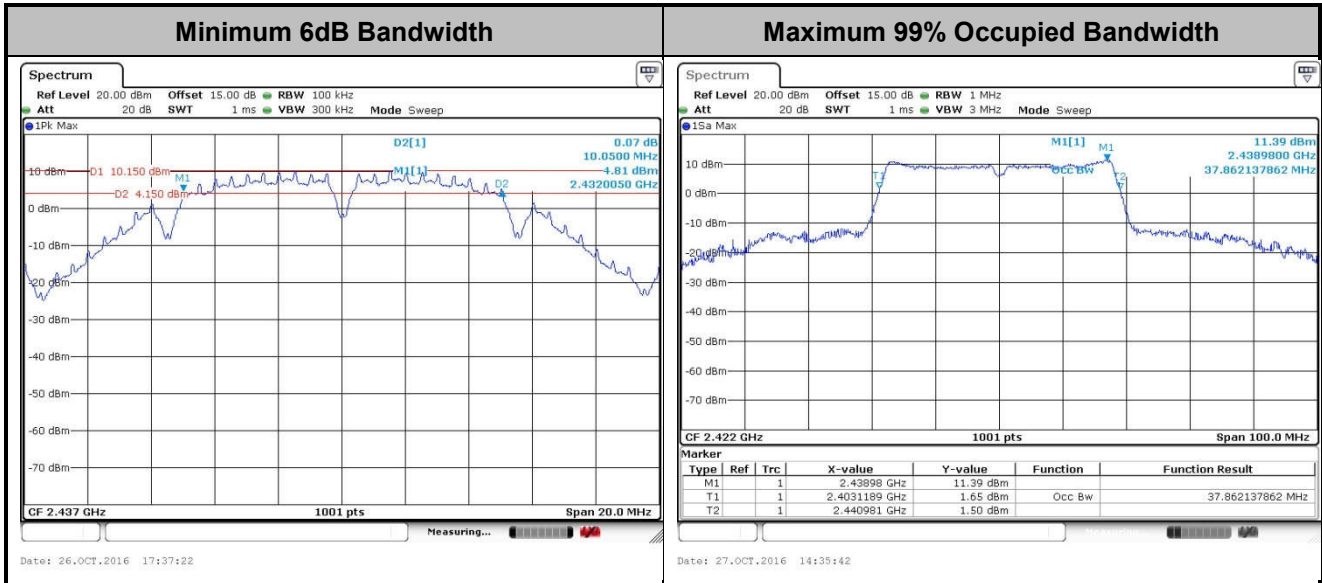

Note : The occupied channel bandwidth is maintained within the band of operation for all of the modulations.

## 3.2 Output Power Measurement

### 3.2.1 Limit of Output Power

For systems using digital modulation in the 2400-2483.5MHz, the limit for output power is 30dBm. If transmitting antenna with directional gain greater than 6dBi is used, the output power from the intentional radiator shall be reduced below the above stated value by the amount in dB that the directional gain of the antenna exceeds 6 dBi. In case of point-to-point operation, the limit has to be reduced by 1dB for every 3dB that the directional gain of the antenna exceeds 6dBi.

### 3.2.2 Measuring Instruments

The measuring equipment is listed in the section 4 of this test report.

### 3.2.3 Test Procedures

1. The testing follows the Measurement Procedure of FCC KDB No. 558074 DTS D01 Meas. Guidance v03r05 section 9.2.3.1 Method AVGPM.
2. The RF output of EUT was connected to the power meter by RF cable and attenuator. The path loss was compensated to the results for each measurement.
3. Set to the maximum power setting and enable the EUT transmit continuously.
4. Measure the conducted output power and record the results in the test report.
5. For MIMO mode, calculation method follows FCC KDB 662911 D01 Multiple Transmitter Output v02r01.

### 3.2.4 Test Setup

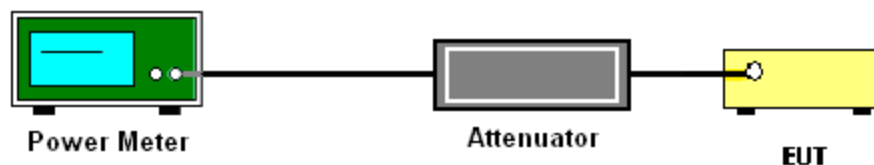





### **3.2.5 Test Result of Peak Output Power (Reporting Only)**

Please refer to Appendix A.

### **3.2.6 Test Result of Average output Power**

Please refer to Appendix A



### 3.3 Power Spectral Density Measurement

#### 3.3.1 Limit of Power Spectral Density

The peak power spectral density shall not be greater than 8dBm in any 3kHz band at any time interval of continuous transmission.

#### 3.3.2 Measuring Instruments

The measuring equipment is listed in the section 4 of this test report.

#### 3.3.3 Test Procedures

1. The testing follows Measurement Procedure 10.5 Method AVGPSD-2 of FCC KDB Publication No. 558074 D01 DTS Meas. Guidance v03r05.
2. The RF output of EUT was connected to the spectrum analyzer by RF cable and attenuator. The path loss was compensated to the results for each measurement.
3. Set to the maximum power setting and enable the EUT transmit continuously.
4. Make the measurement with the spectrum analyzer's resolution bandwidth (RBW) = 10 kHz. Video bandwidth VBW = 30 kHz In order to make an accurate measurement, set the span to 1.5 times DTS Channel Bandwidth. (6dB BW).
5. Number of points in sweep  $\geq 2$  Span / RBW. (This ensures that bin-to-bin spacing is  $\leq$  RBW/2, so that narrowband signals are not lost between frequency bins).
6. Detector = RMS, Sweep time = auto couple.
7. Trace average at least 100 traces in power averaging mode.
8. Add  $10 \log(1/x)$ , where x is the duty cycle, to the measured power in order to compute the average power during the actual transmission times. For example, add  $10 \log(1/0.25) = 6$  dB if the duty cycle is 25 percent.
9. Measure and record the results in the test report. For MIMO mode, calculation method follows FCC KDB 662911 D01 Multiple Transmitter Output v02r01.  
Method (c): Measure and add  $10 \log(N_{ANT})$  dB.

With this technique, spectrum measurements are performed at each output of the device, but rather than summing the spectra or the spectral peaks across the outputs, the quantity  $10 \log(N_{ANT})$  dB is added to each spectrum value before comparing to the emission limit. The addition of  $10 \log(N_{ANT})$  dB serves to apportion the emission limit among the  $N_{ANT}$  outputs so that each output is permitted to contribute no more than  $1/N_{ANT}^{th}$  of the PSD limit .

### 3.3.4 Test Setup

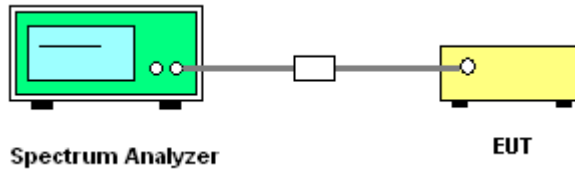

### 3.3.5 Test Result of Power Spectral Density

Please refer to Appendix A.

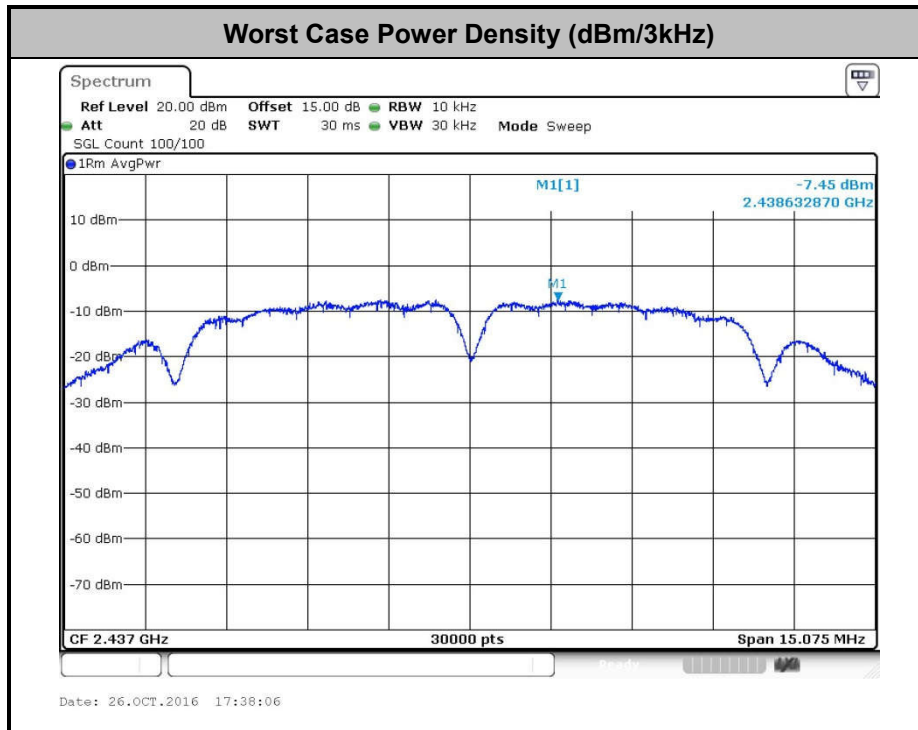

## 3.4 Conducted Band Edges and Spurious Emission Measurement

### 3.4.1 Limit of Conducted Band Edges and Spurious Emission Measurement

In any 100 kHz bandwidth outside of the authorized frequency band, the emissions which fall in the non-restricted bands shall be attenuated at least 20 dB / 30dB relative to the maximum PSD level in 100 kHz by RF conducted measurement and radiated emissions which fall in the restricted bands, as defined in Section 15.205(a), must also comply with the radiated emission limits specified in Section 15.209(a).

### 3.4.2 Measuring Instruments

The measuring equipment is listed in the section 4 of this test report.

### 3.4.3 Test Procedures

1. The testing follows FCC KDB Publication No. 558074 D01 DTS Meas. Guidance v03r05.
2. The RF output of EUT was connected to the spectrum analyzer by RF cable and attenuator. The path loss was compensated to the results for each measurement.
3. Set to the maximum power setting and enable the EUT transmit continuously.
4. Set RBW = 100 kHz, VBW=300 kHz, Peak Detector. Unwanted Emissions measured in any 100 kHz bandwidth outside of the authorized frequency band shall be attenuated by at least 20 dB relative to the maximum in-band peak PSD level in 100 kHz when maximum peak conducted output power procedure is used. If the transmitter complies with the conducted power limits based on the use of RMS averaging over a time interval, the attenuation required under this paragraph shall be 30 dB instead of 20 dB per 15.247(d).
5. Measure and record the results in the test report.
6. The RF fundamental frequency should be excluded against the limit line in the operating frequency band.

### 3.4.4 Test Setup

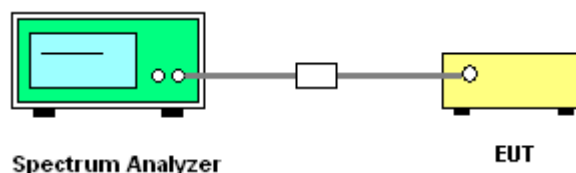



### 3.4.5 Test Result of Conducted Band Edges and Spurious Emission

Number of TX = 2, Ant. 1 (Measured)

Number of TX	2	Ant. :	1
Test Mode :	802.11b	Temperature :	24~26°C
Test Band :	2.4GHz Low	Relative Humidity :	50~53%
Test Channel :	01	Test Engineer :	Bruce Huang

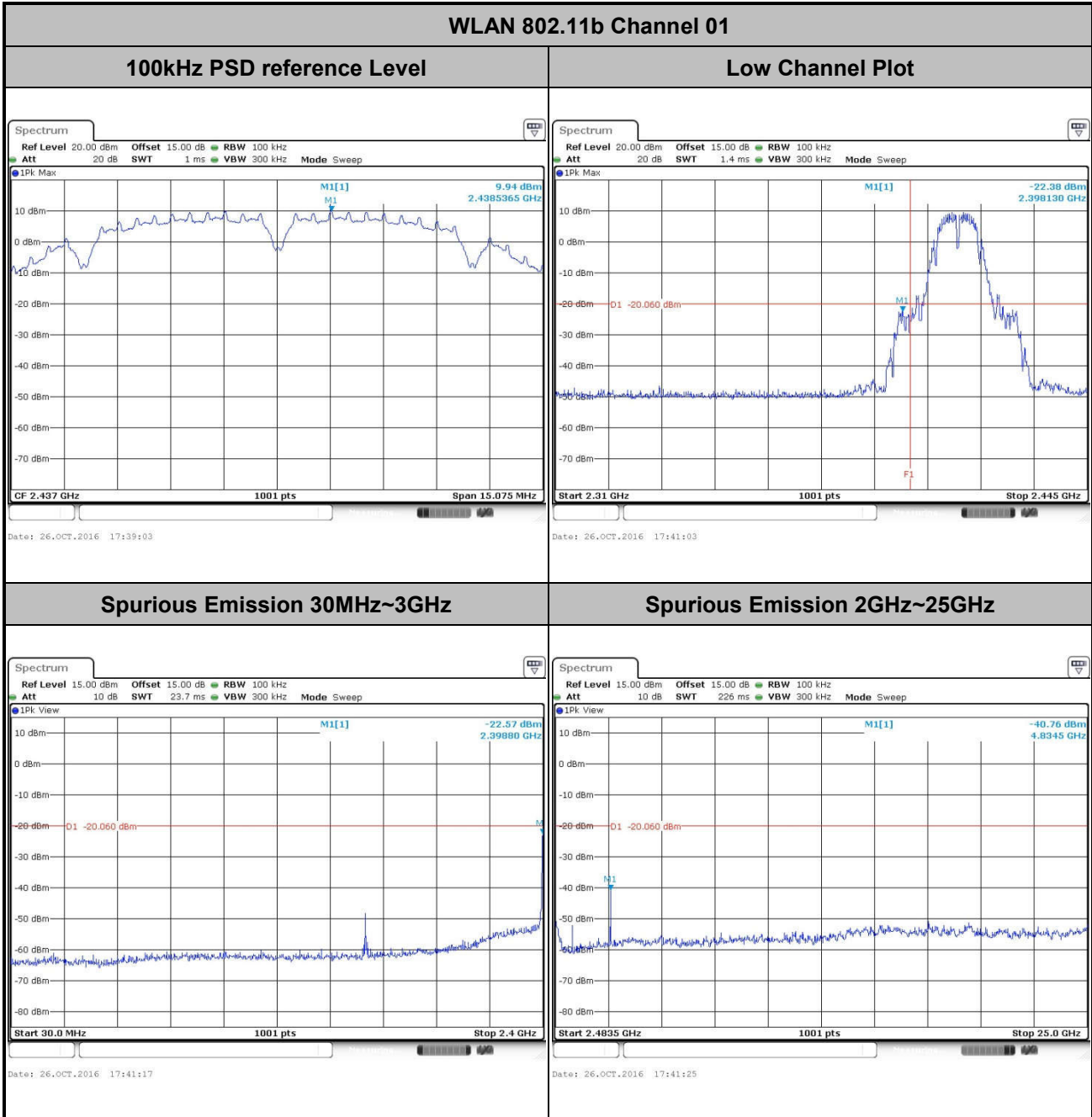



Number of TX :	2	Ant. :	1
Test Mode :	802.11b	Temperature :	24~26°C
Test Band :	2.4GHz Mid	Relative Humidity :	50~53%
Test Channel :	06	Test Engineer :	Bruce Huang

WLAN 802.11b Channel 06

100kHz PSD reference Level

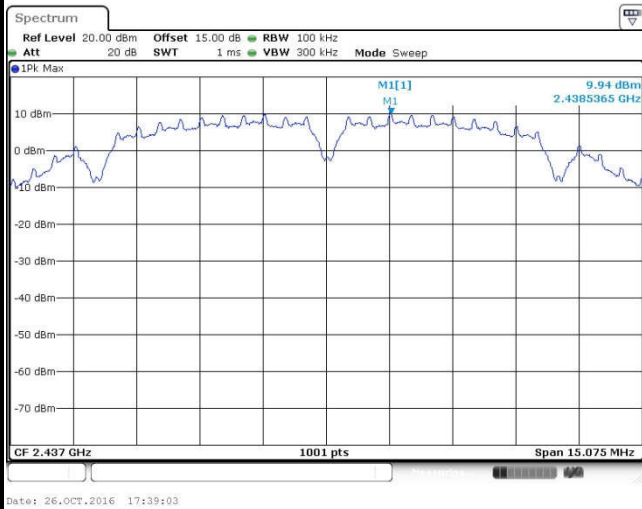

Spurious Emission 30MHz~3GHz

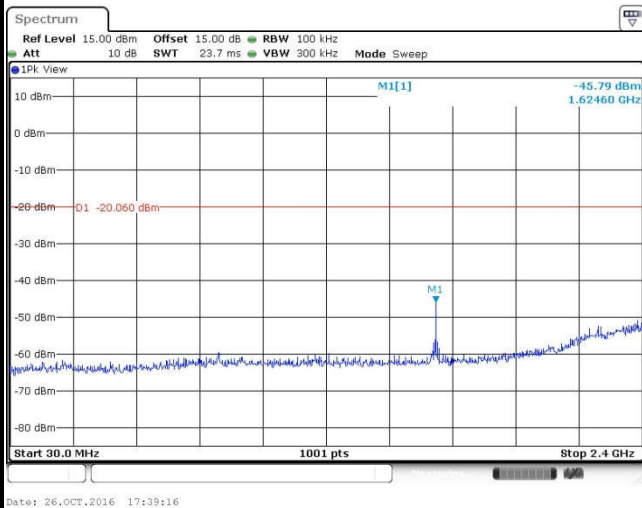

Spurious Emission 2GHz~25GHz

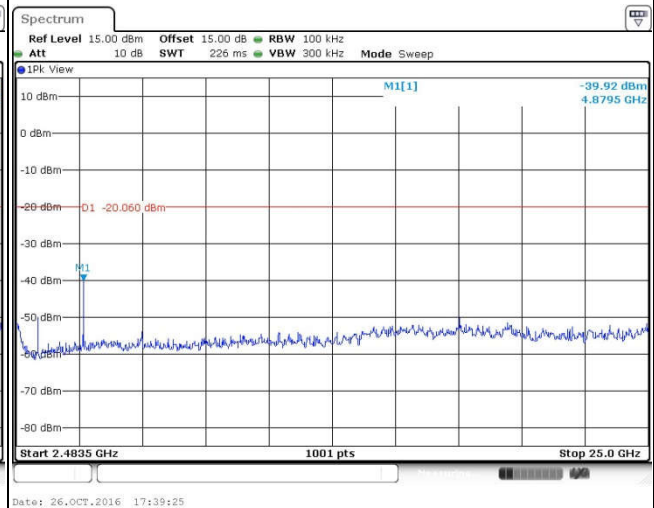



Number of TX :	2	Ant. :	1
Test Mode :	802.11b	Temperature :	24~26°C
Test Band :	2.4GHz High	Relative Humidity :	50~53%
Test Channel :	11	Test Engineer :	Bruce Huang

WLAN 802.11b Channel 11

100kHz PSD reference Level

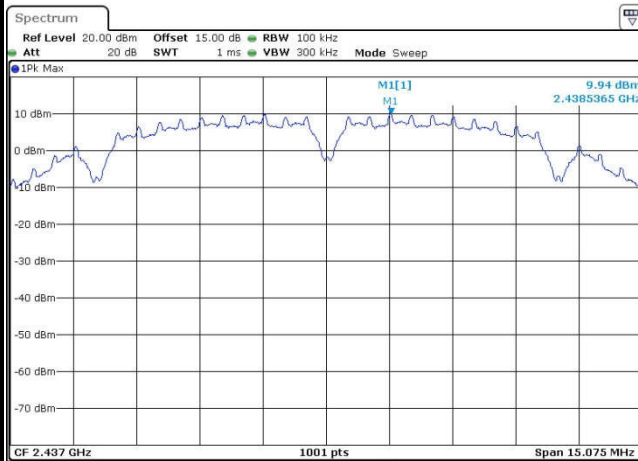

Date: 26.OCT.2016 17:39:03

High Channel Plot

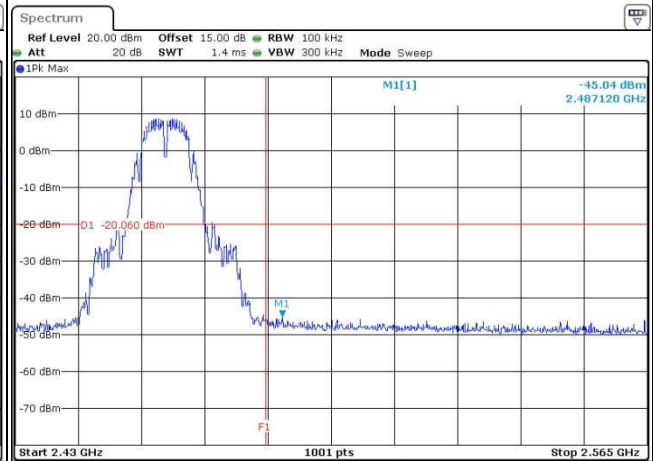

Date: 26.OCT.2016 17:53:58

Spurious Emission 30MHz~3GHz

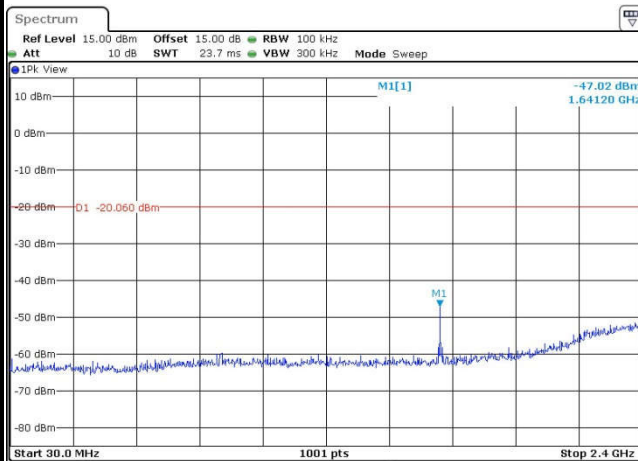

Date: 26.OCT.2016 17:54:08

Spurious Emission 2GHz~25GHz

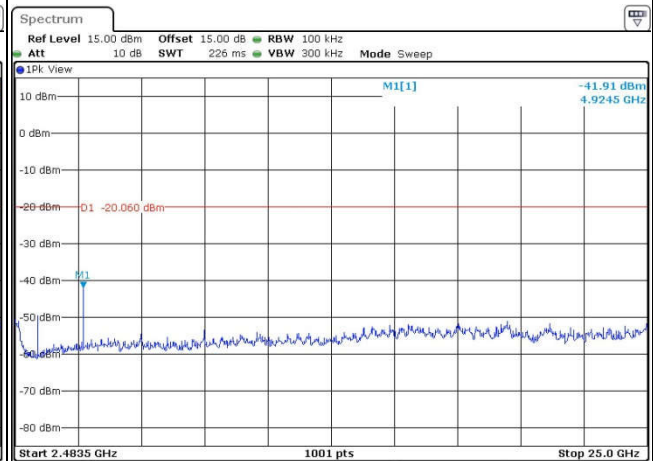

Date: 26.OCT.2016 17:54:17



Number of TX :	2	Ant. :	1
Test Mode :	802.11g	Temperature :	24~26°C
Test Band :	2.4GHz Low	Relative Humidity :	50~53%
Test Channel :	01	Test Engineer :	Bruce Huang

WLAN 802.11g Channel 01

100kHz PSD reference Level

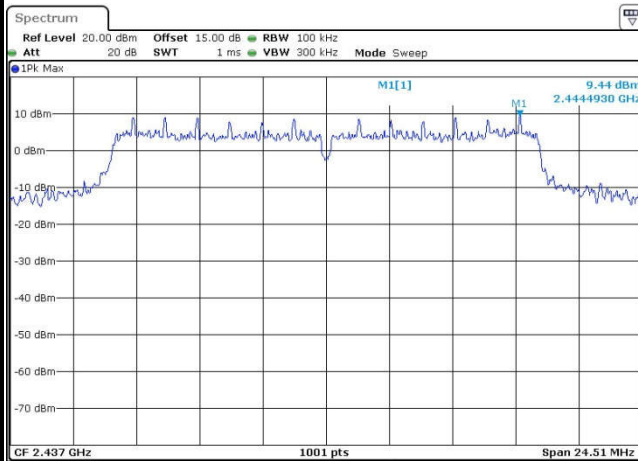

Date: 27.OCT.2016 08:55:28

Low Channel Plot

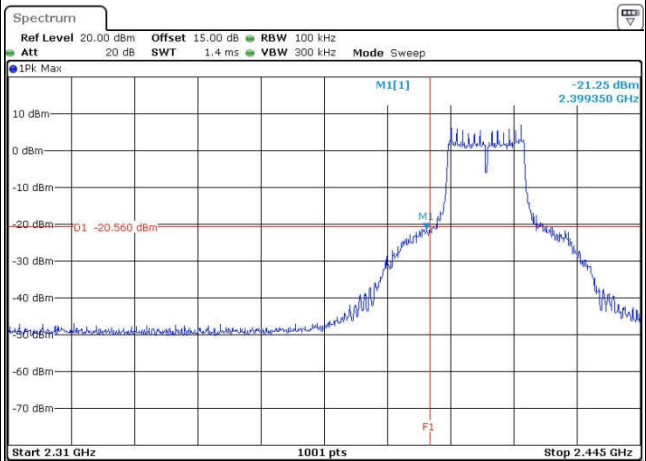

Date: 27.OCT.2016 09:12:20

Spurious Emission 30MHz~3GHz

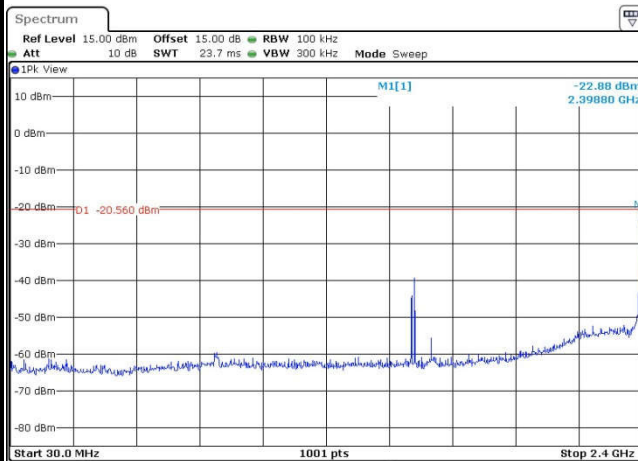

Date: 27.OCT.2016 09:13:06

Spurious Emission 2GHz~25GHz

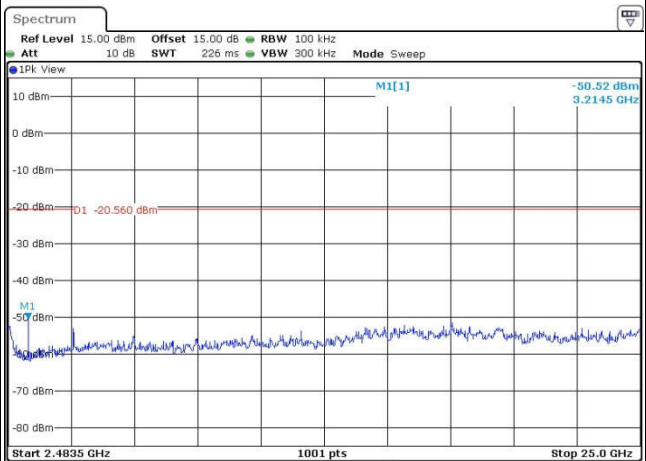

Date: 27.OCT.2016 09:13:15





Number of TX :	2	Ant. :	1
Test Mode :	802.11g	Temperature :	24~26°C
Test Band :	2.4GHz Mid	Relative Humidity :	50~53%
Test Channel :	06	Test Engineer :	Bruce Huang

WLAN 802.11g Channel 06

100kHz PSD reference Level

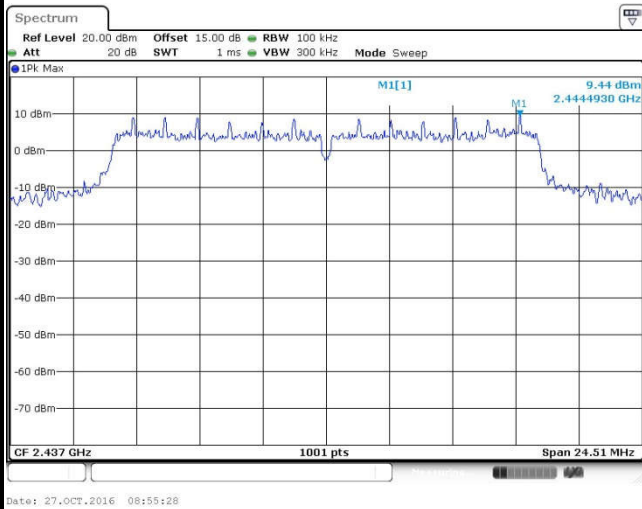

Spurious Emission 30MHz~3GHz

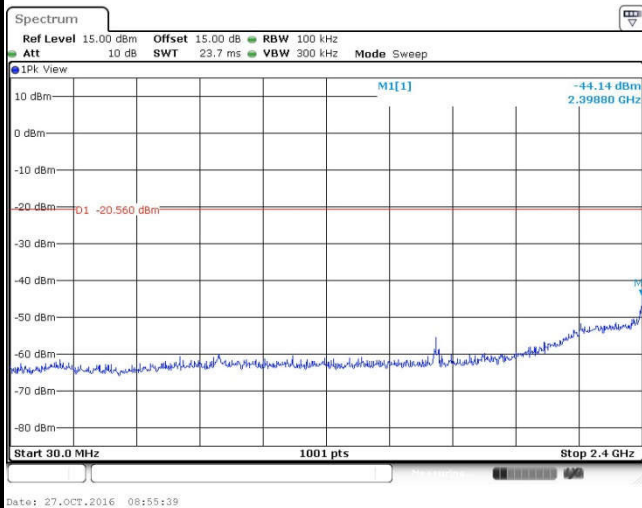

Spurious Emission 2GHz~25GHz

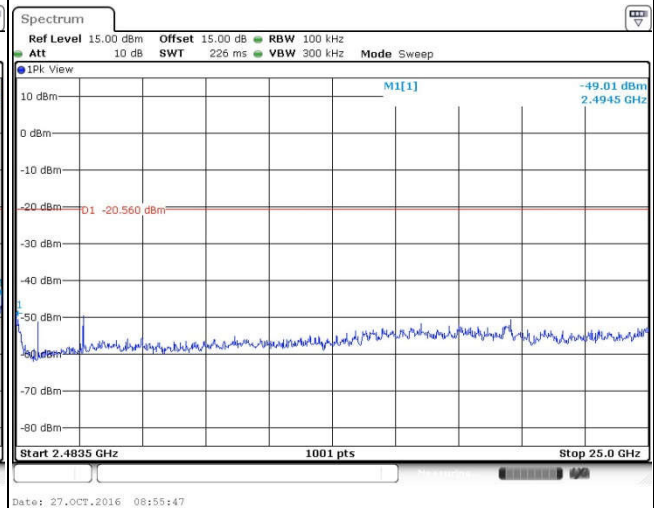



Number of TX :	2	Ant. :	1
Test Mode :	802.11g	Temperature :	24~26°C
Test Band :	2.4GHz High	Relative Humidity :	50~53%
Test Channel :	11	Test Engineer :	Bruce Huang

WLAN 802.11g Channel 11

100kHz PSD reference Level

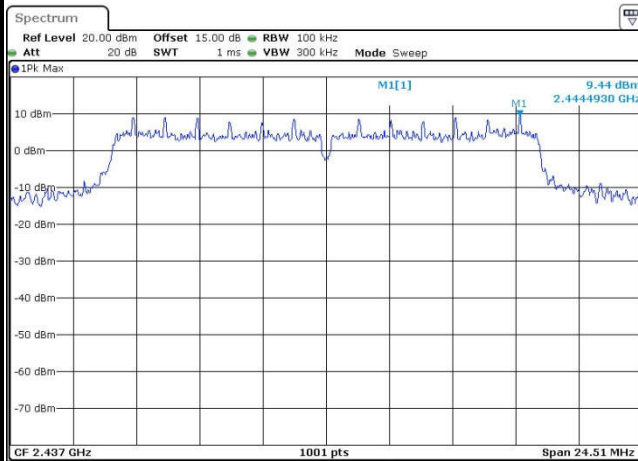

Date: 27.OCT.2016 08:55:28

High Channel Plot

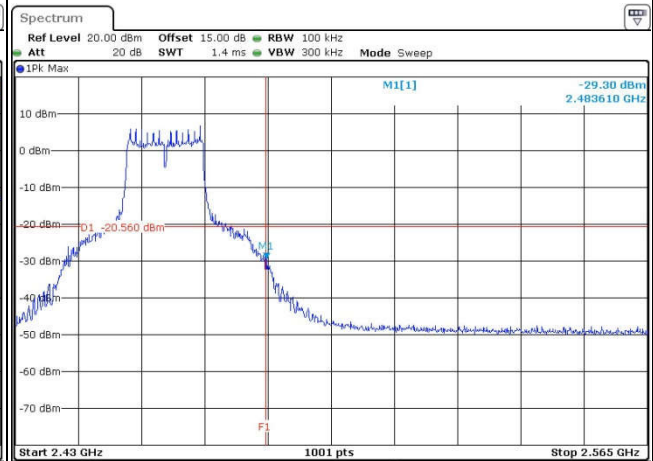

Date: 27.OCT.2016 09:29:09

Spurious Emission 30MHz~3GHz

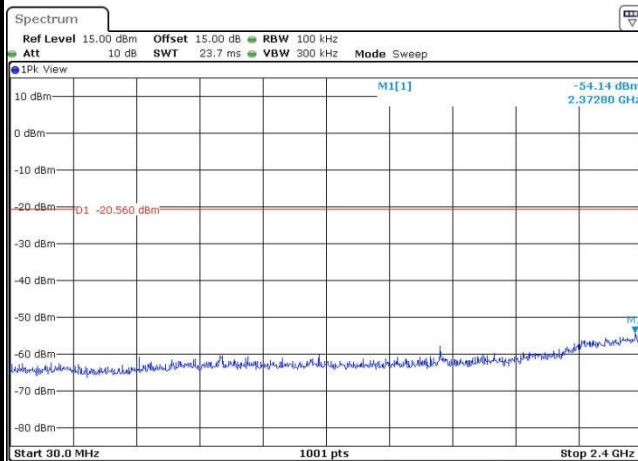

Date: 27.OCT.2016 09:29:21

Spurious Emission 2GHz~25GHz

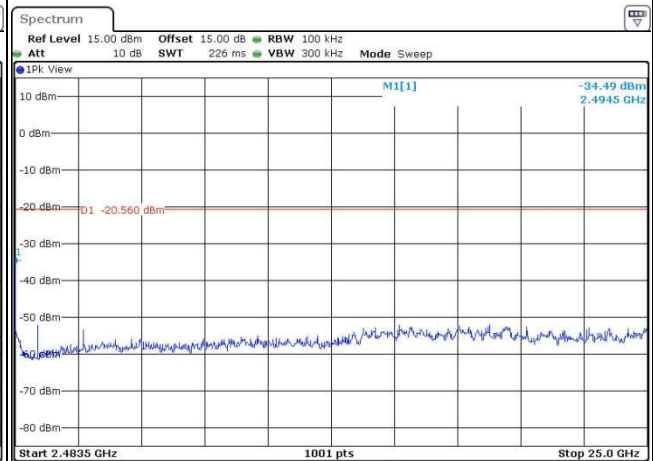

Date: 27.OCT.2016 09:29:30



Number of TX :	2	Ant. :	1
Test Mode :	802.11n HT20	Temperature :	24~26°C
Test Band :	2.4GHz Low	Relative Humidity :	50~53%
Test Channel :	01	Test Engineer :	Bruce Huang

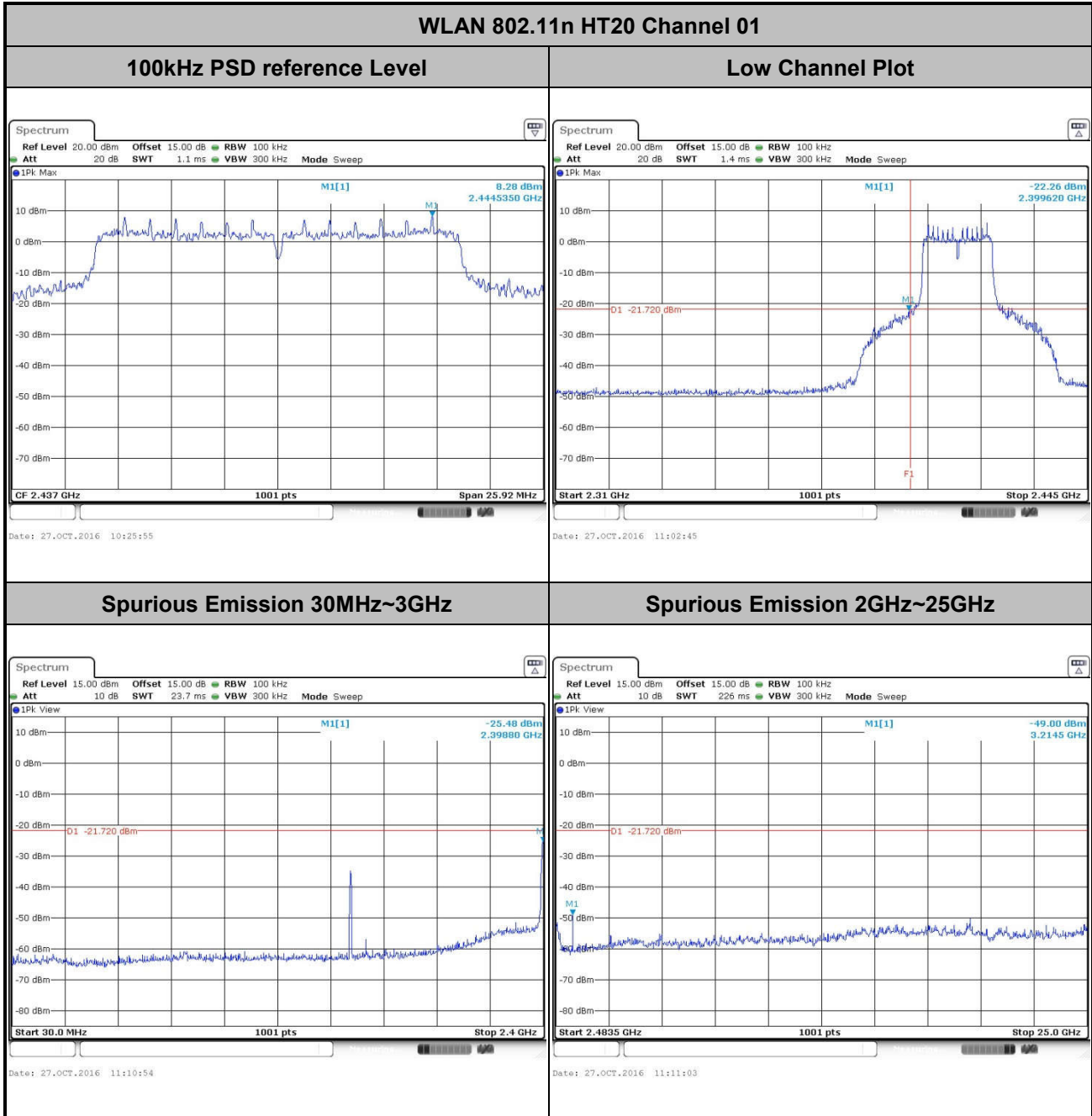



Number of TX :	2	Ant. :	1
Test Mode :	802.11n HT20	Temperature :	24~26°C
Test Band :	2.4GHz Mid	Relative Humidity :	50~53%
Test Channel :	06	Test Engineer :	Bruce Huang

WLAN 802.11n HT20 Channel 06

100kHz PSD reference Level

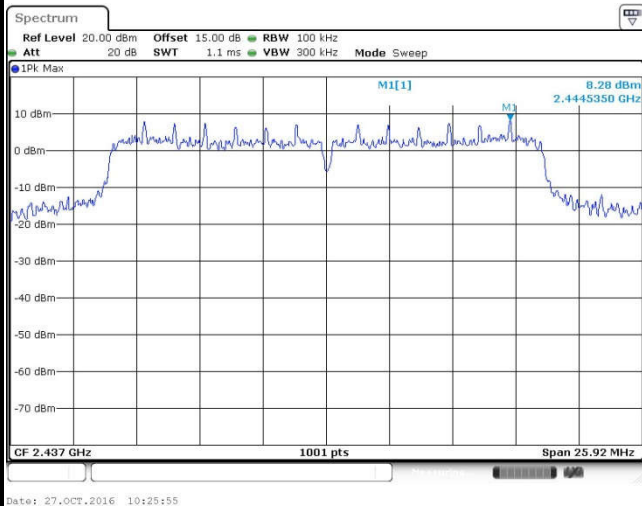

Spurious Emission 30MHz~3GHz

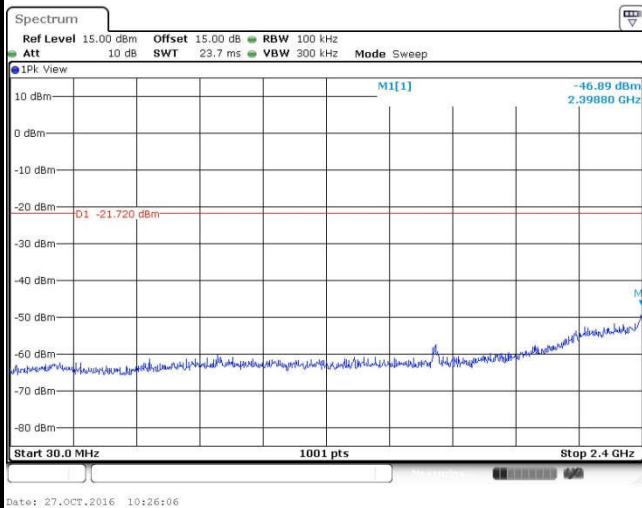

Spurious Emission 2GHz~25GHz

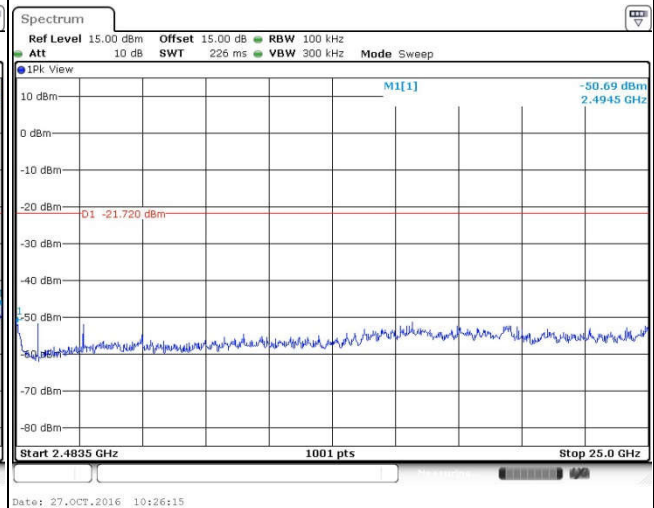



Number of TX :	2	Ant. :	1
Test Mode :	802.11n HT20	Temperature :	24~26°C
Test Band :	2.4GHz High	Relative Humidity :	50~53%
Test Channel :	11	Test Engineer :	Bruce Huang

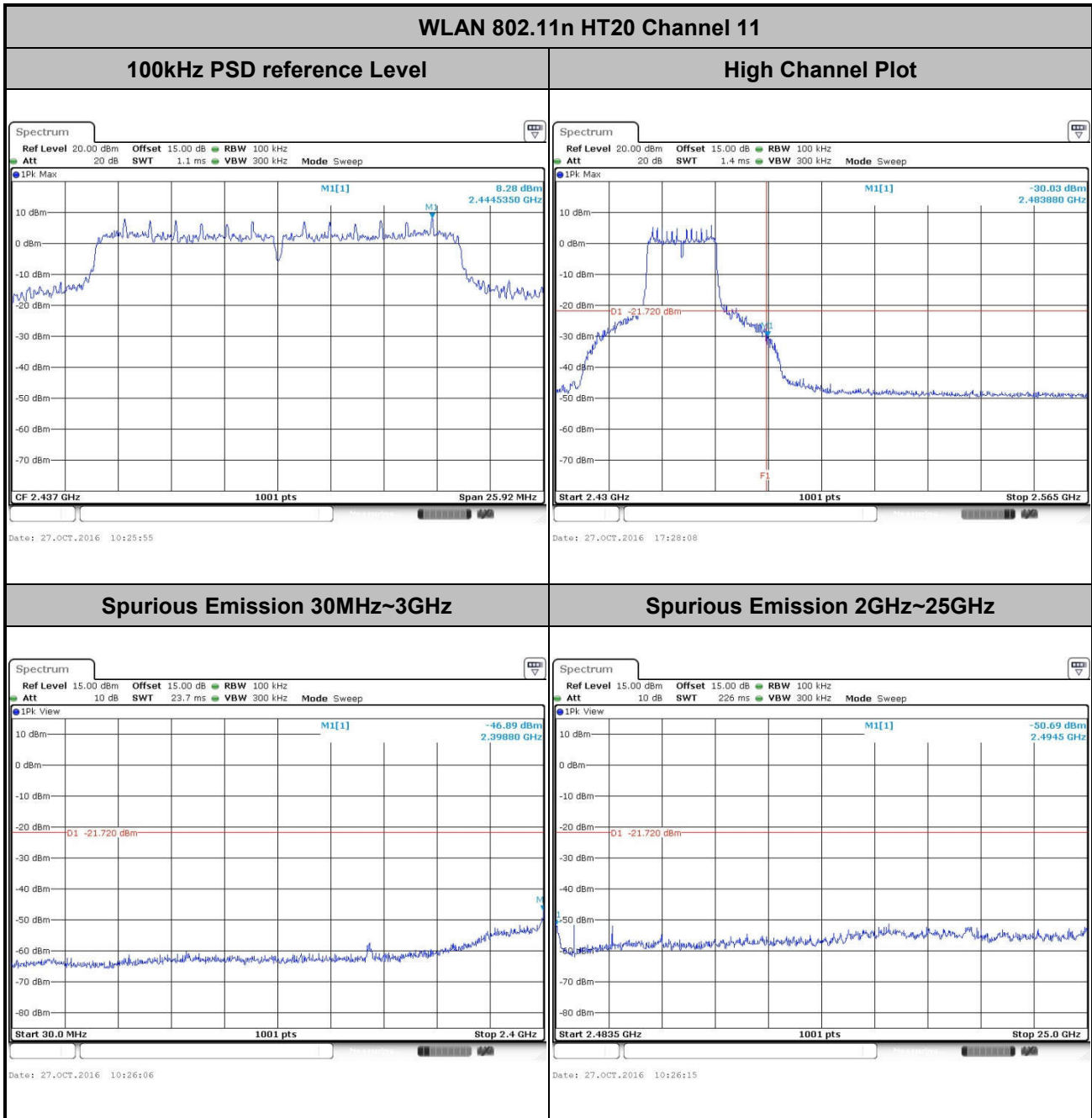



Number of TX :	2	Ant. :	1
Test Mode :	802.11n HT40	Temperature :	24~26°C
Test Band :	2.4GHz Low	Relative Humidity :	50~53%
Test Channel :	03	Test Engineer :	Bruce Huang

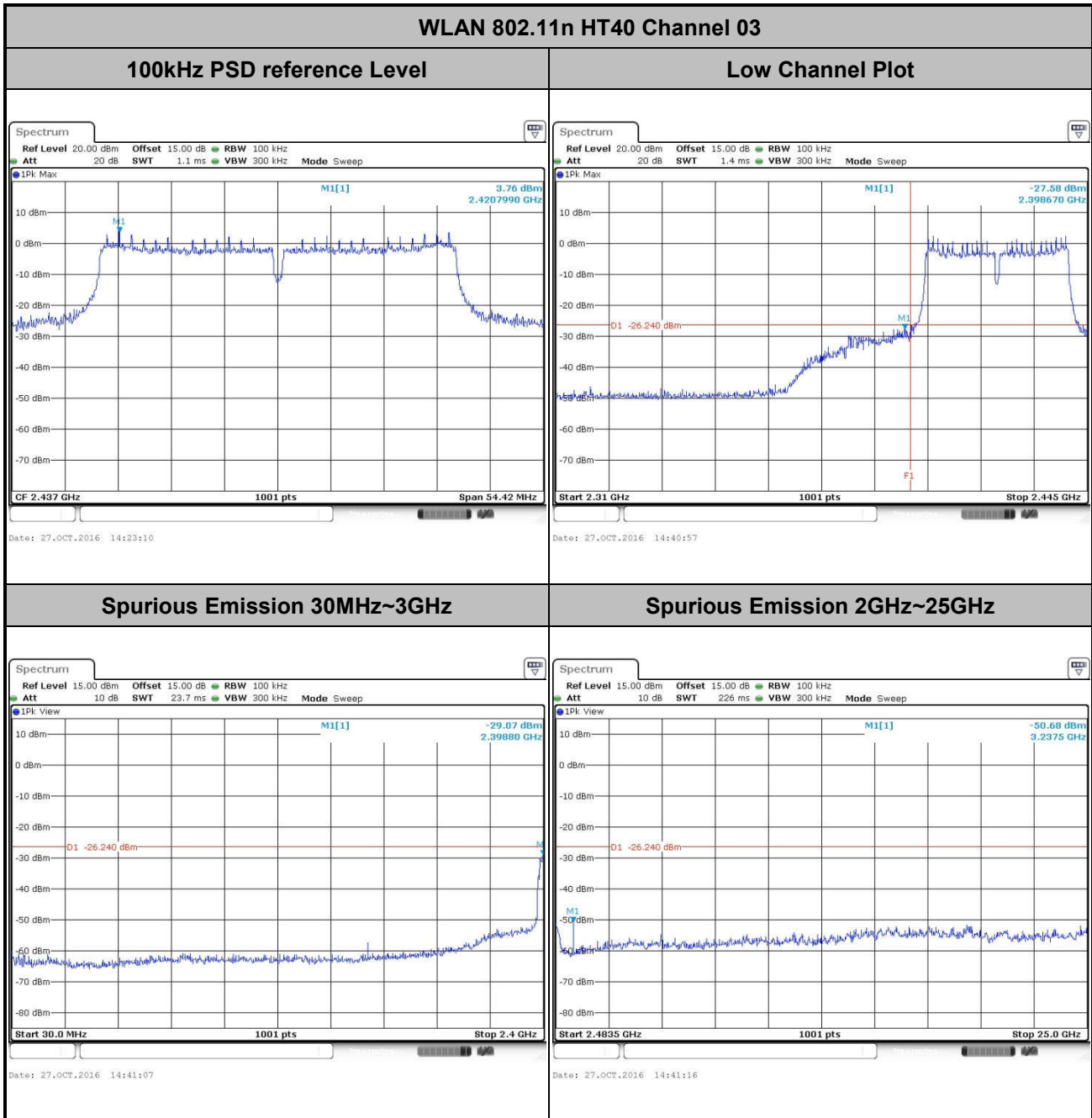



Number of TX :	2	Ant. :	1
Test Mode :	802.11n HT40	Temperature :	24~26°C
Test Band :	2.4GHz Mid	Relative Humidity :	50~53%
Test Channel :	06	Test Engineer :	Bruce Huang

WLAN 802.11n HT40 Channel 06

100kHz PSD reference Level

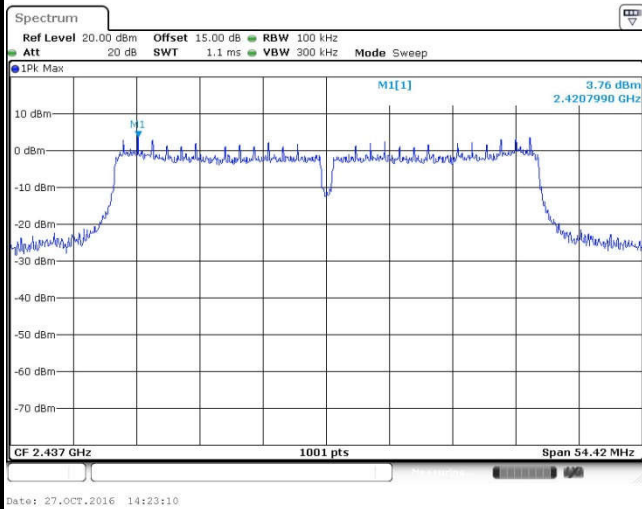

Spurious Emission 30MHz~3GHz

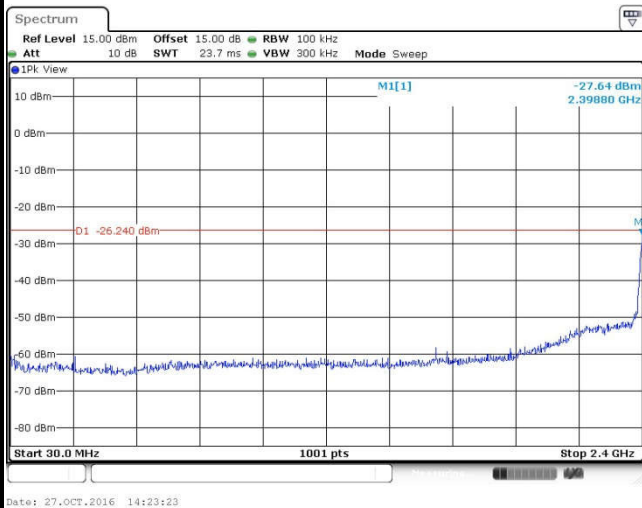

Spurious Emission 2GHz~25GHz

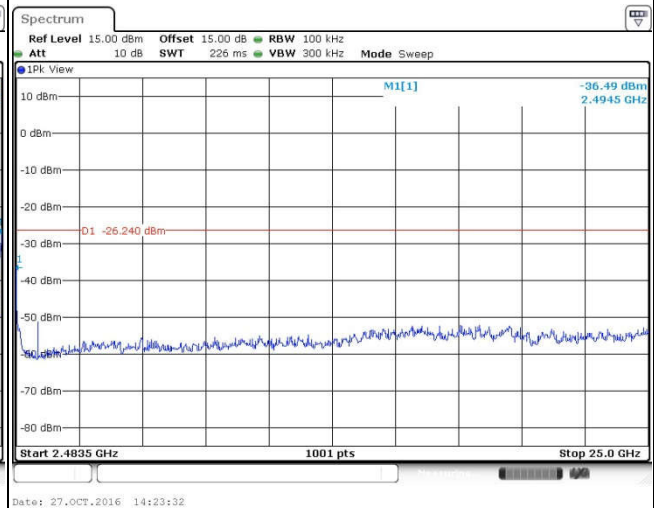



Number of TX :	2	Ant. :	1
Test Mode :	802.11n HT40	Temperature :	24~26°C
Test Band :	2.4GHz High	Relative Humidity :	50~53%
Test Channel :	09	Test Engineer :	Bruce Huang

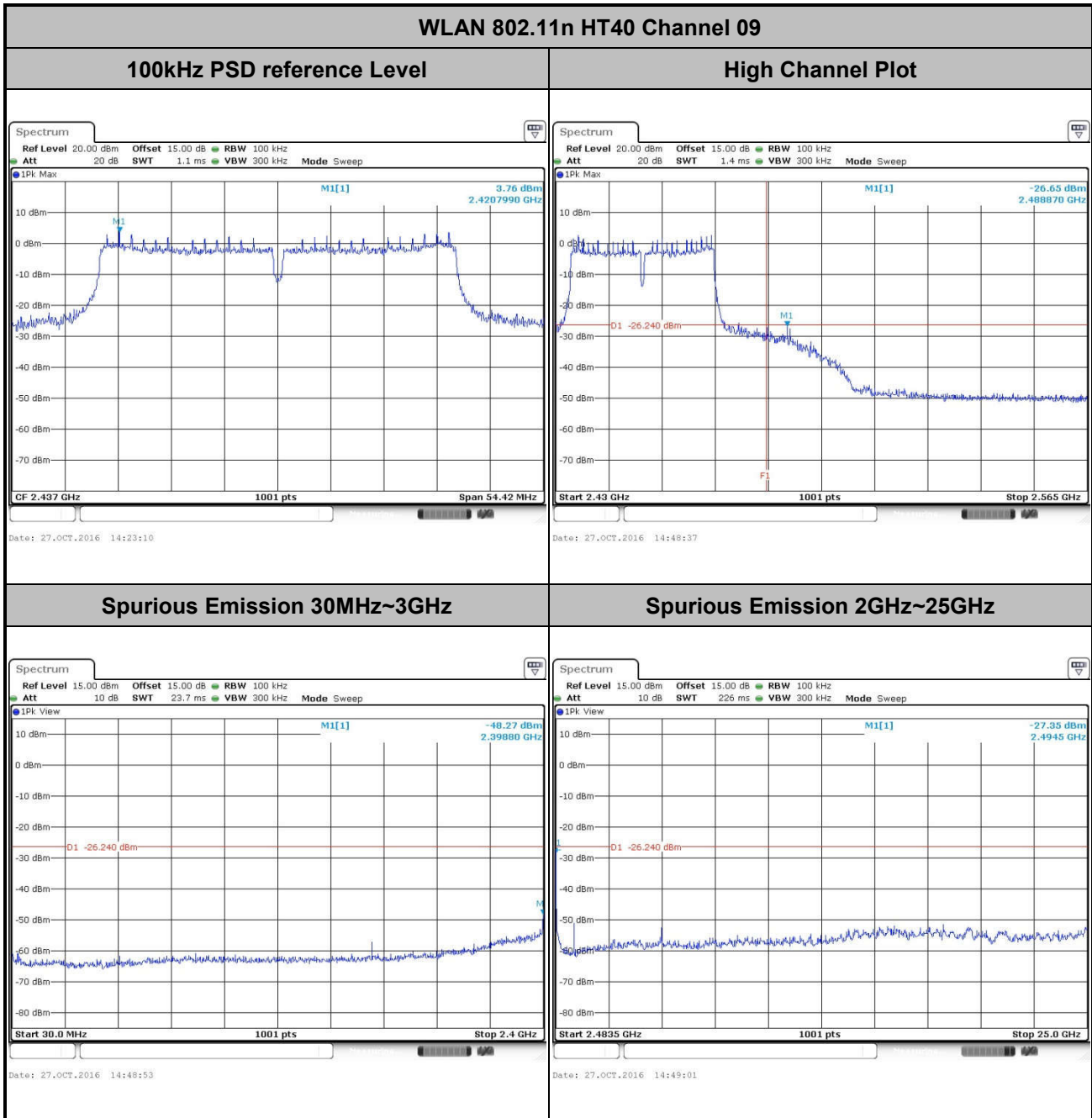





Number of TX = 2 Ant. 2 (Measured)

Number of TX :	2	Ant. :	2
Test Mode :	802.11b	Temperature :	24~26°C
Test Band :	2.4GHz Low	Relative Humidity :	50~53%
Test Channel :	01	Test Engineer :	Bruce Huang

WLAN 802.11b Channel 01

100kHz PSD reference Level

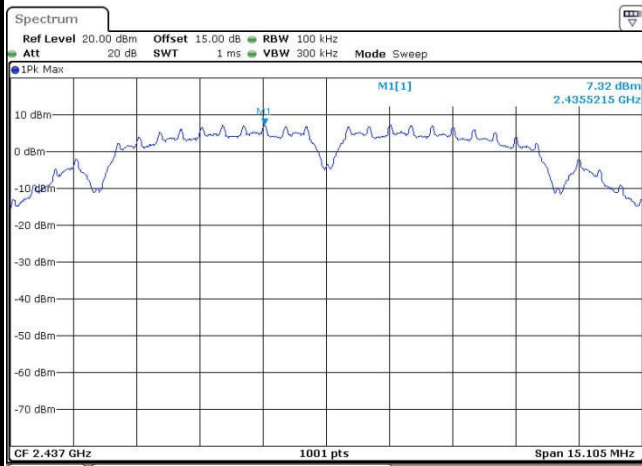

Date: 26.OCT.2016 11:47:08

Low Channel Plot

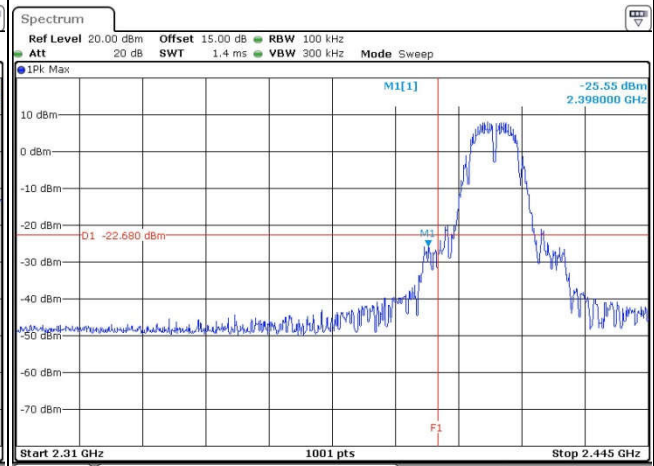

Date: 26.OCT.2016 14:54:53

Spurious Emission 30MHz~3GHz

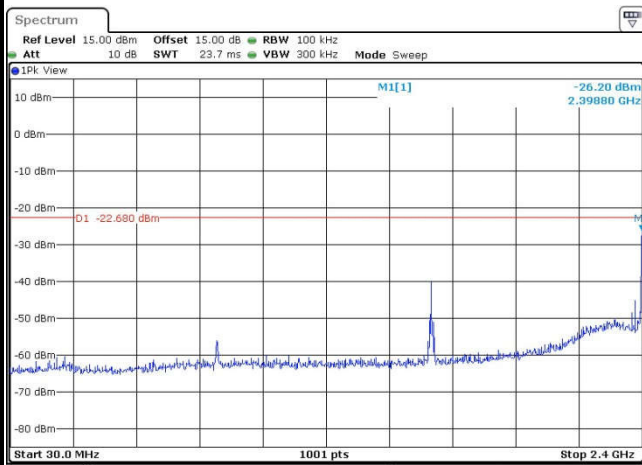

Date: 26.OCT.2016 14:55:03

Spurious Emission 2GHz~25GHz

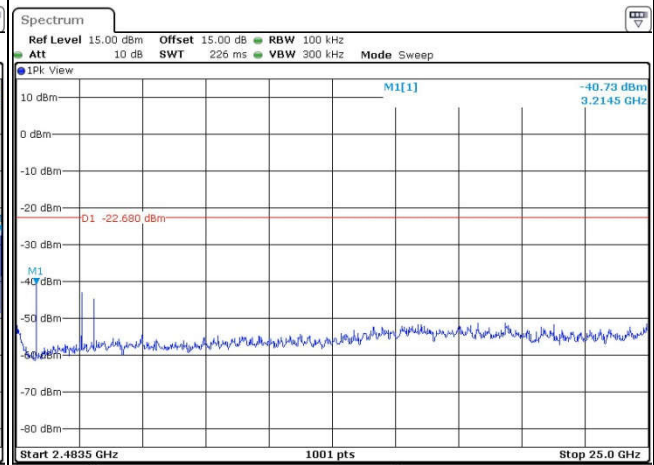

Date: 26.OCT.2016 14:55:12



Number of TX :	2	Ant. :	2
Test Mode :	802.11b	Temperature :	24~26°C
Test Band :	2.4GHz Mid	Relative Humidity :	50~53%
Test Channel :	06	Test Engineer :	Bruce Huang

WLAN 802.11b Channel 06

100kHz PSD reference Level

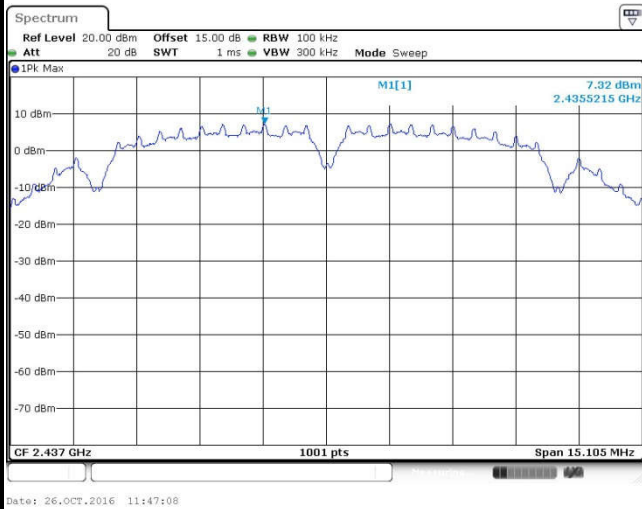

Spurious Emission 30MHz~3GHz

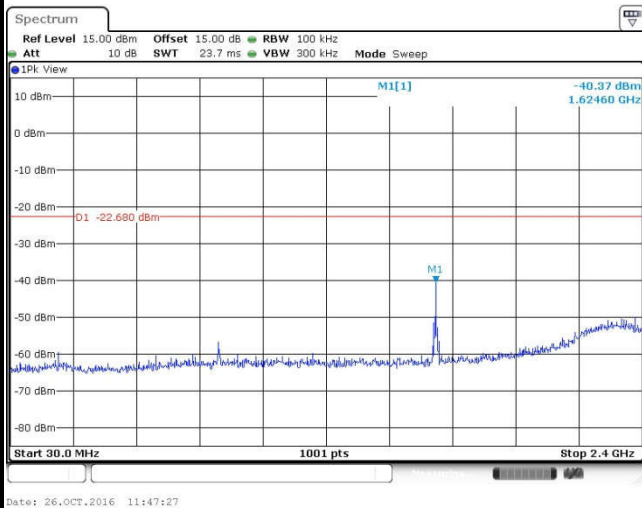

Spurious Emission 2GHz~25GHz

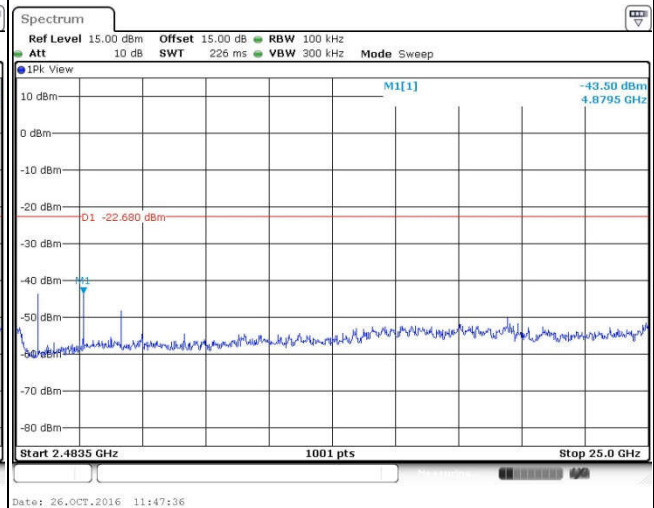



Number of TX :	2	Ant. :	2
Test Mode :	802.11b	Temperature :	24~26°C
Test Band :	2.4GHz High	Relative Humidity :	50~53%
Test Channel :	11	Test Engineer :	Bruce Huang

WLAN 802.11b Channel 11

100kHz PSD reference Level

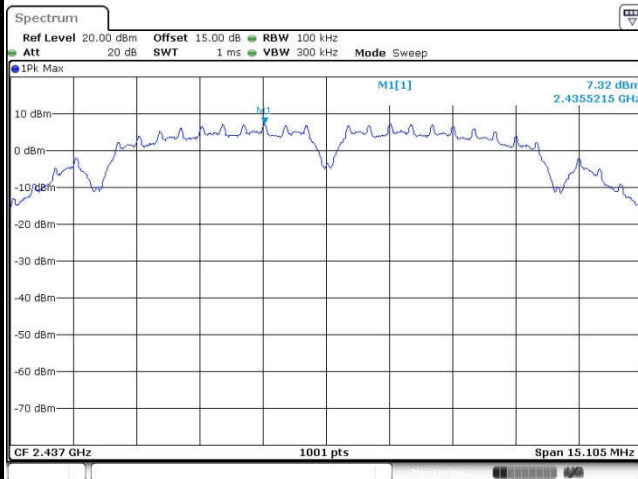

Date: 26.OCT.2016 11:47:08

High Channel Plot

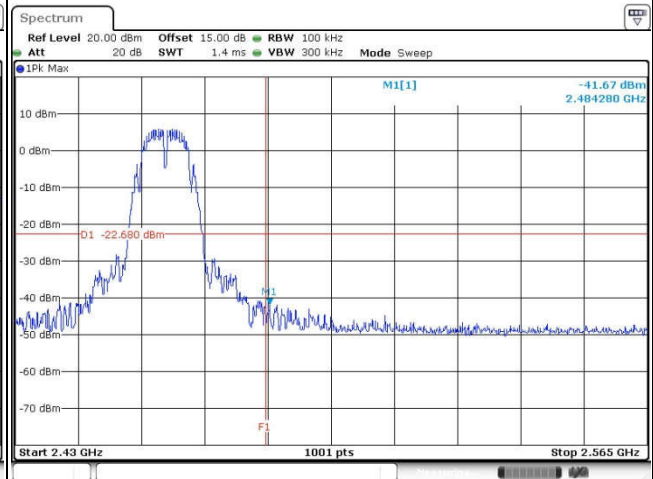

Date: 26.OCT.2016 14:56:26

Spurious Emission 30MHz~3GHz

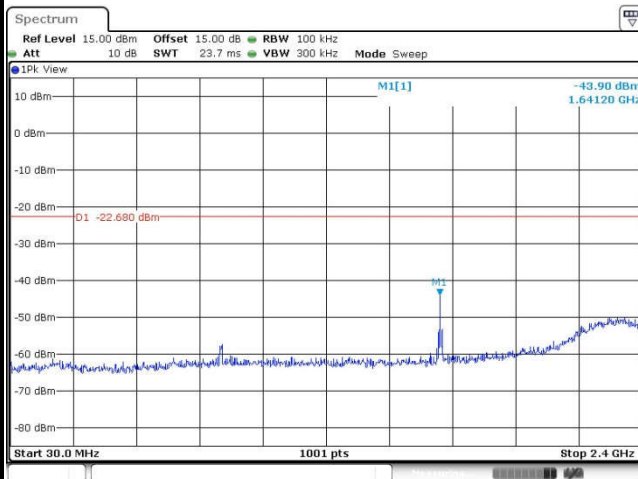

Date: 26.OCT.2016 14:56:36

Spurious Emission 2GHz~25GHz

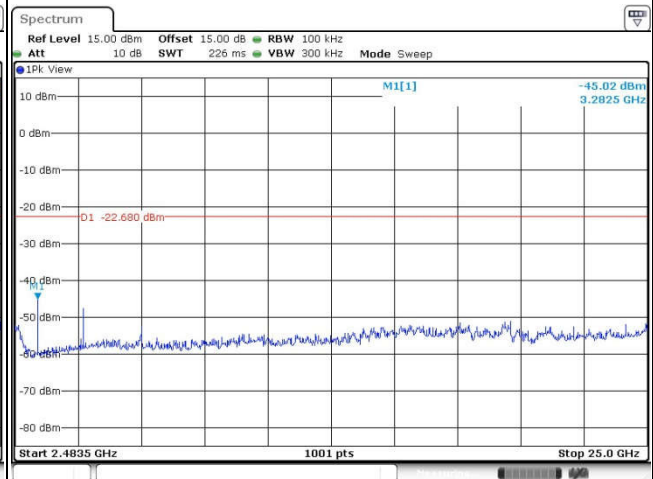

Date: 26.OCT.2016 14:56:45



Number of TX :	2	Ant. :	2
Test Mode :	802.11g	Temperature :	24~26°C
Test Band :	2.4GHz Low	Relative Humidity :	50~53%
Test Channel :	01	Test Engineer :	Bruce Huang

WLAN 802.11g Channel 01

100kHz PSD reference Level

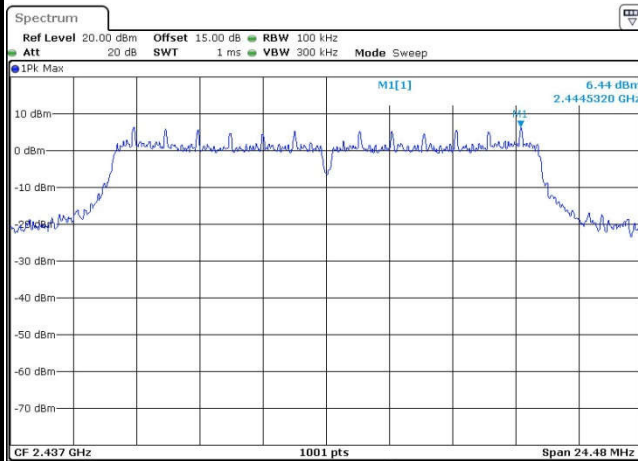

Date: 26.OCT.2016 14:34:50

Low Channel Plot

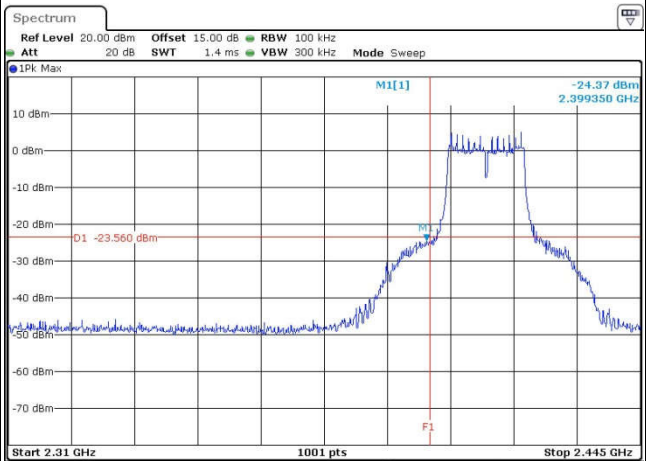

Date: 26.OCT.2016 14:41:17

Spurious Emission 30MHz~3GHz

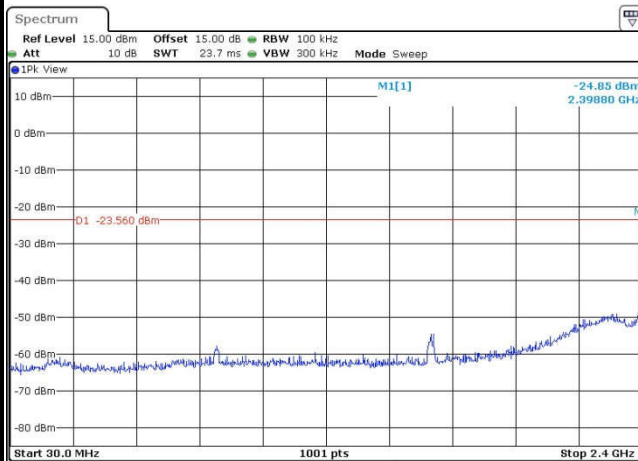

Date: 26.OCT.2016 14:41:31

Spurious Emission 2GHz~25GHz

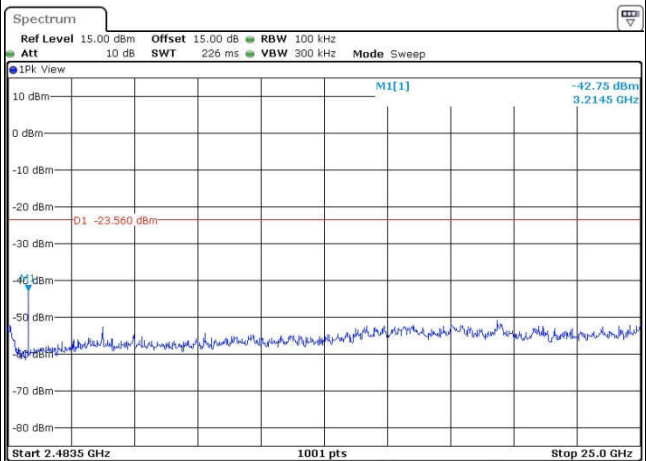

Date: 26.OCT.2016 14:41:39



Number of TX :	2	Ant. :	2
Test Mode :	802.11g	Temperature :	24~26°C
Test Band :	2.4GHz Mid	Relative Humidity :	50~53%
Test Channel :	06	Test Engineer :	Bruce Huang

WLAN 802.11g Channel 06

100kHz PSD reference Level

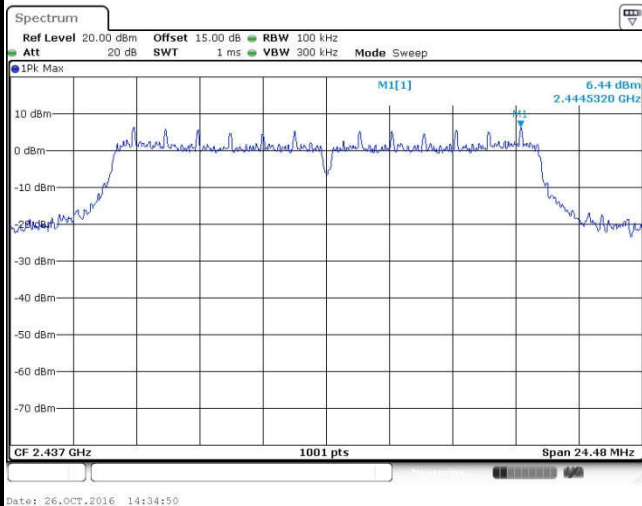

Spurious Emission 30MHz~3GHz

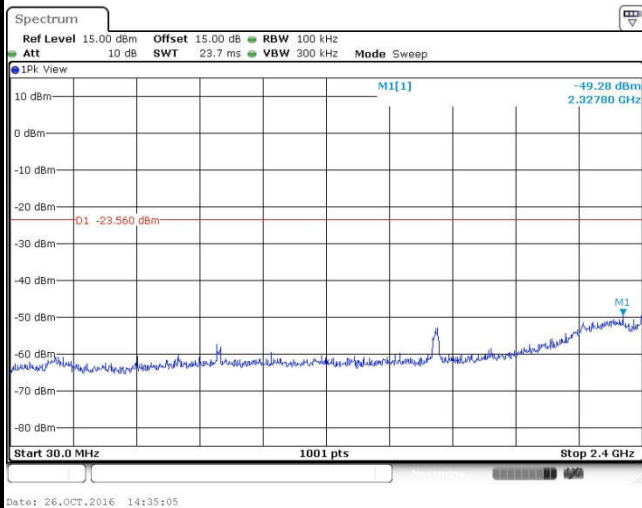

Spurious Emission 2GHz~25GHz

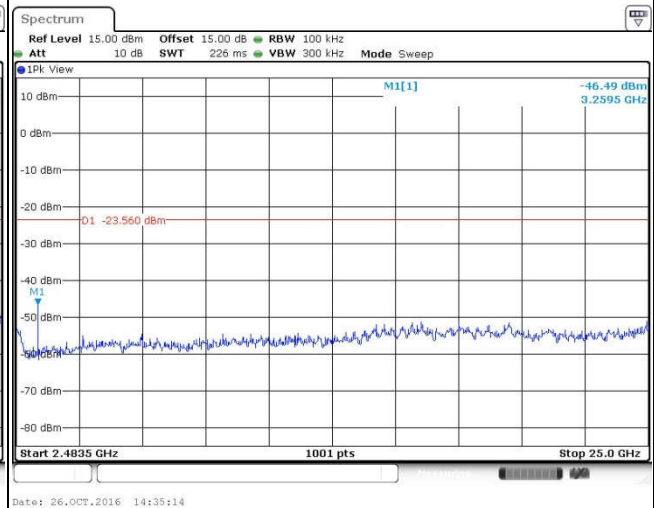



Number of TX :	2	Ant. :	2
Test Mode :	802.11g	Temperature :	24~26°C
Test Band :	2.4GHz High	Relative Humidity :	50~53%
Test Channel :	11	Test Engineer :	Bruce Huang

WLAN 802.11g Channel 11

100kHz PSD reference Level

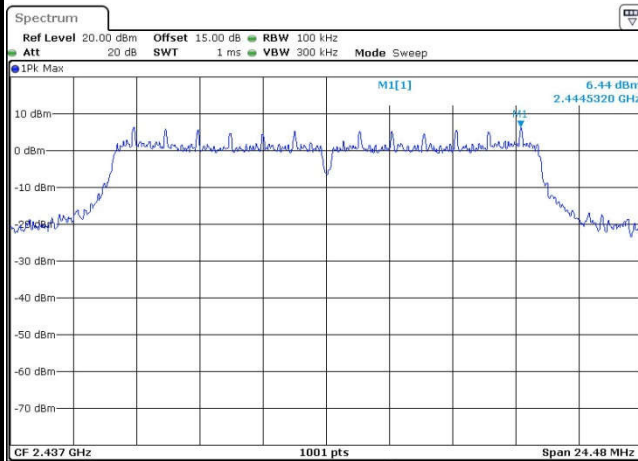

Date: 26.OCT.2016 14:34:50

High Channel Plot

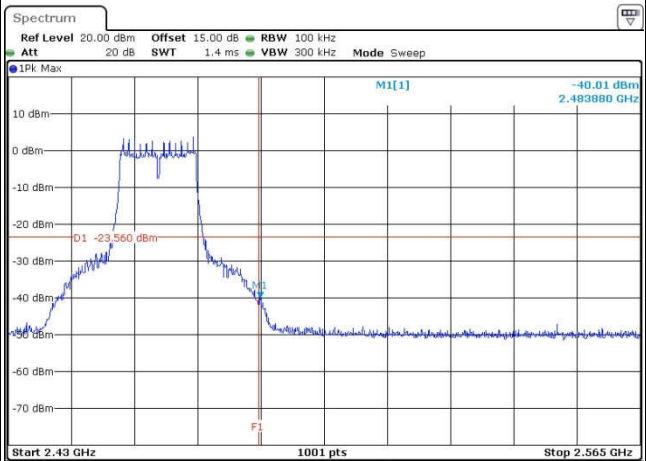

Date: 26.OCT.2016 14:51:45

Spurious Emission 30MHz~3GHz

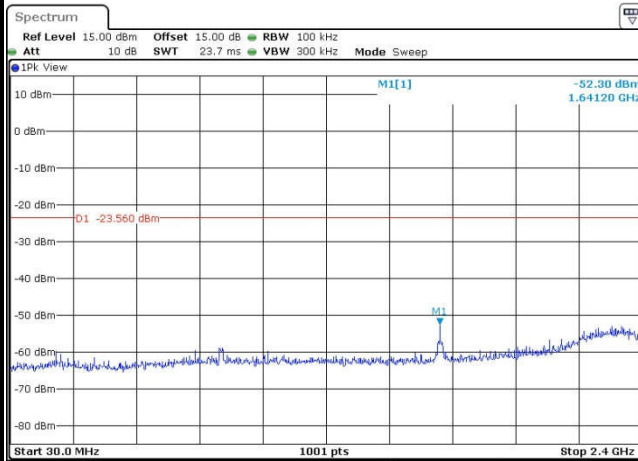

Date: 26.OCT.2016 14:53:03

Spurious Emission 2GHz~25GHz

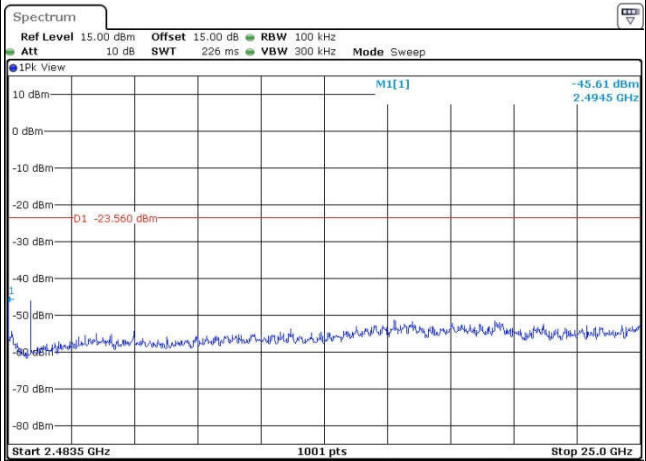

Date: 26.OCT.2016 14:53:12



Number of TX :	2	Ant. :	2
Test Mode :	802.11n HT20	Temperature :	24~26°C
Test Band :	2.4GHz Low	Relative Humidity :	50~53%
Test Channel :	01	Test Engineer :	Bruce Huang

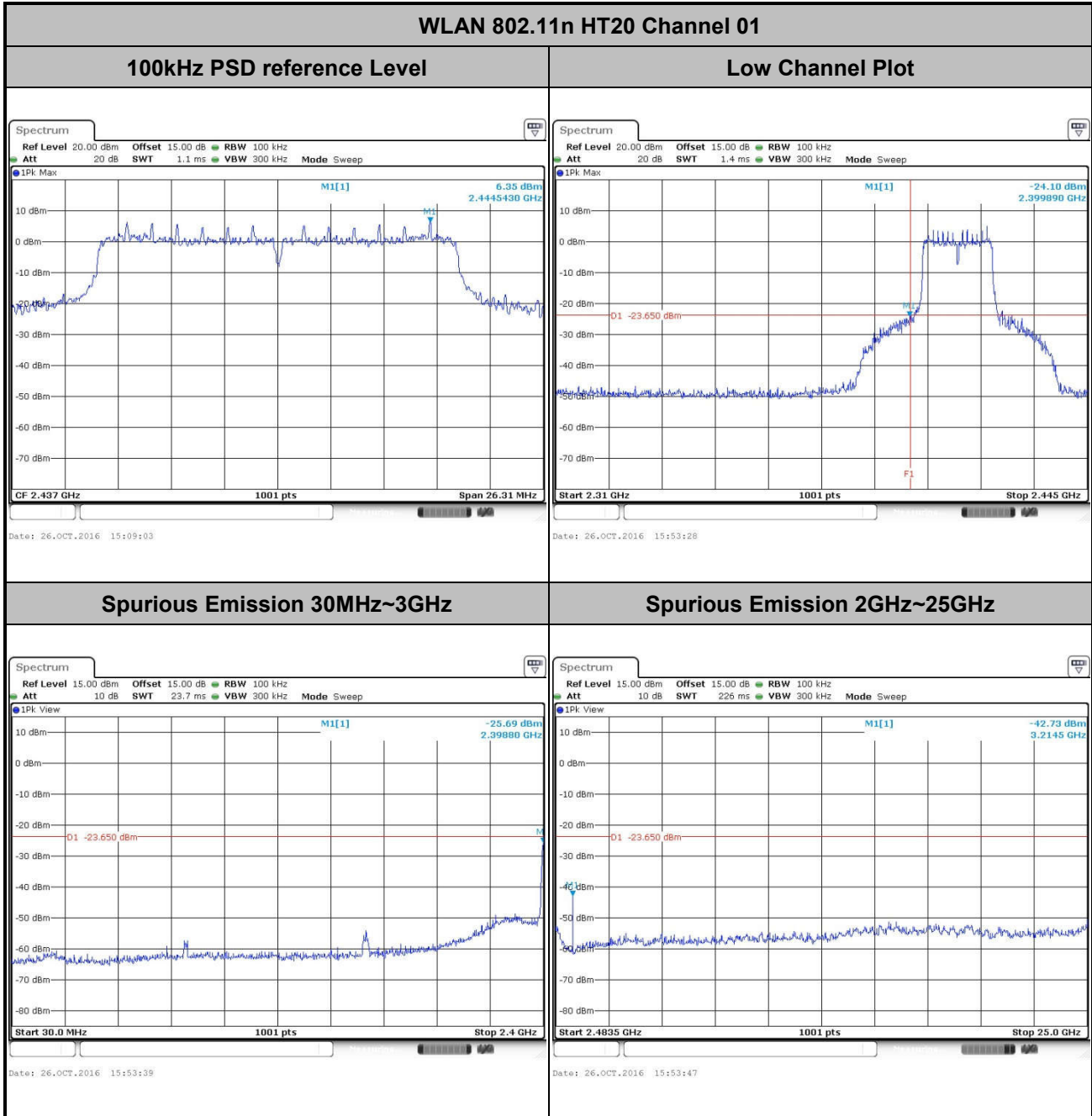



Number of TX :	2	Ant. :	2
Test Mode :	802.11n HT20	Temperature :	24~26°C
Test Band :	2.4GHz Mid	Relative Humidity :	50~53%
Test Channel :	06	Test Engineer :	Bruce Huang

WLAN 802.11n HT20 Channel 06

100kHz PSD reference Level

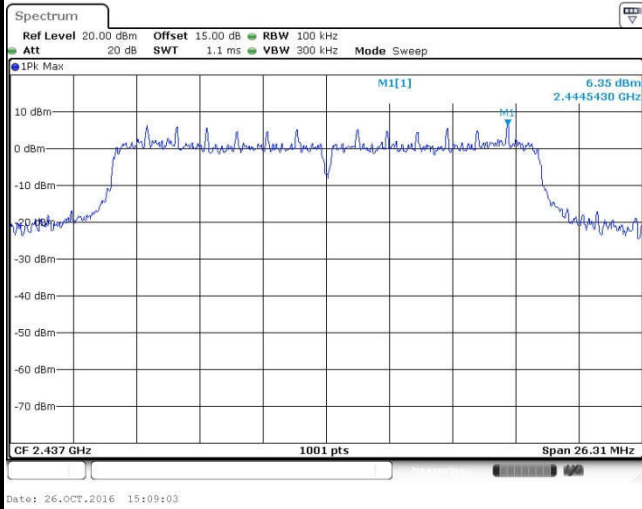

Spurious Emission 30MHz~3GHz

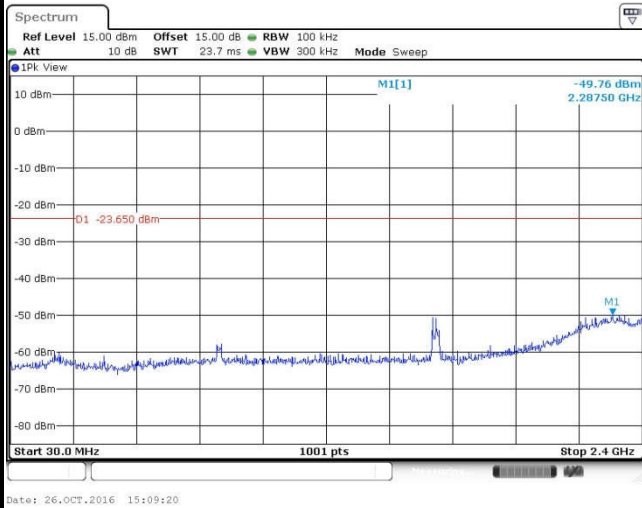

Spurious Emission 2GHz~25GHz

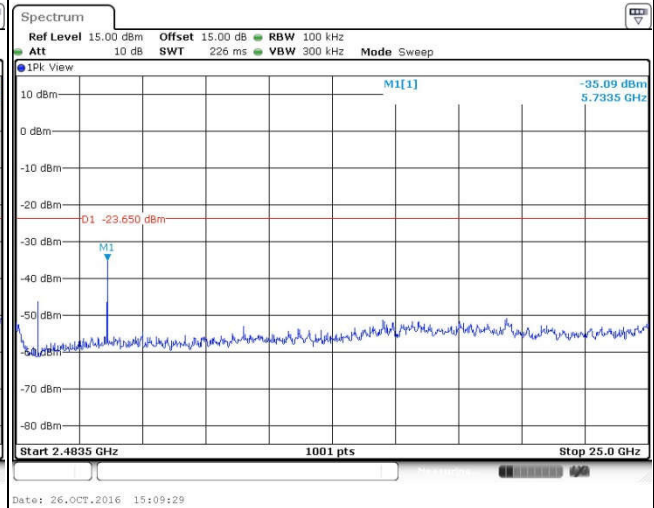





Number of TX :	2	Ant. :	2
Test Mode :	802.11n HT20	Temperature :	24~26°C
Test Band :	2.4GHz High	Relative Humidity :	50~53%
Test Channel :	11	Test Engineer :	Bruce Huang

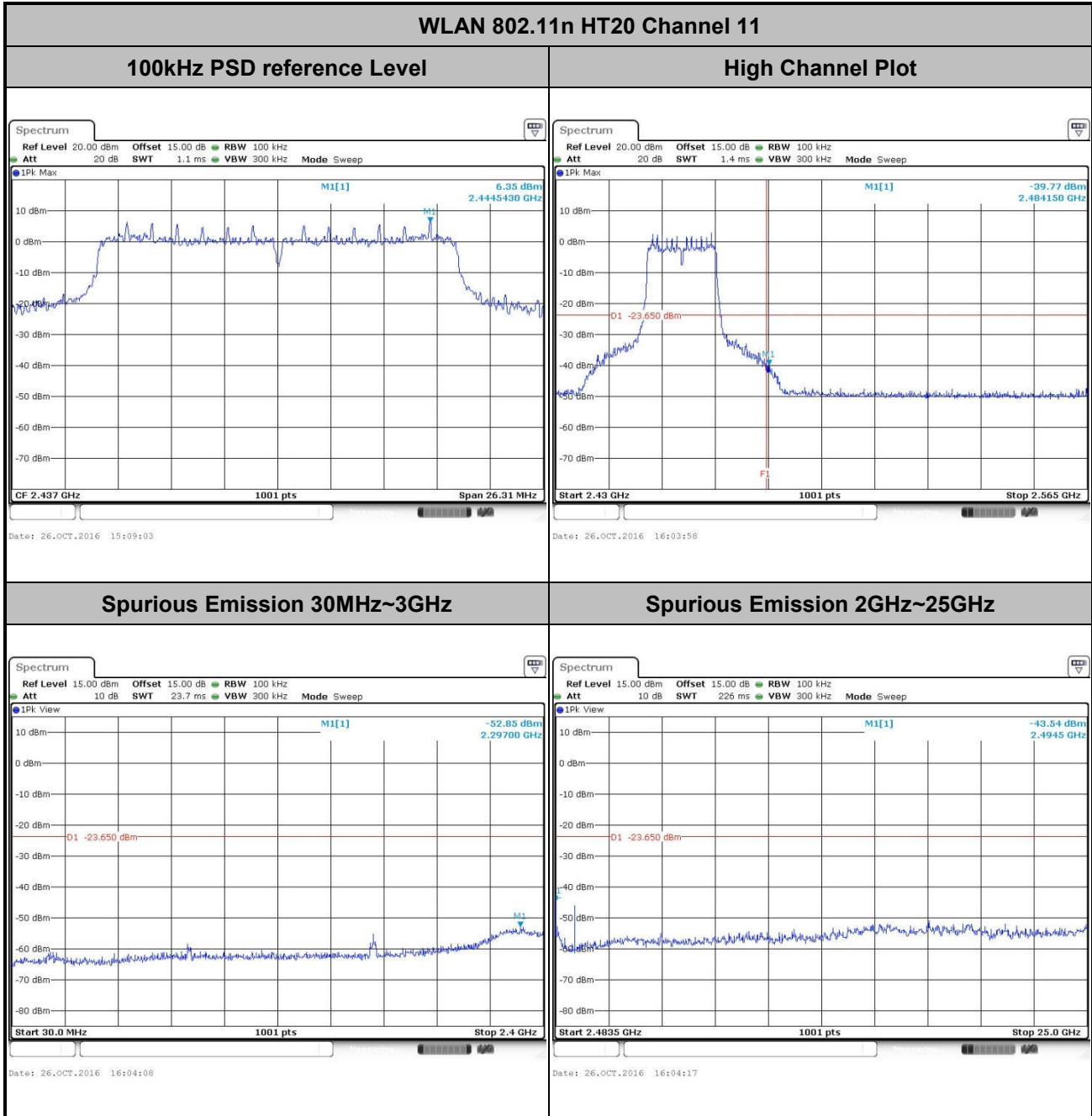



Number of TX :	2	Ant. :	2
Test Mode :	802.11n HT40	Temperature :	24~26°C
Test Band :	2.4GHz Low	Relative Humidity :	50~53%
Test Channel :	03	Test Engineer :	Bruce Huang

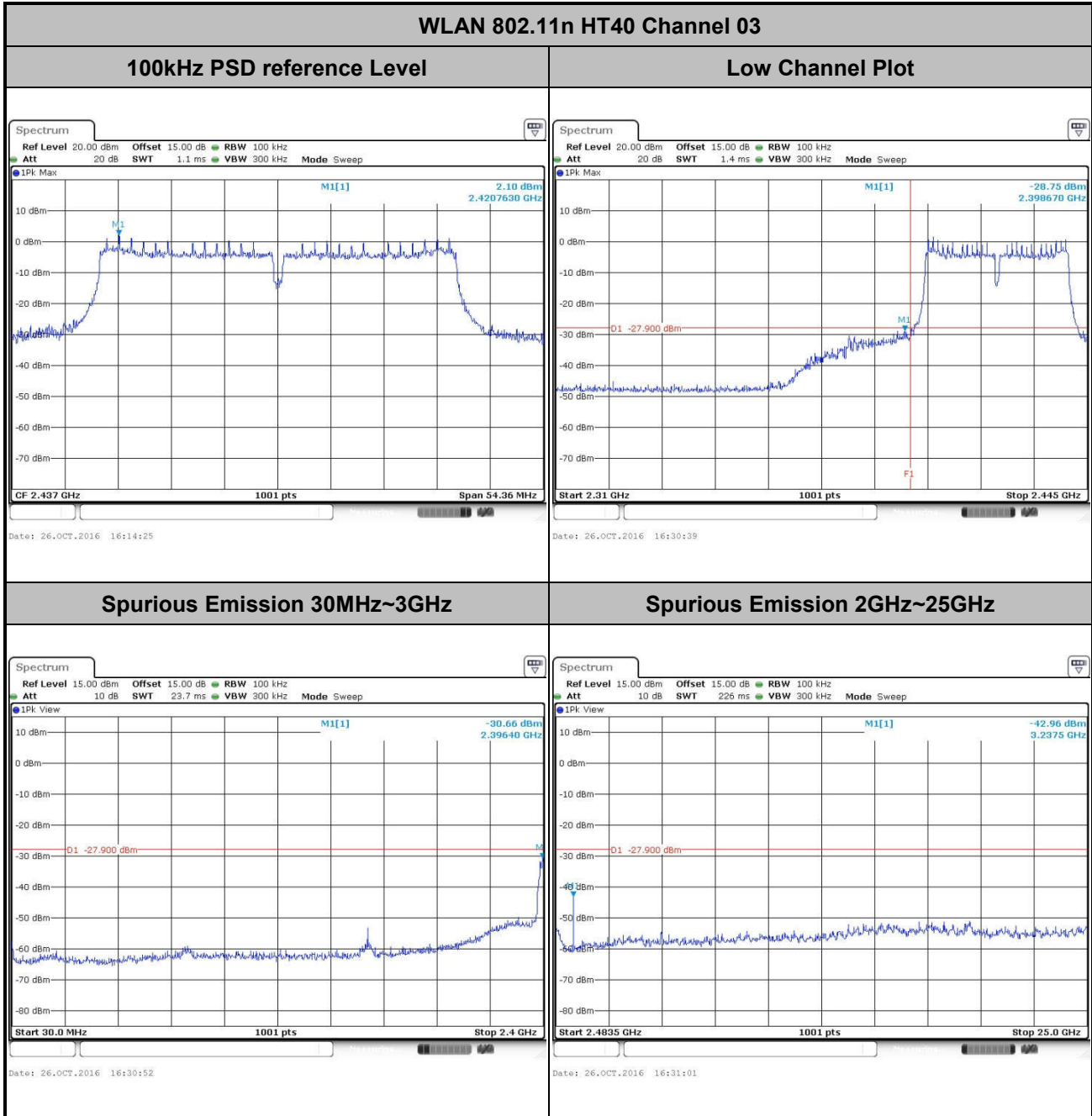



Number of TX :	2	Ant. :	2
Test Mode :	802.11n HT40	Temperature :	24~26°C
Test Band :	2.4GHz Mid	Relative Humidity :	50~53%
Test Channel :	06	Test Engineer :	Bruce Huang

WLAN 802.11n HT40 Channel 06

100kHz PSD reference Level

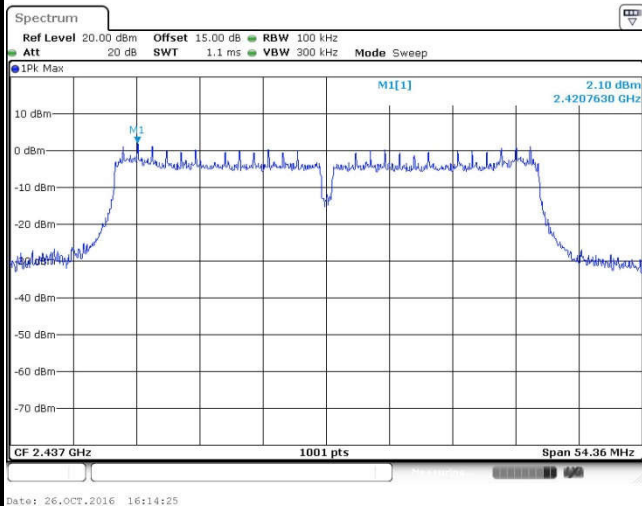

Spurious Emission 30MHz~3GHz

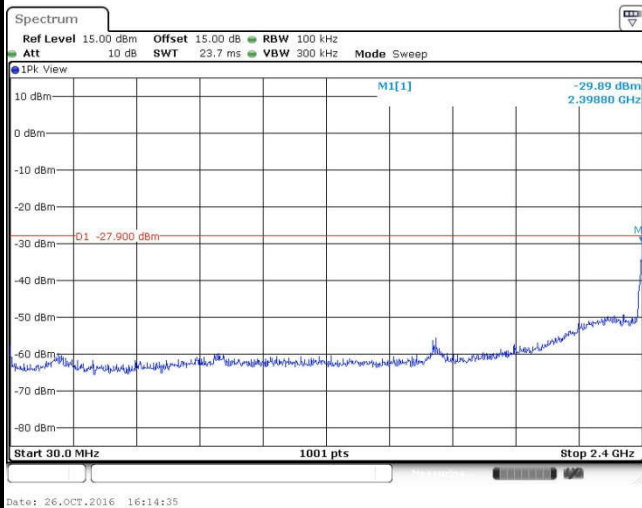

Spurious Emission 2GHz~25GHz

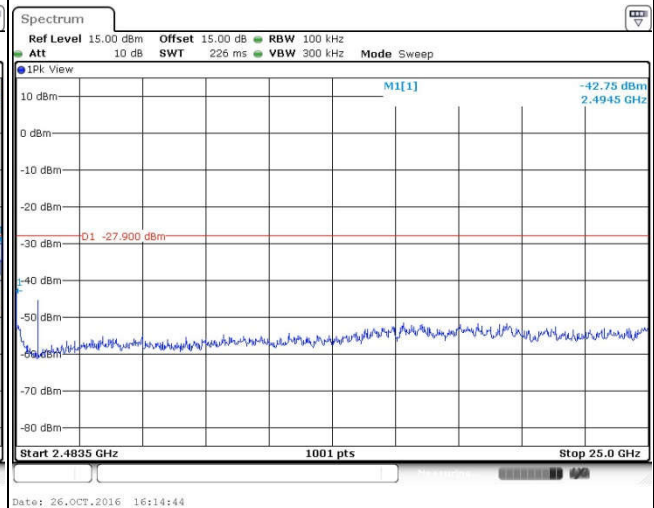



Number of TX :	2	Ant. :	2
Test Mode :	802.11n HT40	Temperature :	24~26°C
Test Band :	2.4GHz High	Relative Humidity :	50~53%
Test Channel :	09	Test Engineer :	Bruce Huang

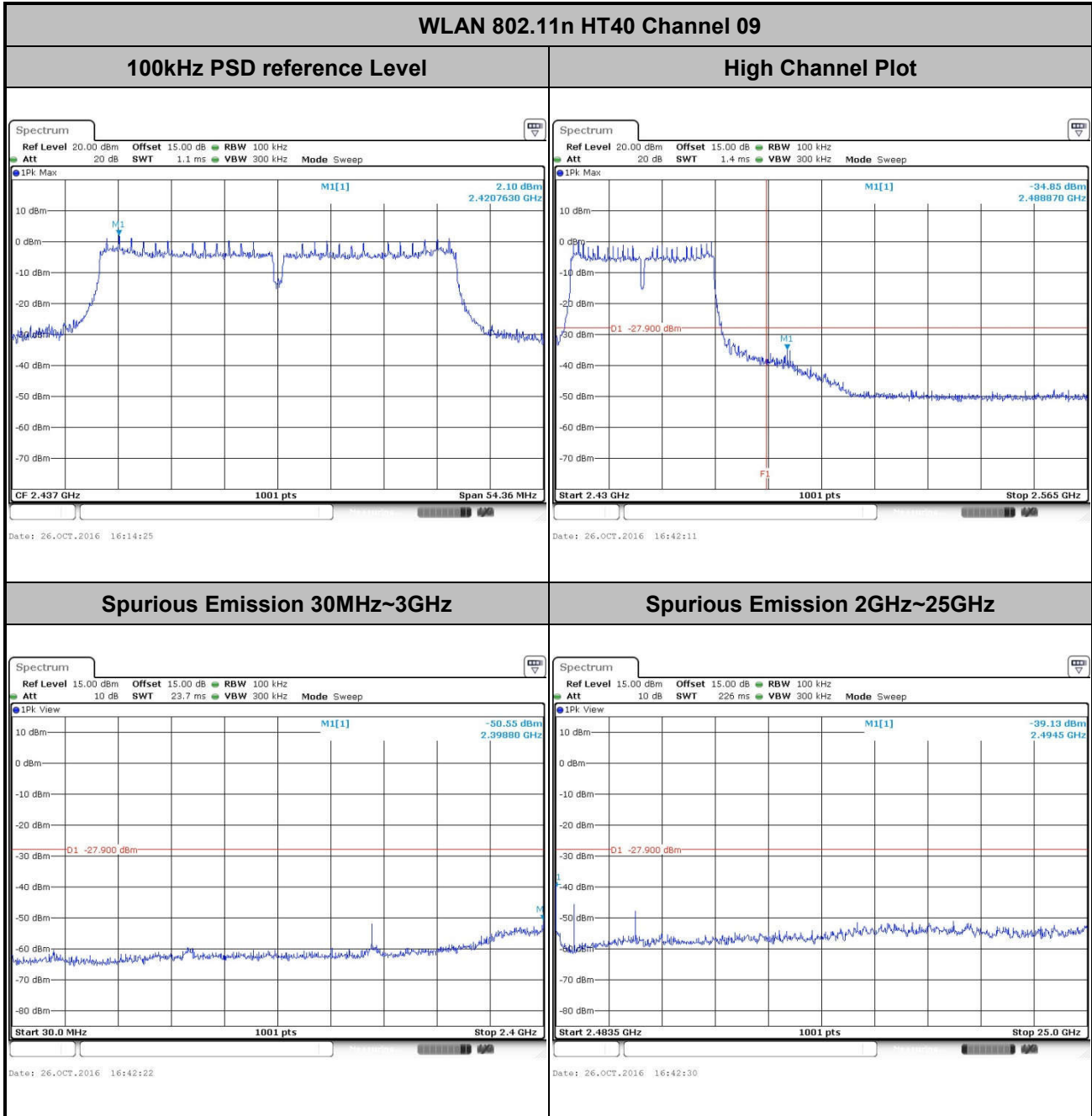



### 3.5 Radiated Band Edges and Spurious Emission Measurement

#### 3.5.1 Limit of Radiated band edge and Spurious Emission Measurement

In any 100 kHz bandwidth outside the intentional radiator frequency band, all harmonics/spurious must be at least 20 dB below the highest emission level within the authorized band. If the output power of this device was measured by spectrum analyzer, the attenuation under this paragraph shall be 30 dB instead of 20 dB. In addition, radiated emissions which fall in the restricted bands must also comply with the FCC section 15.209 limits as below.

Frequency (MHz)	Field Strength (microvolts/meter)	Measurement Distance (meters)
0.009 – 0.490	2400/F(kHz)	300
0.490 – 1.705	24000/F(kHz)	30
1.705 – 30.0	30	30
30 – 88	100	3
88 – 216	150	3
216 - 960	200	3
Above 960	500	3

#### 3.5.2 Measuring Instruments

The measuring equipment is listed in the section 4 of this test report.



### **3.5.3 Test Procedures**

1. The testing follows FCC KDB Publication No. 558074 D01 DTS Meas. Guidance v03r05.
2. The EUT was arranged to its worst case and then tune the antenna tower (from 1 m to 4 m) and turntable (from 0 degree to 360 degrees) to find the maximum reading. A pre-amp and a high pass filter are used for the test in order to get better signal level.
3. The EUT was placed on a turntable with 0.8 meter for frequency below 1GHz and 1.5 meter for frequency above 1GHz respectively above ground.
4. The EUT was set 3 meters from the interference receiving antenna, which was mounted on the top of a variable height antenna tower.
5. Corrected Reading: Antenna Factor + Cable Loss + Read Level - Preamp Factor = Level
6. For measurement below 1GHz, If the emission level of the EUT measured by the peak detector is 3 dB lower than the applicable limit, the peak emission level will be reported. Otherwise, the emission measurement will be repeated using the quasi-peak detector and reported.
7. Use the following spectrum analyzer settings:
  - (1) Span shall wide enough to fully capture the emission being measured;
  - (2) Set RBW=100 kHz for  $f < 1$  GHz; VBW  $\geq$  RBW; Sweep = auto; Detector function = peak; Trace = max hold;
  - (3) Set RBW = 1 MHz, VBW= 3MHz for  $f \geq 1$  GHz for peak measurement.  
For average measurement:
    - VBW = 10 Hz, when duty cycle is no less than 98 percent.
    - VBW  $\geq 1/T$ , when duty cycle is less than 98 percent where T is the minimum transmission duration over which the transmitter is on and is transmitting at its maximum power control level for the tested mode of operation.

### 3.5.4 Test Setup

For radiated emissions below 30MHz

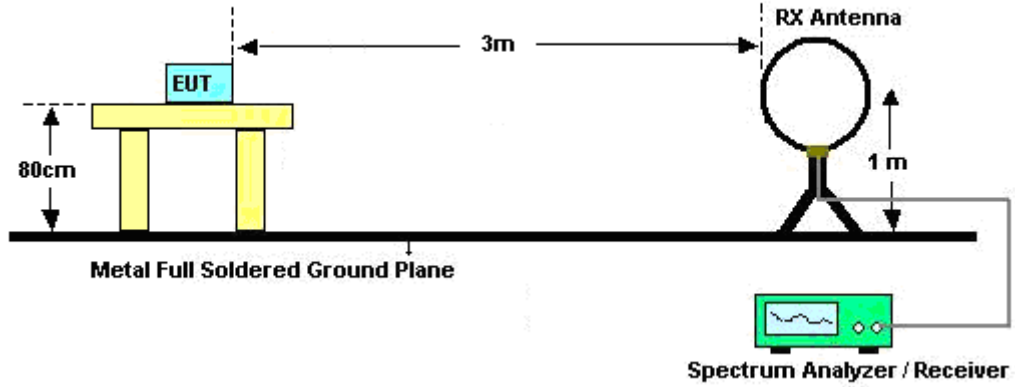

For radiated emissions from 30MHz to 1GHz

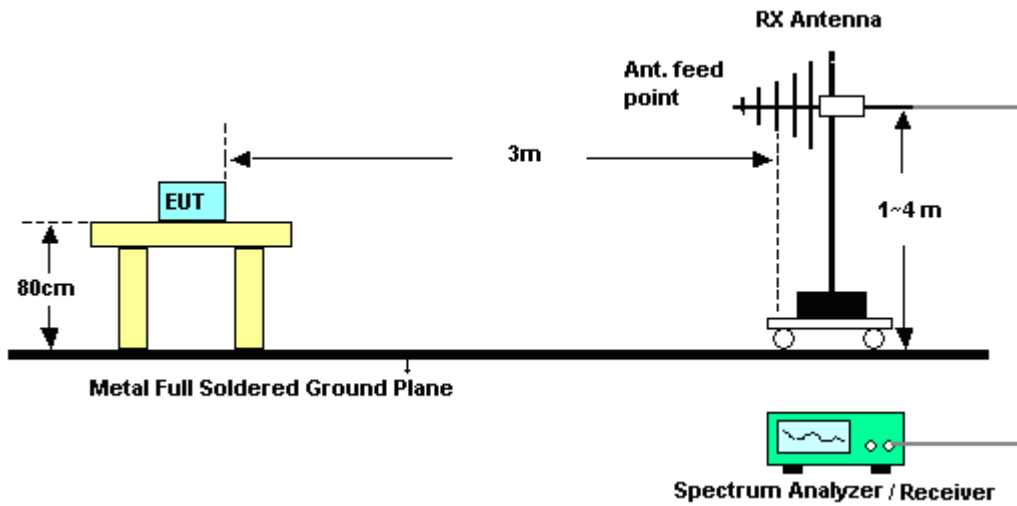

For radiated emissions above 1GHz

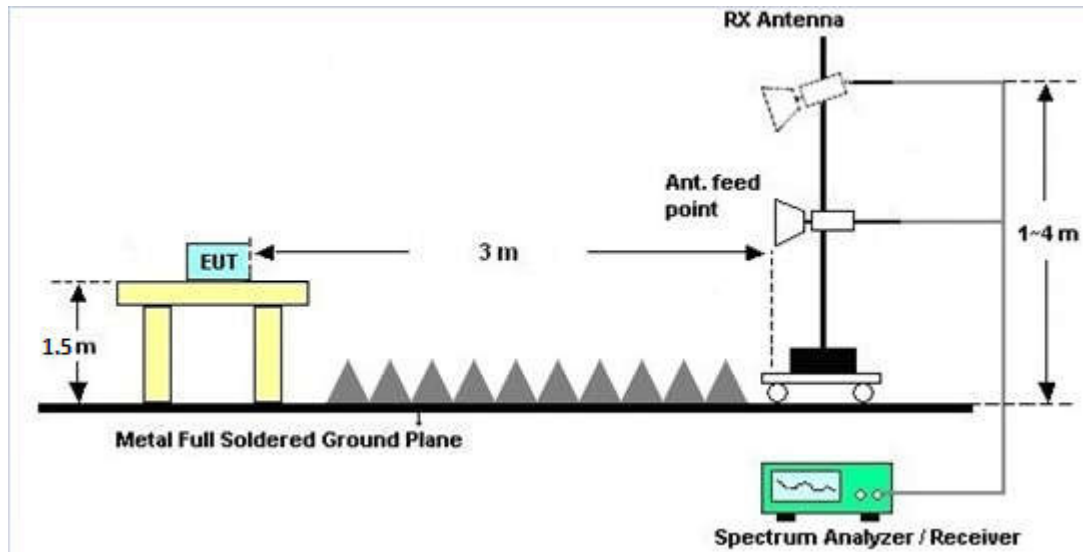

### 3.5.5 Test Results of Radiated Spurious Emissions (9kHz ~ 30MHz)

The low frequency, which started from 9 kHz to 30MHz, was pre-scanned and the result which was 20dB lower than the limit line per 15.31(o) was not reported.

### 3.5.6 Test Result of Radiated Spurious at Band Edges

Please refer to Appendix B.

### 3.5.7 Duty Cycle

Please refer to Appendix C.

### 3.5.8 Test Result of Radiated Spurious Emission (30MHz ~ 10<sup>th</sup> Harmonic)

Please refer to Appendix B.



### 3.6 AC Conducted Emission Measurement

#### 3.6.1 Limit of AC Conducted Emission

For equipment that is designed to be connected to the public utility (AC) power line, the radio frequency voltage that is conducted back onto the AC power line on any frequency or frequencies within the band 150 kHz to 30 MHz shall not exceed the limits in the following table.

Frequency of Emission (MHz)	Conducted Limit (dB $\mu$ V)	
	Quasi-Peak	Average
0.15-0.5	66 to 56*	56 to 46*
0.5-5	56	46
5-30	60	50

\*Decreases with the logarithm of the frequency.

#### 3.6.2 Measuring Instruments

The measuring equipment is listed in the section 4 of this test report.

#### 3.6.3 Test Procedures

1. The EUT was placed 0.4 meter from the conducting wall of the shielding room, and it was kept at least 80 centimeters from any other grounded conducting surface.
2. Connect EUT to the power mains through a line impedance stabilization network (LISN).
3. All the support units are connecting to the other LISN.
4. The LISN provides 50 ohm coupling impedance for the measuring instrument.
5. The FCC states that a 50 ohm, 50 microhenry LISN should be used.
6. Both sides of AC line were checked for maximum conducted interference.
7. The frequency range from 150 kHz to 30 MHz was searched.
8. Set the test-receiver system to Peak Detect Function and specified bandwidth (IF bandwidth = 9kHz) with Maximum Hold Mode.

### 3.6.4 Test Setup

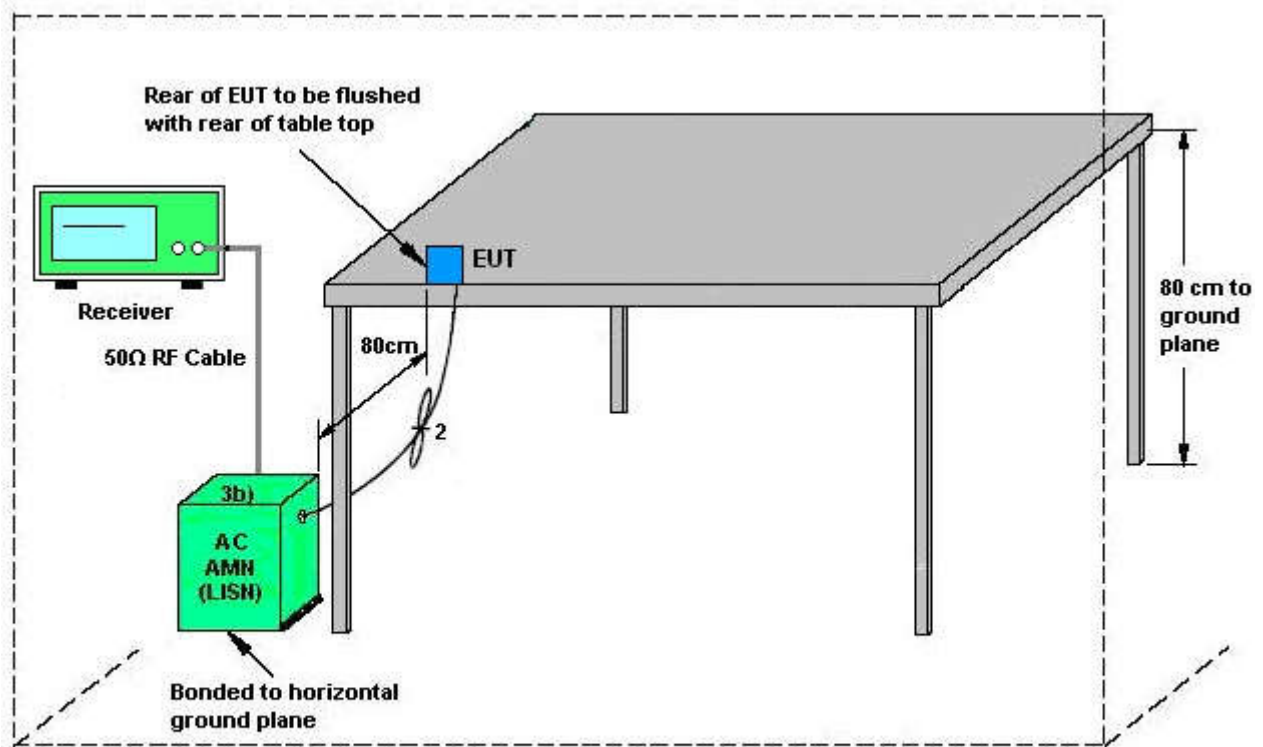

AMN = Artificial mains network (LISN)  
AE = Associated equipment  
EUT = Equipment under test  
ISN = Impedance stabilization network



3.6.5 Test Result of AC Conducted Emission

Test Mode :	Mode 1	Temperature :	21~23°C
Test Engineer :	Tao Cheng	Relative Humidity :	41~42%
Test Voltage :	120Vac / 60Hz	Phase :	Line
Function Type :	WLAN 2.4G Link (Client) + WLAN 2.4G Link (Master) + AC Load + RJ45 Link		

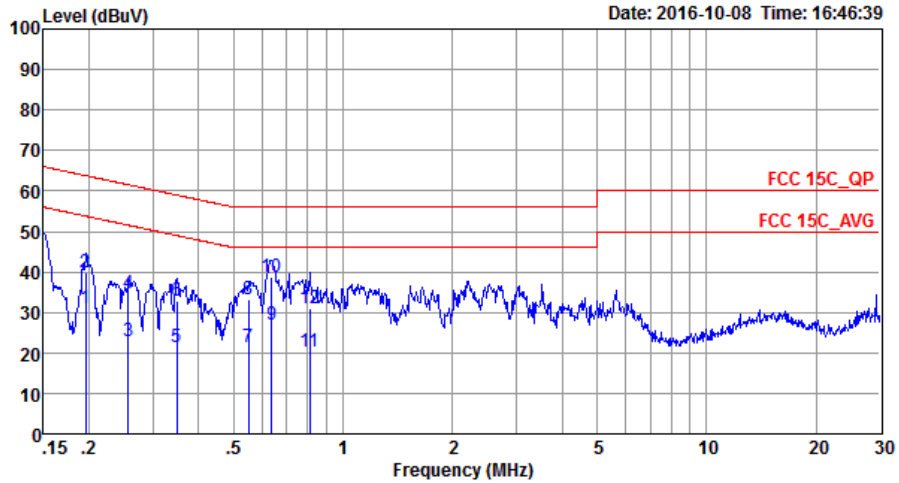

Site : C001-SZ  
 Condition: FCC 15C\_QP LISN\_20160509 LINE

	Freq	Level	Over Limit	Limit Line	Read Level	LISN Factor	Cable Loss	Remark
	MHz	dBuV	dB	dBuV	dBuV	dB	dB	
1	0.20	30.82	-22.98	53.80	20.20	0.11	10.51	Average
2	0.20	39.92	-23.88	63.80	29.30	0.11	10.51	QP
3	0.26	22.76	-28.80	51.56	12.20	0.11	10.45	Average
4	0.26	34.86	-26.70	61.56	24.30	0.11	10.45	QP
5	0.35	21.44	-27.56	49.00	11.00	0.11	10.33	Average
6	0.35	32.74	-26.26	59.00	22.30	0.11	10.33	QP
7	0.55	21.41	-24.59	46.00	11.10	0.11	10.20	Average
8	0.55	33.31	-22.69	56.00	23.00	0.11	10.20	QP
9	0.64	26.79	-19.21	46.00	16.50	0.11	10.18	Average
10 *	0.64	38.89	-17.11	56.00	28.60	0.11	10.18	QP
11	0.81	20.47	-25.53	46.00	10.20	0.11	10.16	Average
12	0.81	30.87	-25.13	56.00	20.60	0.11	10.16	QP



Test Mode :	Mode 1	Temperature :	21~23°C
Test Engineer :	Tao Cheng	Relative Humidity :	41~42%
Test Voltage :	120Vac / 60Hz	Phase :	Neutral
Function Type :	WLAN 2.4G Link (Client) + WLAN 2.4G Link (Master) + AC Load + RJ45 Link		

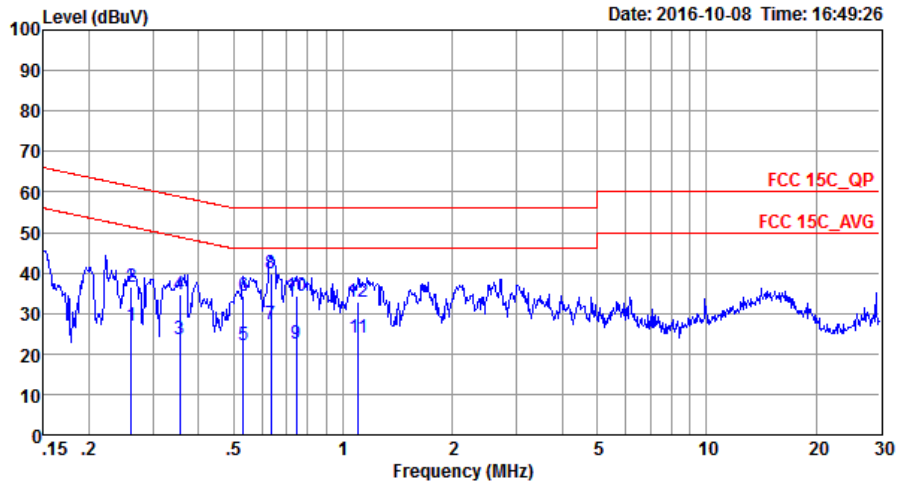

Site : CO01-SZ  
 Condition: FCC 15C\_QP LISN\_20160509 NEUTRAL

	Freq	Level	Over Limit	Limit Line	Read Level	LISN Factor	Cable Loss	Remark
	MHz	dBuV	dB	dBuV	dBuV	dB	dB	
1	0.26	27.06	-24.32	51.38	16.50	0.11	10.45	Average
2	0.26	36.56	-24.82	61.38	26.00	0.11	10.45	QP
3	0.36	23.63	-25.20	48.83	13.20	0.11	10.32	Average
4	0.36	34.73	-24.10	58.83	24.30	0.11	10.32	QP
5	0.53	22.02	-23.98	46.00	11.70	0.11	10.21	Average
6	0.53	34.32	-21.68	56.00	24.00	0.11	10.21	QP
7	0.63	27.39	-18.61	46.00	17.10	0.11	10.18	Average
8 *	0.63	39.79	-16.21	56.00	29.50	0.11	10.18	QP
9	0.74	22.37	-23.63	46.00	12.10	0.11	10.16	Average
10	0.74	34.17	-21.83	56.00	23.90	0.11	10.16	QP
11	1.10	23.97	-22.03	46.00	13.70	0.11	10.16	Average
12	1.10	32.87	-23.13	56.00	22.60	0.11	10.16	QP



### 3.7 Antenna Requirements

#### 3.7.1 Standard Applicable

If directional gain of transmitting Antennas is greater than 6dBi, the power shall be reduced by the same level in dB comparing to gain minus 6dBi. The use of a permanently attached Antenna or of an Antenna that uses a unique coupling to the intentional radiator shall be considered sufficient to comply with the FCC rule.

#### 3.7.2 Antenna Anti-Replacement Construction

An embedded-in antenna design is used.

#### 3.7.3 Antenna Gain

FCC KDB 662911 D01 Multiple Transmitter Output v02r01

For CDD transmissions, directional gain is calculated as

Directional gain =  $G_{ANT} + \text{Array Gain}$ , where Array Gain is as follows.

For power spectral density (PSD) measurements on all devices,

Array Gain =  $10 \log(N_{ANT}/N_{SS}=1)$  dB.

For power measurements on IEEE 802.11 devices,

Array Gain = 0 dB (i.e., no array gain) for  $N_{ANT} \leq 4$ .

Directional gain may be calculated by using the formulas applicable to equal gain antennas with  $G_{ANT}$  set equal to the gain of the antenna having the highest gain;

The EUT supports CDD mode.

For power, the directional gain  $G_{ANT}$  is set equal to the antenna having the highest gain, i.e., F)2)f)i).

For PSD, the directional gain calculation is following F)2)f)ii) of KDB 662911 D01 v02r01.

The power and PSD limit should be modified if the directional gain of EUT is over 6 dBi,

The directional gain "DG" is calculated as following table.

			DG for Power (dBi)	DG for PSD (dBi)	Power Limit Reduction (dB)	PSD Limit Reduction (dB)
	Ant. 1 (dBi)	Ant. 2 (dBi)				
24 GHz	1.91	1.94	1.94	4.94	0.00	0.00

$Power\ Limit\ Reduction = DG(Power) - 6dBi, (min = 0)$

$PSD\ Limit\ Reduction = DG(PSD) - 6dBi, (min = 0)$



## 4 List of Measuring Equipment

Instrument	Manufacturer	Model No.	Serial No.	Characteristics	Calibration Date	Test Date	Due Date	Remark
Spectrum Analyzer	R&S	FSV40	101078	9kHz~40GHz	May 07, 2016	Oct. 26, 2016~ Oct. 27, 2016	May 06, 2017	Conducted (TH01-SZ)
Pulse Power Senor	Anritsu	MA2411B	1207253	30MHz~40GHz	Jan. 12, 2016	Oct. 26, 2016~ Oct. 27, 2016	Jan. 11, 2017	Conducted (TH01-SZ)
Power Meter	Anritsu	ML2495A	1218010	50MHz Bandwidth	Jan. 12, 2016	Oct. 26, 2016~ Oct. 27, 2016	Jan. 11, 2017	Conducted (TH01-SZ)
EMI Test Receiver&SA	KEYSIGHT	N9038A	MY544500 83	20Hz~8.4GHz	May 07, 2016	Oct. 26, 2016	May 06, 2017	Radiation (03CH03-SZ)
EXA Spectrum Anaiyzer	KEYSIGHT	N9010A	MY551502 46	10Hz~44GHz	May 07, 2016	Oct. 26, 2016	May 06, 2017	Radiation (03CH03-SZ)
Loop Antenna	R&S	HFH2-Z2	100354	9kHz~30MHz	May 07, 2016	Oct. 26, 2016	May 06, 2017	Radiation (03CH03-SZ)
Bilog Antenna	TeseQ	CBL6112D	35408	30MHz~2GHz	May 21, 2016	Oct. 26, 2016	May 20, 2017	Radiation (03CH03-SZ)
Double Ridge Horn Antenna	SCHWARZBE CK	BBHA9120D	9120D-135 5	1GHz~18GHz	May 07, 2016	Oct. 26, 2016	May 06, 2017	Radiation (03CH03-SZ)
SHF-EHF Horn	com-power	AH-840	101071	18GHz~40GHz	Aug. 10, 2016	Oct. 26, 2016	Aug. 09, 2017	Radiation (03CH03-SZ)
Amplifier	Burgeon	BPA-530	102210	0.01Hz ~3000MHz	Oct. 11, 2016	Oct. 26, 2016	Oct. 10, 2017	Radiation (03CH03-SZ)
HF Amplifier	MITEQ	AMF-7D-0010 1800-30-10P- R	1943528	1GHz~18GHz	Oct. 11, 2016	Oct. 26, 2016	Oct. 10, 2017	Radiation (03CH03-SZ)
Amplifier	Agilent Technologies	83017A	MY395013 02	500MHz~26.5G Hz	Jan. 12, 2016	Oct. 26, 2016	Jan. 11, 2017	Radiation (03CH03-SZ)
HF Amplifier	MITEQ	TTA1840-35- HG	1871923	18GHz~40GHz	Jul. 16, 2016	Oct. 26, 2016	Jul. 15, 2017	Radiation (03CH03-SZ)
AC Power Source	Chroma	61601	616010001 985	N/A	NCR	Oct. 26, 2016	NCR	Radiation (03CH03-SZ)
Turn Table	EM	EM1000	N/A	0~360 degree	NCR	Oct. 26, 2016	NCR	Radiation (03CH03-SZ)
Antenna Mast	EM	EM1000	N/A	1 m~4 m	NCR	Oct. 26, 2016	NCR	Radiation (03CH03-SZ)
EMI Receiver	R&S	ESCI7	100724	9kHz~3GHz;	Nov. 23, 2015	Oct. 08, 2016	Nov. 22, 2016	Conduction (CO01-SZ)
AC LISN	EMCO	3816/2SH	00103892	9kHz~30MHz	Jan. 12, 2016	Oct. 08, 2016	Jan. 11, 2017	Conduction (CO01-SZ)
AC LISN (for auxiliary equipment)	MessTec	3816/2SH	00103912	9kHz~30MHz	Jan. 12, 2016	Oct. 08, 2016	Jan. 11, 2017	Conduction (CO01-SZ)
AC Power Source	Chroma	61602	616020000 891	100Vac~250Vac	Jul. 16, 2016	Oct. 08, 2016	Jul. 15, 2017	Conduction (CO01-SZ)
Pulse Limiter	COM-POWER	LIT-153 Transient Limiter	53139	150kHz~30MHz	Oct. 20, 2015	Oct. 08, 2016	Oct. 19, 2016	Conduction (CO01-SZ)

NCR: No Calibration Required



## 5 Uncertainty of Evaluation

### Uncertainty of Conducted Emission Measurement (150kHz ~ 30MHz)

Measuring Uncertainty for a Level of Confidence of 95% ( $U = 2Uc(y)$ )	2.5 dB
---	--------

### Uncertainty of Radiated Emission Measurement (30 MHz ~ 1000 MHz)

Measuring Uncertainty for a Level of Confidence of 95% ( $U = 2Uc(y)$ )	5.1 dB
---	--------

### Uncertainty of Radiated Emission Measurement (1000 MHz ~ 18000 MHz)

Measuring Uncertainty for a Level of Confidence of 95% ( $U = 2Uc(y)$ )	5.0 dB
---	--------

### Uncertainty of Radiated Emission Measurement (18000 MHz ~ 40000 MHz)

Measuring Uncertainty for a Level of Confidence of 95% ( $U = 2Uc(y)$ )	5.0 dB
---	--------



## **Appendix A. Conducted Test Results**



Test Engineer:	Bruce Huang	Temperature:	24~26	°C
Test Date:	2016/10/26~2016/10/27	Relative Humidity:	50~53	%

**TEST RESULTS DATA**  
**6dB and 99% Occupied Bandwidth**

2.4GHz Band										
Mod.	Data Rate	NTX	CH.	Freq. (MHz)	99% Occupied BW (MHz)		6dB BW (MHz)		6dB BW Limit (MHz)	Pass/Fail
					Ant 1	Ant 2	Ant 1	Ant 2		
11b	1Mbps	2	1	2412	13.64	13.24	10.07	10.07	0.50	Pass
11b	1Mbps	2	6	2437	13.84	13.24	10.05	10.07	0.50	Pass
11b	1Mbps	2	11	2462	13.24	12.84	10.05	10.07	0.50	Pass
11g	6Mbps	2	1	2412	19.78	18.33	16.32	16.32	0.50	Pass
11g	6Mbps	2	6	2437	27.92	18.78	16.34	16.32	0.50	Pass
11g	6Mbps	2	11	2462	18.93	18.08	16.32	16.32	0.50	Pass
HT20	MCS0	2	1	2412	20.53	18.93	17.28	17.00	0.50	Pass
HT20	MCS0	2	6	2437	28.17	21.58	17.28	17.54	0.50	Pass
HT20	MCS0	2	11	2462	19.23	18.58	17.06	17.06	0.50	Pass
HT40	MCS0	2	3	2422	37.86	37.16	36.28	36.28	0.50	Pass
HT40	MCS0	2	6	2437	37.76	37.26	36.28	36.24	0.50	Pass
HT40	MCS0	2	9	2452	37.46	37.06	36.28	36.28	0.50	Pass

**TEST RESULTS DATA**  
**Peak Output Power**

2.4GHz Band											
Mod.	Data Rate	NTX	CH.	Freq. (MHz)	Peak Conducted Power (dBm)			DG (dBi)		EIRP Power (dBm)	
					Ant 1	Ant 2	SUM	Ant 1	Ant 2	Ant 1	Ant 2
11b	1Mbps	2	1	2412	27.53	26.63	30.11	1.94		32.05	
11b	1Mbps	2	6	2437	27.23	26.35	29.82	1.94		31.76	
11b	1Mbps	2	11	2462	27.20	26.12	29.70	1.94		31.64	
11g	6Mbps	2	1	2412	26.24	25.68	28.98	1.94		30.92	
11g	6Mbps	2	6	2437	27.56	26.84	30.23	1.94		32.17	
11g	6Mbps	2	11	2462	26.95	25.36	29.24	1.94		31.18	
HT20	MCS0	2	1	2412	25.71	26.11	28.92	1.94		30.86	
HT20	MCS0	2	6	2437	27.39	26.87	30.15	1.94		32.09	
HT20	MCS0	2	11	2462	26.91	25.42	29.24	1.94		31.18	
HT40	MCS0	2	3	2422	25.77	25.86	28.83	1.94		30.77	
HT40	MCS0	2	6	2437	27.22	26.01	29.67	1.94		31.61	
HT40	MCS0	2	9	2452	25.89	25.33	28.63	1.94		30.57	

Note: Measured power (dBm) has offset with cable loss.

**TEST RESULTS DATA**  
**Average Output Power**

2.4GHz Band																		
Mod.	Data Rate	NTX	CH.	Freq. (MHz)	Duty Factor (dB)		Average Conducted Power (dBm)			Conducted Power Limit (dBm)		DG (dBi)		EIRP Power (dBm)		EIRP Power Limit (dBm)		Pass /Fail
					Ant 1	Ant 2	Ant 1	Ant 2	SUM	Ant 1	Ant 2	Ant 1	Ant 2	Ant 1	Ant 2	Ant 1	Ant 2	
11b	1Mbps	2	1	2412	0.00	0.00	20.84	19.08	23.06	30.00	1.94	25.00	36.00	Pass				
11b	1Mbps	2	6	2437	0.00	0.00	20.53	18.87	22.79	30.00	1.94	24.73	36.00	Pass				
11b	1Mbps	2	11	2462	0.00	0.00	19.45	17.15	21.46	30.00	1.94	23.40	36.00	Pass				
11g	6Mbps	2	1	2412	0.03	0.03	16.96	15.91	19.48	30.00	1.94	21.42	36.00	Pass				
11g	6Mbps	2	6	2437	0.03	0.03	20.04	18.39	22.30	30.00	1.94	24.24	36.00	Pass				
11g	6Mbps	2	11	2462	0.03	0.03	17.14	14.94	19.19	30.00	1.94	21.13	36.00	Pass				
HT20	MCS0	2	1	2412	0.03	0.04	16.43	16.65	19.55	30.00	1.94	21.49	36.00	Pass				
HT20	MCS0	2	6	2437	0.03	0.04	20.34	18.39	22.48	30.00	1.94	24.42	36.00	Pass				
HT20	MCS0	2	11	2462	0.03	0.04	16.37	13.40	18.14	30.00	1.94	20.08	36.00	Pass				
HT40	MCS0	2	3	2422	0.07	0.07	15.94	14.26	18.20	30.00	1.94	20.14	36.00	Pass				
HT40	MCS0	2	6	2437	0.07	0.07	18.42	16.07	20.42	30.00	1.94	22.36	36.00	Pass				
HT40	MCS0	2	9	2452	0.07	0.07	16.16	13.24	17.96	30.00	1.94	19.90	36.00	Pass				

Note: Measured power (dBm) has offset with cable loss.

**TEST RESULTS DATA**  
**Average Power Spectral Density**

2.4GHz Band												
Mod.	Data Rate	NTX	CH.	Freq. (MHz)	Average PSD (dBm/3kHz)			DG (dBi)		Average PSD Limit (dBm/3kHz)		Pass/Fail
					Ant 1	Ant 2	Worse + 3.01	Ant 1	Ant 2	Ant 1	Ant 2	
11b	1Mbps	2	1	2412	-7.76	-9.06	-4.75	4.94		8.00		Pass
11b	1Mbps	2	6	2437	-7.45	-10.02	-4.44	4.94		8.00		Pass
11b	1Mbps	2	11	2462	-8.67	-12.12	-5.66	4.94		8.00		Pass
11g	6Mbps	2	1	2412	-10.29	-12.80	-7.28	4.94		8.00		Pass
11g	6Mbps	2	6	2437	-8.71	-11.79	-5.70	4.94		8.00		Pass
11g	6Mbps	2	11	2462	-11.28	-14.47	-8.27	4.94		8.00		Pass
HT20	MCS0	2	1	2412	-11.53	-13.01	-8.52	4.94		8.00		Pass
HT20	MCS0	2	6	2437	-9.51	-11.63	-6.50	4.94		8.00		Pass
HT20	MCS0	2	11	2462	-12.19	-15.28	-9.18	4.94		8.00		Pass
HT40	MCS0	2	3	2422	-13.27	-15.40	-10.26	4.94		8.00		Pass
HT40	MCS0	2	6	2437	-13.57	-15.61	-10.56	4.94		8.00		Pass
HT40	MCS0	2	9	2452	-14.65	-16.90	-11.64	4.94		8.00		Pass

Measured power density (dBm) has offset with cable loss.



## Appendix B. Radiated Spurious Emission

2.4GHz 2400~2483.5MHz

WIFI 802.11b (Band Edge @ 3m)

WIFI Ant.	Note	Frequency	Level	Over Limit	Limit Line	Read Level	Antenna Factor	Cable Loss	Preamp Factor	Ant Pos	Table Pos	Peak Avg.	Pol.
1+2		( MHz )	( dBμV/m )	( dB )	( dBμV/m )	( dBμV )	( dB/m )	( dB )	( dB )	( cm )	( deg )	(P/A)	(H/V)
802.11b CH 01 2412MHz		2386.86	58.09	-15.91	74	60.96	27.29	4.86	35.02	151	360	P	H
		2389.38	39.83	-14.17	54	42.7	27.29	4.86	35.02	151	360	A	H
	*	2412	100.4	-	-	103.19	27.33	4.88	35	151	360	P	H
	*	2412	97.75	-	-	100.54	27.33	4.88	35	151	360	A	H
		2387.385	50.71	-23.29	74	53.58	27.29	4.86	35.02	208	79	P	V
		2389.38	37.97	-16.03	54	40.84	27.29	4.86	35.02	208	79	A	V
	*	2412	96.55	-	-	99.34	27.33	4.88	35	208	79	P	V
	*	2412	93.83	-	-	96.62	27.33	4.88	35	208	79	A	V
802.11b CH 06 2437MHz		2344.44	49.95	-24.05	74	52.99	27.19	4.82	35.05	155	360	P	H
		2311.96	37.18	-16.82	54	40.37	27.12	4.79	35.1	155	360	A	H
	*	2437	99.01	-	-	101.7	27.4	4.88	34.97	155	360	P	H
	*	2437	96.35	-	-	99.04	27.4	4.88	34.97	155	360	A	H
		2492.65	51.95	-22.05	74	54.43	27.5	4.92	34.9	155	360	P	H
		2499.3	38.77	-15.23	54	41.25	27.5	4.92	34.9	155	360	A	H
		2375.24	47.87	-26.13	74	50.77	27.26	4.86	35.02	182	67	P	V
		2389.66	36.04	-17.96	54	38.91	27.29	4.86	35.02	182	67	A	V
	*	2437	96.91	-	-	99.6	27.4	4.88	34.97	182	67	P	V
	*	2437	94.37	-	-	97.06	27.4	4.88	34.97	182	67	A	V
		2486.14	48.93	-25.07	74	51.48	27.47	4.9	34.92	182	67	P	V
	2499.02	36.85	-17.15	54	39.33	27.5	4.92	34.9	182	67	A	V	



<b>802.11b CH 11 2462MHz</b>	*	2462	100.85	-	-	103.47	27.43	4.9	34.95	213	360	P	H
	*	2462	98.13	-	-	100.75	27.43	4.9	34.95	213	360	A	H
		2490.2	56.11	-17.89	74	58.61	27.5	4.92	34.92	213	360	P	H
		2483.52	40.9	-13.1	54	43.45	27.47	4.9	34.92	213	360	A	H
	*	2462	97.35	-	-	99.97	27.43	4.9	34.95	182	64	P	V
	*	2462	94.98	-	-	97.6	27.43	4.9	34.95	182	64	A	V
		2484.32	51.15	-22.85	74	53.7	27.47	4.9	34.92	182	64	P	V
		2483.52	38.34	-15.66	54	40.89	27.47	4.9	34.92	182	64	A	V
<b>Remark</b>	1. No other spurious found. 2. All results are PASS against Peak and Average limit line.												



**2.4GHz 2400~2483.5MHz  
WIFI 802.11b (Harmonic @ 3m)**

WIFI Ant. 1+2	Note	Frequency ( MHz )	Level ( dBμV/m )	Over Limit ( dB )	Limit Line ( dBμV/m )	Read Level ( dBμV )	Antenna Factor ( dB/m )	Cable Loss ( dB )	Preamp Factor ( dB )	Ant Pos ( cm )	Table Pos ( deg )	Peak Avg. ( P/A )	Pol. ( H/V )
802.11b CH 01 2412MHz		4824	52.59	-21.41	74	71.45	32.56	6.97	58.39	150	157	P	H
		4824	50.65	-3.35	54	69.51	32.56	6.97	58.39	150	157	A	H
		4824	46.1	-27.9	74	64.96	32.56	6.97	58.39	150	360	P	V
802.11b CH 06 2437MHz		4874	46.16	-27.84	74	65.17	32.66	6.99	58.66	150	0	P	H
		7311	59.45	-14.55	74	71.48	37.66	8.93	58.62	150	135	P	H
		7311	53.66	-0.34	54	65.69	37.66	8.93	58.62	150	135	A	H
		4874	44.18	-29.82	74	63.19	32.66	6.99	58.66	150	360	P	V
		7311	51.89	-22.11	74	63.92	37.66	8.93	58.62	174	100	P	V
		7311	47.95	-6.05	54	59.98	37.66	8.93	58.62	174	100	A	V
802.11b CH 11 2462MHz		4924	46.33	-27.67	74	65.09	32.76	7	58.52	150	347	P	H
		7386	57.27	-16.73	74	68.98	37.68	9.15	58.54	150	132	P	H
		7386	53.32	-0.68	54	65.03	37.68	9.15	58.54	150	132	A	H
		4924	47.61	-26.39	74	66.37	32.76	7	58.52	150	347	P	V
		7386	56.21	-17.79	74	67.92	37.68	9.15	58.54	150	274	P	V
		7386	50.86	-3.14	54	62.57	37.68	9.15	58.54	150	274	A	V
Remark	1. No other spurious found. 2. All results are PASS against Peak and Average limit line.												





2.4GHz 2400~2483.5MHz  
WIFI 802.11g (Band Edge @ 3m)

WIFI Ant. 1+2	Note	Frequency ( MHz )	Level ( dBμV/m )	Over Limit ( dB )	Limit Line ( dBμV/m )	Read Level ( dBμV )	Antenna Factor ( dB/m )	Cable Loss ( dB )	Preamp Factor ( dB )	Ant Pos ( cm )	Table Pos ( deg )	Peak Avg. ( P/A )	Pol. ( H/V )
802.11g CH 01 2412MHz		2389.59	69.44	-4.56	74	72.31	27.29	4.86	35.02	153	356	P	H
		2390	52.85	-1.15	54	55.7	27.29	4.86	35	153	356	A	H
	*	2412	100.85	-	-	103.64	27.33	4.88	35	153	356	P	H
	*	2412	92.61	-	-	95.4	27.33	4.88	35	153	356	A	H
		2389.59	66.76	-7.24	74	69.63	27.29	4.86	35.02	152	89	P	V
		2390	50.47	-3.53	54	53.32	27.29	4.86	35	152	89	A	V
	*	2412	96.62	-	-	99.41	27.33	4.88	35	152	89	P	V
	*	2412	89.02	-	-	91.81	27.33	4.88	35	152	89	A	V
802.11g CH 06 2437MHz		2387.14	53.51	-20.49	74	56.38	27.29	4.86	35.02	214	359	P	H
		2312.24	40.62	-13.38	54	43.81	27.12	4.79	35.1	214	359	A	H
	*	2437	106.77	-	-	109.46	27.4	4.88	34.97	214	359	P	H
	*	2437	98.84	-	-	101.53	27.4	4.88	34.97	214	359	A	H
		2485.44	60.1	-13.9	74	62.65	27.47	4.9	34.92	214	359	P	H
		2483.9	44.33	-9.67	54	46.88	27.47	4.9	34.92	214	359	A	H
		2385.46	49.47	-24.53	74	52.37	27.26	4.86	35.02	151	27	P	V
		2389.94	38.29	-15.71	54	41.14	27.29	4.86	35	151	27	A	V
	*	2437	102.39	-	-	105.08	27.4	4.88	34.97	151	27	P	V
	*	2437	95.27	-	-	97.96	27.4	4.88	34.97	151	27	A	V
		2485.37	57.34	-16.66	74	59.89	27.47	4.9	34.92	151	27	P	V
		2483.83	41.55	-12.45	54	44.1	27.47	4.9	34.92	151	27	A	V



<b>802.11g CH 11 2462MHz</b>	*	2462	102.23	-	-	104.85	27.43	4.9	34.95	158	359	P	H
	*	2462	95.06	-	-	97.68	27.43	4.9	34.95	158	359	A	H
		2484.28	68.75	-5.25	74	71.3	27.47	4.9	34.92	158	359	P	H
		2483.52	52.88	-1.12	54	55.43	27.47	4.9	34.92	158	359	A	H
	*	2462	100.19	-	-	102.81	27.43	4.9	34.95	176	11	P	V
	*	2462	91.98	-	-	94.6	27.43	4.9	34.95	176	11	A	V
		2484.2	69.05	-4.95	74	71.6	27.47	4.9	34.92	176	11	P	V
		2483.52	53	-1	54	55.55	27.47	4.9	34.92	176	11	A	V
<b>Remark</b>	1. No other spurious found. 2. All results are PASS against Peak and Average limit line.												



**2.4GHz 2400~2483.5MHz  
WIFI 802.11g (Harmonic @ 3m)**

WIFI Ant. 1+2	Note	Frequency ( MHz )	Level ( dBμV/m )	Over Limit ( dB )	Limit Line ( dBμV/m )	Read Level ( dBμV )	Antenna Factor ( dB/m )	Cable Loss ( dB )	Preamp Factor ( dB )	Ant Pos ( cm )	Table Pos ( deg )	Peak Avg. (P/A)	Pol. (H/V)
802.11g CH 01 2412MHz		4824	47.98	-26.02	74	66.84	32.56	6.97	58.39	150	360	P	H
		4824	43.71	-30.29	74	62.57	32.56	6.97	58.39	150	360	P	V
802.11g CH 06 2437MHz		4874	47.91	-26.09	74	66.92	32.66	6.99	58.66	150	360	P	H
		7311	63.1	-10.9	74	75.13	37.66	8.93	58.62	174	100	P	H
		7311	52.72	-1.28	54	64.75	37.66	8.93	58.62	174	100	A	H
		4874	46.39	-27.61	74	65.4	32.66	6.99	58.66	150	360	P	V
		7311	57.6	-16.4	74	69.63	37.66	8.93	58.62	174	100	P	V
		7311	47.54	-6.46	54	59.57	37.66	8.93	58.62	174	100	A	V
802.11g CH 11 2462MHz		4924	43.97	-30.03	74	62.73	32.76	7	58.52	150	347	P	H
		7386	59.36	-14.64	74	71.07	37.68	9.15	58.54	153	120	P	H
		7386	45.86	-8.14	54	57.57	37.68	9.15	58.54	153	120	A	H
		4924	43.34	-30.66	74	62.1	32.76	7	58.52	150	347	P	V
		7386	58.4	-15.6	74	70.11	37.68	9.15	58.54	187	82	P	V
			7386	44.38	-9.62	54	56.09	37.68	9.15	58.54	187	82	A
Remark	1. No other spurious found. 2. All results are PASS against Peak and Average limit line.												



2.4GHz 2400~2483.5MHz  
WIFI 802.11n HT20 (Band Edge @ 3m)

WIFI Ant. 1+2	Note	Frequency ( MHz )	Level ( dBμV/m )	Over Limit ( dB )	Limit Line ( dBμV/m )	Read Level ( dBμV )	Antenna Factor ( dB/m )	Cable Loss ( dB )	Preamp Factor ( dB )	Ant Pos ( cm )	Table Pos ( deg )	Peak Avg. ( P/A )	Pol. ( H/V )
802.11n HT20 CH 01 2412MHz		2388.435	70.13	-3.87	74	73	27.29	4.86	35.02	186	17	P	H
		2390	53.83	-0.17	54	56.68	27.29	4.86	35	186	17	A	H
	*	2412	103.3	-	-	106.09	27.33	4.88	35	186	17	P	H
	*	2412	95.04	-	-	97.83	27.33	4.88	35	186	17	A	H
		2388.96	69.18	-4.82	74	72.05	27.29	4.86	35.02	183	85	P	V
		2390	53.13	-0.87	54	55.98	27.29	4.86	35	183	85	A	V
	*	2412	100.66	-	-	103.45	27.33	4.88	35	183	85	P	V
	*	2412	92.56	-	-	95.35	27.33	4.88	35	183	85	A	V
802.11n HT20 CH 06 2437MHz		2382.66	50.2	-23.8	74	53.1	27.26	4.86	35.02	150	359	P	H
		2389.94	38.43	-15.57	54	41.28	27.29	4.86	35	150	359	A	H
	*	2437	102.65	-	-	105.34	27.4	4.88	34.97	150	359	P	H
	*	2437	94.9	-	-	97.59	27.4	4.88	34.97	150	359	A	H
		2487.75	56.3	-17.7	74	58.82	27.5	4.9	34.92	150	359	P	H
		2483.5	42.24	-11.76	54	44.79	27.47	4.9	34.92	150	359	A	H
		2389.52	53.6	-20.4	74	56.47	27.29	4.86	35.02	150	72	P	V
		2389.94	41.55	-12.45	54	44.4	27.29	4.86	35	150	72	A	V
	*	2437	102.69	-	-	105.38	27.4	4.88	34.97	150	72	P	V
	*	2437	95.23	-	-	97.92	27.4	4.88	34.97	150	72	A	V
		2490.48	56.24	-17.76	74	58.74	27.5	4.92	34.92	150	72	P	V
	2483.5	42.36	-11.64	54	44.91	27.47	4.9	34.92	150	72	A	V	



<b>802.11n</b> <b>HT20</b> <b>CH 11</b> <b>2462MHz</b>	*	2462	101.89	-	-	104.51	27.43	4.9	34.95	167	359	P	H
	*	2462	94.38	-	-	97	27.43	4.9	34.95	167	359	A	H
		2484.36	69.52	-4.48	74	72.07	27.47	4.9	34.92	167	359	P	H
		2483.52	53.56	-0.44	54	56.11	27.47	4.9	34.92	167	359	A	H
	*	2462	98.31	-	-	100.93	27.43	4.9	34.95	150	13	P	V
	*	2462	90.75	-	-	93.37	27.43	4.9	34.95	150	13	A	V
		2484.04	64.98	-9.02	74	67.53	27.47	4.9	34.92	150	13	P	V
		2483.52	49.69	-4.31	54	52.24	27.47	4.9	34.92	150	13	A	V
<b>Remark</b>	1. No other spurious found. 2. All results are PASS against Peak and Average limit line.												



**2.4GHz 2400~2483.5MHz  
WIFI 802.11n HT20 (Harmonic @ 3m)**

WIFI Ant. 1+2	Note	Frequency ( MHz )	Level ( dBμV/m )	Over Limit ( dB )	Limit Line ( dBμV/m )	Read Level ( dBμV )	Antenna Factor ( dB/m )	Cable Loss ( dB )	Preamp Factor ( dB )	Ant Pos ( cm )	Table Pos ( deg )	Peak Avg. (P/A)	Pol. (H/V)
802.11n HT20 CH 01 2412MHz		4824	47.42	-26.58	74	66.28	32.56	6.97	58.39	150	360	P	H
		4824	42.7	-31.3	74	61.56	32.56	6.97	58.39	150	360	P	V
802.11n HT20 CH 06 2437MHz		4874	49.93	-24.07	74	68.94	32.66	6.99	58.66	250	0	P	H
		7311	66.29	-7.71	74	78.32	37.66	8.93	58.62	150	126	P	H
		7311	52.17	-1.83	54	64.2	37.66	8.93	58.62	150	126	A	H
		4874	48.34	-25.66	74	67.35	32.66	6.99	58.66	250	0	P	V
		7311	59.24	-14.76	74	71.27	37.66	8.93	58.62	150	211	P	V
		7311	46.2	-7.8	54	58.23	37.66	8.93	58.62	150	211	A	V
802.11n HT20 CH 11 2462MHz		4924	45.44	-28.56	74	64.2	32.76	7	58.52	150	347	P	H
		7386	57.63	-16.37	74	69.34	37.68	9.15	58.54	152	124	P	H
		7386	42.36	-11.64	54	54.07	37.68	9.15	58.54	152	124	A	H
		4924	42.12	-31.88	74	60.88	32.76	7	58.52	150	347	P	V
		7386	54.9	-19.1	74	66.61	37.68	9.15	58.54	244	179	P	V
		7386	40.21	-13.79	54	51.92	37.68	9.15	58.54	244	179	A	V
Remark	1. No other spurious found. 2. All results are PASS against Peak and Average limit line.												



**2.4GHz 2400~2483.5MHz  
WIFI 802.11n HT40 (Band Edge @ 3m)**

WIFI Ant. 1+2	Note	Frequency ( MHz )	Level ( dBμV/m )	Over Limit ( dB )	Limit Line ( dBμV/m )	Read Level ( dBμV )	Antenna Factor ( dB/m )	Cable Loss ( dB )	Preamp Factor ( dB )	Ant Pos ( cm )	Table Pos ( deg )	Peak Avg. ( P/A )	Pol. ( H/V )	
802.11n HT40 CH 03 2422MHz		2386.86	67.13	-6.87	74	70	27.29	4.86	35.02	151	356	P	H	
		2389.94	52.91	-1.09	54	55.76	27.29	4.86	35	151	356	A	H	
	*	2422	95.38	-	-	98.11	27.36	4.88	34.97	151	356	P	H	
	*	2422	87.72	-	-	90.45	27.36	4.88	34.97	151	356	A	H	
		2487.54	53.74	-20.26	74	56.26	27.5	4.9	34.92	151	356	P	H	
		2484.39	40.19	-13.81	54	42.74	27.47	4.9	34.92	151	356	A	H	
		2386.44	64.06	-9.94	74	66.93	27.29	4.86	35.02	178	68	P	V	
		2389.94	51.6	-2.4	54	54.45	27.29	4.86	35	178	68	A	V	
	*	2422	92.74	-	-	95.47	27.36	4.88	34.97	178	68	P	V	
	*	2422	85.58	-	-	88.31	27.36	4.88	34.97	178	68	A	V	
		2490.06	51.98	-22.02	74	54.48	27.5	4.92	34.92	178	68	P	V	
		2484.46	38.32	-15.68	54	40.87	27.47	4.9	34.92	178	68	A	V	
	802.11n HT40 CH 06 2437MHz		2389.94	60.04	-13.96	74	62.89	27.29	4.86	35	153	360	P	H
			2389.52	48.33	-5.67	54	51.2	27.29	4.86	35.02	153	360	A	H
*		2437	96.19	-	-	98.88	27.4	4.88	34.97	153	360	P	H	
*		2437	89.03	-	-	91.72	27.4	4.88	34.97	153	360	A	H	
		2484.74	67.58	-6.42	74	70.13	27.47	4.9	34.92	153	360	P	H	
		2483.5	53.26	-0.74	54	55.81	27.47	4.9	34.92	153	360	A	H	
		2389.66	56.78	-17.22	74	59.65	27.29	4.86	35.02	151	28	P	V	
		2389.94	43.81	-10.19	54	46.66	27.29	4.86	35	151	28	A	V	
*		2437	93.71	-	-	96.4	27.4	4.88	34.97	151	28	P	V	
*		2437	86.43	-	-	89.12	27.4	4.88	34.97	151	28	A	V	
		2484.32	65.2	-8.8	74	67.75	27.47	4.9	34.92	151	28	P	V	
	2483.5	51.17	-2.83	54	53.72	27.47	4.9	34.92	151	28	A	V		



<b>802.11n HT40 CH 09 2452MHz</b>		2321.48	49.09	-24.91	74	52.21	27.16	4.79	35.07	151	360	P	H
		2348.22	37.08	-16.92	54	40.12	27.19	4.82	35.05	151	360	A	H
	*	2452	94.51	-	-	97.16	27.4	4.9	34.95	151	360	P	H
	*	2452	87.17	-	-	89.82	27.4	4.9	34.95	151	360	A	H
		2484.39	68.44	-5.56	74	70.99	27.47	4.9	34.92	151	360	P	H
		2483.5	52.26	-1.74	54	54.81	27.47	4.9	34.92	151	360	A	H
		2320.64	47.65	-26.35	74	50.77	27.16	4.79	35.07	151	62	P	V
		2388.54	36.22	-17.78	54	39.09	27.29	4.86	35.02	151	62	A	V
	*	2452	92.6	-	-	95.25	27.4	4.9	34.95	151	62	P	V
	*	2452	84.06	-	-	86.71	27.4	4.9	34.95	151	62	A	V
		2484.67	65.06	-8.94	74	67.61	27.47	4.9	34.92	151	62	P	V
		2483.5	50.21	-3.79	54	52.76	27.47	4.9	34.92	151	62	A	V
<b>Remark</b>	1. No other spurious found. 2. All results are PASS against Peak and Average limit line.												





**2.4GHz 2400~2483.5MHz  
WIFI 802.11n HT40 (Harmonic @ 3m)**

WIFI Ant. 1+2	Note	Frequency ( MHz )	Level ( dBμV/m )	Over Limit ( dB )	Limit Line ( dBμV/m )	Read Level ( dBμV )	Antenna Factor ( dB/m )	Cable Loss ( dB )	Preamp Factor ( dB )	Ant Pos ( cm )	Table Pos ( deg )	Peak Avg. ( P/A )	Pol. ( H/V )
802.11n HT40 CH 03 2422MHz		4844	46.16	-27.84	74	65.08	32.59	6.97	58.48	150	360	P	H
		7266	53.15	-20.85	74	65.07	37.66	8.95	58.53	200	360	P	H
		7266	43.97	-10.03	54	55.89	37.66	8.95	58.53	200	360	A	H
		4844	43.27	-30.73	74	62.19	32.59	6.97	58.48	150	360	P	V
		7266	49.95	-24.05	74	61.87	37.66	8.95	58.53	200	360	P	V
802.11n HT40 CH 06 2437MHz		4874	44.94	-29.06	74	63.95	32.66	6.99	58.66	150	163	P	H
		7311	55.41	-18.59	74	67.44	37.66	8.93	58.62	150	360	P	H
		7311	45.95	-8.05	54	57.98	37.66	8.93	58.62	150	360	A	H
		4874	43	-31	74	62.01	32.66	6.99	58.66	150	163	P	V
		7311	52.65	-21.35	74	64.68	37.66	8.93	58.62	150	360	P	V
		7311	43.44	-10.56	54	55.47	37.66	8.93	58.62	150	360	A	V
802.11n HT40 CH 09 2452MHz		4904	42.73	-31.27	74	61.64	32.73	7	58.64	150	360	P	H
		7356	51.01	-22.99	74	62.87	37.67	9.04	58.57	150	320	P	H
		7356	42.12	-11.88	54	53.98	37.67	9.04	58.57	150	320	A	H
		4904	41.48	-32.52	74	60.39	32.73	7	58.64	150	360	P	V
		7356	49.37	-24.63	74	61.23	37.67	9.04	58.57	150	320	P	V
Remark	1. No other spurious found. 2. All results are PASS against Peak and Average limit line.												



Emission below 1GHz

2.4GHz WIFI 802.11n HT20 (LF)

WIFI	Note	Frequency	Level	Over	Limit	Read	Antenna	Cable	Preamp	Ant	Table	Peak	Pol.
Ant.				Limit	Line	Level	Factor	Loss	Factor	Pos	Pos	Avg.	
1+2		( MHz )	( dBμV/m )	( dB )	( dBμV/m )	( dBμV )	( dB/m )	( dB )	( dB )	( cm )	( deg )	( P/A )	( H/V )
2.4GHz 802.11n HT20 LF		30.97	26.14	-13.86	40	31.02	26.28	0.62	31.78	-	-	P	H
		76.56	25.05	-14.95	40	41.23	14.67	0.83	31.68	-	-	P	H
		90.14	32.52	-10.98	43.5	45.35	17.8	0.99	31.62	170	200	P	H
		104.69	26.83	-16.67	43.5	38.7	18.7	0.99	31.56	-	-	P	H
		406.36	27.64	-18.36	46	31.2	25.85	1.82	31.23	-	-	P	H
		810.85	31.1	-14.9	46	32.14	27.55	2.65	31.24	-	-	P	H
		48.43	36.33	-3.67	40	50.14	17.3	0.62	31.73	120	150	P	V
		71.71	33	-7	40	50	13.86	0.83	31.69	-	-	P	V
		90.14	39.18	-4.32	43.5	52.01	17.8	0.99	31.62	-	-	P	V
		145.43	25.18	-18.32	43.5	37.56	17.9	1.15	31.43	-	-	P	V
		240.49	30.89	-15.11	46	43.23	17.54	1.4	31.28	-	-	P	V
	409.27	27.78	-18.22	46	31.4	25.79	1.82	31.23	-	-	P	V	
Remark	1. No other spurious found. 2. All results are PASS against limit line.												



**Note symbol**

*	<b>Fundamental Frequency</b> which can be ignored. However, the level of any unwanted emissions shall not exceed the level of the fundamental frequency.
!	Test result is <b>over limit</b> line.
P/A	<b>Peak</b> or <b>Average</b>
H/V	<b>Horizontal</b> or <b>Vertical</b>



A calculation example for radiated spurious emission is shown as below:

WIFI	Note	Frequency	Level	Over	Limit	Read	Antenna	Cable	Preamp	Ant	Table	Peak	Pol.
Ant.				Limit	Line	Level	Factor	Loss	Factor	Pos	Pos	Avg.	
1+2		( MHz )	( dBμV/m )	( dB )	( dBμV/m )	( dBμV )	( dB/m )	( dB )	( dB )	( cm )	( deg )	( P/A )	( H/V )
802.11b		2390	55.45	-18.55	74	54.51	32.22	4.58	35.86	103	308	P	H
CH 01													
2412MHz		2390	43.54	-10.46	54	42.6	32.22	4.58	35.86	103	308	A	H

- Level(dBμV/m) =  
Antenna Factor(dB/m) + Cable Loss(dB) + Read Level(dBμV) - Preamp Factor(dB)
- Over Limit(dB) = Level(dBμV/m) – Limit Line(dBμV/m)

**For Peak Limit @ 2390MHz:**

- Level(dBμV/m)  
= Antenna Factor(dB/m) + Cable Loss(dB) + Read Level(dBμV) - Preamp Factor(dB)  
= 32.22(dB/m) + 4.58(dB) + 54.51(dBμV) – 35.86 (dB)  
= 55.45 (dBμV/m)
- Over Limit(dB)  
= Level(dBμV/m) – Limit Line(dBμV/m)  
= 55.45(dBμV/m) – 74(dBμV/m)  
= -18.55(dB)

**For Average Limit @ 2390MHz:**

- Level(dBμV/m)  
= Antenna Factor(dB/m) + Cable Loss(dB) + Read Level(dBμV) - Preamp Factor(dB)  
= 32.22(dB/m) + 4.58(dB) + 42.6(dBμV) – 35.86 (dB)  
= 43.54 (dBμV/m)
- Over Limit(dB)  
= Level(dBμV/m) – Limit Line(dBμV/m)  
= 43.54(dBμV/m) – 54(dBμV/m)  
= -10.46(dB)

Both peak and average measured complies with the limit line, so test result is “PASS”.



## Appendix C. Duty Cycle Plots

Chain Port	Band	Duty Cycle(%)	T(ms)	1/T(kHz)	VBW Setting
1+2	802.11b	100	-	-	10Hz
1+2	802.11g	99.40	-	-	10Hz
1+2	2.4GHz 802.11n HT20	99.36	-	-	10Hz
1+2	2.4GHz 802.11n HT40	98.30	-	-	10Hz



<Ant 1+2>

802.11b

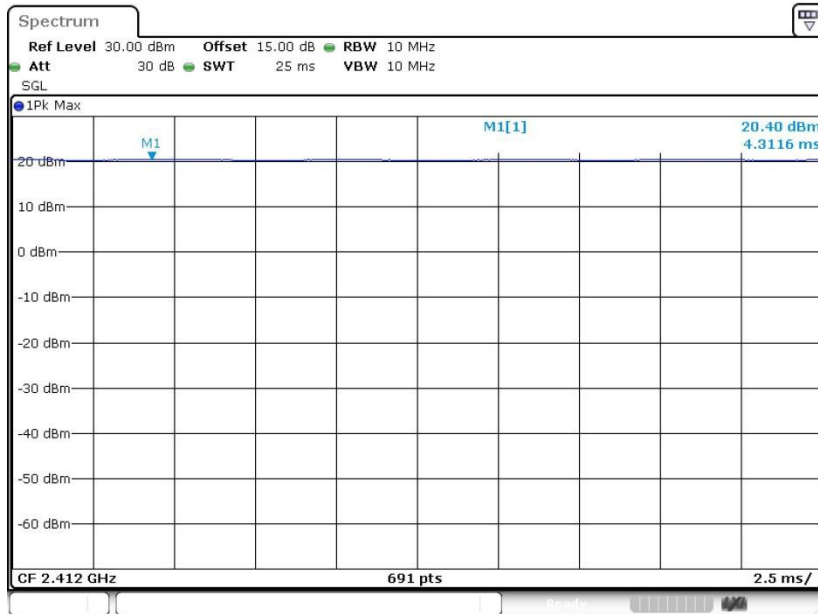

802.11g

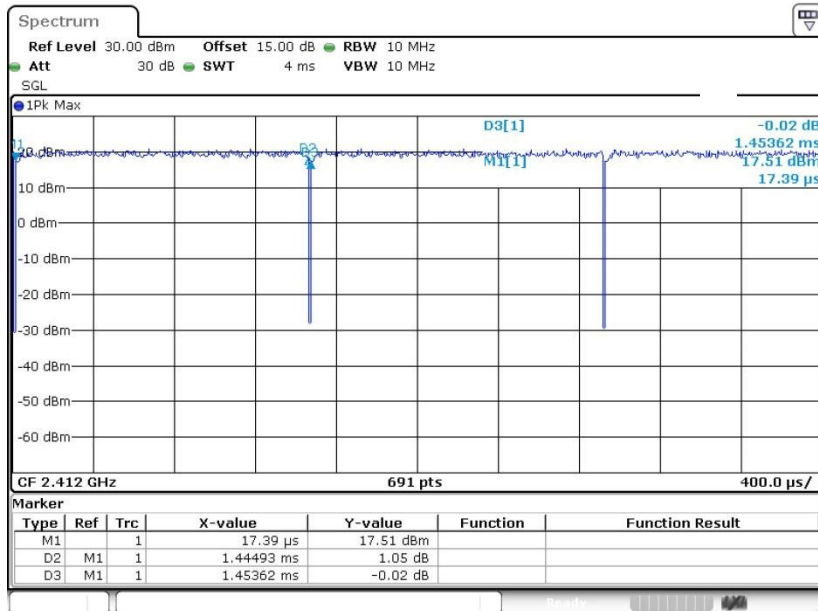



802.11n HT20

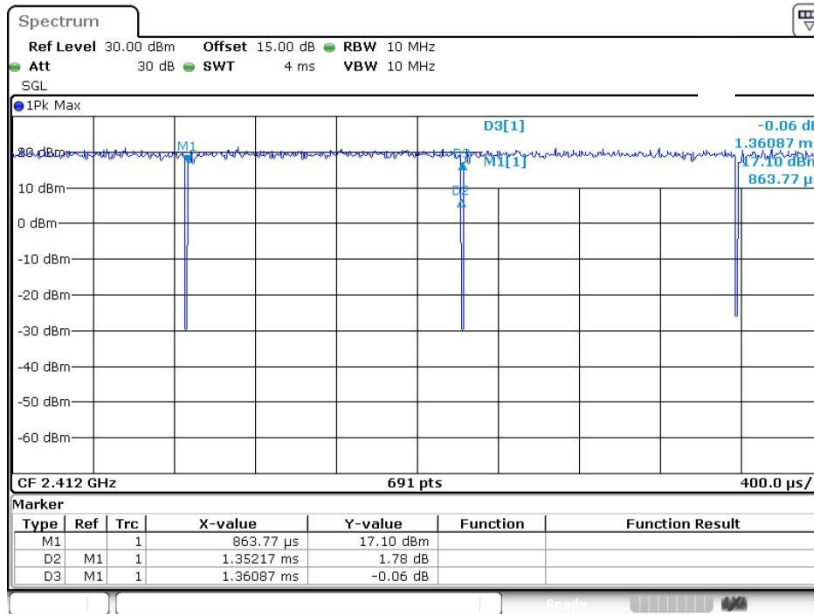

802.11n HT40

