



FCC RF Test Report

APPLICANT : TP-Link Technologies Co., Ltd.
EQUIPMENT : AC1200 Wi-Fi Range Extender with Smart Plug
BRAND NAME : TP-Link
MODEL NAME : RE370K
FCC ID : TE7RE370K
STANDARD : FCC Part 15 Subpart E §15.407
CLASSIFICATION : (NII) Unlicensed National Information Infrastructure

The product was received on Sep. 28, 2016 and testing was completed on Nov. 11, 2016. We, SPORTON INTERNATIONAL (SHENZHEN) INC., would like to declare that the tested sample has been evaluated in accordance with the test procedures and has been in compliance with the applicable technical standards.

The test results in this report apply exclusively to the tested model / sample. Without written approval of SPORTON INTERNATIONAL (SHENZHEN) INC., the test report shall not be reproduced except in full.

Prepared by: Ken Chen / Manager

Approved by: Jones Tsai / Manager



Testing Laboratory
2353

SPORTON INTERNATIONAL (SHENZHEN) INC.

**1F & 2F, Building A, Morning Business Center, No. 4003 ShiGu Rd., Xili Town,
Nanshan District, Shenzhen, Guangdong, P. R. China**



TABLE OF CONTENTS

REVISION HISTORY..... 3

SUMMARY OF TEST RESULT 4

1 GENERAL DESCRIPTION 5

 1.1 Applicant 5

 1.2 Manufacturer 5

 1.3 Product Feature of Equipment Under Test..... 5

 1.4 Product Specification of Equipment Under Test..... 6

 1.5 Modification of EUT 7

 1.6 Testing Location 7

 1.7 Applicable Standards..... 8

2 TEST CONFIGURATION OF EQUIPMENT UNDER TEST 9

 2.1 Carrier Frequency and Channel 9

 2.2 Test Mode 10

 2.3 Connection Diagram of Test System 11

 2.4 Support Unit used in test configuration and system 12

 2.5 EUT Operation Test Setup 12

 2.6 Measurement Results Explanation Example..... 13

3 TEST RESULT 14

 3.1 6dB and 26dB and 99% Occupied Bandwidth Measurement 14

 3.2 Maximum Conducted Output Power Measurement 17

 3.3 Power Spectral Density Measurement 18

 3.4 Unwanted Emissions Measurement..... 21

 3.5 AC Conducted Emission Measurement..... 26

 3.6 Frequency Stability Measurement 30

 3.7 Automatically Discontinue Transmission 31

 3.8 Antenna Requirements 32

4 LIST OF MEASURING EQUIPMENT 33

5 UNCERTAINTY OF EVALUATION 34

APPENDIX A. CONDUCTED TEST RESULTS

APPENDIX B. RADIATED SPURIOUS EMISSION

APPENDIX C. DUTY CYCLE PLOTS

APPENDIX D. SETUP PHOTOGRAPHS



REVISION HISTORY

REPORT NO.	VERSION	DESCRIPTION	ISSUED DATE
FR692804C	Rev. 01	Initial issue of report	Nov. 22, 2016



SUMMARY OF TEST RESULT

Report Section	FCC Rule	IC Rule	Description	Limit	Result	Remark
3.1	15.403(i)	RSS-247 Section 6	6dB, 26dB and 99% Occupied Bandwidth	> 500kHz	Pass	-
3.2	15.407(a)	RSS-247 Section 6	Maximum Conducted Output Power	≤ 30 dBm	Pass	-
3.3	15.407(a)	RSS-247 Section 6	Power Spectral Density	≤ 30 dBm/500kHz	Pass	-
3.4	15.407(b)	RSS-247 Section 6	Unwanted Emissions	15.407(b)(4)(i) & 15.209(a)	Pass	Under limit 1.86 dB at 5649.800 MHz
3.5	15.207	RSS-Gen 8.8	AC Conducted Emission	15.207(a)	Pass	Under limit 15.71 dB at 0.640 MHz
3.6	15.407(g)	-	Frequency Stability	Within Operation Band	Pass	-
3.7	15.407(c)	RSS-247 6.4(2)	Automatically Discontinue Transmission	Discontinue Transmission	Pass	-
3.8	15.203 & 15.407(a)	N/A	Antenna Requirement	N/A	Pass	-



1 General Description

1.1 Applicant

TP-Link Technologies Co., Ltd.

Building 24 (floors 1,3,4,5) and 28 (floors1-4) Central Science and Technology Park, Shennan Rd, Nanshan, Shenzhen, China

1.2 Manufacturer

TP-Link Technologies Co., Ltd.

uilding 24 (floors 1,3,4,5) and 28 (floors1-4) Central Science and Technology Park, Shennan Rd, Nanshan, Shenzhen, China

1.3 Product Feature of Equipment Under Test

Product Feature	
Equipment	AC1200 Wi-Fi Range Extender with Smart Plug
Brand Name	TP-Link
Model Name	RE370K
FCC ID	TE7RE370K
EUT supports Radios application	WLAN2.4GHz 802.11b/g/n HT20/HT40 WLAN5GHz 802.11a/n HT20/HT40 WLAN5GHz 80211ac VHT20/VHT40/VHT80
EUT Stage	Production Unit

Remark: The above EUT's information was declared by manufacturer. Please refer to the specifications or user's manual for more detailed description.



1.4 Product Specification of Equipment Under Test

Standards-related Product Specification										
Tx/Rx Channel Frequency Range	5745 MHz ~ 5825 MHz									
Maximum Output Power	<5745 MHz ~ 5825 MHz> MIMO <Ant. 1 + 2> 802.11a : 27.82 dBm / 0.6053 W 802.11n HT20 : 27.54 dBm / 0.5675 W 802.11n HT40 : 27.47 dBm / 0.5585 W 802.11ac VHT20: 27.40 dBm / 0.5495 W 802.11ac VHT40: 27.45 dBm / 0.5559 W 802.11ac VHT80: 24.63 dBm / 0.2904 W									
99% Occupied Bandwidth	802.11a : 32.72 MHz 802.11n HT20 : 37.01 MHz 802.11n HT40 : 67.53 MHz 802.11ac VHT80 : 76.00 MHz									
Type of Modulation	802.11a/n : OFDM (BPSK / QPSK / 16QAM / 64QAM) 802.11ac : OFDM (BPSK / QPSK / 16QAM / 64QAM / 256QAM)									
Antenna Type / Gain	Ant. 1 : Dipole Antenna with gain 1.99 dBi Ant. 2 : Dipole Antenna with gain 1.92 dBi									
Antenna Function Description	<table border="1"> <thead> <tr> <th></th> <th>Ant. 1</th> <th>Ant. 2</th> </tr> </thead> <tbody> <tr> <td>802.11 a/n/ac SISO</td> <td>V</td> <td>V</td> </tr> <tr> <td>802.11 a/n/ac MIMO</td> <td>V</td> <td>V</td> </tr> </tbody> </table>		Ant. 1	Ant. 2	802.11 a/n/ac SISO	V	V	802.11 a/n/ac MIMO	V	V
	Ant. 1	Ant. 2								
802.11 a/n/ac SISO	V	V								
802.11 a/n/ac MIMO	V	V								

Note: MIMO Ant. 1+2 is a calculated result from sum of the power MIMO Ant. 1 and MIMO Ant. 2.



1.5 Modification of EUT

No modifications are made to the EUT during all test items.

1.6 Testing Location

Test Site	SPORTON INTERNATIONAL (SHENZHEN) INC.	
Test Site Location	1F & 2F, Building A, Morning Business Center, No. 4003 ShiGu Rd., Xili Town, Nanshan District, Shenzhen, Guangdong, P. R. China TEL: +86-755-8637-9589 FAX: +86-755-8637-9595	
Test Site No.	Sporton Site No.	
	TH01-SZ	CO01-SZ

Test Site	SPORTON INTERNATIONAL (SHENZHEN) INC.	
Test Site Location	No. 3 Building, the third floor of south, Shahe River west, Fengzeyuan warehouse, Nanshan District, Shenzhen, Guangdong, P. R. China TEL: +86-755- 3320-2398	
Test Site No.	Sporton Site No.	FCC Registration No.
	03CH03-SZ	565805

Note: The test site complies with ANSI C63.4 2014 requirement.



1.7 Applicable Standards

According to the specifications of the manufacturer, the EUT must comply with the requirements of the following standards:

- ♦ FCC Part 15 Subpart E
- ♦ FCC KDB 789033 D02 General UNII Test Procedures New Rules v01r03
- ♦ FCC KDB 662911 D01 Multiple Transmitter Output v02r01.
- ♦ FCC KDB 644545 D03 Guidance for IEEE 802 11ac New Rules v01
- ♦ ANSI C63.10-2013
- ♦ IC RSS-247 Issue 1
- ♦ IC RSS-Gen Issue 4

Remark:

1. All test items were verified and recorded according to the standards and without any deviation during the test.
2. This EUT has also been tested and complied with the requirements of FCC Part 15, Subpart B, recorded in a separate test report.



2 Test Configuration of Equipment Under Test

The EUT has been associated with peripherals and configuration operated in a manner tended to maximize its emission characteristics in a typical application. Frequency range investigated: conducted emission (150 kHz to 30 MHz) and radiated emission (9 kHz to the 10th harmonic of the highest fundamental frequency or to 40 GHz, whichever is lower).

2.1 Carrier Frequency and Channel

Frequency Band	Channel	Freq. (MHz)	Channel	Freq. (MHz)
5745-5825 MHz Band 4 (U-NII-3)	149	5745	157	5785
	151*	5755	159*	5795
	153	5765	161	5805
	155 [#]	5775	165	5825

Note:

1. The above Frequency and Channel in "*" were 802.11n HT40 and 802.11ac VHT40.
2. The above Frequency and Channel in "[#]" were 802.11ac VHT80.



2.2 Test Mode

Final test mode of conducted test items and radiated spurious emissions are considering the modulation and worse data rates as below table.

MIMO Antenna

Modulation	Data Rate
802.11a	6 Mbps
802.11n HT20	MCS0
802.11n HT40	MCS0
802.11ac VHT20	MCS0
802.11ac VHT40	MCS0
802.11ac VHT80	MCS0

AC Conducted Emission	Mode 1 : WLAN (5G) Link (Client) + WLAN (5G) Link (Master) + AC Load + RJ45 Link
-----------------------	--

Ch. #		Band IV : 5725-5850 MHz		
		802.11a	802.11n HT20	802.11n HT40
L	Low	149	149	151
M	Middle	157	157	-
H	High	165	165	159

Ch. #		Band IV : 5725-5850 MHz		
		802.11ac VHT20	802.11ac VHT40	802.11ac VHT80
L	Low	149	151	-
M	Middle	157	-	155
H	High	165	159	-

2.3 Connection Diagram of Test System

<WLAN Tx Mode>

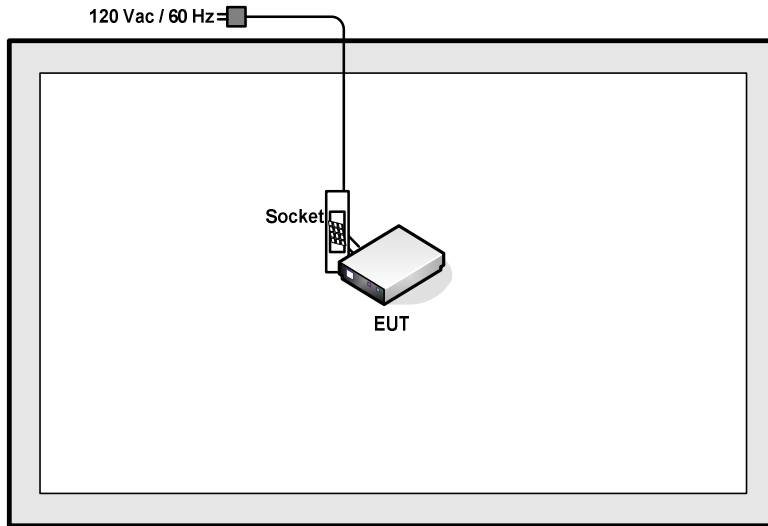

<AC Conducted Emission Mode>

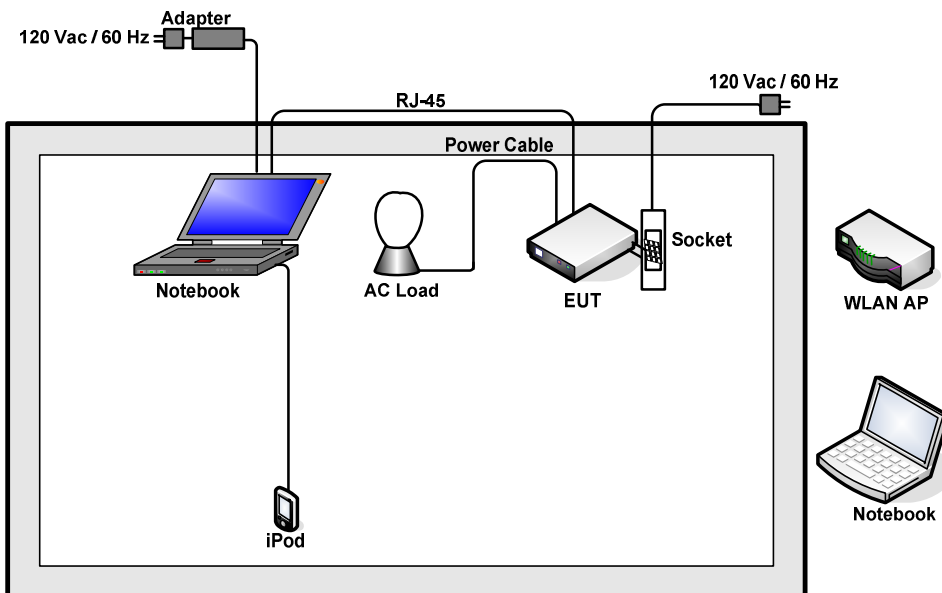



2.4 Support Unit used in test configuration and system

Item	Equipment	Trade Name	Model Name	FCC ID	Data Cable	Power Cord
1.	WLAN AP	D-Link	DIR-820L	KA2IR820LA1	N/A	Unshielded, 1.8 m
2.	Notebook	Lenovo	E450	FCC DoC	N/A	AC I/P: Unshielded, 1.2 m DC O/P: Shielded, 1.8 m
3.	Notebook	Lenovo	E540	FCC DoC	N/A	AC I/P: Unshielded, 1.2 m DC O/P: Shielded, 1.8 m
4.	iPod nano 8GB	Apple	MC690ZP/A	FCC DoC	Shielded, 1.2m	N/A
5.	MicroSD Card	SanDisk	8G class 4	FCC DoC	N/A	N/A
6.	DC Power Supply	GWINSTEK	AnritsuGPS-3030D	N/A	N/A	Unshielded, 1.8 m
7.	AC Load	N/A	N/A	N/A	N/A	N/A
8.	Socket	N/A	N/A	N/A	N/A	N/A
9.	Power Cable	N/A	N/A	N/A	N/A	N/A

2.5 EUT Operation Test Setup

For WLAN RF test items, an engineering test program was provided and enabled to make EUT continuously transmit/receive.

For AC power line conducted emissions, the EUT was set to connect with the Notebook under large package sizes transmission.



2.6 Measurement Results Explanation Example

For all conducted test items:

The offset level is set in the spectrum analyzer to compensate the RF cable loss and attenuator factor between EUT conducted output port and spectrum analyzer. With the offset compensation, the spectrum analyzer reading level is exactly the EUT RF output level.

Example :

The spectrum analyzer offset is derived from RF cable loss and attenuator factor.

Offset = RF cable loss + attenuator factor.

Following shows an offset computation example with cable loss 6.30 dB and 10dB attenuator.

$$\begin{aligned} \text{Offset(dB)} &= \text{RF cable loss(dB)} + \text{attenuator factor(dB)}. \\ &= 6.30 + 10 = 16.30 \text{ (dB)} \end{aligned}$$

3 Test Result

3.1 6dB and 26dB and 99% Occupied Bandwidth Measurement

3.1.1 Description of 6dB and 26dB and 99% Occupied Bandwidth

The minimum 6 dB bandwidth shall be at least 500 kHz.

26dB and 99% Occupied bandwidth are reporting only.

3.1.2 Measuring Instruments

The measuring equipment is listed in the section 4 of this test report.

3.1.3 Test Procedures

1. The testing follows FCC KDB 789033 D02 General UNII Test Procedures New Rules v01r03.
Section C) Emission bandwidth for the band 5.725-5.85GHz
2. Set RBW = 100kHz.
3. Set the VBW $\geq 3 \times$ RBW.
4. Detector = Peak.
5. Trace mode = max hold
6. Measure the maximum width of the emission that is 6 dB down from the peak of the emission.
7. Measure and record the results in the test report.

3.1.4 Test Setup

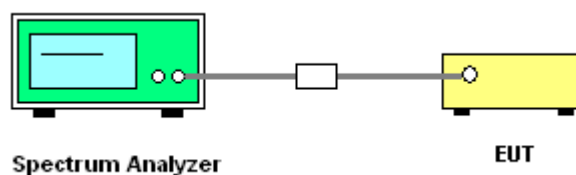



3.1.5 Test Result of 6dB Bandwidth

Please refer to Appendix A.

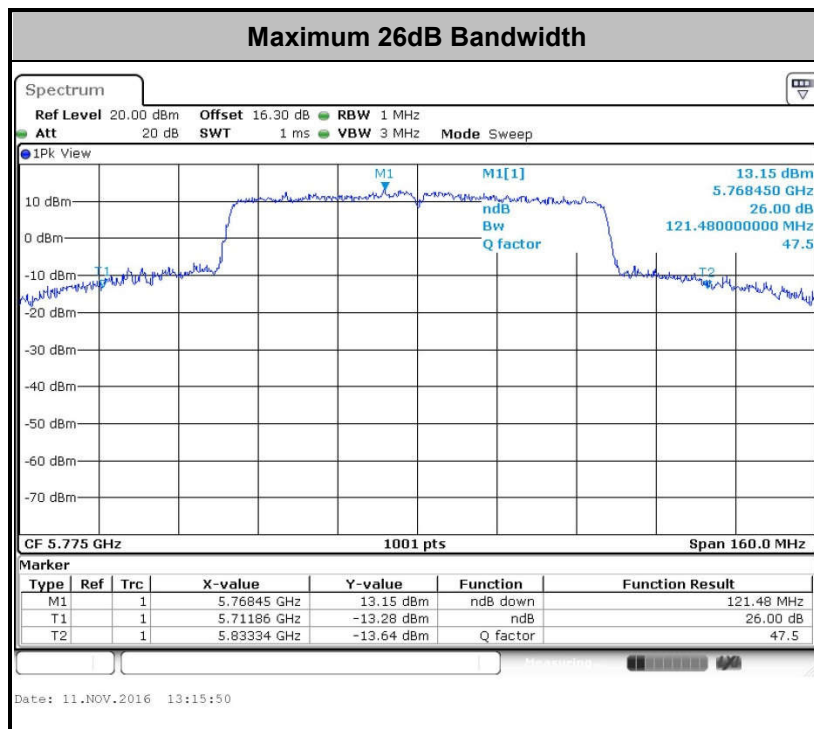
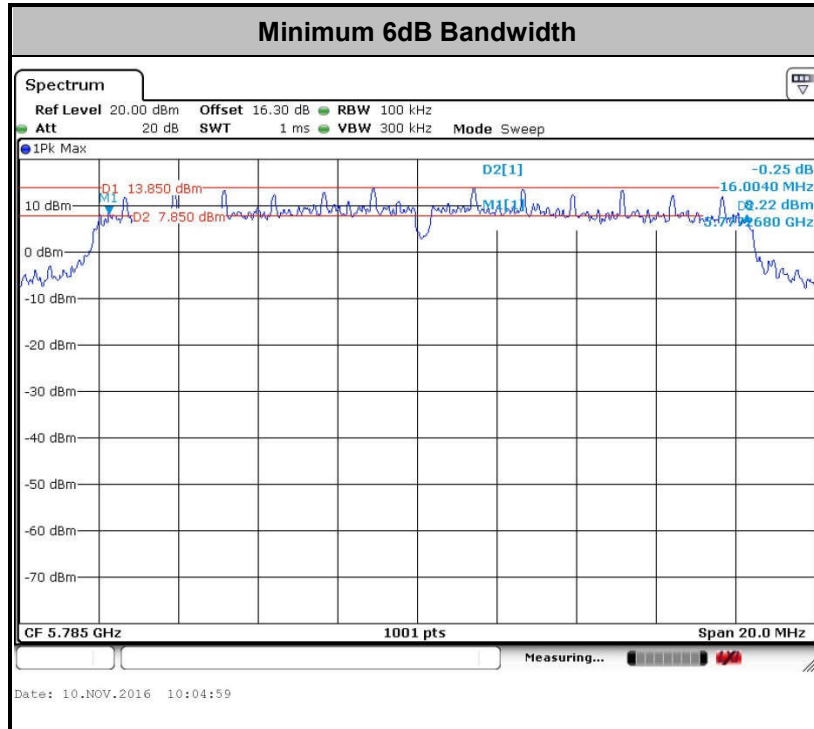

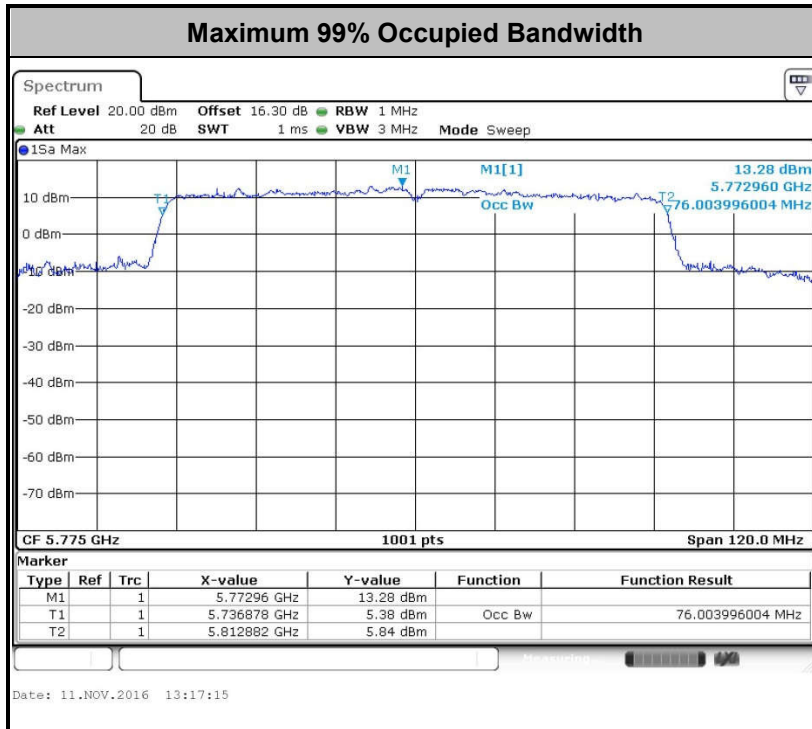

Note: The occupied channel bandwidth is maintained within the band of operation for all of the modulations.

3.2 Maximum Conducted Output Power Measurement

3.2.1 Limit of Maximum Conducted Output Power

For the band 5.725–5.85 GHz, the maximum conducted output power over the frequency band of operation shall not exceed 1 W.

If transmitting antennas of directional gain greater than 6 dBi are used, the peak output power shall be reduced by the amount in dB that the directional gain of the antenna exceeds 6 dBi.

3.2.2 Measuring Instruments

The measuring equipment is listed in the section 4 of this test report.

3.2.3 Test Procedures

The testing follows Method PM of FCC KDB 789033 D02 General UNII Test Procedures New Rules v01r03.

Method PM (Measurement using an RF average power meter):

1. Measurement is performed using a wideband RF power meter.
2. The EUT is configured to transmit continuously with a consistent duty cycle at its maximum power control level.
3. Measure the average power of the transmitter, and the average power is corrected with duty factor, $10 \log(1/x)$, where x is the duty cycle.

3.2.4 Test Setup

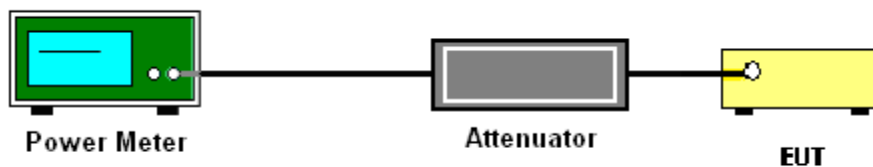

3.2.5 Test Result of Maximum Conducted Output Power

Please refer to Appendix A.



3.3 Power Spectral Density Measurement

3.3.1 Limit of Power Spectral Density

For the band 5.725–5.85 GHz, the maximum power spectral density shall not exceed 30 dBm in any 500-kHz band.

If transmitting antennas of directional gain greater than 6 dBi are used, the peak output power shall be reduced by the amount in dB that the directional gain of the antenna exceeds 6 dBi.

3.3.2 Measuring Instruments

The measuring equipment is listed in the section 4 of this test report.

3.3.3 Test Procedures

The testing follows FCC KDB 789033 D02 General UNII Test Procedures New Rules v01r03. Section F) Maximum power spectral density.

Method SA-2

(trace averaging across on and off times of the EUT transmissions, followed by duty cycle correction).

- Measure the duty cycle.
- Set span to encompass the entire emission bandwidth (EBW) of the signal.
- Set RBW = 300 kHz.
- Set VBW \geq 1 MHz.
- Number of points in sweep \geq 2 Span / RBW.
- Sweep time = auto.
- Detector = RMS
- Trace average at least 100 traces in power averaging mode.
- Add $10 \log(500\text{kHz}/\text{RBW})$ to the test result.
- Add $10 \log(1/x)$, where x is the duty cycle, to the measured power in order to compute the average power during the actual transmission times. For example, add $10 \log(1/0.25) = 6$ dB if the duty cycle is 25 percent.

1. The RF output of EUT was connected to the spectrum analyzer by a low loss cable.
2. Each plot has already offset with cable loss, and attenuator loss. Measure the PPSD and record it.
3. For MIMO mode, calculation method follows FCC KDB 662911 D01 Multiple Transmitter Output v02r01.

Method (c): Measure and add $10 \log(N_{\text{ANT}})$ dB.

With this technique, spectrum measurements are performed at each output of the device, but rather than summing the spectra or the spectral peaks across the outputs, the quantity $10 \log(N_{\text{ANT}})$ dB is added to each spectrum value before comparing to the emission limit. The addition of $10 \log(N_{\text{ANT}})$ dB serves to apportion the emission limit among the N_{ANT} outputs so that each output is permitted to contribute no more than $1/N_{\text{ANT}}^{\text{th}}$ of the PSD limit.

3.3.4 Test Setup

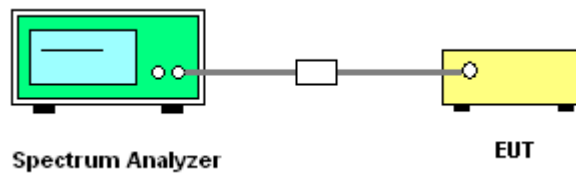



3.3.5 Test Result of Power Spectral Density

Please refer to Appendix A.

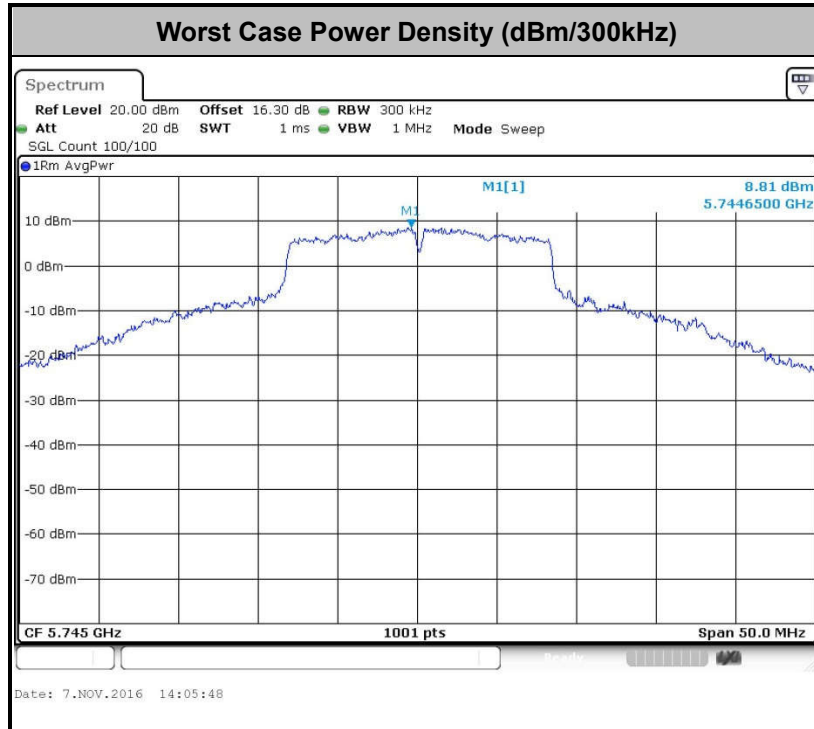



3.4 Unwanted Emissions Measurement

This section as specified in FCC Part 15.407(b) is to measure unwanted emissions through radiated measurement for band edge spurious emissions and out of band emissions measurement. The unwanted emissions shall comply with 15.407(b)(1) to (6), and restricted bands per FCC Part15.205.

3.4.1 Limit of Unwanted Emissions

(1) For transmitters operating in the 5.725-5.85 GHz band:

15.407(b)(4)(i) All emissions shall be limited to a level of -27 dBm/MHz at 75 MHz or more above or below the band edge increasing linearly to 10 dBm/MHz at 25 MHz above or below the band edge, and from 25 MHz above or below the band edge increasing linearly to a level of 15.6 dBm/MHz at 5 MHz above or below the band edge, and from 5 MHz above or below the band edge increasing linearly to a level of 27 dBm/MHz at the band edge.

(2) Unwanted spurious emissions fallen in restricted bands per FCC Part15.205 shall comply with the general field strength limits set forth in § 15.209 as below table,

Frequency (MHz)	Field Strength (microvolts/meter)	Measurement Distance (meters)
0.009 – 0.490	2400/F(kHz)	300
0.490 – 1.705	24000/F(kHz)	30
1.705 – 30.0	30	30
30 – 88	100	3
88 – 216	150	3
216 - 960	200	3
Above 960	500	3

Note: The following formula is used to convert the EIRP to field strength.

$$E = \frac{1000000\sqrt{30P}}{3} \mu\text{V/m, where P is the eirp (Watts)}$$



EIRP (dBm)	Field Strength at 3m (dBμV/m)
-17	78.3
- 27	68.3

(3) KDB 789033 D02 General UNII Test Procedures New Rules v01r03 G)2)c) As specified in 15.407(b), emissions above 1000 MHz that are outside of the restricted bands are subject to a peak emission limit of -27 dBm/MHz (or -17 dBm/MHz as specified in 15.407(b)(4)). However, an out-of-band emission that complies with both the average and peak limits of 15.209 is not required to satisfy the -27 dBm/MHz or -17 dBm/MHz peak emission limit.

3.4.2 Measuring Instruments

The measuring equipment is listed in the section 4 of this test report.

3.4.3 Test Procedures

1. The testing follows FCC KDB 789033 D02 General UNII Test Procedures New Rules v01r03. Section G) Unwanted emissions measurement.

(1) Procedure for Unwanted Emissions Measurements Below 1000MHz

- RBW = 120 kHz
- VBW = 300 kHz
- Detector = Peak
- Trace mode = max hold

(2) Procedure for Peak Unwanted Emissions Measurements Above 1000 MHz

- RBW = 1 MHz
- VBW ≥ 3 MHz
- Detector = Peak
- Sweep time = auto
- Trace mode = max hold

(3) Procedures for Average Unwanted Emissions Measurements Above 1000MHz

- RBW = 1 MHz
- VBW = 10 Hz, when duty cycle is no less than 98 percent.
- VBW ≥ 1/T, when duty cycle is less than 98 percent where T is the minimum transmission duration over which the transmitter is on and is transmitting at its maximum power control level for the tested mode of operation.

2. The EUT was placed on a turntable with 0.8 meter for frequency below 1GHz and 1.5 meter for frequency above 1GHz respectively above ground.
3. The EUT was set 3 meters from the interference receiving antenna which was mounted on the top of a variable height antenna tower.
4. The antenna is a broadband antenna and its height is adjusted between one meter and four meters above ground to find the maximum value of the field strength for both horizontal polarization and vertical polarization of the antenna.
5. For each suspected emission, the EUT was arranged to its worst case and then adjust the antenna tower (from 1 m to 4 m) and turntable (from 0 degree to 360 degrees) to find the maximum reading.
6. For testing below 1GHz, if the emission level of the EUT in peak mode was 3 dB lower than the limit specified, then peak values of EUT will be reported, otherwise, the emissions will be repeated one by one using the CISPR quasi-peak method and reported.
7. For testing above 1GHz, the emission level of the EUT in peak mode was 20dB lower than average limit (that means the emission level in average mode also complies with the limit in average mode), then peak values of EUT will be reported, otherwise, the emissions will be measured in average mode again and reported.

3.4.4 Test Setup

For radiated emissions below 30MHz

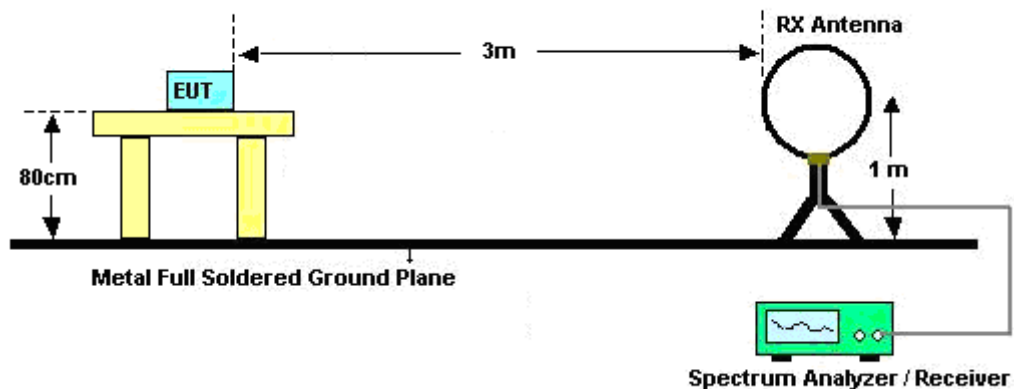

For radiated emissions from 30MHz to 1GHz

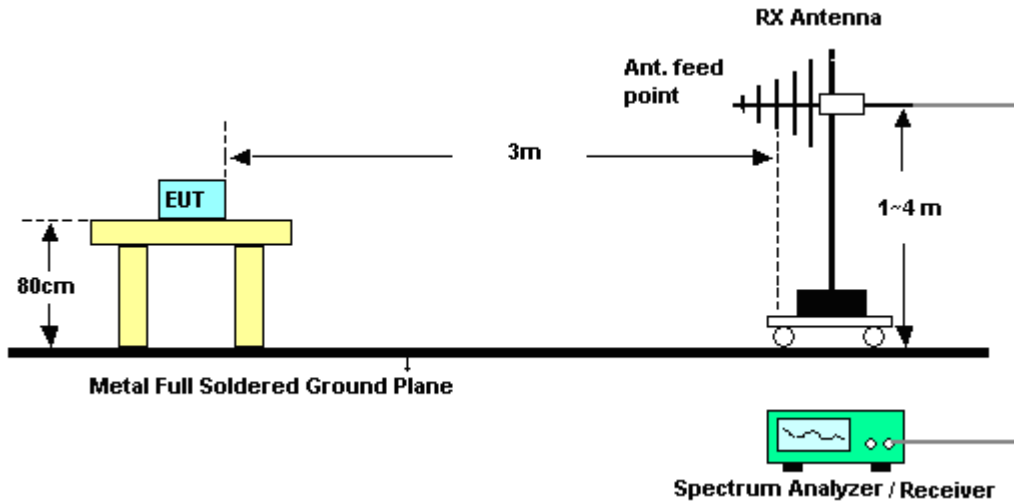

For radiated emissions above 1GHz

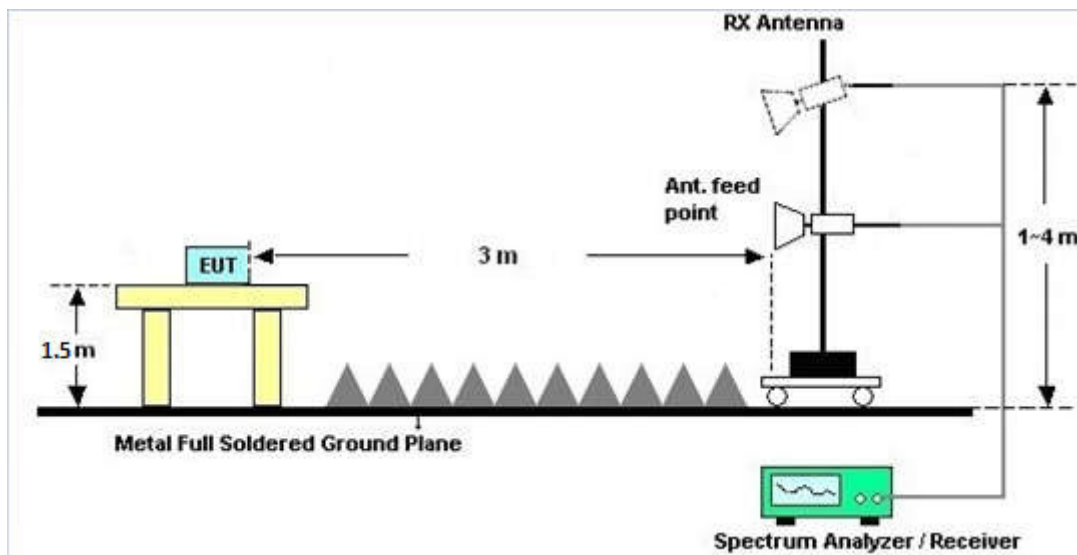



3.4.5 Test Results of Radiated Spurious Emissions (9 kHz ~ 30 MHz)

The low frequency, which started from 9 kHz to 30MHz, was pre-scanned and the result which was 20dB lower than the limit line per 15.31(o) was not reported.

3.4.6 Test Result of Radiated Spurious at Band Edges

Please refer to Appendix B.

3.4.7 Duty Cycle

Please refer to Appendix C.

3.4.8 Test Result of Radiated Spurious Emissions (30MHz ~ 10th Harmonic)

Please refer to Appendix B.



3.5 AC Conducted Emission Measurement

3.5.1 Limit of AC Conducted Emission

For equipment that is designed to be connected to the public utility (AC) power line, the radio frequency voltage that is conducted back onto the AC power line on any frequency or frequencies within the band 150 kHz to 30 MHz shall not exceed the limits in the following table.

Frequency of emission (MHz)	Conducted limit (dB μ V)	
	Quasi-peak	Average
0.15-0.5	66 to 56*	56 to 46*
0.5-5	56	46
5-30	60	50

*Decreases with the logarithm of the frequency.

3.5.2 Measuring Instruments

The measuring equipment is listed in the section 4 of this test report.

3.5.3 Test Procedures

1. The EUT was placed 0.4 meter from the conducting wall of the shielding room was kept at least 80 centimeters from any other grounded conducting surface.
2. Connect EUT to the power mains through a line impedance stabilization network (LISN).
3. All the support units are connecting to the other LISN.
4. The LISN provides 50 ohm coupling impedance for the measuring instrument.
5. The FCC states that a 50 ohm, 50 microhenry LISN should be used.
6. Both sides of AC line were checked for maximum conducted interference.
7. The frequency range from 150 kHz to 30 MHz was searched.
8. Set the test-receiver system to Peak Detect Function and specified bandwidth with Maximum Hold Mode.

3.5.4 Test Setup

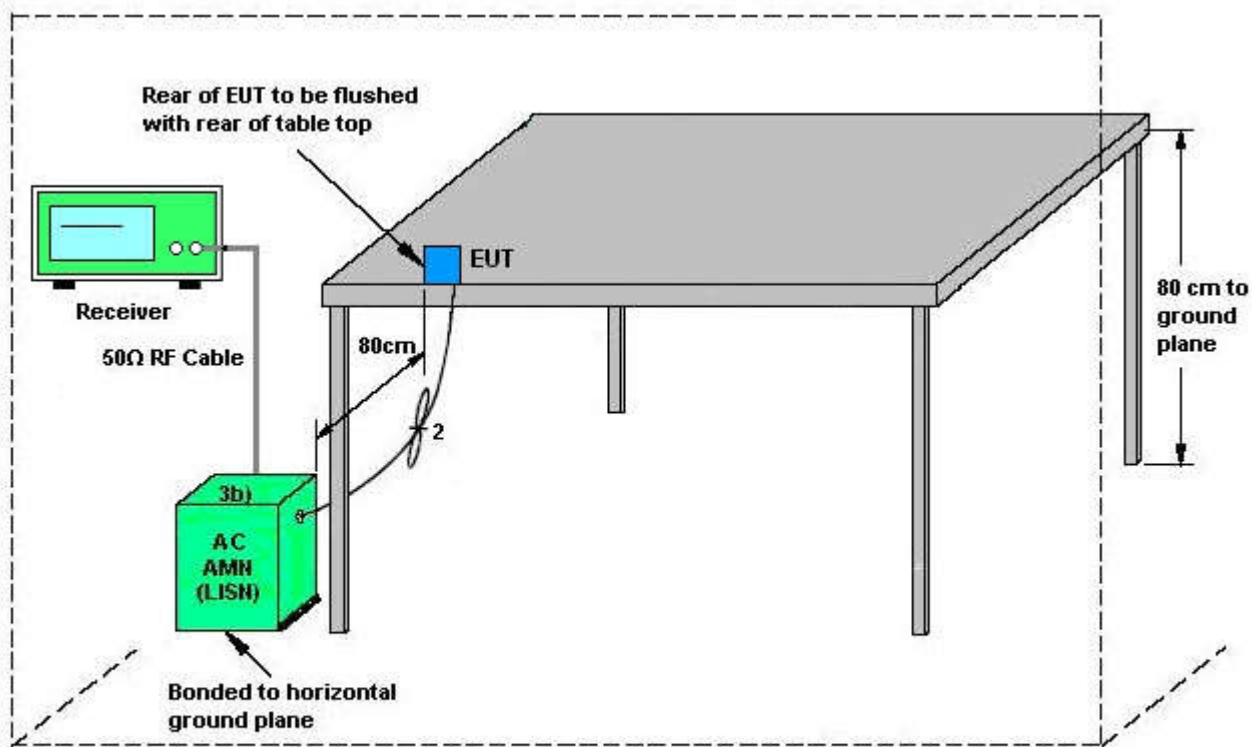

AMN = Artificial mains network (LISN)
AE = Associated equipment
EUT = Equipment under test
ISN = Impedance stabilization network



3.5.5 Test Result of AC Conducted Emission

Test Mode :	Mode 1	Temperature :	21~23°C
Test Engineer :	Tao Cheng	Relative Humidity :	41~42%
Test Voltage :	120Vac / 60Hz	Phase :	Line
Function Type :	WLAN 5G Link (Client) + WLAN 5G Link (Master) + AC Load + RJ45 Link		

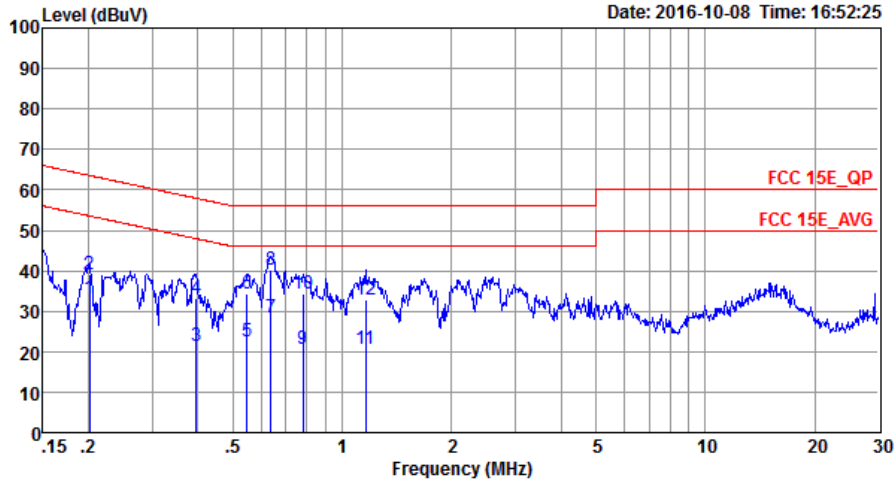

Site : C001-SZ
 Condition: FCC 15E_QP LISN_20160509 LINE

	Freq	Level	Over Limit	Limit Line	Read Level	LISN Factor	Cable Loss	Remark
	MHz	dBuV	dB	dBuV	dBuV	dB	dB	
1	0.20	33.11	-20.43	53.54	22.50	0.11	10.50	Average
2	0.20	39.21	-24.33	63.54	28.60	0.11	10.50	QP
3	0.40	21.57	-26.38	47.95	11.20	0.11	10.26	Average
4	0.40	33.17	-24.78	57.95	22.80	0.11	10.26	QP
5	0.55	22.51	-23.49	46.00	12.20	0.11	10.20	Average
6	0.55	34.21	-21.79	56.00	23.90	0.11	10.20	QP
7	0.64	28.29	-17.71	46.00	18.00	0.11	10.18	Average
8 *	0.64	40.29	-15.71	56.00	30.00	0.11	10.18	QP
9	0.78	20.77	-25.23	46.00	10.50	0.11	10.16	Average
10	0.78	34.17	-21.83	56.00	23.90	0.11	10.16	QP
11	1.16	20.57	-25.43	46.00	10.30	0.11	10.16	Average
12	1.16	32.77	-23.23	56.00	22.50	0.11	10.16	QP



Test Mode :	Mode 1	Temperature :	21~23°C
Test Engineer :	Tao Cheng	Relative Humidity :	41~42%
Test Voltage :	120Vac / 60Hz	Phase :	Neutral
Function Type :	WLAN 5G Link (Client) + WLAN 5G Link (Master) + AC Load + RJ45 Link		

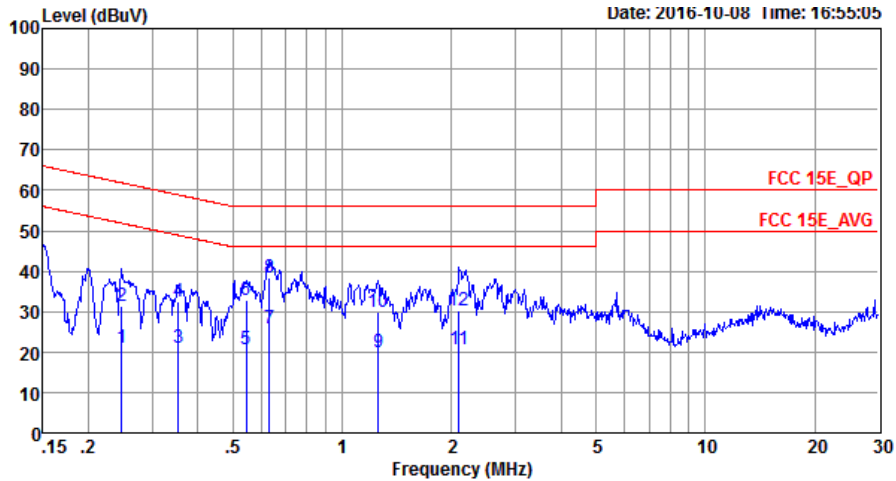

Site : CO01-SZ
 Condition: FCC 15E_QP LISN_20160509 NEUTRAL

	Freq	Level	Over Limit	Limit Line	Read Level	LISN Factor	Cable Loss	Remark
	MHz	dBuV	dB	dBuV	dBuV	dB	dB	
1	0.25	21.07	-30.79	51.86	10.50	0.11	10.46	Average
2	0.25	31.47	-30.39	61.86	20.90	0.11	10.46	QP
3	0.35	21.03	-27.84	48.87	10.60	0.11	10.32	Average
4	0.35	32.33	-26.54	58.87	21.90	0.11	10.32	QP
5	0.54	20.82	-25.18	46.00	10.51	0.11	10.20	Average
6	0.54	32.81	-23.19	56.00	22.50	0.11	10.20	QP
7	0.63	25.69	-20.31	46.00	15.40	0.11	10.18	Average
8 *	0.63	38.29	-17.71	56.00	28.00	0.11	10.18	QP
9	1.26	19.77	-26.23	46.00	9.50	0.11	10.16	Average
10	1.26	29.97	-26.03	56.00	19.70	0.11	10.16	QP
11	2.10	20.58	-25.42	46.00	10.30	0.11	10.17	Average
12	2.10	30.38	-25.62	56.00	20.10	0.11	10.17	QP

3.6 Frequency Stability Measurement

3.6.1 Limit of Frequency Stability

Manufacturers of U-NII devices are responsible for ensuring frequency stability such that an emission is maintained within the band of operation under all conditions of normal operation as specified in the user's manual.

3.6.2 Measuring Instruments

The measuring equipment is listed in the section 4 of this test report.

3.6.3 Test Procedures

1. To ensure emission at the band edge is maintained within the authorized band, those values shall be measured by radiation emissions at upper and lower frequency points, and finally compensated by frequency deviation as procedures below.
2. The EUT was operated at the maximum output power, and connected to the spectrum analyzer, which is set to maximum hold function and peak detector. The peak value of the power envelope was measured and noted. The upper and lower frequency points were respectively measured relatively 10dB lower than the measured peak value.
3. The frequency deviation was calculated by adding the upper frequency point and the lower frequency point divided by two. Those detailed values of frequency deviation are provided in table below.

3.6.4 Test Setup



3.6.5 Test Result of Frequency Stability

Please refer to Appendix A.



3.7 Automatically Discontinue Transmission

3.7.1 Limit of Automatically Discontinue Transmission

The device shall automatically discontinue transmission in case of either absence of information to transmit or operational failure. These provisions are not intended to preclude the transmission of control or signaling information or the use of repetitive codes used by certain digital technologies to complete frame or burst intervals. Applicants shall include in their application for equipment authorization to describe how this requirement is met.

3.7.2 Measuring Instruments

The measuring equipment is listed in the section 4 of this test report.

3.7.3 Test Result of Automatically Discontinue Transmission

While the EUT is not transmitting any information, the EUT can automatically discontinue transmission and become standby mode for power saving. The EUT can detect the controlling signal of ACK message transmitting from remote device and verify whether it shall resend or discontinue transmission.



3.8 Antenna Requirements

3.8.1 Standard Applicable

According to FCC 47 CFR Section 15.407(a)(1)(2) ,if transmitting antenna directional gain is greater than 6 dBi, both the peak transmit power and the peak power spectral density shall be reduced by the amount in dB that the directional gain of the antenna exceeds 6 dBi.

3.8.2 Antenna Anti-Replacement Construction

An embedded-in antenna design is used.

3.8.3 Antenna Gain

FCC KDB 662911 D01 Multiple Transmitter Output v02r01

For CDD transmissions, directional gain is calculated as

Directional gain = G_{ANT} + Array Gain, where Array Gain is as follows.

For power spectral density (PSD) measurements on all devices,

Array Gain = $10 \log(N_{ANT}/N_{SS}=1)$ dB.

For power measurements on IEEE 802.11 devices,

Array Gain = 0 dB (i.e., no array gain) for $N_{ANT} \leq 4$.

Directional gain may be calculated by using the formulas applicable to equal gain antennas with G_{ANT} set equal to the gain of the antenna having the highest gain;

The EUT supports CDD mode.

For power, the directional gain G_{ANT} is set equal to the antenna having the highest gain, i.e., F)2)f)i).

For PSD, the directional gain calculation is following F)2)f)ii) of KDB 662911 D01 v02r01.

The power and PSD limit should be modified if the directional gain of EUT is over 6 dBi,

The directional gain "DG" is calculated as following table.

	Ant 1 (dBi)	Ant 2 (dBi)	DG for Power (dBi)	DG for PSD (dBi)	Power Limit Reduction (dB)	PSD Limit Reduction (dB)
Band IV	1.99	1.92	1.99	4.97	0.00	0.00

Power limit reduction = Composite gain – 6dBi, (min = 0)

PSD limit reduction = Composite gain + PSD Array gain – 6dBi, (min = 0)



4 List of Measuring Equipment

Instrument	Manufacturer	Model No.	Serial No.	Characteristics	Calibration Date	Test Date	Due Date	Remark
Spectrum Analyzer	R&S	FSV40	101078	9kHz~40GHz	May 07, 2016	Nov. 07, 2016~ Nov. 11, 2016	May 06, 2017	Conducted (TH01-SZ)
Pulse Power Sensor	Anritsu	MA2411B	1207253	30MHz~40GHz	Jan. 12, 2016	Nov. 07, 2016~ Nov. 11, 2016	Jan. 11, 2017	Conducted (TH01-SZ)
Power Meter	Anritsu	ML2495A	1218010	50MHz Bandwidth	Jan. 12, 2016	Nov. 07, 2016~ Nov. 11, 2016	Jan. 11, 2017	Conducted (TH01-SZ)
Thermal Chamber	Ten Billion Hongzhangroup	LP-150U	H2014081803	-40~+150°C	Jul. 16, 2016	Nov. 07, 2016~ Nov. 11, 2016	Jul. 15, 2017	Conducted (TH01-SZ)
EMI Test Receiver&SA	KEYSIGHT	N9038A	MY54450083	20Hz~8.4GHz	May 07, 2016	Nov. 09, 2016	May 06, 2017	Radiation (03CH03-SZ)
EXA Spectrum Analyzer	KEYSIGHT	N9010A	MY55150246	10Hz~44GHz	May 07, 2016	Nov. 09, 2016	May 06, 2017	Radiation (03CH03-SZ)
Loop Antenna	R&S	HFH2-Z2	100354	9kHz~30MHz	May 07, 2016	Nov. 09, 2016	May 06, 2017	Radiation (03CH03-SZ)
Bilog Antenna	TeseQ	CBL6112D	35408	30MHz~2GHz	May 21, 2016	Nov. 09, 2016	May 20, 2017	Radiation (03CH03-SZ)
Double Ridge Horn Antenna	SCHWARZBECK	BBHA9120D	9120D-1355	1GHz~18GHz	May 07, 2016	Nov. 09, 2016	May 06, 2017	Radiation (03CH03-SZ)
SHF-EHF Horn	com-power	AH-840	101071	18GHz~40GHz	Aug. 10, 2016	Nov. 09, 2016	Aug. 09, 2017	Radiation (03CH03-SZ)
Amplifier	Burgeon	BPA-530	102210	0.01Hz ~3000MHz	Oct. 11, 2016	Nov. 09, 2016	Oct. 10, 2017	Radiation (03CH03-SZ)
HF Amplifier	MITEQ	AMF-7D-001 01800-30-10 P-R	1943528	1GHz~18GHz	Oct. 11, 2016	Nov. 09, 2016	Oct. 10, 2017	Radiation (03CH03-SZ)
Amplifier	Agilent Technologies	83017A	MY39501302	500MHz~26.5G Hz	Jan. 12, 2016	Nov. 09, 2016	Jan. 11, 2017	Radiation (03CH03-SZ)
HF Amplifier	MITEQ	TTA1840-35-HG	1871923	18GHz~40GHz	Jul. 16, 2016	Nov. 09, 2016	Jul. 15, 2017	Radiation (03CH03-SZ)
AC Power Source	Chroma	61601	616010001985	N/A	NCR	Nov. 09, 2016	NCR	Radiation (03CH03-SZ)
Turn Table	EM	EM1000	N/A	0~360 degree	NCR	Nov. 09, 2016	NCR	Radiation (03CH03-SZ)
Antenna Mast	EM	EM1000	N/A	1 m~4 m	NCR	Nov. 09, 2016	NCR	Radiation (03CH03-SZ)
EMI Receiver	R&S	ESCI7	100724	9kHz~3GHz	Nov. 23, 2015	Oct. 08, 2016	Nov. 22, 2016	Conduction (CO01-SZ)
AC LISN	EMCO	3816/2SH	00103892	9kHz~30MHz	Jan. 12, 2016	Oct. 08, 2016	Jan. 11, 2017	Conduction (CO01-SZ)
AC LISN (for auxiliary equipment)	MessTec	3816/2SH	00103912	9kHz~30MHz	Jan. 12, 2016	Oct. 08, 2016	Jan. 11, 2017	Conduction (CO01-SZ)
AC Power Source	Chroma	61602	616020000891	100Vac~250Vac	Jul. 16, 2016	Oct. 08, 2016	Jul. 15, 2017	Conduction (CO01-SZ)
Pulse Limiter	COM-POWER	LIT-153 Transient Limiter	53139	150kHz~30MHz	Oct. 20, 2015	Oct. 08, 2016	Oct. 19, 2016	Conduction (CO01-SZ)

NCR: No Calibration Required



5 Uncertainty of Evaluation

Uncertainty of Conducted Emission Measurement (150kHz ~ 30MHz)

Measuring Uncertainty for a Level of Confidence of 95% ($U = 2Uc(y)$)	2.5 dB
---	--------

Uncertainty of Radiated Emission Measurement (30 MHz ~ 1000 MHz)

Measuring Uncertainty for a Level of Confidence of 95% ($U = 2Uc(y)$)	5.1 dB
---	--------

Uncertainty of Radiated Emission Measurement (1000 MHz ~ 18000 MHz)

Measuring Uncertainty for a Level of Confidence of 95% ($U = 2Uc(y)$)	5.0 dB
---	--------

Uncertainty of Radiated Emission Measurement (18000 MHz ~ 40000 MHz)

Measuring Uncertainty for a Level of Confidence of 95% ($U = 2Uc(y)$)	5.0 dB
---	--------



Appendix A. Conducted Test Results

Test Engineer:	Sam Zheng	Temperature:	24~26	°C
Test Date:	2016/11/7~2016/11/011	Relative Humidity:	50~53	%

TEST RESULTS DATA
6dB and 26dB EBW and 99% OBW

Band IV													
Mod.	Data Rate	NTX	CH.	Freq. (MHz)	99% Bandwidth (MHz)		26dB Bandwidth (MHz)		6 dB Bandwidth (MHz)		6 dB Bandwidth Min. Limit (MHz)		Pass/Fail
					Ant 1	Ant 2	Ant 1	Ant 2	Ant 1	Ant 2	Ant 1	Ant 2	
11a	6Mbps	2	149	5745	28.97	32.72	38.91	44.86	16.02	16.26	0.5		Pass
11a	6Mbps	2	157	5785	27.82	31.32	38.01	42.76	16.00	16.30	0.5		Pass
11a	6Mbps	2	165	5825	26.07	30.62	36.96	40.36	16.04	16.30	0.5		Pass
HT20	MCS0	2	149	5745	33.97	37.01	44.36	47.40	16.88	17.50	0.5		Pass
HT20	MCS0	2	157	5785	32.72	36.51	44.31	45.46	16.88	17.28	0.5		Pass
HT20	MCS0	2	165	5825	31.17	34.97	42.46	43.56	16.40	17.24	0.5		Pass
HT40	MCS0	2	151	5755	62.24	67.53	81.91	82.18	34.41	35.05	0.5		Pass
HT40	MCS0	2	159	5795	62.04	66.23	82.99	81.37	35.05	34.97	0.5		Pass
VHT80	MCS0	2	155	5775	75.40	76.00	86.47	121.48	75.05	74.97	0.5		Pass

TEST RESULTS DATA
Average Power Table

Band IV														
Mod.	Data Rate	N _{TX}	CH.	Freq. (MHz)	Duty Factor (dB)		Average Conducted Power (dBm)			FCC Conducted Power Limit (dBm)		DG (dBi)		Pass/Fail
					Ant 1	Ant 2	Ant 1	Ant 2	SUM	Ant 1	Ant 2	Ant 1	Ant 2	
11a	6Mbps	2	149	5745	0.57	0.58	24.70	24.92	27.82	30.00		1.99		Pass
11a	6Mbps	2	157	5785	0.57	0.58	24.22	24.54	27.39	30.00		1.99		Pass
11a	6Mbps	2	165	5825	0.57	0.58	23.96	24.44	27.22	30.00		1.99		Pass
HT20	MCS0	2	149	5745	0.63	0.62	24.50	24.57	27.54	30.00		1.99		Pass
HT20	MCS0	2	157	5785	0.63	0.62	23.99	24.41	27.21	30.00		1.99		Pass
HT20	MCS0	2	165	5825	0.63	0.62	23.78	24.36	27.09	30.00		1.99		Pass
HT40	MCS0	2	151	5755	1.16	1.16	24.36	24.55	27.47	30.00		1.99		Pass
HT40	MCS0	2	159	5795	1.16	1.16	24.18	24.54	27.38	30.00		1.99		Pass
VHT20	MCS0	2	149	5745	0.60	0.61	24.41	24.37	27.40	30.00		1.99		Pass
VHT20	MCS0	2	157	5785	0.60	0.61	23.88	24.36	27.14	30.00		1.99		Pass
VHT20	MCS0	2	165	5825	0.60	0.61	23.68	24.32	27.02	30.00		1.99		Pass
VHT40	MCS0	2	151	5755	1.14	1.15	24.35	24.53	27.45	30.00		1.99		Pass
VHT40	MCS0	2	159	5795	1.14	1.15	24.14	24.51	27.34	30.00		1.99		Pass
VHT80	MCS0	2	155	5775	2.08	2.07	20.84	22.28	24.63	30.00		1.99		Pass

TEST RESULTS DATA
Power Spectral Density

Band IV																
Mod.	Data Rate	NTX	CH.	Freq. (MHz)	Duty Factor (dB)		10log (500kHz /RBW) Factor (dB)		Average Power Density (dBm/500kHz)			Average PSD Limit (dBm/500kHz)		DG (dBi)		Pass /Fail
					Ant 1	Ant 2	Ant 1	Ant 2	Ant 1	Ant 2	SUM	Ant 1	Ant 2	Ant 1	Ant 2	
11a	6Mbps	2	149	5745	0.57	0.58	2.22					14.62	30.00	4.97	Pass	
11a	6Mbps	2	157	5785	0.57	0.58	2.22					14.35	30.00	4.97	Pass	
11a	6Mbps	2	165	5825	0.57	0.58	2.22					14.19	30.00	4.97	Pass	
HT20	MCS0	2	149	5745	0.63	0.62	2.22					13.94	30.00	4.97	Pass	
HT20	MCS0	2	157	5785	0.63	0.62	2.22					13.73	30.00	4.97	Pass	
HT20	MCS0	2	165	5825	0.63	0.62	2.22					13.57	30.00	4.97	Pass	
HT40	MCS0	2	151	5755	1.16	1.16	2.22					10.95	30.00	4.97	Pass	
HT40	MCS0	2	159	5795	1.16	1.16	2.22					11.16	30.00	4.97	Pass	
VHT80	MCS0	2	155	5775	2.08	2.07	2.22					5.49	30.00	4.97	Pass	

TEST RESULTS DATA
Frequency Stability

Band IV										
Mod.	Data Rate	NTX	CH.	Freq. (MHz)	Center Frequency (MHz)	Frequency Deviation (MHz)	Frequency Stability (ppm)	Temperature (°C)	Voltage (V)	Note
11a	6Mbps	1	149	5745	5745.025	0.025	4.35	20	90	
11a	6Mbps	1	149	5745	5745.025	0.025	4.35	20	135	
11a	6Mbps	1	149	5745	5745.025	0.025	4.35	20	120	
11a	6Mbps	1	149	5745	5745.025	0.025	4.35	-30	120	
11a	6Mbps	1	149	5745	5745.025	0.025	4.35	50	120	



Appendix B. Radiated Spurious Emission

Band 4 - 5725~5850MHz WIFI 802.11a (Band Edge @ 3m)

WIFI Ant.	Note	Frequency	Level	Over Limit	Limit Line	Read Level	Antenna Factor	Cable Loss	Preamp Factor	Ant Pos	Table Pos	Peak Avg.	Pol.
1+2		(MHz)	(dBμV/m)	(dB)	(dBμV/m)	(dBμV)	(dB/m)	(dB)	(dB)	(cm)	(deg)	(P/A)	(H/V)
802.11a CH 149 5745MHz		5611.8	54.74	-13.56	68.3	47.46	33.12	7.65	33.49	151	153	P	H
		5692.6	74.26	-25.58	99.84	66.86	33.23	7.68	33.51	151	153	P	H
		5718.4	86.81	-23.64	110.45	79.38	33.27	7.68	33.52	151	153	P	H
		5723	92.28	-25.46	117.74	84.85	33.27	7.68	33.52	151	153	P	H
		5745	116.93	-	-	109.43	33.29	7.74	33.53	151	153	P	H
		5745	107.74	-	-	100.24	33.29	7.74	33.53	151	153	A	H
		5643	50.86	-17.44	68.3	43.53	33.17	7.65	33.49	196	108	P	V
		5700	56.28	-49.02	105.3	48.88	33.23	7.68	33.51	196	108	P	V
		5718.2	72.58	-37.82	110.4	65.15	33.27	7.68	33.52	196	108	P	V
		5724.8	79.08	-42.76	121.84	71.65	33.27	7.68	33.52	196	108	P	V
		5745	110.91	-	-	103.41	33.29	7.74	33.53	196	108	P	V
		5745	104.54	-	-	97.04	33.29	7.74	33.53	196	108	A	V
802.11a CH 157 5785MHz		5635.2	54.34	-13.96	68.3	47.01	33.17	7.65	33.49	195	34	P	H
		5692	59.92	-39.48	99.4	52.52	33.23	7.68	33.51	195	34	P	H
		5714.4	68.42	-40.91	109.33	61.01	33.25	7.68	33.52	195	34	P	H
		5721.8	67.7	-47.3	115	60.27	33.27	7.68	33.52	195	34	P	H
		5785	116.93	-	-	109.34	33.33	7.8	33.54	195	34	P	H
		5785	109	-	-	101.41	33.33	7.8	33.54	195	34	A	H
		5851	63.21	-56.81	120.02	55.49	33.41	7.87	33.56	195	34	P	H
		5857.4	62.52	-47.71	110.23	54.78	33.43	7.87	33.56	195	34	P	H
		5877	56.48	-47.33	103.81	48.71	33.46	7.87	33.56	195	34	P	H
		5946.4	53.2	-15.1	68.3	45.29	33.54	7.95	33.58	195	34	P	H
		5645	50.38	-17.92	68.3	43.05	33.17	7.65	33.49	152	270	P	V
		5694.2	51.35	-49.67	101.02	43.95	33.23	7.68	33.51	152	270	P	V
		5719	53.71	-56.91	110.62	46.28	33.27	7.68	33.52	152	270	P	V
		5723.4	54.53	-64.12	118.65	47.1	33.27	7.68	33.52	152	270	P	V
	5785	108.77	-	-	101.18	33.33	7.8	33.54	152	270	P	V	



		5785	101.75	-	-	94.16	33.33	7.8	33.54	152	270	A	V
		5850	57.44	-64.86	122.3	49.72	33.41	7.87	33.56	152	270	P	V
		5856.4	57.7	-52.81	110.51	49.96	33.43	7.87	33.56	152	270	P	V
		5877.4	51.34	-52.18	103.52	43.57	33.46	7.87	33.56	152	270	P	V
		5942.6	48.73	-19.57	68.3	40.82	33.54	7.95	33.58	152	270	P	V
802.11a CH 165 5825MHz		5825	118.42	-	-	110.74	33.39	7.84	33.55	214	37	P	H
		5825	109.74	-	-	102.06	33.39	7.84	33.55	214	37	A	H
		5850.4	87.94	-33.45	121.39	80.22	33.41	7.87	33.56	214	37	P	H
		5856.8	81.96	-28.44	110.4	74.22	33.43	7.87	33.56	214	37	P	H
		5875.4	70.23	-34.77	105	62.46	33.46	7.87	33.56	214	37	P	H
		5928.2	56.5	-11.8	68.3	48.61	33.52	7.95	33.58	214	37	P	H
		5825	110.28	-	-	102.6	33.39	7.84	33.55	151	290	P	V
		5825	102.24	-	-	94.56	33.39	7.84	33.55	151	290	A	V
		5851.6	77.84	-40.81	118.65	70.12	33.41	7.87	33.56	151	290	P	V
		5855.6	77.3	-33.43	110.73	69.56	33.43	7.87	33.56	151	290	P	V
		5876.8	61.43	-42.53	103.96	53.66	33.46	7.87	33.56	151	290	P	V
		5928	50.63	-17.67	68.3	42.74	33.52	7.95	33.58	151	290	P	V
Remark	1. No other spurious found. 2. All results are PASS against Peak and Average limit line.												



Band 4 5725~5850MHz

WIFI 802.11a (Harmonic @ 3m)

WIFI Ant. 1+2	Note	Frequency (MHz)	Level (dBμV/m)	Over Limit (dB)	Limit Line (dBμV/m)	Read Level (dBμV)	Antenna Factor (dB/m)	Cable Loss (dB)	Preamp Factor (dB)	Ant Pos (cm)	Table Pos (deg)	Peak Avg. (P/A)	Pol. (H/V)
802.11a CH 149 5745MHz		11490	58.01	-15.99	74	66.96	39.7	11.1	59.75	250	0	P	H
		11490	49.52	-4.48	54	58.47	39.7	11.1	59.75	250	0	A	H
		17232	56.82	-11.48	68.3	60.12	40.06	14.89	58.25	150	0	P	H
		11490	56.74	-17.26	74	65.69	39.7	11.1	59.75	250	0	P	V
		11490	50.04	-3.96	54	58.99	39.7	11.1	59.75	250	0	A	V
		17238	56.76	-11.54	68.3	60.1	40.06	14.85	58.25	150	0	P	V
802.11a CH 157 5785MHz		11570	57.03	-16.97	74	66.03	39.66	11.17	59.83	250	0	P	H
		11570	49.32	-4.68	54	58.32	39.66	11.17	59.83	250	0	A	H
		17352	54.27	-14.03	68.3	56.95	40.34	14.78	57.8	150	0	P	H
		11570	54.03	-19.97	74	63.03	39.66	11.17	59.83	250	0	P	V
		11570	47.47	-6.53	54	56.47	39.66	11.17	59.83	250	0	A	V
		17352	55.66	-12.64	68.3	58.34	40.34	14.78	57.8	150	0	P	V
802.11a CH 165 5825MHz		11650	54.11	-19.89	74	63.16	39.62	11.23	59.9	146	347	P	H
		11650	46.42	-7.58	54	55.47	39.62	11.23	59.9	146	347	A	H
		17475	55.5	-12.8	68.3	57.56	40.62	14.67	57.35	100	360	P	H
		11650	54.55	-19.45	74	63.6	39.62	11.23	59.9	146	347	P	V
		11650	48.88	-5.12	54	57.93	39.62	11.23	59.9	146	347	A	V
		17475	56.12	-12.18	68.3	58.18	40.62	14.67	57.35	100	360	P	V
Remark	1. No other spurious found. 2. All results are PASS against Peak and Average limit line.												



Band 4 5725~5850MHz

WIFI 802.11n HT20 (Band Edge @ 3m)

WIFI Ant. 1+2	Note	Frequency (MHz)	Level (dBμV/m)	Over Limit (dB)	Limit Line (dBμV/m)	Read Level (dBμV)	Antenna Factor (dB/m)	Cable Loss (dB)	Preamp Factor (dB)	Ant Pos (cm)	Table Pos (deg)	Peak Avg. (P/A)	Pol. (H/V)
802.11n HT20 CH 149 5745MHz		5646.2	64.67	-3.63	68.3	57.32	33.17	7.67	33.49	152	256	P	H
		5700	82.13	-23.17	105.3	74.73	33.23	7.68	33.51	152	256	P	H
		5719.2	93.91	-16.77	110.68	86.48	33.27	7.68	33.52	152	256	P	H
		5724.6	100.02	-21.37	121.39	92.59	33.27	7.68	33.52	152	256	P	H
		5745	118.55	-	-	111.05	33.29	7.74	33.53	152	256	P	H
		5745	109.66	-	-	102.16	33.29	7.74	33.53	152	256	A	H
		5649.2	55.79	-12.51	68.3	48.44	33.17	7.67	33.49	205	36	P	V
		5696.2	68.77	-33.73	102.5	61.37	33.23	7.68	33.51	205	36	P	V
		5717.8	84.23	-26.05	110.28	76.8	33.27	7.68	33.52	205	36	P	V
		5725	91.78	-30.52	122.3	84.35	33.27	7.68	33.52	205	36	P	V
		5745	111.22	-	-	103.72	33.29	7.74	33.53	205	36	P	V
	5745	103.18	-	-	95.68	33.29	7.74	33.53	205	36	A	V	
802.11n HT20 CH 157 5785MHz		5625.4	51.74	-16.56	68.3	44.44	33.14	7.65	33.49	188	123	P	H
		5698.2	54.36	-49.61	103.97	46.96	33.23	7.68	33.51	188	123	P	H
		5716.4	59.37	-50.52	109.89	51.96	33.25	7.68	33.52	188	123	P	H
		5722.4	60.17	-56.2	116.37	52.74	33.27	7.68	33.52	188	123	P	H
		5785	114	-	-	106.41	33.33	7.8	33.54	188	123	P	H
		5785	105.63	-	-	98.04	33.33	7.8	33.54	188	123	A	H
		5852	57.6	-60.14	117.74	49.88	33.41	7.87	33.56	188	123	P	H
		5856.4	58.15	-52.36	110.51	50.41	33.43	7.87	33.56	188	123	P	H
		5876.6	50.8	-53.31	104.11	43.03	33.46	7.87	33.56	188	123	P	H
		5935.6	47.61	-20.69	68.3	39.72	33.52	7.95	33.58	188	123	P	H
		5647.8	52.92	-15.38	68.3	45.57	33.17	7.67	33.49	159	151	P	V
		5699.6	56.9	-48.11	105.01	49.5	33.23	7.68	33.51	159	151	P	V
		5719.4	62.69	-48.04	110.73	55.26	33.27	7.68	33.52	159	151	P	V
		5723	66.55	-51.19	117.74	59.12	33.27	7.68	33.52	159	151	P	V
		5785	116.31	-	-	108.72	33.33	7.8	33.54	159	151	P	V
	5785	107.64	-	-	100.05	33.33	7.8	33.54	159	151	A	V	
	5851.8	63.65	-54.55	118.2	55.93	33.41	7.87	33.56	159	151	P	V	
	5860	61.66	-47.84	109.5	53.92	33.43	7.87	33.56	159	151	P	V	



		5878.4	57.8	-44.97	102.77	50.03	33.46	7.87	33.56	159	151	P	V	
		5936.4	52.42	-15.88	68.3	44.53	33.52	7.95	33.58	159	151	P	V	
802.11n		5825	108.68	-	-	101	33.39	7.84	33.55	151	274	P	H	
		5825	100.26	-	-	92.58	33.39	7.84	33.55	151	274	A	H	
		5850.6	73.27	-47.66	120.93	65.55	33.41	7.87	33.56	151	274	P	H	
		5858.6	67.39	-42.5	109.89	59.65	33.43	7.87	33.56	151	274	P	H	
		5876	57.67	-46.89	104.56	49.9	33.46	7.87	33.56	151	274	P	H	
	HT20		5931.4	49.98	-18.32	68.3	42.09	33.52	7.95	33.58	151	274	P	H
	CH 165		5825	117.5	-	-	109.82	33.39	7.84	33.55	181	34	P	V
	5825MHz		5825	108.96	-	-	101.28	33.39	7.84	33.55	181	34	A	V
			5850.4	87.57	-33.82	121.39	79.85	33.41	7.87	33.56	181	34	P	V
			5856.8	81.73	-28.67	110.4	73.99	33.43	7.87	33.56	181	34	P	V
			5876.4	67.69	-36.57	104.26	59.92	33.46	7.87	33.56	181	34	P	V
		5930.8	54.19	-14.11	68.3	46.3	33.52	7.95	33.58	181	34	P	V	
Remark	<ol style="list-style-type: none"> No other spurious found. All results are PASS against Peak and Average limit line. 													



Band 4 5725~5850MHz
WIFI 802.11n HT20 (Harmonic @ 3m)

WIFI Ant. 1+2	Note	Frequency (MHz)	Level (dBμV/m)	Over Limit (dB)	Limit Line (dBμV/m)	Read Level (dBμV)	Antenna Factor (dB/m)	Cable Loss (dB)	Preamp Factor (dB)	Ant Pos (cm)	Table Pos (deg)	Peak Avg. (P/A)	Pol. (H/V)
802.11n HT20 CH 149 5745MHz		11490	57.45	-16.55	74	66.4	39.7	11.1	59.75	145	265	P	H
		11490	49.87	-4.13	54	58.82	39.7	11.1	59.75	145	265	A	H
		17235	56.15	-12.15	68.3	59.45	40.06	14.89	58.25	174	321	P	H
		11490	54.7	-19.3	74	63.65	39.7	11.1	59.75	145	265	P	V
		11490	46.46	-7.54	54	55.41	39.7	11.1	59.75	145	265	A	V
		17235	55.63	-12.67	68.3	58.93	40.06	14.89	58.25	174	321	P	V
802.11n HT20 CH 157 5785MHz		11570	57.75	-16.25	74	66.75	39.66	11.17	59.83	250	0	P	H
		11570	49.43	-4.57	54	58.43	39.66	11.17	59.83	250	0	A	H
		17352	55.04	-13.26	68.3	57.72	40.34	14.78	57.8	150	0	P	H
		11570	54.98	-19.02	74	63.98	39.66	11.17	59.83	250	0	P	V
		11570	46.16	-7.84	54	55.16	39.66	11.17	59.83	250	0	A	V
		17352	55.7	-12.6	68.3	58.38	40.34	14.78	57.8	150	0	P	V
802.11n HT20 CH 165 5825MHz		11650	55.16	-18.84	74	64.21	39.62	11.23	59.9	146	347	P	H
		11650	46.99	-7.01	54	56.04	39.62	11.23	59.9	146	347	A	H
		17475	56.41	-11.89	68.3	58.47	40.62	14.67	57.35	100	360	P	H
		11650	55.08	-18.92	74	64.13	39.62	11.23	59.9	146	347	P	V
		11650	49.29	-4.71	54	58.34	39.62	11.23	59.9	146	347	A	V
		17475	56.4	-11.9	68.3	58.46	40.62	14.67	57.35	100	360	P	V
Remark	1. No other spurious found. 2. All results are PASS against Peak and Average limit line.												



Band 4 5725~5850MHz
WIFI 802.11n HT40 (Band Edge @ 3m)

Table with 14 columns: WIFI Ant. 1+2, Note, Frequency (MHz), Level (dBµV/m), Over Limit (dB), Limit Line (dBµV/m), Read Level (dBµV), Antenna Factor (dB/m), Cable Loss (dB), Preamp Factor (dB), Ant Pos (cm), Table Pos (deg), Peak Avg. (P/A), Pol. (H/V). Rows include frequency measurements from 5646.2 to 5929.8 MHz.



WIFI Ant. 1+2	Note	Frequency (MHz)	Level (dBμV/m)	Over Limit (dB)	Limit Line (dBμV/m)	Read Level (dBμV)	Antenna Factor (dB/m)	Cable Loss (dB)	Preamp Factor (dB)	Ant Pos (cm)	Table Pos (deg)	Peak Avg. (P/A)	Pol. (H/V)
802.11n HT40 CH 159 5795MHz		5611	50.5	-17.8	68.3	43.22	33.12	7.65	33.49	150	268	P	H
		5697.2	53.17	-50.07	103.24	45.77	33.23	7.68	33.51	150	268	P	H
		5708.4	57.05	-50.6	107.65	49.64	33.25	7.68	33.52	150	268	P	H
		5721	55.89	-57.29	113.18	48.46	33.27	7.68	33.52	150	268	P	H
		5795	111.52	-	-	103.91	33.35	7.8	33.54	150	268	P	H
		5795	104.18	-	-	96.57	33.35	7.8	33.54	150	268	A	H
		5850	63.45	-58.85	122.3	55.73	33.41	7.87	33.56	150	268	P	H
		5857	62.93	-47.41	110.34	55.19	33.43	7.87	33.56	150	268	P	H
		5878	56.43	-46.64	103.07	48.66	33.46	7.87	33.56	150	268	P	H
		5926.4	50.36	-17.94	68.3	42.47	33.52	7.95	33.58	150	268	P	H
		5643.8	55.8	-12.5	68.3	48.47	33.17	7.65	33.49	198	32	P	V
		5693.8	58.94	-41.79	100.73	51.54	33.23	7.68	33.51	198	32	P	V
		5718.6	65.47	-45.04	110.51	58.04	33.27	7.68	33.52	198	32	P	V
		5722.4	65.08	-51.29	116.37	57.65	33.27	7.68	33.52	198	32	P	V
		5795	118.27	-	-	110.66	33.35	7.8	33.54	198	32	P	V
		5795	110.02	-	-	102.41	33.35	7.8	33.54	198	32	A	V
		5850	72.97	-49.33	122.3	65.25	33.41	7.87	33.56	198	32	P	V
		5866.4	71.51	-36.2	107.71	63.77	33.43	7.87	33.56	198	32	P	V
	5876.8	66.63	-37.33	103.96	58.86	33.46	7.87	33.56	198	32	P	V	
	5928.2	55.44	-12.86	68.3	47.55	33.52	7.95	33.58	198	32	P	V	
Remark	1. No other spurious found. 2. All results are PASS against Peak and Average limit line.												



Band 4 5725~5850MHz
WIFI 802.11n HT40 (Harmonic @ 3m)

Table with 14 columns: WIFI Ant. 1+2, Note, Frequency (MHz), Level (dBµV/m), Over Limit (dB), Limit Line (dBµV/m), Read Level (dBµV), Antenna Factor (dB/m), Cable Loss (dB), Preamp Factor (dB), Ant Pos (cm), Table Pos (deg), Peak Avg. (P/A), Pol. (H/V). Rows include data for 802.11n HT40 CH 151 at 5755MHz and 802.11n HT40 CH 159 at 5795MHz.

Remark

- 1. No other spurious found.
2. All results are PASS against Peak and Average limit line.



Band 4 5725~5850MHz
WIFI 802.11ac VHT80 (Band Edge @ 3m)

Table with 14 columns: WIFI Ant. 1+2, Note, Frequency (MHz), Level (dBµV/m), Over Limit (dB), Limit Line (dBµV/m), Read Level (dBµV), Antenna Factor (dB/m), Cable Loss (dB), Preamp Factor (dB), Ant Pos (cm), Table Pos (deg), Peak Avg. (P/A), Pol. (H/V). Rows include frequency measurements from 5649.8 to 5928.4 MHz.

Remark
1. No other spurious found.
2. All results are PASS against Peak and Average limit line.



Band 4 5725~5850MHz

WIFI 802.11ac VHT80 (Harmonic @ 3m)

WIFI Ant. 1+2	Note	Frequency (MHz)	Level (dBμV/m)	Over Limit (dB)	Limit Line (dBμV/m)	Read Level (dBμV)	Antenna Factor (dB/m)	Cable Loss (dB)	Preamp Factor (dB)	Ant Pos (cm)	Table Pos (deg)	Peak Avg. (P/A)	Pol. (H/V)
802.11ac VHT80 CH 155 5775MHz		11550	52.03	-21.97	74	61.04	39.67	11.13	59.81	250	0	P	H
		11550	44.95	-9.05	54	53.96	39.67	11.13	59.81	250	0	A	H
		17328	52.6	-15.7	68.3	55.49	40.26	14.78	57.93	150	0	P	H
		11550	50.2	-23.8	74	59.21	39.67	11.13	59.81	250	0	P	V
		17328	53.23	-15.07	68.3	56.12	40.26	14.78	57.93	150	0	P	V
Remark	1. No other spurious found. 2. All results are PASS against Peak and Average limit line.												



Emission below 1GHz

5GHz WIFI VHT80 (LF @ 3m)

WIFI	Note	Frequency	Level	Over	Limit	Read	Antenna	Cable	Preamp	Ant	Table	Peak	Pol.
Ant.				Limit	Line	Level	Factor	Loss	Factor	Pos	Pos	Avg.	
1+2		(MHz)	(dBμV/m)	(dB)	(dBμV/m)	(dBμV)	(dB/m)	(dB)	(dB)	(cm)	(deg)	(P/A)	(H/V)
5GHz 802.11ac VHT80 LF		30	28.71	-11.29	40	33.17	26.7	0.62	31.78	-	-	P	H
		233.7	29.29	-16.71	46	41.95	17.22	1.4	31.28	-	-	P	H
		299.66	35.7	-10.3	46	46.33	19.1	1.6	31.33	-	-	P	H
		405.39	31.2	-14.8	46	34.74	25.87	1.82	31.23	-	-	P	H
		497.54	33.23	-12.77	46	39.48	22.83	2.07	31.15	-	-	P	H
		870.02	40.79	-5.21	46	41.09	28.26	2.71	31.27	100	0	P	H
		30	30.96	-9.04	40	35.42	26.7	0.62	31.78	100	0	P	V
		166.77	27.91	-15.59	43.5	41.05	17.07	1.15	31.36	-	-	P	V
		398.6	30.38	-15.62	46	33.91	25.89	1.82	31.24	-	-	P	V
		497.54	35.63	-10.37	46	41.88	22.83	2.07	31.15	-	-	P	V
	699.3	36.07	-9.93	46	37.2	27.65	2.44	31.22	-	-	P	V	
	900.09	35.28	-10.72	46	35.29	28.5	2.77	31.28	-	-	P	V	
Remark	1. No other spurious found. 2. All results are PASS against limit line.												



Note symbol

*	Fundamental Frequency which can be ignored. However, the level of any unwanted emissions shall not exceed the level of the fundamental frequency.
!	Test result is over limit line.
P/A	Peak or Average
H/V	Horizontal or Vertical



A calculation example for radiated spurious emission is shown as below:

WIFI	Note	Frequency	Level	Over	Limit	Read	Antenna	Cable	Preamp	Ant	Table	Peak	Pol.
Ant.				Limit	Line	Level	Factor	Loss	Factor	Pos	Pos	Avg.	
1+2		(MHz)	(dBμV/m)	(dB)	(dBμV/m)	(dBμV)	(dB/m)	(dB)	(dB)	(cm)	(deg)	(P/A)	(H/V)
802.11b		2390	55.45	-18.55	74	54.51	32.22	4.58	35.86	103	308	P	H
CH 01													
2412MHz		2390	43.54	-10.46	54	42.6	32.22	4.58	35.86	103	308	A	H

- Level(dBμV/m) =
Antenna Factor(dB/m) + Cable Loss(dB) + Read Level(dBμV) - Preamp Factor(dB)
- Over Limit(dB) = Level(dBμV/m) – Limit Line(dBμV/m)

For Peak Limit @ 2390MHz:

- Level(dBμV/m)
= Antenna Factor(dB/m) + Cable Loss(dB) + Read Level(dBμV) - Preamp Factor(dB)
= 32.22(dB/m) + 4.58(dB) + 54.51(dBμV) – 35.86 (dB)
= 55.45 (dBμV/m)
- Over Limit(dB)
= Level(dBμV/m) – Limit Line(dBμV/m)
= 55.45(dBμV/m) – 74(dBμV/m)
= -18.55(dB)

For Average Limit @ 2390MHz:

- Level(dBμV/m)
= Antenna Factor(dB/m) + Cable Loss(dB) + Read Level(dBμV) - Preamp Factor(dB)
= 32.22(dB/m) + 4.58(dB) + 42.6(dBμV) – 35.86 (dB)
= 43.54 (dBμV/m)
- Over Limit(dB)
= Level(dBμV/m) – Limit Line(dBμV/m)
= 43.54(dBμV/m) – 54(dBμV/m)
= -10.46(dB)

Both peak and average measured complies with the limit line, so test result is “PASS”.

Appendix C. Duty Cycle Plots

Antenna	Band	Duty Cycle(%)	T(ms)	1/T(kHz)	VBW Setting
1+2	802.11a	87.67	1.44	0.69	1KHz
1+2	802.11n HT20	86.73	1.34	0.74	1KHz
1+2	802.11n HT40	76.53	0.67	1.49	3KHz
1+2	802.11ac VHT80	62.03	0.34	2.97	3KHz

<Ant.1+2>

802.11a

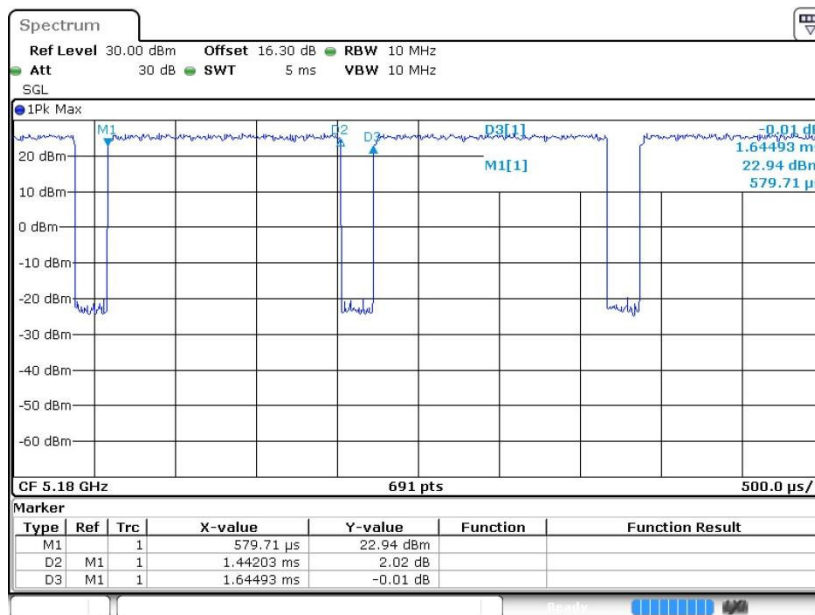



802.11n HT20

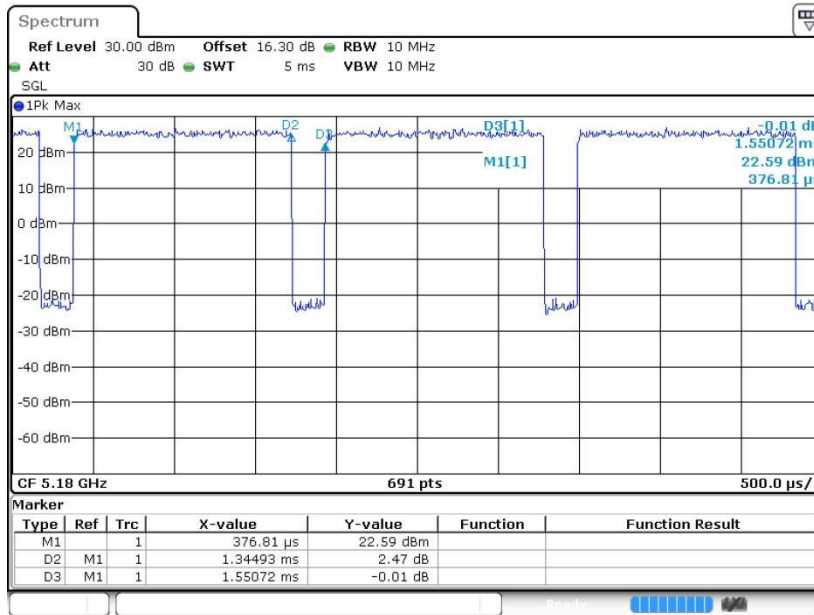

802.11n HT40

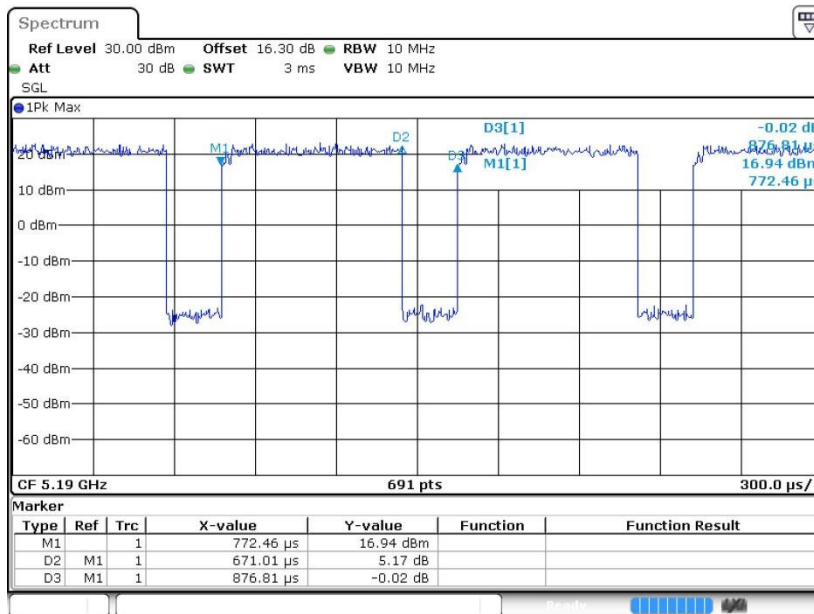



802.11ac VHT80

