



FCC RF Test Report

APPLICANT : TP-LINK TECHNOLOGIES CO., LTD.
EQUIPMENT : AC1200 Wi-Fi Range Extender
BRAND NAME : TP-LINK
MODEL NAME : RE350
FCC ID : TE7RE350
STANDARD : FCC Part 15 Subpart E §15.407
CLASSIFICATION : (NII) Unlicensed National Information Infrastructure

The product was received on Apr. 18, 2016 and testing was completed on Jul. 11, 2016. We, SPORTON INTERNATIONAL INC., would like to declare that the tested sample has been evaluated in accordance with the test procedures and has been in compliance with the applicable technical standards.

The test results in this report apply exclusively to the tested model / sample. Without written approval of SPORTON INTERNATIONAL INC., the test report shall not be reproduced except in full.

Reviewed by: Joseph Lin / Supervisor

Approved by: Jones Tsai / Manager



SPORTON INTERNATIONAL INC.

No. 52, Hwa Ya 1st Rd., Hwa Ya Technology Park, Kwei-Shan District, Tao Yuan City, Taiwan, R.O.C.

SPORTON INTERNATIONAL INC.

TEL : 886-3-327-3456

FAX : 886-3-328-4978

FCC ID : TE7RE350

Page Number : 1 of 30

Report Issued Date : Jul. 21, 2016

Report Version : Rev. 01

Report Template No.: BU5-FR15EWLAC MA Version 1.4



TABLE OF CONTENTS

REVISION HISTORY 3

SUMMARY OF TEST RESULT 4

1 GENERAL DESCRIPTION 5

 1.1 Applicant 5

 1.2 Manufacturer 5

 1.3 Product Feature of Equipment Under Test 5

 1.4 Product Specification of Equipment Under Test 6

 1.5 Modification of EUT 6

 1.6 Testing Location 7

 1.7 Applicable Standards 7

2 TEST CONFIGURATION OF EQUIPMENT UNDER TEST 8

 2.1 Carrier Frequency and Channel 8

 2.2 Test Mode 9

 2.3 Connection Diagram of Test System 10

 2.4 Support Unit used in test configuration and system 11

 2.5 EUT Operation Test Setup 11

 2.6 Measurement Results Explanation Example 11

3 TEST RESULT 12

 3.1 26dB & 99% Occupied Bandwidth Measurement 12

 3.2 Maximum Conducted Output Power Measurement 14

 3.3 Power Spectral Density Measurement 15

 3.4 Unwanted Emissions Measurement 17

 3.5 AC Conducted Emission Measurement 21

 3.6 Frequency Stability Measurement 26

 3.7 Automatically Discontinue Transmission 27

 3.8 Antenna Requirements 28

4 LIST OF MEASURING EQUIPMENT 29

5 UNCERTAINTY OF EVALUATION 30

APPENDIX A. CONDUCTED TEST RESULTS

APPENDIX B. RADIATED SPURIOUS EMISSION

APPENDIX C. RADIATED SPURIOUS EMISSION PLOTS

APPENDIX D. DUTY CYCLE PLOTS

APPENDIX E. SETUP PHOTOGRAPHS



REVISION HISTORY

REPORT NO.	VERSION	DESCRIPTION	ISSUED DATE
FR641813B	Rev. 01	Initial issue of report	Jul. 21, 2016



SUMMARY OF TEST RESULT

Report Section	FCC Rule	Description	Limit	Result	Remark
3.1	2.1049 15.403(i)	26dB & 99% Bandwidth	-	Pass	-
3.2	15.407(a)	Maximum Conducted Output Power	≤ 30 dBm (depend on band)	Pass	-
3.3	15.407(a)	Power Spectral Density	≤ 17 dBm (depend on band)	Pass	-
3.4	15.407(b)	Unwanted Emissions	≤ -17, -27 dBm (depend on band)&15.209(a)	Pass	Under limit 0.30 dB at 5149.240 MHz
3.5	15.207	AC Conducted Emission	15.207(a)	Pass	Under limit 5.10 dB at 0.742 MHz
3.6	15.407(g)	Frequency Stability	Within Operation Band	Pass	-
3.7	15.407(c)	Automatically Discontinue Transmission	Discontinue Transmission	Pass	-
3.8	15.203 & 15.407(a)	Antenna Requirement	N/A	Pass	-



1 General Description

1.1 Applicant

TP-LINK TECHNOLOGIES CO., LTD.

Building 24 (floors 1,3,4,5) and 28 (floors1-4) Central Science and Technology Park,Shennan Rd, Nanshan, Shenzhen, China

1.2 Manufacturer

TP-LINK TECHNOLOGIES CO., LTD.

Building 24 (floors 1,3,4,5) and 28 (floors1-4) Central Science and Technology Park,Shennan Rd, Nanshan, Shenzhen, China

1.3 Product Feature of Equipment Under Test

Product Feature	
Equipment	AC1200 Wi-Fi Range Extender
Brand Name	TP-LINK
Model Name	RE350
FCC ID	TE7RE350
EUT supports Radios application	WLAN 11a/b/g/n HT20/HT40 WLAN 11ac VHT20/VHT40/VHT80
EUT Stage	Identical Prototype

Remark: The above EUT's information was declared by manufacturer. Please refer to the specifications or user's manual for more detailed description.



1.4 Product Specification of Equipment Under Test

Standards-related Product Specification							
Tx/Rx Channel Frequency Range	5180 MHz ~ 5240 MHz						
Maximum Output Power	MIMO <Ant. 1 + 2> 802.11a : 23.93 dBm / 0.2472 W 802.11n HT20 : 23.78 dBm / 0.2388 W 802.11n HT40 : 23.76 dBm / 0.2377 W 802.11ac VHT20: 23.73 dBm / 0.2360 W 802.11ac VHT40: 23.72 dBm / 0.2355 W 802.11ac VHT80: 19.56 dBm / 0.0904 W						
99% Occupied Bandwidth	802.11a : 17.85 MHz 802.11n HT20 : 18.95 MHz 802.11n HT40 : 36.90 MHz 802.11ac VHT20 : 18.95 MHz 802.11ac VHT40 : 37.10 MHz 802.11ac VHT80 : 75.24 MHz						
Type of Modulation	802.11a/n : OFDM (BPSK / QPSK / 16QAM / 64QAM) 802.11ac : OFDM (BPSK / QPSK / 16QAM / 64QAM / 256QAM)						
Antenna Type	Ant. 1 : Dipole Antenna Ant. 2 : Dipole Antenna						
Antenna Gain	Ant. 1 : 3.08 dBi Ant. 2 : 3.08 dBi						
Antenna Function Description	<table border="1"> <thead> <tr> <th></th> <th>Ant. 1</th> <th>Ant. 2</th> </tr> </thead> <tbody> <tr> <td>802.11 a/n/ac MIMO</td> <td>V</td> <td>V</td> </tr> </tbody> </table>		Ant. 1	Ant. 2	802.11 a/n/ac MIMO	V	V
	Ant. 1	Ant. 2					
802.11 a/n/ac MIMO	V	V					

1.5 Modification of EUT

No modifications are made to the EUT during all test items.



1.6 Testing Location

Sporton Lab is accredited to ISO 17025 by Taiwan Accreditation Foundation (TAF code : 1190) and the FCC designation No. TW1022 under the FCC 2.948(e) by Mutual Recognition Agreement (MRA) in FCC Test.

Test Site	SPORTON INTERNATIONAL INC.	
Test Site Location	No. 52, Hwa Ya 1 st Rd., Hwa Ya Technology Park, Kwei-Shan District, Tao Yuan City, Taiwan, R.O.C. TEL: +886-3-327-3456 FAX: +886-3-328-4978	
Test Site No.	Sporton Site No.	
	TH02-HY	CO05-HY

Note: The test site complies with ANSI C63.4 2014 requirement.

Test Site	SPORTON INTERNATIONAL INC.	
Test Site Location	No.58, Aly. 75, Ln. 564, Wenhua 3rd Rd. Guishan Dist, Taoyuan City, Taiwan (R.O.C.) TEL: +886-3-327-0868 FAX: +886-3-327-0855	
Test Site No.	Sporton Site No.	
	03CH10-HY	

Note: The test site complies with ANSI C63.4 2014 requirement.

1.7 Applicable Standards

According to the specifications of the manufacturer, the EUT must comply with the requirements of the following standards:

- FCC Part 15 Subpart E
- FCC KDB 789033 D02 General UNII Test Procedures New Rules v01r02
- FCC KDB 662911 D01 Multiple Transmitter Output v02r01.
- FCC KDB 644545 D03 Guidance for IEEE 802 11ac New Rules v01
- ANSI C63.10-2013

Remark:

1. All test items were verified and recorded according to the standards and without any deviation during the test.
2. This EUT has also been tested and complied with the requirements of FCC Part 15, Subpart B, recorded in a separate test report.



2 Test Configuration of Equipment Under Test

The EUT has been associated with peripherals and configuration operated in a manner tended to maximize its emission characteristics in a typical application. Frequency range investigated: conducted emission (150 kHz to 30 MHz) and radiated emission (9 kHz to the 10th harmonic of the highest fundamental frequency or to 40 GHz, whichever is lower). For radiated measurement, pre-scanned in three orthogonal panels, X, Y, Z. The worst cases (Y plane) were recorded in this report.

2.1 Carrier Frequency and Channel

Frequency Band	Channel	Freq. (MHz)	Channel	Freq. (MHz)
5150-5250 MHz Band 1 (U-NII-1)	36	5180	44	5220
	38	5190	46	5230
	40	5200	48	5240
	42	5210		

Note: The above Frequency and Channel in boldface were 802.11n HT40.



2.2 Test Mode

Final test mode of conducted test items and radiated spurious emissions are considering the modulation and worse data rates as below table.

MIMO Antenna

Modulation	Data Rate
802.11a	6 Mbps
802.11n HT20	MCS0
802.11n HT40	MCS0
802.11ac VHT20	MCS0
802.11ac VHT40	MCS0
802.11ac VHT80	MCS0

Test Cases	
AC Conducted Emission	Mode 1 : WLAN (5GHz) Link 11n HT40 CH38 MCS0 + LAN Link

Ch. #		Band I : 5150-5250 MHz		
		802.11a	802.11n HT20	802.11n HT40
L	Low	36	36	38
M	Middle	44	44	-
H	High	48	48	46

Ch. #		Band I : 5150-5250 MHz		
		802.11ac VHT20	802.11ac VHT40	802.11ac VHT80
L	Low	36	38	-
M	Middle	44	-	42
H	High	48	46	-

2.3 Connection Diagram of Test System

<WLAN Tx Mode>

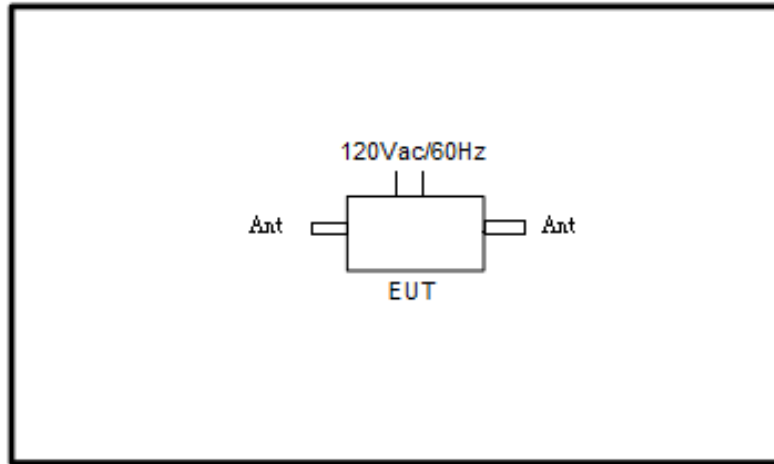

<AC Conducted Emission Mode>

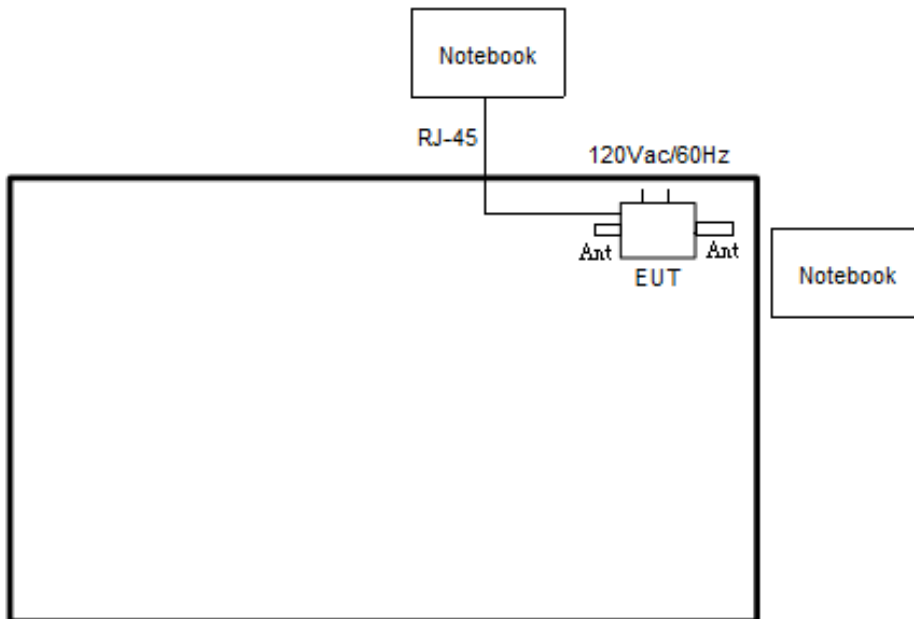



2.4 Support Unit used in test configuration and system

Item	Equipment	Trade Name	Model Name	FCC ID	Data Cable	Power Cord
1.	Notebook	DELL	Latitude E6320	FCC DoC/ Contains FCC ID: QDS-BRCM1054	N/A	AC I/P: Unshielded, 1.2 m DC O/P: Shielded, 1.8 m
2.	Notebook	DELL	P20G	FCC DoC/ Contains FCC ID: QDS-BRCM1051	N/A	AC I/P: Unshielded, 1.2 m DC O/P: Shielded, 1.8 m

2.5 EUT Operation Test Setup

For WLAN function, programmed RF utility, "MT7612E_AP_QA_Tool_V1.0.3.5" installed in the notebook make the EUT provide functions like channel selection and power level for continuous transmitting and receiving signals.

2.6 Measurement Results Explanation Example

For all conducted test items:

The offset level is set in the spectrum analyzer to compensate the RF cable loss and attenuator factor between EUT conducted output port and spectrum analyzer. With the offset compensation, the spectrum analyzer reading level is exactly the EUT RF output level.

Example :

The spectrum analyzer offset is derived from RF cable loss and attenuator factor.

Offset = RF cable loss + attenuator factor.

Following shows an offset computation example with cable loss 4.2 dB and 10dB attenuator.

$$\begin{aligned} \text{Offset(dB)} &= \text{RF cable loss(dB)} + \text{attenuator factor(dB)}. \\ &= 4.2 + 10 = 14.2 \text{ (dB)} \end{aligned}$$

3 Test Result

3.1 26dB & 99% Occupied Bandwidth Measurement

3.1.1 Description of 26dB & 99% Occupied Bandwidth

This section is for reporting purpose only.

There is no restriction limits for bandwidth.

3.1.2 Measuring Instruments

The measuring equipment is listed in the section 4 of this test report.

3.1.3 Test Procedures

1. The testing follows FCC KDB 789033 D02 General UNII Test Procedures New Rules v01r02.
Section C) Emission bandwidth
2. Set RBW = approximately 1% of the emission bandwidth.
3. Set the VBW > RBW.
4. Detector = Peak.
5. Trace mode = max hold
6. Measure the maximum width of the emission that is 26 dB down from the peak of the emission.
Compare this with the RBW setting of the analyzer. Readjust RBW and repeat measurement as needed until the RBW/EBW ratio is approximately 1%.
7. For 99% Bandwidth Measurement, the spectrum analyzer's resolution bandwidth (RBW) is set 1MHz and set the Video bandwidth (VBW) $\geq 3 * RBW$.
8. Measure and record the results in the test report.

3.1.4 Test Setup

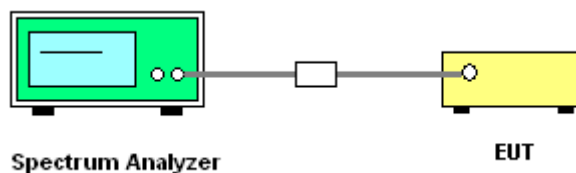



3.1.5 Test Result of 26dB & 99% Occupied Bandwidth

Please refer to Appendix A.

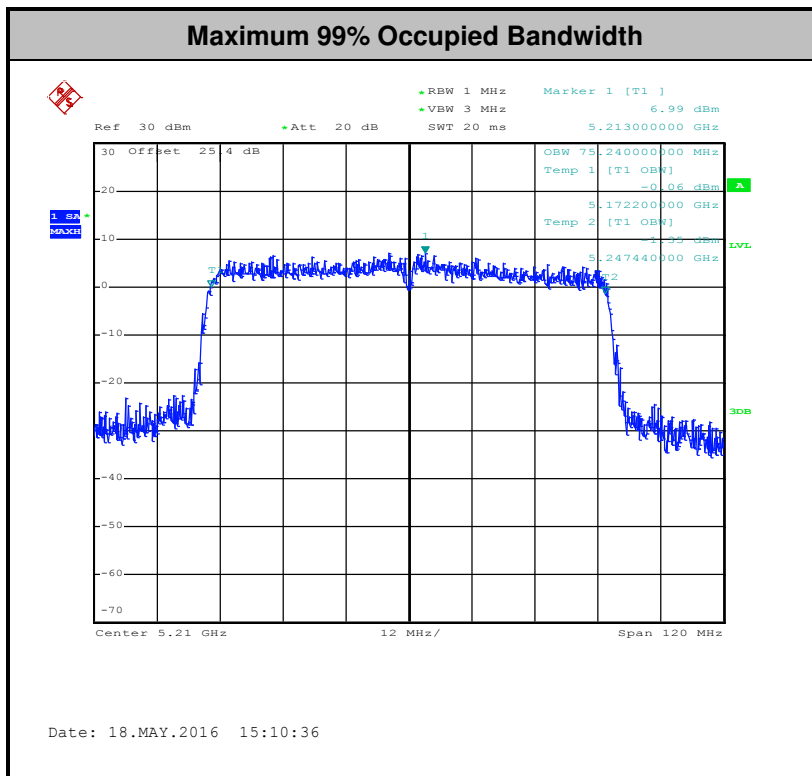
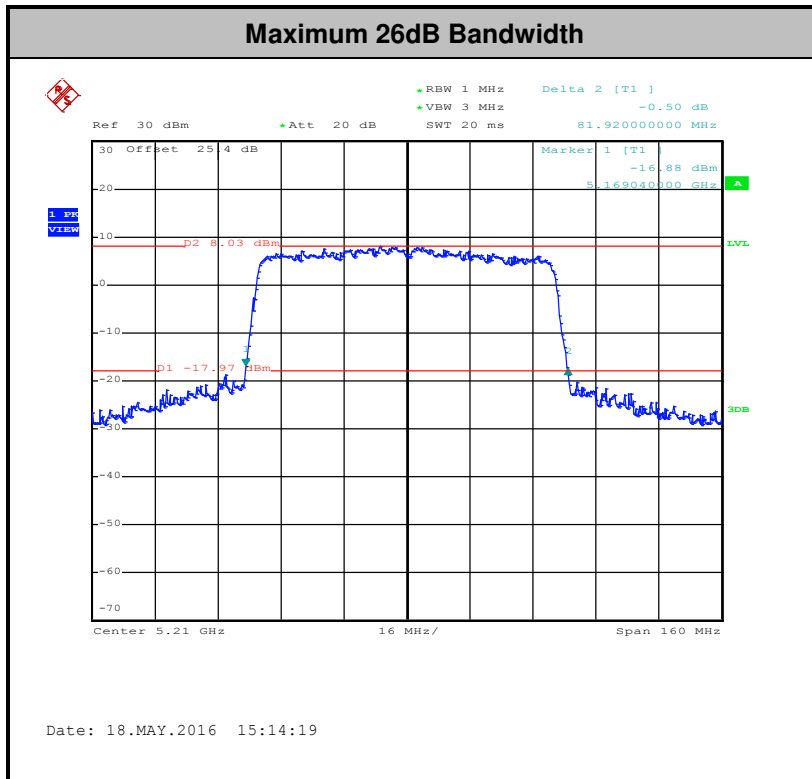

Note: The occupied channel bandwidth is maintained within the band of operation for all of the modulations.

3.2 Maximum Conducted Output Power Measurement

3.2.1 Limit of Maximum Conducted Output Power

For mobile and portable client devices in the 5.15–5.25 GHz band, the maximum conducted output power over the frequency band of operation shall not exceed 1 W.

If transmitting antennas of directional gain greater than 6 dBi are used, the peak output power shall be reduced by the amount in dB that the directional gain of the antenna exceeds 6 dBi.

Note that U-NII-2 band, devices with a maximum e.i.r.p. greater than 500 mW shall implement TPC in order to have the capability to operate at least 6 dB below the maximum permitted e.i.r.p. of 1 W.

3.2.2 Measuring Instruments

The measuring equipment is listed in the section 4 of this test report.

3.2.3 Test Procedures

The testing follows Method PM-G of FCC KDB 789033 D02 General UNII Test Procedures New Rules v01r02.

Method PM (Measurement using a gated RF average power meter):

1. Measurement is performed using a wideband RF power meter.
2. The EUT is configured to transmit at its maximum power control level.
3. Measure the average power of the transmitter
4. Since the measurement is made only during the ON time of the transmitter, no duty cycle correction factor is required.

3.2.4 Test Setup

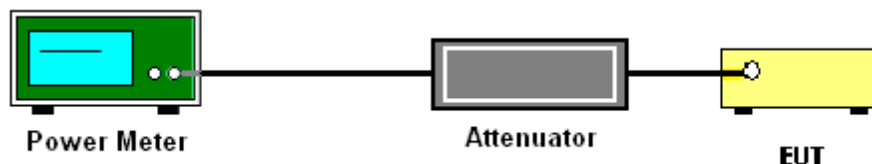

3.2.5 Test Result of Maximum Conducted Output Power

Please refer to Appendix A.



3.3 Power Spectral Density Measurement

3.3.1 Limit of Power Spectral Density

For mobile and portable client devices in the 5.15–5.25 GHz band, the maximum power spectral density shall not exceed 17dBm in any 1 megahertz band.

If transmitting antennas of directional gain greater than 6 dBi are used, the peak output power shall be reduced by the amount in dB that the directional gain of the antenna exceeds 6 dBi.

3.3.2 Measuring Instruments

The measuring equipment is listed in the section 4 of this test report.

3.3.3 Test Procedures

The testing follows FCC KDB 789033 D02 General UNII Test Procedures New Rules v01r02. Section F) Maximum power spectral density.

Method SA-3

(power averaging (rms) detection with max hold):

- Set span to encompass the entire emission bandwidth (EBW) of the signal.
- Set RBW = 1 MHz.
- Set VBW \geq 3 MHz
- Number of points in sweep \geq 2 Span / RBW.
- Sweep time \leq (number of points in sweep) \times T, when duty cycle is less than 98 percent where T is the minimum transmission duration over which the transmitter is on and is transmitting at its maximum power control level for the tested mode of operation.
- Detector = power averaging (rms).
- Trace mode = max hold.
- Allow max hold to run for at least 60 seconds, or longer as needed to allow the trace to stabilize.

1. The RF output of EUT was connected to the spectrum analyzer by a low loss cable.
2. Each plot has already offset with cable loss, and attenuator loss. Measure the PPSD and record it.
3. For MIMO mode, calculation method follows FCC KDB 662911 D01 Multiple Transmitter Output v02r01.

Method (a): Measure and sum the spectra across the outputs.

The total final Power Spectral Density is from a device with 2 transmitter outputs. The spectrum measurements of the individual outputs are all performed with the same span and number of points, the spectrum value in the first spectral bin of output 1 is summed with that in the first spectral bin of output 2 to obtain the value for the first frequency bin of the summed spectrum.

3.3.4 Test Setup

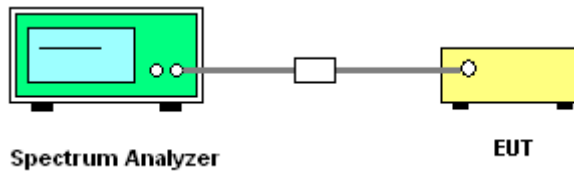

3.3.5 Test Result of Power Spectral Density

Please refer to Appendix A.

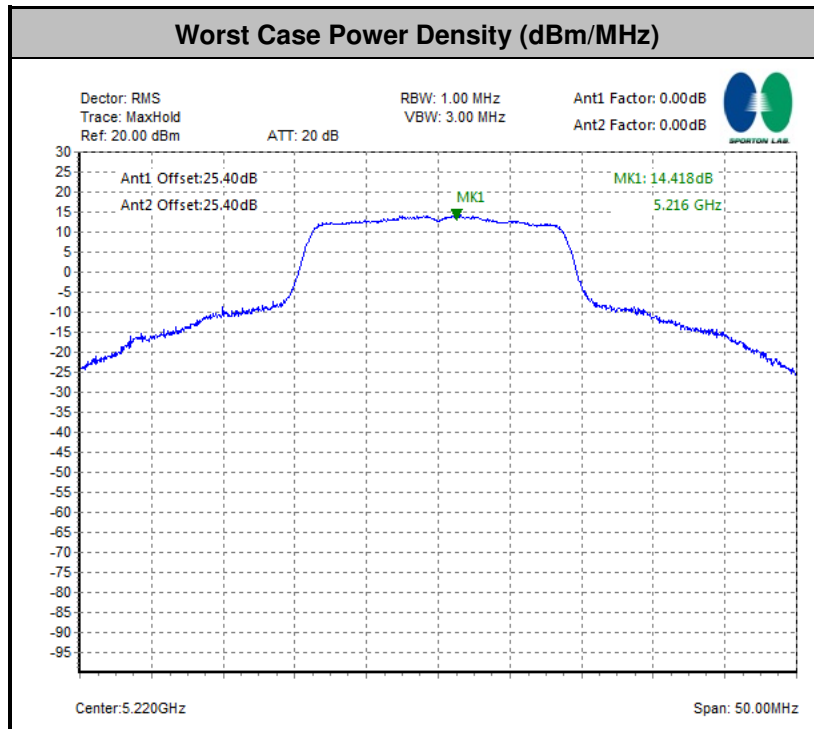

Note: Average Power Density (dB) = Measured value+ Duty Factor



3.4 Unwanted Emissions Measurement

This section as specified in FCC Part 15.407(b) is to measure unwanted emissions through radiated measurement for band edge spurious emissions and out of band emissions measurement. The unwanted emissions shall comply with 15.407(b)(1) to (6), and restricted bands per FCC Part15.205.

3.4.1 Limit of Unwanted Emissions

- (1) For transmitters operating in the 5150-5250 MHz band: all emissions outside of the 5150-5350 MHz band shall not exceed an EIRP of -27dBm/MHz.
- (2) Unwanted spurious emissions fallen in restricted bands per FCC Part15.205 shall comply with the general field strength limits set forth in § 15.209 as below table,

Frequency (MHz)	Field Strength (microvolts/meter)	Measurement Distance (meters)
0.009 – 0.490	2400/F(kHz)	300
0.490 – 1.705	24000/F(kHz)	30
1.705 – 30.0	30	30
30 – 88	100	3
88 – 216	150	3
216 - 960	200	3
Above 960	500	3

Note: The following formula is used to convert the EIRP to field strength.

$$E = \frac{1000000\sqrt{30P}}{3} \mu V/m, \text{ where } P \text{ is the eirp (Watts)}$$

EIRP (dBm)	Field Strength at 3m (dBμV/m)
-17	78.3
- 27	68.3

- (3) KDB789033 D02 v01r02 G)2)c) As specified in 15.407(b), emissions above 1000 MHz that are outside of the restricted bands are subject to a peak emission limit of -27 dBm/MHz (or -17 dBm/MHz as specified in 15.407(b)(4)). However, an out-of-band emission that complies with both the average and peak limits of 15.209 is not required to satisfy the -27 dBm/MHz or -17 dBm/MHz peak emission limit.

3.4.2 Measuring Instruments

The measuring equipment is listed in the section 4 of this test report.



3.4.3 Test Procedures

1. The testing follows FCC KDB 789033 D02 General UNII Test Procedures New Rules v01r02. Section G) Unwanted emissions measurement.
 - (1) Procedure for Unwanted Emissions Measurements Below 1000MHz
 - RBW = 120 kHz
 - VBW = 300 kHz
 - Detector = Peak
 - Trace mode = max hold
 - (2) Procedure for Peak Unwanted Emissions Measurements Above 1000 MHz
 - RBW = 1 MHz
 - VBW \geq 3 MHz
 - Detector = Peak
 - Sweep time = auto
 - Trace mode = max hold
 - (3) Procedures for Average Unwanted Emissions Measurements Above 1000MHz
 - RBW = 1 MHz
 - VBW = 10 Hz, when duty cycle is no less than 98 percent.
 - VBW \geq 1/T, when duty cycle is less than 98 percent where T is the minimum transmission duration over which the transmitter is on and is transmitting at its maximum power control level for the tested mode of operation.
2. The EUT was placed on a turntable with 0.8 meter for frequency below 1GHz and 1.5 meter for frequency above 1GHz respectively above ground.
3. The EUT was set 3 meters from the interference receiving antenna which was mounted on the top of a variable height antenna tower.
4. The antenna is a broadband antenna and its height is adjusted between one meter and four meters above ground to find the maximum value of the field strength for both horizontal polarization and vertical polarization of the antenna.
5. For each suspected emission, the EUT was arranged to its worst case and then adjust the antenna tower (from 1 m to 4 m) and turntable (from 0 degree to 360 degrees) to find the maximum reading.
6. For testing below 1GHz, if the emission level of the EUT in peak mode was 3 dB lower than the limit specified, then peak values of EUT will be reported, otherwise, the emissions will be repeated one by one using the CISPR quasi-peak method and reported.
7. For testing above 1GHz, the emission level of the EUT in peak mode was 20dB lower than average limit (that means the emission level in average mode also complies with the limit in average mode), then peak values of EUT will be reported, otherwise, the emissions will be measured in average mode again and reported.

3.4.4 Test Setup

For radiated emissions below 30MHz

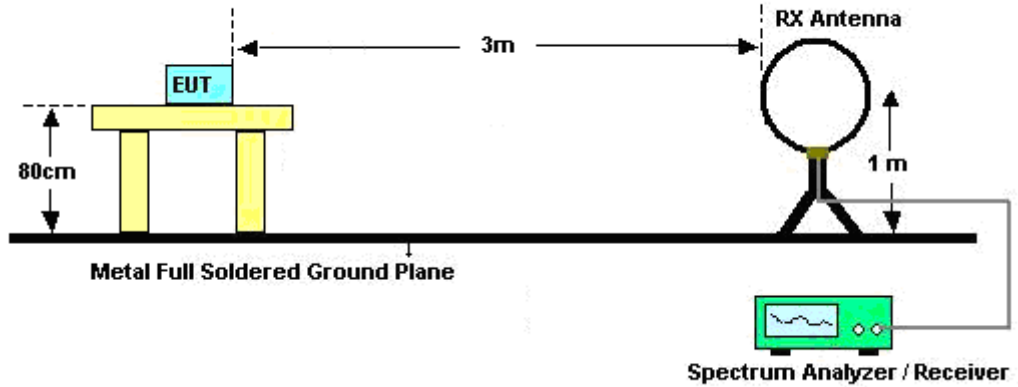

For radiated emissions from 30MHz to 1GHz

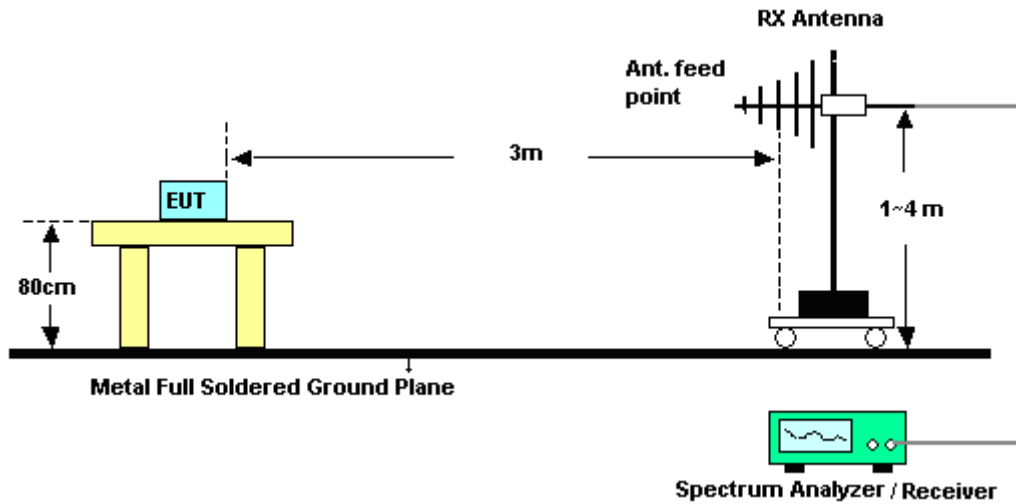

For radiated emissions above 1GHz

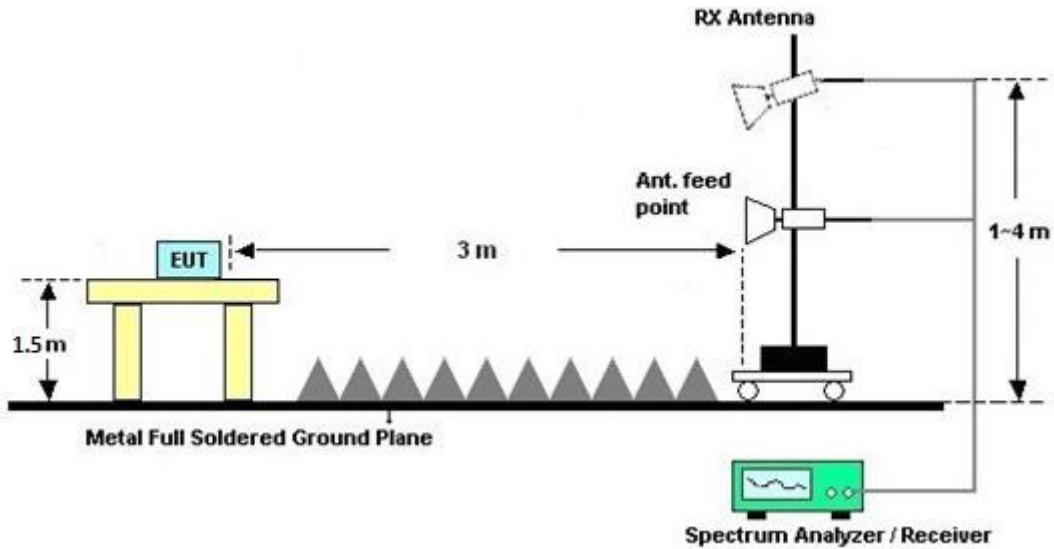

3.4.5 Test Results of Radiated Emissions (9 kHz ~ 30 MHz)

The low frequency, which started from 9 kHz to 30MHz, was pre-scanned and the result which was 20dB lower than the limit line per 15.31(o) was not reported.

3.4.6 Test Result of Radiated Band Edges

Please refer to Appendix B and C.

3.4.7 Duty Cycle

Please refer to Appendix D.

3.4.8 Test Result of Unwanted Radiated Emission (30MHz ~ 10th Harmonic)

Please refer to Appendix B and C.



3.5 AC Conducted Emission Measurement

3.5.1 Limit of AC Conducted Emission

For equipment that is designed to be connected to the public utility (AC) power line, the radio frequency voltage that is conducted back onto the AC power line on any frequency or frequencies within the band 150 kHz to 30 MHz shall not exceed the limits in the following table.

Frequency of emission (MHz)	Conducted limit (dB μ V)	
	Quasi-peak	Average
0.15-0.5	66 to 56*	56 to 46*
0.5-5	56	46
5-30	60	50

*Decreases with the logarithm of the frequency.

3.5.2 Measuring Instruments

The measuring equipment is listed in the section 4 of this test report.

3.5.3 Test Procedures

1. The EUT was placed 0.4 meter from the conducting wall of the shielding room was kept at least 80 centimeters from any other grounded conducting surface.
2. Connect EUT to the power mains through a line impedance stabilization network (LISN).
3. All the support units are connecting to the other LISN.
4. The LISN provides 50 ohm coupling impedance for the measuring instrument.
5. The FCC states that a 50 ohm, 50 microhenry LISN should be used.
6. Both sides of AC line were checked for maximum conducted interference.
7. The frequency range from 150 kHz to 30 MHz was searched.
8. Set the test-receiver system to Peak Detect Function and specified bandwidth with Maximum Hold Mode.

3.5.4 Test Setup

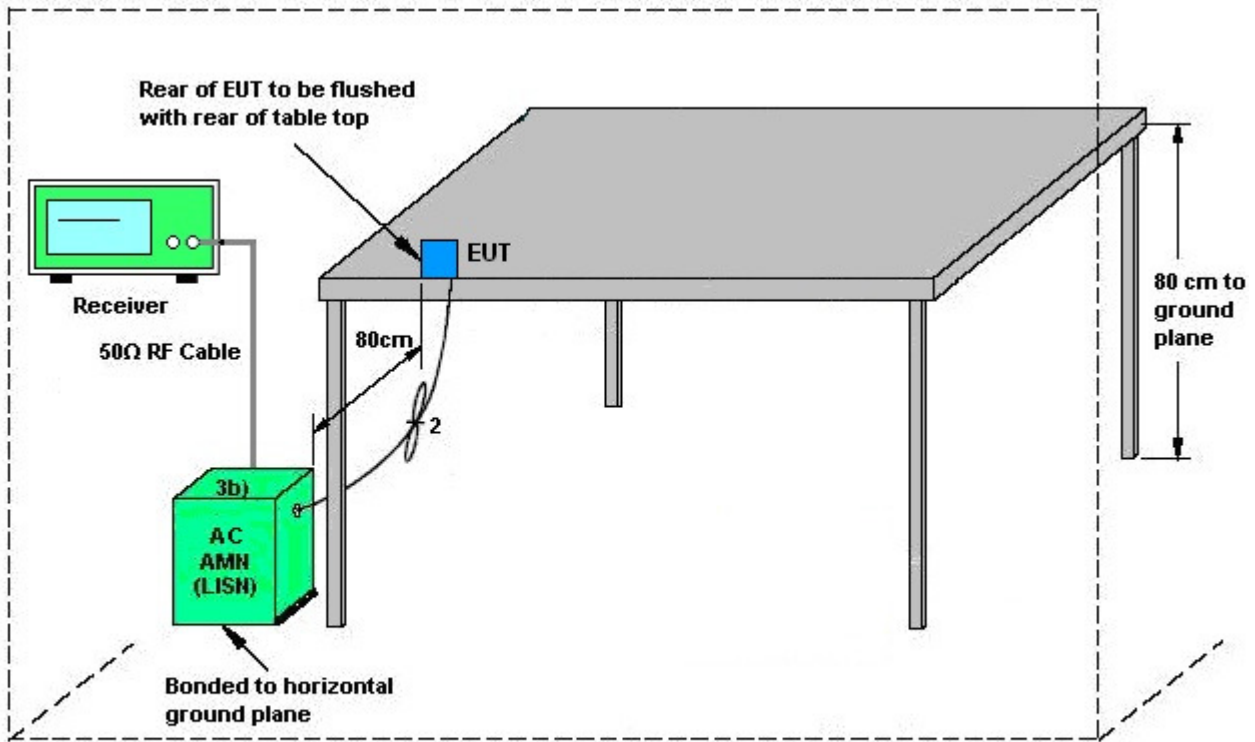

AMN = Artificial mains network (LISN)
AE = Associated equipment
EUT = Equipment under test
ISN = Impedance stabilization network



3.5.5 Test Result of AC Conducted Emission

Test Mode :	Mode 1	Temperature :	22~23°C
Test Engineer :	Arthur Hsieh	Relative Humidity :	50~51%
Test Voltage :	120Vac / 60Hz	Phase :	Line
Function Type :	WLAN (5GHz) Link 11n HT40 CH38 MCS0 + LAN Link		

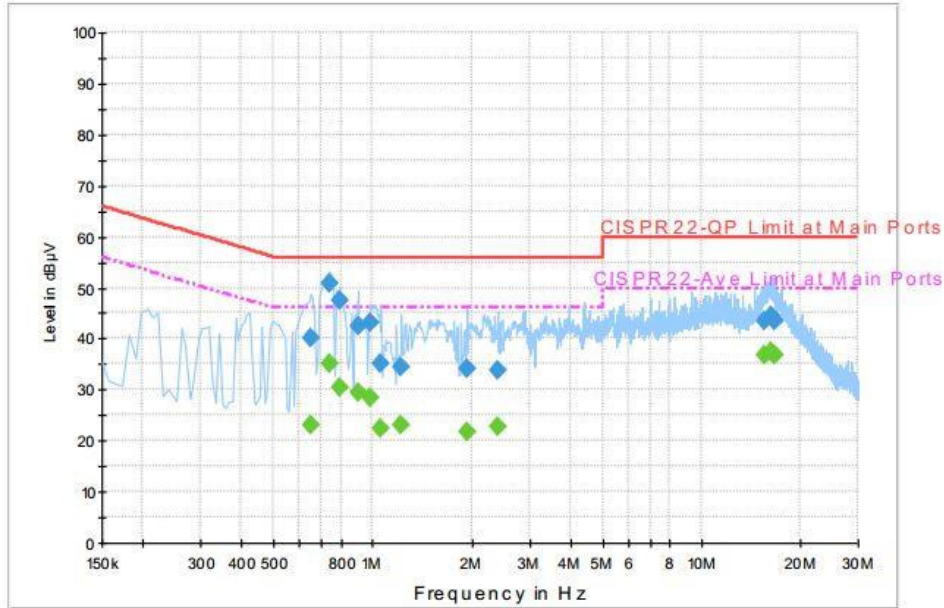

Final Result : QuasiPeak

Frequency (MHz)	QuasiPeak (dBµV)	Filter	Line	Corr. (dB)	Margin (dB)	Limit (dBµV)
0.646000	40.0	Off	L1	19.6	16.0	56.0
0.742000	50.9	Off	L1	19.6	5.1	56.0
0.790000	47.5	Off	L1	19.6	8.5	56.0
0.902000	42.4	Off	L1	19.6	13.6	56.0
0.990000	43.0	Off	L1	19.6	13.0	56.0
1.062000	35.0	Off	L1	19.6	21.0	56.0
1.222000	34.3	Off	L1	19.6	21.7	56.0
1.934000	34.1	Off	L1	19.6	21.9	56.0
2.398000	33.9	Off	L1	19.6	22.1	56.0
15.622000	43.4	Off	L1	19.8	16.6	60.0
16.342000	44.4	Off	L1	19.8	15.6	60.0
16.678000	43.5	Off	L1	19.8	16.5	60.0



Test Mode :	Mode 1	Temperature :	22~23°C
Test Engineer :	Arthur Hsieh	Relative Humidity :	50~51%
Test Voltage :	120Vac / 60Hz	Phase :	Line
Function Type :	WLAN (5GHz) Link 11n HT40 CH38 MCS0 + LAN Link		

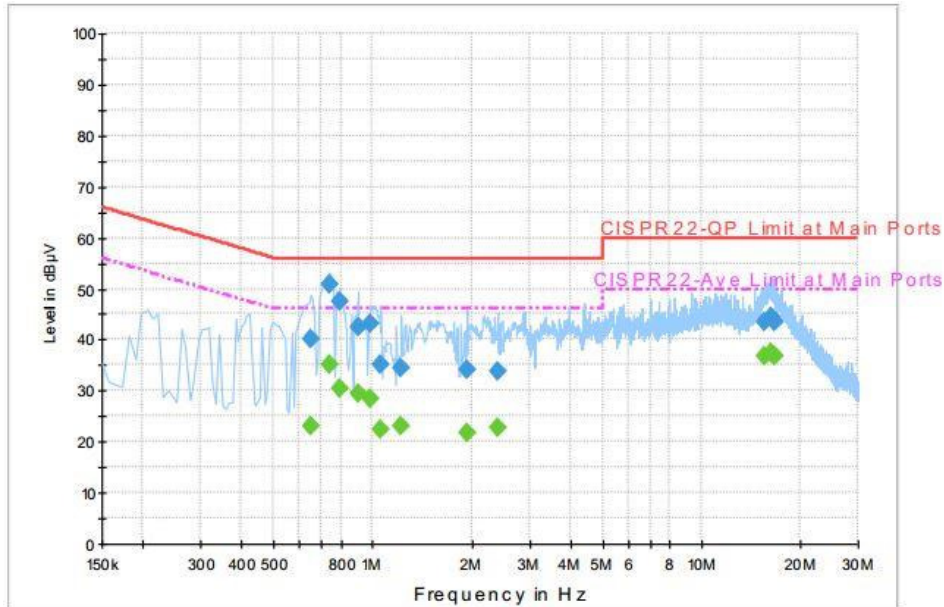

Final Result : Average

Frequency (MHz)	Average (dBµV)	Filter	Line	Corr. (dB)	Margin (dB)	Limit (dBµV)
0.646000	23.0	Off	L1	19.6	23.0	46.0
0.742000	35.1	Off	L1	19.6	10.9	46.0
0.790000	30.4	Off	L1	19.6	15.6	46.0
0.902000	29.6	Off	L1	19.6	16.4	46.0
0.990000	28.3	Off	L1	19.6	17.7	46.0
1.062000	22.3	Off	L1	19.6	23.7	46.0
1.222000	23.0	Off	L1	19.6	23.0	46.0
1.934000	21.7	Off	L1	19.6	24.3	46.0
2.398000	22.6	Off	L1	19.6	23.4	46.0
15.622000	37.0	Off	L1	19.8	13.0	50.0
16.342000	37.3	Off	L1	19.8	12.7	50.0
16.678000	36.7	Off	L1	19.8	13.3	50.0



Test Mode :	Mode 1	Temperature :	22~23°C
Test Engineer :	Arthur Hsieh	Relative Humidity :	50~51%
Test Voltage :	120Vac / 60Hz	Phase :	Neutral
Function Type :	WLAN (5GHz) Link 11n HT40 CH38 MCS0 + LAN Link		

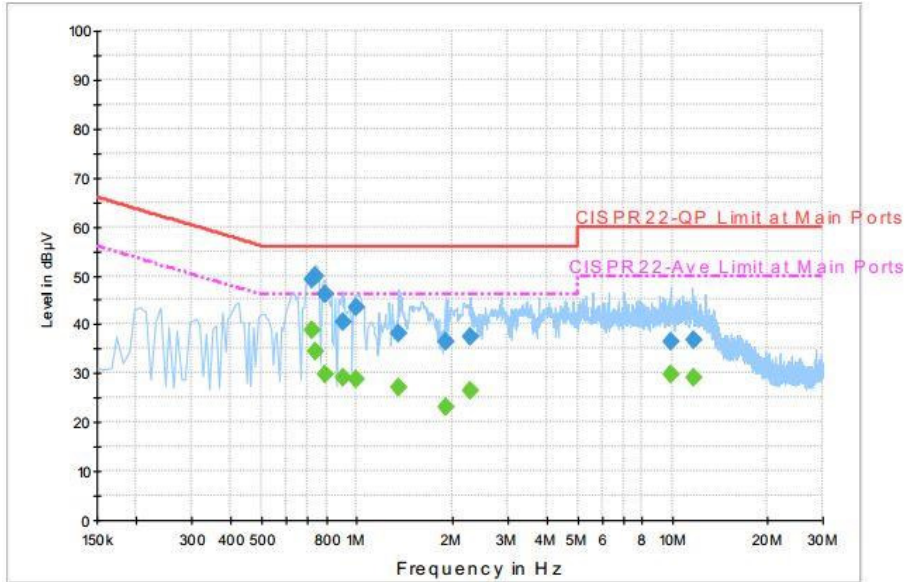

Final Result : QuasiPeak

Frequency (MHz)	QuasiPeak (dBµV)	Filter	Line	Corr. (dB)	Margin (dB)	Limit (dBµV)
0.718000	49.3	Off	N	19.6	6.7	56.0
0.742000	49.7	Off	N	19.6	6.3	56.0
0.790000	46.1	Off	N	19.6	9.9	56.0
0.910000	40.6	Off	N	19.6	15.4	56.0
0.998000	43.4	Off	N	19.6	12.6	56.0
1.350000	38.1	Off	N	19.6	17.9	56.0
1.910000	36.5	Off	N	19.6	19.5	56.0
2.294000	37.6	Off	N	19.6	18.4	56.0
9.862000	36.6	Off	N	19.7	23.4	60.0
11.662000	36.6	Off	N	19.8	23.4	60.0

Final Result : Average

Frequency (MHz)	Average (dBµV)	Filter	Line	Corr. (dB)	Margin (dB)	Limit (dBµV)
0.718000	39.0	Off	N	19.6	7.0	46.0
0.742000	34.4	Off	N	19.6	11.6	46.0
0.790000	29.8	Off	N	19.6	16.2	46.0
0.910000	29.2	Off	N	19.6	16.8	46.0
0.998000	28.9	Off	N	19.6	17.1	46.0
1.350000	27.2	Off	N	19.6	18.8	46.0
1.910000	23.0	Off	N	19.6	23.0	46.0
2.294000	26.4	Off	N	19.6	19.6	46.0
9.862000	29.6	Off	N	19.7	20.4	50.0
11.662000	29.1	Off	N	19.8	20.9	50.0

3.6 Frequency Stability Measurement

3.6.1 Limit of Frequency Stability

Manufacturers of U-NII devices are responsible for ensuring frequency stability such that an emission is maintained within the band of operation under all conditions of normal operation as specified in the user's manual.

3.6.2 Measuring Instruments

The measuring equipment is listed in the section 4 of this test report.

3.6.3 Test Procedures

1. To ensure emission at the band edge is maintained within the authorized band, those values shall be measured by radiation emissions at upper and lower frequency points, and finally compensated by frequency deviation as procedures below.
2. The EUT was operated at the maximum output power, and connected to the spectrum analyzer, which is set to maximum hold function and peak detector. The peak value of the power envelope was measured and noted. The upper and lower frequency points were respectively measured relatively 10dB lower than the measured peak value.
3. The frequency deviation was calculated by adding the upper frequency point and the lower frequency point divided by two. Those detailed values of frequency deviation are provided in table below.

3.6.4 Test Setup

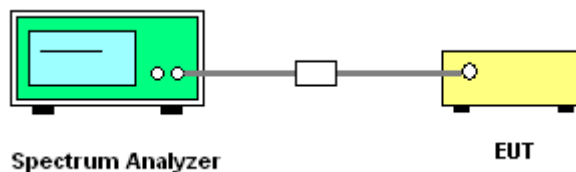

3.6.5 Test Result of Frequency Stability

Please refer to Appendix A.



3.7 Automatically Discontinue Transmission

3.7.1 Limit of Automatically Discontinue Transmission

The device shall automatically discontinue transmission in case of either absence of information to transmit or operational failure. These provisions are not intended to preclude the transmission of control or signaling information or the use of repetitive codes used by certain digital technologies to complete frame or burst intervals. Applicants shall include in their application for equipment authorization to describe how this requirement is met.

3.7.2 Measuring Instruments

The measuring equipment is listed in the section 4 of this test report.

3.7.3 Test Result of Automatically Discontinue Transmission

While the EUT is not transmitting any information, the EUT can automatically discontinue transmission and become standby mode for power saving. The EUT can detect the controlling signal of ACK message transmitting from remote device and verify whether it shall resend or discontinue transmission.



3.8 Antenna Requirements

3.8.1 Standard Applicable

If directional gain of transmitting Antennas is greater than 6dBi, the power shall be reduced by the same level in dB comparing to gain minus 6dBi. For the fixed point-to-point operation, the power shall be reduced by one dB for every 3 dB that the directional gain of the Antenna exceeds 6 dBi. The use of a permanently attached Antenna or of an Antenna that uses a unique coupling to the intentional radiator shall be considered sufficient to comply with the FCC rule.

3.8.2 Antenna Anti-Replacement Construction

An embedded-in antenna design is used.

3.8.3 Antenna Gain

FCC KDB 662911 D01 Multiple Transmitter Output v02r01.

Unequal antenna gains, with equal transmit powers.

For antenna gains given by G1, G2, ..., GN dBi

If transmit signals are correlated, then

$$\text{Directional gain} = 10 \log[(10^{G1/20} + 10^{G2/20} + \dots + 10^{GN/20})^2 / N_{ANT}] \text{ dBi}$$

For CDD transmissions, directional gain is calculated as

$$\text{Directional gain} = G_{ANT} + \text{Array Gain, where Array Gain is as follows.}$$

For power spectral density (PSD) measurements on all devices,

$$\text{Array Gain} = 10 \log(N_{ANT}/N_{SS}=1) \text{ dB.}$$

For power measurements on IEEE 802.11 devices,

$$\text{Array Gain} = 0 \text{ dB (i.e., no array gain) for } N_{ANT} \leq 4.$$

Directional gain may be calculated by using the formulas applicable to equal gain antennas with GANT set equal to the gain of the antenna having the highest gain;

The EUT supports CDD mode.

The power and PSD limit should be modified if the directional gain of EUT is over 6 dBi,

The directional gain "DG" is calculated as following table.

			DG	DG	Power	PSD
			for	for	Limit	Limit
	Ant 1	Ant 2	Power	PSD	Reduction	Reduction
	(dBi)	(dBi)	(dBi)	(dBi)	(dB)	(dB)
Band I	3.08	3.08	3.08	6.09	0.00	0.09

$$\text{Power Limit Reduction} = DG(\text{Power}) - 6\text{dBi, (min = 0)}$$

$$\text{PSD Limit Reduction} = DG(\text{PSD}) - 6\text{dBi, (min = 0)}$$



4 List of Measuring Equipment

Instrument	Manufacturer	Model No.	Serial No.	Characteristics	Calibration Date	Test Date	Due Date	Remark
Power Sensor	DARE	RadiPower	15100041SNO09	10MHz~6GHz	May 03, 2016	May 05, 2016 ~ Jul. 11, 2016	May 02, 2017	Conducted (TH05-HY)
Spectrum Analyzer	Rohde & Schwarz	FSP40	100057	9kHz-40GHz	Nov. 23, 2015	May 05, 2016 ~ Jul. 11, 2016	Nov. 22, 2016	Conducted (TH05-HY)
Temperature Chamber	ESPEC	SU-241	92003713	-30℃ ~95℃	Jun. 15, 2015	May 05, 2016 ~ May 22, 2016	Jun. 14, 2016	Conducted (TH05-HY)
Temperature Chamber	ESPEC	SU-241	92003713	-30℃ ~95℃	Jun. 06, 2016	Jun. 06, 2016 ~ Jul. 11, 2016	Jun. 05, 2017	Conducted (TH05-HY)
AC Power Source	ChainTek	APC-1000W	N/A	N/A	N/A	May 01, 2016	N/A	Conduction (CO05-HY)
EMI Test Receiver	Rohde & Schwarz	ESCI 7	100724	9kHz~7GHz	Aug. 26, 2015	May 01, 2016	Aug. 25, 2016	Conduction (CO05-HY)
LISN	Rohde & Schwarz	ENV216	100080	9kHz~30MHz	Dec. 02, 2015	May 01, 2016	Dec. 01, 2016	Conduction (CO05-HY)
Loop Antenna	Rohde & Schwarz	HFH2-Z2	100315	9 kHz~30 MHz	Sep. 02, 2015	Jun. 08, 2016 ~ Jun. 22, 2016	Sep. 01, 2016	Radiation (03CH10-HY)
Bilog Antenna	TESEQ	CBL 6111D	35413	30MHz~1GHz	Jan. 13, 2016	Jun. 08, 2016 ~ Jun. 22, 2016	Jan. 12, 2017	Radiation (03CH10-HY)
Horn Antenna	SCHWARZBECK	BBHA 9120 D	9120D-1325	1GHz ~ 18GHz	Sep. 30, 2015	Jun. 08, 2016 ~ Jun. 22, 2016	Sep. 29, 2016	Radiation (03CH10-HY)
SHF-EHF Horn Antenna	SCHWARZBECK	BBHA 9170	BBHA9170576	18GHz ~ 40GHz	Apr. 15, 2016	Jun. 08, 2016 ~ Jun. 22, 2016	Apr. 14, 2017	Radiation (03CH10-HY)
EMI Test Receiver	Keysight	N9038A(MXE)	MY55420170	N/A	Mar. 10, 2016	Jun. 08, 2016 ~ Jun. 22, 2016	Mar. 09, 2017	Radiation (03CH10-HY)
Spectrum Analyzer	Keysight	N9010A	MY54200485	10Hz ~ 44GHz	Oct. 15, 2015	Jun. 08, 2016 ~ Jun. 22, 2016	Oct. 14, 2016	Radiation (03CH10-HY)
Amplifier	SONOMA	310N	187311	9kHz~1GHz	Nov. 16, 2015	Jun. 08, 2016 ~ Jun. 22, 2016	Nov. 15, 2016	Radiation (03CH10-HY)
Preamplifier	Keysight	83017A	MY53270078	1GHz~26.5GHz	Nov. 13, 2015	Jun. 08, 2016 ~ Jun. 22, 2016	Nov. 12, 2016	Radiation (03CH10-HY)
Preamplifier	MITEQ	TTA0204	1872107	2GHz~40GHz	Feb. 15, 2016	Jun. 08, 2016 ~ Jun. 22, 2016	Feb. 14, 2017	Radiation (03CH10-HY)
Antenna Mast	EMEC	AM-BS-4500-B	N/A	1~4m	N/A	Jun. 08, 2016 ~ Jun. 22, 2016	N/A	Radiation (03CH10-HY)
Turn Table	EMEC	TT 2200	N/A	0~360 Degree	N/A	Jun. 08, 2016 ~ Jun. 22, 2016	N/A	Radiation (03CH10-HY)



5 Uncertainty of Evaluation

Uncertainty of Conducted Emission Measurement (150kHz ~ 30MHz)

Measuring Uncertainty for a Level of Confidence of 95% ($U = 2Uc(y)$)	2.26
---	------

Uncertainty of Radiated Emission Measurement (30 MHz ~ 1000 MHz)

Measuring Uncertainty for a Level of Confidence of 95% ($U = 2Uc(y)$)	5.50
---	------

Uncertainty of Radiated Emission Measurement (1GHz ~ 40GHz)

Measuring Uncertainty for a Level of Confidence of 95% ($U = 2Uc(y)$)	4.90
---	------



Appendix A. Conducted Test Results

Test Engineer:	AC Chang	Temperature:	21~25	°C
Test Date:	2016/5/5~2016/07/11	Relative Humidity:	51~54	%

TEST RESULTS DATA
26dB and 99% OBW

Band I													
Mod.	Data Rate	NTX	CH.	Freq. (MHz)	99% Bandwidth (MHz)		26 dB Bandwidth (MHz)		IC 99% Bandwidth Power Limit (dBm)		IC 99% Bandwidth EIRP Limit (dBm)		Note
					Ant 1	Ant 2	Ant 1	Ant 2	Ant 1	Ant 2	Ant 1	Ant 2	
11a	6Mbps	2	36	5180	17.80	17.55	32.60	32.20	-	-	22.44		
11a	6Mbps	2	44	5220	17.70	17.85	33.50	33.80	-	-	22.48		
11a	6Mbps	2	48	5240	17.85	17.85	30.40	34.00	-	-	22.52		
HT20	MCS0	2	36	5180	18.85	18.55	41.30	39.70	-	-	22.68		
HT20	MCS0	2	44	5220	18.70	18.95	39.80	41.80	-	-	22.72		
HT20	MCS0	2	48	5240	18.65	18.90	39.60	41.60	-	-	22.71		
HT40	MCS0	2	38	5190	36.30	36.30	41.76	41.76	-	-	23.01		
HT40	MCS0	2	46	5230	36.70	36.90	70.74	75.06	-	-	23.01		
VHT20	MCS0	2	36	5180	18.95	18.50	43.00	39.30	-	-	22.67		
VHT20	MCS0	2	44	5220	18.80	18.95	39.40	41.40	-	-	22.74		
VHT20	MCS0	2	48	5240	18.70	18.95	41.70	41.80	-	-	22.72		
VHT40	MCS0	2	38	5190	36.40	36.30	41.58	41.76	-	-	23.01		
VHT40	MCS0	2	46	5230	36.70	37.10	68.58	74.88	-	-	23.01		
VHT80	MCS0	2	42	5210	75.24	75.12	81.60	81.92	-	-	23.01		

TEST RESULTS DATA
Average Power Table

FCC Band I												
Mod.	Data Rate	NTX	CH.	Freq. (MHz)	Average Conducted Power (dBm)			FCC Conducted Power Limit (dBm)		DG (dBi)		Pass/Fail
					Ant 1	Ant 2	SUM	Ant 1	Ant 2	Ant 1	Ant 2	
11a	6Mbps	2	36	5180	20.90	20.50	23.71	30.00		3.08	Pass	
11a	6Mbps	2	44	5220	20.70	20.60	23.66	30.00		3.08	Pass	
11a	6Mbps	2	48	5240	20.50	21.30	23.93	30.00		3.08	Pass	
HT20	MCS0	2	36	5180	20.50	20.60	23.56	30.00		3.08	Pass	
HT20	MCS0	2	44	5220	20.70	20.40	23.56	30.00		3.08	Pass	
HT20	MCS0	2	48	5240	20.30	21.20	23.78	30.00		3.08	Pass	
HT40	MCS0	2	38	5190	17.20	17.10	20.16	30.00		3.08	Pass	
HT40	MCS0	2	46	5230	20.80	20.70	23.76	30.00		3.08	Pass	
VHT20	MCS0	2	36	5180	20.40	20.60	23.51	30.00		3.08	Pass	
VHT20	MCS0	2	44	5220	20.60	20.40	23.51	30.00		3.08	Pass	
VHT20	MCS0	2	48	5240	20.30	21.10	23.73	30.00		3.08	Pass	
VHT40	MCS0	2	38	5190	17.00	16.90	19.96	30.00		3.08	Pass	
VHT40	MCS0	2	46	5230	20.40	21.00	23.72	30.00		3.08	Pass	
VHT80	MCS0	2	42	5210	16.50	16.60	19.56	30.00		3.08	Pass	

TEST RESULTS DATA
Power Spectral Density

FCC Band I												
Mod.	Data Rate	NTX	CH.	Freq. (MHz)	Average Power Density (dBm/MHz)			Average PSD Limit (dBm/MHz)		DG (dBi)		Pass /Fail
					Ant 1	Ant 2	SUM	Ant 1	Ant 2	Ant 1	Ant 2	
11a	6Mbps	2	36	5180			14.27	16.91	6.09		Pass	
11a	6Mbps	2	44	5220			13.78	16.91	6.09		Pass	
11a	6Mbps	2	48	5240			13.30	16.91	6.09		Pass	
HT20	MCS0	2	36	5180			13.20	16.91	6.09		Pass	
HT20	MCS0	2	44	5220			14.34	16.91	6.09		Pass	
HT20	MCS0	2	48	5240			14.13	16.91	6.09		Pass	
HT40	MCS0	2	38	5190			7.64	16.91	6.09		Pass	
HT40	MCS0	2	46	5230			10.42	16.91	6.09		Pass	
VHT20	MCS0	2	36	5180			13.66	16.91	6.09		Pass	
VHT20	MCS0	2	44	5220			14.42	16.91	6.09		Pass	
VHT20	MCS0	2	48	5240			13.98	16.91	6.09		Pass	
VHT40	MCS0	2	38	5190			7.51	16.91	6.09		Pass	
VHT40	MCS0	2	46	5230			10.37	16.91	6.09		Pass	
VHT80	MCS0	2	42	5210			3.79	16.91	6.09		Pass	

TEST RESULTS DATA
Frequency Stability

Band I										
Mod.	Data Rate	NTX	CH.	Freq. (MHz)	Center Frequency (MHz)	Frequency Deviation (MHz)	Frequency Stability (ppm)	Temperature (°C)	Voltage (V)	Note
11a	6Mbps	1	36	5180	5180.000	0.000	0.00	20	100	
11a	6Mbps	1	36	5180	5180.000	0.000	0.00	20	240	
11a	6Mbps	1	36	5180	5180.000	0.000	0.00	20	220	
11a	6Mbps	1	36	5180	5180.000	0.000	0.00	-30	220	
11a	6Mbps	1	36	5180	5180.000	0.000	0.00	50	220	



Appendix B. Radiated Spurious Emission

Test Engineer :	Tsung Lee, Stan Hsieh and Ken Wu	Temperature :	20~24°C
		Relative Humidity :	51~55%

Band 1 - 5150~5250MHz

WIFI 802.11a (Band Edge @ 3m)

WIFI Ant. 1+2	Note	Frequency (MHz)	Level (dBμV/m)	Over Limit (dB)	Limit Line (dBμV/m)	Read Level (dBμV)	Antenna Factor (dB/m)	Cable Loss (dB)	Preamp Factor (dB)	Ant Pos (cm)	Table Pos (deg)	Peak Avg. (P/A)	Pol. (H/V)	
802.11a CH 36 5180MHz		5149	65.16	-8.84	74	57.81	31.98	7.94	32.57	158	194	P	H	
		5150	49.96	-4.04	54	42.61	31.98	7.94	32.57	158	194	A	H	
	*	5182	110.51	-	-	103.15	32.02	7.91	32.57	158	194	P	H	
	*	5182	104.18	-	-	96.82	32.02	7.91	32.57	158	194	A	H	
													H	
													H	
			5150	63.48	-10.52	74	56.13	31.98	7.94	32.57	163	26	P	V
			5150	53.07	-0.93	54	45.72	31.98	7.94	32.57	163	26	A	V
	*		5178	114.25	-	-	106.89	32.02	7.91	32.57	163	26	P	V
	*		5178	107.28	-	-	99.92	32.02	7.91	32.57	163	26	A	V
													V	
													V	
802.11a CH 44 5220MHz		5148.2	48.88	-25.12	74	41.53	31.98	7.94	32.57	172	193	P	H	
		5138.58	39.83	-14.17	54	32.5	31.96	7.94	32.57	172	193	A	H	
	*	5224	110.8	-	-	103.3	32.06	8.01	32.57	172	193	P	H	
	*	5224	104.18	-	-	96.68	32.06	8.01	32.57	172	193	A	H	
			5368.32	47.77	-26.23	74	39.81	32.24	8.29	32.57	172	193	P	H
			5351.04	37.98	-16.02	54	30.1	32.22	8.23	32.57	172	193	A	H
			5127.4	51.4	-22.6	74	44.07	31.96	7.94	32.57	268	27	P	V
			5140.4	41.26	-12.74	54	33.91	31.98	7.94	32.57	268	27	A	V
	*		5222	115.8	-	-	108.3	32.06	8.01	32.57	268	27	P	V
	*		5222	107.62	-	-	100.12	32.06	8.01	32.57	268	27	A	V
			5381.1	48.09	-25.91	74	40.11	32.26	8.29	32.57	268	27	P	V
			5351.4	39.59	-14.41	54	31.71	32.22	8.23	32.57	268	27	A	V



802.11a CH 48 5240MHz		5130.78	48.52	-25.48	74	41.19	31.96	7.94	32.57	338	180	P	H
		5148.46	39.77	-14.23	54	32.42	31.98	7.94	32.57	338	180	A	H
	*	5238	113.1	-	-	105.58	32.08	8.01	32.57	338	180	P	H
	*	5238	104.59	-	-	97.07	32.08	8.01	32.57	338	180	A	H
		5369.04	48.65	-25.35	74	40.69	32.24	8.29	32.57	338	180	P	H
		5355.72	39.88	-14.12	54	32	32.22	8.23	32.57	338	180	A	H
		5134.68	52.41	-21.59	74	45.08	31.96	7.94	32.57	138	13	P	V
		5147.42	42.19	-11.81	54	34.84	31.98	7.94	32.57	138	13	A	V
	*	5242	116.71	-	-	109.06	32.1	8.12	32.57	138	13	P	V
	*	5242	108.06	-	-	100.41	32.1	8.12	32.57	138	13	A	V
		5352.48	51.09	-22.91	74	43.21	32.22	8.23	32.57	138	13	P	V
		5350.86	41.85	-12.15	54	33.97	32.22	8.23	32.57	138	13	A	V
Remark	1. No other spurious found. 2. All results are PASS against Peak and Average limit line.												



Band 1 5150~5250MHz
WIFI 802.11a (Harmonic @ 3m)

WIFI Ant. 1+2	Note	Frequency (MHz)	Level (dBμV/m)	Over Limit (dB)	Limit Line (dBμV/m)	Read Level (dBμV)	Antenna Factor (dB/m)	Cable Loss (dB)	Preamp Factor (dB)	Ant Pos (cm)	Table Pos (deg)	Peak Avg. (P/A)	Pol. (H/V)
802.11a CH 36 5180MHz		10360	46.94	-27.06	74	46.19	39.69	11.96	50.9	100	0	P	H
		15540	46.86	-27.14	74	45.97	38.04	14.76	51.91	100	0	P	H
													H
													H
		10360	47.41	-26.59	74	46.66	39.69	11.96	50.9	100	0	P	V
		15540	47.5	-26.5	74	46.61	38.04	14.76	51.91	100	0	P	V
													V
													V
802.11a CH 44 5220MHz		10440	49.14	-24.86	74	48.22	39.79	12.03	50.9	100	0	P	H
		15660	47.76	-26.24	74	47.05	37.85	14.79	51.93	100	0	P	H
													H
													H
		10440	49.91	-24.09	74	48.99	39.79	12.03	50.9	100	0	P	V
		15660	47.78	-26.22	74	47.07	37.85	14.79	51.93	100	0	P	V
													V
													V
802.11a CH 48 5240MHz		10480	48.6	-25.4	74	47.57	39.87	12.06	50.9	100	0	P	H
		15720	47.28	-26.72	74	46.68	37.74	14.81	51.95	100	0	P	H
													H
													H
		10480	49.42	-24.58	74	48.39	39.87	12.06	50.9	100	0	P	V
		15720	47.42	-26.58	74	46.82	37.74	14.81	51.95	100	0	P	V
													V
													V
Remark	1. No other spurious found. 2. All results are PASS against Peak and Average limit line.												



**Band 1 5150~5250MHz
WIFI 802.11n HT20 (Band Edge @ 3m)**

WIFI Ant. 1+2	Note	Frequency (MHz)	Level (dBμV/m)	Over Limit (dB)	Limit Line (dBμV/m)	Read Level (dBμV)	Antenna Factor (dB/m)	Cable Loss (dB)	Preamp Factor (dB)	Ant Pos (cm)	Table Pos (deg)	Peak Avg. (P/A)	Pol. (H/V)	
802.11n HT20 CH 36 5180MHz		5150	64.93	-9.07	74	57.58	31.98	7.94	32.57	154	193	P	H	
		5150	50.25	-3.75	54	42.9	31.98	7.94	32.57	154	193	A	H	
	*	5178	110.2	-	-	102.84	32.02	7.91	32.57	154	193	P	H	
	*	5178	103.89	-	-	96.53	32.02	7.91	32.57	154	193	A	H	
													H	
													H	
			5150	68.27	-5.73	74	60.92	31.98	7.94	32.57	175	26	P	V
			5150	53.26	-0.74	54	45.91	31.98	7.94	32.57	175	26	A	V
		*	5178	113.16	-	-	105.8	32.02	7.91	32.57	175	26	P	V
		*	5178	106.4	-	-	99.04	32.02	7.91	32.57	175	26	A	V
													V	
													V	
802.11n HT20 CH 44 5220MHz		5144.04	48.99	-25.01	74	41.64	31.98	7.94	32.57	198	210	P	H	
		5146.12	39.47	-14.53	54	32.12	31.98	7.94	32.57	198	210	A	H	
	*	5218	111.11	-	-	103.61	32.06	8.01	32.57	198	210	P	H	
	*	5218	103.75	-	-	96.25	32.06	8.01	32.57	198	210	A	H	
			5381.1	46.67	-27.33	74	38.69	32.26	8.29	32.57	198	210	P	H
			5350.32	38.44	-15.56	54	30.56	32.22	8.23	32.57	198	210	A	H
			5138.06	53	-21	74	45.67	31.96	7.94	32.57	198	24	P	V
			5150.02	43.57	-10.43	54	36.22	31.98	7.94	32.57	198	24	A	V
		*	5218	115.6	-	-	108.1	32.06	8.01	32.57	198	24	P	V
		*	5218	107.78	-	-	100.28	32.06	8.01	32.57	198	24	A	V
		5350.5	49.66	-24.34	74	41.78	32.22	8.23	32.57	198	24	P	V	
		5351.4	40.79	-13.21	54	32.91	32.22	8.23	32.57	198	24	A	V	



802.11n HT20 CH 48 5240MHz		5138.84	49.28	-24.72	74	41.95	31.96	7.94	32.57	157	193	P	H
		5149.5	40.3	-13.7	54	32.95	31.98	7.94	32.57	157	193	A	H
	*	5242	111.21	-	-	103.56	32.1	8.12	32.57	157	193	P	H
	*	5242	104.69	-	-	97.04	32.1	8.12	32.57	157	193	A	H
		5360.94	48.6	-25.4	74	40.7	32.24	8.23	32.57	157	193	P	H
		5350.86	38.89	-15.11	54	31.01	32.22	8.23	32.57	157	193	A	H
		5082.16	51.59	-22.41	74	44.3	31.9	7.96	32.57	195	26	P	V
		5148.72	42.49	-11.51	54	35.14	31.98	7.94	32.57	195	26	A	V
	*	5242	115.6	-	-	107.95	32.1	8.12	32.57	195	26	P	V
	*	5242	108.38	-	-	100.73	32.1	8.12	32.57	195	26	A	V
		5373.9	49.27	-24.73	74	41.31	32.24	8.29	32.57	195	26	P	V
		5351.76	40.9	-13.1	54	33.02	32.22	8.23	32.57	195	26	A	V
Remark	1. No other spurious found. 2. All results are PASS against Peak and Average limit line.												



Band 1 5150~5250MHz
WIFI 802.11n HT20 (Harmonic @ 3m)

WIFI Ant. 1+2	Note	Frequency (MHz)	Level (dBμV/m)	Over Limit (dB)	Limit Line (dBμV/m)	Read Level (dBμV)	Antenna Factor (dB/m)	Cable Loss (dB)	Preamp Factor (dB)	Ant Pos (cm)	Table Pos (deg)	Peak Avg. (P/A)	Pol. (H/V)	
802.11n HT20 CH 36 5180MHz		10360	50.05	-23.95	74	49.3	39.69	11.96	50.9	100	0	P	H	
		15540	49.22	-24.78	74	48.33	38.04	14.76	51.91	100	0	P	H	
													H	
													H	
			10360	50.47	-23.53	74	49.72	39.69	11.96	50.9	100	0	P	V
			15540	48.08	-25.92	74	47.19	38.04	14.76	51.91	100	0	P	V
														V
802.11n HT20 CH 44 5220MHz		10440	51.76	-16.54	68.3	50.84	39.79	12.03	50.9	100	0	P	H	
		15660	47.74	-26.26	74	47.03	37.85	14.79	51.93	100	0	P	H	
													H	
													H	
			10440	52.07	-16.23	68.3	51.15	39.79	12.03	50.9	100	0	P	V
			15660	48.66	-25.34	74	47.95	37.85	14.79	51.93	100	0	P	V
														V
802.11n HT20 CH 48 5240MHz		10480	50.38	-17.92	68.3	49.35	39.87	12.06	50.9	100	0	P	H	
		15720	48.23	-25.77	74	47.63	37.74	14.81	51.95	100	0	P	H	
													H	
													H	
			10480	54.56	-13.74	68.3	53.53	39.87	12.06	50.9	100	0	P	V
			15720	47.28	-26.72	74	46.68	37.74	14.81	51.95	100	0	P	V
														V
Remark	1. No other spurious found.													
	2. All results are PASS against Peak and Average limit line.													



**Band 1 5150~5250MHz
WIFI 802.11n HT40 (Band Edge @ 3m)**

WIFI Ant. 1+2	Note	Frequency (MHz)	Level (dBμV/m)	Over Limit (dB)	Limit Line (dBμV/m)	Read Level (dBμV)	Antenna Factor (dB/m)	Cable Loss (dB)	Preamp Factor (dB)	Ant Pos (cm)	Table Pos (deg)	Peak Avg. (P/A)	Pol. (H/V)
802.11n HT40 CH 38 5190MHz		5150	59.76	-14.24	74	52.41	31.98	7.94	32.57	145	182	P	H
		5149.76	50.8	-3.2	54	43.45	31.98	7.94	32.57	145	182	A	H
	*	5192	106.1	-	-	98.72	32.04	7.91	32.57	145	182	P	H
	*	5192	99.51	-	-	92.13	32.04	7.91	32.57	145	182	A	H
		5385.24	47.21	-26.79	74	39.23	32.26	8.29	32.57	145	182	P	H
		5354.28	38.44	-15.56	54	30.56	32.22	8.23	32.57	145	182	A	H
		5146.38	65.55	-8.45	74	58.2	31.98	7.94	32.57	177	11	P	V
		5149.24	53.7	-0.3	54	46.35	31.98	7.94	32.57	177	11	A	V
	*	5188	109.33	-	-	101.97	32.02	7.91	32.57	177	11	P	V
	*	5188	102.36	-	-	95	32.02	7.91	32.57	177	11	A	V
		5350.68	47.65	-26.35	74	39.77	32.22	8.23	32.57	177	11	P	V
		5350.32	39.32	-14.68	54	31.44	32.22	8.23	32.57	177	11	A	V
802.11n HT40 CH 46 5230MHz		5150	52.01	-21.99	74	44.66	31.98	7.94	32.57	174	179	P	H
		5149.5	43.45	-10.55	54	36.1	31.98	7.94	32.57	174	179	A	H
	*	5230	109.25	-	-	101.73	32.08	8.01	32.57	174	179	P	H
	*	5230	102.68	-	-	95.16	32.08	8.01	32.57	174	179	A	H
		5350.68	47.95	-26.05	74	40.07	32.22	8.23	32.57	174	179	P	H
		5357.16	39.73	-14.27	54	31.85	32.22	8.23	32.57	174	179	A	H
		5150	55.9	-18.1	74	48.55	31.98	7.94	32.57	143	10	P	V
		5149.5	45.89	-8.11	54	38.54	31.98	7.94	32.57	143	10	A	V
	*	5230	112.63	-	-	105.11	32.08	8.01	32.57	143	10	P	V
	*	5230	105.64	-	-	98.12	32.08	8.01	32.57	143	10	A	V
	5392.44	50.99	-23.01	74	43.01	32.26	8.29	32.57	143	10	P	V	
	5355.36	42.05	-11.95	54	34.17	32.22	8.23	32.57	143	10	A	V	
Remark	1. No other spurious found. 2. All results are PASS against Peak and Average limit line.												



Band 1 5150~5250MHz
WIFI 802.11n HT40 (Harmonic @ 3m)

WIFI Ant. 1+2	Note	Frequency (MHz)	Level (dBμV/m)	Over Limit (dB)	Limit Line (dBμV/m)	Read Level (dBμV)	Antenna Factor (dB/m)	Cable Loss (dB)	Preamp Factor (dB)	Ant Pos (cm)	Table Pos (deg)	Peak Avg. (P/A)	Pol. (H/V)
802.11n HT40 CH 38 5190MHz		10380	47.45	-26.55	74	46.68	39.71	11.96	50.9	100	0	P	H
		15570	46.58	-27.42	74	45.74	37.99	14.77	51.92	100	0	P	H
													H
													H
		10380	47.7	-26.3	74	46.93	39.71	11.96	50.9	100	0	P	V
		15570	47.21	-26.79	74	46.37	37.99	14.77	51.92	100	0	P	V
													V
													V
802.11n HT40 CH 46 5230MHz		10460	48.66	-25.34	74	47.71	39.82	12.03	50.9	100	0	P	H
		15690	46.37	-27.63	74	45.71	37.8	14.8	51.94	100	0	P	H
													H
													H
		10460	47.43	-26.57	74	46.48	39.82	12.03	50.9	100	0	P	V
		15690	47.4	-26.6	74	46.74	37.8	14.8	51.94	100	0	P	V
													V
													V
Remark	1. No other spurious found. 2. All results are PASS against Peak and Average limit line.												



Band 1 5150~5250MHz
WIFI 802.11ac VHT80 (Band Edge @ 3m)

WIFI Ant. 1+2	Note	Frequency (MHz)	Level (dBμV/m)	Over Limit (dB)	Limit Line (dBμV/m)	Read Level (dBμV)	Antenna Factor (dB/m)	Cable Loss (dB)	Preamp Factor (dB)	Ant Pos (cm)	Table Pos (deg)	Peak Avg. (P/A)	Pol. (H/V)
802.11ac VHT80 CH 42 5210MHz		5149.5	59.6	-14.4	74	52.25	31.98	7.94	32.57	155	180	P	H
		5148.2	50.07	-3.93	54	42.72	31.98	7.94	32.57	155	180	A	H
	*	5212	101.9	-	-	94.4	32.06	8.01	32.57	155	180	P	H
	*	5212	95.17	-	-	87.67	32.06	8.01	32.57	155	180	A	H
		5384.88	46.23	-27.77	74	38.25	32.26	8.29	32.57	155	180	P	H
		5357.16	38.51	-15.49	54	30.63	32.22	8.23	32.57	155	180	A	H
		5150	60.8	-13.2	74	53.45	31.98	7.94	32.57	191	10	P	V
		5147.94	52.92	-1.08	54	45.57	31.98	7.94	32.57	191	10	A	V
	*	5208	104.25	-	-	96.75	32.06	8.01	32.57	191	10	P	V
	*	5208	97.93	-	-	90.43	32.06	8.01	32.57	191	10	A	V
		5391.54	47.53	-26.47	74	39.55	32.26	8.29	32.57	191	10	P	V
		5352.3	39.06	-14.94	54	31.18	32.22	8.23	32.57	191	10	A	V
Remark	1. No other spurious found. 2. All results are PASS against Peak and Average limit line.												



Band 1 5150~5250MHz
WIFI 802.11ac VHT80 (Harmonic @ 3m)

WIFI Ant. 1+2	Note	Frequency (MHz)	Level (dBμV/m)	Over Limit (dB)	Limit Line (dBμV/m)	Read Level (dBμV)	Antenna Factor (dB/m)	Cable Loss (dB)	Preamp Factor (dB)	Ant Pos (cm)	Table Pos (deg)	Peak Avg. (P/A)	Pol. (H/V)	
802.11ac VHT80 CH 42 5210MHz		10420	48.06	-25.94	74	47.19	39.77	12	50.9	100	0	P	H	
		15630	46.68	-27.32	74	45.95	37.88	14.78	51.93	100	0	P	H	
													H	
													H	
			10420	47.47	-26.53	74	46.6	39.77	12	50.9	100	0	P	V
			15630	48.25	-25.75	74	47.52	37.88	14.78	51.93	100	0	P	V
														V
														V
Remark	1. No other spurious found. 2. All results are PASS against Peak and Average limit line.													



Emission below 1GHz
WIFI 802.11n HT40 (LF @ 3m)

WIFI	Note	Frequency	Level	Over	Limit	Read	Antenna	Cable	Preamp	Ant	Table	Peak	Pol.	
Ant.				Limit	Line	Level	Factor	Loss	Factor	Pos	Pos	Avg.		
1+2		(MHz)	(dBμV/m)	(dB)	(dBμV/m)	(dBμV)	(dB/m)	(dB)	(dB)	(cm)	(deg)	(P/A)	(H/V)	
802.11n HT40 LF		81.84	29.6	-10.4	40	47.33	14.02	0.93	32.68	-	-	P	H	
		108.57	34.71	-8.79	43.5	49	17.21	1.14	32.64	-	-	P	H	
		250.05	27.48	-18.52	46	39.65	18.8	1.76	32.73	-	-	P	H	
		419	40	-6	46	47.99	22.71	2.16	32.86	100	150	P	H	
		595.4	28.91	-17.09	46	33.96	25.4	2.57	33.02	-	-	P	H	
		958.7	32.67	-13.33	46	31.04	30	3.29	31.66	-	-	P	H	
														H
														H
														H
														H
														H
														H
			45.12	31.36	-8.64	40	45.94	17.28	0.93	32.79	-	-	P	V
			106.68	35.1	-8.4	43.5	49.57	17.03	1.14	32.64	100	25	P	V
			264.36	21.8	-24.2	46	33.17	19.6	1.76	32.73	-	-	P	V
			419.7	37.5	-8.5	46	45.48	22.72	2.16	32.86	-	-	P	V
			799.8	31.24	-14.76	46	33.25	27.9	2.97	32.88	-	-	P	V
			959.4	32.47	-13.53	46	30.84	30	3.29	31.66	-	-	P	V
														V
														V
													V	
													V	
													V	
													V	
Remark	1. No other spurious found. 2. All results are PASS against limit line.													



Note symbol

*	Fundamental Frequency which can be ignored. However, the level of any unwanted emissions shall not exceed the level of the fundamental frequency.
!	Test result is over limit line.
P/A	Peak or Average
H/V	Horizontal or Vertical



A calculation example for radiated spurious emission is shown as below:

WIFI	Note	Frequency	Level	Over	Limit	Read	Antenna	Cable	Preamp	Ant	Table	Peak	Pol.
Ant.				Limit	Line	Level	Factor	Loss	Factor	Pos	Pos	Avg.	
1+2		(MHz)	(dBμV/m)	(dB)	(dBμV/m)	(dBμV)	(dB/m)	(dB)	(dB)	(cm)	(deg)	(P/A)	(H/V)
802.11b		2390	55.45	-18.55	74	54.51	32.22	4.58	35.86	103	308	P	H
CH 01													
2412MHz		2390	43.54	-10.46	54	42.6	32.22	4.58	35.86	103	308	A	H

- Level(dBμV/m) =
Antenna Factor(dB/m) + Cable Loss(dB) + Read Level(dBμV) - Preamp Factor(dB)
- Over Limit(dB) = Level(dBμV/m) – Limit Line(dBμV/m)

For Peak Limit @ 2390MHz:

- Level(dBμV/m)
= Antenna Factor(dB/m) + Cable Loss(dB) + Read Level(dBμV) - Preamp Factor(dB)
= 32.22(dB/m) + 4.58(dB) + 54.51(dBμV) – 35.86 (dB)
= 55.45 (dBμV/m)
- Over Limit(dB)
= Level(dBμV/m) – Limit Line(dBμV/m)
= 55.45(dBμV/m) – 74(dBμV/m)
= -18.55(dB)

For Average Limit @ 2390MHz:

- Level(dBμV/m)
= Antenna Factor(dB/m) + Cable Loss(dB) + Read Level(dBμV) - Preamp Factor(dB)
= 32.22(dB/m) + 4.58(dB) + 42.6(dBμV) – 35.86 (dB)
= 43.54 (dBμV/m)
- Over Limit(dB)
= Level(dBμV/m) – Limit Line(dBμV/m)
= 43.54(dBμV/m) – 54(dBμV/m)
= -10.46(dB)

Both peak and average measured complies with the limit line, so test result is “PASS”.



Appendix C. Radiated Spurious Emission

Test Engineer :	Tsung Lee, Stan Hsieh and Ken Wu	Temperature :	20~24°C
		Relative Humidity :	51~55%

Note symbol

-L	Low channel location
-R	High channel location



Band 1 - 5150~5250MHz
WIFI 802.11a (Band Edge @ 3m)

WIFI	Band 1 5150~5250MHz Band Edge @ 3m	
ANT	802.11a CH36 5180MHz	
1+2	Horizontal	Fundamental
Peak	<p>Site : 03CH10-HY Condition : FCC CLASS-B 3m HORN 9120D-HF HORIZONTAL RBW:1000.000KHz VBW:3000.000KHz SWT:Auto Detector : Peak Project : 641813 Mode : 1</p>	<p>Site : 03CH10-HY Condition : FCC CLASS-B 3m HORN 9120D-HF HORIZONTAL RBW:1000.000KHz VBW:3000.000KHz SWT:Auto Detector : Peak Project : 641813 Mode : 1</p>
Avg.	<p>Site : 03CH10-HY Condition : FCC CLASS-B (AVG) 3m HORN 9120D-HF HORIZONTAL RBW:1000.000KHz VBW:1.000KHz SWT:Auto Detector : Peak Project : 641813 Mode : 1</p>	

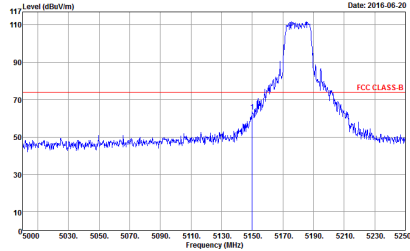
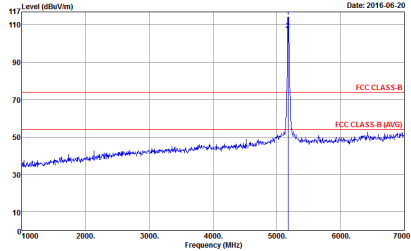
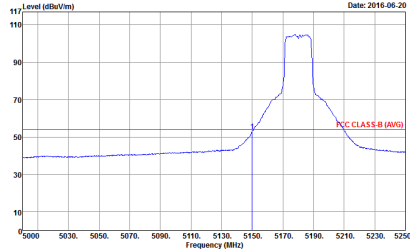

WIFI	Band 1 5150~5250MHz Band Edge @ 3m	
ANT	802.11a CH36 5180MHz	
1+2	Vertical	Fundamental
Peak	 <p>Date: 2016-06-20</p> <p>Site : 03CH10-HY Condition : FCC CLASS-B 3m HORN 9120D-HF VERTICAL RBW:1000.000KHz VBW:3000.000KHz SWT:Auto Detector : Peak Project : 641813 Mode : 1</p>	 <p>Date: 2016-06-20</p> <p>Site : 03CH10-HY Condition : FCC CLASS-B 3m HORN 9120D-HF VERTICAL RBW:1000.000KHz VBW:3000.000KHz SWT:Auto Detector : Peak Project : 641813 Mode : 1</p>
Avg.	 <p>Date: 2016-06-20</p> <p>Site : 03CH10-HY Condition : FCC CLASS-B (AVG) 3m HORN 9120D-HF VERTICAL RBW:1000.000KHz VBW:1.000KHz SWT:Auto Detector : Peak Project : 641813 Mode : 1</p>	

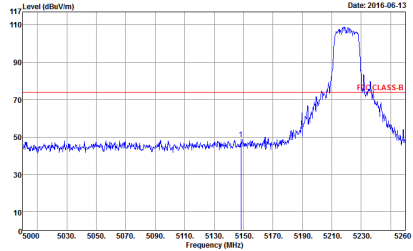
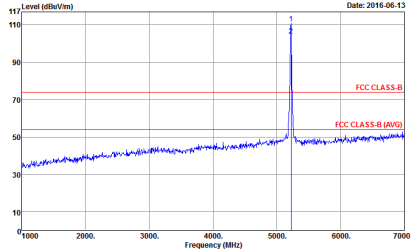
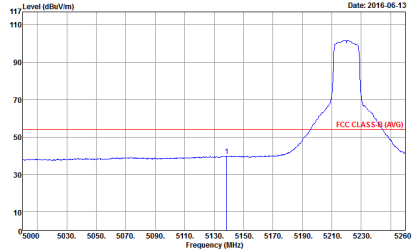

WIFI	Band 1 5150~5250MHz Band Edge @ 3m	
ANT	802.11a CH44 5220MHz - L	
1+2	Horizontal	Fundamental
Peak	 <p>Date: 2016-06-13</p> <p>Site : 03CH10-#Y Condition : FCC CLASS-B 3m HORN 9120D-HF HORIZONTAL RBW:1000.000KHz VBW:3000.000KHz SWT:Auto Detector : Peak Project : 641813 Mode : 2</p>	 <p>Date: 2016-06-13</p> <p>Site : 03CH10-#Y Condition : FCC CLASS-B 3m HORN 9120D-HF HORIZONTAL RBW:1000.000KHz VBW:3000.000KHz SWT:Auto Detector : Peak Project : 641813 Mode : 2</p>
Avg.	 <p>Date: 2016-06-13</p> <p>Site : 03CH10-#Y Condition : FCC CLASS-B (AVG) 3m HORN 9120D-HF HORIZONTAL RBW:1000.000KHz VBW:1.000KHz SWT:Auto Detector : Peak Project : 641813 Mode : 2</p>	



WIFI	Band 1 5150~5250MHz Band Edge @ 3m	
ANT	802.11a CH44 5220MHz - R	
1+2	Horizontal	Fundamental
Peak	<p> Site : 03CH10-HY Condition : FCC CLASS-B 3m HORN 9120D-HF HORIZONTAL RBW:1000.000KHz VBW:3000.000KHz SWT:Auto Detector : Peak Project : 641813 Mode : 2 </p>	
Avg.	<p> Site : 03CH10-HY Condition : FCC CLASS-B (AVG) 3m HORN 9120D-HF HORIZONTAL RBW:1000.000KHz VBW:1.000KHz SWT:Auto Detector : Peak Project : 641813 Mode : 2 </p>	

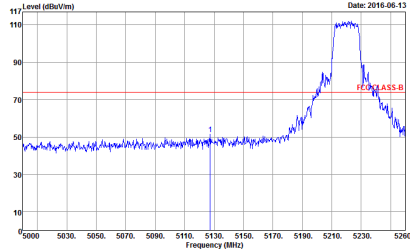
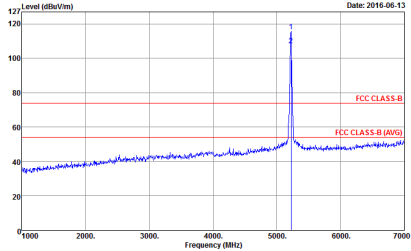
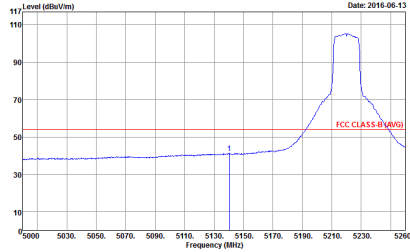

WIFI	Band 1 5150~5250MHz Band Edge @ 3m	
ANT	802.11a CH44 5220MHz - L	
1+2	Vertical	Fundamental
Peak	 <p>Site : 03CH10-HY Condition : FCC CLASS-B 3m HORN 9120D-HF VERTICAL RBW:1000.000KHz VBW:3000.000KHz SWT:Auto Detector : Peak Project : 641813 Mode : 2</p>	 <p>Site : 03CH10-HY Condition : FCC CLASS-B 3m HORN 9120D-HF VERTICAL RBW:1000.000KHz VBW:3000.000KHz SWT:Auto Detector : Peak Project : 641813 Mode : 2</p>
Avg.	 <p>Site : 03CH10-HY Condition : FCC CLASS-B (AVG) 3m HORN 9120D-HF VERTICAL RBW:1000.000KHz VBW:1.000KHz SWT:Auto Detector : Peak Project : 641813 Mode : 2</p>	



WIFI	Band 1 5150~5250MHz Band Edge @ 3m	
ANT	802.11a CH44 5220MHz - R	
1+2	Vertical	Fundamental
Peak	<p> Site : 03CH10-HY Condition : FCC CLASS-B 3m HORN 9120D-HF VERTICAL : RBW:1000.000KHz VBW:3000.000KHz SWT:Auto Detector : Peak Project : 641813 Mode : 2 </p>	
Avg.	<p> Site : 03CH10-HY Condition : FCC CLASS-B (AVG) 3m HORN 9120D-HF VERTICAL : RBW:1000.000KHz VBW:1.000KHz SWT:Auto Detector : Peak Project : 641813 Mode : 2 </p>	

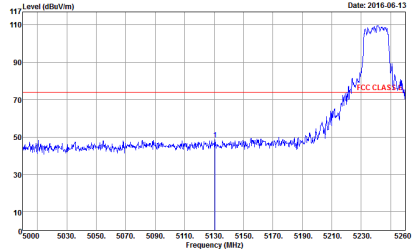
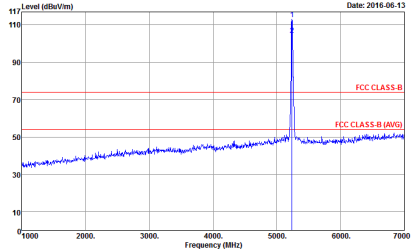
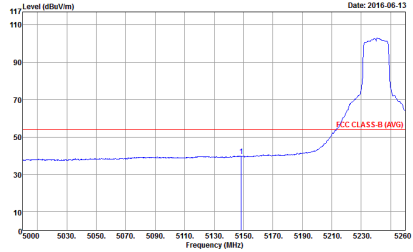

WIFI	Band 1 5150~5250MHz Band Edge @ 3m	
ANT	802.11a CH48 5240MHz - L	
1+2	Horizontal	Fundamental
Peak	 <p>Date: 2016-06-13</p> <p>Site : 03CH10-#Y Condition : FCC CLASS-B 3m HORN 9120D-HF HORIZONTAL RBW:1000.000KHz VBW:3000.000KHz SWT:Auto Detector : Peak Project : 641813 Mode : 3</p>	 <p>Date: 2016-06-13</p> <p>Site : 03CH10-#Y Condition : FCC CLASS-B 3m HORN 9120D-HF HORIZONTAL RBW:1000.000KHz VBW:3000.000KHz SWT:Auto Detector : Peak Project : 641813 Mode : 3</p>
Avg.	 <p>Date: 2016-06-13</p> <p>Site : 03CH10-#Y Condition : FCC CLASS-B (AVG) 3m HORN 9120D-HF HORIZONTAL RBW:1000.000KHz VBW:1.000KHz SWT:Auto Detector : Peak Project : 641813 Mode : 3</p>	



WIFI	Band 1 5150~5250MHz Band Edge @ 3m	
ANT	802.11a CH48 5240MHz - R	
1+2	Horizontal	Fundamental
Peak	<p>Site : 03CH10-HY Condition : FCC CLASS-B 3m HORN 9120D-HF HORIZONTAL : RBW:1000.000KHz VBW:3000.000KHz SWT:Auto Detector : Peak Project : 641813 Mode : 3</p>	
Avg.	<p>Site : 03CH10-HY Condition : FCC CLASS-B (AVG) 3m HORN 9120D-HF HORIZONTAL : RBW:1000.000KHz VBW:1.000KHz SWT:Auto Detector : Peak Project : 641813 Mode : 3</p>	

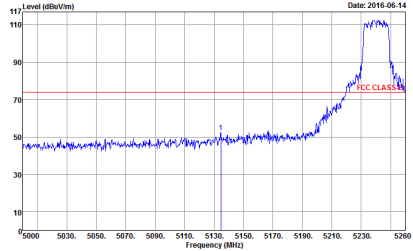
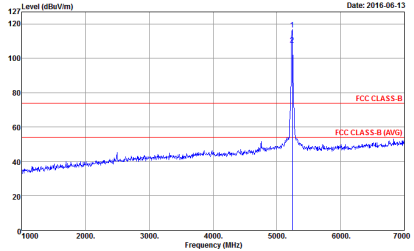
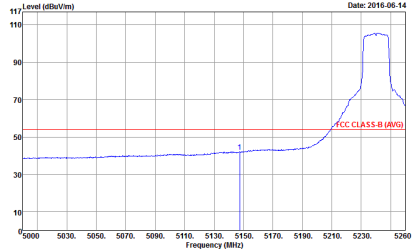

WIFI	Band 1 5150~5250MHz Band Edge @ 3m	
ANT	802.11a CH48 5240MHz - L	
1+2	Vertical	Fundamental
Peak	 <p>Date: 2016-06-14</p> <p>Site : 03CH10-HY Condition : FCC CLASS-B 3m HORN 9120D-HF VERTICAL RBW:1000.000KHz VBW:3000.000KHz SWT:Auto Detector : Peak Project : 641813 Mode : 3</p>	 <p>Date: 2016-06-13</p> <p>Site : 03CH10-HY Condition : FCC CLASS-B 3m HORN 9120D-HF VERTICAL RBW:1000.000KHz VBW:3000.000KHz SWT:Auto Detector : Peak Project : 641813 Mode : 3</p>
Avg.	 <p>Date: 2016-06-14</p> <p>Site : 03CH10-HY Condition : FCC CLASS-B (AVG) 3m HORN 9120D-HF VERTICAL RBW:1000.000KHz VBW:1.000KHz SWT:Auto Detector : Peak Project : 641813 Mode : 3</p>	

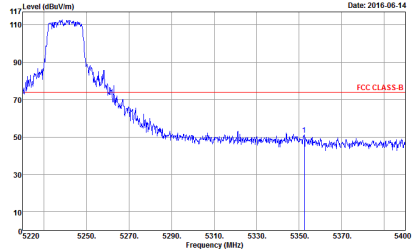
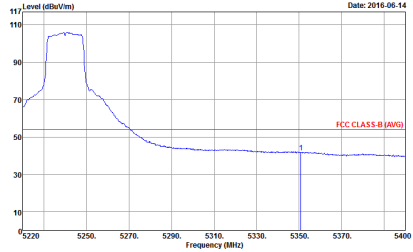

WIFI	Band 1 5150~5250MHz Band Edge @ 3m	
ANT	802.11a CH48 5240MHz - R	
1+2	Vertical	Fundamental
Peak	 <p>Site : 03CH10-HY Condition : FCC CLASS-B 3m HORN 9120D-HF VERTICAL RBW:1000.000KHz VBW:3000.000KHz SWT:Auto Detector : Peak Project : 641813 Mode : 3</p>	
Avg.	 <p>Site : 03CH10-HY Condition : FCC CLASS-B (AVG) 3m HORN 9120D-HF VERTICAL RBW:1000.000KHz VBW:1.000KHz SWT:Auto Detector : Peak Project : 641813 Mode : 3</p>	

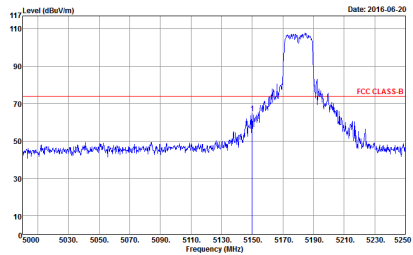
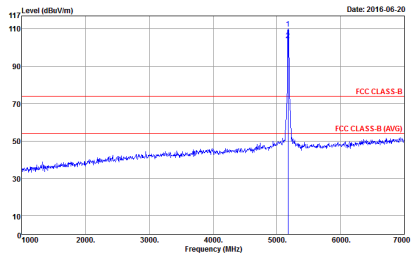
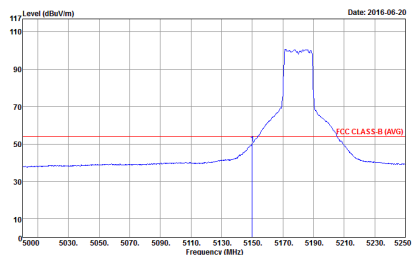

Band 1 5150~5250MHz
WIFI 802.11n HT20 (Band Edge @ 3m)

WIFI	Band 1 5150~5250MHz Band Edge @ 3m	
ANT	802.11n HT20 CH36 5180MHz	
1+2	Horizontal	Fundamental
<p>Peak</p>	 <p>Site : 03CH10-HY Condition : FCC CLASS-B 3m HORN 9120D-HF HORIZONTAL Detector : Peak Project : 641813 Mode : 4</p>	 <p>Site : 03CH10-HY Condition : FCC CLASS-B 3m HORN 9120D-HF HORIZONTAL Detector : Peak Project : 641813 Mode : 4</p>
<p>Avg.</p>	 <p>Site : 03CH10-HY Condition : FCC CLASS-B (AVG) 3m HORN 9120D-HF HORIZONTAL Detector : Peak Project : 641813 Mode : 4</p>	



WIFI	Band 1 5150~5250MHz Band Edge @ 3m	
ANT	802.11n HT20 CH36 5180MHz	
1+2	Vertical	Fundamental
Peak	<p>Date: 2016-06-20</p> <p>Site : 03CH10-#Y Condition : FCC CLASS-B 3m HORN 9120D-HF VERTICAL RBW:1000.000KHz VBW:3000.000KHz SWT:Auto Detector : Peak Project : 641813 Mode : 4</p>	<p>Date: 2016-06-20</p> <p>Site : 03CH10-#Y Condition : FCC CLASS-B 3m HORN 9120D-HF VERTICAL RBW:1000.000KHz VBW:3000.000KHz SWT:Auto Detector : Peak Project : 641813 Mode : 4</p>
Avg.	<p>Date: 2016-06-20</p> <p>Site : 03CH10-#Y Condition : FCC CLASS-B (AVG) 3m HORN 9120D-HF VERTICAL RBW:1000.000KHz VBW:1.000KHz SWT:Auto Detector : Peak Project : 641813 Mode : 4</p>	

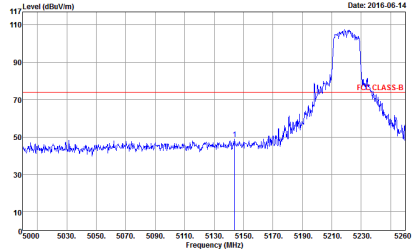
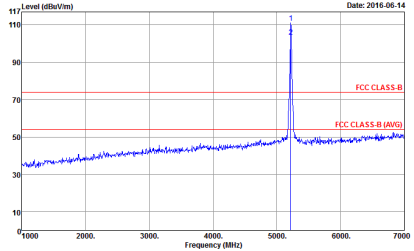
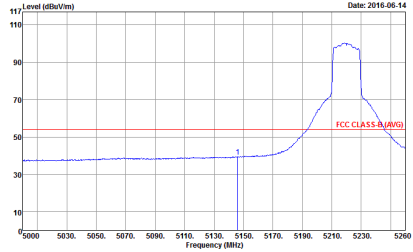

WIFI	Band 1 5150~5250MHz Band Edge @ 3m	
ANT	802.11n HT20 CH44 5220MHz - L	
1+2	Horizontal	Fundamental
<p>Peak</p>	 <p>Date: 2016-06-14</p> <p>Site : 03CH10-#Y Condition : FCC CLASS-B 3m HORN 9120D-HF HORIZONTAL RBW:1000.000KHz VBW:3000.000KHz SWT:Auto Detector : Peak Project : 641813 Mode : 5</p>	 <p>Date: 2016-06-14</p> <p>Site : 03CH10-#Y Condition : FCC CLASS-B 3m HORN 9120D-HF HORIZONTAL RBW:1000.000KHz VBW:3000.000KHz SWT:Auto Detector : Peak Project : 641813 Mode : 5</p>
<p>Avg.</p>	 <p>Date: 2016-06-14</p> <p>Site : 03CH10-#Y Condition : FCC CLASS-B (AVG) 3m HORN 9120D-HF HORIZONTAL RBW:1000.000KHz VBW:1.000KHz SWT:Auto Detector : Peak Project : 641813 Mode : 5</p>	

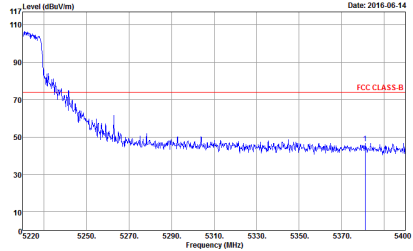
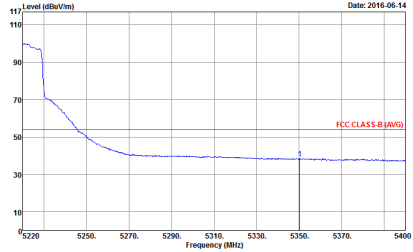

WIFI	Band 1 5150~5250MHz Band Edge @ 3m	
ANT	802.11n HT20 CH44 5220MHz - R	
1+2	Horizontal	Fundamental
<p>Peak</p>	 <p>Site : 03CH10-HY Condition : FCC CLASS-B 3m HORN 9120D-HF HORIZONTAL RBW:1000.000KHz VBW:3000.000KHz SWT:Auto Detector : Peak Project : 641813 Mode : 5</p>	
<p>Avg.</p>	 <p>Site : 03CH10-HY Condition : FCC CLASS-B (AVG) 3m HORN 9120D-HF HORIZONTAL RBW:1000.000KHz VBW:1.000KHz SWT:Auto Detector : Peak Project : 641813 Mode : 5</p>	

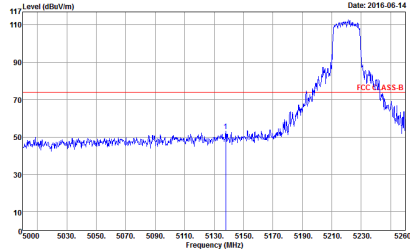
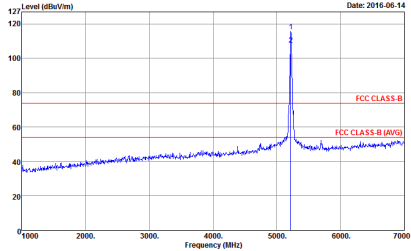
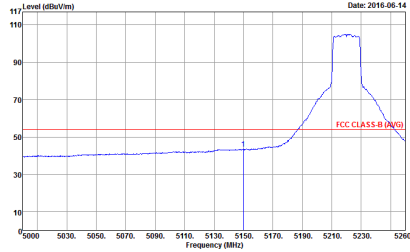

WIFI	Band 1 5150~5250MHz Band Edge @ 3m	
ANT	802.11n HT20 CH44 5220MHz - L	
1+2	Vertical	Fundamental
Peak	 <p> Site : 03CH10-HY Condition : FCC CLASS-B 3m HORN 9120D-HF VERTICAL RBW:1000.000KHz VBW:3000.000KHz SWT:Auto Detector : Peak Project : 641813 Mode : 5 </p>	 <p> Site : 03CH10-HY Condition : FCC CLASS-B 3m HORN 9120D-HF VERTICAL RBW:1000.000KHz VBW:3000.000KHz SWT:Auto Detector : Peak Project : 641813 Mode : 5 </p>
Avg.	 <p> Site : 03CH10-HY Condition : FCC CLASS-B (AVG) 3m HORN 9120D-HF VERTICAL RBW:1000.000KHz VBW:1.000KHz SWT:Auto Detector : Peak Project : 641813 Mode : 5 </p>	

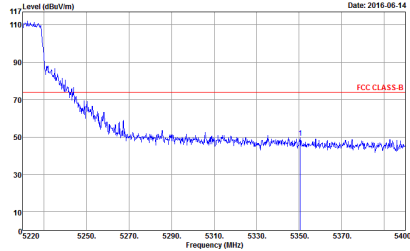
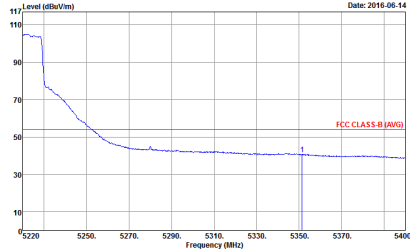

WIFI	Band 1 5150~5250MHz Band Edge @ 3m	
ANT	802.11n HT20 CH44 5220MHz - R	
1+2	Vertical	Fundamental
Peak	 <p>Site : 03CH10-HY Condition : FCC CLASS-B 3m HORN 9120D-HF VERTICAL : RBW:1000.000KHz VBW:3000.000KHz SWT:Auto Detector : Peak Project : 641813 Mode : 5</p>	
Avg.	 <p>Site : 03CH10-HY Condition : FCC CLASS-B (AVG) 3m HORN 9120D-HF VERTICAL : RBW:1000.000KHz VBW:1.000KHz SWT:Auto Detector : Peak Project : 641813 Mode : 5</p>	

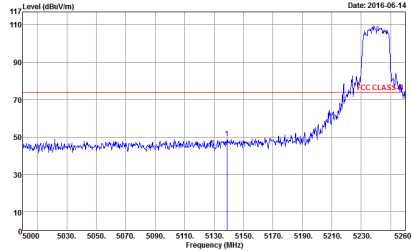
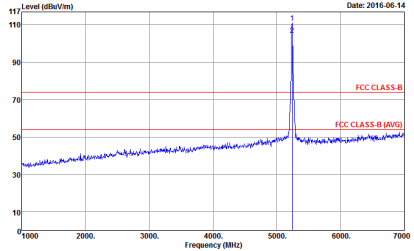
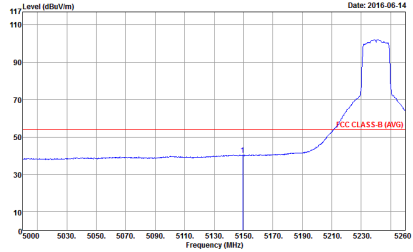

WIFI	Band 1 5150~5250MHz Band Edge @ 3m	
ANT	802.11n HT20 CH48 5240MHz - L	
1+2	Horizontal	Fundamental
Peak	 <p>Date: 2016-06-14</p> <p>Site : 03CH10-HY Condition : FCC CLASS-B 3m HORN 9120D-HF HORIZONTAL RBW:1000.000KHz VBW:3000.000KHz SWT:Auto Detector : Peak Project : 641813 Mode : 6</p>	 <p>Date: 2016-06-14</p> <p>Site : 03CH10-HY Condition : FCC CLASS-B 3m HORN 9120D-HF HORIZONTAL RBW:1000.000KHz VBW:3000.000KHz SWT:Auto Detector : Peak Project : 641813 Mode : 6</p>
Avg.	 <p>Date: 2016-06-14</p> <p>Site : 03CH10-HY Condition : FCC CLASS-B (AVG) 3m HORN 9120D-HF HORIZONTAL RBW:1000.000KHz VBW:1.000KHz SWT:Auto Detector : Peak Project : 641813 Mode : 6</p>	

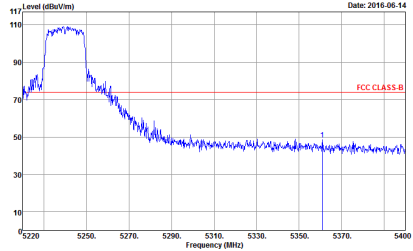
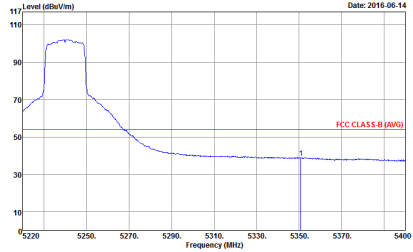

WIFI	Band 1 5150~5250MHz Band Edge @ 3m	
ANT	802.11n HT20 CH48 5240MHz - R	
1+2	Horizontal	Fundamental
Peak	 <p>Site : 03CH10-HY Condition : FCC CLASS-B 3m HORN 9120D-HF HORIZONTAL : RBW:1000.000KHz VBW:3000.000KHz SWT:Auto Detector : Peak Project : 641813 Mode : 6</p>	
Avg.	 <p>Site : 03CH10-HY Condition : FCC CLASS-B (AVG) 3m HORN 9120D-HF HORIZONTAL : RBW:1000.000KHz VBW:1.000KHz SWT:Auto Detector : Peak Project : 641813 Mode : 6</p>	

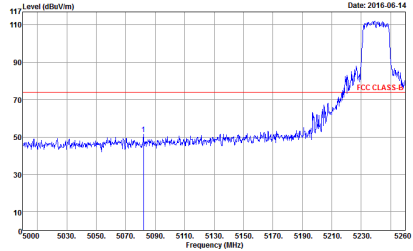
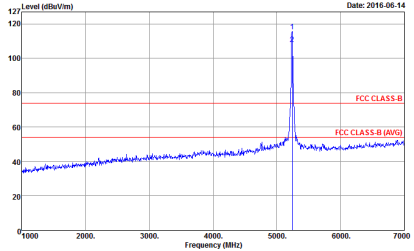
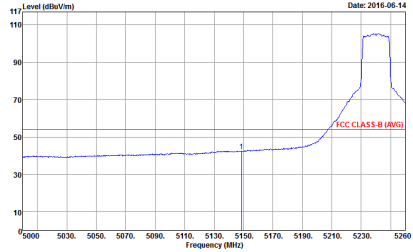

WIFI	Band 1 5150~5250MHz Band Edge @ 3m	
ANT	802.11n HT20 CH48 5240MHz - L	
1+2	Vertical	Fundamental
Peak	 <p>Date: 2016-06-14</p> <p>Site : 03CH10-HY Condition : FCC CLASS-B 3m HORN 9120D-HF VERTICAL RBW:1000.000KHz VBW:3000.000KHz SWT:Auto Detector : Peak Project : 641813 Mode : 6</p>	 <p>Date: 2016-06-14</p> <p>Site : 03CH10-HY Condition : FCC CLASS-B 3m HORN 9120D-HF VERTICAL RBW:1000.000KHz VBW:3000.000KHz SWT:Auto Detector : Peak Project : 641813 Mode : 6</p>
Avg.	 <p>Date: 2016-06-14</p> <p>Site : 03CH10-HY Condition : FCC CLASS-B (AVG) 3m HORN 9120D-HF VERTICAL RBW:1000.000KHz VBW:1.000KHz SWT:Auto Detector : Peak Project : 641813 Mode : 6</p>	

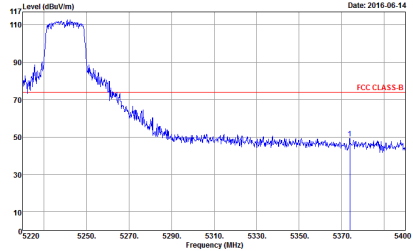
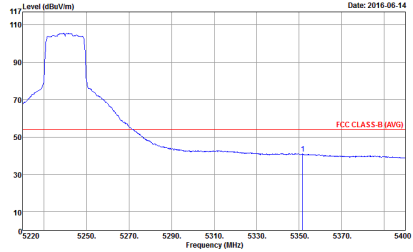

WIFI	Band 1 5150~5250MHz Band Edge @ 3m	
ANT	802.11n HT20 CH48 5240MHz - R	
1+2	Vertical	Fundamental
<p>Peak</p>	 <p>Date: 2016-06-14</p> <p>Site : 03CH10-HY Condition : FCC CLASS-B 3m HORN 9120D-HF VERTICAL : RBW:1000.000KHz VBW:3000.000KHz SWT:Auto Detector : Peak Project : 641813 Mode : 6</p>	
<p>Avg.</p>	 <p>Date: 2016-06-14</p> <p>Site : 03CH10-HY Condition : FCC CLASS-B (AVG) 3m HORN 9120D-HF VERTICAL : RBW:1000.000KHz VBW:1.000KHz SWT:Auto Detector : Peak Project : 641813 Mode : 6</p>	



Band 1 5150~5250MHz
WIFI 802.11n HT40 (Band Edge @ 3m)

Table with 2 columns: WIFI (Band 1 5150~5250MHz Band Edge @ 3m), ANT (802.11n HT40 CH38 5190MHz - L). Rows include '1+2' (Horizontal, Fundamental) and 'Peak' (Horizontal, Fundamental) plots. The 'Avg.' row contains a single plot for the Horizontal orientation. Each plot shows Level (dBuV/m) vs Frequency (MHz) with FCC CLASS-B and FCC CLASS-B (AVG) limits.



WIFI	Band 1 5150~5250MHz Band Edge @ 3m	
ANT	802.11n HT40 CH38 5190MHz - R	
1+2	Horizontal	Fundamental
<p>Peak</p>	<p>Date: 2016-06-20</p> <p>Site : 03CH10-HY Condition : FCC CLASS-B 3m HORN 9120D-HF HORIZONTAL RBW:1000.000KHz VBW:3000.000KHz SWT:Auto Detector : Peak Project : 641813 Mode : 7</p>	
<p>Avg.</p>	<p>Date: 2016-06-20</p> <p>Site : 03CH10-HY Condition : FCC CLASS-B (AVG) 3m HORN 9120D-HF HORIZONTAL RBW:1000.000KHz VBW:3.000KHz SWT:Auto Detector : Peak Project : 641813 Mode : 7</p>	

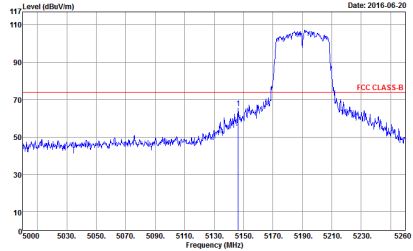
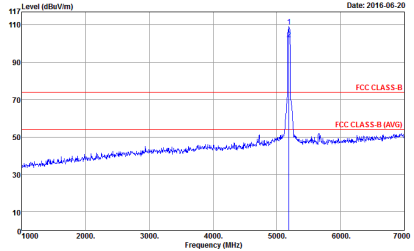
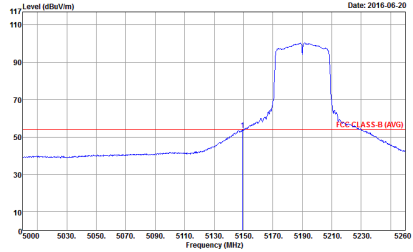

WIFI	Band 1 5150~5250MHz Band Edge @ 3m	
ANT	802.11n HT40 CH38 5190MHz - L	
1+2	Vertical	Fundamental
Peak	 <p>Date: 2016-06-20</p> <p>Site : 03CH10-HY Condition : FCC CLASS-B 3m HORN 9120D-HF VERTICAL RBW:1000.000KHz VBW:3000.000KHz SWT:Auto Detector : Peak Project : 641813 Mode : 7</p>	 <p>Date: 2016-06-20</p> <p>Site : 03CH10-HY Condition : FCC CLASS-B 3m HORN 9120D-HF VERTICAL RBW:1000.000KHz VBW:3000.000KHz SWT:Auto Detector : Peak Project : 641813 Mode : 7</p>
Avg.	 <p>Date: 2016-06-20</p> <p>Site : 03CH10-HY Condition : FCC CLASS-B (AVG) 3m HORN 9120D-HF VERTICAL RBW:1000.000KHz VBW:3.000KHz SWT:Auto Detector : Peak Project : 641813 Mode : 7</p>	

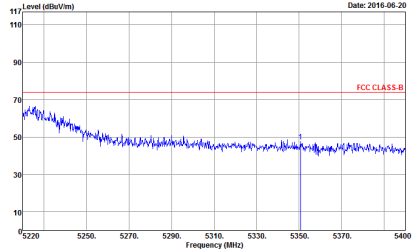
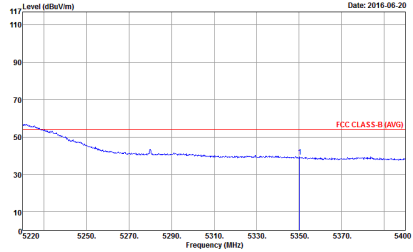

WIFI	Band 1 5150~5250MHz Band Edge @ 3m	
ANT	802.11n HT40 CH38 5190MHz - R	
1+2	Vertical	Fundamental
Peak	 <p>Date: 2016-06-20</p> <p>Site : 03CH10-HY Condition : FCC CLASS-B 3m HORN 9120D-HF VERTICAL : RBW:1000.000KHz VBW:3000.000KHz SWT:Auto Detector : Peak Project : 641813 Mode : 7</p>	
Avg.	 <p>Date: 2016-06-20</p> <p>Site : 03CH10-HY Condition : FCC CLASS-B (AVG) 3m HORN 9120D-HF VERTICAL : RBW:1000.000KHz VBW:3.000KHz SWT:Auto Detector : Peak Project : 641813 Mode : 7</p>	

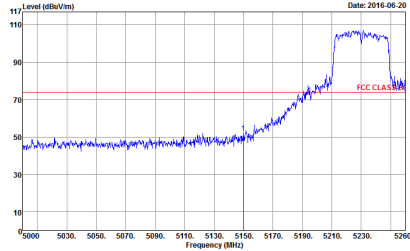
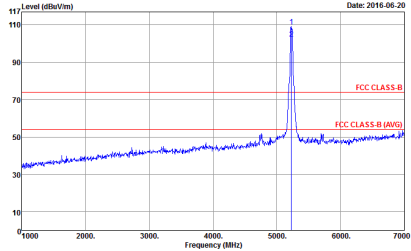
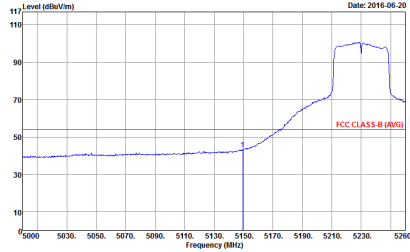

WIFI	Band 1 5150~5250MHz Band Edge @ 3m	
ANT	802.11n HT40 CH46 5230MHz - L	
1+2	Horizontal	Fundamental
Peak	 <p>Site : 03CH10-HY Condition : FCC CLASS-B 3m HORN 9120D-HF HORIZONTAL : RBW:1000.000KHz VBW:3000.000KHz SWT:Auto Detector : Peak Project : 641813 Mode : 8</p>	 <p>Site : 03CH10-HY Condition : FCC CLASS-B 3m HORN 9120D-HF HORIZONTAL : RBW:1000.000KHz VBW:3000.000KHz SWT:Auto Detector : Peak Project : 641813 Mode : 8</p>
Avg.	 <p>Site : 03CH10-HY Condition : FCC CLASS-B (AVG) 3m HORN 9120D-HF HORIZONTAL : RBW:1000.000KHz VBW:3.000KHz SWT:Auto Detector : Peak Project : 641813 Mode : 8</p>	

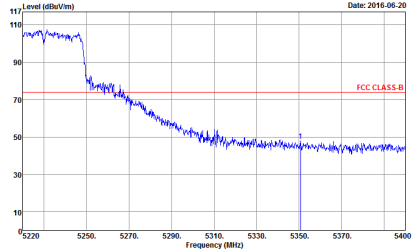
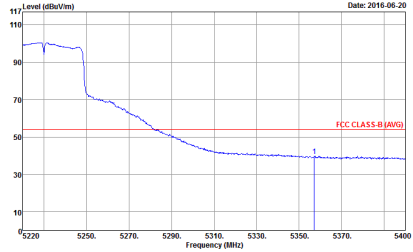

WIFI	Band 1 5150~5250MHz Band Edge @ 3m	
ANT	802.11n HT40 CH46 5230MHz - R	
1+2	Horizontal	Fundamental
Peak	 <p>Date: 2016-06-20</p> <p>Site : 03CH10-HY Condition : FCC CLASS-B 3m HORN 9120D-HF HORIZONTAL : RBW:1000.000KHz VBW:3000.000KHz SWT:Auto Detector : Peak Project : 641813 Mode : 8</p>	
Avg.	 <p>Date: 2016-06-20</p> <p>Site : 03CH10-HY Condition : FCC CLASS-B (AVG) 3m HORN 9120D-HF HORIZONTAL : RBW:1000.000KHz VBW:3.000KHz SWT:Auto Detector : Peak Project : 641813 Mode : 8</p>	

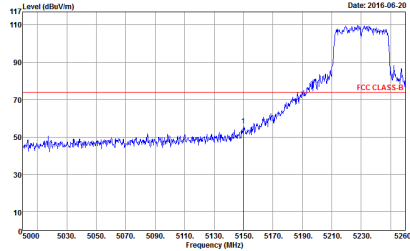
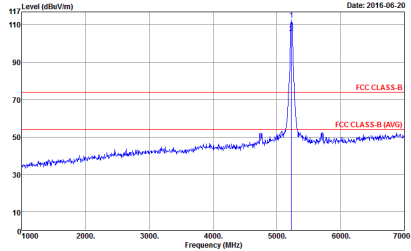
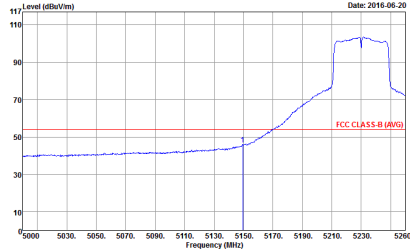

WIFI	Band 1 5150~5250MHz Band Edge @ 3m	
ANT	802.11n HT40 CH46 5230MHz - L	
1+2	Vertical	Fundamental
Peak	 <p>Date: 2016-06-20</p> <p>Site : 03CH10-HY Condition : FCC CLASS-B 3m HORN 9120D-HF VERTICAL RBW:1000.000KHz VBW:3000.000KHz SWT:Auto Detector : Peak Project : 641813 Mode : 8</p>	 <p>Date: 2016-06-20</p> <p>Site : 03CH10-HY Condition : FCC CLASS-B 3m HORN 9120D-HF VERTICAL RBW:1000.000KHz VBW:3000.000KHz SWT:Auto Detector : Peak Project : 641813 Mode : 8</p>
Avg.	 <p>Date: 2016-06-20</p> <p>Site : 03CH10-HY Condition : FCC CLASS-B (AVG) 3m HORN 9120D-HF VERTICAL RBW:1000.000KHz VBW:3.000KHz SWT:Auto Detector : Peak Project : 641813 Mode : 8</p>	

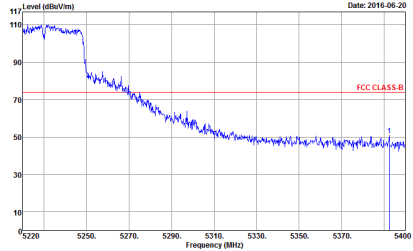
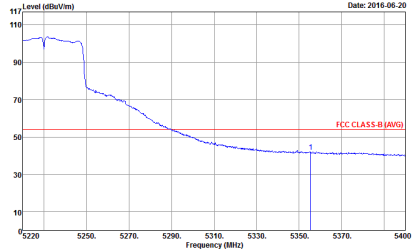

WIFI	Band 1 5150~5250MHz Band Edge @ 3m	
ANT	802.11n HT40 CH46 5230MHz - R	
1+2	Vertical	Fundamental
Peak	 <p>Date: 2016-06-20</p> <p>Site : 03CH10-HY Condition : FCC CLASS-B 3m HORN 9120D-HF VERTICAL : RBW:1000.000KHz VBW:3000.000KHz SWT:Auto Detector : Peak Project : 641813 Mode : 8</p>	
Avg.	 <p>Date: 2016-06-20</p> <p>Site : 03CH10-HY Condition : FCC CLASS-B (AVG) 3m HORN 9120D-HF VERTICAL : RBW:1000.000KHz VBW:3.000KHz SWT:Auto Detector : Peak Project : 641813 Mode : 8</p>	

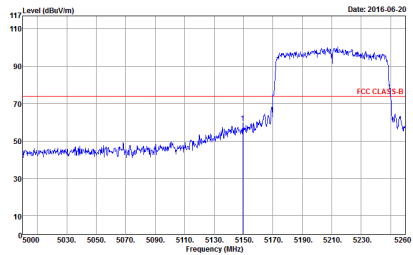
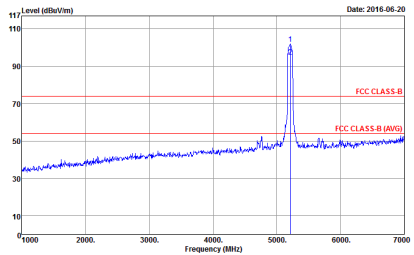
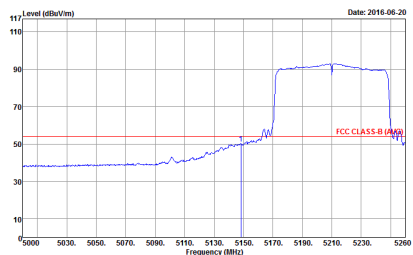

Band 1 5150~5250MHz
WIFI 802.11ac VHT80 (Band Edge @ 3m)

WIFI	Band 1 5150~5250MHz Band Edge @ 3m	
ANT	802.11ac VHT80 CH42 5210MHz - L	
1+2	Horizontal	Fundamental
<p>Peak</p>	 <p>Date: 2016-06-20</p> <p>Site : 03CH10-HY Condition : FCC CLASS-B 3m HORN 9120D-HF HORIZONTAL RBW:1000.000KHz VBW:3000.000KHz SWT:Auto Detector : Peak Project : 641813 Mode : 9</p>	 <p>Date: 2016-06-20</p> <p>Site : 03CH10-HY Condition : FCC CLASS-B 3m HORN 9120D-HF HORIZONTAL RBW:1000.000KHz VBW:3000.000KHz SWT:Auto Detector : Peak Project : 641813 Mode : 9</p>
<p>Avg.</p>	 <p>Date: 2016-06-20</p> <p>Site : 03CH10-HY Condition : FCC CLASS-B (AVG) 3m HORN 9120D-HF HORIZONTAL RBW:1000.000KHz VBW:3.000KHz SWT:Auto Detector : Peak Project : 641813 Mode : 9</p>	

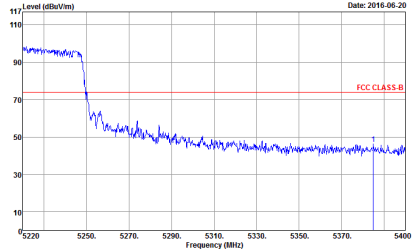
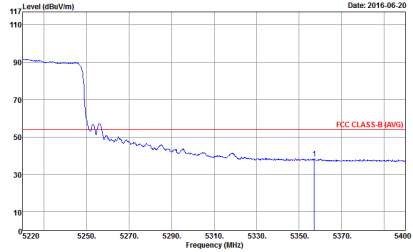

WIFI	Band 1 5150~5250MHz Band Edge @ 3m	
ANT	802.11ac VHT80 CH42 5210MHz - R	
1+2	Horizontal	Fundamental
<p>Peak</p>	 <p>Date: 2016-06-20</p> <p>Site : 03CH10-HY Condition : FCC CLASS-B 3m HORN 9120D-HF HORIZONTAL RBW:1000.000KHz VBW:3000.000KHz SWT:Auto Detector : Peak Project : 641813 Mode : 9</p>	
<p>Avg.</p>	 <p>Date: 2016-06-20</p> <p>Site : 03CH10-HY Condition : FCC CLASS-B (AVG) 3m HORN 9120D-HF HORIZONTAL RBW:1000.000KHz VBW:3.000KHz SWT:Auto Detector : Peak Project : 641813 Mode : 9</p>	



WIFI	Band 1 5150~5250MHz Band Edge @ 3m	
ANT	802.11ac VHT80 CH42 5210MHz - L	
1+2	Vertical	Fundamental
<p>Peak</p>	<p>Site : 03CH10-#Y Condition : FCC CLASS-B 3m HORN 9120D-HF VERTICAL RBW:1000.000KHz VBW:3000.000KHz SWT:Auto Detector : Peak Project : 641813 Mode : 9</p>	<p>Site : 03CH10-#Y Condition : FCC CLASS-B 3m HORN 9120D-HF VERTICAL RBW:1000.000KHz VBW:3000.000KHz SWT:Auto Detector : Peak Project : 641813 Mode : 9</p>
<p>Avg.</p>	<p>Site : 03CH10-#Y Condition : FCC CLASS-B (AVG) 3m HORN 9120D-HF VERTICAL RBW:1000.000KHz VBW:3.000KHz SWT:Auto Detector : Peak Project : 641813 Mode : 9</p>	

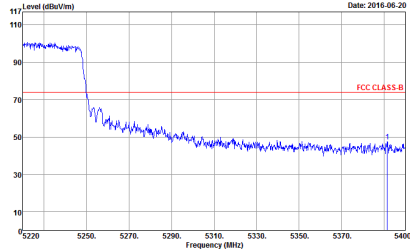
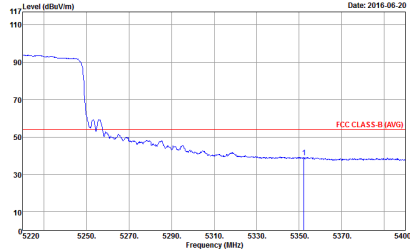

WIFI	Band 1 5150~5250MHz Band Edge @ 3m	
ANT	802.11ac VHT80 CH42 5210MHz - R	
1+2	Vertical	Fundamental
<p>Peak</p>	 <p>Date: 2016-06-20</p> <p>Site : 03CH10-HY Condition : FCC CLASS-B 3m HORN 9120D-HF VERTICAL : RBW:1000.000KHz VBW:3000.000KHz SWT:Auto Detector : Peak Project : 641813 Mode : 9</p>	
<p>Avg.</p>	 <p>Date: 2016-06-20</p> <p>Site : 03CH10-HY Condition : FCC CLASS-B (AVG) 3m HORN 9120D-HF VERTICAL : RBW:1000.000KHz VBW:3.000KHz SWT:Auto Detector : Peak Project : 641813 Mode : 9</p>	



Band 1 - 5150~5250MHz

WIFI 802.11a (Harmonic @ 3m)

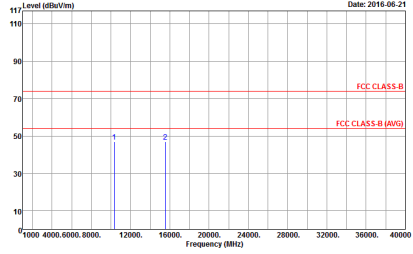
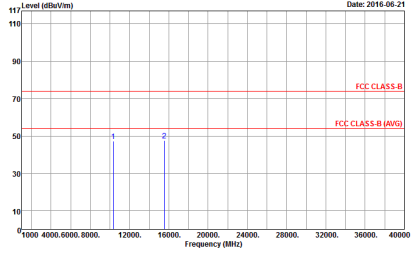
WIFI	Band 1 5150~5250MHz Harmonic @ 3m	
ANT	802.11a CH36 5180MHz	
1+2	Horizontal	Vertical
Peak Avg.	 <p>Site : 03CH10-HY Condition : FCC CLASS-B 3m HORN 9120D-HF HORIZONTAL Detector : Peak Project : 641813 Mode : 1</p>	 <p>Site : 03CH10-HY Condition : FCC CLASS-B 3m HORN 9120D-HF VERTICAL Detector : Peak Project : 641813 Mode : 1</p>

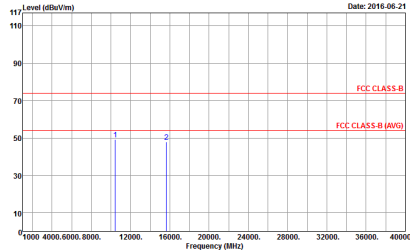
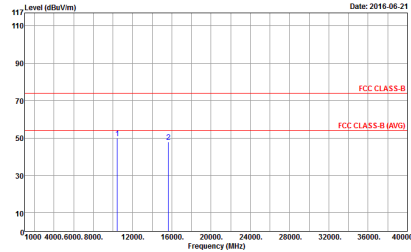

WIFI	Band 1 5150~5250MHz Harmonic @ 3m	
ANT	802.11a CH44 5220MHz	
1+2	Horizontal	Vertical
<p>Peak</p> <p>Avg.</p>	 <p style="font-size: small;">Date: 2016-06-21</p> <p style="font-size: x-small;">Site : 03CH10-#Y Condition : FCC CLASS-B 3m HORN 9120D-HF HORIZONTAL Detector : Peak Project : 641813 Mode : 2</p>	 <p style="font-size: small;">Date: 2016-06-21</p> <p style="font-size: x-small;">Site : 03CH10-#Y Condition : FCC CLASS-B 3m HORN 9120D-HF VERTICAL Detector : Peak Project : 641813 Mode : 2</p>

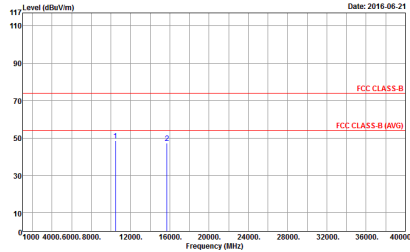
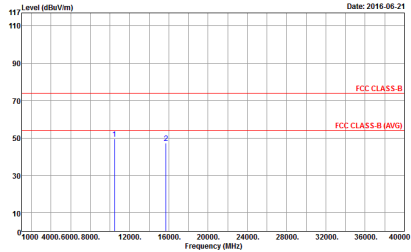

WIFI	Band 1 5150~5250MHz Harmonic @ 3m	
ANT	802.11a CH48 5240MHz	
1+2	Horizontal	Vertical
Peak Avg.	 <p>Site : 03CH10-#Y Condition : FCC CLASS-B 3m HORN 9120D-HF HORIZONTAL Detector : Peak Project : 641813 Mode : 3</p>	 <p>Site : 03CH10-#Y Condition : FCC CLASS-B 3m HORN 9120D-HF VERTICAL Detector : Peak Project : 641813 Mode : 3</p>



Band 1 5150~5250MHz
WIFI 802.11n HT20 (Harmonic @ 3m)

WIFI	Band 1 5150~5250MHz Harmonic @ 3m	
ANT	802.11n HT20 CH36 5180MHz	
1+2	Horizontal	Vertical
Peak Avg.	<p>Site : 03CH10-HY Condition : FCC CLASS-B 3m HORN 9120D-HF HORIZONTAL Detector : Peak Project : 641813 Mode : 4</p>	<p>Site : 03CH10-HY Condition : FCC CLASS-B 3m HORN 9120D-HF VERTICAL Detector : Peak Project : 641813 Mode : 4</p>

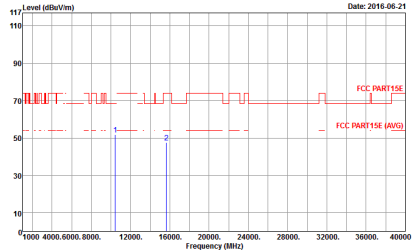
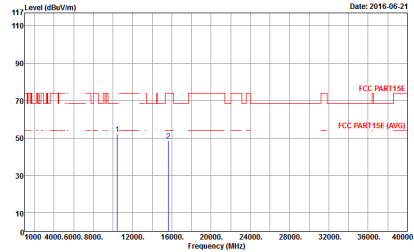

WIFI	Band 1 5150~5250MHz Harmonic @ 3m	
ANT	802.11n HT20 CH44 5220MHz	
1+2	Horizontal	Vertical
Peak Avg.	 <p>Site : 03CH10-#Y Condition : FCC PART 15E 3m HORN 9120D-HF HORIZONTAL Detector : Peak Project : 641813 Mode : 5</p>	 <p>Site : 03CH10-#Y Condition : FCC PART 15E 3m HORN 9120D-HF VERTICAL Detector : Peak Project : 641813 Mode : 5</p>

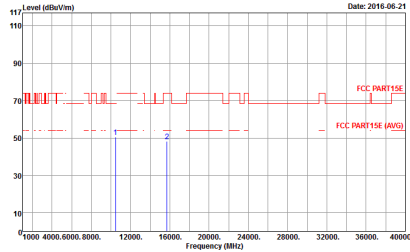
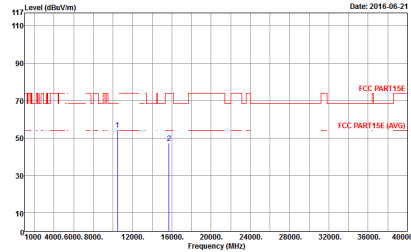

WIFI	Band 1 5150~5250MHz Harmonic @ 3m	
ANT	802.11n HT20 CH48 5240MHz	
1+2	Horizontal	Vertical
Peak Avg.	 <p>Site : 03CH10-HY Condition : FCC PART15E 3m HORN 9120D-HF HORIZONTAL Detector : Peak Project : 641813 Mode : 6</p>	 <p>Site : 03CH10-HY Condition : FCC PART15E 3m HORN 9120D-HF VERTICAL Detector : Peak Project : 641813 Mode : 6</p>

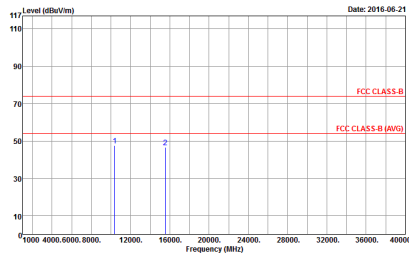
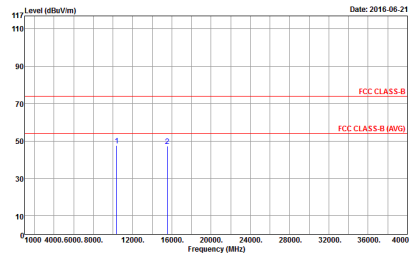

Band 1 5150~5250MHz
WIFI 802.11n HT40 (Harmonic @ 3m)

WIFI	Band 1 5150~5250MHz Harmonic @ 3m	
ANT	802.11n HT40 CH38 5190MHz	
1+2	Horizontal	Vertical
Peak Avg.	 <p>Site : 03CH10-HY Condition : FCC CLASS-B 3m HORN 9120D-HF HORIZONTAL Detector : Peak Project : 641813 Mode : 7</p>	 <p>Site : 03CH10-HY Condition : FCC CLASS-B 3m HORN 9120D-HF VERTICAL Detector : Peak Project : 641813 Mode : 7</p>



Band 1 5150~5250MHz
WIFI 802.11ac VHT80 (Harmonic @ 3m)

Table with 2 columns: Horizontal and Vertical. Each column contains a spectrum plot showing Level (dBuV/m) vs Frequency (MHz) with FCC CLASS-B and FCC CLASS-B (AVG) limits. Includes metadata for Site, Condition, Detector, Project, and Mode.



Emission below 1GHz
5GHz WIFI 802.11n HT40 (LF)

WIFI	5GHz WIFI	
ANT	802.11n HT40 LF	
1+2	Horizontal	Vertical
QP / Peak	<p>Site : 03CH10-HY Condition : FCC CLASS-B 3m BT-LOG 6111D-LF HORIZONTAL Detector : Peak Project : 641813 Mode : 10</p>	<p>Site : 03CH10-HY Condition : FCC CLASS-B 3m BT-LOG 6111D-LF VERTICAL Detector : Peak Project : 641813 Mode : 10</p>



Appendix D. Duty Cycle Plots

Antenna	Band	Duty Cycle(%)	T(us)	1/T(kHz)	VBW Setting
1+2	5GHz 802.11a for Ant. 1	96.7*	1440	0.69	1kHz
1+2	5GHz 802.11a for Ant. 2	96.6*	1440	0.69	1kHz
1+2	5GHz 802.11n HT20 for Ant. 1	96.6*	1350	0.74	1kHz
1+2	5GHz 802.11n HT20 for Ant. 2	96.7*	1355	0.74	1kHz
1+2	5GHz 802.11n HT40 for Ant. 1	95.0*	670	1.49	3kHz
1+2	5GHz 802.11n HT40 for Ant. 2	95.0*	668	1.50	3kHz
1+2	5GHz 802.11ac VHT80 for Ant. 1	92.9*	336	2.98	3kHz
1+2	5GHz 802.11ac V HT80 for Ant. 2	92.9*	334	2.99	3kHz

Note *: Duty cycle is not a constant value during the continuous transmission.



MIMO <Ant. 1+2(1)>

802.11a

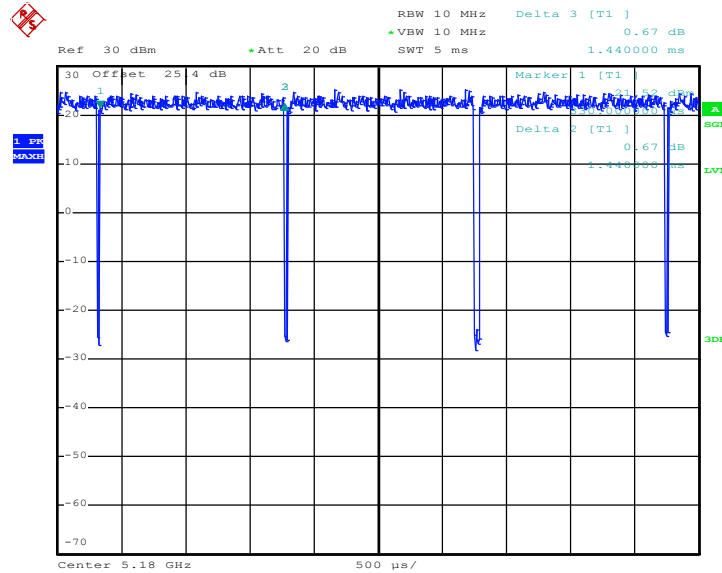

Date: 5.MAY.2016 14:59:38

802.11n HT20

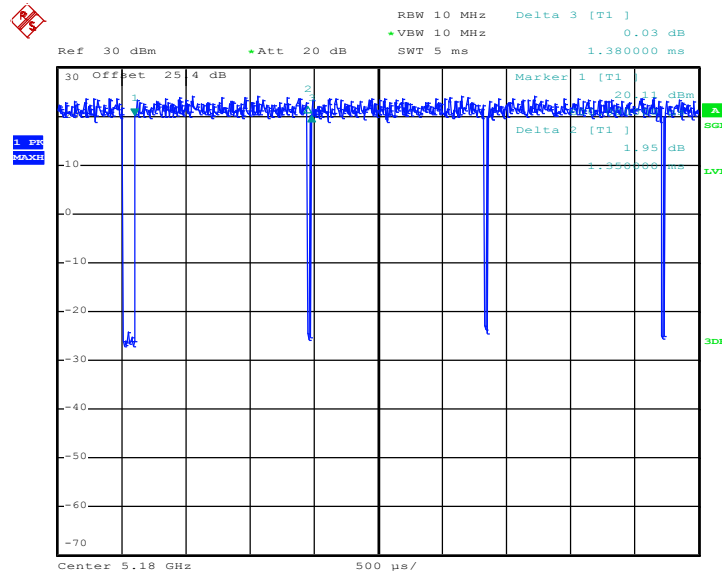

Date: 5.MAY.2016 15:45:39



802.11n HT40

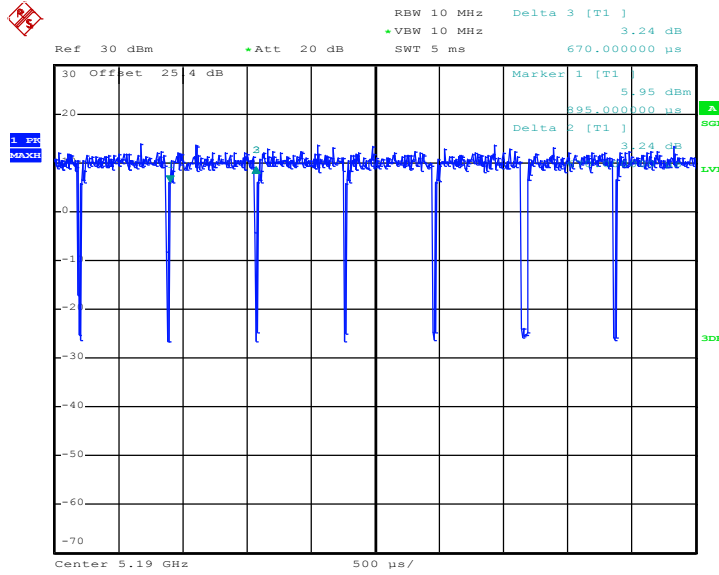

Date: 13.MAY.2016 11:25:33

802.11ac VTH80

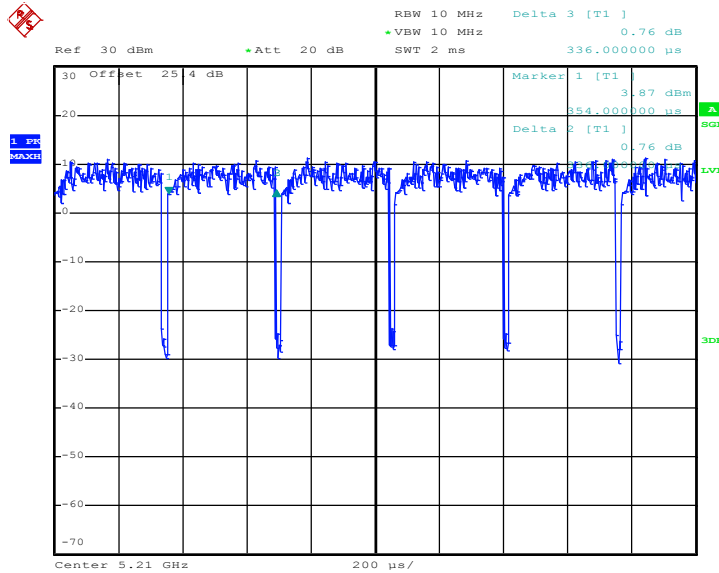

Date: 13.MAY.2016 11:31:16



MIMO <Ant. 1+2(2)>

802.11a

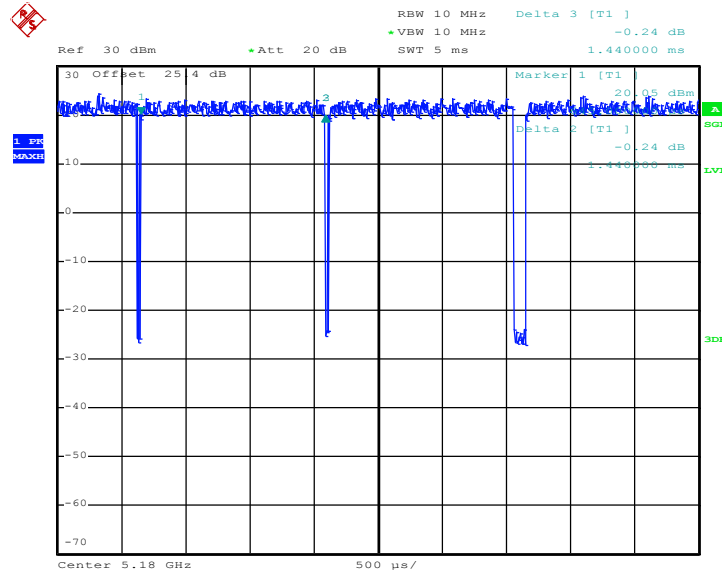

Date: 5.MAY.2016 15:00:24

802.11n HT20

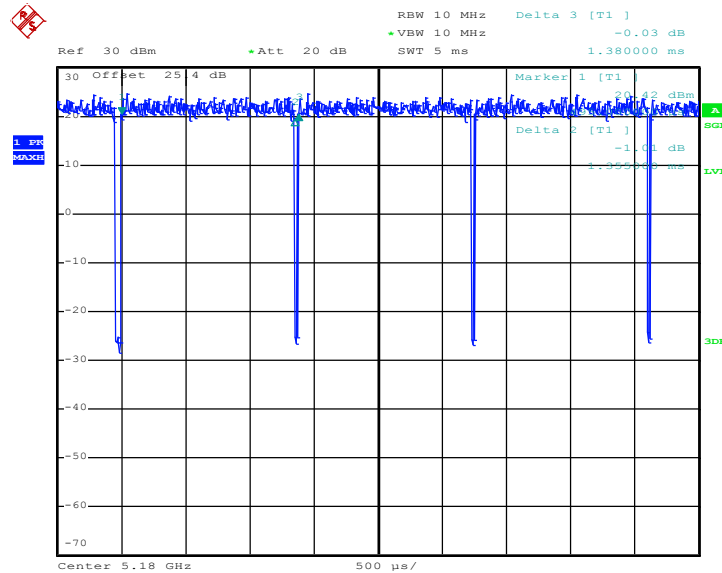

Date: 5.MAY.2016 15:46:43



802.11n HT40

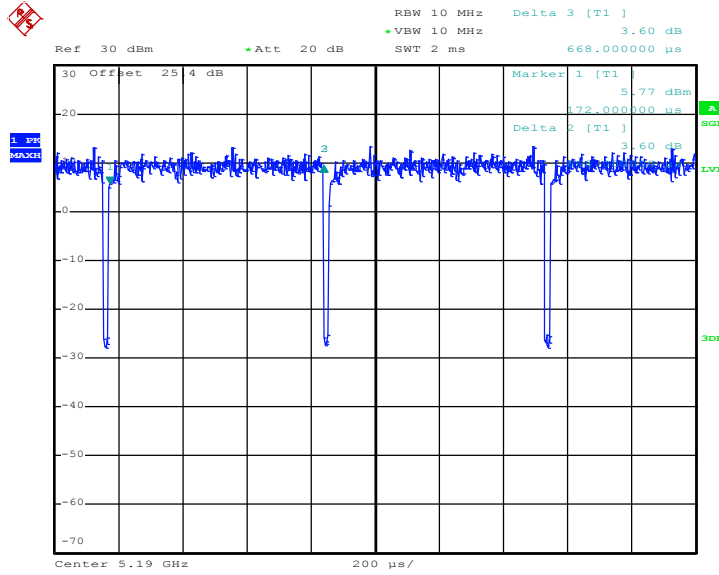

Date: 13.MAY.2016 11:26:52

802.11ac VTH80

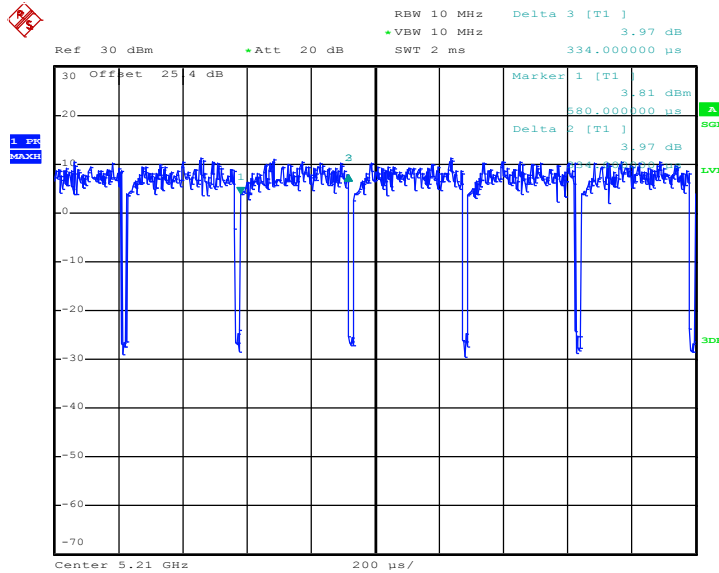

Date: 13.MAY.2016 11:32:59