

MEASUREMENT REPORT

FCC PART 15C / WLAN 802.11b/g/n

FCC ID: TE7RE315

Applicant: TP-Link Technologies Co., Ltd.

Application Type: Certification

Product: AC750 Wi-Fi Range Extender
AC1200 Wi-Fi Range Extender

Model No.: RE215, RE315

Brand Name: tp-link

FCC Classification: Digital Transmission System (DTS)

FCC Rule Part(s): Part 15 Subpart C (Section 15.247)

Test Procedure(s): ANSI C63.10-2013

Test Date: August 21, 2020 ~ January 06, 2021

Reviewed By:



(Kevin Guo)

Approved By:

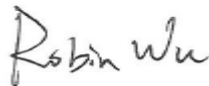

(Robin Wu)



The test results relate only to the samples tested.

This equipment has been shown to be capable of compliance with the applicable technical standards as indicated in the measurement report and was tested in accordance with the measurement procedures specified in ANSI C63.10-2013. Test results reported herein relate only to the item(s) tested.

The test report shall not be reproduced except in full without the written approval of MRT Technology (Suzhou) Co., Ltd.

Revision History

Report No.	Version	Description	Issue Date	Note
2008RSU037-U2	Rev. 01	Initial Report	01-06-2021	Valid

CONTENTS

Description	Page
1. General Information	5
1.1. Applicant	5
1.2. Manufacturer	5
1.3. Testing Facility.....	5
2. PRODUCT INFORMATION	6
2.1. Equipment Description	6
2.2. Product Specification Subjective to this Report	6
2.3. Working Frequencies for this report.....	7
2.4. Description of Available Antennas	7
2.5. Test Mode	8
2.6. Configuration of Test System	8
2.7. Test System Details	8
2.8. Description of Test Software.....	8
2.9. Duty Cycle.....	9
2.10. EMI Suppression Device(s)/Modifications.....	9
2.11. Test Environment Condition.....	9
3. ANTENNA REQUIREMENTS.....	10
4. TEST EQUIPMENT CALIBRATION DATE.....	11
5. MEASUREMENT UNCERTAINTY	15
6. TEST RESULT	16
6.1. Summary.....	16
6.2. 6dB Bandwidth Measurement.....	17
6.2.1. Test Limit	17
6.2.2. Test Procedure used.....	17
6.2.3. Test Setting.....	17
6.2.4. Test Setup	17
6.2.5. Test Result.....	18
6.3. Output Power Measurement.....	21
6.3.1. Test Limit	21
6.3.2. Test Procedure Used	21
6.3.3. Test Setting.....	21
6.3.4. Test Setup	21
6.3.5. Test Result.....	22

6.4.	Power Spectral Density Measurement.....	23
6.4.1.	Test Limit	23
6.4.2.	Test Procedure Used	23
6.4.3.	Test Setting.....	23
6.4.4.	Test Setup	24
6.4.5.	Test Result.....	25
6.5.	Conducted Band Edge and Out-of-Band Emissions	30
6.5.1.	Test Limit	30
6.5.2.	Test Procedure Used	30
6.5.3.	Test Setting.....	30
6.5.4.	Test Setup	31
6.5.5.	Test Result.....	32
6.6.	Radiated Spurious Emission Measurement	49
6.6.1.	Test Limit	49
6.6.2.	Test Procedure Used	49
6.6.3.	Test Setting.....	49
6.6.4.	Test Setup	51
6.6.5.	Test Result.....	52
6.7.	Radiated Restricted Band Edge Measurement.....	66
6.7.1.	Test Limit	66
6.7.2.	Test Procedure Used	67
6.7.3.	Test Setting.....	67
6.7.4.	Test Setup	68
6.7.5.	Test Result.....	69
6.8.	AC Conducted Emissions Measurement	137
6.8.1.	Test Limit	137
6.8.2.	Test Setup	137
6.8.3.	Test Result.....	138
7.	CONCLUSION	140
	Appendix A - Test Setup Photograph	141
	Appendix B - EUT Photograph.....	142

2. PRODUCT INFORMATION

2.1. Equipment Description

Product Name:	AC750 Wi-Fi Range Extender AC1200 Wi-Fi Range Extender
Model No.:	RE215, RE315
Brand Name:	tp-link
Wi-Fi Specification:	802.11a/b/g/n/ac
EUT Identification No.:	20200821Sample#01 (Conducted) 20200821Sample#03 (Radiated & AC conducted emission)

Note: There is the same hardware design, PCB layout between the models, different models and product names for different marketing requirements. Only RE315 (Product name: AC1200 Wi-Fi Range Extender) was selected for final tests.

2.2. Product Specification Subjective to this Report

Frequency Range:	802.11b/g/n-HT20: 2412 ~ 2462MHz 802.11n-HT40: 2422 ~ 2452MHz
Channel Number:	802.11b/g/n-HT20: 11 802.11n-HT40: 7
Type of Modulation:	802.11b: DSSS 802.11g/n: OFDM
Data Rate:	802.11b: 1/2/5.5/11Mbps 802.11g: 6/9/12/18/24/36/48/54Mbps 802.11n: up to 300Mbps

Note: For other features of this EUT, test report will be issued separately.

2.3. Working Frequencies for this report

802.11b/g/n-HT20

Channel	Frequency	Channel	Frequency	Channel	Frequency
01	2412 MHz	02	2417 MHz	03	2422 MHz
04	2427 MHz	05	2432 MHz	06	2437 MHz
07	2442 MHz	08	2447 MHz	09	2452 MHz
10	2457 MHz	11	2462 MHz	--	--

802.11n-HT40

Channel	Frequency	Channel	Frequency	Channel	Frequency
03	2422 MHz	04	2427 MHz	05	2432 MHz
06	2437 MHz	07	2442 MHz	08	2447 MHz
09	2452 MHz	--	--	--	--

2.4. Description of Available Antennas

Antenna Type	Frequency Band (MHz)	T _x Paths	Max Antenna Gain (dBi)	Beamforming Directional Gain (dBi)	CDD Directional Gain (dBi)	
					For Power	For PSD
Dipole Antenna	2412 ~ 2462	2	2.0	--	2.0	5.01
	5150 ~ 5850	2	3.0	6.01	3.0	6.01

Note 1: The EUT supports Cyclic Delay Diversity (CDD) mode, and CDD signals are correlated.

If all antennas have the same gain, G_{ANT} , Directional gain = $G_{ANT} + \text{Array Gain}$, where Array Gain is as follows.

- For power spectral density (PSD) measurements on all devices,
Array Gain = $10 \log (N_{ANT} / N_{SS})$ dB;
- For power measurements on IEEE 802.11 devices,
Array Gain = 0 dB for $N_{ANT} \leq 4$;

Note 2: The EUT also supports Beam Forming mode, and the Beam Forming support 802.11ac, not include 802.11a/b/g/n. BF Directional gain = $G_{ANT} + 10 \log (N_{ANT})$.

Note 3: All information is provided by the manufacturer.

2.5. Test Mode

Test Mode	Mode 1: Transmit by 802.11b (1Mbps) (CDD mode)
	Mode 2: Transmit by 802.11g (6Mbps) (CDD mode)
	Mode 3: Transmit by 802.11n-HT20 (MCS0) (CDD mode)
	Mode 4: Transmit by 802.11n-HT40 (MCS0) (CDD mode)

2.6. Configuration of Test System

The device was tested per the guidance ANSI C63.10: 2013 was used to reference the appropriate EUT setup for radiated emissions testing and AC line conducted testing.

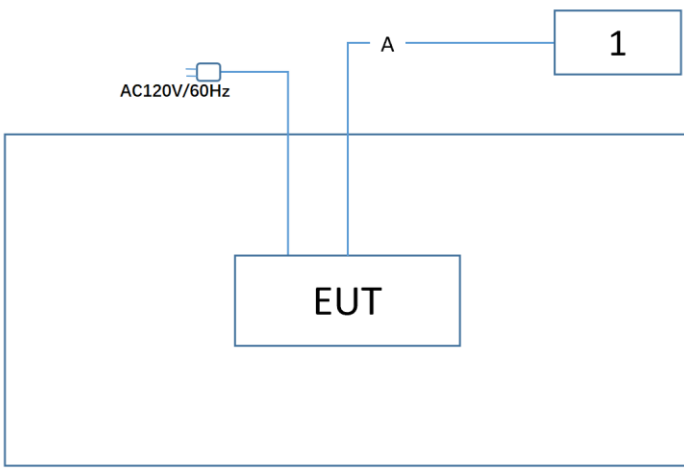
Connection Diagram – Radiated Emission testing (CDD mode) & AC Conducted Emissions		
		
Signal Cable Type	Signal Cable Description	
A	LAN Cable	Non shielded, > 10m
B	LAN Cable	Non shielded, 3.0m

2.7. Test System Details

Product	Manufacturer	Model No.
1 Notebook	Lenovo	X230

2.8. Description of Test Software

The test utility software used during testing was “QATool_Dbg.exe”, and the version was 0.0.0.70.

Note: Final power setting please refer to operational description.

2.9. Duty Cycle

2.4GHz WLAN (DTS) operation is possible in 20MHz channel bandwidths. The maximum achievable duty cycles for all modes were determined based on measurements performed on a spectrum analyzer in zero-span mode with RBW = 8MHz, VBW = 50MHz. The RBW and VBW were both greater than 50/T, where T is the minimum transmission duration, and the number of sweep points across T was greater than 100. The duty cycles are as follows:

Test Mode	Duty Cycle
802.11b	98.15%
802.11g	97.42%
802.11n-HT20	93.70%
802.11n-HT40	89.01%

Duty Cycle (T = Transmission Duration)	
802.11b (T = 8.406ms)	802.11g (T = 1.396ms)
802.11n-HT20 (T = 1.308ms)	802.11n-HT40 (T = 646.8us)

2.10. EMI Suppression Device(s)/Modifications

No EMI suppression device(s) were added and/or no modifications were made during testing.

2.11. Test Environment Condition

Ambient Temperature	15°C~35°C
Relative Humidity	20%RH ~75%RH

3. ANTENNA REQUIREMENTS

Excerpt from §15.203 of the FCC Rules/Regulations:

“An intentional radiator antenna shall be designed to ensure that no antenna other than that furnished by the responsible party can be used with the device. The use of a permanently attached antenna or of an antenna that uses a unique coupling to the intentional radiator shall be considered sufficient to comply with the provisions of this section.”

- The antenna of the device is **permanently attached**.
- There are no provisions for connection to an external antenna.

Conclusion:

The unit complies with the requirement of §15.203.

4. TEST EQUIPMENT CALIBRATION DATE

Conducted Emission (WZ-SR2)

Instrument	Manufacturer	Type No.	Asset No.	Cali. Interval	Cali. Due Date
EMI Test Receiver	R&S	ESR3	MRTSUE06185	1 year	2021/01/18
Two-Line V-Network	R&S	ENV216	MRTSUE06002	1 year	2021/09/09
Thermal Hygrometer	testo	608-H1	MRTSUE06404	1 year	2021/07/26

Conducted Emission (SIP-SR2)

Instrument	Manufacturer	Type No.	Asset No.	Cali. Interval	Cali. Due Date
EMI Test Receiver	R&S	ESR3	MRTSUE06613	1 year	2021/07/02
Two-Line V-Network	R&S	ENV216	MRTSUE06003	1 year	2021/09/09
Thermal Hygrometer	testo	608-H1	MRTSUE06621	1 year	2021/12/03

Radiated Emission (WZ-AC1)

Instrument	Manufacturer	Type No.	Asset No.	Cali. Interval	Cali. Due Date
EMI Test Receiver	R&S	ESR7	MRTSUE06001	1 year	2021/01/18
PXA Signal Analyzer	Keysight	N9030B	MRTSUE06395	1 year	2021/08/30
Loop Antenna	Schwarzbeck	FMZB 1519	MRTSUE06025	1 year	2021/11/08
Bilog Period Antenna	Schwarzbeck	VULB 9168	MRTSUE06172	1 year	2021/08/08
Horn Antenna	Schwarzbeck	BBHA 9120D	MRTSUE06023	1 year	2021/09/27
Horn Antenna	Schwarzbeck	BBHA9170	MRTSUE06597	1 year	2021/12/14
Microwave System Amplifier	Agilent	83017A	MRTSUE06076	1 year	2021/11/14
Preamplifier	Schwarzbeck	BBV 9721	MRTSUE06121	1 year	2021/06/11
Thermal Hygrometer	testo	608-H1	MRTSUE06403	1 year	2021/07/26
Anechoic Chamber	TDK	Chamber-AC1	MRTSUE06212	1 year	2021/04/30

Radiated Emission (WZ-AC2)

Instrument	Manufacturer	Type No.	Asset No.	Cali. Interval	Cali. Due Date
MXE EMI Receiver	Keysight	N9038A	MRTSUE06125	1 year	2021/07/02
Loop Antenna	Schwarzbeck	FMZB 1519	MRTSUE06025	1 year	2021/11/08
Bilog Period Antenna	Schwarzbeck	VULB 9162	MRTSUE06022	1 year	2021/05/26
Broad-Band Horn Antenna	Schwarzbeck	BBHA 9120D	MRTSUE06171	1 year	2021/10/25
Horn Antenna	Schwarzbeck	BBHA9170	MRTSUE06597	1 year	2021/12/14
Broadband Coaxial Preamplifier	Schwarzbeck	BBV 9718	MRTSUE06176	1 year	2021/11/14
Preamplifier	Schwarzbeck	BBV 9721	MRTSUE06121	1 year	2021/06/11
Thermal Hygrometer	Minggao	ETH529	MRTSUE06170	1 year	2021/12/08
Anechoic Chamber	RIKEN	Chamber-AC2	MRTSUE06213	1 year	2021/04/30

Radiated Emission (SIP-AC1)

Instrument	Manufacturer	Type No.	Asset No.	Cali. Interval	Cali. Due Date
EMI Test Receiver	R&S	ESR3	MRTSUE06612	1 year	2021/07/02
EXA Signal Analyzer	Keysight	N9010B	MRTSUE06559	1 year	2021/07/23
Loop Antenna	Schwarzbeck	FMZB 1519	MRTSUE06025	1 year	2021/11/08
Bilog Period Antenna	Schwarzbeck	VULB9168	MRTSUE06645	1 year	2021/08/30
Double Ridged Horn Antenna	R&S	HF907	MRTSUE06610	1 year	2021/08/30
Preamplifier	EMCI	EMC051845SE	MRTSUE06600	1 year	2021/11/09
Thermal Hygrometer	testo	608-H1	MRTSUE06620	1 year	2021/12/03
Anechoic Chamber	RIKEN	SIP-AC1	MRTSUE06554	1 year	2021/12/24

Radiated Emission (SIP-AC2)

Instrument	Manufacturer	Type No.	Asset No.	Cali. Interval	Cali. Due Date
EMI Test Receiver	R&S	ESR3	MRTSUE06613	1 year	2021/07/02
MXA Signal Analyzer	Keysight	N9020B	MRTSUE06604	1 year	2021/09/26
Loop Antenna	Schwarzbeck	FMZB 1519	MRTSUE06025	1 year	2021/11/08
Bilog Period Antenna	Schwarzbeck	VULB9168	MRTSUE06646	1 year	2021/08/30
Horn Antenna	Schwarzbeck	BBHA9120D	MRTSUE06648	1 year	2021/11/26
Horn Antenna	Schwarzbeck	BBHA9170	MRTSUE06599	1 year	2021/11/26
Preamplifier	EMCI	EMC051845SE	MRTSUE06644	1 year	2021/11/09
Preamplifier	EMCI	EMC184045SE	MRTSUE06602	1 year	2021/10/21
Thermal Hygrometer	testo	608-H1	MRTSUE06624	1 year	2021/12/03
Anechoic Chamber	RIKEN	SIP-AC2	MRTSUE06781	1 year	2021/12/24

Radiated Emission (SIP-AC3)

Instrument	Manufacturer	Type No.	Asset No.	Cali. Interval	Cali. Due Date
EMI Test Receiver	R&S	ESR3	MRTSUE06612	1 year	2021/07/02
EXA Signal Analyzer	Keysight	N9010B	MRTSUE06559	1 year	2021/07/23
Loop Antenna	Schwarzbeck	FMZB 1519	MRTSUE06025	1 year	2021/11/08
Bilog Period Antenna	Schwarzbeck	VULB9168	MRTSUE06647	1 year	2021/08/08
Double Ridged Horn Antenna	R&S	HF907	MRTSUE06611	1 year	2021/09/13
Horn Antenna	Schwarzbeck	BBHA9170	MRTSUE06598	1 year	2021/11/26
Preamplifier	EMCI	EMC012645SE	MRTSUE06642	1 year	2021/01/16
Preamplifier	EMCI	EMC184045SE	MRTSUE06641	1 year	2021/01/16
Thermal Hygrometer	testo	608-H1	MRTSUE06622	1 year	2021/12/03
Anechoic Chamber	RIKEN	SIP-AC3	MRTSUE06782	1 year	2021/12/24

Conducted Test Equipment (WZ-TR3)

Instrument	Manufacturer	Type No.	Asset No.	Cali. Interval	Cali. Due Date
EXA Signal Analyzer	Agilent	N9020A	MRTSUE06106	1 year	2021/04/14
EXA Signal Analyzer	Keysight	N9010B	MRTSUE06607	1 year	2021/01/08
Signal Analyzer	R&S	FSV40	MRTSUE06218	1 year	2021/04/14
Power Meter	Agilent	U2021XA	MRTSUE06030	1 year	2021/10/22
USB wideband power sensor	Keysight	U2021XA	MRTSUE06446	1 year	2021/08/30
USB wideband power sensor	Keysight	U2021XA	MRTSUE06447	1 year	2021/08/08
Bluetooth Test Set	Anritsu	MT8852B-042	MRTSUE06389	1 year	2021/06/11
Audio Analyzer	Agilent	U8903B	MRTSUE06143	1 year	2021/06/11
Modulation Analyzer	HP	HP8901A	MRTSUE06098	1 year	2021/09/26
Wideband Radio Communication Tester	R&S	CMW 500	MRTSUE06243	1 year	2021/10/20
Attenuator	MVE	3dB	MRTSUE06529	1 year	2021/12/12
Attenuator	MVE	6dB	MRTSUE06534	1 year	2021/12/12
Attenuator	MVE	10dB	MRTSUE06540	1 year	2021/12/12
Attenuator	MVE	20dB	MRTSUE06547	1 year	2021/12/12
DC Power Supply	GWINSTEK	DPS-3303C	MRTSUE06064	N/A	N/A
Temperature & Humidity Chamber	BAOYT	BYH-150CL	MRTSUE06051	1 year	2021/10/21
Thermal Hygrometer	testo	608-H1	MRTSUE06401	1 year	2021/07/26

Conducted Test Equipment (SIP-SR5)

Instrument	Manufacturer	Type No.	Asset No.	Cali. Interval	Cali. Due Date
Signal Analyzer	R&S	FSV40	MRTSUE06218	1 year	2021/04/14
PXA Signal Analyzer	Keysight	N9030B	MRTSUE06395	1 year	2021/08/30
USB wideband power sensor	Agilent	U2021XA	MRTSUE06595	1 year	2021/09/26
USB wideband power sensor	Agilent	U2021XA	MRTSUE06596	1 year	2021/09/26
Wideband Radio Communication Tester	R&S	CMW 500	MRTSUE06243	1 year	2021/10/20
Bluetooth Test Set	Anritsu	MT8852B-042	MRTSUE06389	1 year	2021/06/11
Attenuator	MVE	3dB	MRTSUE06530	1 year	2021/12/12
Attenuator	MVE	6dB	MRTSUE06535	1 year	2021/12/12
Attenuator	MVE	10dB	MRTSUE06541	1 year	2021/12/12
Attenuator	MVE	20dB	MRTSUE06548	1 year	2021/12/12
Temperature Chamber	BAOYT	BYG-408CS	MRTSUE06847	1 year	2021/03/31
Thermal Hygrometer	testo	622	MRTSUE06629	1 year	2021/11/25

Software	Version	Function
EMI Software	V3	EMI Test Software

5. MEASUREMENT UNCERTAINTY

Where relevant, the following test uncertainty levels have been estimated for tests performed on the EUT as specified in CISPR 16-4-2. This uncertainty represents an expanded uncertainty expressed at approximately the 95% confidence level using a coverage factor of $k = 2$.

AC Conducted Emission Measurement
Measurement Uncertainty for a Level of Confidence of 95% ($U=2Uc(y)$): 9kHz~150kHz: 3.74dB 150kHz~30MHz: 3.44dB
Radiated Disturbance
Measurement Uncertainty for a Level of Confidence of 95% ($U=2Uc(y)$): Horizontal: 30MHz~300MHz: 5.04dB 300MHz~1GHz: 4.95dB 1GHz~40GHz: 6.40dB Vertical: 30MHz~300MHz: 5.24dB 300MHz~1GHz: 6.03dB 1GHz~40GHz: 6.40dB
Spurious Emissions, Conducted
Measuring Uncertainty for a Level of Confidence of 95% ($U=2Uc(y)$): 0.78dB
Output Power
Measuring Uncertainty for a Level of Confidence of 95% ($U=2Uc(y)$): 1.13dB
Power Spectrum Density
Measuring Uncertainty for a Level of Confidence of 95% ($U=2Uc(y)$): 1.15dB
Occupied Bandwidth
Measuring Uncertainty for a Level of Confidence of 95% ($U=2Uc(y)$): 0.28%

6. TEST RESULT

6.1. Summary

FCC Section(s)	Test Description	Test Limit	Test Condition	Test Result	Reference
15.247(a)(2)	6dB Bandwidth	$\geq 500\text{kHz}$	Conducted	Pass	Section 6.2
15.247(b)(3)	Output Power	$\leq 30\text{dBm}$		Pass	Section 6.3
15.247(e)	Power Spectral Density	$\leq 8\text{dBm}/3\text{kHz}$		Pass	Section 6.4
15.247(d)	Band Edge / Out-of-Band Emissions	$\geq 30\text{dBc}$ (Average)		Pass	Section 6.5
15.205 15.209	General Field Strength (Restricted Bands and Radiated Emission)	Emissions in restricted bands must meet the radiated limits detailed in 15.209	Radiated	Pass	Section 6.6 & 6.7
15.207	AC Conducted Emissions 150kHz - 30MHz	< FCC 15.207 limits	Line Conducted	Pass	Section 6.8

Notes:

- 1) The analyzer plots shown in this section were all taken with a correction table loaded into the analyzer. The correction table was used to account for the losses of the cables and attenuators used as part of the system to connect the EUT to the analyzer at all frequencies of interest.
- 2) Output power test was verified over all data rates of each mode (data refers to operational description), and then choose the maximum power output (low data rate) for the final test of each channel.
- 3) For radiated emission tests, every axis (X, Y, Z) was also verified. The test results shown in the following sections represent the worst-case emissions.
- 4) Test Items "6dB Bandwidth" showed the worst test data in this report.

6.2. 6dB Bandwidth Measurement

6.2.1. Test Limit

The minimum 6dB bandwidth shall be at least 500 kHz.

6.2.2. Test Procedure used

ANSI C63.10 - 2013 - Section 11.8

6.2.3. Test Setting

1. The Spectrum's automatic bandwidth measurement capability was used to perform the 6dB bandwidth measurement. The "X" dB bandwidth parameter was set to $X = 6$. The bandwidth measurement was not influenced by any intermediate power nulls in the fundamental emission.
2. Set RBW = 100 kHz
3. VBW $\geq 3 \times$ RBW
4. Detector = Peak
5. Trace mode = Max hold
6. Sweep = Auto couple
7. Allow the trace to stabilize

6.2.4. Test Setup

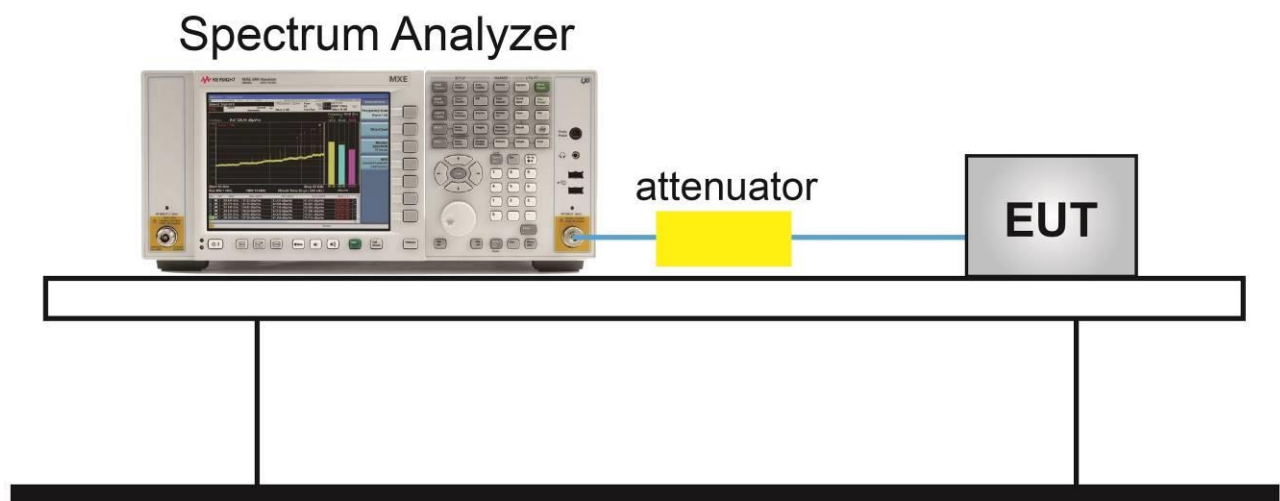

6.2.5. Test Result

Product	AC1200 Wi-Fi Range Extender	Test Engineer	Amy Zhang
Test Site	WZ-TR3	Test Date	2021/01/05

Test Mode	Data Rate / MCS	Channel No.	Frequency (MHz)	6dB Bandwidth (MHz)	Limit (MHz)	Result
802.11b	1Mbps	01	2412	9.61	≥ 0.5	Pass
802.11b	1Mbps	06	2437	10.08	≥ 0.5	Pass
802.11b	1Mbps	11	2462	10.07	≥ 0.5	Pass
802.11g	6Mbps	01	2412	15.06	≥ 0.5	Pass
802.11g	6Mbps	06	2437	15.12	≥ 0.5	Pass
802.11g	6Mbps	11	2462	15.06	≥ 0.5	Pass
802.11n-HT20	MCS0	01	2412	15.12	≥ 0.5	Pass
802.11n-HT20	MCS0	06	2437	15.12	≥ 0.5	Pass
802.11n-HT20	MCS0	11	2462	15.09	≥ 0.5	Pass
802.11n-HT40	MCS0	03	2422	33.86	≥ 0.5	Pass
802.11n-HT40	MCS0	06	2437	32.58	≥ 0.5	Pass
802.11n-HT40	MCS0	09	2452	35.10	≥ 0.5	Pass

802.11b 6dB Bandwidth

Channel 01 (2412MHz)

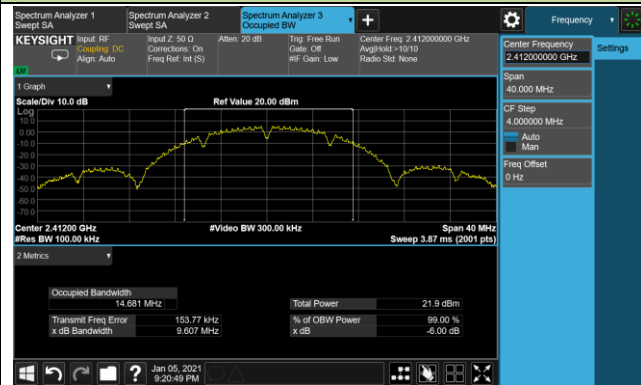

Channel 06 (2437MHz)

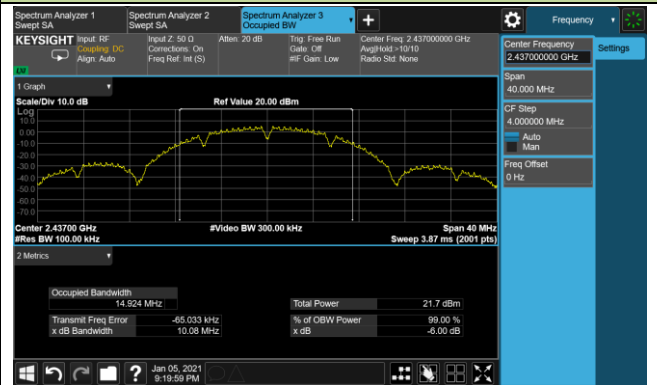

Channel 11 (2462MHz)

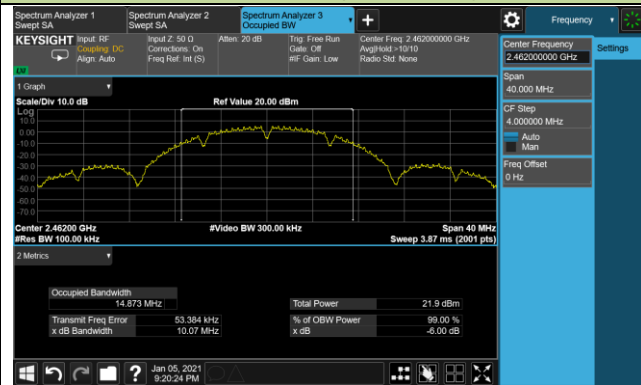

802.11g 6dB Bandwidth

Channel 01 (2412MHz)



Channel 06 (2437MHz)

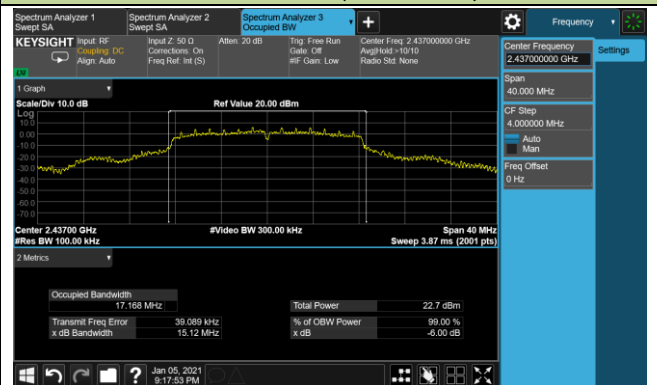

Channel 11 (2462MHz)

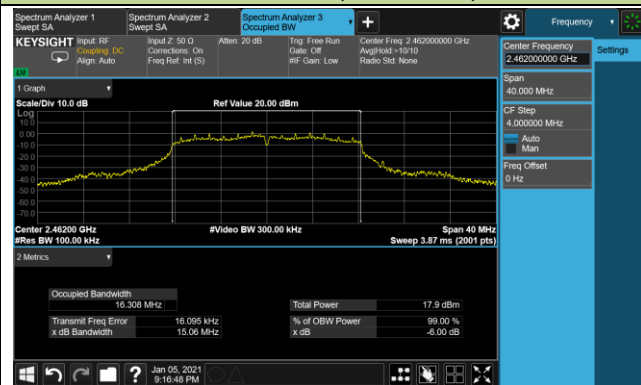

802.11n-HT20 6dB Bandwidth

Channel 01 (2412MHz)

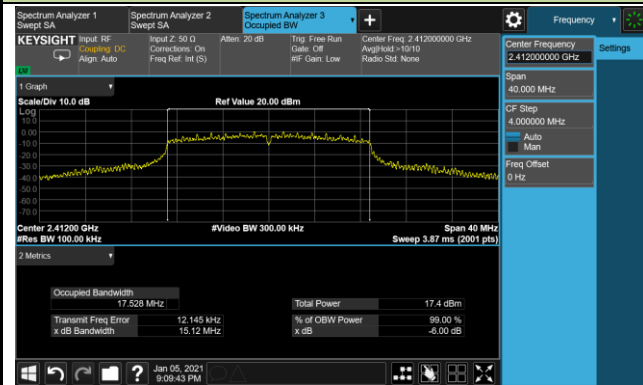

Channel 06 (2437MHz)

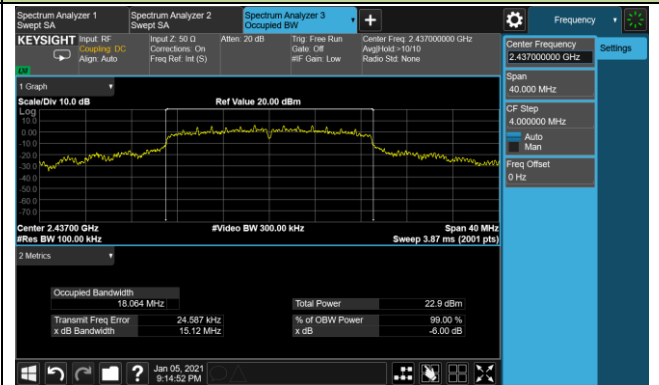

Channel 11 (2462MHz)

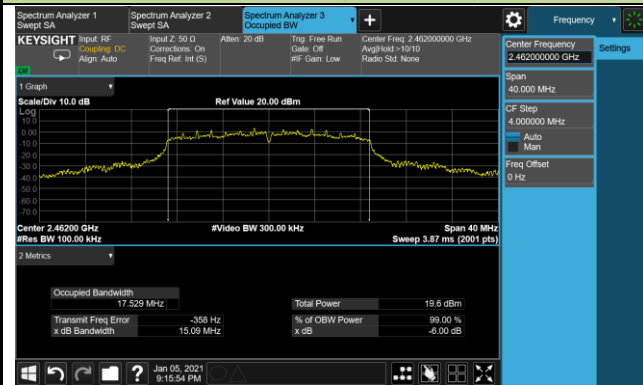

802.11n-HT40 6dB Bandwidth

Channel 03 (2422MHz)

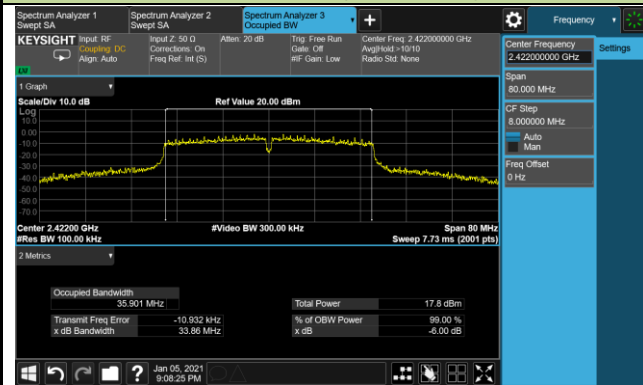

Channel 06 (2437MHz)

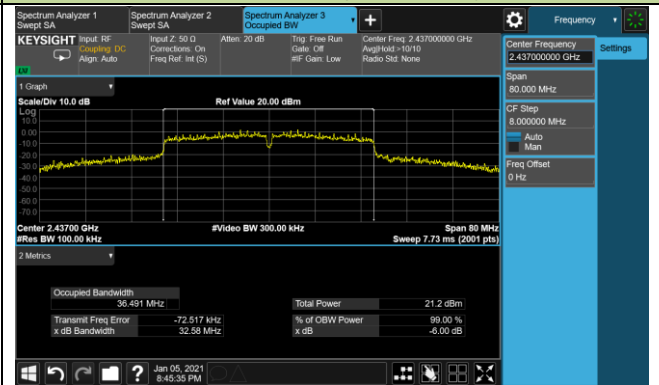

Channel 09 (2452MHz)

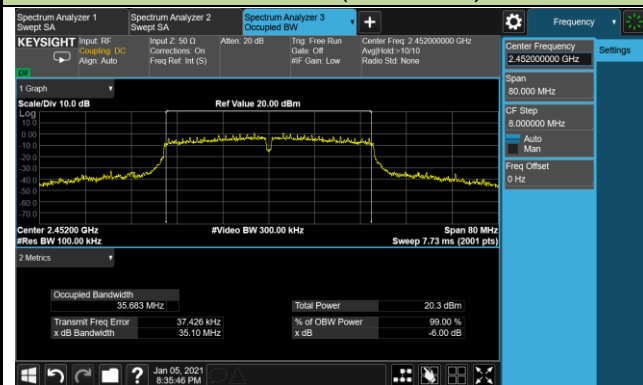

6.3. Output Power Measurement

6.3.1. Test Limit

The maximum output power shall be less 1 Watt (30dBm).

The conducted output power limit specified in paragraph FCC Part 15.247(b) of this section is based on the use of antennas with directional gains that do not exceed 6 dBi. If transmitting antennas of directional gain greater than 6 dBi are used, the conducted output power from the intentional radiator shall be reduced below the stated values in paragraphs FCC Part 15.247(b)(3) of this section, as appropriate, by the amount in dB that the directional gain of the antenna exceeds 6 dBi.

6.3.2. Test Procedure Used

ANSI C63.10 - 2013 - Section 11.9.2.3.2

6.3.3. Test Setting

Average Power Measurement

Average power measurements were performed only when the EUT was transmitting at its maximum power control level using a broadband power meter with a pulse sensor. The power meter implemented triggering and gating capabilities which were set up such that power measurements were recorded only during the ON time of the transmitter.

6.3.4. Test Setup

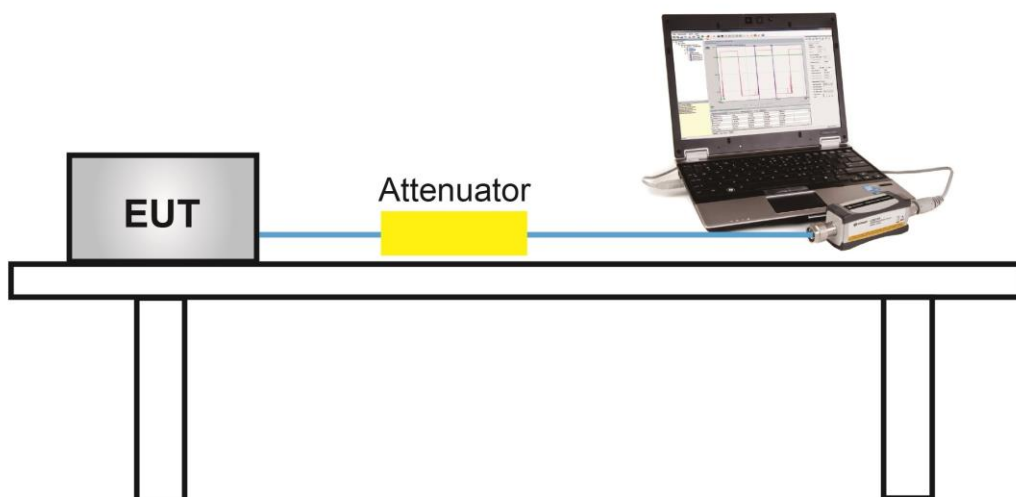

6.3.5. Test Result

Product	AC1200 Wi-Fi Range Extender	Test Engineer	Amy Zhang
Test Site	WZ-TR3	Test Date	2021/01/05

Test Mode	Data Rate/ MCS	Channel No.	Freq. (MHz)	Ant 0 Average Power (dBm)	Ant 1 Average Power (dBm)	Total Average Power (dBm)	Limit (dBm)	Result
CDD Mode								
802.11b	1Mbps	01	2412	18.49	19.10	21.82	≤ 30.00	Pass
802.11b	1Mbps	06	2437	18.35	18.99	21.69	≤ 30.00	Pass
802.11b	1Mbps	11	2462	18.14	18.69	21.43	≤ 30.00	Pass
802.11g	6Mbps	01	2412	15.20	16.01	18.63	≤ 30.00	Pass
802.11g	6Mbps	02	2417	18.51	18.97	21.76	≤ 30.00	Pass
802.11g	6Mbps	06	2437	18.33	18.90	21.63	≤ 30.00	Pass
802.11g	6Mbps	09	2452	18.35	19.15	21.78	≤ 30.00	Pass
802.11g	6Mbps	11	2462	15.91	16.59	19.27	≤ 30.00	Pass
802.11n-HT20	MCS0	01	2412	15.32	16.00	18.68	≤ 30.00	Pass
802.11n-HT20	MCS0	02	2417	18.41	18.96	21.70	≤ 30.00	Pass
802.11n-HT20	MCS0	06	2437	18.04	18.73	21.41	≤ 30.00	Pass
802.11n-HT20	MCS0	10	2457	18.21	18.97	21.62	≤ 30.00	Pass
802.11n-HT20	MCS0	11	2462	14.61	15.76	18.23	≤ 30.00	Pass
802.11n-HT40	MCS0	03	2422	14.11	14.51	17.32	≤ 30.00	Pass
802.11n-HT40	MCS0	04	2427	16.37	16.83	19.62	≤ 30.00	Pass
802.11n-HT40	MCS0	06	2437	18.52	18.97	21.76	≤ 30.00	Pass
802.11n-HT40	MCS0	08	2447	15.33	15.79	18.58	≤ 30.00	Pass
802.11n-HT40	MCS0	09	2452	13.41	14.55	17.03	≤ 30.00	Pass

Note: Total Average Power (dBm) = $10 \cdot \log \{10^{(\text{Ant 0 Average Power} / 10)} + 10^{(\text{Ant 1 Average Power} / 10)}\}$ (dBm).

6.4. Power Spectral Density Measurement

6.4.1. Test Limit

The maximum permissible power spectral density is 8dBm in any 3 kHz band.

The same method of determining the conducted output power shall be used to determine the power spectral density.

6.4.2. Test Procedure Used

ANSI C63.10 - 2013 - Section 11.10.5

6.4.3. Test Setting

1. Measure the duty cycle (x) of the transmitter output signal.
2. Set instrument center frequency to DTS channel center frequency.
3. Set span to at least 1.5 times the OBW.
4. RBW = 10 kHz.
5. VBW = 30 kHz.
6. Detector = RMS.
7. Ensure that the number of measurement points in the sweep $\geq 2 \times \text{span}/\text{RBW}$.
8. Sweep time = auto couple.
9. Don't use sweep triggering. Allow sweep to "free run".
10. Employ trace averaging (RMS) mode over a minimum of 100 traces.
11. Use the peak marker function to determine the maximum amplitude level.
12. Add $10 \log (1/x)$, where x is the duty cycle measured in step (a), to the measured PSD to compute the average PSD during the actual transmission time. If measured value exceeds requirement specified by regulatory agency, then reduce RBW (but no less than 3 kHz) and repeat (note that this may require zooming in on the emission of interest and reducing the span to meet the minimum measurement point requirement as the RBW is reduced).

6.4.4. Test Setup

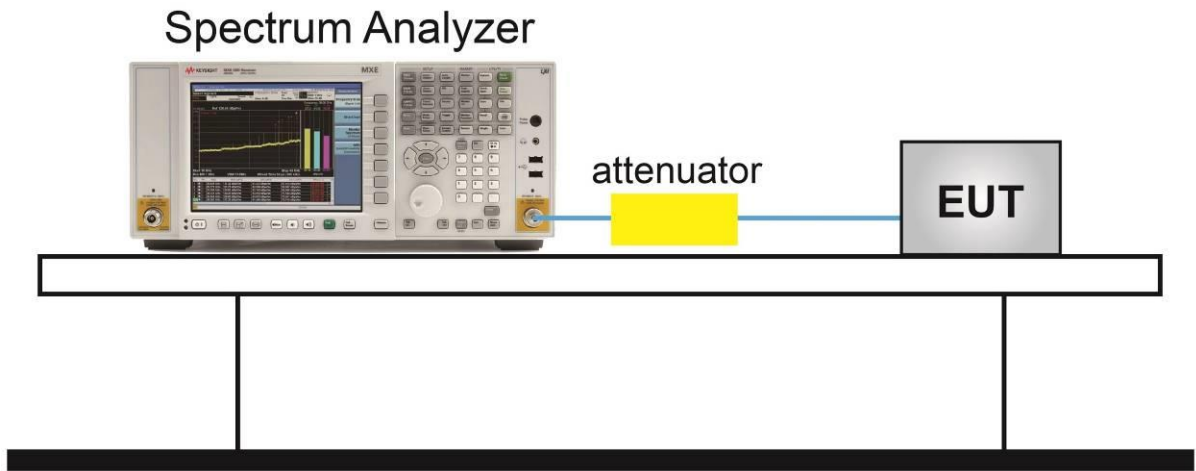

6.4.5. Test Result

Product	AC1200 Wi-Fi Range Extender	Test Engineer	Amy Zhang
Test Site	WZ-TR3	Test Date	2021/01/05

Test Mode	Data Rate/MCS	Channel No.	Freq. (MHz)	Ant 0 PSD (dBm/10kHz)	Ant 1 PSD (dBm/10kHz)	Duty Cycle (%)	10*log (1/x)	Total PSD (dBm/10kHz)	Limit (dBm/3kHz)	Result
CDD Mode										
802.11b	1Mbps	01	2412	-8.06	-6.61	98.15	0.08	-4.26	≤ 8.00	Pass
802.11b	1Mbps	06	2437	-7.23	-6.74	98.15	0.08	-3.97	≤ 8.00	Pass
802.11b	1Mbps	11	2462	-8.23	-8.17	98.15	0.08	-5.19	≤ 8.00	Pass
802.11g	6Mbps	01	2412	-13.16	-13.07	97.42	0.11	-9.99	≤ 8.00	Pass
802.11g	6Mbps	06	2437	-8.71	-8.49	97.42	0.11	-5.47	≤ 8.00	Pass
802.11g	6Mbps	11	2462	-11.07	-11.31	97.42	0.11	-8.06	≤ 8.00	Pass
802.11n-HT20	MCS0	01	2412	-12.79	-13.09	93.70	0.28	-9.64	≤ 8.00	Pass
802.11n-HT20	MCS0	06	2437	-8.87	-8.54	93.70	0.28	-5.41	≤ 8.00	Pass
802.11n-HT20	MCS0	11	2462	-12.33	-11.05	93.70	0.28	-8.35	≤ 8.00	Pass
802.11n-HT40	MCS0	03	2422	-18.04	-17.78	89.01	0.51	-14.39	≤ 8.00	Pass
802.11n-HT40	MCS0	06	2437	-13.35	-12.83	89.01	0.51	-9.57	≤ 8.00	Pass
802.11n-HT40	MCS0	09	2452	-17.81	-17.30	89.01	0.51	-14.03	≤ 8.00	Pass

Note:

When EUT duty cycle > 98%, Total AVGPDS = $10 \cdot \log \{10^{(\text{Ant 0 AVGPDS}/10)} + 10^{(\text{Ant 1 AVGPDS}/10)}\}$

When EUT duty cycle ≤ 98%, Total AVGPDS = $10 \cdot \log \{10^{(\text{Ant 0 AVGPDS}/10)} + 10^{(\text{Ant 1 AVGPDS}/10)}\} + 10 \cdot \log (1/\text{Duty Cycle})$.

802.11b AVGPDS -Ant 0

Channel 01 (2412MHz)

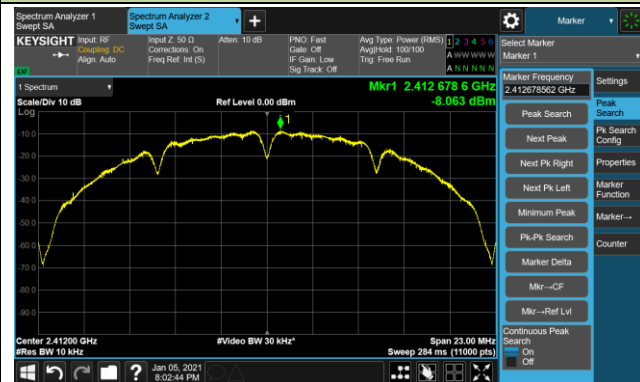

Channel 06 (2437MHz)



Channel 11 (2462MHz)



802.11g - AVGPDS -Ant 0

Channel 01 (2412MHz)

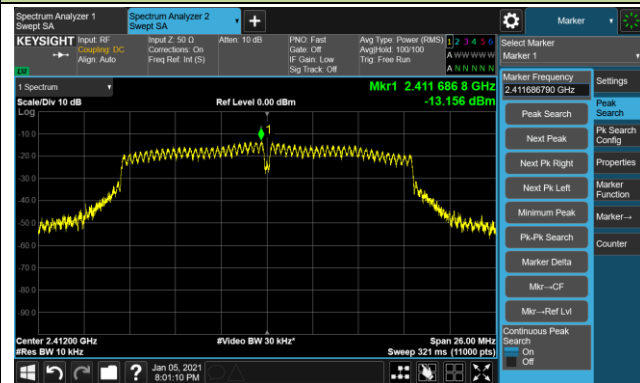

Channel 06 (2437MHz)

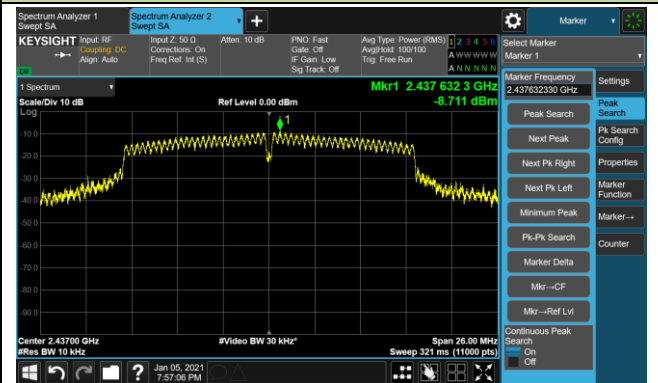

Channel 11 (2462MHz)

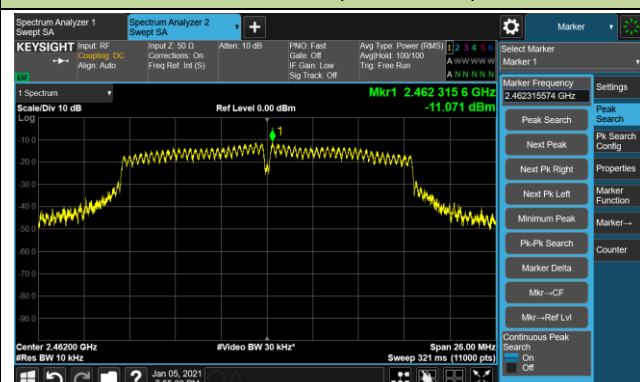

802.11n-HT20 – AVGPSD -Ant 0

Channel 01 (2412MHz)

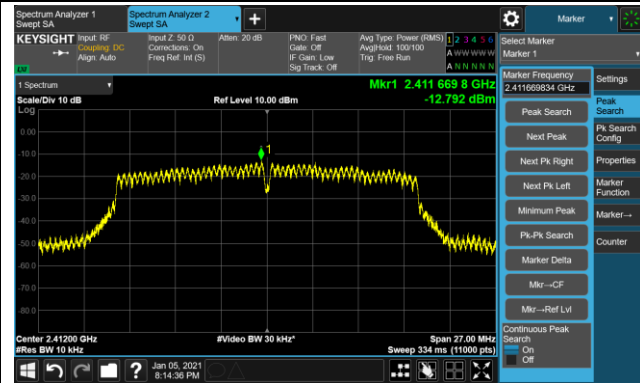

Channel 06 (2437MHz)

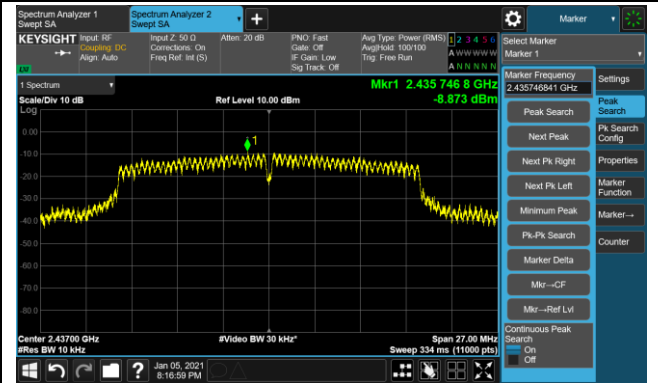

Channel 11 (2462MHz)

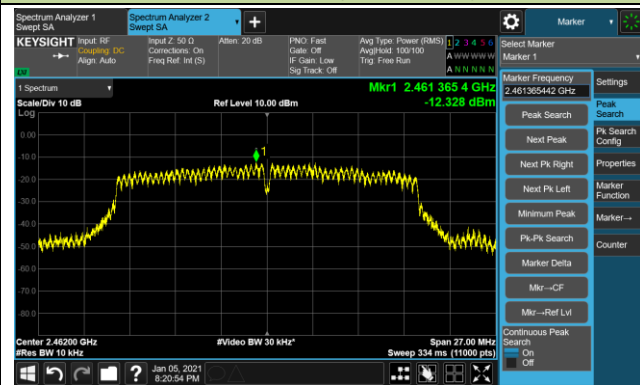

802.11n-HT40 – AVGPSD -Ant 0

Channel 03 (2422MHz)

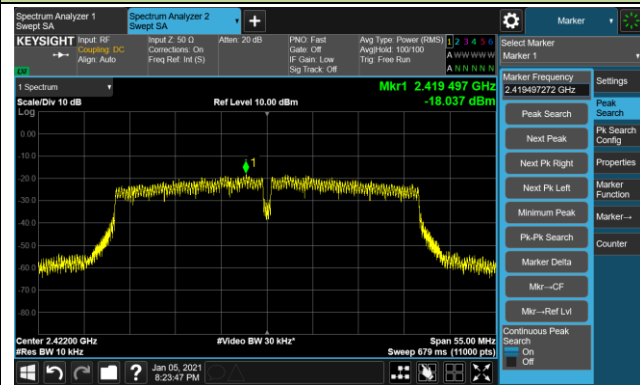

Channel 06 (2437MHz)

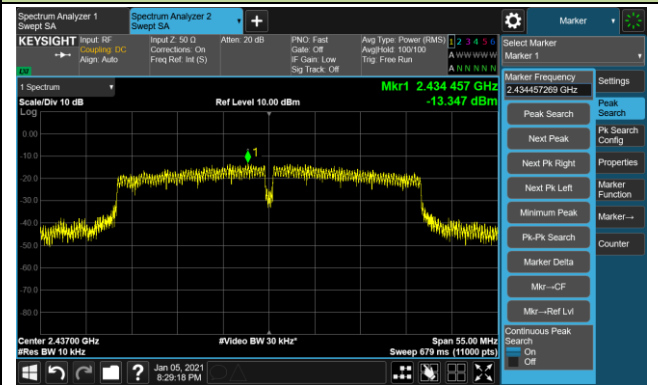

Channel 09 (2452MHz)

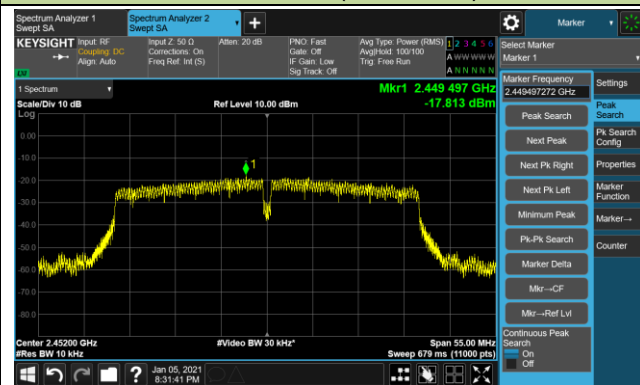

802.11b AVGPDS -Ant 1

Channel 01 (2412MHz)



Channel 06 (2437MHz)



Channel 11 (2462MHz)



802.11g - AVGPDS-Ant 1

Channel 01 (2412MHz)

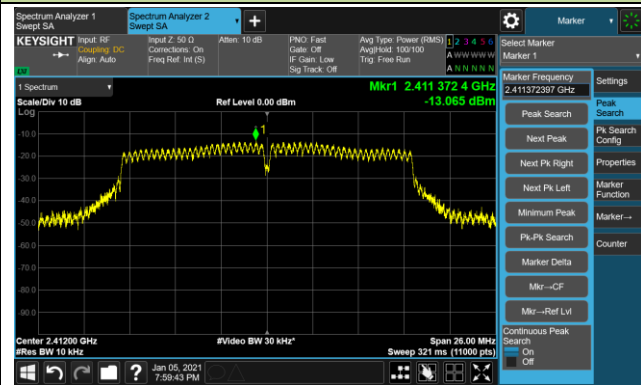

Channel 06 (2437MHz)

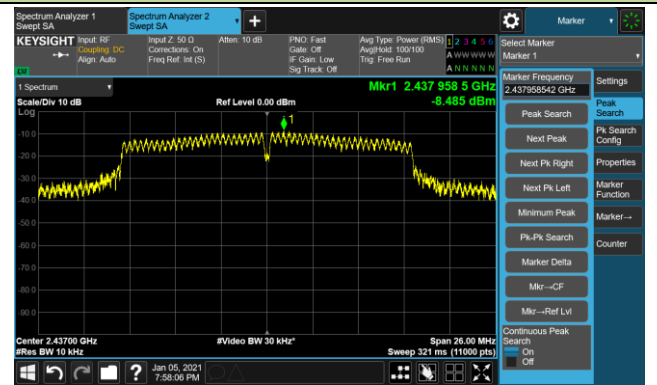

Channel 11 (2462MHz)

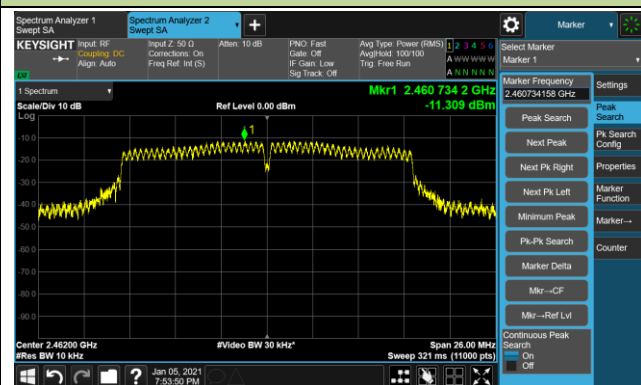

802.11n-HT20 – AVGPSD -Ant 1

Channel 01 (2412MHz)

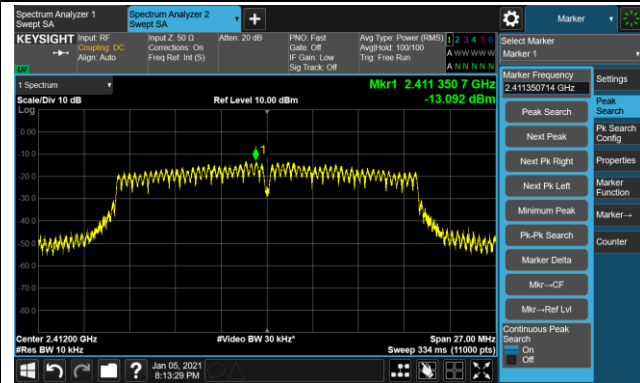

Channel 06 (2437MHz)

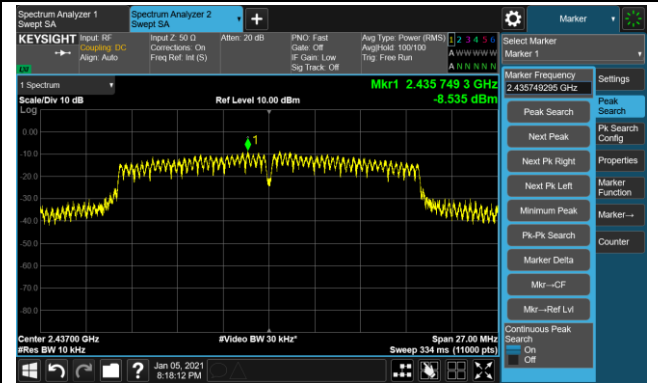

Channel 11 (2462MHz)

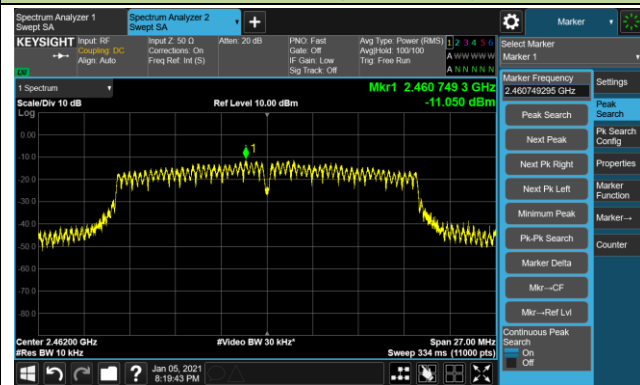

802.11n-HT40 – AVGPSD -Ant 1

Channel 03 (2422MHz)

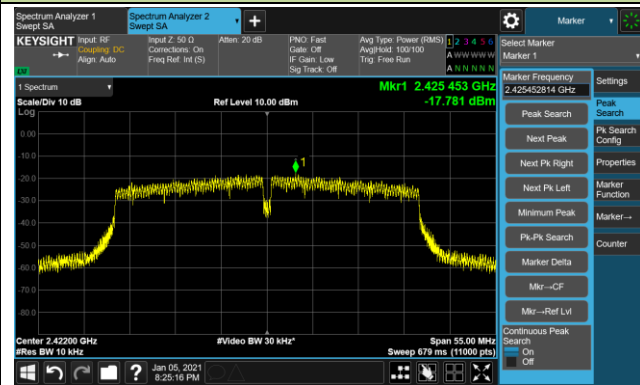

Channel 06 (2437MHz)

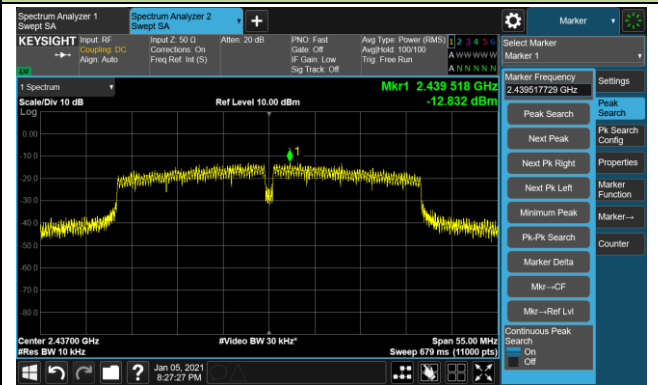

Channel 09 (2452MHz)

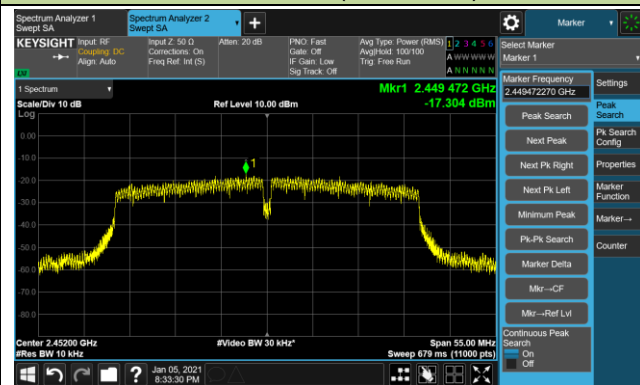

6.5. Conducted Band Edge and Out-of-Band Emissions

6.5.1. Test Limit

The limit for out-of-band spurious emissions at the band edge is 30dB below the fundamental emission level, as determined from the in-band power measurement of the DTS channel performed in a 100 kHz bandwidth per the PSD procedure.

6.5.2. Test Procedure Used

ANSI C63.10-2013 - Section 11.11

6.5.3. Test Setting

Reference level measurement

1. Set instrument center frequency to DTS channel center frequency
2. Set the span to ≥ 1.5 times the DTS bandwidth
3. Set the RBW = 100 kHz
4. Set the VBW $\geq 3 \times$ RBW
5. Detector = peak
6. Sweep time = auto couple
7. Trace mode = max hold
8. Allow trace to fully stabilize

Emission level measurement

1. Set the center frequency and span to encompass frequency range to be measured
2. RBW = 100kHz
3. VBW = 300kHz
4. Detector = Peak
5. Trace mode = max hold
6. Sweep time = auto couple
7. The trace was allowed to stabilize

6.5.4. Test Setup

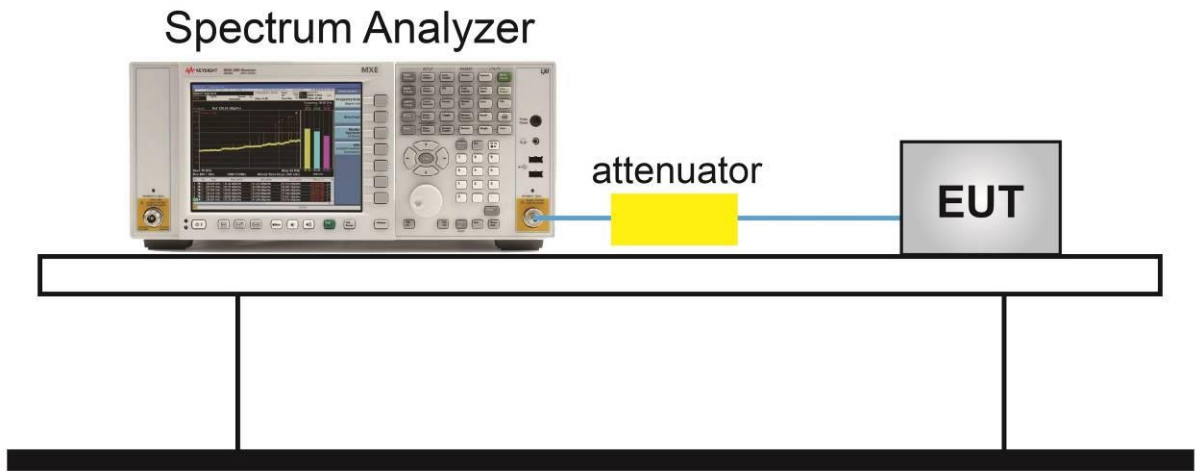

6.5.5. Test Result

Product	AC1200 Wi-Fi Range Extender	Test Engineer	Amy Zhang
Test Site	WZ-TR3	Test Date	2021/01/05

Test Mode	Data Rate / MCS	Channel No.	Frequency (MHz)	Limit	Result
802.11b	1Mbps	01	2412	30dBc	Pass
802.11b	1Mbps	06	2437	30dBc	Pass
802.11b	1Mbps	11	2462	30dBc	Pass
802.11g	6Mbps	01	2412	30dBc	Pass
802.11g	6Mbps	06	2437	30dBc	Pass
802.11g	6Mbps	11	2462	30dBc	Pass
802.11n-HT20	MCS0	01	2412	30dBc	Pass
802.11n-HT20	MCS0	06	2437	30dBc	Pass
802.11n-HT20	MCS0	11	2462	30dBc	Pass
802.11n-HT40	MCS0	03	2422	30dBc	Pass
802.11n-HT40	MCS0	06	2437	30dBc	Pass
802.11n-HT40	MCS0	09	2452	30dBc	Pass

802.11b Out-of-Band Emissions -Ant 0

Channel 01 (2412MHz)

100kHz PSD Reference Level

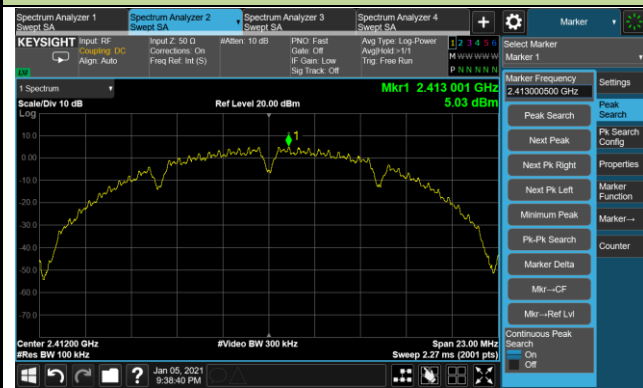

Low Band Edge

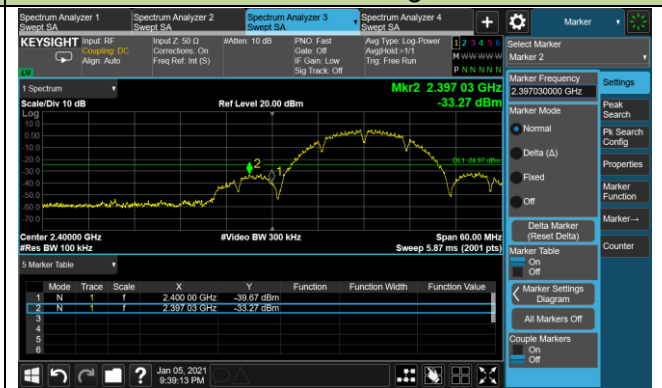

Spurious Emission

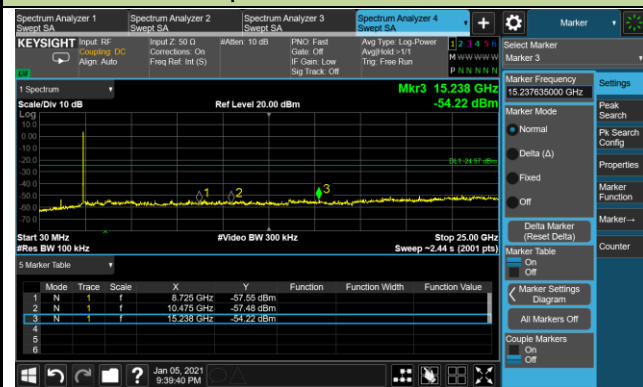

Channel 06 (2437MHz)

100kHz PSD Reference Level



Spurious Emission

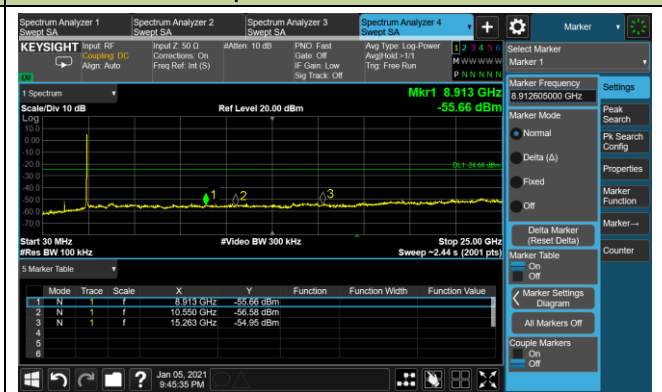

802.11b Out-of-Band Emissions -Ant 0

Channel 11 (2462MHz)

100kHz PSD Reference Level

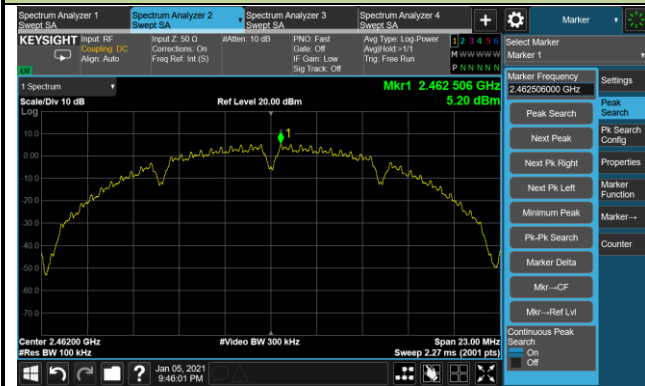

High Band Edge

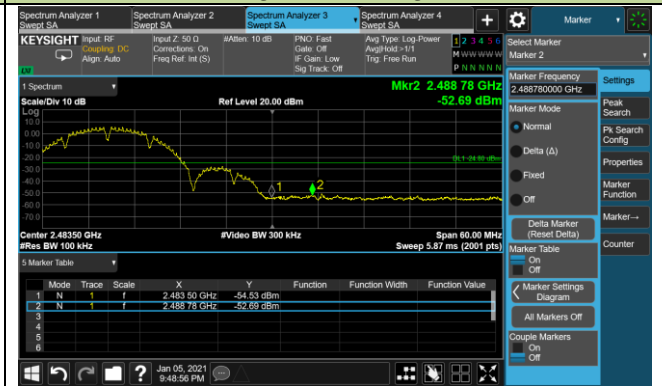

Spurious Emission

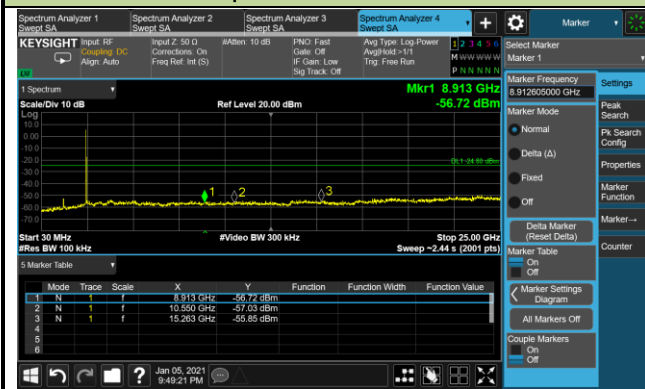

802.11g Out-of-Band Emissions -Ant 0

Channel 01 (2412MHz)

100kHz PSD Reference Level



Low Band Edge



Spurious Emission

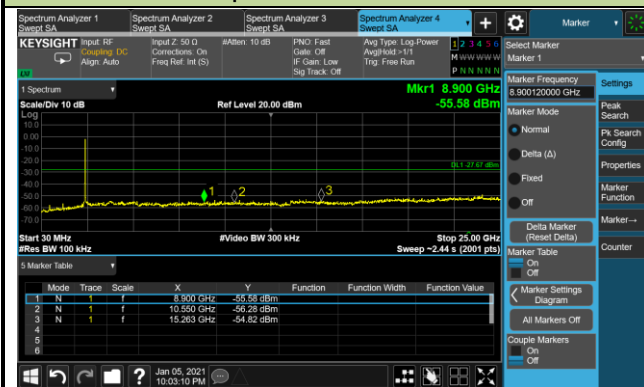

Channel 06 (2437MHz)

100kHz PSD Reference Level

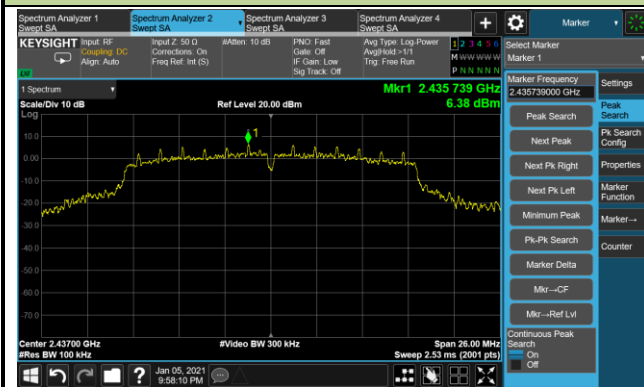

Spurious Emission

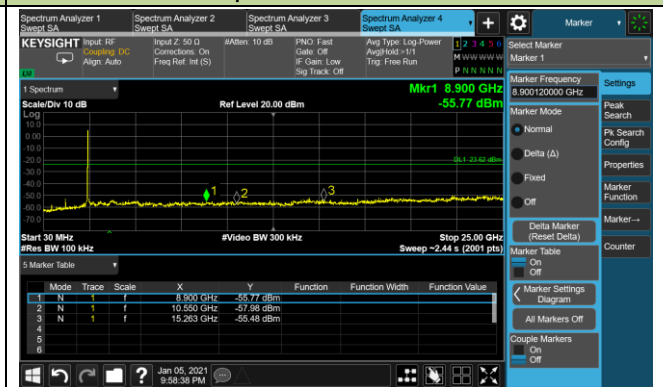

802.11g Out-of-Band Emissions -Ant 0
Channel 11 (2462MHz)

100kHz PSD Reference Level

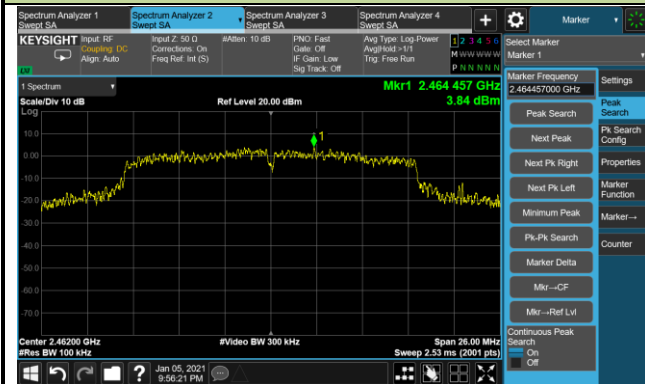

High Band Edge

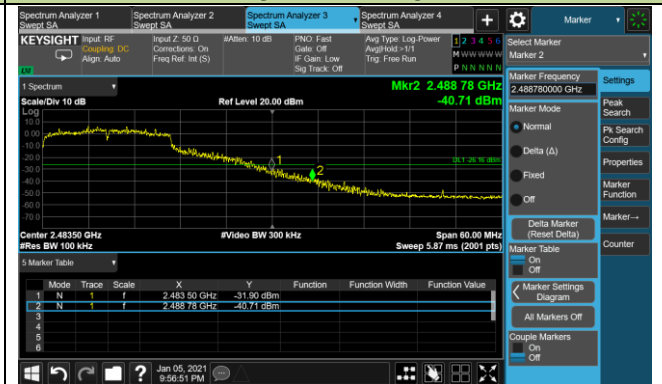

Spurious Emission

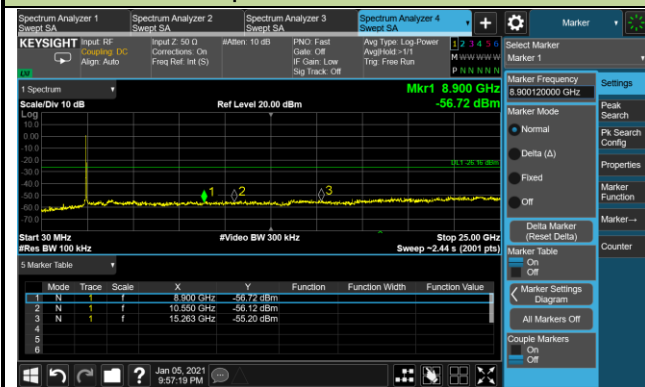

802.11n-HT20 Out-of-Band Emissions -Ant 0

Channel 01 (2412MHz)

100kHz PSD Reference Level



Low Band Edge

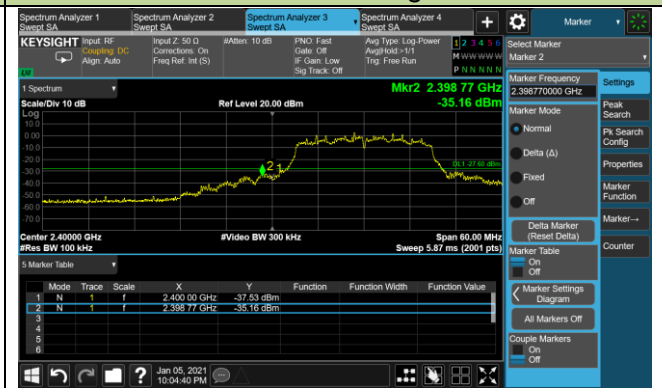

Spurious Emission

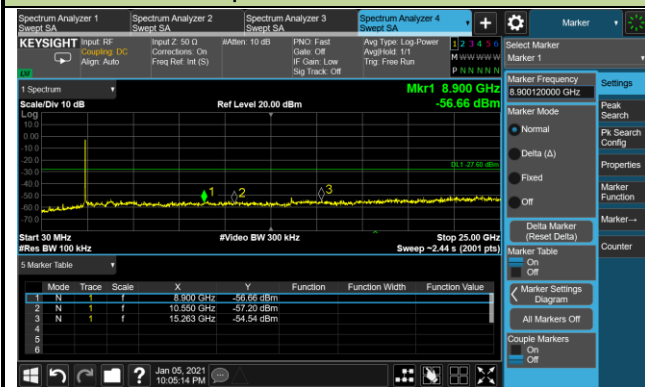

Channel 06 (2437MHz)

100kHz PSD Reference Level

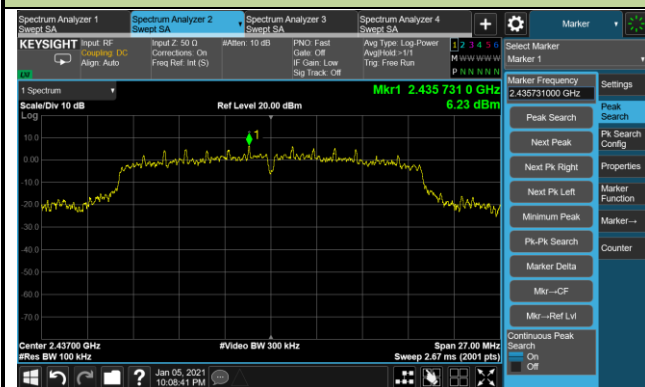

Spurious Emission

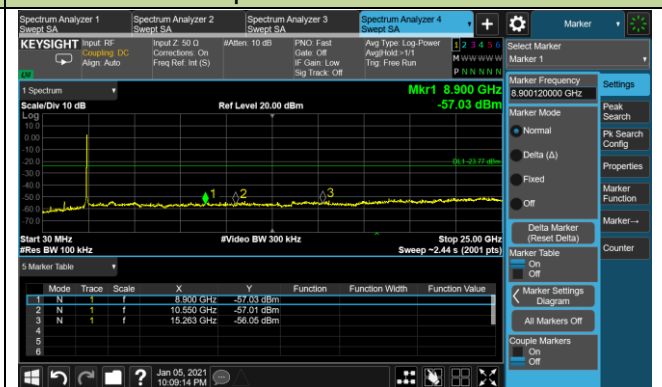

802.11n-HT20 Out-of-Band Emissions -Ant 0
Channel 11 (2462MHz)

100kHz PSD Reference Level

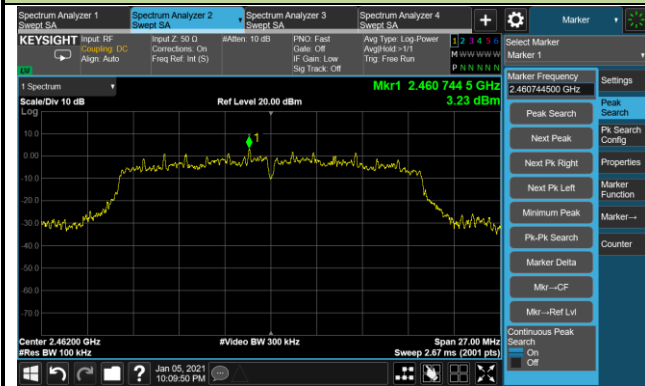

High Band Edge

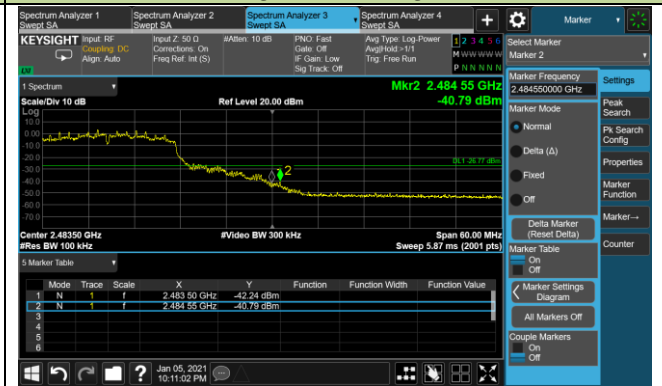

Spurious Emission

