



# DYNAMIC FREQUENCY SELECTION

## DFS Test Report (Extender Mode)

**APPLICANT** : TP-Link Technologies Co., Ltd.  
**EQUIPMENT** : AC1200 Wi-Fi Range Extender  
**BRAND NAME** : TP-Link  
**MODEL NAME** : RE305  
**FCC ID** : TE7RE305  
**STANDARD** : FCC Part 15 Subpart E  
**CLASSIFICATION** : (NII) Unlicensed National Information Infrastructure

The product was received on Sep. 02, 2016 and completely tested on Dec. 12, 2016. We, SPORTON INTERNATIONAL INC., would like to declare that the tested sample has been evaluated in accordance with the procedures and shown to be compliant with the applicable technical standards.

The test results in this report apply exclusively to the tested model / sample. Without written approval of SPORTON INTERNATIONAL INC., the test report shall not be reproduced except in full.

Reviewed by: Joseph Lin / Supervisor

Approved by: Jones Tsai / Manager



### **SPORTON INTERNATIONAL INC.**

No. 52, Hwa Ya 1<sup>st</sup> Rd., Hwa Ya Technology Park, Kwei-Shan District, Tao Yuan City, Taiwan, R.O.C.

SPORTON INTERNATIONAL INC.

TEL : 886-3-327-3456

FAX : 886-3-328-4978

FCC ID : TE7RE305

Page Number : 1 of 55

Report Issued Date : Feb. 15, 2017

Report Version : Rev. 01



# TABLE OF CONTENTS

**REVISION HISTORY..... 3**

**SUMMARY OF DYNAMIC FREQUENCY SELECTION TEST..... 4**

**1 GENERAL DESCRIPTION ..... 5**

    1.1 Applicant ..... 5

    1.2 Manufacturer ..... 5

    1.3 Feature of Equipment Under Test ..... 5

    1.4 Product Specification of Equipment Under Test ..... 5

    1.5 Testing Site ..... 6

    1.6 Applied Standards ..... 6

    1.7 Support Unit used in test configuration and system ..... 6

**2 REQUIREMENTS AND PARAMETERS FOR DFS TEST ..... 7**

    2.1 Applicability of DFS Requirements ..... 7

    2.2 DFS Detection Thresholds ..... 9

    2.3 DFS Response requirement values ..... 10

    2.4 Short Pulse Radar Test Waveforms ..... 11

    2.5 Long Pulse Radar Test Waveform ..... 13

    2.6 Frequency Hopping Radar Test Waveform ..... 15

**3 CALIBRATION SETUP AND DFS TEST RESULTS ..... 16**

    3.1 Calibration of Radar Waveform ..... 16

    3.2 U-NII Detection Bandwidth (7.8.1) ..... 23

    3.3 Channel Availability Check (7.8.2) ..... 30

    3.4 In-Service Monitoring: Channel Move Time, Channel Closing Transmission Time and  
    Non-Occupancy Period (7.8.3) ..... 31

    3.5 Statistical Performance Check (7.8.4) ..... 41

**4 LIST OF MEASURING EQUIPMENT ..... 55**

**APPENDIX A. RADAR PARAMETERS**

**APPENDIX B. SETUP PHOTOGRAPHS**





## SUMMARY OF DYNAMIC FREQUENCY SELECTION TEST

UNII	Description	Limit	Result
U-NII Band 2-A 5250-5350MHz	Channel Availability Check Time	> 60sec	N.R.
	U-NII Detection Bandwidth	> 100% of the U-NII 99% transmission power bandwidth	Pass
	Statistical Performance Check	Type 1,2,3,4 >= 60% Type 1~4 and 5 >= 80% Type 6 >= 70%	Pass
	Channel Move Time	< 10 sec	Pass
	Channel Closing Transmission Time	< 200 ms + aggregate of 60 ms over remaining 10 s period	Pass
	Non-Occupancy Period Test	> 30 minutes	Pass
U-NII Band 2-C 5470-5725MHz	Channel Availability Check Time	> 60sec	N.R.
	U-NII Detection Bandwidth	> 100% of the U-NII 99% transmission power bandwidth	Pass
	Statistical Performance Check	Type 1,2,3,4 >= 60% Type 1~4 and 5 >= 80% Type 6 >= 70%	Pass
	Channel Move Time	< 10 sec	Pass
	Channel Closing Transmission Time	< 200 ms + aggregate of 60 ms over remaining 10 s period	Pass
	Non-Occupancy Period Test	> 30 minutes	Pass

N.R. : Not Required.



# 1 General Description

## 1.1 Applicant

**TP-Link Technologies Co., Ltd.**

Building 24 (floors 1,3,4,5) and 28 (floors1-4) Central Science and Technology Park, Shennan Rd, Nanshan, Shenzhen, China

## 1.2 Manufacturer

**TP-Link Technologies Co., Ltd.**

Building 24 (floors 1,3,4,5) and 28 (floors1-4) Central Science and Technology Park, Shennan Rd, Nanshan, Shenzhen, China

## 1.3 Feature of Equipment Under Test

Product Feature	
<b>Equipment</b>	AC1200 Wi-Fi Range Extender
<b>Brand Name</b>	TP-Link
<b>Model Name</b>	RE305
<b>FCC ID</b>	TE7RE305
<b>EUT supports Radios application</b>	WLAN 11a/b/g/n HT20/40 WLAN 11ac VHT20/40/80
<b>EUT Stage</b>	Identical Prototype

**Remark:** The above EUT's information was declared by manufacturer. Please refer to the specifications or user's manual for more detailed description.

## 1.4 Product Specification of Equipment Under Test

Product Specification subjective to this standard	
<b>DFS Function</b>	Client with radar detection (Extender Mode)
<b>Tx/Rx Channel Frequency Range</b>	5260 MHz ~ 5320 MHz 5500 MHz ~ 5700 MHz
<b>EUT support WLAN function</b>	<b>&lt;5260 MHz ~ 5320 MHz&gt;</b> 802.11a 802.11n HT20/40 802.11ac VHT20/40/80 <b>&lt;5500 MHz ~ 5700 MHz &gt;</b> 802.11a 802.11n HT20/40 802.11ac VHT20/40/80
<b>Type of Modulation</b>	802.11a/n: OFDM (BPSK / QPSK / 16QAM / 64QAM) 802.11ac: OFDM (BPSK / QPSK / 16QAM / 64QAM / 256QAM)



### 1.5 Testing Site

<b>Test Site</b>	SPORTON INTERNATIONAL INC.
<b>Test Site Location</b>	No. 52, Hwa Ya 1 <sup>st</sup> Rd., Hwa Ya Technology Park, Kwei-Shan Hsiang, Tao Yuan Hsien, Taiwan, R.O.C. TEL: +886-3-3273456 / FAX: +886-3-3284978
<b>Test Site No.</b>	<b>Sporton Site No.</b>
	DFS02-HY

### 1.6 Applied Standards

According to the specifications of the manufacturer, the EUT must comply with the requirements of the following standards:

- ♦ FCC Part 15 Subpart E
- ♦ FCC KDB 905462 D02 UNII DFS Compliance Procedures New Rules v02
- ♦ FCC KDB 905462 D04 Operational Modes for DFS Testing New Rules v01

**Remark:** All test items were verified and recorded according to the standards and without any deviation during the test.

### 1.7 Support Unit used in test configuration and system

Item	Equipment	Trade Name	Model Name	FCC ID
1.	Notebook	Lenovo	Edge E335	PPD-AR5B95
2.	WLAN Dongle	Linksys	AE6000	Q87-AE6000
3.	WiFi AP	Cisco	Air-AP3702E-A-K9	LDK102087



## 2 Requirements and Parameters for DFS Test

### 2.1 Applicability of DFS Requirements

EUT is considered as a client with radar detection device.

**Table 1: Applicability of DFS Requirements Prior to Use of a Channel**

Requirement	Operational Mode		
	Master	Client Without Radar Detection	Client With Radar Detection
Non-Occupancy Period	Yes	Not required	Yes
DFS Detection Threshold	Yes	Not required	Yes
Channel Availability Check Time	Yes	Not required	Not required
U-NII Detection Bandwidth	Yes	Not required	Yes

**Table 2: Applicability of DFS requirements during normal operation**

Requirement	Operational Mode		
	Master	Client Without Radar Detection	Client With Radar Detection
DFS Detection Threshold	Yes	Not required	Yes
Channel Closing Transmission Time	Yes	Yes	Yes
Channel Move Time	Yes	Yes	Yes
U-NII Detection Bandwidth	Yes	Not required	Yes
Client Beacon Test	Not required	Yes	Not required



Additional requirements for devices with multiple bandwidth modes	Operational Mode	
	Master or Client With Radar Detection	Client Without Radar Detection
U-NII Detection Bandwidth and Statistical Performance Check	All BW modes must be tested	Not required
Channel Move Time and Channel Closing Transmission Time	Test using widest BW mode available	Test using the widest BW mode available for the link
All other tests	Any single BW mode	Not required

**Note**  
Frequencies selected for statistical performance check (Section 7.8.4) should include several frequencies within the radar detection bandwidth and frequencies near the edge of the radar detection bandwidth. For 802.11 devices it is suggested to select frequencies in each of the bonded 20 MHz channels and the channel center frequency.





## 2.2 DFS Detection Thresholds

Table 3 below provides the DFS Detection Thresholds for Master Devices as well as Client Devices incorporating In-Service Monitoring.

**Table 3: DFS Detection Thresholds for Master Devices**

Maximum Transmit Power	Value (see notes 1, 2, and 3)
EIRP ≥ 200 milliwatt	-64 dBm
EIRP < 200 milliwatt and power spectral density < 10 dBm/MHz	-62 dBm
EIRP < 200 milliwatt that do not meet the power spectral density requirement	-64 dBm
<p><b>Note 1:</b> This is the level at the input of the receiver assuming a 0 dBi receive antenna.</p> <p><b>Note 2:</b> Throughout these test procedures an additional 1 dB has been added to the amplitude of the test transmission waveforms to account for variations in measurement equipment. This will ensure that the test signal is at or above the detection threshold level to trigger a DFS response.</p> <p><b>Note 3:</b> EIRP is based on the highest antenna gain. For MIMO devices refer to KDB Publication 662911 D01.</p>	

The radar *Detection Threshold*, lowest antenna gain is the parameter of Interference *radar DFS detection threshold*, The Interference *Detection Threshold* is the ( -64dBm) + (3) [dBi]+ 1 dB= -60 dBm.



## 2.3 DFS Response requirement values

Table 4 provides the response requirements for Master and Client Devices incorporating DFS.

**Table 4: DFS Response Requirement Values**

Parameter	Value
<i>Non-occupancy period</i>	Minimum 30 minutes
<i>Channel Availability Check Time</i>	60 seconds
<i>Channel Move Time</i>	10 seconds See Note 1.
<i>Channel Closing Transmission Time</i>	200 milliseconds + an aggregate of 60 milliseconds over remaining 10 second period. See Notes 1 and 2.
<i>U-NII Detection Bandwidth</i>	Minimum 100% of the 99% power bandwidth See Note 3.

**Note 1:** *Channel Move Time* and the *Channel Closing Transmission Time* should be performed with Radar Type 0. The measurement timing begins at the end of the Radar Type 0 burst.

**Note 2:** The *Channel Closing Transmission Time* is comprised of 200 milliseconds starting at the beginning of the *Channel Move Time* plus any additional intermittent control signals required to facilitate *Channel* changes (an aggregate of 60 milliseconds) during the remainder of the 10 second period. The aggregate duration of control signals will not count quiet periods in between transmissions.

**Note 3:** During the *U-NII Detection Bandwidth* detection test, radar type 0 is used and for each frequency step the minimum percentage of detection is 90%. Measurements are performed with no data traffic.



## 2.4 Short Pulse Radar Test Waveforms

Radar Type 0 was used in the evaluation of the Client device for the purpose of measuring the Channel Move Time and the Channel Closing Transmission Time.

Radar Type	Pulse Width (μsec)	PRI (μsec)	Number of Pulses	Minimum Percentage of Successful Detection	Minimum Trials
0	1	1428	18	See Note 1.	See Note 1.
1	1	Test A Test B	Roundup $\left\{ \left( \frac{1}{360} \right) \cdot \left( \frac{19 \cdot 10^6}{PRI_{\mu sec}} \right) \right\}$	60%	30
2	1-5	150-230	23-29	60%	30
3	6-10	200-500	16-18	60%	30
4	11-20	200-500	12-16	60%	30
Aggregate (Radar Types 1-4)				80%	120
<p><b>Note 1:</b> Short Pulse Radar Type 0 should be used for the detection bandwidth test, channel move time, and channel closing time tests.</p>					

Test A: 15 unique PRI values randomly selected from the list of 23 PRI values in Table 5a

Test B: 15 unique PRI values randomly selected within the range of 518-3066 μsec, with a minimum increment of 1 μsec, excluding PRI values selected in Test A

A minimum of 30 unique waveforms are required for each of the Short Pulse Radar Types 2 through 4. If more than 30 waveforms are used for Short Pulse Radar Types 2 through 4, then each additional waveform must also be unique and not repeated from the previous waveforms.

If more than 30 waveforms are used for Short Pulse Radar Type 1, then each additional waveform is generated with Test B and must also be unique and not repeated from the previous waveforms in Tests A or B.

The aggregate is the average of the percentage of successful detections of short pulse radar types 1-4.



Table 5a - Pulse Repetition Intervals Values for Test A

Pulse Repetition Frequency Number (1 to 23)	Pulse Repetition Frequency (Pulses Per Second)	Pulse Repetition Interval (Microseconds)
1	1930.5	518
2	1858.7	538
3	1792.1	558
4	1730.1	578
5	1672.2	598
6	1618.1	618
7	1567.4	638
8	1519.8	658
9	1474.9	678
10	1432.7	698
11	1392.8	718
12	1355.0	738
13	1319.3	758
14	1285.3	778
15	1253.1	798
16	1222.5	818
17	1193.3	838
18	1165.5	858
19	1139.0	878
20	1113.6	898
21	1089.3	918
22	1066.1	938
23	326.2	3066



## 2.5 Long Pulse Radar Test Waveform

Radar Type	Pulse Width (µsec)	Chirp Width (MHz)	PRI (µsec)	Number of Pulses per Burst	Number of Bursts	Minimum Percentage of Successful Detection	Minimum Trials
5	50-100	5-20	1000-2000	1-3	8-20	80%	30

The parameters for this waveform are randomly chosen. Thirty unique waveforms are required for the Long Pulse radar test signal. If more than 30 waveforms are used for the Long Pulse radar test signal, then each additional waveform must also be unique and not repeated from the previous waveforms. Each waveform is defined as follows:

Note: The center frequency for each of the 30 trials of the Bin 5 radar shall be randomly selected within 80% of the Occupied Bandwidth.

- (1) The transmission period for the Long Pulse Radar test signal is 12 seconds.
- (2) There are a total of 8 to 20 Bursts in the 12 second period, with the number of Bursts being randomly chosen. This number is Burst\_Count.
- (3) Each Burst consists of 1 to 3 pulses, with the number of pulses being randomly chosen. Each Burst within the 12 second sequence may have a different number of pulses.
- (4) The pulse width is between 50 and 100 microseconds, with the pulse width being randomly chosen. Each pulse within a Burst will have the same pulse width. Pulses in different Bursts may have different pulse widths.
- (5) Each pulse has a linear frequency modulated chirp between 5 and 20 MHz, with the chirp width being randomly chosen. Each pulse within a **transmission period** will have the same chirp width. The chirp is centered on the pulse. For example, with a radar frequency of 5300 MHz and a 20 MHz chirped signal, the chirp starts at 5290 MHz and ends at 5310 MHz
- (6) If more than one pulse is present in a Burst, the time between the pulses will be between 1000 and 2000 microseconds, with the time being randomly chosen. If three pulses are present in a Burst, the time between the first and second pulses is chosen independently of the time between the second and third pulses.
- (7) The 12 second transmission period is divided into even intervals. The number of intervals is equal to Burst\_Count. Each interval is of length  $(12,000,000 / \text{Burst\_Count})$  microseconds. Each interval contains one Burst. The start time for the Burst, relative to the beginning of the interval, is between 1 and  $[(12,000,000 / \text{Burst\_Count}) - (\text{Total Burst Length}) + (\text{One Random PRI Interval})]$  microseconds, with the start time being randomly chosen. The step interval for the start time is 1 microsecond. The start time for each Burst is chosen independently.

**A representative example of a Long Pulse radar test waveform:**

- (1) The total test signal length is 12 seconds.
- (2) 8 Bursts are randomly generated for the Burst\_Count.
- (3) Burst 1 has 2 randomly generated pulses.
- (4) The pulse width (for both pulses) is randomly selected to be 75 microseconds.
- (5) The PRI is randomly selected to be at 1213 microseconds.
- (6) Bursts 2 through 8 are generated using steps 3 – 5.
- (7) Each Burst is contained in even intervals of 1,500,000 microseconds. The starting location for Pulse 1, Burst 1 is randomly generated (1 to 1,500,000 minus the total Burst 1 length + 1 random PRI interval) at the 325,001 microsecond step. Bursts 2 through 8 randomly fall in successive 1,500,000 microsecond intervals (i.e. Burst 2 falls in the 1,500,001 – 3,000,000 microsecond range).

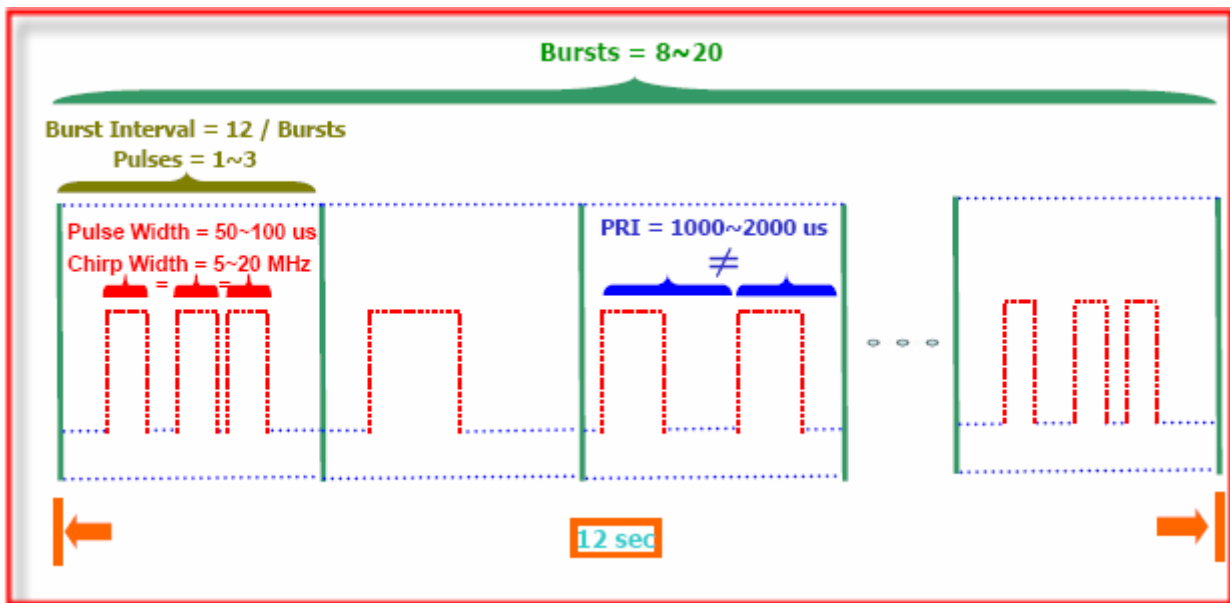

## 2.6 Frequency Hopping Radar Test Waveform

Radar Type	Pulse Width (μsec)	PRI (μsec)	Pulses per Hop	Hopping Rate (kHz)	Hopping Sequence Length (msec)	Minimum Percentage of Successful Detection	Minimum Trials
6	1	333	9	0.333	300	70%	30

For the Frequency Hopping Radar Type, the same Burst parameters are used for each waveform. The hopping sequence is different for each waveform and a 100-length segment is selected from the hopping sequence defined by the following algorithm:

The first frequency in a hopping sequence is selected randomly from the group of 475 integer frequencies from 5250 – 5724 MHz. Next, the frequency that was just chosen is removed from the group and a frequency is randomly selected from the remaining 474 frequencies in the group. This process continues until all 475 frequencies are chosen for the set. For selection of a random frequency, the frequencies remaining within the group are always treated as equally likely.

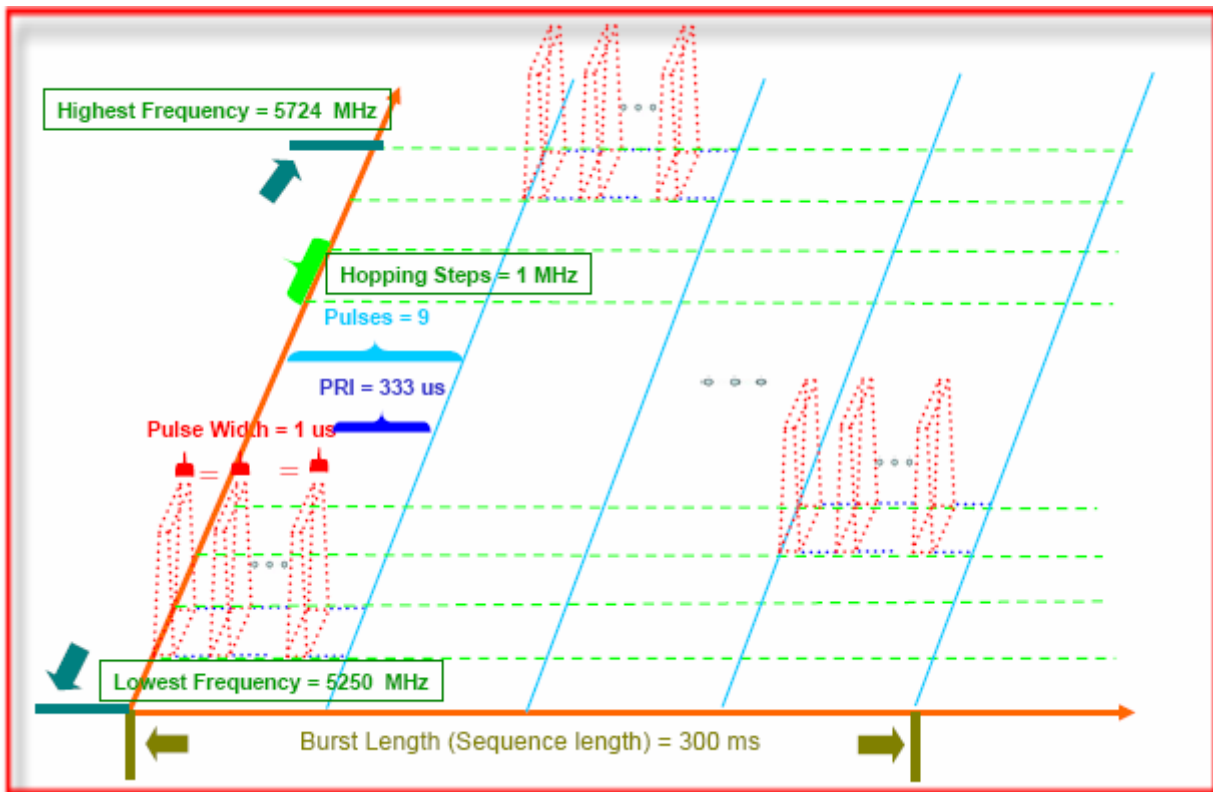

### 3 Calibration Setup and DFS Test Results

#### 3.1 Calibration of Radar Waveform

##### 3.1.1 Radar Waveform Calibration Procedure

The Interference Radar Detection Threshold Level is  $(-64) + (3) \text{ [dBi]} + 1\text{ dB} = -60 \text{ dBm}$  that had been taken into account the output power range and antenna gain. The following equipment setup was used to calibrate the radiated Radar Waveform. A vector signal generator was utilized to establish the test signal level for radar type 0~6. During this process there were no transmissions by the Master, Extender or Client Device. The spectrum analyzer was switched to the zero span (Time Domain) at the frequency of the Radar Waveform generator. Peak detection was used. The spectrum analyzer resolution bandwidth (RBW) and video bandwidth (VBW) were set to 3 MHz to measure the radar waveform. The vector signal generator amplitude was set so that the power level measured at the spectrum analyzer was  $(-64) + (3) \text{ [dBi]} + 1\text{ dB} = -60 \text{ dBm}$ . Capture the spectrum analyzer plots on radar waveform.

##### 3.1.2 Conducted Calibration Setup

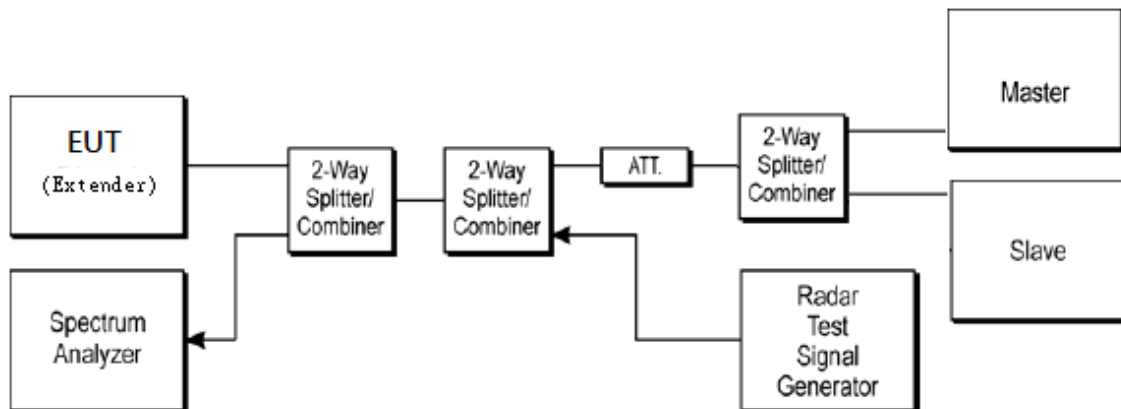

##### 3.1.3 Calibration Deviation

There is no deviation with the original standard.





### 3.1.4 Radar Waveform Calibration Result

<20MHz / 5300MHz>

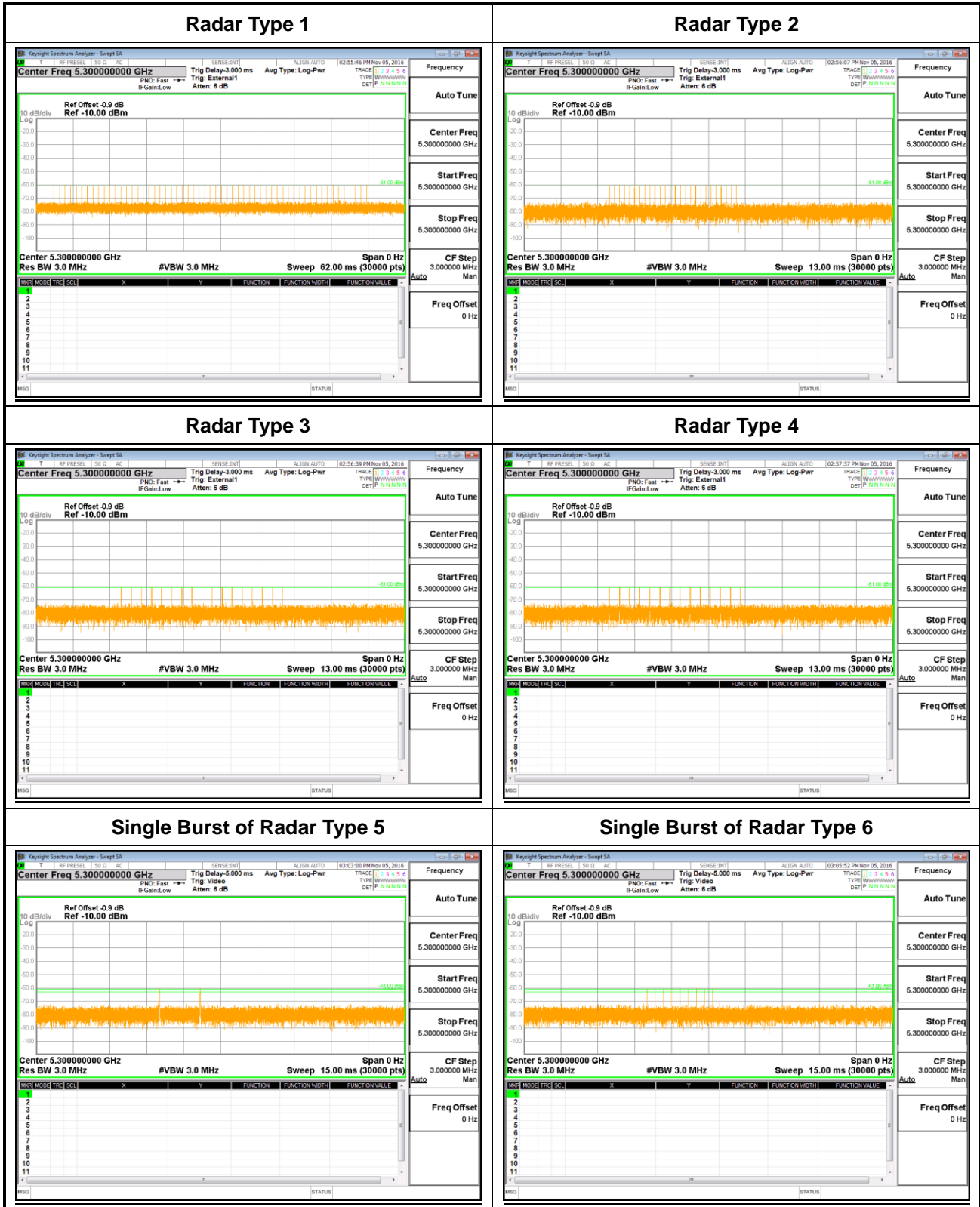



<40MHz / 5310MHz>

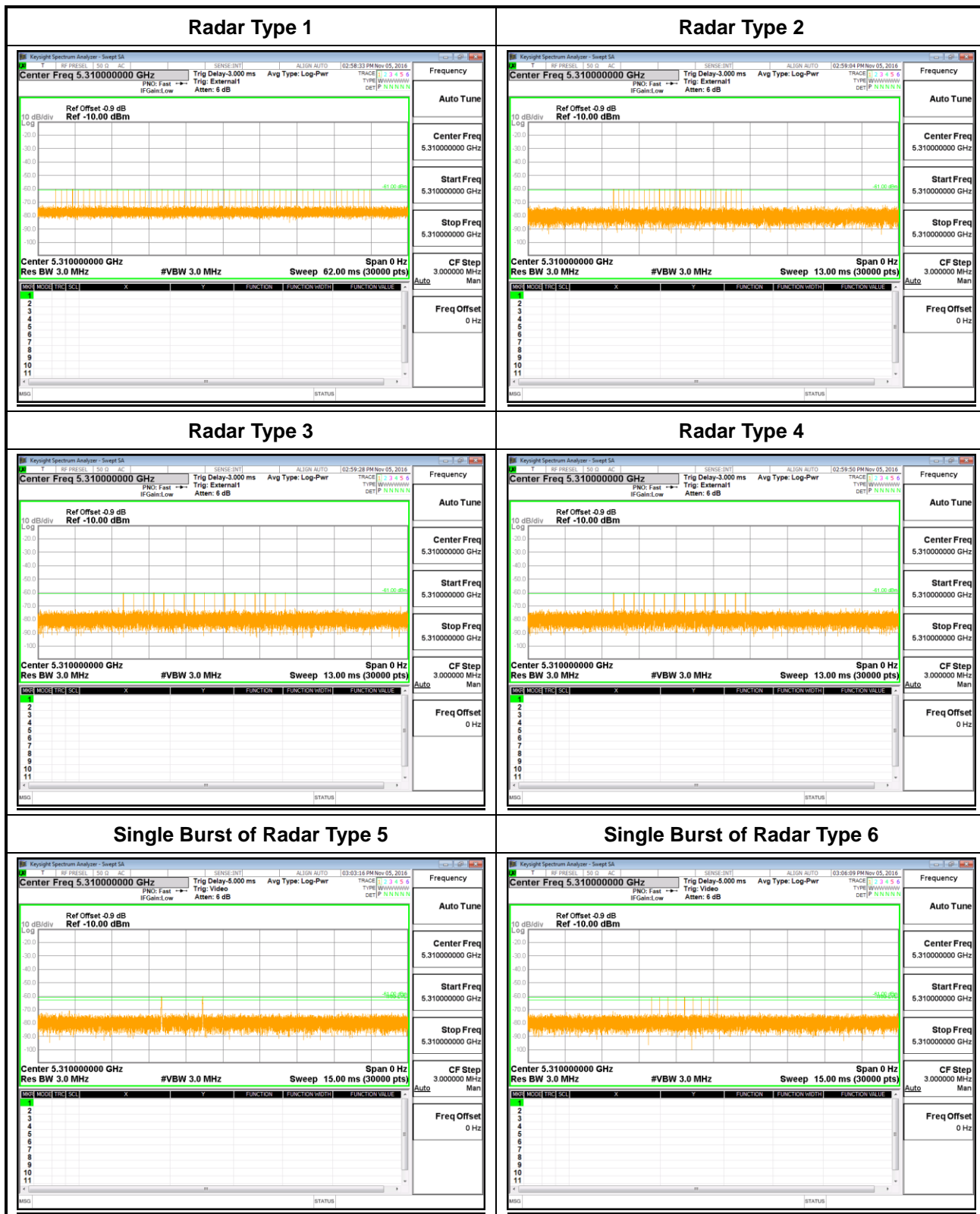



<80MHz / 5290MHz>

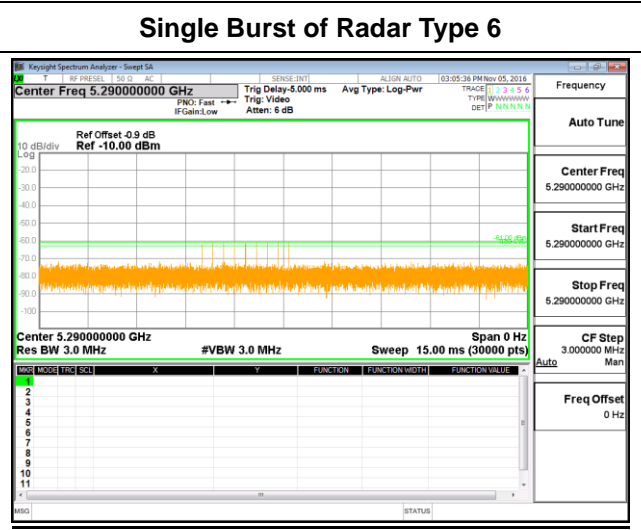
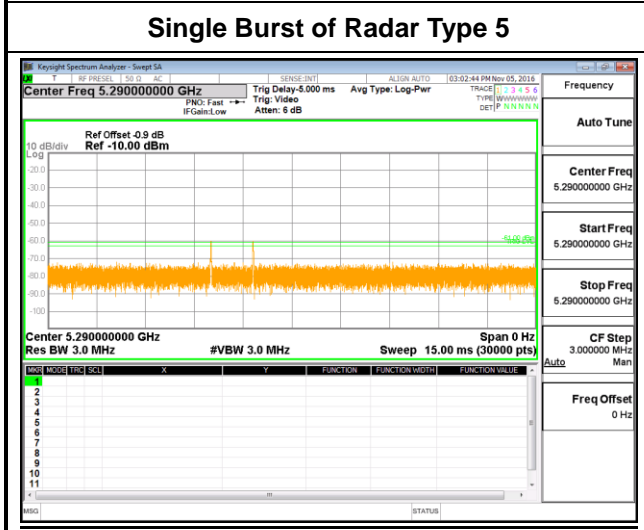
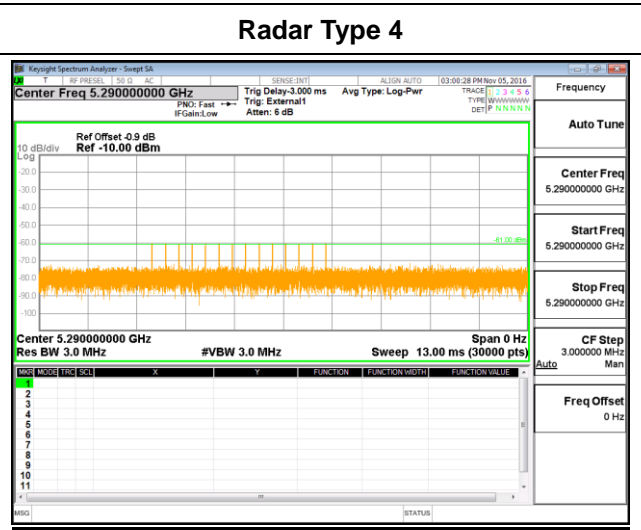
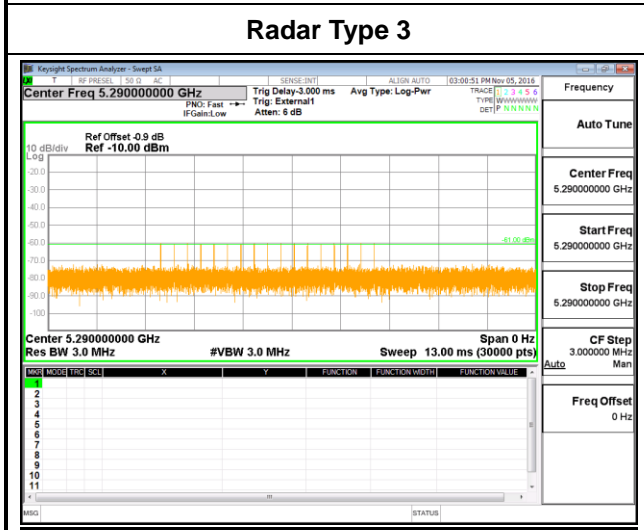
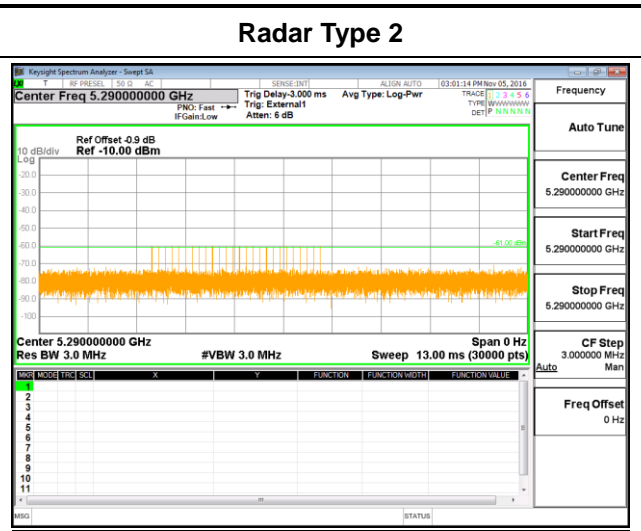
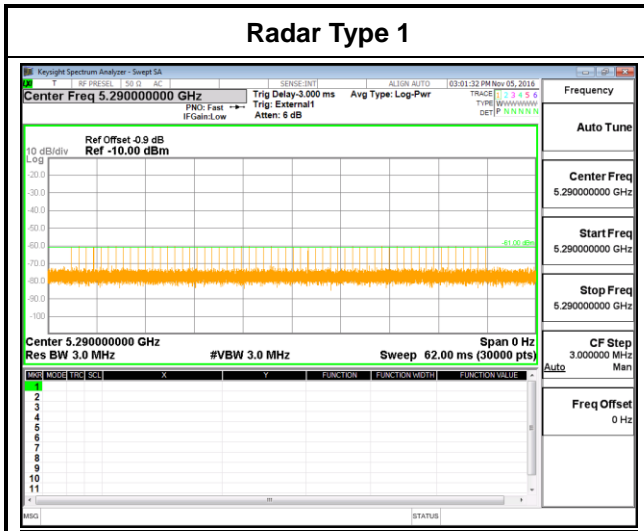



<20MHz / 5500MHz>

Radar Type 1

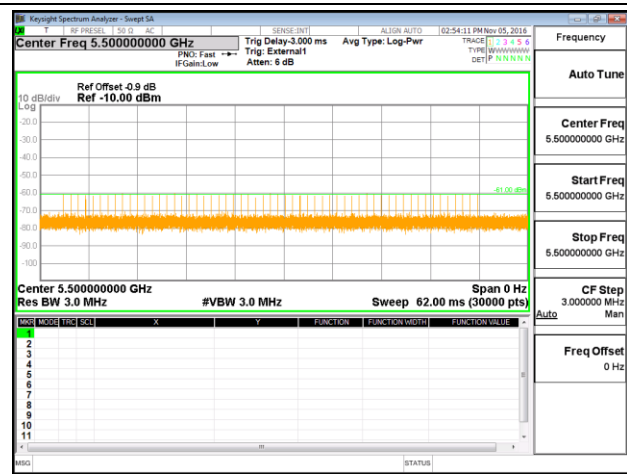

Radar Type 2

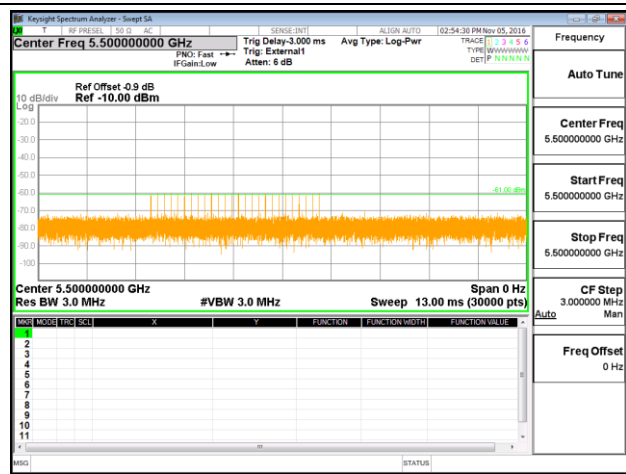

Radar Type 3

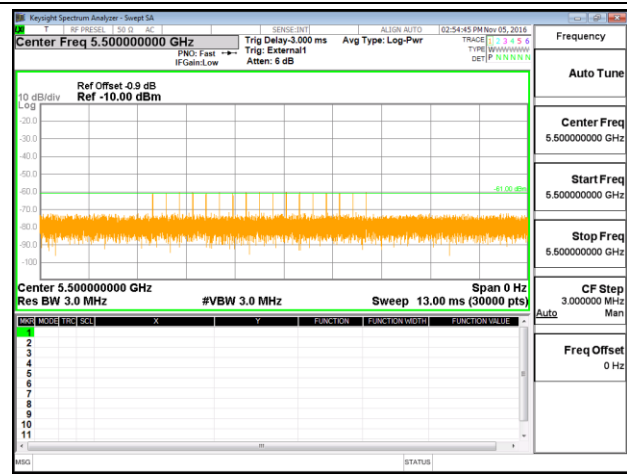

Radar Type 4

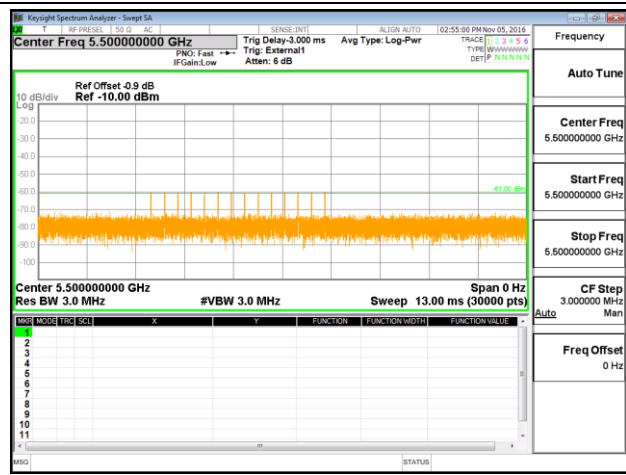

Single Burst of Radar Type 5

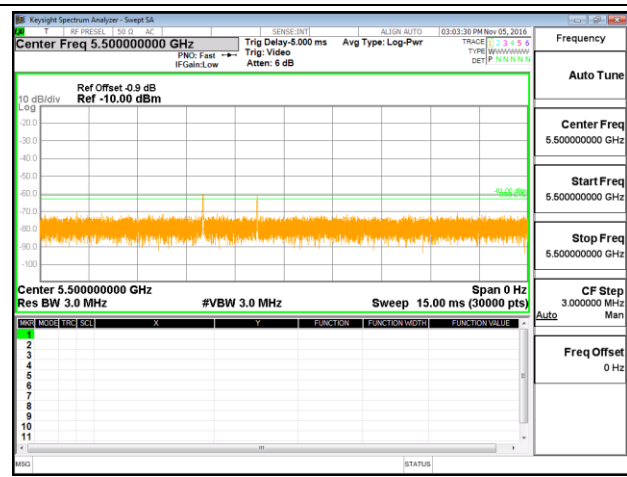

Single Burst of Radar Type 6

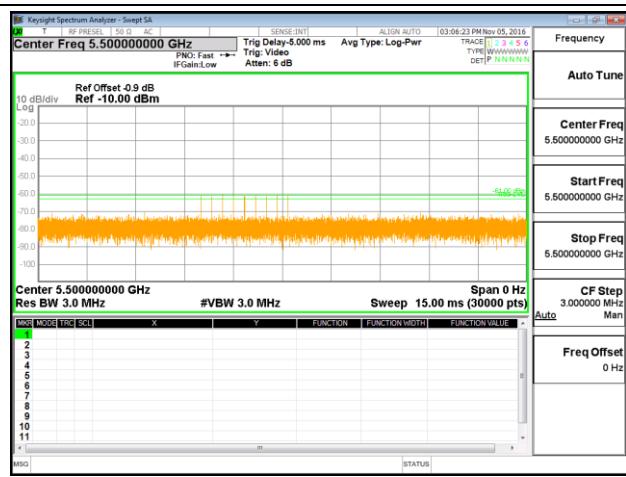



<40MHz / 5510MHz>

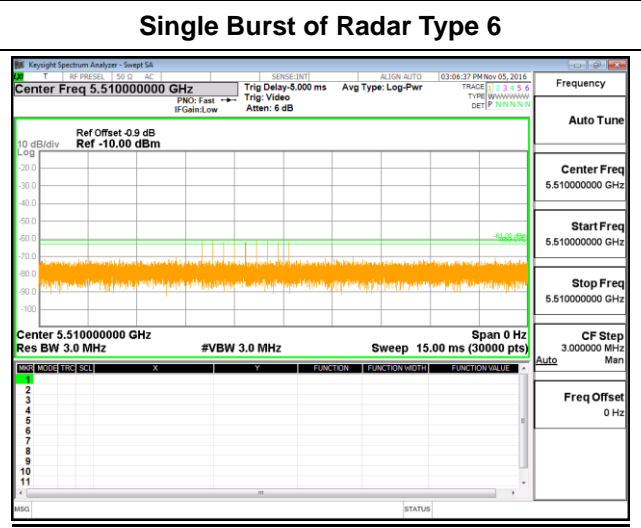
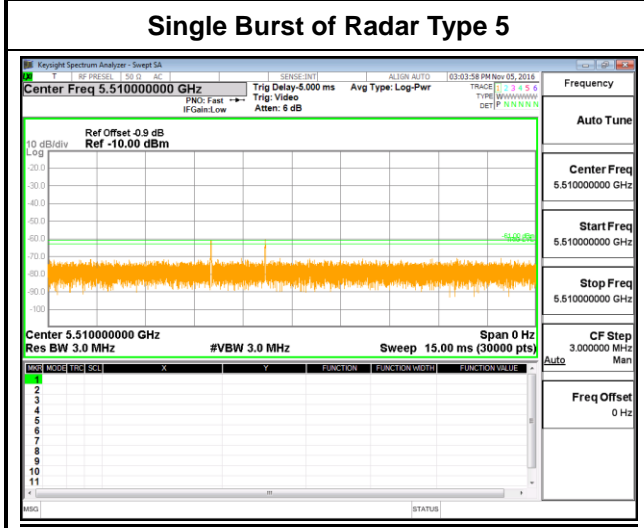
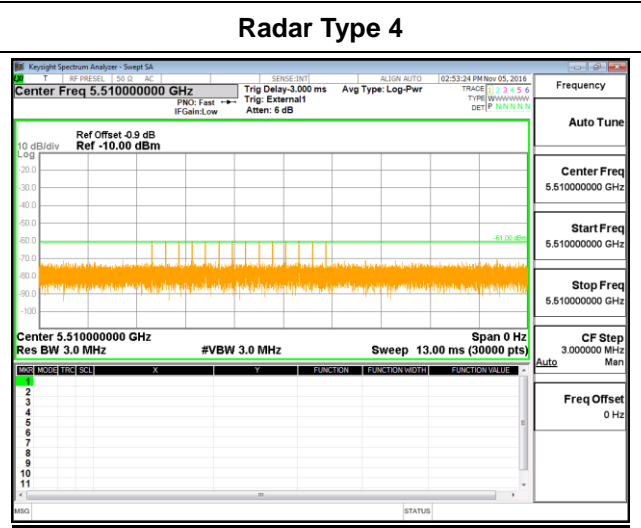
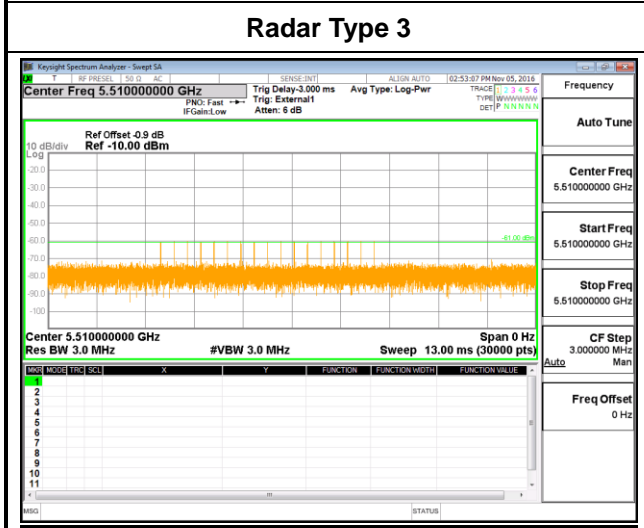
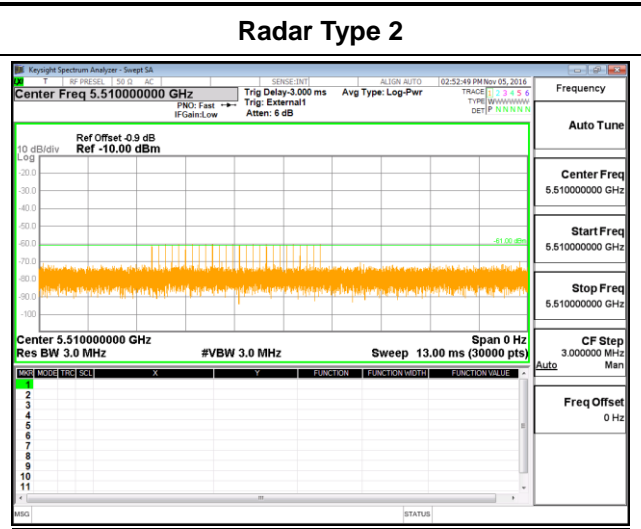
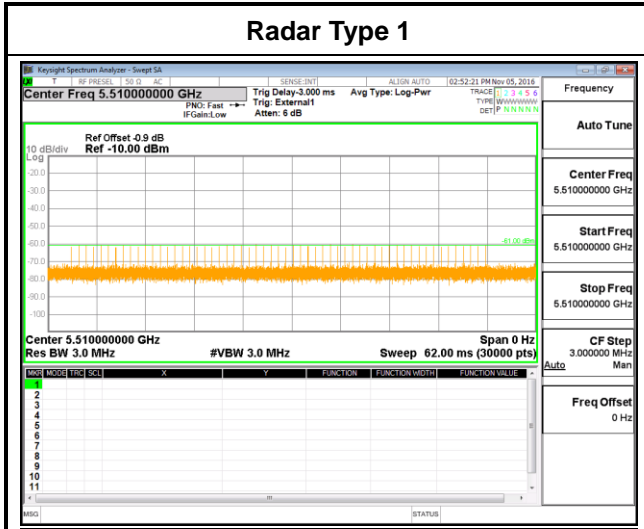



<80MHz / 5530MHz>

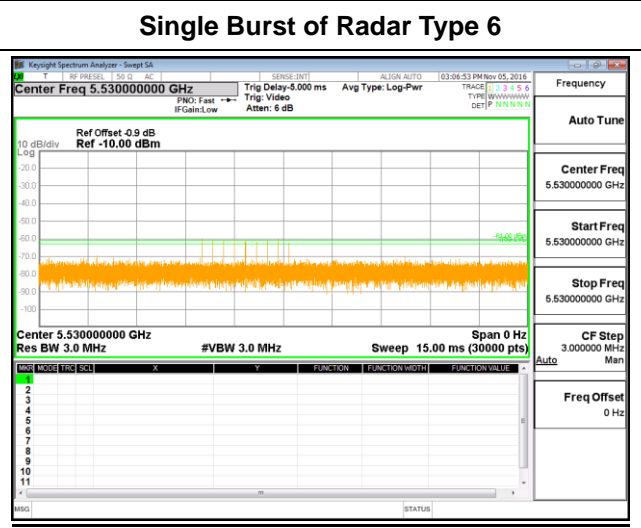
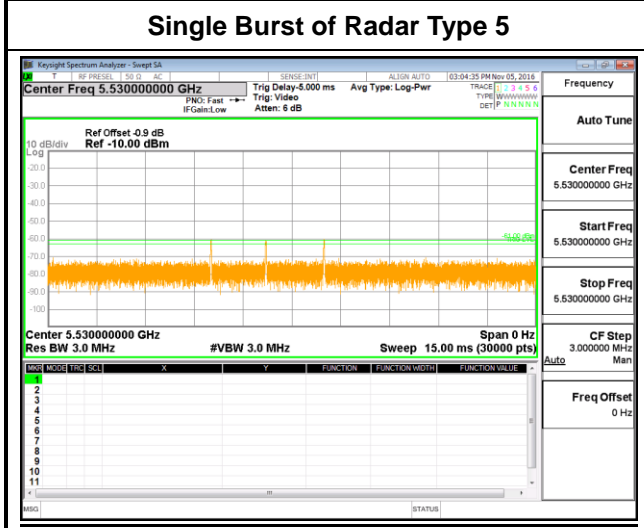
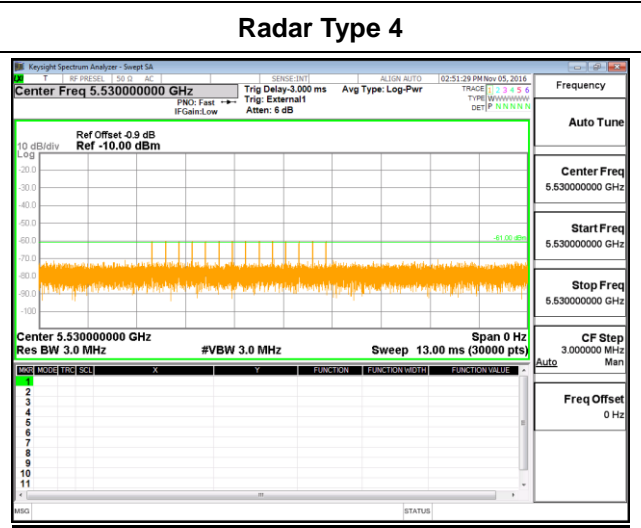
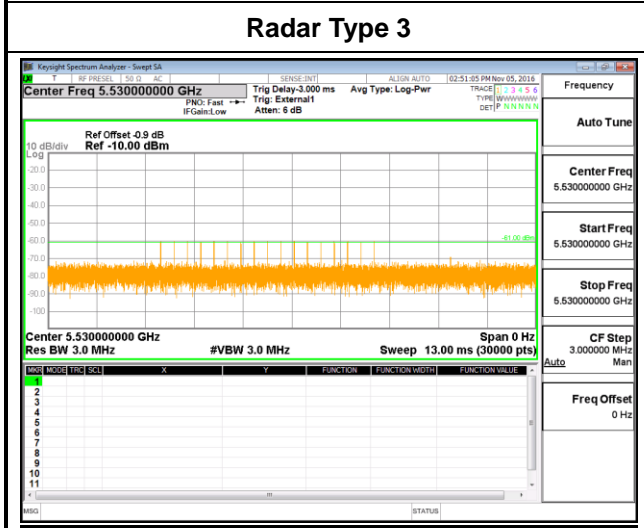
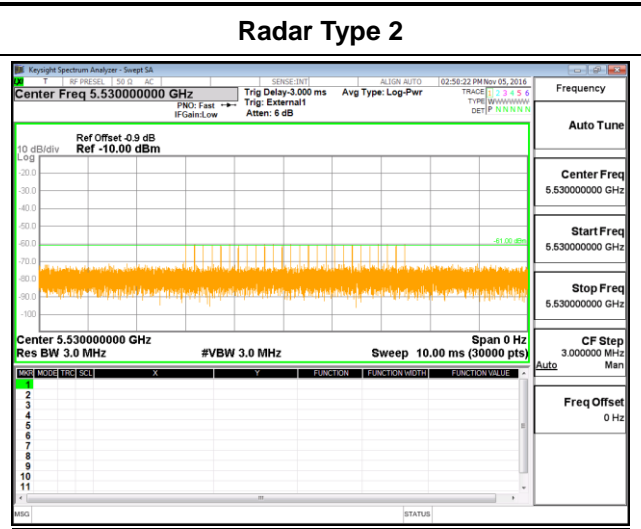
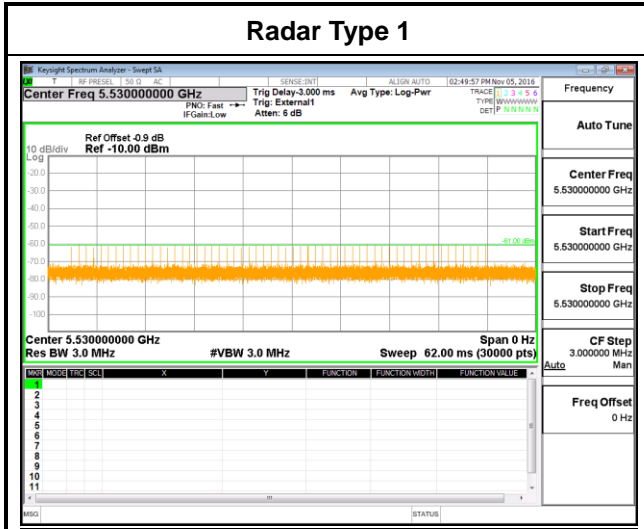

### 3.2 U-NII Detection Bandwidth (7.8.1)

#### 3.2.1 Limit of U-NII Detection Bandwidth

The U-NII Detection Bandwidth shall contain minimum 100% of the 99% power bandwidth.

During the U-NII Detection Bandwidth detection test, radar type 0 is used and for each frequency step the minimum percentage of detection is 90%. Measurements are performed with no data traffic.

#### 3.2.2 Test Procedures

- (1) Adjust the equipment to produce a single burst of the Short Pulse Radar Type 0 at the center frequency of the EUT Operating Channel at the specified DFS Detection Threshold level.
- (2) Set the EUT up as a standalone device (no associated Client or Master, as appropriate) and no traffic. Frame based systems will be set to a talk/listen ratio of 0%/100% during this test.
- (3) Generate a single radar burst, and note the response of the EUT. Repeat for a minimum of 10 trials. The EUT must detect the Radar Waveform using the specified U-NII Detection Bandwidth criterion.
- (4) Starting at the center frequency of the EUT operating Channel, increase the radar frequency in 5 MHz steps, repeating the above test sequence, until the detection rate falls below the U-NII Detection Bandwidth criterion specified in report clause 2.3. Repeat this measurement in 1MHz steps at frequencies 5 MHz below where the detection rate begins to fall. Record the highest frequency (denote as  $F_H$ ) at which detection is greater than or equal to the U-NII Detection Bandwidth criterion. Recording the detection rate at frequencies above  $F_H$  is not required to demonstrate compliance.
- (5) Starting at the center frequency of the EUT operating Channel, decrease the radar frequency in 5 MHz steps, repeating the above test sequence, until the detection rate falls below the U-NII Detection Bandwidth criterion specified in report clause 2.3. Repeat this measurement in 1MHz steps at frequencies 5 MHz above where the detection rate begins to fall. Record the lowest frequency (denote as  $F_L$ ) at which detection is greater than or equal to the U-NII Detection Bandwidth criterion. Recording the detection rate at frequencies below  $F_L$  is not required to demonstrate compliance.
- (6) The U-NII Detection Bandwidth is calculated as follows:  

$$U\text{-NII Detection Bandwidth} = F_H - F_L$$

#### 3.2.3 Test Setup

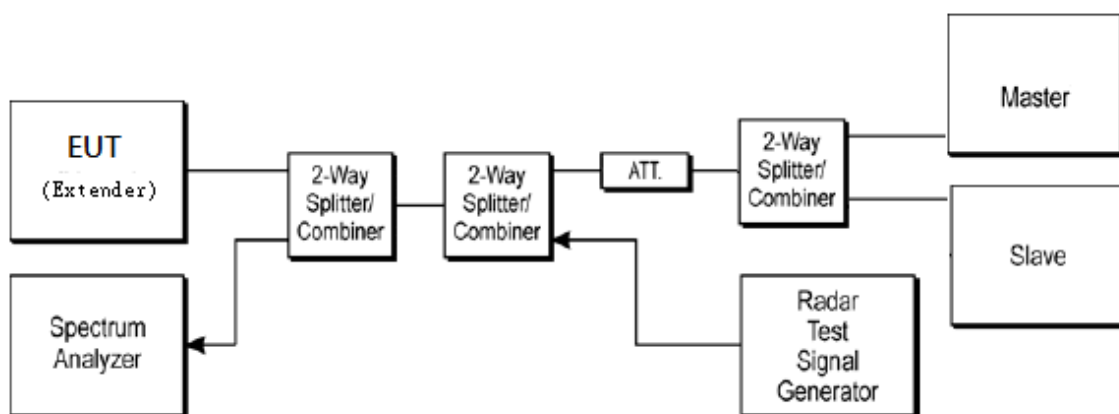

#### 3.2.4 Test Deviation

There is no deviation with the original standard.



3.2.5 Result of U-NII Detection Bandwidth

<20MHz / 5300MHz>

Frequency (MHz)	Fc	Trial Number (Detection = Y, No Detection = N)										Rate (%)	F <sub>H</sub> /F <sub>L</sub>
		1	2	3	4	5	6	7	8	9	10		
5289	-11	N	N	N	Y	N	N	Y	N	N	Y	30	
5290	-10	Y	Y	Y	Y	Y	Y	Y	Y	Y	Y	100	F <sub>L</sub>
5291	-9	Y	Y	Y	Y	Y	Y	Y	Y	Y	Y	100	
5292	-8	Y	Y	Y	Y	Y	Y	Y	Y	Y	Y	100	
5293	-7	Y	Y	Y	Y	Y	Y	Y	Y	Y	Y	100	
5294	-6	Y	Y	Y	Y	Y	Y	Y	Y	Y	Y	100	
5295	-5	Y	Y	Y	Y	Y	Y	Y	Y	Y	Y	100	
5300	0	Y	Y	Y	Y	Y	Y	Y	Y	Y	Y	100	
5305	+5	Y	Y	Y	Y	Y	Y	Y	Y	Y	Y	100	
5306	+6	Y	Y	Y	Y	Y	Y	Y	Y	Y	Y	100	
5307	+7	Y	Y	Y	Y	Y	Y	Y	Y	Y	Y	100	
5308	+8	Y	Y	Y	Y	Y	Y	Y	Y	Y	Y	100	
5309	+9	Y	Y	Y	Y	Y	Y	Y	Y	Y	Y	100	
5310	+10	Y	Y	Y	Y	Y	Y	Y	Y	Y	Y	100	F <sub>H</sub>
5311	+11	Y	Y	N	N	Y	N	N	Y	N	Y	50	

Detection Bandwidth = F<sub>H</sub> - F<sub>L</sub> = 5310 - 5290 = 20 MHz

EUT 99% Bandwidth = 17.863 MHz (Refer to channel 60)





<40MHz / 5310MHz>

Frequency (MHz)	Fc	Trial Number (Detection = V, No Detection = N)										Rate (%)	F <sub>H</sub> /F <sub>L</sub>
		1	2	3	4	5	6	7	8	9	10		
5289	-21	N	N	N	N	N	N	N	N	N	N	0	
5290	-20	Y	Y	Y	Y	Y	Y	Y	Y	Y	Y	100	F <sub>L</sub>
5291	-19	Y	Y	Y	Y	Y	Y	Y	Y	Y	Y	100	
5292	-18	Y	Y	Y	Y	Y	Y	Y	Y	Y	Y	100	
5293	-17	Y	Y	Y	Y	Y	Y	Y	Y	Y	Y	100	
5294	-16	Y	Y	Y	Y	Y	Y	Y	Y	Y	Y	100	
5295	-15	Y	Y	Y	Y	Y	Y	Y	Y	Y	Y	100	
5300	-10	Y	Y	Y	Y	Y	Y	Y	Y	Y	Y	100	
5305	-5	Y	Y	Y	Y	Y	Y	Y	Y	Y	Y	100	
5310	0	Y	Y	Y	Y	Y	Y	Y	Y	Y	Y	100	
5315	+5	Y	Y	Y	Y	Y	Y	Y	Y	Y	Y	100	
5320	+10	Y	Y	Y	Y	Y	Y	Y	Y	Y	Y	100	
5325	+15	Y	Y	Y	Y	Y	Y	Y	Y	Y	Y	100	
5326	+16	Y	Y	Y	Y	Y	Y	Y	Y	Y	Y	100	
5327	+17	Y	Y	Y	Y	Y	Y	Y	Y	Y	Y	100	
5328	+18	Y	Y	Y	Y	Y	Y	Y	Y	Y	Y	100	
5329	+19	Y	Y	Y	Y	Y	Y	Y	Y	Y	Y	100	
5330	+20	Y	Y	Y	Y	Y	Y	Y	Y	Y	Y	100	F <sub>H</sub>
5331	+21	N	N	N	N	N	N	N	N	N	N	0	

Detection Bandwidth = F<sub>H</sub> - F<sub>L</sub> = 5330 - 5290 = 40 MHz

EUT 99% Bandwidth = 36.023 MHz (Refer to channel 62)



<80MHz / 5290MHz>

Frequency (MHz)	Fc	Trial Number (Detection = V, No Detection = N)										Rate (%)	F <sub>H</sub> /F <sub>L</sub>
		1	2	3	4	5	6	7	8	9	10		
5250	-40	N	N	N	N	N	N	Y	N	N	N	10	
5251	-39	Y	Y	Y	Y	Y	Y	Y	Y	Y	Y	100	F <sub>L</sub>
5252	-38	Y	Y	Y	Y	Y	Y	Y	Y	Y	Y	100	
5253	-37	Y	Y	Y	Y	Y	Y	Y	Y	Y	Y	100	
5254	-36	Y	Y	Y	Y	Y	Y	Y	Y	Y	Y	100	
5255	-35	Y	Y	Y	Y	Y	Y	Y	Y	Y	Y	100	
5260	-30	Y	Y	Y	Y	Y	Y	Y	Y	Y	Y	100	
5265	-25	Y	Y	Y	Y	Y	Y	Y	Y	Y	Y	100	
5270	-20	Y	Y	Y	Y	Y	Y	Y	Y	Y	Y	100	
5275	-15	Y	Y	Y	Y	Y	Y	Y	Y	Y	Y	100	
5380	-10	Y	Y	Y	Y	Y	Y	Y	Y	Y	Y	100	
5285	-5	Y	Y	Y	Y	Y	Y	Y	Y	Y	Y	100	
5290	0	Y	Y	Y	Y	Y	Y	Y	Y	Y	Y	100	
5295	+5	Y	Y	Y	Y	Y	Y	Y	Y	Y	Y	100	
5300	+10	Y	Y	Y	Y	Y	Y	Y	Y	Y	Y	100	
5305	+15	Y	Y	Y	Y	Y	Y	Y	Y	Y	Y	100	
5310	+20	Y	Y	Y	Y	Y	Y	Y	Y	Y	Y	100	
5315	+25	Y	Y	Y	Y	Y	Y	Y	Y	Y	Y	100	
5320	+30	Y	Y	Y	Y	Y	Y	Y	Y	Y	Y	100	
5325	+35	Y	Y	Y	Y	Y	Y	Y	Y	Y	Y	100	
5326	+36	Y	Y	Y	Y	Y	Y	Y	Y	Y	Y	100	
5327	+37	Y	Y	Y	Y	Y	Y	Y	Y	Y	Y	100	
5328	+38	Y	Y	Y	Y	Y	Y	Y	Y	Y	Y	100	
5329	+39	Y	Y	Y	Y	Y	Y	Y	Y	Y	Y	100	F <sub>H</sub>
5330	+40	N	N	N	N	N	N	N	N	N	N	0	

Detection Bandwidth = F<sub>H</sub> – F<sub>L</sub> = 5329 – 5251 = 78 MHz

EUT 99% Bandwidth = 74.534 MHz (Refer to channel 58)



<20MHz / 5500MHz>

Frequency (MHz)	Fc	Trial Number (Detection = V, No Detection = N)										Rate (%)	F <sub>H</sub> /F <sub>L</sub>
		1	2	3	4	5	6	7	8	9	10		
5489	-11	Y	Y	N	Y	Y	N	Y	Y	N	Y	70	
5490	-10	Y	Y	Y	Y	Y	Y	Y	Y	Y	Y	100	F <sub>L</sub>
5491	-9	Y	Y	Y	Y	Y	Y	Y	Y	Y	Y	100	
5492	-8	Y	Y	Y	Y	Y	Y	Y	Y	Y	Y	100	
5493	-7	Y	Y	Y	Y	Y	Y	Y	Y	Y	Y	100	
5494	-6	Y	Y	Y	Y	Y	Y	Y	Y	Y	Y	100	
5495	-5	Y	Y	Y	Y	Y	Y	Y	Y	Y	Y	100	
5500	0	Y	Y	Y	Y	Y	Y	Y	Y	Y	Y	100	
5505	+5	Y	Y	Y	Y	Y	Y	Y	Y	Y	Y	100	
5506	+6	Y	Y	Y	Y	Y	Y	Y	Y	Y	Y	100	
5507	+7	Y	Y	Y	Y	Y	Y	Y	Y	Y	Y	100	
5508	+8	Y	Y	Y	Y	Y	Y	Y	Y	Y	Y	100	
5509	+9	Y	Y	Y	Y	Y	Y	Y	Y	Y	Y	100	
5510	+10	Y	Y	Y	Y	Y	Y	Y	Y	Y	Y	100	F <sub>H</sub>
5511	+11	Y	Y	N	Y	N	Y	Y	Y	N	Y	70	

Detection Bandwidth = F<sub>H</sub> – F<sub>L</sub>=5510 – 5490 = 20 MHz

EUT 99% Bandwidth = 17.898 MHz (Refer to channel 100)



<40MHz / 5510MHz>

Frequency (MHz)	Fc	Trial Number (Detection = V, No Detection = N)										Rate (%)	F <sub>H</sub> /F <sub>L</sub>
		1	2	3	4	5	6	7	8	9	10		
5489	-21	N	N	N	N	N	N	N	N	N	N	0	
5490	-20	Y	Y	Y	Y	Y	Y	N	Y	Y	Y	90	F <sub>L</sub>
5491	-19	Y	Y	Y	Y	Y	Y	Y	Y	Y	Y	100	
5492	-18	Y	Y	Y	Y	Y	Y	Y	Y	Y	Y	100	
5493	-17	Y	Y	Y	Y	Y	Y	Y	Y	Y	Y	100	
5494	-16	Y	Y	Y	Y	Y	Y	Y	Y	Y	Y	100	
5495	-15	Y	Y	Y	Y	Y	Y	Y	Y	Y	Y	100	
5500	-10	Y	Y	Y	Y	Y	Y	Y	Y	Y	Y	100	
5505	-5	Y	Y	Y	Y	Y	Y	Y	Y	Y	Y	100	
5510	0	Y	Y	Y	Y	Y	Y	Y	Y	Y	Y	100	
5515	+5	Y	Y	Y	Y	Y	Y	Y	Y	Y	Y	100	
5520	+10	Y	Y	Y	Y	Y	Y	Y	Y	Y	Y	100	
5525	+15	Y	Y	Y	Y	Y	Y	Y	Y	Y	Y	100	
5526	+16	Y	Y	Y	Y	Y	Y	Y	Y	Y	Y	100	
5527	+17	Y	Y	Y	Y	Y	Y	Y	Y	Y	Y	100	
5528	+18	Y	Y	Y	Y	Y	Y	Y	Y	Y	Y	100	
5529	+19	Y	Y	Y	Y	Y	Y	Y	Y	Y	Y	100	
5530	+20	Y	Y	Y	Y	Y	Y	Y	Y	Y	Y	100	F <sub>H</sub>
5531	+21	N	N	N	N	N	N	N	N	N	N	0	

Detection Bandwidth = F<sub>H</sub> - F<sub>L</sub> = 5530 - 5490 = 40 MHz

EUT 99% Bandwidth = 36.188 MHz (Refer to channel 102)



<80MHz / 5530MHz>

Frequency (MHz)	Fc	Trial Number (Detection = V, No Detection = N)										Rate (%)	F <sub>H</sub> /F <sub>L</sub>
		1	2	3	4	5	6	7	8	9	10		
5490	-40	N	N	N	N	N	N	N	N	N	N	0	
5491	-39	Y	Y	Y	Y	Y	Y	Y	Y	Y	Y	100	F <sub>L</sub>
5492	-38	Y	Y	Y	Y	Y	Y	Y	Y	Y	Y	100	
5493	-37	Y	Y	Y	Y	Y	Y	Y	Y	Y	Y	100	
5494	-36	Y	Y	Y	Y	Y	Y	Y	Y	Y	Y	100	
5495	-35	Y	Y	Y	Y	Y	Y	Y	Y	Y	Y	100	
5500	-30	Y	Y	Y	Y	Y	Y	Y	Y	Y	Y	100	
5505	-25	Y	Y	Y	Y	Y	Y	Y	Y	Y	Y	100	
5510	-20	Y	Y	Y	Y	Y	Y	Y	Y	Y	Y	100	
5515	-15	Y	Y	Y	Y	Y	Y	Y	Y	Y	Y	100	
5520	-10	Y	Y	Y	Y	Y	Y	Y	Y	Y	Y	100	
5525	-5	Y	Y	Y	Y	Y	Y	Y	Y	Y	Y	100	
5530	0	Y	Y	Y	Y	Y	Y	Y	Y	Y	Y	100	
5535	+5	Y	Y	Y	Y	Y	Y	Y	Y	Y	Y	100	
5540	+10	Y	Y	Y	Y	Y	Y	Y	Y	Y	Y	100	
5545	+15	Y	Y	Y	Y	Y	Y	Y	Y	Y	Y	100	
5550	+20	Y	Y	Y	Y	Y	Y	Y	Y	Y	Y	100	
5555	+25	Y	Y	Y	Y	Y	Y	Y	Y	Y	Y	100	
5560	+30	Y	Y	Y	Y	Y	Y	Y	Y	Y	Y	100	
5565	+35	Y	Y	Y	Y	Y	Y	Y	Y	Y	Y	100	
5566	+36	Y	Y	Y	Y	Y	Y	Y	Y	Y	Y	100	
5567	+37	Y	Y	Y	Y	Y	Y	Y	Y	Y	Y	100	
5568	+38	Y	Y	Y	Y	Y	Y	Y	Y	Y	Y	100	
5569	+39	Y	Y	Y	Y	Y	Y	Y	Y	Y	Y	100	F <sub>H</sub>
5570	+40	N	N	N	N	N	N	N	N	N	N	0	

Detection Bandwidth = F<sub>H</sub> – F<sub>L</sub> = 5569 – 5491 = 78 MHz

EUT 99% Bandwidth = 75.717 MHz (Refer to channel 106)



### 3.3 Channel Availability Check (7.8.2)

EUT is considered as a client with radar detection device.

Hence, channel availability check is not applicable according to Table 1.

Requirement	Operational Mode		
	Master	Client Without Radar Detection	Client With Radar Detection
Non-Occupancy Period	Yes	Not required	Yes
DFS Detection Threshold	Yes	Not required	Yes
Channel Availability Check Time	Yes	Not required	Not required
U-NII Detection Bandwidth	Yes	Not required	Yes



### **3.4 In-Service Monitoring: Channel Move Time, Channel Closing Transmission Time and Non-Occupancy Period (7.8.3)**

#### **3.4.1 Limit of In-Service Monitoring**

The EUT has In-Service Monitoring function to continuously monitor the radar signals, If radar is detected, it must leave the channel (Shutdown). The Channel Move Time to cease all transmissions on the current Channel upon detection of a Radar Waveform above the DFS Detection Threshold within 10 sec. The total duration of Channel Closing Transmission Time is comprised of 200 milliseconds starting at the beginning of the Channel Move Time plus any additional intermittent control signals required to facilitate Channel changes (an aggregate of 60 milliseconds) during the remainder of the 10 second period. The aggregate duration of control signals will not count quiet periods in between transmissions.

Non-Occupancy Period time is 30 minute during which a Channel will not be utilized after a Radar Waveform is detected on that Channel.

### 3.4.2 Test Procedures

- (1) One frequency will be chosen from the Operating Channels of the EUT within the 5250-5350 MHz or 5470-5725 MHz bands. For 802.11 devices, the test frequency must contain control signals. This can be verified by disabling channel loading and monitoring the spectrum analyzer. If no control signals are detected, another frequency must be selected within the emission bandwidth where control signals are detected.
- (2) As the EUT is a Client with radar detection device (extender mode), another Client Device will be used and it is assumed that the Client will associate with the EUT (extender mode). For radiated tests, the emissions of the Radar Waveform generator will be directed towards the EUT (Extender mode). If the EUT (Extender mode) has antenna gain, the main beam of the antenna will be directed toward the radar emitter. Vertical polarization is used for testing.
- (3) The TCP protocol unicast data stream was generated by the iperf software command line with at least 17% activity ratio over any 100ms period.
- (4) Timing plots are reported with calculations demonstrating a minimum channel loading of approximately 17% or greater. For example, channel loading can be estimated by setting the spectrum analyzer for zero span and approximate the Time On/ (Time On + Off Time).
- (5) At time T<sub>0</sub> the Radar Waveform generator sends a Burst of pulses for one of the Short Pulse Radar Types 1-4 at DFS Detection Threshold levels on the Operating Channel. An additional 1 dB is added to the radar test signal to ensure it is at or above the DFS Detection Threshold, accounting for equipment variations/errors.
- (6) Observe the transmissions of the EUT at the end of the radar Burst on the Operating Channel for duration greater than 10 seconds. Measure and record the transmissions from the EUT during the observation time (Channel Move Time). Measure and record the Channel Move Time and Channel Closing Transmission Time if radar detection occurs.
- (7) When operating as a Master Device, monitor the EUT for more than 30 minutes following instant T<sub>2</sub> to verify that the EUT does not resume any transmissions on this Channel. Perform this test once and record the measurement result.

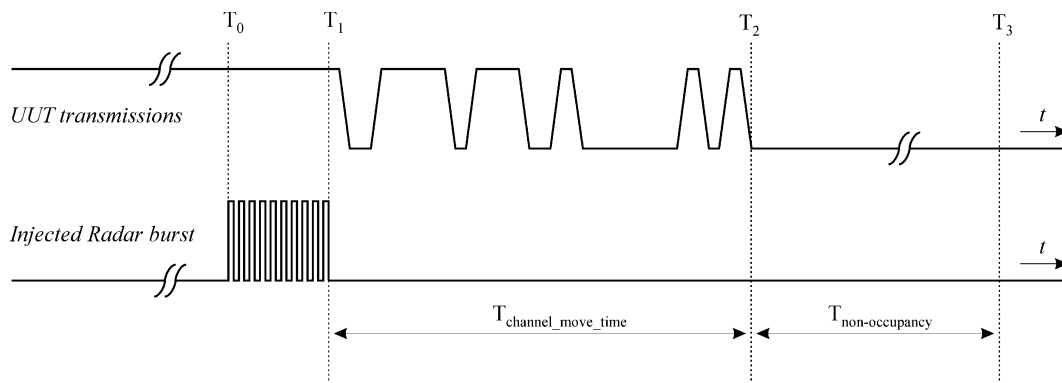

- (8) One 12 seconds plot is reported for the Short Pulse Radar Type 0.
- (9) Measurement of the aggregate duration of the Channel Closing Transmission Time method. With the spectrum analyzer set to zero span tuned to the center frequency of the EUT operating channel at the radar simulated frequency, peak detection, and max hold, the dwell time per bin is given by:  $Dwell (0.1ms) = S (3000ms) / B (30000)$ ; where Dwell is the dwell time per spectrum analyzer sampling bin, S is the sweep time and B is the number of spectrum analyzer sampling bins. An upper bound of the aggregate duration of the intermittent control signals of Channel Closing Transmission Time is calculated by:  $C (ms) = N \times Dwell (0.1 ms)$ ; where C is the Closing Time, N is the number of spectrum analyzer sampling bins (intermittent control signals) showing a U-NII transmission and Dwell is the dwell time per bin.



### 3.4.3 Test Setup

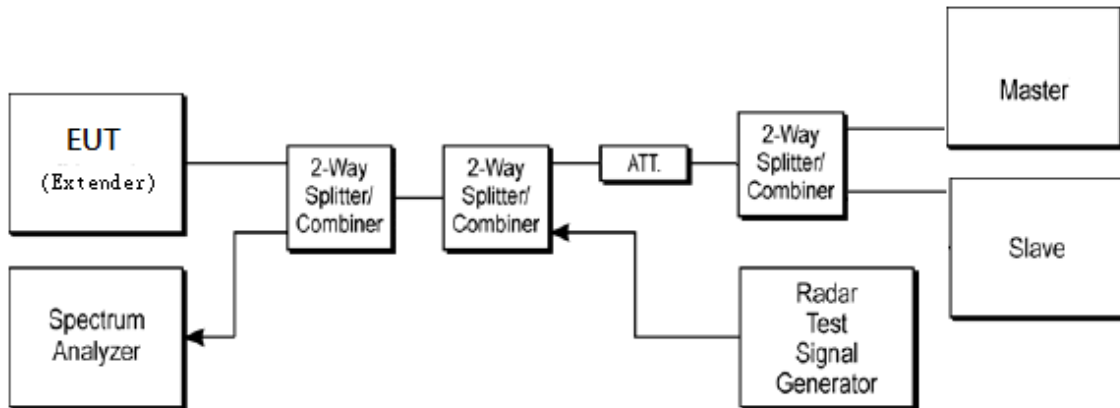

### 3.4.4 Test Deviation

There is no deviation with the original standard.



3.4.5 Result of Channel Move Time, Channel Closing Transmission Time and Non-Occupancy Period for Client Beacon Test

Test Mode :	Client with radar detection (Extender Mode)	Temperature :	24.3-25.2°C
Test Engineer :	Bill Kuo	Relative Humidity :	44-47%

BW / Channel	Test Item	Test Result	Limit	Pass/Fail
80MHz /5290MHz	Channel Move Time	0.9918 s	< 10s	Pass
	Channel Closing Transmission Time	200ms + 36.4 ms	< 260ms	Pass
	Non-Occupancy Period	≥ 30	≥ 30 min	Pass
80MHz /5530MHz	Channel Move Time	0.9774 s	< 10s	Pass
	Channel Closing Transmission Time	200ms + 29.9 ms	< 260ms	Pass
	Non-Occupancy Period	≥ 30	≥ 30 min	Pass

Note: The Channel Closing Transmission Time is comprised of 200 milliseconds starting at the beginning of the Channel Move Time plus any additional intermittent control signals required to facilitate a Channel move (an aggregate of 60 milliseconds) during the remainder of the 10 seconds period. The aggregate duration of control signals will not count quiet periods in between transmissions.



### 3.4.6 Channel Move Time, Channel Closing Transmission Time and Non-Occupancy Period Test Plots

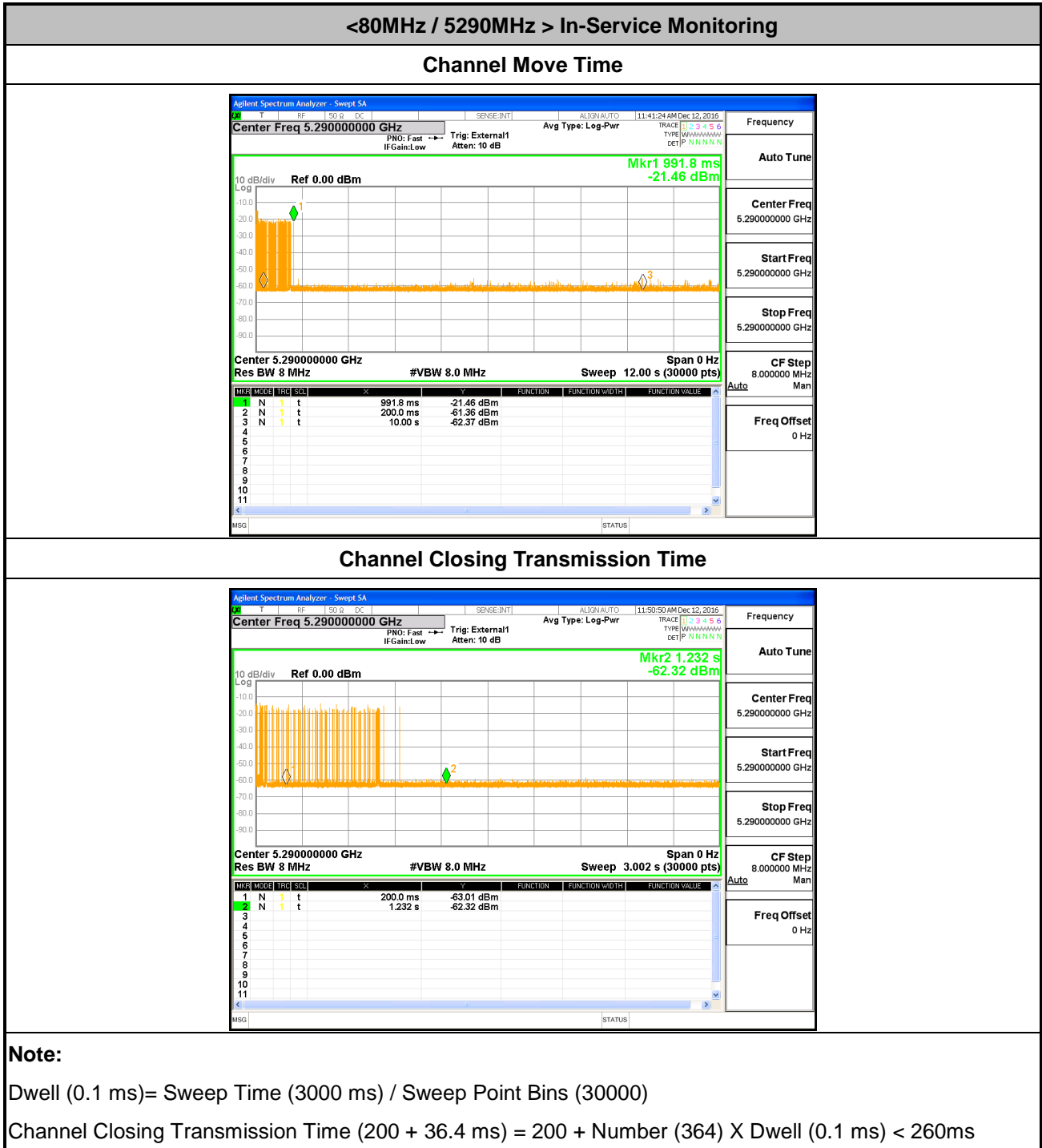



<80MHz / 5530MHz > In-Service Monitoring

Channel Move Time

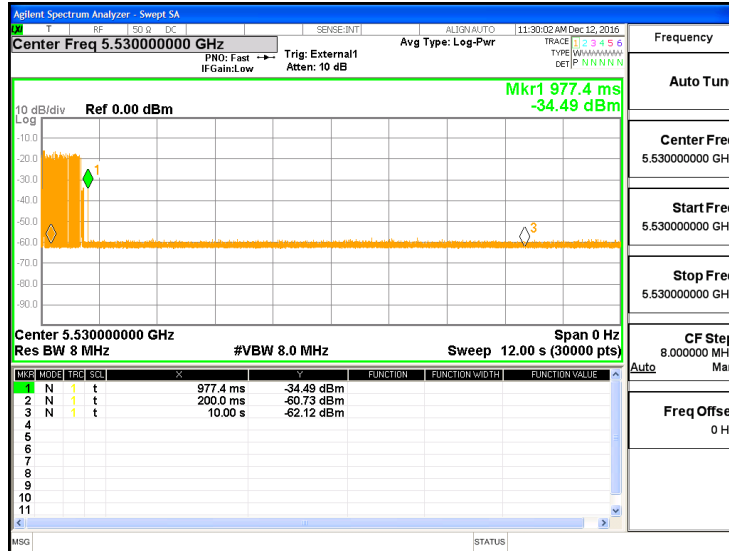

Channel Closing Transmission Time

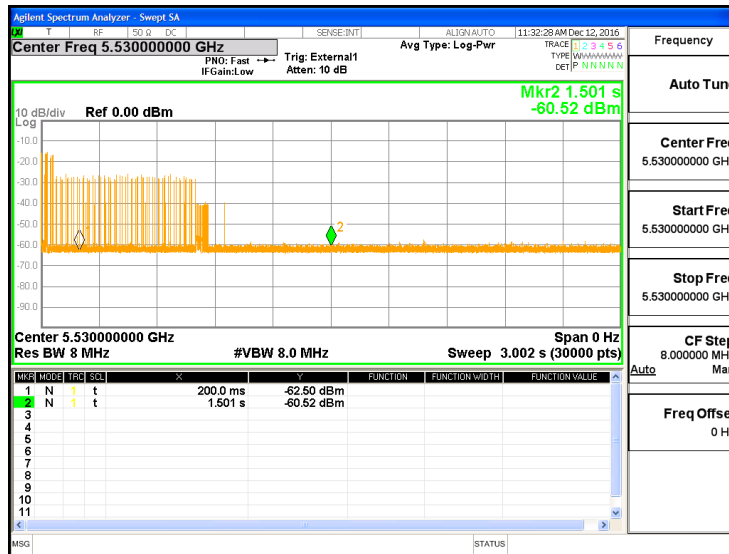

Note:

Dwell (0.1 ms)= Sweep Time (3000 ms) / Sweep Point Bins (30000)

Channel Closing Transmission Time (200 + 29.9 ms) = 200 + Number (299) X Dwell (0.1 ms) < 260ms



<80MHz / 5290MHz > In-Service Monitoring

Non-Occupancy Period



<80MHz / 5530MHz > In-Service Monitoring

Non-Occupancy Period





### 3.4.7 Long Pulsed Radar Type Channel Move Time Test Plots (22second)

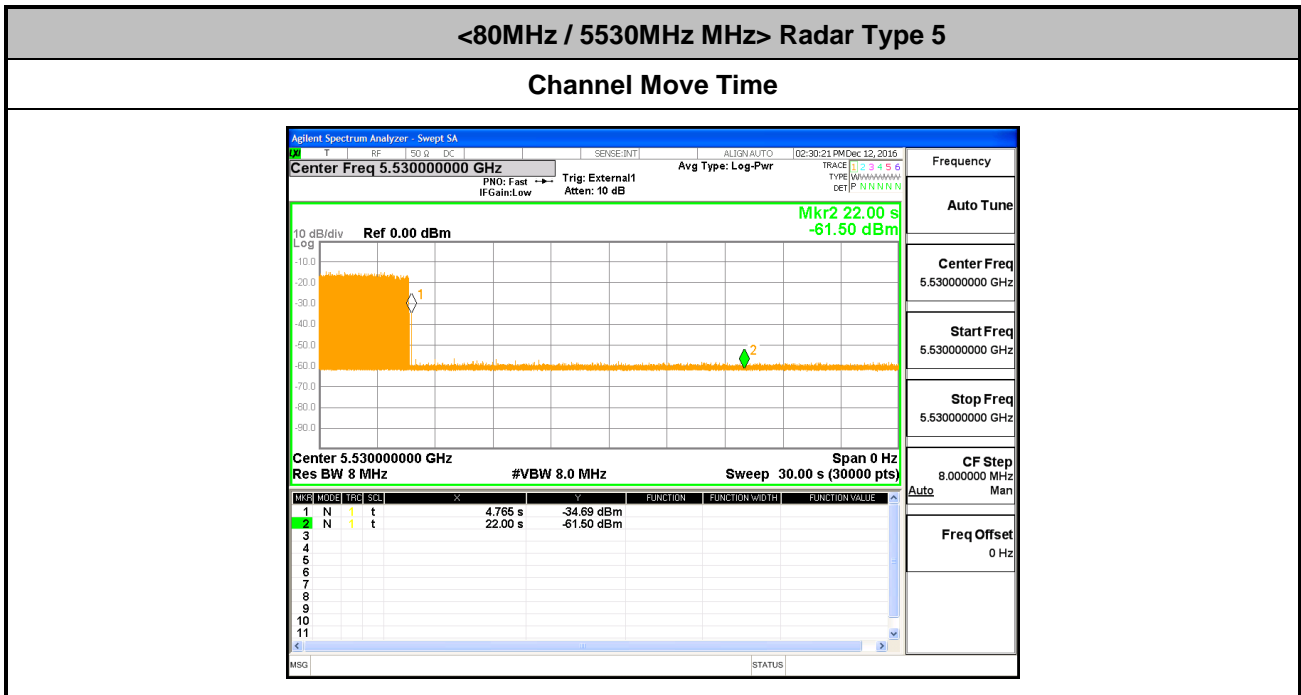
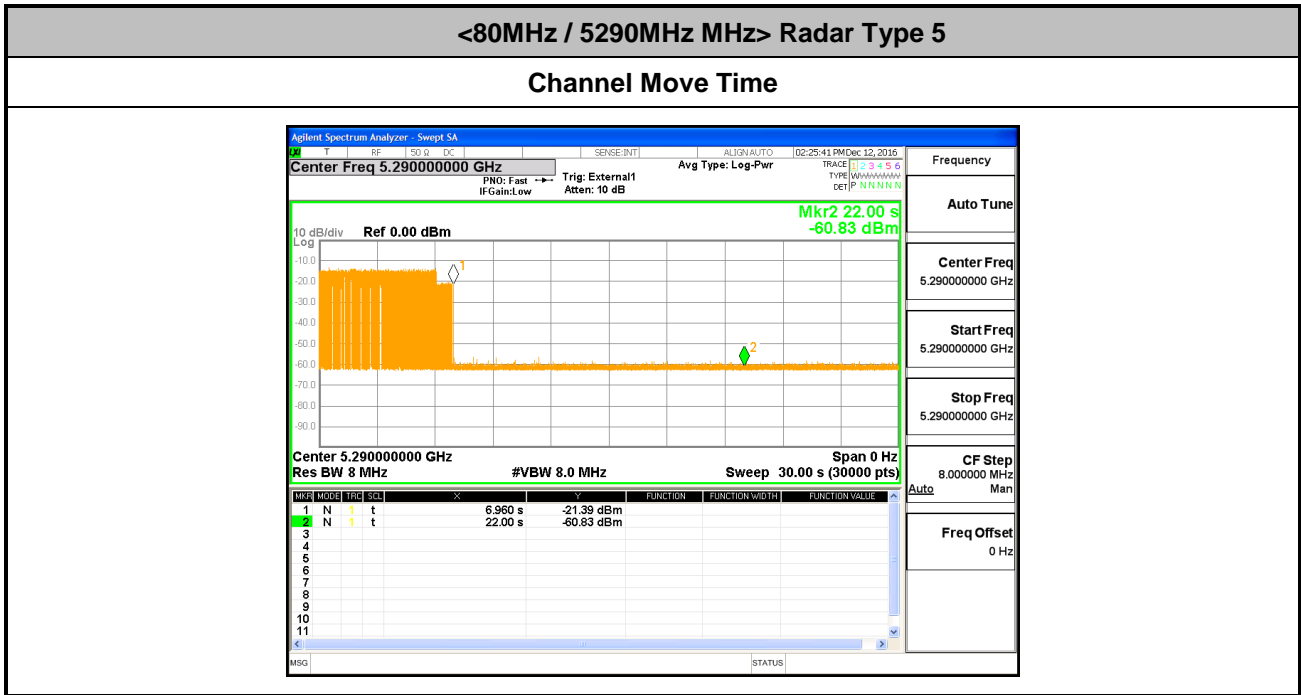

EUT (Extender) MAC Address: 02-0A-EA-11-99-8C (020a.ea11.998c)

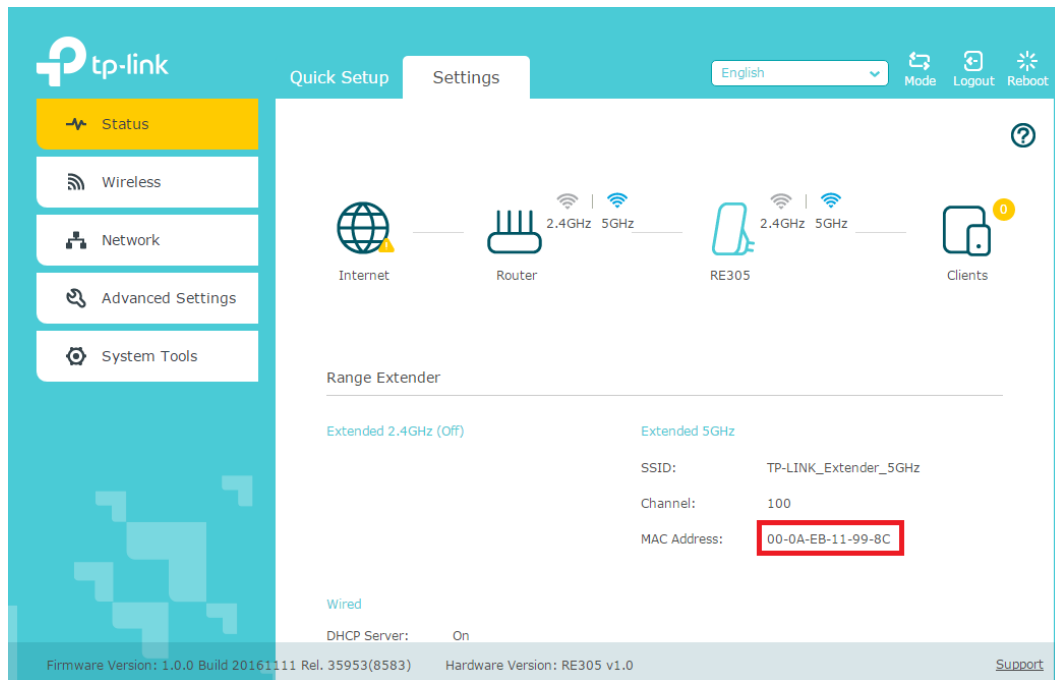

000a.ebac.24ff is deauthenticated from the CISCO AP after the radar signal is injected on the EUT.

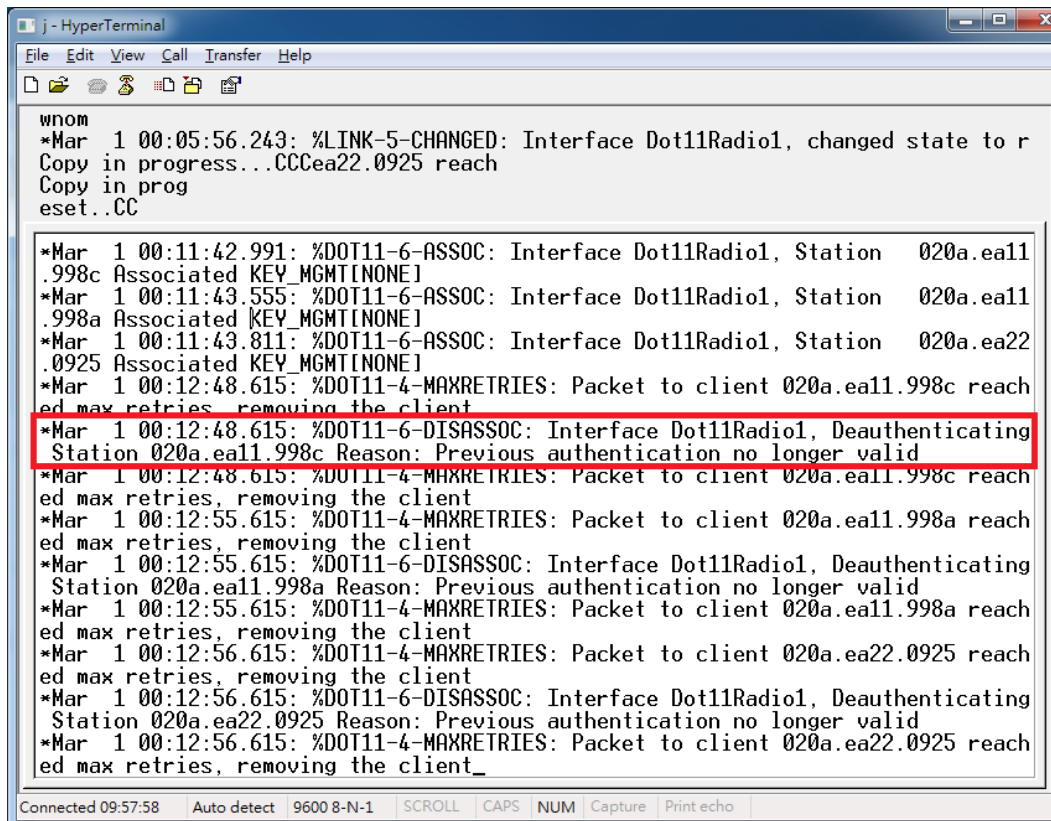

### 3.4.8 Data Traffic Channel Loading and Noise Floor Plots

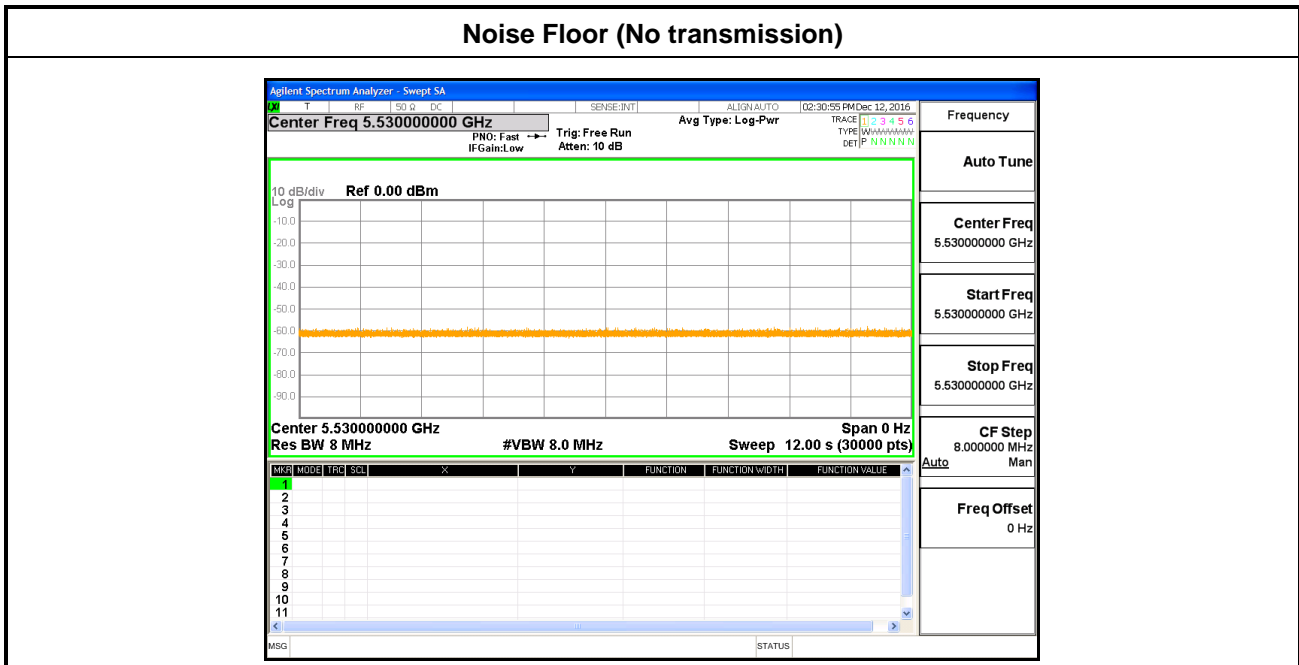
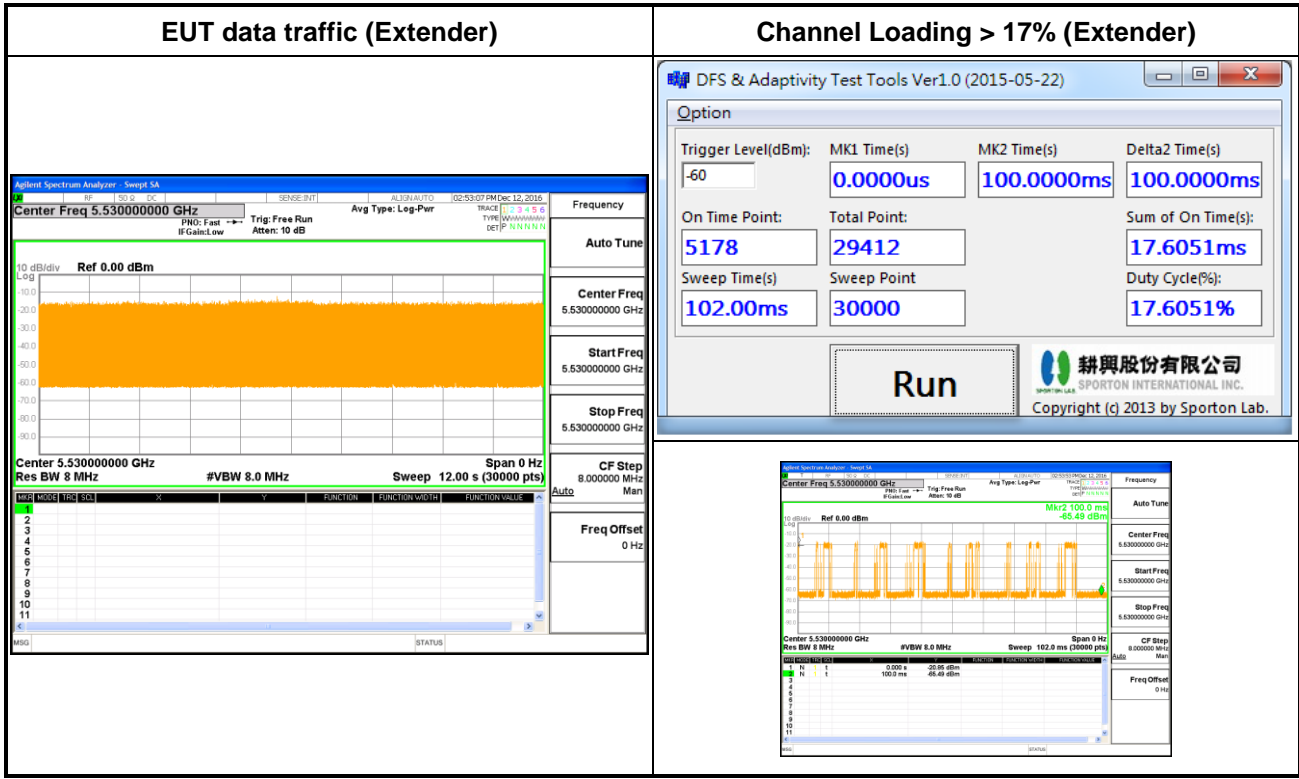





### 3.5 Statistical Performance Check (7.8.4)

#### 3.5.1 Limit of Statistical Performance Check

##### Short Pulse Radar Test

Once the performance requirements check is complete, statistical data will be gathered, to determine the ability of the device to detect the radar test waveforms (Short Pulse Radar Types 1-4) found in **Table 5**. The device can utilize a test mode to demonstrate when detection occurs to prevent the need to reset the device between trials. The percentage of successful detection is calculated by:

$$\frac{\text{TotalWaveformDetections}}{\text{TotalWaveformTrials}} \times 100 = \text{Percentage of Successful Detection Radar Waveform } N = P_d N$$

In addition an aggregate minimum percentage of successful detection across all Short Pulse Radar Types 1-4 is required and is calculated as follows:

$$\frac{P_d 1 + P_d 2 + P_d 3 + P_d 4}{4}$$

The minimum number of trails, minimum percentage of successful detection and the aggregate minimum percentage of successful detection are found in **Table 5**.

**Table 5 – Short Pulse Radar Test Waveforms**

Radar Type	Pulse Width (µsec)	PRI (µsec)	Number of Pulses	Minimum Percentage of Successful Detection	Minimum Number of Trials
1	1	1428	18	60%	30
2	1-5	150-230	23-29	60%	30
3	6-10	200-500	16-18	60%	30
4	11-20	200-500	12-16	60%	30
Aggregate (Radar Types 1-4)				80%	120

A minimum of 30 unique waveforms are required for each of the Short Pulse Radar Types 1 through 4. For Short Pulse Radar Type 0, the same waveform is used a minimum of 30 times. If more than 30 waveforms are used for Short Pulse Radar Types 1 through 4, then each additional waveform must also be unique and not repeated from the previous waveforms.



Radar Type	Number of Trials	Number of Successful Detections	Minimum Percentage of Successful Detection
1	35	29	82.9%
2	30	18	60%
3	30	27	90%
4	50	44	88%
Aggregate $(82.9\% + 60\% + 90\% + 88\%)/4 = 80.2\%$			



**Long Pulse Radar Test**

Statistical data will be gathered to determine the ability of the device to detect the Long Pulse Radar Type 5 found in **Table 6**. The device can utilize a test mode to demonstrate when detection occurs to prevent the need to reset the device between trials.

**Table 6 – Long Pulse Radar Test Waveform**

Radar Type	Pulse Width (μsec)	Chirp Width (MHz)	PRI (μsec)	Number of Pulses per Burst	Number of Bursts	Minimum Percentage of Successful Detection	Minimum Number of Trials
5	50-100	5-20	1000-2000	1-3	8-20	80%	30

The parameters for this waveform are randomly chosen. Thirty unique waveforms are required for the Long Pulse Radar Type waveforms. If more than 30 waveforms are used for the Long Pulse Radar Type waveforms, then each additional waveform must also be unique and not repeated from the previous waveforms.

Three subsets of trials will be performed with a minimum of ten trials per subset.

The subset of trials differs in where the Long Pulse Type 5 Signal is tuned in frequency:

- a) The Channel center frequency (subset case 1).
- b) Tuned frequencies such that 90% of the Long Pulse Type 5 frequency modulation is within the low edge of the UUT Occupied Bandwidth (subset case 2).
- c) Tuned frequencies such that 90% of the Long Pulse Type 5 frequency modulation is within the high edge of the UUT Occupied Bandwidth (subset case 3).

For subset case 1: the center frequency of the signal generator will remain fixed at the center of the UUT Channel.

For subset case 2: to retain 90% frequency overlap between the radar signal and the UUT Occupied Bandwidth, the center frequency of the signal generator will vary for each of the ten trials in subset case 2.

The center frequency of the signal generator for each trial is calculated by:  $FL + (0.4 * Chirp Width [in MHz])$

For subset case 3: to retain 90% frequency overlap between the radar signal and the UUT Occupied Bandwidth, the center frequency of the signal generator will vary for each of the ten trials in subset case 3.

The center frequency of the signal generator for each trial is calculated by:  $FH - (0.4 * Chirp Width [in MHz])$

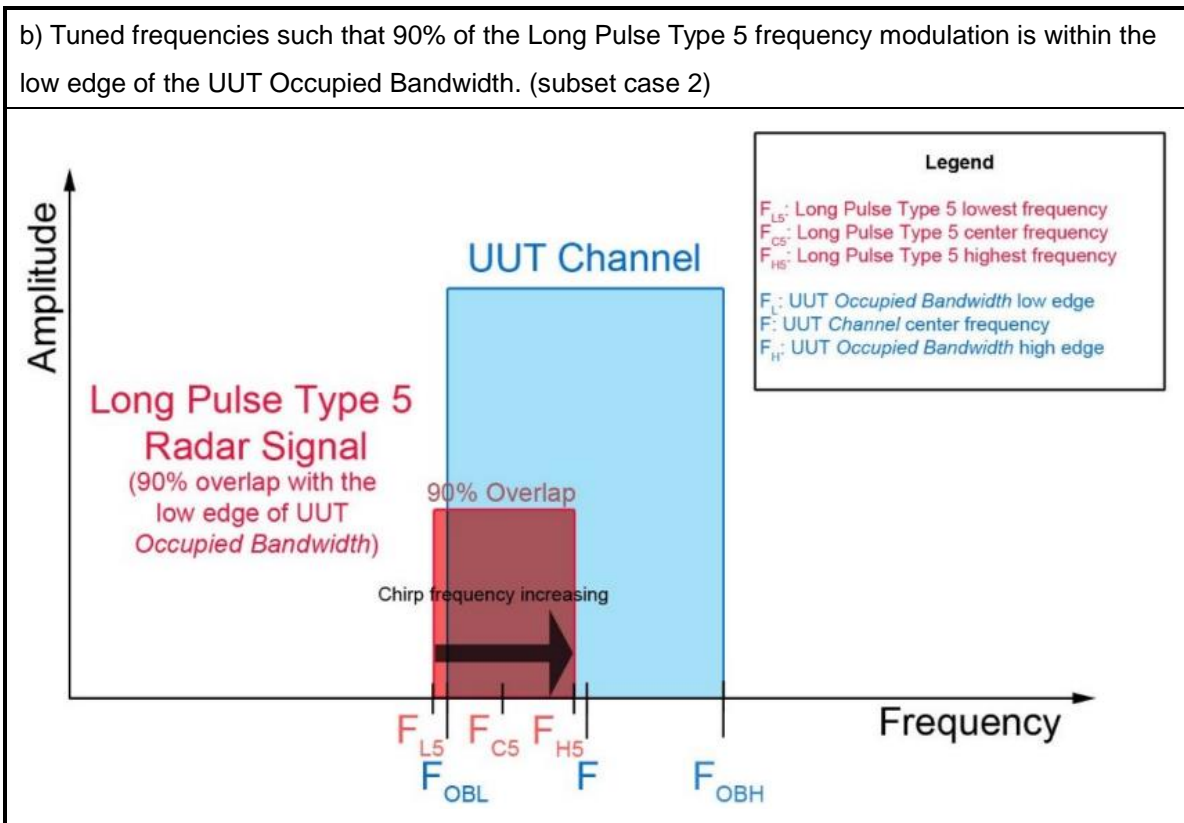
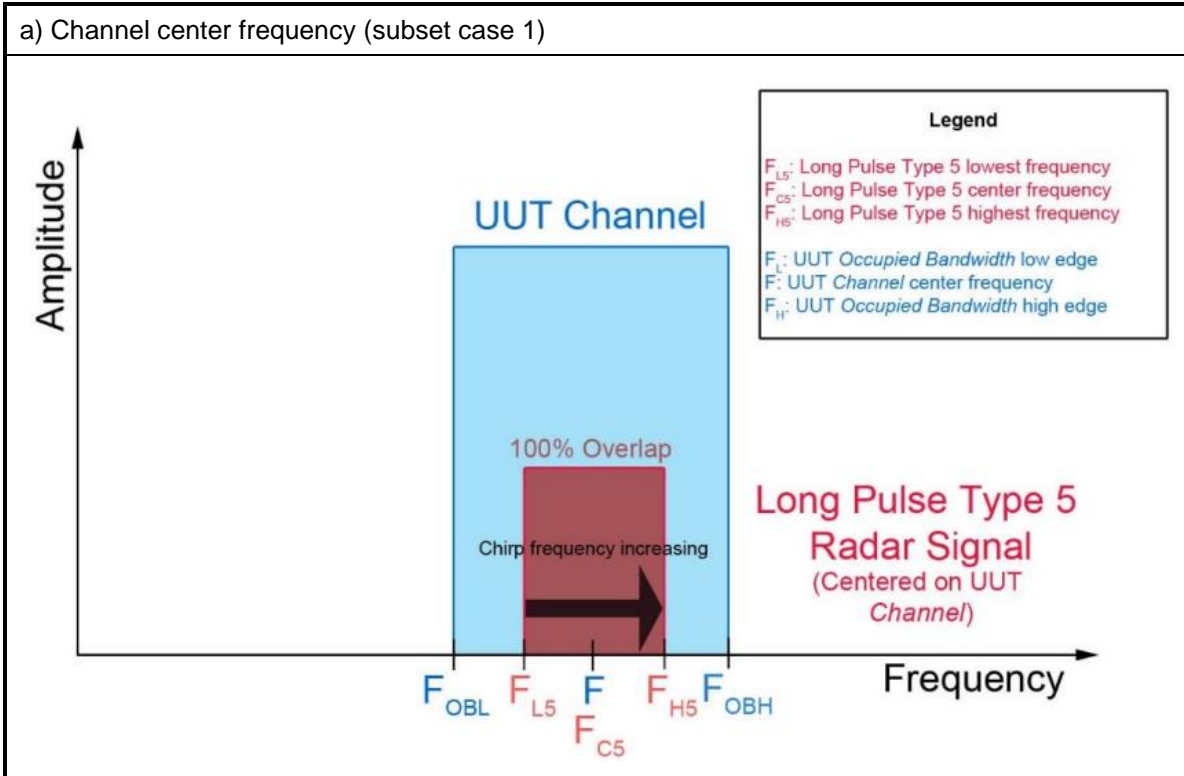

c) Tuned frequencies such that 90% of the Long Pulse Type 5 frequency modulation is within the high edge of the UUT Occupied Bandwidth. (subset case 3)

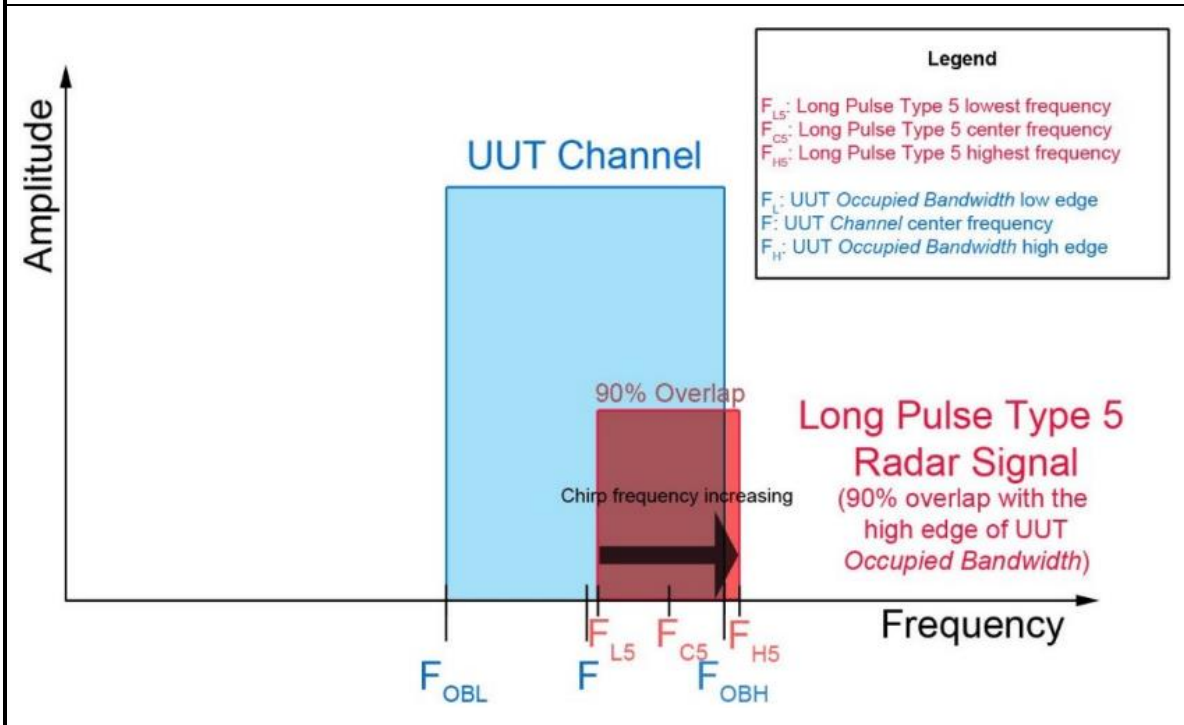

The percentage of successful detection is calculated by:

$$\frac{\text{TotalWaveformDetections}}{\text{TotalWaveformTrials}} \times 100$$



**Frequency Hopping Radar Test**

Statistical data will be gathered to determine the ability of the device to detect the Frequency Hopping radar test signal (radar type 6) found in **Table 7**. The device can utilize a test mode to demonstrate when detection occurs to prevent the need to reset the device between trial runs. The probability of successful detection is calculated by:

$$\frac{TotalWaveformDetections}{TotalWaveformTrials} \times 100$$

**Table 7 – Frequency Hopping Radar Test Waveform**

Radars Type	Pulse Width (µsec)	PRI (µsec)	Pulses per Hop	Hopping Rate (kHz)	Hopping Sequence Length (msec)	Minimum Percentage of Successful Detection	Minimum Number of Trials
6	1	333	9	0.333	300	70%	30

For the Frequency Hopping Radar Type, the same *Burst* parameters are used for each waveform. The hopping sequence is different for each waveform and a 100-length segment is selected from the hopping sequence defined by the following algorithm:

The first frequency in a hopping sequence is selected randomly from the group of 475 integer frequencies from 5250 – 5724 MHz. Next, the frequency that was just chosen is removed from the group and a frequency is randomly selected from the remaining 474 frequencies in the group. This process continues until all 475 frequencies are chosen for the set. For selection of a random frequency, the frequencies remaining within the group are always treated as equally likely.

### 3.5.2 Test Procedures

- (1) One frequency will be chosen from the Operating Channels of the EUT within the 5250-5350 MHz or 5470-5725 MHz bands.
- (2) In case the EUT is a Master Device, a U-NII device operating as a Client Device will be used and it is assumed that the Client will associate with the EUT (Master). If the Master Device has antenna gain, the main beam of the antenna will be directed toward the radar emitter. Vertical polarization is used for testing.
- (3) The TCP protocol unicast data stream was generated by the iperf software command line with at least 17% activity ratio over any 100ms period.
- (4) At time  $T_0$  the Radar Waveform generator sends a Burst of pulses for each of the Radar Types 1-6 at DFS Detection Threshold levels on the Operating Channel. An additional 1 dB is added to the radar test signal to ensure it is at or above the DFS Detection Threshold, accounting for equipment variations/errors.
- (5) Observe the transmissions of the EUT at the end of the Burst on the Operating Channel for duration greater than 10 seconds for Short Pulse Radar Types 1-4 and 6 to ensure detection occurs.
- (6) Observe the transmissions of the EUT at the end of the Burst on the Operating Channel for duration greater than 22 seconds for Long Pulse Radar Type 5 to ensure detection occurs.

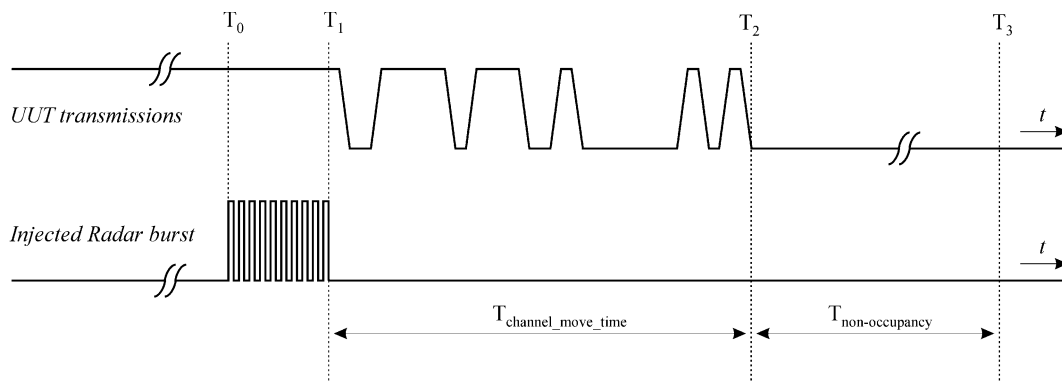

### 3.5.3 Test Setup

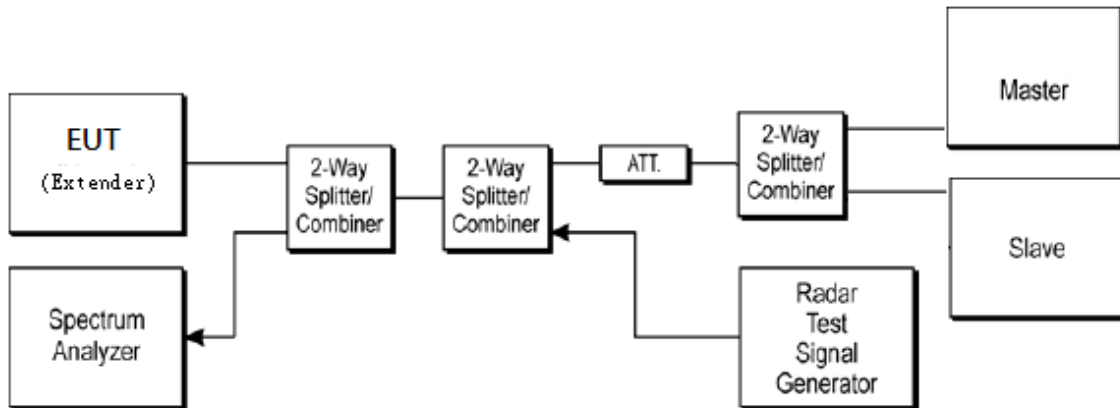

### 3.5.4 Test Deviation

There is no deviation with the original standard.





3.5.5 Result of Statistical Performance Check

<20MHz / 5300MHz>

(Detection = Y, No Detection = N)						
Trial Number	Type 1	Type 2	Type 3	Type 4	Type 5	Type 6
1	Y	Y	Y	Y	Y	Y
2	Y	Y	Y	Y	Y	Y
3	Y	Y	Y	Y	Y	Y
4	Y	Y	Y	Y	Y	Y
5	N	Y	Y	Y	Y	Y
6	Y	Y	Y	N	Y	Y
7	Y	N	Y	Y	N	Y
8	Y	Y	Y	Y	Y	Y
9	Y	Y	Y	Y	Y	Y
10	Y	Y	Y	Y	Y	Y
11	Y	Y	Y	Y	Y	Y
12	Y	Y	Y	Y	Y	Y
13	Y	Y	Y	Y	Y	N
14	Y	Y	Y	Y	Y	Y
15	N	Y	Y	Y	Y	Y
16	Y	Y	N	N	Y	Y
17	Y	Y	Y	Y	Y	Y
18	Y	Y	Y	Y	Y	Y
19	Y	Y	Y	Y	Y	Y
20	Y	Y	Y	Y	Y	Y
21	Y	Y	Y	Y	Y	Y
22	Y	Y	Y	Y	Y	Y
23	Y	N	Y	Y	Y	Y
24	Y	Y	Y	Y	Y	N
25	N	Y	Y	Y	N	Y
26	Y	Y	Y	Y	Y	Y
27	Y	Y	Y	Y	Y	Y
28	Y	Y	Y	N	Y	Y
29	Y	Y	N	Y	Y	Y
30	Y	Y	Y	Y	Y	Y
<b>Trial of Detection</b>	<b>27/30</b>	<b>28/30</b>	<b>28/30</b>	<b>27/30</b>	<b>28/30</b>	<b>28/30</b>
<b>Probability (%)</b>	<b>90%</b>	<b>93.33%</b>	<b>93.33%</b>	<b>90%</b>	<b>93.33%</b>	<b>93.33%</b>
<b>Limit (%)</b>	<b>&gt;= 60%</b>	<b>&gt;= 60%</b>	<b>&gt;= 60%</b>	<b>&gt;= 60%</b>	<b>&gt;= 80%</b>	<b>&gt;= 70%</b>
<b>Average Probability of Radar Type 1~4 (%)</b>	<b>91.67% ( &gt;=80% )</b>					



<40MHz / 5310MHz>

(Detection = Y, No Detection = N)						
Trial Number	Type 1	Type 2	Type 3	Type 4	Type 5	Type 6
1	Y	Y	Y	Y	Y	Y
2	Y	Y	Y	N	Y	Y
3	Y	Y	Y	Y	Y	Y
4	Y	Y	Y	Y	N	Y
5	Y	Y	Y	Y	Y	Y
6	Y	Y	Y	Y	Y	Y
7	Y	N	N	Y	Y	Y
8	Y	Y	Y	Y	Y	Y
9	N	Y	Y	Y	Y	Y
10	Y	Y	Y	Y	Y	Y
11	Y	Y	Y	Y	Y	Y
12	Y	Y	Y	Y	Y	N
13	Y	Y	Y	Y	Y	Y
14	N	Y	Y	Y	N	Y
15	Y	Y	Y	Y	Y	Y
16	Y	Y	Y	N	Y	Y
17	Y	Y	Y	Y	Y	Y
18	Y	Y	Y	Y	Y	Y
19	Y	Y	Y	Y	Y	Y
20	Y	N	N	Y	Y	Y
21	N	Y	Y	Y	Y	Y
22	Y	Y	Y	Y	Y	Y
23	Y	Y	Y	Y	N	Y
24	Y	Y	Y	Y	Y	Y
25	Y	Y	N	Y	Y	N
26	Y	Y	Y	Y	Y	Y
27	Y	Y	Y	Y	Y	Y
28	Y	Y	Y	Y	Y	Y
29	Y	Y	Y	N	Y	Y
30	Y	Y	Y	Y	Y	Y
<b>Trial of Detection</b>	<b>27/30</b>	<b>28/30</b>	<b>27/30</b>	<b>27/30</b>	<b>27/30</b>	<b>28/30</b>
<b>Probability (%)</b>	<b>90%</b>	<b>93.33%</b>	<b>90%</b>	<b>90%</b>	<b>90%</b>	<b>93.33%</b>
<b>Limit (%)</b>	<b>&gt;= 60%</b>	<b>&gt;= 60%</b>	<b>&gt;= 60%</b>	<b>&gt;= 60%</b>	<b>&gt;= 80%</b>	<b>&gt;= 70%</b>
<b>Average Probability of Radar Type 1~4 (%)</b>	<b>90.83% ( &gt;=80% )</b>					



<80MHz / 5290MHz>

(Detection = Y, No Detection = N)						
Trial Number	Type 1	Type 2	Type 3	Type 4	Type 5	Type 6
1	Y	Y	Y	Y	Y	Y
2	Y	Y	Y	Y	Y	Y
3	Y	Y	Y	Y	Y	Y
4	Y	Y	Y	N	Y	Y
5	Y	Y	N	Y	N	Y
6	Y	N	Y	Y	Y	Y
7	N	Y	Y	Y	Y	Y
8	Y	Y	Y	Y	N	Y
9	Y	N	Y	Y	Y	Y
10	Y	Y	Y	Y	Y	Y
11	Y	Y	Y	Y	Y	Y
12	Y	Y	Y	Y	Y	Y
13	Y	Y	Y	Y	Y	Y
14	Y	Y	Y	Y	Y	Y
15	Y	Y	N	Y	Y	N
16	N	Y	Y	Y	Y	Y
17	Y	Y	Y	N	Y	Y
18	Y	Y	Y	Y	Y	Y
19	Y	Y	Y	N	Y	Y
20	Y	N	Y	Y	N	Y
21	Y	Y	Y	Y	Y	Y
22	Y	Y	Y	Y	Y	Y
23	Y	Y	Y	Y	Y	Y
24	Y	Y	Y	Y	Y	N
25	Y	Y	Y	Y	Y	Y
26	N	Y	Y	Y	Y	Y
27	Y	Y	N	Y	Y	Y
28	Y	Y	Y	Y	Y	Y
29	Y	Y	Y	Y	Y	Y
30	Y	Y	Y	Y	Y	Y
<b>Trial of Detection</b>	<b>27/30</b>	<b>27/30</b>	<b>27/30</b>	<b>27/30</b>	<b>27/30</b>	<b>28/30</b>
<b>Probability (%)</b>	<b>90%</b>	<b>90%</b>	<b>90%</b>	<b>90%</b>	<b>90%</b>	<b>93.33%</b>
<b>Limit (%)</b>	<b>&gt;= 60%</b>	<b>&gt;= 60%</b>	<b>&gt;= 60%</b>	<b>&gt;= 60%</b>	<b>&gt;= 80%</b>	<b>&gt;= 70%</b>
<b>Average Probability of Radar Type 1~4 (%)</b>	<b>90% ( &gt;=80% )</b>					



<20MHz / 5500MHz>

(Detection = Y, No Detection = N)						
Trial Number	Type 1	Type 2	Type 3	Type 4	Type 5	Type 6
1	Y	Y	Y	Y	Y	Y
2	Y	Y	N	Y	Y	Y
3	Y	Y	Y	Y	Y	Y
4	Y	Y	Y	Y	Y	Y
5	N	Y	Y	Y	Y	Y
6	Y	Y	N	Y	Y	Y
7	Y	Y	Y	Y	Y	Y
8	Y	Y	Y	Y	N	Y
9	N	Y	Y	Y	Y	Y
10	Y	Y	Y	Y	Y	Y
11	Y	Y	Y	Y	Y	Y
12	Y	Y	Y	N	Y	Y
13	Y	Y	Y	N	Y	Y
14	Y	Y	Y	Y	Y	Y
15	Y	N	Y	Y	Y	Y
16	Y	N	Y	Y	N	Y
17	Y	Y	Y	Y	Y	Y
18	Y	Y	Y	Y	Y	Y
19	Y	Y	N	Y	Y	Y
20	Y	Y	Y	Y	Y	N
21	N	Y	Y	Y	Y	Y
22	Y	Y	Y	Y	Y	Y
23	Y	Y	Y	Y	Y	Y
24	Y	Y	Y	Y	Y	Y
25	Y	Y	Y	Y	Y	Y
26	Y	Y	Y	N	Y	Y
27	Y	Y	Y	Y	Y	Y
28	Y	N	Y	Y	Y	Y
29	Y	Y	Y	Y	Y	Y
30	Y	Y	Y	Y	Y	Y
<b>Trial of Detection</b>	<b>27/30</b>	<b>27/30</b>	<b>27/30</b>	<b>27/30</b>	<b>28/30</b>	<b>29/30</b>
<b>Probability (%)</b>	<b>90%</b>	<b>90%</b>	<b>90%</b>	<b>90%</b>	<b>93.33%</b>	<b>96.67%</b>
<b>Limit (%)</b>	<b>&gt;= 60%</b>	<b>&gt;= 60%</b>	<b>&gt;= 60%</b>	<b>&gt;= 60%</b>	<b>&gt;= 80%</b>	<b>&gt;= 70%</b>
<b>Average Probability of Radar Type 1~4 (%)</b>	<b>90% ( &gt;=80% )</b>					



<40MHz / 5510MHz>

(Detection = Y, No Detection = N)						
Trial Number	Type 1	Type 2	Type 3	Type 4	Type 5	Type 6
1	Y	Y	Y	Y	Y	Y
2	Y	Y	Y	N	Y	Y
3	Y	Y	Y	Y	Y	Y
4	Y	Y	Y	Y	Y	Y
5	N	Y	Y	Y	Y	Y
6	Y	Y	N	Y	Y	Y
7	N	Y	Y	Y	Y	Y
8	Y	Y	Y	N	Y	Y
9	Y	Y	Y	Y	Y	Y
10	Y	Y	Y	Y	Y	Y
11	Y	Y	Y	Y	Y	Y
12	Y	Y	Y	Y	Y	Y
13	Y	N	Y	Y	N	Y
14	Y	Y	Y	Y	Y	Y
15	Y	Y	N	Y	Y	Y
16	Y	Y	Y	Y	Y	Y
17	Y	Y	Y	Y	Y	N
18	Y	Y	Y	N	Y	Y
19	Y	N	Y	Y	Y	Y
20	Y	Y	Y	Y	Y	Y
21	Y	Y	Y	Y	Y	Y
22	Y	Y	Y	Y	Y	Y
23	Y	Y	N	Y	Y	Y
24	Y	Y	Y	Y	Y	N
25	Y	Y	Y	Y	Y	Y
26	Y	Y	Y	Y	Y	Y
27	Y	Y	Y	Y	Y	Y
28	Y	Y	Y	Y	Y	Y
29	Y	Y	Y	Y	Y	Y
30	Y	Y	Y	Y	Y	Y
<b>Trial of Detection</b>	<b>28/30</b>	<b>28/30</b>	<b>27/30</b>	<b>27/30</b>	<b>29/30</b>	<b>28/30</b>
<b>Probability (%)</b>	<b>93.33%</b>	<b>93.33%</b>	<b>90%</b>	<b>90%</b>	<b>96.67%</b>	<b>93.33%</b>
<b>Limit (%)</b>	<b>&gt;= 60%</b>	<b>&gt;= 60%</b>	<b>&gt;= 60%</b>	<b>&gt;= 60%</b>	<b>&gt;= 80%</b>	<b>&gt;= 70%</b>
<b>Average Probability of Radar Type 1~4 (%)</b>	<b>91.67% ( &gt;=80% )</b>					



<80MHz / 5530MHz>

(Detection = Y, No Detection = N)						
Trial Number	Type 1	Type 2	Type 3	Type 4	Type 5	Type 6
1	Y	Y	Y	Y	Y	Y
2	Y	Y	Y	Y	Y	Y
3	Y	Y	Y	Y	Y	Y
4	Y	Y	Y	Y	Y	Y
5	Y	Y	Y	Y	Y	Y
6	Y	Y	Y	N	Y	Y
7	Y	N	Y	N	Y	Y
8	Y	Y	Y	Y	N	Y
9	Y	N	Y	Y	Y	Y
10	Y	Y	Y	Y	Y	Y
11	Y	Y	Y	Y	Y	Y
12	Y	Y	Y	Y	Y	Y
13	Y	Y	N	Y	Y	Y
14	N	Y	Y	Y	N	Y
15	Y	Y	Y	Y	Y	Y
16	Y	Y	Y	Y	Y	Y
17	Y	Y	Y	N	Y	Y
18	Y	Y	Y	Y	Y	Y
19	Y	Y	Y	Y	Y	Y
20	Y	Y	Y	Y	Y	Y
21	Y	Y	Y	Y	Y	Y
22	Y	N	Y	Y	Y	N
23	Y	Y	Y	Y	Y	Y
24	Y	Y	Y	Y	Y	Y
25	N	Y	N	Y	Y	Y
26	Y	Y	Y	Y	Y	Y
27	Y	Y	Y	Y	Y	Y
28	Y	Y	Y	Y	Y	Y
29	Y	Y	Y	Y	Y	Y
30	Y	Y	N	Y	Y	Y
<b>Trial of Detection</b>	<b>28/30</b>	<b>27/30</b>	<b>27/30</b>	<b>27/30</b>	<b>28/30</b>	<b>29/30</b>
<b>Probability (%)</b>	<b>93.33%</b>	<b>90%</b>	<b>90%</b>	<b>90%</b>	<b>93.33%</b>	<b>96.67%</b>
<b>Limit (%)</b>	<b>&gt;= 60%</b>	<b>&gt;= 60%</b>	<b>&gt;= 60%</b>	<b>&gt;= 60%</b>	<b>&gt;= 80%</b>	<b>&gt;= 70%</b>
<b>Average Probability of Radar Type 1~4 (%)</b>	<b>90.83% ( &gt;=80% )</b>					



## 4 List of Measuring Equipment

Instrument	Manufacturer	Model No.	Serial No.	Characteristics	Calibration Date	Test Date	Due Date	Remark
Signal Generator	Keysight	N5172B	MY53052190	9kHz~6GHz	Apr. 29, 2016	Nov. 05, 2016 ~ Dec. 12, 2016	Apr. 28, 2017	DFS (DFS02-HY)
Spectrum Analyzer	Keysight	N9010A	MY56070412	10Hz~7GHz	Aug. 05, 2016	Nov. 05, 2016 ~ Dec. 12, 2016	Aug. 04, 2017	DFS (DFS02-HY)



## **Appendix A. Radar Parameters**



**Channel 60 Bandwidth 20MHz**

Test Engineer:	Bill Kuo	Temperature:	21~25	°C
Test Date:	2016/11/5~2016/12/12	Relative Humidity:	51~54	%

**DFS Radar Parameters**  
**FCC Radar Type 1**  
**Channel 60 Bandwidth 20MHz**

Trial #	Pulse Repetition Frequency Number (1 to 23)	Pulse Repetition Frequency (Pulses Per Second)	Pulse Repetition Interval (Microseconds)	Detection (Yes / No)
1	22	1066.10	938	Yes
2	10	1432.66	698	Yes
3	6	1618.12	618	Yes
4	2	1858.74	538	Yes
5	19	1138.95	878	No
6	12	326.16	3066	Yes
7	7	1567.40	638	Yes
8	21	1089.32	918	Yes
9	17	1193.32	838	Yes
10	18	1165.50	858	Yes
11	15	1253.13	798	Yes
12	11	1392.76	718	Yes
13	4	1730.10	578	Yes
14	5	1672.24	598	Yes
15	3	1792.11	558	No
16		394.32	2536	Yes
17		1035.20	966	Yes
18		1209.19	827	Yes
19		399.84	2501	Yes
20		385.36	2595	Yes
21		897.67	1114	Yes
22		768.05	1302	Yes
23		328.41	3045	Yes
24		615.76	1624	Yes
25		347.46	2878	No
26		973.71	1027	Yes
27		402.41	2485	Yes
28		625.00	1600	Yes
29		853.24	1172	Yes
30		849.62	1177	Yes

**DFS Radar Parameters**  
**FCC Radar Type 2**  
**Channel 60 Bandwidth 20MHz**

Trial #	Number Pulses per Burst	Pulse Width (Microseconds)	Pulse Repetition Interval (Microseconds)	Detection (Yes / No)
1	26	3.20	179	Yes
2	23	1.10	207	Yes
3	24	2.10	230	Yes
4	29	4.80	200	Yes
5	28	3.90	214	Yes
6	26	2.90	222	Yes
7	26	3.20	204	No
8	25	2.50	192	Yes
9	26	3.10	164	Yes
10	23	1.20	156	Yes
11	27	3.90	210	Yes
12	29	4.60	201	Yes
13	26	3.20	162	Yes
14	25	2.20	197	Yes
15	29	4.50	163	Yes
16	26	3.00	203	Yes
17	29	5.00	168	Yes
18	25	2.40	217	Yes
19	26	2.90	191	Yes
20	25	2.30	166	Yes
21	27	3.70	150	Yes
22	25	2.20	176	Yes
23	29	4.90	195	No
24	26	2.90	202	Yes
25	25	2.50	178	Yes
26	23	1.10	206	Yes
27	27	3.80	155	Yes
28	29	4.70	157	Yes
29	25	2.40	224	Yes
30	28	4.20	159	Yes

**DFS Radar Parameters**  
**FCC Radar Type 3**  
**Channel 60 Bandwidth 20MHz**

Trial #	Number Pulses per Burst	Pulse Width (Microseconds)	Pulse Repetition Interval (Microseconds)	Detection (Yes / No)
1	17	8.20	355	Yes
2	16	6.10	487	Yes
3	16	7.10	344	Yes
4	18	9.80	288	Yes
5	18	8.90	230	Yes
6	17	7.90	432	Yes
7	17	8.20	207	Yes
8	17	7.50	443	Yes
9	17	8.10	439	Yes
10	16	6.20	223	Yes
11	18	8.90	208	Yes
12	18	9.60	463	Yes
13	17	8.20	441	Yes
14	16	7.20	323	Yes
15	18	9.50	297	Yes
16	17	8.00	412	No
17	18	10.00	324	Yes
18	17	7.40	271	Yes
19	17	7.90	349	Yes
20	16	7.30	409	Yes
21	18	8.70	373	Yes
22	16	7.20	254	Yes
23	18	9.90	274	Yes
24	17	7.90	278	Yes
25	17	7.50	317	Yes
26	16	6.10	260	Yes
27	18	8.80	211	Yes
28	18	9.70	272	Yes
29	17	7.40	264	No
30	18	9.20	284	Yes

**DFS Radar Parameters**  
**FCC Radar Type 4**  
**Channel 60 Bandwidth 20MHz**

Trial #	Number Pulses per Burst	Pulse Width (Microseconds)	Pulse Repetition Interval (Microseconds)	Detection (Yes / No)
1	14	16.00	355	Yes
2	12	11.30	487	Yes
3	13	13.50	344	Yes
4	16	19.40	288	Yes
5	15	17.50	230	Yes
6	14	15.30	432	No
7	14	15.90	207	Yes
8	13	14.30	443	Yes
9	14	15.80	439	Yes
10	12	11.50	223	Yes
11	15	17.40	208	Yes
12	16	19.00	463	Yes
13	14	16.00	441	Yes
14	13	13.80	323	Yes
15	16	18.90	297	Yes
16	14	15.50	412	No
17	16	19.90	324	Yes
18	13	14.10	271	Yes
19	14	15.20	349	Yes
20	13	13.80	409	Yes
21	15	17.10	373	Yes
22	13	13.80	254	Yes
23	16	19.80	274	Yes
24	14	15.30	278	Yes
25	13	14.50	317	Yes
26	12	11.30	260	Yes
27	15	17.30	211	Yes
28	16	19.20	272	No
29	13	14.20	264	Yes
30	15	18.20	284	Yes

**DFS Radar Parameters**  
**FCC Radar Type 5**  
**Channel 60 Bandwidth 20MHz**

Trial Number:			1			Detection (Yes/No)
Number of Bursts in Trial:			15			
Chirp Center Frequency:			5300			
Burst	Number of Pulses	Pulse Width (Microseconds)	Chirp Width (MHz)	Pulse 1-to-2 Spacing (µsec)	Pulse 2-to-3 Spacing (µsec)	Starting Location Within Interval (µsec)
1	2	77.8	13	1477		636185
2	1	51.9	13			32674
3	1	63.8	13			226294
4	3	96.6	13	1786	1843	417976
5	3	85.9	13	1215	1729	611152
6	2	73.7	13	1549		8789
7	2	77.2	13	1819		201917
8	2	68.4	13	1114		395530
9	2	76.7	13	1155		588564
10	1	53.2	13			783794
11	3	85.7	13	1695	1394	177933
12	3	94.3	13	1426	1935	370624
13	2	77.6	13	1671		564893
14	1	65.7	13			759583
15	3	93.5	13	1130	1468	154262
16						
17						
18						
19						
20						

Trial Number:			2			Detection (Yes/No)
Number of Bursts in Trial:			8			
Chirp Center Frequency:			5300			
Burst	Number of Pulses	Pulse Width (Microseconds)	Chirp Width (MHz)	Pulse 1-to-2 Spacing (µsec)	Pulse 2-to-3 Spacing (µsec)	Starting Location Within Interval (µsec)
1	2	75	5	1527		653020
2	3	99.4	5	1262	1257	1015643
3	2	67.4	5	1403		1379398
4	2	73.6	5	1041		245489
5	1	65.9	5			609113
6	3	83.8	5	1292	1419	970852
7	1	65.5	5			1335913
8	3	98.6	5	1796	1728	200406
9						
10						
11						
12						
13						
14						
15						
16						
17						
18						
19						
20						

**DFS Radar Parameters**  
**FCC Radar Type 5**  
**Channel 60 Bandwidth 20MHz**

Trial Number:			3			Detection (Yes/No) Yes
Number of Bursts in Trial:			11			
Chirp Center Frequency:			5300			
Burst	Number of Pulses	Pulse Width (Microseconds)	Chirp Width (MHz)	Pulse 1-to-2 Spacing ( $\mu$ sec)	Pulse 2-to-3 Spacing ( $\mu$ sec)	Starting Location Within Interval ( $\mu$ sec)
1	2	73.8	9	1538		409565
2	2	69.5	9	1649		673692
3	1	51.9	9			938562
4	3	84.6	9	1032	1271	113209
5	3	95.4	9	1903	1388	376726
6	2	68	9	1351		641212
7	3	89.6	9	1514	1573	903714
8	2	81.9	9	1689		80863
9	3	88.3	9	1330	1838	344067
10	1	53.7	9			609331
11	3	91.3	9	1106	1001	871542
12						
13						
14						
15						
16						
17						
18						
19						
20						

Trial Number:			4			Detection (Yes/No) Yes
Number of Bursts in Trial:			20			
Chirp Center Frequency:			5300			
Burst	Number of Pulses	Pulse Width (Microseconds)	Chirp Width (MHz)	Pulse 1-to-2 Spacing ( $\mu$ sec)	Pulse 2-to-3 Spacing ( $\mu$ sec)	Starting Location Within Interval ( $\mu$ sec)
1	2	68.1	19	1355		26541
2	1	58.7	19			171821
3	2	75.3	19	1640		316229
4	1	56.4	19			461864
5	3	99.7	19	1708	1159	8677
6	1	57.7	19			153995
7	1	59.5	19			299238
8	2	80	19	1369		443177
9	2	82	19	1197		587671
10	2	82.8	19	1005		135674
11	3	88	19	1928	1101	279928
12	3	93.2	19	1907	1223	424279
13	2	70.4	19	1360		570132
14	3	95.3	19	1955	1775	117439
15	2	81.9	19	1545		262502
16	3	98.5	19	1169	1062	406573
17	1	65	19			553328
18	3	85.4	19	1637	1425	99799
19	3	91.6	19	1445	1325	244095
20	2	67.3	19	1218		390012

**DFS Radar Parameters**  
**FCC Radar Type 5**  
**Channel 60 Bandwidth 20MHz**

Trial Number:			5			Detection (Yes/No)
Number of Bursts in Trial:			17			
Chirp Center Frequency:			5300			Yes
Burst	Number of Pulses	Pulse Width (Microseconds)	Chirp Width (MHz)	Pulse 1-to-2 Spacing (µsec)	Pulse 2-to-3 Spacing (µsec)	Starting Location Within Interval (µsec)
1	2	67.9	16	1133		629614
2	1	62.3	16			96856
3	1	53.3	16			267719
4	3	90	16	1153	1346	436784
5	2	77.1	16	1646		608289
6	3	83.9	16	1232	1459	75610
7	3	89.1	16	1384	1939	245638
8	2	81.8	16	1676		416355
9	1	50.3	16			588736
10	3	87.1	16	1996	1756	54571
11	2	71.3	16	1815		225175
12	3	97.5	16	1465	1132	394825
13	3	90.6	16	1040	1354	565361
14	3	86.3	16	1183	1792	33643
15	3	97.6	16	1073	1361	203957
16	3	84.7	16	1718	1854	373812
17	3	99.7	16	1244	1988	544060
18						
19						
20						

Trial Number:			6			Detection (Yes/No)
Number of Bursts in Trial:			14			
Chirp Center Frequency:			5300			Yes
Burst	Number of Pulses	Pulse Width (Microseconds)	Chirp Width (MHz)	Pulse 1-to-2 Spacing (µsec)	Pulse 2-to-3 Spacing (µsec)	Starting Location Within Interval (µsec)
1	3	92.9	12	1564	1407	15438
2	2	67.7	12	1747		222486
3	1	65.8	12			430731
4	1	56.3	12			637784
5	1	53.7	12			845342
6	3	83.5	12	1930	1025	196720
7	1	65.8	12			404955
8	3	85.9	12	1034	1808	610711
9	2	76.3	12	1926		818057
10	2	81.5	12	1714		171459
11	3	89.4	12	1594	1827	377969
12	1	63.4	12			586875
13	2	69.6	12	1925		792834
14	2	74.5	12	1846		146044
15						
16						
17						
18						
19						
20						



**DFS Radar Parameters**  
**FCC Radar Type 5**  
**Channel 60 Bandwidth 20MHz**

Trial Number:			7			Detection (Yes/No)
Number of Bursts in Trial:			15			
Chirp Center Frequency:			5300			
Burst	Number of Pulses	Pulse Width (Microseconds)	Chirp Width (MHz)	Pulse 1-to-2 Spacing (µsec)	Pulse 2-to-3 Spacing (µsec)	Starting Location Within Interval (µsec)
1	1	52.6	10			51446
2	3	84.1	10	1725	1529	292696
3	3	97.7	10	1868	1805	533989
4	3	97.3	10	1446	1755	775564
5	3	98.8	10	1386	1302	21542
6	2	72.2	10	1184		263385
7	2	67.6	10	1027		505581
8	2	75.7	10	1871		747058
9	1	60.9	10			989976
10	1	64.2	10			234024
11	2	78.8	10	1604		475207
12	3	87.5	10	1712	1683	715825
13						
14						
15						
16						
17						
18						
19						
20						

Trial Number:			8			Detection (Yes/No)
Number of Bursts in Trial:			12			
Chirp Center Frequency:			5300			
Burst	Number of Pulses	Pulse Width (Microseconds)	Chirp Width (MHz)	Pulse 1-to-2 Spacing (µsec)	Pulse 2-to-3 Spacing (µsec)	Starting Location Within Interval (µsec)
1	1	52.6	10			51446
2	3	84.1	10	1725	1529	292696
3	3	97.7	10	1868	1805	533989
4	3	97.3	10	1446	1755	775564
5	3	98.8	10	1386	1302	21542
6	2	72.2	10	1184		263385
7	2	67.6	10	1027		505581
8	2	75.7	10	1871		747058
9	1	60.9	10			989976
10	1	64.2	10			234024
11	2	78.8	10	1604		475207
12	3	87.5	10	1712	1683	715825
13						
14						
15						
16						
17						
18						
19						
20						

**DFS Radar Parameters**  
**FCC Radar Type 5**  
**Channel 60 Bandwidth 20MHz**

Trial Number:			9			Detection (Yes/No)
Number of Bursts in Trial:			14			
Chirp Center Frequency:			5300			
Burst	Number of Pulses	Pulse Width (Microseconds )	Chirp Width (MHz)	Pulse 1-to-2 Spacing (µsec)	Pulse 2-to-3 Spacing (µsec)	Starting Location Within Interval (µsec)
1	1	54.1	13			823112
2	1	50.7	13			174965
3	1	52.3	13			382216
4	3	99.8	13	1696	1949	587395
5	2	68.4	13	1099		796897
6	2	80.8	13	1505		149042
7	1	62.5	13			356750
8	2	74.8	13	1204		563824
9	1	50.8	13			772314
10	1	54	13			123796
11	1	63	13			331215
12	3	91.8	13	1270	1347	537402
13	2	79.3	13	1992		744805
14	1	64.3	13			98172
15						
16						
17						
18						
19						
20						

Trial Number:			10			Detection (Yes/No)
Number of Bursts in Trial:			8			
Chirp Center Frequency:			5300			
Burst	Number of Pulses	Pulse Width (Microseconds )	Chirp Width (MHz)	Pulse 1-to-2 Spacing (µsec)	Pulse 2-to-3 Spacing (µsec)	Starting Location Within Interval (µsec)
1	1	63.4	6			535615
2	1	52	6			898668
3	3	97.2	6	1605	1583	1259235
4	2	78.7	6	1743		127106
5	2	74.2	6	1219		490358
6	3	88.7	6	1934	1273	852409
7	1	54.3	6			1217152
8	3	95.4	6	1555	1791	82296
9						
10						
11						
12						
13						
14						
15						
16						
17						
18						
19						
20						

**DFS Radar Parameters**  
**FCC Radar Type 5**  
**Channel 60 Bandwidth 20MHz**

Trial Number:			11			Detection (Yes/No)
Number of Bursts in Trial:			17			
Chirp Center Frequency:			5297.3925			
Burst	Number of Pulses	Pulse Width (Microseconds)	Chirp Width (MHz)	Pulse 1-to-2 Spacing (µsec)	Pulse 2-to-3 Spacing (µsec)	Starting Location Within Interval (µsec)
1	2	73.7	16	1497		209249
2	3	97.4	16	1754	1613	378386
3	3	91.7	16	1702	1462	548411
4	1	66.2	16			17733
5	2	70.8	16	1821		187952
6	1	52.3	16			359277
7	2	78.9	16	1984		528886
8	2	70.9	16	1358		700166
9	2	75.6	16	1430		167197
10	1	59.1	16			338262
11	2	77	16	1304		508324
12	2	67.9	16	1083		678689
13	2	81.2	16	1932		146031
14	2	78.7	16	1121		316923
15	1	63.3	16			488056
16	2	68.9	16	1423		657326
17	1	59.3	16			125509
18						
19						
20						

Trial Number:			12			Detection (Yes/No)
Number of Bursts in Trial:			19			
Chirp Center Frequency:			5298.5925			
Burst	Number of Pulses	Pulse Width (Microseconds)	Chirp Width (MHz)	Pulse 1-to-2 Spacing (µsec)	Pulse 2-to-3 Spacing (µsec)	Starting Location Within Interval (µsec)
1	3	98.9	19	1680	1488	263736
2	2	82.3	19	1855		416459
3	3	86.7	19	1400	1919	567902
4	3	89.7	19	1068	1282	92979
5	3	98.6	19	1194	1461	245155
6	2	71.1	19	1789		397609
7	1	55.9	19			551431
8	2	67.9	19	1372		74413
9	3	84.4	19	1107	1443	226559
10	1	58.8	19			380056
11	1	65.6	19			533408
12	2	78.5	19	1704		55547
13	2	82.3	19	1686		207876
14	3	90.1	19	1071	1266	359771
15	3	90.2	19	1089	1950	511297
16	2	83.1	19	1406		36803
17	1	58.8	19			189652
18	2	77	19	1657		341809
19	1	55	19			495737
20						

**DFS Radar Parameters**  
**FCC Radar Type 5**  
**Channel 60 Bandwidth 20MHz**

Trial Number:			13			Detection (Yes/No)
Number of Bursts in Trial:			15			
Chirp Center Frequency:			5296.1925			
Burst	Number of Pulses	Pulse Width (Microseconds)	Chirp Width (MHz)	Pulse 1-to-2 Spacing (µsec)	Pulse 2-to-3 Spacing (µsec)	Starting Location Within Interval (µsec)
1	1	58.1	13			22911
2	1	52.1	13			216473
3	1	59.9	13			410004
4	1	60.2	13			603671
5	3	95.9	13	1906	1608	794160
6	2	79.9	13	1859		192251
7	2	78.5	13	1917		385590
8	1	53.8	13			579862
9	1	64.7	13			773423
10	1	61.4	13			168898
11	2	83.2	13	1858		361606
12	3	84.7	13	1677	1638	553866
13	3	88.7	13	1528	1058	747241
14	2	78.3	13	1951		144710
15	2	69.3	13	1717		337856
16						
17						
18						
19						
20						

Trial Number:			14			Detection (Yes/No)
Number of Bursts in Trial:			12			
Chirp Center Frequency:			5294.9925			
Burst	Number of Pulses	Pulse Width (Microseconds)	Chirp Width (MHz)	Pulse 1-to-2 Spacing (µsec)	Pulse 2-to-3 Spacing (µsec)	Starting Location Within Interval (µsec)
1	2	75.3	10	1612		664275
2	1	56.3	10			907886
3	2	67.7	10	1185		151316
4	1	55.6	10			393746
5	2	75.2	10	1267		635093
6	2	76.3	10	1305		876993
7	3	85.7	10	1362	1924	121278
8	3	98.4	10	1550	1249	362696
9	3	86.4	10	1439	1046	604342
10	3	93.6	10	1031	1452	846453
11	1	63.3	10			91871
12	3	92.4	10	1673	1322	333050
13						
14						
15						
16						
17						
18						
19						
20						

**DFS Radar Parameters**  
**FCC Radar Type 5**  
**Channel 60 Bandwidth 20MHz**

Trial Number:			15			Detection (Yes/No)
Number of Bursts in Trial:			19			
Chirp Center Frequency:			5298.1925			
Burst	Number of Pulses	Pulse Width (Microseconds )	Chirp Width (MHz)	Pulse 1-to-2 Spacing (µsec)	Pulse 2-to-3 Spacing (µsec)	Starting Location Within Interval (µsec)
1	3	93.3	18	1912	1535	361323
2	2	69.1	18	1794		515261
3	3	86.9	18	1152	1148	39025
4	3	84.9	18	1948	1118	190900
5	2	72.3	18	1916		343941
6	1	51.7	18			497624
7	1	58.3	18			20319
8	1	60.8	18			172999
9	1	57.1	18			325872
10	3	88.9	18	1964	1489	475841
11	2	72	18	1297		1489
12	3	90.9	18	1566	1370	153647
13	1	59.8	18			307096
14	2	70	18	1291		458804
15	2	67.2	18	1881		610798
16	3	91.2	18	1832	1661	134759
17	1	56.5	18			288306
18	1	51.2	18			441296
19	2	74.1	18	1245		592780
20						

Trial Number:			16			Detection (Yes/No)
Number of Bursts in Trial:			14			
Chirp Center Frequency:			5295.7925			
Burst	Number of Pulses	Pulse Width (Microseconds )	Chirp Width (MHz)	Pulse 1-to-2 Spacing (µsec)	Pulse 2-to-3 Spacing (µsec)	Starting Location Within Interval (µsec)
1	2	76.9	12	1140		158286
2	1	50.2	12			366024
3	1	62.9	12			573452
4	1	64.7	12			780619
5	3	83.8	12	1097	1621	132455
6	1	65.4	12			340207
7	1	53.2	12			548208
8	1	51.7	12			755333
9	2	78.7	12	1168		107117
10	2	72.4	12	1343		314500
11	1	53.8	12			522447
12	2	73.6	12	1553		728517
13	2	66.7	12	1122		81611
14	2	82.5	12	1019		288948
15						
16						
17						
18						
19						
20						

**DFS Radar Parameters**  
**FCC Radar Type 5**  
**Channel 60 Bandwidth 20MHz**

Trial Number:			17			Detection (Yes/No)
Number of Bursts in Trial:			20			
Chirp Center Frequency:			5298.9925			
Burst	Number of Pulses	Pulse Width (Microseconds)	Chirp Width (MHz)	Pulse 1-to-2 Spacing ( $\mu$ sec)	Pulse 2-to-3 Spacing ( $\mu$ sec)	Starting Location Within Interval ( $\mu$ sec)
1	3	87.6	20	1055	1840	345766
2	3	85.2	20	1541	1408	490019
3	3	84.8	20	1889	1463	39073
4	2	77.9	20	1460		183923
5	2	76.5	20	1485		328777
6	1	60.9	20			474728
7	2	83	20	1010		21394
8	2	80.4	20	1752		165992
9	2	67.5	20	1181		310973
10	1	62.1	20			456884
11	3	86.4	20	1966	1263	3515
12	3	84.3	20	1188	1788	147928
13	2	76.9	20	1537		293225
14	3	95.8	20	1298	1844	436922
15	1	55.2	20			584015
16	1	59	20			130832
17	3	94.5	20	1700	1283	274684
18	3	91.9	20	1978	1165	418579
19	3	85.2	20	1551	1189	563464
20	2	69.5	20	1224		112787

Trial Number:			18			Detection (Yes/No)
Number of Bursts in Trial:			12			
Chirp Center Frequency:			5294.9925			
Burst	Number of Pulses	Pulse Width (Microseconds)	Chirp Width (MHz)	Pulse 1-to-2 Spacing ( $\mu$ sec)	Pulse 2-to-3 Spacing ( $\mu$ sec)	Starting Location Within Interval ( $\mu$ sec)
1	3	86.4	10	1918	1455	429224
2	3	92.2	10	1719	1895	670241
3	2	80.4	10	1899		912880
4	1	54.3	10			158603
5	1	53.1	10			400824
6	2	69.4	10	1546		641915
7	2	69.1	10	1639		883823
8	3	100	10	1438	1595	128373
9	2	79.6	10	1705		370379
10	3	88.4	10	1579	1623	611194
11	1	53.3	10			855665
12	1	65.3	10			98897
13						
14						
15						
16						
17						
18						
19						
20						

**DFS Radar Parameters**  
**FCC Radar Type 5**  
**Channel 60 Bandwidth 20MHz**

Trial Number:			19			Detection (Yes/No)
Number of Bursts in Trial:			14			
Chirp Center Frequency:			5295.7925			
Burst	Number of Pulses	Pulse Width (Microseconds)	Chirp Width (MHz)	Pulse 1-to-2 Spacing (usec)	Pulse 2-to-3 Spacing (usec)	Starting Location Within Interval (usec)
1	1	55.3	12			292143
2	1	58.3	12			499633
3	2	72.3	12	1039.000		706377
4	3	84.8	12	1761.000	1721.000	58989
5	2	82.5	12	1431.000		266161
6	1	63.3	12			474469
7	2	80	12	1913.000		680544
8	3	90.3	12	1853.000	1123.000	33519
9	3	91.1	12	1783.000	1172.000	240319
10	3	96.6	12	1036.000	1385.000	447400
11	2	82.7	12	1990.000		654516
12	1	50.7	12			8083
13	2	78.4	12	1109.000		215435
14	3	99.5	12	1965.000	1869.000	421325
15						
16						
17						
18						
19						
20						

Trial Number:			20			Detection (Yes/No)
Number of Bursts in Trial:			12			
Chirp Center Frequency:			5294.9925			
Burst	Number of Pulses	Pulse Width (Microseconds)	Chirp Width (MHz)	Pulse 1-to-2 Spacing (usec)	Pulse 2-to-3 Spacing (usec)	Starting Location Within Interval (usec)
1	3	88.6	10	1067	1927	733725
2	1	57.4	10			977882
3	3	96.6	10	1658	1324	221197
4	2	69.7	10	1945		462915
5	2	77.9	10	1317		705071
6	1	62	10			947923
7	3	88.4	10	1077	1366	191373
8	3	97.3	10	1896	1367	432561
9	3	96.2	10	1787	1672	674004
10	3	95.4	10	1892	1414	915842
11	1	54.8	10			162176
12	2	80.4	10	1436		403553
13						
14						
15						
16						
17						
18						
19						
20						

**DFS Radar Parameters**  
**FCC Radar Type 5**  
**Channel 60 Bandwidth 20MHz**

Trial Number:			21			Detection (Yes/No)
Number of Bursts in Trial:			16			
Chirp Center Frequency:			5303.0075			
Burst	Number of Pulses	Pulse Width (Microseconds)	Chirp Width (MHz)	Pulse 1-to-2 Spacing (µsec)	Pulse 2-to-3 Spacing (µsec)	Starting Location Within Interval (µsec)
1	2	74.7	15	1611		483470
2	1	57.1	15			666072
3	3	91.9	15	1475	1276	98810
4	2	83.1	15	1772		279914
5	1	50.7	15			462536
6	2	79.2	15	1600		642324
7	1	58.7	15			76831
8	2	71	15	1567		257785
9	2	79	15	1960		438554
10	2	68.5	15	1428		620397
11	2	73.5	15	1352		54310
12	2	70.5	15	1115		235506
13	2	76.6	15	1300		417036
14	2	81.2	15	1675		597974
15	1	61.8	15			32086
16	3	94.9	15	1206	1860	212751
17						
18						
19						
20						

Trial Number:			22			Detection (Yes/No)
Number of Bursts in Trial:			12			
Chirp Center Frequency:			5305.4075			
Burst	Number of Pulses	Pulse Width (Microseconds)	Chirp Width (MHz)	Pulse 1-to-2 Spacing (µsec)	Pulse 2-to-3 Spacing (µsec)	Starting Location Within Interval (µsec)
1	2	78.5	9	1698		526149
2	3	89.8	9	1962	1167	767135
3	1	59.4	9			12955
4	2	79.6	9	1890		254612
5	2	76	9	1811		496588
6	1	53.6	9			739728
7	2	80.9	9	1053		980872
8	1	61.6	9			225249
9	1	53.4	9			467279
10	1	59.9	9			709720
11	1	60.4	9			951847
12	3	91.4	9	1726	1227	194839
13						
14						
15						
16						
17						
18						
19						
20						



**DFS Radar Parameters**  
**FCC Radar Type 5**  
**Channel 60 Bandwidth 20MHz**

Trial Number:			23			Detection (Yes/No)
Number of Bursts in Trial:			20			
Chirp Center Frequency:			5301.0075			
Burst	Number of Pulses	Pulse Width (Microseconds )	Chirp Width (MHz)	Pulse 1-to-2 Spacing (µsec)	Pulse 2-to-3 Spacing (µsec)	Starting Location Within Interval (µsec)
1	2	77	20	1363		261858
2	1	58.1	20			407646
3	1	62.1	20			552319
4	2	76.9	20	1236		99107
5	2	80	20	1852		243514
6	1	52	20			389464
7	3	88.6	20	1995	1905	531093
8	2	72.9	20	1387		81159
9	3	98.5	20	1746	1389	225245
10	1	57.9	20			371906
11	3	95.9	20	1870	1066	514197
12	1	53.5	20			63561
13	3	92	20	1654	1458	207510
14	1	57.3	20			353638
15	2	70.5	20	1586		497515
16	2	70	20	1664		45553
17	3	84	20	1630	1176	189821
18	2	76.1	20	1057		335330
19	3	93.2	20	1018	1340	478825
20	3	96.8	20	1614	1817	27594

Trial Number:			24			Detection (Yes/No)
Number of Bursts in Trial:			14			
Chirp Center Frequency:			5304.2075			
Burst	Number of Pulses	Pulse Width (Microseconds )	Chirp Width (MHz)	Pulse 1-to-2 Spacing (µsec)	Pulse 2-to-3 Spacing (µsec)	Starting Location Within Interval (µsec)
1	1	50.1	12			247117
2	3	93.5	12	1081	1413	453362
3	2	68.8	12	1577		660875
4	1	56.3	12			14140
5	3	86	12	1108	1987	220734
6	2	75.2	12	1536		428367
7	1	54.4	12			636681
8	2	71.1	12	1243		843157
9	2	76.2	12	1770		195585
10	2	80.2	12	1209		403231
11	2	79.7	12	1214		610202
12	3	90.9	12	1862	1601	815229
13	2	68.7	12	1441		170267
14	2	67.4	12	1313		377306
15						
16						
17						
18						
19						
20						

**DFS Radar Parameters**  
**FCC Radar Type 5**  
**Channel 60 Bandwidth 20MHz**

Trial Number:			25			Detection (Yes/No)
Number of Bursts in Trial:			13			
Chirp Center Frequency:			5304.6075			
Burst	Number of Pulses	Pulse Width (Microseconds )	Chirp Width (MHz)	Pulse 1-to-2 Spacing (µsec)	Pulse 2-to-3 Spacing (µsec)	Starting Location Within Interval (µsec)
1	3	94	11	1748	1941	628071
2	2	70.8	11	1201		853391
3	1	56.3	11			156223
4	3	96.7	11	1163	1332	378734
5	3	90.6	11	1582	1498	601331
6	2	74.5	11	1281		825462
7	3	92.6	11	1669	1222	128265
8	3	89	11	1135	1380	351161
9	3	96.5	11	1822	1602	573425
10	2	70.5	11	1178		798431
11	3	94	11	1629	1956	100737
12	1	55.8	11			324661
13	3	87.7	11	1963	1164	546278
14						
15						
16						
17						
18						
19						
20						

Trial Number:			26			Detection (Yes/No)
Number of Bursts in Trial:			8			
Chirp Center Frequency:			5307.0075			
Burst	Number of Pulses	Pulse Width (Microseconds )	Chirp Width (MHz)	Pulse 1-to-2 Spacing (µsec)	Pulse 2-to-3 Spacing (µsec)	Starting Location Within Interval (µsec)
1	2	68.6	5	1161		1253842
2	2	83.1	5	1315		119486
3	1	60.9	5			482958
4	2	77.7	5	1158		845641
5	2	77.4	5	1510		1208428
6	2	66.8	5	1323		74748
7	1	63.7	5			438300
8	3	91.2	5	1681	1275	800152
9						
10						
11						
12						
13						
14						
15						
16						
17						
18						
19						
20						

**DFS Radar Parameters**  
**FCC Radar Type 5**  
**Channel 60 Bandwidth 20MHz**

Trial Number:			27			Detection (Yes/No)
Number of Bursts in Trial:			17			
Chirp Center Frequency:			5302.6075			
Burst	Number of Pulses	Pulse Width (Microseconds)	Chirp Width (MHz)	Pulse 1-to-2 Spacing (µsec)	Pulse 2-to-3 Spacing (µsec)	Starting Location Within Interval (µsec)
1	3	83.6	16	1195	1000	545865
2	3	89.4	16	1627	1656	14067
3	1	55.8	16			184953
4	3	90.9	16	1554	1998	353759
5	1	54.7	16			526388
6	3	97.7	16	1202	1250	694806
7	2	67.5	16	1434		163568
8	3	96.7	16	1469	1268	333410
9	2	68.3	16	1954		504006
10	2	78.3	16	1082		675297
11	1	55	16			142890
12	3	84.9	16	1936	1199	312479
13	2	74.6	16	1856		482953
14	1	63.3	16			655022
15	3	99.8	16	1515	1120	121457
16	1	63.6	16			292606
17	3	87.3	16	1051	1831	461322
18						
19						
20						

Trial Number:			28			Detection (Yes/No)
Number of Bursts in Trial:			19			
Chirp Center Frequency:			5301.4075			
Burst	Number of Pulses	Pulse Width (Microseconds)	Chirp Width (MHz)	Pulse 1-to-2 Spacing (µsec)	Pulse 2-to-3 Spacing (µsec)	Starting Location Within Interval (µsec)
1	3	85.6	19	1078	1015	565136
2	2	68.6	19	1780		89970
3	1	54.2	19			243121
4	1	61.2	19			396034
5	3	97.1	19	1969	1100	546225
6	3	98.3	19	1699	1622	70998
7	1	62.4	19			224093
8	2	80.2	19	1769		376127
9	3	87.5	19	1448	1179	527806
10	3	85.8	19	1348	1472	52247
11	3	88.1	19	1124	1631	204582
12	1	65.3	19			357941
13	1	52.5	19			510977
14	1	52.3	19			33698
15	2	74.1	19	1200		186023
16	1	54.9	19			339327
17	2	76.2	19	1502		491053
18	1	60.4	19			14858
19	2	81.5	19	1103		167387
20						

**DFS Radar Parameters**  
**FCC Radar Type 5**  
**Channel 60 Bandwidth 20MHz**

Trial Number:			29			Detection (Yes/No)
Number of Bursts in Trial:			12			
Chirp Center Frequency:			5305.0075			
Burst	Number of Pulses	Pulse Width (Microseconds)	Chirp Width (MHz)	Pulse 1-to-2 Spacing (µsec)	Pulse 2-to-3 Spacing (µsec)	Starting Location Within Interval (µsec)
1	1	50.5	10			507709
2	1	55.7	10			750249
3	3	85.8	10	1002	1967	989003
4	2	76.9	10	1474		235634
5	2	75.1	10	1052		477675
6	3	92.3	10	1486	1492	718312
7	2	78.1	10	1757		960895
8	3	92.2	10	1252	1713	205370
9	3	89	10	1706	1411	446940
10	2	70.9	10	1620		689225
11	1	63.1	10			932305
12	1	55.3	10			176231
13						
14						
15						
16						
17						
18						
19						
20						

Trial Number:			30			Detection (Yes/No)
Number of Bursts in Trial:			18			
Chirp Center Frequency:			5302.2075			
Burst	Number of Pulses	Pulse Width (Microseconds)	Chirp Width (MHz)	Pulse 1-to-2 Spacing (µsec)	Pulse 2-to-3 Spacing (µsec)	Starting Location Within Interval (µsec)
1	3	83.4	17	1205	1801	277485
2	3	97.3	17	1826	1635	437880
3	3	90.4	17	1986	1674	598445
4	3	91.8	17	1151	1802	97088
5	3	98.2	17	1977	1766	257251
6	1	59.5	17			419893
7	2	80	17	1137		580724
8	3	86.5	17	1128	1828	77366
9	3	91.1	17	1599	1442	238032
10	3	93.5	17	1373	1087	398605
11	1	60.7	17			562025
12	2	67.2	17	1405		57684
13	1	61.8	17			219083
14	2	79.4	17	1667		379234
15	2	81.4	17	1464		540896
16	1	65.7	17			37916
17	2	76	17	1255		198794
18	2	81	17	1668		359754
19						
20						

**DFS Radar Parameters**  
**FCC Radar Type 1**  
**Channel 62 Bandwidth 40MHz**

Trial #	Pulse Repetition Frequency Number (1 to 23)	Pulse Repetition Frequency (Pulses Per Second)	Pulse Repetition Interval (Microseconds)	Detection (Yes / No)
1	22	1066.10	938	Yes
2	10	1432.66	698	Yes
3	6	1618.12	618	Yes
4	2	1858.74	538	Yes
5	19	1138.95	878	Yes
6	12	326.16	3066	Yes
7	7	1567.40	638	Yes
8	21	1089.32	918	Yes
9	17	1193.32	838	No
10	18	1165.50	858	Yes
11	15	1253.13	798	Yes
12	11	1392.76	718	Yes
13	4	1730.10	578	Yes
14	5	1672.24	598	No
15	3	1792.11	558	Yes
16		394.32	2536	Yes
17		1035.20	966	Yes
18		1209.19	827	Yes
19		399.84	2501	Yes
20		385.36	2595	Yes
21		897.67	1114	No
22		768.05	1302	Yes
23		328.41	3045	Yes
24		615.76	1624	Yes
25		347.46	2878	Yes
26		973.71	1027	Yes
27		402.41	2485	Yes
28		625.00	1600	Yes
29		853.24	1172	Yes
30		849.62	1177	Yes

**DFS Radar Parameters**  
**FCC Radar Type 2**  
**Channel 62 Bandwidth 40MHz**

Trial #	Number Pulses per Burst	Pulse Width (Microseconds)	Pulse Repetition Interval (Microseconds)	Detection (Yes / No)
1	26	3.20	179	Yes
2	23	1.10	207	Yes
3	24	2.10	230	Yes
4	29	4.80	200	Yes
5	28	3.90	214	Yes
6	26	2.90	222	Yes
7	26	3.20	204	No
8	25	2.50	192	Yes
9	26	3.10	164	Yes
10	23	1.20	156	Yes
11	27	3.90	210	Yes
12	29	4.60	201	Yes
13	26	3.20	162	Yes
14	25	2.20	197	Yes
15	29	4.50	163	Yes
16	26	3.00	203	Yes
17	29	5.00	168	Yes
18	25	2.40	217	Yes
19	26	2.90	191	Yes
20	25	2.30	166	No
21	27	3.70	150	Yes
22	25	2.20	176	Yes
23	29	4.90	195	Yes
24	26	2.90	202	Yes
25	25	2.50	178	Yes
26	23	1.10	206	Yes
27	27	3.80	155	Yes
28	29	4.70	157	Yes
29	25	2.40	224	Yes
30	28	4.20	159	Yes

**DFS Radar Parameters**  
**FCC Radar Type 3**  
**Channel 62 Bandwidth 40MHz**

Trial #	Number Pulses per Burst	Pulse Width (Microseconds)	Pulse Repetition Interval (Microseconds)	Detection (Yes / No)
1	17	8.20	355	Yes
2	16	6.10	487	Yes
3	16	7.10	344	Yes
4	18	9.80	288	Yes
5	18	8.90	230	Yes
6	17	7.90	432	Yes
7	17	8.20	207	No
8	17	7.50	443	Yes
9	17	8.10	439	Yes
10	16	6.20	223	Yes
11	18	8.90	208	Yes
12	18	9.60	463	Yes
13	17	8.20	441	Yes
14	16	7.20	323	Yes
15	18	9.50	297	Yes
16	17	8.00	412	Yes
17	18	10.00	324	Yes
18	17	7.40	271	Yes
19	17	7.90	349	Yes
20	16	7.30	409	No
21	18	8.70	373	Yes
22	16	7.20	254	Yes
23	18	9.90	274	Yes
24	17	7.90	278	Yes
25	17	7.50	317	No
26	16	6.10	260	Yes
27	18	8.80	211	Yes
28	18	9.70	272	Yes
29	17	7.40	264	Yes
30	18	9.20	284	Yes

**DFS Radar Parameters**  
**FCC Radar Type 4**  
**Channel 62 Bandwidth 40MHz**

Trial #	Number Pulses per Burst	Pulse Width (Microseconds)	Pulse Repetition Interval (Microseconds)	Detection (Yes / No)
1	14	16.00	355	Yes
2	12	11.30	487	No
3	13	13.50	344	Yes
4	16	19.40	288	Yes
5	15	17.50	230	Yes
6	14	15.30	432	Yes
7	14	15.90	207	Yes
8	13	14.30	443	Yes
9	14	15.80	439	Yes
10	12	11.50	223	Yes
11	15	17.40	208	Yes
12	16	19.00	463	Yes
13	14	16.00	441	Yes
14	13	13.80	323	Yes
15	16	18.90	297	Yes
16	14	15.50	412	No
17	16	19.90	324	Yes
18	13	14.10	271	Yes
19	14	15.20	349	Yes
20	13	13.80	409	Yes
21	15	17.10	373	Yes
22	13	13.80	254	Yes
23	16	19.80	274	Yes
24	14	15.30	278	Yes
25	13	14.50	317	Yes
26	12	11.30	260	Yes
27	15	17.30	211	Yes
28	16	19.20	272	Yes
29	13	14.20	264	No
30	15	18.20	284	Yes



**DFS Radar Parameters**  
**FCC Radar Type 5**  
**Channel 62 Bandwidth 40MHz**

Trial Number:			1			Detection (Yes/No)
Number of Bursts in Trial:			15			
Chirp Center Frequency:			5310			
Burst	Number of Pulses	Pulse Width (Microseconds)	Chirp Width (MHz)	Pulse 1-to-2 Spacing (µsec)	Pulse 2-to-3 Spacing (µsec)	Starting Location Within Interval (µsec)
1	2	77.8	13	1477		636185
2	1	51.9	13			32674
3	1	63.8	13			226294
4	3	96.6	13	1786	1843	417976
5	3	85.9	13	1215	1729	611152
6	2	73.7	13	1549		8789
7	2	77.2	13	1819		201917
8	2	68.4	13	1114		395530
9	2	76.7	13	1155		588564
10	1	53.2	13			783794
11	3	85.7	13	1695	1394	177933
12	3	94.3	13	1426	1935	370624
13	2	77.6	13	1671		564893
14	1	65.7	13			759583
15	3	93.5	13	1130	1468	154262
16						
17						
18						
19						
20						

Trial Number:			2			Detection (Yes/No)
Number of Bursts in Trial:			8			
Chirp Center Frequency:			5310			
Burst	Number of Pulses	Pulse Width (Microseconds)	Chirp Width (MHz)	Pulse 1-to-2 Spacing (µsec)	Pulse 2-to-3 Spacing (µsec)	Starting Location Within Interval (µsec)
1	2	75	5	1527		653020
2	3	99.4	5	1262	1257	1015643
3	2	67.4	5	1403		1379398
4	2	73.6	5	1041		245489
5	1	65.9	5			609113
6	3	83.8	5	1292	1419	970852
7	1	65.5	5			1335913
8	3	98.6	5	1796	1728	200406
9						
10						
11						
12						
13						
14						
15						
16						
17						
18						
19						
20						

**DFS Radar Parameters**  
**FCC Radar Type 5**  
**Channel 62 Bandwidth 40MHz**

Trial Number:			3			Detection (Yes/No)
Number of Bursts in Trial:			11			
Chirp Center Frequency:			5310			
Burst	Number of Pulses	Pulse Width (Microseconds)	Chirp Width (MHz)	Pulse 1-to-2 Spacing ( $\mu$ sec)	Pulse 2-to-3 Spacing ( $\mu$ sec)	Starting Location Within Interval ( $\mu$ sec)
1	2	73.8	9	1538		409565
2	2	69.5	9	1649		673692
3	1	51.9	9			938562
4	3	84.6	9	1032	1271	113209
5	3	95.4	9	1903	1388	376726
6	2	68	9	1351		641212
7	3	89.6	9	1514	1573	903714
8	2	81.9	9	1689		80863
9	3	88.3	9	1330	1838	344067
10	1	53.7	9			609331
11	3	91.3	9	1106	1001	871542
12						
13						
14						
15						
16						
17						
18						
19						
20						

Trial Number:			4			Detection (Yes/No)
Number of Bursts in Trial:			20			
Chirp Center Frequency:			5310			
Burst	Number of Pulses	Pulse Width (Microseconds)	Chirp Width (MHz)	Pulse 1-to-2 Spacing ( $\mu$ sec)	Pulse 2-to-3 Spacing ( $\mu$ sec)	Starting Location Within Interval ( $\mu$ sec)
1	2	68.1	19	1355		26541
2	1	58.7	19			171821
3	2	75.3	19	1640		316229
4	1	56.4	19			461864
5	3	99.7	19	1708	1159	8677
6	1	57.7	19			153995
7	1	59.5	19			299238
8	2	80	19	1369		443177
9	2	82	19	1197		587671
10	2	82.8	19	1005		135674
11	3	88	19	1928	1101	279928
12	3	93.2	19	1907	1223	424279
13	2	70.4	19	1360		570132
14	3	95.3	19	1955	1775	117439
15	2	81.9	19	1545		262502
16	3	98.5	19	1169	1062	406573
17	1	65	19			553328
18	3	85.4	19	1637	1425	99799
19	3	91.6	19	1445	1325	244095
20	2	67.3	19	1218		390012

**DFS Radar Parameters**  
**FCC Radar Type 5**  
**Channel 62 Bandwidth 40MHz**

Trial Number:			5			Detection (Yes/No)
Number of Bursts in Trial:			17			
Chirp Center Frequency:			5310			Yes
Burst	Number of Pulses	Pulse Width (Microseconds)	Chirp Width (MHz)	Pulse 1-to-2 Spacing (µsec)	Pulse 2-to-3 Spacing (µsec)	Starting Location Within Interval (µsec)
1	2	67.9	16	1133		629614
2	1	62.3	16			96856
3	1	53.3	16			267719
4	3	90	16	1153	1346	436784
5	2	77.1	16	1646		608289
6	3	83.9	16	1232	1459	75610
7	3	89.1	16	1384	1939	245638
8	2	81.8	16	1676		416355
9	1	50.3	16			588736
10	3	87.1	16	1996	1756	54571
11	2	71.3	16	1815		225175
12	3	97.5	16	1465	1132	394825
13	3	90.6	16	1040	1354	565361
14	3	86.3	16	1183	1792	33643
15	3	97.6	16	1073	1361	203957
16	3	84.7	16	1718	1854	373812
17	3	99.7	16	1244	1988	544060
18						
19						
20						

Trial Number:			6			Detection (Yes/No)
Number of Bursts in Trial:			14			
Chirp Center Frequency:			5310			Yes
Burst	Number of Pulses	Pulse Width (Microseconds)	Chirp Width (MHz)	Pulse 1-to-2 Spacing (µsec)	Pulse 2-to-3 Spacing (µsec)	Starting Location Within Interval (µsec)
1	3	92.9	12	1564	1407	15438
2	2	67.7	12	1747		222486
3	1	65.8	12			430731
4	1	56.3	12			637784
5	1	53.7	12			845342
6	3	83.5	12	1930	1025	196720
7	1	65.8	12			404955
8	3	85.9	12	1034	1808	610711
9	2	76.3	12	1926		818057
10	2	81.5	12	1714		171459
11	3	89.4	12	1594	1827	377969
12	1	63.4	12			586875
13	2	69.6	12	1925		792834
14	2	74.5	12	1846		146044
15						
16						
17						
18						
19						
20						

**DFS Radar Parameters**  
**FCC Radar Type 5**  
**Channel 62 Bandwidth 40MHz**

Trial Number:			7			Detection (Yes/No)
Number of Bursts in Trial:			15			
Chirp Center Frequency:			5310			
Burst	Number of Pulses	Pulse Width (Microseconds)	Chirp Width (MHz)	Pulse 1-to-2 Spacing (µsec)	Pulse 2-to-3 Spacing (µsec)	Starting Location Within Interval (µsec)
1	1	52.6	10			51446
2	3	84.1	10	1725	1529	292696
3	3	97.7	10	1868	1805	533989
4	3	97.3	10	1446	1755	775564
5	3	98.8	10	1386	1302	21542
6	2	72.2	10	1184		263385
7	2	67.6	10	1027		505581
8	2	75.7	10	1871		747058
9	1	60.9	10			989976
10	1	64.2	10			234024
11	2	78.8	10	1604		475207
12	3	87.5	10	1712	1683	715825
13						
14						
15						
16						
17						
18						
19						
20						

Trial Number:			8			Detection (Yes/No)
Number of Bursts in Trial:			12			
Chirp Center Frequency:			5310			
Burst	Number of Pulses	Pulse Width (Microseconds)	Chirp Width (MHz)	Pulse 1-to-2 Spacing (µsec)	Pulse 2-to-3 Spacing (µsec)	Starting Location Within Interval (µsec)
1	1	52.6	10			51446
2	3	84.1	10	1725	1529	292696
3	3	97.7	10	1868	1805	533989
4	3	97.3	10	1446	1755	775564
5	3	98.8	10	1386	1302	21542
6	2	72.2	10	1184		263385
7	2	67.6	10	1027		505581
8	2	75.7	10	1871		747058
9	1	60.9	10			989976
10	1	64.2	10			234024
11	2	78.8	10	1604		475207
12	3	87.5	10	1712	1683	715825
13						
14						
15						
16						
17						
18						
19						
20						

**DFS Radar Parameters**  
**FCC Radar Type 5**  
**Channel 62 Bandwidth 40MHz**

Trial Number:			9			Detection (Yes/No)
Number of Bursts in Trial:			14			
Chirp Center Frequency:			5310			
Burst	Number of Pulses	Pulse Width (Microseconds)	Chirp Width (MHz)	Pulse 1-to-2 Spacing (µsec)	Pulse 2-to-3 Spacing (µsec)	Starting Location Within Interval (µsec)
1	1	54.1	13			823112
2	1	50.7	13			174965
3	1	52.3	13			382216
4	3	99.8	13	1696	1949	587395
5	2	68.4	13	1099		796897
6	2	80.8	13	1505		149042
7	1	62.5	13			356750
8	2	74.8	13	1204		563824
9	1	50.8	13			772314
10	1	54	13			123796
11	1	63	13			331215
12	3	91.8	13	1270	1347	537402
13	2	79.3	13	1992		744805
14	1	64.3	13			98172
15						
16						
17						
18						
19						
20						

Trial Number:			10			Detection (Yes/No)
Number of Bursts in Trial:			8			
Chirp Center Frequency:			5310			
Burst	Number of Pulses	Pulse Width (Microseconds)	Chirp Width (MHz)	Pulse 1-to-2 Spacing (µsec)	Pulse 2-to-3 Spacing (µsec)	Starting Location Within Interval (µsec)
1	1	63.4	6			535615
2	1	52	6			898668
3	3	97.2	6	1605	1583	1259235
4	2	78.7	6	1743		127106
5	2	74.2	6	1219		490358
6	3	88.7	6	1934	1273	852409
7	1	54.3	6			1217152
8	3	95.4	6	1555	1791	82296
9						
10						
11						
12						
13						
14						
15						
16						
17						
18						
19						
20						

**DFS Radar Parameters**  
**FCC Radar Type 5**  
**Channel 62 Bandwidth 40MHz**

Trial Number:			11			Detection (Yes/No)
Number of Bursts in Trial:			17			
Chirp Center Frequency:			5298.309			
Burst	Number of Pulses	Pulse Width (Microseconds)	Chirp Width (MHz)	Pulse 1-to-2 Spacing (µsec)	Pulse 2-to-3 Spacing (µsec)	Starting Location Within Interval (µsec)
1	2	73.7	16	1497		209249
2	3	97.4	16	1754	1613	378386
3	3	91.7	16	1702	1462	548411
4	1	66.2	16			17733
5	2	70.8	16	1821		187952
6	1	52.3	16			359277
7	2	78.9	16	1984		528886
8	2	70.9	16	1358		700166
9	2	75.6	16	1430		167197
10	1	59.1	16			338262
11	2	77	16	1304		508324
12	2	67.9	16	1083		678689
13	2	81.2	16	1932		146031
14	2	78.7	16	1121		316923
15	1	63.3	16			488056
16	2	68.9	16	1423		657326
17	1	59.3	16			125509
18						
19						
20						

Trial Number:			12			Detection (Yes/No)
Number of Bursts in Trial:			19			
Chirp Center Frequency:			5299.509			
Burst	Number of Pulses	Pulse Width (Microseconds)	Chirp Width (MHz)	Pulse 1-to-2 Spacing (µsec)	Pulse 2-to-3 Spacing (µsec)	Starting Location Within Interval (µsec)
1	3	98.9	19	1680	1488	263736
2	2	82.3	19	1855		416459
3	3	86.7	19	1400	1919	567902
4	3	89.7	19	1068	1282	92979
5	3	98.6	19	1194	1461	245155
6	2	71.1	19	1789		397609
7	1	55.9	19			551431
8	2	67.9	19	1372		74413
9	3	84.4	19	1107	1443	226559
10	1	58.8	19			380056
11	1	65.6	19			533408
12	2	78.5	19	1704		55547
13	2	82.3	19	1686		207876
14	3	90.1	19	1071	1266	359771
15	3	90.2	19	1089	1950	511297
16	2	83.1	19	1406		36803
17	1	58.8	19			189652
18	2	77	19	1657		341809
19	1	55	19			495737
20						

**DFS Radar Parameters**  
**FCC Radar Type 5**  
**Channel 62 Bandwidth 40MHz**

Trial Number:			13			Detection (Yes/No)
Number of Bursts in Trial:			15			
Chirp Center Frequency:			5297.109			
Burst	Number of Pulses	Pulse Width (Microseconds)	Chirp Width (MHz)	Pulse 1-to-2 Spacing (µsec)	Pulse 2-to-3 Spacing (µsec)	Starting Location Within Interval (µsec)
1	1	58.1	13			22911
2	1	52.1	13			216473
3	1	59.9	13			410004
4	1	60.2	13			603671
5	3	95.9	13	1906	1608	794160
6	2	79.9	13	1859		192251
7	2	78.5	13	1917		385590
8	1	53.8	13			579862
9	1	64.7	13			773423
10	1	61.4	13			168898
11	2	83.2	13	1858		361606
12	3	84.7	13	1677	1638	553866
13	3	88.7	13	1528	1058	747241
14	2	78.3	13	1951		144710
15	2	69.3	13	1717		337856
16						
17						
18						
19						
20						

Trial Number:			14			Detection (Yes/No)
Number of Bursts in Trial:			12			
Chirp Center Frequency:			5295.909			
Burst	Number of Pulses	Pulse Width (Microseconds)	Chirp Width (MHz)	Pulse 1-to-2 Spacing (µsec)	Pulse 2-to-3 Spacing (µsec)	Starting Location Within Interval (µsec)
1	2	75.3	10	1612		664275
2	1	56.3	10			907886
3	2	67.7	10	1185		151316
4	1	55.6	10			393746
5	2	75.2	10	1267		635093
6	2	76.3	10	1305		876993
7	3	85.7	10	1362	1924	121278
8	3	98.4	10	1550	1249	362696
9	3	86.4	10	1439	1046	604342
10	3	93.6	10	1031	1452	846453
11	1	63.3	10			91871
12	3	92.4	10	1673	1322	333050
13						
14						
15						
16						
17						
18						
19						
20						

**DFS Radar Parameters**  
**FCC Radar Type 5**  
**Channel 62 Bandwidth 40MHz**

Trial Number:			15			Detection (Yes/No)
Number of Bursts in Trial:			19			
Chirp Center Frequency:			5299.109			
Burst	Number of Pulses	Pulse Width (Microseconds )	Chirp Width (MHz)	Pulse 1-to-2 Spacing (µsec)	Pulse 2-to-3 Spacing (µsec)	Starting Location Within Interval (µsec)
1	3	93.3	18	1912	1535	361323
2	2	69.1	18	1794		515261
3	3	86.9	18	1152	1148	39025
4	3	84.9	18	1948	1118	190900
5	2	72.3	18	1916		343941
6	1	51.7	18			497624
7	1	58.3	18			20319
8	1	60.8	18			172999
9	1	57.1	18			325872
10	3	88.9	18	1964	1489	475841
11	2	72	18	1297		1489
12	3	90.9	18	1566	1370	153647
13	1	59.8	18			307096
14	2	70	18	1291		458804
15	2	67.2	18	1881		610798
16	3	91.2	18	1832	1661	134759
17	1	56.5	18			288306
18	1	51.2	18			441296
19	2	74.1	18	1245		592780
20						

Trial Number:			16			Detection (Yes/No)
Number of Bursts in Trial:			14			
Chirp Center Frequency:			5296.709			
Burst	Number of Pulses	Pulse Width (Microseconds )	Chirp Width (MHz)	Pulse 1-to-2 Spacing (µsec)	Pulse 2-to-3 Spacing (µsec)	Starting Location Within Interval (µsec)
1	2	76.9	12	1140		158286
2	1	50.2	12			366024
3	1	62.9	12			573452
4	1	64.7	12			780619
5	3	83.8	12	1097	1621	132455
6	1	65.4	12			340207
7	1	53.2	12			548208
8	1	51.7	12			755333
9	2	78.7	12	1168		107117
10	2	72.4	12	1343		314500
11	1	53.8	12			522447
12	2	73.6	12	1553		728517
13	2	66.7	12	1122		81611
14	2	82.5	12	1019		288948
15						
16						
17						
18						
19						
20						



**DFS Radar Parameters**  
**FCC Radar Type 5**  
**Channel 62 Bandwidth 40MHz**

Trial Number:			17			Detection (Yes/No)
Number of Bursts in Trial:			20			
Chirp Center Frequency:			5299.909			
Burst	Number of Pulses	Pulse Width (Microseconds)	Chirp Width (MHz)	Pulse 1-to-2 Spacing (µsec)	Pulse 2-to-3 Spacing (µsec)	Starting Location Within Interval (µsec)
1	3	87.6	20	1055	1840	345766
2	3	85.2	20	1541	1408	490019
3	3	84.8	20	1889	1463	39073
4	2	77.9	20	1460		183923
5	2	76.5	20	1485		328777
6	1	60.9	20			474728
7	2	83	20	1010		21394
8	2	80.4	20	1752		165992
9	2	67.5	20	1181		310973
10	1	62.1	20			456884
11	3	86.4	20	1966	1263	3515
12	3	84.3	20	1188	1788	147928
13	2	76.9	20	1537		293225
14	3	95.8	20	1298	1844	436922
15	1	55.2	20			584015
16	1	59	20			130832
17	3	94.5	20	1700	1283	274684
18	3	91.9	20	1978	1165	418579
19	3	85.2	20	1551	1189	563464
20	2	69.5	20	1224		112787

Trial Number:			18			Detection (Yes/No)
Number of Bursts in Trial:			12			
Chirp Center Frequency:			5295.909			
Burst	Number of Pulses	Pulse Width (Microseconds)	Chirp Width (MHz)	Pulse 1-to-2 Spacing (µsec)	Pulse 2-to-3 Spacing (µsec)	Starting Location Within Interval (µsec)
1	3	86.4	10	1918	1455	429224
2	3	92.2	10	1719	1895	670241
3	2	80.4	10	1899		912880
4	1	54.3	10			158603
5	1	53.1	10			400824
6	2	69.4	10	1546		641915
7	2	69.1	10	1639		883823
8	3	100	10	1438	1595	128373
9	2	79.6	10	1705		370379
10	3	88.4	10	1579	1623	611194
11	1	53.3	10			855665
12	1	65.3	10			98897
13						
14						
15						
16						
17						
18						
19						
20						

**DFS Radar Parameters**  
**FCC Radar Type 5**  
**Channel 62 Bandwidth 40MHz**

Trial Number:			19			Detection (Yes/No)
Number of Bursts in Trial:			14			
Chirp Center Frequency:			5296.709			
Burst	Number of Pulses	Pulse Width (Microseconds )	Chirp Width (MHz)	Pulse 1-to-2 Spacing (µsec)	Pulse 2-to-3 Spacing (µsec)	Starting Location Within Interval (µsec)
1	1	55.3	12			292143
2	1	58.3	12			499633
3	2	72.3	12	1039.000		706377
4	3	84.8	12	1761.000	1721.000	58989
5	2	82.5	12	1431.000		266161
6	1	63.3	12			474469
7	2	80	12	1913.000		680544
8	3	90.3	12	1853.000	1123.000	33519
9	3	91.1	12	1783.000	1172.000	240319
10	3	96.6	12	1036.000	1385.000	447400
11	2	82.7	12	1990.000		654516
12	1	50.7	12			8083
13	2	78.4	12	1109.000		215435
14	3	99.5	12	1965.000	1869.000	421325
15						
16						
17						
18						
19						
20						

Trial Number:			20			Detection (Yes/No)
Number of Bursts in Trial:			12			
Chirp Center Frequency:			5295.909			
Burst	Number of Pulses	Pulse Width (Microseconds )	Chirp Width (MHz)	Pulse 1-to-2 Spacing (µsec)	Pulse 2-to-3 Spacing (µsec)	Starting Location Within Interval (µsec)
1	3	88.6	10	1067	1927	733725
2	1	57.4	10			977882
3	3	96.6	10	1658	1324	221197
4	2	69.7	10	1945		462915
5	2	77.9	10	1317		705071
6	1	62	10			947923
7	3	88.4	10	1077	1366	191373
8	3	97.3	10	1896	1367	432561
9	3	96.2	10	1787	1672	674004
10	3	95.4	10	1892	1414	915842
11	1	54.8	10			162176
12	2	80.4	10	1436		403553
13						
14						
15						
16						
17						
18						
19						
20						

**DFS Radar Parameters**  
**FCC Radar Type 5**  
**Channel 62 Bandwidth 40MHz**

Trial Number:			21			Detection (Yes/No)
Number of Bursts in Trial:			16			
Chirp Center Frequency:			5322.091			
Burst	Number of Pulses	Pulse Width (Microseconds)	Chirp Width (MHz)	Pulse 1-to-2 Spacing (µsec)	Pulse 2-to-3 Spacing (µsec)	Starting Location Within Interval (µsec)
1	2	74.7	15	1611		483470
2	1	57.1	15			666072
3	3	91.9	15	1475	1276	98810
4	2	83.1	15	1772		279914
5	1	50.7	15			462536
6	2	79.2	15	1600		642324
7	1	58.7	15			76831
8	2	71	15	1567		257785
9	2	79	15	1960		438554
10	2	68.5	15	1428		620397
11	2	73.5	15	1352		54310
12	2	70.5	15	1115		235506
13	2	76.6	15	1300		417036
14	2	81.2	15	1675		597974
15	1	61.8	15			32086
16	3	94.9	15	1206	1860	212751
17						
18						
19						
20						

Trial Number:			22			Detection (Yes/No)
Number of Bursts in Trial:			12			
Chirp Center Frequency:			5324.491			
Burst	Number of Pulses	Pulse Width (Microseconds)	Chirp Width (MHz)	Pulse 1-to-2 Spacing (µsec)	Pulse 2-to-3 Spacing (µsec)	Starting Location Within Interval (µsec)
1	2	78.5	9	1698		526149
2	3	89.8	9	1962	1167	767135
3	1	59.4	9			12955
4	2	79.6	9	1890		254612
5	2	76	9	1811		496588
6	1	53.6	9			739728
7	2	80.9	9	1053		980872
8	1	61.6	9			225249
9	1	53.4	9			467279
10	1	59.9	9			709720
11	1	60.4	9			951847
12	3	91.4	9	1726	1227	194839
13						
14						
15						
16						
17						
18						
19						
20						

**DFS Radar Parameters**  
**FCC Radar Type 5**  
**Channel 62 Bandwidth 40MHz**

Trial Number:			23			Detection (Yes/No)
Number of Bursts in Trial:			20			
Chirp Center Frequency:			5320.091			
Burst	Number of Pulses	Pulse Width (Microseconds)	Chirp Width (MHz)	Pulse 1-to-2 Spacing (µsec)	Pulse 2-to-3 Spacing (µsec)	Starting Location Within Interval (µsec)
1	2	77	20	1363		261858
2	1	58.1	20			407646
3	1	62.1	20			552319
4	2	76.9	20	1236		99107
5	2	80	20	1852		243514
6	1	52	20			389464
7	3	88.6	20	1995	1905	531093
8	2	72.9	20	1387		81159
9	3	98.5	20	1746	1389	225245
10	1	57.9	20			371906
11	3	95.9	20	1870	1066	514197
12	1	53.5	20			63561
13	3	92	20	1654	1458	207510
14	1	57.3	20			353638
15	2	70.5	20	1586		497515
16	2	70	20	1664		45553
17	3	84	20	1630	1176	189821
18	2	76.1	20	1057		335330
19	3	93.2	20	1018	1340	478825
20	3	96.8	20	1614	1817	27594

Trial Number:			24			Detection (Yes/No)
Number of Bursts in Trial:			14			
Chirp Center Frequency:			5323.291			
Burst	Number of Pulses	Pulse Width (Microseconds)	Chirp Width (MHz)	Pulse 1-to-2 Spacing (µsec)	Pulse 2-to-3 Spacing (µsec)	Starting Location Within Interval (µsec)
1	1	50.1	12			247117
2	3	93.5	12	1081	1413	453362
3	2	68.8	12	1577		660875
4	1	56.3	12			14140
5	3	86	12	1108	1987	220734
6	2	75.2	12	1536		428367
7	1	54.4	12			636681
8	2	71.1	12	1243		843157
9	2	76.2	12	1770		195585
10	2	80.2	12	1209		403231
11	2	79.7	12	1214		610202
12	3	90.9	12	1862	1601	815229
13	2	68.7	12	1441		170267
14	2	67.4	12	1313		377306
15						
16						
17						
18						
19						
20						

**DFS Radar Parameters**  
**FCC Radar Type 5**  
**Channel 62 Bandwidth 40MHz**

Trial Number:			25			Detection (Yes/No)
Number of Bursts in Trial:			13			
Chirp Center Frequency:			5323.691			
Burst	Number of Pulses	Pulse Width (Microseconds)	Chirp Width (MHz)	Pulse 1-to-2 Spacing (µsec)	Pulse 2-to-3 Spacing (µsec)	Starting Location Within Interval (µsec)
1	3	94	11	1748	1941	628071
2	2	70.8	11	1201		853391
3	1	56.3	11			156223
4	3	96.7	11	1163	1332	378734
5	3	90.6	11	1582	1498	601331
6	2	74.5	11	1281		825462
7	3	92.6	11	1669	1222	128265
8	3	89	11	1135	1380	351161
9	3	96.5	11	1822	1602	573425
10	2	70.5	11	1178		798431
11	3	94	11	1629	1956	100737
12	1	55.8	11			324661
13	3	87.7	11	1963	1164	546278
14						
15						
16						
17						
18						
19						
20						

Trial Number:			26			Detection (Yes/No)
Number of Bursts in Trial:			8			
Chirp Center Frequency:			5326.091			
Burst	Number of Pulses	Pulse Width (Microseconds)	Chirp Width (MHz)	Pulse 1-to-2 Spacing (µsec)	Pulse 2-to-3 Spacing (µsec)	Starting Location Within Interval (µsec)
1	2	68.6	5	1161		1253842
2	2	83.1	5	1315		119486
3	1	60.9	5			482958
4	2	77.7	5	1158		845641
5	2	77.4	5	1510		1208428
6	2	66.8	5	1323		74748
7	1	63.7	5			438300
8	3	91.2	5	1681	1275	800152
9						
10						
11						
12						
13						
14						
15						
16						
17						
18						
19						
20						

**DFS Radar Parameters**  
**FCC Radar Type 5**  
**Channel 62 Bandwidth 40MHz**

Trial Number:			27			Detection (Yes/No)
Number of Bursts in Trial:			17			
Chirp Center Frequency:			5321.691			
Burst	Number of Pulses	Pulse Width (Microseconds)	Chirp Width (MHz)	Pulse 1-to-2 Spacing (µsec)	Pulse 2-to-3 Spacing (µsec)	Starting Location Within Interval (µsec)
1	3	83.6	16	1195	1000	545865
2	3	89.4	16	1627	1656	14067
3	1	55.8	16			184953
4	3	90.9	16	1554	1998	353759
5	1	54.7	16			526388
6	3	97.7	16	1202	1250	694806
7	2	67.5	16	1434		163568
8	3	96.7	16	1469	1268	333410
9	2	68.3	16	1954		504006
10	2	78.3	16	1082		675297
11	1	55	16			142890
12	3	84.9	16	1936	1199	312479
13	2	74.6	16	1856		482953
14	1	63.3	16			655022
15	3	99.8	16	1515	1120	121457
16	1	63.6	16			292606
17	3	87.3	16	1051	1831	461322
18						
19						
20						

Trial Number:			28			Detection (Yes/No)
Number of Bursts in Trial:			19			
Chirp Center Frequency:			5320.491			
Burst	Number of Pulses	Pulse Width (Microseconds)	Chirp Width (MHz)	Pulse 1-to-2 Spacing (µsec)	Pulse 2-to-3 Spacing (µsec)	Starting Location Within Interval (µsec)
1	3	85.6	19	1078	1015	565136
2	2	68.6	19	1780		89970
3	1	54.2	19			243121
4	1	61.2	19			396034
5	3	97.1	19	1969	1100	546225
6	3	98.3	19	1699	1622	70998
7	1	62.4	19			224093
8	2	80.2	19	1769		376127
9	3	87.5	19	1448	1179	527806
10	3	85.8	19	1348	1472	52247
11	3	88.1	19	1124	1631	204582
12	1	65.3	19			357941
13	1	52.5	19			510977
14	1	52.3	19			33698
15	2	74.1	19	1200		186023
16	1	54.9	19			339327
17	2	76.2	19	1502		491053
18	1	60.4	19			14858
19	2	81.5	19	1103		167387
20						

**DFS Radar Parameters**  
**FCC Radar Type 5**  
**Channel 62 Bandwidth 40MHz**

Trial Number:			29			Detection (Yes/No)
Number of Bursts in Trial:			12			
Chirp Center Frequency:			5324.091			Yes
Burst	Number of Pulses	Pulse Width (Microseconds )	Chirp Width (MHz)	Pulse 1-to-2 Spacing (usec)	Pulse 2-to-3 Spacing (usec)	Starting Location Within Interval (usec)
1	1	50.5	10			507709
2	1	55.7	10			750249
3	3	85.8	10	1002	1967	989003
4	2	76.9	10	1474		235634
5	2	75.1	10	1052		477675
6	3	92.3	10	1486	1492	718312
7	2	78.1	10	1757		960895
8	3	92.2	10	1252	1713	205370
9	3	89	10	1706	1411	446940
10	2	70.9	10	1620		689225
11	1	63.1	10			932305
12	1	55.3	10			176231
13						
14						
15						
16						
17						
18						
19						
20						

Trial Number:			30			Detection (Yes/No)
Number of Bursts in Trial:			18			
Chirp Center Frequency:			5321.291			Yes
Burst	Number of Pulses	Pulse Width (Microseconds )	Chirp Width (MHz)	Pulse 1-to-2 Spacing (usec)	Pulse 2-to-3 Spacing (usec)	Starting Location Within Interval (usec)
1	3	83.4	17	1205	1801	277485
2	3	97.3	17	1826	1635	437880
3	3	90.4	17	1986	1674	598445
4	3	91.8	17	1151	1802	97088
5	3	98.2	17	1977	1766	257251
6	1	59.5	17			419893
7	2	80	17	1137		580724
8	3	86.5	17	1128	1828	77366
9	3	91.1	17	1599	1442	238032
10	3	93.5	17	1373	1087	398605
11	1	60.7	17			562025
12	2	67.2	17	1405		57684
13	1	61.8	17			219083
14	2	79.4	17	1667		379234
15	2	81.4	17	1464		540896
16	1	65.7	17			37916
17	2	76	17	1255		198794
18	2	81	17	1668		359754
19						
20						

**DFS Radar Parameters**  
**FCC Radar Type 1**  
**Channel 58 Bandwidth 80MHz**

Trial #	Pulse Repetition Frequency Number (1 to 23)	Pulse Repetition Frequency (Pulses Per Second)	Pulse Repetition Interval (Microseconds)	Detection (Yes / No)
1	22	1066.10	938	Yes
2	10	1432.66	698	Yes
3	6	1618.12	618	Yes
4	2	1858.74	538	Yes
5	19	1138.95	878	Yes
6	12	326.16	3066	Yes
7	7	1567.40	638	No
8	21	1089.32	918	Yes
9	17	1193.32	838	Yes
10	18	1165.50	858	Yes
11	15	1253.13	798	Yes
12	11	1392.76	718	Yes
13	4	1730.10	578	Yes
14	5	1672.24	598	Yes
15	3	1792.11	558	Yes
16		394.32	2536	No
17		1035.20	966	Yes
18		1209.19	827	Yes
19		399.84	2501	Yes
20		385.36	2595	Yes
21		897.67	1114	Yes
22		768.05	1302	Yes
23		328.41	3045	Yes
24		615.76	1624	Yes
25		347.46	2878	Yes
26		973.71	1027	No
27		402.41	2485	Yes
28		625.00	1600	Yes
29		853.24	1172	Yes
30		849.62	1177	Yes



**DFS Radar Parameters**  
**FCC Radar Type 2**  
**Channel 58 Bandwidth 80MHz**

Trial #	Number Pulses per Burst	Pulse Width (Microseconds)	Pulse Repetition Interval (Microseconds)	Detection (Yes / No)
1	26	3.20	179	Yes
2	23	1.10	207	Yes
3	24	2.10	230	Yes
4	29	4.80	200	Yes
5	28	3.90	214	Yes
6	26	2.90	222	No
7	26	3.20	204	Yes
8	25	2.50	192	Yes
9	26	3.10	164	No
10	23	1.20	156	Yes
11	27	3.90	210	Yes
12	29	4.60	201	Yes
13	26	3.20	162	Yes
14	25	2.20	197	Yes
15	29	4.50	163	Yes
16	26	3.00	203	Yes
17	29	5.00	168	Yes
18	25	2.40	217	Yes
19	26	2.90	191	Yes
20	25	2.30	166	No
21	27	3.70	150	Yes
22	25	2.20	176	Yes
23	29	4.90	195	Yes
24	26	2.90	202	Yes
25	25	2.50	178	Yes
26	23	1.10	206	Yes
27	27	3.80	155	Yes
28	29	4.70	157	Yes
29	25	2.40	224	Yes
30	28	4.20	159	Yes

**DFS Radar Parameters**  
**FCC Radar Type 3**  
**Channel 58 Bandwidth 80MHz**

Trial #	Number Pulses per Burst	Pulse Width (Microseconds)	Pulse Repetition Interval (Microseconds)	Detection (Yes / No)
1	17	8.20	355	Yes
2	16	6.10	487	Yes
3	16	7.10	344	Yes
4	18	9.80	288	Yes
5	18	8.90	230	No
6	17	7.90	432	Yes
7	17	8.20	207	Yes
8	17	7.50	443	Yes
9	17	8.10	439	Yes
10	16	6.20	223	Yes
11	18	8.90	208	Yes
12	18	9.60	463	Yes
13	17	8.20	441	Yes
14	16	7.20	323	Yes
15	18	9.50	297	No
16	17	8.00	412	Yes
17	18	10.00	324	Yes
18	17	7.40	271	Yes
19	17	7.90	349	Yes
20	16	7.30	409	Yes
21	18	8.70	373	Yes
22	16	7.20	254	Yes
23	18	9.90	274	Yes
24	17	7.90	278	Yes
25	17	7.50	317	Yes
26	16	6.10	260	Yes
27	18	8.80	211	No
28	18	9.70	272	Yes
29	17	7.40	264	Yes
30	18	9.20	284	Yes

**DFS Radar Parameters**  
**FCC Radar Type 4**  
**Channel 58 Bandwidth 80MHz**

Trial #	Number Pulses per Burst	Pulse Width (Microseconds)	Pulse Repetition Interval (Microseconds)	Detection (Yes / No)
1	14	16.00	355	Yes
2	12	11.30	487	Yes
3	13	13.50	344	Yes
4	16	19.40	288	No
5	15	17.50	230	Yes
6	14	15.30	432	Yes
7	14	15.90	207	Yes
8	13	14.30	443	Yes
9	14	15.80	439	Yes
10	12	11.50	223	Yes
11	15	17.40	208	Yes
12	16	19.00	463	Yes
13	14	16.00	441	Yes
14	13	13.80	323	Yes
15	16	18.90	297	Yes
16	14	15.50	412	Yes
17	16	19.90	324	No
18	13	14.10	271	Yes
19	14	15.20	349	No
20	13	13.80	409	Yes
21	15	17.10	373	Yes
22	13	13.80	254	Yes
23	16	19.80	274	Yes
24	14	15.30	278	Yes
25	13	14.50	317	Yes
26	12	11.30	260	Yes
27	15	17.30	211	Yes
28	16	19.20	272	Yes
29	13	14.20	264	Yes
30	15	18.20	284	Yes

**DFS Radar Parameters**  
**FCC Radar Type 5**  
**Channel 58 Bandwidth 80MHz**

Trial Number:			1			Detection (Yes/No)
Number of Bursts in Trial:			15			
Chirp Center Frequency:			5290			
Burst	Number of Pulses	Pulse Width (Microseconds)	Chirp Width (MHz)	Pulse 1-to-2 Spacing (µsec)	Pulse 2-to-3 Spacing (µsec)	Starting Location Within Interval (µsec)
1	2	77.8	13	1477		636185
2	1	51.9	13			32674
3	1	63.8	13			226294
4	3	96.6	13	1786	1843	417976
5	3	85.9	13	1215	1729	611152
6	2	73.7	13	1549		8789
7	2	77.2	13	1819		201917
8	2	68.4	13	1114		395530
9	2	76.7	13	1155		588564
10	1	53.2	13			783794
11	3	85.7	13	1695	1394	177933
12	3	94.3	13	1426	1935	370624
13	2	77.6	13	1671		564893
14	1	65.7	13			759583
15	3	93.5	13	1130	1468	154262
16						
17						
18						
19						
20						

Trial Number:			2			Detection (Yes/No)
Number of Bursts in Trial:			8			
Chirp Center Frequency:			5290			
Burst	Number of Pulses	Pulse Width (Microseconds)	Chirp Width (MHz)	Pulse 1-to-2 Spacing (µsec)	Pulse 2-to-3 Spacing (µsec)	Starting Location Within Interval (µsec)
1	2	75	5	1527		653020
2	3	99.4	5	1262	1257	1015643
3	2	67.4	5	1403		1379398
4	2	73.6	5	1041		245489
5	1	65.9	5			609113
6	3	83.8	5	1292	1419	970852
7	1	65.5	5			1335913
8	3	98.6	5	1796	1728	200406
9						
10						
11						
12						
13						
14						
15						
16						
17						
18						
19						
20						

**DFS Radar Parameters**  
**FCC Radar Type 5**  
**Channel 58 Bandwidth 80MHz**

Trial Number:			3			Detection (Yes/No) Yes
Number of Bursts in Trial:			11			
Chirp Center Frequency:			5290			
Burst	Number of Pulses	Pulse Width (Microseconds)	Chirp Width (MHz)	Pulse 1-to-2 Spacing ( $\mu$ sec)	Pulse 2-to-3 Spacing ( $\mu$ sec)	Starting Location Within Interval ( $\mu$ sec)
1	2	73.8	9	1538		409565
2	2	69.5	9	1649		673692
3	1	51.9	9			938562
4	3	84.6	9	1032	1271	113209
5	3	95.4	9	1903	1388	376726
6	2	68	9	1351		641212
7	3	89.6	9	1514	1573	903714
8	2	81.9	9	1689		80863
9	3	88.3	9	1330	1838	344067
10	1	53.7	9			609331
11	3	91.3	9	1106	1001	871542
12						
13						
14						
15						
16						
17						
18						
19						
20						

Trial Number:			4			Detection (Yes/No) Yes
Number of Bursts in Trial:			20			
Chirp Center Frequency:			5290			
Burst	Number of Pulses	Pulse Width (Microseconds)	Chirp Width (MHz)	Pulse 1-to-2 Spacing ( $\mu$ sec)	Pulse 2-to-3 Spacing ( $\mu$ sec)	Starting Location Within Interval ( $\mu$ sec)
1	2	68.1	19	1355		26541
2	1	58.7	19			171821
3	2	75.3	19	1640		316229
4	1	56.4	19			461864
5	3	99.7	19	1708	1159	8677
6	1	57.7	19			153995
7	1	59.5	19			299238
8	2	80	19	1369		443177
9	2	82	19	1197		587671
10	2	82.8	19	1005		135674
11	3	88	19	1928	1101	279928
12	3	93.2	19	1907	1223	424279
13	2	70.4	19	1360		570132
14	3	95.3	19	1955	1775	117439
15	2	81.9	19	1545		262502
16	3	98.5	19	1169	1062	406573
17	1	65	19			553328
18	3	85.4	19	1637	1425	99799
19	3	91.6	19	1445	1325	244095
20	2	67.3	19	1218		390012

**DFS Radar Parameters**  
**FCC Radar Type 5**  
**Channel 58 Bandwidth 80MHz**

Trial Number:			5			Detection (Yes/No)
Number of Bursts in Trial:			17			
Chirp Center Frequency:			5290			No
Burst	Number of Pulses	Pulse Width (Microseconds )	Chirp Width (MHz)	Pulse 1-to-2 Spacing ( $\mu$ sec)	Pulse 2-to-3 Spacing ( $\mu$ sec)	Starting Location Within Interval ( $\mu$ sec)
1	2	67.9	16	1133		629614
2	1	62.3	16			96856
3	1	53.3	16			267719
4	3	90	16	1153	1346	436784
5	2	77.1	16	1646		608289
6	3	83.9	16	1232	1459	75610
7	3	89.1	16	1384	1939	245638
8	2	81.8	16	1676		416355
9	1	50.3	16			588736
10	3	87.1	16	1996	1756	54571
11	2	71.3	16	1815		225175
12	3	97.5	16	1465	1132	394825
13	3	90.6	16	1040	1354	565361
14	3	86.3	16	1183	1792	33643
15	3	97.6	16	1073	1361	203957
16	3	84.7	16	1718	1854	373812
17	3	99.7	16	1244	1988	544060
18						
19						
20						

Trial Number:			6			Detection (Yes/No)
Number of Bursts in Trial:			14			
Chirp Center Frequency:			5290			Yes
Burst	Number of Pulses	Pulse Width (Microseconds )	Chirp Width (MHz)	Pulse 1-to-2 Spacing ( $\mu$ sec)	Pulse 2-to-3 Spacing ( $\mu$ sec)	Starting Location Within Interval ( $\mu$ sec)
1	3	92.9	12	1564	1407	15438
2	2	67.7	12	1747		222486
3	1	65.8	12			430731
4	1	56.3	12			637784
5	1	53.7	12			845342
6	3	83.5	12	1930	1025	196720
7	1	65.8	12			404955
8	3	85.9	12	1034	1808	610711
9	2	76.3	12	1926		818057
10	2	81.5	12	1714		171459
11	3	89.4	12	1594	1827	377969
12	1	63.4	12			586875
13	2	69.6	12	1925		792834
14	2	74.5	12	1846		146044
15						
16						
17						
18						
19						
20						

**DFS Radar Parameters**  
**FCC Radar Type 5**  
**Channel 58 Bandwidth 80MHz**

Trial Number:			7			Detection (Yes/No)
Number of Bursts in Trial:			15			
Chirp Center Frequency:			5290			
Burst	Number of Pulses	Pulse Width (Microseconds)	Chirp Width (MHz)	Pulse 1-to-2 Spacing (µsec)	Pulse 2-to-3 Spacing (µsec)	Starting Location Within Interval (µsec)
1	1	52.6	10			51446
2	3	84.1	10	1725	1529	292696
3	3	97.7	10	1868	1805	533989
4	3	97.3	10	1446	1755	775564
5	3	98.8	10	1386	1302	21542
6	2	72.2	10	1184		263385
7	2	67.6	10	1027		505581
8	2	75.7	10	1871		747058
9	1	60.9	10			989976
10	1	64.2	10			234024
11	2	78.8	10	1604		475207
12	3	87.5	10	1712	1683	715825
13						
14						
15						
16						
17						
18						
19						
20						

Trial Number:			8			Detection (Yes/No)
Number of Bursts in Trial:			12			
Chirp Center Frequency:			5290			
Burst	Number of Pulses	Pulse Width (Microseconds)	Chirp Width (MHz)	Pulse 1-to-2 Spacing (µsec)	Pulse 2-to-3 Spacing (µsec)	Starting Location Within Interval (µsec)
1	1	52.6	10			51446
2	3	84.1	10	1725	1529	292696
3	3	97.7	10	1868	1805	533989
4	3	97.3	10	1446	1755	775564
5	3	98.8	10	1386	1302	21542
6	2	72.2	10	1184		263385
7	2	67.6	10	1027		505581
8	2	75.7	10	1871		747058
9	1	60.9	10			989976
10	1	64.2	10			234024
11	2	78.8	10	1604		475207
12	3	87.5	10	1712	1683	715825
13						
14						
15						
16						
17						
18						
19						
20						

**DFS Radar Parameters**  
**FCC Radar Type 5**  
**Channel 58 Bandwidth 80MHz**

Trial Number:			9			Detection (Yes/No)
Number of Bursts in Trial:			14			
Chirp Center Frequency:			5290			
Burst	Number of Pulses	Pulse Width (Microseconds )	Chirp Width (MHz)	Pulse 1-to-2 Spacing (µsec)	Pulse 2-to-3 Spacing (µsec)	Starting Location Within Interval (µsec)
1	1	54.1	13			823112
2	1	50.7	13			174965
3	1	52.3	13			382216
4	3	99.8	13	1696	1949	587395
5	2	68.4	13	1099		796897
6	2	80.8	13	1505		149042
7	1	62.5	13			356750
8	2	74.8	13	1204		563824
9	1	50.8	13			772314
10	1	54	13			123796
11	1	63	13			331215
12	3	91.8	13	1270	1347	537402
13	2	79.3	13	1992		744805
14	1	64.3	13			98172
15						
16						
17						
18						
19						
20						

Trial Number:			10			Detection (Yes/No)
Number of Bursts in Trial:			8			
Chirp Center Frequency:			5290			
Burst	Number of Pulses	Pulse Width (Microseconds )	Chirp Width (MHz)	Pulse 1-to-2 Spacing (µsec)	Pulse 2-to-3 Spacing (µsec)	Starting Location Within Interval (µsec)
1	1	63.4	6			535615
2	1	52	6			898668
3	3	97.2	6	1605	1583	1259235
4	2	78.7	6	1743		127106
5	2	74.2	6	1219		490358
6	3	88.7	6	1934	1273	852409
7	1	54.3	6			1217152
8	3	95.4	6	1555	1791	82296
9						
10						
11						
12						
13						
14						
15						
16						
17						
18						
19						
20						



**DFS Radar Parameters**  
**FCC Radar Type 5**  
**Channel 58 Bandwidth 80MHz**

Trial Number:			11			Detection (Yes/No)
Number of Bursts in Trial:			17			
Chirp Center Frequency:			5258.639			
Burst	Number of Pulses	Pulse Width (Microseconds)	Chirp Width (MHz)	Pulse 1-to-2 Spacing (µsec)	Pulse 2-to-3 Spacing (µsec)	Starting Location Within Interval (µsec)
1	2	73.7	16	1497		209249
2	3	97.4	16	1754	1613	378386
3	3	91.7	16	1702	1462	548411
4	1	66.2	16			17733
5	2	70.8	16	1821		187952
6	1	52.3	16			359277
7	2	78.9	16	1984		528886
8	2	70.9	16	1358		700166
9	2	75.6	16	1430		167197
10	1	59.1	16			338262
11	2	77	16	1304		508324
12	2	67.9	16	1083		678689
13	2	81.2	16	1932		146031
14	2	78.7	16	1121		316923
15	1	63.3	16			488056
16	2	68.9	16	1423		657326
17	1	59.3	16			125509
18						
19						
20						

Trial Number:			12			Detection (Yes/No)
Number of Bursts in Trial:			19			
Chirp Center Frequency:			5259.839			
Burst	Number of Pulses	Pulse Width (Microseconds)	Chirp Width (MHz)	Pulse 1-to-2 Spacing (µsec)	Pulse 2-to-3 Spacing (µsec)	Starting Location Within Interval (µsec)
1	3	98.9	19	1680	1488	263736
2	2	82.3	19	1855		416459
3	3	86.7	19	1400	1919	567902
4	3	89.7	19	1068	1282	92979
5	3	98.6	19	1194	1461	245155
6	2	71.1	19	1789		397609
7	1	55.9	19			551431
8	2	67.9	19	1372		74413
9	3	84.4	19	1107	1443	226559
10	1	58.8	19			380056
11	1	65.6	19			533408
12	2	78.5	19	1704		55547
13	2	82.3	19	1686		207876
14	3	90.1	19	1071	1266	359771
15	3	90.2	19	1089	1950	511297
16	2	83.1	19	1406		36803
17	1	58.8	19			189652
18	2	77	19	1657		341809
19	1	55	19			495737
20						

**DFS Radar Parameters**  
**FCC Radar Type 5**  
**Channel 58 Bandwidth 80MHz**

Trial Number:			13			Detection (Yes/No)
Number of Bursts in Trial:			15			
Chirp Center Frequency:			5257.439			
Burst	Number of Pulses	Pulse Width (Microseconds)	Chirp Width (MHz)	Pulse 1-to-2 Spacing (usec)	Pulse 2-to-3 Spacing (usec)	Starting Location Within Interval (usec)
1	1	58.1	13			22911
2	1	52.1	13			216473
3	1	59.9	13			410004
4	1	60.2	13			603671
5	3	95.9	13	1906	1608	794160
6	2	79.9	13	1859		192251
7	2	78.5	13	1917		385590
8	1	53.8	13			579862
9	1	64.7	13			773423
10	1	61.4	13			168898
11	2	83.2	13	1858		361606
12	3	84.7	13	1677	1638	553866
13	3	88.7	13	1528	1058	747241
14	2	78.3	13	1951		144710
15	2	69.3	13	1717		337856
16						
17						
18						
19						
20						

Trial Number:			14			Detection (Yes/No)
Number of Bursts in Trial:			12			
Chirp Center Frequency:			5256.239			
Burst	Number of Pulses	Pulse Width (Microseconds)	Chirp Width (MHz)	Pulse 1-to-2 Spacing (usec)	Pulse 2-to-3 Spacing (usec)	Starting Location Within Interval (usec)
1	2	75.3	10	1612		664275
2	1	56.3	10			907886
3	2	67.7	10	1185		151316
4	1	55.6	10			393746
5	2	75.2	10	1267		635093
6	2	76.3	10	1305		876993
7	3	85.7	10	1362	1924	121278
8	3	98.4	10	1550	1249	362696
9	3	86.4	10	1439	1046	604342
10	3	93.6	10	1031	1452	846453
11	1	63.3	10			91871
12	3	92.4	10	1673	1322	333050
13						
14						
15						
16						
17						
18						
19						
20						

**DFS Radar Parameters**  
**FCC Radar Type 5**  
**Channel 58 Bandwidth 80MHz**

Trial Number:			15			Detection (Yes/No)
Number of Bursts in Trial:			19			
Chirp Center Frequency:			5259.439			
Burst	Number of Pulses	Pulse Width (Microseconds)	Chirp Width (MHz)	Pulse 1-to-2 Spacing (µsec)	Pulse 2-to-3 Spacing (µsec)	Starting Location Within Interval (µsec)
1	3	93.3	18	1912	1535	361323
2	2	69.1	18	1794		515261
3	3	86.9	18	1152	1148	39025
4	3	84.9	18	1948	1118	190900
5	2	72.3	18	1916		343941
6	1	51.7	18			497624
7	1	58.3	18			20319
8	1	60.8	18			172999
9	1	57.1	18			325872
10	3	88.9	18	1964	1489	475841
11	2	72	18	1297		1489
12	3	90.9	18	1566	1370	153647
13	1	59.8	18			307096
14	2	70	18	1291		458804
15	2	67.2	18	1881		610798
16	3	91.2	18	1832	1661	134759
17	1	56.5	18			288306
18	1	51.2	18			441296
19	2	74.1	18	1245		592780
20						

Trial Number:			16			Detection (Yes/No)
Number of Bursts in Trial:			14			
Chirp Center Frequency:			5257.039			
Burst	Number of Pulses	Pulse Width (Microseconds)	Chirp Width (MHz)	Pulse 1-to-2 Spacing (µsec)	Pulse 2-to-3 Spacing (µsec)	Starting Location Within Interval (µsec)
1	2	76.9	12	1140		158286
2	1	50.2	12			366024
3	1	62.9	12			573452
4	1	64.7	12			780619
5	3	83.8	12	1097	1621	132455
6	1	65.4	12			340207
7	1	53.2	12			548208
8	1	51.7	12			755333
9	2	78.7	12	1168		107117
10	2	72.4	12	1343		314500
11	1	53.8	12			522447
12	2	73.6	12	1553		728517
13	2	66.7	12	1122		81611
14	2	82.5	12	1019		288948
15						
16						
17						
18						
19						
20						

**DFS Radar Parameters**  
**FCC Radar Type 5**  
**Channel 58 Bandwidth 80MHz**

Trial Number:			17			Detection (Yes/No)
Number of Bursts in Trial:			20			
Chirp Center Frequency:			5260.239			
Burst	Number of Pulses	Pulse Width (Microseconds )	Chirp Width (MHz)	Pulse 1-to-2 Spacing (µsec)	Pulse 2-to-3 Spacing (µsec)	Starting Location Within Interval (µsec)
1	3	87.6	20	1055	1840	345766
2	3	85.2	20	1541	1408	490019
3	3	84.8	20	1889	1463	39073
4	2	77.9	20	1460		183923
5	2	76.5	20	1485		328777
6	1	60.9	20			474728
7	2	83	20	1010		21394
8	2	80.4	20	1752		165992
9	2	67.5	20	1181		310973
10	1	62.1	20			456884
11	3	86.4	20	1966	1263	3515
12	3	84.3	20	1188	1788	147928
13	2	76.9	20	1537		293225
14	3	95.8	20	1298	1844	436922
15	1	55.2	20			584015
16	1	59	20			130832
17	3	94.5	20	1700	1283	274684
18	3	91.9	20	1978	1165	418579
19	3	85.2	20	1551	1189	563464
20	2	69.5	20	1224		112787

Trial Number:			18			Detection (Yes/No)
Number of Bursts in Trial:			12			
Chirp Center Frequency:			5256.239			
Burst	Number of Pulses	Pulse Width (Microseconds )	Chirp Width (MHz)	Pulse 1-to-2 Spacing (µsec)	Pulse 2-to-3 Spacing (µsec)	Starting Location Within Interval (µsec)
1	3	86.4	10	1918	1455	429224
2	3	92.2	10	1719	1895	670241
3	2	80.4	10	1899		912880
4	1	54.3	10			158603
5	1	53.1	10			400824
6	2	69.4	10	1546		641915
7	2	69.1	10	1639		883823
8	3	100	10	1438	1595	128373
9	2	79.6	10	1705		370379
10	3	88.4	10	1579	1623	611194
11	1	53.3	10			855665
12	1	65.3	10			98897
13						
14						
15						
16						
17						
18						
19						
20						

**DFS Radar Parameters**  
**FCC Radar Type 5**  
**Channel 58 Bandwidth 80MHz**

Trial Number:			19			Detection (Yes/No)
Number of Bursts in Trial:			14			
Chirp Center Frequency:			5257.039			
Burst	Number of Pulses	Pulse Width (Microseconds)	Chirp Width (MHz)	Pulse 1-to-2 Spacing (usec)	Pulse 2-to-3 Spacing (usec)	Starting Location Within Interval (usec)
1	1	55.3	12			292143
2	1	58.3	12			499633
3	2	72.3	12	1039.000		706377
4	3	84.8	12	1761.000	1721.000	58989
5	2	82.5	12	1431.000		266161
6	1	63.3	12			474469
7	2	80	12	1913.000		680544
8	3	90.3	12	1853.000	1123.000	33519
9	3	91.1	12	1783.000	1172.000	240319
10	3	96.6	12	1036.000	1385.000	447400
11	2	82.7	12	1990.000		654516
12	1	50.7	12			8083
13	2	78.4	12	1109.000		215435
14	3	99.5	12	1965.000	1869.000	421325
15						
16						
17						
18						
19						
20						

Trial Number:			20			Detection (Yes/No)
Number of Bursts in Trial:			12			
Chirp Center Frequency:			5256.239			
Burst	Number of Pulses	Pulse Width (Microseconds)	Chirp Width (MHz)	Pulse 1-to-2 Spacing (usec)	Pulse 2-to-3 Spacing (usec)	Starting Location Within Interval (usec)
1	3	88.6	10	1067	1927	733725
2	1	57.4	10			977882
3	3	96.6	10	1658	1324	221197
4	2	69.7	10	1945		462915
5	2	77.9	10	1317		705071
6	1	62	10			947923
7	3	88.4	10	1077	1366	191373
8	3	97.3	10	1896	1367	432561
9	3	96.2	10	1787	1672	674004
10	3	95.4	10	1892	1414	915842
11	1	54.8	10			162176
12	2	80.4	10	1436		403553
13						
14						
15						
16						
17						
18						
19						
20						

**DFS Radar Parameters**  
**FCC Radar Type 5**  
**Channel 58 Bandwidth 80MHz**

Trial Number:			21			Detection (Yes/No)
Number of Bursts in Trial:			16			
Chirp Center Frequency:			5321.761			
Burst	Number of Pulses	Pulse Width (Microseconds)	Chirp Width (MHz)	Pulse 1-to-2 Spacing ( $\mu$ sec)	Pulse 2-to-3 Spacing ( $\mu$ sec)	Starting Location Within Interval ( $\mu$ sec)
1	2	74.7	15	1611		483470
2	1	57.1	15			666072
3	3	91.9	15	1475	1276	98810
4	2	83.1	15	1772		279914
5	1	50.7	15			462536
6	2	79.2	15	1600		642324
7	1	58.7	15			76831
8	2	71	15	1567		257785
9	2	79	15	1960		438554
10	2	68.5	15	1428		620397
11	2	73.5	15	1352		54310
12	2	70.5	15	1115		235506
13	2	76.6	15	1300		417036
14	2	81.2	15	1675		597974
15	1	61.8	15			32086
16	3	94.9	15	1206	1860	212751
17						
18						
19						
20						

Trial Number:			22			Detection (Yes/No)
Number of Bursts in Trial:			12			
Chirp Center Frequency:			5324.161			
Burst	Number of Pulses	Pulse Width (Microseconds)	Chirp Width (MHz)	Pulse 1-to-2 Spacing ( $\mu$ sec)	Pulse 2-to-3 Spacing ( $\mu$ sec)	Starting Location Within Interval ( $\mu$ sec)
1	2	78.5	9	1698		526149
2	3	89.8	9	1962	1167	767135
3	1	59.4	9			12955
4	2	79.6	9	1890		254612
5	2	76	9	1811		496588
6	1	53.6	9			739728
7	2	80.9	9	1053		980872
8	1	61.6	9			225249
9	1	53.4	9			467279
10	1	59.9	9			709720
11	1	60.4	9			951847
12	3	91.4	9	1726	1227	194839
13						
14						
15						
16						
17						
18						
19						
20						

**DFS Radar Parameters**  
**FCC Radar Type 5**  
**Channel 58 Bandwidth 80MHz**

Trial Number:			23			Detection (Yes/No)
Number of Bursts in Trial:			20			
Chirp Center Frequency:			5319.761			
Burst	Number of Pulses	Pulse Width (Microseconds)	Chirp Width (MHz)	Pulse 1-to-2 Spacing (µsec)	Pulse 2-to-3 Spacing (µsec)	Starting Location Within Interval (µsec)
1	2	77	20	1363		261858
2	1	58.1	20			407646
3	1	62.1	20			552319
4	2	76.9	20	1236		99107
5	2	80	20	1852		243514
6	1	52	20			389464
7	3	88.6	20	1995	1905	531093
8	2	72.9	20	1387		81159
9	3	98.5	20	1746	1389	225245
10	1	57.9	20			371906
11	3	95.9	20	1870	1066	514197
12	1	53.5	20			63561
13	3	92	20	1654	1458	207510
14	1	57.3	20			353638
15	2	70.5	20	1586		497515
16	2	70	20	1664		45553
17	3	84	20	1630	1176	189821
18	2	76.1	20	1057		335330
19	3	93.2	20	1018	1340	478825
20	3	96.8	20	1614	1817	27594

Trial Number:			24			Detection (Yes/No)
Number of Bursts in Trial:			14			
Chirp Center Frequency:			5322.961			
Burst	Number of Pulses	Pulse Width (Microseconds)	Chirp Width (MHz)	Pulse 1-to-2 Spacing (µsec)	Pulse 2-to-3 Spacing (µsec)	Starting Location Within Interval (µsec)
1	1	50.1	12			247117
2	3	93.5	12	1081	1413	453362
3	2	68.8	12	1577		660875
4	1	56.3	12			14140
5	3	86	12	1108	1987	220734
6	2	75.2	12	1536		428367
7	1	54.4	12			636681
8	2	71.1	12	1243		843157
9	2	76.2	12	1770		195585
10	2	80.2	12	1209		403231
11	2	79.7	12	1214		610202
12	3	90.9	12	1862	1601	815229
13	2	68.7	12	1441		170267
14	2	67.4	12	1313		377306
15						
16						
17						
18						
19						
20						

**DFS Radar Parameters**  
**FCC Radar Type 5**  
**Channel 58 Bandwidth 80MHz**

Trial Number:			25			Detection (Yes/No)
Number of Bursts in Trial:			13			
Chirp Center Frequency:			5323.361			
Burst	Number of Pulses	Pulse Width (Microseconds)	Chirp Width (MHz)	Pulse 1-to-2 Spacing (µsec)	Pulse 2-to-3 Spacing (µsec)	Starting Location Within Interval (µsec)
1	3	94	11	1748	1941	628071
2	2	70.8	11	1201		853391
3	1	56.3	11			156223
4	3	96.7	11	1163	1332	378734
5	3	90.6	11	1582	1498	601331
6	2	74.5	11	1281		825462
7	3	92.6	11	1669	1222	128265
8	3	89	11	1135	1380	351161
9	3	96.5	11	1822	1602	573425
10	2	70.5	11	1178		798431
11	3	94	11	1629	1956	100737
12	1	55.8	11			324661
13	3	87.7	11	1963	1164	546278
14						
15						
16						
17						
18						
19						
20						

Trial Number:			26			Detection (Yes/No)
Number of Bursts in Trial:			8			
Chirp Center Frequency:			5325.761			
Burst	Number of Pulses	Pulse Width (Microseconds)	Chirp Width (MHz)	Pulse 1-to-2 Spacing (µsec)	Pulse 2-to-3 Spacing (µsec)	Starting Location Within Interval (µsec)
1	2	68.6	5	1161		1253842
2	2	83.1	5	1315		119486
3	1	60.9	5			482958
4	2	77.7	5	1158		845641
5	2	77.4	5	1510		1208428
6	2	66.8	5	1323		74748
7	1	63.7	5			438300
8	3	91.2	5	1681	1275	800152
9						
10						
11						
12						
13						
14						
15						
16						
17						
18						
19						
20						



**DFS Radar Parameters**  
**FCC Radar Type 5**  
**Channel 58 Bandwidth 80MHz**

Trial Number:			27			Detection (Yes/No)
Number of Bursts in Trial:			17			
Chirp Center Frequency:			5321.361			
Burst	Number of Pulses	Pulse Width (Microseconds)	Chirp Width (MHz)	Pulse 1-to-2 Spacing (µsec)	Pulse 2-to-3 Spacing (µsec)	Starting Location Within Interval (µsec)
1	3	83.6	16	1195	1000	545865
2	3	89.4	16	1627	1656	14067
3	1	55.8	16			184953
4	3	90.9	16	1554	1998	353759
5	1	54.7	16			526388
6	3	97.7	16	1202	1250	694806
7	2	67.5	16	1434		163568
8	3	96.7	16	1469	1268	333410
9	2	68.3	16	1954		504006
10	2	78.3	16	1082		675297
11	1	55	16			142890
12	3	84.9	16	1936	1199	312479
13	2	74.6	16	1856		482953
14	1	63.3	16			655022
15	3	99.8	16	1515	1120	121457
16	1	63.6	16			292606
17	3	87.3	16	1051	1831	461322
18						
19						
20						

Trial Number:			28			Detection (Yes/No)
Number of Bursts in Trial:			19			
Chirp Center Frequency:			5320.161			
Burst	Number of Pulses	Pulse Width (Microseconds)	Chirp Width (MHz)	Pulse 1-to-2 Spacing (µsec)	Pulse 2-to-3 Spacing (µsec)	Starting Location Within Interval (µsec)
1	3	85.6	19	1078	1015	565136
2	2	68.6	19	1780		89970
3	1	54.2	19			243121
4	1	61.2	19			396034
5	3	97.1	19	1969	1100	546225
6	3	98.3	19	1699	1622	70998
7	1	62.4	19			224093
8	2	80.2	19	1769		376127
9	3	87.5	19	1448	1179	527806
10	3	85.8	19	1348	1472	52247
11	3	88.1	19	1124	1631	204582
12	1	65.3	19			357941
13	1	52.5	19			510977
14	1	52.3	19			33698
15	2	74.1	19	1200		186023
16	1	54.9	19			339327
17	2	76.2	19	1502		491053
18	1	60.4	19			14858
19	2	81.5	19	1103		167387
20						

**DFS Radar Parameters**  
**FCC Radar Type 5**  
**Channel 58 Bandwidth 80MHz**

Trial Number:			29			Detection (Yes/No)
Number of Bursts in Trial:			12			
Chirp Center Frequency:			5323.761			
Burst	Number of Pulses	Pulse Width (Microseconds)	Chirp Width (MHz)	Pulse 1-to-2 Spacing (µsec)	Pulse 2-to-3 Spacing (µsec)	Starting Location Within Interval (µsec)
1	1	50.5	10			507709
2	1	55.7	10			750249
3	3	85.8	10	1002	1967	989003
4	2	76.9	10	1474		235634
5	2	75.1	10	1052		477675
6	3	92.3	10	1486	1492	718312
7	2	78.1	10	1757		960895
8	3	92.2	10	1252	1713	205370
9	3	89	10	1706	1411	446940
10	2	70.9	10	1620		689225
11	1	63.1	10			932305
12	1	55.3	10			176231
13						
14						
15						
16						
17						
18						
19						
20						

Trial Number:			30			Detection (Yes/No)
Number of Bursts in Trial:			18			
Chirp Center Frequency:			5320.961			
Burst	Number of Pulses	Pulse Width (Microseconds)	Chirp Width (MHz)	Pulse 1-to-2 Spacing (µsec)	Pulse 2-to-3 Spacing (µsec)	Starting Location Within Interval (µsec)
1	3	83.4	17	1205	1801	277485
2	3	97.3	17	1826	1635	437880
3	3	90.4	17	1986	1674	598445
4	3	91.8	17	1151	1802	97088
5	3	98.2	17	1977	1766	257251
6	1	59.5	17			419893
7	2	80	17	1137		580724
8	3	86.5	17	1128	1828	77366
9	3	91.1	17	1599	1442	238032
10	3	93.5	17	1373	1087	398605
11	1	60.7	17			562025
12	2	67.2	17	1405		57684
13	1	61.8	17			219083
14	2	79.4	17	1667		379234
15	2	81.4	17	1464		540896
16	1	65.7	17			37916
17	2	76	17	1255		198794
18	2	81	17	1668		359754
19						
20						

**DFS Radar Parameters**  
**FCC Radar Type 1**  
**Channel 100 Bandwidth 20MHz**

Trial #	Pulse Repetition Frequency Number (1 to 23)	Pulse Repetition Frequency (Pulses Per Second)	Pulse Repetition Interval (Microseconds)	Detection (Yes / No)
1	22	1066.10	938	Yes
2	10	1432.66	698	Yes
3	6	1618.12	618	Yes
4	2	1858.74	538	Yes
5	19	1138.95	878	No
6	12	326.16	3066	Yes
7	7	1567.40	638	Yes
8	21	1089.32	918	Yes
9	17	1193.32	838	No
10	18	1165.50	858	Yes
11	15	1253.13	798	Yes
12	11	1392.76	718	Yes
13	4	1730.10	578	Yes
14	5	1672.24	598	Yes
15	3	1792.11	558	Yes
16		394.32	2536	Yes
17		1035.20	966	Yes
18		1209.19	827	Yes
19		399.84	2501	Yes
20		385.36	2595	Yes
21		897.67	1114	No
22		768.05	1302	Yes
23		328.41	3045	Yes
24		615.76	1624	Yes
25		347.46	2878	Yes
26		973.71	1027	Yes
27		402.41	2485	Yes
28		625.00	1600	Yes
29		853.24	1172	Yes
30		849.62	1177	Yes

**DFS Radar Parameters**  
**FCC Radar Type 2**  
**Channel 100 Bandwidth 20MHz**

Trial #	Number Pulses per Burst	Pulse Width (Microseconds)	Pulse Repetition Interval (Microseconds)	Detection (Yes / No)
1	26	3.20	179	Yes
2	23	1.10	207	Yes
3	24	2.10	230	Yes
4	29	4.80	200	Yes
5	28	3.90	214	Yes
6	26	2.90	222	Yes
7	26	3.20	204	Yes
8	25	2.50	192	Yes
9	26	3.10	164	Yes
10	23	1.20	156	Yes
11	27	3.90	210	Yes
12	29	4.60	201	Yes
13	26	3.20	162	Yes
14	25	2.20	197	Yes
15	29	4.50	163	No
16	26	3.00	203	No
17	29	5.00	168	Yes
18	25	2.40	217	Yes
19	26	2.90	191	Yes
20	25	2.30	166	Yes
21	27	3.70	150	Yes
22	25	2.20	176	Yes
23	29	4.90	195	Yes
24	26	2.90	202	Yes
25	25	2.50	178	Yes
26	23	1.10	206	Yes
27	27	3.80	155	Yes
28	29	4.70	157	No
29	25	2.40	224	Yes
30	28	4.20	159	Yes

**DFS Radar Parameters**  
**FCC Radar Type 3**  
**Channel 100 Bandwidth 20MHz**

Trial #	Number Pulses per Burst	Pulse Width (Microseconds)	Pulse Repetition Interval (Microseconds)	Detection (Yes / No)
1	17	8.20	355	Yes
2	16	6.10	487	No
3	16	7.10	344	Yes
4	18	9.80	288	Yes
5	18	8.90	230	Yes
6	17	7.90	432	No
7	17	8.20	207	Yes
8	17	7.50	443	Yes
9	17	8.10	439	Yes
10	16	6.20	223	Yes
11	18	8.90	208	Yes
12	18	9.60	463	Yes
13	17	8.20	441	Yes
14	16	7.20	323	Yes
15	18	9.50	297	Yes
16	17	8.00	412	Yes
17	18	10.00	324	Yes
18	17	7.40	271	Yes
19	17	7.90	349	No
20	16	7.30	409	Yes
21	18	8.70	373	Yes
22	16	7.20	254	Yes
23	18	9.90	274	Yes
24	17	7.90	278	Yes
25	17	7.50	317	Yes
26	16	6.10	260	Yes
27	18	8.80	211	Yes
28	18	9.70	272	Yes
29	17	7.40	264	Yes
30	18	9.20	284	Yes

**DFS Radar Parameters**  
**FCC Radar Type 4**  
**Channel 100 Bandwidth 20MHz**

Trial #	Number Pulses per Burst	Pulse Width (Microseconds)	Pulse Repetition Interval (Microseconds)	Detection (Yes / No)
1	14	16.00	355	Yes
2	12	11.30	487	Yes
3	13	13.50	344	Yes
4	16	19.40	288	Yes
5	15	17.50	230	Yes
6	14	15.30	432	Yes
7	14	15.90	207	Yes
8	13	14.30	443	Yes
9	14	15.80	439	Yes
10	12	11.50	223	Yes
11	15	17.40	208	Yes
12	16	19.00	463	No
13	14	16.00	441	No
14	13	13.80	323	Yes
15	16	18.90	297	Yes
16	14	15.50	412	Yes
17	16	19.90	324	Yes
18	13	14.10	271	Yes
19	14	15.20	349	Yes
20	13	13.80	409	Yes
21	15	17.10	373	Yes
22	13	13.80	254	Yes
23	16	19.80	274	Yes
24	14	15.30	278	Yes
25	13	14.50	317	Yes
26	12	11.30	260	No
27	15	17.30	211	Yes
28	16	19.20	272	Yes
29	13	14.20	264	Yes
30	15	18.20	284	Yes

**DFS Radar Parameters**  
**FCC Radar Type 5**  
**Channel 100 Bandwidth 20MHz**

Trial Number:			1			Detection (Yes/No)
Number of Bursts in Trial:			15			
Chirp Center Frequency:			5500			
Burst	Number of Pulses	Pulse Width (Microseconds)	Chirp Width (MHz)	Pulse 1-to-2 Spacing (µsec)	Pulse 2-to-3 Spacing (µsec)	Starting Location Within Interval (µsec)
1	2	77.8	13	1477		636185
2	1	51.9	13			32674
3	1	63.8	13			226294
4	3	96.6	13	1786	1843	417976
5	3	85.9	13	1215	1729	611152
6	2	73.7	13	1549		8789
7	2	77.2	13	1819		201917
8	2	68.4	13	1114		395530
9	2	76.7	13	1155		588564
10	1	53.2	13			783794
11	3	85.7	13	1695	1394	177933
12	3	94.3	13	1426	1935	370624
13	2	77.6	13	1671		564893
14	1	65.7	13			759583
15	3	93.5	13	1130	1468	154262
16						
17						
18						
19						
20						

Trial Number:			2			Detection (Yes/No)
Number of Bursts in Trial:			8			
Chirp Center Frequency:			5500			
Burst	Number of Pulses	Pulse Width (Microseconds)	Chirp Width (MHz)	Pulse 1-to-2 Spacing (µsec)	Pulse 2-to-3 Spacing (µsec)	Starting Location Within Interval (µsec)
1	2	75	5	1527		653020
2	3	99.4	5	1262	1257	1015643
3	2	67.4	5	1403		1379398
4	2	73.6	5	1041		245489
5	1	65.9	5			609113
6	3	83.8	5	1292	1419	970852
7	1	65.5	5			1335913
8	3	98.6	5	1796	1728	200406
9						
10						
11						
12						
13						
14						
15						
16						
17						
18						
19						
20						

**DFS Radar Parameters**  
**FCC Radar Type 5**  
**Channel 100 Bandwidth 20MHz**

Trial Number:			3			Detection (Yes/No) Yes
Number of Bursts in Trial:			11			
Chirp Center Frequency:			5500			
Burst	Number of Pulses	Pulse Width (Microseconds)	Chirp Width (MHz)	Pulse 1-to-2 Spacing ( $\mu$ sec)	Pulse 2-to-3 Spacing ( $\mu$ sec)	Starting Location Within Interval ( $\mu$ sec)
1	2	73.8	9	1538		409565
2	2	69.5	9	1649		673692
3	1	51.9	9			938562
4	3	84.6	9	1032	1271	113209
5	3	95.4	9	1903	1388	376726
6	2	68	9	1351		641212
7	3	89.6	9	1514	1573	903714
8	2	81.9	9	1689		80863
9	3	88.3	9	1330	1838	344067
10	1	53.7	9			609331
11	3	91.3	9	1106	1001	871542
12						
13						
14						
15						
16						
17						
18						
19						
20						

Trial Number:			4			Detection (Yes/No) Yes
Number of Bursts in Trial:			20			
Chirp Center Frequency:			5500			
Burst	Number of Pulses	Pulse Width (Microseconds)	Chirp Width (MHz)	Pulse 1-to-2 Spacing ( $\mu$ sec)	Pulse 2-to-3 Spacing ( $\mu$ sec)	Starting Location Within Interval ( $\mu$ sec)
1	2	68.1	19	1355		26541
2	1	58.7	19			171821
3	2	75.3	19	1640		316229
4	1	56.4	19			461864
5	3	99.7	19	1708	1159	8677
6	1	57.7	19			153995
7	1	59.5	19			299238
8	2	80	19	1369		443177
9	2	82	19	1197		587671
10	2	82.8	19	1005		135674
11	3	88	19	1928	1101	279928
12	3	93.2	19	1907	1223	424279
13	2	70.4	19	1360		570132
14	3	95.3	19	1955	1775	117439
15	2	81.9	19	1545		262502
16	3	98.5	19	1169	1062	406573
17	1	65	19			553328
18	3	85.4	19	1637	1425	99799
19	3	91.6	19	1445	1325	244095
20	2	67.3	19	1218		390012



**DFS Radar Parameters**  
**FCC Radar Type 5**  
**Channel 100 Bandwidth 20MHz**

Trial Number:			5			Detection (Yes/No)
Number of Bursts in Trial:			17			
Chirp Center Frequency:			5500			Yes
Burst	Number of Pulses	Pulse Width (Microseconds )	Chirp Width (MHz)	Pulse 1-to-2 Spacing (µsec)	Pulse 2-to-3 Spacing (µsec)	Starting Location Within Interval (µsec)
1	2	67.9	16	1133		629614
2	1	62.3	16			96856
3	1	53.3	16			267719
4	3	90	16	1153	1346	436784
5	2	77.1	16	1646		608289
6	3	83.9	16	1232	1459	75610
7	3	89.1	16	1384	1939	245638
8	2	81.8	16	1676		416355
9	1	50.3	16			588736
10	3	87.1	16	1996	1756	54571
11	2	71.3	16	1815		225175
12	3	97.5	16	1465	1132	394825
13	3	90.6	16	1040	1354	565361
14	3	86.3	16	1183	1792	33643
15	3	97.6	16	1073	1361	203957
16	3	84.7	16	1718	1854	373812
17	3	99.7	16	1244	1988	544060
18						
19						
20						

Trial Number:			6			Detection (Yes/No)
Number of Bursts in Trial:			14			
Chirp Center Frequency:			5500			Yes
Burst	Number of Pulses	Pulse Width (Microseconds )	Chirp Width (MHz)	Pulse 1-to-2 Spacing (µsec)	Pulse 2-to-3 Spacing (µsec)	Starting Location Within Interval (µsec)
1	3	92.9	12	1564	1407	15438
2	2	67.7	12	1747		222486
3	1	65.8	12			430731
4	1	56.3	12			637784
5	1	53.7	12			845342
6	3	83.5	12	1930	1025	196720
7	1	65.8	12			404955
8	3	85.9	12	1034	1808	610711
9	2	76.3	12	1926		818057
10	2	81.5	12	1714		171459
11	3	89.4	12	1594	1827	377969
12	1	63.4	12			586875
13	2	69.6	12	1925		792834
14	2	74.5	12	1846		146044
15						
16						
17						
18						
19						
20						

**DFS Radar Parameters**  
**FCC Radar Type 5**  
**Channel 100 Bandwidth 20MHz**

Trial Number:			7			Detection (Yes/No)
Number of Bursts in Trial:			15			
Chirp Center Frequency:			5500			
Burst	Number of Pulses	Pulse Width (Microseconds)	Chirp Width (MHz)	Pulse 1-to-2 Spacing (µsec)	Pulse 2-to-3 Spacing (µsec)	Starting Location Within Interval (µsec)
1	1	52.6	10			51446
2	3	84.1	10	1725	1529	292696
3	3	97.7	10	1868	1805	533989
4	3	97.3	10	1446	1755	775564
5	3	98.8	10	1386	1302	21542
6	2	72.2	10	1184		263385
7	2	67.6	10	1027		505581
8	2	75.7	10	1871		747058
9	1	60.9	10			989976
10	1	64.2	10			234024
11	2	78.8	10	1604		475207
12	3	87.5	10	1712	1683	715825
13						
14						
15						
16						
17						
18						
19						
20						

Trial Number:			8			Detection (Yes/No)
Number of Bursts in Trial:			12			
Chirp Center Frequency:			5500			
Burst	Number of Pulses	Pulse Width (Microseconds)	Chirp Width (MHz)	Pulse 1-to-2 Spacing (µsec)	Pulse 2-to-3 Spacing (µsec)	Starting Location Within Interval (µsec)
1	1	52.6	10			51446
2	3	84.1	10	1725	1529	292696
3	3	97.7	10	1868	1805	533989
4	3	97.3	10	1446	1755	775564
5	3	98.8	10	1386	1302	21542
6	2	72.2	10	1184		263385
7	2	67.6	10	1027		505581
8	2	75.7	10	1871		747058
9	1	60.9	10			989976
10	1	64.2	10			234024
11	2	78.8	10	1604		475207
12	3	87.5	10	1712	1683	715825
13						
14						
15						
16						
17						
18						
19						
20						

**DFS Radar Parameters**  
**FCC Radar Type 5**  
**Channel 100 Bandwidth 20MHz**

Trial Number:			9			Detection (Yes/No)
Number of Bursts in Trial:			14			
Chirp Center Frequency:			5500			
Burst	Number of Pulses	Pulse Width (Microseconds)	Chirp Width (MHz)	Pulse 1-to-2 Spacing (µsec)	Pulse 2-to-3 Spacing (µsec)	Starting Location Within Interval (µsec)
1	1	54.1	13			823112
2	1	50.7	13			174965
3	1	52.3	13			382216
4	3	99.8	13	1696	1949	587395
5	2	68.4	13	1099		796897
6	2	80.8	13	1505		149042
7	1	62.5	13			356750
8	2	74.8	13	1204		563824
9	1	50.8	13			772314
10	1	54	13			123796
11	1	63	13			331215
12	3	91.8	13	1270	1347	537402
13	2	79.3	13	1992		744805
14	1	64.3	13			98172
15						
16						
17						
18						
19						
20						

Trial Number:			10			Detection (Yes/No)
Number of Bursts in Trial:			8			
Chirp Center Frequency:			5500			
Burst	Number of Pulses	Pulse Width (Microseconds)	Chirp Width (MHz)	Pulse 1-to-2 Spacing (µsec)	Pulse 2-to-3 Spacing (µsec)	Starting Location Within Interval (µsec)
1	1	63.4	6			535615
2	1	52	6			898668
3	3	97.2	6	1605	1583	1259235
4	2	78.7	6	1743		127106
5	2	74.2	6	1219		490358
6	3	88.7	6	1934	1273	852409
7	1	54.3	6			1217152
8	3	95.4	6	1555	1791	82296
9						
10						
11						
12						
13						
14						
15						
16						
17						
18						
19						
20						

**DFS Radar Parameters**  
**FCC Radar Type 5**  
**Channel 100 Bandwidth 20MHz**

Trial Number:			11			Detection (Yes/No)
Number of Bursts in Trial:			17			
Chirp Center Frequency:			5497.424			
Burst	Number of Pulses	Pulse Width (Microseconds)	Chirp Width (MHz)	Pulse 1-to-2 Spacing (µsec)	Pulse 2-to-3 Spacing (µsec)	Starting Location Within Interval (µsec)
1	2	73.7	16	1497		209249
2	3	97.4	16	1754	1613	378386
3	3	91.7	16	1702	1462	548411
4	1	66.2	16			17733
5	2	70.8	16	1821		187952
6	1	52.3	16			359277
7	2	78.9	16	1984		528886
8	2	70.9	16	1358		700166
9	2	75.6	16	1430		167197
10	1	59.1	16			338262
11	2	77	16	1304		508324
12	2	67.9	16	1083		678689
13	2	81.2	16	1932		146031
14	2	78.7	16	1121		316923
15	1	63.3	16			488056
16	2	68.9	16	1423		657326
17	1	59.3	16			125509
18						
19						
20						

Trial Number:			12			Detection (Yes/No)
Number of Bursts in Trial:			19			
Chirp Center Frequency:			5498.624			
Burst	Number of Pulses	Pulse Width (Microseconds)	Chirp Width (MHz)	Pulse 1-to-2 Spacing (µsec)	Pulse 2-to-3 Spacing (µsec)	Starting Location Within Interval (µsec)
1	3	98.9	19	1680	1488	263736
2	2	82.3	19	1855		416459
3	3	86.7	19	1400	1919	567902
4	3	89.7	19	1068	1282	92979
5	3	98.6	19	1194	1461	245155
6	2	71.1	19	1789		397609
7	1	55.9	19			551431
8	2	67.9	19	1372		74413
9	3	84.4	19	1107	1443	226559
10	1	58.8	19			380056
11	1	65.6	19			533408
12	2	78.5	19	1704		55547
13	2	82.3	19	1686		207876
14	3	90.1	19	1071	1266	359771
15	3	90.2	19	1089	1950	511297
16	2	83.1	19	1406		36803
17	1	58.8	19			189652
18	2	77	19	1657		341809
19	1	55	19			495737
20						

**DFS Radar Parameters**  
**FCC Radar Type 5**  
**Channel 100 Bandwidth 20MHz**

Trial Number:			13			Detection (Yes/No)
Number of Bursts in Trial:			15			
Chirp Center Frequency:			5496.224			
Burst	Number of Pulses	Pulse Width (Microseconds)	Chirp Width (MHz)	Pulse 1-to-2 Spacing (µsec)	Pulse 2-to-3 Spacing (µsec)	Starting Location Within Interval (µsec)
1	1	58.1	13			22911
2	1	52.1	13			216473
3	1	59.9	13			410004
4	1	60.2	13			603671
5	3	95.9	13	1906	1608	794160
6	2	79.9	13	1859		192251
7	2	78.5	13	1917		385590
8	1	53.8	13			579862
9	1	64.7	13			773423
10	1	61.4	13			168898
11	2	83.2	13	1858		361606
12	3	84.7	13	1677	1638	553866
13	3	88.7	13	1528	1058	747241
14	2	78.3	13	1951		144710
15	2	69.3	13	1717		337856
16						
17						
18						
19						
20						

Trial Number:			14			Detection (Yes/No)
Number of Bursts in Trial:			12			
Chirp Center Frequency:			5495.024			
Burst	Number of Pulses	Pulse Width (Microseconds)	Chirp Width (MHz)	Pulse 1-to-2 Spacing (µsec)	Pulse 2-to-3 Spacing (µsec)	Starting Location Within Interval (µsec)
1	2	75.3	10	1612		664275
2	1	56.3	10			907886
3	2	67.7	10	1185		151316
4	1	55.6	10			393746
5	2	75.2	10	1267		635093
6	2	76.3	10	1305		876993
7	3	85.7	10	1362	1924	121278
8	3	98.4	10	1550	1249	362696
9	3	86.4	10	1439	1046	604342
10	3	93.6	10	1031	1452	846453
11	1	63.3	10			91871
12	3	92.4	10	1673	1322	333050
13						
14						
15						
16						
17						
18						
19						
20						

**DFS Radar Parameters**  
**FCC Radar Type 5**  
**Channel 100 Bandwidth 20MHz**

Trial Number:			15			Detection (Yes/No)
Number of Bursts in Trial:			19			
Chirp Center Frequency:			5498.224			
Burst	Number of Pulses	Pulse Width (Microseconds)	Chirp Width (MHz)	Pulse 1-to-2 Spacing (µsec)	Pulse 2-to-3 Spacing (µsec)	Starting Location Within Interval (µsec)
1	3	93.3	18	1912	1535	361323
2	2	69.1	18	1794		515261
3	3	86.9	18	1152	1148	39025
4	3	84.9	18	1948	1118	190900
5	2	72.3	18	1916		343941
6	1	51.7	18			497624
7	1	58.3	18			20319
8	1	60.8	18			172999
9	1	57.1	18			325872
10	3	88.9	18	1964	1489	475841
11	2	72	18	1297		1489
12	3	90.9	18	1566	1370	153647
13	1	59.8	18			307096
14	2	70	18	1291		458804
15	2	67.2	18	1881		610798
16	3	91.2	18	1832	1661	134759
17	1	56.5	18			288306
18	1	51.2	18			441296
19	2	74.1	18	1245		592780
20						

Trial Number:			16			Detection (Yes/No)
Number of Bursts in Trial:			14			
Chirp Center Frequency:			5495.824			
Burst	Number of Pulses	Pulse Width (Microseconds)	Chirp Width (MHz)	Pulse 1-to-2 Spacing (µsec)	Pulse 2-to-3 Spacing (µsec)	Starting Location Within Interval (µsec)
1	2	76.9	12	1140		158286
2	1	50.2	12			366024
3	1	62.9	12			573452
4	1	64.7	12			780619
5	3	83.8	12	1097	1621	132455
6	1	65.4	12			340207
7	1	53.2	12			548208
8	1	51.7	12			755333
9	2	78.7	12	1168		107117
10	2	72.4	12	1343		314500
11	1	53.8	12			522447
12	2	73.6	12	1553		728517
13	2	66.7	12	1122		81611
14	2	82.5	12	1019		288948
15						
16						
17						
18						
19						
20						

**DFS Radar Parameters**  
**FCC Radar Type 5**  
**Channel 100 Bandwidth 20MHz**

Trial Number:			17			Detection (Yes/No)
Number of Bursts in Trial:			20			
Chirp Center Frequency:			5499.024			
Burst	Number of Pulses	Pulse Width (Microseconds)	Chirp Width (MHz)	Pulse 1-to-2 Spacing (µsec)	Pulse 2-to-3 Spacing (µsec)	Starting Location Within Interval (µsec)
1	3	87.6	20	1055	1840	345766
2	3	85.2	20	1541	1408	490019
3	3	84.8	20	1889	1463	39073
4	2	77.9	20	1460		183923
5	2	76.5	20	1485		328777
6	1	60.9	20			474728
7	2	83	20	1010		21394
8	2	80.4	20	1752		165992
9	2	67.5	20	1181		310973
10	1	62.1	20			456884
11	3	86.4	20	1966	1263	3515
12	3	84.3	20	1188	1788	147928
13	2	76.9	20	1537		293225
14	3	95.8	20	1298	1844	436922
15	1	55.2	20			584015
16	1	59	20			130832
17	3	94.5	20	1700	1283	274684
18	3	91.9	20	1978	1165	418579
19	3	85.2	20	1551	1189	563464
20	2	69.5	20	1224		112787

Trial Number:			18			Detection (Yes/No)
Number of Bursts in Trial:			12			
Chirp Center Frequency:			5495.024			
Burst	Number of Pulses	Pulse Width (Microseconds)	Chirp Width (MHz)	Pulse 1-to-2 Spacing (µsec)	Pulse 2-to-3 Spacing (µsec)	Starting Location Within Interval (µsec)
1	3	86.4	10	1918	1455	429224
2	3	92.2	10	1719	1895	670241
3	2	80.4	10	1899		912880
4	1	54.3	10			158603
5	1	53.1	10			400824
6	2	69.4	10	1546		641915
7	2	69.1	10	1639		883823
8	3	100	10	1438	1595	128373
9	2	79.6	10	1705		370379
10	3	88.4	10	1579	1623	611194
11	1	53.3	10			855665
12	1	65.3	10			98897
13						
14						
15						
16						
17						
18						
19						
20						

**DFS Radar Parameters**  
**FCC Radar Type 5**  
**Channel 100 Bandwidth 20MHz**

Trial Number:			19			Detection (Yes/No)
Number of Bursts in Trial:			14			
Chirp Center Frequency:			5495.824			
Burst	Number of Pulses	Pulse Width (Microseconds)	Chirp Width (MHz)	Pulse 1-to-2 Spacing (usec)	Pulse 2-to-3 Spacing (usec)	Starting Location Within Interval (usec)
1	1	55.3	12			292143
2	1	58.3	12			499633
3	2	72.3	12	1039.000		706377
4	3	84.8	12	1761.000	1721.000	58989
5	2	82.5	12	1431.000		266161
6	1	63.3	12			474469
7	2	80	12	1913.000		680544
8	3	90.3	12	1853.000	1123.000	33519
9	3	91.1	12	1783.000	1172.000	240319
10	3	96.6	12	1036.000	1385.000	447400
11	2	82.7	12	1990.000		654516
12	1	50.7	12			8083
13	2	78.4	12	1109.000		215435
14	3	99.5	12	1965.000	1869.000	421325
15						
16						
17						
18						
19						
20						

Trial Number:			20			Detection (Yes/No)
Number of Bursts in Trial:			12			
Chirp Center Frequency:			5495.024			
Burst	Number of Pulses	Pulse Width (Microseconds)	Chirp Width (MHz)	Pulse 1-to-2 Spacing (usec)	Pulse 2-to-3 Spacing (usec)	Starting Location Within Interval (usec)
1	3	88.6	10	1067	1927	733725
2	1	57.4	10			977882
3	3	96.6	10	1658	1324	221197
4	2	69.7	10	1945		462915
5	2	77.9	10	1317		705071
6	1	62	10			947923
7	3	88.4	10	1077	1366	191373
8	3	97.3	10	1896	1367	432561
9	3	96.2	10	1787	1672	674004
10	3	95.4	10	1892	1414	915842
11	1	54.8	10			162176
12	2	80.4	10	1436		403553
13						
14						
15						
16						
17						
18						
19						
20						



**DFS Radar Parameters**  
**FCC Radar Type 5**  
**Channel 100 Bandwidth 20MHz**

Trial Number:			21			Detection (Yes/No)
Number of Bursts in Trial:			16			
Chirp Center Frequency:			5502.976			
Burst	Number of Pulses	Pulse Width (Microseconds)	Chirp Width (MHz)	Pulse 1-to-2 Spacing (µsec)	Pulse 2-to-3 Spacing (µsec)	Starting Location Within Interval (µsec)
1	2	74.7	15	1611		483470
2	1	57.1	15			666072
3	3	91.9	15	1475	1276	98810
4	2	83.1	15	1772		279914
5	1	50.7	15			462536
6	2	79.2	15	1600		642324
7	1	58.7	15			76831
8	2	71	15	1567		257785
9	2	79	15	1960		438554
10	2	68.5	15	1428		620397
11	2	73.5	15	1352		54310
12	2	70.5	15	1115		235506
13	2	76.6	15	1300		417036
14	2	81.2	15	1675		597974
15	1	61.8	15			32086
16	3	94.9	15	1206	1860	212751
17						
18						
19						
20						

Trial Number:			22			Detection (Yes/No)
Number of Bursts in Trial:			12			
Chirp Center Frequency:			5505.376			
Burst	Number of Pulses	Pulse Width (Microseconds)	Chirp Width (MHz)	Pulse 1-to-2 Spacing (µsec)	Pulse 2-to-3 Spacing (µsec)	Starting Location Within Interval (µsec)
1	2	78.5	9	1698		526149
2	3	89.8	9	1962	1167	767135
3	1	59.4	9			12955
4	2	79.6	9	1890		254612
5	2	76	9	1811		496588
6	1	53.6	9			739728
7	2	80.9	9	1053		980872
8	1	61.6	9			225249
9	1	53.4	9			467279
10	1	59.9	9			709720
11	1	60.4	9			951847
12	3	91.4	9	1726	1227	194839
13						
14						
15						
16						
17						
18						
19						
20						

**DFS Radar Parameters**  
**FCC Radar Type 5**  
**Channel 100 Bandwidth 20MHz**

Trial Number:			23			Detection (Yes/No)
Number of Bursts in Trial:			20			
Chirp Center Frequency:			5500.976			
Burst	Number of Pulses	Pulse Width (Microseconds )	Chirp Width (MHz)	Pulse 1-to-2 Spacing (µsec)	Pulse 2-to-3 Spacing (µsec)	Starting Location Within Interval (µsec)
1	2	77	20	1363		261858
2	1	58.1	20			407646
3	1	62.1	20			552319
4	2	76.9	20	1236		99107
5	2	80	20	1852		243514
6	1	52	20			389464
7	3	88.6	20	1995	1905	531093
8	2	72.9	20	1387		81159
9	3	98.5	20	1746	1389	225245
10	1	57.9	20			371906
11	3	95.9	20	1870	1066	514197
12	1	53.5	20			63561
13	3	92	20	1654	1458	207510
14	1	57.3	20			353638
15	2	70.5	20	1586		497515
16	2	70	20	1664		45553
17	3	84	20	1630	1176	189821
18	2	76.1	20	1057		335330
19	3	93.2	20	1018	1340	478825
20	3	96.8	20	1614	1817	27594

Trial Number:			24			Detection (Yes/No)
Number of Bursts in Trial:			14			
Chirp Center Frequency:			5504.176			
Burst	Number of Pulses	Pulse Width (Microseconds )	Chirp Width (MHz)	Pulse 1-to-2 Spacing (µsec)	Pulse 2-to-3 Spacing (µsec)	Starting Location Within Interval (µsec)
1	1	50.1	12			247117
2	3	93.5	12	1081	1413	453362
3	2	68.8	12	1577		660875
4	1	56.3	12			14140
5	3	86	12	1108	1987	220734
6	2	75.2	12	1536		428367
7	1	54.4	12			636681
8	2	71.1	12	1243		843157
9	2	76.2	12	1770		195585
10	2	80.2	12	1209		403231
11	2	79.7	12	1214		610202
12	3	90.9	12	1862	1601	815229
13	2	68.7	12	1441		170267
14	2	67.4	12	1313		377306
15						
16						
17						
18						
19						
20						

**DFS Radar Parameters**  
**FCC Radar Type 5**  
**Channel 100 Bandwidth 20MHz**

Trial Number:			25			Detection (Yes/No)
Number of Bursts in Trial:			13			
Chirp Center Frequency:			5504.576			
Burst	Number of Pulses	Pulse Width (Microseconds)	Chirp Width (MHz)	Pulse 1-to-2 Spacing (µsec)	Pulse 2-to-3 Spacing (µsec)	Starting Location Within Interval (µsec)
1	3	94	11	1748	1941	628071
2	2	70.8	11	1201		853391
3	1	56.3	11			156223
4	3	96.7	11	1163	1332	378734
5	3	90.6	11	1582	1498	601331
6	2	74.5	11	1281		825462
7	3	92.6	11	1669	1222	128265
8	3	89	11	1135	1380	351161
9	3	96.5	11	1822	1602	573425
10	2	70.5	11	1178		798431
11	3	94	11	1629	1956	100737
12	1	55.8	11			324661
13	3	87.7	11	1963	1164	546278
14						
15						
16						
17						
18						
19						
20						

Trial Number:			26			Detection (Yes/No)
Number of Bursts in Trial:			8			
Chirp Center Frequency:			5506.976			
Burst	Number of Pulses	Pulse Width (Microseconds)	Chirp Width (MHz)	Pulse 1-to-2 Spacing (µsec)	Pulse 2-to-3 Spacing (µsec)	Starting Location Within Interval (µsec)
1	2	68.6	5	1161		1253842
2	2	83.1	5	1315		119486
3	1	60.9	5			482958
4	2	77.7	5	1158		845641
5	2	77.4	5	1510		1208428
6	2	66.8	5	1323		74748
7	1	63.7	5			438300
8	3	91.2	5	1681	1275	800152
9						
10						
11						
12						
13						
14						
15						
16						
17						
18						
19						
20						

**DFS Radar Parameters**  
**FCC Radar Type 5**  
**Channel 100 Bandwidth 20MHz**

Trial Number:			27			Detection (Yes/No)
Number of Bursts in Trial:			17			
Chirp Center Frequency:			5502.576			
Burst	Number of Pulses	Pulse Width (Microseconds)	Chirp Width (MHz)	Pulse 1-to-2 Spacing (µsec)	Pulse 2-to-3 Spacing (µsec)	Starting Location Within Interval (µsec)
1	3	83.6	16	1195	1000	545865
2	3	89.4	16	1627	1656	14067
3	1	55.8	16			184953
4	3	90.9	16	1554	1998	353759
5	1	54.7	16			526388
6	3	97.7	16	1202	1250	694806
7	2	67.5	16	1434		163568
8	3	96.7	16	1469	1268	333410
9	2	68.3	16	1954		504006
10	2	78.3	16	1082		675297
11	1	55	16			142890
12	3	84.9	16	1936	1199	312479
13	2	74.6	16	1856		482953
14	1	63.3	16			655022
15	3	99.8	16	1515	1120	121457
16	1	63.6	16			292606
17	3	87.3	16	1051	1831	461322
18						
19						
20						

Trial Number:			28			Detection (Yes/No)
Number of Bursts in Trial:			19			
Chirp Center Frequency:			5501.376			
Burst	Number of Pulses	Pulse Width (Microseconds)	Chirp Width (MHz)	Pulse 1-to-2 Spacing (µsec)	Pulse 2-to-3 Spacing (µsec)	Starting Location Within Interval (µsec)
1	3	85.6	19	1078	1015	565136
2	2	68.6	19	1780		89970
3	1	54.2	19			243121
4	1	61.2	19			396034
5	3	97.1	19	1969	1100	546225
6	3	98.3	19	1699	1622	70998
7	1	62.4	19			224093
8	2	80.2	19	1769		376127
9	3	87.5	19	1448	1179	527806
10	3	85.8	19	1348	1472	52247
11	3	88.1	19	1124	1631	204582
12	1	65.3	19			357941
13	1	52.5	19			510977
14	1	52.3	19			33698
15	2	74.1	19	1200		186023
16	1	54.9	19			339327
17	2	76.2	19	1502		491053
18	1	60.4	19			14858
19	2	81.5	19	1103		167387
20						

**DFS Radar Parameters**  
**FCC Radar Type 5**  
**Channel 100 Bandwidth 20MHz**

Trial Number:			29			Detection (Yes/No)
Number of Bursts in Trial:			12			
Chirp Center Frequency:			5504.976			Yes
Burst	Number of Pulses	Pulse Width (Microseconds)	Chirp Width (MHz)	Pulse 1-to-2 Spacing (usec)	Pulse 2-to-3 Spacing (usec)	Starting Location Within Interval (usec)
1	1	50.5	10			507709
2	1	55.7	10			750249
3	3	85.8	10	1002	1967	989003
4	2	76.9	10	1474		235634
5	2	75.1	10	1052		477675
6	3	92.3	10	1486	1492	718312
7	2	78.1	10	1757		960895
8	3	92.2	10	1252	1713	205370
9	3	89	10	1706	1411	446940
10	2	70.9	10	1620		689225
11	1	63.1	10			932305
12	1	55.3	10			176231
13						
14						
15						
16						
17						
18						
19						
20						

Trial Number:			30			Detection (Yes/No)
Number of Bursts in Trial:			18			
Chirp Center Frequency:			5502.176			Yes
Burst	Number of Pulses	Pulse Width (Microseconds)	Chirp Width (MHz)	Pulse 1-to-2 Spacing (usec)	Pulse 2-to-3 Spacing (usec)	Starting Location Within Interval (usec)
1	3	83.4	17	1205	1801	277485
2	3	97.3	17	1826	1635	437880
3	3	90.4	17	1986	1674	598445
4	3	91.8	17	1151	1802	97088
5	3	98.2	17	1977	1766	257251
6	1	59.5	17			419893
7	2	80	17	1137		580724
8	3	86.5	17	1128	1828	77366
9	3	91.1	17	1599	1442	238032
10	3	93.5	17	1373	1087	398605
11	1	60.7	17			562025
12	2	67.2	17	1405		57684
13	1	61.8	17			219083
14	2	79.4	17	1667		379234
15	2	81.4	17	1464		540896
16	1	65.7	17			37916
17	2	76	17	1255		198794
18	2	81	17	1668		359754
19						
20						

**DFS Radar Parameters**  
**FCC Radar Type 1**  
**Channel 102 Bandwidth 40MHz**

Trial #	Pulse Repetition Frequency Number (1 to 23)	Pulse Repetition Frequency (Pulses Per Second)	Pulse Repetition Interval (Microseconds)	Detection (Yes / No)
1	22	1066.10	938	Yes
2	10	1432.66	698	Yes
3	6	1618.12	618	Yes
4	2	1858.74	538	Yes
5	19	1138.95	878	No
6	12	326.16	3066	Yes
7	7	1567.40	638	No
8	21	1089.32	918	Yes
9	17	1193.32	838	Yes
10	18	1165.50	858	Yes
11	15	1253.13	798	Yes
12	11	1392.76	718	Yes
13	4	1730.10	578	Yes
14	5	1672.24	598	Yes
15	3	1792.11	558	Yes
16		394.32	2536	Yes
17		1035.20	966	Yes
18		1209.19	827	Yes
19		399.84	2501	Yes
20		385.36	2595	Yes
21		897.67	1114	Yes
22		768.05	1302	Yes
23		328.41	3045	Yes
24		615.76	1624	Yes
25		347.46	2878	Yes
26		973.71	1027	Yes
27		402.41	2485	Yes
28		625.00	1600	Yes
29		853.24	1172	Yes
30		849.62	1177	Yes

**DFS Radar Parameters**  
**FCC Radar Type 2**  
**Channel 102 Bandwidth 40MHz**

Trial #	Number Pulses per Burst	Pulse Width (Microseconds)	Pulse Repetition Interval (Microseconds)	Detection (Yes / No)
1	26	3.20	179	Yes
2	23	1.10	207	Yes
3	24	2.10	230	Yes
4	29	4.80	200	Yes
5	28	3.90	214	Yes
6	26	2.90	222	Yes
7	26	3.20	204	Yes
8	25	2.50	192	Yes
9	26	3.10	164	Yes
10	23	1.20	156	Yes
11	27	3.90	210	Yes
12	29	4.60	201	Yes
13	26	3.20	162	No
14	25	2.20	197	Yes
15	29	4.50	163	Yes
16	26	3.00	203	Yes
17	29	5.00	168	Yes
18	25	2.40	217	Yes
19	26	2.90	191	No
20	25	2.30	166	Yes
21	27	3.70	150	Yes
22	25	2.20	176	Yes
23	29	4.90	195	Yes
24	26	2.90	202	Yes
25	25	2.50	178	Yes
26	23	1.10	206	Yes
27	27	3.80	155	Yes
28	29	4.70	157	Yes
29	25	2.40	224	Yes
30	28	4.20	159	Yes

**DFS Radar Parameters**  
**FCC Radar Type 3**  
**Channel 102 Bandwidth 40MHz**

Trial #	Number Pulses per Burst	Pulse Width (Microseconds)	Pulse Repetition Interval (Microseconds)	Detection (Yes / No)
1	17	8.20	355	Yes
2	16	6.10	487	Yes
3	16	7.10	344	Yes
4	18	9.80	288	Yes
5	18	8.90	230	Yes
6	17	7.90	432	No
7	17	8.20	207	Yes
8	17	7.50	443	Yes
9	17	8.10	439	Yes
10	16	6.20	223	Yes
11	18	8.90	208	Yes
12	18	9.60	463	Yes
13	17	8.20	441	Yes
14	16	7.20	323	Yes
15	18	9.50	297	No
16	17	8.00	412	Yes
17	18	10.00	324	Yes
18	17	7.40	271	Yes
19	17	7.90	349	Yes
20	16	7.30	409	Yes
21	18	8.70	373	Yes
22	16	7.20	254	Yes
23	18	9.90	274	No
24	17	7.90	278	Yes
25	17	7.50	317	Yes
26	16	6.10	260	Yes
27	18	8.80	211	Yes
28	18	9.70	272	Yes
29	17	7.40	264	Yes
30	18	9.20	284	Yes



**DFS Radar Parameters**  
**FCC Radar Type 4**  
**Channel 102 Bandwidth 40MHz**

Trial #	Number Pulses per Burst	Pulse Width (Microseconds)	Pulse Repetition Interval (Microseconds)	Detection (Yes / No)
1	14	16.00	355	Yes
2	12	11.30	487	No
3	13	13.50	344	Yes
4	16	19.40	288	Yes
5	15	17.50	230	Yes
6	14	15.30	432	Yes
7	14	15.90	207	Yes
8	13	14.30	443	No
9	14	15.80	439	Yes
10	12	11.50	223	Yes
11	15	17.40	208	Yes
12	16	19.00	463	Yes
13	14	16.00	441	Yes
14	13	13.80	323	Yes
15	16	18.90	297	Yes
16	14	15.50	412	Yes
17	16	19.90	324	Yes
18	13	14.10	271	No
19	14	15.20	349	Yes
20	13	13.80	409	Yes
21	15	17.10	373	Yes
22	13	13.80	254	Yes
23	16	19.80	274	Yes
24	14	15.30	278	Yes
25	13	14.50	317	Yes
26	12	11.30	260	Yes
27	15	17.30	211	Yes
28	16	19.20	272	Yes
29	13	14.20	264	Yes
30	15	18.20	284	Yes

**DFS Radar Parameters**  
**FCC Radar Type 5**  
**Channel 102 Bandwidth 40MHz**

Trial Number:			1			Detection (Yes/No)
Number of Bursts in Trial:			15			
Chirp Center Frequency:			5510			
Burst	Number of Pulses	Pulse Width (Microseconds)	Chirp Width (MHz)	Pulse 1-to-2 Spacing (µsec)	Pulse 2-to-3 Spacing (µsec)	Starting Location Within Interval (µsec)
1	2	77.8	13	1477		636185
2	1	51.9	13			32674
3	1	63.8	13			226294
4	3	96.6	13	1786	1843	417976
5	3	85.9	13	1215	1729	611152
6	2	73.7	13	1549		8789
7	2	77.2	13	1819		201917
8	2	68.4	13	1114		395530
9	2	76.7	13	1155		588564
10	1	53.2	13			783794
11	3	85.7	13	1695	1394	177933
12	3	94.3	13	1426	1935	370624
13	2	77.6	13	1671		564893
14	1	65.7	13			759583
15	3	93.5	13	1130	1468	154262
16						
17						
18						
19						
20						

Trial Number:			2			Detection (Yes/No)
Number of Bursts in Trial:			8			
Chirp Center Frequency:			5510			
Burst	Number of Pulses	Pulse Width (Microseconds)	Chirp Width (MHz)	Pulse 1-to-2 Spacing (µsec)	Pulse 2-to-3 Spacing (µsec)	Starting Location Within Interval (µsec)
1	2	75	5	1527		653020
2	3	99.4	5	1262	1257	1015643
3	2	67.4	5	1403		1379398
4	2	73.6	5	1041		245489
5	1	65.9	5			609113
6	3	83.8	5	1292	1419	970852
7	1	65.5	5			1335913
8	3	98.6	5	1796	1728	200406
9						
10						
11						
12						
13						
14						
15						
16						
17						
18						
19						
20						

**DFS Radar Parameters**  
**FCC Radar Type 5**  
**Channel 102 Bandwidth 40MHz**

Trial Number:			3			Detection (Yes/No) Yes
Number of Bursts in Trial:			11			
Chirp Center Frequency:			5510			
Burst	Number of Pulses	Pulse Width (Microseconds)	Chirp Width (MHz)	Pulse 1-to-2 Spacing (µsec)	Pulse 2-to-3 Spacing (µsec)	Starting Location Within Interval (µsec)
1	2	73.8	9	1538		409565
2	2	69.5	9	1649		673692
3	1	51.9	9			938562
4	3	84.6	9	1032	1271	113209
5	3	95.4	9	1903	1388	376726
6	2	68	9	1351		641212
7	3	89.6	9	1514	1573	903714
8	2	81.9	9	1689		80863
9	3	88.3	9	1330	1838	344067
10	1	53.7	9			609331
11	3	91.3	9	1106	1001	871542
12						
13						
14						
15						
16						
17						
18						
19						
20						

Trial Number:			4			Detection (Yes/No) Yes
Number of Bursts in Trial:			20			
Chirp Center Frequency:			5510			
Burst	Number of Pulses	Pulse Width (Microseconds)	Chirp Width (MHz)	Pulse 1-to-2 Spacing (µsec)	Pulse 2-to-3 Spacing (µsec)	Starting Location Within Interval (µsec)
1	2	68.1	19	1355		26541
2	1	58.7	19			171821
3	2	75.3	19	1640		316229
4	1	56.4	19			461864
5	3	99.7	19	1708	1159	8677
6	1	57.7	19			153995
7	1	59.5	19			299238
8	2	80	19	1369		443177
9	2	82	19	1197		587671
10	2	82.8	19	1005		135674
11	3	88	19	1928	1101	279928
12	3	93.2	19	1907	1223	424279
13	2	70.4	19	1360		570132
14	3	95.3	19	1955	1775	117439
15	2	81.9	19	1545		262502
16	3	98.5	19	1169	1062	406573
17	1	65	19			553328
18	3	85.4	19	1637	1425	99799
19	3	91.6	19	1445	1325	244095
20	2	67.3	19	1218		390012

**DFS Radar Parameters**  
**FCC Radar Type 5**  
**Channel 102 Bandwidth 40MHz**

Trial Number:			5			Detection (Yes/No)
Number of Bursts in Trial:			17			
Chirp Center Frequency:			5510			Yes
Burst	Number of Pulses	Pulse Width (Microseconds)	Chirp Width (MHz)	Pulse 1-to-2 Spacing ( $\mu$ sec)	Pulse 2-to-3 Spacing ( $\mu$ sec)	Starting Location Within Interval ( $\mu$ sec)
1	2	67.9	16	1133		629614
2	1	62.3	16			96856
3	1	53.3	16			267719
4	3	90	16	1153	1346	436784
5	2	77.1	16	1646		608289
6	3	83.9	16	1232	1459	75610
7	3	89.1	16	1384	1939	245638
8	2	81.8	16	1676		416355
9	1	50.3	16			588736
10	3	87.1	16	1996	1756	54571
11	2	71.3	16	1815		225175
12	3	97.5	16	1465	1132	394825
13	3	90.6	16	1040	1354	565361
14	3	86.3	16	1183	1792	33643
15	3	97.6	16	1073	1361	203957
16	3	84.7	16	1718	1854	373812
17	3	99.7	16	1244	1988	544060
18						
19						
20						

Trial Number:			6			Detection (Yes/No)
Number of Bursts in Trial:			14			
Chirp Center Frequency:			5510			Yes
Burst	Number of Pulses	Pulse Width (Microseconds)	Chirp Width (MHz)	Pulse 1-to-2 Spacing ( $\mu$ sec)	Pulse 2-to-3 Spacing ( $\mu$ sec)	Starting Location Within Interval ( $\mu$ sec)
1	3	92.9	12	1564	1407	15438
2	2	67.7	12	1747		222486
3	1	65.8	12			430731
4	1	56.3	12			637784
5	1	53.7	12			845342
6	3	83.5	12	1930	1025	196720
7	1	65.8	12			404955
8	3	85.9	12	1034	1808	610711
9	2	76.3	12	1926		818057
10	2	81.5	12	1714		171459
11	3	89.4	12	1594	1827	377969
12	1	63.4	12			586875
13	2	69.6	12	1925		792834
14	2	74.5	12	1846		146044
15						
16						
17						
18						
19						
20						

**DFS Radar Parameters**  
**FCC Radar Type 5**  
**Channel 102 Bandwidth 40MHz**

Trial Number:			7			Detection (Yes/No)
Number of Bursts in Trial:			15			
Chirp Center Frequency:			5510			
Burst	Number of Pulses	Pulse Width (Microseconds)	Chirp Width (MHz)	Pulse 1-to-2 Spacing (µsec)	Pulse 2-to-3 Spacing (µsec)	Starting Location Within Interval (µsec)
1	1	52.6	10			51446
2	3	84.1	10	1725	1529	292696
3	3	97.7	10	1868	1805	533989
4	3	97.3	10	1446	1755	775564
5	3	98.8	10	1386	1302	21542
6	2	72.2	10	1184		263385
7	2	67.6	10	1027		505581
8	2	75.7	10	1871		747058
9	1	60.9	10			989976
10	1	64.2	10			234024
11	2	78.8	10	1604		475207
12	3	87.5	10	1712	1683	715825
13						
14						
15						
16						
17						
18						
19						
20						

Trial Number:			8			Detection (Yes/No)
Number of Bursts in Trial:			12			
Chirp Center Frequency:			5510			
Burst	Number of Pulses	Pulse Width (Microseconds)	Chirp Width (MHz)	Pulse 1-to-2 Spacing (µsec)	Pulse 2-to-3 Spacing (µsec)	Starting Location Within Interval (µsec)
1	1	52.6	10			51446
2	3	84.1	10	1725	1529	292696
3	3	97.7	10	1868	1805	533989
4	3	97.3	10	1446	1755	775564
5	3	98.8	10	1386	1302	21542
6	2	72.2	10	1184		263385
7	2	67.6	10	1027		505581
8	2	75.7	10	1871		747058
9	1	60.9	10			989976
10	1	64.2	10			234024
11	2	78.8	10	1604		475207
12	3	87.5	10	1712	1683	715825
13						
14						
15						
16						
17						
18						
19						
20						

**DFS Radar Parameters**  
**FCC Radar Type 5**  
**Channel 102 Bandwidth 40MHz**

Trial Number:			9			Detection (Yes/No)
Number of Bursts in Trial:			14			
Chirp Center Frequency:			5510			
Burst	Number of Pulses	Pulse Width (Microseconds)	Chirp Width (MHz)	Pulse 1-to-2 Spacing (µsec)	Pulse 2-to-3 Spacing (µsec)	Starting Location Within Interval (µsec)
1	1	54.1	13			823112
2	1	50.7	13			174965
3	1	52.3	13			382216
4	3	99.8	13	1696	1949	587395
5	2	68.4	13	1099		796897
6	2	80.8	13	1505		149042
7	1	62.5	13			356750
8	2	74.8	13	1204		563824
9	1	50.8	13			772314
10	1	54	13			123796
11	1	63	13			331215
12	3	91.8	13	1270	1347	537402
13	2	79.3	13	1992		744805
14	1	64.3	13			98172
15						
16						
17						
18						
19						
20						

Trial Number:			10			Detection (Yes/No)
Number of Bursts in Trial:			8			
Chirp Center Frequency:			5510			
Burst	Number of Pulses	Pulse Width (Microseconds)	Chirp Width (MHz)	Pulse 1-to-2 Spacing (µsec)	Pulse 2-to-3 Spacing (µsec)	Starting Location Within Interval (µsec)
1	1	63.4	6			535615
2	1	52	6			898668
3	3	97.2	6	1605	1583	1259235
4	2	78.7	6	1743		127106
5	2	74.2	6	1219		490358
6	3	88.7	6	1934	1273	852409
7	1	54.3	6			1217152
8	3	95.4	6	1555	1791	82296
9						
10						
11						
12						
13						
14						
15						
16						
17						
18						
19						
20						

**DFS Radar Parameters**  
**FCC Radar Type 5**  
**Channel 102 Bandwidth 40MHz**

Trial Number:			11			Detection (Yes/No)
Number of Bursts in Trial:			17			
Chirp Center Frequency:			5498.203			
Burst	Number of Pulses	Pulse Width (Microseconds)	Chirp Width (MHz)	Pulse 1-to-2 Spacing (µsec)	Pulse 2-to-3 Spacing (µsec)	Starting Location Within Interval (µsec)
1	2	73.7	16	1497		209249
2	3	97.4	16	1754	1613	378386
3	3	91.7	16	1702	1462	548411
4	1	66.2	16			17733
5	2	70.8	16	1821		187952
6	1	52.3	16			359277
7	2	78.9	16	1984		528886
8	2	70.9	16	1358		700166
9	2	75.6	16	1430		167197
10	1	59.1	16			338262
11	2	77	16	1304		508324
12	2	67.9	16	1083		678689
13	2	81.2	16	1932		146031
14	2	78.7	16	1121		316923
15	1	63.3	16			488056
16	2	68.9	16	1423		657326
17	1	59.3	16			125509
18						
19						
20						

Trial Number:			12			Detection (Yes/No)
Number of Bursts in Trial:			19			
Chirp Center Frequency:			5499.403			
Burst	Number of Pulses	Pulse Width (Microseconds)	Chirp Width (MHz)	Pulse 1-to-2 Spacing (µsec)	Pulse 2-to-3 Spacing (µsec)	Starting Location Within Interval (µsec)
1	3	98.9	19	1680	1488	263736
2	2	82.3	19	1855		416459
3	3	86.7	19	1400	1919	567902
4	3	89.7	19	1068	1282	92979
5	3	98.6	19	1194	1461	245155
6	2	71.1	19	1789		397609
7	1	55.9	19			551431
8	2	67.9	19	1372		74413
9	3	84.4	19	1107	1443	226559
10	1	58.8	19			380056
11	1	65.6	19			533408
12	2	78.5	19	1704		55547
13	2	82.3	19	1686		207876
14	3	90.1	19	1071	1266	359771
15	3	90.2	19	1089	1950	511297
16	2	83.1	19	1406		36803
17	1	58.8	19			189652
18	2	77	19	1657		341809
19	1	55	19			495737
20						

**DFS Radar Parameters**  
**FCC Radar Type 5**  
**Channel 102 Bandwidth 40MHz**

Trial Number:			13			Detection (Yes/No)
Number of Bursts in Trial:			15			
Chirp Center Frequency:			5497.003			
Burst	Number of Pulses	Pulse Width (Microseconds)	Chirp Width (MHz)	Pulse 1-to-2 Spacing (µsec)	Pulse 2-to-3 Spacing (µsec)	Starting Location Within Interval (µsec)
1	1	58.1	13			22911
2	1	52.1	13			216473
3	1	59.9	13			410004
4	1	60.2	13			603671
5	3	95.9	13	1906	1608	794160
6	2	79.9	13	1859		192251
7	2	78.5	13	1917		385590
8	1	53.8	13			579862
9	1	64.7	13			773423
10	1	61.4	13			168898
11	2	83.2	13	1858		361606
12	3	84.7	13	1677	1638	553866
13	3	88.7	13	1528	1058	747241
14	2	78.3	13	1951		144710
15	2	69.3	13	1717		337856
16						
17						
18						
19						
20						

Trial Number:			14			Detection (Yes/No)
Number of Bursts in Trial:			12			
Chirp Center Frequency:			5495.803			
Burst	Number of Pulses	Pulse Width (Microseconds)	Chirp Width (MHz)	Pulse 1-to-2 Spacing (µsec)	Pulse 2-to-3 Spacing (µsec)	Starting Location Within Interval (µsec)
1	2	75.3	10	1612		664275
2	1	56.3	10			907886
3	2	67.7	10	1185		151316
4	1	55.6	10			393746
5	2	75.2	10	1267		635093
6	2	76.3	10	1305		876993
7	3	85.7	10	1362	1924	121278
8	3	98.4	10	1550	1249	362696
9	3	86.4	10	1439	1046	604342
10	3	93.6	10	1031	1452	846453
11	1	63.3	10			91871
12	3	92.4	10	1673	1322	333050
13						
14						
15						
16						
17						
18						
19						
20						



**DFS Radar Parameters**  
**FCC Radar Type 5**  
**Channel 102 Bandwidth 40MHz**

Trial Number:			15			Detection (Yes/No)
Number of Bursts in Trial:			19			
Chirp Center Frequency:			5499.003			
Burst	Number of Pulses	Pulse Width (Microseconds)	Chirp Width (MHz)	Pulse 1-to-2 Spacing (µsec)	Pulse 2-to-3 Spacing (µsec)	Starting Location Within Interval (µsec)
1	3	93.3	18	1912	1535	361323
2	2	69.1	18	1794		515261
3	3	86.9	18	1152	1148	39025
4	3	84.9	18	1948	1118	190900
5	2	72.3	18	1916		343941
6	1	51.7	18			497624
7	1	58.3	18			20319
8	1	60.8	18			172999
9	1	57.1	18			325872
10	3	88.9	18	1964	1489	475841
11	2	72	18	1297		1489
12	3	90.9	18	1566	1370	153647
13	1	59.8	18			307096
14	2	70	18	1291		458804
15	2	67.2	18	1881		610798
16	3	91.2	18	1832	1661	134759
17	1	56.5	18			288306
18	1	51.2	18			441296
19	2	74.1	18	1245		592780
20						

Trial Number:			16			Detection (Yes/No)
Number of Bursts in Trial:			14			
Chirp Center Frequency:			5496.603			
Burst	Number of Pulses	Pulse Width (Microseconds)	Chirp Width (MHz)	Pulse 1-to-2 Spacing (µsec)	Pulse 2-to-3 Spacing (µsec)	Starting Location Within Interval (µsec)
1	2	76.9	12	1140		158286
2	1	50.2	12			366024
3	1	62.9	12			573452
4	1	64.7	12			780619
5	3	83.8	12	1097	1621	132455
6	1	65.4	12			340207
7	1	53.2	12			548208
8	1	51.7	12			755333
9	2	78.7	12	1168		107117
10	2	72.4	12	1343		314500
11	1	53.8	12			522447
12	2	73.6	12	1553		728517
13	2	66.7	12	1122		81611
14	2	82.5	12	1019		288948
15						
16						
17						
18						
19						
20						

**DFS Radar Parameters**  
**FCC Radar Type 5**  
**Channel 102 Bandwidth 40MHz**

Trial Number:			17			Detection (Yes/No)
Number of Bursts in Trial:			20			
Chirp Center Frequency:			5499.803			
Burst	Number of Pulses	Pulse Width (Microseconds)	Chirp Width (MHz)	Pulse 1-to-2 Spacing ( $\mu$ sec)	Pulse 2-to-3 Spacing ( $\mu$ sec)	Starting Location Within Interval ( $\mu$ sec)
1	3	87.6	20	1055	1840	345766
2	3	85.2	20	1541	1408	490019
3	3	84.8	20	1889	1463	39073
4	2	77.9	20	1460		183923
5	2	76.5	20	1485		328777
6	1	60.9	20			474728
7	2	83	20	1010		21394
8	2	80.4	20	1752		165992
9	2	67.5	20	1181		310973
10	1	62.1	20			456884
11	3	86.4	20	1966	1263	3515
12	3	84.3	20	1188	1788	147928
13	2	76.9	20	1537		293225
14	3	95.8	20	1298	1844	436922
15	1	55.2	20			584015
16	1	59	20			130832
17	3	94.5	20	1700	1283	274684
18	3	91.9	20	1978	1165	418579
19	3	85.2	20	1551	1189	563464
20	2	69.5	20	1224		112787

Trial Number:			18			Detection (Yes/No)
Number of Bursts in Trial:			12			
Chirp Center Frequency:			5495.803			
Burst	Number of Pulses	Pulse Width (Microseconds)	Chirp Width (MHz)	Pulse 1-to-2 Spacing ( $\mu$ sec)	Pulse 2-to-3 Spacing ( $\mu$ sec)	Starting Location Within Interval ( $\mu$ sec)
1	3	86.4	10	1918	1455	429224
2	3	92.2	10	1719	1895	670241
3	2	80.4	10	1899		912880
4	1	54.3	10			158603
5	1	53.1	10			400824
6	2	69.4	10	1546		641915
7	2	69.1	10	1639		883823
8	3	100	10	1438	1595	128373
9	2	79.6	10	1705		370379
10	3	88.4	10	1579	1623	611194
11	1	53.3	10			855665
12	1	65.3	10			98897
13						
14						
15						
16						
17						
18						
19						
20						

**DFS Radar Parameters**  
**FCC Radar Type 5**  
**Channel 102 Bandwidth 40MHz**

Trial Number:			19			Detection (Yes/No)
Number of Bursts in Trial:			14			
Chirp Center Frequency:			5496.603			Yes
Burst	Number of Pulses	Pulse Width (Microseconds)	Chirp Width (MHz)	Pulse 1-to-2 Spacing (usec)	Pulse 2-to-3 Spacing (usec)	Starting Location Within Interval (usec)
1	1	55.3	12			292143
2	1	58.3	12			499633
3	2	72.3	12	1039.000		706377
4	3	84.8	12	1761.000	1721.000	58989
5	2	82.5	12	1431.000		266161
6	1	63.3	12			474469
7	2	80	12	1913.000		680544
8	3	90.3	12	1853.000	1123.000	33519
9	3	91.1	12	1783.000	1172.000	240319
10	3	96.6	12	1036.000	1385.000	447400
11	2	82.7	12	1990.000		654516
12	1	50.7	12			8083
13	2	78.4	12	1109.000		215435
14	3	99.5	12	1965.000	1869.000	421325
15						
16						
17						
18						
19						
20						

Trial Number:			20			Detection (Yes/No)
Number of Bursts in Trial:			12			
Chirp Center Frequency:			5495.803			Yes
Burst	Number of Pulses	Pulse Width (Microseconds)	Chirp Width (MHz)	Pulse 1-to-2 Spacing (usec)	Pulse 2-to-3 Spacing (usec)	Starting Location Within Interval (usec)
1	3	88.6	10	1067	1927	733725
2	1	57.4	10			977882
3	3	96.6	10	1658	1324	221197
4	2	69.7	10	1945		462915
5	2	77.9	10	1317		705071
6	1	62	10			947923
7	3	88.4	10	1077	1366	191373
8	3	97.3	10	1896	1367	432561
9	3	96.2	10	1787	1672	674004
10	3	95.4	10	1892	1414	915842
11	1	54.8	10			162176
12	2	80.4	10	1436		403553
13						
14						
15						
16						
17						
18						
19						
20						

**DFS Radar Parameters**  
**FCC Radar Type 5**  
**Channel 102 Bandwidth 40MHz**

Trial Number:			21			Detection (Yes/No)
Number of Bursts in Trial:			16			
Chirp Center Frequency:			5522.197			
Burst	Number of Pulses	Pulse Width (Microseconds)	Chirp Width (MHz)	Pulse 1-to-2 Spacing (µsec)	Pulse 2-to-3 Spacing (µsec)	Starting Location Within Interval (µsec)
1	2	74.7	15	1611		483470
2	1	57.1	15			666072
3	3	91.9	15	1475	1276	98810
4	2	83.1	15	1772		279914
5	1	50.7	15			462536
6	2	79.2	15	1600		642324
7	1	58.7	15			76831
8	2	71	15	1567		257785
9	2	79	15	1960		438554
10	2	68.5	15	1428		620397
11	2	73.5	15	1352		54310
12	2	70.5	15	1115		235506
13	2	76.6	15	1300		417036
14	2	81.2	15	1675		597974
15	1	61.8	15			32086
16	3	94.9	15	1206	1860	212751
17						
18						
19						
20						

Trial Number:			22			Detection (Yes/No)
Number of Bursts in Trial:			12			
Chirp Center Frequency:			5524.597			
Burst	Number of Pulses	Pulse Width (Microseconds)	Chirp Width (MHz)	Pulse 1-to-2 Spacing (µsec)	Pulse 2-to-3 Spacing (µsec)	Starting Location Within Interval (µsec)
1	2	78.5	9	1698		526149
2	3	89.8	9	1962	1167	767135
3	1	59.4	9			12955
4	2	79.6	9	1890		254612
5	2	76	9	1811		496588
6	1	53.6	9			739728
7	2	80.9	9	1053		980872
8	1	61.6	9			225249
9	1	53.4	9			467279
10	1	59.9	9			709720
11	1	60.4	9			951847
12	3	91.4	9	1726	1227	194839
13						
14						
15						
16						
17						
18						
19						
20						

**DFS Radar Parameters**  
**FCC Radar Type 5**  
**Channel 102 Bandwidth 40MHz**

Trial Number:			23			Detection (Yes/No)
Number of Bursts in Trial:			20			
Chirp Center Frequency:			5520.197			
Burst	Number of Pulses	Pulse Width (Microseconds)	Chirp Width (MHz)	Pulse 1-to-2 Spacing (µsec)	Pulse 2-to-3 Spacing (µsec)	Starting Location Within Interval (µsec)
1	2	77	20	1363		261858
2	1	58.1	20			407646
3	1	62.1	20			552319
4	2	76.9	20	1236		99107
5	2	80	20	1852		243514
6	1	52	20			389464
7	3	88.6	20	1995	1905	531093
8	2	72.9	20	1387		81159
9	3	98.5	20	1746	1389	225245
10	1	57.9	20			371906
11	3	95.9	20	1870	1066	514197
12	1	53.5	20			63561
13	3	92	20	1654	1458	207510
14	1	57.3	20			353638
15	2	70.5	20	1586		497515
16	2	70	20	1664		45553
17	3	84	20	1630	1176	189821
18	2	76.1	20	1057		335330
19	3	93.2	20	1018	1340	478825
20	3	96.8	20	1614	1817	27594

Trial Number:			24			Detection (Yes/No)
Number of Bursts in Trial:			14			
Chirp Center Frequency:			5523.397			
Burst	Number of Pulses	Pulse Width (Microseconds)	Chirp Width (MHz)	Pulse 1-to-2 Spacing (µsec)	Pulse 2-to-3 Spacing (µsec)	Starting Location Within Interval (µsec)
1	1	50.1	12			247117
2	3	93.5	12	1081	1413	453362
3	2	68.8	12	1577		660875
4	1	56.3	12			14140
5	3	86	12	1108	1987	220734
6	2	75.2	12	1536		428367
7	1	54.4	12			636681
8	2	71.1	12	1243		843157
9	2	76.2	12	1770		195585
10	2	80.2	12	1209		403231
11	2	79.7	12	1214		610202
12	3	90.9	12	1862	1601	815229
13	2	68.7	12	1441		170267
14	2	67.4	12	1313		377306
15						
16						
17						
18						
19						
20						

**DFS Radar Parameters**  
**FCC Radar Type 5**  
**Channel 102 Bandwidth 40MHz**

Trial Number:			25			Detection (Yes/No)
Number of Bursts in Trial:			13			
Chirp Center Frequency:			5523.797			
Burst	Number of Pulses	Pulse Width (Microseconds)	Chirp Width (MHz)	Pulse 1-to-2 Spacing (µsec)	Pulse 2-to-3 Spacing (µsec)	Starting Location Within Interval (µsec)
1	3	94	11	1748	1941	628071
2	2	70.8	11	1201		853391
3	1	56.3	11			156223
4	3	96.7	11	1163	1332	378734
5	3	90.6	11	1582	1498	601331
6	2	74.5	11	1281		825462
7	3	92.6	11	1669	1222	128265
8	3	89	11	1135	1380	351161
9	3	96.5	11	1822	1602	573425
10	2	70.5	11	1178		798431
11	3	94	11	1629	1956	100737
12	1	55.8	11			324661
13	3	87.7	11	1963	1164	546278
14						
15						
16						
17						
18						
19						
20						

Trial Number:			26			Detection (Yes/No)
Number of Bursts in Trial:			8			
Chirp Center Frequency:			5526.197			
Burst	Number of Pulses	Pulse Width (Microseconds)	Chirp Width (MHz)	Pulse 1-to-2 Spacing (µsec)	Pulse 2-to-3 Spacing (µsec)	Starting Location Within Interval (µsec)
1	2	68.6	5	1161		1253842
2	2	83.1	5	1315		119486
3	1	60.9	5			482958
4	2	77.7	5	1158		845641
5	2	77.4	5	1510		1208428
6	2	66.8	5	1323		74748
7	1	63.7	5			438300
8	3	91.2	5	1681	1275	800152
9						
10						
11						
12						
13						
14						
15						
16						
17						
18						
19						
20						

**DFS Radar Parameters**  
**FCC Radar Type 5**  
**Channel 102 Bandwidth 40MHz**

Trial Number:			27			Detection (Yes/No)
Number of Bursts in Trial:			17			
Chirp Center Frequency:			5521.797			
Burst	Number of Pulses	Pulse Width (Microseconds)	Chirp Width (MHz)	Pulse 1-to-2 Spacing (µsec)	Pulse 2-to-3 Spacing (µsec)	Starting Location Within Interval (µsec)
1	3	83.6	16	1195	1000	545865
2	3	89.4	16	1627	1656	14067
3	1	55.8	16			184953
4	3	90.9	16	1554	1998	353759
5	1	54.7	16			526388
6	3	97.7	16	1202	1250	694806
7	2	67.5	16	1434		163568
8	3	96.7	16	1469	1268	333410
9	2	68.3	16	1954		504006
10	2	78.3	16	1082		675297
11	1	55	16			142890
12	3	84.9	16	1936	1199	312479
13	2	74.6	16	1856		482953
14	1	63.3	16			655022
15	3	99.8	16	1515	1120	121457
16	1	63.6	16			292606
17	3	87.3	16	1051	1831	461322
18						
19						
20						

Trial Number:			28			Detection (Yes/No)
Number of Bursts in Trial:			19			
Chirp Center Frequency:			5520.597			
Burst	Number of Pulses	Pulse Width (Microseconds)	Chirp Width (MHz)	Pulse 1-to-2 Spacing (µsec)	Pulse 2-to-3 Spacing (µsec)	Starting Location Within Interval (µsec)
1	3	85.6	19	1078	1015	565136
2	2	68.6	19	1780		89970
3	1	54.2	19			243121
4	1	61.2	19			396034
5	3	97.1	19	1969	1100	546225
6	3	98.3	19	1699	1622	70998
7	1	62.4	19			224093
8	2	80.2	19	1769		376127
9	3	87.5	19	1448	1179	527806
10	3	85.8	19	1348	1472	52247
11	3	88.1	19	1124	1631	204582
12	1	65.3	19			357941
13	1	52.5	19			510977
14	1	52.3	19			33698
15	2	74.1	19	1200		186023
16	1	54.9	19			339327
17	2	76.2	19	1502		491053
18	1	60.4	19			14858
19	2	81.5	19	1103		167387
20						

**DFS Radar Parameters**  
**FCC Radar Type 5**  
**Channel 102 Bandwidth 40MHz**

Trial Number:			29			Detection (Yes/No)
Number of Bursts in Trial:			12			
Chirp Center Frequency:			5524.197			Yes
Burst	Number of Pulses	Pulse Width (Microseconds)	Chirp Width (MHz)	Pulse 1-to-2 Spacing (µsec)	Pulse 2-to-3 Spacing (µsec)	Starting Location Within Interval (µsec)
1	1	50.5	10			507709
2	1	55.7	10			750249
3	3	85.8	10	1002	1967	989003
4	2	76.9	10	1474		235634
5	2	75.1	10	1052		477675
6	3	92.3	10	1486	1492	718312
7	2	78.1	10	1757		960895
8	3	92.2	10	1252	1713	205370
9	3	89	10	1706	1411	446940
10	2	70.9	10	1620		689225
11	1	63.1	10			932305
12	1	55.3	10			176231
13						
14						
15						
16						
17						
18						
19						
20						

Trial Number:			30			Detection (Yes/No)
Number of Bursts in Trial:			18			
Chirp Center Frequency:			5521.397			Yes
Burst	Number of Pulses	Pulse Width (Microseconds)	Chirp Width (MHz)	Pulse 1-to-2 Spacing (µsec)	Pulse 2-to-3 Spacing (µsec)	Starting Location Within Interval (µsec)
1	3	83.4	17	1205	1801	277485
2	3	97.3	17	1826	1635	437880
3	3	90.4	17	1986	1674	598445
4	3	91.8	17	1151	1802	97088
5	3	98.2	17	1977	1766	257251
6	1	59.5	17			419893
7	2	80	17	1137		580724
8	3	86.5	17	1128	1828	77366
9	3	91.1	17	1599	1442	238032
10	3	93.5	17	1373	1087	398605
11	1	60.7	17			562025
12	2	67.2	17	1405		57684
13	1	61.8	17			219083
14	2	79.4	17	1667		379234
15	2	81.4	17	1464		540896
16	1	65.7	17			37916
17	2	76	17	1255		198794
18	2	81	17	1668		359754
19						
20						



**DFS Radar Parameters**  
**FCC Radar Type 1**  
**Channel 106 Bandwidth 80MHz**

Trial #	Pulse Repetition Frequency Number (1 to 23)	Pulse Repetition Frequency (Pulses Per Second)	Pulse Repetition Interval (Microseconds)	Detection (Yes / No)
1	22	1066.10	938	Yes
2	10	1432.66	698	Yes
3	6	1618.12	618	Yes
4	2	1858.74	538	Yes
5	19	1138.95	878	Yes
6	12	326.16	3066	Yes
7	7	1567.40	638	Yes
8	21	1089.32	918	Yes
9	17	1193.32	838	Yes
10	18	1165.50	858	Yes
11	15	1253.13	798	Yes
12	11	1392.76	718	Yes
13	4	1730.10	578	Yes
14	5	1672.24	598	No
15	3	1792.11	558	Yes
16		394.32	2536	Yes
17		1035.20	966	Yes
18		1209.19	827	Yes
19		399.84	2501	Yes
20		385.36	2595	Yes
21		897.67	1114	Yes
22		768.05	1302	Yes
23		328.41	3045	Yes
24		615.76	1624	Yes
25		347.46	2878	No
26		973.71	1027	Yes
27		402.41	2485	Yes
28		625.00	1600	Yes
29		853.24	1172	Yes
30		849.62	1177	Yes

**DFS Radar Parameters**  
**FCC Radar Type 2**  
**Channel 106 Bandwidth 80MHz**

Trial #	Number Pulses per Burst	Pulse Width (Microseconds)	Pulse Repetition Interval (Microseconds)	Detection (Yes / No)
1	26	3.20	179	Yes
2	23	1.10	207	Yes
3	24	2.10	230	Yes
4	29	4.80	200	Yes
5	28	3.90	214	Yes
6	26	2.90	222	Yes
7	26	3.20	204	No
8	25	2.50	192	Yes
9	26	3.10	164	No
10	23	1.20	156	Yes
11	27	3.90	210	Yes
12	29	4.60	201	Yes
13	26	3.20	162	Yes
14	25	2.20	197	Yes
15	29	4.50	163	Yes
16	26	3.00	203	Yes
17	29	5.00	168	Yes
18	25	2.40	217	Yes
19	26	2.90	191	Yes
20	25	2.30	166	Yes
21	27	3.70	150	Yes
22	25	2.20	176	No
23	29	4.90	195	Yes
24	26	2.90	202	Yes
25	25	2.50	178	Yes
26	23	1.10	206	Yes
27	27	3.80	155	Yes
28	29	4.70	157	Yes
29	25	2.40	224	Yes
30	28	4.20	159	Yes

**DFS Radar Parameters**  
**FCC Radar Type 3**  
**Channel 106 Bandwidth 80MHz**

Trial #	Number Pulses per Burst	Pulse Width (Microseconds)	Pulse Repetition Interval (Microseconds)	Detection (Yes / No)
1	17	8.20	355	Yes
2	16	6.10	487	Yes
3	16	7.10	344	Yes
4	18	9.80	288	Yes
5	18	8.90	230	Yes
6	17	7.90	432	Yes
7	17	8.20	207	Yes
8	17	7.50	443	Yes
9	17	8.10	439	Yes
10	16	6.20	223	Yes
11	18	8.90	208	Yes
12	18	9.60	463	Yes
13	17	8.20	441	No
14	16	7.20	323	Yes
15	18	9.50	297	Yes
16	17	8.00	412	Yes
17	18	10.00	324	Yes
18	17	7.40	271	Yes
19	17	7.90	349	Yes
20	16	7.30	409	Yes
21	18	8.70	373	Yes
22	16	7.20	254	Yes
23	18	9.90	274	Yes
24	17	7.90	278	Yes
25	17	7.50	317	No
26	16	6.10	260	Yes
27	18	8.80	211	Yes
28	18	9.70	272	Yes
29	17	7.40	264	Yes
30	18	9.20	284	No

**DFS Radar Parameters**  
**FCC Radar Type 4**  
**Channel 106 Bandwidth 80MHz**

Trial #	Number Pulses per Burst	Pulse Width (Microseconds)	Pulse Repetition Interval (Microseconds)	Detection (Yes / No)
1	14	16.00	355	Yes
2	12	11.30	487	Yes
3	13	13.50	344	Yes
4	16	19.40	288	Yes
5	15	17.50	230	Yes
6	14	15.30	432	No
7	14	15.90	207	No
8	13	14.30	443	Yes
9	14	15.80	439	Yes
10	12	11.50	223	Yes
11	15	17.40	208	Yes
12	16	19.00	463	Yes
13	14	16.00	441	Yes
14	13	13.80	323	Yes
15	16	18.90	297	Yes
16	14	15.50	412	Yes
17	16	19.90	324	No
18	13	14.10	271	Yes
19	14	15.20	349	Yes
20	13	13.80	409	Yes
21	15	17.10	373	Yes
22	13	13.80	254	Yes
23	16	19.80	274	Yes
24	14	15.30	278	Yes
25	13	14.50	317	Yes
26	12	11.30	260	Yes
27	15	17.30	211	Yes
28	16	19.20	272	Yes
29	13	14.20	264	Yes
30	15	18.20	284	Yes

**DFS Radar Parameters**  
**FCC Radar Type 5**  
**Channel 106 Bandwidth 80MHz**

Trial Number:			1			Detection (Yes/No)
Number of Bursts in Trial:			15			
Chirp Center Frequency:			5530			
Burst	Number of Pulses	Pulse Width (Microseconds)	Chirp Width (MHz)	Pulse 1-to-2 Spacing (µsec)	Pulse 2-to-3 Spacing (µsec)	Starting Location Within Interval (µsec)
1	2	77.8	13	1477		636185
2	1	51.9	13			32674
3	1	63.8	13			226294
4	3	96.6	13	1786	1843	417976
5	3	85.9	13	1215	1729	611152
6	2	73.7	13	1549		8789
7	2	77.2	13	1819		201917
8	2	68.4	13	1114		395530
9	2	76.7	13	1155		588564
10	1	53.2	13			783794
11	3	85.7	13	1695	1394	177933
12	3	94.3	13	1426	1935	370624
13	2	77.6	13	1671		564893
14	1	65.7	13			759583
15	3	93.5	13	1130	1468	154262
16						
17						
18						
19						
20						

Trial Number:			2			Detection (Yes/No)
Number of Bursts in Trial:			8			
Chirp Center Frequency:			5530			
Burst	Number of Pulses	Pulse Width (Microseconds)	Chirp Width (MHz)	Pulse 1-to-2 Spacing (µsec)	Pulse 2-to-3 Spacing (µsec)	Starting Location Within Interval (µsec)
1	2	75	5	1527		653020
2	3	99.4	5	1262	1257	1015643
3	2	67.4	5	1403		1379398
4	2	73.6	5	1041		245489
5	1	65.9	5			609113
6	3	83.8	5	1292	1419	970852
7	1	65.5	5			1335913
8	3	98.6	5	1796	1728	200406
9						
10						
11						
12						
13						
14						
15						
16						
17						
18						
19						
20						

**DFS Radar Parameters**  
**FCC Radar Type 5**  
**Channel 106 Bandwidth 80MHz**

Trial Number:			3			Detection (Yes/No) Yes
Number of Bursts in Trial:			11			
Chirp Center Frequency:			5530			
Burst	Number of Pulses	Pulse Width (Microseconds)	Chirp Width (MHz)	Pulse 1-to-2 Spacing (usec)	Pulse 2-to-3 Spacing (usec)	Starting Location Within Interval (usec)
1	2	73.8	9	1538		409565
2	2	69.5	9	1649		673692
3	1	51.9	9			938562
4	3	84.6	9	1032	1271	113209
5	3	95.4	9	1903	1388	376726
6	2	68	9	1351		641212
7	3	89.6	9	1514	1573	903714
8	2	81.9	9	1689		80863
9	3	88.3	9	1330	1838	344067
10	1	53.7	9			609331
11	3	91.3	9	1106	1001	871542
12						
13						
14						
15						
16						
17						
18						
19						
20						

Trial Number:			4			Detection (Yes/No) Yes
Number of Bursts in Trial:			20			
Chirp Center Frequency:			5530			
Burst	Number of Pulses	Pulse Width (Microseconds)	Chirp Width (MHz)	Pulse 1-to-2 Spacing (usec)	Pulse 2-to-3 Spacing (usec)	Starting Location Within Interval (usec)
1	2	68.1	19	1355		26541
2	1	58.7	19			171821
3	2	75.3	19	1640		316229
4	1	56.4	19			461864
5	3	99.7	19	1708	1159	8677
6	1	57.7	19			153995
7	1	59.5	19			299238
8	2	80	19	1369		443177
9	2	82	19	1197		587671
10	2	82.8	19	1005		135674
11	3	88	19	1928	1101	279928
12	3	93.2	19	1907	1223	424279
13	2	70.4	19	1360		570132
14	3	95.3	19	1955	1775	117439
15	2	81.9	19	1545		262502
16	3	98.5	19	1169	1062	406573
17	1	65	19			553328
18	3	85.4	19	1637	1425	99799
19	3	91.6	19	1445	1325	244095
20	2	67.3	19	1218		390012

**DFS Radar Parameters**  
**FCC Radar Type 5**  
**Channel 106 Bandwidth 80MHz**

Trial Number:			5			Detection (Yes/No)
Number of Bursts in Trial:			17			
Chirp Center Frequency:			5530			Yes
Burst	Number of Pulses	Pulse Width (Microseconds )	Chirp Width (MHz)	Pulse 1-to-2 Spacing ( $\mu$ sec)	Pulse 2-to-3 Spacing ( $\mu$ sec)	Starting Location Within Interval ( $\mu$ sec)
1	2	67.9	16	1133		629614
2	1	62.3	16			96856
3	1	53.3	16			267719
4	3	90	16	1153	1346	436784
5	2	77.1	16	1646		608289
6	3	83.9	16	1232	1459	75610
7	3	89.1	16	1384	1939	245638
8	2	81.8	16	1676		416355
9	1	50.3	16			588736
10	3	87.1	16	1996	1756	54571
11	2	71.3	16	1815		225175
12	3	97.5	16	1465	1132	394825
13	3	90.6	16	1040	1354	565361
14	3	86.3	16	1183	1792	33643
15	3	97.6	16	1073	1361	203957
16	3	84.7	16	1718	1854	373812
17	3	99.7	16	1244	1988	544060
18						
19						
20						

Trial Number:			6			Detection (Yes/No)
Number of Bursts in Trial:			14			
Chirp Center Frequency:			5530			Yes
Burst	Number of Pulses	Pulse Width (Microseconds )	Chirp Width (MHz)	Pulse 1-to-2 Spacing ( $\mu$ sec)	Pulse 2-to-3 Spacing ( $\mu$ sec)	Starting Location Within Interval ( $\mu$ sec)
1	3	92.9	12	1564	1407	15438
2	2	67.7	12	1747		222486
3	1	65.8	12			430731
4	1	56.3	12			637784
5	1	53.7	12			845342
6	3	83.5	12	1930	1025	196720
7	1	65.8	12			404955
8	3	85.9	12	1034	1808	610711
9	2	76.3	12	1926		818057
10	2	81.5	12	1714		171459
11	3	89.4	12	1594	1827	377969
12	1	63.4	12			586875
13	2	69.6	12	1925		792834
14	2	74.5	12	1846		146044
15						
16						
17						
18						
19						
20						

**DFS Radar Parameters**  
**FCC Radar Type 5**  
**Channel 106 Bandwidth 80MHz**

Trial Number:			7			Detection (Yes/No)
Number of Bursts in Trial:			15			
Chirp Center Frequency:			5530			
Burst	Number of Pulses	Pulse Width (Microseconds)	Chirp Width (MHz)	Pulse 1-to-2 Spacing (µsec)	Pulse 2-to-3 Spacing (µsec)	Starting Location Within Interval (µsec)
1	1	52.6	10			51446
2	3	84.1	10	1725	1529	292696
3	3	97.7	10	1868	1805	533989
4	3	97.3	10	1446	1755	775564
5	3	98.8	10	1386	1302	21542
6	2	72.2	10	1184		263385
7	2	67.6	10	1027		505581
8	2	75.7	10	1871		747058
9	1	60.9	10			989976
10	1	64.2	10			234024
11	2	78.8	10	1604		475207
12	3	87.5	10	1712	1683	715825
13						
14						
15						
16						
17						
18						
19						
20						

Trial Number:			8			Detection (Yes/No)
Number of Bursts in Trial:			12			
Chirp Center Frequency:			5530			
Burst	Number of Pulses	Pulse Width (Microseconds)	Chirp Width (MHz)	Pulse 1-to-2 Spacing (µsec)	Pulse 2-to-3 Spacing (µsec)	Starting Location Within Interval (µsec)
1	1	52.6	10			51446
2	3	84.1	10	1725	1529	292696
3	3	97.7	10	1868	1805	533989
4	3	97.3	10	1446	1755	775564
5	3	98.8	10	1386	1302	21542
6	2	72.2	10	1184		263385
7	2	67.6	10	1027		505581
8	2	75.7	10	1871		747058
9	1	60.9	10			989976
10	1	64.2	10			234024
11	2	78.8	10	1604		475207
12	3	87.5	10	1712	1683	715825
13						
14						
15						
16						
17						
18						
19						
20						



**DFS Radar Parameters**  
**FCC Radar Type 5**  
**Channel 106 Bandwidth 80MHz**

Trial Number:			9			Detection (Yes/No)
Number of Bursts in Trial:			14			
Chirp Center Frequency:			5530			
Burst	Number of Pulses	Pulse Width (Microseconds)	Chirp Width (MHz)	Pulse 1-to-2 Spacing (µsec)	Pulse 2-to-3 Spacing (µsec)	Starting Location Within Interval (µsec)
1	1	54.1	13			823112
2	1	50.7	13			174965
3	1	52.3	13			382216
4	3	99.8	13	1696	1949	587395
5	2	68.4	13	1099		796897
6	2	80.8	13	1505		149042
7	1	62.5	13			356750
8	2	74.8	13	1204		563824
9	1	50.8	13			772314
10	1	54	13			123796
11	1	63	13			331215
12	3	91.8	13	1270	1347	537402
13	2	79.3	13	1992		744805
14	1	64.3	13			98172
15						
16						
17						
18						
19						
20						

Trial Number:			10			Detection (Yes/No)
Number of Bursts in Trial:			8			
Chirp Center Frequency:			5530			
Burst	Number of Pulses	Pulse Width (Microseconds)	Chirp Width (MHz)	Pulse 1-to-2 Spacing (µsec)	Pulse 2-to-3 Spacing (µsec)	Starting Location Within Interval (µsec)
1	1	63.4	6			535615
2	1	52	6			898668
3	3	97.2	6	1605	1583	1259235
4	2	78.7	6	1743		127106
5	2	74.2	6	1219		490358
6	3	88.7	6	1934	1273	852409
7	1	54.3	6			1217152
8	3	95.4	6	1555	1791	82296
9						
10						
11						
12						
13						
14						
15						
16						
17						
18						
19						
20						

**DFS Radar Parameters**  
**FCC Radar Type 5**  
**Channel 106 Bandwidth 80MHz**

Trial Number:			11			Detection (Yes/No)
Number of Bursts in Trial:			17			
Chirp Center Frequency:			5498.806			
Burst	Number of Pulses	Pulse Width (Microseconds)	Chirp Width (MHz)	Pulse 1-to-2 Spacing (µsec)	Pulse 2-to-3 Spacing (µsec)	Starting Location Within Interval (µsec)
1	2	73.7	16	1497		209249
2	3	97.4	16	1754	1613	378386
3	3	91.7	16	1702	1462	548411
4	1	66.2	16			17733
5	2	70.8	16	1821		187952
6	1	52.3	16			359277
7	2	78.9	16	1984		528886
8	2	70.9	16	1358		700166
9	2	75.6	16	1430		167197
10	1	59.1	16			338262
11	2	77	16	1304		508324
12	2	67.9	16	1083		678689
13	2	81.2	16	1932		146031
14	2	78.7	16	1121		316923
15	1	63.3	16			488056
16	2	68.9	16	1423		657326
17	1	59.3	16			125509
18						
19						
20						

Trial Number:			12			Detection (Yes/No)
Number of Bursts in Trial:			19			
Chirp Center Frequency:			5500.006			
Burst	Number of Pulses	Pulse Width (Microseconds)	Chirp Width (MHz)	Pulse 1-to-2 Spacing (µsec)	Pulse 2-to-3 Spacing (µsec)	Starting Location Within Interval (µsec)
1	3	98.9	19	1680	1488	263736
2	2	82.3	19	1855		416459
3	3	86.7	19	1400	1919	567902
4	3	89.7	19	1068	1282	92979
5	3	98.6	19	1194	1461	245155
6	2	71.1	19	1789		397609
7	1	55.9	19			551431
8	2	67.9	19	1372		74413
9	3	84.4	19	1107	1443	226559
10	1	58.8	19			380056
11	1	65.6	19			533408
12	2	78.5	19	1704		55547
13	2	82.3	19	1686		207876
14	3	90.1	19	1071	1266	359771
15	3	90.2	19	1089	1950	511297
16	2	83.1	19	1406		36803
17	1	58.8	19			189652
18	2	77	19	1657		341809
19	1	55	19			495737
20						

**DFS Radar Parameters**  
**FCC Radar Type 5**  
**Channel 106 Bandwidth 80MHz**

Trial Number:			13			Detection (Yes/No)
Number of Bursts in Trial:			15			
Chirp Center Frequency:			5497.606			
Burst	Number of Pulses	Pulse Width (Microseconds )	Chirp Width (MHz)	Pulse 1-to-2 Spacing (µsec)	Pulse 2-to-3 Spacing (µsec)	Starting Location Within Interval (µsec)
1	1	58.1	13			22911
2	1	52.1	13			216473
3	1	59.9	13			410004
4	1	60.2	13			603671
5	3	95.9	13	1906	1608	794160
6	2	79.9	13	1859		192251
7	2	78.5	13	1917		385590
8	1	53.8	13			579862
9	1	64.7	13			773423
10	1	61.4	13			168898
11	2	83.2	13	1858		361606
12	3	84.7	13	1677	1638	553866
13	3	88.7	13	1528	1058	747241
14	2	78.3	13	1951		144710
15	2	69.3	13	1717		337856
16						
17						
18						
19						
20						

Trial Number:			14			Detection (Yes/No)
Number of Bursts in Trial:			12			
Chirp Center Frequency:			5496.406			
Burst	Number of Pulses	Pulse Width (Microseconds )	Chirp Width (MHz)	Pulse 1-to-2 Spacing (µsec)	Pulse 2-to-3 Spacing (µsec)	Starting Location Within Interval (µsec)
1	2	75.3	10	1612		664275
2	1	56.3	10			907886
3	2	67.7	10	1185		151316
4	1	55.6	10			393746
5	2	75.2	10	1267		635093
6	2	76.3	10	1305		876993
7	3	85.7	10	1362	1924	121278
8	3	98.4	10	1550	1249	362696
9	3	86.4	10	1439	1046	604342
10	3	93.6	10	1031	1452	846453
11	1	63.3	10			91871
12	3	92.4	10	1673	1322	333050
13						
14						
15						
16						
17						
18						
19						
20						

**DFS Radar Parameters**  
**FCC Radar Type 5**  
**Channel 106 Bandwidth 80MHz**

Trial Number:			15			Detection (Yes/No)
Number of Bursts in Trial:			19			
Chirp Center Frequency:			5499.606			
Burst	Number of Pulses	Pulse Width (Microseconds)	Chirp Width (MHz)	Pulse 1-to-2 Spacing (µsec)	Pulse 2-to-3 Spacing (µsec)	Starting Location Within Interval (µsec)
1	3	93.3	18	1912	1535	361323
2	2	69.1	18	1794		515261
3	3	86.9	18	1152	1148	39025
4	3	84.9	18	1948	1118	190900
5	2	72.3	18	1916		343941
6	1	51.7	18			497624
7	1	58.3	18			20319
8	1	60.8	18			172999
9	1	57.1	18			325872
10	3	88.9	18	1964	1489	475841
11	2	72	18	1297		1489
12	3	90.9	18	1566	1370	153647
13	1	59.8	18			307096
14	2	70	18	1291		458804
15	2	67.2	18	1881		610798
16	3	91.2	18	1832	1661	134759
17	1	56.5	18			288306
18	1	51.2	18			441296
19	2	74.1	18	1245		592780
20						

Trial Number:			16			Detection (Yes/No)
Number of Bursts in Trial:			14			
Chirp Center Frequency:			5497.206			
Burst	Number of Pulses	Pulse Width (Microseconds)	Chirp Width (MHz)	Pulse 1-to-2 Spacing (µsec)	Pulse 2-to-3 Spacing (µsec)	Starting Location Within Interval (µsec)
1	2	76.9	12	1140		158286
2	1	50.2	12			366024
3	1	62.9	12			573452
4	1	64.7	12			780619
5	3	83.8	12	1097	1621	132455
6	1	65.4	12			340207
7	1	53.2	12			548208
8	1	51.7	12			755333
9	2	78.7	12	1168		107117
10	2	72.4	12	1343		314500
11	1	53.8	12			522447
12	2	73.6	12	1553		728517
13	2	66.7	12	1122		81611
14	2	82.5	12	1019		288948
15						
16						
17						
18						
19						
20						

**DFS Radar Parameters**  
**FCC Radar Type 5**  
**Channel 106 Bandwidth 80MHz**

Trial Number:			17			Detection (Yes/No)
Number of Bursts in Trial:			20			
Chirp Center Frequency:			5500.406			
Burst	Number of Pulses	Pulse Width (Microseconds)	Chirp Width (MHz)	Pulse 1-to-2 Spacing (µsec)	Pulse 2-to-3 Spacing (µsec)	Starting Location Within Interval (µsec)
1	3	87.6	20	1055	1840	345766
2	3	85.2	20	1541	1408	490019
3	3	84.8	20	1889	1463	39073
4	2	77.9	20	1460		183923
5	2	76.5	20	1485		328777
6	1	60.9	20			474728
7	2	83	20	1010		21394
8	2	80.4	20	1752		165992
9	2	67.5	20	1181		310973
10	1	62.1	20			456884
11	3	86.4	20	1966	1263	3515
12	3	84.3	20	1188	1788	147928
13	2	76.9	20	1537		293225
14	3	95.8	20	1298	1844	436922
15	1	55.2	20			584015
16	1	59	20			130832
17	3	94.5	20	1700	1283	274684
18	3	91.9	20	1978	1165	418579
19	3	85.2	20	1551	1189	563464
20	2	69.5	20	1224		112787

Trial Number:			18			Detection (Yes/No)
Number of Bursts in Trial:			12			
Chirp Center Frequency:			5496.406			
Burst	Number of Pulses	Pulse Width (Microseconds)	Chirp Width (MHz)	Pulse 1-to-2 Spacing (µsec)	Pulse 2-to-3 Spacing (µsec)	Starting Location Within Interval (µsec)
1	3	86.4	10	1918	1455	429224
2	3	92.2	10	1719	1895	670241
3	2	80.4	10	1899		912880
4	1	54.3	10			158603
5	1	53.1	10			400824
6	2	69.4	10	1546		641915
7	2	69.1	10	1639		883823
8	3	100	10	1438	1595	128373
9	2	79.6	10	1705		370379
10	3	88.4	10	1579	1623	611194
11	1	53.3	10			855665
12	1	65.3	10			98897
13						
14						
15						
16						
17						
18						
19						
20						

**DFS Radar Parameters**  
**FCC Radar Type 5**  
**Channel 106 Bandwidth 80MHz**

Trial Number:			19			Detection (Yes/No)
Number of Bursts in Trial:			14			
Chirp Center Frequency:			5497.206			
Burst	Number of Pulses	Pulse Width (Microseconds)	Chirp Width (MHz)	Pulse 1-to-2 Spacing (usec)	Pulse 2-to-3 Spacing (usec)	Starting Location Within Interval (usec)
1	1	55.3	12			292143
2	1	58.3	12			499633
3	2	72.3	12	1039.000		706377
4	3	84.8	12	1761.000	1721.000	58989
5	2	82.5	12	1431.000		266161
6	1	63.3	12			474469
7	2	80	12	1913.000		680544
8	3	90.3	12	1853.000	1123.000	33519
9	3	91.1	12	1783.000	1172.000	240319
10	3	96.6	12	1036.000	1385.000	447400
11	2	82.7	12	1990.000		654516
12	1	50.7	12			8083
13	2	78.4	12	1109.000		215435
14	3	99.5	12	1965.000	1869.000	421325
15						
16						
17						
18						
19						
20						

Trial Number:			20			Detection (Yes/No)
Number of Bursts in Trial:			12			
Chirp Center Frequency:			5496.406			
Burst	Number of Pulses	Pulse Width (Microseconds)	Chirp Width (MHz)	Pulse 1-to-2 Spacing (usec)	Pulse 2-to-3 Spacing (usec)	Starting Location Within Interval (usec)
1	3	88.6	10	1067	1927	733725
2	1	57.4	10			977882
3	3	96.6	10	1658	1324	221197
4	2	69.7	10	1945		462915
5	2	77.9	10	1317		705071
6	1	62	10			947923
7	3	88.4	10	1077	1366	191373
8	3	97.3	10	1896	1367	432561
9	3	96.2	10	1787	1672	674004
10	3	95.4	10	1892	1414	915842
11	1	54.8	10			162176
12	2	80.4	10	1436		403553
13						
14						
15						
16						
17						
18						
19						
20						

**DFS Radar Parameters**  
**FCC Radar Type 5**  
**Channel 106 Bandwidth 80MHz**

Trial Number:			21			Detection (Yes/No)
Number of Bursts in Trial:			16			
Chirp Center Frequency:			5561.594			
Burst	Number of Pulses	Pulse Width (Microseconds)	Chirp Width (MHz)	Pulse 1-to-2 Spacing ( $\mu$ sec)	Pulse 2-to-3 Spacing ( $\mu$ sec)	Starting Location Within Interval ( $\mu$ sec)
1	2	74.7	15	1611		483470
2	1	57.1	15			666072
3	3	91.9	15	1475	1276	98810
4	2	83.1	15	1772		279914
5	1	50.7	15			462536
6	2	79.2	15	1600		642324
7	1	58.7	15			76831
8	2	71	15	1567		257785
9	2	79	15	1960		438554
10	2	68.5	15	1428		620397
11	2	73.5	15	1352		54310
12	2	70.5	15	1115		235506
13	2	76.6	15	1300		417036
14	2	81.2	15	1675		597974
15	1	61.8	15			32086
16	3	94.9	15	1206	1860	212751
17						
18						
19						
20						

Trial Number:			22			Detection (Yes/No)
Number of Bursts in Trial:			12			
Chirp Center Frequency:			5563.994			
Burst	Number of Pulses	Pulse Width (Microseconds)	Chirp Width (MHz)	Pulse 1-to-2 Spacing ( $\mu$ sec)	Pulse 2-to-3 Spacing ( $\mu$ sec)	Starting Location Within Interval ( $\mu$ sec)
1	2	78.5	9	1698		526149
2	3	89.8	9	1962	1167	767135
3	1	59.4	9			12955
4	2	79.6	9	1890		254612
5	2	76	9	1811		496588
6	1	53.6	9			739728
7	2	80.9	9	1053		980872
8	1	61.6	9			225249
9	1	53.4	9			467279
10	1	59.9	9			709720
11	1	60.4	9			951847
12	3	91.4	9	1726	1227	194839
13						
14						
15						
16						
17						
18						
19						
20						

**DFS Radar Parameters**  
**FCC Radar Type 5**  
**Channel 106 Bandwidth 80MHz**

Trial Number:			23			Detection (Yes/No)
Number of Bursts in Trial:			20			
Chirp Center Frequency:			5559.594			
Burst	Number of Pulses	Pulse Width (Microseconds)	Chirp Width (MHz)	Pulse 1-to-2 Spacing (µsec)	Pulse 2-to-3 Spacing (µsec)	Starting Location Within Interval (µsec)
1	2	77	20	1363		261858
2	1	58.1	20			407646
3	1	62.1	20			552319
4	2	76.9	20	1236		99107
5	2	80	20	1852		243514
6	1	52	20			389464
7	3	88.6	20	1995	1905	531093
8	2	72.9	20	1387		81159
9	3	98.5	20	1746	1389	225245
10	1	57.9	20			371906
11	3	95.9	20	1870	1066	514197
12	1	53.5	20			63561
13	3	92	20	1654	1458	207510
14	1	57.3	20			353638
15	2	70.5	20	1586		497515
16	2	70	20	1664		45553
17	3	84	20	1630	1176	189821
18	2	76.1	20	1057		335330
19	3	93.2	20	1018	1340	478825
20	3	96.8	20	1614	1817	27594

Trial Number:			24			Detection (Yes/No)
Number of Bursts in Trial:			14			
Chirp Center Frequency:			5562.794			
Burst	Number of Pulses	Pulse Width (Microseconds)	Chirp Width (MHz)	Pulse 1-to-2 Spacing (µsec)	Pulse 2-to-3 Spacing (µsec)	Starting Location Within Interval (µsec)
1	1	50.1	12			247117
2	3	93.5	12	1081	1413	453362
3	2	68.8	12	1577		660875
4	1	56.3	12			14140
5	3	86	12	1108	1987	220734
6	2	75.2	12	1536		428367
7	1	54.4	12			636681
8	2	71.1	12	1243		843157
9	2	76.2	12	1770		195585
10	2	80.2	12	1209		403231
11	2	79.7	12	1214		610202
12	3	90.9	12	1862	1601	815229
13	2	68.7	12	1441		170267
14	2	67.4	12	1313		377306
15						
16						
17						
18						
19						
20						



**DFS Radar Parameters**  
**FCC Radar Type 5**  
**Channel 106 Bandwidth 80MHz**

Trial Number:			25			Detection (Yes/No)
Number of Bursts in Trial:			13			
Chirp Center Frequency:			5563.194			
Burst	Number of Pulses	Pulse Width (Microseconds)	Chirp Width (MHz)	Pulse 1-to-2 Spacing (µsec)	Pulse 2-to-3 Spacing (µsec)	Starting Location Within Interval (µsec)
1	3	94	11	1748	1941	628071
2	2	70.8	11	1201		853391
3	1	56.3	11			156223
4	3	96.7	11	1163	1332	378734
5	3	90.6	11	1582	1498	601331
6	2	74.5	11	1281		825462
7	3	92.6	11	1669	1222	128265
8	3	89	11	1135	1380	351161
9	3	96.5	11	1822	1602	573425
10	2	70.5	11	1178		798431
11	3	94	11	1629	1956	100737
12	1	55.8	11			324661
13	3	87.7	11	1963	1164	546278
14						
15						
16						
17						
18						
19						
20						

Trial Number:			26			Detection (Yes/No)
Number of Bursts in Trial:			8			
Chirp Center Frequency:			5565.594			
Burst	Number of Pulses	Pulse Width (Microseconds)	Chirp Width (MHz)	Pulse 1-to-2 Spacing (µsec)	Pulse 2-to-3 Spacing (µsec)	Starting Location Within Interval (µsec)
1	2	68.6	5	1161		1253842
2	2	83.1	5	1315		119486
3	1	60.9	5			482958
4	2	77.7	5	1158		845641
5	2	77.4	5	1510		1208428
6	2	66.8	5	1323		74748
7	1	63.7	5			438300
8	3	91.2	5	1681	1275	800152
9						
10						
11						
12						
13						
14						
15						
16						
17						
18						
19						
20						

**DFS Radar Parameters**  
**FCC Radar Type 5**  
**Channel 106 Bandwidth 80MHz**

Trial Number:			27			Detection (Yes/No)
Number of Bursts in Trial:			17			
Chirp Center Frequency:			5561.194			
Burst	Number of Pulses	Pulse Width (Microseconds)	Chirp Width (MHz)	Pulse 1-to-2 Spacing (µsec)	Pulse 2-to-3 Spacing (µsec)	Starting Location Within Interval (µsec)
1	3	83.6	16	1195	1000	545865
2	3	89.4	16	1627	1656	14067
3	1	55.8	16			184953
4	3	90.9	16	1554	1998	353759
5	1	54.7	16			526388
6	3	97.7	16	1202	1250	694806
7	2	67.5	16	1434		163568
8	3	96.7	16	1469	1268	333410
9	2	68.3	16	1954		504006
10	2	78.3	16	1082		675297
11	1	55	16			142890
12	3	84.9	16	1936	1199	312479
13	2	74.6	16	1856		482953
14	1	63.3	16			655022
15	3	99.8	16	1515	1120	121457
16	1	63.6	16			292606
17	3	87.3	16	1051	1831	461322
18						
19						
20						

Trial Number:			28			Detection (Yes/No)
Number of Bursts in Trial:			19			
Chirp Center Frequency:			5559.994			
Burst	Number of Pulses	Pulse Width (Microseconds)	Chirp Width (MHz)	Pulse 1-to-2 Spacing (µsec)	Pulse 2-to-3 Spacing (µsec)	Starting Location Within Interval (µsec)
1	3	85.6	19	1078	1015	565136
2	2	68.6	19	1780		89970
3	1	54.2	19			243121
4	1	61.2	19			396034
5	3	97.1	19	1969	1100	546225
6	3	98.3	19	1699	1622	70998
7	1	62.4	19			224093
8	2	80.2	19	1769		376127
9	3	87.5	19	1448	1179	527806
10	3	85.8	19	1348	1472	52247
11	3	88.1	19	1124	1631	204582
12	1	65.3	19			357941
13	1	52.5	19			510977
14	1	52.3	19			33698
15	2	74.1	19	1200		186023
16	1	54.9	19			339327
17	2	76.2	19	1502		491053
18	1	60.4	19			14858
19	2	81.5	19	1103		167387
20						

**DFS Radar Parameters**  
**FCC Radar Type 5**  
**Channel 106 Bandwidth 80MHz**

Trial Number:			29			Detection (Yes/No)
Number of Bursts in Trial:			12			
Chirp Center Frequency:			5563.594			Yes
Burst	Number of Pulses	Pulse Width (Microseconds)	Chirp Width (MHz)	Pulse 1-to-2 Spacing (usec)	Pulse 2-to-3 Spacing (usec)	Starting Location Within Interval (usec)
1	1	50.5	10			507709
2	1	55.7	10			750249
3	3	85.8	10	1002	1967	989003
4	2	76.9	10	1474		235634
5	2	75.1	10	1052		477675
6	3	92.3	10	1486	1492	718312
7	2	78.1	10	1757		960895
8	3	92.2	10	1252	1713	205370
9	3	89	10	1706	1411	446940
10	2	70.9	10	1620		689225
11	1	63.1	10			932305
12	1	55.3	10			176231
13						
14						
15						
16						
17						
18						
19						
20						

Trial Number:			30			Detection (Yes/No)
Number of Bursts in Trial:			18			
Chirp Center Frequency:			5560.794			Yes
Burst	Number of Pulses	Pulse Width (Microseconds)	Chirp Width (MHz)	Pulse 1-to-2 Spacing (usec)	Pulse 2-to-3 Spacing (usec)	Starting Location Within Interval (usec)
1	3	83.4	17	1205	1801	277485
2	3	97.3	17	1826	1635	437880
3	3	90.4	17	1986	1674	598445
4	3	91.8	17	1151	1802	97088
5	3	98.2	17	1977	1766	257251
6	1	59.5	17			419893
7	2	80	17	1137		580724
8	3	86.5	17	1128	1828	77366
9	3	91.1	17	1599	1442	238032
10	3	93.5	17	1373	1087	398605
11	1	60.7	17			562025
12	2	67.2	17	1405		57684
13	1	61.8	17			219083
14	2	79.4	17	1667		379234
15	2	81.4	17	1464		540896
16	1	65.7	17			37916
17	2	76	17	1255		198794
18	2	81	17	1668		359754
19						
20						

## Appendix B. Setup Photographs

Front View



EUT

