



# DYNAMIC FREQUENCY SELECTION

## DFS Test Report (Extender Mode)

APPLICANT : TP-LINK TECHNOLOGIES CO., LTD.  
EQUIPMENT : AC750 Wi-Fi Range Extender with Smart Plug  
BRAND NAME : TP-LINK  
MODEL NAME : RE270K  
FCC ID : TE7RE270K  
STANDARD : FCC Part 15 Subpart E  
CLASSIFICATION : (NII) Unlicensed National Information Infrastructure

The product was received on Sep. 10, 2016 and completely tested on Sep. 29, 2016. We, SPORTON INTERNATIONAL INC., would like to declare that the tested sample has been evaluated in accordance with the procedures and shown to be compliant with the applicable technical standards.

The test results in this report apply exclusively to the tested model / sample. Without written approval of SPORTON INTERNATIONAL INC., the test report shall not be reproduced except in full.

Reviewed by: Joseph Lin / Supervisor

Approved by: Jones Tsai / Manager



**SPORTON INTERNATIONAL INC.**

No. 52, Hwa Ya 1<sup>st</sup> Rd., Hwa Ya Technology Park, Kwei-Shan Hsiang, Tao Yuan Hsien, Taiwan, R.O.C.

SPORTON INTERNATIONAL INC.

TEL : 886-3-327-3456

FAX : 886-3-328-4978

FCC ID : TE7RE270K

Page Number : 1 of 55

Report Issued Date : Oct. 27, 2016

Report Version : Rev. 01



# TABLE OF CONTENTS

**REVISION HISTORY.....3**

**SUMMARY OF DYNAMIC FREQUENCY SELECTION TEST.....4**

**1 GENERAL DESCRIPTION .....5**

1.1 Applicant .....5

1.2 Manufacturer.....5

1.3 Feature of Equipment Under Test .....5

1.4 Product Specification of Equipment Under Test.....5

1.5 Testing Site .....6

1.6 Applied Standards .....6

1.7 Support Unit used in test configuration and system .....6

**2 REQUIREMENTS AND PARAMETERS FOR DFS TEST .....7**

2.1 Applicability of DFS Requirements .....7

2.2 DFS Detection Thresholds.....9

2.3 DFS Response requirement values.....10

2.4 Short Pulse Radar Test Waveforms .....11

2.5 Long Pulse Radar Test Waveform .....13

2.6 Frequency Hopping Radar Test Waveform .....15

**3 CALIBRATION SETUP AND DFS TEST RESULTS .....16**

3.1 Calibration of Radar Waveform .....16

3.2 U-NII Detection Bandwidth (7.8.1).....23

3.3 Channel Availability Check (7.8.2).....30

3.4 In-Service Monitoring: Channel Move Time, Channel Closing Transmission Time and Non-Occupancy Period (7.8.3) .....31

3.5 Statistical Performance Check (7.8.4) .....41

**4 LIST OF MEASURING EQUIPMENT .....55**

**APPENDIX A. RADAR PARAMETERS**

**APPENDIX B. SETUP PHOTOGRAPHS**



### REVISION HISTORY

REPORT NO.	VERSION	DESCRIPTION	ISSUED DATE
FZ691005B	Rev. 01	Initial issue of report	Oct. 27, 2016



## SUMMARY OF DYNAMIC FREQUENCY SELECTION TEST

UNII	Description	Limit	Result
U-NII Band 2-A 5250-5350MHz	Channel Availability Check Time	> 60sec	N.R.
	U-NII Detection Bandwidth	> 100% of the U-NII 99% transmission power bandwidth	Pass
	Statistical Performance Check	Type 1,2,3,4 >= 60% Type 1~4 and 5 >= 80% Type 6 >= 70%	Pass
	Channel Move Time	< 10 sec	Pass
	Channel Closing Transmission Time	< 200 ms + aggregate of 60 ms over remaining 10 s period	Pass
	Non-Occupancy Period Test	> 30 minutes	Pass
U-NII Band 2-C 5470-5725MHz	Channel Availability Check Time	> 60sec	N.R.
	U-NII Detection Bandwidth	> 100% of the U-NII 99% transmission power bandwidth	Pass
	Statistical Performance Check	Type 1,2,3,4 >= 60% Type 1~4 and 5 >= 80% Type 6 >= 70%	Pass
	Channel Move Time	< 10 sec	Pass
	Channel Closing Transmission Time	< 200 ms + aggregate of 60 ms over remaining 10 s period	Pass
	Non-Occupancy Period Test	> 30 minutes	Pass

N.R. : Not Required.



# 1 General Description

## 1.1 Applicant

**TP-LINK TECHNOLOGIES CO., LTD.**

Building 24 (floors 1,3,4,5) and 28 (floors1-4) Central Science and Technology Park, Shennan Rd, Nanshan, Shenzhen, China

## 1.2 Manufacturer

**TP-LINK TECHNOLOGIES CO., LTD.**

Building 24 (floors 1,3,4,5) and 28 (floors1-4) Central Science and Technology Park, Shennan Rd, Nanshan, Shenzhen, China

## 1.3 Feature of Equipment Under Test

Product Feature	
<b>Equipment</b>	AC750 Wi-Fi Range Extender with Smart Plug
<b>Brand Name</b>	TP-LINK
<b>Model Name</b>	RE270K
<b>FCC ID</b>	TE7RE270K
<b>EUT supports Radios application</b>	WLAN 11a/b/g/n HT20/40 WLAN 11ac VHT20/40/80
<b>EUT Stage</b>	Production Unit

**Remark:** The above EUT's information was declared by manufacturer. Please refer to the specifications or user's manual for more detailed description.

## 1.4 Product Specification of Equipment Under Test

Product Specification subjective to this standard	
<b>DFS Function</b>	Client with radar detection (Extender Mode)
<b>Tx/Rx Channel Frequency Range</b>	5260 MHz ~ 5320 MHz 5500 MHz ~ 5700 MHz
<b>EUT support WLAN function</b>	<5260 MHz ~ 5320 MHz> 802.11a 802.11n HT20/40 802.11ac VHT20/40/80 <5500 MHz ~ 5700 MHz > 802.11a 802.11n HT20/40 802.11ac VHT20/40/80
<b>Type of Modulation</b>	802.11a/n: OFDM (BPSK / QPSK / 16QAM / 64QAM) 802.11ac: OFDM (BPSK / QPSK / 16QAM / 64QAM / 256QAM)

## 1.5 Testing Site

<b>Test Site</b>	SPORTON INTERNATIONAL INC.
<b>Test Site Location</b>	No. 52, Hwa Ya 1 <sup>st</sup> Rd., Hwa Ya Technology Park, Kwei-Shan Hsiang, Tao Yuan Hsien, Taiwan, R.O.C. TEL: +886-3-3273456 / FAX: +886-3-3284978
<b>Test Site No.</b>	<b>Sporton Site No.</b>
	DFS02-HY

## 1.6 Applied Standards

According to the specifications of the manufacturer, the EUT must comply with the requirements of the following standards:

- ♦ FCC Part 15 Subpart E
- ♦ FCC KDB 905462 D02 UNII DFS Compliance Procedures New Rules v02
- ♦ FCC KDB 905462 D04 Operational Modes for DFS Testing New Rules v01

**Remark:** All test items were verified and recorded according to the standards and without any deviation during the test.

## 1.7 Support Unit used in test configuration and system

Item	Equipment	Trade Name	Model Name	FCC ID
1.	Notebook	Lenovo	Edge E335	PPD-AR5B95
2.	WLAN Dongle	Linksys	AE6000	Q87-AE6000
3.	WiFi AP	Cisco	Air-AP3702E-A-K9	LDK102087



## 2 Requirements and Parameters for DFS Test

### 2.1 Applicability of DFS Requirements

EUT is considered as a client with radar detection device.

**Table 1: Applicability of DFS Requirements Prior to Use of a Channel**

Requirement	Operational Mode		
	Master	Client Without Radar Detection	Client With Radar Detection
Non-Occupancy Period	Yes	Not required	Yes
DFS Detection Threshold	Yes	Not required	Yes
Channel Availability Check Time	Yes	Not required	Not required
U-NII Detection Bandwidth	Yes	Not required	Yes

**Table 2: Applicability of DFS requirements during normal operation**

Requirement	Operational Mode		
	Master	Client Without Radar Detection	Client With Radar Detection
DFS Detection Threshold	Yes	Not required	Yes
Channel Closing Transmission Time	Yes	Yes	Yes
Channel Move Time	Yes	Yes	Yes
U-NII Detection Bandwidth	Yes	Not required	Yes
Client Beacon Test	N/A	Yes	Yes



Additional requirements for devices with multiple bandwidth modes	Operational Mode	
	Master or Client With Radar Detection	Client Without Radar Detection
U-NII Detection Bandwidth and Statistical Performance Check	All BW modes must be tested	Not required
Channel Move Time and Channel Closing Transmission Time	Test using widest BW mode available	Test using the widest BW mode available for the link
All other tests	Any single BW mode	Not required

**Note**  
Frequencies selected for statistical performance check (Section 7.8.4) should include several frequencies within the radar detection bandwidth and frequencies near the edge of the radar detection bandwidth. For 802.11 devices it is suggested to select frequencies in each of the bonded 20 MHz channels and the channel center frequency.





## 2.2 DFS Detection Thresholds

Table 3 below provides the DFS Detection Thresholds for Master Devices as well as Client Devices incorporating In-Service Monitoring.

**Table 3: DFS Detection Thresholds for Master Devices**

Maximum Transmit Power	Value (see notes 1, 2, and 3)
EIRP ≥ 200 milliwatt	-64 dBm
EIRP < 200 milliwatt and power spectral density < 10 dBm/MHz	-62 dBm
EIRP < 200 milliwatt that do not meet the power spectral density requirement	-64 dBm
<p><b>Note 1:</b> This is the level at the input of the receiver assuming a 0 dBi receive antenna.</p> <p><b>Note 2:</b> Throughout these test procedures an additional 1 dB has been added to the amplitude of the test transmission waveforms to account for variations in measurement equipment. This will ensure that the test signal is at or above the detection threshold level to trigger a DFS response.</p> <p><b>Note 3:</b> EIRP is based on the highest antenna gain. For MIMO devices refer to KDB Publication 662911 D01.</p>	

The radar *Detection Threshold*, lowest antenna gain is the parameter of Interference *radar DFS detection threshold*, The Interference *Detection Threshold* is the  $(-62dBm) + (1.92) [dBi] + 1 dB = -59.08 dBm$ .



## 2.3 DFS Response requirement values

Table 4 provides the response requirements for Master and Client Devices incorporating DFS.

**Table 4: DFS Response Requirement Values**

Parameter	Value
<i>Non-occupancy period</i>	Minimum 30 minutes
<i>Channel Availability Check Time</i>	60 seconds
<i>Channel Move Time</i>	10 seconds See Note 1.
<i>Channel Closing Transmission Time</i>	200 milliseconds + an aggregate of 60 milliseconds over remaining 10 second period. See Notes 1 and 2.
<i>U-NII Detection Bandwidth</i>	Minimum 100% of the 99% power bandwidth See Note 3.

**Note 1:** *Channel Move Time* and the *Channel Closing Transmission Time* should be performed with Radar Type 0. The measurement timing begins at the end of the Radar Type 0 burst.

**Note 2:** The *Channel Closing Transmission Time* is comprised of 200 milliseconds starting at the beginning of the *Channel Move Time* plus any additional intermittent control signals required to facilitate *Channel* changes (an aggregate of 60 milliseconds) during the remainder of the 10 second period. The aggregate duration of control signals will not count quiet periods in between transmissions.

**Note 3:** During the *U-NII Detection Bandwidth* detection test, radar type 0 is used and for each frequency step the minimum percentage of detection is 90%. Measurements are performed with no data traffic.



## 2.4 Short Pulse Radar Test Waveforms

Radar Type 0 was used in the evaluation of the Client device for the purpose of measuring the Channel Move Time and the Channel Closing Transmission Time.

Radar Type	Pulse Width (μsec)	PRI (μsec)	Number of Pulses	Minimum Percentage of Successful Detection	Minimum Trials
0	1	1428	18	See Note 1.	See Note 1.
1	1	Test A Test B	Roundup $\left\{ \left( \frac{1}{360} \right) \cdot \left( \frac{19 \cdot 10^6}{PRI_{\mu sec}} \right) \right\}$	60%	30
2	1-5	150-230	23-29	60%	30
3	6-10	200-500	16-18	60%	30
4	11-20	200-500	12-16	60%	30
Aggregate (Radar Types 1-4)				80%	120
<b>Note 1:</b> Short Pulse Radar Type 0 should be used for the detection bandwidth test, channel move time, and channel closing time tests.					

Test A: 15 unique PRI values randomly selected from the list of 23 PRI values in Table 5a  
 Test B: 15 unique PRI values randomly selected within the range of 518-3066 μsec, with a minimum increment of 1 μsec, excluding PRI values selected in Test A

A minimum of 30 unique waveforms are required for each of the Short Pulse Radar Types 2 through 4. If more than 30 waveforms are used for Short Pulse Radar Types 2 through 4, then each additional waveform must also be unique and not repeated from the previous waveforms.

If more than 30 waveforms are used for Short Pulse Radar Type 1, then each additional waveform is generated with Test B and must also be unique and not repeated from the previous waveforms in Tests A or B.

The aggregate is the average of the percentage of successful detections of short pulse radar types 1-4.



Table 5a - Pulse Repetition Intervals Values for Test A

Pulse Repetition Frequency Number (1 to 23)	Pulse Repetition Frequency (Pulses Per Second)	Pulse Repetition Interval (Microseconds)
1	1930.5	518
2	1858.7	538
3	1792.1	558
4	1730.1	578
5	1672.2	598
6	1618.1	618
7	1567.4	638
8	1519.8	658
9	1474.9	678
10	1432.7	698
11	1392.8	718
12	1355.0	738
13	1319.3	758
14	1285.3	778
15	1253.1	798
16	1222.5	818
17	1193.3	838
18	1165.5	858
19	1139.0	878
20	1113.6	898
21	1089.3	918
22	1066.1	938
23	326.2	3066



## 2.5 Long Pulse Radar Test Waveform

Radar Type	Pulse Width (µsec)	Chirp Width (MHz)	PRI (µsec)	Number of Pulses per Burst	Number of Bursts	Minimum Percentage of Successful Detection	Minimum Trials
5	50-100	5-20	1000-2000	1-3	8-20	80%	30

The parameters for this waveform are randomly chosen. Thirty unique waveforms are required for the Long Pulse radar test signal. If more than 30 waveforms are used for the Long Pulse radar test signal, then each additional waveform must also be unique and not repeated from the previous waveforms. Each waveform is defined as follows:

Note: The center frequency for each of the 30 trials of the Bin 5 radar shall be randomly selected within 80% of the Occupied Bandwidth.

- (1) The transmission period for the Long Pulse Radar test signal is 12 seconds.
- (2) There are a total of 8 to 20 Bursts in the 12 second period, with the number of Bursts being randomly chosen. This number is Burst\_Count.
- (3) Each Burst consists of 1 to 3 pulses, with the number of pulses being randomly chosen. Each Burst within the 12 second sequence may have a different number of pulses.
- (4) The pulse width is between 50 and 100 microseconds, with the pulse width being randomly chosen. Each pulse within a Burst will have the same pulse width. Pulses in different Bursts may have different pulse widths.
- (5) Each pulse has a linear frequency modulated chirp between 5 and 20 MHz, with the chirp width being randomly chosen. Each pulse within a **transmission period** will have the same chirp width. The chirp is centered on the pulse. For example, with a radar frequency of 5300 MHz and a 20 MHz chirped signal, the chirp starts at 5290 MHz and ends at 5310 MHz
- (6) If more than one pulse is present in a Burst, the time between the pulses will be between 1000 and 2000 microseconds, with the time being randomly chosen. If three pulses are present in a Burst, the time between the first and second pulses is chosen independently of the time between the second and third pulses.
- (7) The 12 second transmission period is divided into even intervals. The number of intervals is equal to Burst\_Count. Each interval is of length  $(12,000,000 / \text{Burst\_Count})$  microseconds. Each interval contains one Burst. The start time for the Burst, relative to the beginning of the interval, is between 1 and  $[(12,000,000 / \text{Burst\_Count}) - (\text{Total Burst Length}) + (\text{One Random PRI Interval})]$  microseconds, with the start time being randomly chosen. The step interval for the start time is 1 microsecond. The start time for each Burst is chosen independently.

**A representative example of a Long Pulse radar test waveform:**

- (1) The total test signal length is 12 seconds.
- (2) 8 Bursts are randomly generated for the Burst\_Count.
- (3) Burst 1 has 2 randomly generated pulses.
- (4) The pulse width (for both pulses) is randomly selected to be 75 microseconds.
- (5) The PRI is randomly selected to be at 1213 microseconds.
- (6) Bursts 2 through 8 are generated using steps 3 – 5.
- (7) Each Burst is contained in even intervals of 1,500,000 microseconds. The starting location for Pulse 1, Burst 1 is randomly generated (1 to 1,500,000 minus the total Burst 1 length + 1 random PRI interval) at the 325,001 microsecond step. Bursts 2 through 8 randomly fall in successive 1,500,000 microsecond intervals (i.e. Burst 2 falls in the 1,500,001 – 3,000,000 microsecond range).

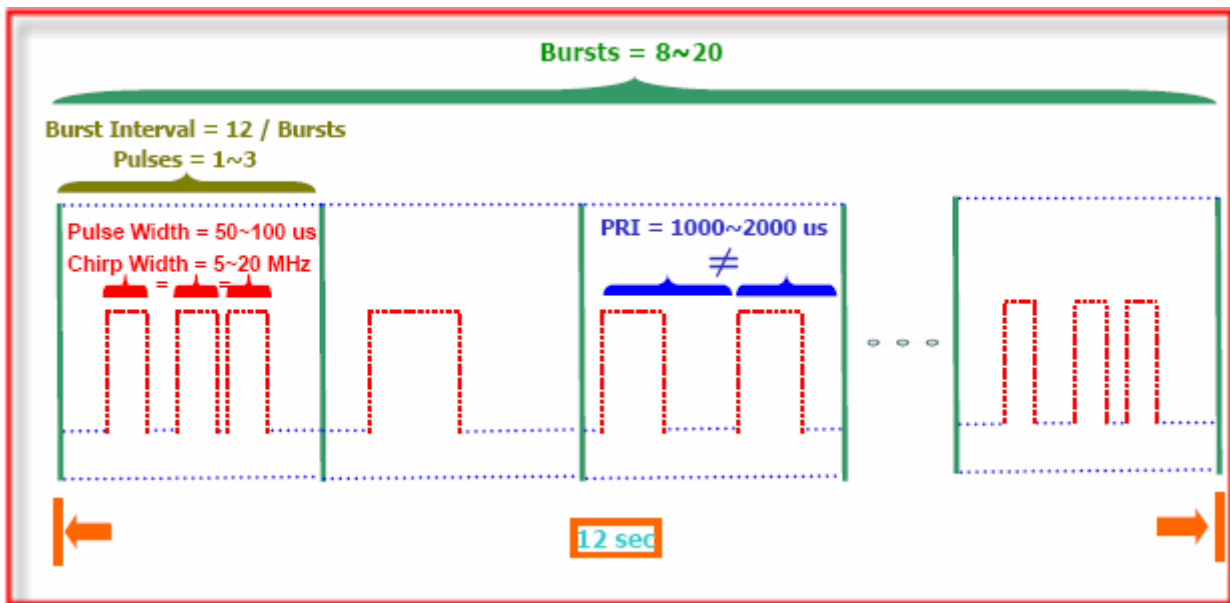

## 2.6 Frequency Hopping Radar Test Waveform

Radar Type	Pulse Width (μsec)	PRI (μsec)	Pulses per Hop	Hopping Rate (kHz)	Hopping Sequence Length (msec)	Minimum Percentage of Successful Detection	Minimum Trials
6	1	333	9	0.333	300	70%	30

For the Frequency Hopping Radar Type, the same Burst parameters are used for each waveform. The hopping sequence is different for each waveform and a 100-length segment is selected from the hopping sequence defined by the following algorithm:

The first frequency in a hopping sequence is selected randomly from the group of 475 integer frequencies from 5250 – 5724 MHz. Next, the frequency that was just chosen is removed from the group and a frequency is randomly selected from the remaining 474 frequencies in the group. This process continues until all 475 frequencies are chosen for the set. For selection of a random frequency, the frequencies remaining within the group are always treated as equally likely.

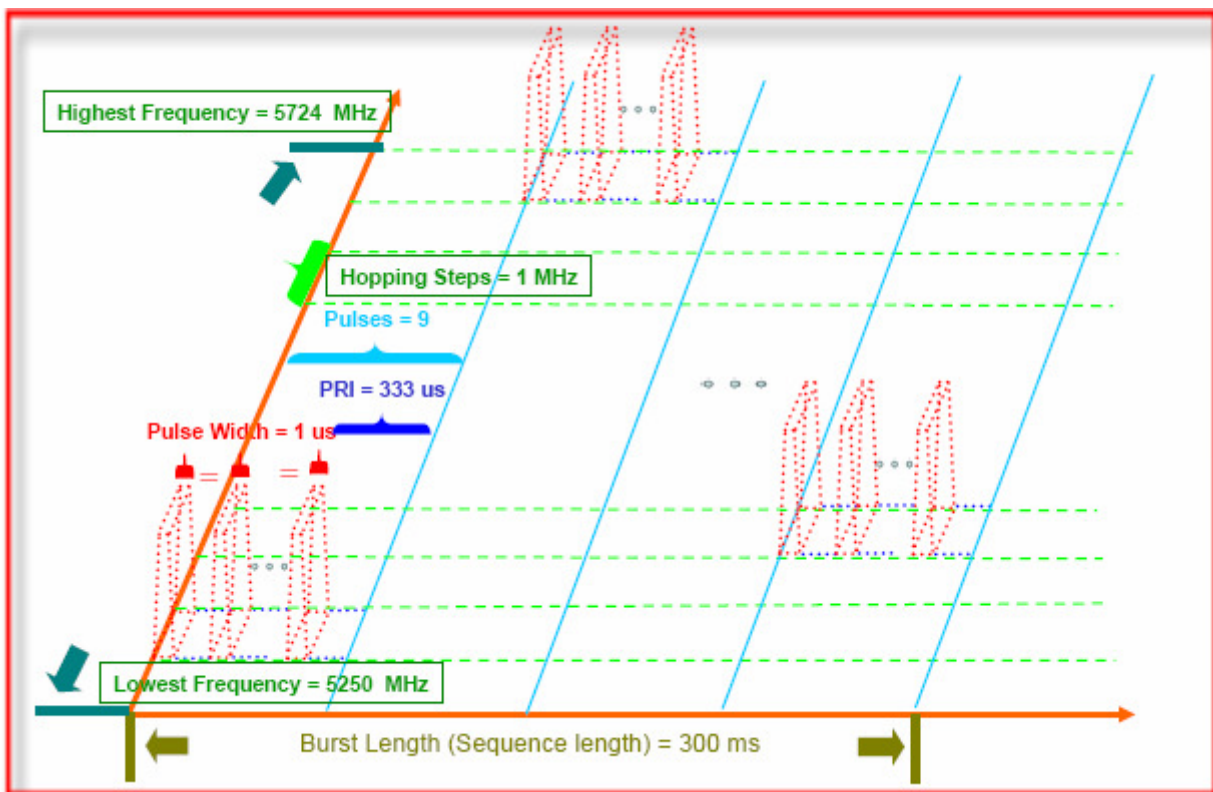

### 3 Calibration Setup and DFS Test Results

#### 3.1 Calibration of Radar Waveform

##### 3.1.1 Radar Waveform Calibration Procedure

The Interference Radar Detection Threshold Level is  $(-62) + (1.92) \text{ [dBi]} + 1 \text{ dB} = -59.08 \text{ dBm}$  that had been taken into account the output power range and antenna gain. The following equipment setup was used to calibrate the radiated Radar Waveform. A vector signal generator was utilized to establish the test signal level for radar type 0~6. During this process there were no transmissions by the Master, Extender or Client Device. The spectrum analyzer was switched to the zero span (Time Domain) at the frequency of the Radar Waveform generator. Peak detection was used. The spectrum analyzer resolution bandwidth (RBW) and video bandwidth (VBW) were set to 3 MHz to measure the radar waveform. The vector signal generator amplitude was set so that the power level measured at the spectrum analyzer was  $(-62) + (1.92) \text{ [dBi]} + 1 \text{ dB} = -59.08 \text{ dBm}$ . Capture the spectrum analyzer plots on radar waveform.

##### 3.1.2 Conducted Calibration Setup

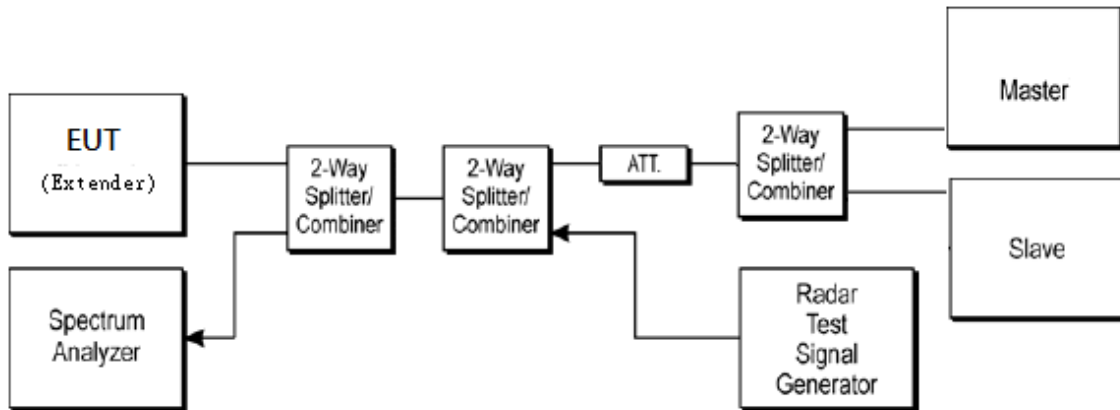

##### 3.1.3 Calibration Deviation

There is no deviation with the original standard.





### 3.1.4 Radar Waveform Calibration Result

<20MHz / 5300MHz>

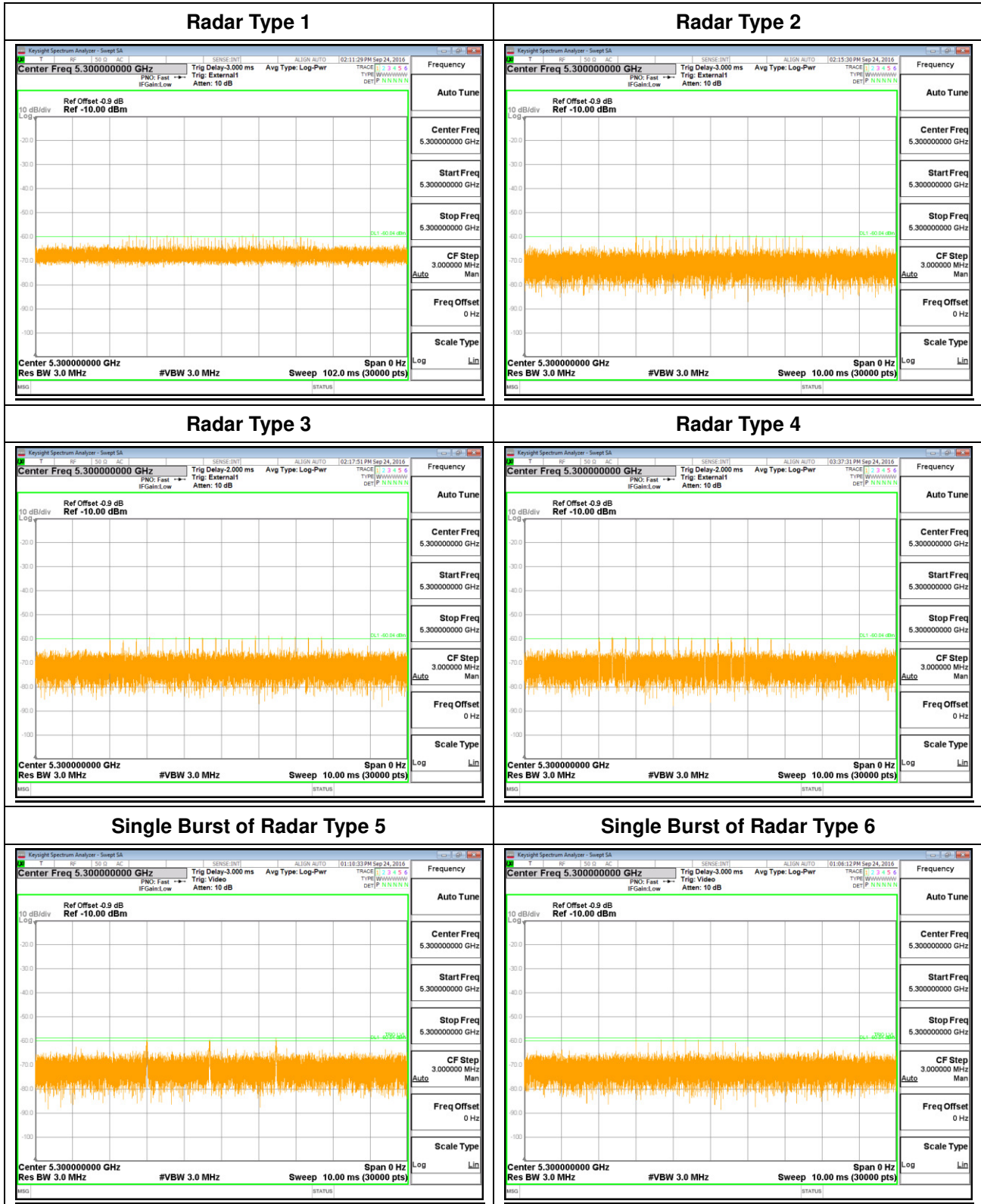



<40MHz / 5310MHz>

Radar Type 1

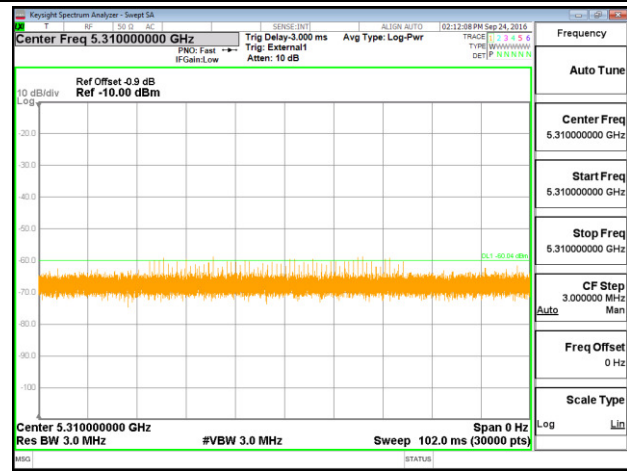

Radar Type 2

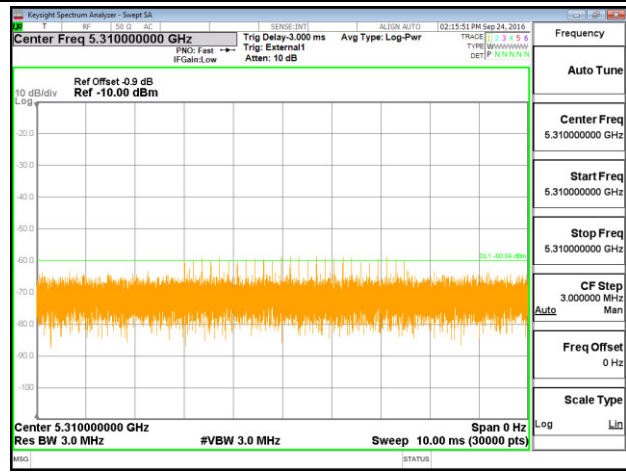

Radar Type 3

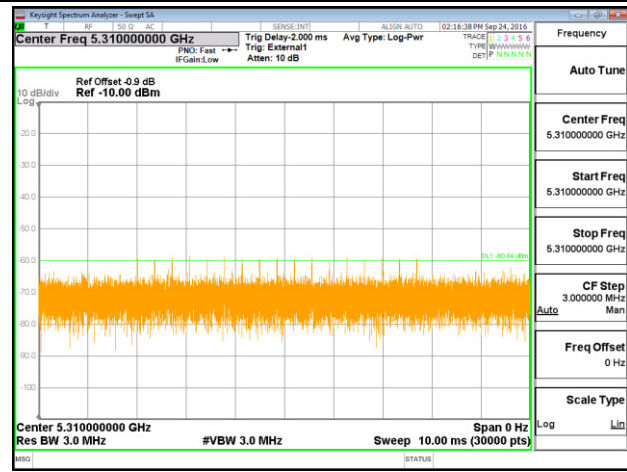

Radar Type 4

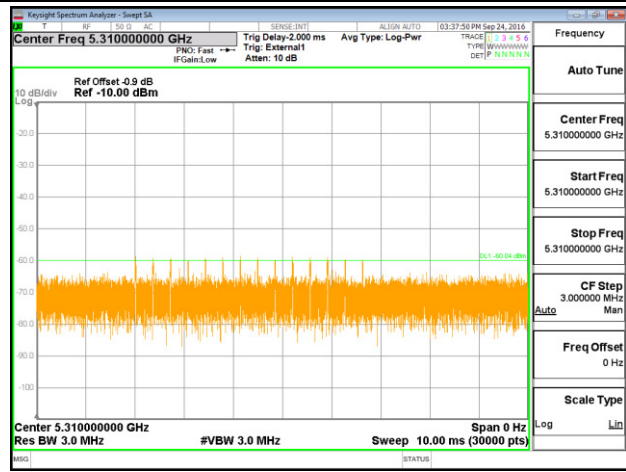

Single Burst of Radar Type 5

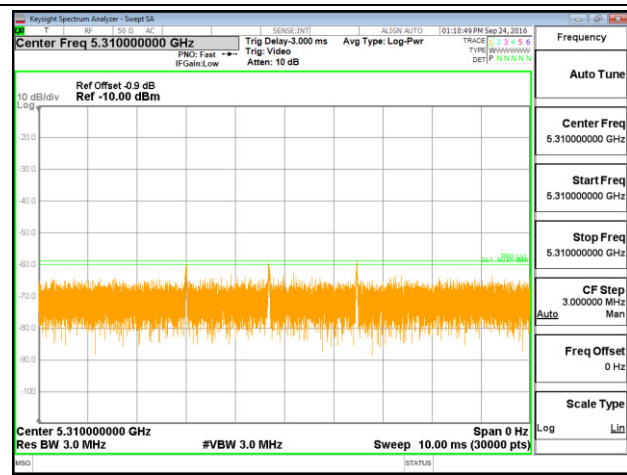

Single Burst of Radar Type 6

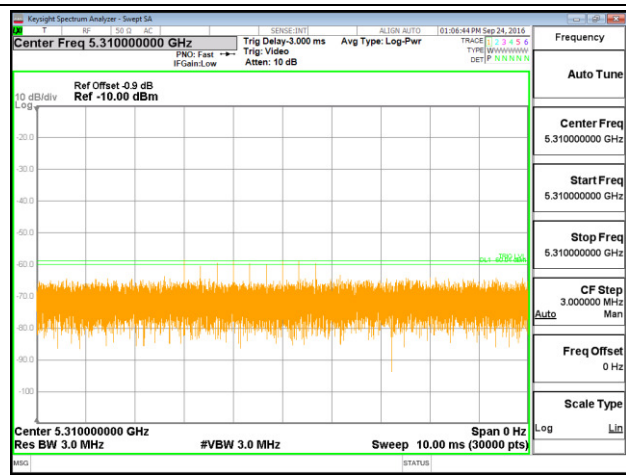



<80MHz / 5290MHz>

Radar Type 1

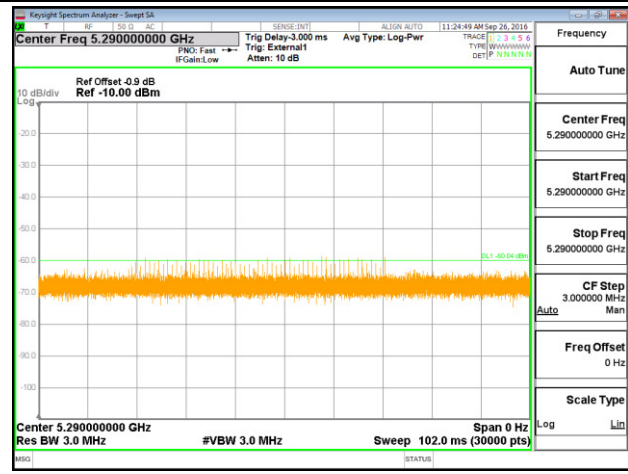

Radar Type 2

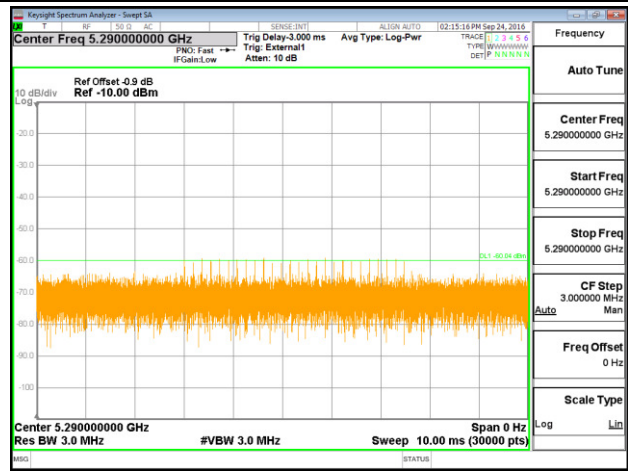

Radar Type 3

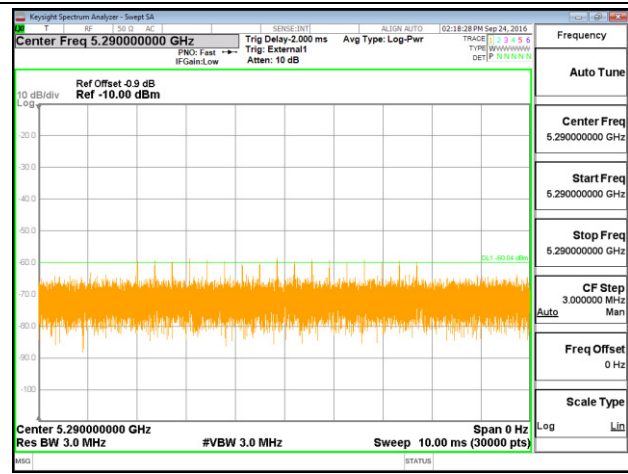

Radar Type 4

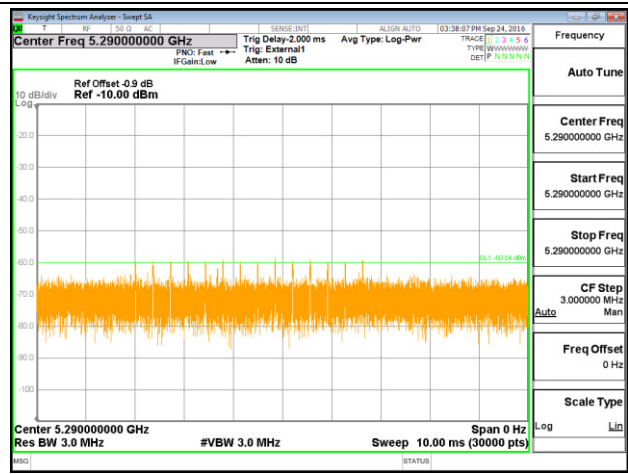

Single Burst of Radar Type 5

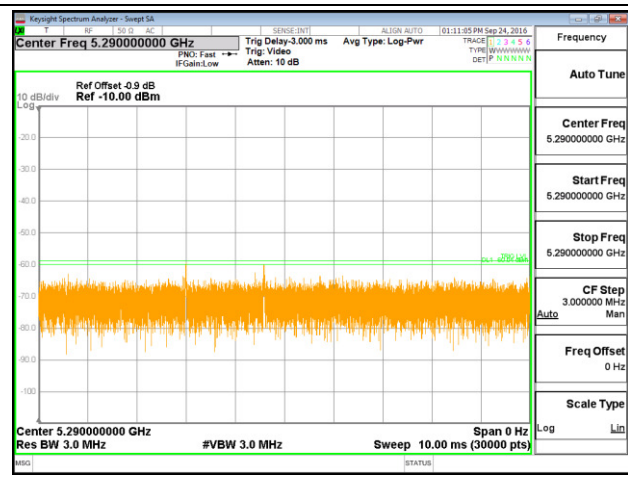

Single Burst of Radar Type 6

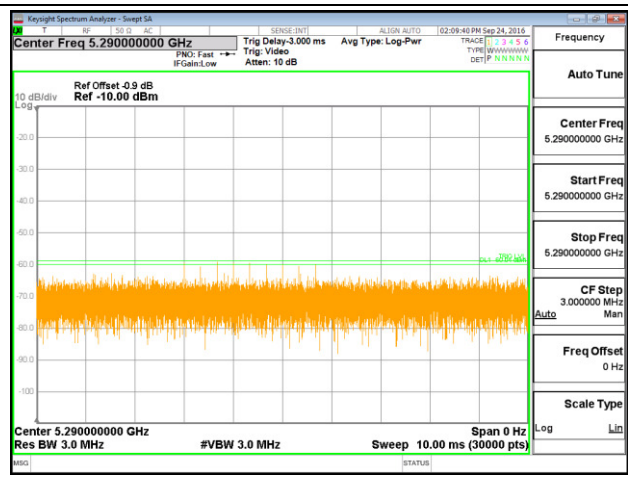



<20MHz / 5500MHz>

Radar Type 1

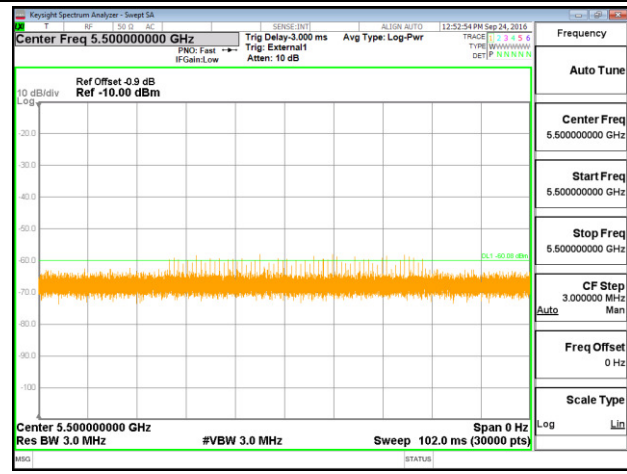

Radar Type 2

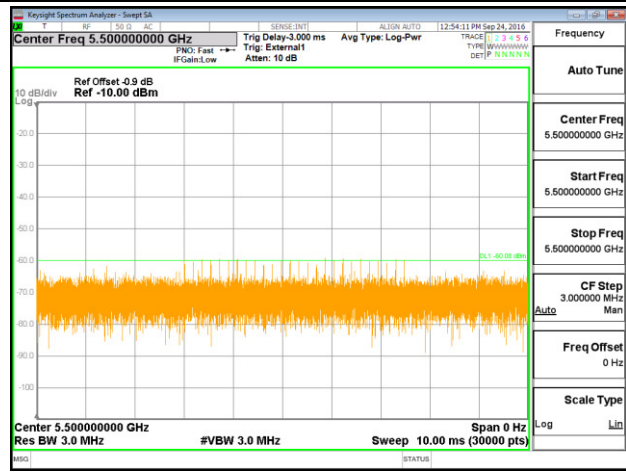

Radar Type 3

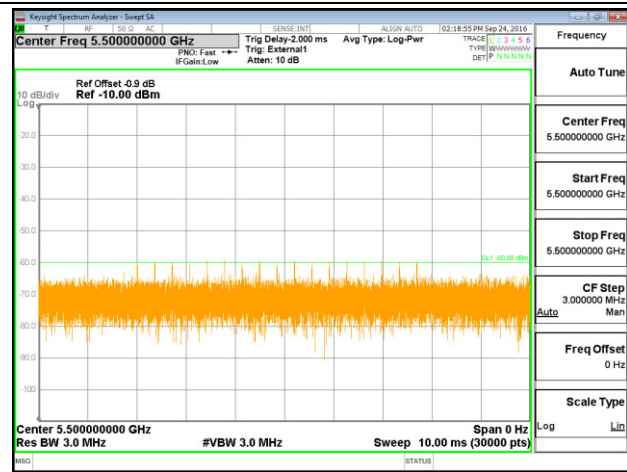

Radar Type 4

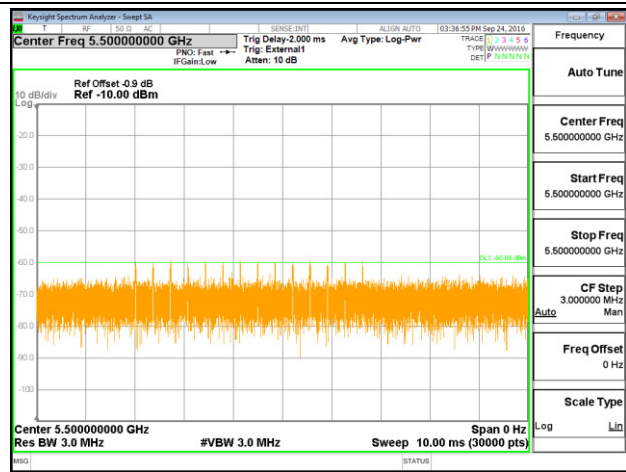

Single Burst of Radar Type 5

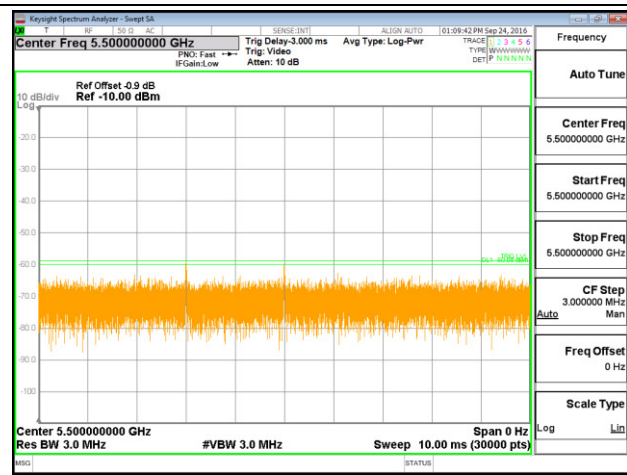

Single Burst of Radar Type 6

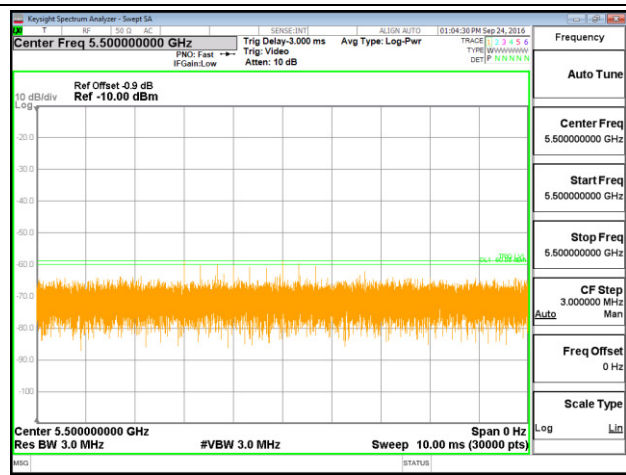



<40MHz / 5510MHz>

Radar Type 1

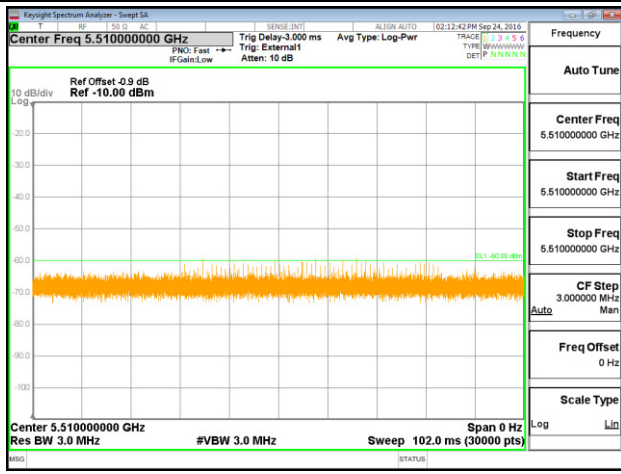

Radar Type 2

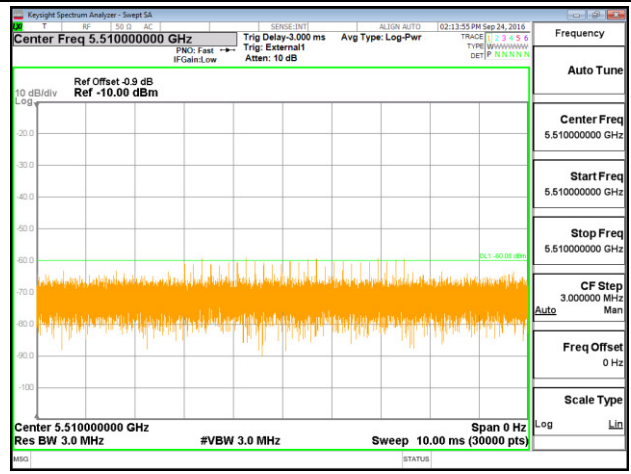

Radar Type 3

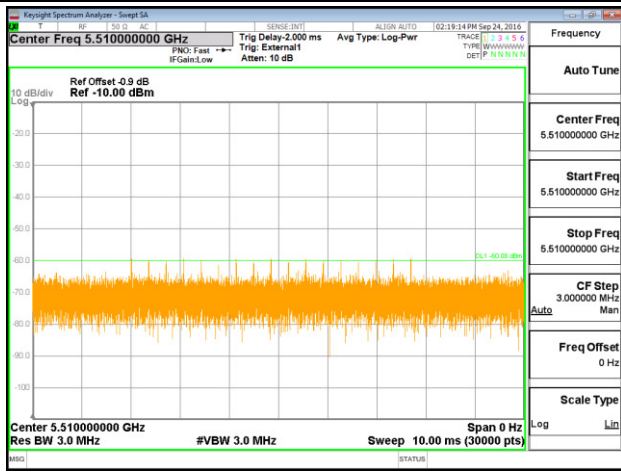

Radar Type 4

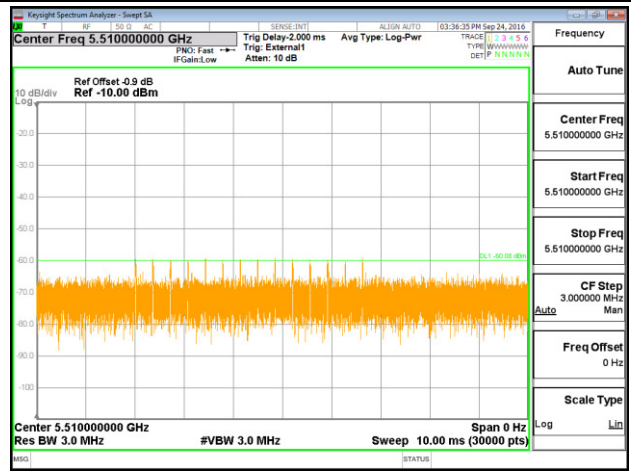

Single Burst of Radar Type 5

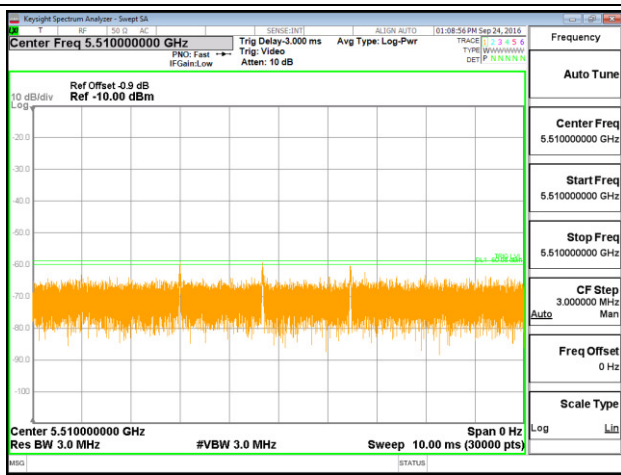

Single Burst of Radar Type 6

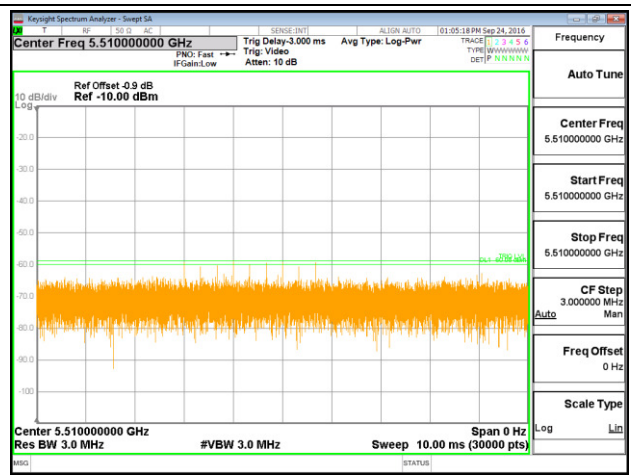



<80MHz / 5530MHz>

Radar Type 1

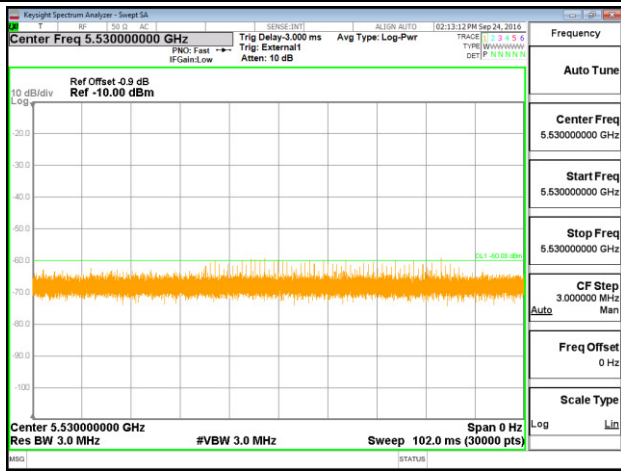

Radar Type 2

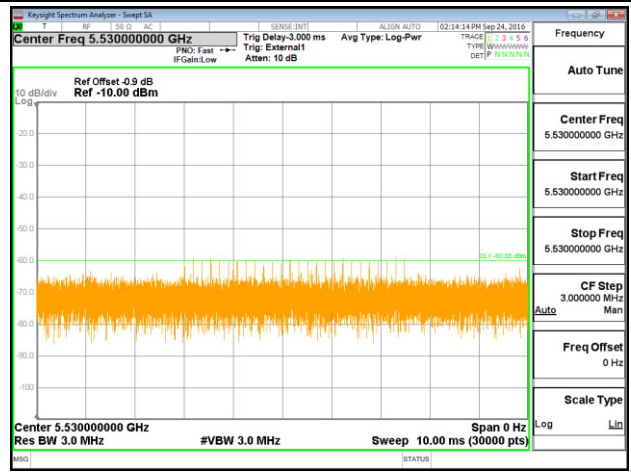

Radar Type 3

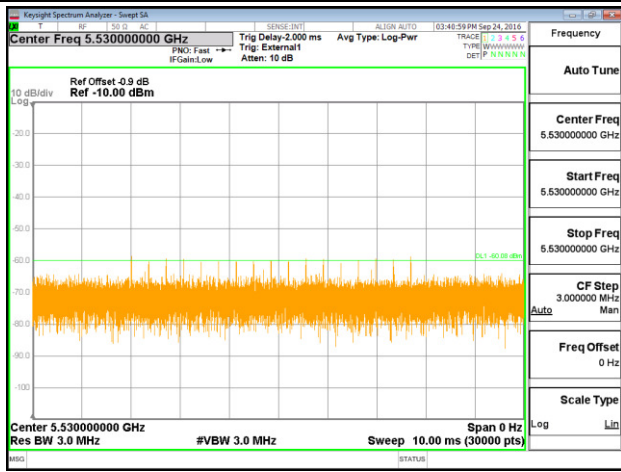

Radar Type 4

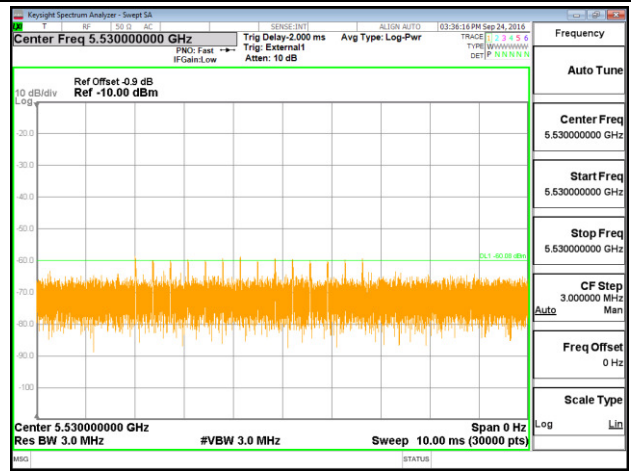

Single Burst of Radar Type 5

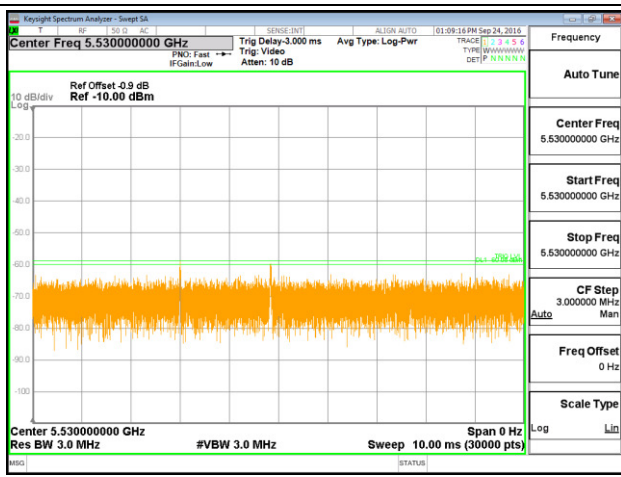

Single Burst of Radar Type 6

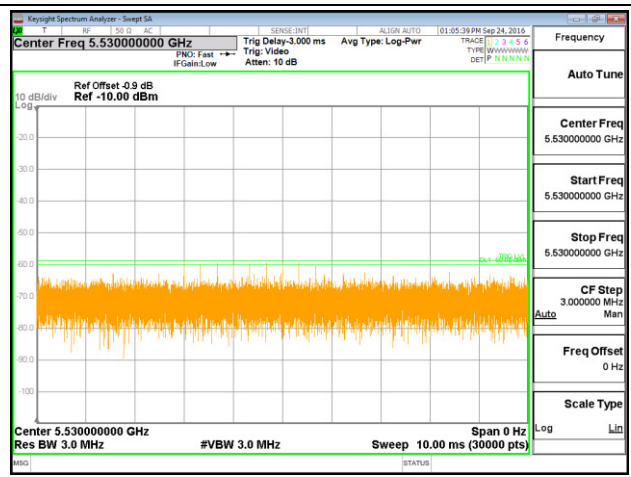

### 3.2 U-NII Detection Bandwidth (7.8.1)

#### 3.2.1 Limit of U-NII Detection Bandwidth

The U-NII Detection Bandwidth shall contain minimum 100% of the 99% power bandwidth.

During the U-NII Detection Bandwidth detection test, radar type 0 is used and for each frequency step the minimum percentage of detection is 90%. Measurements are performed with no data traffic.

#### 3.2.2 Test Procedures

- (1) Adjust the equipment to produce a single burst of the Short Pulse Radar Type 0 at the center frequency of the EUT Operating Channel at the specified DFS Detection Threshold level.
- (2) Set the EUT up as a standalone device (no associated Client or Master, as appropriate) and no traffic. Frame based systems will be set to a talk/listen ratio of 0%/100% during this test.
- (3) Generate a single radar burst, and note the response of the EUT. Repeat for a minimum of 10 trials. The EUT must detect the Radar Waveform using the specified U-NII Detection Bandwidth criterion.
- (4) Starting at the center frequency of the EUT operating Channel, increase the radar frequency in 5 MHz steps, repeating the above test sequence, until the detection rate falls below the U-NII Detection Bandwidth criterion specified in report clause 2.3. Repeat this measurement in 1MHz steps at frequencies 5 MHz below where the detection rate begins to fall. Record the highest frequency (denote as  $F_H$ ) at which detection is greater than or equal to the U-NII Detection Bandwidth criterion. Recording the detection rate at frequencies above  $F_H$  is not required to demonstrate compliance.
- (5) Starting at the center frequency of the EUT operating Channel, decrease the radar frequency in 5 MHz steps, repeating the above test sequence, until the detection rate falls below the U-NII Detection Bandwidth criterion specified in report clause 2.3. Repeat this measurement in 1MHz steps at frequencies 5 MHz above where the detection rate begins to fall. Record the lowest frequency (denote as  $F_L$ ) at which detection is greater than or equal to the U-NII Detection Bandwidth criterion. Recording the detection rate at frequencies below  $F_L$  is not required to demonstrate compliance.
- (6) The U-NII Detection Bandwidth is calculated as follows:  

$$U-NII\ Detection\ Bandwidth = F_H - F_L$$

#### 3.2.3 Test Setup

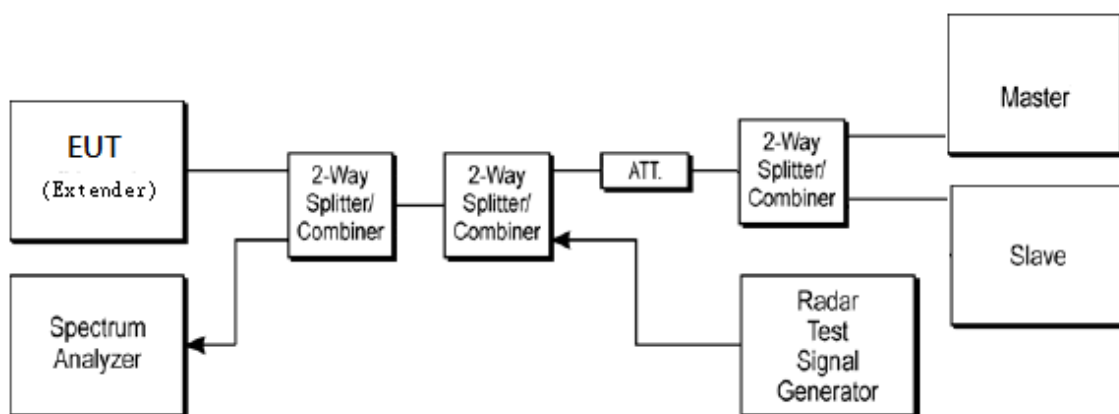

#### 3.2.4 Test Deviation

There is no deviation with the original standard.



3.2.5 Result of U-NII Detection Bandwidth

<20MHz/ 5300MHz >

Frequency (MHz)	Fc	Trial Number (Detection = Y, No Detection = N)										Rate (%)	F <sub>H</sub> /F <sub>L</sub>
		1	2	3	4	5	6	7	8	9	10		
5288	-12	N	N	N	N	N	N	N	N	N	N	0	
5289	-11	Y	Y	Y	Y	Y	Y	Y	Y	Y	Y	100	F <sub>L</sub>
5290	-10	Y	Y	Y	Y	Y	Y	Y	Y	Y	Y	100	
5291	-9	Y	Y	Y	Y	Y	Y	Y	Y	Y	Y	100	
5292	-8	Y	Y	Y	Y	Y	Y	Y	Y	Y	Y	100	
5293	-7	Y	Y	Y	Y	Y	Y	Y	Y	Y	Y	100	
5294	-6	Y	Y	Y	Y	Y	Y	Y	Y	Y	Y	100	
5295	-5	Y	Y	Y	Y	Y	Y	Y	Y	Y	Y	100	
5300	0	Y	Y	Y	Y	Y	Y	Y	Y	Y	Y	100	
5305	+5	Y	Y	Y	Y	Y	Y	Y	Y	Y	Y	100	
5306	+6	Y	Y	Y	Y	Y	Y	Y	Y	Y	Y	100	
5307	+7	Y	Y	Y	Y	Y	Y	Y	Y	Y	Y	100	
5308	+8	Y	Y	Y	Y	Y	Y	Y	Y	Y	Y	100	
5309	+9	Y	Y	Y	Y	Y	Y	Y	Y	Y	Y	100	
5310	+10	Y	Y	Y	Y	Y	Y	Y	Y	Y	Y	100	
5311	+11	Y	Y	Y	Y	Y	N	Y	Y	Y	Y	90	F <sub>H</sub>
5312	+12	N	N	N	N	N	N	N	N	N	N	0	

Detection Bandwidth = F<sub>H</sub> – F<sub>L</sub> = 5311 – 5289 = 22 MHz

EUT 99% Bandwidth = 17.992 MHz (Refer to channel 60)





<40MHz / 5310MHz >

Frequency (MHz)	Fc	Trial Number (Detection = V, No Detection = N)										Rate (%)	F <sub>H</sub> /F <sub>L</sub>
		1	2	3	4	5	6	7	8	9	10		
5288	-22	N	N	Y	N	N	N	Y	N	N	N	20	
5289	-21	Y	Y	Y	Y	Y	Y	Y	Y	Y	Y	100	F <sub>L</sub>
5290	-20	Y	Y	Y	Y	Y	Y	Y	Y	Y	Y	100	
5291	-19	Y	Y	Y	Y	Y	Y	Y	Y	Y	Y	100	
5292	-18	Y	Y	Y	Y	Y	Y	Y	Y	Y	Y	100	
5293	-17	Y	Y	Y	Y	Y	Y	Y	Y	Y	Y	100	
5294	-16	Y	Y	Y	Y	Y	Y	Y	Y	Y	Y	100	
5295	-15	Y	Y	Y	Y	Y	Y	Y	Y	Y	Y	100	
5300	-10	Y	Y	Y	Y	Y	Y	Y	Y	Y	Y	100	
5305	-5	Y	Y	Y	Y	Y	Y	Y	Y	Y	Y	100	
5310	0	Y	Y	Y	Y	Y	Y	Y	Y	Y	Y	100	
5315	+5	Y	Y	Y	Y	Y	Y	Y	Y	Y	Y	100	
5320	+10	Y	Y	Y	Y	Y	Y	Y	Y	Y	Y	100	
5325	+15	Y	Y	Y	Y	Y	Y	Y	Y	Y	Y	100	
5326	+16	Y	Y	Y	Y	Y	Y	Y	Y	Y	Y	100	
5327	+17	Y	Y	Y	Y	Y	Y	Y	Y	Y	Y	100	
5328	+18	Y	Y	Y	Y	Y	Y	Y	Y	Y	Y	100	
5329	+19	Y	Y	Y	Y	Y	Y	Y	Y	Y	Y	100	
5330	+20	Y	Y	Y	Y	Y	Y	Y	Y	Y	Y	100	
5331	+21	Y	Y	Y	Y	Y	Y	Y	Y	Y	Y	100	F <sub>H</sub>
5332	+22	N	N	N	N	N	N	N	N	N	N	0	

Detection Bandwidth = F<sub>H</sub> – F<sub>L</sub> = 5331 – 5289 = 42 MHz

EUT 99% Bandwidth = 36.349 MHz (Refer to channel 62)



<80MHz /5290MHz >

Frequency (MHz)	Fc	Trial Number (Detection = V, No Detection = N)										Rate (%)	F <sub>H</sub> /F <sub>L</sub>
		1	2	3	4	5	6	7	8	9	10		
5249	-41	N	N	N	N	N	N	N	N	N	N	0	
5250	-40	Y	Y	Y	Y	Y	Y	Y	Y	Y	Y	100	F <sub>L</sub>
5251	-39	Y	Y	Y	Y	Y	Y	Y	Y	Y	Y	100	
5252	-38	Y	Y	Y	Y	Y	Y	Y	Y	Y	Y	100	
5253	-37	Y	Y	Y	Y	Y	Y	Y	Y	Y	Y	100	
5254	-36	Y	Y	Y	Y	Y	Y	Y	Y	Y	Y	100	
5255	-35	Y	Y	Y	Y	Y	Y	Y	Y	Y	Y	100	
5260	-30	Y	Y	Y	Y	Y	Y	Y	Y	Y	Y	100	
5265	-25	Y	Y	Y	Y	Y	Y	Y	Y	Y	Y	100	
5270	-20	Y	Y	Y	Y	Y	Y	Y	Y	Y	Y	100	
5275	-15	Y	Y	Y	Y	Y	Y	Y	Y	Y	Y	100	
5380	-10	Y	Y	Y	Y	Y	Y	Y	Y	Y	Y	100	
5285	-5	Y	Y	Y	Y	Y	Y	Y	Y	Y	Y	100	
5290	0	Y	Y	Y	Y	Y	Y	Y	Y	Y	Y	100	
5295	+5	Y	Y	Y	Y	Y	Y	Y	Y	Y	Y	100	
5300	+10	Y	Y	Y	Y	Y	Y	Y	Y	Y	Y	100	
5305	+15	Y	Y	Y	Y	Y	Y	Y	Y	Y	Y	100	
5310	+20	Y	Y	Y	Y	Y	Y	Y	Y	Y	Y	100	
5315	+25	Y	Y	Y	Y	Y	Y	Y	Y	Y	Y	100	
5320	+30	Y	Y	Y	Y	Y	Y	Y	Y	Y	Y	100	
5325	+35	Y	Y	Y	Y	Y	Y	Y	Y	Y	Y	100	
5326	+36	Y	Y	Y	Y	Y	Y	Y	Y	Y	Y	100	
5327	+37	Y	Y	Y	Y	Y	Y	Y	Y	Y	Y	100	
5328	+38	Y	Y	Y	Y	Y	Y	Y	Y	Y	Y	100	
5329	+39	Y	Y	Y	Y	Y	Y	Y	Y	Y	Y	100	
5330	+40	Y	Y	Y	Y	Y	Y	Y	Y	Y	Y	100	F <sub>H</sub>
5331	+41	N	N	N	N	Y	N	N	N	N	N	10	

Detection Bandwidth = F<sub>H</sub> – F<sub>L</sub> = 5330 – 5250 = 80 MHz

EUT 99% Bandwidth = 71.868 MHz (Refer to channel 58)



<20MHz/ 5500MHz >

Frequency (MHz)	Fc	Trial Number (Detection = V, No Detection = N)										Rate (%)	F <sub>H</sub> /F <sub>L</sub>
		1	2	3	4	5	6	7	8	9	10		
5488	-12	N	N	N	N	N	N	N	N	N	N	0	
5489	-11	Y	Y	Y	Y	Y	Y	Y	N	Y	Y	90	F <sub>L</sub>
5490	-10	Y	Y	Y	Y	Y	Y	Y	Y	Y	Y	100	
5491	-9	Y	Y	Y	Y	Y	Y	Y	Y	Y	Y	100	
5492	-8	Y	Y	Y	Y	Y	Y	Y	Y	Y	Y	100	
5493	-7	Y	Y	Y	Y	Y	Y	Y	Y	Y	Y	100	
5494	-6	Y	Y	Y	Y	Y	Y	Y	Y	Y	Y	100	
5495	-5	Y	Y	Y	Y	Y	Y	Y	Y	Y	Y	100	
5500	0	Y	Y	Y	Y	Y	Y	Y	Y	Y	Y	100	
5505	+5	Y	Y	Y	Y	Y	Y	Y	Y	Y	Y	100	
5506	+6	Y	Y	Y	Y	Y	Y	Y	Y	Y	Y	100	
5507	+7	Y	Y	Y	Y	Y	Y	Y	Y	Y	Y	100	
5508	+8	Y	Y	Y	Y	Y	Y	Y	Y	Y	Y	100	
5509	+9	Y	Y	Y	Y	Y	Y	Y	Y	Y	Y	100	
5510	+10	Y	Y	Y	Y	Y	Y	Y	Y	Y	Y	100	
5511	+11	Y	Y	Y	Y	Y	N	Y	Y	Y	Y	90	F <sub>H</sub>
5512	+12	N	N	N	N	N	N	N	N	N	N	0	

Detection Bandwidth = F<sub>H</sub> – F<sub>L</sub>=5511 – 5489 = 22 MHz

EUT 99% Bandwidth = 17.981 MHz (Refer to channel 100)



<40MHz / 5510MHz >

Frequency (MHz)	Fc	Trial Number (Detection = V, No Detection = N)										Rate (%)	F <sub>H</sub> /F <sub>L</sub>
		1	2	3	4	5	6	7	8	9	10		
5488	-22	N	N	N	N	N	N	N	N	N	N	0	
5489	-21	Y	N	Y	Y	Y	Y	Y	Y	Y	Y	90	F <sub>L</sub>
5490	-20	Y	Y	Y	Y	Y	Y	Y	Y	Y	Y	100	
5491	-19	Y	Y	Y	Y	Y	Y	Y	Y	Y	Y	100	
5492	-18	Y	Y	Y	Y	Y	Y	Y	Y	Y	Y	100	
5493	-17	Y	Y	Y	Y	Y	Y	Y	Y	Y	Y	100	
5494	-16	Y	Y	Y	Y	Y	Y	Y	Y	Y	Y	100	
5495	-15	Y	Y	Y	Y	Y	Y	Y	Y	Y	Y	100	
5500	-10	Y	Y	Y	Y	Y	Y	Y	Y	Y	Y	100	
5505	-5	Y	Y	Y	Y	Y	Y	Y	Y	Y	Y	100	
5510	0	Y	Y	Y	Y	Y	Y	Y	Y	Y	Y	100	
5515	+5	Y	Y	Y	Y	Y	Y	Y	Y	Y	Y	100	
5520	+10	Y	Y	Y	Y	Y	Y	Y	Y	Y	Y	100	
5525	+15	Y	Y	Y	Y	Y	Y	Y	Y	Y	Y	100	
5526	+16	Y	Y	Y	Y	Y	Y	Y	Y	Y	Y	100	
5527	+17	Y	Y	Y	Y	Y	Y	Y	Y	Y	Y	100	
5528	+18	Y	Y	Y	Y	Y	Y	Y	Y	Y	Y	100	
5529	+19	Y	Y	Y	Y	Y	Y	Y	Y	Y	Y	100	
5530	+20	Y	Y	Y	Y	Y	Y	Y	Y	Y	Y	100	
5531	+21	Y	Y	Y	Y	Y	Y	Y	Y	Y	Y	100	F <sub>H</sub>
5532	+22	N	Y	N	N	Y	N	N	Y	N	N	30	

Detection Bandwidth = F<sub>H</sub> – F<sub>L</sub> = 5531 – 5489 = 42 MHz

EUT 99% Bandwidth = 36.370 MHz (Refer to channel 102)



<80MHz / 5530MHz >

Frequency (MHz)	Fc	Trial Number (Detection = V, No Detection = N)										Rate (%)	F <sub>H</sub> /F <sub>L</sub>
		1	2	3	4	5	6	7	8	9	10		
5489	-41	N	N	N	N	Y	N	N	N	N	N	10	
5490	-40	Y	Y	Y	Y	Y	Y	Y	Y	Y	Y	100	F <sub>L</sub>
5491	-39	Y	Y	Y	Y	Y	Y	Y	Y	Y	Y	100	
5492	-38	Y	Y	Y	Y	Y	Y	Y	Y	Y	Y	100	
5493	-37	Y	Y	Y	Y	Y	Y	Y	Y	Y	Y	100	
5494	-36	Y	Y	Y	Y	Y	Y	Y	Y	Y	Y	100	
5495	-35	Y	Y	Y	Y	Y	Y	Y	Y	Y	Y	100	
5500	-30	Y	Y	Y	Y	Y	Y	Y	Y	Y	Y	100	
5505	-25	Y	Y	Y	Y	Y	Y	Y	Y	Y	Y	100	
5510	-20	Y	Y	Y	Y	Y	Y	Y	Y	Y	Y	100	
5515	-15	Y	Y	Y	Y	Y	Y	Y	Y	Y	Y	100	
5520	-10	Y	Y	Y	Y	Y	Y	Y	Y	Y	Y	100	
5525	-5	Y	Y	Y	Y	Y	Y	Y	Y	Y	Y	100	
5530	0	Y	Y	Y	Y	Y	Y	Y	Y	Y	Y	100	
5535	+5	Y	Y	Y	Y	Y	Y	Y	Y	Y	Y	100	
5540	+10	Y	Y	Y	Y	Y	Y	Y	Y	Y	Y	100	
5545	+15	Y	Y	Y	Y	Y	Y	Y	Y	Y	Y	100	
5550	+20	Y	Y	Y	Y	Y	Y	Y	Y	Y	Y	100	
5555	+25	Y	Y	Y	Y	Y	Y	Y	Y	Y	Y	100	
5560	+30	Y	Y	Y	Y	Y	Y	Y	Y	Y	Y	100	
5565	+35	Y	Y	Y	Y	Y	Y	Y	Y	Y	Y	100	
5566	+36	Y	Y	Y	Y	Y	Y	Y	Y	Y	Y	100	
5567	+37	Y	Y	Y	Y	Y	Y	Y	Y	Y	Y	100	
5568	+38	Y	Y	Y	Y	Y	Y	Y	Y	Y	Y	100	
5569	+39	Y	Y	Y	Y	Y	Y	Y	Y	Y	Y	100	
5570	+40	Y	Y	Y	Y	Y	Y	Y	Y	Y	Y	100	F <sub>H</sub>
5571	+41	N	N	Y	N	N	Y	N	N	N	N	20	

Detection Bandwidth = F<sub>H</sub> – F<sub>L</sub> = 5570 – 5490 = 80 MHz

EUT 99% Bandwidth = 73.887 MHz (Refer to channel 106)



### 3.3 Channel Availability Check (7.8.2)

EUT is considered as a client with radar detection device.

Hence, channel availability check is not applicable according to Table 1.

Requirement	Operational Mode		
	Master	Client Without Radar Detection	Client With Radar Detection
Non-Occupancy Period	Yes	Not required	Yes
DFS Detection Threshold	Yes	Not required	Yes
Channel Availability Check Time	Yes	Not required	Not required
U-NII Detection Bandwidth	Yes	Not required	Yes



### **3.4 In-Service Monitoring: Channel Move Time, Channel Closing Transmission Time and Non-Occupancy Period (7.8.3)**

#### **3.4.1 Limit of In-Service Monitoring**

The EUT has In-Service Monitoring function to continuously monitor the radar signals, If radar is detected, it must leave the channel (Shutdown). The Channel Move Time to cease all transmissions on the current Channel upon detection of a Radar Waveform above the DFS Detection Threshold within 10 sec. The total duration of Channel Closing Transmission Time is comprised of 200 milliseconds starting at the beginning of the Channel Move Time plus any additional intermittent control signals required to facilitate Channel changes (an aggregate of 60 milliseconds) during the remainder of the 10 second period. The aggregate duration of control signals will not count quiet periods in between transmissions.

Non-Occupancy Period time is 30 minute during which a Channel will not be utilized after a Radar Waveform is detected on that Channel.

### 3.4.2 Test Procedures

- (1) One frequency will be chosen from the Operating Channels of the EUT within the 5250-5350 MHz or 5470-5725 MHz bands. For 802.11 devices, the test frequency must contain control signals. This can be verified by disabling channel loading and monitoring the spectrum analyzer. If no control signals are detected, another frequency must be selected within the emission bandwidth where control signals are detected.
- (2) In case the EUT is a Master Device, a U-NII device operating as a Client Device will be used and it is assumed that the Client will associate with the EUT (Master). For radiated tests, the emissions of the Radar Waveform generator will be directed towards the Master Device. If the Master Device has antenna gain, the main beam of the antenna will be directed toward the radar emitter. Vertical polarization is used for testing.
- (3) The TCP protocol unicast data stream was generated by the iperf software command line with at least 17% activity ratio over any 100ms period.
- (4) Timing plots are reported with calculations demonstrating a minimum channel loading of approximately 17% or greater. For example, channel loading can be estimated by setting the spectrum analyzer for zero span and approximate the Time On/ (Time On + Off Time).
- (5) At time T<sub>0</sub> the Radar Waveform generator sends a Burst of pulses for one of the Short Pulse Radar Types 1-4 at DFS Detection Threshold levels on the Operating Channel. An additional 1 dB is added to the radar test signal to ensure it is at or above the DFS Detection Threshold, accounting for equipment variations/errors.
- (6) Observe the transmissions of the EUT at the end of the radar Burst on the Operating Channel for duration greater than 10 seconds. Measure and record the transmissions from the EUT during the observation time (Channel Move Time). Measure and record the Channel Move Time and Channel Closing Transmission Time if radar detection occurs.
- (7) When operating as a Master Device, monitor the EUT for more than 30 minutes following instant T<sub>2</sub> to verify that the EUT does not resume any transmissions on this Channel. Perform this test once and record the measurement result.

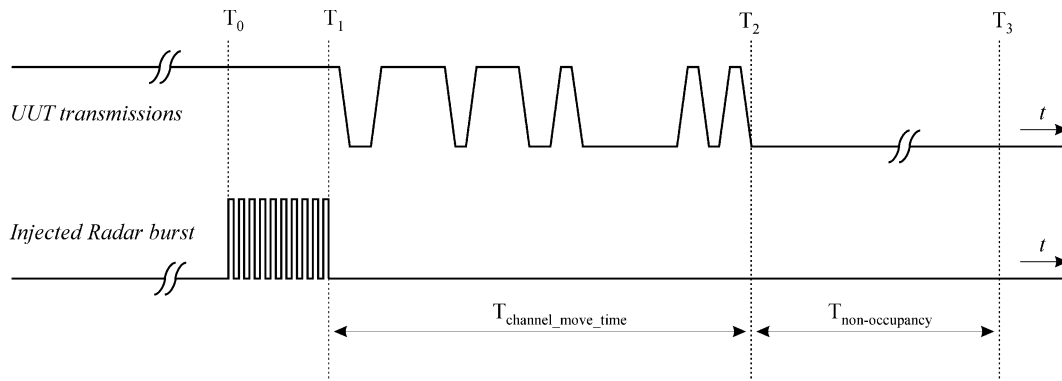

- (8) One 12 seconds plot is reported for the Short Pulse Radar Type 0.
- (9) Measurement of the aggregate duration of the Channel Closing Transmission Time method. With the spectrum analyzer set to zero span tuned to the center frequency of the EUT operating channel at the radar simulated frequency, peak detection, and max hold, the dwell time per bin is given by:  $Dwell (0.1ms) = S (3000ms) / B (30000)$ ; where Dwell is the dwell time per spectrum analyzer sampling bin, S is the sweep time and B is the number of spectrum analyzer sampling bins. An upper bound of the aggregate duration of the intermittent control signals of Channel Closing Transmission Time is calculated by:  $C (ms) = N \times Dwell (0.1 ms)$ ; where C is the Closing Time, N is the number of spectrum analyzer sampling bins (intermittent control signals) showing a U-NII transmission and Dwell is the dwell time per bin.



### 3.4.3 Test Setup

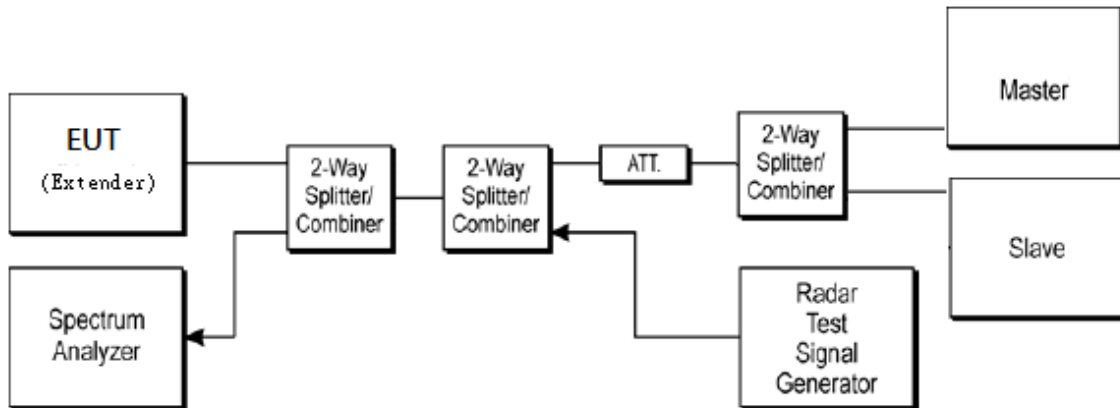

### 3.4.4 Test Deviation

There is no deviation with the original standard.



3.4.5 Result of Channel Move Time, Channel Closing Transmission Time and Non-Occupancy Period for Client Beacon Test

<b>Test Mode :</b>	Client with radar detection (Extender Mode)	<b>Temperature :</b>	24.3-25.2°C
<b>Test Engineer :</b>	Bill Kuo	<b>Relative Humidity :</b>	44-47%

BW / Channel	Test Item	Test Result	Limit	Pass/Fail
80MHz /5290MHz	Channel Move Time	0.7725 s	< 10s	Pass
	Channel Closing Transmission Time	200ms + 48.2 ms	< 260ms	Pass
	Non-Occupancy Period	≥ 30	≥ 30 min	Pass
80MHz /5530MHz	Channel Move Time	0.7805 s	< 10s	Pass
	Channel Closing Transmission Time	200ms + 57.7 ms	< 260ms	Pass
	Non-Occupancy Period	≥ 30	≥ 30 min	Pass

**Note:** The Channel Closing Transmission Time is comprised of 200 milliseconds starting at the beginning of the Channel Move Time plus any additional intermittent control signals required to facilitate a Channel move (an aggregate of 60 milliseconds) during the remainder of the 10 seconds period. The aggregate duration of control signals will not count quiet periods in between transmissions.



### 3.4.6 Channel Move Time, Channel Closing Transmission Time and Non-Occupancy Period Test Plots

**<80MHz / 5290MHz > In-Service Monitoring**

**Channel Move Time**

Mkpr	Mode	Trig	Scl	X	Y	Function	Function Width	Function Value
1	N	1	t	772.5 ms	-13.35 dBm			
2	N	1	t	200.0 ms	-13.65 dBm			
3	N	1	t	10.00 s	-48.75 dBm			

**Channel Closing Transmission Time**

Mkpr	Mode	Trig	Scl	X	Y	Function	Function Width	Function Value
1	N	1	t	200.0 ms	-48.30 dBm			
2	N	1	t	1.001 s	-49.88 dBm			

**Note:**

Dwell (0.1 ms)= Sweep Time (3000 ms) / Sweep Point Bins (30000)

Channel Closing Transmission Time ( 200 + 48.2 ms) = 200 + Number (482) X Dwell (0.1 ms) < 260ms



<80MHz / 5530MHz > In-Service Monitoring

Channel Move Time



Channel Closing Transmission Time

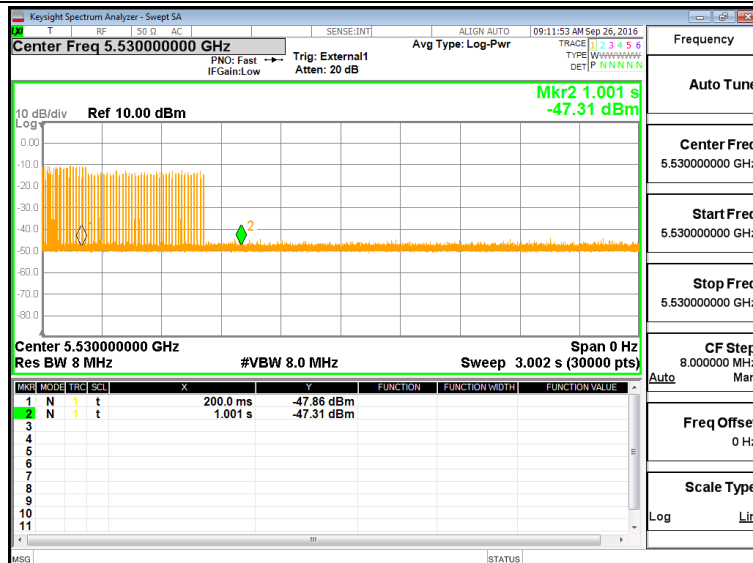

Note:

Dwell (0.1 ms) = Sweep Time (3000 ms) / Sweep Point Bins (30000)

Channel Closing Transmission Time (200 + 57.7 ms) = 200 + Number (577) X Dwell (0.1 ms) < 260ms



<80MHz / 5290MHz > In-Service Monitoring

Non-Occupancy Period



<80MHz / 5530MHz > In-Service Monitoring

Non-Occupancy Period

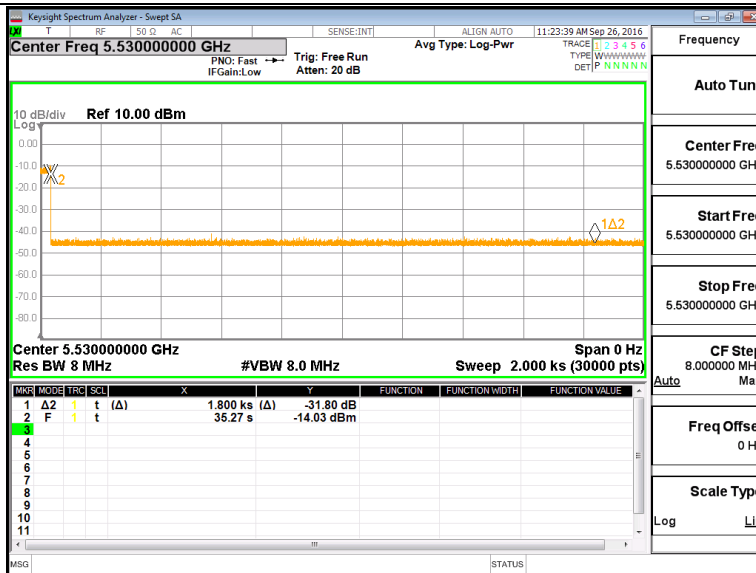



### 3.4.7 Long Pulsed Radar Type Channel Move Time Test Plots (22second)

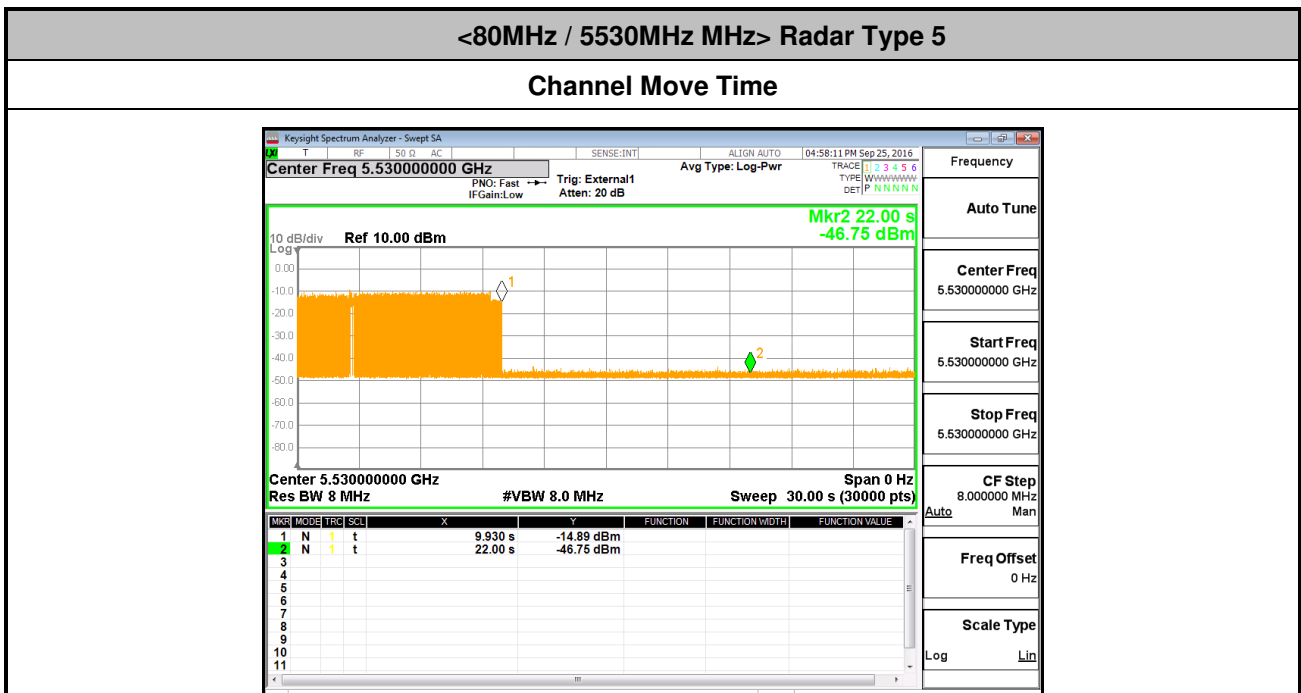
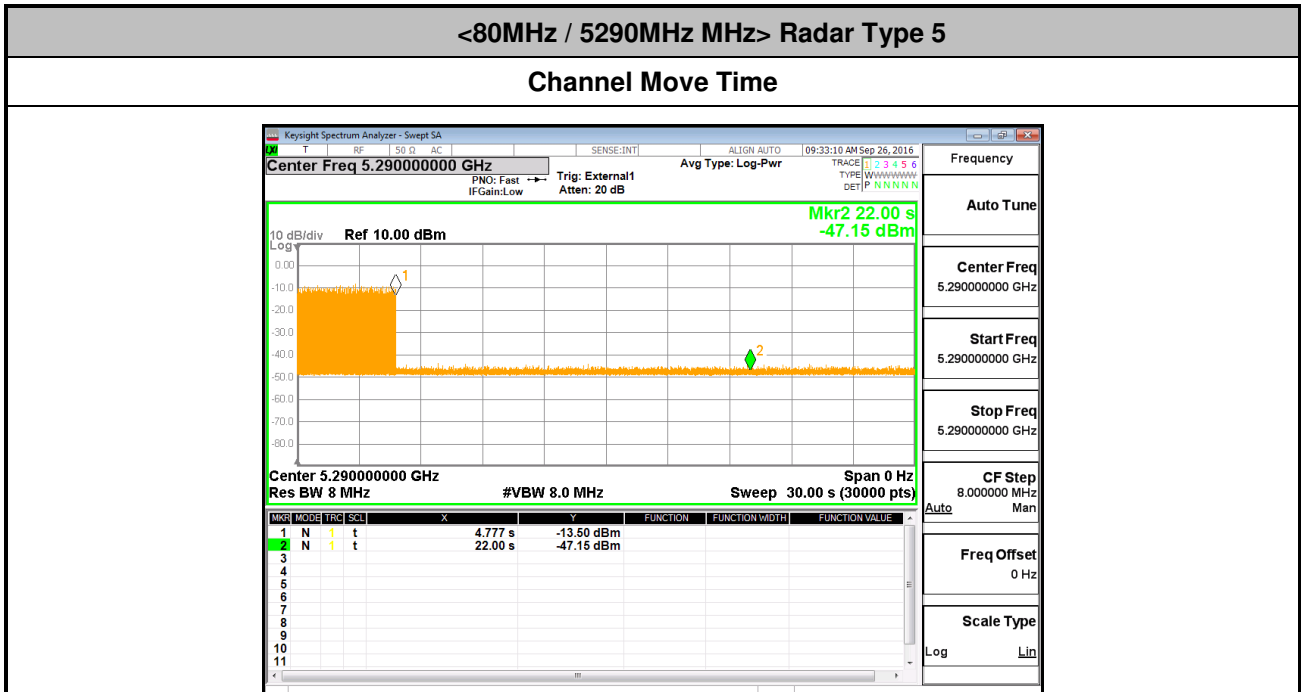

EUT (Extender) MAC Address: 00-0A-EB-AC-24-FF (000a.ebac.24ff)

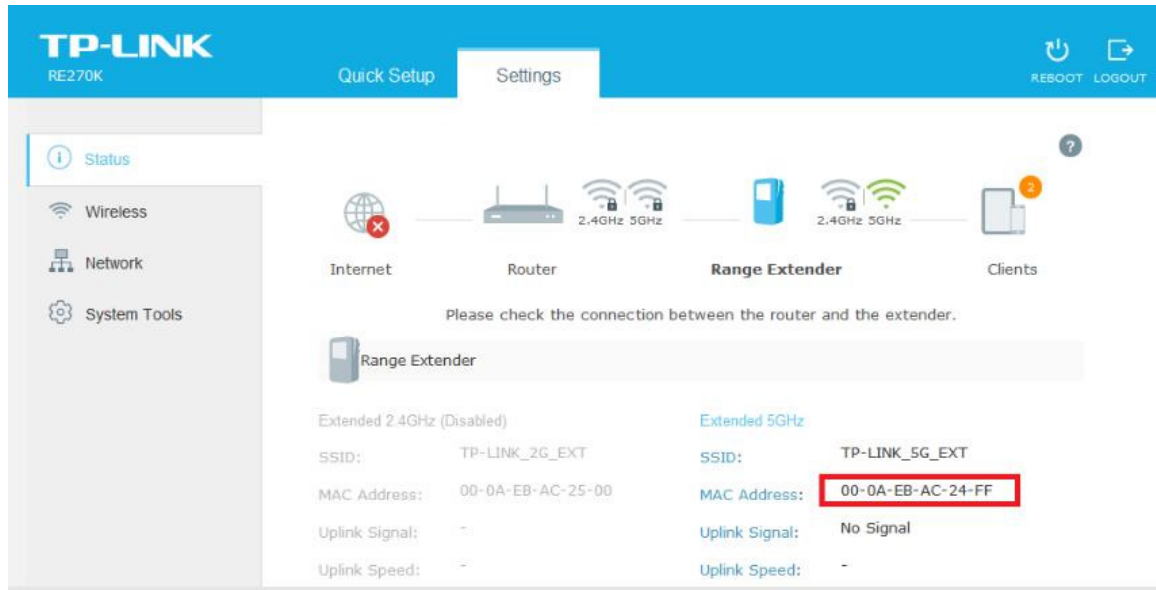

The image shows the TP-LINK RE270K web interface. The 'Settings' tab is active, and the 'Range Extender' section is expanded. The 'Extended 2.4GHz (Disabled)' section shows SSID: TP-LINK\_2G\_EXT and MAC Address: 00-0A-EB-AC-25-00. The 'Extended 5GHz' section shows SSID: TP-LINK\_5G\_EXT and MAC Address: 00-0A-EB-AC-24-FF, which is highlighted with a red rectangular box. The 'Uplink Signal' for the 5GHz section is 'No Signal'.

000a.ebac.24ff is deauthenticated from the CISCO AP after the radar signal is injected on the EUT.

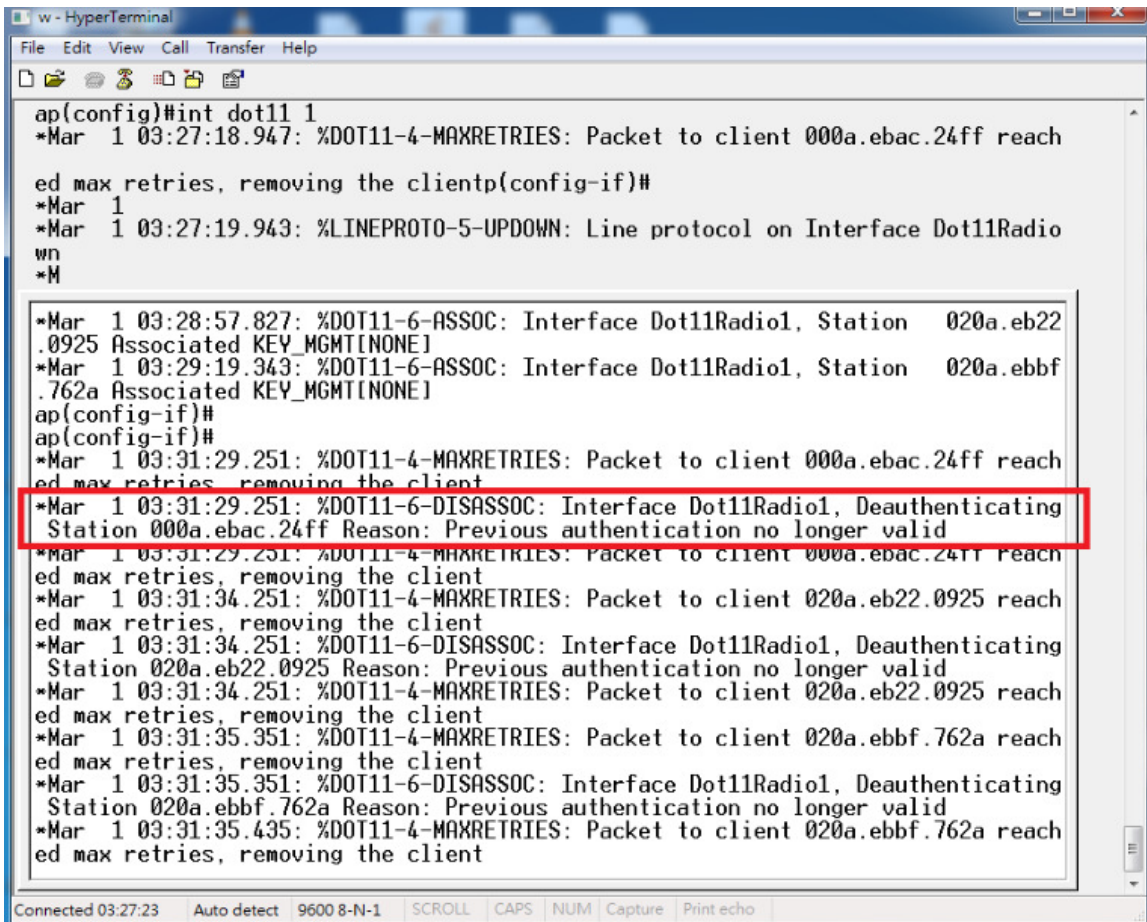

```
ap(config)#int dot11 1
*Mar 1 03:27:18.947: %DOT11-4-MAXRETRIES: Packet to client 000a.ebac.24ff reach
ed max retries, removing the client
ap(config-if)#
*Mar 1
*Mar 1 03:27:19.943: %LINEPROTO-5-UPDOWN: Line protocol on Interface Dot11Radio
wn
*M
*Mar 1 03:28:57.827: %DOT11-6-ASSOC: Interface Dot11Radio1, Station 020a.eb22
.0925 Associated KEY_MGMT[NONE]
*Mar 1 03:29:19.343: %DOT11-6-ASSOC: Interface Dot11Radio1, Station 020a.ebbf
.762a Associated KEY_MGMT[NONE]
ap(config-if)#
ap(config-if)#
*Mar 1 03:31:29.251: %DOT11-4-MAXRETRIES: Packet to client 000a.ebac.24ff reach
ed max retries, removing the client
*Mar 1 03:31:29.251: %DOT11-6-DISASSOC: Interface Dot11Radio1, Deauthenticating
Station 000a.ebac.24ff Reason: Previous authentication no longer valid
*Mar 1 03:31:29.251: %DOT11-4-MAXRETRIES: Packet to client 000a.ebac.24ff reach
ed max retries, removing the client
*Mar 1 03:31:34.251: %DOT11-4-MAXRETRIES: Packet to client 020a.eb22.0925 reach
ed max retries, removing the client
*Mar 1 03:31:34.251: %DOT11-6-DISASSOC: Interface Dot11Radio1, Deauthenticating
Station 020a.eb22.0925 Reason: Previous authentication no longer valid
*Mar 1 03:31:34.251: %DOT11-4-MAXRETRIES: Packet to client 020a.eb22.0925 reach
ed max retries, removing the client
*Mar 1 03:31:35.351: %DOT11-4-MAXRETRIES: Packet to client 020a.ebbf.762a reach
ed max retries, removing the client
*Mar 1 03:31:35.351: %DOT11-6-DISASSOC: Interface Dot11Radio1, Deauthenticating
Station 020a.ebbf.762a Reason: Previous authentication no longer valid
*Mar 1 03:31:35.435: %DOT11-4-MAXRETRIES: Packet to client 020a.ebbf.762a reach
ed max retries, removing the client
```



### 3.4.8 Data Traffic Channel Loading and Noise Floor Plots

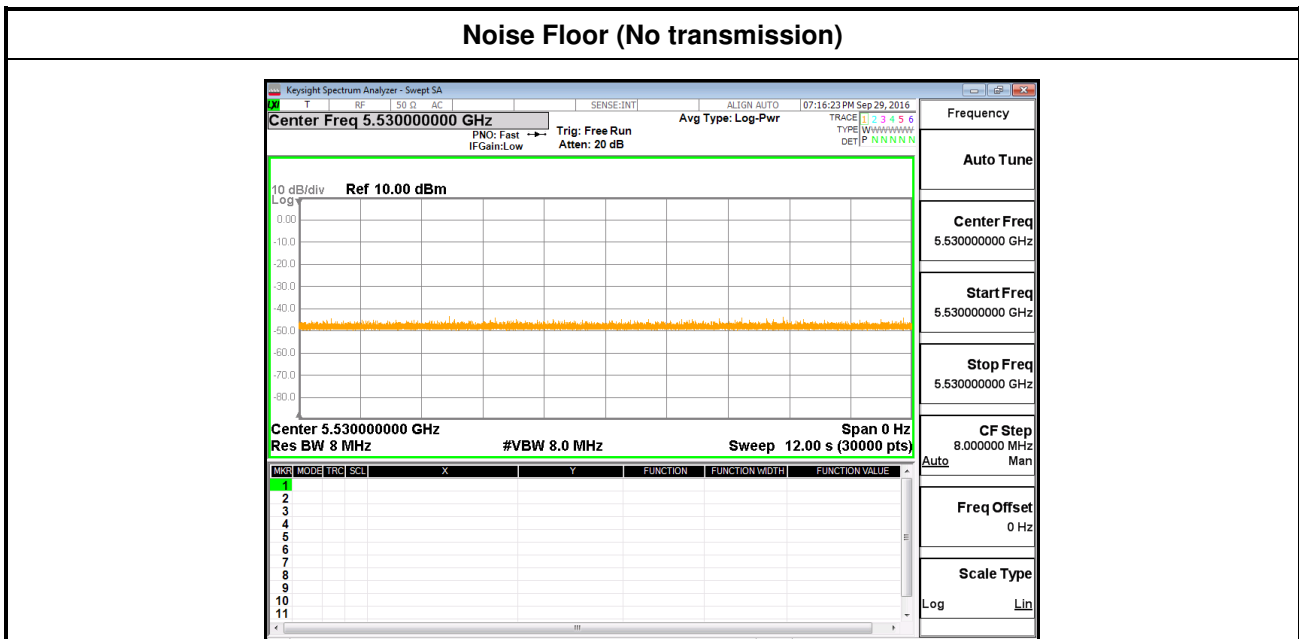
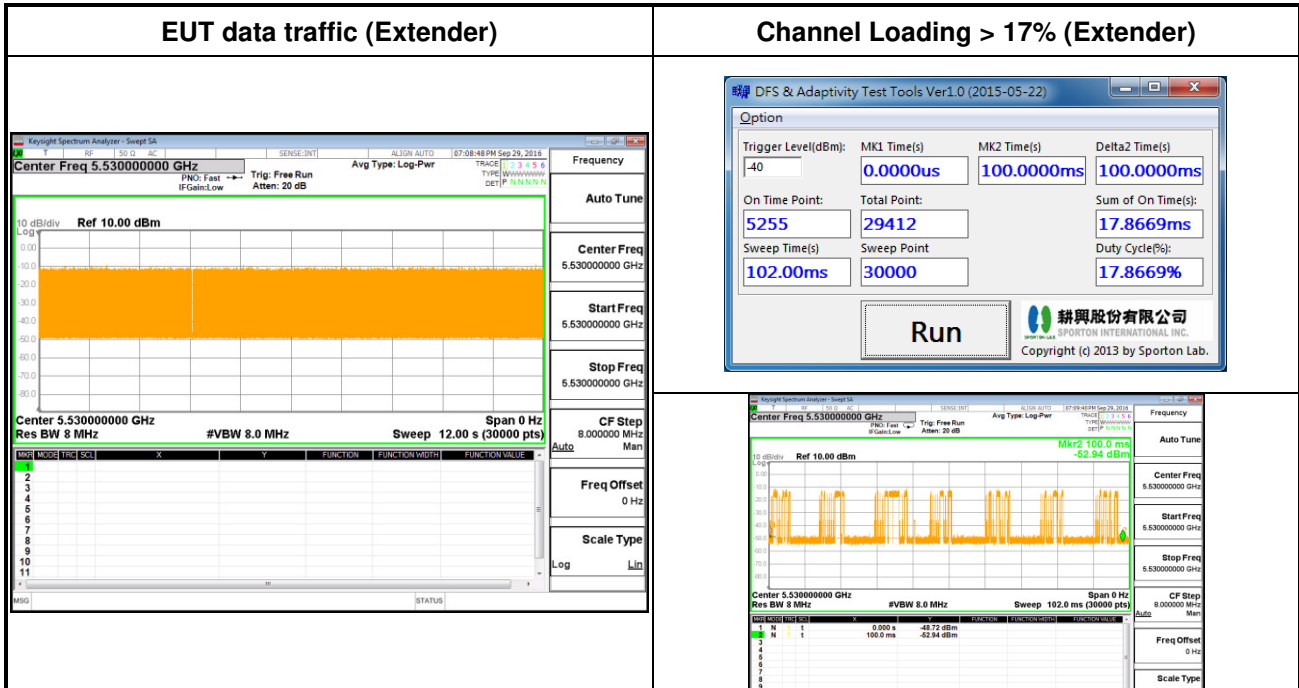





### 3.5 Statistical Performance Check (7.8.4)

#### 3.5.1 Limit of Statistical Performance Check

##### Short Pulse Radar Test

Once the performance requirements check is complete, statistical data will be gathered, to determine the ability of the device to detect the radar test waveforms (Short Pulse Radar Types 1-4) found in **Table 5**. The device can utilize a test mode to demonstrate when detection occurs to prevent the need to reset the device between trials. The percentage of successful detection is calculated by:

$$\frac{\text{TotalWaveformDetections}}{\text{TotalWaveformTrials}} \times 100 = \text{Percentage of Successful Detection Radar Waveform } N = P_d N$$

In addition an aggregate minimum percentage of successful detection across all Short Pulse Radar Types 1-4 is required and is calculated as follows:

$$\frac{P_d 1 + P_d 2 + P_d 3 + P_d 4}{4}$$

The minimum number of trails, minimum percentage of successful detection and the aggregate minimum percentage of successful detection are found in **Table 5**.

**Table 5 – Short Pulse Radar Test Waveforms**

Radar Type	Pulse Width (µsec)	PRI (µsec)	Number of Pulses	Minimum Percentage of Successful Detection	Minimum Number of Trials
1	1	1428	18	60%	30
2	1-5	150-230	23-29	60%	30
3	6-10	200-500	16-18	60%	30
4	11-20	200-500	12-16	60%	30
Aggregate (Radar Types 1-4)				80%	120

A minimum of 30 unique waveforms are required for each of the Short Pulse Radar Types 1 through 4. For Short Pulse Radar Type 0, the same waveform is used a minimum of 30 times. If more than 30 waveforms are used for Short Pulse Radar Types 1 through 4, then each additional waveform must also be unique and not repeated from the previous waveforms.



Radar Type	Number of Trials	Number of Successful Detections	Minimum Percentage of Successful Detection
1	35	29	82.9%
2	30	18	60%
3	30	27	90%
4	50	44	88%
Aggregate $(82.9\% + 60\% + 90\% + 88\%)/4 = 80.2\%$			



**Long Pulse Radar Test**

Statistical data will be gathered to determine the ability of the device to detect the Long Pulse Radar Type 5 found in **Table 6**. The device can utilize a test mode to demonstrate when detection occurs to prevent the need to reset the device between trials.

**Table 6 – Long Pulse Radar Test Waveform**

Radar Type	Pulse Width (μsec)	Chirp Width (MHz)	PRI (μsec)	Number of Pulses per Burst	Number of Bursts	Minimum Percentage of Successful Detection	Minimum Number of Trials
5	50-100	5-20	1000-2000	1-3	8-20	80%	30

The parameters for this waveform are randomly chosen. Thirty unique waveforms are required for the Long Pulse Radar Type waveforms. If more than 30 waveforms are used for the Long Pulse Radar Type waveforms, then each additional waveform must also be unique and not repeated from the previous waveforms.

Three subsets of trials will be performed with a minimum of ten trials per subset.

The subset of trials differs in where the Long Pulse Type 5 Signal is tuned in frequency:

- a) The Channel center frequency (subset case 1).
- b) Tuned frequencies such that 90% of the Long Pulse Type 5 frequency modulation is within the low edge of the UUT Occupied Bandwidth (subset case 2).
- c) Tuned frequencies such that 90% of the Long Pulse Type 5 frequency modulation is within the high edge of the UUT Occupied Bandwidth (subset case 3).

For subset case 1: the center frequency of the signal generator will remain fixed at the center of the UUT Channel.

For subset case 2: to retain 90% frequency overlap between the radar signal and the UUT Occupied Bandwidth, the center frequency of the signal generator will vary for each of the ten trials in subset case 2.

The center frequency of the signal generator for each trial is calculated by:  $FL + (0.4 * Chirp\ Width\ [in\ MHz])$

For subset case 3: to retain 90% frequency overlap between the radar signal and the UUT Occupied Bandwidth, the center frequency of the signal generator will vary for each of the ten trials in subset case 3.

The center frequency of the signal generator for each trial is calculated by:  $FH - (0.4 * Chirp\ Width\ [in\ MHz])$

a) Channel center frequency (subset case 1)

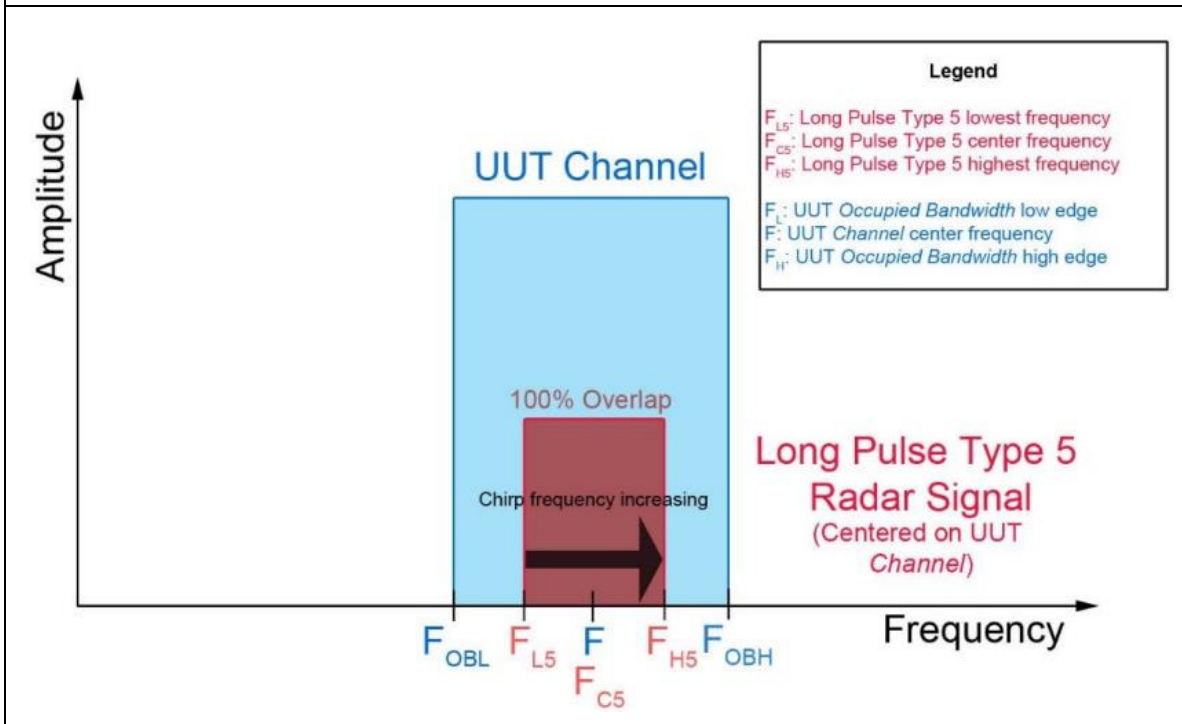

b) Tuned frequencies such that 90% of the Long Pulse Type 5 frequency modulation is within the low edge of the UUT Occupied Bandwidth. (subset case 2)

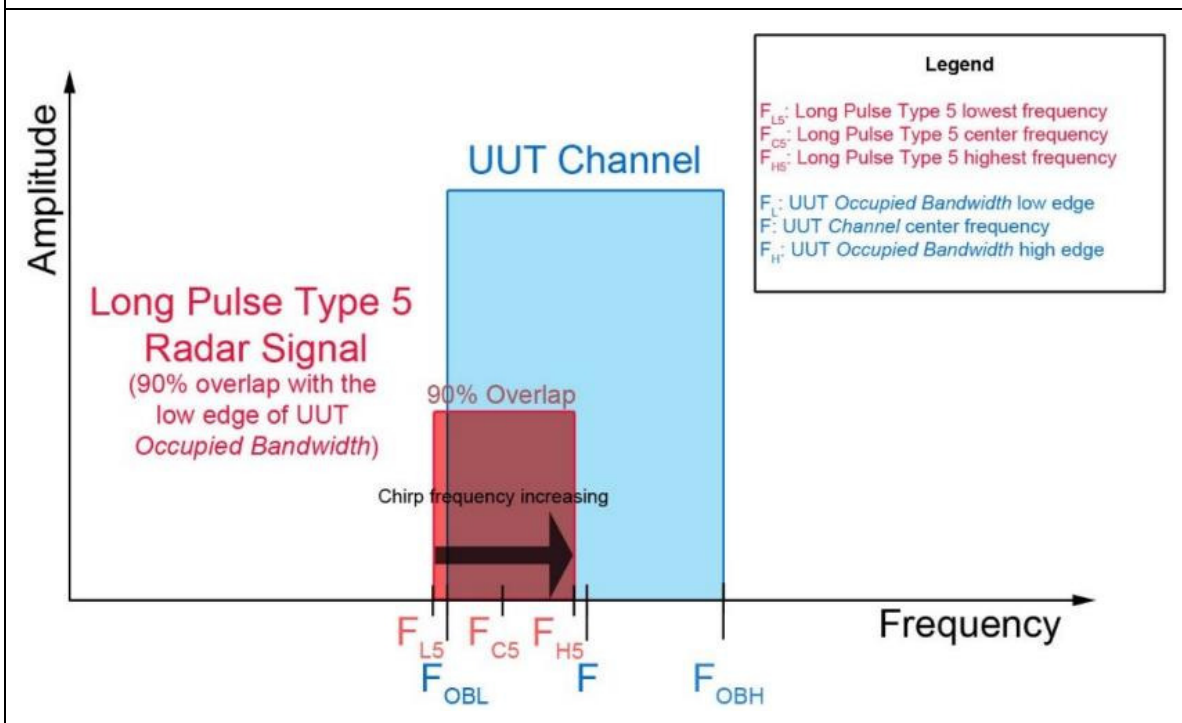

c) Tuned frequencies such that 90% of the Long Pulse Type 5 frequency modulation is within the high edge of the UUT Occupied Bandwidth. (subset case 3)

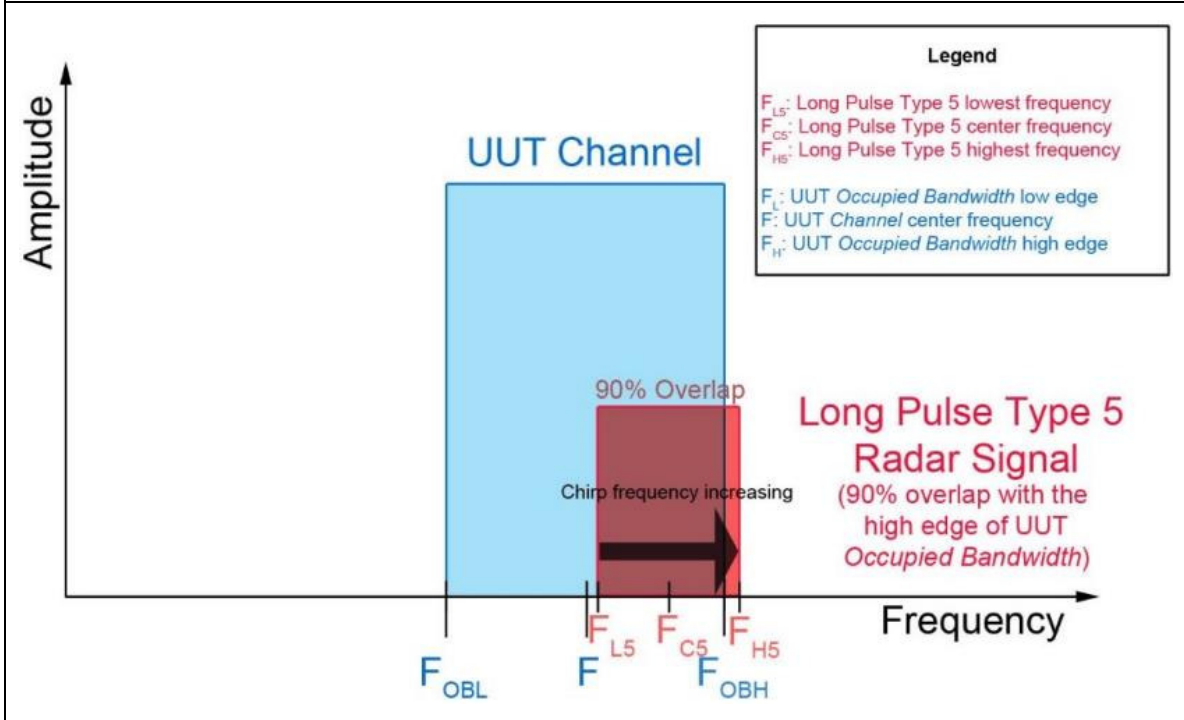

The percentage of successful detection is calculated by:

$$\frac{\text{TotalWaveformDetections}}{\text{TotalWaveformTrials}} \times 100$$



**Frequency Hopping Radar Test**

Statistical data will be gathered to determine the ability of the device to detect the Frequency Hopping radar test signal (radar type 6) found in **Table 7**. The device can utilize a test mode to demonstrate when detection occurs to prevent the need to reset the device between trial runs. The probability of successful detection is calculated by:

$$\frac{TotalWaveformDetections}{TotalWaveformTrials} \times 100$$

**Table 7 – Frequency Hopping Radar Test Waveform**

Radars Type	Pulse Width (µsec)	PRI (µsec)	Pulses per Hop	Hopping Rate (kHz)	Hopping Sequence Length (msec)	Minimum Percentage of Successful Detection	Minimum Number of Trials
6	1	333	9	0.333	300	70%	30

For the Frequency Hopping Radar Type, the same *Burst* parameters are used for each waveform. The hopping sequence is different for each waveform and a 100-length segment is selected from the hopping sequence defined by the following algorithm:

The first frequency in a hopping sequence is selected randomly from the group of 475 integer frequencies from 5250 – 5724 MHz. Next, the frequency that was just chosen is removed from the group and a frequency is randomly selected from the remaining 474 frequencies in the group. This process continues until all 475 frequencies are chosen for the set. For selection of a random frequency, the frequencies remaining within the group are always treated as equally likely.

### 3.5.2 Test Procedures

- (1) One frequency will be chosen from the Operating Channels of the EUT within the 5250-5350 MHz or 5470-5725 MHz bands.
- (2) In case the EUT is a Master Device, a U-NII device operating as a Client Device will be used and it is assumed that the Client will associate with the EUT (Master). If the Master Device has antenna gain, the main beam of the antenna will be directed toward the radar emitter. Vertical polarization is used for testing.
- (3) The TCP protocol unicast data stream was generated by the iperf software command line with at least 17% activity ratio over any 100ms period.
- (4) At time  $T_0$  the Radar Waveform generator sends a Burst of pulses for each of the Radar Types 1-6 at DFS Detection Threshold levels on the Operating Channel. An additional 1 dB is added to the radar test signal to ensure it is at or above the DFS Detection Threshold, accounting for equipment variations/errors.
- (5) Observe the transmissions of the EUT at the end of the Burst on the Operating Channel for duration greater than 10 seconds for Short Pulse Radar Types 1-4 and 6 to ensure detection occurs.
- (6) Observe the transmissions of the EUT at the end of the Burst on the Operating Channel for duration greater than 22 seconds for Long Pulse Radar Type 5 to ensure detection occurs.

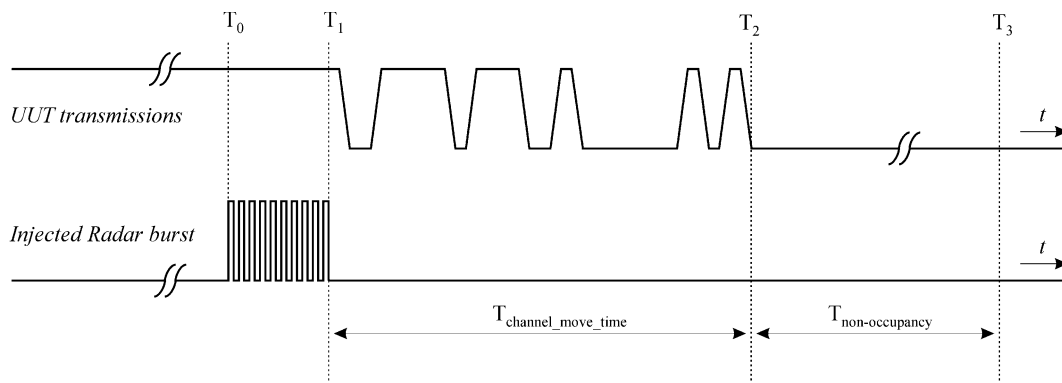

### 3.5.3 Test Setup

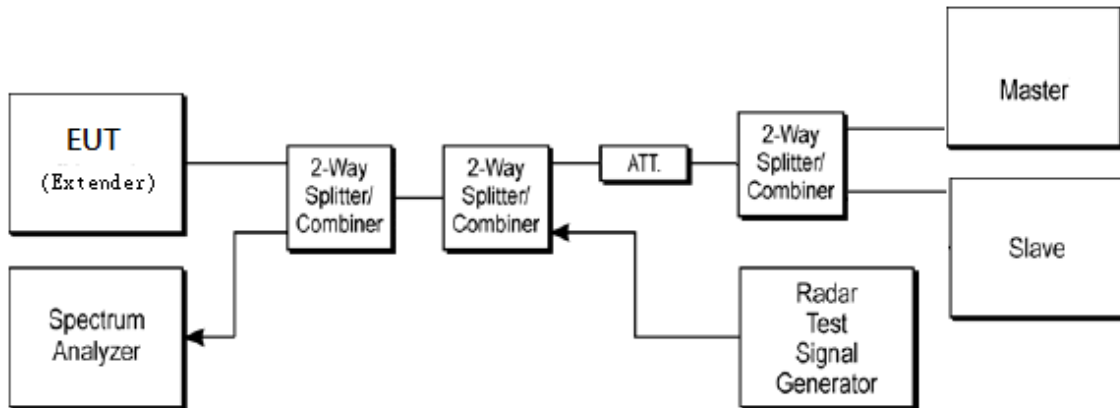

### 3.5.4 Test Deviation

There is no deviation with the original standard.





3.5.5 Result of Statistical Performance Check

<20MHz / 5300MHz >

(Detection = Y, No Detection = N)						
Trial Number	Type 1	Type 2	Type 3	Type 4	Type 5	Type 6
1	Y	Y	Y	Y	Y	Y
2	Y	Y	Y	Y	Y	Y
3	Y	Y	Y	Y	Y	Y
4	Y	Y	Y	Y	Y	Y
5	Y	Y	Y	Y	Y	Y
6	Y	Y	Y	Y	Y	Y
7	N	Y	N	Y	Y	Y
8	Y	Y	Y	Y	Y	Y
9	Y	Y	Y	Y	Y	Y
10	Y	N	Y	Y	N	Y
11	Y	Y	Y	Y	Y	Y
12	Y	Y	Y	Y	Y	Y
13	Y	Y	Y	Y	Y	Y
14	Y	Y	Y	Y	Y	N
15	Y	Y	Y	Y	Y	Y
16	Y	Y	Y	Y	Y	Y
17	Y	Y	Y	Y	Y	Y
18	Y	Y	Y	Y	Y	Y
19	Y	Y	Y	Y	N	Y
20	Y	Y	Y	Y	Y	Y
21	N	Y	Y	Y	Y	Y
22	Y	Y	Y	Y	Y	Y
23	Y	Y	N	Y	Y	Y
24	Y	Y	Y	Y	Y	Y
25	Y	Y	Y	Y	Y	Y
26	Y	Y	Y	N	Y	Y
27	Y	N	Y	Y	Y	Y
28	Y	Y	Y	Y	Y	Y
29	Y	Y	Y	Y	Y	Y
30	Y	Y	Y	Y	Y	Y
<b>Trial of Detection</b>	<b>28/30</b>	<b>28/30</b>	<b>28/30</b>	<b>29/30</b>	<b>28/30</b>	<b>29/30</b>
<b>Probability (%)</b>	<b>93.33%</b>	<b>93.33%</b>	<b>93.33%</b>	<b>96.67%</b>	<b>93.33%</b>	<b>96.67%</b>
<b>Limit (%)</b>	<b>&gt;= 60%</b>	<b>&gt;= 60%</b>	<b>&gt;= 60%</b>	<b>&gt;= 60%</b>	<b>&gt;= 80%</b>	<b>&gt;= 70%</b>
<b>Average Probability of Radar Type 1~4 (%)</b>	<b>94.17% ( &gt;=80% )</b>					



<40MHz /5310MHz >

(Detection = Y, No Detection = N)						
Trial Number	Type 1	Type 2	Type 3	Type 4	Type 5	Type 6
1	Y	Y	Y	Y	Y	Y
2	Y	Y	Y	Y	Y	Y
3	Y	Y	Y	Y	Y	Y
4	Y	Y	Y	Y	Y	Y
5	Y	Y	Y	Y	Y	Y
6	Y	Y	Y	Y	Y	N
7	N	Y	Y	Y	Y	Y
8	Y	Y	Y	Y	Y	Y
9	Y	Y	Y	Y	Y	Y
10	Y	Y	Y	Y	Y	Y
11	Y	Y	Y	Y	Y	Y
12	Y	Y	N	Y	Y	Y
13	Y	Y	Y	Y	Y	Y
14	Y	N	Y	Y	Y	Y
15	Y	Y	Y	Y	Y	Y
16	Y	Y	Y	N	Y	Y
17	Y	Y	N	Y	Y	N
18	Y	Y	Y	Y	N	Y
19	Y	Y	Y	Y	Y	Y
20	Y	Y	Y	Y	Y	Y
21	Y	Y	Y	Y	Y	Y
22	Y	Y	Y	N	Y	Y
23	Y	Y	Y	Y	Y	Y
24	Y	N	Y	Y	Y	Y
25	Y	Y	Y	Y	Y	Y
26	Y	Y	Y	Y	Y	Y
27	Y	Y	Y	Y	Y	Y
28	Y	Y	Y	Y	Y	Y
29	Y	Y	Y	Y	Y	Y
30	Y	Y	Y	Y	Y	Y
<b>Trial of Detection</b>	<b>29/30</b>	<b>28/30</b>	<b>28/30</b>	<b>28/30</b>	<b>29/30</b>	<b>28/30</b>
<b>Probability (%)</b>	<b>96.67%</b>	<b>93.33%</b>	<b>93.33%</b>	<b>93.33%</b>	<b>96.67%</b>	<b>93.33%</b>
<b>Limit (%)</b>	<b>&gt;= 60%</b>	<b>&gt;= 60%</b>	<b>&gt;= 60%</b>	<b>&gt;= 60%</b>	<b>&gt;= 80%</b>	<b>&gt;= 70%</b>
<b>Average Probability of Radar Type 1~4 (%)</b>			<b>94.17% ( &gt;=80% )</b>			



<80MHz / 5290MHz >

(Detection = Y, No Detection = N)						
Trial Number	Type 1	Type 2	Type 3	Type 4	Type 5	Type 6
1	Y	Y	Y	Y	Y	Y
2	N	Y	Y	Y	Y	Y
3	Y	Y	N	Y	Y	Y
4	Y	Y	Y	Y	Y	Y
5	Y	Y	Y	Y	Y	Y
6	Y	Y	Y	Y	Y	Y
7	Y	Y	Y	Y	N	Y
8	Y	Y	Y	Y	Y	Y
9	Y	Y	Y	Y	Y	Y
10	Y	Y	Y	Y	Y	Y
11	Y	Y	Y	N	Y	Y
12	Y	Y	Y	Y	Y	Y
13	Y	N	Y	Y	Y	Y
14	Y	Y	Y	Y	Y	N
15	Y	Y	Y	Y	Y	Y
16	Y	Y	Y	Y	Y	Y
17	Y	Y	Y	Y	Y	Y
18	Y	Y	Y	Y	Y	Y
19	Y	Y	Y	Y	Y	Y
20	Y	Y	Y	Y	Y	Y
21	Y	Y	N	Y	Y	Y
22	Y	Y	Y	Y	Y	Y
23	Y	Y	Y	Y	Y	Y
24	Y	Y	Y	Y	Y	Y
25	Y	Y	Y	Y	Y	Y
26	Y	Y	Y	Y	N	Y
27	Y	Y	Y	Y	Y	Y
28	Y	Y	Y	Y	Y	Y
29	Y	Y	Y	Y	Y	N
30	Y	Y	Y	Y	Y	Y
<b>Trial of Detection</b>	<b>29/30</b>	<b>29/30</b>	<b>28/30</b>	<b>29/30</b>	<b>28/30</b>	<b>28/30</b>
<b>Probability (%)</b>	<b>96.67%</b>	<b>96.67%</b>	<b>93.33%</b>	<b>96.67%</b>	<b>93.33%</b>	<b>93.33%</b>
<b>Limit (%)</b>	<b>&gt;= 60%</b>	<b>&gt;= 60%</b>	<b>&gt;= 60%</b>	<b>&gt;= 60%</b>	<b>&gt;= 80%</b>	<b>&gt;= 70%</b>
<b>Average Probability of Radar Type 1~4 (%)</b>	<b>95.83% ( &gt;=80% )</b>					



<20MHz / 5500MHz >

(Detection = Y, No Detection = N)						
Trial Number	Type 1	Type 2	Type 3	Type 4	Type 5	Type 6
1	Y	Y	Y	Y	Y	Y
2	N	Y	Y	Y	Y	Y
3	Y	Y	Y	Y	Y	Y
4	Y	Y	Y	Y	Y	Y
5	Y	Y	Y	Y	Y	Y
6	Y	Y	Y	Y	Y	Y
7	Y	N	Y	Y	Y	Y
8	Y	Y	N	Y	Y	Y
9	Y	Y	Y	Y	N	Y
10	Y	Y	Y	Y	Y	Y
11	Y	Y	Y	Y	Y	Y
12	Y	Y	Y	Y	Y	Y
13	Y	Y	Y	N	Y	Y
14	Y	Y	Y	Y	Y	Y
15	Y	Y	Y	Y	N	Y
16	N	Y	Y	Y	Y	Y
17	Y	N	Y	Y	Y	Y
18	Y	Y	Y	Y	Y	Y
19	Y	Y	Y	Y	Y	Y
20	Y	Y	Y	Y	Y	Y
21	Y	Y	Y	Y	Y	Y
22	Y	Y	Y	Y	Y	Y
23	Y	Y	Y	Y	Y	Y
24	Y	Y	Y	Y	Y	Y
25	Y	Y	Y	Y	Y	Y
26	Y	Y	Y	Y	Y	Y
27	Y	Y	N	Y	Y	Y
28	N	Y	Y	Y	Y	N
29	Y	Y	Y	Y	Y	Y
30	Y	Y	Y	Y	Y	Y
<b>Trial of Detection</b>	<b>27/30</b>	<b>28/30</b>	<b>28/30</b>	<b>29/30</b>	<b>28/30</b>	<b>29/30</b>
<b>Probability (%)</b>	<b>90%</b>	<b>93.33%</b>	<b>93.33%</b>	<b>96.67%</b>	<b>93.33%</b>	<b>96.67%</b>
<b>Limit (%)</b>	<b>&gt;= 60%</b>	<b>&gt;= 60%</b>	<b>&gt;= 60%</b>	<b>&gt;= 60%</b>	<b>&gt;= 80%</b>	<b>&gt;= 70%</b>
<b>Average Probability of Radar Type 1~4 (%)</b>			<b>93.33% ( &gt;=80% )</b>			



<40MHz / 5510MHz >

(Detection = Y, No Detection = N)						
Trial Number	Type 1	Type 2	Type 3	Type 4	Type 5	Type 6
1	Y	Y	Y	Y	Y	Y
2	Y	Y	Y	Y	Y	Y
3	Y	Y	Y	Y	Y	Y
4	Y	Y	N	Y	N	Y
5	Y	Y	Y	Y	Y	Y
6	Y	Y	Y	Y	Y	N
7	Y	Y	Y	Y	Y	Y
8	Y	Y	Y	Y	Y	Y
9	Y	Y	Y	Y	Y	Y
10	Y	Y	Y	Y	Y	Y
11	N	Y	Y	Y	Y	Y
12	Y	Y	Y	Y	Y	Y
13	Y	Y	Y	Y	Y	Y
14	Y	Y	Y	Y	Y	Y
15	Y	Y	Y	Y	Y	N
16	Y	Y	Y	Y	Y	Y
17	Y	Y	Y	Y	Y	Y
18	Y	N	Y	N	Y	Y
19	Y	Y	Y	Y	Y	Y
20	Y	Y	Y	Y	Y	Y
21	Y	N	Y	Y	Y	Y
22	Y	Y	Y	Y	Y	Y
23	Y	Y	Y	Y	Y	Y
24	Y	Y	Y	Y	Y	Y
25	Y	Y	Y	Y	Y	Y
26	Y	Y	Y	Y	Y	Y
27	Y	Y	Y	Y	Y	Y
28	Y	Y	Y	Y	Y	Y
29	Y	Y	Y	N	Y	Y
30	Y	Y	Y	Y	Y	Y
<b>Trial of Detection</b>	<b>29/30</b>	<b>28/30</b>	<b>29/30</b>	<b>28/30</b>	<b>29/30</b>	<b>28/30</b>
<b>Probability (%)</b>	<b>96.67%</b>	<b>93.33%</b>	<b>96.67%</b>	<b>93.33%</b>	<b>96.67%</b>	<b>93.33%</b>
<b>Limit (%)</b>	<b>&gt;= 60%</b>	<b>&gt;= 60%</b>	<b>&gt;= 60%</b>	<b>&gt;= 60%</b>	<b>&gt;= 80%</b>	<b>&gt;= 70%</b>
<b>Average Probability of Radar Type 1~4 (%)</b>			<b>95% ( &gt;=80% )</b>			



<80MHz / 5530MHz >

(Detection = Y, No Detection = N)						
Trial Number	Type 1	Type 2	Type 3	Type 4	Type 5	Type 6
1	Y	Y	Y	Y	Y	Y
2	Y	Y	Y	N	Y	Y
3	Y	Y	N	Y	Y	Y
4	Y	Y	Y	Y	Y	Y
5	Y	Y	Y	Y	Y	Y
6	Y	N	Y	Y	Y	Y
7	Y	Y	Y	Y	Y	Y
8	Y	Y	Y	Y	Y	Y
9	N	Y	Y	Y	Y	Y
10	Y	Y	Y	Y	N	Y
11	Y	Y	Y	Y	Y	Y
12	Y	Y	Y	Y	Y	Y
13	Y	Y	Y	Y	Y	Y
14	Y	Y	Y	Y	N	Y
15	Y	N	Y	Y	Y	Y
16	Y	Y	Y	Y	Y	Y
17	N	Y	Y	Y	Y	Y
18	Y	Y	Y	Y	Y	Y
19	Y	Y	Y	Y	Y	N
20	Y	Y	Y	Y	Y	Y
21	Y	Y	Y	Y	Y	Y
22	Y	Y	Y	Y	Y	Y
23	Y	Y	Y	Y	Y	Y
24	Y	N	Y	N	Y	Y
25	Y	Y	Y	Y	Y	Y
26	Y	Y	Y	Y	Y	Y
27	Y	Y	Y	Y	Y	Y
28	Y	Y	Y	Y	Y	Y
29	Y	Y	Y	Y	Y	Y
30	Y	Y	Y	Y	Y	Y
<b>Trial of Detection</b>	<b>28/30</b>	<b>27/30</b>	<b>29/30</b>	<b>28/30</b>	<b>28/30</b>	<b>29/30</b>
<b>Probability (%)</b>	<b>93.33%</b>	<b>90%</b>	<b>96.67%</b>	<b>93.33%</b>	<b>93.33%</b>	<b>96.67%</b>
<b>Limit (%)</b>	<b>&gt;= 60%</b>	<b>&gt;= 60%</b>	<b>&gt;= 60%</b>	<b>&gt;= 60%</b>	<b>&gt;= 80%</b>	<b>&gt;= 70%</b>
<b>Average Probability of Radar Type 1~4 (%)</b>			<b>93.33% ( &gt;=80% )</b>			



## 4 List of Measuring Equipment

Instrument	Manufacturer	Model No.	Serial No.	Characteristics	Calibration Date	Test Date	Due Date	Remark
Signal Generator	Keysight	N5172B	MY53052190	9kHz~6GHz	Apr. 29, 2016	Sep. 24, 2016~ Sep. 29, 2016	Apr. 28, 2017	DFS (DFS02-HY)
Spectrum Analyzer	Keysight	N9010A	MY56070412	10Hz~7GHz	Aug. 05, 2016	Sep. 24, 2016~ Sep. 29, 2016	Aug. 04, 2017	DFS (DFS02-HY)



## **Appendix A. Radar Parameters**



**Channel 58 Bandwidth 80MHz**

Test Engineer:	Bill Kuo	Temperature:	21~25	°C
Test Date:	2016/09/24~2016/09/29	Relative Humidity:	51~54	%

**DFS Radar Parameters**  
**FCC Radar Type 1**  
**Channel 58 Bandwidth 80MHz**

Trial #	Pulse Repetition Frequency Number (1 to 23)	Pulse Repetition Frequency (Pulses Per Second)	Pulse Repetition Interval (Microseconds)	Detection (Yes / No)
1	22	1066.10	938	Yes
2	10	1432.66	698	No
3	6	1618.12	618	Yes
4	2	1858.74	538	Yes
5	19	1138.95	878	Yes
6	12	326.16	3066	Yes
7	7	1567.40	638	Yes
8	21	1089.32	918	Yes
9	17	1193.32	838	Yes
10	18	1165.50	858	Yes
11	15	1253.13	798	Yes
12	11	1392.76	718	Yes
13	4	1730.10	578	Yes
14	5	1672.24	598	Yes
15	3	1792.11	558	Yes
16		394.32	2536	Yes
17		1035.20	966	Yes
18		1209.19	827	Yes
19		399.84	2501	Yes
20		385.36	2595	Yes
21		897.67	1114	Yes
22		768.05	1302	Yes
23		328.41	3045	Yes
24		615.76	1624	Yes
25		347.46	2878	Yes
26		973.71	1027	Yes
27		402.41	2485	Yes
28		625.00	1600	Yes
29		853.24	1172	Yes
30		849.62	1177	Yes

**DFS Radar Parameters**  
**FCC Radar Type 2**  
**Channel 58 Bandwidth 80MHz**

Trial #	Number Pulses per Burst	Pulse Width (Microseconds)	Pulse Repetition Interval (Microseconds)	Detection (Yes / No)
1	26	3.20	179	Yes
2	23	1.10	207	Yes
3	24	2.10	230	Yes
4	29	4.80	200	Yes
5	28	3.90	214	Yes
6	26	2.90	222	Yes
7	26	3.20	204	Yes
8	25	2.50	192	Yes
9	26	3.10	164	Yes
10	23	1.20	156	Yes
11	27	3.90	210	Yes
12	29	4.60	201	Yes
13	26	3.20	162	No
14	25	2.20	197	Yes
15	29	4.50	163	Yes
16	26	3.00	203	Yes
17	29	5.00	168	Yes
18	25	2.40	217	Yes
19	26	2.90	191	Yes
20	25	2.30	166	Yes
21	27	3.70	150	Yes
22	25	2.20	176	Yes
23	29	4.90	195	Yes
24	26	2.90	202	Yes
25	25	2.50	178	Yes
26	23	1.10	206	Yes
27	27	3.80	155	Yes
28	29	4.70	157	Yes
29	25	2.40	224	Yes
30	28	4.20	159	Yes

**DFS Radar Parameters**  
**FCC Radar Type 3**  
**Channel 58 Bandwidth 80MHz**

Trial #	Number Pulses per Burst	Pulse Width (Microseconds)	Pulse Repetition Interval (Microseconds)	Detection (Yes / No)
1	57	1.00	938	Yes
2	76	1.00	698	Yes
3	86	1.00	618	No
4	99	1.00	538	Yes
5	61	1.00	878	Yes
6	18	1.00	3066	Yes
7	83	1.00	638	Yes
8	58	1.00	918	Yes
9	63	1.00	838	Yes
10	62	1.00	858	Yes
11	67	1.00	798	Yes
12	74	1.00	718	Yes
13	92	1.00	578	Yes
14	89	1.00	598	Yes
15	95	1.00	558	Yes
16	21	1.00	2536	Yes
17	55	1.00	966	Yes
18	64	1.00	827	Yes
19	22	1.00	2501	Yes
20	21	1.00	2595	Yes
21	48	1.00	1114	No
22	41	1.00	1302	Yes
23	18	1.00	3045	Yes
24	33	1.00	1624	Yes
25	19	1.00	2878	Yes
26	52	1.00	1027	Yes
27	22	1.00	2485	Yes
28	33	1.00	1600	Yes
29	46	1.00	1172	Yes
30	45	1.00	1177	Yes

**DFS Radar Parameters**  
**FCC Radar Type 4**  
**Channel 58 Bandwidth 80MHz**

Trial #	Number Pulses per Burst	Pulse Width (Microseconds)	Pulse Repetition Interval (Microseconds)	Detection (Yes / No)
1	57	1.00	938	Yes
2	76	1.00	698	Yes
3	86	1.00	618	Yes
4	99	1.00	538	Yes
5	61	1.00	878	Yes
6	18	1.00	3066	Yes
7	83	1.00	638	Yes
8	58	1.00	918	Yes
9	63	1.00	838	Yes
10	62	1.00	858	Yes
11	67	1.00	798	No
12	74	1.00	718	Yes
13	92	1.00	578	Yes
14	89	1.00	598	Yes
15	95	1.00	558	Yes
16	21	1.00	2536	Yes
17	55	1.00	966	Yes
18	64	1.00	827	Yes
19	22	1.00	2501	Yes
20	21	1.00	2595	Yes
21	48	1.00	1114	Yes
22	41	1.00	1302	Yes
23	18	1.00	3045	Yes
24	33	1.00	1624	Yes
25	19	1.00	2878	Yes
26	52	1.00	1027	Yes
27	22	1.00	2485	Yes
28	33	1.00	1600	Yes
29	46	1.00	1172	Yes
30	45	1.00	1177	Yes

**DFS Radar Parameters**  
**FCC Radar Type 5**  
**Channel 58 Bandwidth 80MHz**

Trial Number:			1			Detection (Yes/No)
Number of Bursts in Trial:			9			
Chirp Center Frequency:			5290			
Burst	Number of Pulses	Pulse Width (Microseconds)	Chirp Width (MHz)	Pulse 1-to-2 Spacing (µsec)	Pulse 2-to-3 Spacing (µsec)	Starting Location Within Interval (µsec)
1	1	55	6			456091
2	1	64.9	6			778946
3	1	52	6			1101904
4	2	74.2	6	1019		93064
5	2	76.7	6	1180		415903
6	1	60	6			739340
7	1	53.1	6			1062002
8	2	80.8	6	1772		53279
9	2	66.8	6	1308		375962
10						
11						
12						
13						
14						
15						
16						
17						
18						
19						
20						

Trial Number:			2			Detection (Yes/No)
Number of Bursts in Trial:			11			
Chirp Center Frequency:			5290			
Burst	Number of Pulses	Pulse Width (Microseconds)	Chirp Width (MHz)	Pulse 1-to-2 Spacing (µsec)	Pulse 2-to-3 Spacing (µsec)	Starting Location Within Interval (µsec)
1	1	57.3	9			572286
2	1	60.1	9			836083
3	3	89.6	9	1440	1575	11057
4	2	79.5	9	1369		274996
5	3	98.8	9	1099	1275	538369
6	3	84.7	9	1650	1769	801389
7	1	51.4	9			1068068
8	2	69.8	9	1983		242218
9	2	83.3	9	1950		506136
10	1	50.9	9			770863
11	2	71.4	9	1116		1034768
12						
13						
14						
15						
16						
17						
18						
19						
20						

**DFS Radar Parameters**  
**FCC Radar Type 5**  
**Channel 58 Bandwidth 80MHz**

Trial Number:			3			Detection (Yes/No)
Number of Bursts in Trial:			8			
Chirp Center Frequency:			5290			
Burst	Number of Pulses	Pulse Width (Microseconds)	Chirp Width (MHz)	Pulse 1-to-2 Spacing (µsec)	Pulse 2-to-3 Spacing (µsec)	Starting Location Within Interval (µsec)
1	3	94.2	5	1478	1777	288532
2	2	82.9	5	1681		651974
3	2	73.5	5	1889		1014683
4	2	75.8	5	1295		1378001
5	2	69.7	5	1075		244188
6	3	86.9	5	1907	1463	606557
7	3	97.4	5	1072	1173	969693
8	2	76.9	5	1193		1333926
9						
10						
11						
12						
13						
14						
15						
16						
17						
18						
19						
20						

Trial Number:			4			Detection (Yes/No)
Number of Bursts in Trial:			8			
Chirp Center Frequency:			5290			
Burst	Number of Pulses	Pulse Width (Microseconds)	Chirp Width (MHz)	Pulse 1-to-2 Spacing (µsec)	Pulse 2-to-3 Spacing (µsec)	Starting Location Within Interval (µsec)
1	1	66.2	12			113987
2	1	63.2	12			321486
3	2	81.6	12	1624		528264
4	3	97.1	12	1125	1787	733969
5	1	62.5	12			88396
6	1	61.5	12			295881
7	3	92.6	12	1645	1343	501606
8	3	92.5	12	1899	1591	708477
9	1	56.1	12			62881
10	3	85.6	12	1837	1392	269320
11	1	61	12			477893
12	1	51.8	12			685309
13	3	95.8	12	1327	1249	37176
14	1	58.5	12			244764
15						
16						
17						
18						
19						
20						

**DFS Radar Parameters**  
**FCC Radar Type 5**  
**Channel 58 Bandwidth 80MHz**

Trial Number:			5			Detection (Yes/No)
Number of Bursts in Trial:			14			
Chirp Center Frequency:			5290			Yes
Burst	Number of Pulses	Pulse Width (Microseconds)	Chirp Width (MHz)	Pulse 1-to-2 Spacing (µsec)	Pulse 2-to-3 Spacing (µsec)	Starting Location Within Interval (µsec)
1	2	75.4	13	1733		451522
2	3	90.7	13	1570	1285	657471
3	3	87.6	13	1868	1643	11695
4	3	93.5	13	1371	1579	218584
5	3	94.5	13	1105	1147	425679
6	1	53.9	13			634053
7	3	98.2	13	1652	1311	839188
8	3	97.5	13	1351	1316	193137
9	2	83.2	13	1490		400517
10	3	99.6	13	1642	1680	606704
11	1	62.1	13			815936
12	1	51.5	13			168219
13	2	72.3	13	1628		375144
14	2	72.1	13	1065		582695
15						
16						
17						
18						
19						
20						

Trial Number:			6			Detection (Yes/No)
Number of Bursts in Trial:			10			
Chirp Center Frequency:			5290			Yes
Burst	Number of Pulses	Pulse Width (Microseconds)	Chirp Width (MHz)	Pulse 1-to-2 Spacing (µsec)	Pulse 2-to-3 Spacing (µsec)	Starting Location Within Interval (µsec)
1	3	91.4	8	1268	1362	1105275
2	2	76.2	8	1870		199366
3	1	54.4	8			490358
4	3	89.9	8	1256	1414	779365
5	1	62.6	8			1071413
6	2	76.3	8	1387		163769
7	1	64.6	8			454651
8	1	53.6	8			745006
9	2	75.7	8	1431		1034301
10	1	63.1	8			128079
11						
12						
13						
14						
15						
16						
17						
18						
19						
20						



**DFS Radar Parameters**  
**FCC Radar Type 5**  
**Channel 58 Bandwidth 80MHz**

Trial Number:			7			Detection (Yes/No)
Number of Bursts in Trial:			8			
Chirp Center Frequency:			5290			
Burst	Number of Pulses	Pulse Width (Microseconds)	Chirp Width (MHz)	Pulse 1-to-2 Spacing ( $\mu$ sec)	Pulse 2-to-3 Spacing ( $\mu$ sec)	Starting Location Within Interval ( $\mu$ sec)
1	2	75.6	14	1155		216520
2	3	85.6	14	1993	1103	396614
3	1	57.4	14			579687
4	2	82.8	14	1995		12889
5	3	88.3	14	1447	1358	193680
6	2	76.3	14	1892		374938
7	3	92.4	14	1841	1127	555060
8	3	93.4	14	1225	1449	736781
9	2	78.8	14	1508		171787
10	2	68.8	14	1329		353186
11	2	80.1	14	1041		534595
12	2	82.1	14	1583		715294
13	3	84.9	14	1169	1756	149063
14	1	60.9	14			331211
15	3	89.2	14	1793	1655	510715
16	2	70.5	14	1404		693078
17						
18						
19						
20						

Trial Number:			8			Detection (Yes/No)
Number of Bursts in Trial:			16			
Chirp Center Frequency:			5290			
Burst	Number of Pulses	Pulse Width (Microseconds)	Chirp Width (MHz)	Pulse 1-to-2 Spacing ( $\mu$ sec)	Pulse 2-to-3 Spacing ( $\mu$ sec)	Starting Location Within Interval ( $\mu$ sec)
1	2	75.6	14	1155		216520
2	3	85.6	14	1993	1103	396614
3	1	57.4	14			579687
4	2	82.8	14	1995		12889
5	3	88.3	14	1447	1358	193680
6	2	76.3	14	1892		374938
7	3	92.4	14	1841	1127	555060
8	3	93.4	14	1225	1449	736781
9	2	78.8	14	1508		171787
10	2	68.8	14	1329		353186
11	2	80.1	14	1041		534595
12	2	82.1	14	1583		715294
13	3	84.9	14	1169	1756	149063
14	1	60.9	14			331211
15	3	89.2	14	1793	1655	510715
16	2	70.5	14	1404		693078
17						
18						
19						
20						

**DFS Radar Parameters**  
**FCC Radar Type 5**  
**Channel 58 Bandwidth 80MHz**

Trial Number:			9			Detection (Yes/No)
Number of Bursts in Trial:			12			
Chirp Center Frequency:			5290			
Burst	Number of Pulses	Pulse Width (Microseconds)	Chirp Width (MHz)	Pulse 1-to-2 Spacing (µsec)	Pulse 2-to-3 Spacing (µsec)	Starting Location Within Interval (µsec)
1	1	51.1	10			169836
2	2	79.9	10	1817		411435
3	2	81.1	10	1203		653492
4	2	71.2	10	1523		894783
5	3	89.2	10	1910	1152	139593
6	2	69.5	10	1149		381670
7	3	94	10	1755	1973	622378
8	2	71.8	10	1465		865458
9	1	65	10			110246
10	2	74.4	10	1489		351980
11	1	66.4	10			594506
12	2	76.5	10	1040		835513
13						
14						
15						
16						
17						
18						
19						
20						

Trial Number:			10			Detection (Yes/No)
Number of Bursts in Trial:			9			
Chirp Center Frequency:			5290			
Burst	Number of Pulses	Pulse Width (Microseconds)	Chirp Width (MHz)	Pulse 1-to-2 Spacing (µsec)	Pulse 2-to-3 Spacing (µsec)	Starting Location Within Interval (µsec)
1	3	97.8	7	1882	1779	106978
2	1	55.9	7			430424
3	1	52.1	7			753353
4	3	99	7	1767	1057	1073995
5	2	77.3	7	1498		67384
6	1	63.1	7			390566
7	2	76	7	1717		712399
8	3	86.7	7	1195	1667	1034158
9	1	64.6	7			27685
10						
11						
12						
13						
14						
15						
16						
17						
18						
19						
20						

**DFS Radar Parameters**  
**FCC Radar Type 5**  
**Channel 58 Bandwidth 80MHz**

Trial Number:			11			Detection (Yes/No)
Number of Bursts in Trial:			10			
Chirp Center Frequency:			5255.2125			
Burst	Number of Pulses	Pulse Width (Microseconds)	Chirp Width (MHz)	Pulse 1-to-2 Spacing (µsec)	Pulse 2-to-3 Spacing (µsec)	Starting Location Within Interval (µsec)
1	1	58.6	8			315543
2	3	88	8	1770	1571	604519
3	2	78.2	8	1828		895230
4	3	97.6	8	1496	1028	1185129
5	2	69.3	8	1140		279539
6	3	97.5	8	1468	1623	569056
7	3	95.9	8	1951	1279	858767
8	2	73.5	8	1480		1150807
9	3	93.7	8	1025	1969	243392
10	2	78.2	8	1388		534084
11						
12						
13						
14						
15						
16						
17						
18						
19						
20						

Trial Number:			12			Detection (Yes/No)
Number of Bursts in Trial:			18			
Chirp Center Frequency:			5258.8125			
Burst	Number of Pulses	Pulse Width (Microseconds)	Chirp Width (MHz)	Pulse 1-to-2 Spacing (µsec)	Pulse 2-to-3 Spacing (µsec)	Starting Location Within Interval (µsec)
1	1	66.1	17			458266
2	2	78.8	17	1011		618238
3	3	85.7	17	1196	1739	115058
4	3	91.1	17	1002	1952	275495
5	1	65.3	17			438138
6	1	53	17			599661
7	1	51	17			95681
8	1	59.8	17			257166
9	1	56.1	17			418283
10	3	91.6	17	1314	1801	576878
11	3	85.6	17	1415	1931	75439
12	2	67.8	17	1340		236781
13	1	63.8	17			398735
14	1	59.8	17			559395
15	1	65.8	17			55892
16	3	95.7	17	1865	1231	216175
17	2	72.9	17	1848		377480
18	1	66.6	17			539999
19						
20						

**DFS Radar Parameters**  
**FCC Radar Type 5**  
**Channel 58 Bandwidth 80MHz**

Trial Number:			13			Detection (Yes/No) Yes
Number of Bursts in Trial:			15			
Chirp Center Frequency:			5257.6125			
Burst	Number of Pulses	Pulse Width (Microseconds)	Chirp Width (MHz)	Pulse 1-to-2 Spacing (µsec)	Pulse 2-to-3 Spacing (µsec)	Starting Location Within Interval (µsec)
1	2	81.1	14	1691		43173
2	1	54.7	14			237072
3	2	71.7	14	1670		429725
4	3	85	14	1339	1900	621518
5	1	52.4	14			19432
6	1	55.8	14			213028
7	3	92.5	14	1427	1153	405290
8	3	92	14	1990	1317	597929
9	1	52.8	14			794345
10	2	73.6	14	1715		188943
11	2	69.9	14	1102		382243
12	2	72	14	1878		574958
13	3	98.2	14	1020	1958	767112
14	3	98.3	14	1277	1686	164814
15	2	71.3	14	1296		358432
16						
17						
18						
19						
20						

Trial Number:			14			Detection (Yes/No) Yes
Number of Bursts in Trial:			20			
Chirp Center Frequency:			5260.0125			
Burst	Number of Pulses	Pulse Width (Microseconds)	Chirp Width (MHz)	Pulse 1-to-2 Spacing (µsec)	Pulse 2-to-3 Spacing (µsec)	Starting Location Within Interval (µsec)
1	3	96.2	20	1464	1142	412467
2	1	50.2	20			559149
3	3	97.8	20	1221	1168	105622
4	1	62	20			251304
5	1	64.8	20			396581
6	3	86.9	20	1208	1270	539601
7	3	95.9	20	1963	1750	87618
8	2	76.2	20	1318		232979
9	1	53.3	20			378329
10	2	69.8	20	1703		521958
11	3	95.2	20	1187	1557	69956
12	2	79	20	1968		214668
13	3	90.8	20	1822	1297	358915
14	2	74.2	20	1816		504640
15	2	68.3	20	1761		52265
16	2	81.8	20	1323		197219
17	2	73.6	20	1189		342218
18	2	74.6	20	1410		486611
19	2	79.3	20	1441		34446
20	3	92.5	20	1661	1771	178766

**DFS Radar Parameters**  
**FCC Radar Type 5**  
**Channel 58 Bandwidth 80MHz**

Trial Number:			15			Detection (Yes/No)
Number of Bursts in Trial:			17			
Chirp Center Frequency:			5258.4125			
Burst	Number of Pulses	Pulse Width (Microseconds)	Chirp Width (MHz)	Pulse 1-to-2 Spacing (µsec)	Pulse 2-to-3 Spacing (µsec)	Starting Location Within Interval (µsec)
1	3	88.9	16	1239	1759	380606
2	1	56.5	16			553212
3	2	81.2	16	1330		19594
4	2	76.3	16	1862		190008
5	2	79.9	16	1368		360470
6	3	98.7	16	1510	1320	529951
7	2	73.4	16	1529		701560
8	1	50.2	16			169324
9	2	77.5	16	1067		339969
10	3	89.9	16	1344	1559	509095
11	3	84.2	16	1901	1918	677997
12	3	93.5	16	1656	1355	147725
13	3	87.3	16	1432	1731	317636
14	3	96.5	16	1511	1732	487504
15	2	67.6	16	1078		659989
16	1	59.6	16			127277
17	2	68	16	1156		297601
18						
19						
20						

Trial Number:			16			Detection (Yes/No)
Number of Bursts in Trial:			8			
Chirp Center Frequency:			5254.0125			
Burst	Number of Pulses	Pulse Width (Microseconds)	Chirp Width (MHz)	Pulse 1-to-2 Spacing (µsec)	Pulse 2-to-3 Spacing (µsec)	Starting Location Within Interval (µsec)
1	3	83.7	5	1908	1548	995497
2	1	58.1	5			1361600
3	2	79.8	5	1885		225782
4	3	85.2	5	1647	1080	588360
5	2	78.5	5	1887		951829
6	2	68.4	5	1269		1315202
7	1	65.1	5			181313
8	1	57.3	5			544812
9						
10						
11						
12						
13						
14						
15						
16						
17						
18						
19						
20						

**DFS Radar Parameters**  
**FCC Radar Type 5**  
**Channel 58 Bandwidth 80MHz**

Trial Number:			17			Detection (Yes/No)
Number of Bursts in Trial:			13			
Chirp Center Frequency:			5256.4125			
Burst	Number of Pulses	Pulse Width (Microseconds)	Chirp Width (MHz)	Pulse 1-to-2 Spacing ( $\mu$ sec)	Pulse 2-to-3 Spacing ( $\mu$ sec)	Starting Location Within Interval ( $\mu$ sec)
1	2	76.8	11	1829		557698
2	1	51.7	11			782182
3	2	67.8	11	1402		83874
4	3	84.5	11	1036	1500	306513
5	3	91.9	11	1855	1519	529020
6	3	96.4	11	1988	1331	751885
7	3	97.4	11	1991	1337	56297
8	2	68.9	11	1858		279421
9	1	55.8	11			503662
10	2	82.5	11	1538		725515
11	3	89.7	11	1095	1710	28860
12	2	69.1	11	1029		252246
13	2	71.5	11	1785		475029
14						
15						
16						
17						
18						
19						
20						

Trial Number:			18			Detection (Yes/No)
Number of Bursts in Trial:			16			
Chirp Center Frequency:			5258.0125			
Burst	Number of Pulses	Pulse Width (Microseconds)	Chirp Width (MHz)	Pulse 1-to-2 Spacing ( $\mu$ sec)	Pulse 2-to-3 Spacing ( $\mu$ sec)	Starting Location Within Interval ( $\mu$ sec)
1	2	82.1	15	1760		566651
2	1	66.2	15			1143
3	1	63.5	15			182789
4	3	95.7	15	1083	1418	362933
5	3	98.8	15	1254	1088	543876
6	1	63.5	15			727356
7	3	85.7	15	1283	1651	159683
8	1	51.6	15			341898
9	3	91.8	15	1399	1640	521273
10	3	94.3	15	1108	1675	702317
11	1	56.5	15			137881
12	1	58.7	15			319662
13	1	63.7	15			501159
14	3	90	15	1438	1925	679274
15	1	66.5	15			115593
16	3	99.6	15	1632	1171	296127
17						
18						
19						
20						

**DFS Radar Parameters**  
**FCC Radar Type 5**  
**Channel 58 Bandwidth 80MHz**

Trial Number:			19			Detection (Yes/No)
Number of Bursts in Trial:			13			
Chirp Center Frequency:			5256.4125			
Burst	Number of Pulses	Pulse Width (Microseconds)	Chirp Width (MHz)	Pulse 1-to-2 Spacing (µsec)	Pulse 2-to-3 Spacing (µsec)	Starting Location Within Interval (µsec)
1	1	65.7	11			534549
2	3	85.6	11	1321.000	1726.000	755351
3	3	93.6	11	1863.000	1370.000	59514
4	3	86.8	11	1998.000	1603.000	282206
5	2	74.6	11	1505.000		505905
6	2	81.5	11	1808.000		728563
7	1	64	11			32199
8	2	78	11	1916.000		255085
9	3	90.6	11	1299.000	1596.000	477956
10	3	96.6	11	1692.000	1133.000	700648
11	1	51.5	11			4666
12	3	92	11	1584.000	1457.000	227313
13	1	66.2	11			451522
14						
15						
16						
17						
18						
19						
20						

Trial Number:			20			Detection (Yes/No)
Number of Bursts in Trial:			13			
Chirp Center Frequency:			5256.4125			
Burst	Number of Pulses	Pulse Width (Microseconds)	Chirp Width (MHz)	Pulse 1-to-2 Spacing (µsec)	Pulse 2-to-3 Spacing (µsec)	Starting Location Within Interval (µsec)
1	1	65.7	11			534549
2	3	85.6	11	1321	1726	755351
3	3	93.6	11	1863	1370	59514
4	3	86.8	11	1998	1603	282206
5	2	74.6	11	1505		505905
6	2	81.5	11	1808		728563
7	1	64	11			32199
8	2	78	11	1916		255085
9	3	90.6	11	1299	1596	477956
10	3	96.6	11	1692	1133	700648
11	1	51.5	11			4666
12	3	92	11	1584	1457	227313
13	1	66.2	11			451522
14						
15						
16						
17						
18						
19						
20						

**DFS Radar Parameters**  
**FCC Radar Type 5**  
**Channel 58 Bandwidth 80MHz**

Trial Number:			21			Detection (Yes/No) Yes
Number of Bursts in Trial:			19			
Chirp Center Frequency:			5320.3875			
Burst	Number of Pulses	Pulse Width (Microseconds)	Chirp Width (MHz)	Pulse 1-to-2 Spacing (µsec)	Pulse 2-to-3 Spacing (µsec)	Starting Location Within Interval (µsec)
1	3	89.6	19	1913	1976	458587
2	2	79.8	19	1367		612743
3	1	54.9	19			137244
4	2	79.4	19	1803		289280
5	1	55.7	19			442917
6	3	85.1	19	1606	1143	592930
7	1	57.4	19			118375
8	1	61.2	19			271325
9	2	75.8	19	1811		422480
10	2	78.2	19	1852		574802
11	1	56.3	19			99538
12	2	80.9	19	1220		251892
13	2	69.4	19	1687		404285
14	3	98.6	19	1518	1154	555798
15	2	72.1	19	1332		80537
16	1	51.5	19			233486
17	1	53	19			386496
18	1	52.6	19			539575
19	2	79.1	19	1949		61718
20						

Trial Number:			22			Detection (Yes/No) Yes
Number of Bursts in Trial:			16			
Chirp Center Frequency:			5321.9875			
Burst	Number of Pulses	Pulse Width (Microseconds)	Chirp Width (MHz)	Pulse 1-to-2 Spacing (µsec)	Pulse 2-to-3 Spacing (µsec)	Starting Location Within Interval (µsec)
1	2	69.3	15	1877		254487
2	1	57.8	15			436785
3	2	79.9	15	2000		616628
4	1	63.1	15			51159
5	2	69.9	15	1380		232224
6	3	99	15	1994	1160	412665
7	2	77	15	1860		594490
8	1	60.2	15			28800
9	2	80.3	15	1798		209873
10	2	78.6	15	1522		391228
11	2	68.2	15	1608		571946
12	2	67.2	15	1114		6427
13	3	88.5	15	1446	1406	187164
14	2	74.6	15	1682		368451
15	2	83.3	15	1853		549946
16	2	67.7	15	1423		731000
17						
18						
19						
20						



**DFS Radar Parameters**  
**FCC Radar Type 5**  
**Channel 58 Bandwidth 80MHz**

Trial Number:			23			Detection (Yes/No)
Number of Bursts in Trial:			14			
Chirp Center Frequency:			5323.1875			
Burst	Number of Pulses	Pulse Width (Microseconds)	Chirp Width (MHz)	Pulse 1-to-2 Spacing ( $\mu$ sec)	Pulse 2-to-3 Spacing ( $\mu$ sec)	Starting Location Within Interval ( $\mu$ sec)
1	2	80.6	12	1325		188949
2	2	83.3	12	1202		396121
3	3	86.7	12	1451	1372	602317
4	1	63.1	12			811814
5	2	68	12	1807		163477
6	3	89.5	12	1134	1416	370010
7	3	94.4	12	1948	1058	577001
8	3	90	12	1047	1705	784127
9	1	57.4	12			138193
10	3	87.2	12	1074	1001	344709
11	1	55.9	12			553281
12	1	55.2	12			761200
13	2	82.9	12	1212		112482
14	3	92	12	1473	1922	318957
15						
16						
17						
18						
19						
20						

Trial Number:			24			Detection (Yes/No)
Number of Bursts in Trial:			14			
Chirp Center Frequency:			5322.7875			
Burst	Number of Pulses	Pulse Width (Microseconds)	Chirp Width (MHz)	Pulse 1-to-2 Spacing ( $\mu$ sec)	Pulse 2-to-3 Spacing ( $\mu$ sec)	Starting Location Within Interval ( $\mu$ sec)
1	2	76.5	13	1555		526518
2	3	87.5	13	1504	1599	732507
3	3	93.9	13	1664	1391	86736
4	2	72.4	13	1614		294120
5	2	72.6	13	1106		501671
6	1	58.4	13			709310
7	1	59.6	13			61533
8	1	66.6	13			268913
9	3	85	13	1186	1796	475077
10	2	80.5	13	1727		682804
11	2	78.8	13	1452		35899
12	2	74.8	13	1935		242795
13	2	77.2	13	1197		450389
14	2	82.6	13	1082		657756
15						
16						
17						
18						
19						
20						

**DFS Radar Parameters**  
**FCC Radar Type 5**  
**Channel 58 Bandwidth 80MHz**

Trial Number:			25			Detection (Yes/No)
Number of Bursts in Trial:			13			
Chirp Center Frequency:			5323.5875			
Burst	Number of Pulses	Pulse Width (Microseconds)	Chirp Width (MHz)	Pulse 1-to-2 Spacing (µsec)	Pulse 2-to-3 Spacing (µsec)	Starting Location Within Interval (µsec)
1	1	57.5	11			11192
2	1	61	11			234643
3	2	67.9	11	1502		457245
4	1	56.2	11			681769
5	3	86.1	11	1228	1031	902590
6	2	80.9	11	1445		206945
7	3	91.5	11	1455	1122	429305
8	2	68.2	11	1015		653478
9	1	66.3	11			877390
10	3	89.5	11	1543	1470	178971
11	1	61.1	11			403302
12	2	79.9	11	1214		625531
13	1	63.5	11			850373
14						
15						
16						
17						
18						
19						
20						

Trial Number:			26			Detection (Yes/No)
Number of Bursts in Trial:			17			
Chirp Center Frequency:			5321.5875			
Burst	Number of Pulses	Pulse Width (Microseconds)	Chirp Width (MHz)	Pulse 1-to-2 Spacing (µsec)	Pulse 2-to-3 Spacing (µsec)	Starting Location Within Interval (µsec)
1	3	90	16	1185	1509	115777
2	1	55.7	16			286979
3	2	82.7	16	1904		456477
4	3	93	16	1765	1223	625877
5	2	71.7	16	1073		95108
6	2	77.4	16	1237		265667
7	3	88.3	16	1250	1017	435305
8	1	52.1	16			607978
9	2	80.7	16	1532		74051
10	2	73.3	16	1272		244577
11	1	66	16			415586
12	1	51.9	16			586282
13	2	74.8	16	1845		52957
14	1	58	16			223816
15	1	63.9	16			394907
16	3	98.3	16	1042	1007	563737
17	1	56.1	16			32086
18						
19						
20						

**DFS Radar Parameters**  
**FCC Radar Type 5**  
**Channel 58 Bandwidth 80MHz**

Trial Number:			27			Detection (Yes/No)
Number of Bursts in Trial:			20			
Chirp Center Frequency:			5319.9875			
Burst	Number of Pulses	Pulse Width (Microseconds)	Chirp Width (MHz)	Pulse 1-to-2 Spacing ( $\mu$ sec)	Pulse 2-to-3 Spacing ( $\mu$ sec)	Starting Location Within Interval ( $\mu$ sec)
1	3	84.4	20	1006	1288	171798
2	3	93.2	20	1704	1121	316209
3	1	62.2	20			463045
4	1	61.7	20			9381
5	2	82.4	20	1923		154002
6	3	96.5	20	1257	1352	298454
7	2	69.3	20	1714		443388
8	3	99.7	20	1753	1016	587670
9	2	69.1	20	1145		136359
10	1	52	20			281692
11	1	50.4	20			426935
12	1	58.2	20			571957
13	2	71.1	20	1539		118444
14	1	54.4	20			264113
15	1	61.3	20			408792
16	3	92.8	20	1255	1719	551905
17	3	95	20	1481	1342	100355
18	2	69.7	20	1499		245551
19	1	60.9	20			391316
20	1	52.2	20			536137

Trial Number:			28			Detection (Yes/No)
Number of Bursts in Trial:			14			
Chirp Center Frequency:			5322.7875			
Burst	Number of Pulses	Pulse Width (Microseconds)	Chirp Width (MHz)	Pulse 1-to-2 Spacing ( $\mu$ sec)	Pulse 2-to-3 Spacing ( $\mu$ sec)	Starting Location Within Interval ( $\mu$ sec)
1	3	87.5	13	1209	1978	118213
2	1	57	13			326346
3	3	97.5	13	1615	1349	531858
4	3	88.9	13	1984	1005	738617
5	2	80.5	13	1010		92995
6	2	76.9	13	1764		300151
7	3	87.7	13	1987	1119	506096
8	1	51.9	13			716032
9	1	54.3	13			67531
10	1	61.3	13			275052
11	2	72.8	13	1886		481481
12	2	77.5	13	1071		689565
13	2	69.9	13	1503		41917
14	1	60.2	13			249630
15						
16						
17						
18						
19						
20						

**DFS Radar Parameters**  
**FCC Radar Type 5**  
**Channel 58 Bandwidth 80MHz**

Trial Number:			29			Detection (Yes/No)
Number of Bursts in Trial:			12			
Chirp Center Frequency:			5323.9875			
Burst	Number of Pulses	Pulse Width (Microseconds)	Chirp Width (MHz)	Pulse 1-to-2 Spacing (µsec)	Pulse 2-to-3 Spacing (µsec)	Starting Location Within Interval (µsec)
1	1	55.1	10			533545
2	2	67.9	10	1100		774812
3	2	67.6	10	1790		19150
4	1	51.7	10			261321
5	1	57.5	10			503712
6	1	59.3	10			745934
7	1	63.4	10			988293
8	3	93.4	10	1746	1707	230686
9	1	52.6	10			473625
10	2	75.3	10	1786		714764
11	3	87.8	10	1281	1979	955073
12	3	94	10	1309	1176	201103
13						
14						
15						
16						
17						
18						
19						
20						

Trial Number:			30			Detection (Yes/No)
Number of Bursts in Trial:			13			
Chirp Center Frequency:			5324.3875			
Burst	Number of Pulses	Pulse Width (Microseconds)	Chirp Width (MHz)	Pulse 1-to-2 Spacing (µsec)	Pulse 2-to-3 Spacing (µsec)	Starting Location Within Interval (µsec)
1	1	59.5	9			484104
2	2	68.8	9	1426		747546
3	1	54.6	9			1012254
4	1	59.2	9			187514
5	2	79.9	9	1597		451068
6	3	88.4	9	1823	1077	714344
7	1	53	9			980078
8	3	96.1	9	1068	1109	154584
9	2	68.7	9	1736		418486
10	2	77.4	9	1857		682304
11	3	95.8	9	1941	1893	944646
12	2	76.2	12	1770		563316
13	1	60.6	12			788278
14						
15						
16						
17						
18						
19						
20						

**DFS Radar Parameters**  
**FCC Radar Type 1**  
**Channel 60 Bandwidth 20MHz**

Trial #	Pulse Repetition Frequency Number (1 to 23)	Pulse Repetition Frequency (Pulses Per Second)	Pulse Repetition Interval (Microseconds)	Detection (Yes / No)
1	1	1930.50	518	Yes
2	12	1355.01	738	Yes
3	15	1253.13	798	Yes
4	13	1319.26	758	Yes
5	8	1519.76	658	Yes
6	11	1392.76	718	Yes
7	21	1089.32	918	No
8	12	326.16	3066	Yes
9	4	1730.10	578	Yes
10	20	1113.59	898	Yes
11	2	1858.74	538	Yes
12	22	1066.10	938	Yes
13	5	1672.24	598	Yes
14	17	1193.32	838	Yes
15	7	1567.40	638	Yes
16		346.98	2882	Yes
17		394.01	2538	Yes
18		1897.53	527	Yes
19		447.23	2236	Yes
20		1285.35	778	Yes
21		1557.63	642	No
22		469.48	2130	Yes
23		1069.52	935	Yes
24		626.17	1597	Yes
25		373.69	2676	Yes
26		586.85	1704	Yes
27		689.18	1451	Yes
28		765.11	1307	Yes
29		432.90	2310	Yes
30		449.84	2223	Yes

**DFS Radar Parameters**  
**FCC Radar Type 2**  
**Channel 60 Bandwidth 20MHz**

Trial #	Number Pulses per Burst	Pulse Width (Microseconds)	Pulse Repetition Interval (Microseconds)	Detection (Yes / No)
1	23	1.40	198	Yes
2	25	2.20	224	Yes
3	23	1.10	176	Yes
4	26	2.90	182	Yes
5	26	3.10	229	Yes
6	24	1.80	202	Yes
7	23	1.20	228	Yes
8	27	3.50	194	Yes
9	25	2.30	157	Yes
10	24	1.60	167	No
11	24	1.80	199	Yes
12	28	4.20	230	Yes
13	27	3.40	152	Yes
14	29	5.00	217	Yes
15	27	3.80	186	Yes
16	23	1.10	206	Yes
17	25	2.60	180	Yes
18	27	3.70	165	Yes
19	23	1.00	188	Yes
20	25	2.70	227	Yes
21	29	4.60	219	Yes
22	27	3.60	203	Yes
23	26	2.90	184	Yes
24	26	3.10	178	Yes
25	25	2.60	221	Yes
26	28	4.00	153	Yes
27	29	4.80	193	No
28	26	3.20	210	Yes
29	25	2.30	162	Yes
30	24	2.00	181	Yes

**DFS Radar Parameters**  
**FCC Radar Type 3**  
**Channel 60 Bandwidth 20MHz**

Trial #	Number Pulses per Burst	Pulse Width (Microseconds)	Pulse Repetition Interval (Microseconds)	Detection (Yes / No)
1	16	6.40	465	Yes
2	16	7.20	383	Yes
3	16	6.10	271	Yes
4	17	7.90	440	Yes
5	17	8.10	341	Yes
6	16	6.80	318	Yes
7	16	6.20	334	No
8	17	8.50	494	Yes
9	17	7.30	245	Yes
10	16	6.60	215	Yes
11	16	6.80	282	Yes
12	18	9.20	485	Yes
13	17	8.40	258	Yes
14	18	10.00	437	Yes
15	18	8.80	320	Yes
16	16	6.10	200	Yes
17	17	7.60	220	Yes
18	17	8.70	401	Yes
19	16	6.00	399	Yes
20	17	7.70	205	Yes
21	18	9.60	470	Yes
22	17	8.60	491	Yes
23	17	7.90	297	No
24	17	8.10	202	Yes
25	17	7.60	391	Yes
26	18	9.00	396	Yes
27	18	9.80	397	Yes
28	17	8.20	288	Yes
29	16	7.30	219	Yes
30	16	7.00	261	Yes

**DFS Radar Parameters**  
**FCC Radar Type 4**  
**Channel 60 Bandwidth 20MHz**

Trial #	Number Pulses per Burst	Pulse Width (Microseconds)	Pulse Repetition Interval (Microseconds)	Detection (Yes / No)
1	12	11.90	465	Yes
2	13	13.70	383	Yes
3	12	11.30	271	Yes
4	14	15.30	440	Yes
5	14	15.80	341	Yes
6	13	12.80	318	Yes
7	12	11.50	334	Yes
8	15	16.60	494	Yes
9	13	14.00	245	Yes
10	12	12.30	215	Yes
11	13	12.80	282	Yes
12	15	18.10	485	Yes
13	14	16.30	258	Yes
14	16	19.80	437	Yes
15	15	17.30	320	Yes
16	12	11.20	200	Yes
17	13	14.50	220	Yes
18	15	17.00	401	Yes
19	12	11.10	399	Yes
20	14	14.80	205	Yes
21	16	19.00	470	Yes
22	15	16.90	491	Yes
23	14	15.20	297	Yes
24	14	15.60	202	Yes
25	13	14.50	391	Yes
26	15	17.70	396	No
27	16	19.60	397	Yes
28	14	15.80	288	Yes
29	13	13.90	219	Yes
30	13	13.40	261	Yes



**DFS Radar Parameters**  
**FCC Radar Type 5**  
**Channel 60 Bandwidth 20MHz**

Trial Number:			1			Detection (Yes/No)
Number of Bursts in Trial:			9			
Chirp Center Frequency:			5300			
Burst	Number of Pulses	Pulse Width (Microseconds )	Chirp Width (MHz)	Pulse 1-to-2 Spacing (µsec)	Pulse 2-to-3 Spacing (µsec)	Starting Location Within Interval (µsec)
1	1	55	6			456091
2	1	64.9	6			778946
3	1	52	6			1101904
4	2	74.2	6	1019		93064
5	2	76.7	6	1180		415903
6	1	60	6			739340
7	1	53.1	6			1062002
8	2	80.8	6	1772		53279
9	2	66.8	6	1308		375962
10						
11						
12						
13						
14						
15						
16						
17						
18						
19						
20						

Trial Number:			2			Detection (Yes/No)
Number of Bursts in Trial:			11			
Chirp Center Frequency:			5300			
Burst	Number of Pulses	Pulse Width (Microseconds )	Chirp Width (MHz)	Pulse 1-to-2 Spacing (µsec)	Pulse 2-to-3 Spacing (µsec)	Starting Location Within Interval (µsec)
1	1	57.3	9			572286
2	1	60.1	9			836083
3	3	89.6	9	1440	1575	11057
4	2	79.5	9	1369		274996
5	3	98.8	9	1099	1275	538369
6	3	84.7	9	1650	1769	801389
7	1	51.4	9			1068068
8	2	69.8	9	1983		242218
9	2	83.3	9	1950		506136
10	1	50.9	9			770863
11	2	71.4	9	1116		1034768
12						
13						
14						
15						
16						
17						
18						
19						
20						

**DFS Radar Parameters**  
**FCC Radar Type 5**  
**Channel 60 Bandwidth 20MHz**

Trial Number:			3			Detection (Yes/No)
Number of Bursts in Trial:			8			
Chirp Center Frequency:			5300			
Burst	Number of Pulses	Pulse Width (Microseconds)	Chirp Width (MHz)	Pulse 1-to-2 Spacing (µsec)	Pulse 2-to-3 Spacing (µsec)	Starting Location Within Interval (µsec)
1	3	94.2	5	1478	1777	288532
2	2	82.9	5	1681		651974
3	2	73.5	5	1889		1014683
4	2	75.8	5	1295		1378001
5	2	69.7	5	1075		244188
6	3	86.9	5	1907	1463	606557
7	3	97.4	5	1072	1173	969693
8	2	76.9	5	1193		1333926
9						
10						
11						
12						
13						
14						
15						
16						
17						
18						
19						
20						

Trial Number:			4			Detection (Yes/No)
Number of Bursts in Trial:			8			
Chirp Center Frequency:			5300			
Burst	Number of Pulses	Pulse Width (Microseconds)	Chirp Width (MHz)	Pulse 1-to-2 Spacing (µsec)	Pulse 2-to-3 Spacing (µsec)	Starting Location Within Interval (µsec)
1	1	66.2	12			113987
2	1	63.2	12			321486
3	2	81.6	12	1624		528264
4	3	97.1	12	1125	1787	733969
5	1	62.5	12			88396
6	1	61.5	12			295881
7	3	92.6	12	1645	1343	501606
8	3	92.5	12	1899	1591	708477
9	1	56.1	12			62881
10	3	85.6	12	1837	1392	269320
11	1	61	12			477893
12	1	51.8	12			685309
13	3	95.8	12	1327	1249	37176
14	1	58.5	12			244764
15						
16						
17						
18						
19						
20						

**DFS Radar Parameters**  
**FCC Radar Type 5**  
**Channel 60 Bandwidth 20MHz**

Trial Number:			5			Detection (Yes/No)
Number of Bursts in Trial:			14			
Chirp Center Frequency:			5300			Yes
Burst	Number of Pulses	Pulse Width (Microseconds)	Chirp Width (MHz)	Pulse 1-to-2 Spacing (µsec)	Pulse 2-to-3 Spacing (µsec)	Starting Location Within Interval (µsec)
1	2	75.4	13	1733		451522
2	3	90.7	13	1570	1285	657471
3	3	87.6	13	1868	1643	11695
4	3	93.5	13	1371	1579	218584
5	3	94.5	13	1105	1147	425679
6	1	53.9	13			634053
7	3	98.2	13	1652	1311	839188
8	3	97.5	13	1351	1316	193137
9	2	83.2	13	1490		400517
10	3	99.6	13	1642	1680	606704
11	1	62.1	13			815936
12	1	51.5	13			168219
13	2	72.3	13	1628		375144
14	2	72.1	13	1065		582695
15						
16						
17						
18						
19						
20						

Trial Number:			6			Detection (Yes/No)
Number of Bursts in Trial:			10			
Chirp Center Frequency:			5300			Yes
Burst	Number of Pulses	Pulse Width (Microseconds)	Chirp Width (MHz)	Pulse 1-to-2 Spacing (µsec)	Pulse 2-to-3 Spacing (µsec)	Starting Location Within Interval (µsec)
1	3	91.4	8	1268	1362	1105275
2	2	76.2	8	1870		199366
3	1	54.4	8			490358
4	3	89.9	8	1256	1414	779365
5	1	62.6	8			1071413
6	2	76.3	8	1387		163769
7	1	64.6	8			454651
8	1	53.6	8			745006
9	2	75.7	8	1431		1034301
10	1	63.1	8			128079
11						
12						
13						
14						
15						
16						
17						
18						
19						
20						

**DFS Radar Parameters**  
**FCC Radar Type 5**  
**Channel 60 Bandwidth 20MHz**

Trial Number:			7			Detection (Yes/No)
Number of Bursts in Trial:			8			
Chirp Center Frequency:			5300			
Burst	Number of Pulses	Pulse Width (Microseconds)	Chirp Width (MHz)	Pulse 1-to-2 Spacing (µsec)	Pulse 2-to-3 Spacing (µsec)	Starting Location Within Interval (µsec)
1	2	75.6	14	1155		216520
2	3	85.6	14	1993	1103	396614
3	1	57.4	14			579687
4	2	82.8	14	1995		12889
5	3	88.3	14	1447	1358	193680
6	2	76.3	14	1892		374938
7	3	92.4	14	1841	1127	555060
8	3	93.4	14	1225	1449	736781
9	2	78.8	14	1508		171787
10	2	68.8	14	1329		353186
11	2	80.1	14	1041		534595
12	2	82.1	14	1583		715294
13	3	84.9	14	1169	1756	149063
14	1	60.9	14			331211
15	3	89.2	14	1793	1655	510715
16	2	70.5	14	1404		693078
17						
18						
19						
20						

Trial Number:			8			Detection (Yes/No)
Number of Bursts in Trial:			16			
Chirp Center Frequency:			5300			
Burst	Number of Pulses	Pulse Width (Microseconds)	Chirp Width (MHz)	Pulse 1-to-2 Spacing (µsec)	Pulse 2-to-3 Spacing (µsec)	Starting Location Within Interval (µsec)
1	2	75.6	14	1155		216520
2	3	85.6	14	1993	1103	396614
3	1	57.4	14			579687
4	2	82.8	14	1995		12889
5	3	88.3	14	1447	1358	193680
6	2	76.3	14	1892		374938
7	3	92.4	14	1841	1127	555060
8	3	93.4	14	1225	1449	736781
9	2	78.8	14	1508		171787
10	2	68.8	14	1329		353186
11	2	80.1	14	1041		534595
12	2	82.1	14	1583		715294
13	3	84.9	14	1169	1756	149063
14	1	60.9	14			331211
15	3	89.2	14	1793	1655	510715
16	2	70.5	14	1404		693078
17						
18						
19						
20						

**DFS Radar Parameters**  
**FCC Radar Type 5**  
**Channel 60 Bandwidth 20MHz**

Trial Number:			9			Detection (Yes/No)
Number of Bursts in Trial:			12			
Chirp Center Frequency:			5300			
Burst	Number of Pulses	Pulse Width (Microseconds)	Chirp Width (MHz)	Pulse 1-to-2 Spacing (µsec)	Pulse 2-to-3 Spacing (µsec)	Starting Location Within Interval (µsec)
1	1	51.1	10			169836
2	2	79.9	10	1817		411435
3	2	81.1	10	1203		653492
4	2	71.2	10	1523		894783
5	3	89.2	10	1910	1152	139593
6	2	69.5	10	1149		381670
7	3	94	10	1755	1973	622378
8	2	71.8	10	1465		865458
9	1	65	10			110246
10	2	74.4	10	1489		351980
11	1	66.4	10			594506
12	2	76.5	10	1040		835513
13						
14						
15						
16						
17						
18						
19						
20						

Trial Number:			10			Detection (Yes/No)
Number of Bursts in Trial:			9			
Chirp Center Frequency:			5300			
Burst	Number of Pulses	Pulse Width (Microseconds)	Chirp Width (MHz)	Pulse 1-to-2 Spacing (µsec)	Pulse 2-to-3 Spacing (µsec)	Starting Location Within Interval (µsec)
1	3	97.8	7	1882	1779	106978
2	1	55.9	7			430424
3	1	52.1	7			753353
4	3	99	7	1767	1057	1073995
5	2	77.3	7	1498		67384
6	1	63.1	7			390566
7	2	76	7	1717		712399
8	3	86.7	7	1195	1667	1034158
9	1	64.6	7			27685
10						
11						
12						
13						
14						
15						
16						
17						
18						
19						
20						

**DFS Radar Parameters**  
**FCC Radar Type 5**  
**Channel 60 Bandwidth 20MHz**

Trial Number:			11			Detection (Yes/No)
Number of Bursts in Trial:			10			
Chirp Center Frequency:			5294.048			
Burst	Number of Pulses	Pulse Width (Microseconds)	Chirp Width (MHz)	Pulse 1-to-2 Spacing (µsec)	Pulse 2-to-3 Spacing (µsec)	Starting Location Within Interval (µsec)
1	1	58.6	8			315543
2	3	88	8	1770	1571	604519
3	2	78.2	8	1828		895230
4	3	97.6	8	1496	1028	1185129
5	2	69.3	8	1140		279539
6	3	97.5	8	1468	1623	569056
7	3	95.9	8	1951	1279	858767
8	2	73.5	8	1480		1150807
9	3	93.7	8	1025	1969	243392
10	2	78.2	8	1388		534084
11						
12						
13						
14						
15						
16						
17						
18						
19						
20						

Trial Number:			12			Detection (Yes/No)
Number of Bursts in Trial:			18			
Chirp Center Frequency:			5297.648			
Burst	Number of Pulses	Pulse Width (Microseconds)	Chirp Width (MHz)	Pulse 1-to-2 Spacing (µsec)	Pulse 2-to-3 Spacing (µsec)	Starting Location Within Interval (µsec)
1	1	66.1	17			458266
2	2	78.8	17	1011		618238
3	3	85.7	17	1196	1739	115058
4	3	91.1	17	1002	1952	275495
5	1	65.3	17			438138
6	1	53	17			599661
7	1	51	17			95681
8	1	59.8	17			257166
9	1	56.1	17			418283
10	3	91.6	17	1314	1801	576878
11	3	85.6	17	1415	1931	75439
12	2	67.8	17	1340		236781
13	1	63.8	17			398735
14	1	59.8	17			559395
15	1	65.8	17			55892
16	3	95.7	17	1865	1231	216175
17	2	72.9	17	1848		377480
18	1	66.6	17			539999
19						
20						

**DFS Radar Parameters**  
**FCC Radar Type 5**  
**Channel 60 Bandwidth 20MHz**

Trial Number:			13			Detection (Yes/No)
Number of Bursts in Trial:			15			
Chirp Center Frequency:			5296.448			Yes
Burst	Number of Pulses	Pulse Width (Microseconds)	Chirp Width (MHz)	Pulse 1-to-2 Spacing (µsec)	Pulse 2-to-3 Spacing (µsec)	Starting Location Within Interval (µsec)
1	2	81.1	14	1691		43173
2	1	54.7	14			237072
3	2	71.7	14	1670		429725
4	3	85	14	1339	1900	621518
5	1	52.4	14			19432
6	1	55.8	14			213028
7	3	92.5	14	1427	1153	405290
8	3	92	14	1990	1317	597929
9	1	52.8	14			794345
10	2	73.6	14	1715		188943
11	2	69.9	14	1102		382243
12	2	72	14	1878		574958
13	3	98.2	14	1020	1958	767112
14	3	98.3	14	1277	1686	164814
15	2	71.3	14	1296		358432
16						
17						
18						
19						
20						

Trial Number:			14			Detection (Yes/No)
Number of Bursts in Trial:			20			
Chirp Center Frequency:			5298.848			Yes
Burst	Number of Pulses	Pulse Width (Microseconds)	Chirp Width (MHz)	Pulse 1-to-2 Spacing (µsec)	Pulse 2-to-3 Spacing (µsec)	Starting Location Within Interval (µsec)
1	3	96.2	20	1464	1142	412467
2	1	50.2	20			559149
3	3	97.8	20	1221	1168	105622
4	1	62	20			251304
5	1	64.8	20			396581
6	3	86.9	20	1208	1270	539601
7	3	95.9	20	1963	1750	87618
8	2	76.2	20	1318		232979
9	1	53.3	20			378329
10	2	69.8	20	1703		521958
11	3	95.2	20	1187	1557	69956
12	2	79	20	1968		214668
13	3	90.8	20	1822	1297	358915
14	2	74.2	20	1816		504640
15	2	68.3	20	1761		52265
16	2	81.8	20	1323		197219
17	2	73.6	20	1189		342218
18	2	74.6	20	1410		486611
19	2	79.3	20	1441		34446
20	3	92.5	20	1661	1771	178766

**DFS Radar Parameters**  
**FCC Radar Type 5**  
**Channel 60 Bandwidth 20MHz**

Trial Number:			15			Detection (Yes/No)
Number of Bursts in Trial:			17			
Chirp Center Frequency:			5297.248			
Burst	Number of Pulses	Pulse Width (Microseconds)	Chirp Width (MHz)	Pulse 1-to-2 Spacing (µsec)	Pulse 2-to-3 Spacing (µsec)	Starting Location Within Interval (µsec)
1	3	88.9	16	1239	1759	380606
2	1	56.5	16			553212
3	2	81.2	16	1330		19594
4	2	76.3	16	1862		190008
5	2	79.9	16	1368		360470
6	3	98.7	16	1510	1320	529951
7	2	73.4	16	1529		701560
8	1	50.2	16			169324
9	2	77.5	16	1067		339969
10	3	89.9	16	1344	1559	509095
11	3	84.2	16	1901	1918	677997
12	3	93.5	16	1656	1355	147725
13	3	87.3	16	1432	1731	317636
14	3	96.5	16	1511	1732	487504
15	2	67.6	16	1078		659989
16	1	59.6	16			127277
17	2	68	16	1156		297601
18						
19						
20						

Trial Number:			16			Detection (Yes/No)
Number of Bursts in Trial:			8			
Chirp Center Frequency:			5292.848			
Burst	Number of Pulses	Pulse Width (Microseconds)	Chirp Width (MHz)	Pulse 1-to-2 Spacing (µsec)	Pulse 2-to-3 Spacing (µsec)	Starting Location Within Interval (µsec)
1	3	83.7	5	1908	1548	995497
2	1	58.1	5			1361600
3	2	79.8	5	1885		225782
4	3	85.2	5	1647	1080	588360
5	2	78.5	5	1887		951829
6	2	68.4	5	1269		1315202
7	1	65.1	5			181313
8	1	57.3	5			544812
9						
10						
11						
12						
13						
14						
15						
16						
17						
18						
19						
20						



**DFS Radar Parameters**  
**FCC Radar Type 5**  
**Channel 60 Bandwidth 20MHz**

Trial Number:			17			Detection (Yes/No)
Number of Bursts in Trial:			13			
Chirp Center Frequency:			5295.248			
Burst	Number of Pulses	Pulse Width (Microseconds)	Chirp Width (MHz)	Pulse 1-to-2 Spacing ( $\mu$ sec)	Pulse 2-to-3 Spacing ( $\mu$ sec)	Starting Location Within Interval ( $\mu$ sec)
1	2	76.8	11	1829		557698
2	1	51.7	11			782182
3	2	67.8	11	1402		83874
4	3	84.5	11	1036	1500	306513
5	3	91.9	11	1855	1519	529020
6	3	96.4	11	1988	1331	751885
7	3	97.4	11	1991	1337	56297
8	2	68.9	11	1858		279421
9	1	55.8	11			503662
10	2	82.5	11	1538		725515
11	3	89.7	11	1095	1710	28860
12	2	69.1	11	1029		252246
13	2	71.5	11	1785		475029
14						
15						
16						
17						
18						
19						
20						

Trial Number:			18			Detection (Yes/No)
Number of Bursts in Trial:			16			
Chirp Center Frequency:			5296.848			
Burst	Number of Pulses	Pulse Width (Microseconds)	Chirp Width (MHz)	Pulse 1-to-2 Spacing ( $\mu$ sec)	Pulse 2-to-3 Spacing ( $\mu$ sec)	Starting Location Within Interval ( $\mu$ sec)
1	2	82.1	15	1760		566651
2	1	66.2	15			1143
3	1	63.5	15			182789
4	3	95.7	15	1083	1418	362933
5	3	98.8	15	1254	1088	543876
6	1	63.5	15			727356
7	3	85.7	15	1283	1651	159683
8	1	51.6	15			341898
9	3	91.8	15	1399	1640	521273
10	3	94.3	15	1108	1675	702317
11	1	56.5	15			137881
12	1	58.7	15			319662
13	1	63.7	15			501159
14	3	90	15	1438	1925	679274
15	1	66.5	15			115593
16	3	99.6	15	1632	1171	296127
17						
18						
19						
20						

**DFS Radar Parameters**  
**FCC Radar Type 5**  
**Channel 60 Bandwidth 20MHz**

Trial Number:			19			Detection (Yes/No)
Number of Bursts in Trial:			8			
Chirp Center Frequency:			5292.848			
Burst	Number of Pulses	Pulse Width (Microseconds)	Chirp Width (MHz)	Pulse 1-to-2 Spacing (µsec)	Pulse 2-to-3 Spacing (µsec)	Starting Location Within Interval (µsec)
1	1	57.2	5			958469
2	1	60.3	5			1321531
3	3	88.2	5	1773.000	1804.000	186176
4	1	66.1	5			550007
5	2	68.9	5	1944.000		912150
6	1	53	5			1276596
7	3	96.9	5	1879.000	1258.000	141585
8	1	55.6	5			505262
9						
10						
11						
12						
13						
14						
15						
16						
17						
18						
19						
20						

Trial Number:			20			Detection (Yes/No)
Number of Bursts in Trial:			13			
Chirp Center Frequency:			5295.248			
Burst	Number of Pulses	Pulse Width (Microseconds)	Chirp Width (MHz)	Pulse 1-to-2 Spacing (µsec)	Pulse 2-to-3 Spacing (µsec)	Starting Location Within Interval (µsec)
1	1	65.7	11			534549
2	3	85.6	11	1321	1726	755351
3	3	93.6	11	1863	1370	59514
4	3	86.8	11	1998	1603	282206
5	2	74.6	11	1505		505905
6	2	81.5	11	1808		728563
7	1	64	11			32199
8	2	78	11	1916		255085
9	3	90.6	11	1299	1596	477956
10	3	96.6	11	1692	1133	700648
11	1	51.5	11			4666
12	3	92	11	1584	1457	227313
13	1	66.2	11			451522
14						
15						
16						
17						
18						
19						
20						

**DFS Radar Parameters**  
**FCC Radar Type 5**  
**Channel 60 Bandwidth 20MHz**

Trial Number:			21			Detection (Yes/No)
Number of Bursts in Trial:			19			
Chirp Center Frequency:			5301.552			
Burst	Number of Pulses	Pulse Width (Microseconds)	Chirp Width (MHz)	Pulse 1-to-2 Spacing ( $\mu$ sec)	Pulse 2-to-3 Spacing ( $\mu$ sec)	Starting Location Within Interval ( $\mu$ sec)
1	3	89.6	19	1913	1976	458587
2	2	79.8	19	1367		612743
3	1	54.9	19			137244
4	2	79.4	19	1803		289280
5	1	55.7	19			442917
6	3	85.1	19	1606	1143	592930
7	1	57.4	19			118375
8	1	61.2	19			271325
9	2	75.8	19	1811		422480
10	2	78.2	19	1852		574802
11	1	56.3	19			99538
12	2	80.9	19	1220		251892
13	2	69.4	19	1687		404285
14	3	98.6	19	1518	1154	555798
15	2	72.1	19	1332		80537
16	1	51.5	19			233486
17	1	53	19			386496
18	1	52.6	19			539575
19	2	79.1	19	1949		61718
20						

Trial Number:			22			Detection (Yes/No)
Number of Bursts in Trial:			16			
Chirp Center Frequency:			5303.152			
Burst	Number of Pulses	Pulse Width (Microseconds)	Chirp Width (MHz)	Pulse 1-to-2 Spacing ( $\mu$ sec)	Pulse 2-to-3 Spacing ( $\mu$ sec)	Starting Location Within Interval ( $\mu$ sec)
1	2	69.3	15	1877		254487
2	1	57.8	15			436785
3	2	79.9	15	2000		616628
4	1	63.1	15			51159
5	2	69.9	15	1380		232224
6	3	99	15	1994	1160	412665
7	2	77	15	1860		594490
8	1	60.2	15			28800
9	2	80.3	15	1798		209873
10	2	78.6	15	1522		391228
11	2	68.2	15	1608		571946
12	2	67.2	15	1114		6427
13	3	88.5	15	1446	1406	187164
14	2	74.6	15	1682		368451
15	2	83.3	15	1853		549946
16	2	67.7	15	1423		731000
17						
18						
19						
20						

**DFS Radar Parameters**  
**FCC Radar Type 5**  
**Channel 60 Bandwidth 20MHz**

Trial Number:			23			Detection (Yes/No)
Number of Bursts in Trial:			14			
Chirp Center Frequency:			5304.352			
Burst	Number of Pulses	Pulse Width (Microseconds)	Chirp Width (MHz)	Pulse 1-to-2 Spacing ( $\mu$ sec)	Pulse 2-to-3 Spacing ( $\mu$ sec)	Starting Location Within Interval ( $\mu$ sec)
1	2	80.6	12	1325		188949
2	2	83.3	12	1202		396121
3	3	86.7	12	1451	1372	602317
4	1	63.1	12			811814
5	2	68	12	1807		163477
6	3	89.5	12	1134	1416	370010
7	3	94.4	12	1948	1058	577001
8	3	90	12	1047	1705	784127
9	1	57.4	12			138193
10	3	87.2	12	1074	1001	344709
11	1	55.9	12			553281
12	1	55.2	12			761200
13	2	82.9	12	1212		112482
14	3	92	12	1473	1922	318957
15						
16						
17						
18						
19						
20						

Trial Number:			24			Detection (Yes/No)
Number of Bursts in Trial:			14			
Chirp Center Frequency:			5303.952			
Burst	Number of Pulses	Pulse Width (Microseconds)	Chirp Width (MHz)	Pulse 1-to-2 Spacing ( $\mu$ sec)	Pulse 2-to-3 Spacing ( $\mu$ sec)	Starting Location Within Interval ( $\mu$ sec)
1	2	76.5	13	1555		526518
2	3	87.5	13	1504	1599	732507
3	3	93.9	13	1664	1391	86736
4	2	72.4	13	1614		294120
5	2	72.6	13	1106		501671
6	1	58.4	13			709310
7	1	59.6	13			61533
8	1	66.6	13			268913
9	3	85	13	1186	1796	475077
10	2	80.5	13	1727		682804
11	2	78.8	13	1452		35899
12	2	74.8	13	1935		242795
13	2	77.2	13	1197		450389
14	2	82.6	13	1082		657756
15						
16						
17						
18						
19						
20						

**DFS Radar Parameters**  
**FCC Radar Type 5**  
**Channel 60 Bandwidth 20MHz**

Trial Number:			25			Detection (Yes/No)
Number of Bursts in Trial:			13			
Chirp Center Frequency:			5304.752			
Burst	Number of Pulses	Pulse Width (Microseconds)	Chirp Width (MHz)	Pulse 1-to-2 Spacing (µsec)	Pulse 2-to-3 Spacing (µsec)	Starting Location Within Interval (µsec)
1	1	57.5	11			11192
2	1	61	11			234643
3	2	67.9	11	1502		457245
4	1	56.2	11			681769
5	3	86.1	11	1228	1031	902590
6	2	80.9	11	1445		206945
7	3	91.5	11	1455	1122	429305
8	2	68.2	11	1015		653478
9	1	66.3	11			877390
10	3	89.5	11	1543	1470	178971
11	1	61.1	11			403302
12	2	79.9	11	1214		625531
13	1	63.5	11			850373
14						
15						
16						
17						
18						
19						
20						

Trial Number:			26			Detection (Yes/No)
Number of Bursts in Trial:			17			
Chirp Center Frequency:			5302.752			
Burst	Number of Pulses	Pulse Width (Microseconds)	Chirp Width (MHz)	Pulse 1-to-2 Spacing (µsec)	Pulse 2-to-3 Spacing (µsec)	Starting Location Within Interval (µsec)
1	3	90	16	1185	1509	115777
2	1	55.7	16			286979
3	2	82.7	16	1904		456477
4	3	93	16	1765	1223	625877
5	2	71.7	16	1073		95108
6	2	77.4	16	1237		265667
7	3	88.3	16	1250	1017	435305
8	1	52.1	16			607978
9	2	80.7	16	1532		74051
10	2	73.3	16	1272		244577
11	1	66	16			415586
12	1	51.9	16			586282
13	2	74.8	16	1845		52957
14	1	58	16			223816
15	1	63.9	16			394907
16	3	98.3	16	1042	1007	563737
17	1	56.1	16			32086
18						
19						
20						

**DFS Radar Parameters**  
**FCC Radar Type 5**  
**Channel 60 Bandwidth 20MHz**

Trial Number:			27			Detection (Yes/No)
Number of Bursts in Trial:			20			
Chirp Center Frequency:			5301.152			
Burst	Number of Pulses	Pulse Width (Microseconds)	Chirp Width (MHz)	Pulse 1-to-2 Spacing ( $\mu$ sec)	Pulse 2-to-3 Spacing ( $\mu$ sec)	Starting Location Within Interval ( $\mu$ sec)
1	3	84.4	20	1006	1288	171798
2	3	93.2	20	1704	1121	316209
3	1	62.2	20			463045
4	1	61.7	20			9381
5	2	82.4	20	1923		154002
6	3	96.5	20	1257	1352	298454
7	2	69.3	20	1714		443388
8	3	99.7	20	1753	1016	587670
9	2	69.1	20	1145		136359
10	1	52	20			281692
11	1	50.4	20			426935
12	1	58.2	20			571957
13	2	71.1	20	1539		118444
14	1	54.4	20			264113
15	1	61.3	20			408792
16	3	92.8	20	1255	1719	551905
17	3	95	20	1481	1342	100355
18	2	69.7	20	1499		245551
19	1	60.9	20			391316
20	1	52.2	20			536137

Trial Number:			28			Detection (Yes/No)
Number of Bursts in Trial:			14			
Chirp Center Frequency:			5303.952			
Burst	Number of Pulses	Pulse Width (Microseconds)	Chirp Width (MHz)	Pulse 1-to-2 Spacing ( $\mu$ sec)	Pulse 2-to-3 Spacing ( $\mu$ sec)	Starting Location Within Interval ( $\mu$ sec)
1	3	87.5	13	1209	1978	118213
2	1	57	13			326346
3	3	97.5	13	1615	1349	531858
4	3	88.9	13	1984	1005	738617
5	2	80.5	13	1010		92995
6	2	76.9	13	1764		300151
7	3	87.7	13	1987	1119	506096
8	1	51.9	13			716032
9	1	54.3	13			67531
10	1	61.3	13			275052
11	2	72.8	13	1886		481481
12	2	77.5	13	1071		689565
13	2	69.9	13	1503		41917
14	1	60.2	13			249630
15						
16						
17						
18						
19						
20						

**DFS Radar Parameters**  
**FCC Radar Type 5**  
**Channel 60 Bandwidth 20MHz**

Trial Number:			29			Detection (Yes/No)
Number of Bursts in Trial:			12			
Chirp Center Frequency:			5305.152			
Burst	Number of Pulses	Pulse Width (Microseconds)	Chirp Width (MHz)	Pulse 1-to-2 Spacing (µsec)	Pulse 2-to-3 Spacing (µsec)	Starting Location Within Interval (µsec)
1	1	55.1	10			533545
2	2	67.9	10	1100		774812
3	2	67.6	10	1790		19150
4	1	51.7	10			261321
5	1	57.5	10			503712
6	1	59.3	10			745934
7	1	63.4	10			988293
8	3	93.4	10	1746	1707	230686
9	1	52.6	10			473625
10	2	75.3	10	1786		714764
11	3	87.8	10	1281	1979	955073
12	3	94	10	1309	1176	201103
13						
14						
15						
16						
17						
18						
19						
20						

Trial Number:			30			Detection (Yes/No)
Number of Bursts in Trial:			13			
Chirp Center Frequency:			5305.552			
Burst	Number of Pulses	Pulse Width (Microseconds)	Chirp Width (MHz)	Pulse 1-to-2 Spacing (µsec)	Pulse 2-to-3 Spacing (µsec)	Starting Location Within Interval (µsec)
1	1	59.5	9			484104
2	2	68.8	9	1426		747546
3	1	54.6	9			1012254
4	1	59.2	9			187514
5	2	79.9	9	1597		451068
6	3	88.4	9	1823	1077	714344
7	1	53	9			980078
8	3	96.1	9	1068	1109	154584
9	2	68.7	9	1736		418486
10	2	77.4	9	1857		682304
11	3	95.8	9	1941	1893	944646
12	2	76.2	12	1770		563316
13	1	60.6	12			788278
14						
15						
16						
17						
18						
19						
20						

**DFS Radar Parameters**  
**FCC Radar Type 1**  
**Channel 62 Bandwidth 40MHz**

Trial #	Pulse Repetition Frequency Number (1 to 23)	Pulse Repetition Frequency (Pulses Per Second)	Pulse Repetition Interval (Microseconds)	Detection (Yes / No)
1	1	1930.50	518	Yes
2	12	1355.01	738	Yes
3	15	1253.13	798	Yes
4	13	1319.26	758	Yes
5	8	1519.76	658	Yes
6	11	1392.76	718	Yes
7	21	1089.32	918	No
8	12	326.16	3066	Yes
9	4	1730.10	578	Yes
10	20	1113.59	898	Yes
11	2	1858.74	538	Yes
12	22	1066.10	938	Yes
13	5	1672.24	598	Yes
14	17	1193.32	838	Yes
15	7	1567.40	638	Yes
16		346.98	2882	Yes
17		394.01	2538	Yes
18		1897.53	527	Yes
19		447.23	2236	Yes
20		1285.35	778	Yes
21		1557.63	642	Yes
22		469.48	2130	Yes
23		1069.52	935	Yes
24		626.17	1597	Yes
25		373.69	2676	Yes
26		586.85	1704	Yes
27		689.18	1451	Yes
28		765.11	1307	Yes
29		432.90	2310	Yes
30		449.84	2223	Yes



**DFS Radar Parameters**  
**FCC Radar Type 2**  
**Channel 62 Bandwidth 40MHz**

Trial #	Number Pulses per Burst	Pulse Width (Microseconds)	Pulse Repetition Interval (Microseconds)	Detection (Yes / No)
1	23	1.40	198	Yes
2	25	2.20	224	Yes
3	23	1.10	176	Yes
4	26	2.90	182	Yes
5	26	3.10	229	Yes
6	24	1.80	202	Yes
7	23	1.20	228	Yes
8	27	3.50	194	Yes
9	25	2.30	157	Yes
10	24	1.60	167	Yes
11	24	1.80	199	Yes
12	28	4.20	230	Yes
13	27	3.40	152	Yes
14	29	5.00	217	No
15	27	3.80	186	Yes
16	23	1.10	206	Yes
17	25	2.60	180	Yes
18	27	3.70	165	Yes
19	23	1.00	188	Yes
20	25	2.70	227	Yes
21	29	4.60	219	Yes
22	27	3.60	203	Yes
23	26	2.90	184	Yes
24	26	3.10	178	No
25	25	2.60	221	Yes
26	28	4.00	153	Yes
27	29	4.80	193	Yes
28	26	3.20	210	Yes
29	25	2.30	162	Yes
30	24	2.00	181	Yes

**DFS Radar Parameters**  
**FCC Radar Type 3**  
**Channel 62 Bandwidth 40MHz**

Trial #	Number Pulses per Burst	Pulse Width (Microseconds)	Pulse Repetition Interval (Microseconds)	Detection (Yes / No)
1	16	6.40	465	Yes
2	16	7.20	383	Yes
3	16	6.10	271	Yes
4	17	7.90	440	Yes
5	17	8.10	341	Yes
6	16	6.80	318	Yes
7	16	6.20	334	Yes
8	17	8.50	494	Yes
9	17	7.30	245	Yes
10	16	6.60	215	Yes
11	16	6.80	282	Yes
12	18	9.20	485	No
13	17	8.40	258	Yes
14	18	10.00	437	Yes
15	18	8.80	320	Yes
16	16	6.10	200	Yes
17	17	7.60	220	No
18	17	8.70	401	Yes
19	16	6.00	399	Yes
20	17	7.70	205	Yes
21	18	9.60	470	Yes
22	17	8.60	491	Yes
23	17	7.90	297	Yes
24	17	8.10	202	Yes
25	17	7.60	391	Yes
26	18	9.00	396	Yes
27	18	9.80	397	Yes
28	17	8.20	288	Yes
29	16	7.30	219	Yes
30	16	7.00	261	Yes

**DFS Radar Parameters**  
**FCC Radar Type 4**  
**Channel 62 Bandwidth 40MHz**

Trial #	Number Pulses per Burst	Pulse Width (Microseconds)	Pulse Repetition Interval (Microseconds)	Detection (Yes / No)
1	12	11.90	465	Yes
2	13	13.70	383	Yes
3	12	11.30	271	Yes
4	14	15.30	440	Yes
5	14	15.80	341	Yes
6	13	12.80	318	Yes
7	12	11.50	334	Yes
8	15	16.60	494	Yes
9	13	14.00	245	Yes
10	12	12.30	215	Yes
11	13	12.80	282	Yes
12	15	18.10	485	Yes
13	14	16.30	258	Yes
14	16	19.80	437	Yes
15	15	17.30	320	Yes
16	12	11.20	200	No
17	13	14.50	220	Yes
18	15	17.00	401	Yes
19	12	11.10	399	Yes
20	14	14.80	205	Yes
21	16	19.00	470	Yes
22	15	16.90	491	No
23	14	15.20	297	Yes
24	14	15.60	202	Yes
25	13	14.50	391	Yes
26	15	17.70	396	Yes
27	16	19.60	397	Yes
28	14	15.80	288	Yes
29	13	13.90	219	Yes
30	13	13.40	261	Yes

**DFS Radar Parameters**  
**FCC Radar Type 5**  
**Channel 62 Bandwidth 40MHz**

Trial Number:			1			Detection (Yes/No)
Number of Bursts in Trial:			9			
Chirp Center Frequency:			5310			
Burst	Number of Pulses	Pulse Width (Microseconds )	Chirp Width (MHz)	Pulse 1-to-2 Spacing (µsec)	Pulse 2-to-3 Spacing (µsec)	Starting Location Within Interval (µsec)
1	1	55	6			456091
2	1	64.9	6			778946
3	1	52	6			1101904
4	2	74.2	6	1019		93064
5	2	76.7	6	1180		415903
6	1	60	6			739340
7	1	53.1	6			1062002
8	2	80.8	6	1772		53279
9	2	66.8	6	1308		375962
10						
11						
12						
13						
14						
15						
16						
17						
18						
19						
20						

Trial Number:			2			Detection (Yes/No)
Number of Bursts in Trial:			11			
Chirp Center Frequency:			5310			
Burst	Number of Pulses	Pulse Width (Microseconds )	Chirp Width (MHz)	Pulse 1-to-2 Spacing (µsec)	Pulse 2-to-3 Spacing (µsec)	Starting Location Within Interval (µsec)
1	1	57.3	9			572286
2	1	60.1	9			836083
3	3	89.6	9	1440	1575	11057
4	2	79.5	9	1369		274996
5	3	98.8	9	1099	1275	538369
6	3	84.7	9	1650	1769	801389
7	1	51.4	9			1068068
8	2	69.8	9	1983		242218
9	2	83.3	9	1950		506136
10	1	50.9	9			770863
11	2	71.4	9	1116		1034768
12						
13						
14						
15						
16						
17						
18						
19						
20						

**DFS Radar Parameters**  
**FCC Radar Type 5**  
**Channel 62 Bandwidth 40MHz**

Trial Number:			3			Detection (Yes/No)
Number of Bursts in Trial:			8			
Chirp Center Frequency:			5310			
Burst	Number of Pulses	Pulse Width (Microseconds)	Chirp Width (MHz)	Pulse 1-to-2 Spacing (µsec)	Pulse 2-to-3 Spacing (µsec)	Starting Location Within Interval (µsec)
1	3	94.2	5	1478	1777	288532
2	2	82.9	5	1681		651974
3	2	73.5	5	1889		1014683
4	2	75.8	5	1295		1378001
5	2	69.7	5	1075		244188
6	3	86.9	5	1907	1463	606557
7	3	97.4	5	1072	1173	969693
8	2	76.9	5	1193		1333926
9						
10						
11						
12						
13						
14						
15						
16						
17						
18						
19						
20						

Trial Number:			4			Detection (Yes/No)
Number of Bursts in Trial:			8			
Chirp Center Frequency:			5310			
Burst	Number of Pulses	Pulse Width (Microseconds)	Chirp Width (MHz)	Pulse 1-to-2 Spacing (µsec)	Pulse 2-to-3 Spacing (µsec)	Starting Location Within Interval (µsec)
1	1	66.2	12			113987
2	1	63.2	12			321486
3	2	81.6	12	1624		528264
4	3	97.1	12	1125	1787	733969
5	1	62.5	12			88396
6	1	61.5	12			295881
7	3	92.6	12	1645	1343	501606
8	3	92.5	12	1899	1591	708477
9	1	56.1	12			62881
10	3	85.6	12	1837	1392	269320
11	1	61	12			477893
12	1	51.8	12			685309
13	3	95.8	12	1327	1249	37176
14	1	58.5	12			244764
15						
16						
17						
18						
19						
20						

**DFS Radar Parameters**  
**FCC Radar Type 5**  
**Channel 62 Bandwidth 40MHz**

Trial Number:			5			Detection (Yes/No)
Number of Bursts in Trial:			14			
Chirp Center Frequency:			5310			Yes
Burst	Number of Pulses	Pulse Width (Microseconds)	Chirp Width (MHz)	Pulse 1-to-2 Spacing (µsec)	Pulse 2-to-3 Spacing (µsec)	Starting Location Within Interval (µsec)
1	2	75.4	13	1733		451522
2	3	90.7	13	1570	1285	657471
3	3	87.6	13	1868	1643	11695
4	3	93.5	13	1371	1579	218584
5	3	94.5	13	1105	1147	425679
6	1	53.9	13			634053
7	3	98.2	13	1652	1311	839188
8	3	97.5	13	1351	1316	193137
9	2	83.2	13	1490		400517
10	3	99.6	13	1642	1680	606704
11	1	62.1	13			815936
12	1	51.5	13			168219
13	2	72.3	13	1628		375144
14	2	72.1	13	1065		582695
15						
16						
17						
18						
19						
20						

Trial Number:			6			Detection (Yes/No)
Number of Bursts in Trial:			10			
Chirp Center Frequency:			5310			Yes
Burst	Number of Pulses	Pulse Width (Microseconds)	Chirp Width (MHz)	Pulse 1-to-2 Spacing (µsec)	Pulse 2-to-3 Spacing (µsec)	Starting Location Within Interval (µsec)
1	3	91.4	8	1268	1362	1105275
2	2	76.2	8	1870		199366
3	1	54.4	8			490358
4	3	89.9	8	1256	1414	779365
5	1	62.6	8			1071413
6	2	76.3	8	1387		163769
7	1	64.6	8			454651
8	1	53.6	8			745006
9	2	75.7	8	1431		1034301
10	1	63.1	8			128079
11						
12						
13						
14						
15						
16						
17						
18						
19						
20						

**DFS Radar Parameters**  
**FCC Radar Type 5**  
**Channel 62 Bandwidth 40MHz**

Trial Number:			7			Detection (Yes/No)
Number of Bursts in Trial:			8			
Chirp Center Frequency:			5310			
Burst	Number of Pulses	Pulse Width (Microseconds)	Chirp Width (MHz)	Pulse 1-to-2 Spacing (µsec)	Pulse 2-to-3 Spacing (µsec)	Starting Location Within Interval (µsec)
1	2	75.6	14	1155		216520
2	3	85.6	14	1993	1103	396614
3	1	57.4	14			579687
4	2	82.8	14	1995		12889
5	3	88.3	14	1447	1358	193680
6	2	76.3	14	1892		374938
7	3	92.4	14	1841	1127	555060
8	3	93.4	14	1225	1449	736781
9	2	78.8	14	1508		171787
10	2	68.8	14	1329		353186
11	2	80.1	14	1041		534595
12	2	82.1	14	1583		715294
13	3	84.9	14	1169	1756	149063
14	1	60.9	14			331211
15	3	89.2	14	1793	1655	510715
16	2	70.5	14	1404		693078
17						
18						
19						
20						

Trial Number:			8			Detection (Yes/No)
Number of Bursts in Trial:			16			
Chirp Center Frequency:			5310			
Burst	Number of Pulses	Pulse Width (Microseconds)	Chirp Width (MHz)	Pulse 1-to-2 Spacing (µsec)	Pulse 2-to-3 Spacing (µsec)	Starting Location Within Interval (µsec)
1	2	75.6	14	1155		216520
2	3	85.6	14	1993	1103	396614
3	1	57.4	14			579687
4	2	82.8	14	1995		12889
5	3	88.3	14	1447	1358	193680
6	2	76.3	14	1892		374938
7	3	92.4	14	1841	1127	555060
8	3	93.4	14	1225	1449	736781
9	2	78.8	14	1508		171787
10	2	68.8	14	1329		353186
11	2	80.1	14	1041		534595
12	2	82.1	14	1583		715294
13	3	84.9	14	1169	1756	149063
14	1	60.9	14			331211
15	3	89.2	14	1793	1655	510715
16	2	70.5	14	1404		693078
17						
18						
19						
20						

**DFS Radar Parameters**  
**FCC Radar Type 5**  
**Channel 62 Bandwidth 40MHz**

Trial Number:			9			Detection (Yes/No)
Number of Bursts in Trial:			12			
Chirp Center Frequency:			5310			Yes
Burst	Number of Pulses	Pulse Width (Microseconds)	Chirp Width (MHz)	Pulse 1-to-2 Spacing (µsec)	Pulse 2-to-3 Spacing (µsec)	Starting Location Within Interval (µsec)
1	1	51.1	10			169836
2	2	79.9	10	1817		411435
3	2	81.1	10	1203		653492
4	2	71.2	10	1523		894783
5	3	89.2	10	1910	1152	139593
6	2	69.5	10	1149		381670
7	3	94	10	1755	1973	622378
8	2	71.8	10	1465		865458
9	1	65	10			110246
10	2	74.4	10	1489		351980
11	1	66.4	10			594506
12	2	76.5	10	1040		835513
13						
14						
15						
16						
17						
18						
19						
20						

Trial Number:			10			Detection (Yes/No)
Number of Bursts in Trial:			9			
Chirp Center Frequency:			5310			Yes
Burst	Number of Pulses	Pulse Width (Microseconds)	Chirp Width (MHz)	Pulse 1-to-2 Spacing (µsec)	Pulse 2-to-3 Spacing (µsec)	Starting Location Within Interval (µsec)
1	3	97.8	7	1882	1779	106978
2	1	55.9	7			430424
3	1	52.1	7			753353
4	3	99	7	1767	1057	1073995
5	2	77.3	7	1498		67384
6	1	63.1	7			390566
7	2	76	7	1717		712399
8	3	86.7	7	1195	1667	1034158
9	1	64.6	7			27685
10						
11						
12						
13						
14						
15						
16						
17						
18						
19						
20						



**DFS Radar Parameters**  
**FCC Radar Type 5**  
**Channel 62 Bandwidth 40MHz**

Trial Number:			11			Detection (Yes/No)
Number of Bursts in Trial:			10			
Chirp Center Frequency:			5294.994			
Burst	Number of Pulses	Pulse Width (Microseconds)	Chirp Width (MHz)	Pulse 1-to-2 Spacing (µsec)	Pulse 2-to-3 Spacing (µsec)	Starting Location Within Interval (µsec)
1	1	58.6	8			315543
2	3	88	8	1770	1571	604519
3	2	78.2	8	1828		895230
4	3	97.6	8	1496	1028	1185129
5	2	69.3	8	1140		279539
6	3	97.5	8	1468	1623	569056
7	3	95.9	8	1951	1279	858767
8	2	73.5	8	1480		1150807
9	3	93.7	8	1025	1969	243392
10	2	78.2	8	1388		534084
11						
12						
13						
14						
15						
16						
17						
18						
19						
20						

Trial Number:			12			Detection (Yes/No)
Number of Bursts in Trial:			18			
Chirp Center Frequency:			5298.594			
Burst	Number of Pulses	Pulse Width (Microseconds)	Chirp Width (MHz)	Pulse 1-to-2 Spacing (µsec)	Pulse 2-to-3 Spacing (µsec)	Starting Location Within Interval (µsec)
1	1	66.1	17			458266
2	2	78.8	17	1011		618238
3	3	85.7	17	1196	1739	115058
4	3	91.1	17	1002	1952	275495
5	1	65.3	17			438138
6	1	53	17			599661
7	1	51	17			95681
8	1	59.8	17			257166
9	1	56.1	17			418283
10	3	91.6	17	1314	1801	576878
11	3	85.6	17	1415	1931	75439
12	2	67.8	17	1340		236781
13	1	63.8	17			398735
14	1	59.8	17			559395
15	1	65.8	17			55892
16	3	95.7	17	1865	1231	216175
17	2	72.9	17	1848		377480
18	1	66.6	17			539999
19						
20						

**DFS Radar Parameters**  
**FCC Radar Type 5**  
**Channel 62 Bandwidth 40MHz**

Trial Number:			13			Detection (Yes/No)
Number of Bursts in Trial:			15			
Chirp Center Frequency:			5297.394			
Burst	Number of Pulses	Pulse Width (Microseconds)	Chirp Width (MHz)	Pulse 1-to-2 Spacing (µsec)	Pulse 2-to-3 Spacing (µsec)	Starting Location Within Interval (µsec)
1	2	81.1	14	1691		43173
2	1	54.7	14			237072
3	2	71.7	14	1670		429725
4	3	85	14	1339	1900	621518
5	1	52.4	14			19432
6	1	55.8	14			213028
7	3	92.5	14	1427	1153	405290
8	3	92	14	1990	1317	597929
9	1	52.8	14			794345
10	2	73.6	14	1715		188943
11	2	69.9	14	1102		382243
12	2	72	14	1878		574958
13	3	98.2	14	1020	1958	767112
14	3	98.3	14	1277	1686	164814
15	2	71.3	14	1296		358432
16						
17						
18						
19						
20						

Trial Number:			14			Detection (Yes/No)
Number of Bursts in Trial:			20			
Chirp Center Frequency:			5299.794			
Burst	Number of Pulses	Pulse Width (Microseconds)	Chirp Width (MHz)	Pulse 1-to-2 Spacing (µsec)	Pulse 2-to-3 Spacing (µsec)	Starting Location Within Interval (µsec)
1	3	96.2	20	1464	1142	412467
2	1	50.2	20			559149
3	3	97.8	20	1221	1168	105622
4	1	62	20			251304
5	1	64.8	20			396581
6	3	86.9	20	1208	1270	539601
7	3	95.9	20	1963	1750	87618
8	2	76.2	20	1318		232979
9	1	53.3	20			378329
10	2	69.8	20	1703		521958
11	3	95.2	20	1187	1557	69956
12	2	79	20	1968		214668
13	3	90.8	20	1822	1297	358915
14	2	74.2	20	1816		504640
15	2	68.3	20	1761		52265
16	2	81.8	20	1323		197219
17	2	73.6	20	1189		342218
18	2	74.6	20	1410		486611
19	2	79.3	20	1441		34446
20	3	92.5	20	1661	1771	178766

**DFS Radar Parameters**  
**FCC Radar Type 5**  
**Channel 62 Bandwidth 40MHz**

Trial Number:			15			Detection (Yes/No)
Number of Bursts in Trial:			17			
Chirp Center Frequency:			5298.194			
Burst	Number of Pulses	Pulse Width (Microseconds)	Chirp Width (MHz)	Pulse 1-to-2 Spacing (µsec)	Pulse 2-to-3 Spacing (µsec)	Starting Location Within Interval (µsec)
1	3	88.9	16	1239	1759	380606
2	1	56.5	16			553212
3	2	81.2	16	1330		19594
4	2	76.3	16	1862		190008
5	2	79.9	16	1368		360470
6	3	98.7	16	1510	1320	529951
7	2	73.4	16	1529		701560
8	1	50.2	16			169324
9	2	77.5	16	1067		339969
10	3	89.9	16	1344	1559	509095
11	3	84.2	16	1901	1918	677997
12	3	93.5	16	1656	1355	147725
13	3	87.3	16	1432	1731	317636
14	3	96.5	16	1511	1732	487504
15	2	67.6	16	1078		659989
16	1	59.6	16			127277
17	2	68	16	1156		297601
18						
19						
20						

Trial Number:			16			Detection (Yes/No)
Number of Bursts in Trial:			8			
Chirp Center Frequency:			5293.794			
Burst	Number of Pulses	Pulse Width (Microseconds)	Chirp Width (MHz)	Pulse 1-to-2 Spacing (µsec)	Pulse 2-to-3 Spacing (µsec)	Starting Location Within Interval (µsec)
1	3	83.7	5	1908	1548	995497
2	1	58.1	5			1361600
3	2	79.8	5	1885		225782
4	3	85.2	5	1647	1080	588360
5	2	78.5	5	1887		951829
6	2	68.4	5	1269		1315202
7	1	65.1	5			181313
8	1	57.3	5			544812
9						
10						
11						
12						
13						
14						
15						
16						
17						
18						
19						
20						

**DFS Radar Parameters**  
**FCC Radar Type 5**  
**Channel 62 Bandwidth 40MHz**

Trial Number:			17			Detection (Yes/No)
Number of Bursts in Trial:			13			
Chirp Center Frequency:			5296.194			
Burst	Number of Pulses	Pulse Width (Microseconds)	Chirp Width (MHz)	Pulse 1-to-2 Spacing ( $\mu$ sec)	Pulse 2-to-3 Spacing ( $\mu$ sec)	Starting Location Within Interval ( $\mu$ sec)
1	2	76.8	11	1829		557698
2	1	51.7	11			782182
3	2	67.8	11	1402		83874
4	3	84.5	11	1036	1500	306513
5	3	91.9	11	1855	1519	529020
6	3	96.4	11	1988	1331	751885
7	3	97.4	11	1991	1337	56297
8	2	68.9	11	1858		279421
9	1	55.8	11			503662
10	2	82.5	11	1538		725515
11	3	89.7	11	1095	1710	28860
12	2	69.1	11	1029		252246
13	2	71.5	11	1785		475029
14						
15						
16						
17						
18						
19						
20						

Trial Number:			18			Detection (Yes/No)
Number of Bursts in Trial:			16			
Chirp Center Frequency:			5297.794			
Burst	Number of Pulses	Pulse Width (Microseconds)	Chirp Width (MHz)	Pulse 1-to-2 Spacing ( $\mu$ sec)	Pulse 2-to-3 Spacing ( $\mu$ sec)	Starting Location Within Interval ( $\mu$ sec)
1	2	82.1	15	1760		566651
2	1	66.2	15			1143
3	1	63.5	15			182789
4	3	95.7	15	1083	1418	362933
5	3	98.8	15	1254	1088	543876
6	1	63.5	15			727356
7	3	85.7	15	1283	1651	159683
8	1	51.6	15			341898
9	3	91.8	15	1399	1640	521273
10	3	94.3	15	1108	1675	702317
11	1	56.5	15			137881
12	1	58.7	15			319662
13	1	63.7	15			501159
14	3	90	15	1438	1925	679274
15	1	66.5	15			115593
16	3	99.6	15	1632	1171	296127
17						
18						
19						
20						

**DFS Radar Parameters**  
**FCC Radar Type 5**  
**Channel 62 Bandwidth 40MHz**

Trial Number:			19			Detection (Yes/No)
Number of Bursts in Trial:			8			
Chirp Center Frequency:			5293.794			
Burst	Number of Pulses	Pulse Width (Microseconds)	Chirp Width (MHz)	Pulse 1-to-2 Spacing (µsec)	Pulse 2-to-3 Spacing (µsec)	Starting Location Within Interval (µsec)
1	1	57.2	5			958469
2	1	60.3	5			1321531
3	3	88.2	5	1773.000	1804.000	186176
4	1	66.1	5			550007
5	2	68.9	5	1944.000		912150
6	1	53	5			1276596
7	3	96.9	5	1879.000	1258.000	141585
8	1	55.6	5			505262
9						
10						
11						
12						
13						
14						
15						
16						
17						
18						
19						
20						

Trial Number:			20			Detection (Yes/No)
Number of Bursts in Trial:			13			
Chirp Center Frequency:			5296.194			
Burst	Number of Pulses	Pulse Width (Microseconds)	Chirp Width (MHz)	Pulse 1-to-2 Spacing (µsec)	Pulse 2-to-3 Spacing (µsec)	Starting Location Within Interval (µsec)
1	1	65.7	11			534549
2	3	85.6	11	1321	1726	755351
3	3	93.6	11	1863	1370	59514
4	3	86.8	11	1998	1603	282206
5	2	74.6	11	1505		505905
6	2	81.5	11	1808		728563
7	1	64	11			32199
8	2	78	11	1916		255085
9	3	90.6	11	1299	1596	477956
10	3	96.6	11	1692	1133	700648
11	1	51.5	11			4666
12	3	92	11	1584	1457	227313
13	1	66.2	11			451522
14						
15						
16						
17						
18						
19						
20						

**DFS Radar Parameters**  
**FCC Radar Type 5**  
**Channel 62 Bandwidth 40MHz**

Trial Number:			21			Detection (Yes/No)
Number of Bursts in Trial:			19			
Chirp Center Frequency:			5320.606			
Burst	Number of Pulses	Pulse Width (Microseconds)	Chirp Width (MHz)	Pulse 1-to-2 Spacing (µsec)	Pulse 2-to-3 Spacing (µsec)	Starting Location Within Interval (µsec)
1	3	89.6	19	1913	1976	458587
2	2	79.8	19	1367		612743
3	1	54.9	19			137244
4	2	79.4	19	1803		289280
5	1	55.7	19			442917
6	3	85.1	19	1606	1143	592930
7	1	57.4	19			118375
8	1	61.2	19			271325
9	2	75.8	19	1811		422480
10	2	78.2	19	1852		574802
11	1	56.3	19			99538
12	2	80.9	19	1220		251892
13	2	69.4	19	1687		404285
14	3	98.6	19	1518	1154	555798
15	2	72.1	19	1332		80537
16	1	51.5	19			233486
17	1	53	19			386496
18	1	52.6	19			539575
19	2	79.1	19	1949		61718
20						

Trial Number:			22			Detection (Yes/No)
Number of Bursts in Trial:			16			
Chirp Center Frequency:			5322.206			
Burst	Number of Pulses	Pulse Width (Microseconds)	Chirp Width (MHz)	Pulse 1-to-2 Spacing (µsec)	Pulse 2-to-3 Spacing (µsec)	Starting Location Within Interval (µsec)
1	2	69.3	15	1877		254487
2	1	57.8	15			436785
3	2	79.9	15	2000		616628
4	1	63.1	15			51159
5	2	69.9	15	1380		232224
6	3	99	15	1994	1160	412665
7	2	77	15	1860		594490
8	1	60.2	15			28800
9	2	80.3	15	1798		209873
10	2	78.6	15	1522		391228
11	2	68.2	15	1608		571946
12	2	67.2	15	1114		6427
13	3	88.5	15	1446	1406	187164
14	2	74.6	15	1682		368451
15	2	83.3	15	1853		549946
16	2	67.7	15	1423		731000
17						
18						
19						
20						

**DFS Radar Parameters**  
**FCC Radar Type 5**  
**Channel 62 Bandwidth 40MHz**

Trial Number:			23			Detection (Yes/No)
Number of Bursts in Trial:			14			
Chirp Center Frequency:			5323.406			
Burst	Number of Pulses	Pulse Width (Microseconds)	Chirp Width (MHz)	Pulse 1-to-2 Spacing (µsec)	Pulse 2-to-3 Spacing (µsec)	Starting Location Within Interval (µsec)
1	2	80.6	12	1325		188949
2	2	83.3	12	1202		396121
3	3	86.7	12	1451	1372	602317
4	1	63.1	12			811814
5	2	68	12	1807		163477
6	3	89.5	12	1134	1416	370010
7	3	94.4	12	1948	1058	577001
8	3	90	12	1047	1705	784127
9	1	57.4	12			138193
10	3	87.2	12	1074	1001	344709
11	1	55.9	12			553281
12	1	55.2	12			761200
13	2	82.9	12	1212		112482
14	3	92	12	1473	1922	318957
15						
16						
17						
18						
19						
20						

Trial Number:			24			Detection (Yes/No)
Number of Bursts in Trial:			14			
Chirp Center Frequency:			5323.006			
Burst	Number of Pulses	Pulse Width (Microseconds)	Chirp Width (MHz)	Pulse 1-to-2 Spacing (µsec)	Pulse 2-to-3 Spacing (µsec)	Starting Location Within Interval (µsec)
1	2	76.5	13	1555		526518
2	3	87.5	13	1504	1599	732507
3	3	93.9	13	1664	1391	86736
4	2	72.4	13	1614		294120
5	2	72.6	13	1106		501671
6	1	58.4	13			709310
7	1	59.6	13			61533
8	1	66.6	13			268913
9	3	85	13	1186	1796	475077
10	2	80.5	13	1727		682804
11	2	78.8	13	1452		35899
12	2	74.8	13	1935		242795
13	2	77.2	13	1197		450389
14	2	82.6	13	1082		657756
15						
16						
17						
18						
19						
20						

**DFS Radar Parameters**  
**FCC Radar Type 5**  
**Channel 62 Bandwidth 40MHz**

Trial Number:			25			Detection (Yes/No)
Number of Bursts in Trial:			13			
Chirp Center Frequency:			5323.806			
Burst	Number of Pulses	Pulse Width (Microseconds)	Chirp Width (MHz)	Pulse 1-to-2 Spacing ( $\mu$ sec)	Pulse 2-to-3 Spacing ( $\mu$ sec)	Starting Location Within Interval ( $\mu$ sec)
1	1	57.5	11			11192
2	1	61	11			234643
3	2	67.9	11	1502		457245
4	1	56.2	11			681769
5	3	86.1	11	1228	1031	902590
6	2	80.9	11	1445		206945
7	3	91.5	11	1455	1122	429305
8	2	68.2	11	1015		653478
9	1	66.3	11			877390
10	3	89.5	11	1543	1470	178971
11	1	61.1	11			403302
12	2	79.9	11	1214		625531
13	1	63.5	11			850373
14						
15						
16						
17						
18						
19						
20						

Trial Number:			26			Detection (Yes/No)
Number of Bursts in Trial:			17			
Chirp Center Frequency:			5321.806			
Burst	Number of Pulses	Pulse Width (Microseconds)	Chirp Width (MHz)	Pulse 1-to-2 Spacing ( $\mu$ sec)	Pulse 2-to-3 Spacing ( $\mu$ sec)	Starting Location Within Interval ( $\mu$ sec)
1	3	90	16	1185	1509	115777
2	1	55.7	16			286979
3	2	82.7	16	1904		456477
4	3	93	16	1765	1223	625877
5	2	71.7	16	1073		95108
6	2	77.4	16	1237		265667
7	3	88.3	16	1250	1017	435305
8	1	52.1	16			607978
9	2	80.7	16	1532		74051
10	2	73.3	16	1272		244577
11	1	66	16			415586
12	1	51.9	16			586282
13	2	74.8	16	1845		52957
14	1	58	16			223816
15	1	63.9	16			394907
16	3	98.3	16	1042	1007	563737
17	1	56.1	16			32086
18						
19						
20						



**DFS Radar Parameters**  
**FCC Radar Type 5**  
**Channel 62 Bandwidth 40MHz**

Trial Number:			27			Detection (Yes/No)
Number of Bursts in Trial:			20			
Chirp Center Frequency:			5320.206			
Burst	Number of Pulses	Pulse Width (Microseconds)	Chirp Width (MHz)	Pulse 1-to-2 Spacing ( $\mu$ sec)	Pulse 2-to-3 Spacing ( $\mu$ sec)	Starting Location Within Interval ( $\mu$ sec)
1	3	84.4	20	1006	1288	171798
2	3	93.2	20	1704	1121	316209
3	1	62.2	20			463045
4	1	61.7	20			9381
5	2	82.4	20	1923		154002
6	3	96.5	20	1257	1352	298454
7	2	69.3	20	1714		443388
8	3	99.7	20	1753	1016	587670
9	2	69.1	20	1145		136359
10	1	52	20			281692
11	1	50.4	20			426935
12	1	58.2	20			571957
13	2	71.1	20	1539		118444
14	1	54.4	20			264113
15	1	61.3	20			408792
16	3	92.8	20	1255	1719	551905
17	3	95	20	1481	1342	100355
18	2	69.7	20	1499		245551
19	1	60.9	20			391316
20	1	52.2	20			536137

Trial Number:			28			Detection (Yes/No)
Number of Bursts in Trial:			14			
Chirp Center Frequency:			5323.006			
Burst	Number of Pulses	Pulse Width (Microseconds)	Chirp Width (MHz)	Pulse 1-to-2 Spacing ( $\mu$ sec)	Pulse 2-to-3 Spacing ( $\mu$ sec)	Starting Location Within Interval ( $\mu$ sec)
1	3	87.5	13	1209	1978	118213
2	1	57	13			326346
3	3	97.5	13	1615	1349	531858
4	3	88.9	13	1984	1005	738617
5	2	80.5	13	1010		92995
6	2	76.9	13	1764		300151
7	3	87.7	13	1987	1119	506096
8	1	51.9	13			716032
9	1	54.3	13			67531
10	1	61.3	13			275052
11	2	72.8	13	1886		481481
12	2	77.5	13	1071		689565
13	2	69.9	13	1503		41917
14	1	60.2	13			249630
15						
16						
17						
18						
19						
20						

**DFS Radar Parameters**  
**FCC Radar Type 5**  
**Channel 62 Bandwidth 40MHz**

Trial Number:			29			Detection (Yes/No)
Number of Bursts in Trial:			12			
Chirp Center Frequency:			5324.206			
Burst	Number of Pulses	Pulse Width (Microseconds)	Chirp Width (MHz)	Pulse 1-to-2 Spacing (µsec)	Pulse 2-to-3 Spacing (µsec)	Starting Location Within Interval (µsec)
1	1	55.1	10			533545
2	2	67.9	10	1100		774812
3	2	67.6	10	1790		19150
4	1	51.7	10			261321
5	1	57.5	10			503712
6	1	59.3	10			745934
7	1	63.4	10			988293
8	3	93.4	10	1746	1707	230686
9	1	52.6	10			473625
10	2	75.3	10	1786		714764
11	3	87.8	10	1281	1979	955073
12	3	94	10	1309	1176	201103
13						
14						
15						
16						
17						
18						
19						
20						

Trial Number:			30			Detection (Yes/No)
Number of Bursts in Trial:			13			
Chirp Center Frequency:			5324.606			
Burst	Number of Pulses	Pulse Width (Microseconds)	Chirp Width (MHz)	Pulse 1-to-2 Spacing (µsec)	Pulse 2-to-3 Spacing (µsec)	Starting Location Within Interval (µsec)
1	1	59.5	9			484104
2	2	68.8	9	1426		747546
3	1	54.6	9			1012254
4	1	59.2	9			187514
5	2	79.9	9	1597		451068
6	3	88.4	9	1823	1077	714344
7	1	53	9			980078
8	3	96.1	9	1068	1109	154584
9	2	68.7	9	1736		418486
10	2	77.4	9	1857		682304
11	3	95.8	9	1941	1893	944646
12	2	76.2	12	1770		563316
13	1	60.6	12			788278
14						
15						
16						
17						
18						
19						
20						

**DFS Radar Parameters**  
**FCC Radar Type 1**  
**Channel 100 Bandwidth 20MHz**

Trial #	Pulse Repetition Frequency Number (1 to 23)	Pulse Repetition Frequency (Pulses Per Second)	Pulse Repetition Interval (Microseconds)	Detection (Yes / No)
1	1	1930.50	518	Yes
2	12	1355.01	738	No
3	15	1253.13	798	Yes
4	13	1319.26	758	Yes
5	8	1519.76	658	Yes
6	11	1392.76	718	Yes
7	21	1089.32	918	Yes
8	12	326.16	3066	Yes
9	4	1730.10	578	Yes
10	20	1113.59	898	Yes
11	2	1858.74	538	Yes
12	22	1066.10	938	Yes
13	5	1672.24	598	Yes
14	17	1193.32	838	Yes
15	7	1567.40	638	Yes
16		346.98	2882	No
17		394.01	2538	Yes
18		1897.53	527	Yes
19		447.23	2236	Yes
20		1285.35	778	Yes
21		1557.63	642	Yes
22		469.48	2130	Yes
23		1069.52	935	Yes
24		626.17	1597	Yes
25		373.69	2676	Yes
26		586.85	1704	Yes
27		689.18	1451	Yes
28		765.11	1307	No
29		432.90	2310	Yes
30		449.84	2223	Yes

**DFS Radar Parameters**  
**FCC Radar Type 2**  
**Channel 100 Bandwidth 20MHz**

Trial #	Number Pulses per Burst	Pulse Width (Microseconds)	Pulse Repetition Interval (Microseconds)	Detection (Yes / No)
1	23	1.40	198	Yes
2	25	2.20	224	Yes
3	23	1.10	176	Yes
4	26	2.90	182	Yes
5	26	3.10	229	Yes
6	24	1.80	202	Yes
7	23	1.20	228	No
8	27	3.50	194	Yes
9	25	2.30	157	Yes
10	24	1.60	167	Yes
11	24	1.80	199	Yes
12	28	4.20	230	Yes
13	27	3.40	152	Yes
14	29	5.00	217	Yes
15	27	3.80	186	Yes
16	23	1.10	206	Yes
17	25	2.60	180	No
18	27	3.70	165	Yes
19	23	1.00	188	Yes
20	25	2.70	227	Yes
21	29	4.60	219	Yes
22	27	3.60	203	Yes
23	26	2.90	184	Yes
24	26	3.10	178	Yes
25	25	2.60	221	Yes
26	28	4.00	153	Yes
27	29	4.80	193	Yes
28	26	3.20	210	Yes
29	25	2.30	162	Yes
30	24	2.00	181	Yes

**DFS Radar Parameters**  
**FCC Radar Type 3**  
**Channel 100 Bandwidth 20MHz**

Trial #	Number Pulses per Burst	Pulse Width (Microseconds)	Pulse Repetition Interval (Microseconds)	Detection (Yes / No)
1	16	6.40	465	Yes
2	16	7.20	383	Yes
3	16	6.10	271	Yes
4	17	7.90	440	Yes
5	17	8.10	341	Yes
6	16	6.80	318	Yes
7	16	6.20	334	Yes
8	17	8.50	494	No
9	17	7.30	245	Yes
10	16	6.60	215	Yes
11	16	6.80	282	Yes
12	18	9.20	485	Yes
13	17	8.40	258	Yes
14	18	10.00	437	Yes
15	18	8.80	320	Yes
16	16	6.10	200	Yes
17	17	7.60	220	Yes
18	17	8.70	401	Yes
19	16	6.00	399	Yes
20	17	7.70	205	Yes
21	18	9.60	470	Yes
22	17	8.60	491	Yes
23	17	7.90	297	Yes
24	17	8.10	202	Yes
25	17	7.60	391	Yes
26	18	9.00	396	Yes
27	18	9.80	397	No
28	17	8.20	288	Yes
29	16	7.30	219	Yes
30	16	7.00	261	Yes

**DFS Radar Parameters**  
**FCC Radar Type 4**  
**Channel 100 Bandwidth 20MHz**

Trial #	Number Pulses per Burst	Pulse Width (Microseconds)	Pulse Repetition Interval (Microseconds)	Detection (Yes / No)
1	12	11.90	465	Yes
2	13	13.70	383	Yes
3	12	11.30	271	Yes
4	14	15.30	440	Yes
5	14	15.80	341	Yes
6	13	12.80	318	Yes
7	12	11.50	334	Yes
8	15	16.60	494	Yes
9	13	14.00	245	Yes
10	12	12.30	215	Yes
11	13	12.80	282	Yes
12	15	18.10	485	Yes
13	14	16.30	258	No
14	16	19.80	437	Yes
15	15	17.30	320	Yes
16	12	11.20	200	Yes
17	13	14.50	220	Yes
18	15	17.00	401	Yes
19	12	11.10	399	Yes
20	14	14.80	205	Yes
21	16	19.00	470	Yes
22	15	16.90	491	Yes
23	14	15.20	297	Yes
24	14	15.60	202	Yes
25	13	14.50	391	Yes
26	15	17.70	396	Yes
27	16	19.60	397	Yes
28	14	15.80	288	Yes
29	13	13.90	219	Yes
30	13	13.40	261	Yes

**DFS Radar Parameters**  
**FCC Radar Type 5**  
**Channel 100 Bandwidth 20MHz**

Trial Number:			1			Detection (Yes/No)
Number of Bursts in Trial:			9			
Chirp Center Frequency:			5500			
Burst	Number of Pulses	Pulse Width (Microseconds )	Chirp Width (MHz)	Pulse 1-to-2 Spacing (µsec)	Pulse 2-to-3 Spacing (µsec)	Starting Location Within Interval (µsec)
1	1	55	6			456091
2	1	64.9	6			778946
3	1	52	6			1101904
4	2	74.2	6	1019		93064
5	2	76.7	6	1180		415903
6	1	60	6			739340
7	1	53.1	6			1062002
8	2	80.8	6	1772		53279
9	2	66.8	6	1308		375962
10						
11						
12						
13						
14						
15						
16						
17						
18						
19						
20						

Trial Number:			2			Detection (Yes/No)
Number of Bursts in Trial:			11			
Chirp Center Frequency:			5500			
Burst	Number of Pulses	Pulse Width (Microseconds )	Chirp Width (MHz)	Pulse 1-to-2 Spacing (µsec)	Pulse 2-to-3 Spacing (µsec)	Starting Location Within Interval (µsec)
1	1	57.3	9			572286
2	1	60.1	9			836083
3	3	89.6	9	1440	1575	11057
4	2	79.5	9	1369		274996
5	3	98.8	9	1099	1275	538369
6	3	84.7	9	1650	1769	801389
7	1	51.4	9			1068068
8	2	69.8	9	1983		242218
9	2	83.3	9	1950		506136
10	1	50.9	9			770863
11	2	71.4	9	1116		1034768
12						
13						
14						
15						
16						
17						
18						
19						
20						

**DFS Radar Parameters**  
**FCC Radar Type 5**  
**Channel 100 Bandwidth 20MHz**

Trial Number:			3			Detection (Yes/No)
Number of Bursts in Trial:			8			
Chirp Center Frequency:			5500			
Burst	Number of Pulses	Pulse Width (Microseconds)	Chirp Width (MHz)	Pulse 1-to-2 Spacing (µsec)	Pulse 2-to-3 Spacing (µsec)	Starting Location Within Interval (µsec)
1	3	94.2	5	1478	1777	288532
2	2	82.9	5	1681		651974
3	2	73.5	5	1889		1014683
4	2	75.8	5	1295		1378001
5	2	69.7	5	1075		244188
6	3	86.9	5	1907	1463	606557
7	3	97.4	5	1072	1173	969693
8	2	76.9	5	1193		1333926
9						
10						
11						
12						
13						
14						
15						
16						
17						
18						
19						
20						

Trial Number:			4			Detection (Yes/No)
Number of Bursts in Trial:			8			
Chirp Center Frequency:			5500			
Burst	Number of Pulses	Pulse Width (Microseconds)	Chirp Width (MHz)	Pulse 1-to-2 Spacing (µsec)	Pulse 2-to-3 Spacing (µsec)	Starting Location Within Interval (µsec)
1	1	66.2	12			113987
2	1	63.2	12			321486
3	2	81.6	12	1624		528264
4	3	97.1	12	1125	1787	733969
5	1	62.5	12			88396
6	1	61.5	12			295881
7	3	92.6	12	1645	1343	501606
8	3	92.5	12	1899	1591	708477
9	1	56.1	12			62881
10	3	85.6	12	1837	1392	269320
11	1	61	12			477893
12	1	51.8	12			685309
13	3	95.8	12	1327	1249	37176
14	1	58.5	12			244764
15						
16						
17						
18						
19						
20						



**DFS Radar Parameters**  
**FCC Radar Type 5**  
**Channel 100 Bandwidth 20MHz**

Trial Number:			5			Detection (Yes/No)
Number of Bursts in Trial:			14			
Chirp Center Frequency:			5500			Yes
Burst	Number of Pulses	Pulse Width (Microseconds)	Chirp Width (MHz)	Pulse 1-to-2 Spacing (µsec)	Pulse 2-to-3 Spacing (µsec)	Starting Location Within Interval (µsec)
1	2	75.4	13	1733		451522
2	3	90.7	13	1570	1285	657471
3	3	87.6	13	1868	1643	11695
4	3	93.5	13	1371	1579	218584
5	3	94.5	13	1105	1147	425679
6	1	53.9	13			634053
7	3	98.2	13	1652	1311	839188
8	3	97.5	13	1351	1316	193137
9	2	83.2	13	1490		400517
10	3	99.6	13	1642	1680	606704
11	1	62.1	13			815936
12	1	51.5	13			168219
13	2	72.3	13	1628		375144
14	2	72.1	13	1065		582695
15						
16						
17						
18						
19						
20						

Trial Number:			6			Detection (Yes/No)
Number of Bursts in Trial:			10			
Chirp Center Frequency:			5500			Yes
Burst	Number of Pulses	Pulse Width (Microseconds)	Chirp Width (MHz)	Pulse 1-to-2 Spacing (µsec)	Pulse 2-to-3 Spacing (µsec)	Starting Location Within Interval (µsec)
1	3	91.4	8	1268	1362	1105275
2	2	76.2	8	1870		199366
3	1	54.4	8			490358
4	3	89.9	8	1256	1414	779365
5	1	62.6	8			1071413
6	2	76.3	8	1387		163769
7	1	64.6	8			454651
8	1	53.6	8			745006
9	2	75.7	8	1431		1034301
10	1	63.1	8			128079
11						
12						
13						
14						
15						
16						
17						
18						
19						
20						

**DFS Radar Parameters**  
**FCC Radar Type 5**  
**Channel 100 Bandwidth 20MHz**

Trial Number:			7			Detection (Yes/No)
Number of Bursts in Trial:			8			
Chirp Center Frequency:			5500			
Burst	Number of Pulses	Pulse Width (Microseconds)	Chirp Width (MHz)	Pulse 1-to-2 Spacing ( $\mu$ sec)	Pulse 2-to-3 Spacing ( $\mu$ sec)	Starting Location Within Interval ( $\mu$ sec)
1	2	75.6	14	1155		216520
2	3	85.6	14	1993	1103	396614
3	1	57.4	14			579687
4	2	82.8	14	1995		12889
5	3	88.3	14	1447	1358	193680
6	2	76.3	14	1892		374938
7	3	92.4	14	1841	1127	555060
8	3	93.4	14	1225	1449	736781
9	2	78.8	14	1508		171787
10	2	68.8	14	1329		353186
11	2	80.1	14	1041		534595
12	2	82.1	14	1583		715294
13	3	84.9	14	1169	1756	149063
14	1	60.9	14			331211
15	3	89.2	14	1793	1655	510715
16	2	70.5	14	1404		693078
17						
18						
19						
20						

Trial Number:			8			Detection (Yes/No)
Number of Bursts in Trial:			16			
Chirp Center Frequency:			5500			
Burst	Number of Pulses	Pulse Width (Microseconds)	Chirp Width (MHz)	Pulse 1-to-2 Spacing ( $\mu$ sec)	Pulse 2-to-3 Spacing ( $\mu$ sec)	Starting Location Within Interval ( $\mu$ sec)
1	2	75.6	14	1155		216520
2	3	85.6	14	1993	1103	396614
3	1	57.4	14			579687
4	2	82.8	14	1995		12889
5	3	88.3	14	1447	1358	193680
6	2	76.3	14	1892		374938
7	3	92.4	14	1841	1127	555060
8	3	93.4	14	1225	1449	736781
9	2	78.8	14	1508		171787
10	2	68.8	14	1329		353186
11	2	80.1	14	1041		534595
12	2	82.1	14	1583		715294
13	3	84.9	14	1169	1756	149063
14	1	60.9	14			331211
15	3	89.2	14	1793	1655	510715
16	2	70.5	14	1404		693078
17						
18						
19						
20						

**DFS Radar Parameters**  
**FCC Radar Type 5**  
**Channel 100 Bandwidth 20MHz**

Trial Number:			9			Detection (Yes/No)
Number of Bursts in Trial:			12			
Chirp Center Frequency:			5500			
Burst	Number of Pulses	Pulse Width (Microseconds)	Chirp Width (MHz)	Pulse 1-to-2 Spacing (µsec)	Pulse 2-to-3 Spacing (µsec)	Starting Location Within Interval (µsec)
1	1	51.1	10			169836
2	2	79.9	10	1817		411435
3	2	81.1	10	1203		653492
4	2	71.2	10	1523		894783
5	3	89.2	10	1910	1152	139593
6	2	69.5	10	1149		381670
7	3	94	10	1755	1973	622378
8	2	71.8	10	1465		865458
9	1	65	10			110246
10	2	74.4	10	1489		351980
11	1	66.4	10			594506
12	2	76.5	10	1040		835513
13						
14						
15						
16						
17						
18						
19						
20						

Trial Number:			10			Detection (Yes/No)
Number of Bursts in Trial:			9			
Chirp Center Frequency:			5500			
Burst	Number of Pulses	Pulse Width (Microseconds)	Chirp Width (MHz)	Pulse 1-to-2 Spacing (µsec)	Pulse 2-to-3 Spacing (µsec)	Starting Location Within Interval (µsec)
1	3	97.8	7	1882	1779	106978
2	1	55.9	7			430424
3	1	52.1	7			753353
4	3	99	7	1767	1057	1073995
5	2	77.3	7	1498		67384
6	1	63.1	7			390566
7	2	76	7	1717		712399
8	3	86.7	7	1195	1667	1034158
9	1	64.6	7			27685
10						
11						
12						
13						
14						
15						
16						
17						
18						
19						
20						

**DFS Radar Parameters**  
**FCC Radar Type 5**  
**Channel 100 Bandwidth 20MHz**

Trial Number:			11			Detection (Yes/No)
Number of Bursts in Trial:			10			
Chirp Center Frequency:			5494.0735			
Burst	Number of Pulses	Pulse Width (Microseconds)	Chirp Width (MHz)	Pulse 1-to-2 Spacing (µsec)	Pulse 2-to-3 Spacing (µsec)	Starting Location Within Interval (µsec)
1	1	58.6	8			315543
2	3	88	8	1770	1571	604519
3	2	78.2	8	1828		895230
4	3	97.6	8	1496	1028	1185129
5	2	69.3	8	1140		279539
6	3	97.5	8	1468	1623	569056
7	3	95.9	8	1951	1279	858767
8	2	73.5	8	1480		1150807
9	3	93.7	8	1025	1969	243392
10	2	78.2	8	1388		534084
11						
12						
13						
14						
15						
16						
17						
18						
19						
20						

Trial Number:			12			Detection (Yes/No)
Number of Bursts in Trial:			18			
Chirp Center Frequency:			5497.6735			
Burst	Number of Pulses	Pulse Width (Microseconds)	Chirp Width (MHz)	Pulse 1-to-2 Spacing (µsec)	Pulse 2-to-3 Spacing (µsec)	Starting Location Within Interval (µsec)
1	1	66.1	17			458266
2	2	78.8	17	1011		618238
3	3	85.7	17	1196	1739	115058
4	3	91.1	17	1002	1952	275495
5	1	65.3	17			438138
6	1	53	17			599661
7	1	51	17			95681
8	1	59.8	17			257166
9	1	56.1	17			418283
10	3	91.6	17	1314	1801	576878
11	3	85.6	17	1415	1931	75439
12	2	67.8	17	1340		236781
13	1	63.8	17			398735
14	1	59.8	17			559395
15	1	65.8	17			55892
16	3	95.7	17	1865	1231	216175
17	2	72.9	17	1848		377480
18	1	66.6	17			539999
19						
20						

**DFS Radar Parameters**  
**FCC Radar Type 5**  
**Channel 100 Bandwidth 20MHz**

Trial Number:			13			Detection (Yes/No) Yes
Number of Bursts in Trial:			15			
Chirp Center Frequency:			5496.4735			
Burst	Number of Pulses	Pulse Width (Microseconds)	Chirp Width (MHz)	Pulse 1-to-2 Spacing (µsec)	Pulse 2-to-3 Spacing (µsec)	Starting Location Within Interval (µsec)
1	2	81.1	14	1691		43173
2	1	54.7	14			237072
3	2	71.7	14	1670		429725
4	3	85	14	1339	1900	621518
5	1	52.4	14			19432
6	1	55.8	14			213028
7	3	92.5	14	1427	1153	405290
8	3	92	14	1990	1317	597929
9	1	52.8	14			794345
10	2	73.6	14	1715		188943
11	2	69.9	14	1102		382243
12	2	72	14	1878		574958
13	3	98.2	14	1020	1958	767112
14	3	98.3	14	1277	1686	164814
15	2	71.3	14	1296		358432
16						
17						
18						
19						
20						

Trial Number:			14			Detection (Yes/No) Yes
Number of Bursts in Trial:			20			
Chirp Center Frequency:			5498.8735			
Burst	Number of Pulses	Pulse Width (Microseconds)	Chirp Width (MHz)	Pulse 1-to-2 Spacing (µsec)	Pulse 2-to-3 Spacing (µsec)	Starting Location Within Interval (µsec)
1	3	96.2	20	1464	1142	412467
2	1	50.2	20			559149
3	3	97.8	20	1221	1168	105622
4	1	62	20			251304
5	1	64.8	20			396581
6	3	86.9	20	1208	1270	539601
7	3	95.9	20	1963	1750	87618
8	2	76.2	20	1318		232979
9	1	53.3	20			378329
10	2	69.8	20	1703		521958
11	3	95.2	20	1187	1557	69956
12	2	79	20	1968		214668
13	3	90.8	20	1822	1297	358915
14	2	74.2	20	1816		504640
15	2	68.3	20	1761		52265
16	2	81.8	20	1323		197219
17	2	73.6	20	1189		342218
18	2	74.6	20	1410		486611
19	2	79.3	20	1441		34446
20	3	92.5	20	1661	1771	178766

**DFS Radar Parameters**  
**FCC Radar Type 5**  
**Channel 100 Bandwidth 20MHz**

Trial Number:			15			Detection (Yes/No)
Number of Bursts in Trial:			17			
Chirp Center Frequency:			5497.2735			
Burst	Number of Pulses	Pulse Width (Microseconds)	Chirp Width (MHz)	Pulse 1-to-2 Spacing (µsec)	Pulse 2-to-3 Spacing (µsec)	Starting Location Within Interval (µsec)
1	3	88.9	16	1239	1759	380606
2	1	56.5	16			553212
3	2	81.2	16	1330		19594
4	2	76.3	16	1862		190008
5	2	79.9	16	1368		360470
6	3	98.7	16	1510	1320	529951
7	2	73.4	16	1529		701560
8	1	50.2	16			169324
9	2	77.5	16	1067		339969
10	3	89.9	16	1344	1559	509095
11	3	84.2	16	1901	1918	677997
12	3	93.5	16	1656	1355	147725
13	3	87.3	16	1432	1731	317636
14	3	96.5	16	1511	1732	487504
15	2	67.6	16	1078		659989
16	1	59.6	16			127277
17	2	68	16	1156		297601
18						
19						
20						

Trial Number:			16			Detection (Yes/No)
Number of Bursts in Trial:			8			
Chirp Center Frequency:			5492.8735			
Burst	Number of Pulses	Pulse Width (Microseconds)	Chirp Width (MHz)	Pulse 1-to-2 Spacing (µsec)	Pulse 2-to-3 Spacing (µsec)	Starting Location Within Interval (µsec)
1	3	83.7	5	1908	1548	995497
2	1	58.1	5			1361600
3	2	79.8	5	1885		225782
4	3	85.2	5	1647	1080	588360
5	2	78.5	5	1887		951829
6	2	68.4	5	1269		1315202
7	1	65.1	5			181313
8	1	57.3	5			544812
9						
10						
11						
12						
13						
14						
15						
16						
17						
18						
19						
20						

**DFS Radar Parameters**  
**FCC Radar Type 5**  
**Channel 100 Bandwidth 20MHz**

Trial Number:			17			Detection (Yes/No) Yes
Number of Bursts in Trial:			13			
Chirp Center Frequency:			5495.2735			
Burst	Number of Pulses	Pulse Width (Microseconds)	Chirp Width (MHz)	Pulse 1-to-2 Spacing (µsec)	Pulse 2-to-3 Spacing (µsec)	Starting Location Within Interval (µsec)
1	2	76.8	11	1829		557698
2	1	51.7	11			782182
3	2	67.8	11	1402		83874
4	3	84.5	11	1036	1500	306513
5	3	91.9	11	1855	1519	529020
6	3	96.4	11	1988	1331	751885
7	3	97.4	11	1991	1337	56297
8	2	68.9	11	1858		279421
9	1	55.8	11			503662
10	2	82.5	11	1538		725515
11	3	89.7	11	1095	1710	28860
12	2	69.1	11	1029		252246
13	2	71.5	11	1785		475029
14						
15						
16						
17						
18						
19						
20						

Trial Number:			18			Detection (Yes/No) Yes
Number of Bursts in Trial:			16			
Chirp Center Frequency:			5496.8735			
Burst	Number of Pulses	Pulse Width (Microseconds)	Chirp Width (MHz)	Pulse 1-to-2 Spacing (µsec)	Pulse 2-to-3 Spacing (µsec)	Starting Location Within Interval (µsec)
1	2	82.1	15	1760		566651
2	1	66.2	15			1143
3	1	63.5	15			182789
4	3	95.7	15	1083	1418	362933
5	3	98.8	15	1254	1088	543876
6	1	63.5	15			727356
7	3	85.7	15	1283	1651	159683
8	1	51.6	15			341898
9	3	91.8	15	1399	1640	521273
10	3	94.3	15	1108	1675	702317
11	1	56.5	15			137881
12	1	58.7	15			319662
13	1	63.7	15			501159
14	3	90	15	1438	1925	679274
15	1	66.5	15			115593
16	3	99.6	15	1632	1171	296127
17						
18						
19						
20						

**DFS Radar Parameters**  
**FCC Radar Type 5**  
**Channel 100 Bandwidth 20MHz**

Trial Number:			19			Detection (Yes/No) Yes
Number of Bursts in Trial:			8			
Chirp Center Frequency:			5492.8735			
Burst	Number of Pulses	Pulse Width (Microseconds)	Chirp Width (MHz)	Pulse 1-to-2 Spacing (µsec)	Pulse 2-to-3 Spacing (µsec)	Starting Location Within Interval (µsec)
1	1	57.2	5			958469
2	1	60.3	5			1321531
3	3	88.2	5	1773.000	1804.000	186176
4	1	66.1	5			550007
5	2	68.9	5	1944.000		912150
6	1	53	5			1276596
7	3	96.9	5	1879.000	1258.000	141585
8	1	55.6	5			505262
9						
10						
11						
12						
13						
14						
15						
16						
17						
18						
19						
20						

Trial Number:			20			Detection (Yes/No) Yes
Number of Bursts in Trial:			13			
Chirp Center Frequency:			5495.2735			
Burst	Number of Pulses	Pulse Width (Microseconds)	Chirp Width (MHz)	Pulse 1-to-2 Spacing (µsec)	Pulse 2-to-3 Spacing (µsec)	Starting Location Within Interval (µsec)
1	1	65.7	11			534549
2	3	85.6	11	1321	1726	755351
3	3	93.6	11	1863	1370	59514
4	3	86.8	11	1998	1603	282206
5	2	74.6	11	1505		505905
6	2	81.5	11	1808		728563
7	1	64	11			32199
8	2	78	11	1916		255085
9	3	90.6	11	1299	1596	477956
10	3	96.6	11	1692	1133	700648
11	1	51.5	11			4666
12	3	92	11	1584	1457	227313
13	1	66.2	11			451522
14						
15						
16						
17						
18						
19						
20						



**DFS Radar Parameters**  
**FCC Radar Type 5**  
**Channel 100 Bandwidth 20MHz**

Trial Number:			21			Detection (Yes/No) Yes
Number of Bursts in Trial:			19			
Chirp Center Frequency:			5501.5265			
Burst	Number of Pulses	Pulse Width (Microseconds)	Chirp Width (MHz)	Pulse 1-to-2 Spacing (µsec)	Pulse 2-to-3 Spacing (µsec)	Starting Location Within Interval (µsec)
1	3	89.6	19	1913	1976	458587
2	2	79.8	19	1367		612743
3	1	54.9	19			137244
4	2	79.4	19	1803		289280
5	1	55.7	19			442917
6	3	85.1	19	1606	1143	592930
7	1	57.4	19			118375
8	1	61.2	19			271325
9	2	75.8	19	1811		422480
10	2	78.2	19	1852		574802
11	1	56.3	19			99538
12	2	80.9	19	1220		251892
13	2	69.4	19	1687		404285
14	3	98.6	19	1518	1154	555798
15	2	72.1	19	1332		80537
16	1	51.5	19			233486
17	1	53	19			386496
18	1	52.6	19			539575
19	2	79.1	19	1949		61718
20						

Trial Number:			22			Detection (Yes/No) Yes
Number of Bursts in Trial:			16			
Chirp Center Frequency:			5503.1265			
Burst	Number of Pulses	Pulse Width (Microseconds)	Chirp Width (MHz)	Pulse 1-to-2 Spacing (µsec)	Pulse 2-to-3 Spacing (µsec)	Starting Location Within Interval (µsec)
1	2	69.3	15	1877		254487
2	1	57.8	15			436785
3	2	79.9	15	2000		616628
4	1	63.1	15			51159
5	2	69.9	15	1380		232224
6	3	99	15	1994	1160	412665
7	2	77	15	1860		594490
8	1	60.2	15			28800
9	2	80.3	15	1798		209873
10	2	78.6	15	1522		391228
11	2	68.2	15	1608		571946
12	2	67.2	15	1114		6427
13	3	88.5	15	1446	1406	187164
14	2	74.6	15	1682		368451
15	2	83.3	15	1853		549946
16	2	67.7	15	1423		731000
17						
18						
19						
20						

**DFS Radar Parameters**  
**FCC Radar Type 5**  
**Channel 100 Bandwidth 20MHz**

Trial Number:			23			Detection (Yes/No)
Number of Bursts in Trial:			14			
Chirp Center Frequency:			5504.3265			
Burst	Number of Pulses	Pulse Width (Microseconds)	Chirp Width (MHz)	Pulse 1-to-2 Spacing (µsec)	Pulse 2-to-3 Spacing (µsec)	Starting Location Within Interval (µsec)
1	2	80.6	12	1325		188949
2	2	83.3	12	1202		396121
3	3	86.7	12	1451	1372	602317
4	1	63.1	12			811814
5	2	68	12	1807		163477
6	3	89.5	12	1134	1416	370010
7	3	94.4	12	1948	1058	577001
8	3	90	12	1047	1705	784127
9	1	57.4	12			138193
10	3	87.2	12	1074	1001	344709
11	1	55.9	12			553281
12	1	55.2	12			761200
13	2	82.9	12	1212		112482
14	3	92	12	1473	1922	318957
15						
16						
17						
18						
19						
20						

Trial Number:			24			Detection (Yes/No)
Number of Bursts in Trial:			14			
Chirp Center Frequency:			5503.9265			
Burst	Number of Pulses	Pulse Width (Microseconds)	Chirp Width (MHz)	Pulse 1-to-2 Spacing (µsec)	Pulse 2-to-3 Spacing (µsec)	Starting Location Within Interval (µsec)
1	2	76.5	13	1555		526518
2	3	87.5	13	1504	1599	732507
3	3	93.9	13	1664	1391	86736
4	2	72.4	13	1614		294120
5	2	72.6	13	1106		501671
6	1	58.4	13			709310
7	1	59.6	13			61533
8	1	66.6	13			268913
9	3	85	13	1186	1796	475077
10	2	80.5	13	1727		682804
11	2	78.8	13	1452		35899
12	2	74.8	13	1935		242795
13	2	77.2	13	1197		450389
14	2	82.6	13	1082		657756
15						
16						
17						
18						
19						
20						

**DFS Radar Parameters**  
**FCC Radar Type 5**  
**Channel 100 Bandwidth 20MHz**

Trial Number:			25			Detection (Yes/No)
Number of Bursts in Trial:			13			
Chirp Center Frequency:			5504.7265			
Burst	Number of Pulses	Pulse Width (Microseconds)	Chirp Width (MHz)	Pulse 1-to-2 Spacing (µsec)	Pulse 2-to-3 Spacing (µsec)	Starting Location Within Interval (µsec)
1	1	57.5	11			11192
2	1	61	11			234643
3	2	67.9	11	1502		457245
4	1	56.2	11			681769
5	3	86.1	11	1228	1031	902590
6	2	80.9	11	1445		206945
7	3	91.5	11	1455	1122	429305
8	2	68.2	11	1015		653478
9	1	66.3	11			877390
10	3	89.5	11	1543	1470	178971
11	1	61.1	11			403302
12	2	79.9	11	1214		625531
13	1	63.5	11			850373
14						
15						
16						
17						
18						
19						
20						

Trial Number:			26			Detection (Yes/No)
Number of Bursts in Trial:			17			
Chirp Center Frequency:			5502.7265			
Burst	Number of Pulses	Pulse Width (Microseconds)	Chirp Width (MHz)	Pulse 1-to-2 Spacing (µsec)	Pulse 2-to-3 Spacing (µsec)	Starting Location Within Interval (µsec)
1	3	90	16	1185	1509	115777
2	1	55.7	16			286979
3	2	82.7	16	1904		456477
4	3	93	16	1765	1223	625877
5	2	71.7	16	1073		95108
6	2	77.4	16	1237		265667
7	3	88.3	16	1250	1017	435305
8	1	52.1	16			607978
9	2	80.7	16	1532		74051
10	2	73.3	16	1272		244577
11	1	66	16			415586
12	1	51.9	16			586282
13	2	74.8	16	1845		52957
14	1	58	16			223816
15	1	63.9	16			394907
16	3	98.3	16	1042	1007	563737
17	1	56.1	16			32086
18						
19						
20						

**DFS Radar Parameters**  
**FCC Radar Type 5**  
**Channel 100 Bandwidth 20MHz**

Trial Number:			27			Detection (Yes/No)
Number of Bursts in Trial:			20			
Chirp Center Frequency:			5501.1265			
Burst	Number of Pulses	Pulse Width (Microseconds)	Chirp Width (MHz)	Pulse 1-to-2 Spacing ( $\mu$ sec)	Pulse 2-to-3 Spacing ( $\mu$ sec)	Starting Location Within Interval ( $\mu$ sec)
1	3	84.4	20	1006	1288	171798
2	3	93.2	20	1704	1121	316209
3	1	62.2	20			463045
4	1	61.7	20			9381
5	2	82.4	20	1923		154002
6	3	96.5	20	1257	1352	298454
7	2	69.3	20	1714		443388
8	3	99.7	20	1753	1016	587670
9	2	69.1	20	1145		136359
10	1	52	20			281692
11	1	50.4	20			426935
12	1	58.2	20			571957
13	2	71.1	20	1539		118444
14	1	54.4	20			264113
15	1	61.3	20			408792
16	3	92.8	20	1255	1719	551905
17	3	95	20	1481	1342	100355
18	2	69.7	20	1499		245551
19	1	60.9	20			391316
20	1	52.2	20			536137

Trial Number:			28			Detection (Yes/No)
Number of Bursts in Trial:			14			
Chirp Center Frequency:			5503.9265			
Burst	Number of Pulses	Pulse Width (Microseconds)	Chirp Width (MHz)	Pulse 1-to-2 Spacing ( $\mu$ sec)	Pulse 2-to-3 Spacing ( $\mu$ sec)	Starting Location Within Interval ( $\mu$ sec)
1	3	87.5	13	1209	1978	118213
2	1	57	13			326346
3	3	97.5	13	1615	1349	531858
4	3	88.9	13	1984	1005	738617
5	2	80.5	13	1010		92995
6	2	76.9	13	1764		300151
7	3	87.7	13	1987	1119	506096
8	1	51.9	13			716032
9	1	54.3	13			67531
10	1	61.3	13			275052
11	2	72.8	13	1886		481481
12	2	77.5	13	1071		689565
13	2	69.9	13	1503		41917
14	1	60.2	13			249630
15						
16						
17						
18						
19						
20						

**DFS Radar Parameters**  
**FCC Radar Type 5**  
**Channel 100 Bandwidth 20MHz**

Trial Number:			29			Detection (Yes/No) Yes
Number of Bursts in Trial:			12			
Chirp Center Frequency:			5505.1265			
Burst	Number of Pulses	Pulse Width (Microseconds)	Chirp Width (MHz)	Pulse 1-to-2 Spacing (µsec)	Pulse 2-to-3 Spacing (µsec)	Starting Location Within Interval (µsec)
1	1	55.1	10			533545
2	2	67.9	10	1100		774812
3	2	67.6	10	1790		19150
4	1	51.7	10			261321
5	1	57.5	10			503712
6	1	59.3	10			745934
7	1	63.4	10			988293
8	3	93.4	10	1746	1707	230686
9	1	52.6	10			473625
10	2	75.3	10	1786		714764
11	3	87.8	10	1281	1979	955073
12	3	94	10	1309	1176	201103
13						
14						
15						
16						
17						
18						
19						
20						

Trial Number:			30			Detection (Yes/No) Yes
Number of Bursts in Trial:			13			
Chirp Center Frequency:			5505.5265			
Burst	Number of Pulses	Pulse Width (Microseconds)	Chirp Width (MHz)	Pulse 1-to-2 Spacing (µsec)	Pulse 2-to-3 Spacing (µsec)	Starting Location Within Interval (µsec)
1	1	59.5	9			484104
2	2	68.8	9	1426		747546
3	1	54.6	9			1012254
4	1	59.2	9			187514
5	2	79.9	9	1597		451068
6	3	88.4	9	1823	1077	714344
7	1	53	9			980078
8	3	96.1	9	1068	1109	154584
9	2	68.7	9	1736		418486
10	2	77.4	9	1857		682304
11	3	95.8	9	1941	1893	944646
12	2	76.2	12	1770		563316
13	1	60.6	12			788278
14						
15						
16						
17						
18						
19						
20						

**DFS Radar Parameters**  
**FCC Radar Type 1**  
**Channel 102 Bandwidth 40MHz**

Trial #	Pulse Repetition Frequency Number (1 to 23)	Pulse Repetition Frequency (Pulses Per Second)	Pulse Repetition Interval (Microseconds)	Detection (Yes / No)
1	1	1930.50	518	Yes
2	12	1355.01	738	Yes
3	15	1253.13	798	Yes
4	13	1319.26	758	Yes
5	8	1519.76	658	Yes
6	11	1392.76	718	Yes
7	21	1089.32	918	Yes
8	12	326.16	3066	Yes
9	4	1730.10	578	Yes
10	20	1113.59	898	Yes
11	2	1858.74	538	No
12	22	1066.10	938	Yes
13	5	1672.24	598	Yes
14	17	1193.32	838	Yes
15	7	1567.40	638	Yes
16		346.98	2882	Yes
17		394.01	2538	Yes
18		1897.53	527	Yes
19		447.23	2236	Yes
20		1285.35	778	Yes
21		1557.63	642	Yes
22		469.48	2130	Yes
23		1069.52	935	Yes
24		626.17	1597	Yes
25		373.69	2676	Yes
26		586.85	1704	Yes
27		689.18	1451	Yes
28		765.11	1307	Yes
29		432.90	2310	Yes
30		449.84	2223	Yes

**DFS Radar Parameters**  
**FCC Radar Type 2**  
**Channel 102 Bandwidth 40MHz**

Trial #	Number Pulses per Burst	Pulse Width (Microseconds)	Pulse Repetition Interval (Microseconds)	Detection (Yes / No)
1	23	1.40	198	Yes
2	25	2.20	224	Yes
3	23	1.10	176	Yes
4	26	2.90	182	Yes
5	26	3.10	229	Yes
6	24	1.80	202	Yes
7	23	1.20	228	Yes
8	27	3.50	194	Yes
9	25	2.30	157	Yes
10	24	1.60	167	Yes
11	24	1.80	199	Yes
12	28	4.20	230	Yes
13	27	3.40	152	Yes
14	29	5.00	217	Yes
15	27	3.80	186	Yes
16	23	1.10	206	Yes
17	25	2.60	180	Yes
18	27	3.70	165	No
19	23	1.00	188	Yes
20	25	2.70	227	Yes
21	29	4.60	219	No
22	27	3.60	203	Yes
23	26	2.90	184	Yes
24	26	3.10	178	Yes
25	25	2.60	221	Yes
26	28	4.00	153	Yes
27	29	4.80	193	Yes
28	26	3.20	210	Yes
29	25	2.30	162	Yes
30	24	2.00	181	Yes

**DFS Radar Parameters**  
**FCC Radar Type 3**  
**Channel 102 Bandwidth 40MHz**

Trial #	Number Pulses per Burst	Pulse Width (Microseconds)	Pulse Repetition Interval (Microseconds)	Detection (Yes / No)
1	16	6.40	465	Yes
2	16	7.20	383	Yes
3	16	6.10	271	Yes
4	17	7.90	440	No
5	17	8.10	341	Yes
6	16	6.80	318	Yes
7	16	6.20	334	Yes
8	17	8.50	494	Yes
9	17	7.30	245	Yes
10	16	6.60	215	Yes
11	16	6.80	282	Yes
12	18	9.20	485	Yes
13	17	8.40	258	Yes
14	18	10.00	437	Yes
15	18	8.80	320	Yes
16	16	6.10	200	Yes
17	17	7.60	220	Yes
18	17	8.70	401	Yes
19	16	6.00	399	Yes
20	17	7.70	205	Yes
21	18	9.60	470	Yes
22	17	8.60	491	Yes
23	17	7.90	297	Yes
24	17	8.10	202	Yes
25	17	7.60	391	Yes
26	18	9.00	396	Yes
27	18	9.80	397	Yes
28	17	8.20	288	Yes
29	16	7.30	219	Yes
30	16	7.00	261	Yes



**DFS Radar Parameters**  
**FCC Radar Type 4**  
**Channel 102 Bandwidth 40MHz**

Trial #	Number Pulses per Burst	Pulse Width (Microseconds)	Pulse Repetition Interval (Microseconds)	Detection (Yes / No)
1	12	11.90	465	Yes
2	13	13.70	383	Yes
3	12	11.30	271	Yes
4	14	15.30	440	Yes
5	14	15.80	341	Yes
6	13	12.80	318	Yes
7	12	11.50	334	Yes
8	15	16.60	494	Yes
9	13	14.00	245	Yes
10	12	12.30	215	Yes
11	13	12.80	282	Yes
12	15	18.10	485	Yes
13	14	16.30	258	Yes
14	16	19.80	437	Yes
15	15	17.30	320	Yes
16	12	11.20	200	Yes
17	13	14.50	220	Yes
18	15	17.00	401	No
19	12	11.10	399	Yes
20	14	14.80	205	Yes
21	16	19.00	470	Yes
22	15	16.90	491	Yes
23	14	15.20	297	Yes
24	14	15.60	202	Yes
25	13	14.50	391	Yes
26	15	17.70	396	Yes
27	16	19.60	397	Yes
28	14	15.80	288	Yes
29	13	13.90	219	No
30	13	13.40	261	Yes

**DFS Radar Parameters**  
**FCC Radar Type 5**  
**Channel 102 Bandwidth 40MHz**

Trial Number:			1			Detection (Yes/No)
Number of Bursts in Trial:			9			
Chirp Center Frequency:			5510			
Burst	Number of Pulses	Pulse Width (Microseconds )	Chirp Width (MHz)	Pulse 1-to-2 Spacing (µsec)	Pulse 2-to-3 Spacing (µsec)	Starting Location Within Interval (µsec)
1	1	55	6			456091
2	1	64.9	6			778946
3	1	52	6			1101904
4	2	74.2	6	1019		93064
5	2	76.7	6	1180		415903
6	1	60	6			739340
7	1	53.1	6			1062002
8	2	80.8	6	1772		53279
9	2	66.8	6	1308		375962
10						
11						
12						
13						
14						
15						
16						
17						
18						
19						
20						

Trial Number:			2			Detection (Yes/No)
Number of Bursts in Trial:			11			
Chirp Center Frequency:			5510			
Burst	Number of Pulses	Pulse Width (Microseconds )	Chirp Width (MHz)	Pulse 1-to-2 Spacing (µsec)	Pulse 2-to-3 Spacing (µsec)	Starting Location Within Interval (µsec)
1	1	57.3	9			572286
2	1	60.1	9			836083
3	3	89.6	9	1440	1575	11057
4	2	79.5	9	1369		274996
5	3	98.8	9	1099	1275	538369
6	3	84.7	9	1650	1769	801389
7	1	51.4	9			1068068
8	2	69.8	9	1983		242218
9	2	83.3	9	1950		506136
10	1	50.9	9			770863
11	2	71.4	9	1116		1034768
12						
13						
14						
15						
16						
17						
18						
19						
20						

**DFS Radar Parameters**  
**FCC Radar Type 5**  
**Channel 102 Bandwidth 40MHz**

Trial Number:			3			Detection (Yes/No)
Number of Bursts in Trial:			8			
Chirp Center Frequency:			5510			
Burst	Number of Pulses	Pulse Width (Microseconds)	Chirp Width (MHz)	Pulse 1-to-2 Spacing (µsec)	Pulse 2-to-3 Spacing (µsec)	Starting Location Within Interval (µsec)
1	3	94.2	5	1478	1777	288532
2	2	82.9	5	1681		651974
3	2	73.5	5	1889		1014683
4	2	75.8	5	1295		1378001
5	2	69.7	5	1075		244188
6	3	86.9	5	1907	1463	606557
7	3	97.4	5	1072	1173	969693
8	2	76.9	5	1193		1333926
9						
10						
11						
12						
13						
14						
15						
16						
17						
18						
19						
20						

Trial Number:			4			Detection (Yes/No)
Number of Bursts in Trial:			8			
Chirp Center Frequency:			5510			
Burst	Number of Pulses	Pulse Width (Microseconds)	Chirp Width (MHz)	Pulse 1-to-2 Spacing (µsec)	Pulse 2-to-3 Spacing (µsec)	Starting Location Within Interval (µsec)
1	1	66.2	12			113987
2	1	63.2	12			321486
3	2	81.6	12	1624		528264
4	3	97.1	12	1125	1787	733969
5	1	62.5	12			88396
6	1	61.5	12			295881
7	3	92.6	12	1645	1343	501606
8	3	92.5	12	1899	1591	708477
9	1	56.1	12			62881
10	3	85.6	12	1837	1392	269320
11	1	61	12			477893
12	1	51.8	12			685309
13	3	95.8	12	1327	1249	37176
14	1	58.5	12			244764
15						
16						
17						
18						
19						
20						

**DFS Radar Parameters**  
**FCC Radar Type 5**  
**Channel 102 Bandwidth 40MHz**

Trial Number:			5			Detection (Yes/No)
Number of Bursts in Trial:			14			
Chirp Center Frequency:			5510			Yes
Burst	Number of Pulses	Pulse Width (Microseconds)	Chirp Width (MHz)	Pulse 1-to-2 Spacing (µsec)	Pulse 2-to-3 Spacing (µsec)	Starting Location Within Interval (µsec)
1	2	75.4	13	1733		451522
2	3	90.7	13	1570	1285	657471
3	3	87.6	13	1868	1643	11695
4	3	93.5	13	1371	1579	218584
5	3	94.5	13	1105	1147	425679
6	1	53.9	13			634053
7	3	98.2	13	1652	1311	839188
8	3	97.5	13	1351	1316	193137
9	2	83.2	13	1490		400517
10	3	99.6	13	1642	1680	606704
11	1	62.1	13			815936
12	1	51.5	13			168219
13	2	72.3	13	1628		375144
14	2	72.1	13	1065		582695
15						
16						
17						
18						
19						
20						

Trial Number:			6			Detection (Yes/No)
Number of Bursts in Trial:			10			
Chirp Center Frequency:			5510			Yes
Burst	Number of Pulses	Pulse Width (Microseconds)	Chirp Width (MHz)	Pulse 1-to-2 Spacing (µsec)	Pulse 2-to-3 Spacing (µsec)	Starting Location Within Interval (µsec)
1	3	91.4	8	1268	1362	1105275
2	2	76.2	8	1870		199366
3	1	54.4	8			490358
4	3	89.9	8	1256	1414	779365
5	1	62.6	8			1071413
6	2	76.3	8	1387		163769
7	1	64.6	8			454651
8	1	53.6	8			745006
9	2	75.7	8	1431		1034301
10	1	63.1	8			128079
11						
12						
13						
14						
15						
16						
17						
18						
19						
20						

**DFS Radar Parameters**  
**FCC Radar Type 5**  
**Channel 102 Bandwidth 40MHz**

Trial Number:			7			Detection (Yes/No)
Number of Bursts in Trial:			8			
Chirp Center Frequency:			5510			
Burst	Number of Pulses	Pulse Width (Microseconds)	Chirp Width (MHz)	Pulse 1-to-2 Spacing (µsec)	Pulse 2-to-3 Spacing (µsec)	Starting Location Within Interval (µsec)
1	2	75.6	14	1155		216520
2	3	85.6	14	1993	1103	396614
3	1	57.4	14			579687
4	2	82.8	14	1995		12889
5	3	88.3	14	1447	1358	193680
6	2	76.3	14	1892		374938
7	3	92.4	14	1841	1127	555060
8	3	93.4	14	1225	1449	736781
9	2	78.8	14	1508		171787
10	2	68.8	14	1329		353186
11	2	80.1	14	1041		534595
12	2	82.1	14	1583		715294
13	3	84.9	14	1169	1756	149063
14	1	60.9	14			331211
15	3	89.2	14	1793	1655	510715
16	2	70.5	14	1404		693078
17						
18						
19						
20						

Trial Number:			8			Detection (Yes/No)
Number of Bursts in Trial:			16			
Chirp Center Frequency:			5510			
Burst	Number of Pulses	Pulse Width (Microseconds)	Chirp Width (MHz)	Pulse 1-to-2 Spacing (µsec)	Pulse 2-to-3 Spacing (µsec)	Starting Location Within Interval (µsec)
1	2	75.6	14	1155		216520
2	3	85.6	14	1993	1103	396614
3	1	57.4	14			579687
4	2	82.8	14	1995		12889
5	3	88.3	14	1447	1358	193680
6	2	76.3	14	1892		374938
7	3	92.4	14	1841	1127	555060
8	3	93.4	14	1225	1449	736781
9	2	78.8	14	1508		171787
10	2	68.8	14	1329		353186
11	2	80.1	14	1041		534595
12	2	82.1	14	1583		715294
13	3	84.9	14	1169	1756	149063
14	1	60.9	14			331211
15	3	89.2	14	1793	1655	510715
16	2	70.5	14	1404		693078
17						
18						
19						
20						

**DFS Radar Parameters**  
**FCC Radar Type 5**  
**Channel 102 Bandwidth 40MHz**

Trial Number:			9			Detection (Yes/No)
Number of Bursts in Trial:			12			
Chirp Center Frequency:			5510			Yes
Burst	Number of Pulses	Pulse Width (Microseconds)	Chirp Width (MHz)	Pulse 1-to-2 Spacing (µsec)	Pulse 2-to-3 Spacing (µsec)	Starting Location Within Interval (µsec)
1	1	51.1	10			169836
2	2	79.9	10	1817		411435
3	2	81.1	10	1203		653492
4	2	71.2	10	1523		894783
5	3	89.2	10	1910	1152	139593
6	2	69.5	10	1149		381670
7	3	94	10	1755	1973	622378
8	2	71.8	10	1465		865458
9	1	65	10			110246
10	2	74.4	10	1489		351980
11	1	66.4	10			594506
12	2	76.5	10	1040		835513
13						
14						
15						
16						
17						
18						
19						
20						

Trial Number:			10			Detection (Yes/No)
Number of Bursts in Trial:			9			
Chirp Center Frequency:			5510			Yes
Burst	Number of Pulses	Pulse Width (Microseconds)	Chirp Width (MHz)	Pulse 1-to-2 Spacing (µsec)	Pulse 2-to-3 Spacing (µsec)	Starting Location Within Interval (µsec)
1	3	97.8	7	1882	1779	106978
2	1	55.9	7			430424
3	1	52.1	7			753353
4	3	99	7	1767	1057	1073995
5	2	77.3	7	1498		67384
6	1	63.1	7			390566
7	2	76	7	1717		712399
8	3	86.7	7	1195	1667	1034158
9	1	64.6	7			27685
10						
11						
12						
13						
14						
15						
16						
17						
18						
19						
20						

**DFS Radar Parameters**  
**FCC Radar Type 5**  
**Channel 102 Bandwidth 40MHz**

Trial Number:			11			Detection (Yes/No)
Number of Bursts in Trial:			10			
Chirp Center Frequency:			5494.977			
Burst	Number of Pulses	Pulse Width (Microseconds)	Chirp Width (MHz)	Pulse 1-to-2 Spacing (µsec)	Pulse 2-to-3 Spacing (µsec)	Starting Location Within Interval (µsec)
1	1	58.6	8			315543
2	3	88	8	1770	1571	604519
3	2	78.2	8	1828		895230
4	3	97.6	8	1496	1028	1185129
5	2	69.3	8	1140		279539
6	3	97.5	8	1468	1623	569056
7	3	95.9	8	1951	1279	858767
8	2	73.5	8	1480		1150807
9	3	93.7	8	1025	1969	243392
10	2	78.2	8	1388		534084
11						
12						
13						
14						
15						
16						
17						
18						
19						
20						

Trial Number:			12			Detection (Yes/No)
Number of Bursts in Trial:			18			
Chirp Center Frequency:			5498.577			
Burst	Number of Pulses	Pulse Width (Microseconds)	Chirp Width (MHz)	Pulse 1-to-2 Spacing (µsec)	Pulse 2-to-3 Spacing (µsec)	Starting Location Within Interval (µsec)
1	1	66.1	17			458266
2	2	78.8	17	1011		618238
3	3	85.7	17	1196	1739	115058
4	3	91.1	17	1002	1952	275495
5	1	65.3	17			438138
6	1	53	17			599661
7	1	51	17			95681
8	1	59.8	17			257166
9	1	56.1	17			418283
10	3	91.6	17	1314	1801	576878
11	3	85.6	17	1415	1931	75439
12	2	67.8	17	1340		236781
13	1	63.8	17			398735
14	1	59.8	17			559395
15	1	65.8	17			55892
16	3	95.7	17	1865	1231	216175
17	2	72.9	17	1848		377480
18	1	66.6	17			539999
19						
20						

**DFS Radar Parameters**  
**FCC Radar Type 5**  
**Channel 102 Bandwidth 40MHz**

Trial Number:			13			Detection (Yes/No)
Number of Bursts in Trial:			15			
Chirp Center Frequency:			5497.377			Yes
Burst	Number of Pulses	Pulse Width (Microseconds)	Chirp Width (MHz)	Pulse 1-to-2 Spacing (µsec)	Pulse 2-to-3 Spacing (µsec)	Starting Location Within Interval (µsec)
1	2	81.1	14	1691		43173
2	1	54.7	14			237072
3	2	71.7	14	1670		429725
4	3	85	14	1339	1900	621518
5	1	52.4	14			19432
6	1	55.8	14			213028
7	3	92.5	14	1427	1153	405290
8	3	92	14	1990	1317	597929
9	1	52.8	14			794345
10	2	73.6	14	1715		188943
11	2	69.9	14	1102		382243
12	2	72	14	1878		574958
13	3	98.2	14	1020	1958	767112
14	3	98.3	14	1277	1686	164814
15	2	71.3	14	1296		358432
16						
17						
18						
19						
20						

Trial Number:			14			Detection (Yes/No)
Number of Bursts in Trial:			20			
Chirp Center Frequency:			5499.777			Yes
Burst	Number of Pulses	Pulse Width (Microseconds)	Chirp Width (MHz)	Pulse 1-to-2 Spacing (µsec)	Pulse 2-to-3 Spacing (µsec)	Starting Location Within Interval (µsec)
1	3	96.2	20	1464	1142	412467
2	1	50.2	20			559149
3	3	97.8	20	1221	1168	105622
4	1	62	20			251304
5	1	64.8	20			396581
6	3	86.9	20	1208	1270	539601
7	3	95.9	20	1963	1750	87618
8	2	76.2	20	1318		232979
9	1	53.3	20			378329
10	2	69.8	20	1703		521958
11	3	95.2	20	1187	1557	69956
12	2	79	20	1968		214668
13	3	90.8	20	1822	1297	358915
14	2	74.2	20	1816		504640
15	2	68.3	20	1761		52265
16	2	81.8	20	1323		197219
17	2	73.6	20	1189		342218
18	2	74.6	20	1410		486611
19	2	79.3	20	1441		34446
20	3	92.5	20	1661	1771	178766



**DFS Radar Parameters**  
**FCC Radar Type 5**  
**Channel 102 Bandwidth 40MHz**

Trial Number:			15			Detection (Yes/No)
Number of Bursts in Trial:			17			
Chirp Center Frequency:			5498.177			
Burst	Number of Pulses	Pulse Width (Microseconds)	Chirp Width (MHz)	Pulse 1-to-2 Spacing (µsec)	Pulse 2-to-3 Spacing (µsec)	Starting Location Within Interval (µsec)
1	3	88.9	16	1239	1759	380606
2	1	56.5	16			553212
3	2	81.2	16	1330		19594
4	2	76.3	16	1862		190008
5	2	79.9	16	1368		360470
6	3	98.7	16	1510	1320	529951
7	2	73.4	16	1529		701560
8	1	50.2	16			169324
9	2	77.5	16	1067		339969
10	3	89.9	16	1344	1559	509095
11	3	84.2	16	1901	1918	677997
12	3	93.5	16	1656	1355	147725
13	3	87.3	16	1432	1731	317636
14	3	96.5	16	1511	1732	487504
15	2	67.6	16	1078		659989
16	1	59.6	16			127277
17	2	68	16	1156		297601
18						
19						
20						

Trial Number:			16			Detection (Yes/No)
Number of Bursts in Trial:			8			
Chirp Center Frequency:			5493.777			
Burst	Number of Pulses	Pulse Width (Microseconds)	Chirp Width (MHz)	Pulse 1-to-2 Spacing (µsec)	Pulse 2-to-3 Spacing (µsec)	Starting Location Within Interval (µsec)
1	3	83.7	5	1908	1548	995497
2	1	58.1	5			1361600
3	2	79.8	5	1885		225782
4	3	85.2	5	1647	1080	588360
5	2	78.5	5	1887		951829
6	2	68.4	5	1269		1315202
7	1	65.1	5			181313
8	1	57.3	5			544812
9						
10						
11						
12						
13						
14						
15						
16						
17						
18						
19						
20						

**DFS Radar Parameters**  
**FCC Radar Type 5**  
**Channel 102 Bandwidth 40MHz**

Trial Number:			17			Detection (Yes/No)
Number of Bursts in Trial:			13			
Chirp Center Frequency:			5496.177			
Burst	Number of Pulses	Pulse Width (Microseconds)	Chirp Width (MHz)	Pulse 1-to-2 Spacing (µsec)	Pulse 2-to-3 Spacing (µsec)	Starting Location Within Interval (µsec)
1	2	76.8	11	1829		557698
2	1	51.7	11			782182
3	2	67.8	11	1402		83874
4	3	84.5	11	1036	1500	306513
5	3	91.9	11	1855	1519	529020
6	3	96.4	11	1988	1331	751885
7	3	97.4	11	1991	1337	56297
8	2	68.9	11	1858		279421
9	1	55.8	11			503662
10	2	82.5	11	1538		725515
11	3	89.7	11	1095	1710	28860
12	2	69.1	11	1029		252246
13	2	71.5	11	1785		475029
14						
15						
16						
17						
18						
19						
20						

Trial Number:			18			Detection (Yes/No)
Number of Bursts in Trial:			16			
Chirp Center Frequency:			5497.777			
Burst	Number of Pulses	Pulse Width (Microseconds)	Chirp Width (MHz)	Pulse 1-to-2 Spacing (µsec)	Pulse 2-to-3 Spacing (µsec)	Starting Location Within Interval (µsec)
1	2	82.1	15	1760		566651
2	1	66.2	15			1143
3	1	63.5	15			182789
4	3	95.7	15	1083	1418	362933
5	3	98.8	15	1254	1088	543876
6	1	63.5	15			727356
7	3	85.7	15	1283	1651	159683
8	1	51.6	15			341898
9	3	91.8	15	1399	1640	521273
10	3	94.3	15	1108	1675	702317
11	1	56.5	15			137881
12	1	58.7	15			319662
13	1	63.7	15			501159
14	3	90	15	1438	1925	679274
15	1	66.5	15			115593
16	3	99.6	15	1632	1171	296127
17						
18						
19						
20						

**DFS Radar Parameters**  
**FCC Radar Type 5**  
**Channel 102 Bandwidth 40MHz**

Trial Number:			19			Detection (Yes/No)
Number of Bursts in Trial:			8			
Chirp Center Frequency:			5493.777			
Burst	Number of Pulses	Pulse Width (Microseconds)	Chirp Width (MHz)	Pulse 1-to-2 Spacing (µsec)	Pulse 2-to-3 Spacing (µsec)	Starting Location Within Interval (µsec)
1	1	57.2	5			958469
2	1	60.3	5			1321531
3	3	88.2	5	1773.000	1804.000	186176
4	1	66.1	5			550007
5	2	68.9	5	1944.000		912150
6	1	53	5			1276596
7	3	96.9	5	1879.000	1258.000	141585
8	1	55.6	5			505262
9						
10						
11						
12						
13						
14						
15						
16						
17						
18						
19						
20						

Trial Number:			20			Detection (Yes/No)
Number of Bursts in Trial:			13			
Chirp Center Frequency:			5496.177			
Burst	Number of Pulses	Pulse Width (Microseconds)	Chirp Width (MHz)	Pulse 1-to-2 Spacing (µsec)	Pulse 2-to-3 Spacing (µsec)	Starting Location Within Interval (µsec)
1	1	65.7	11			534549
2	3	85.6	11	1321	1726	755351
3	3	93.6	11	1863	1370	59514
4	3	86.8	11	1998	1603	282206
5	2	74.6	11	1505		505905
6	2	81.5	11	1808		728563
7	1	64	11			32199
8	2	78	11	1916		255085
9	3	90.6	11	1299	1596	477956
10	3	96.6	11	1692	1133	700648
11	1	51.5	11			4666
12	3	92	11	1584	1457	227313
13	1	66.2	11			451522
14						
15						
16						
17						
18						
19						
20						

**DFS Radar Parameters**  
**FCC Radar Type 5**  
**Channel 102 Bandwidth 40MHz**

Trial Number:			21			Detection (Yes/No)
Number of Bursts in Trial:			19			
Chirp Center Frequency:			5520.623			
Burst	Number of Pulses	Pulse Width (Microseconds)	Chirp Width (MHz)	Pulse 1-to-2 Spacing (µsec)	Pulse 2-to-3 Spacing (µsec)	Starting Location Within Interval (µsec)
1	3	89.6	19	1913	1976	458587
2	2	79.8	19	1367		612743
3	1	54.9	19			137244
4	2	79.4	19	1803		289280
5	1	55.7	19			442917
6	3	85.1	19	1606	1143	592930
7	1	57.4	19			118375
8	1	61.2	19			271325
9	2	75.8	19	1811		422480
10	2	78.2	19	1852		574802
11	1	56.3	19			99538
12	2	80.9	19	1220		251892
13	2	69.4	19	1687		404285
14	3	98.6	19	1518	1154	555798
15	2	72.1	19	1332		80537
16	1	51.5	19			233486
17	1	53	19			386496
18	1	52.6	19			539575
19	2	79.1	19	1949		61718
20						

Trial Number:			22			Detection (Yes/No)
Number of Bursts in Trial:			16			
Chirp Center Frequency:			5522.223			
Burst	Number of Pulses	Pulse Width (Microseconds)	Chirp Width (MHz)	Pulse 1-to-2 Spacing (µsec)	Pulse 2-to-3 Spacing (µsec)	Starting Location Within Interval (µsec)
1	2	69.3	15	1877		254487
2	1	57.8	15			436785
3	2	79.9	15	2000		616628
4	1	63.1	15			51159
5	2	69.9	15	1380		232224
6	3	99	15	1994	1160	412665
7	2	77	15	1860		594490
8	1	60.2	15			28800
9	2	80.3	15	1798		209873
10	2	78.6	15	1522		391228
11	2	68.2	15	1608		571946
12	2	67.2	15	1114		6427
13	3	88.5	15	1446	1406	187164
14	2	74.6	15	1682		368451
15	2	83.3	15	1853		549946
16	2	67.7	15	1423		731000
17						
18						
19						
20						

**DFS Radar Parameters**  
**FCC Radar Type 5**  
**Channel 102 Bandwidth 40MHz**

Trial Number:			23			Detection (Yes/No)
Number of Bursts in Trial:			14			
Chirp Center Frequency:			5523.423			
Burst	Number of Pulses	Pulse Width (Microseconds)	Chirp Width (MHz)	Pulse 1-to-2 Spacing ( $\mu$ sec)	Pulse 2-to-3 Spacing ( $\mu$ sec)	Starting Location Within Interval ( $\mu$ sec)
1	2	80.6	12	1325		188949
2	2	83.3	12	1202		396121
3	3	86.7	12	1451	1372	602317
4	1	63.1	12			811814
5	2	68	12	1807		163477
6	3	89.5	12	1134	1416	370010
7	3	94.4	12	1948	1058	577001
8	3	90	12	1047	1705	784127
9	1	57.4	12			138193
10	3	87.2	12	1074	1001	344709
11	1	55.9	12			553281
12	1	55.2	12			761200
13	2	82.9	12	1212		112482
14	3	92	12	1473	1922	318957
15						
16						
17						
18						
19						
20						

Trial Number:			24			Detection (Yes/No)
Number of Bursts in Trial:			14			
Chirp Center Frequency:			5523.023			
Burst	Number of Pulses	Pulse Width (Microseconds)	Chirp Width (MHz)	Pulse 1-to-2 Spacing ( $\mu$ sec)	Pulse 2-to-3 Spacing ( $\mu$ sec)	Starting Location Within Interval ( $\mu$ sec)
1	2	76.5	13	1555		526518
2	3	87.5	13	1504	1599	732507
3	3	93.9	13	1664	1391	86736
4	2	72.4	13	1614		294120
5	2	72.6	13	1106		501671
6	1	58.4	13			709310
7	1	59.6	13			61533
8	1	66.6	13			268913
9	3	85	13	1186	1796	475077
10	2	80.5	13	1727		682804
11	2	78.8	13	1452		35899
12	2	74.8	13	1935		242795
13	2	77.2	13	1197		450389
14	2	82.6	13	1082		657756
15						
16						
17						
18						
19						
20						

**DFS Radar Parameters**  
**FCC Radar Type 5**  
**Channel 102 Bandwidth 40MHz**

Trial Number:			25			Detection (Yes/No)
Number of Bursts in Trial:			13			
Chirp Center Frequency:			5523.823			
Burst	Number of Pulses	Pulse Width (Microseconds)	Chirp Width (MHz)	Pulse 1-to-2 Spacing ( $\mu$ sec)	Pulse 2-to-3 Spacing ( $\mu$ sec)	Starting Location Within Interval ( $\mu$ sec)
1	1	57.5	11			11192
2	1	61	11			234643
3	2	67.9	11	1502		457245
4	1	56.2	11			681769
5	3	86.1	11	1228	1031	902590
6	2	80.9	11	1445		206945
7	3	91.5	11	1455	1122	429305
8	2	68.2	11	1015		653478
9	1	66.3	11			877390
10	3	89.5	11	1543	1470	178971
11	1	61.1	11			403302
12	2	79.9	11	1214		625531
13	1	63.5	11			850373
14						
15						
16						
17						
18						
19						
20						

Trial Number:			26			Detection (Yes/No)
Number of Bursts in Trial:			17			
Chirp Center Frequency:			5521.823			
Burst	Number of Pulses	Pulse Width (Microseconds)	Chirp Width (MHz)	Pulse 1-to-2 Spacing ( $\mu$ sec)	Pulse 2-to-3 Spacing ( $\mu$ sec)	Starting Location Within Interval ( $\mu$ sec)
1	3	90	16	1185	1509	115777
2	1	55.7	16			286979
3	2	82.7	16	1904		456477
4	3	93	16	1765	1223	625877
5	2	71.7	16	1073		95108
6	2	77.4	16	1237		265667
7	3	88.3	16	1250	1017	435305
8	1	52.1	16			607978
9	2	80.7	16	1532		74051
10	2	73.3	16	1272		244577
11	1	66	16			415586
12	1	51.9	16			586282
13	2	74.8	16	1845		52957
14	1	58	16			223816
15	1	63.9	16			394907
16	3	98.3	16	1042	1007	563737
17	1	56.1	16			32086
18						
19						
20						

**DFS Radar Parameters**  
**FCC Radar Type 5**  
**Channel 102 Bandwidth 40MHz**

Trial Number:			27			Detection (Yes/No)
Number of Bursts in Trial:			20			
Chirp Center Frequency:			5520.223			
Burst	Number of Pulses	Pulse Width (Microseconds)	Chirp Width (MHz)	Pulse 1-to-2 Spacing ( $\mu$ sec)	Pulse 2-to-3 Spacing ( $\mu$ sec)	Starting Location Within Interval ( $\mu$ sec)
1	3	84.4	20	1006	1288	171798
2	3	93.2	20	1704	1121	316209
3	1	62.2	20			463045
4	1	61.7	20			9381
5	2	82.4	20	1923		154002
6	3	96.5	20	1257	1352	298454
7	2	69.3	20	1714		443388
8	3	99.7	20	1753	1016	587670
9	2	69.1	20	1145		136359
10	1	52	20			281692
11	1	50.4	20			426935
12	1	58.2	20			571957
13	2	71.1	20	1539		118444
14	1	54.4	20			264113
15	1	61.3	20			408792
16	3	92.8	20	1255	1719	551905
17	3	95	20	1481	1342	100355
18	2	69.7	20	1499		245551
19	1	60.9	20			391316
20	1	52.2	20			536137

Trial Number:			28			Detection (Yes/No)
Number of Bursts in Trial:			14			
Chirp Center Frequency:			5523.023			
Burst	Number of Pulses	Pulse Width (Microseconds)	Chirp Width (MHz)	Pulse 1-to-2 Spacing ( $\mu$ sec)	Pulse 2-to-3 Spacing ( $\mu$ sec)	Starting Location Within Interval ( $\mu$ sec)
1	3	87.5	13	1209	1978	118213
2	1	57	13			326346
3	3	97.5	13	1615	1349	531858
4	3	88.9	13	1984	1005	738617
5	2	80.5	13	1010		92995
6	2	76.9	13	1764		300151
7	3	87.7	13	1987	1119	506096
8	1	51.9	13			716032
9	1	54.3	13			67531
10	1	61.3	13			275052
11	2	72.8	13	1886		481481
12	2	77.5	13	1071		689565
13	2	69.9	13	1503		41917
14	1	60.2	13			249630
15						
16						
17						
18						
19						
20						

**DFS Radar Parameters**  
**FCC Radar Type 5**  
**Channel 102 Bandwidth 40MHz**

Trial Number:			29			Detection (Yes/No)
Number of Bursts in Trial:			12			
Chirp Center Frequency:			5524.223			
Burst	Number of Pulses	Pulse Width (Microseconds)	Chirp Width (MHz)	Pulse 1-to-2 Spacing (µsec)	Pulse 2-to-3 Spacing (µsec)	Starting Location Within Interval (µsec)
1	1	55.1	10			533545
2	2	67.9	10	1100		774812
3	2	67.6	10	1790		19150
4	1	51.7	10			261321
5	1	57.5	10			503712
6	1	59.3	10			745934
7	1	63.4	10			988293
8	3	93.4	10	1746	1707	230686
9	1	52.6	10			473625
10	2	75.3	10	1786		714764
11	3	87.8	10	1281	1979	955073
12	3	94	10	1309	1176	201103
13						
14						
15						
16						
17						
18						
19						
20						

Trial Number:			30			Detection (Yes/No)
Number of Bursts in Trial:			13			
Chirp Center Frequency:			5524.623			
Burst	Number of Pulses	Pulse Width (Microseconds)	Chirp Width (MHz)	Pulse 1-to-2 Spacing (µsec)	Pulse 2-to-3 Spacing (µsec)	Starting Location Within Interval (µsec)
1	1	59.5	9			484104
2	2	68.8	9	1426		747546
3	1	54.6	9			1012254
4	1	59.2	9			187514
5	2	79.9	9	1597		451068
6	3	88.4	9	1823	1077	714344
7	1	53	9			980078
8	3	96.1	9	1068	1109	154584
9	2	68.7	9	1736		418486
10	2	77.4	9	1857		682304
11	3	95.8	9	1941	1893	944646
12	2	76.2	12	1770		563316
13	1	60.6	12			788278
14						
15						
16						
17						
18						
19						
20						



**DFS Radar Parameters**  
**FCC Radar Type 1**  
**Channel 106 Bandwidth 80MHz**

Trial #	Pulse Repetition Frequency Number (1 to 23)	Pulse Repetition Frequency (Pulses Per Second)	Pulse Repetition Interval (Microseconds)	Detection (Yes / No)
1	1	1930.50	518	Yes
2	12	1355.01	738	Yes
3	15	1253.13	798	Yes
4	13	1319.26	758	Yes
5	8	1519.76	658	Yes
6	11	1392.76	718	Yes
7	21	1089.32	918	Yes
8	12	326.16	3066	Yes
9	4	1730.10	578	No
10	20	1113.59	898	Yes
11	2	1858.74	538	Yes
12	22	1066.10	938	Yes
13	5	1672.24	598	Yes
14	17	1193.32	838	Yes
15	7	1567.40	638	Yes
16		346.98	2882	Yes
17		394.01	2538	No
18		1897.53	527	Yes
19		447.23	2236	Yes
20		1285.35	778	Yes
21		1557.63	642	Yes
22		469.48	2130	Yes
23		1069.52	935	Yes
24		626.17	1597	Yes
25		373.69	2676	Yes
26		586.85	1704	Yes
27		689.18	1451	Yes
28		765.11	1307	Yes
29		432.90	2310	Yes
30		449.84	2223	Yes

**DFS Radar Parameters**  
**FCC Radar Type 2**  
**Channel 106 Bandwidth 80MHz**

Trial #	Number Pulses per Burst	Pulse Width (Microseconds)	Pulse Repetition Interval (Microseconds)	Detection (Yes / No)
1	23	1.40	198	Yes
2	25	2.20	224	Yes
3	23	1.10	176	Yes
4	26	2.90	182	Yes
5	26	3.10	229	Yes
6	24	1.80	202	No
7	23	1.20	228	Yes
8	27	3.50	194	Yes
9	25	2.30	157	Yes
10	24	1.60	167	Yes
11	24	1.80	199	Yes
12	28	4.20	230	Yes
13	27	3.40	152	Yes
14	29	5.00	217	Yes
15	27	3.80	186	No
16	23	1.10	206	Yes
17	25	2.60	180	Yes
18	27	3.70	165	Yes
19	23	1.00	188	Yes
20	25	2.70	227	Yes
21	29	4.60	219	Yes
22	27	3.60	203	Yes
23	26	2.90	184	Yes
24	26	3.10	178	No
25	25	2.60	221	Yes
26	28	4.00	153	Yes
27	29	4.80	193	Yes
28	26	3.20	210	Yes
29	25	2.30	162	Yes
30	24	2.00	181	Yes

**DFS Radar Parameters**  
**FCC Radar Type 3**  
**Channel 106 Bandwidth 80MHz**

Trial #	Number Pulses per Burst	Pulse Width (Microseconds)	Pulse Repetition Interval (Microseconds)	Detection (Yes / No)
1	16	6.40	465	Yes
2	16	7.20	383	Yes
3	16	6.10	271	No
4	17	7.90	440	Yes
5	17	8.10	341	Yes
6	16	6.80	318	Yes
7	16	6.20	334	Yes
8	17	8.50	494	Yes
9	17	7.30	245	Yes
10	16	6.60	215	Yes
11	16	6.80	282	Yes
12	18	9.20	485	Yes
13	17	8.40	258	Yes
14	18	10.00	437	Yes
15	18	8.80	320	Yes
16	16	6.10	200	Yes
17	17	7.60	220	Yes
18	17	8.70	401	Yes
19	16	6.00	399	Yes
20	17	7.70	205	Yes
21	18	9.60	470	Yes
22	17	8.60	491	Yes
23	17	7.90	297	Yes
24	17	8.10	202	Yes
25	17	7.60	391	Yes
26	18	9.00	396	Yes
27	18	9.80	397	Yes
28	17	8.20	288	Yes
29	16	7.30	219	Yes
30	16	7.00	261	Yes

**DFS Radar Parameters**  
**FCC Radar Type 4**  
**Channel 106 Bandwidth 80MHz**

Trial #	Number Pulses per Burst	Pulse Width (Microseconds)	Pulse Repetition Interval (Microseconds)	Detection (Yes / No)
1	12	11.90	465	Yes
2	13	13.70	383	No
3	12	11.30	271	Yes
4	14	15.30	440	Yes
5	14	15.80	341	Yes
6	13	12.80	318	Yes
7	12	11.50	334	Yes
8	15	16.60	494	Yes
9	13	14.00	245	Yes
10	12	12.30	215	Yes
11	13	12.80	282	Yes
12	15	18.10	485	Yes
13	14	16.30	258	Yes
14	16	19.80	437	Yes
15	15	17.30	320	Yes
16	12	11.20	200	Yes
17	13	14.50	220	Yes
18	15	17.00	401	Yes
19	12	11.10	399	Yes
20	14	14.80	205	Yes
21	16	19.00	470	Yes
22	15	16.90	491	Yes
23	14	15.20	297	Yes
24	14	15.60	202	No
25	13	14.50	391	Yes
26	15	17.70	396	Yes
27	16	19.60	397	Yes
28	14	15.80	288	Yes
29	13	13.90	219	Yes
30	13	13.40	261	Yes

**DFS Radar Parameters**  
**FCC Radar Type 5**  
**Channel 106 Bandwidth 80MHz**

Trial Number:			1			Detection (Yes/No)
Number of Bursts in Trial:			9			
Chirp Center Frequency:			5530			
Burst	Number of Pulses	Pulse Width (Microseconds)	Chirp Width (MHz)	Pulse 1-to-2 Spacing (µsec)	Pulse 2-to-3 Spacing (µsec)	Starting Location Within Interval (µsec)
1	1	55	6			456091
2	1	64.9	6			778946
3	1	52	6			1101904
4	2	74.2	6	1019		93064
5	2	76.7	6	1180		415903
6	1	60	6			739340
7	1	53.1	6			1062002
8	2	80.8	6	1772		53279
9	2	66.8	6	1308		375962
10						
11						
12						
13						
14						
15						
16						
17						
18						
19						
20						

Trial Number:			2			Detection (Yes/No)
Number of Bursts in Trial:			11			
Chirp Center Frequency:			5530			
Burst	Number of Pulses	Pulse Width (Microseconds)	Chirp Width (MHz)	Pulse 1-to-2 Spacing (µsec)	Pulse 2-to-3 Spacing (µsec)	Starting Location Within Interval (µsec)
1	1	57.3	9			572286
2	1	60.1	9			836083
3	3	89.6	9	1440	1575	11057
4	2	79.5	9	1369		274996
5	3	98.8	9	1099	1275	538369
6	3	84.7	9	1650	1769	801389
7	1	51.4	9			1068068
8	2	69.8	9	1983		242218
9	2	83.3	9	1950		506136
10	1	50.9	9			770863
11	2	71.4	9	1116		1034768
12						
13						
14						
15						
16						
17						
18						
19						
20						

**DFS Radar Parameters**  
**FCC Radar Type 5**  
**Channel 106 Bandwidth 80MHz**

Trial Number:			3			Detection (Yes/No)
Number of Bursts in Trial:			8			
Chirp Center Frequency:			5530			
Burst	Number of Pulses	Pulse Width (Microseconds)	Chirp Width (MHz)	Pulse 1-to-2 Spacing (µsec)	Pulse 2-to-3 Spacing (µsec)	Starting Location Within Interval (µsec)
1	3	94.2	5	1478	1777	288532
2	2	82.9	5	1681		651974
3	2	73.5	5	1889		1014683
4	2	75.8	5	1295		1378001
5	2	69.7	5	1075		244188
6	3	86.9	5	1907	1463	606557
7	3	97.4	5	1072	1173	969693
8	2	76.9	5	1193		1333926
9						
10						
11						
12						
13						
14						
15						
16						
17						
18						
19						
20						

Trial Number:			4			Detection (Yes/No)
Number of Bursts in Trial:			8			
Chirp Center Frequency:			5530			
Burst	Number of Pulses	Pulse Width (Microseconds)	Chirp Width (MHz)	Pulse 1-to-2 Spacing (µsec)	Pulse 2-to-3 Spacing (µsec)	Starting Location Within Interval (µsec)
1	1	66.2	12			113987
2	1	63.2	12			321486
3	2	81.6	12	1624		528264
4	3	97.1	12	1125	1787	733969
5	1	62.5	12			88396
6	1	61.5	12			295881
7	3	92.6	12	1645	1343	501606
8	3	92.5	12	1899	1591	708477
9	1	56.1	12			62881
10	3	85.6	12	1837	1392	269320
11	1	61	12			477893
12	1	51.8	12			685309
13	3	95.8	12	1327	1249	37176
14	1	58.5	12			244764
15						
16						
17						
18						
19						
20						

**DFS Radar Parameters**  
**FCC Radar Type 5**  
**Channel 106 Bandwidth 80MHz**

Trial Number:			5			Detection (Yes/No)
Number of Bursts in Trial:			14			
Chirp Center Frequency:			5530			
Burst	Number of Pulses	Pulse Width (Microseconds)	Chirp Width (MHz)	Pulse 1-to-2 Spacing (µsec)	Pulse 2-to-3 Spacing (µsec)	Starting Location Within Interval (µsec)
1	2	75.4	13	1733		451522
2	3	90.7	13	1570	1285	657471
3	3	87.6	13	1868	1643	11695
4	3	93.5	13	1371	1579	218584
5	3	94.5	13	1105	1147	425679
6	1	53.9	13			634053
7	3	98.2	13	1652	1311	839188
8	3	97.5	13	1351	1316	193137
9	2	83.2	13	1490		400517
10	3	99.6	13	1642	1680	606704
11	1	62.1	13			815936
12	1	51.5	13			168219
13	2	72.3	13	1628		375144
14	2	72.1	13	1065		582695
15						
16						
17						
18						
19						
20						

Trial Number:			6			Detection (Yes/No)
Number of Bursts in Trial:			10			
Chirp Center Frequency:			5530			
Burst	Number of Pulses	Pulse Width (Microseconds)	Chirp Width (MHz)	Pulse 1-to-2 Spacing (µsec)	Pulse 2-to-3 Spacing (µsec)	Starting Location Within Interval (µsec)
1	3	91.4	8	1268	1362	1105275
2	2	76.2	8	1870		199366
3	1	54.4	8			490358
4	3	89.9	8	1256	1414	779365
5	1	62.6	8			1071413
6	2	76.3	8	1387		163769
7	1	64.6	8			454651
8	1	53.6	8			745006
9	2	75.7	8	1431		1034301
10	1	63.1	8			128079
11						
12						
13						
14						
15						
16						
17						
18						
19						
20						

**DFS Radar Parameters**  
**FCC Radar Type 5**  
**Channel 106 Bandwidth 80MHz**

Trial Number:			7			Detection (Yes/No)
Number of Bursts in Trial:			8			
Chirp Center Frequency:			5530			
Burst	Number of Pulses	Pulse Width (Microseconds)	Chirp Width (MHz)	Pulse 1-to-2 Spacing (µsec)	Pulse 2-to-3 Spacing (µsec)	Starting Location Within Interval (µsec)
1	2	75.6	14	1155		216520
2	3	85.6	14	1993	1103	396614
3	1	57.4	14			579687
4	2	82.8	14	1995		12889
5	3	88.3	14	1447	1358	193680
6	2	76.3	14	1892		374938
7	3	92.4	14	1841	1127	555060
8	3	93.4	14	1225	1449	736781
9	2	78.8	14	1508		171787
10	2	68.8	14	1329		353186
11	2	80.1	14	1041		534595
12	2	82.1	14	1583		715294
13	3	84.9	14	1169	1756	149063
14	1	60.9	14			331211
15	3	89.2	14	1793	1655	510715
16	2	70.5	14	1404		693078
17						
18						
19						
20						

Trial Number:			8			Detection (Yes/No)
Number of Bursts in Trial:			16			
Chirp Center Frequency:			5530			
Burst	Number of Pulses	Pulse Width (Microseconds)	Chirp Width (MHz)	Pulse 1-to-2 Spacing (µsec)	Pulse 2-to-3 Spacing (µsec)	Starting Location Within Interval (µsec)
1	2	75.6	14	1155		216520
2	3	85.6	14	1993	1103	396614
3	1	57.4	14			579687
4	2	82.8	14	1995		12889
5	3	88.3	14	1447	1358	193680
6	2	76.3	14	1892		374938
7	3	92.4	14	1841	1127	555060
8	3	93.4	14	1225	1449	736781
9	2	78.8	14	1508		171787
10	2	68.8	14	1329		353186
11	2	80.1	14	1041		534595
12	2	82.1	14	1583		715294
13	3	84.9	14	1169	1756	149063
14	1	60.9	14			331211
15	3	89.2	14	1793	1655	510715
16	2	70.5	14	1404		693078
17						
18						
19						
20						



**DFS Radar Parameters**  
**FCC Radar Type 5**  
**Channel 106 Bandwidth 80MHz**

Trial Number:			9			Detection (Yes/No)
Number of Bursts in Trial:			12			
Chirp Center Frequency:			5530			
Burst	Number of Pulses	Pulse Width (Microseconds)	Chirp Width (MHz)	Pulse 1-to-2 Spacing (µsec)	Pulse 2-to-3 Spacing (µsec)	Starting Location Within Interval (µsec)
1	1	51.1	10			169836
2	2	79.9	10	1817		411435
3	2	81.1	10	1203		653492
4	2	71.2	10	1523		894783
5	3	89.2	10	1910	1152	139593
6	2	69.5	10	1149		381670
7	3	94	10	1755	1973	622378
8	2	71.8	10	1465		865458
9	1	65	10			110246
10	2	74.4	10	1489		351980
11	1	66.4	10			594506
12	2	76.5	10	1040		835513
13						
14						
15						
16						
17						
18						
19						
20						

Trial Number:			10			Detection (Yes/No)
Number of Bursts in Trial:			9			
Chirp Center Frequency:			5530			
Burst	Number of Pulses	Pulse Width (Microseconds)	Chirp Width (MHz)	Pulse 1-to-2 Spacing (µsec)	Pulse 2-to-3 Spacing (µsec)	Starting Location Within Interval (µsec)
1	3	97.8	7	1882	1779	106978
2	1	55.9	7			430424
3	1	52.1	7			753353
4	3	99	7	1767	1057	1073995
5	2	77.3	7	1498		67384
6	1	63.1	7			390566
7	2	76	7	1717		712399
8	3	86.7	7	1195	1667	1034158
9	1	64.6	7			27685
10						
11						
12						
13						
14						
15						
16						
17						
18						
19						
20						

**DFS Radar Parameters**  
**FCC Radar Type 5**  
**Channel 106 Bandwidth 80MHz**

Trial Number:			11			Detection (Yes/No)
Number of Bursts in Trial:			10			
Chirp Center Frequency:			5495.1575			
Burst	Number of Pulses	Pulse Width (Microseconds)	Chirp Width (MHz)	Pulse 1-to-2 Spacing (µsec)	Pulse 2-to-3 Spacing (µsec)	Starting Location Within Interval (µsec)
1	1	58.6	8			315543
2	3	88	8	1770	1571	604519
3	2	78.2	8	1828		895230
4	3	97.6	8	1496	1028	1185129
5	2	69.3	8	1140		279539
6	3	97.5	8	1468	1623	569056
7	3	95.9	8	1951	1279	858767
8	2	73.5	8	1480		1150807
9	3	93.7	8	1025	1969	243392
10	2	78.2	8	1388		534084
11						
12						
13						
14						
15						
16						
17						
18						
19						
20						

Trial Number:			12			Detection (Yes/No)
Number of Bursts in Trial:			18			
Chirp Center Frequency:			5498.7575			
Burst	Number of Pulses	Pulse Width (Microseconds)	Chirp Width (MHz)	Pulse 1-to-2 Spacing (µsec)	Pulse 2-to-3 Spacing (µsec)	Starting Location Within Interval (µsec)
1	1	66.1	17			458266
2	2	78.8	17	1011		618238
3	3	85.7	17	1196	1739	115058
4	3	91.1	17	1002	1952	275495
5	1	65.3	17			438138
6	1	53	17			599661
7	1	51	17			95681
8	1	59.8	17			257166
9	1	56.1	17			418283
10	3	91.6	17	1314	1801	576878
11	3	85.6	17	1415	1931	75439
12	2	67.8	17	1340		236781
13	1	63.8	17			398735
14	1	59.8	17			559395
15	1	65.8	17			55892
16	3	95.7	17	1865	1231	216175
17	2	72.9	17	1848		377480
18	1	66.6	17			539999
19						
20						

**DFS Radar Parameters**  
**FCC Radar Type 5**  
**Channel 106 Bandwidth 80MHz**

Trial Number:			13			Detection (Yes/No) Yes
Number of Bursts in Trial:			15			
Chirp Center Frequency:			5497.5575			
Burst	Number of Pulses	Pulse Width (Microseconds)	Chirp Width (MHz)	Pulse 1-to-2 Spacing (µsec)	Pulse 2-to-3 Spacing (µsec)	Starting Location Within Interval (µsec)
1	2	81.1	14	1691		43173
2	1	54.7	14			237072
3	2	71.7	14	1670		429725
4	3	85	14	1339	1900	621518
5	1	52.4	14			19432
6	1	55.8	14			213028
7	3	92.5	14	1427	1153	405290
8	3	92	14	1990	1317	597929
9	1	52.8	14			794345
10	2	73.6	14	1715		188943
11	2	69.9	14	1102		382243
12	2	72	14	1878		574958
13	3	98.2	14	1020	1958	767112
14	3	98.3	14	1277	1686	164814
15	2	71.3	14	1296		358432
16						
17						
18						
19						
20						

Trial Number:			14			Detection (Yes/No) No
Number of Bursts in Trial:			20			
Chirp Center Frequency:			5499.9575			
Burst	Number of Pulses	Pulse Width (Microseconds)	Chirp Width (MHz)	Pulse 1-to-2 Spacing (µsec)	Pulse 2-to-3 Spacing (µsec)	Starting Location Within Interval (µsec)
1	3	96.2	20	1464	1142	412467
2	1	50.2	20			559149
3	3	97.8	20	1221	1168	105622
4	1	62	20			251304
5	1	64.8	20			396581
6	3	86.9	20	1208	1270	539601
7	3	95.9	20	1963	1750	87618
8	2	76.2	20	1318		232979
9	1	53.3	20			378329
10	2	69.8	20	1703		521958
11	3	95.2	20	1187	1557	69956
12	2	79	20	1968		214668
13	3	90.8	20	1822	1297	358915
14	2	74.2	20	1816		504640
15	2	68.3	20	1761		52265
16	2	81.8	20	1323		197219
17	2	73.6	20	1189		342218
18	2	74.6	20	1410		486611
19	2	79.3	20	1441		34446
20	3	92.5	20	1661	1771	178766

**DFS Radar Parameters**  
**FCC Radar Type 5**  
**Channel 106 Bandwidth 80MHz**

Trial Number:			15			Detection (Yes/No)
Number of Bursts in Trial:			17			
Chirp Center Frequency:			5498.3575			
Burst	Number of Pulses	Pulse Width (Microseconds)	Chirp Width (MHz)	Pulse 1-to-2 Spacing (µsec)	Pulse 2-to-3 Spacing (µsec)	Starting Location Within Interval (µsec)
1	3	88.9	16	1239	1759	380606
2	1	56.5	16			553212
3	2	81.2	16	1330		19594
4	2	76.3	16	1862		190008
5	2	79.9	16	1368		360470
6	3	98.7	16	1510	1320	529951
7	2	73.4	16	1529		701560
8	1	50.2	16			169324
9	2	77.5	16	1067		339969
10	3	89.9	16	1344	1559	509095
11	3	84.2	16	1901	1918	677997
12	3	93.5	16	1656	1355	147725
13	3	87.3	16	1432	1731	317636
14	3	96.5	16	1511	1732	487504
15	2	67.6	16	1078		659989
16	1	59.6	16			127277
17	2	68	16	1156		297601
18						
19						
20						

Trial Number:			16			Detection (Yes/No)
Number of Bursts in Trial:			8			
Chirp Center Frequency:			5493.9575			
Burst	Number of Pulses	Pulse Width (Microseconds)	Chirp Width (MHz)	Pulse 1-to-2 Spacing (µsec)	Pulse 2-to-3 Spacing (µsec)	Starting Location Within Interval (µsec)
1	3	83.7	5	1908	1548	995497
2	1	58.1	5			1361600
3	2	79.8	5	1885		225782
4	3	85.2	5	1647	1080	588360
5	2	78.5	5	1887		951829
6	2	68.4	5	1269		1315202
7	1	65.1	5			181313
8	1	57.3	5			544812
9						
10						
11						
12						
13						
14						
15						
16						
17						
18						
19						
20						

**DFS Radar Parameters**  
**FCC Radar Type 5**  
**Channel 106 Bandwidth 80MHz**

Trial Number:			17			Detection (Yes/No)
Number of Bursts in Trial:			13			
Chirp Center Frequency:			5496.3575			
Burst	Number of Pulses	Pulse Width (Microseconds)	Chirp Width (MHz)	Pulse 1-to-2 Spacing (µsec)	Pulse 2-to-3 Spacing (µsec)	Starting Location Within Interval (µsec)
1	2	76.8	11	1829		557698
2	1	51.7	11			782182
3	2	67.8	11	1402		83874
4	3	84.5	11	1036	1500	306513
5	3	91.9	11	1855	1519	529020
6	3	96.4	11	1988	1331	751885
7	3	97.4	11	1991	1337	56297
8	2	68.9	11	1858		279421
9	1	55.8	11			503662
10	2	82.5	11	1538		725515
11	3	89.7	11	1095	1710	28860
12	2	69.1	11	1029		252246
13	2	71.5	11	1785		475029
14						
15						
16						
17						
18						
19						
20						

Trial Number:			18			Detection (Yes/No)
Number of Bursts in Trial:			16			
Chirp Center Frequency:			5497.9575			
Burst	Number of Pulses	Pulse Width (Microseconds)	Chirp Width (MHz)	Pulse 1-to-2 Spacing (µsec)	Pulse 2-to-3 Spacing (µsec)	Starting Location Within Interval (µsec)
1	2	82.1	15	1760		566651
2	1	66.2	15			1143
3	1	63.5	15			182789
4	3	95.7	15	1083	1418	362933
5	3	98.8	15	1254	1088	543876
6	1	63.5	15			727356
7	3	85.7	15	1283	1651	159683
8	1	51.6	15			341898
9	3	91.8	15	1399	1640	521273
10	3	94.3	15	1108	1675	702317
11	1	56.5	15			137881
12	1	58.7	15			319662
13	1	63.7	15			501159
14	3	90	15	1438	1925	679274
15	1	66.5	15			115593
16	3	99.6	15	1632	1171	296127
17						
18						
19						
20						

**DFS Radar Parameters**  
**FCC Radar Type 5**  
**Channel 106 Bandwidth 80MHz**

Trial Number:			19			Detection (Yes/No)
Number of Bursts in Trial:			8			
Chirp Center Frequency:			5493.9575			
Burst	Number of Pulses	Pulse Width (Microseconds)	Chirp Width (MHz)	Pulse 1-to-2 Spacing (µsec)	Pulse 2-to-3 Spacing (µsec)	Starting Location Within Interval (µsec)
1	1	57.2	5			958469
2	1	60.3	5			1321531
3	3	88.2	5	1773.000	1804.000	186176
4	1	66.1	5			550007
5	2	68.9	5	1944.000		912150
6	1	53	5			1276596
7	3	96.9	5	1879.000	1258.000	141585
8	1	55.6	5			505262
9						
10						
11						
12						
13						
14						
15						
16						
17						
18						
19						
20						

Trial Number:			20			Detection (Yes/No)
Number of Bursts in Trial:			13			
Chirp Center Frequency:			5496.3575			
Burst	Number of Pulses	Pulse Width (Microseconds)	Chirp Width (MHz)	Pulse 1-to-2 Spacing (µsec)	Pulse 2-to-3 Spacing (µsec)	Starting Location Within Interval (µsec)
1	1	65.7	11			534549
2	3	85.6	11	1321	1726	755351
3	3	93.6	11	1863	1370	59514
4	3	86.8	11	1998	1603	282206
5	2	74.6	11	1505		505905
6	2	81.5	11	1808		728563
7	1	64	11			32199
8	2	78	11	1916		255085
9	3	90.6	11	1299	1596	477956
10	3	96.6	11	1692	1133	700648
11	1	51.5	11			4666
12	3	92	11	1584	1457	227313
13	1	66.2	11			451522
14						
15						
16						
17						
18						
19						
20						

**DFS Radar Parameters**  
**FCC Radar Type 5**  
**Channel 106 Bandwidth 80MHz**

Trial Number:			21			Detection (Yes/No) Yes
Number of Bursts in Trial:			19			
Chirp Center Frequency:			5560.4425			
Burst	Number of Pulses	Pulse Width (Microseconds)	Chirp Width (MHz)	Pulse 1-to-2 Spacing (µsec)	Pulse 2-to-3 Spacing (µsec)	Starting Location Within Interval (µsec)
1	3	89.6	19	1913	1976	458587
2	2	79.8	19	1367		612743
3	1	54.9	19			137244
4	2	79.4	19	1803		289280
5	1	55.7	19			442917
6	3	85.1	19	1606	1143	592930
7	1	57.4	19			118375
8	1	61.2	19			271325
9	2	75.8	19	1811		422480
10	2	78.2	19	1852		574802
11	1	56.3	19			99538
12	2	80.9	19	1220		251892
13	2	69.4	19	1687		404285
14	3	98.6	19	1518	1154	555798
15	2	72.1	19	1332		80537
16	1	51.5	19			233486
17	1	53	19			386496
18	1	52.6	19			539575
19	2	79.1	19	1949		61718
20						

Trial Number:			22			Detection (Yes/No) Yes
Number of Bursts in Trial:			16			
Chirp Center Frequency:			5562.0425			
Burst	Number of Pulses	Pulse Width (Microseconds)	Chirp Width (MHz)	Pulse 1-to-2 Spacing (µsec)	Pulse 2-to-3 Spacing (µsec)	Starting Location Within Interval (µsec)
1	2	69.3	15	1877		254487
2	1	57.8	15			436785
3	2	79.9	15	2000		616628
4	1	63.1	15			51159
5	2	69.9	15	1380		232224
6	3	99	15	1994	1160	412665
7	2	77	15	1860		594490
8	1	60.2	15			28800
9	2	80.3	15	1798		209873
10	2	78.6	15	1522		391228
11	2	68.2	15	1608		571946
12	2	67.2	15	1114		6427
13	3	88.5	15	1446	1406	187164
14	2	74.6	15	1682		368451
15	2	83.3	15	1853		549946
16	2	67.7	15	1423		731000
17						
18						
19						
20						

**DFS Radar Parameters**  
**FCC Radar Type 5**  
**Channel 106 Bandwidth 80MHz**

Trial Number:			23			Detection (Yes/No)
Number of Bursts in Trial:			14			
Chirp Center Frequency:			5563.2425			
Burst	Number of Pulses	Pulse Width (Microseconds)	Chirp Width (MHz)	Pulse 1-to-2 Spacing (µsec)	Pulse 2-to-3 Spacing (µsec)	Starting Location Within Interval (µsec)
1	2	80.6	12	1325		188949
2	2	83.3	12	1202		396121
3	3	86.7	12	1451	1372	602317
4	1	63.1	12			811814
5	2	68	12	1807		163477
6	3	89.5	12	1134	1416	370010
7	3	94.4	12	1948	1058	577001
8	3	90	12	1047	1705	784127
9	1	57.4	12			138193
10	3	87.2	12	1074	1001	344709
11	1	55.9	12			553281
12	1	55.2	12			761200
13	2	82.9	12	1212		112482
14	3	92	12	1473	1922	318957
15						
16						
17						
18						
19						
20						

Trial Number:			24			Detection (Yes/No)
Number of Bursts in Trial:			14			
Chirp Center Frequency:			5562.8425			
Burst	Number of Pulses	Pulse Width (Microseconds)	Chirp Width (MHz)	Pulse 1-to-2 Spacing (µsec)	Pulse 2-to-3 Spacing (µsec)	Starting Location Within Interval (µsec)
1	2	76.5	13	1555		526518
2	3	87.5	13	1504	1599	732507
3	3	93.9	13	1664	1391	86736
4	2	72.4	13	1614		294120
5	2	72.6	13	1106		501671
6	1	58.4	13			709310
7	1	59.6	13			61533
8	1	66.6	13			268913
9	3	85	13	1186	1796	475077
10	2	80.5	13	1727		682804
11	2	78.8	13	1452		35899
12	2	74.8	13	1935		242795
13	2	77.2	13	1197		450389
14	2	82.6	13	1082		657756
15						
16						
17						
18						
19						
20						



**DFS Radar Parameters**  
**FCC Radar Type 5**  
**Channel 106 Bandwidth 80MHz**

Trial Number:			25			Detection (Yes/No)
Number of Bursts in Trial:			13			
Chirp Center Frequency:			5563.6425			
Burst	Number of Pulses	Pulse Width (Microseconds )	Chirp Width (MHz)	Pulse 1-to-2 Spacing (µsec)	Pulse 2-to-3 Spacing (µsec)	Starting Location Within Interval (µsec)
1	1	57.5	11			11192
2	1	61	11			234643
3	2	67.9	11	1502		457245
4	1	56.2	11			681769
5	3	86.1	11	1228	1031	902590
6	2	80.9	11	1445		206945
7	3	91.5	11	1455	1122	429305
8	2	68.2	11	1015		653478
9	1	66.3	11			877390
10	3	89.5	11	1543	1470	178971
11	1	61.1	11			403302
12	2	79.9	11	1214		625531
13	1	63.5	11			850373
14						
15						
16						
17						
18						
19						
20						

Trial Number:			26			Detection (Yes/No)
Number of Bursts in Trial:			17			
Chirp Center Frequency:			5561.6425			
Burst	Number of Pulses	Pulse Width (Microseconds )	Chirp Width (MHz)	Pulse 1-to-2 Spacing (µsec)	Pulse 2-to-3 Spacing (µsec)	Starting Location Within Interval (µsec)
1	3	90	16	1185	1509	115777
2	1	55.7	16			286979
3	2	82.7	16	1904		456477
4	3	93	16	1765	1223	625877
5	2	71.7	16	1073		95108
6	2	77.4	16	1237		265667
7	3	88.3	16	1250	1017	435305
8	1	52.1	16			607978
9	2	80.7	16	1532		74051
10	2	73.3	16	1272		244577
11	1	66	16			415586
12	1	51.9	16			586282
13	2	74.8	16	1845		52957
14	1	58	16			223816
15	1	63.9	16			394907
16	3	98.3	16	1042	1007	563737
17	1	56.1	16			32086
18						
19						
20						

**DFS Radar Parameters**  
**FCC Radar Type 5**  
**Channel 106 Bandwidth 80MHz**

Trial Number:			27			Detection (Yes/No)
Number of Bursts in Trial:			20			
Chirp Center Frequency:			5560.0425			
Burst	Number of Pulses	Pulse Width (Microseconds)	Chirp Width (MHz)	Pulse 1-to-2 Spacing ( $\mu$ sec)	Pulse 2-to-3 Spacing ( $\mu$ sec)	Starting Location Within Interval ( $\mu$ sec)
1	3	84.4	20	1006	1288	171798
2	3	93.2	20	1704	1121	316209
3	1	62.2	20			463045
4	1	61.7	20			9381
5	2	82.4	20	1923		154002
6	3	96.5	20	1257	1352	298454
7	2	69.3	20	1714		443388
8	3	99.7	20	1753	1016	587670
9	2	69.1	20	1145		136359
10	1	52	20			281692
11	1	50.4	20			426935
12	1	58.2	20			571957
13	2	71.1	20	1539		118444
14	1	54.4	20			264113
15	1	61.3	20			408792
16	3	92.8	20	1255	1719	551905
17	3	95	20	1481	1342	100355
18	2	69.7	20	1499		245551
19	1	60.9	20			391316
20	1	52.2	20			536137

Trial Number:			28			Detection (Yes/No)
Number of Bursts in Trial:			14			
Chirp Center Frequency:			5562.8425			
Burst	Number of Pulses	Pulse Width (Microseconds)	Chirp Width (MHz)	Pulse 1-to-2 Spacing ( $\mu$ sec)	Pulse 2-to-3 Spacing ( $\mu$ sec)	Starting Location Within Interval ( $\mu$ sec)
1	3	87.5	13	1209	1978	118213
2	1	57	13			326346
3	3	97.5	13	1615	1349	531858
4	3	88.9	13	1984	1005	738617
5	2	80.5	13	1010		92995
6	2	76.9	13	1764		300151
7	3	87.7	13	1987	1119	506096
8	1	51.9	13			716032
9	1	54.3	13			67531
10	1	61.3	13			275052
11	2	72.8	13	1886		481481
12	2	77.5	13	1071		689565
13	2	69.9	13	1503		41917
14	1	60.2	13			249630
15						
16						
17						
18						
19						
20						

**DFS Radar Parameters**  
**FCC Radar Type 5**  
**Channel 106 Bandwidth 80MHz**

Trial Number:			29			Detection (Yes/No) Yes
Number of Bursts in Trial:			12			
Chirp Center Frequency:			5564.0425			
Burst	Number of Pulses	Pulse Width (Microseconds)	Chirp Width (MHz)	Pulse 1-to-2 Spacing (µsec)	Pulse 2-to-3 Spacing (µsec)	Starting Location Within Interval (µsec)
1	1	55.1	10			533545
2	2	67.9	10	1100		774812
3	2	67.6	10	1790		19150
4	1	51.7	10			261321
5	1	57.5	10			503712
6	1	59.3	10			745934
7	1	63.4	10			988293
8	3	93.4	10	1746	1707	230686
9	1	52.6	10			473625
10	2	75.3	10	1786		714764
11	3	87.8	10	1281	1979	955073
12	3	94	10	1309	1176	201103
13						
14						
15						
16						
17						
18						
19						
20						

Trial Number:			30			Detection (Yes/No) Yes
Number of Bursts in Trial:			13			
Chirp Center Frequency:			5564.4425			
Burst	Number of Pulses	Pulse Width (Microseconds)	Chirp Width (MHz)	Pulse 1-to-2 Spacing (µsec)	Pulse 2-to-3 Spacing (µsec)	Starting Location Within Interval (µsec)
1	1	59.5	9			484104
2	2	68.8	9	1426		747546
3	1	54.6	9			1012254
4	1	59.2	9			187514
5	2	79.9	9	1597		451068
6	3	88.4	9	1823	1077	714344
7	1	53	9			980078
8	3	96.1	9	1068	1109	154584
9	2	68.7	9	1736		418486
10	2	77.4	9	1857		682304
11	3	95.8	9	1941	1893	944646
12	2	76.2	12	1770		563316
13	1	60.6	12			788278
14						
15						
16						
17						
18						
19						
20						