

# MEASUREMENT REPORT

## FCC PART 15.407/ WLAN 802.11a/n/ac

---

**FCC ID:** TE7RE230V2

**Applicant:** TP-Link Technologies Co., Ltd.

**Application Type:** Certification

**Product:** AC750 Wi-Fi Range Extender  
AC1200 Wi-Fi Range Extender

**Model No.:** RE230, RE330

**Brand Name:** tp-link

**FCC Classification:** Unlicensed National Information Infrastructure (NII)

**FCC Rule Part(s):** Part15 Subpart E (Section 15.407)

**Test Procedure(s):** ANSI C63.10-2013, KDB 789033 D02v02r01  
KDB 662911 D01v02r01

**Test Date:** August 31 ~ November 06, 2020

Reviewed By:

  
( Kevin Guo )

Approved By:

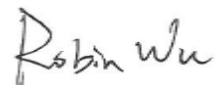
  
( Robin Wu )



The test results relate only to the samples tested.

This equipment has been shown to be capable of compliance with the applicable technical standards as indicated in the measurement report and was tested in accordance with the measurement procedures specified in KDB 789033 D02v02r01. Test results reported here in relate only to the item(s) tested.

The test report shall not be reproduced except in full without the written approval of MRT Technology (Suzhou) Co., Ltd.

---

## Revision History

Report No.	Version	Description	Issue Date	Note
2008RSU036-U3	Rev. 01	Initial Report	12-30-2020	Valid

---

## CONTENTS

Description	Page
<b>1. General Information.....</b>	<b>6</b>
1.1. Applicant.....	6
1.2. Manufacturer .....	6
1.3. Testing Facility .....	6
<b>2. PRODUCT INFORMATION .....</b>	<b>7</b>
2.1. Equipment Description.....	7
2.2. Product Specification Subjective to this Report.....	7
2.3. Working Frequencies for this Report.....	8
2.4. Description of Available Antennas .....	9
2.5. Test Mode .....	9
2.6. Configuration of Test System.....	10
2.7. Test System Details.....	10
2.8. Description of Test Software.....	10
2.9. Duty Cycle .....	11
2.10. EMI Suppression Device(s)/Modifications .....	11
2.11. Test Environment Condition .....	11
<b>3. ANTENNA REQUIREMENTS.....</b>	<b>12</b>
<b>4. TEST EQUIPMENT CALIBRATION DATE.....</b>	<b>13</b>
<b>5. MEASUREMENT UNCERTAINTY.....</b>	<b>17</b>
<b>6. TEST RESULT .....</b>	<b>18</b>
6.1. Summary .....	18
6.2. 26dB Bandwidth Measurement.....	19
6.2.1. Test Limit .....	19
6.2.2. Test ProcedureUsed .....	19
6.2.3. Test Setting.....	19
6.2.4. Test Setup .....	19
6.2.5. Test Result.....	20
6.3. 6dB Bandwidth Measurement.....	28
6.3.1. Test Limit .....	28
6.3.2. Test Procedure Used .....	28
6.3.3. Test Setting.....	28
6.3.4. Test Setup .....	28
6.3.5. Test Result.....	29
6.4. Output Power Measurement.....	32

---

6.4.1. Test Limit .....	32
6.4.2. Test Procedure Used .....	32
6.4.3. Test Setting.....	32
6.4.4. Test Setup .....	32
6.4.5. Test Result.....	33
6.5. Transmit Power Control .....	35
6.5.1. Test Limit .....	35
6.5.2. Test Procedure Used .....	35
6.5.3. Test Setting.....	35
6.5.4. Test Setup .....	35
6.5.5. Test Result.....	35
6.6. Power Spectral Density Measurement .....	36
6.6.1. Test Limit .....	36
6.6.2. Test Procedure Used .....	36
6.6.3. Test Setting.....	36
6.6.4. Test Setup .....	37
6.6.5. Test Result.....	38
6.7. Frequency Stability Measurement.....	53
6.7.1. Test Limit .....	53
6.7.2. Test Procedure Used .....	53
6.7.3. Test Setup .....	54
6.7.4. Test Result.....	55
6.8. Radiated Spurious Emission Measurement .....	56
6.8.1. Test Limit .....	56
6.8.2. Test Procedure Used .....	56
6.8.3. Test Setting.....	56
6.8.4. Test Setup .....	58
6.8.5. Test Result.....	59
6.9. Radiated RestrictedBand Edge Measurement .....	99
6.9.1. Test Limit .....	99
6.9.2. Test Procedure Used .....	100
6.9.3. Test Setting.....	101
6.9.4. Test Setup .....	102
6.9.5. Test Result.....	103
6.10. AC Conducted Emissions Measurement.....	185
6.10.1. Test Limit .....	185
6.10.2. Test Setup .....	185
6.10.3. Test Result.....	186

**7. CONCLUSION..... 188**

**Appendix A - Test Setup Photograph ..... 189**

**Appendix B - EUT Photograph..... 190**

## 1. General Information

### 1.1. Applicant

TP-Link Technologies Co., Ltd.

Building 24 (floors 1,3,4,5) and 28 (floors1-4), Central Science and Technology Park,Nanshan Shenzhen, 518057 China

### 1.2. Manufacturer

TP-Link Technologies Co., Ltd.

Building 24 (floors 1,3,4,5) and 28 (floors1-4), Central Science and Technology Park,Nanshan Shenzhen, 518057 China

### 1.3. Testing Facility

<input checked="" type="checkbox"/>	<p><b>Test Site – MRT Suzhou Laboratory</b></p> <hr/> <p><b>Laboratory Location (Suzhou – Wuzhong)</b> D8 Building, No.2 Tian'edang Rd., Wuzhong Economic Development Zone, Suzhou, China</p> <p><b>Laboratory Location (Suzhou – SIP)</b> 4b Building, Liando U Valley, No.200 Xingpu Rd., Shengpu Town, Suzhou Industrial Park, China</p> <hr/> <p><b>Laboratory Accreditations</b></p> <table style="width: 100%; border: none;"> <tr> <td style="width: 50%;">A2LA: 3628.01</td> <td style="width: 50%;">CNAS: L10551</td> </tr> <tr> <td>FCC: CN1166</td> <td>ISED: CN0001</td> </tr> <tr> <td colspan="2">VCCI: R-20025, G-20034, C-20020, T-20020</td> </tr> </table>	A2LA: 3628.01	CNAS: L10551	FCC: CN1166	ISED: CN0001	VCCI: R-20025, G-20034, C-20020, T-20020	
A2LA: 3628.01	CNAS: L10551						
FCC: CN1166	ISED: CN0001						
VCCI: R-20025, G-20034, C-20020, T-20020							
<input type="checkbox"/>	<p><b>Test Site – MRT Shenzhen Laboratory</b></p> <hr/> <p><b>Laboratory Location (Shenzhen)</b> 1G, Building A, Junxiangda Building, Zhongshanyuan Road West, Nanshan District, Shenzhen, China</p> <hr/> <p><b>Laboratory Accreditations</b></p> <table style="width: 100%; border: none;"> <tr> <td style="width: 50%;">A2LA: 3628.02</td> <td style="width: 50%;">CNAS: L10551</td> </tr> <tr> <td>FCC: CN1284</td> <td>ISED: CN0105</td> </tr> </table>	A2LA: 3628.02	CNAS: L10551	FCC: CN1284	ISED: CN0105		
A2LA: 3628.02	CNAS: L10551						
FCC: CN1284	ISED: CN0105						
<input type="checkbox"/>	<p><b>Test Site – MRT Taiwan Laboratory</b></p> <hr/> <p><b>Laboratory Location (Taiwan)</b> No. 38, Fuxing 2<sup>nd</sup> Rd., Guishan Dist., Taoyuan City 333, Taiwan (R.O.C.)</p> <hr/> <p><b>Laboratory Accreditations</b></p> <table style="width: 100%; border: none;"> <tr> <td style="width: 50%;">TAF: L3261-190725</td> <td style="width: 50%;"></td> </tr> <tr> <td>FCC: 291082, TW3261</td> <td>ISED: TW3261</td> </tr> </table>	TAF: L3261-190725		FCC: 291082, TW3261	ISED: TW3261		
TAF: L3261-190725							
FCC: 291082, TW3261	ISED: TW3261						

## 2. PRODUCT INFORMATION

### 2.1. Equipment Description

Product Name:	AC750 Wi-Fi Range Extender AC1200 Wi-Fi Range Extender
Model No.:	RE230, RE330
Brand Name:	tp-link
Wi-Fi Specification:	802.11a/b/g/n/ac
EUT Identification No.:	20200821Sample#01 (Conducted) 20200821Sample#02 (Radiated & AC conducted emission)

Note: There is the same hardware design, PCB layout between the models, different models and product names for different marketing requirements. Only RE230 (Product name: AC750 Wi-Fi Range Extender) was selected for final tests.

### 2.2. Product Specification Subjective to this Report

Frequency Range:	For 802.11a/n-HT20/ac-VHT20: 5180~5240MHz, 5260~5320MHz, 5500~5700MHz, 5745~5825MHz For 802.11n-HT40/ac-VHT40: 5190~5230MHz, 5270~5310MHz, 5510~5670MHz, 5755~5795MHz For 802.11ac-VHT80: 5210MHz, 5290MHz, 5530MHz, 5610 MHz, 5775MHz
Type of Modulation:	802.11a/n/ac: OFDM
Data Rate:	802.11a: 6/9/12/18/24/36/48/54Mbps 802.11n: up to 300Mbps 802.11ac: up to 866.6Mbps

Note: For other features of this EUT, test report will be issued separately.

### 2.3. Working Frequencies for this Report

#### 802.11a/n-HT20/ac-VHT20

Channel	Frequency	Channel	Frequency	Channel	Frequency
36	5180 MHz	40	5200 MHz	44	5220 MHz
48	5240 MHz	52	5260 MHz	56	5280 MHz
60	5300 MHz	64	5320 MHz	100	5500 MHz
104	5520 MHz	108	5540 MHz	112	5560 MHz
116	5580 MHz	120	5600 MHz	124	5620 MHz
128	5640 MHz	132	5660 MHz	136	5680 MHz
140	5700 MHz	149	5745 MHz	153	5765 MHz
157	5785 MHz	161	5805 MHz	165	5825 MHz

#### 802.11n-HT40/ac-VHT40

Channel	Frequency	Channel	Frequency	Channel	Frequency
38	5190 MHz	46	5230 MHz	54	5270 MHz
62	5310 MHz	102	5510 MHz	110	5550 MHz
118	5590 MHz	126	5630 MHz	134	5670 MHz
151	5755 MHz	159	5795 MHz	--	--

#### 802.11ac-VHT80

Channel	Frequency	Channel	Frequency	Channel	Frequency
42	5210 MHz	58	5290 MHz	106	5530 MHz
122	5610 MHz	155	5775 MHz	--	--



## 2.4. Description of Available Antennas

Antenna Type	Frequency Band (MHz)	T <sub>X</sub> Paths	Max Antenna Gain (dBi)	Beamforming Directional Gain (dBi)	CDD Directional Gain (dBi)	
					For Power	For PSD
PCB Antenna	2412 ~ 2462	2	2.0	--	2.0	5.01
	5150 ~ 5850	2	3.0	6.01	3.0	6.01

Note 1: The EUT supports Cyclic Delay Diversity (CDD) mode, and CDD signals are correlated.

If all antennas have the same gain,  $G_{ANT}$ , Directional gain =  $G_{ANT} + \text{Array Gain}$ , where Array Gain is as follows.

- For power spectral density (PSD) measurements on all devices,  
Array Gain =  $10 \log (N_{ANT} / N_{SS})$  dB;
- For power measurements on IEEE 802.11 devices,  
Array Gain = 0 dB for  $N_{ANT} \leq 4$ ;

Note 2: The EUT also supports Beam Forming mode, and the Beamforming support 802.11n/ac, not include 802.11a/b/g. BF Directional gain =  $G_{ANT} + 10 \log (N_{ANT})$ .

Note 3: All information is provided by the manufacturer.

## 2.5. Test Mode

Test Mode	Mode 1: Transmit by 802.11a (6Mbps) (CDD mode)
	Mode 2: Transmit by 802.11ac-VHT20 (MCS0) (CDD mode)
	Mode 3: Transmit by 802.11ac-VHT40 (MCS0) (CDD mode)
	Mode 4: Transmit by 802.11ac-VHT80 (MCS0) (CDD mode)
	Mode 5: Transmit by 802.11ac-VHT20 (MCS0) (Beamforming mode)
	Mode 6: Transmit by 802.11ac-VHT40 (MCS0) (Beamforming mode)
	Mode 7: Transmit by 802.11ac-VHT80 (MCS0) (Beamforming mode)

Note 1: Due to the same modulation between 802.11n and 802.11ac, so 802.11n-HT20 and HT40 are covered by 802.11ac-VHT20 and VHT40 in this report, meanwhile, power setting for 802.11n-HT20 and HT40 will not be greater than 802.11ac-VHT20 and VHT40.

Note 2: Due to CDD mode was the worst mode, so all test items were evaluated in this report. The beamforming mode only evaluated the RF output power.

## 2.6. Configuration of Test System

The device was tested per the guidance ANSI C63.10: 2013 was used to reference the appropriate EUT setup for radiated emissions testing and AC line conducted testing.

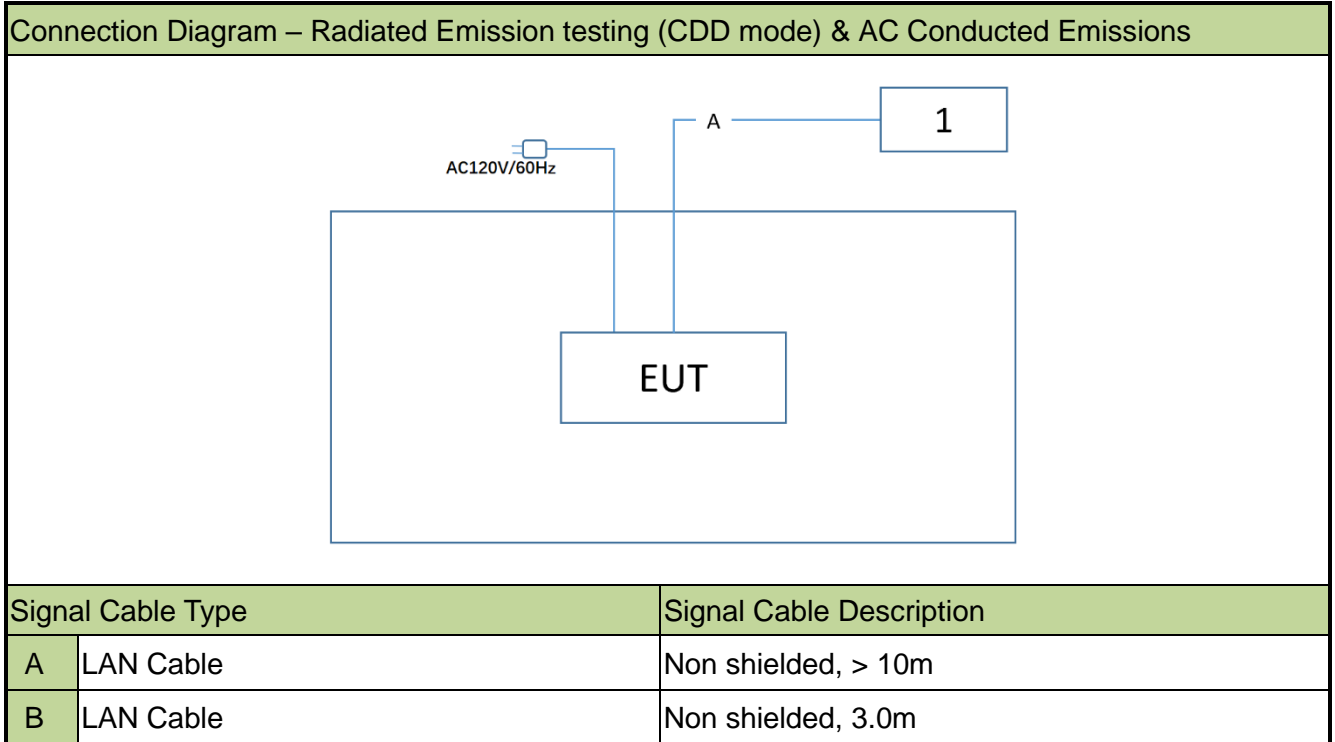

## 2.7. Test System Details

The types for all equipments, plus descriptions of all cables used in the tested system (including inserted cards) are:

Product	Manufacturer	Model No.	Serial No.	Power Cord	
1	Notebook	Lenovo	X230	N/A	Non-Shielded, 1.8m

## 2.8. Description of Test Software

The test utility software used during testing was “QATool\_Dbg.exe”, and the version was 0.0.0.70.

Note: Final power setting please refer to operational description.

## 2.9. Duty Cycle

5GHz (NII) operation is possible in 20MHz, 40MHz and 80MHz channel bandwidths. The maximum achievable duty cycles for all modes were determined based on measurements performed on a spectrum analyzer in zero-span mode with RBW = 8MHz, VBW = 50MHz. The RBW and VBW were both greater than 50/T, where T is the minimum transmission duration, and the number of sweep points across T was greater than 100. The duty cycles are as follows:

Test Mode	Duty Cycle
802.11a	92.60%
802.11ac-VHT20	92.09%
802.11ac-VHT40	91.56%
802.11ac-VHT80	88.89%

Duty Cycle (T = Transmission Duration)	
802.11a (T = 4.130ms)	802.11ac-VHT20 (T = 3.840ms)
802.11ac-VHT40 (T = 3.690ms)	802.11ac-VHT80 (T = 2.560ms)

The screenshots show the following marker data from the 'Marker Table' in each plot:

- 802.11a (T = 4.130ms):** AMkr3 4.460 ms, 0.73 dB. Marker Table: 1 Δ 4.130 ms (Δ) 0.07937 dB, 2 F 2.790 ms 22.60 dBm, 3 Δ 4.460 ms (Δ) 0.73 dB, 4 F 2.790 ms 22.60 dBm.
- 802.11ac-VHT20 (T = 3.840ms):** AMkr3 4.170 ms, 0.07 dB. Marker Table: 1 Δ 3.840 ms (Δ) -1.174 dB, 2 F 9.960 ms 22.58 dBm, 3 Δ 4.170 ms (Δ) 0.07 dB, 4 F 9.960 ms 22.58 dBm.
- 802.11ac-VHT40 (T = 3.690ms):** AMkr3 4.030 ms, 1.42 dB. Marker Table: 1 Δ 3.690 ms (Δ) 3.046 dB, 2 F 7.130 ms 12.32 dBm, 3 Δ 4.030 ms (Δ) 1.42 dB, 4 F 7.130 ms 12.32 dBm.
- 802.11ac-VHT80 (T = 2.560ms):** AMkr3 2.880 ms, -0.40 dB. Marker Table: 1 Δ 2.560 ms (Δ) 4.609 dB, 2 F 8.340 ms 9.874 dBm, 3 Δ 2.880 ms (Δ) -0.40 dB, 4 F 8.340 ms 9.874 dBm.

## 2.10. EMI Suppression Device(s)/Modifications

No EMI suppression device(s) were added and/or no modifications were made during testing.

## 2.11. Test Environment Condition

Ambient Temperature	15°C~35°C
Relative Humidity	20%RH ~75%RH

### 3. ANTENNA REQUIREMENTS

**Excerpt from §15.203 of the FCC Rules/Regulations:**

“An intentional radiator antenna shall be designed to ensure that no antenna other than that furnished by the responsible party can be used with the device. The use of a permanently attached antenna or of an antenna that uses a unique coupling to the intentional radiator shall be considered sufficient to comply with the provisions of this section.”

- The antenna of the device is **permanently attached**.
- There are no provisions for connection to an external antenna.

**Conclusion:**

The unit complies with the requirement of §15.203.

#### 4. TEST EQUIPMENT CALIBRATION DATE

##### Conducted Emission (WZ-SR2)

Instrument	Manufacturer	Type No.	Asset No.	Cali. Interval	Cali. Due Date
EMI Test Receiver	R&S	ESR3	MRTSUE06185	1 year	2021/01/18
Two-Line V-Network	R&S	ENV216	MRTSUE06002	1 year	2021/09/09
Thermal Hygrometer	testo	608-H1	MRTSUE06404	1 year	2021/07/26
Shielding Room	MIX-BEP	Chamber-SR2	MRTSUE06215	N/A	N/A

##### Conducted Emission (SIP-SR2)

Instrument	Manufacturer	Type No.	Asset No.	Cali. Interval	Cali. Due Date
EMI Test Receiver	R&S	ESR3	MRTSUE06613	1 year	2021/07/02
Two-Line V-Network	R&S	ENV216	MRTSUE06003	1 year	2021/09/09
Thermal Hygrometer	testo	608-H1	MRTSUE06621	1 year	2020/12/29

##### Radiated Emission (WZ-AC1)

Instrument	Manufacturer	Type No.	Asset No.	Cali. Interval	Cali. Due Date
EMI Test Receiver	R&S	ESR7	MRTSUE06001	1 year	2021/01/18
PXA Signal Analyzer	Keysight	N9030B	MRTSUE06395	1 year	2021/08/30
Loop Antenna	Schwarzbeck	FMZB 1519	MRTSUE06025	1 year	2021/11/08
Bilog Period Antenna	Schwarzbeck	VULB 9168	MRTSUE06172	1 year	2021/08/08
Horn Antenna	Schwarzbeck	BBHA 9120D	MRTSUE06023	1 year	2021/09/27
Horn Antenna	Schwarzbeck	BBHA9170	MRTSUE06597	1 year	2021/12/14
Microwave System Amplifier	Agilent	83017A	MRTSUE06076	1 year	2021/11/14
Preamplifier	Schwarzbeck	BBV 9721	MRTSUE06121	1 year	2021/06/11
Thermal Hygrometer	testo	608-H1	MRTSUE06403	1 year	2021/07/26
Anechoic Chamber	TDK	Chamber-AC1	MRTSUE06212	1 year	2021/04/30

## Radiated Emission (WZ-AC2)

Instrument	Manufacturer	Type No.	Asset No.	Cali. Interval	Cali. Due Date
MXE EMI Receiver	Keysight	N9038A	MRTSUE06125	1 year	2021/07/02
Loop Antenna	Schwarzbeck	FMZB 1519	MRTSUE06025	1 year	2021/11/08
Bilog Period Antenna	Schwarzbeck	VULB 9162	MRTSUE06022	1 year	2021/05/26
Broad-Band Horn Antenna	Schwarzbeck	BBHA 9120D	MRTSUE06171	1 year	2021/10/25
Horn Antenna	Schwarzbeck	BBHA9170	MRTSUE06597	1 year	2021/12/14
Broadband Coaxial Preamplifier	Schwarzbeck	BBV 9718	MRTSUE06176	1 year	2021/11/14
Preamplifier	Schwarzbeck	BBV 9721	MRTSUE06121	1 year	2021/06/11
Thermal Hygrometer	Minggao	ETH529	MRTSUE06170	1 year	2021/12/08
Anechoic Chamber	RIKEN	Chamber-AC2	MRTSUE06213	1 year	2021/04/30

## Radiated Emission (SIP-AC1)

Instrument	Manufacturer	Type No.	Asset No.	Cali. Interval	Cali. Due Date
EMI Test Receiver	R&S	ESR3	MRTSUE06612	1 year	2021/07/02
EXA Signal Analyzer	Keysight	N9010B	MRTSUE06559	1 year	2021/07/23
Loop Antenna	Schwarzbeck	FMZB 1519	MRTSUE06025	1 year	2021/11/08
Bilog Period Antenna	Schwarzbeck	VULB9168	MRTSUE06645	1 year	2021/08/30
Double Ridged Horn Antenna	R&S	HF907	MRTSUE06610	1 year	2021/08/30
Preamplifier	EMCI	EMC051845SE	MRTSUE06600	1 year	2021/11/09
Thermal Hygrometer	testo	608-H1	MRTSUE06620	1 year	2020/12/29
Anechoic Chamber	RIKEN	SIP-AC1	MRTSUE06554	1 year	2020/12/25

## Radiated Emission (SIP-AC2)

Instrument	Manufacturer	Type No.	Asset No.	Cali. Interval	Cali. Due Date
EMI Test Receiver	R&S	ESR3	MRTSUE06613	1 year	2021/07/02
MXA Signal Analyzer	Keysight	N9020B	MRTSUE06604	1 year	2021/09/26
Loop Antenna	Schwarzbeck	FMZB 1519	MRTSUE06025	1 year	2021/11/08
Bilog Period Antenna	Schwarzbeck	VULB9168	MRTSUE06646	1 year	2021/08/30
Horn Antenna	Schwarzbeck	BBHA9120D	MRTSUE06648	1 year	2021/11/26
Horn Antenna	Schwarzbeck	BBHA9170	MRTSUE06599	1 year	2021/11/26
Preamplifier	EMCI	EMC051845SE	MRTSUE06644	1 year	2021/11/09
Preamplifier	EMCI	EMC184045SE	MRTSUE06602	1 year	2021/10/21
Thermal Hygrometer	testo	608-H1	MRTSUE06624	1 year	2020/12/29
Anechoic Chamber	RIKEN	SIP-AC2	MRTSUE06781	1 year	2020/12/25

## Radiated Emission (SIP-AC3)

Instrument	Manufacturer	Type No.	Asset No.	Cali. Interval	Cali. Due Date
EMI Test Receiver	R&S	ESR3	MRTSUE06612	1 year	2021/07/02
EXA Signal Analyzer	Keysight	N9010B	MRTSUE06559	1 year	2021/07/23
Loop Antenna	Schwarzbeck	FMZB 1519	MRTSUE06025	1 year	2021/11/08
Bilog Period Antenna	Schwarzbeck	VULB9168	MRTSUE06647	1 year	2021/08/08
Double Ridged Horn Antenna	R&S	HF907	MRTSUE06611	1 year	2021/09/13
Horn Antenna	Schwarzbeck	BBHA9170	MRTSUE06598	1 year	2021/11/26
Preamplifier	EMCI	EMC012645SE	MRTSUE06642	1 year	2021/01/16
Preamplifier	EMCI	EMC184045SE	MRTSUE06641	1 year	2021/01/16
Thermal Hygrometer	testo	608-H1	MRTSUE06622	1 year	2020/12/29
Anechoic Chamber	RIKEN	SIP-AC3	MRTSUE06782	1 year	2020/12/25

## Conducted Test Equipment (WZ-TR3)

Instrument	Manufacturer	Type No.	Asset No.	Cali. Interval	Cali. Due Date
EXA Signal Analyzer	Agilent	N9020A	MRTSUE06106	1 year	2021/04/14
EXA Signal Analyzer	Keysight	N9010B	MRTSUE06607	1 year	2021/01/08
Signal Analyzer	R&S	FSV40	MRTSUE06218	1 year	2021/04/14
Power Meter	Agilent	U2021XA	MRTSUE06030	1 year	2021/10/22
USB wideband power sensor	Keysight	U2021XA	MRTSUE06446	1 year	2021/08/30
USB wideband power sensor	Keysight	U2021XA	MRTSUE06447	1 year	2021/08/08
Bluetooth Test Set	Anritsu	MT8852B-042	MRTSUE06389	1 year	2021/06/11
Audio Analyzer	Agilent	U8903B	MRTSUE06143	1 year	2021/06/11
Modulation Analyzer	HP	HP8901A	MRTSUE06098	1 year	2021/09/26
Wideband Radio Communication Tester	R&S	CMW 500	MRTSUE06243	1 year	2021/10/20
Attenuator	MVE	3dB	MRTSUE06529	1 year	2021/12/12
Attenuator	MVE	6dB	MRTSUE06534	1 year	2021/12/12
Attenuator	MVE	10dB	MRTSUE06540	1 year	2021/12/12
Attenuator	MVE	20dB	MRTSUE06547	1 year	2021/12/12
DC Power Supply	GWINSTEK	DPS-3303C	MRTSUE06064	N/A	N/A
Temperature & Humidity Chamber	BAOYT	BYH-150CL	MRTSUE06051	1 year	2021/10/21
Thermal Hygrometer	testo	608-H1	MRTSUE06401	1 year	2021/07/26

## Conducted Test Equipment (SIP-SR5)

Instrument	Manufacturer	Type No.	Asset No.	Cali. Interval	Cali. Due Date
Signal Analyzer	R&S	FSV40	MRTSUE06218	1 year	2021/04/14
PXA Signal Analyzer	Keysight	N9030B	MRTSUE06395	1 year	2021/08/30
USB wideband power sensor	Agilent	U2021XA	MRTSUE06595	1 year	2021/09/26
USB wideband power sensor	Agilent	U2021XA	MRTSUE06596	1 year	2021/09/26
Wideband Radio Communication Tester	R&S	CMW 500	MRTSUE06243	1 year	2021/10/20
Bluetooth Test Set	Anritsu	MT8852B-042	MRTSUE06389	1 year	2021/06/11
Attenuator	MVE	3dB	MRTSUE06530	1 year	2021/12/12
Attenuator	MVE	6dB	MRTSUE06535	1 year	2021/12/12
Attenuator	MVE	10dB	MRTSUE06541	1 year	2021/12/12
Attenuator	MVE	20dB	MRTSUE06548	1 year	2021/12/12
Temperature Chamber	BAOYT	BYG-408CS	MRTSUE06847	1 year	2021/03/31
Thermal Hygrometer	testo	622	MRTSUE06629	1 year	2020/12/30

Software	Version	Function
EMI Software	V3	EMI Test Software



## 5. MEASUREMENT UNCERTAINTY

Where relevant, the following test uncertainty levels have been estimated for tests performed on the EUT as specified in CISPR 16-4-2. This uncertainty represents an expanded uncertainty expressed at approximately the 95% confidence level using a coverage factor of  $k = 2$ .

<b>AC Conducted Emission Measurement</b>
Measurement Uncertainty for a Level of Confidence of 95% ( $U=2Uc(y)$ ): 9kHz~150kHz: 3.74dB 150kHz~30MHz: 3.44dB
<b>Radiated Disturbance</b>
Measurement Uncertainty for a Level of Confidence of 95% ( $U=2Uc(y)$ ): Horizontal: 30MHz~300MHz: 5.04dB 300MHz~1GHz: 4.95dB 1GHz~40GHz: 6.40dB Vertical: 30MHz~300MHz: 5.24dB 300MHz~1GHz: 6.03dB 1GHz~40GHz: 6.40dB
<b>Spurious Emissions, Conducted</b>
Measuring Uncertainty for a Level of Confidence of 95% ( $U=2Uc(y)$ ): 0.78dB
<b>Output Power</b>
Measuring Uncertainty for a Level of Confidence of 95% ( $U=2Uc(y)$ ): 1.13dB
<b>Power Spectrum Density</b>
Measuring Uncertainty for a Level of Confidence of 95% ( $U=2Uc(y)$ ): 1.15dB
<b>Occupied Bandwidth</b>
Measuring Uncertainty for a Level of Confidence of 95% ( $U=2Uc(y)$ ): 0.28%

## 6. TEST RESULT

### 6.1. Summary

FCC Section(s)	Test Description	Test Limit	Test Condition	Test Result	Reference
15.407(a)	26dB Bandwidth	N/A	Conducted	Pass	Section 6.2
15.407(e)	6dB Bandwidth	$\geq 500\text{kHz}$		Pass	Section 6.3
15.407(a)(1)(iv), (2),(3)	Maximum Conducted Output Power	Refer to Section 6.4		Pass	Section 6.4
15.407(h)(1)	Transmit Power Control	$\leq 24\text{dBm}$		N/A	Section 6.5
15.407(a)(1)(iv), (2), (3), (5)	Power Spectral Density	U-NII-1&U-NII-2: $\leq 11\text{dBm/MHz}$ U-NII-3: $\leq 30\text{dBm}/500\text{kHz}$		Pass	Section 6.6
15.407(g)	Frequency Stability	N/A		Pass	Section 6.7
15.407(b)(1), (2), (3), (4)(i)	Undesirable Emissions	Refer to Section 6.8	Radiated	Pass	Section 6.8 Section 6.9
15.205, 15.209 15.407(b)(7), (8), (9)	General Field Strength (Restricted Bands and Radiated Emission)	Emissions in restricted bands must meet the radiated limits detailed in 15.209		Pass	
15.207	AC Conducted Emissions 150kHz-30MHz	< FCC 15.207 limits	Line Conducted	Pass	Section 6.10

Notes:

- 1) The analyzer plots shown in this section were all taken with a correction table loaded into the analyzer. The correction table was used to account for the losses of the cables and attenuators used as part of the system to connect the EUT to the analyzer at all frequencies of interest.
- 2) Output power test was verified over all data rates of each mode (data refers to operational description), and then choose the maximum power output (low data rate) for final test of each channel.
- 3) For radiated emission test, every axis (X, Y, Z) was also verified. The test results shown in the following sections represent the worst-case emissions.
- 4) Test Items "26dB Bandwidth" & "6dB Bandwidth" showed the worst test data in this report.

## 6.2. 26dB Bandwidth Measurement

### 6.2.1. Test Limit

N/A

### 6.2.2. Test Procedure Used

KDB 789033 D02v02r01 -Section C.1

### 6.2.3. Test Setting

1. The analyzers' automatic bandwidth measurement capability was used to perform the 26dB bandwidth measurement. The "X" dB bandwidth parameter was set to  $X = 26$ . The automatic bandwidth measurement function also has the capability of simultaneously measuring the 99% occupied bandwidth. The bandwidth measurement was not influenced by any intermediated power nulls in the fundamental emission.
2. RBW = approximately 1% of the emission bandwidth.
3. VBW  $\geq 3 \times$  RBW.
4. Detector = Peak.
5. Trace mode = max hold.

### 6.2.4. Test Setup

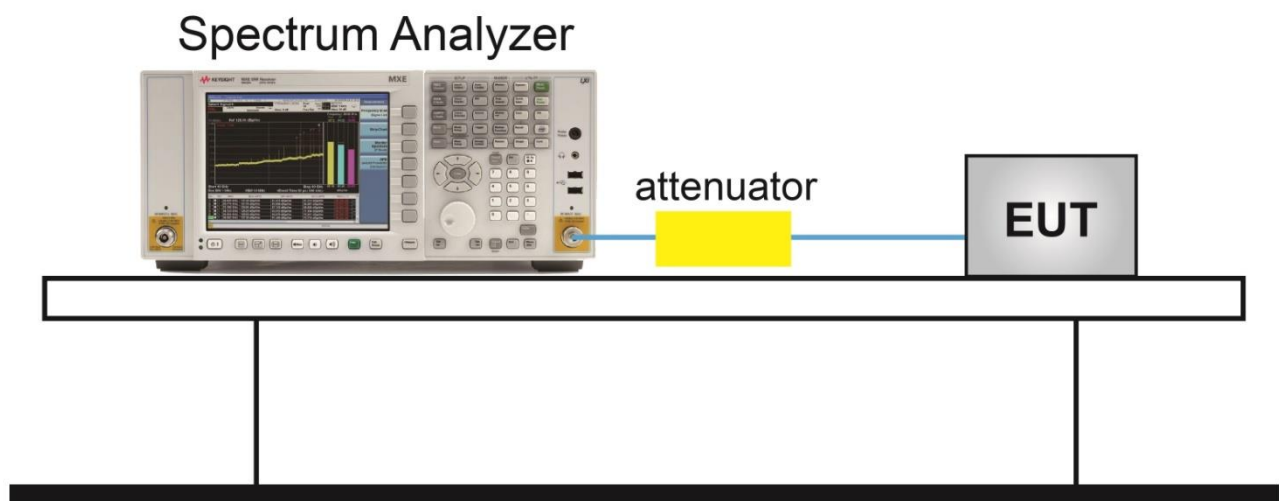

### 6.2.5. Test Result

Product	AC750 Wi-Fi Range Extender	Test Engineer	Amy Zhang
Test Site	WZ-TR3	Test Date	2020/09/02

Test Mode	Data Rate/ MCS	Channel No.	Frequency (MHz)	26dB Bandwidth (MHz)
802.11a	6Mbps	36	5180	32.20
802.11a	6Mbps	44	5220	35.72
802.11a	6Mbps	48	5240	35.61
802.11a	6Mbps	52	5260	33.71
802.11a	6Mbps	60	5300	33.69
802.11a	6Mbps	64	5320	34.01
802.11a	6Mbps	100	5500	30.82
802.11a	6Mbps	116	5580	33.39
802.11a	6Mbps	140	5700	23.71
802.11a	6Mbps	149	5745	37.69
802.11a	6Mbps	157	5785	37.15
802.11a	6Mbps	165	5825	35.78
802.11ac-VHT20	MCS0	36	5180	35.21
802.11ac-VHT20	MCS0	44	5220	36.25
802.11ac-VHT20	MCS0	48	5240	39.41
802.11ac-VHT20	MCS0	52	5260	32.29
802.11ac-VHT20	MCS0	60	5300	33.93
802.11ac-VHT20	MCS0	64	5320	33.65
802.11ac-VHT20	MCS0	100	5500	26.38
802.11ac-VHT20	MCS0	116	5580	37.89
802.11ac-VHT20	MCS0	140	5700	20.52
802.11ac-VHT20	MCS0	149	5745	38.35
802.11ac-VHT20	MCS0	157	5785	38.43
802.11ac-VHT20	MCS0	165	5825	36.62

Test Mode	Data Rate/ MCS	Channel No.	Frequency (MHz)	26dB Bandwidth (MHz)
802.11ac-VHT40	MCS0	38	5190	39.92
802.11ac-VHT40	MCS0	46	5230	79.26
802.11ac-VHT40	MCS0	54	5270	79.01
802.11ac-VHT40	MCS0	62	5310	40.89
802.11ac-VHT40	MCS0	102	5510	40.30
802.11ac-VHT40	MCS0	110	5550	78.41
802.11ac-VHT40	MCS0	134	5670	62.17
802.11ac-VHT40	MCS0	151	5755	79.44
802.11ac-VHT40	MCS0	159	5795	78.45
802.11ac-VHT80	MCS0	42	5210	79.93
802.11ac-VHT80	MCS0	58	5290	79.65
802.11ac-VHT80	MCS0	106	5530	80.13
802.11ac-VHT80	MCS0	122	5610	139.8
802.11ac-VHT80	MCS0	155	5775	158.5

802.11a 26dB Bandwidth

Channel 36 (5180MHz)



Channel 44 (5220MHz)



Channel 48 (5240MHz)

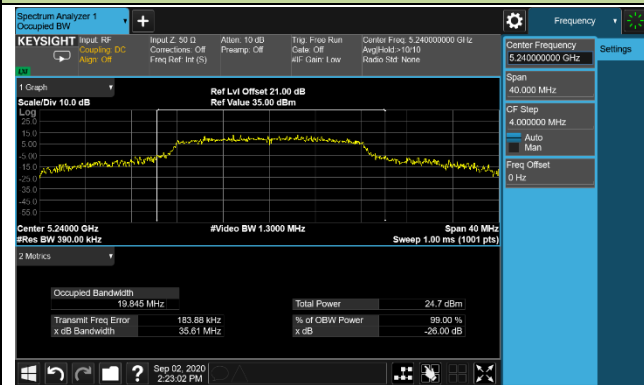

Channel 52 (5260MHz)



Channel 60 (5300MHz)



Channel 64 (5320MHz)

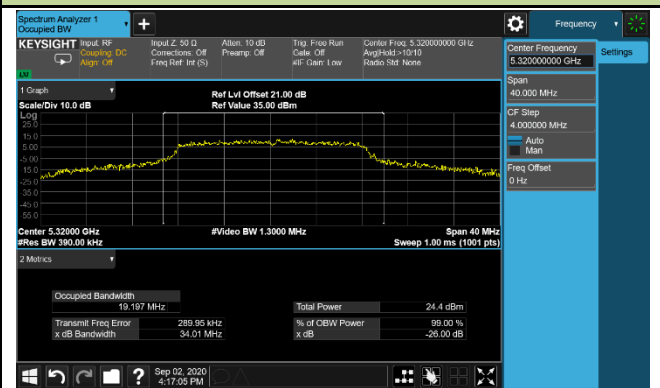

Channel 100 (5500MHz)



Channel 116 (5580MHz)

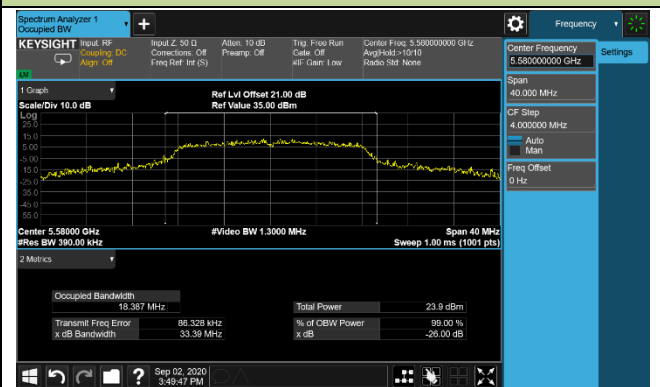

802.11a 26dB Bandwidth

Channel 140 (5700MHz)



Channel 149 (5745MHz)

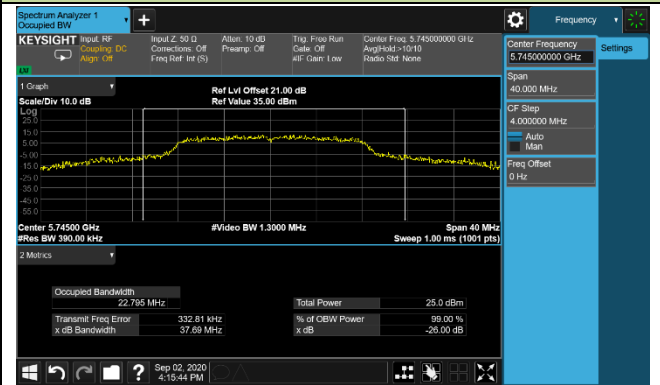

Channel 157 (5785MHz)



Channel 165 (5825MHz)



802.11ac-VHT20 26dB Bandwidth

Channel 36 (5180MHz)



Channel 44 (5220MHz)



Channel 48 (5240MHz)

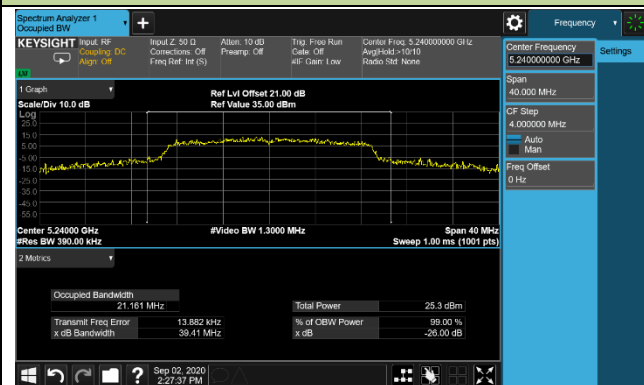

Channel 52 (5260MHz)



Channel 60 (5300MHz)

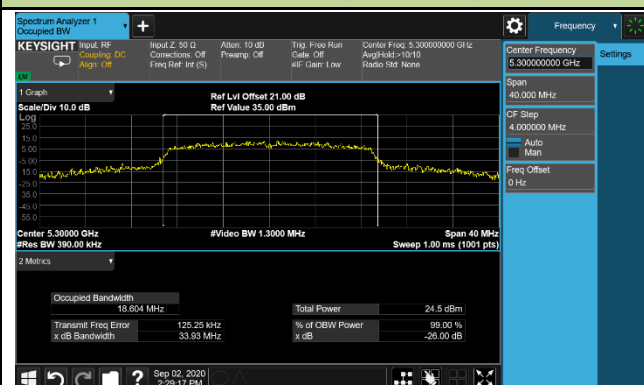

Channel 64 (5320MHz)



Channel 100 (5500MHz)

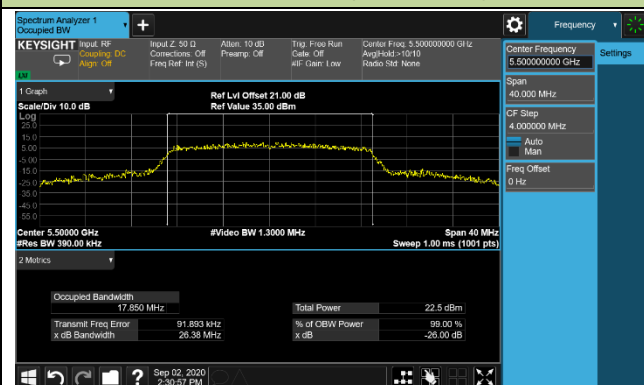

Channel 116 (5580MHz)

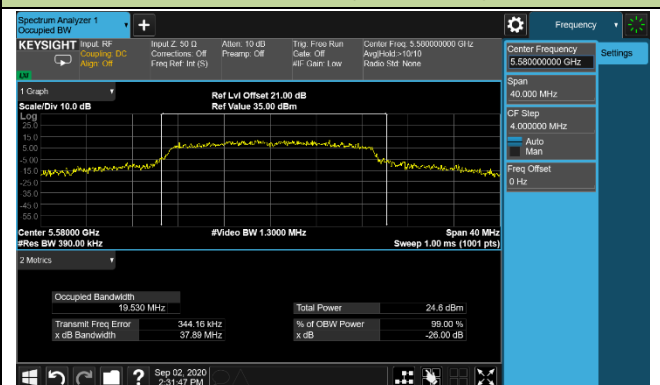



802.11ac-VHT20 26dB Bandwidth

Channel 140 (5700MHz)

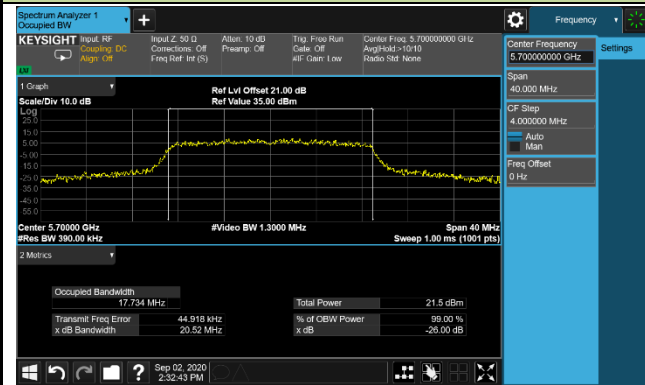

Channel 149 (5745MHz)



Channel 157 (5785MHz)



Channel 165 (5825MHz)

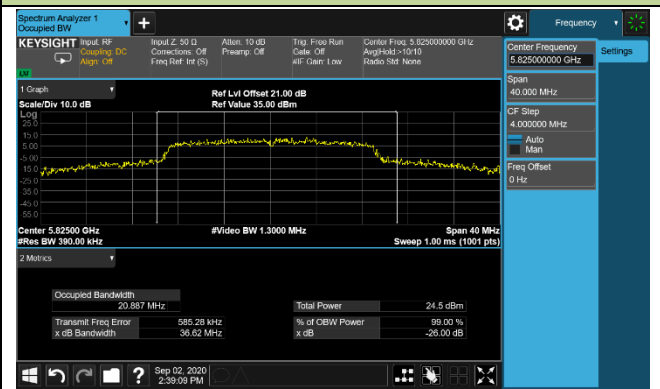

802.11ac-VHT40 26dB Bandwidth

Channel 38 (5190MHz)

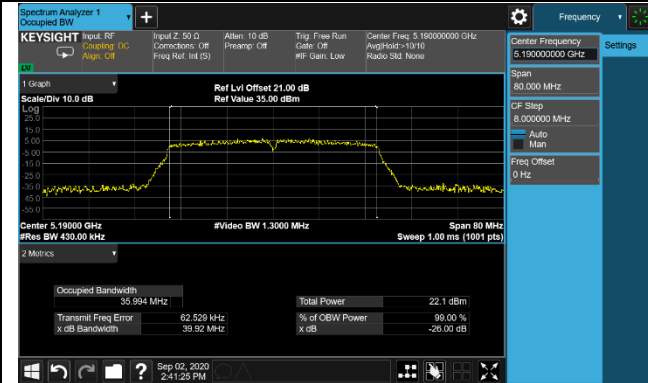

Channel 46 (5230MHz)

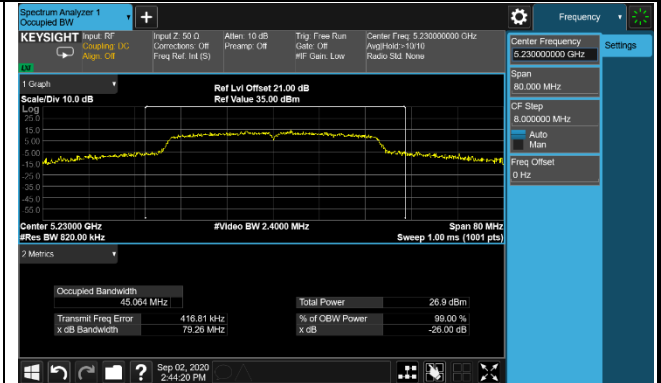

Channel 54 (5270MHz)



Channel 62 (5310MHz)

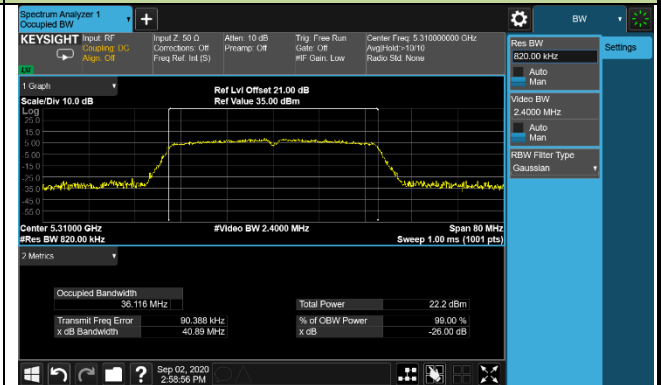

Channel 102 (5510MHz)

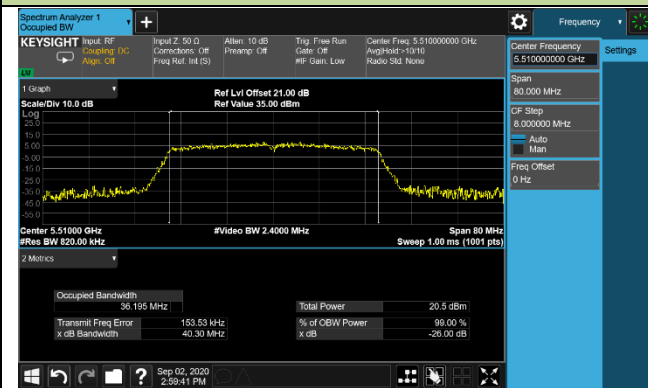

Channel 110 (5550MHz)

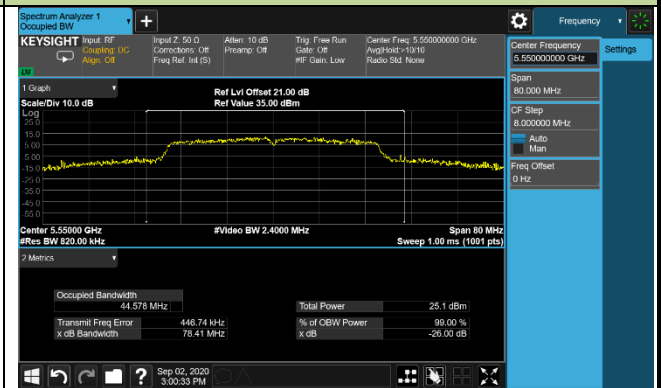

Channel 134 (5670MHz)

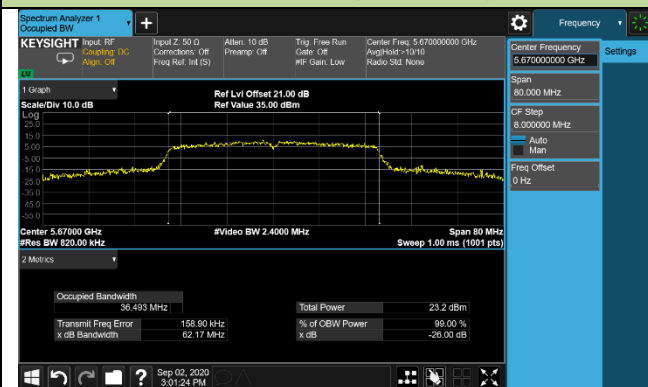

Channel 151 (5755MHz)

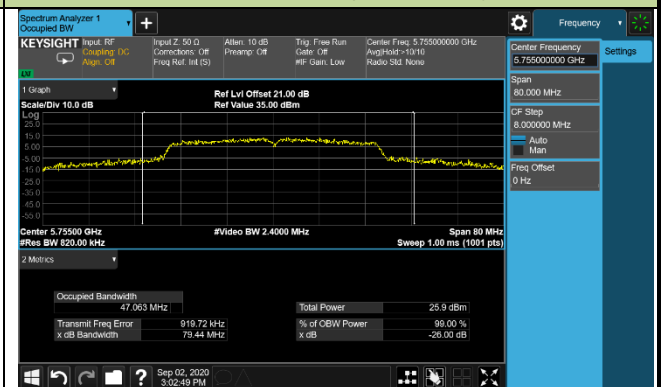

802.11ac-VHT40 26dB Bandwidth

Channel 159 (5795MHz)

--

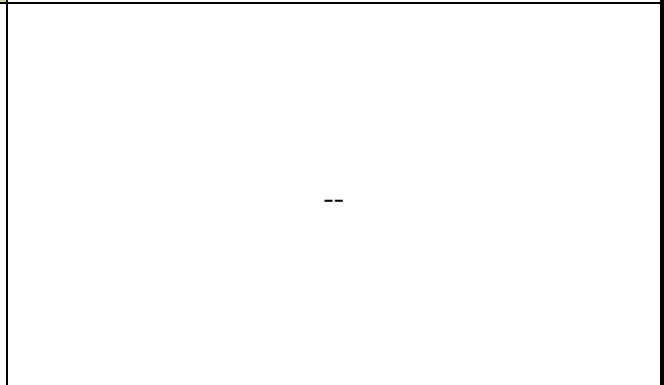
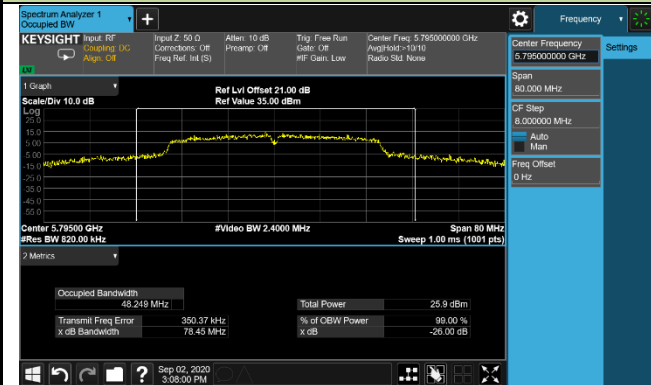

802.11ac-VHT80 26dB Bandwidth

Channel 42 (5210MHz)

Channel 58 (5290MHz)

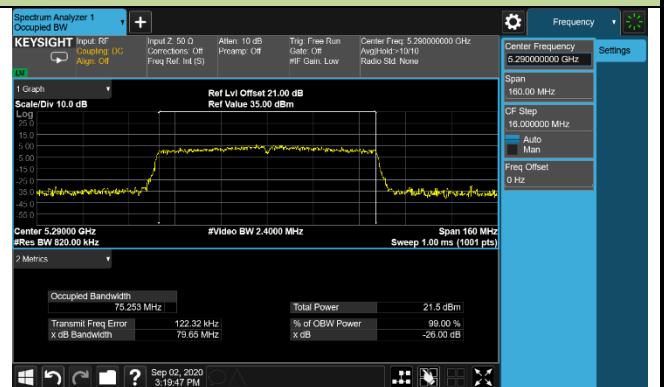
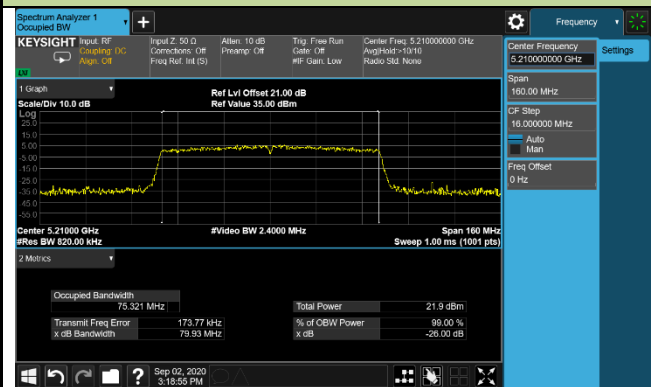

Channel 106 (5530MHz)

Channel 122 (5610MHz)

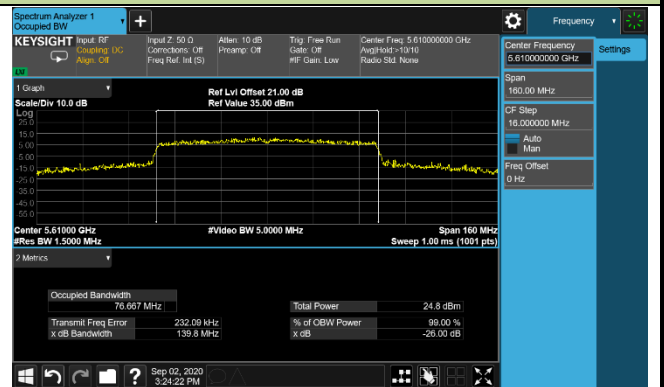
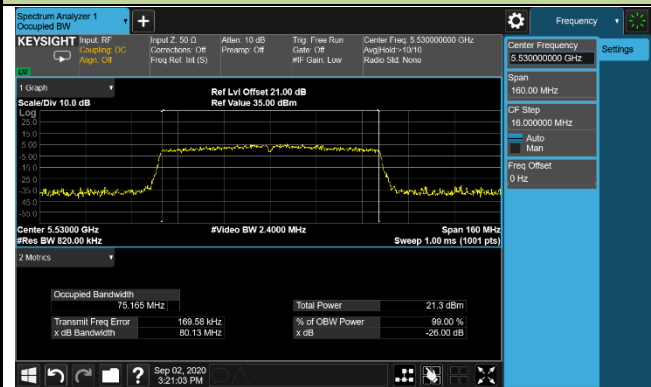

Channel 155 (5775MHz)

--

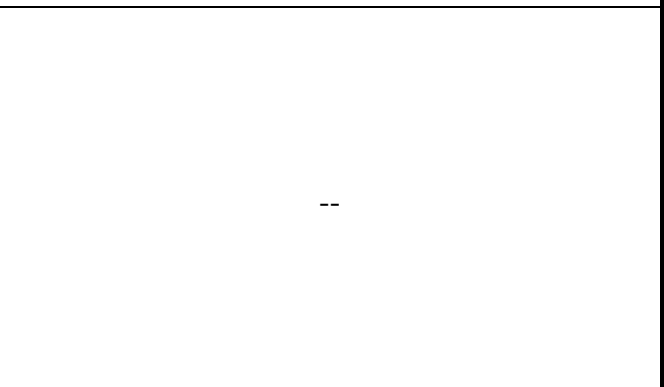
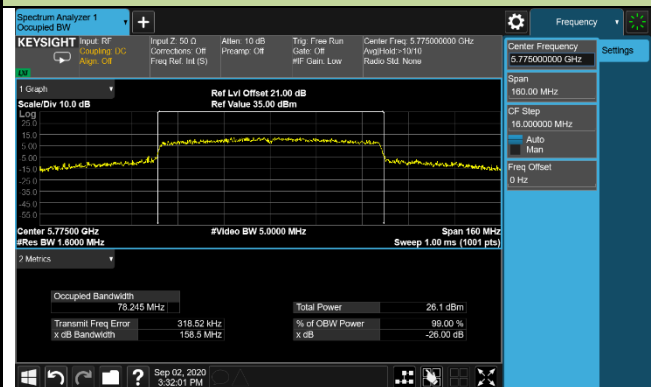

### 6.3. 6dB Bandwidth Measurement

#### 6.3.1. Test Limit

The minimum 6dB bandwidth shall be at least 500 kHz.

#### 6.3.2. Test Procedure Used

KDB 789033 D02v02r01 - Section C.2

#### 6.3.3. Test Setting

1. Set center frequency to the nominal EUT channel center frequency.
2. RBW = 100 kHz.
3. VBW  $\geq 3 \times$  RBW.
4. Detector = Peak.
5. Trace mode = Max hold.
6. Sweep = Auto couple.
7. Allow the trace to stabilize.
8. Measure the maximum width of the emission that is constrained by the frequencies associated with the two outermost amplitude points (upper and lower frequencies) that are attenuated by 6 dB relative to the maximum level measured in the fundamental emission.

#### 6.3.4. Test Setup

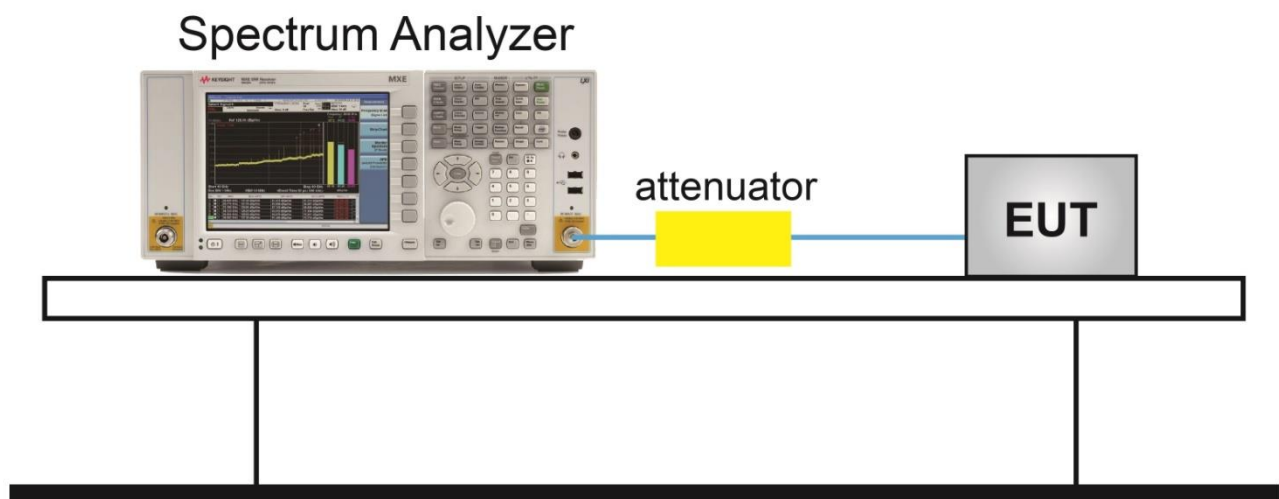

### 6.3.5. Test Result

Product	AC750 Wi-Fi Range Extender	Test Engineer	Amy Zhang
Test Site	WZ-TR3	Test Date	2020/09/11

Test Mode	Data Rate/ MCS	Channel No.	Frequency (MHz)	6dB Bandwidth (MHz)	Limit (MHz)	Result
802.11a	6Mbps	149	5745	15.03	≥ 0.5	Pass
802.11a	6Mbps	157	5785	15.09	≥ 0.5	Pass
802.11a	6Mbps	165	5825	16.29	≥ 0.5	Pass
802.11ac-VHT20	MCS0	149	5745	17.59	≥ 0.5	Pass
802.11ac-VHT20	MCS0	157	5785	17.56	≥ 0.5	Pass
802.11ac-VHT20	MCS0	165	5825	17.28	≥ 0.5	Pass
802.11ac-VHT40	MCS0	151	5755	31.57	≥ 0.5	Pass
802.11ac-VHT40	MCS0	159	5795	32.59	≥ 0.5	Pass
802.11ac-VHT80	MCS0	155	5775	65.64	≥ 0.5	Pass

802.11a 6dB Bandwidth

Channel 149 (5745MHz)

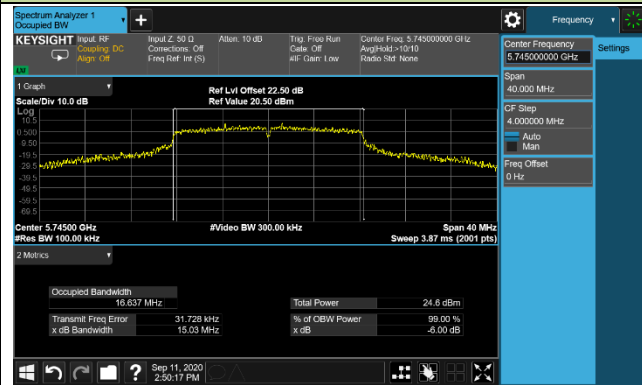

Channel 157 (5785MHz)

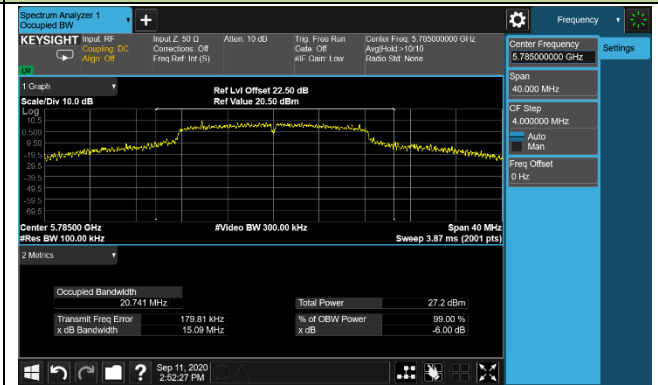

Channel 165 (5825MHz)



802.11ac-VHT20 6dB Bandwidth

Channel 149 (5745MHz)



Channel 157 (5785MHz)

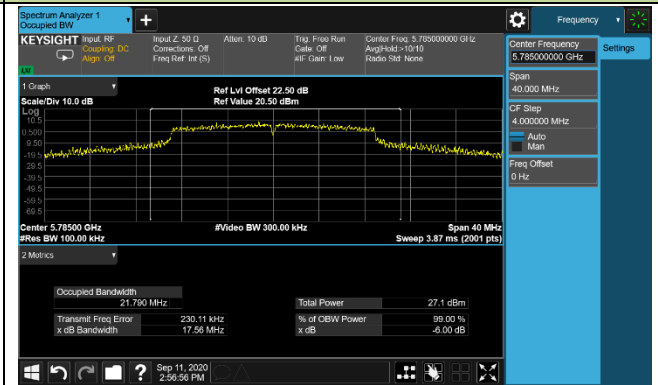

Channel 165 (5825MHz)



802.11ac-VHT40 6dB Bandwidth

Channel 151 (5755MHz)

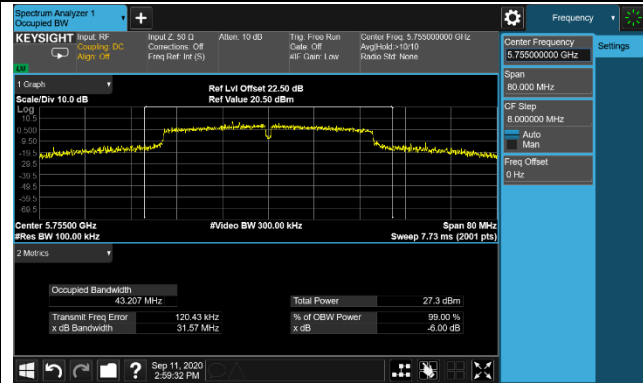

Channel 159 (5795MHz)

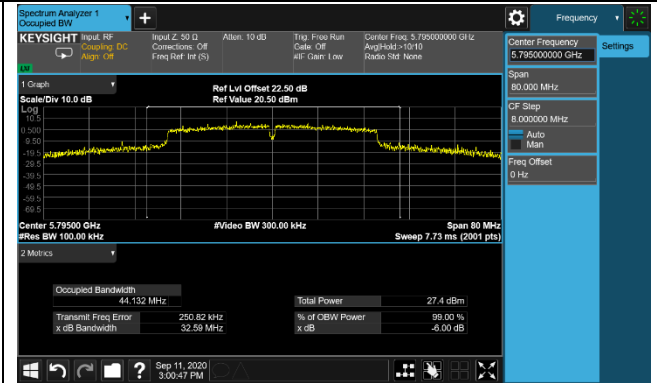

802.11ac-VHT80 6dB Bandwidth

Channel 155 (5775MHz)

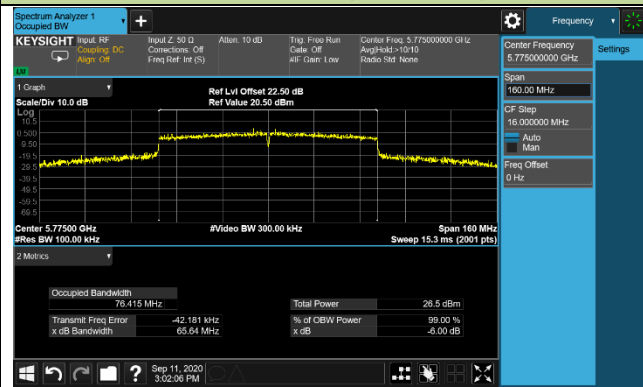

## 6.4. Output Power Measurement

### 6.4.1. Test Limit

For the band 5.15-5.25 GHz, the maximum conducted output power over the frequency band of operation shall not exceed 1 W provided the maximum antenna gain does not exceed 6 dBi.

For the 5.25-5.35 GHz and 5.47-5.725 GHz bands, the maximum conducted output power over the frequency bands of operation shall not exceed the lesser of 250 mW or  $11 \text{ dBm} + 10 \log B$ , where B is the 26 dB emission bandwidth in megahertz.

For the band 5.725-5.85 GHz, the maximum conducted output power over the frequency band of operation shall not exceed 1 W (30dBm).

If transmitting antennas of directional gain greater than 6dBi are used, the maximum conducted output power shall be reduced by the amount in dB that the directional gain of the antenna exceeds 6dBi.

### 6.4.2. Test Procedure Used

KDB 789033D02v02r01- Section E)3)b) Method PM-G

### 6.4.3. Test Setting

Average power measurements were performed only when the EUT was transmitting at its maximum power control level using a broadband power meter with a pulse sensor. The power meter implemented triggering and gating capabilities which were set up such that power measurements were recorded only during the ON time of the transmitter.

### 6.4.4. Test Setup

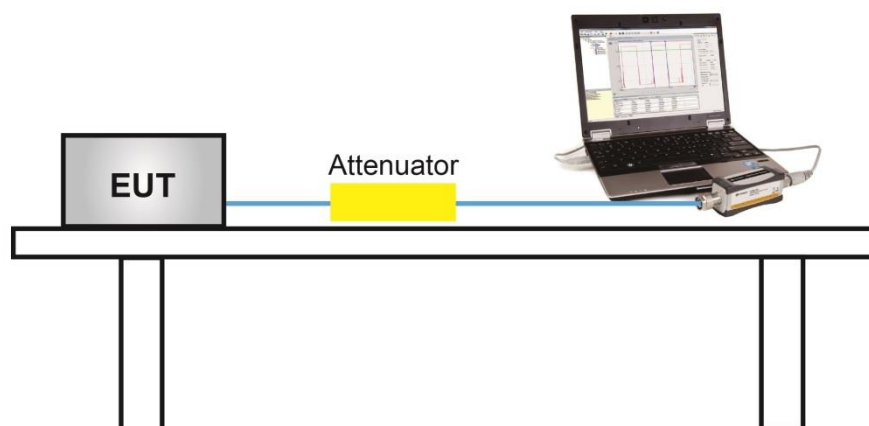



### 6.4.5. Test Result

Product	AC750 Wi-Fi Range Extender	Test Engineer	Amy Zhang
Test Site	WZ-TR3	Test Date	2020/09/02

Test Mode	Data Rate/ MCS	Channel No.	Freq. (MHz)	Ant 0 Average Power (dBm)	Ant 1 Average Power (dBm)	Total Average Power (dBm)	Average Power Limit (dBm)	Result
<b>CDD mode</b>								
11a	6Mbps	36	5180	18.84	19.36	22.12	≤ 30.00	Pass
11a	6Mbps	44	5220	20.11	20.35	23.24	≤ 30.00	Pass
11a	6Mbps	48	5240	20.15	20.41	23.29	≤ 30.00	Pass
11a	6Mbps	52	5260	18.12	19.28	21.75	≤ 23.98	Pass
11a	6Mbps	60	5300	17.74	18.14	20.95	≤ 23.98	Pass
11a	6Mbps	64	5320	17.64	18.22	20.95	≤ 23.98	Pass
11a	6Mbps	100	5500	18.07	18.32	21.21	≤ 23.98	Pass
11a	6Mbps	116	5580	17.92	18.18	21.06	≤ 23.98	Pass
11a	6Mbps	140	5700	17.05	17.26	20.17	≤ 23.98	Pass
11a	6Mbps	149	5745	20.06	20.61	23.35	≤ 30.00	Pass
11a	6Mbps	157	5785	20.07	20.70	23.41	≤ 30.00	Pass
11a	6Mbps	165	5825	19.75	20.41	23.10	≤ 30.00	Pass
<b>CDD and Beamforming mode</b>								
11ac-VHT20	MCS0	36	5180	17.39	17.71	20.56	≤ 30.00	Pass
11ac-VHT20	MCS0	44	5220	20.05	20.38	23.23	≤ 30.00	Pass
11ac-VHT20	MCS0	48	5240	20.07	20.40	23.25	≤ 30.00	Pass
11ac-VHT20	MCS0	52	5260	18.18	18.39	21.30	≤ 23.98	Pass
11ac-VHT20	MCS0	60	5300	18.24	18.25	21.26	≤ 23.98	Pass
11ac-VHT20	MCS0	64	5320	18.11	18.25	21.19	≤ 23.98	Pass
11ac-VHT20	MCS0	100	5500	17.10	17.62	20.38	≤ 23.98	Pass
11ac-VHT20	MCS0	116	5580	18.18	18.31	21.26	≤ 23.98	Pass
11ac-VHT20	MCS0	140	5700	16.08	16.21	19.16	≤ 23.98	Pass
11ac-VHT20	MCS0	149	5745	20.03	20.61	23.34	≤ 30.00	Pass
11ac-VHT20	MCS0	157	5785	20.01	20.63	23.34	≤ 30.00	Pass
11ac-VHT20	MCS0	165	5825	19.74	20.31	23.04	≤ 30.00	Pass

Test Mode	Data Rate/ MCS	Channel No.	Freq. (MHz)	Ant 0 Average Power (dBm)	Ant 1 Average Power (dBm)	Total Average Power (dBm)	Average Power Limit (dBm)	Result
CDD and Beamforming mode								
11ac-VHT40	MCS0	38	5190	15.56	15.71	18.65	≤ 30.00	Pass
11ac-VHT40	MCS0	46	5230	20.09	20.41	23.26	≤ 30.00	Pass
11ac-VHT40	MCS0	54	5270	20.01	20.58	23.31	≤ 23.98	Pass
11ac-VHT40	MCS0	62	5310	15.57	15.74	18.67	≤ 23.98	Pass
11ac-VHT40	MCS0	102	5510	15.09	15.62	18.37	≤ 23.98	Pass
11ac-VHT40	MCS0	110	5550	20.04	20.45	23.26	≤ 23.98	Pass
11ac-VHT40	MCS0	134	5670	16.97	17.92	20.48	≤ 23.98	Pass
11ac-VHT40	MCS0	151	5755	20.02	20.26	23.15	≤ 30.00	Pass
11ac-VHT40	MCS0	159	5795	20.03	20.28	23.17	≤ 30.00	Pass
11ac-VHT80	MCS0	42	5210	15.16	15.37	18.28	≤ 30.00	Pass
11ac-VHT80	MCS0	58	5290	15.06	15.57	18.33	≤ 23.98	Pass
11ac-VHT80	MCS0	106	5530	14.75	15.23	18.01	≤ 23.98	Pass
11ac-VHT80	MCS0	122	5610	17.95	18.83	21.42	≤ 23.98	Pass
11ac-VHT80	MCS0	155	5775	18.69	19.27	22.00	≤ 30.00	Pass

Note 1: Total Average Power (dBm) =  $10 \cdot \log\{10^{(\text{ANT 0 Average Power}/10)} + 10^{(\text{ANT 1 Average Power}/10)}\}$  (dBm).

Note 2: Average Power Limit Calculation as below:

802.11a/ac-VHT20/ac-VHT40/ac-VHT80: Limit = 23.98dBm.

Note 3: CDD and Beamforming mode have the same power setting.

## 6.5. Transmit Power Control

### 6.5.1. Test Limit

The U-NII device is required to have the capability to operate at least 6 dB below the mean EIRP value of 30 dBm.

### 6.5.2. Test Procedure Used

ANSI C63.10-2013- Section 12.3.3.2 Method PM-G

### 6.5.3. Test Setting

Average power measurements were performed only when the EUT was transmitting at its maximum power control level using a broadband power meter with a pulse sensor. The power meter implemented triggering and gating capabilities which were set up such that power measurements were recorded only during the ON time of the transmitter.

### 6.5.4. Test Setup

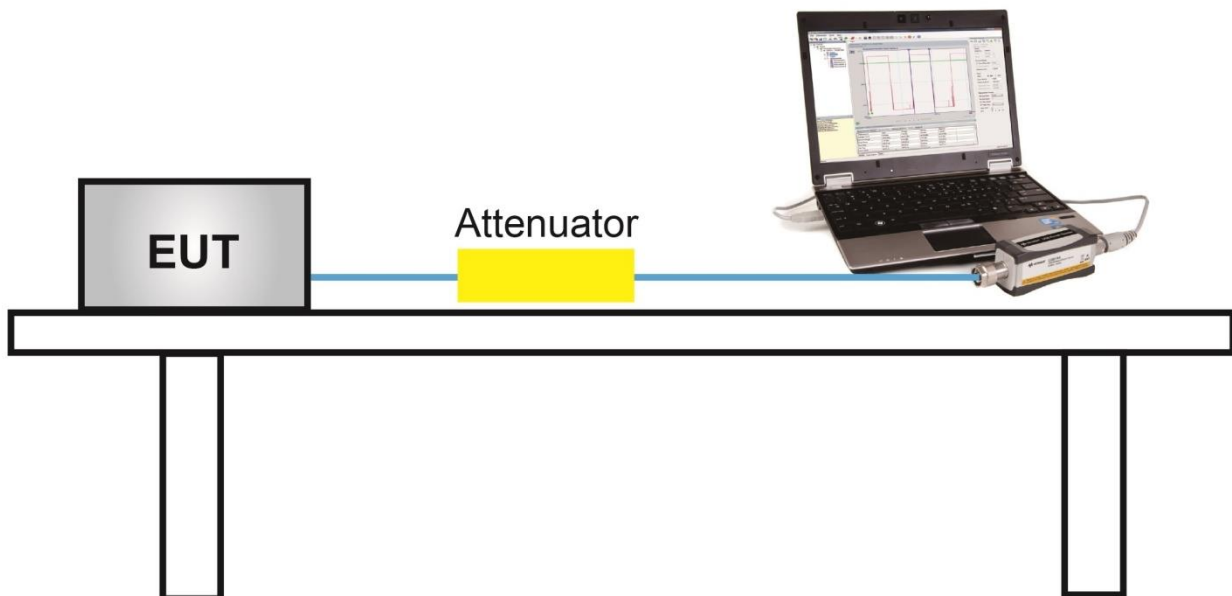

### 6.5.5. Test Result

Device supports TPC mechanism, details refer to the operational description.

## **6.6. Power Spectral Density Measurement**

### **6.6.1. Test Limit**

For the band 5.15-5.25 GHz, the maximum power spectral density shall not exceed 17 dBm in any 1 megahertz band.

For the 5.25-5.35 GHz and 5.47-5.725 GHz bands, the maximum power spectral density shall not exceed 11 dBm in any 1 megahertz band.

For the band 5.725-5.85 GHz, the maximum power spectral density shall not exceed 30 dBm in any 500-kHz band.

If transmitting antennas of directional gain greater than 6dBi are used, the peak power spectral density shall be reduced by the amount in dB that the directional gain of the antenna exceeds 6dBi.

### **6.6.2. Test Procedure Used**

KDB 789033 D02v02r01 - Section F

### **6.6.3. Test Setting**

1. Analyzer was set to the center frequency of the UNII channel under investigation
2. Span was set to encompass the entire 26dB EBW of the signal.
3. RBW = 1MHz, if measurement bandwidth of Maximum PSD is specified in 500 kHz,  
RBW = 510KHz
4. VBW  $\geq$  3RBW
5. Number of sweep points  $\geq 2 \times$  (span / RBW)
6. Detector = power averaging (Average)
7. Sweep time = auto
8. Trigger = free run
9. Use the peak search function on the instrument to find the peak of the spectrum and record its value.
10. Add  $10 \cdot \log(1/x)$ , where x is the duty cycle, to the measured power in order to compute the average power during the actual transmission times (because the measurement represents an average over both the on and off times of the transmission). For example, add  $10 \cdot \log(1/0.25) = 6$  dB if the duty cycle is 25 percent.

### 6.6.4. Test Setup

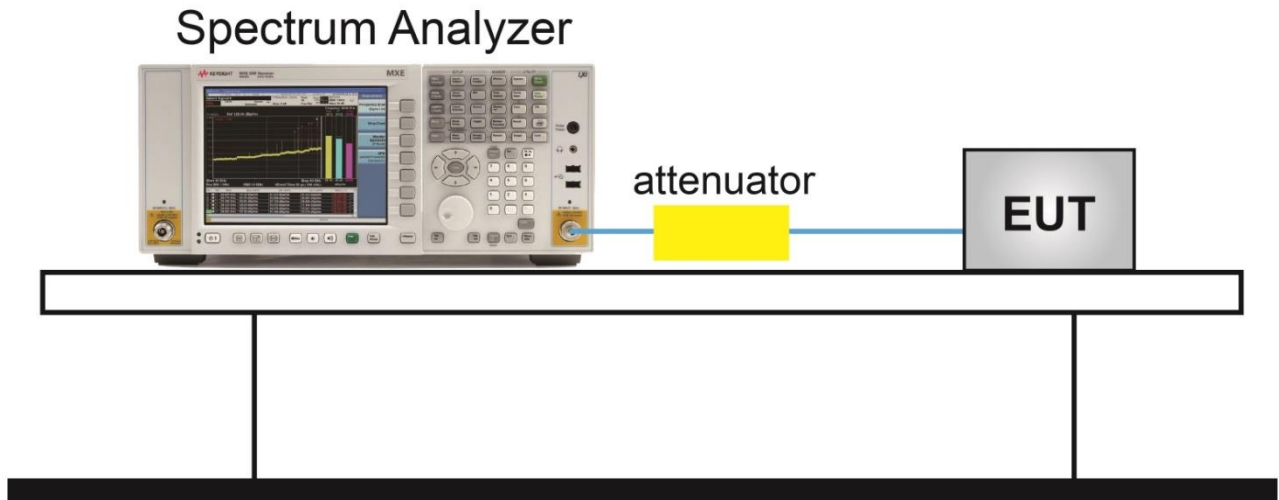

**6.6.5. Test Result**

Product	AC750 Wi-Fi Range Extender	Test Engineer	Amy Zhang
Test Site	WZ-TR3	Test Date	2020/09/02, 2020/09/03
Test Item	Power Spectral Density (UNII-Band 1 & UNII-2a & UNII-2c)		

Test Mode	Data Rate/ MCS	Channel No.	Freq. (MHz)	Ant 0 PSD (dBm/MHz)	Ant 1 PSD (dBm/MHz)	Duty Cycle (%)	Total PSD (dBm/ MHz)	PSD Limit (dBm/MHz)	Result
11a	6Mbps	36	5180	8.94	8.62	92.60	12.13	≤ 16.99	Pass
11a	6Mbps	44	5220	9.94	10.58	92.60	13.62	≤ 16.99	Pass
11a	6Mbps	48	5240	10.03	10.68	92.60	13.71	≤ 16.99	Pass
11a	6Mbps	52	5260	7.45	7.66	92.60	10.90	≤ 10.99	Pass
11a	6Mbps	60	5300	7.35	7.55	92.60	10.80	≤ 10.99	Pass
11a	6Mbps	64	5320	7.42	7.40	92.60	10.75	≤ 10.99	Pass
11a	6Mbps	100	5500	6.95	7.31	92.60	10.48	≤ 10.99	Pass
11a	6Mbps	116	5580	7.21	7.49	92.60	10.70	≤ 10.99	Pass
11a	6Mbps	140	5700	6.80	6.90	92.60	10.19	≤ 10.99	Pass
11ac-VHT20	MCS0	36	5180	7.91	8.60	92.09	11.64	≤ 16.99	Pass
11ac-VHT20	MCS0	44	5220	9.51	10.11	92.09	13.19	≤ 16.99	Pass
11ac-VHT20	MCS0	48	5240	8.67	9.28	92.09	12.35	≤ 16.99	Pass
11ac-VHT20	MCS0	52	5260	7.27	7.46	92.09	10.73	≤ 10.99	Pass
11ac-VHT20	MCS0	60	5300	7.35	7.26	92.09	10.67	≤ 10.99	Pass
11ac-VHT20	MCS0	64	5320	7.51	7.31	92.09	10.78	≤ 10.99	Pass
11ac-VHT20	MCS0	100	5500	7.24	7.23	92.09	10.60	≤ 10.99	Pass
11ac-VHT20	MCS0	116	5580	7.36	7.46	92.09	10.78	≤ 10.99	Pass
11ac-VHT20	MCS0	140	5700	6.16	6.35	92.09	9.62	≤ 10.99	Pass
11ac-VHT40	MCS0	38	5190	2.93	3.25	91.56	6.49	≤ 16.99	Pass
11ac-VHT40	MCS0	46	5230	7.32	7.35	91.56	10.73	≤ 16.99	Pass
11ac-VHT40	MCS0	54	5270	7.32	7.53	91.56	10.82	≤ 10.99	Pass
11ac-VHT40	MCS0	62	5310	2.72	2.85	91.56	6.18	≤ 10.99	Pass
11ac-VHT40	MCS0	102	5510	1.93	2.02	91.56	5.37	≤ 10.99	Pass
11ac-VHT40	MCS0	110	5550	6.61	6.84	91.56	10.12	≤ 10.99	Pass
11ac-VHT40	MCS0	134	5670	4.56	4.96	91.56	8.16	≤ 10.99	Pass

Test Mode	Data Rate/ MCS	Channel No.	Freq. (MHz)	Ant 0 PSD (dBm/MHz)	Ant 1 PSD (dBm/MHz)	Duty Cycle (%)	Total PSD (dBm/ MHz)	PSD Limit (dBm/MHz)	Result
11ac-VHT80	MCS0	42	5210	-0.28	-0.35	88.89	3.21	≤ 16.99	Pass
11ac-VHT80	MCS0	58	5290	-0.50	0.13	88.89	3.35	≤ 10.99	Pass
11ac-VHT80	MCS0	106	5530	-1.16	-0.89	88.89	2.50	≤ 10.99	Pass
11ac-VHT80	MCS0	122	5610	1.86	2.49	88.89	5.71	≤ 10.99	Pass

Note 1:

When EUT duty cycle > 98%, the total PSD (dBm/MHz) =  $10 \cdot \log \{10^{(\text{Ant 0 PSD}/10)} + 10^{(\text{Ant 1 PSD}/10)}\}$  (dBm/MHz).

When EUT duty cycle < 98%, the total PSD (dBm/MHz) =  $10 \cdot \log \{10^{(\text{Ant 0 PSD}/10)} + 10^{(\text{Ant 1 PSD}/10)}\}$  (dBm/MHz) +  $10 \cdot \log (1/\text{Duty Cycle})$ .

Note 2: PSD Limit Calculation as below:

For 5150-5250MHz: PSD Limit = 17 – (6.01 - 6) = 16.99dBm/MHz

For 5250-5350MHz and 5470-5725MHz: PSD Limit = 11 – (6.01 - 6) = 10.99dBm/MHz

Product	AC750 Wi-Fi Range Extender	Test Engineer	Amy Zhang
Test Site	TR3	Test Date	2020/09/02, 2020/09/03
Test Item	Power Spectral Density (UNII-Band 3)		

Test Mode	Data Rate/ MCS	Channel No.	Freq. (MHz)	Ant 0 PSD (dBm/510K Hz)	Ant 1 PSD (dBm/510K Hz)	Duty Cycle (%)	Total PSD (dBm/ 510KHz)	PSD Limit (dBm/500K Hz)	Result
11a	6Mbps	149	5745	6.54	7.28	92.60	10.27	≤ 29.99	Pass
11a	6Mbps	157	5785	6.19	6.45	92.60	9.67	≤ 29.99	Pass
11a	6Mbps	165	5825	6.75	7.30	92.60	10.38	≤ 29.99	Pass
11ac-VHT20	MCS0	149	5745	7.05	7.56	92.09	10.68	≤ 29.99	Pass
11ac-VHT20	MCS0	157	5785	7.20	7.23	92.09	10.58	≤ 29.99	Pass
11ac-VHT20	MCS0	165	5825	7.33	7.03	92.09	10.55	≤ 29.99	Pass
11ac-VHT40	MCS0	151	5755	4.32	4.46	91.56	7.78	≤ 29.99	Pass
11ac-VHT40	MCS0	159	5795	4.61	4.84	91.56	8.12	≤ 29.99	Pass
11ac-VHT80	MCS0	155	5775	0.32	0.24	88.89	3.80	≤ 29.99	Pass

Note 1:

When EUT duty cycle > 98%, the total PSD (dBm / 510kHz) =  $10 \cdot \log\{10^{(\text{Ant 0 AVGPSD}/10)} + 10^{(\text{Ant 1 AVGPSD}/10)}\}$ .

When EUT duty cycle < 98%, the total PSD (dBm / 510kHz) =  $10 \cdot \log\{10^{(\text{Ant 0 AVGPSD}/10)} + 10^{(\text{Ant 1 AVGPSD}/10)}\}$   
 +  $10 \cdot \log(1/\text{Duty cycle})$ .

Note 2: PSD Limit Calculation as below:

For 5725-5850MHz: PSD Limit = 30 - (6.01 - 6) = 29.99dBm/MHz;



### 802.11a Power Spectral Density – Ant 0

**Channel 36 (5180MHz)**



**Channel 44 (5220MHz)**

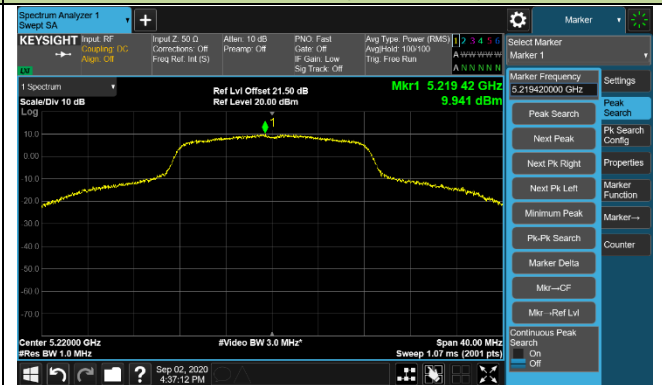

**Channel 48 (5240MHz)**



**Channel 52 (5260MHz)**

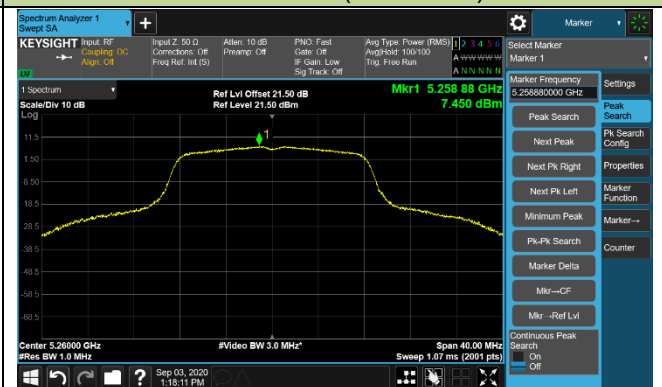

**Channel 60 (5300MHz)**



**Channel 64 (5320MHz)**

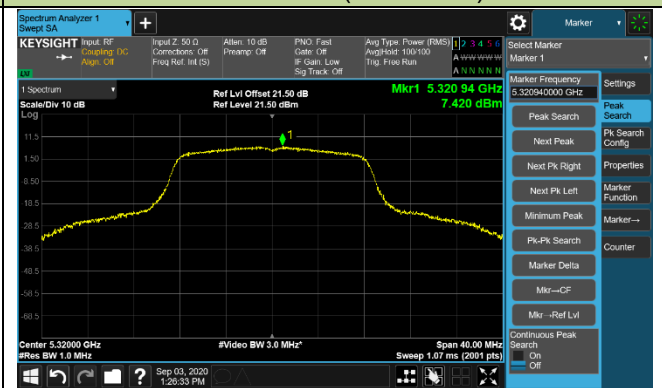

**Channel 100 (5500MHz)**

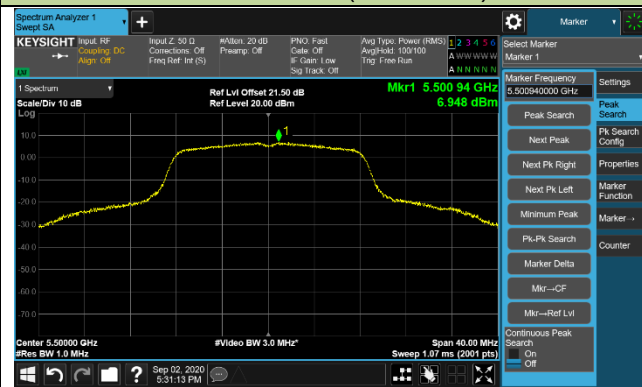

**Channel 116 (5580MHz)**

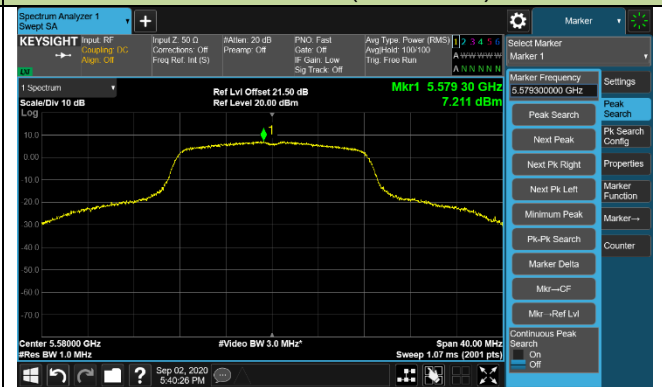

### 802.11a Power Spectral Density – Ant 0

Channel 140 (5700MHz)

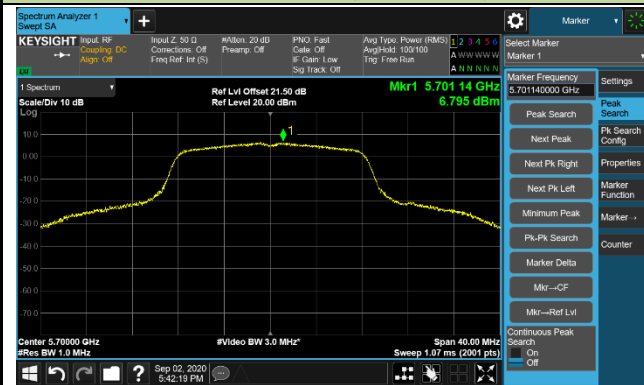

Channel 149 (5745MHz)

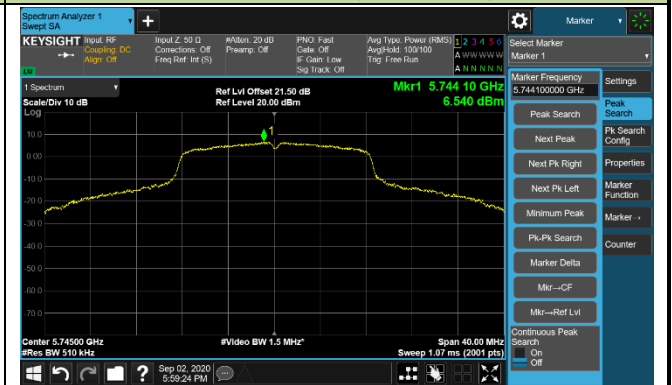

Channel 157 (5785MHz)

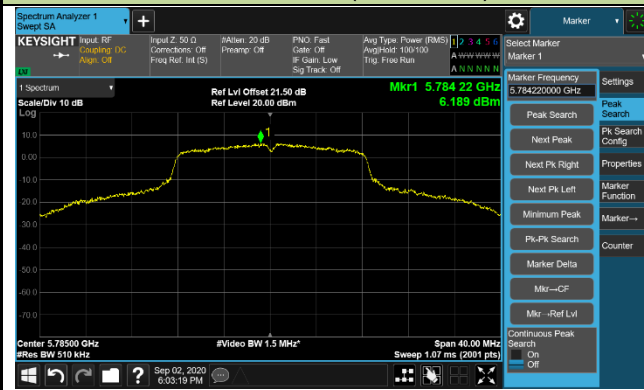

Channel 165 (5825MHz)



### 802.11ac-VHT20 Power Spectral Density – Ant 0

Channel 36 (5180MHz)

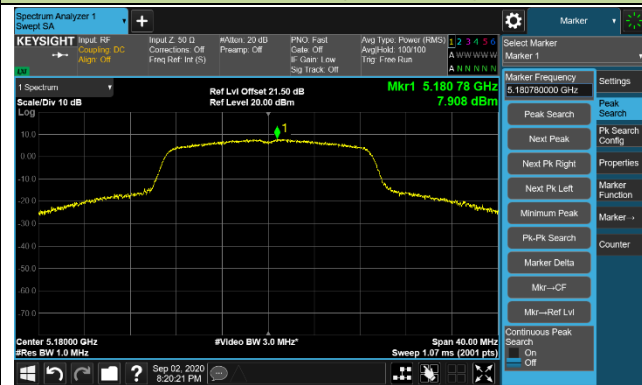

Channel 44 (5220MHz)

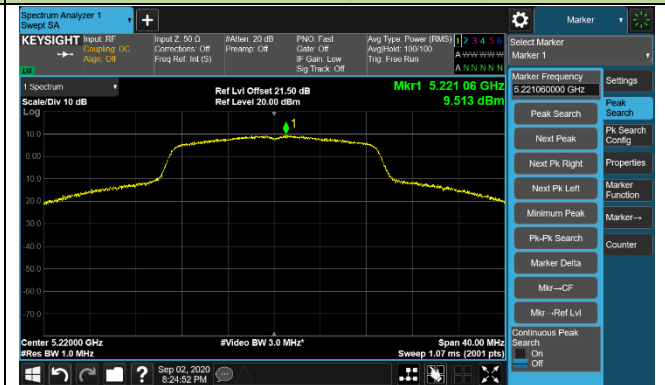

Channel 48 (5240MHz)

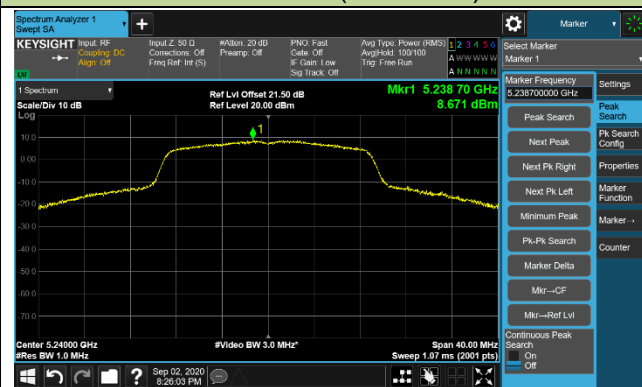

Channel 52 (5260MHz)

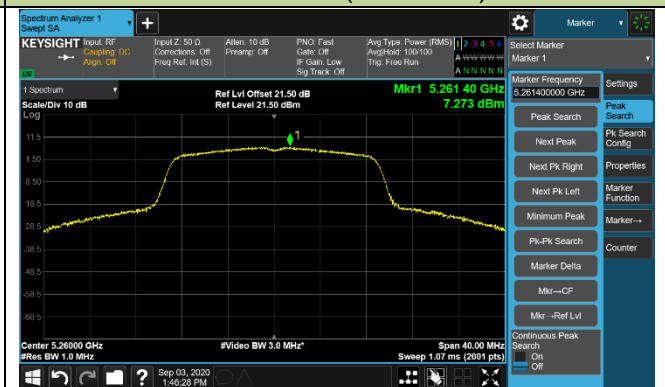

Channel 60 (5300MHz)

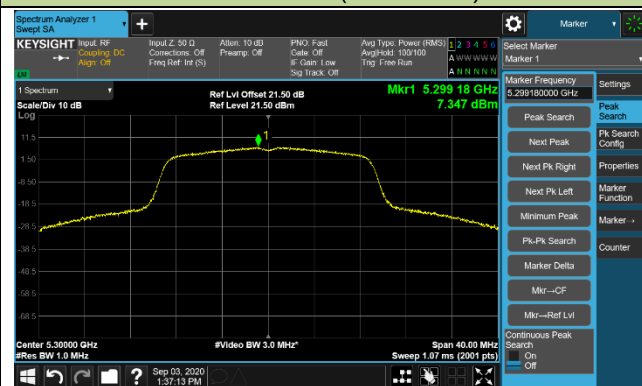

Channel 64 (5320MHz)

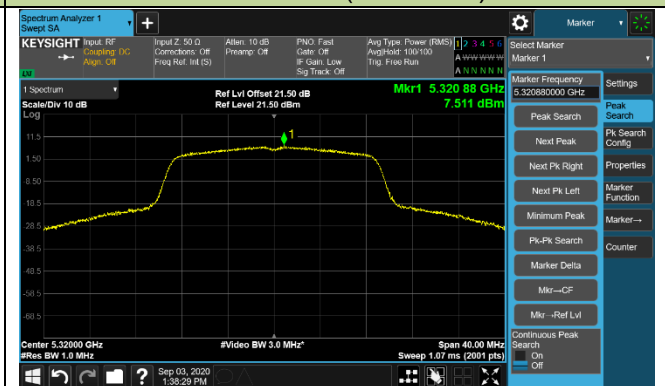

Channel 100 (5500MHz)

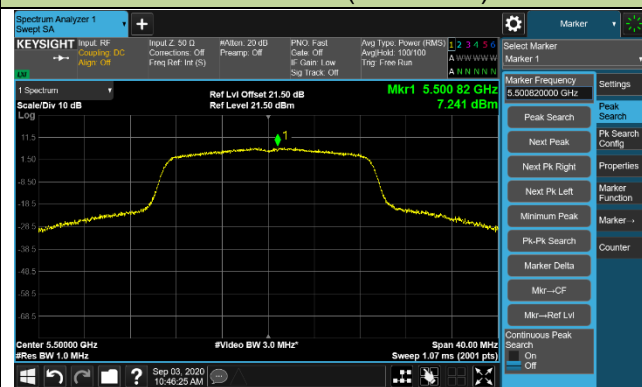

Channel 116 (5580MHz)

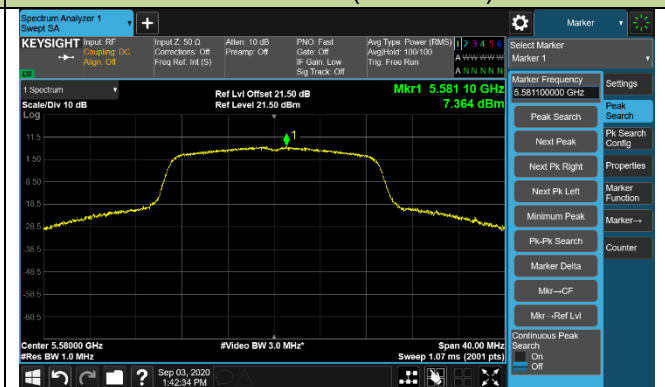

### 802.11ac-VHT20 Power Spectral Density – Ant 0

Channel 140 (5700MHz)

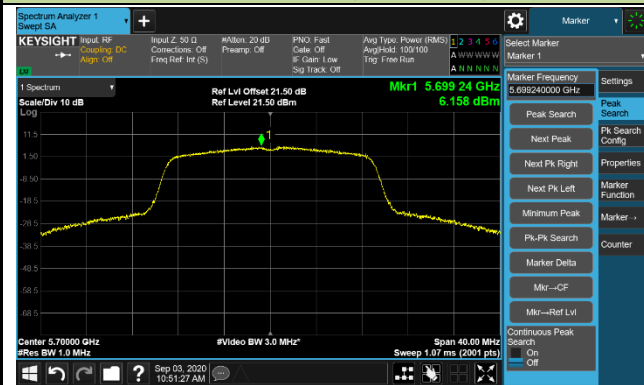

Channel 149 (5745MHz)

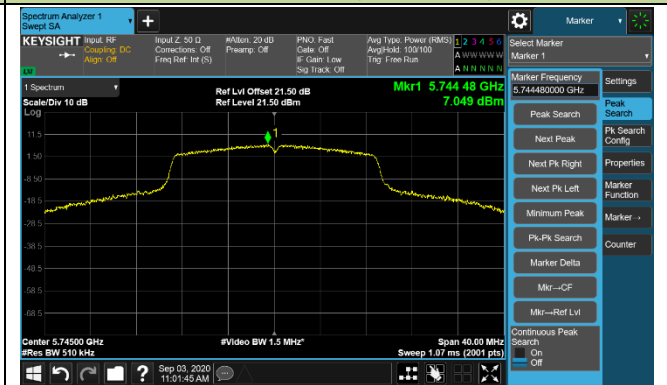

Channel 157 (5785MHz)



Channel 165 (5825MHz)

