

TP-LINK®

User Guide

RE200

AC750 WiFi Range Extender



COPYRIGHT & TRADEMARKS

Specifications are subject to change without notice. **TP-LINK**[®] is a registered trademark of TP-LINK TECHNOLOGIES CO., LTD. Other brands and product names are trademarks or registered trademarks of their respective holders.

No part of the specifications may be reproduced in any form or by any means or used to make any derivative such as translation, transformation, or adaptation without permission from TP-LINK TECHNOLOGIES CO., LTD. Copyright © 2014 TP-LINK TECHNOLOGIES CO., LTD.

All rights reserved.

<http://www.tp-link.com>

FCC STATEMENT



This equipment has been tested and found to comply with the limits for a Class B digital device, pursuant to part 15 of the FCC Rules. These limits are designed to provide reasonable protection against harmful interference in a residential installation. This equipment generates, uses and can radiate radio frequency energy and, if not installed and used in accordance with the instructions, may cause harmful interference to radio communications. However, there is no guarantee that interference will not occur in a particular installation. If this equipment does cause harmful interference to radio or television reception, which can be determined by turning the equipment off and on, the user is encouraged to try to correct the interference by one or more of the following measures:

- Reorient or relocate the receiving antenna.
- Increase the separation between the equipment and receiver.
- Connect the equipment into an outlet on a circuit different from that to which the receiver is connected.
- Consult the dealer or an experienced radio/ TV technician for help.

This device complies with part 15 of the FCC Rules. Operation is subject to the following two conditions:

- 1) This device may not cause harmful interference.
- 2) This device must accept any interference received, including interference that may cause undesired operation.

Any changes or modifications not expressly approved by the party responsible for compliance could void the user's authority to operate the equipment.

Note: The manufacturer is not responsible for any radio or tv interference caused by unauthorized modifications to this equipment. Such modifications could void the user's authority to operate the equipment.

FCC RF Radiation Exposure Statement

This equipment complies with FCC RF radiation exposure limits set forth for an uncontrolled environment. This device and its antenna must not be co-located or operating in conjunction with any other antenna or transmitter.

"To comply with FCC RF exposure compliance requirements, this grant is applicable to only Mobile Configurations. The antennas used for this transmitter must be installed to provide a separation distance of at least 20 cm from all persons and must not be co-located or operating in conjunction with any other antenna or transmitter."

CE Mark Warning

CE 1588 ⚠

This is a class B product. In a domestic environment, this product may cause radio interference, in which case the user may be required to take adequate measures.

National Restrictions

This device is intended for home and office use in all EU countries (and other countries following the EU directive 1999/5/EC) without any limitation except for the countries mentioned below:

Country	Restriction	Reason/remark
Bulgaria	None	General authorization required for outdoor use and public service
France	Outdoor use limited to 10 mW e.i.r.p. within the band 2454-2483.5 MHz	Military Radiolocation use. Refarming of the 2.4 GHz band has been ongoing in recent years to allow current relaxed regulation. Full implementation planned 2012
Italy	None	If used outside of own premises, general authorization is required
Luxembourg	None	General authorization required for network and service supply(not for spectrum)
Norway	Implemented	This subsection does not apply for the geographical area within a radius of 20 km from the centre of Ny-Ålesund
Russian Federation	None	Only for indoor applications

Note: Please don't use the product outdoors in France.

Canadian Compliance Statement

This device complies with Industry Canada license-exempt RSS standard(s). Operation is subject to the following two conditions:

- (1) This device may not cause interference, and
- (2) This device must accept any interference, including interference that may cause undesired operation of the device.

Cet appareil est conforme aux normes CNR exemptes de licence d'Industrie Canada. Le fonctionnement est soumis aux deux conditions suivantes:

- (1) cet appareil ne doit pas provoquer d'interférences et
- (2) cet appareil doit accepter toute interférence, y compris celles susceptibles de provoquer un fonctionnement non souhaité de l'appareil.

Industry Canada Statement

Complies with the Canadian ICES-003 Class B specifications.

Cet appareil numérique de la classe B est conforme à la norme NMB-003 du Canada.

This device complies with RSS 210 of Industry Canada. This Class B device meets all the requirements of the Canadian interference-causing equipment regulations.

Cet appareil numérique de la Classe B respecte toutes les exigences du Règlement sur le matériel brouilleur du Canada.

Korea Warning Statements

당해 무선설비는 운용중 전파혼신 가능성이 있음.

NCC Notice & BSMI Notice

注意！

依據 低功率電波輻射性電機管理辦法

第十二條 經型式認證合格之低功率射頻電機，非經許可，公司、商號或使用者均不得擅自變更頻率、加大功率或變更原設計之特性或功能。

第十四條 低功率射頻電機之使用不得影響飛航安全及干擾合法通行；經發現有干擾現象時，應立即停用，並改善至無干擾時方得繼續使用。前項合法通信，指依電信規定作業之無線電信。低功率射頻電機需忍受合法通信或工業、科學以及醫療用電波輻射性電機設備之干擾。

減少電磁波影響，請妥適使用。

於 5.25GHz 至 5.35GHz 區域內操作之無線設備的警告聲明

工作頻率 5.250~5.350GHz 該頻段限於室內使用。

* 2.4GHz 電磁波曝露量 MPE 標準值 $1\text{mW}/\text{cm}^2$ ，送測產品實測值為 $0.3279\text{mW}/\text{cm}^2$ 。

* 5GHz 電磁波曝露量 MPE 標準值 $1\text{mW}/\text{cm}^2$ ，送測產品實測值為 $0.1492\text{mW}/\text{cm}^2$ 。

安全諮詢及注意事項

- 請使用原裝電源供應器或只能按照本產品注明的電源類型使用本產品。
- 清潔本產品之前請先拔掉電源線。請勿使用液體、噴霧清潔劑或濕布進行清潔。
- 注意防潮，請勿將水或其他液體潑灑到本產品上。
- 插槽與開口供通風使用，以確保本產品的操作可靠並防止過熱，請勿堵塞或覆蓋開口。
- 請勿將本產品置放於靠近熱源的地方。除非有正常的通風，否則不可放在密閉位置中。
- 請不要私自打開機殼，不要嘗試自行維修本產品，請由授權的專業人士進行此項工作。



5150-5250MHz is limited to use indoor only

5150-5250MHz est limitée à une utilisation en intérieur uniquement

Продукт сертифіковано згідно с правилами системи УкрСЕПРО на відповідність вимогам нормативних документів та вимогам, що передбачені чинними законодавчими актами України.

EAC

Safety Information

- When product has power button, the power button is one of the way to shut off the product; when there is no power button, the only way to completely shut off power is to disconnect the product or the power adapter from the power source.
- Don't disassemble the product, or make repairs yourself. You run the risk of electric shock and voiding the limited warranty. If you need service, please contact us.
- Avoid water and wet locations.
- 5150-5250 is indoor use only

DECLARATION OF CONFORMITY

For the following equipment:

Product Description: **AC750 WiFi Range Extender**

Model No.: **RE200**

Trademark: **TP-LINK**

We declare under our own responsibility that the above products satisfy all the technical regulations applicable to the product within the scope of Council Directives:

Directives 1999/5/EC, Directives 2004/108/EC, Directives 2006/95/EC, Directives 1999/519/EC, Directives 2011/65/EU

The above product is in conformity with the following standards or other normative documents

EN 300 328 V1.8.1(2012-06)

ETSI EN 301 489-1 V1.9.2:2011& ETSI EN 301 489-17 V2.2.1:2012

EN55022:2010+AC:2011,Class B

EN 55024:2010

EN 61000-3-2:2006+A1:2009+A2:2009

EN 61000-3-3:2013

EN 60950-1:2006+A11: 2009+A1:2010+A12:2011

EN 62311:2008

The product carries the CE Mark:

CE 1588 

Person responsible for making this declaration:



Yang Hongliang

Product Manager of International Business

Date of issue: 2014

TP-LINK TECHNOLOGIES CO., LTD.

Building 24 (floors 1, 3, 4, 5), and 28 (floors 1-4) Central Science and Technology Park,
Shennan Rd, Nanshan, Shenzhen, China

CONTENTS

Package Contents	1
Chapter 1 Introduction	2
1.1 Product Overview.....	2
1.2 Main Features	2
1.3 Appearance.....	2
Chapter 2 Hardware Installation	4
2.1 Before You Begin.....	4
2.2 Basic Requirements.....	4
2.3 Connecting the Device.....	5
Chapter 3 Quick Installation Guide	6
Chapter 4 Configure the Device	12
4.1 Status.....	12
4.2 Quick Setup	14
4.3 Network.....	14
4.3.1 LAN.....	15
4.3.2 DHCP Settings.....	16
4.3.3 DHCP Client List.....	18
4.4 Wireless	18
4.4.1 Connect To Existing Network	19
4.4.2 Extender Settings	19
4.4.3 Advanced Settings.....	20
4.4.4 High Speed	21
4.4.5 Wireless Statistics.....	21
4.5 LED On/Off	22
4.6 System Tools	22
4.6.1 Firmware Upgrade.....	23
4.6.2 Factory Defaults.....	24
4.6.3 Backup & Restore.....	24
4.6.4 Reboot	25
4.6.5 Password.....	25
4.6.6 System Log.....	26
Appendix A: Factory Defaults	27
Appendix B: Troubleshooting	28
Appendix C: Specifications	30
Appendix D: Glossary	31

Package Contents

The following items should be found in your package:

- RE200 AC750 WiFi Range Extender
- Ethernet Cable
- Quick Installation Guide
- Resource CD for RE200 AC750 WiFi Range Extender, including:
 - This User Guide

 **Note:**

Make sure that the package contains the above items. If any of the listed items is damaged or missing, please contact your distributor.

Conventions

The Range Extender, the Device or RE200 mentioned in this User guide stands for RE200 AC750 WiFi Range Extender without any explanations.

Parameters provided in the pictures are just references for setting up the product, which may differ from the actual situation. You can set the parameters according to your demand.

The power plug may differ from the picture illustrated in this UG due to different regional power specifications. As follows we just take that of EU version for example.

Chapter 1 Introduction

1.1 Product Overview

The RE200 AC750 WiFi Range Extender is dedicated to Small Office/Home Office (SOHO) wireless network solutions. It will enlarge your existing wireless network and mobility within your wireless network while also allowing you to connect a wired device to a wireless environment. Increased mobility and the absence of cabling will be beneficial for your network.

With using IEEE 802.11ac wireless technology, this device can transmit wireless data at the rate of up to 300Mbps (2.4GHz) + 433Mbps (5GHz). With multiple protection measures, including wireless LAN 64/128/152-bit WEP encryption, Wi-Fi protected Access (WPA2-PSK, WPA-PSK), the RE200 AC750 WiFi Range Extender delivers complete data privacy. It is also compatible with all IEEE 802.11n, IEEE 802.11a, IEEE 802.11b and IEEE 802.11g products.

It supports an easy wireless connection to the root Router/AP (equipped with WPS/QSS button) by pressing the WPS button on the front panel. It also supports an easy, web-based setup for installation and management. Even though you may not be familiar with the Range Extender, you can easily configure it with the help of this Guide. Before installing the Range Extender, please look through this Guide to get the full information of the RE200 AC750 WiFi Range Extender.

1.2 Main Features

- Complies with IEEE 802.11ac
- Provides multiple encryption security Types including: 64/128/152-bit WEP and WPA-PSK/WPA2-PSK
- Supports Built-in DHCP server
- Supports Firmware Upgrade
- Supports Web-based Management

1.3 Appearance

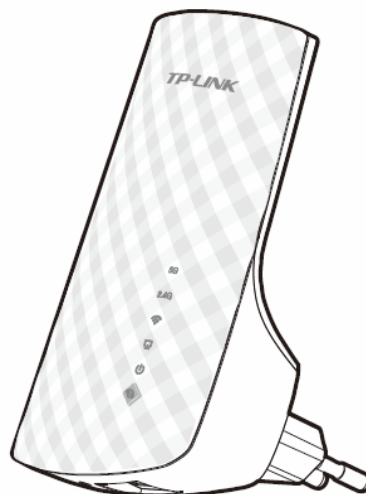

Figure 1-1

● **LED Explanation:**





Name	Status	Indication
5G/2.4G	Solid Green	The Range Extender is connected to the 5G/2.4G wireless network of your main Router/AP, and the signal strength is strong.
	Solid Red	The Range Extender is connected to the 5G/2.4G wireless network of your main Router/AP, but the signal strength is weak.
	Off	The Range Extender isn't connected to your main Router/AP.
 Wireless Signal	On	The Range Extender's wireless function is enabled.
	Off	The Range Extender's wireless function is disabled.
 ETHERNET	On	A device is connected to the ETHERNET port, but there is no activity.
	Flashing	A device is connected to the ETHERNET port, and is active.
	Off	No device is connected to the ETHERNET port.
 Power	On	The Range Extender is on.
	Off	The Range Extender is off.
 RE	On	The Range Extender has established a secure connection.
	Flashing	The Range Extender is establishing a secure connection.
	Off	No active connection.

Table 1-1

-  **(RANGE EXTENDER/WPS):** If your Wireless router or AP supports WPS or QSS function, you can press the WPS or QSS button and then press the RANGE EXTENDER button to establish a secure connection between the Wireless router or AP and the Range Extender RE200.
- **RESET:** This button is used to restore the Range Extender's factory default settings.
There are two ways to reset the Range Extender's factory defaults:
Method One: With the Range Extender powered on, use a pin to press **RESET** button (about 1 seconds) until all the LEDs flash once. And then release the button and wait the Range Extender to reboot to its factory default settings.
Method Two: Restore the default settings from "**System Tools > Factory Defaults**" of the Range Extender's Web-based Management page.
- **ETHERNET:** One 10/100Mbps RJ45 Ethernet port used to add wireless connectivity to an Ethernet-enabled device such as Internet TV, DVR, Gaming console and so on. Please note that this port is not allowed to be connected with router or AP.

Chapter 2 Hardware Installation

2.1 Before You Begin

Please read this User Guide carefully before installing and using the equipment. The operating distance range of your wireless connection can vary significantly depending on the physical position of the wireless devices. Factors that can weaken signals by getting in the way of your network's radio waves are metal appliances or obstructions, and walls. Typical ranges vary based on the types of materials and background RF (radio frequency) noise in your home or office.

In order to optimize the performance of RE200, please follow the instructions below to achieve an **ideal location** (please make sure it is always within the wireless coverage of the wireless router).

- 1) *Half-way Between* - Generally, the ideal location for RE200 is half-way between the Wireless router and Wireless Client. If the wireless signal is not satisfactory, you may place RE200 somewhat nearer to the Wireless router.

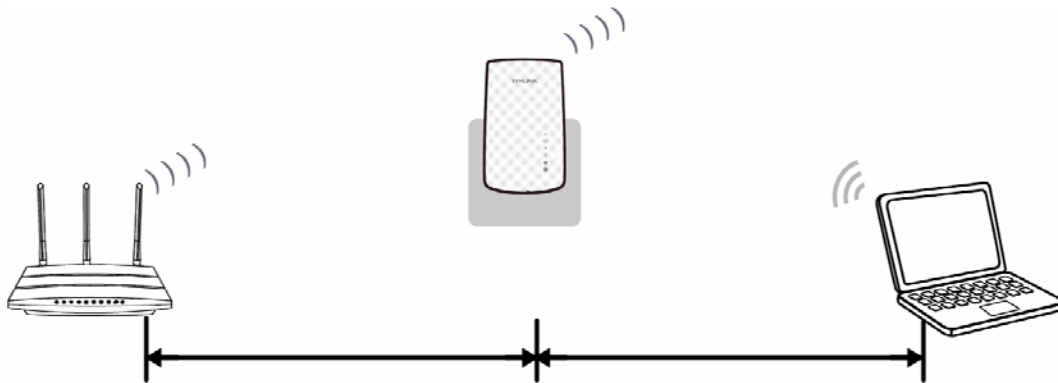

- 2) *No Obstacles and Spacious* - Clear obstacles in the way between RE200 and Wireless router. It's better to locate it in a spacious place, such as near the corridors.
- 3) *No Interference* - Keep RE200 far away from wireless interference, which may come from electrical appliances that works in the same frequency band as RE200, such as Blue tooth devices, cordless phones, microwave ovens, etc.

 **Note:**

TP-LINK recommends that you connect to the Range Extender *when* your home network connection is poor, or when you want a larger wireless coverage to eliminate “dead zones”. As in compliance with the wireless transmission protocol, all the Range Extender devices are set to work in half-duplex instead of full-duplex mode. In other words, the Range Extender has to process one-way communication between your root Wireless Router or AP and the terminal clients; so the transmission time will be double-increased, while the speed will be decreased.

2.2 Basic Requirements

- Place your Range Extender in a well-ventilated place far from direct sunlight, any heater or heating vent.
- Leave at least 2 inches (5cm) space around the device for heat dissipation.
- Turn off your Range Extender and unplug the power adapter in a lighting storm to avoid damage.

- Use Web browser, such as Microsoft Internet Explorer 5.0 or above, Netscape Navigator 6.0 or above.
- Operating temperature of the Range Extender should be 0°C~40°C (32°F~104°F).
- Operating humidity of the Range Extender should be 10%~90%RH (Non-condensing).

2.3 Connecting the Device

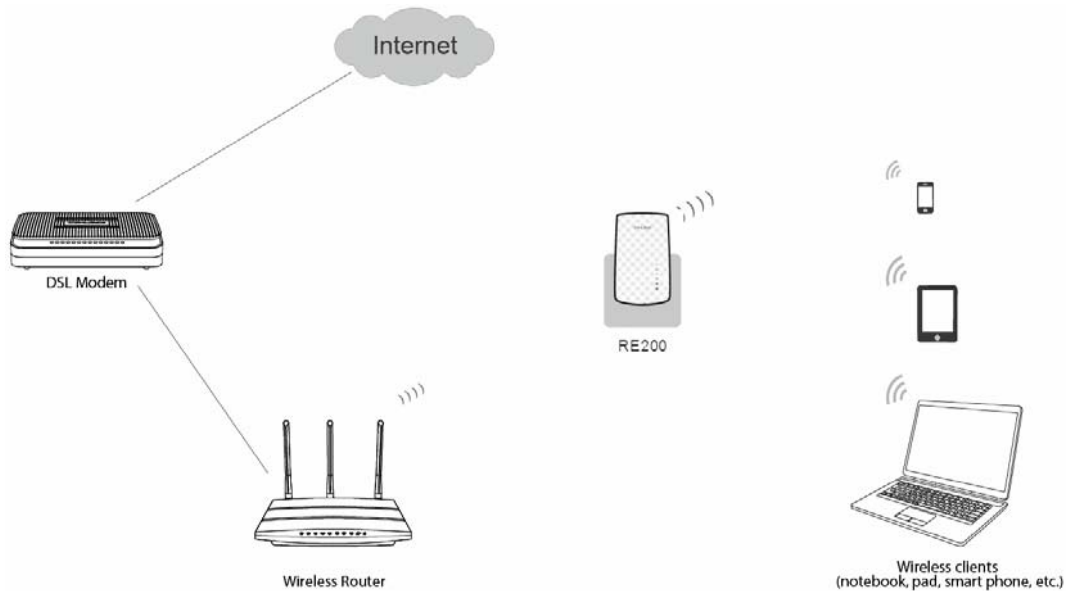

Figure 2-1 Typical connection of RE200

To establish a typical connection of the Range Extender, please take the following steps:

1. Connect the Cable/DSL modem to a Wireless router with an Ethernet cable.
2. Plug your RE200 directly to a standard electrical wall socket, which is near the Wireless router.
3. Connect your Wireless Clients (such as notebook, pad, smart phone, etc.) to RE200 wirelessly. Or you can connect your PC to the sole LAN port of Range Extender via an Ethernet cable.
4. Log in the web-based management page of RE200 and complete the configurations. (Please refer to [Chapter 3 Quick Installation Guide](#) or [Chapter 4 Configure the Device](#) for the configurations, as you need.) Through the web page configuration you can successfully connect RE200 to the wireless router.
5. Adjust an ideal location for RE200. (Please refer to Section [2.1 Before You Begin](#) for detailed information about ideal location.)

Chapter 3 Quick Installation Guide

This chapter will guide you to configure your PC to communicate with the Range Extender and to configure and manage the RE200 AC750 WiFi Range Extender easily with a Web-based utility.

With a Web-based utility, it is easy to configure and manage the RE200 AC750 WiFi Range Extender. The Web-based utility can be used on any Windows, Macintosh or UNIX OS with a Web browser, such as Microsoft Internet Explorer, Mozilla Firefox or Apple Safari.

1. To access the configuration utility, open a web-browser and type in the domain name <http://tplinkextender.net> in the address field of the browser.

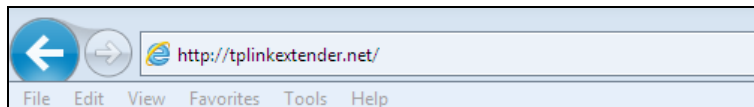

Figure 3-1 Login to the Range Extender

After a moment, a login window will appear as shown in Figure 3-2. Enter **admin** for the User Name and Password (both in lower case letters). Then click **OK** or press Enter.

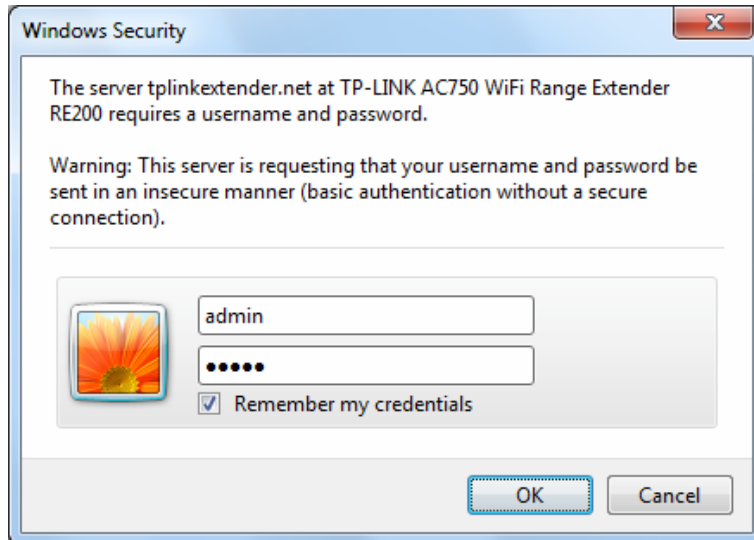

Figure 3-2 Login Windows

 **Note:**

If the above screen does not prompt, it means that your web-browser has been set to a proxy. Go to **Tools menu>Internet Options>Connections>LAN Settings**, in the screen that appears, cancel the **Using Proxy** checkbox, and click **OK** to finish it.

2. After successful login, there will pop up the **Quick Setup Start** page. Click **Next** to get the quick setup started.

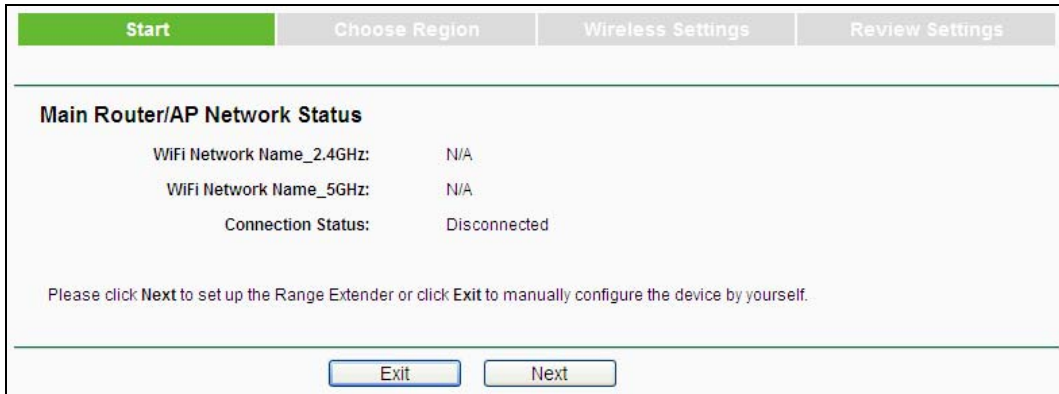

Figure 3-3 Quick Setup Start

Note:

If you want to go through the Quick Setup right away, you can click **Exit** and enter the main menu of the device.

3. The device will detect the existing 2.4GHz network. Please wait for a while.

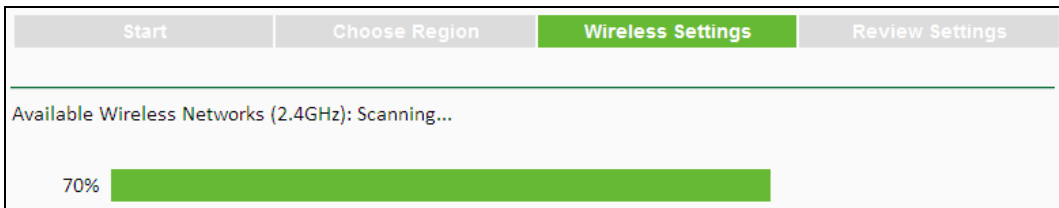

Figure 3-4 Quick Setup – Detect Existing Network

- A list of available 2.4GHz wireless network will appear. Check the box before the SSID of your desired network, and then click **Next**.

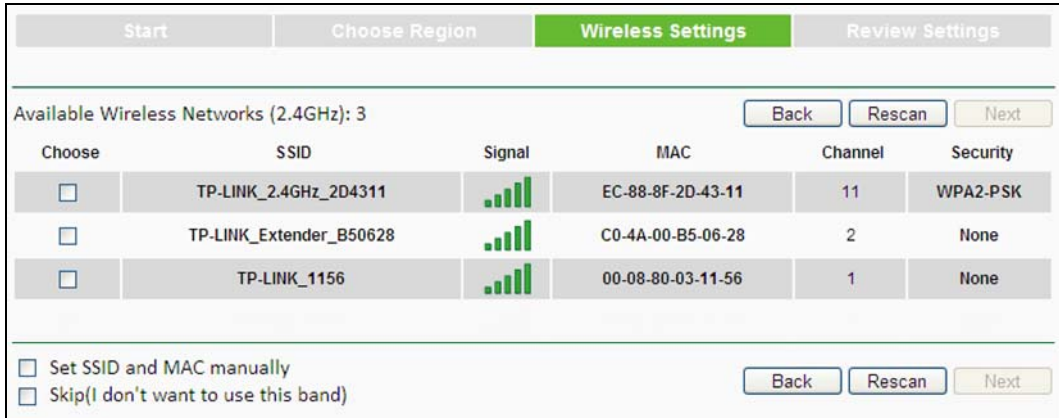

Figure 3-5 Quick Setup – Available Wireless Networks

Note:

- If you could not find your wireless network name (SSID) in the list, you can click **Rescan** to redetect it or tick the checkbox before "Set SSID and MAC Manually" to manually configure the wireless settings.
 - If you don't want to use the 2.4GHz band, you can check the box of **Skip** at the bottom of the page.
- Wireless Settings page will appear as shown in Figure 3-7. Enter the WiFi Password of your main Router/AP, name your range extender WiFi network or keep it default, and then click **Next** to continue.

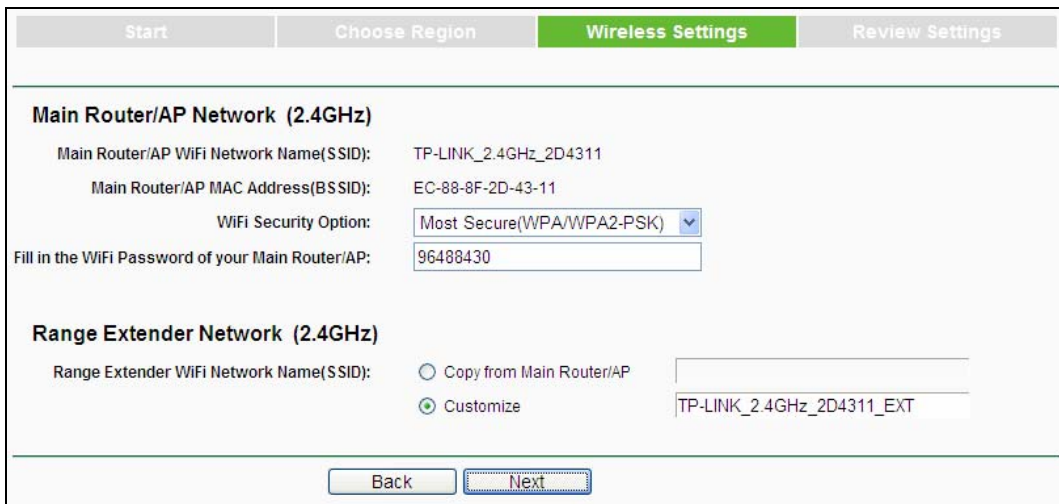

Figure 3-6 Quick Setup – Wireless Settings

- A list of available 5GHz wireless network will appear. Check the box before the SSID of your desired network, and then click **Next**.

Choose	SSID	Signal	MAC	Channel	Security
<input checked="" type="checkbox"/>	TP-LINK_5GHz_2D4312		EC-88-8F-2D-43-12	36	WPA2-PSK
<input type="checkbox"/>	TP-LINK_Extender_B50840		C0-4A-00-CF-71-9E	48	None
<input type="checkbox"/>	TP-LINK-6017		00-02-00-03-0E-4A	40	WPA2-PSK

Set SSID and MAC manually
 Skip(I don't want to use this band)

Figure 3-7 Quick Setup – Available Wireless Networks

Note:

- If you could not find your wireless network name (SSID) in the list, you can click **Rescan** to redetect it or tick the checkbox before "Set SSID and MAC Manually" to manually configure the wireless settings.
 - If you don't want to use the 5GHz band, you can check the box of **Skip** at the bottom of the page.
- Wireless Settings page will appear as shown in Figure 3-9. Enter the WiFi Password of your main Router/AP, name your range extender WiFi network or keep it default, and then click **Next** to continue.

Main Router/AP Network (5GHz)
 Main Router/AP WiFi Network Name(SSID): TP-LINK_5GHz_2D4312
 Main Router/AP MAC Address(BSSID): EC-88-8F-2D-43-12
 WiFi Security Option: Most Secure(WPA/WPA2-PSK)
 Fill in the WiFi Password of your Main Router/AP: 96488430

Range Extender Network (5GHz)
 Range Extender WiFi Network Name(SSID): Copy from Main Router/AP Customize TP-LINK_5GHz_2D4312_EXT

Figure 3-8 Quick Setup – Wireless Settings

- Double-check your wireless setting and network setting, when Figure 3-10 appears. If verified, click **Finish** to complete the Quick Setup. If there is anything wrong, click **Back** to return to the previous pages and reconfigure it.

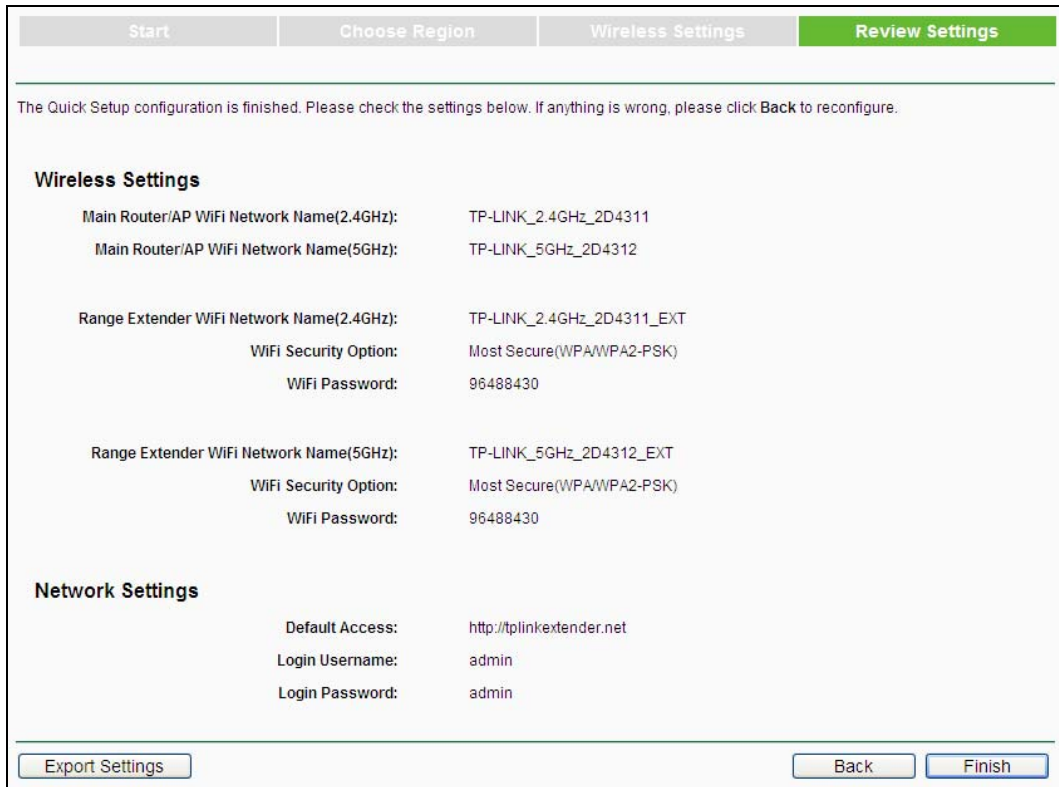

Figure 3-9 Quick Setup – Review Settings

Note:

It's recommended to click the **Export Settings** button to save these settings as a txt file for your future reference.

- When the Range Extender is restarting (as shown in Figure 3-11), please wait for a while patiently until Figure 3-12 appears. Then you have successfully extended the root device's wireless signal.

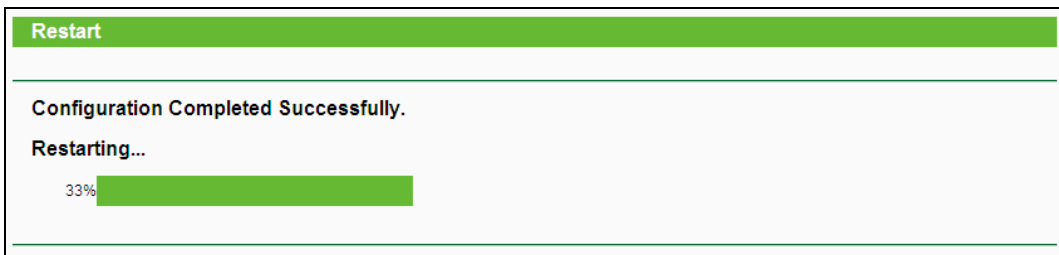

Figure 3-10 Quick Setup – Restarting

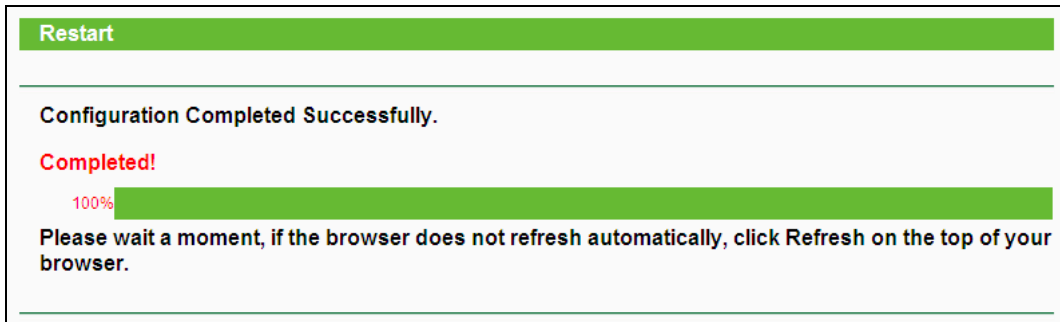

Figure 3-11 Quick Setup – Completed

Chapter 4 Configure the Device

This Chapter describes how to configure your Range Extender via the web-based management page. The RE200 AC750 WiFi Range Extender is easy to configure and manage with the Web-based (Internet Explorer, Netscape® Navigator, Firefox, Safari, Opera or Chrome) management page, which can be launched on any windows, Macintosh or UNIX OS with a web browser.

After a successful login, you can configure and manage the device. There are six main menus on the leftmost column of the web-based management page: **Status**, **Quick Setup Wizard**, **Network**, **Wireless**, **LED On/Off** and **System Tools**. Submenus will be available after clicking one of the main menus. On the right of the web-based management page are the detailed explanations and instructions for the corresponding page.

4.1 Status

Selecting **Status** will enable you to view the Range Extender's current status and configuration, all of which are read-only.

Status

Firmware Version: 3.14.2 Build 140415 Rel.52432n
 Hardware Version: RE200 v1 00000000

Connection Status to Existing Network (2.4GHz)
 Main Router/AP WiFi Network Name: TP-LINK_2.4GHz_2D4311
 Main Router/AP MAC Address: EC-88-8F-2D-43-11
 Signal Strength: 100%
 Connection Status: Connected

Connection Status to Existing Network (5GHz)
 Main Router/AP WiFi Network Name: TP-LINK_5GHz_2D4312
 Main Router/AP MAC Address: EC-88-8F-2D-43-12
 Signal Strength: 92%
 Connection Status: Connected

Range Extender Status (2.4GHz)
 Range Extender WiFi Network Name: TP-LINK_2.4GHz_2D4311_EXT
 Range Extender MAC Address: 00-0A-EB-13-09-19
 Channel: 11
 Channel Width: Automatic

Range Extender Status (5GHz)
 Range Extender WiFi Network Name: TP-LINK_5GHz_2D4312_EXT
 Range Extender MAC Address: 00-0A-EB-13-09-1B
 Channel: 36
 Channel Width: Automatic

Wired
 MAC Address: 00-0A-EB-13-09-19
 IP Address: 192.168.0.103
 Subnet Mask: 255.255.255.0

Traffic Statistics

	Received	Sent
Bytes:	0	0
Packets:	0	0

System Up Time: 0 days 00:03:59 Refresh

Figure 4-1 Status

- **Firmware Version** - This field displays the current firmware version of the Range Extender.
- **Hardware Version** - This field displays the current hardware version of the Range Extender.
- **Connection Status to Existing Network (2.4GHz or 5GHz)** - This part shows you the current information of the root wireless network which the device is connecting to.
 - **Main Router/AP WiFi Network Name (SSID)** - It shows the name of the wireless network which your device is connecting to.
 - **Signal Strength** - It shows the root wireless network's signal strength that the device has received.

- **Connection Status** - It shows whether your device has been connected to a wireless network currently. "**Connected**" means the range extender have connected to a wireless network, while if it shows "disconnected", you can click "**connect**" to connect.
- **Range Extender Status (2.4GHz or 5GHz)** - These are the current wireless settings or information of the device.
 - **Range Extender WiFi Network Name (SSID)** - The Device's wireless network name (SSID) which your PC or other device can be connected to.
 - **Range Extender MAC Address** - The physical address of the system, as seen from the **Network -> LAN** page.
 - **Channel** - The current wireless channel in use.
 - **Channel Width** - The bandwidth of the wireless channel.
- **Wired** - The following is the information of Wired LAN. You can configure them in the **Network** page.
 - **Range Extender MAC Address** - The physical address of the system, as seen from the **Network -> LAN** page.
 - **Range Extender IP Address** - The IP address of the wired LAN.
 - **Subnet Mask** - The subnet mask associated with IP address.
- **Traffic Statistics** - The system traffic statistics.
 - **Received (Bytes)** - Traffic that counted in bytes has been received from wireless.
 - **Received (Packets)** - Traffic that counted in packets has been received from wireless.
 - **Sent (Bytes)** - Traffic that counted in bytes has been sent out from wireless.
 - **Sent (Packets)** - Traffic that counted in packets has been sent out from wireless.
- **System Up Time** - The length of the time since the device was last powered on or reset. Click the **Refresh** button to get the latest status and settings of the device.

4.2 Quick Setup

Please refer to [Chapter 3 Quick Installation Guide](#).

4.3 Network

The **Network** option allows you to customize your local network manually by changing the default settings of the Range Extender. There are three submenus under the DHCP menu: **LAN**, **DHCP Settings** and **DHCP Client List**. Clicking one of them will enable you to configure the corresponding function. The detailed explanations for each submenu are provided below.

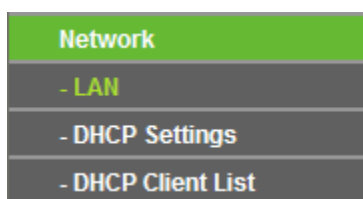

Figure 4-2 Network Menu

4.3.1 LAN

Selecting **Network** > **LAN** will enable you to configure the IP parameters of Network on this page.

The screenshot shows the LAN configuration interface with a green header bar labeled 'LAN'. Below the header, the MAC Address is fixed at 00-0A-EB-13-09-19. The 'Type' dropdown menu is set to 'Dynamic IP'. The IP Address field contains 192.168.0.103, the Subnet Mask field contains 255.255.255.0, and the Gateway field contains 192.168.0.1. A note below the fields states: 'Note: The IP parameters cannot be configured if you have chosen Dynamic IP.' At the bottom of the form is a 'Save' button.

Figure 4-3 LAN – Dynamic IP

The screenshot shows the LAN configuration interface with a green header bar labeled 'LAN'. Below the header, the MAC Address is fixed at 00-0A-EB-13-09-19. The 'Type' dropdown menu is set to 'Static IP'. The IP Address field contains 192.168.0.103, the Subnet Mask field contains 255.255.255.0, and the Gateway field contains 192.168.0.1. At the bottom of the form is a 'Save' button.

Figure 4-4 LAN – Static IP

- **MAC Address** - The physical address of the LAN port, as seen from the LAN. The value cannot be changed.
- **Type** - Several IP types are supported, including: (1) Dynamic IP; (2) Static IP, and they are explained below.
 - **Dynamic IP** - In this type, if your range extender have connected to a router, your client will dynamically get a IP Address / Gateway from the router, otherwise the client will get a IP Address / Gateway in the same network as you set below. And this type is recommended.
 - **Static IP** - In this type, you can configure IP Address / Gateway manually.
- **IP Address** - Enter the IP address of your Range Extender in dotted-decimal notation (factory default setting is 192.168.0.254).
- **Subnet Mask** - An address code that determines the size of the network. Normally use 255.255.255.0 as the subnet mask.
- **Gateway** - The gateway should be in the same subnet as your IP address.

 **Note:**

1. The IP parameters cannot be configured if you have chosen Dynamic IP. In this situation the device will automatically configure the IP parameters appropriate to your need.

2. If you are not familiar with the setting items in this page, it's strongly recommended to keep the provided default values, otherwise may result in lower wireless network performance or even can't work.
3. If you choose Static IP, the domain name log in function won't work, and you have to use the IP you set to log in the Range Extender's web based utility.

4.3.2 DHCP Settings

DHCP stands for Dynamic Host Configuration Protocol. The DHCP Server will automatically assign dynamic IP addresses to the computers on the network. This protocol simplifies network management and allows new wireless devices to receive IP addresses automatically without the need to manually assign new IP addresses.

Selecting **Network > DHCP Settings** will enable you to set up the Range Extender as a DHCP (Dynamic Host Configuration Protocol) server, which provides the TCP/IP configuration for all the PCs that are connected to the system on the LAN. The DHCP Server can be configured on the page (shown as Figure 4-6), only when you've set the Network LAN type as Static IP in Figure 4-3.

Note:

The DHCP Settings function cannot be configured if you have chosen Dynamic IP (DHCP) in **Network -> LAN**, in which situation the device will help you configure the DHCP automatically as you need. The DHCP Settings page will appear as Figure 4-5.

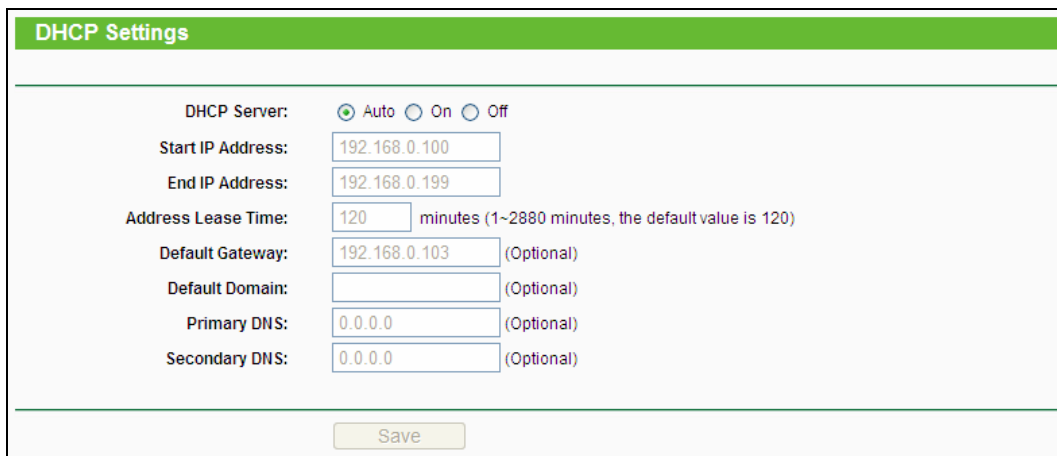

The screenshot shows the 'DHCP Settings' page with a green header. The 'DHCP Server' option is set to 'Auto' (selected with a radio button). Below it are input fields for 'Start IP Address' (192.168.0.100), 'End IP Address' (192.168.0.199), 'Address Lease Time' (120 minutes), 'Default Gateway' (192.168.0.103), 'Default Domain', 'Primary DNS' (0.0.0.0), and 'Secondary DNS' (0.0.0.0). A 'Save' button is at the bottom.

Figure 4-5 DHCP Settings – Auto

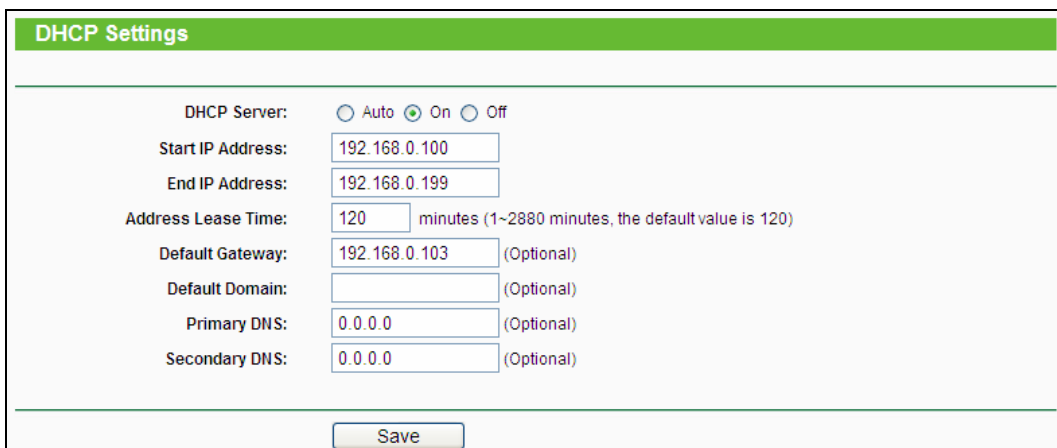

The screenshot shows the 'DHCP Settings' page with a green header. The 'DHCP Server' option is set to 'On' (selected with a radio button). Below it are input fields for 'Start IP Address' (192.168.0.100), 'End IP Address' (192.168.0.199), 'Address Lease Time' (120 minutes), 'Default Gateway' (192.168.0.103), 'Default Domain', 'Primary DNS' (0.0.0.0), and 'Secondary DNS' (0.0.0.0). A 'Save' button is at the bottom.

Figure 4-6 DHCP Settings – On

The screenshot shows the DHCP Settings interface. At the top, there is a green header with the text "DHCP Settings". Below this, there are several configuration fields:

- DHCP Server:** Three radio buttons are present: "Auto", "On", and "Off". The "Off" radio button is selected.
- Start IP Address:** A text input field containing "192.168.0.100".
- End IP Address:** A text input field containing "192.168.0.199".
- Address Lease Time:** A text input field containing "120", followed by the text "minutes (1~2880 minutes, the default value is 120)".
- Default Gateway:** A text input field containing "192.168.0.103" with "(Optional)" to its right.
- Default Domain:** An empty text input field with "(Optional)" to its right.
- Primary DNS:** A text input field containing "0.0.0.0" with "(Optional)" to its right.
- Secondary DNS:** A text input field containing "0.0.0.0" with "(Optional)" to its right.

At the bottom of the form, there is a "Save" button.

Figure 4-7 DHCP Settings – Off

- **DHCP Server** - Selecting the radio button before **Auto/On/Off** will disable/enable the DHCP server on your Range Extender. The default setting is **Auto**. If you disable the Server, you must have another DHCP server within your network or else you must manually configure the computer.
- **Start IP Address** - This field specifies the first address in the IP Address pool. 192.168.0.100 is the default start IP address.
- **End IP Address** - This field specifies the last address in the IP Address pool. 192.168.0.199 is the default end IP address.
- **Address Lease Time** - Enter the amount of time for the PC to connect to the Range Extender with its current assigned dynamic IP address. The time is measured in minutes. After the time is up, the PC will be automatically assigned a new dynamic IP address. The range of the time is 1 ~ 2880 minutes. The default value is 120 minutes.
- **Default Gateway (Optional)** - Enter the IP address of the gateway for your LAN. The factory default setting is 0.0.0.0.
- **Default Domain (Optional)** - Enter the domain name of the your DHCP server. You can leave the field blank.
- **Primary DNS (Optional)** - Enter the DNS IP address provided by your ISP. Consult your ISP if you don't know the DNS value. The factory default setting is 0.0.0.0.
- **Secondary DNS (Optional)** - Enter the IP address of another DNS server if your ISP provides two DNS servers. The factory default setting is 0.0.0.0.

Click **Save** to save the changes.

 **Note:**

To use the DHCP server function of the device, you should configure all computers in the LAN as "Obtain an IP Address automatically" mode. This function will not take effect until the device reboots.

4.3.3 DHCP Client List

Selecting **Network > DHCP Client List** will enable you to view the Client Name, MAC Address, Assigned IP and Lease Time for each DHCP Client attached to the device (Figure 4-8).

DHCP Client List				
ID	Client Name	MAC Address	Assigned IP	Lease Time
1	tplink16461	50-E5-49-C8-E2-7A	192.168.0.101	00:00:51

Figure 4-8 DHCP Clients List

- **ID** - Here displays the index of the DHCP client.
- **Client Name** - Here displays the name of the DHCP client.
- **MAC Address** - Here displays the MAC address of the DHCP client.
- **Assigned IP** - Here displays the IP address that the Range Extender has allocated to the DHCP client.
- **Lease Time** - Here displays the time of the DHCP client leased. Before the time is up, DHCP client will request to renew the lease automatically.

You cannot change any of the values on this page. To update this page and to show the current attached devices, click on the **Refresh** button.

4.4 Wireless

The **Wireless** option, improving functionality and performance for wireless network, can help you make the Range Extender an ideal solution for your wireless network. Here you can create a wireless local area network just through a few settings. Wireless Settings is used for the configuration of some basic parameters of the Range Extender.

There are five submenus under the Wireless menu (shown in Figure 4-9): **Connect To Existing Network**, **Extender Settings**, **Advanced Settings**, **High Speed** and **Wireless Statistics**. Click any of them, and you will be able to configure the corresponding function. The detailed explanations for each submenu are provided below.

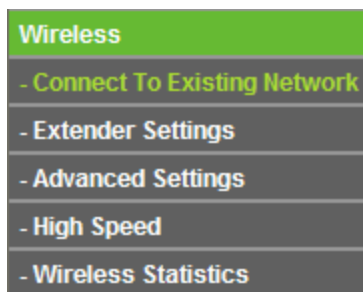

Figure 4-9 Wireless menu

4.4.1 Connect To Existing Network

Selecting **Wireless > Connect To Existing Network** will guide you to set the basic parameters to get a connection to the internet (show in Figure 4-10).

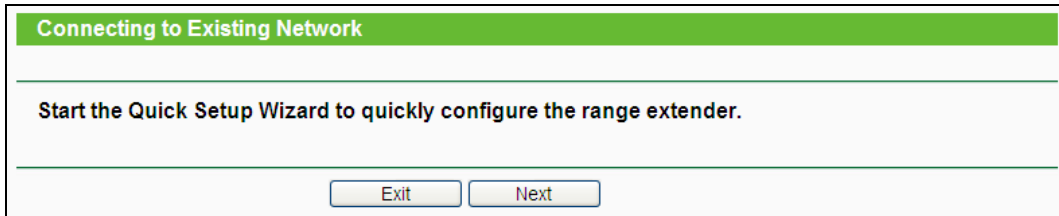

Figure 4-10 Connect to Existing Network

Click the **Next** button to continue, for detailed steps, please refer to [Chapter 3 Quick Installation Guide](#).

Click the **Exit** button to quit.

4.4.2 Extender Settings

Selecting **Wireless > Extender Settings** will enable you to configure the basic settings for your wireless network on the screen below (Figure 4-11)

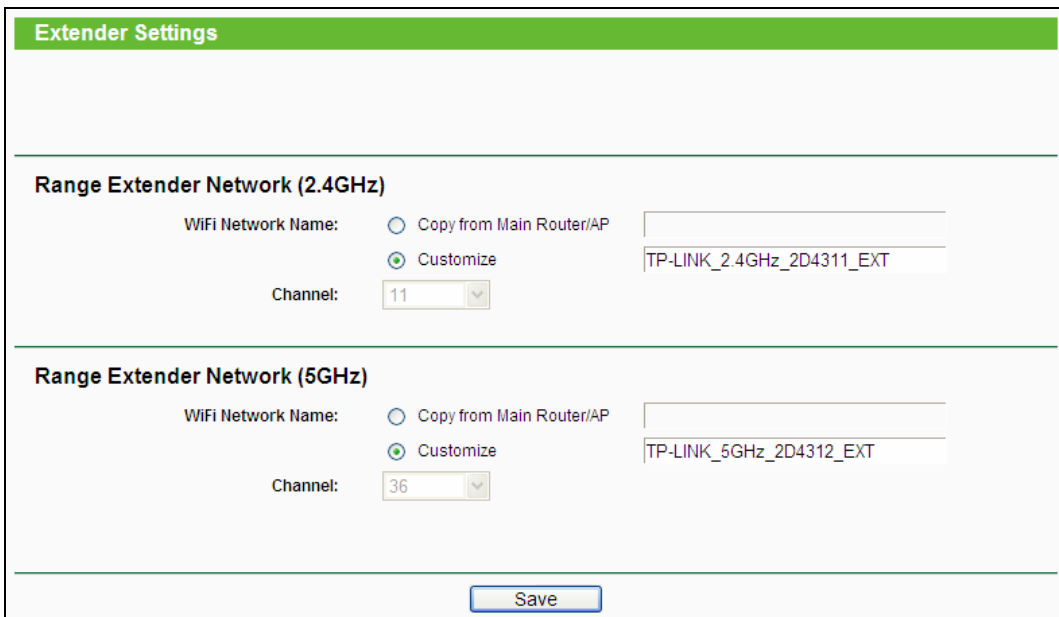

Figure 4-11 Extender Settings

- **WiFi Network Name (2.4GHz or 5GHz)**- The Range Extender's wireless network name (SSID) which your PC or other device can be connected to.
- **Channel** - The current wireless channel in use.

Click **Save** to save the changes.

4.4.3 Advanced Settings

Selecting **Wireless > Advanced Settings** will allow you to do some advanced settings for the device in the following screen shown in Figure 4-12.

Figure 4-12 Extender Settings

- **Beacon Interval** - Specifies a value between 40-1000 milliseconds. The beacons are the packets sent by the device to synchronize a wireless network. Beacon Interval value determines the time interval of the beacons. The default value is 100.
- **RTS Threshold** - Specifies the RTS (Request to Send) Threshold. If the packet is larger than the specified RTS Threshold size, the device will send RTS frames to a particular receiving station and negotiate the sending of a data frame. The default value is 2346.
- **RTS Threshold** - Specifies the RTS (Request to Send) Threshold. If the packet is larger than the specified RTS Threshold size, the device will send RTS frames to a particular receiving station and negotiate the sending of a data frame. The default value is 2346.
- **Fragmentation Threshold** - This value is the maximum size determining whether packets will be fragmented. Setting the Fragmentation Threshold too low may result in poor network performance since excessive packets. 2346 is the default setting and is recommended.
- **DTIM Interval** - Determines the interval of the Delivery Traffic Indication Message (DTIM). You can specify the value between 1-255 Beacon Intervals. The default value is 1, which indicates the DTIM Interval is the same as Beacon Interval.
- **Enable WMM** - WMM function can guarantee the packets with high- priority messages being transmitted preferentially. It is strongly recommended enabled.
- **Enable Short GI** - This function is recommended for it will increase the data capacity by reducing the guard interval time.
- **Enable AP Isolation** - Isolates all connected wireless stations so that wireless stations cannot access each other through WLAN.

4.4.4 High Speed

Selecting **Wireless > High Speed** allows you to configure the wireless mode for your device (show in Figure 4-13).

Figure 4-13 High Speed

- **MAC Address** - Shows the connected wireless station's MAC address.
- **Current Status** - The connected wireless station's running status, one of STA-AUTH / STA-ASSOC / STA-JOINED / WPA / WPA-PSK / WPA2 / WPA2-PSK / AP-UP / AP-DOWN / Disconnected.
- **Dual Band Mode** - Dual Band Mode relays both the 2.4GHz and 5GHz WiFi signal bands at the same time.
- **High Speed Single-Band Modes** - High Speed Single-Band Modes relay only a single WiFi signal band. There are two High Speed Single-Band Modes:
 - Connect to the main router or AP on the 2.4GHz band and connect to your devices on the 5GHz band;
 - Connect to the main router or AP on the 5GHz band and connect to your devices on the 2.4GHz band.

Each band has one CPU. In Single Band Mode, both CPUs are used for the single band communication. Thus, High Speed Single Band Modes are twice as fast as Dual Band Mode.

4.4.5 Wireless Statistics

Selecting **Wireless > Wireless Statistics** will allow you to see the wireless transmission information in the following screen shown in Figure 4-14.

ID	MAC Address	Current Status	Received Packets	Sent Packets
1	60-d9-c7-7b-d0-9b	STA-ASSOC	132	16

Figure 4-14 Wireless Statistics

- **MAC Address** - Shows the connected wireless station's MAC address.

- **Current Status** - The connected wireless station's running status, one of STA-AUTH / STA-ASSOC / STA-JOINED / WPA / WPA-PSK / WPA2 / WPA2-PSK / AP-UP / AP-DOWN / Disconnected.
- **Received Packets** - packets received by the station.
- **Sent Packets** - packets sent by the station.

You cannot change any of the values on this page. To update this page and to show the current connected wireless stations, click the **Refresh** button.

If the numbers of connected wireless stations go beyond one page, click the **Next** button to go to the next page and click the **Previous** button to return the previous page.

 **Note:**

This page will be refreshed automatically every 5 seconds.

4.5 LED On/Off

The **LED On/Off** option will allow you to turn on or off the LED status of your Range Extender (shown in Figure 4-15).

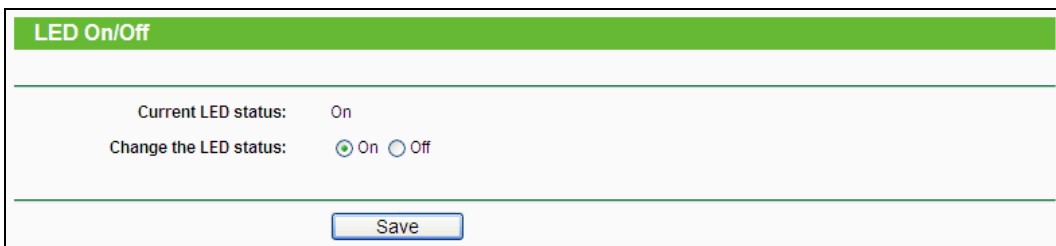

Figure 4-15 LED On/Off

- **LED Status** - Shows if the LED is On or Off.
- **Change the LED Setting** - Switch the LED On or Off.

 **Note:**

Switching the LED On or Off does not affect the extender's performance or function.

4.6 System Tools

System Tools option helps you to optimize the configuration of your device. You can upgrade the Range Extender to the latest version of firmware as well as backup or restore the Range Extender's configuration files. It's suggested that you change the default password to a more secure one because it controls access to the device's web-based management page. Besides, you can find out what happened to the system in System Log.

There are six submenus under the **System Tools** menu (shown as Figure 4-16): **Firmware Upgrade**, **Factory Defaults**, **Backup & Restore**, **Reboot**, **Password**, and **System Log**. Clicking any of them will enable you to configure the corresponding function. The detailed explanations for each submenu are provided below.

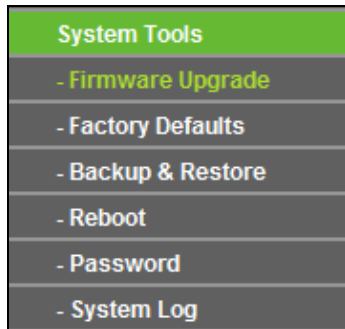

Figure 4-16 The System Tools menu

4.6.1 Firmware Upgrade

Selecting **System Tools** > **Firmware Upgrade** allows you to upgrade the latest version of firmware for the device on the screen shown in Figure 4-17.

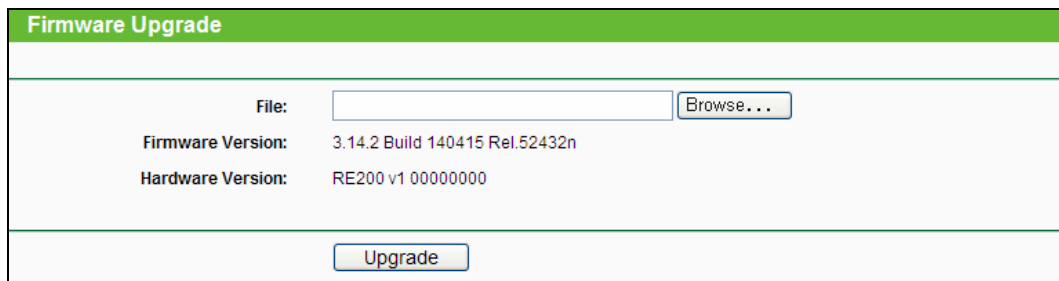

Figure 4-17 Firmware Upgrade

New firmware versions are posted at <http://www.tp-link.com> and can be downloaded for free.

- **Firmware Version** - Here displays the current firmware version.
- **Hardware Version** - Here displays the current hardware version. The hardware version of the upgrade file must accord with the current hardware version.

Note:

1. There is no need to upgrade the firmware unless the new firmware has a new feature you want to use. However, when experiencing problems caused by the device itself, you can try to upgrade the firmware.
2. Before upgrading the device's firmware, you should write down some of your customized settings to avoid losing important configuration settings of device.

To upgrade the device's firmware, follow these instructions:

1. Download a more recent firmware upgrade file from the TP-LINK website (<http://www.tp-link.com>).
2. Enter the path name or click **Browse...** to select the downloaded file on the computer into the **File** blank.
3. Click **Upgrade**.

Note:

Do not turn off the device or press the **Reset** button while the firmware is being upgraded. The device will reboot after the Upgrading has been finished.

4.6.2 Factory Defaults

Selecting **System Tools > Factory Default** allows you to restore the factory default settings for the device on the screen shown in Figure 4-18.

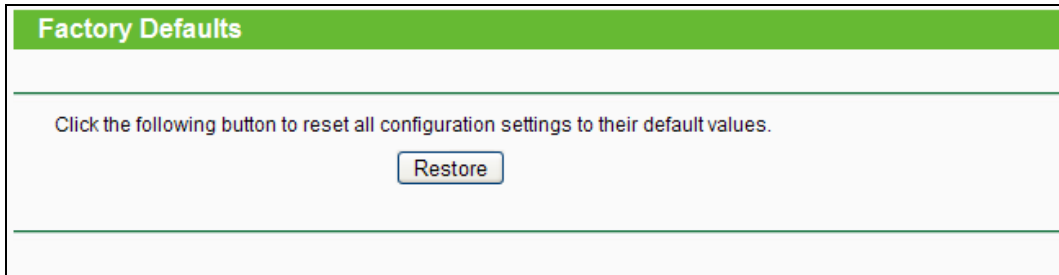

Figure 4-18 Restore Factory Defaults

Click **Restore** to reset all configuration settings to their default values.

- Default **User Name**: admin
- Default **Password**: admin
- Default **IP Address**: 192.168.0.254
- Default **Subnet Mask**: 255.255.255.0

Note:

Any settings you have saved will be lost when the default settings are restored.

4.6.3 Backup & Restore

Selecting **System Tools > Backup & Restore** allows you to save all configuration settings to your local computer as a file or restore the device's configuration on the screen shown in Figure 4-19.

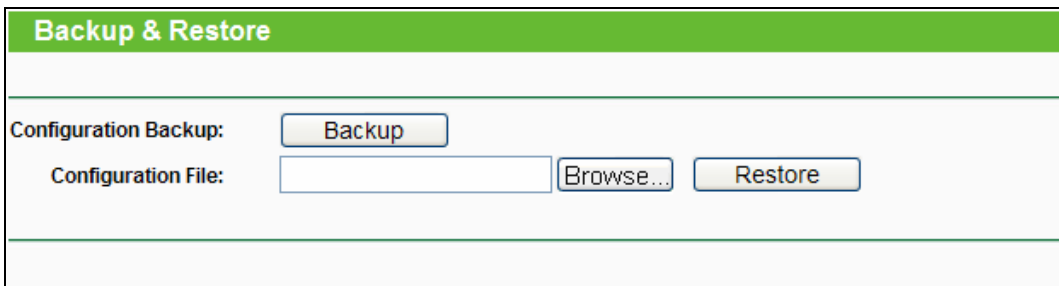

Figure 4-19 Save or Restore the Configuration

Click **Backup** to save all configuration settings to your local computer as a file.

To restore the device's configuration, follow these instructions:

- Click **Browse...** to find the configuration file which you want to restore.
- Click **Restore** to update the configuration with the file whose path is the one you have input or selected in the blank.

Note:

The current configuration will be covered with the uploading configuration file. Wrong process will lead this device unmanaged. The restoring process lasts for 20 seconds and this device will restart automatically then. Keep the power of this device on during the process, in case of any damage.

4.6.4 Reboot

Selecting **System Tools** > **Reboot** allows you to reboot the device on the screen shown in Figure 4-20.

The screenshot shows a web interface with a green header bar containing the word "Reboot". Below the header, there is a white area with the text "Click this button to reboot this device." centered. Below this text is a single button labeled "Reboot".

Figure 4-20 Reboot the device

Click the **Reboot** button to reboot the device.

Some settings of the device will take effect only after rebooting, which include:

- Change LAN IP Address (System will reboot automatically).
- Change the DHCP Settings.
- Change the Wireless configurations.
- Change the Web Management Port.
- Upgrade the firmware of the device (system will reboot automatically).
- Restore the device's settings to factory defaults (system will reboot automatically).
- Update the configuration with a file (system will reboot automatically).

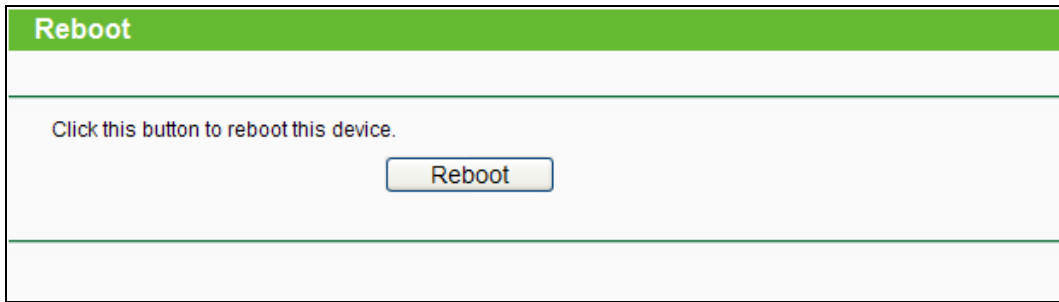
4.6.5 Password

Selecting **System Tools** > **Password** allows you to change the factory default user name and password of the device on the screen shown in Figure 4-21.

The screenshot shows a web interface with a green header bar containing the word "Password". Below the header, there is a white area with a red warning message: "The username and password must not exceed 14 characters in length and must not include any spaces!". Below the warning, there are six input fields arranged in three pairs. The first pair is labeled "Old User Name:" and "Old Password:". The second pair is labeled "New User Name:" and "New Password:". The third pair is labeled "Confirm New Password:". At the bottom of the form, there are two buttons: "Save" and "Clear All".

Figure 4-21 Password

It is strongly recommended that you change the factory default user name and password of the device. All users who try to access the device's web-based management page or Quick Setup will be prompted for the device's user name and password.

Note:

The new user name and password must not exceed 14 characters in length and must not include any spaces. Enter the new Password twice to confirm it.

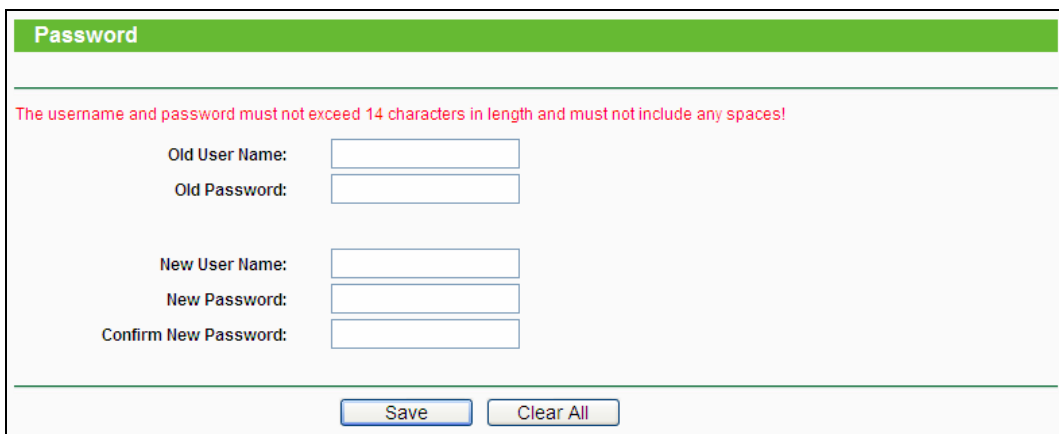
Click **Save** when finished.

Click **Clear All** to clear all.

4.6.6 System Log

Selecting **System Tools > System Log** allows you to query the Logs of the device on the screen shown in Figure 4-22.

The screenshot shows the 'System Log' interface. At the top, there is a green header with the text 'System Log'. Below the header, there are several controls: 'Auto Mail Feature: Disabled' with a 'Mail Settings' button, 'Log Type: All' dropdown, and 'Log Level: ALL' dropdown. A table displays log entries with columns for Index, Time, Type, Level, and Log Content. Below the table, there is a 'Time = 0:04:46 287s' indicator, version and build information ('H-Ver = RE200 v1 00000000 : S-Ver = 3.14.2 Build 140526 Rel.55316n'), IP address information ('L = 192.168.0.254 : M = 255.255.255.0'), and DHCP status ('W1 = DHCP : W = 0.0.0.0 : M = 0.0.0.0 : G = 0.0.0.0'). At the bottom, there are buttons for 'Refresh', 'Save Log', 'Mail Log', and 'Clear Log'. A pagination bar at the very bottom includes 'Previous', 'Next', 'Current No. 1', and 'Page'.

Index	Time	Type	Level	Log Content
3	1st day 00:04:45	DHCP	NOTICE	DHCP server started
2	1st day 00:04:45	OTHER	WARNING	LAN IP and mask changed to 192.168.0.254 255.255.255.0
1	1st day 00:04:29	OTHER	INFO	User clear system log.

Figure 4-22 System Log

The device can keep logs of all traffic. You can query the logs to find what happened to the device.

- **Log Type** - By selecting the log type, only logs of this type will be shown.
- **Log Level** - By selecting the log level, only logs of this level will be shown.

Click the **Refresh** button to show the latest log list.

Click the **Save Log** button to save all the logs in a txt file.

Click the **Mail Log** button to send an email of current logs manually according to the address and validation information set in Mail Settings. The result will be shown in the later log soon.

Click the **Clear Log** button to delete all the logs from the system permanently, not just from the page.

Click the **Next** button to go to the next page, or click the **Previous** button return to the previous page.

Appendix A: Factory Defaults

Item	Default Value
Common Default Settings	
Username	admin
Password	admin
IP Address	192.168.0.254
Subnet Mask	255.255.255.0
Domain	http://tplinkextender.net
Wireless	
SSID	TP-LINK_Extender_2.4GHz, TP-LINK_Extender_5GHz
Wireless Security	Disabled
Wireless MAC Address Filtering	Disabled

Appendix B: Troubleshooting

T1. How do I restore my Range Extender's configuration to its factory default settings?

There are TWO methods available to restore the factory defaults.

Method 1:

With the Range Extender RE200 powered on, use a pin to press the **RESET** button on the rear panel for 1 second before releasing it.

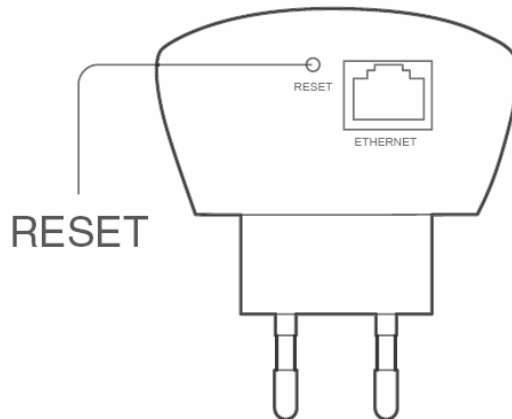

Method 2:

Get logged in to the web-based management page of RE200, then go to “**System Tools** -> **Factory Defaults**” and click “**Restore**”.

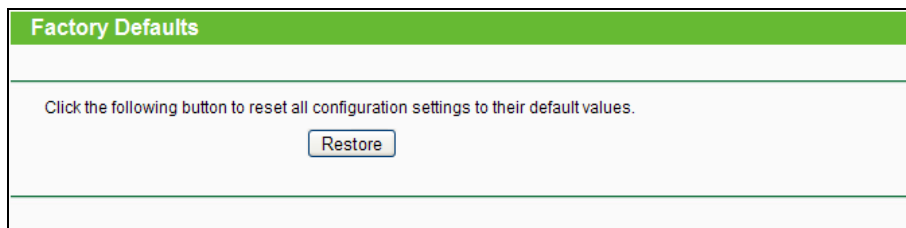

Note:

Once the Range Extender is reset, the current configuration settings will be lost and you will need to reconfigure it.

T2. What can I do if I forget my password?

- 1) Restore the Range Extender's configuration to its factory default settings. If you don't know how to do that, please refer to previous **T1**;
- 2) Use the default user name and password: **admin, admin**;
- 3) Try to reconfigure your Range Extender by following the instructions of this UG.

T3. What can I do if I cannot access the web-based configuration page?

- 1) Check to verify all the connections (either wireless or wired ones) are proper. If yes, please proceed to the next step; otherwise, check the connections again.
- 2) Try to obtain an IP address and gateway; if succeed, open your web-browser, enter the default domain <http://tplinkextender.net> in the address field and get logged in.

If you are unable to log in, please **RESET** the device, and then use the default IP address to get into the web-based configuration page, reconfigure the device.

- 3) Feel free to contact our technical support, if the problem still persists.

T4. How can I know that my wireless signal has been repeated and boosted by RE200?

An easy way is to compare the signal strength of your target wireless network (symbolized by its SSID), with RE200 in operation vs. out of operation. Before comparison, you'd better make sure your computer can obtain an IP address from your target wireless network and thus access the Internet, either via RE200 or without.

T5. Will the Range Extender work if I connect the ETHERNET port of it to the router via Ethernet cable?

Sorry, it won't work. The Range Extender is designed to connect wirelessly to the router, while the ETHERNET port is designed to connect with a wired device, like Internet TV, Gaming console, DVR and so on.

T6. Why does the wireless transmission rate speed down, while the wireless signal is stronger after repeated by RE200?

In compliance with the wireless transmission protocol, all the Range Extender devices are set to work in half-duplex instead of full-duplex mode. In other words, the Range Extender has to process one-way communication between your root Wireless Router or AP and the terminal clients; so the transmission time will be double-increased, while the speed will be decreased. TP-LINK recommends that you connect to the Range Extender when your home network connection is poor, or when you want a larger wireless coverage to eliminate "dead zones".

Appendix C: Specifications

General	
Standards and Protocols	IEEE 802.3, 802.3u, 802.11ac, 802.11n, 802.11b and 802.11g, TCP/IP, DHCP
Safety & Emission	CE
Ports	One 10/100M Auto-Negotiation LAN RJ45 port
Wireless	
Frequency Band	2.4~2.4835GHz, 5.15-5.25GHz, 5.725-5.85GHz
Radio Data Rate	11ac: up to 433Mbps (Automatic) 11n: up to 300Mbps (Automatic) 11g: 54/48/36/24/18/12/9/6M (Automatic) 11b: 11/5.5/2/1M (Automatic)
Frequency Expansion	DSSS (Direct Sequence Spread Spectrum)
Modulation	DBPSK, DQPSK, CCK, OFDM, 16-QAM, 64-QAM
Security	WEP, WPA-PSK, WPA2-PSK
Sensitivity @PER	270M: -68dBm@10% PER 108M: -68dBm@10% PER; 54M: -68dBm@10% PER 11M: -85dBm@8% PER; 6M: -88dBm@10% PER 1M: -90dBm@8% PER
Physical and Environment	
Working Temperature	0°C~40°C (32°F~104°F)
Working Humidity	10% ~ 90% RH, Non-condensing
Storage Temperature	-40°C~70°C(-40°F~158°F)
Storage Humidity	5% ~ 95% RH, Non-condensing

Appendix D: Glossary

- **802.11ac** - IEEE 802.11ac is a wireless computer networking standard of 802.11. This specification will enable multi-station WLAN throughput of at least 1 gigabit per second. This is accomplished by extending the air interface concepts embraced by 802.11n: wider RF bandwidth, more MIMO spatial streams, multi-user MIMO, and high-density modulation (up to 256 QAM).
- **802.11n** - 802.11n builds upon previous 802.11 standards by adding MIMO (multiple-input multiple-output). MIMO uses multiple transmitter and receiver antennas to allow for increased data throughput via spatial multiplexing and increased range by exploiting the spatial diversity, perhaps through coding schemes like Alamouti coding. The Enhanced Wireless Consortium (EWC) was formed to help accelerate the IEEE 802.11n development process and promote a technology specification for interoperability of next-generation wireless local area networking (WLAN) products.
- **802.11b** - The 802.11b standard specifies a wireless networking at 11 Mbps using direct-sequence spread-spectrum (DSSS) technology and operating in the unlicensed radio spectrum at 2.4GHz, and WEP encryption for security. 802.11b networks are also referred to as Wi-Fi networks.
- **802.11g** - specification for wireless networking at 54 Mbps using direct-sequence spread-spectrum (DSSS) technology, using OFDM modulation and operating in the unlicensed radio spectrum at 2.4GHz, and backward compatibility with IEEE 802.11b devices, and WEP encryption for security.
- **Access Point (Range Extender)** - A wireless LAN transceiver or "base station" that can connect a wired LAN to one or many wireless devices. Access points can also bridge to each other.
- **DNS (Domain Name System)** – An Internet Service that translates the names of websites into IP addresses.
- **Domain Name** - A descriptive name for an address or group of addresses on the Internet.
- **DoS (Denial of Service)** - A hacker attack designed to prevent your computer or network from operating or communicating.
- **DSL (Digital Subscriber Line)** - A technology that allows data to be sent or received over existing traditional phone lines.
- **ISP (Internet Service Provider)** - A company that provides access to the Internet.
- **MTU (Maximum Transmission Unit)** - The size in bytes of the largest packet that can be transmitted.
- **SSID** - A **S**ervice **S**et **I**dentification is a thirty-two character (maximum) alphanumeric key identifying a wireless local area network. For the wireless devices in a network to communicate with each other, all devices must be configured with the same SSID. This is typically the configuration parameter for a wireless PC card. It corresponds to the ESSID in the wireless Access Point and to the wireless network name.
- **WEP (Wired Equivalent Privacy)** - A data privacy mechanism based on a 64-bit or 128-bit or 152-bit shared key algorithm, as described in the IEEE 802.11 standard.

- **Wi-Fi** –A trademark of the Wi-Fi Alliance and the brand name for products using the IEEE 802.11 family of standards.
- **WLAN (Wireless Local Area Network)** - A group of computers and associated devices communicate with each other wirelessly, which network serving users are limited in a local area.
- **WPA (Wi-Fi Protected Access)** - WPA is a security technology for wireless networks that improves on the authentication and encryption features of WEP (Wired Equivalent Privacy). In fact, WPA was developed by the networking industry in response to the shortcomings of WEP. One of the key technologies behind WPA is the Temporal Key Integrity Protocol (TKIP). TKIP addresses the encryption weaknesses of WEP. Another key component of WPA is built-in authentication that WEP does not offer. With this feature, WPA provides roughly comparable security to VPN tunneling with WEP, with the benefit of easier administration and use. This is similar to 802.1x support and requires a RADIUS server in order to implement. The Wi-Fi Alliance will call this, WPA-Enterprise. One variation of WPA is called WPA Pre Shared Key or WPA-Personal for short - this provides an authentication alternative to an expensive RADIUS server. WPA-Personal is a simplified but still powerful form of WPA most suitable for home Wi-Fi networking. To use WPA-Personal, a person sets a static key or "passphrase" as with WEP. But, using TKIP, WPA-Personal automatically changes the keys at a preset time interval, making it much more difficult for hackers to find and exploit them. The Wi-Fi Alliance will call this, WPA-Personal.