

## FCC 47 CFR PART 15 SUBPART E

Product Type : AC1900 Touch Screen Wi-Fi Gigabit Router  
Applicant : TP-LINK TECHNOLOGIES CO., LTD.  
Address : Building 24 (floors 1,3,4,5) and 28 (floors1-4) Central Science and Technology Park,Shennan Rd, Nanshan, Shenzhen,China  
Trade Name : TP-LINK  
Model Number : Touch P5  
Test Specification : FCC 47 CFR PART 15 SUBPART E: Oct., 2014  
ANSI C63.10-2013  
Application Purpose : Original  
Receive Date : Jun. 08, 2015  
Test Period : Jun. 23 ~ Aug. 17, 2015  
Issue Date : Oct. 23, 2015

### Issue by

A Test Lab Techno Corp.  
No. 140-1, Changan Street, Bade City,  
Taoyuan County 334, Taiwan R.O.C.  
Tel : +86-3-2710188 / Fax : +86-3-2710190



Taiwan Accreditation Foundation accreditation number: 1330

**Note:** This report shall not be reproduced except in full, without the written approval of A Test Lab Techno Corp. This document may be altered or revised by A Test Lab Techno Corp. personnel only, and shall be noted in the revision section of the document. The client should not use it to claim product endorsement by TAF, or any government agencies. The test results in the report only apply to the tested sample.

**Revision History**

Rev.	Issue Date	Revisions	Revised By
00	Aug. 27, 2015	Initial Issue	
01	Sep. 16, 2015	Revised report information.	Peggy Chang
02	Oct. 23, 2015	Revised report information.	Peggy Chang

## Verification of Compliance

Issued Date: 10/23/2015

Product Type : AC1900 Touch Screen Wi-Fi Gigabit Router  
Applicant : TP-LINK TECHNOLOGIES CO., LTD.  
Address : Building 24 (floors 1,3,4,5) and 28 (floors1-4) Central Science and Technology Park,Shennan Rd, Nanshan, Shenzhen,China  
Trade Name : TP-LINK  
Model Number : Touch P5  
FCC ID : TE7P5  
EUT Rated Voltage : DC 12V, 3.3A  
Test Voltage : 120 Vac / 60 Hz  
Applicable Standard : FCC 47 CFR PART 15 SUBPART E: Oct., 2014  
ANSI C63.10-2013  
  
Test Result : Complied  
Application Purpose : Original  
Performing Lab. : A Test Lab Techno Corp.

No. 140-1, Changan Street, Bade City,  
Taoyuan County 334, Taiwan R.O.C.  
Tel : +86-3-2710188 / Fax : +86-3-2710190



Taiwan Accreditation Foundation accreditation number: 1330

<http://www.atl-lab.com.tw/e-index.htm>

A Test Lab Techno Corp. tested the above equipment in accordance with the requirements set forth in the above standards. All indications of Pass/Fail in this report are opinions expressed by A Test Lab Techno Corp. based on interpretations and/or observations of test results. Measurement Uncertainties were not taken into account and are published for informational purposes only. The test results show that the equipment tested is capable of demonstrating compliance with the requirements as documented in this report.

Approved By : Fly Lu (Manager)      Reviewed By : Eric Ou Yang (Testing Engineer)

## TABLE OF CONTENTS

<b>1</b>	<b>General Information.....</b>	<b>6</b>
	1.1. Summary of Test Result.....	6
	1.2. Measurement Uncertainty.....	6
<b>2</b>	<b>EUT Description .....</b>	<b>7</b>
<b>3</b>	<b>Test Methodology .....</b>	<b>8</b>
	3.1. Mode of Operation .....	8
	3.2. EUT Exercise Software.....	12
	3.3. Configuration of Test System Details.....	13
	3.4. Test Site Environment.....	14
<b>4</b>	<b>AC Power Conducted Emission Measurement.....</b>	<b>15</b>
	4.1. Limit .....	15
	4.2. Test Instruments.....	15
	4.3. Test Setup .....	15
	4.4. Test Procedure.....	16
	4.5. Test Result .....	17
<b>5</b>	<b>Radiated Emission Measurement .....</b>	<b>19</b>
	5.1. Limit .....	19
	5.2. Test Instruments.....	19
	5.3. Setup.....	20
	5.4. Test Procedure.....	22
	5.5. Test Result .....	24
<b>6</b>	<b>Maximum Conducted Output Power Measurement .....</b>	<b>46</b>
	6.1. Limit .....	46
	6.2. Test Setup .....	46
	6.3. Test Instruments.....	46
	6.4. Test Procedure.....	46
	6.5. Test Result .....	47
<b>7</b>	<b>26dB RF Bandwidth &amp; 99 % Occupied Bandwidth Measurement.....</b>	<b>50</b>
	7.1. Limit .....	50
	7.2. Test Setup .....	50
	7.3. Test Instruments.....	50
	7.4. Test Procedure.....	50
	7.5. Test Result .....	51
	7.6. Test Graphs.....	55

<b>8</b>	<b>Peak Power Spectral Density Measurement .....</b>	<b>70</b>
8.1.	Limit .....	70
8.2.	Test Setup .....	70
8.3.	Test Instruments.....	70
8.4.	Test Procedure.....	70
8.5.	Test Result .....	71
8.6.	Test Graphs.....	75
<b>9</b>	<b>Frequency Stability Measurement .....</b>	<b>96</b>
9.1.	Limit .....	96
9.2.	Test Setup .....	96
9.3.	Test Instruments.....	96
9.4.	Test Procedure.....	97
9.5.	Test Result .....	97
<b>10</b>	<b>Antenna Requirement.....</b>	<b>101</b>
10.1.	Limit .....	101
10.2.	Antenna Connector Construction.....	101

## 1 General Information

### 1.1. Summary of Test Result

Standard	Item	Result	Remark
FCC			
15.407(b)(6) 15.207	AC Power Conducted Emission	PASS	---
15.407(b) 15.205 / 15.209	Transmitter Radiated Emissions	PASS	---
15.407(a)	Maximum Conducted Output Power	PASS	---
15.407(a)	26dB RF Bandwidth	Reference	---
15.407(a)	6dB RF Bandwidth	PASS	----
15.407(a)	Peak Power Spectral Density	PASS	---
15.407(g)	Frequency Stability	PASS	---
15.407(a) 15.203	Antenna Requirement	PASS	---

The test results of this report relate only to the tested sample(s) identified in this report. Manufacturer or whom it may concern should recognize the pass or fail of the test result.

### 1.2. Measurement Uncertainty

Measurement Item	Frequency Range	Uncertainty (dB)	
Conducted Emission	9kHz ~ 30MHz	± 2.020	
Radiated Emission	30MHz ~ 1000MHz	Horizontal	± 3.960
		Vertical	± 3.570
	1000MHz ~ 18000MHz	Horizontal	± 3.072
		Vertical	± 3.028
	18000MHz ~ 40000MHz	Horizontal	± 3.622
		Vertical	± 3.506

## 2 EUT Description

Product Type	AC1900 Touch Screen Wi-Fi Gigabit Router				
Trade Name	TP-LINK				
Model No.	Touch P5				
Applicant	TP-LINK TECHNOLOGIES CO., LTD. Building 24 (floors 1,3,4,5) and 28 (floors1-4) Central Science and Technology Park,Shennan Rd, Nanshan, Shenzhen,China				
Manufacturer	TP-LINK TECHNOLOGIES CO., LTD. Building 24 (floors 1,3,4,5) and 28 (floors1-4) Central Science and Technology Park,Shennan Rd, Nanshan, Shenzhen,China				
FCC ID	TE7P5				
Operate Freq. Band	Frequency Range (MHz)	Band	Channel Bandwidth	Number of Channels	Data Rate
IEEE 802.11a	5180 – 5240	U-NII Band I	20MHz	3	Up to 54Mbps
IEEE 802.11n 20 MHz	5180 – 5240	U-NII Band I	20MHz	3	Up to 216.7Mbps
IEEE 802.11n 40 MHz	5190 – 5230	U-NII Band I	40MHz	2	Up to 450Mbps
IEEE 802.11ac 20 MHz	5180 – 5240	U-NII Band I	20MHz	3	Up to 260.1Mbps
IEEE 802.11ac 40 MHz	5190 – 5230	U-NII Band I	40MHz	2	Up to 600Mbps
IEEE 802.11ac 80 MHz	5210	U-NII Band I	80MHz	1	Up to 1299.9Mbps
Modulation Type	OFDM				
Antenna Type	Omni Directional Antenna				
Antenna Max. Gain	2 dBi				
Antenna Delivery	3TX + 3RX				
RF Output Power	IEEE 802.11a	U-NII Band I:	0.454 W / 26.57 dBm		
	IEEE 802.11ac 20 MHz	U-NII Band I:	0.479 W / 26.81 dBm		
	IEEE 802.11ac 40 MHz	U-NII Band I:	0.855 W / 29.32 dBm		
	IEEE 802.11ac 80 MHz	U-NII Band I:	0.095 W / 19.79 dBm		
	Beamforming on				
	IEEE 802.11ac 20 MHz	U-NII Band I:	0.278 W / 24.44 dBm		
	IEEE 802.11ac 40 MHz	U-NII Band I:	0.485 W / 26.86 dBm		
IEEE 802.11ac 80 MHz	U-NII Band I:	0.055 W / 17.40 dBm			
Frequency stability specification	± 20 ppm				
Temperature Range	0 ~ 40 °C				
Component List					
Power adapter	Trade Name	Ten Pao		Model Number	S048CU1200330
	I/P: 100-240VAC, 50/60Hz, 1.5A				
	O/P: 12.0VDC, 3300mA				
	Cable out: Non-Shielded, 1.5m, Non-Detachable at Power Adapter				

### 3 Test Methodology

#### 3.1. Mode of Operation

Decision of Test ATL has verified the construction and function in typical operation. All the test modes were carried out with the EUT in normal operation, which was shown in this test report and defined as:

Test Mode
Mode 1: Normal Operation Mode
Mode 2: IEEE 802.11a Link Mode
Mode 3: IEEE 802.11ac 20MHz Link Mode
Mode 4: IEEE 802.11ac 40MHz Link Mode
Mode 5: IEEE 802.11ac 80MHz Link Mode

Software used to control the EUT for staying in continuous transmitting mode was programmed.

After verification, all tests were carried out with the worst case test modes as shown below except radiated spurious emission below 1GHz and power line conducted emissions below 30MHz, which worst case was in normal link mode only.

Note: U-NII Band III 20MHz / 40MHz are only evaluated ac mode.

Test Mode	Band	Data Rate	Test Channel
IEEE 802.11a Link Mode	U-NII Band I	6M	36, 40, 48
IEEE 802.11ac 20MHz Link Mode	U-NII Band I	19.5M	36, 40, 48
IEEE 802.11ac 40MHz Link Mode	U-NII Band I	40.5M	38, 46
IEEE 802.11ac 80MHz Link Mode	U-NII Band I	87.9M	42



**Duty cycle**

Test Mode	Frequency (MHz)	on time (ms)	on+off time (ms)	Duty cycle	Duty Factor (dB)	1/T Minimum VBW (kHz)
Mode 2: IEEE 802.11a Link Mode	5180.0	2.088	2.163	0.965	0.153	0.479
Mode 3: IEEE 802.11ac 20MHz Link Mode	5180.0	0.713	0.775	0.919	0.365	1.404
Mode 4: IEEE 802.11ac 40MHz Link Mode	5190.0	0.380	0.450	0.844	0.734	2.632
Mode 5: IEEE 802.11ac 80MHz Link Mode	5210.0	0.210	0.220	0.955	0.202	4.762

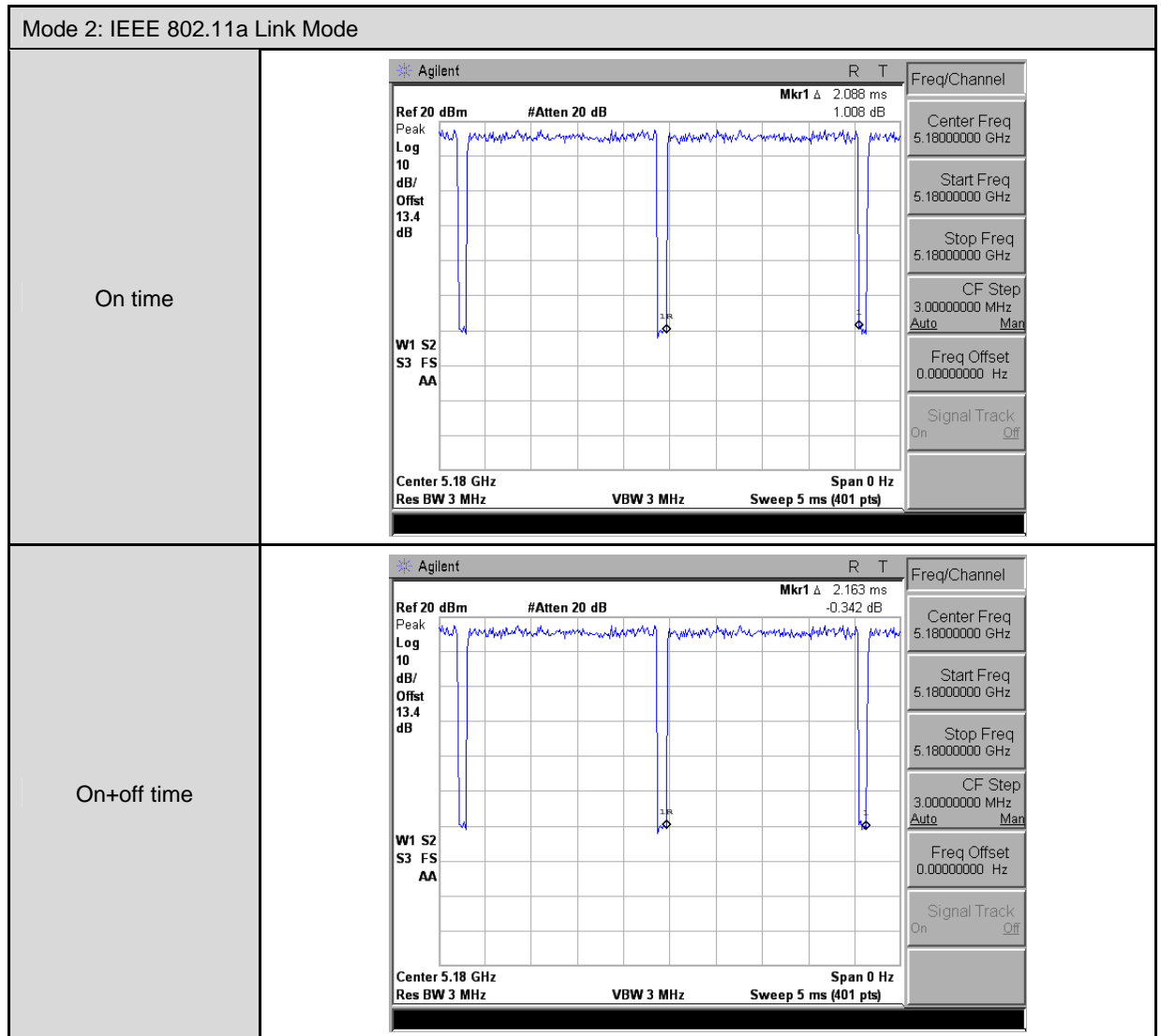
**Duty Cycle Graphs**





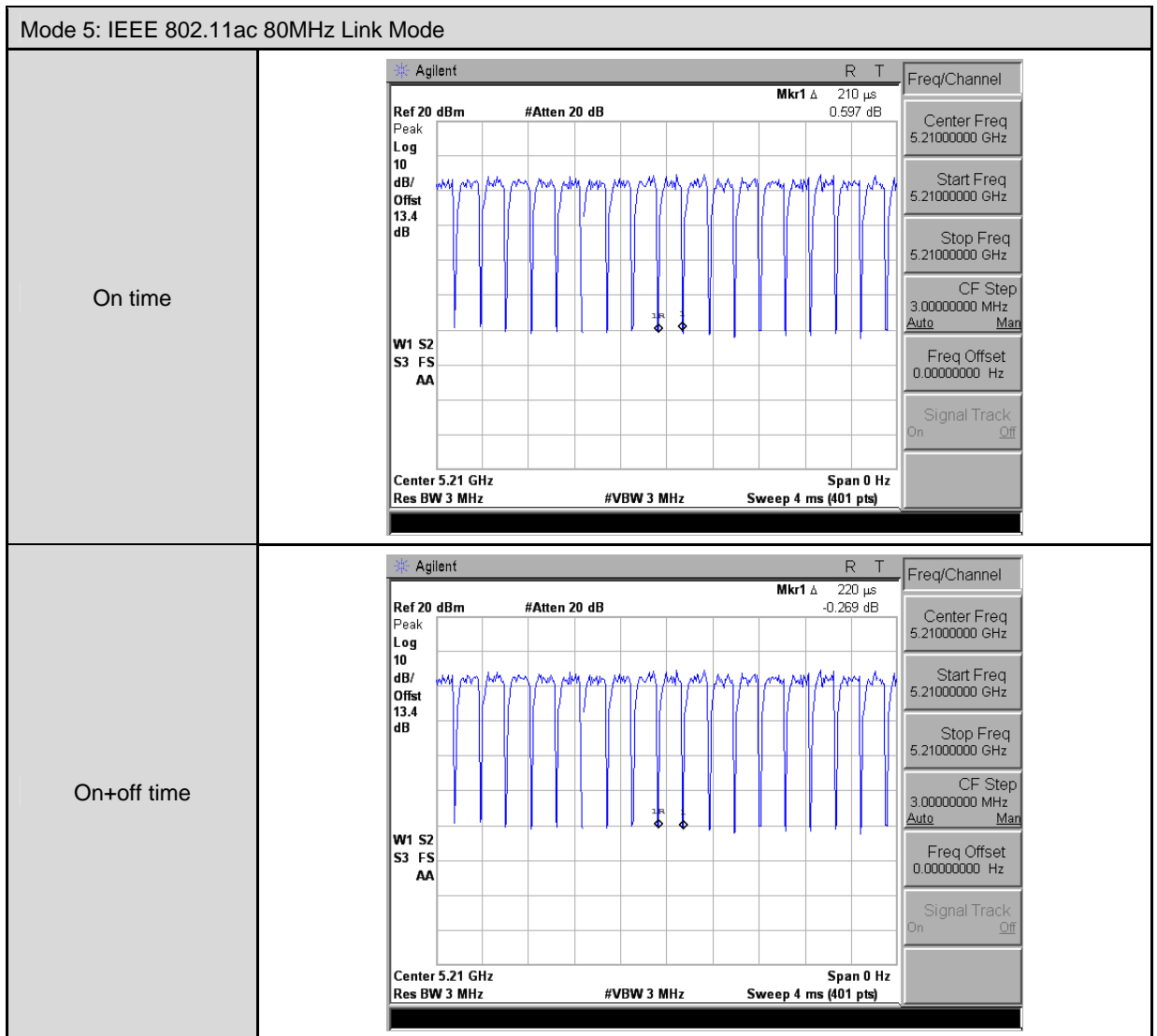

### 3.2. EUT Exercise Software

The EUT is operated in the engineering mode to fix the TX frequency for the purposes of measurement. According to its specifications, the EUT must comply with the requirements of Section 15.407 under the FCC Rules Part 15 Subpart E.

1.	Setup the EUT shown on 3.3.
2.	Turn on the power of all equipment.
3.	Turn on Wi-Fi function link to Notebook.
4.	EUT run test program.

### 3.3. Configuration of Test System Details

Conducted Emission

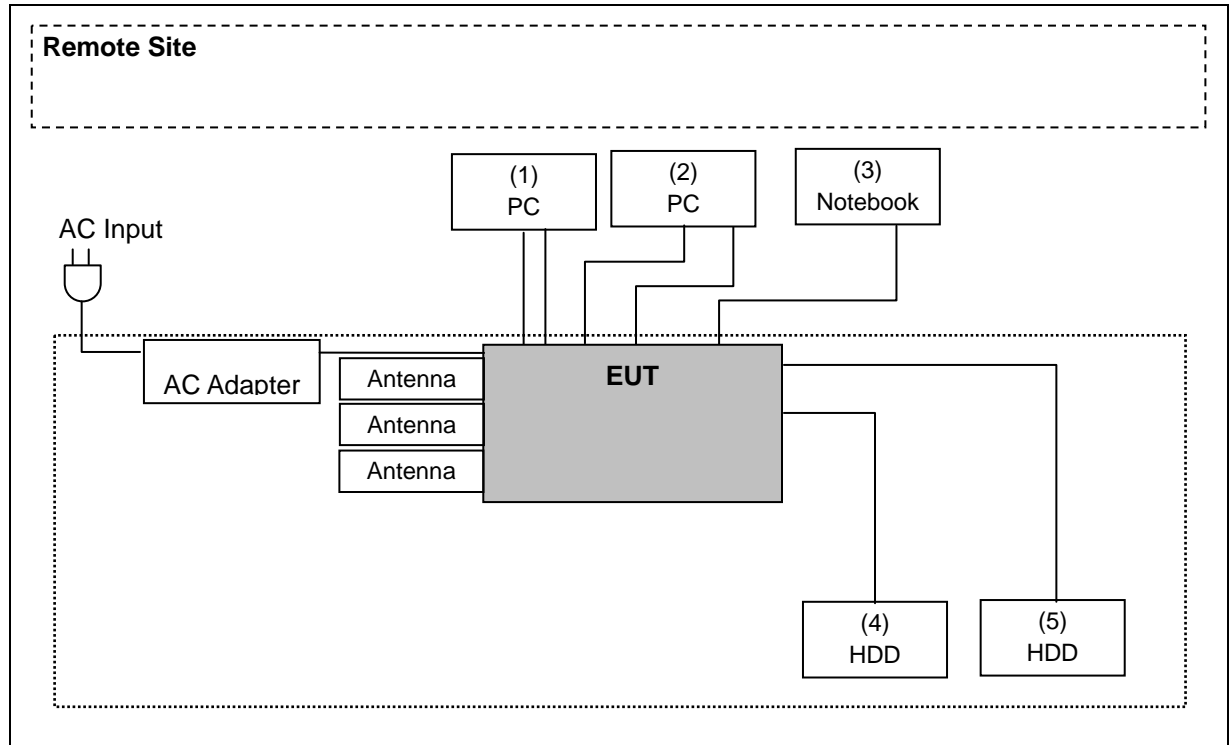

Devices Description					
	Product	Manufacturer	Model Number	Serial Number	Power Cord
(1)	PC	DELL	T3610	F5XBW02	Non-Shielded, 1.8m
(2)	PC	DELL	9020	HJMBW02	Non-Shielded, 1.8m
(3)	Notebook	DELL	LAPTITU	6699565657	Non-Shielded, 0.8m
(4)	HDD	My passport	WDBKXH5000ABK-03	SN:WX71A8241990	Power by EUT
(5)	HDD	My passport	WDBKXH5000ABK-03	SN:WX51A92W7432	Power by EUT

Radiated Emission

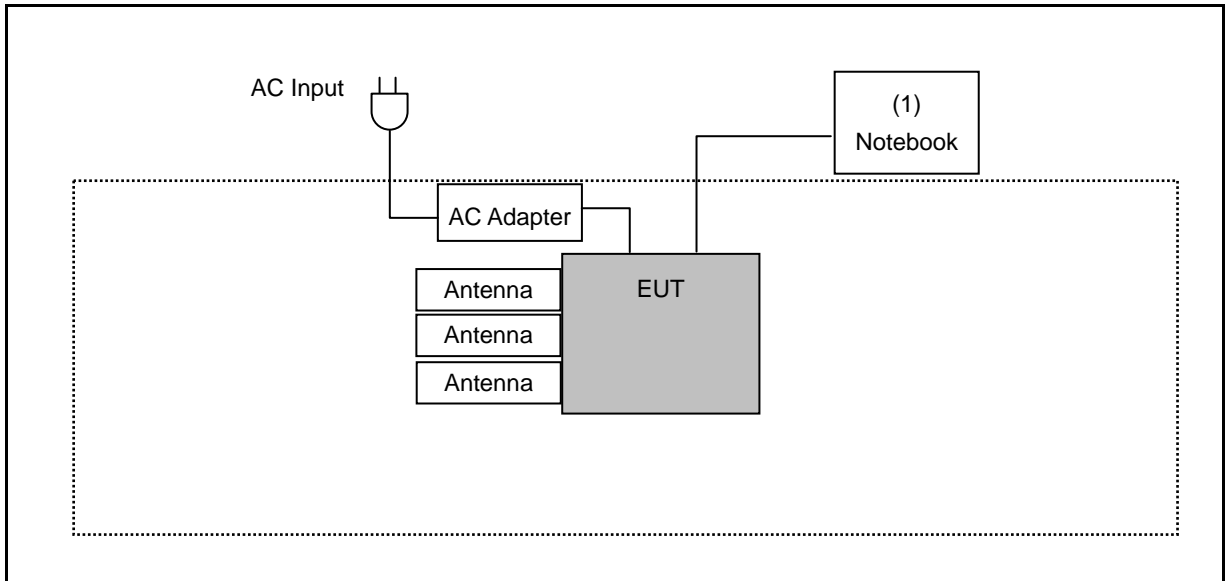

Devices Description					
Product	Manufacturer	Model Number	Serial Number	Power Cord	
(1)	Notebook	DELL	LAPTITU	6699565657	Non-Shielded, 0.8m

**3.4. Test Site Environment**

Items	Required (IEC 60068-1)	Actual
Temperature (°C)	15-35	26
Humidity (%RH)	25-75	60
Barometric pressure (mbar)	860-1060	950

## 4 AC Power Conducted Emission Measurement

### 4.1. Limit

Frequency (MHz)	Quasi-peak	Average
0.15 - 0.5	66 to 56	56 to 46
0.50 - 5.0	56	46
5.0 - 30.0	60	50

### 4.2. Test Instruments

Describe	Manufacturer	Model Number	Serial Number	Cal. Date	Remark
Test Receiver	R&S	ESCI	100367	06/25/2015	(1)
LISN	R&S	ENV216	101040	03/10/2015	(1)
LISN	R&S	ENV216	101041	03/06/2015	(1)
Test Site	ATL	TE05	TE05	N.C.R.	-----

Remark: (1) Calibration period 1 year. (2) Calibration period 2 years.

Note: N.C.R. = No Calibration Request.

### 4.3. Test Setup

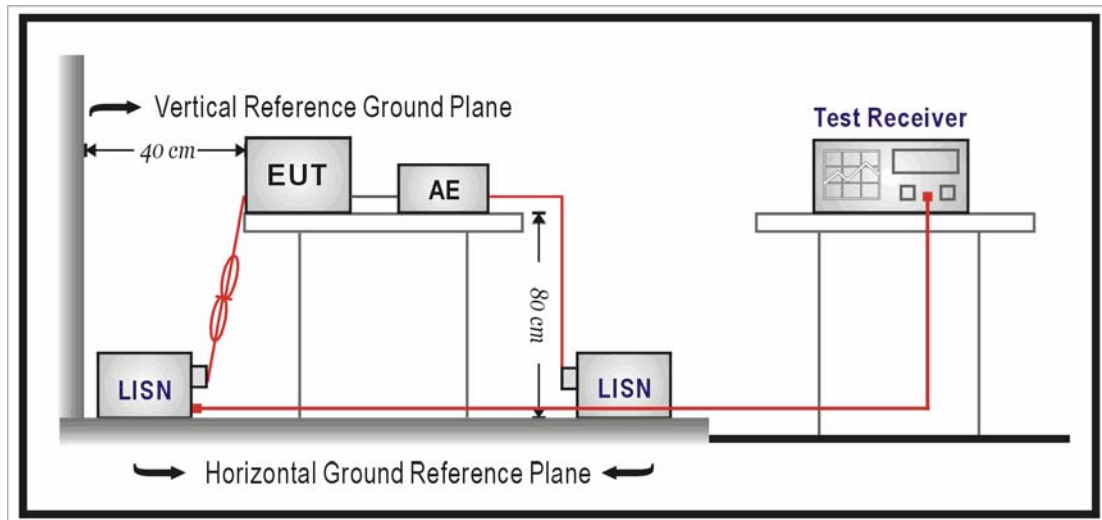

#### **4.4. Test Procedure**

The power line conducted emission measurements were performed in a shielded enclosure. The EUT was assembled on a wooden table which is 80 centimeters high, was placed 40 centimeters from the back wall and at least 1 meter from the sidewall.

Power was fed to the EUT from the public utility power grid through a line filter and EMCO Model 3162/2 SH Line Impedance Stabilization Networks (LISN). The LISN housing, measuring instrumentation case, ground plane, etc., were electrically bonded together at the same RF potential. The Spectrum analyzer was connected to the AC line through an isolation transformer. The 50-ohm output of the LISN was connected to the spectrum analyzer directly. Conducted emission levels were in the CISPR quasi-peak detection mode. The analyzer's 6 dB bandwidth was set to 9 KHz. No post-detector video filter was used.

The spectrum was scanned from 150 KHz to 30 MHz. The physical arrangement of the test system and associated cabling was varied (within the scope of arrangements likely to be encountered in actual use) to determine the effect on the unit's emanations in amplitude and frequency. All spurious emission frequencies were observed. The highest emission amplitudes relative to the appropriate limit were measured and have been recorded in paragraph 4.1.



#### 4.5. Test Result

Standard:	FCC Part 15E	Line:	L1
Test item:	Conducted Emission	Power:	AC 120V/60Hz
Model Number:	Touch P5	Temp.(°C)/Hum.(%RH):	26(°C)/60%RH
Test Mode:	Mode 1	Date:	06/28/2015
		Test By:	Eric Ou Yang

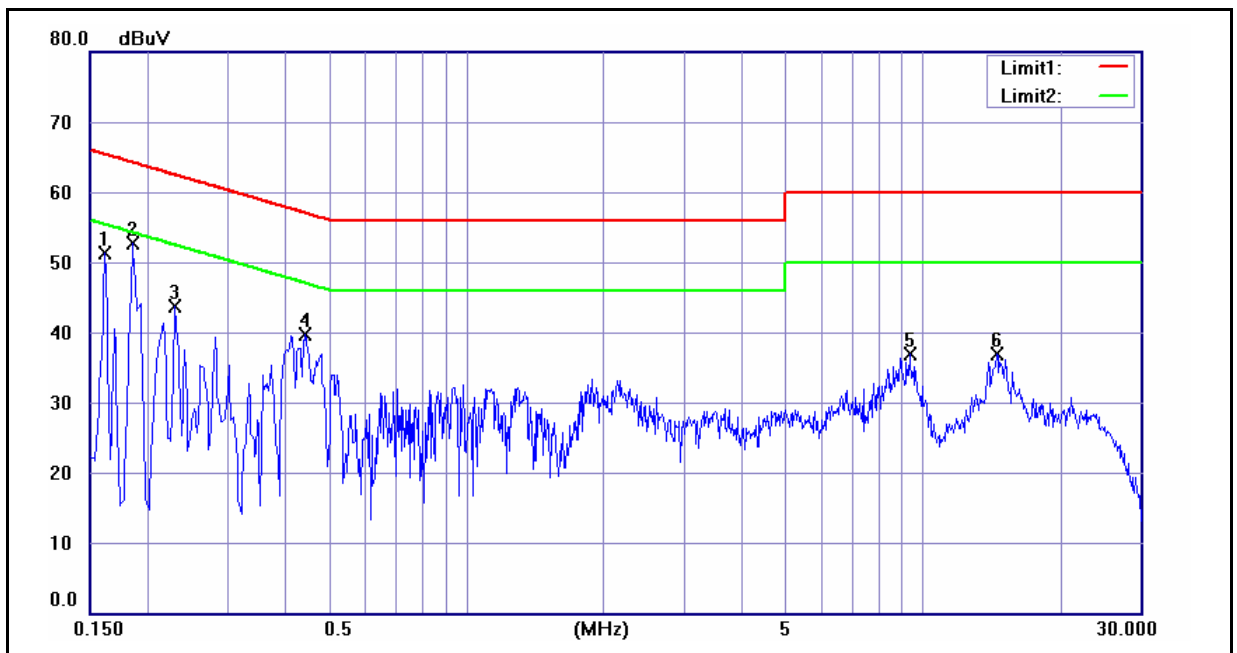

No.	Frequency (MHz)	QP reading (dBuV)	AVG reading (dBuV)	Correction factor (dB)	QP result (dBuV)	AVG result (dBuV)	QP limit (dBuV)	AVG limit (dBuV)	QP margin (dB)	AVG margin (dB)	Remark
1	0.1620	36.94	11.67	9.60	46.54	21.27	65.36	55.36	-18.82	-34.09	Pass
2	0.1860	41.72	24.36	9.60	51.32	33.96	64.21	54.21	-12.89	-20.25	Pass
3	0.2300	33.65	16.13	9.60	43.25	25.73	62.45	52.45	-19.20	-26.72	Pass
4	0.4460	28.41	19.20	9.61	38.02	28.81	56.95	46.95	-18.93	-18.14	Pass
5	9.3900	19.44	11.35	9.93	29.37	21.28	60.00	50.00	-30.63	-28.72	Pass
6	14.5660	21.70	16.73	10.08	31.78	26.81	60.00	50.00	-28.22	-23.19	Pass

Standard:	FCC Part 15E	Line:	N
Test item:	Conducted Emission	Power:	AC 120V/60Hz
Model Number:	Touch P5	Temp.(°C)/Hum.(%RH):	26(°C)/60%RH
Test Mode:	Mode 1	Date:	06/28/2015
		Test By:	Eric Ou Yang

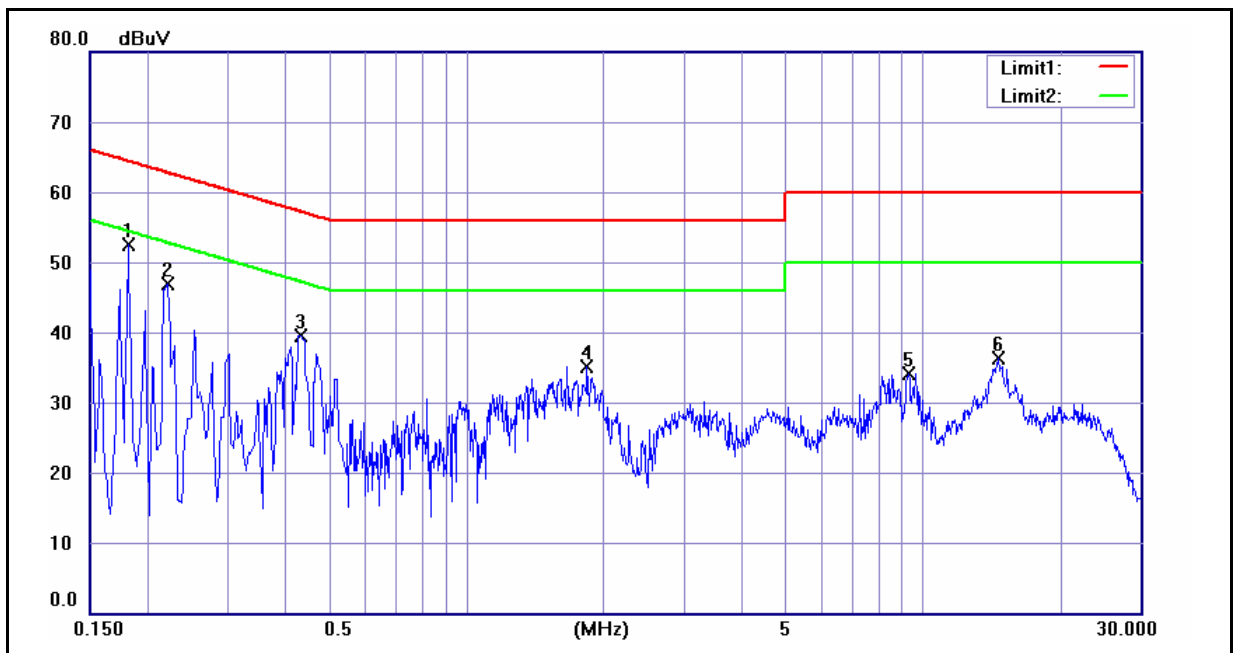

No.	Frequency (MHz)	QP reading (dBuV)	AVG reading (dBuV)	Correction factor (dB)	QP result (dBuV)	AVG result (dBuV)	QP limit (dBuV)	AVG limit (dBuV)	QP margin (dB)	AVG margin (dB)	Remark
1	0.1820	41.86	24.18	9.60	51.46	33.78	64.39	54.39	-12.93	-20.61	Pass
2	0.2220	35.05	18.78	9.60	44.65	28.38	62.74	52.74	-18.09	-24.36	Pass
3	0.4340	28.49	17.82	9.61	38.10	27.43	57.18	47.18	-19.08	-19.75	Pass
4	1.8460	21.07	13.27	9.69	30.76	22.96	56.00	46.00	-25.24	-23.04	Pass
5	9.3500	16.60	8.25	9.95	26.55	18.20	60.00	50.00	-33.45	-31.80	Pass
6	14.7140	21.59	16.31	10.10	31.69	26.41	60.00	50.00	-28.31	-23.59	Pass

## 5 Radiated Emission Measurement

### 5.1. Limit

Limits of Radiated Emission Measurement

Emissions radiated outside of the specified bands, shall be according to the general radiated limits in 15.209 as following:

Frequency Range (MHz)	Field Strength (microvolts/meter)	Measurement Distance (meters)
0.009 ~ 0.490	2400/F(kHz)	300
0.490 ~ 1.705	24000/F(kHz)	30
1.705 ~ 30.0	30	30
30 ~ 88	10	3
88 ~ 216	150	3
216 ~ 960	200	3
Above 960	500	3

Note: 1. The lower limit shall apply at the transition frequencies.

2. Emission level (dBuV/m) = 20 log Emission level (uV/m).

3. As shown in 15.35(b), for frequencies above 1000MHz, the field strength limits are based on average detector, however, the peak field strength of any emission shall not exceed the maximum permitted average limits, specified above by more than 20dB under any condition of modulation.

### 5.2. Test Instruments

3 Meter Chamber					
Equipment	Manufacturer	Model Number	Serial Number	Cal. Date	Remark
RF Pre-selector	Agilent	N9039A	MY46520256	01/06/2015	(1)
Spectrum Analyzer	Agilent	E4446A	MY46180578	01/06/2015	(1)
Pre Amplifier	Agilent	8449B	3008A02237	02/24/2015	(1)
Pre Amplifier	Agilent	8447D	2944A10961	02/24/2015	(1)
Broadband Antenna (30MHz~1GHz)	SCHWARZBECK MESS-ELEKTRONIK	VULB9163	9163-270	07/18/2014	(1)
Horn Antenna (1~18GHz)	SCHWARZBECK MESS-ELEKTRONIK	BBHA9120D	9120D-550	06/10/2015	(1)
Horn Antenna (18~40GHz)	SCHWARZBECK MESS-ELEKTRONIK	BBHA9170	9170-320	07/02/2014	(1)
Bore-sight Antenna Tower	MF	MFA-520BSN	1308243	N.C.R.	-----
Test Site	ATL	TE01	888001	08/28/2014	(1)

Remark: (1) Calibration period 1 year. (2) Calibration period 2 years.

Note: N.C.R. = No Calibration Request.

### 5.3. Setup

9kHz ~ 30MHz

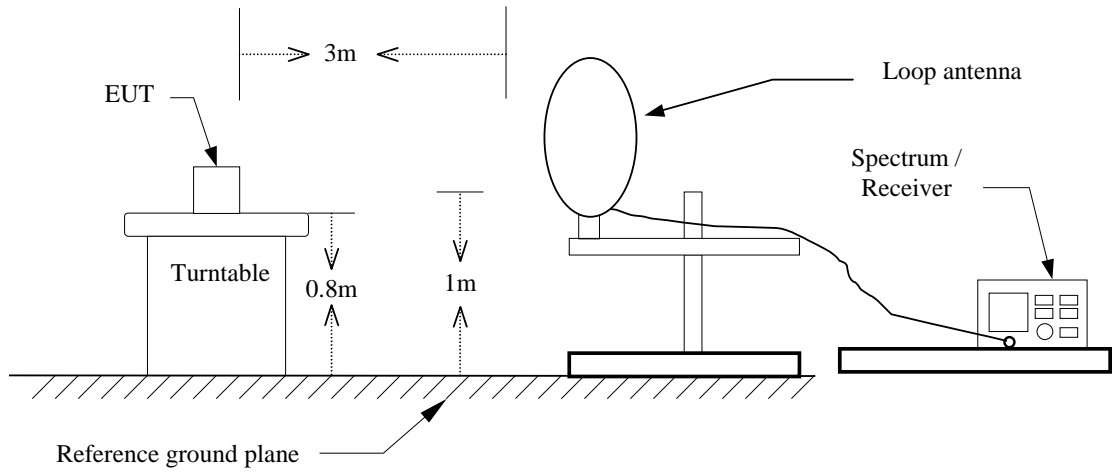

30MHz ~ 1GHz

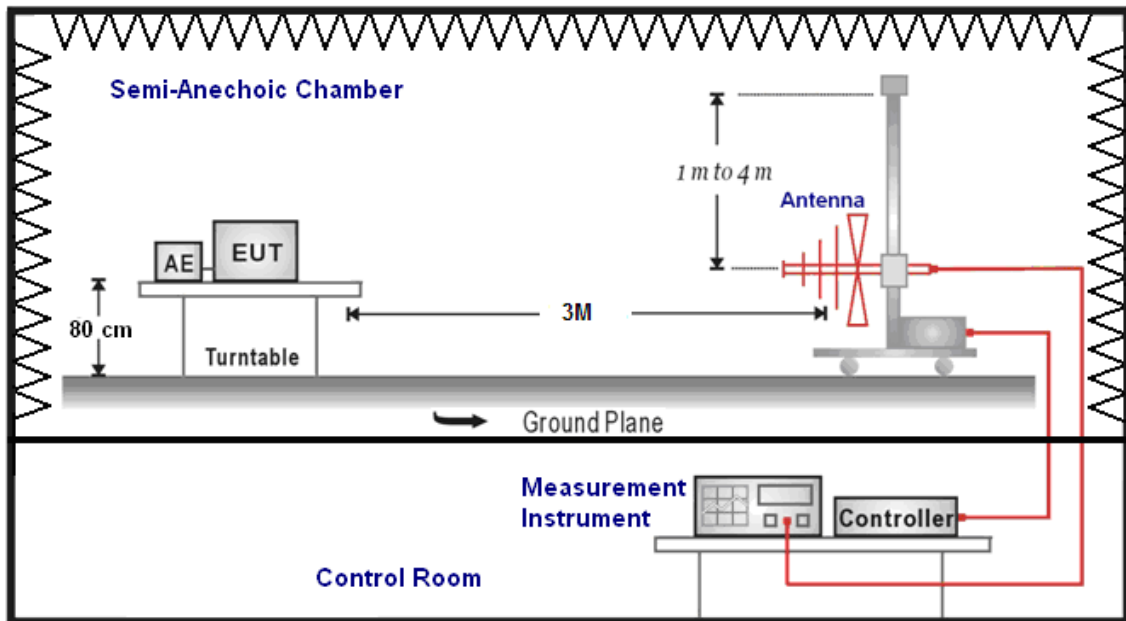

Above 1GHz

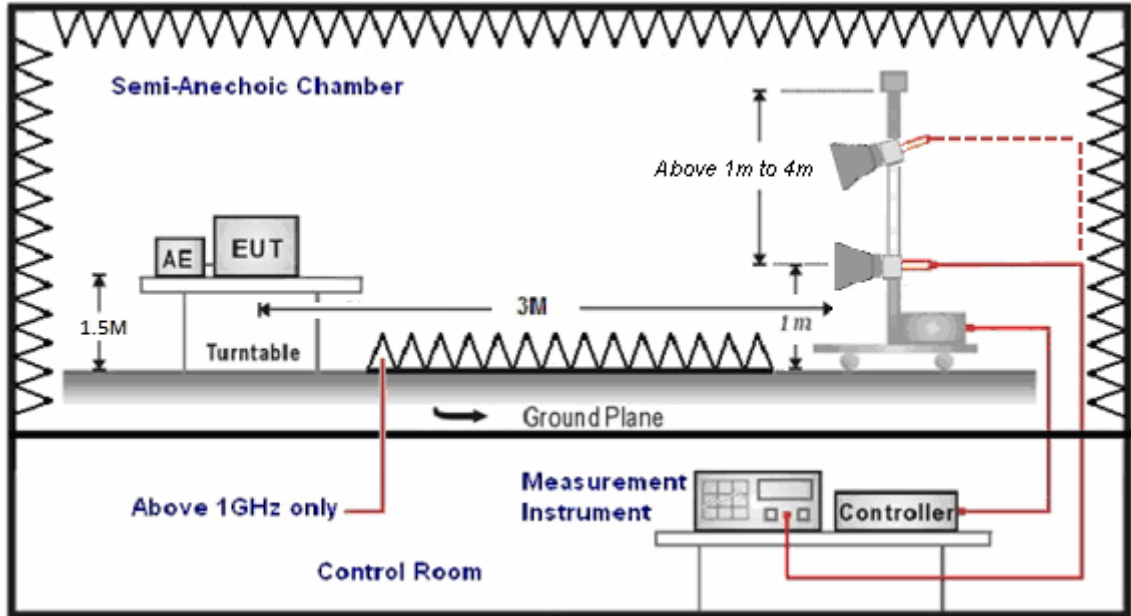

## 5.4. Test Procedure

Final radiation measurements were made on a three-meter, Semi Anechoic Chamber. The EUT system was placed on a nonconductive turntable which is 0.8 or 1.5 meters height (below 1GHz use 0.8m turntable / above 1GHz use 1.5m turntable), top surface 1.0 x 1.5 meter. The spectrum was examined from 250 MHz to 2.5 GHz in order to cover the whole spectrum below 10th harmonic which could generate from the EUT. During the test, EUT was set to transmit continuously & Measurements spectrum range from 9 kHz to 40 GHz is investigated.

For measurements below 1 GHz the resolution bandwidth is set to 100 kHz for peak detection measurements or 120 kHz for quasi-peak detection measurements. Peak detection is used unless otherwise noted as quasi-peak.

For restricted measurements above 1 GHz the resolution bandwidth is set to 1 MHz, and then the video bandwidth is set to 3 MHz for peak measurements and 10 Hz for average measurements when Duty cycle > 0.98 / 1/T for average measurements when Duty cycle < 0.98.

For out of band measurements above 1 GHz the resolution bandwidth is set to 1 MHz, and then the video bandwidth is set to 3 MHz for peak measurements.

A nonconductive material surrounded the EUT to supporting the EUT for standing on three orthogonal planes. At each condition, the EUT was rotated 360 degrees, and the antenna was raised and lowered from one to four meters to find the maximum emission levels. Measurements were taken using both horizontal and vertical antenna polarization.

SCHWARZBECK MESS-ELEKTRONIK Trilog-Broadband Antenna (mode SB AC VULB) at 3 Meter and the ETS-Lindgren Double-Ridged Waveguide Horn antenna (model 3117) Schwarzbeck Mess-Elektronik Broadband Horn Antenna (BBHA 9170) was used in frequencies 1 – 40 GHz at a distance of 3 meter. The Antenna at an angle toward the source of the emission. All test results were extrapolated to equivalent signal at 3 meters utilizing an inverse linear distance extrapolation Factor (20dB/decade).

For testing above 1GHz, the emission level of the EUT in peak mode was 20dB lower than average limit (that means the emission level in peak mode also complies with the limit in average mode), then testing will be stopped and peak values of EUT will be reported, otherwise, the emissions will be measured in average mode again and reported.

Appropriate preamplifiers were used for improving sensitivity and precautions were taken to avoid overloading or desensitizing the spectrum analyzer. No post – detector video filters were used in the test.

The spectrum analyzer's 6 dB bandwidth was set to 1 MHz, and the analyzer was operated in the peak detection mode, for frequencies both below and up 1 GHz. The average levels were obtained by subtracting the duty cycle correction factor from the peak readings.

The following procedures were used to convert the emission levels measured in decibels referenced to 1 microvolt (dBuV) into field intensity in micro volts per meter (uV/m).

The actual field intensity in decibels referenced to 1 microvolt in to field intensity in micro volts per meter (dBuV/m).

The actual field intensity in referenced to 1 microvolt per meter (dBuV/m) is determined by algebraically adding the measured reading in dBuV, the antenna factor (dB), and cable loss (dB) and Subtracting the gain of preamplifier (dB) is auto calculate in spectrum analyzer.

(1)  $\text{Amplitude (dBuV/m)} = \text{FI (dBuV)} + \text{AF (dBuV)} + \text{CL (dBuV)} - \text{Gain (dB)}$

FI= Reading of the field intensity.

AF= Antenna factor.

CL= Cable loss.

P.S Amplitude is auto calculate in spectrum analyzer.

(2)  $\text{Actual Amplitude (dBuV/m)} = \text{Amplitude (dBuV)} - \text{Dis(dB)}$

The FCC specified emission limits were calculated according the EUT operating frequency and by following linear interpolation equations:

(a) For fundamental frequency : Transmitter Output < +30dBm

(b) For spurious frequency : Spurious emission limits = fundamental emission limit /10

## 5.5. Test Result

Below 1GHz

Standard:	FCC Part 15E	Test Distance:	3m
Test item:	Radiated Emission	Power:	AC 120V/60Hz
Model Number:	Touch P5	Temp.(°C)/Hum.(%RH):	26(°C)/60%RH
Test Mode:	Mode 1	Date:	06/28/2015
		Test By:	Eric Ou Yang

Frequency (MHz)	Reading (dBuV)	Correct Factor (dB/m)	Result (dBuV/m)	Limit (dBuV/m)	Margin (dB)	Remark	Ant.Polar. H / V
180.0000	39.03	-12.38	26.65	43.50	-16.85	QP	H
250.0000	37.00	-11.34	25.66	46.00	-20.34	QP	H
450.0000	35.38	-6.30	29.08	46.00	-16.92	QP	H
600.0000	26.16	-3.15	23.01	46.00	-22.99	QP	H
720.0000	25.58	-0.98	24.60	46.00	-21.40	QP	H
845.5000	24.21	1.24	25.45	46.00	-20.55	QP	H
126.5000	38.42	-13.46	24.96	43.50	-18.54	QP	V
195.0000	37.43	-13.48	23.95	43.50	-19.55	QP	V
328.0000	31.40	-8.90	22.50	46.00	-23.50	QP	V
484.0000	25.09	-5.70	19.39	46.00	-26.61	QP	V
606.5000	25.30	-3.07	22.23	46.00	-23.77	QP	V
783.0000	25.89	0.20	26.09	46.00	-19.91	QP	V

Note: No emission found between lowest internal used/generated frequency to 30MHz (9kHz~30MHz).



Standard:	FCC Part 15E	Test Distance:	3m
Test item:	Radiated Emission	Power:	AC 120V/60Hz
Model Number:	Touch P5	Temp.(°C)/Hum.(%RH):	26(°C)/60%RH
Test Mode:	Mode 1	Date:	06/28/2015
Description:	Beamforming on	Test By:	Eric Ou Yang

Frequency (MHz)	Reading (dBuV)	Correct Factor (dB/m)	Result (dBuV/m)	Limit (dBuV/m)	Margin (dB)	Remark	Ant.Polar. H / V
204.5000	44.69	-13.68	31.01	43.50	-12.49	QP	H
250.0000	42.29	-11.34	30.95	46.00	-15.05	QP	H
360.0000	33.78	-8.26	25.52	46.00	-20.48	QP	H
450.0000	31.20	-6.30	24.90	46.00	-21.10	QP	H
667.0000	26.11	-2.17	23.94	46.00	-22.06	QP	H
873.0000	25.23	1.93	27.16	46.00	-18.84	QP	H
166.0000	44.30	-11.51	32.79	43.50	-10.71	QP	V
217.0000	42.75	-13.22	29.53	46.00	-16.47	QP	V
450.0000	35.98	-6.30	29.68	46.00	-16.32	QP	V
570.0000	26.45	-3.95	22.50	46.00	-23.50	QP	V
737.0000	27.49	-0.56	26.93	46.00	-19.07	QP	V
871.0000	26.11	1.88	27.99	46.00	-18.01	QP	V

Note: No emission found between lowest internal used/generated frequency to 30MHz (9kHz~30MHz).

## Above 1GHz

Standard:	FCC Part 15E			Test Distance:	3m		
Test item:	Radiated Emission			Power:	AC 120V/60Hz		
Model Number:	Touch P5			Temp.(°C)/Hum.(%RH):	26(°C)/60%RH		
Test Mode:	Mode 2			Date:	06/28/2015		
Frequency:	5180MHz			Test By:	Eric Ou Yang		
Frequency (MHz)	Reading (dBuV)	Correct Factor (dB/m)	Result (dBuV/m)	Limit (dBuV/m)	Margin (dB)	Remark	Ant.Polar. H / V
2827.000	36.69	5.66	42.35	74.00	-31.65	peak	H
4591.000	34.11	9.90	44.01	74.00	-29.99	peak	H
7671.000	32.34	13.30	45.64	74.00	-28.36	peak	H
2841.000	36.91	5.70	42.61	74.00	-31.39	peak	V
4563.000	32.99	9.86	42.85	74.00	-31.15	peak	V
7699.000	31.86	13.33	45.19	74.00	-28.81	peak	V

Standard:	FCC Part 15E			Test Distance:	3m		
Test item:	Radiated Emission			Power:	AC 120V/60Hz		
Model Number:	Touch P5			Temp.(°C)/Hum.(%RH):	26(°C)/60%RH		
Test Mode:	Mode 2			Date:	06/28/2015		
Frequency:	5200MHz			Test By:	Eric Ou Yang		
Frequency (MHz)	Reading (dBuV)	Correct Factor (dB/m)	Result (dBuV/m)	Limit (dBuV/m)	Margin (dB)	Remark	Ant.Polar. H / V
2834.000	37.24	5.67	42.91	74.00	-31.09	peak	H
4647.000	34.08	9.98	44.06	74.00	-29.94	peak	H
7678.000	35.90	13.30	49.20	74.00	-24.80	peak	H
2827.000	39.21	5.66	44.87	74.00	-29.13	peak	V
4619.000	34.34	9.94	44.28	74.00	-29.72	peak	V
7671.000	38.64	13.30	51.94	74.00	-22.06	peak	V

Standard:	FCC Part 15E			Test Distance:	3m		
Test item:	Radiated Emission			Power:	AC 120V/60Hz		
Model Number:	Touch P5			Temp.(°C)/Hum.(%RH):	26(°C)/60%RH		
Test Mode:	Mode 2			Date:	06/28/2015		
Frequency:	5240MHz			Test By:	Eric Ou Yang		
Frequency (MHz)	Reading (dBuV)	Correct Factor (dB/m)	Result (dBuV/m)	Limit (dBuV/m)	Margin (dB)	Remark	Ant.Polar. H / V
2827.000	38.58	5.66	44.24	74.00	-29.76	peak	H
4549.000	34.28	9.83	44.11	74.00	-29.89	peak	H
7685.000	32.94	13.30	46.24	74.00	-27.76	peak	H
2841.000	38.18	5.70	43.88	74.00	-30.12	peak	V
4626.000	33.93	9.95	43.88	74.00	-30.12	peak	V
7657.000	33.28	13.28	46.56	74.00	-27.44	peak	V

Standard:	FCC Part 15E			Test Distance:	3m		
Test item:	Radiated Emission			Power:	AC 120V/60Hz		
Model Number:	Touch P5			Temp.(°C)/Hum.(%RH):	26(°C)/60%RH		
Test Mode:	Mode 3			Date:	06/28/2015		
Frequency:	5180MHz			Test By:	Eric Ou Yang		
Frequency (MHz)	Reading (dBuV)	Correct Factor (dB/m)	Result (dBuV/m)	Limit (dBuV/m)	Margin (dB)	Remark	Ant.Polar. H / V
2855.000	36.40	5.74	42.14	74.00	-31.86	peak	H
4570.000	33.74	9.87	43.61	74.00	-30.39	peak	H
7657.000	33.04	13.28	46.32	74.00	-27.68	peak	H
2834.000	37.00	5.67	42.67	74.00	-31.33	peak	V
4549.000	33.79	9.83	43.62	74.00	-30.38	peak	V
7699.000	32.72	13.33	46.05	74.00	-27.95	peak	V

Standard:	FCC Part 15E			Test Distance:	3m		
Test item:	Radiated Emission			Power:	AC 120V/60Hz		
Model Number:	Touch P5			Temp.(°C)/Hum.(%RH):	26(°C)/60%RH		
Test Mode:	Mode 3			Date:	06/28/2015		
Frequency:	5200MHz			Test By:	Eric Ou Yang		
Frequency (MHz)	Reading (dBuV)	Correct Factor (dB/m)	Result (dBuV/m)	Limit (dBuV/m)	Margin (dB)	Remark	Ant.Polar. H / V
2841.000	37.36	5.70	43.06	74.00	-30.94	peak	H
4542.000	33.36	9.83	43.19	74.00	-30.81	peak	H
7650.000	33.75	13.27	47.02	74.00	-26.98	peak	H
2855.000	37.40	5.73	43.13	74.00	-30.87	peak	V
4542.000	34.85	9.83	44.68	74.00	-29.32	peak	V
7706.000	38.30	13.34	51.64	74.00	-22.36	peak	V

Standard:	FCC Part 15E			Test Distance:	3m		
Test item:	Radiated Emission			Power:	AC 120V/60Hz		
Model Number:	Touch P5			Temp.(°C)/Hum.(%RH):	26(°C)/60%RH		
Test Mode:	Mode 3			Date:	06/28/2015		
Frequency:	5240MHz			Test By:	Eric Ou Yang		
Frequency (MHz)	Reading (dBuV)	Correct Factor (dB/m)	Result (dBuV/m)	Limit (dBuV/m)	Margin (dB)	Remark	Ant.Polar. H / V
2834.000	36.09	5.67	41.76	74.00	-32.24	peak	H
4542.000	33.45	9.83	43.28	74.00	-30.72	peak	H
7629.000	33.79	13.25	47.04	74.00	-26.96	peak	H
2834.000	36.48	5.67	42.15	74.00	-31.85	peak	V
4549.000	34.59	9.83	44.42	74.00	-29.58	peak	V
7699.000	33.15	13.33	46.48	74.00	-27.52	peak	V

Standard:	FCC Part 15E	Test Distance:	3m
Test item:	Radiated Emission	Power:	AC 120V/60Hz
Model Number:	Touch P5	Temp.(°C)/Hum.(%RH):	26(°C)/60%RH
Test Mode:	Mode 4	Date:	06/28/2015
Frequency:	5190MHz	Test By:	Eric Ou Yang

Frequency (MHz)	Reading (dBuV)	Correct Factor (dB/m)	Result (dBuV/m)	Limit (dBuV/m)	Margin (dB)	Remark	Ant.Polar. H / V
2855.000	37.71	5.74	43.45	74.00	-30.55	peak	H
4549.000	34.13	9.83	43.96	74.00	-30.04	peak	H
7685.000	33.64	13.30	46.94	74.00	-27.06	peak	H
2834.000	36.76	5.67	42.43	74.00	-31.57	peak	V
4570.000	34.22	9.87	44.09	74.00	-29.91	peak	V
7706.000	32.58	13.34	45.92	74.00	-28.08	peak	V

Standard:	FCC Part 15E	Test Distance:	3m
Test item:	Radiated Emission	Power:	AC 120V/60Hz
Model Number:	Touch P5	Temp.(°C)/Hum.(%RH):	26(°C)/60%RH
Test Mode:	Mode 4	Date:	06/28/2015
Frequency:	5230MHz	Test By:	Eric Ou Yang

Frequency (MHz)	Reading (dBuV)	Correct Factor (dB/m)	Result (dBuV/m)	Limit (dBuV/m)	Margin (dB)	Remark	Ant.Polar. H / V
2841.000	37.00	5.70	42.70	74.00	-31.30	peak	H
4598.000	33.97	9.91	43.88	74.00	-30.12	peak	H
7685.000	33.69	13.30	46.99	74.00	-27.01	peak	H
2855.000	37.69	5.74	43.43	74.00	-30.57	peak	V
4563.000	33.56	9.86	43.42	74.00	-30.58	peak	V
7678.000	32.73	13.30	46.03	74.00	-27.97	peak	V

Standard:	FCC Part 15E	Test Distance:	3m
Test item:	Radiated Emission	Power:	AC 120V/60Hz
Model Number:	Touch P5	Temp.(°C)/Hum.(%RH):	26(°C)/60%RH
Test Mode:	Mode 5	Date:	06/28/2015
Frequency:	5210MHz	Test By:	Eric Ou Yang

Frequency (MHz)	Reading (dBuV)	Correct Factor (dB/m)	Result (dBuV/m)	Limit (dBuV/m)	Margin (dB)	Remark	Ant.Polar. H / V
2827.000	37.02	5.66	42.68	74.00	-31.32	peak	H
4591.000	33.06	9.90	42.96	74.00	-31.04	peak	H
7671.000	35.56	13.30	48.86	74.00	-25.14	peak	H
2834.000	36.89	5.67	42.56	74.00	-31.44	peak	V
4563.000	34.21	9.86	44.07	74.00	-29.93	peak	V
7706.000	38.43	13.34	51.77	74.00	-22.23	peak	V

Standard:	FCC Part 15E	Test Distance:	3m
Test item:	Radiated Emission	Power:	AC 120V/60Hz
Model Number:	Touch P5	Temp.(°C)/Hum.(%RH):	26(°C)/60%RH
Test Mode:	Mode 3	Date:	06/28/2015
Frequency:	5180MHz	Test By:	Eric Ou Yang
Description:	Beamforming on		

Frequency (MHz)	Reading (dBuV)	Correct Factor (dB/m)	Result (dBuV/m)	Limit (dBuV/m)	Margin (dB)	Remark	Ant.Polar. H / V
2743.000	36.78	5.44	42.22	74.00	-31.78	peak	H
4255.000	33.05	9.28	42.33	74.00	-31.67	peak	H
7601.000	32.52	13.22	45.74	74.00	-28.26	peak	H
2743.000	38.29	5.44	43.73	74.00	-30.27	peak	V
4185.000	33.59	9.13	42.72	74.00	-31.28	peak	V
7538.000	32.63	13.15	45.78	74.00	-28.22	peak	V

Standard:	FCC Part 15E	Test Distance:	3m
Test item:	Radiated Emission	Power:	AC 120V/60Hz
Model Number:	Touch P5	Temp.(°C)/Hum.(%RH):	26(°C)/60%RH
Test Mode:	Mode 3	Date:	06/28/2015
Frequency:	5200MHz	Test By:	Eric Ou Yang
Description:	Beamforming on		

Frequency (MHz)	Reading (dBuV)	Correct Factor (dB/m)	Result (dBuV/m)	Limit (dBuV/m)	Margin (dB)	Remark	Ant.Polar. H / V
2757.000	35.70	5.48	41.18	74.00	-32.82	peak	H
4311.000	34.02	9.39	43.41	74.00	-30.59	peak	H
7566.000	32.41	13.19	45.60	74.00	-28.40	peak	H
2722.000	38.67	5.38	44.05	74.00	-29.95	peak	V
4283.000	32.90	9.34	42.24	74.00	-31.76	peak	V
7587.000	33.81	13.20	47.01	74.00	-26.99	peak	V

Standard:	FCC Part 15E	Test Distance:	3m
Test item:	Radiated Emission	Power:	AC 120V/60Hz
Model Number:	Touch P5	Temp.(°C)/Hum.(%RH):	26(°C)/60%RH
Test Mode:	Mode 3	Date:	06/28/2015
Frequency:	5240MHz	Test By:	Eric Ou Yang
Description:	Beamforming on		

Frequency (MHz)	Reading (dBuV)	Correct Factor (dB/m)	Result (dBuV/m)	Limit (dBuV/m)	Margin (dB)	Remark	Ant.Polar. H / V
2743.000	36.29	5.44	41.73	74.00	-32.27	peak	H
4339.000	33.48	9.45	42.93	74.00	-31.07	peak	H
7482.000	33.14	13.10	46.24	74.00	-27.76	peak	H
2722.000	36.88	5.38	42.26	74.00	-31.74	peak	V
4297.000	33.61	9.37	42.98	74.00	-31.02	peak	V
7594.000	33.80	13.22	47.02	74.00	-26.98	peak	V

Standard:	FCC Part 15E	Test Distance:	3m
Test item:	Radiated Emission	Power:	AC 120V/60Hz
Model Number:	Touch P5	Temp.(°C)/Hum.(%RH):	26(°C)/60%RH
Test Mode:	Mode 4	Date:	06/28/2015
Frequency:	5190MHz	Test By:	Eric Ou Yang
Description:	Beamforming on		

Frequency (MHz)	Reading (dBuV)	Correct Factor (dB/m)	Result (dBuV/m)	Limit (dBuV/m)	Margin (dB)	Remark	Ant.Polar. H / V
2722.000	36.99	5.38	42.37	74.00	-31.63	peak	H
4318.000	32.57	9.40	41.97	74.00	-32.03	peak	H
7559.000	33.93	13.17	47.10	74.00	-26.90	peak	H
2729.000	36.85	5.41	42.26	74.00	-31.74	peak	V
4311.000	33.62	9.39	43.01	74.00	-30.99	peak	V
7587.000	33.29	13.20	46.49	74.00	-27.51	peak	V

Standard:	FCC Part 15E	Test Distance:	3m
Test item:	Radiated Emission	Power:	AC 120V/60Hz
Model Number:	Touch P5	Temp.(°C)/Hum.(%RH):	26(°C)/60%RH
Test Mode:	Mode 4	Date:	06/28/2015
Frequency:	5230MHz	Test By:	Eric Ou Yang
Description:	Beamforming on		

Frequency (MHz)	Reading (dBuV)	Correct Factor (dB/m)	Result (dBuV/m)	Limit (dBuV/m)	Margin (dB)	Remark	Ant.Polar. H / V
2757.000	35.92	5.48	41.40	74.00	-32.60	peak	H
4290.000	34.04	9.35	43.39	74.00	-30.61	peak	H
7566.000	33.34	13.19	46.53	74.00	-27.47	peak	H
2743.000	36.88	5.44	42.32	74.00	-31.68	peak	V
4290.000	33.39	9.35	42.74	74.00	-31.26	peak	V
7594.000	32.09	13.22	45.31	74.00	-28.69	peak	V



Standard:	FCC Part 15E	Test Distance:	3m
Test item:	Radiated Emission	Power:	AC 120V/60Hz
Model Number:	Touch P5	Temp.(°C)/Hum.(%RH):	26(°C)/60%RH
Test Mode:	Mode 5	Date:	06/28/2015
Frequency:	5210MHz	Test By:	Eric Ou Yang
Description:	Beamforming on		

Frequency (MHz)	Reading (dBuV)	Correct Factor (dB/m)	Result (dBuV/m)	Limit (dBuV/m)	Margin (dB)	Remark	Ant.Polar. H / V
2743.000	36.23	5.44	41.67	74.00	-32.33	peak	H
4255.000	33.95	9.28	43.23	74.00	-30.77	peak	H
7559.000	34.64	13.17	47.81	74.00	-26.19	peak	H
2729.000	36.55	5.41	41.96	74.00	-32.04	peak	V
4283.000	33.67	9.34	43.01	74.00	-30.99	peak	V
7573.000	37.15	13.20	50.35	74.00	-23.65	peak	V

Standard:	FCC Part 15E	Test Distance:	3m
Test item:	Radiated Emission	Power:	AC 120V/60Hz
Model Number:	Touch P5	Temp.(°C)/Hum.(%RH):	26(°C)/60%RH
Mode:	2.4GHz+5GHz	Date:	06/26/2015
	Simultaneous Transmitting	Test By:	Eric Ou Yang

Frequency (MHz)	Reading (dBuV)	Correct Factor (dB/m)	Result (dBuV/m)	Limit (dBuV/m)	Margin (dB)	Remark	Ant.Polar. H / V
2837.000	36.51	-0.91	35.60	74.00	-38.40	peak	H
4755.000	43.43	4.40	47.83	74.00	-26.17	peak	H
7571.000	35.76	10.13	45.89	74.00	-28.11	peak	H
2832.000	36.37	-0.93	35.44	74.00	-38.56	peak	V
4763.000	44.80	4.43	49.23	74.00	-24.77	peak	V
7566.000	35.71	10.06	45.77	74.00	-28.23	peak	V

**Band Edge**

Standard:	FCC Part 15E	Test Distance:	3m
Test item:	Radiated Emission	Power:	AC 120V/60Hz
Model Number:	Touch P5	Temp.(°C)/Hum.(%RH):	26(°C)/60%RH
Test Mode:	Mode 2	Date:	07/01/2015
Frequency:	5180 MHz	Test By:	Eric Ou Yang

Frequency (MHz)	Reading (dBuV)	Correct Factor (dB/m)	Result (dBuV/m)	Limit (dBuV/m)	Margin (dB)	Remark	Ant.Polar. H / V
4970.400	48.10	10.48	58.58	74.00	-15.42	peak	H
4970.400	36.08	10.48	46.56	54.00	-7.44	AVG	H
5150.000	46.40	10.74	57.14	74.00	-16.86	peak	H
5150.000	36.48	10.74	47.22	54.00	-6.78	AVG	H
5093.600	50.79	10.65	61.44	74.00	-12.56	peak	V
5093.600	41.73	10.65	52.38	54.00	-1.62	AVG	V
5150.000	55.27	10.74	66.01	74.00	-7.99	peak	V
5150.000	41.39	10.74	52.13	54.00	-1.87	AVG	V

Standard:	FCC Part 15E	Test Distance:	3m
Test item:	Radiated Emission	Power:	AC 120V/60Hz
Model Number:	Touch P5	Temp.(°C)/Hum.(%RH):	26(°C)/60%RH
Test Mode:	Mode 2	Date:	07/01/2015
Frequency:	5200 MHz	Test By:	Eric Ou Yang

Frequency (MHz)	Reading (dBuV)	Correct Factor (dB/m)	Result (dBuV/m)	Limit (dBuV/m)	Margin (dB)	Remark	Ant.Polar. H / V
5104.800	48.70	10.68	59.38	74.00	-14.62	peak	H
5104.800	35.89	10.68	46.57	54.00	-7.43	AVG	H
5150.000	45.61	10.74	56.35	74.00	-17.65	peak	H
5150.000	36.03	10.74	46.77	54.00	-7.23	AVG	H
5350.000	45.81	11.05	56.86	74.00	-17.14	peak	H
5350.000	35.58	11.05	46.63	54.00	-7.37	AVG	H
5355.360	47.76	11.05	58.81	74.00	-15.19	peak	H
5355.360	37.38	11.05	48.43	54.00	-5.57	AVG	H
5116.320	54.88	10.69	65.57	74.00	-8.43	peak	V
5116.320	42.52	10.69	53.21	54.00	-0.79	AVG	V
5150.000	49.57	10.74	60.31	74.00	-13.69	peak	V
5150.000	39.85	10.74	50.59	54.00	-3.41	AVG	V
5350.000	46.78	11.05	57.83	74.00	-16.17	peak	V
5350.000	39.66	11.05	50.71	54.00	-3.29	AVG	V
5363.040	52.35	11.07	63.42	74.00	-10.58	peak	V
5363.040	41.95	11.07	53.02	54.00	-0.98	AVG	V

Standard: FCC Part 15E		Test Distance: 3m	
Test item: Radiated Emission		Power: AC 120V/60Hz	
Model Number: Touch P5		Temp.(°C)/Hum.(%RH): 26(°C)/60%RH	
Test Mode: Mode 2		Date: 07/01/2015	
Frequency: 5240 MHz		Test By: Eric Ou Yang	

Frequency (MHz)	Reading (dBuV)	Correct Factor (dB/m)	Result (dBuV/m)	Limit (dBuV/m)	Margin (dB)	Remark	Ant.Polar. H / V
5350.000	45.86	11.05	56.91	74.00	-17.09	peak	H
5350.000	35.23	11.05	46.28	54.00	-7.72	AVG	H
5403.900	47.88	11.12	59.00	74.00	-15.00	peak	H
5403.900	36.29	11.12	47.41	54.00	-6.59	AVG	H
5350.000	46.28	11.05	57.33	74.00	-16.67	peak	V
5350.000	38.78	11.05	49.83	54.00	-4.17	AVG	V
5403.020	50.10	11.12	61.22	74.00	-12.78	peak	V
5403.020	40.91	11.12	52.03	54.00	-1.97	AVG	V

Standard: FCC Part 15E		Test Distance: 3m	
Test item: Radiated Emission		Power: AC 120V/60Hz	
Model Number: Touch P5		Temp.(°C)/Hum.(%RH): 26(°C)/60%RH	
Test Mode: Mode 3		Date: 07/01/2015	
Frequency: 5180 MHz		Test By: Eric Ou Yang	

Frequency (MHz)	Reading (dBuV)	Correct Factor (dB/m)	Result (dBuV/m)	Limit (dBuV/m)	Margin (dB)	Remark	Ant.Polar. H / V
4869.600	50.01	10.33	60.34	74.00	-13.66	peak	H
4869.600	36.03	10.33	46.36	54.00	-7.64	AVG	H
5150.000	46.02	10.74	56.76	74.00	-17.24	peak	H
5150.000	37.73	10.74	48.47	54.00	-5.53	AVG	H
5099.200	51.57	10.67	62.24	74.00	-11.76	peak	V
5099.200	40.12	10.67	50.79	54.00	-3.21	AVG	V
5150.000	55.43	10.74	66.17	74.00	-7.83	peak	V
5150.000	42.41	10.74	53.15	54.00	-0.85	AVG	V

Standard:	FCC Part 15E	Test Distance:	3m
Test item:	Radiated Emission	Power:	AC 120V/60Hz
Model Number:	Touch P5	Temp.(°C)/Hum.(%RH):	26(°C)/60%RH
Test Mode:	Mode 3	Date:	07/01/2015
Frequency:	5200 MHz	Test By:	Eric Ou Yang

Frequency (MHz)	Reading (dBuV)	Correct Factor (dB/m)	Result (dBuV/m)	Limit (dBuV/m)	Margin (dB)	Remark	Ant.Polar. H / V
5033.760	47.92	10.58	58.50	74.00	-15.50	peak	H
5033.760	36.40	10.58	46.98	54.00	-7.02	AVG	H
5150.000	46.66	10.74	57.40	74.00	-16.60	peak	H
5150.000	36.05	10.74	46.79	54.00	-7.21	AVG	H
5350.000	44.98	11.05	56.03	74.00	-17.97	peak	H
5350.000	35.52	11.05	46.57	54.00	-7.43	AVG	H
5359.200	47.84	11.06	58.90	74.00	-15.10	peak	H
5359.200	35.55	11.06	46.61	54.00	-7.39	AVG	H
5123.040	53.78	10.71	64.49	74.00	-9.51	peak	V
5123.040	42.44	10.71	53.15	54.00	-0.85	AVG	V
5150.000	50.41	10.74	61.15	74.00	-12.85	peak	V
5150.000	39.94	10.74	50.68	54.00	-3.32	AVG	V
5350.000	46.82	11.05	57.87	74.00	-16.13	peak	V
5350.000	39.99	11.05	51.04	54.00	-2.96	AVG	V
5358.240	51.78	11.06	62.84	74.00	-11.16	peak	V
5358.240	42.26	11.06	53.32	54.00	-0.68	AVG	V

Standard:	FCC Part 15E	Test Distance:	3m
Test item:	Radiated Emission	Power:	AC 120V/60Hz
Model Number:	Touch P5	Temp.(°C)/Hum.(%RH):	26(°C)/60%RH
Test Mode:	Mode 3	Date:	07/01/2015
Frequency:	5240 MHz	Test By:	Eric Ou Yang

Frequency (MHz)	Reading (dBuV)	Correct Factor (dB/m)	Result (dBuV/m)	Limit (dBuV/m)	Margin (dB)	Remark	Ant.Polar. H / V
5350.000	45.82	11.05	56.87	74.00	-17.13	peak	H
5350.000	35.86	11.05	46.91	54.00	-7.09	AVG	H
5398.620	48.21	11.12	59.33	74.00	-14.67	peak	H
5398.620	37.87	11.12	48.99	54.00	-5.01	AVG	H
5350.000	46.33	11.05	57.38	74.00	-16.62	peak	V
5350.000	36.75	11.05	47.80	54.00	-6.20	AVG	V
5398.180	51.89	11.12	63.01	74.00	-10.99	peak	V
5398.180	41.43	11.12	52.55	54.00	-1.45	AVG	V

Standard:	FCC Part 15E			Test Distance:	3m		
Test item:	Radiated Emission			Power:	AC 120V/60Hz		
Model Number:	Touch P5			Temp.(°C)/Hum.(%RH):	26(°C)/60%RH		
Test Mode:	Mode 4			Date:	07/01/2015		
Frequency:	5190 MHz			Test By:	Eric Ou Yang		
Frequency (MHz)	Reading (dBuV)	Correct Factor (dB/m)	Result (dBuV/m)	Limit (dBuV/m)	Margin (dB)	Remark	Ant.Polar. H / V
5000.500	48.67	10.52	59.19	74.00	-14.81	peak	H
5000.500	38.96	10.52	49.48	54.00	-4.52	AVG	H
5150.000	46.65	10.74	57.39	74.00	-16.61	peak	H
5150.000	37.83	10.74	48.57	54.00	-5.43	AVG	H
5146.100	54.65	10.74	65.39	74.00	-8.61	peak	V
5146.100	40.57	10.74	51.31	54.00	-2.69	AVG	V
5150.000	54.17	10.74	64.91	74.00	-9.09	peak	V
5150.000	41.94	10.74	52.68	54.00	-1.32	AVG	V

Standard:	FCC Part 15E			Test Distance:	3m		
Test item:	Radiated Emission			Power:	AC 120V/60Hz		
Model Number:	Touch P5			Temp.(°C)/Hum.(%RH):	26(°C)/60%RH		
Test Mode:	Mode 4			Date:	07/01/2015		
Frequency:	5230 MHz			Test By:	Eric Ou Yang		
Frequency (MHz)	Reading (dBuV)	Correct Factor (dB/m)	Result (dBuV/m)	Limit (dBuV/m)	Margin (dB)	Remark	Ant.Polar. H / V
5350.000	46.65	11.05	57.70	74.00	-16.30	peak	H
5350.000	35.78	11.05	46.83	54.00	-7.17	AVG	H
5384.330	48.25	11.10	59.35	74.00	-14.65	peak	H
5384.330	36.62	11.10	47.72	54.00	-6.28	AVG	H
5350.000	45.26	11.05	56.31	74.00	-17.69	peak	V
5350.000	36.85	11.05	47.90	54.00	-6.10	AVG	V
5386.170	51.78	11.10	62.88	74.00	-11.12	peak	V
5386.170	41.05	11.10	52.15	54.00	-1.85	AVG	V

Standard:	FCC Part 15E	Test Distance:	3m
Test item:	Radiated Emission	Power:	AC 120V/60Hz
Model Number:	Touch P5	Temp.(°C)/Hum.(%RH):	26(°C)/60%RH
Test Mode:	Mode 5	Date:	07/01/2015
Frequency:	5210 MHz	Test By:	Eric Ou Yang

Frequency (MHz)	Reading (dBuV)	Correct Factor (dB/m)	Result (dBuV/m)	Limit (dBuV/m)	Margin (dB)	Remark	Ant.Polar. H / V
5146.100	47.61	10.74	58.35	74.00	-15.65	peak	H
5146.100	36.84	10.74	47.58	54.00	-6.42	AVG	H
5150.000	46.26	10.74	57.00	74.00	-17.00	peak	H
5150.000	37.31	10.74	48.05	54.00	-5.95	AVG	H
5350.000	46.17	11.05	57.22	74.00	-16.78	peak	H
5350.000	35.49	11.05	46.54	54.00	-7.46	AVG	H
5369.250	48.20	11.08	59.28	74.00	-14.72	peak	H
5369.250	35.53	11.08	46.61	54.00	-7.39	AVG	H
5140.420	54.58	10.73	65.31	74.00	-8.69	peak	V
5140.420	41.73	10.73	52.46	54.00	-1.54	AVG	V
5150.000	52.20	10.74	62.94	74.00	-11.06	peak	V
5150.000	41.98	10.74	52.72	54.00	-1.28	AVG	V
5350.000	45.99	11.05	57.04	74.00	-16.96	peak	V
5350.000	35.71	11.05	46.76	54.00	-7.24	AVG	V
5391.000	48.34	11.10	59.44	74.00	-14.56	peak	V
5391.000	35.74	11.10	46.84	54.00	-7.16	AVG	V



Standard:	FCC Part 15E	Test Distance:	3m
Test item:	Radiated Emission	Power:	AC 120V/60Hz
Model Number:	Touch P5	Temp.(°C)/Hum.(%RH):	26(°C)/60%RH
Test Mode:	Mode 3	Date:	07/01/2015
Frequency:	5180 MHz	Test By:	Eric Ou Yang
Description:	Beamforming on		

Frequency (MHz)	Reading (dBuV)	Correct Factor (dB/m)	Result (dBuV/m)	Limit (dBuV/m)	Margin (dB)	Remark	Ant.Polar. H / V
4800.300	49.29	10.22	59.51	74.00	-14.49	peak	H
4800.300	36.00	10.22	46.22	54.00	-7.78	AVG	H
5150.000	45.90	10.74	56.64	74.00	-17.36	peak	H
5150.000	36.76	10.74	47.50	54.00	-6.50	AVG	H
5105.500	50.47	10.68	61.15	74.00	-12.85	peak	V
5105.500	39.15	10.68	49.83	54.00	-4.17	AVG	V
5150.000	49.24	10.74	59.98	74.00	-14.02	peak	V
5150.000	41.35	10.74	52.09	54.00	-1.91	AVG	V

Standard:	FCC Part 15E	Test Distance:	3m
Test item:	Radiated Emission	Power:	AC 120V/60Hz
Model Number:	Touch P5	Temp.(°C)/Hum.(%RH):	26(°C)/60%RH
Test Mode:	Mode 3	Date:	07/01/2015
Frequency:	5200 MHz	Test By:	Eric Ou Yang
Description:	Beamforming on		

Frequency (MHz)	Reading (dBuV)	Correct Factor (dB/m)	Result (dBuV/m)	Limit (dBuV/m)	Margin (dB)	Remark	Ant.Polar. H / V
5350.000	46.32	11.05	57.37	74.00	-16.63	peak	H
5350.000	35.61	11.05	46.66	54.00	-7.34	AVG	H
5376.720	47.96	11.08	59.04	74.00	-14.96	peak	H
5376.720	36.45	11.08	47.53	54.00	-6.47	AVG	H
5035.680	48.08	10.58	58.66	74.00	-15.34	peak	H
5035.680	36.15	10.58	46.73	54.00	-7.27	AVG	H
5150.000	46.32	10.74	57.06	74.00	-16.94	peak	H
5150.000	36.08	10.74	46.82	54.00	-7.18	AVG	H
5123.040	53.61	10.71	64.32	74.00	-9.68	peak	V
5123.040	41.37	10.71	52.08	54.00	-1.92	AVG	V
5150.000	49.12	10.74	59.86	74.00	-14.14	peak	V
5150.000	38.85	10.74	49.59	54.00	-4.41	AVG	V
5350.000	46.54	11.05	57.59	74.00	-16.41	peak	V
5350.000	39.22	11.05	50.27	54.00	-3.73	AVG	V
5359.200	49.99	11.06	61.05	74.00	-12.95	peak	V
5359.200	41.14	11.06	52.20	54.00	-1.80	AVG	V

Standard:	FCC Part 15E	Test Distance:	3m
Test item:	Radiated Emission	Power:	AC 120V/60Hz
Model Number:	Touch P5	Temp.(°C)/Hum.(%RH):	26(°C)/60%RH
Test Mode:	Mode 3	Date:	07/01/2015
Frequency:	5240 MHz	Test By:	Eric Ou Yang
Description:	Beamforming on		

Frequency (MHz)	Reading (dBuV)	Correct Factor (dB/m)	Result (dBuV/m)	Limit (dBuV/m)	Margin (dB)	Remark	Ant.Polar. H / V
5350.000	46.91	11.05	57.96	74.00	-16.04	peak	H
5350.000	35.77	11.05	46.82	54.00	-7.18	AVG	H
5403.680	48.42	11.12	59.54	74.00	-14.46	peak	H
5403.680	36.82	11.12	47.94	54.00	-6.06	AVG	H
5350.000	45.59	11.05	56.64	74.00	-17.36	peak	V
5350.000	36.50	11.05	47.55	54.00	-6.45	AVG	V
5404.120	51.05	11.12	62.17	74.00	-11.83	peak	V
5404.120	40.37	11.12	51.49	54.00	-2.51	AVG	V

Standard:	FCC Part 15E	Test Distance:	3m
Test item:	Radiated Emission	Power:	AC 120V/60Hz
Model Number:	Touch P5	Temp.(°C)/Hum.(%RH):	26(°C)/60%RH
Test Mode:	Mode 4	Date:	07/01/2015
Frequency:	5190 MHz	Test By:	Eric Ou Yang
Description:	Beamforming on		

Frequency (MHz)	Reading (dBuV)	Correct Factor (dB/m)	Result (dBuV/m)	Limit (dBuV/m)	Margin (dB)	Remark	Ant.Polar. H / V
5006.800	47.07	10.53	57.60	74.00	-16.40	peak	H
5006.800	37.86	10.53	48.39	54.00	-5.61	AVG	H
5150.000	46.35	10.74	57.09	74.00	-16.91	peak	H
5150.000	36.93	10.74	47.67	54.00	-6.33	AVG	H
5144.700	50.67	10.74	61.41	74.00	-12.59	peak	V
5144.700	39.44	10.74	50.18	54.00	-3.82	AVG	V
5150.000	51.41	10.74	62.15	74.00	-11.85	peak	V
5150.000	40.85	10.74	51.59	54.00	-2.41	AVG	V

Standard:	FCC Part 15E	Test Distance:	3m
Test item:	Radiated Emission	Power:	AC 120V/60Hz
Model Number:	Touch P5	Temp.(°C)/Hum.(%RH):	26(°C)/60%RH
Test Mode:	Mode 4	Date:	07/01/2015
Frequency:	5230 MHz	Test By:	Eric Ou Yang
Description:	Beamforming on		

Frequency (MHz)	Reading (dBuV)	Correct Factor (dB/m)	Result (dBuV/m)	Limit (dBuV/m)	Margin (dB)	Remark	Ant.Polar. H / V
5350.000	45.97	11.05	57.02	74.00	-16.98	peak	H
5350.000	35.70	11.05	46.75	54.00	-7.25	AVG	H
5382.490	47.15	11.10	58.25	74.00	-15.75	peak	H
5382.490	35.83	11.10	46.93	54.00	-7.07	AVG	H
5350.000	47.06	11.05	58.11	74.00	-15.89	peak	V
5350.000	36.03	11.05	47.08	54.00	-6.92	AVG	V
5377.660	50.50	11.08	61.58	74.00	-12.42	peak	V
5377.660	39.13	11.08	50.21	54.00	-3.79	AVG	V

Standard:	FCC Part 15E	Test Distance:	3m				
Test item:	Radiated Emission	Power:	AC 120V/60Hz				
Model Number:	Touch P5	Temp.(°C)/Hum.(%RH):	26(°C)/60%RH				
Test Mode:	Mode 5	Date:	07/01/2015				
Frequency:	5210 MHz	Test By:	Eric Ou Yang				
Description:	Beamforming on						
Frequency (MHz)	Reading (dBuV)	Correct Factor (dB/m)	Result (dBuV/m)	Limit (dBuV/m)	Margin (dB)	Remark	Ant.Polar. H / V
4900.440	48.37	10.37	58.74	74.00	-15.26	peak	H
4900.440	36.05	10.37	46.42	54.00	-7.58	AVG	H
5150.000	47.59	10.74	58.33	74.00	-15.67	peak	H
5150.000	36.37	10.74	47.11	54.00	-6.89	AVG	H
5350.000	47.33	11.05	58.38	74.00	-15.62	peak	H
5350.000	35.34	11.05	46.39	54.00	-7.61	AVG	H
5367.250	47.72	11.07	58.79	74.00	-15.21	peak	H
5367.250	35.44	11.07	46.51	54.00	-7.49	AVG	H
5146.810	55.95	10.74	66.69	74.00	-7.31	peak	V
5146.810	40.64	10.74	51.38	54.00	-2.62	AVG	V
5150.000	54.69	10.74	65.43	74.00	-8.57	peak	V
5150.000	41.03	10.74	51.77	54.00	-2.23	AVG	V
5350.000	47.04	11.05	58.09	74.00	-15.91	peak	V
5350.000	35.54	11.05	46.59	54.00	-7.41	AVG	V
5399.500	47.98	11.12	59.10	74.00	-14.90	peak	V
5399.500	35.78	11.12	46.90	54.00	-7.10	AVG	V

## 6 Maximum Conducted Output Power Measurement

### 6.1. Limit

Conducted Output Power

Frequency Range (MHz)	FCC Limit
5.150 ~ 5.250 GHz	The lesser of 1000mW (30dBm)
5.250 ~ 5.350 GHz	The lesser of 250mW (24dBm) or 11dBm + 10log (B)
5.470 ~ 5.725 GHz	The lesser of 250mW (24dBm) or 11dBm + 10log (B)
5.725 ~ 5.850 GHz	The lesser of 1000mW (30dBm)

Note: Where B is the 26dB emission bandwidth in MHz.

Note2: Conducted Output Power of Beamforming on Limit

$$5180 - 5240 \text{ MHz} : \text{Directional gain} = G_{ANT} + 10 \cdot \log(N_{ANT}/N_{SS}) = 6.77 \text{ dBi} > 6 \text{ dBi} \cdot$$

$$\text{Power Limit} = 30 - (6.77 - 6) = 29.23 \text{ dBm/MHz}$$

### 6.2. Test Setup

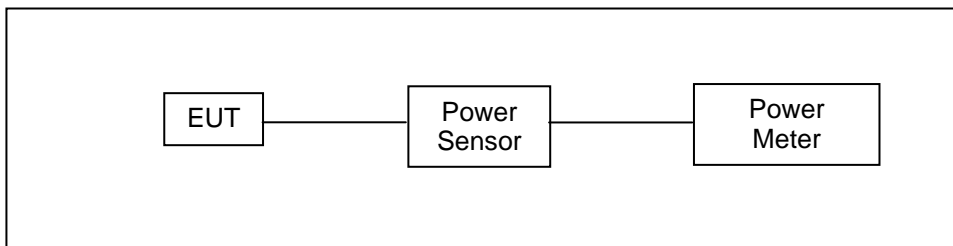

### 6.3. Test Instruments

Equipment	Manufacturer	Model Number	Serial Number	Cal. Date	Remark
Power Sensor	Anritsu	MA2411B	1126022	08/21/2014	(1)
Power Meter	Anritsu	ML2495A	1135009	08/21/2014	(1)
Test Site	ATL	TE02	TE02	N.C.R.	-----

Remark: (1) Calibration period 1 year. (2) Calibration period 2 years.

Note: N.C.R. = No Calibration Request.

### 6.4. Test Procedure

The test is performed in accordance with KDB789033: D02 General UNII Test Procedures New Rules v01, Guidelines for Compliance Testing of Unlicensed National Information Infrastructure (U-NII) Devices - Part 15, Subpart E.

**6.5. Test Result**

Model Number		Touch P5								
Test Item		Maximum Conducted Output Power								
Test Mode		Mode 2: IEEE 802.11a Link Mode								
Date of Test		08/17/2015				Test Site		TE02		
Frequency (MHz)	Data Rate	ANT-0		ANT-1		ANT-2		ANT-0+1+2		FCC Limit (dBm)
		Average Power		Average Power		Average Power		Average Power		
		(dBm)	(W)	(dBm)	(W)	(dBm)	(W)	(dBm)	(W)	
5180	6M	18.38	0.069	18.50	0.071	18.02	0.063	23.08	0.203	< 30
5200		21.86	0.153	22.03	0.160	21.49	0.141	<b>26.57</b>	<b>0.454</b>	
5220		19.79	0.095	19.90	0.098	19.41	0.087	24.48	0.280	
5240		19.89	0.097	19.97	0.099	19.37	0.086	24.52	0.283	
5180	54M	18.11	0.065	18.25	0.067	17.77	0.060	22.82	0.191	< 30
5200		21.67	0.147	21.87	0.154	21.28	0.134	26.38	0.435	
5220		19.51	0.089	19.63	0.092	19.13	0.082	24.20	0.263	
5240		19.64	0.092	19.72	0.094	19.10	0.081	24.27	0.267	

Model Number		Touch P5								
Test Item		Maximum Conducted Output Power								
Test Mode		Mode 3: IEEE 802.11ac 20MHz Link Mode								
Date of Test		08/17/2015				Test Site		TE02		
Frequency (MHz)	Data Rate	ANT-0		ANT-1		ANT-2		ANT-0+1+2		FCC Limit (dBm)
		Average Power		Average Power		Average Power		Average Power		
		(dBm)	(W)	(dBm)	(W)	(dBm)	(W)	(dBm)	(W)	
5180	19.5M	18.44	0.070	18.61	0.073	17.89	0.062	23.10	0.204	< 30
5200		21.94	0.156	22.25	0.168	21.31	0.135	26.62	0.459	
5220		22.19	0.166	22.33	0.171	21.55	0.143	<b>26.81</b>	<b>0.479</b>	
5240		22.09	0.162	22.31	0.170	21.60	0.145	26.78	0.477	
5180	234M	18.09	0.064	18.23	0.067	17.54	0.057	22.73	0.188	< 30
5200		21.76	0.150	21.99	0.158	21.01	0.126	26.38	0.434	
5220		21.83	0.152	21.96	0.157	21.17	0.131	26.44	0.440	
5240		21.71	0.148	21.96	0.157	21.25	0.133	26.42	0.439	

Model Number		Touch P5								
Test Item		Maximum Conducted Output Power								
Test Mode		Mode 4: IEEE 802.11ac 40MHz Link Mode								
Date of Test		08/17/2015				Test Site		TE02		
Frequency (MHz)	Data Rate	ANT-0		ANT-1		ANT-2		ANT-0+1+2		FCC Limit (dBm)
		Average Power		Average Power		Average Power		Average Power		
		(dBm)	(W)	(dBm)	(W)	(dBm)	(W)	(dBm)	(W)	
5190	40.5M	15.48	0.035	16.73	0.047	16.34	0.043	20.99	0.125	< 30
5230		24.75	0.299	24.95	0.313	23.88	0.244	<b>29.32</b>	<b>0.855</b>	
5190	540M	15.15	0.033	16.44	0.044	16.04	0.040	20.68	0.117	< 30
5230		23.76	0.238	23.97	0.249	22.85	0.193	28.32	0.680	

Model Number		Touch P5								
Test Item		Maximum Conducted Output Power								
Test Mode		Mode 5: IEEE 802.11ac 80MHz Link Mode								
Date of Test		08/17/2015				Test Site		TE02		
Frequency (MHz)	Data Rate	ANT-0		ANT-1		ANT-2		ANT-0+1+2		FCC Limit (dBm)
		Average Power		Average Power		Average Power		Average Power		
		(dBm)	(W)	(dBm)	(W)	(dBm)	(W)	(dBm)	(W)	
5210	87.9M	14.63	0.029	15.42	0.035	14.97	0.031	<b>19.79</b>	<b>0.095</b>	< 30
5210	1170M	13.86	0.024	14.52	0.028	14.05	0.025	18.92	0.078	< 30



Model Number		Touch P5								
Test Item		Maximum Conducted Output Power								
Test Mode		Mode 3: IEEE 802.11ac 20MHz Link Mode								
Date of Test		08/17/2015				Test Site		TE02		
Beamforming on										
Frequency (MHz)	Data Rate	ANT-0		ANT-1		ANT-2		ANT-0+1+2		FCC Limit (dBm)
		Average Power		Average Power		Average Power		Average Power		
		(dBm)	(W)	(dBm)	(W)	(dBm)	(W)	(dBm)	(W)	
5180	19.5M	16.04	0.040	16.26	0.042	15.56	0.036	20.73	0.118	< 29.23
5200		19.55	0.090	19.97	0.099	19.01	0.080	24.30	0.269	
5220		19.81	0.096	20.08	0.102	18.91	0.078	24.40	0.275	
5240		19.69	0.093	19.98	0.100	19.31	0.085	<b>24.44</b>	<b>0.278</b>	
5180	234M	15.69	0.037	15.93	0.039	15.24	0.033	20.40	0.110	< 29.23
5200		19.38	0.087	19.61	0.091	18.84	0.077	24.06	0.255	
5220		19.48	0.089	19.71	0.094	18.71	0.074	24.09	0.257	
5240		19.31	0.085	19.65	0.092	18.96	0.079	24.09	0.256	

Model Number		Touch P5								
Test Item		Maximum Conducted Output Power								
Test Mode		Mode 4: IEEE 802.11ac 40MHz Link Mode								
Date of Test		08/17/2015				Test Site		TE02		
Beamforming on										
Frequency (MHz)	Data Rate	ANT-0		ANT-1		ANT-2		ANT-0+1+2		FCC Limit (dBm)
		Average Power		Average Power		Average Power		Average Power		
		(dBm)	(W)	(dBm)	(W)	(dBm)	(W)	(dBm)	(W)	
5190	40.5M	13.02	0.020	14.44	0.028	14.05	0.025	18.65	0.073	< 29.23
5230		22.19	0.166	22.52	0.179	21.48	0.141	<b>26.86</b>	<b>0.485</b>	
5190	540M	12.68	0.019	14.11	0.026	13.75	0.024	18.33	0.068	< 29.23
5230		21.20	0.132	21.68	0.147	20.55	0.114	25.94	0.393	< 29.23

Model Number		Touch P5								
Test Item		Maximum Conducted Output Power								
Test Mode		Mode 5: IEEE 802.11ac 80MHz Link Mode								
Date of Test		08/17/2015				Test Site		TE02		
Beamforming on										
Frequency (MHz)	Data Rate	ANT-0		ANT-1		ANT-2		ANT-0+1+2		FCC Limit (dBm)
		Average Power		Average Power		Average Power		Average Power		
		(dBm)	(W)	(dBm)	(W)	(dBm)	(W)	(dBm)	(W)	
5210	87.9M	12.09	0.016	13.06	0.020	12.67	0.018	<b>17.40</b>	<b>0.055</b>	< 29.23
5210	1170M	11.39	0.014	12.25	0.017	11.69	0.015	16.56	0.045	< 29.23

## 7 26dB RF Bandwidth & 99 % Occupied Bandwidth Measurement

### 7.1. Limit

N/A

### 7.2. Test Setup

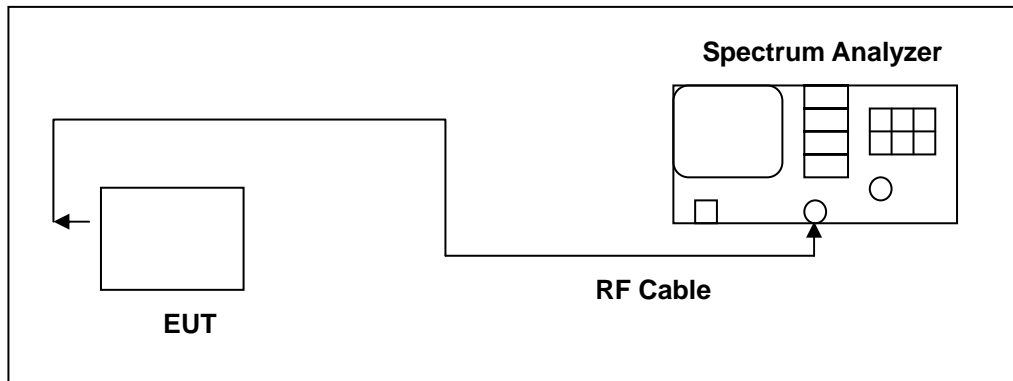

### 7.3. Test Instruments

Equipment	Manufacturer	Model Number	Serial Number	Cal. Date	Remark
Spectrum Analyzer	Agilent	E4445A	MY45300744	12/16/2014	(1)
Test Site	ATL	TE02	TE02	N.C.R.	-----

Remark: (1) Calibration period 1 year. (2) Calibration period 2 years.

Note: N.C.R. = No Calibration Request.

### 7.4. Test Procedure

The test is performed in accordance with KDB789033: D02 General UNII Test Procedures New Rules v01, Guidelines for Compliance Testing of Unlicensed National Information Infrastructure (U-NII) Devices - Part 15, Subpart E.

**7.5. Test Result**

Model Number	Touch P5			
Test Item	26dB RF Bandwidth & 99 % Occupied Bandwidth Measurement			
Test Mode	Mode 2: IEEE 802.11a Link Mode			
Date of Test	06/23/2015	Test Site	TE02	
Frequency (MHz)	ANT-0		ANT-1	
	26dB Bandwidth (MHz)	99 % Occupied Bandwidth	26dB Bandwidth (MHz)	99 % Occupied Bandwidth
5180	20.549	16.906	20.465	16.840
5200	20.811	16.871	21.120	16.798
5240	20.340	16.885	20.394	16.770
Frequency (MHz)	ANT-2			
	26dB Bandwidth (MHz)		99 % Occupied Bandwidth	
5180	20.445		16.756	
5200	20.585		16.741	
5240	20.257		16.721	

Model Number	Touch P5			
Test Item	26dB RF Bandwidth & 99 % Occupied Bandwidth Measurement			
Test Mode	Mode 3: IEEE 802.11ac 20MHz Link Mode			
Date of Test	06/09/2015	Test Site	TE02	
Frequency (MHz)	ANT-0		ANT-1	
	26dB Bandwidth (MHz)	99 % Occupied Bandwidth	26dB Bandwidth (MHz)	99 % Occupied Bandwidth
5180	20.808	17.947	20.643	17.827
5200	20.943	17.831	20.486	17.821
5240	20.744	17.890	20.497	17.781
Frequency (MHz)	ANT-2			
	26dB Bandwidth (MHz)		99 % Occupied Bandwidth	
5180	20.666		17.832	
5200	20.903		17.837	
5240	20.550		17.806	

Note: The 99% occupied bandwidth not crossed 5250MHz.

Model Number	Touch P5			
Test Item	26dB RF Bandwidth & 99 % Occupied Bandwidth Measurement			
Test Mode	Mode 4: IEEE 802.11ac 40MHz Link Mode			
Date of Test	06/09/2015	Test Site	TE02	
Frequency (MHz)	ANT-0		ANT-1	
	26dB Bandwidth (MHz)	99 % Occupied Bandwidth	26dB Bandwidth (MHz)	99 % Occupied Bandwidth
5190	41.163	36.615	40.740	36.561
5230	41.464	36.548	41.440	36.516
Frequency (MHz)	ANT-2			
	26dB Bandwidth (MHz)		99 % Occupied Bandwidth	
5190	40.696		36.480	
5230	41.287		36.561	

Model Number	Touch P5			
Test Item	26dB RF Bandwidth & 99 % Occupied Bandwidth Measurement			
Test Mode	Mode 5: IEEE 802.11ac 80MHz Link Mode			
Date of Test	05/06/2015	Test Site	TE02	
Frequency (MHz)	ANT-0		ANT-1	
	26dB Bandwidth (MHz)	99 % Occupied Bandwidth	26dB Bandwidth (MHz)	99 % Occupied Bandwidth
5210	82.445	75.468	81.819	75.594
Frequency (MHz)	ANT-2			
	26dB Bandwidth (MHz)		99 % Occupied Bandwidth	
5210	81.577		75.482	

Note: The 99% occupied bandwidth not crossed 5250MHz.

Model Number	Touch P5			
Test Item	26dB RF Bandwidth & 99 % Occupied Bandwidth Measurement			
Test Mode	Mode 3: IEEE 802.11ac 20MHz Link Mode			
Date of Test	06/09/2015	Test Site	TE02	
Beamforming on				
Frequency (MHz)	ANT-0		ANT-1	
	26dB Bandwidth (MHz)	99 % Occupied Bandwidth	26dB Bandwidth (MHz)	99 % Occupied Bandwidth
5180	20.808	17.947	20.643	17.827
5200	20.943	17.831	20.486	17.821
5240	20.744	17.890	20.497	17.781
Frequency (MHz)	ANT-2			
	26dB Bandwidth (MHz)		99 % Occupied Bandwidth	
5180	20.666		17.832	
5200	20.903		17.837	
5240	20.550		17.806	

Model Number	Touch P5			
Test Item	26dB RF Bandwidth & 99 % Occupied Bandwidth Measurement			
Test Mode	Mode 4: IEEE 802.11ac 40MHz Link Mode			
Date of Test	06/09/2015	Test Site	TE02	
Beamforming on				
Frequency (MHz)	ANT-0		ANT-1	
	26dB Bandwidth (MHz)	99 % Occupied Bandwidth	26dB Bandwidth (MHz)	99 % Occupied Bandwidth
5190	41.163	36.615	40.740	36.561
5230	41.464	36.548	41.440	36.516
Frequency (MHz)	ANT-2			
	26dB Bandwidth (MHz)		99 % Occupied Bandwidth	
5190	40.696		36.480	
5230	41.287		36.561	

Note: The 99% occupied bandwidth not crossed 5250MHz.

Model Number	Touch P5			
Test Item	26dB RF Bandwidth & 99 % Occupied Bandwidth Measurement			
Test Mode	Mode 5: IEEE 802.11ac 80MHz Link Mode			
Date of Test	05/06/2015	Test Site	TE02	
Beamforming on				
Frequency (MHz)	ANT-0		ANT-1	
	26dB Bandwidth (MHz)	99 % Occupied Bandwidth	26dB Bandwidth (MHz)	99 % Occupied Bandwidth
5210	82.445	75.468	81.819	75.594
Frequency (MHz)	ANT-2			
	26dB Bandwidth (MHz)		99 % Occupied Bandwidth	
5210	81.577		75.482	

Note: The 99% occupied bandwidth not crossed 5250MHz.

**7.6. Test Graphs**

Mode 2: IEEE 802.11a Link Mode_ ANT-0	
5180	<p>Agilent R T</p> <p>Ch Freq 5.18 GHz Trng Free</p> <p>Occupied Bandwidth</p> <p>Ref 20 dBm #Atten 20 dB</p> <p>#Peak Log 10 dB/Offset 13.4 dB</p> <p>Center 5.18 GHz Span 25 MHz</p> <p>#Res BW 300 kHz #VBW 1 MHz Sweep 4 ms (401 pts)</p> <p><b>Occupied Bandwidth 16.9055 MHz</b></p> <p>Occ BW % Pwr 99.00 % x dB -26.00 dB</p> <p>Transmit Freq Error -19.732 kHz</p> <p>x dB Bandwidth 20.549 MHz</p> <p>Freq/Channel</p> <p>Center Freq 5.1800000 GHz</p> <p>Start Freq 5.1675000 GHz</p> <p>Stop Freq 5.1925000 GHz</p> <p>CF Step 2.5000000 MHz Auto Man</p> <p>Freq Offset 0.0000000 Hz</p> <p>Signal Track On Off</p>
5200	<p>Agilent R T</p> <p>Ch Freq 5.2 GHz Trng Free</p> <p>Occupied Bandwidth</p> <p>Ref 20 dBm #Atten 20 dB</p> <p>#Peak Log 10 dB/Offset 13.4 dB</p> <p>Center 5.2 GHz Span 25 MHz</p> <p>#Res BW 300 kHz #VBW 1 MHz Sweep 4 ms (401 pts)</p> <p><b>Occupied Bandwidth 16.8706 MHz</b></p> <p>Occ BW % Pwr 99.00 % x dB -26.00 dB</p> <p>Transmit Freq Error -34.675 kHz</p> <p>x dB Bandwidth 20.811 MHz</p> <p>Freq/Channel</p> <p>Center Freq 5.2000000 GHz</p> <p>Start Freq 5.1875000 GHz</p> <p>Stop Freq 5.2125000 GHz</p> <p>CF Step 2.5000000 MHz Auto Man</p> <p>Freq Offset 0.0000000 Hz</p> <p>Signal Track On Off</p>
5240	<p>Agilent R T</p> <p>Ch Freq 5.24 GHz Trng Free</p> <p>Occupied Bandwidth</p> <p>Ref 20 dBm #Atten 20 dB</p> <p>#Peak Log 10 dB/Offset 13.4 dB</p> <p>Center 5.24 GHz Span 25 MHz</p> <p>#Res BW 300 kHz #VBW 1 MHz Sweep 4 ms (401 pts)</p> <p><b>Occupied Bandwidth 16.8853 MHz</b></p> <p>Occ BW % Pwr 99.00 % x dB -26.00 dB</p> <p>Transmit Freq Error -8.480 kHz</p> <p>x dB Bandwidth 20.340 MHz</p> <p>Freq/Channel</p> <p>Center Freq 5.2400000 GHz</p> <p>Start Freq 5.2275000 GHz</p> <p>Stop Freq 5.2525000 GHz</p> <p>CF Step 2.5000000 MHz Auto Man</p> <p>Freq Offset 0.0000000 Hz</p> <p>Signal Track On Off</p>

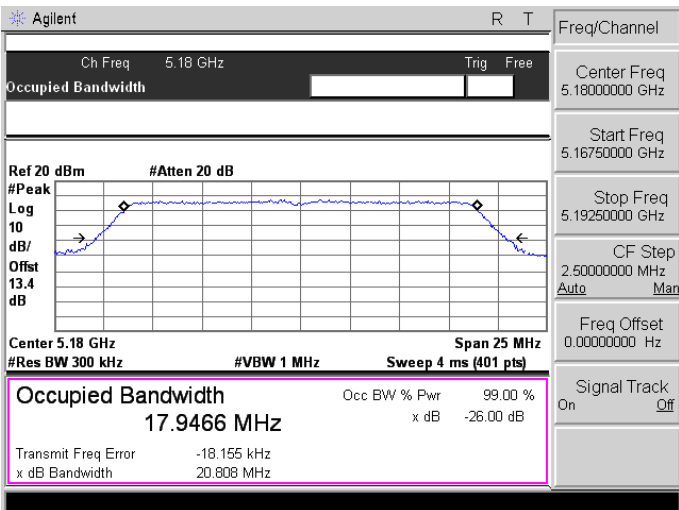
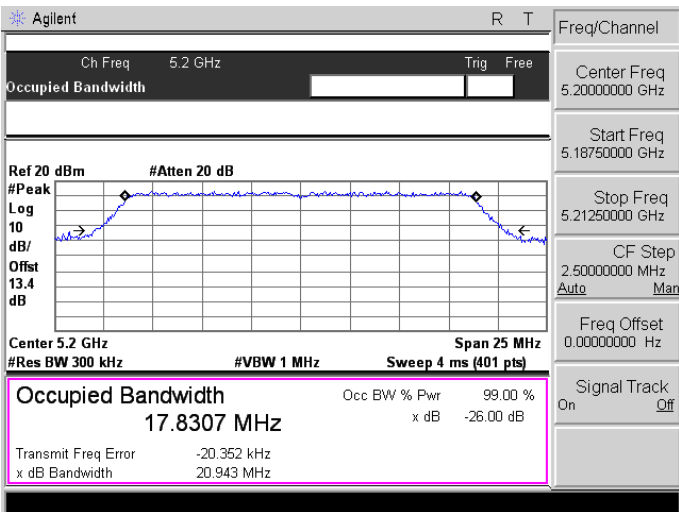
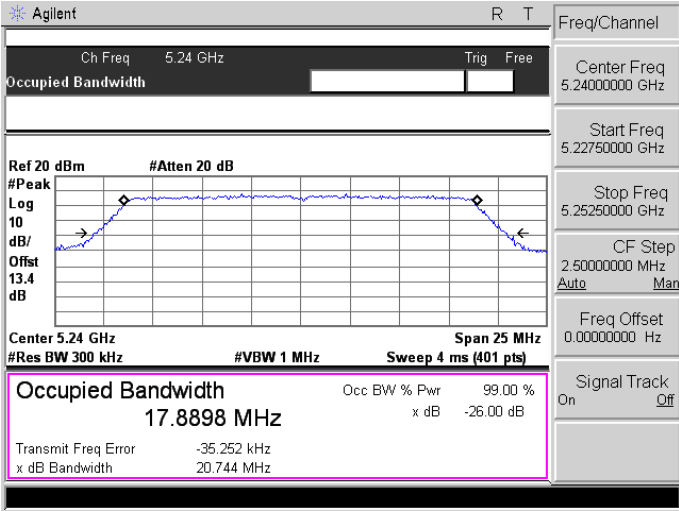
Mode 3: IEEE 802.11ac 20MHz Link Mode_ ANT-0	
5180	 <p>Agilent R T</p> <p>Ch Freq 5.18 GHz Trng Free</p> <p>Occupied Bandwidth</p> <p>Ref 20 dBm #Atten 20 dB</p> <p>#Peak Log 10 dB/Offst 13.4 dB</p> <p>Center 5.18 GHz Span 25 MHz #Res BW 300 kHz #VBW 1 MHz Sweep 4 ms (401 pts)</p> <p><b>Occupied Bandwidth 17.9466 MHz</b></p> <p>Occ BW % Pwr 99.00 % x dB -26.00 dB</p> <p>Transmit Freq Error -18.155 kHz x dB Bandwidth 20.808 MHz</p> <p>Freq/Channel</p> <p>Center Freq 5.18000000 GHz</p> <p>Start Freq 5.16750000 GHz</p> <p>Stop Freq 5.19250000 GHz</p> <p>CF Step 2.50000000 MHz Auto Man</p> <p>Freq Offset 0.00000000 Hz</p> <p>Signal Track On Off</p>
5200	 <p>Agilent R T</p> <p>Ch Freq 5.2 GHz Trng Free</p> <p>Occupied Bandwidth</p> <p>Ref 20 dBm #Atten 20 dB</p> <p>#Peak Log 10 dB/Offst 13.4 dB</p> <p>Center 5.2 GHz Span 25 MHz #Res BW 300 kHz #VBW 1 MHz Sweep 4 ms (401 pts)</p> <p><b>Occupied Bandwidth 17.8307 MHz</b></p> <p>Occ BW % Pwr 99.00 % x dB -26.00 dB</p> <p>Transmit Freq Error -20.352 kHz x dB Bandwidth 20.943 MHz</p> <p>Freq/Channel</p> <p>Center Freq 5.20000000 GHz</p> <p>Start Freq 5.18750000 GHz</p> <p>Stop Freq 5.21250000 GHz</p> <p>CF Step 2.50000000 MHz Auto Man</p> <p>Freq Offset 0.00000000 Hz</p> <p>Signal Track On Off</p>
5240	 <p>Agilent R T</p> <p>Ch Freq 5.24 GHz Trng Free</p> <p>Occupied Bandwidth</p> <p>Ref 20 dBm #Atten 20 dB</p> <p>#Peak Log 10 dB/Offst 13.4 dB</p> <p>Center 5.24 GHz Span 25 MHz #Res BW 300 kHz #VBW 1 MHz Sweep 4 ms (401 pts)</p> <p><b>Occupied Bandwidth 17.8898 MHz</b></p> <p>Occ BW % Pwr 99.00 % x dB -26.00 dB</p> <p>Transmit Freq Error -35.252 kHz x dB Bandwidth 20.744 MHz</p> <p>Freq/Channel</p> <p>Center Freq 5.24000000 GHz</p> <p>Start Freq 5.22750000 GHz</p> <p>Stop Freq 5.25250000 GHz</p> <p>CF Step 2.50000000 MHz Auto Man</p> <p>Freq Offset 0.00000000 Hz</p> <p>Signal Track On Off</p>



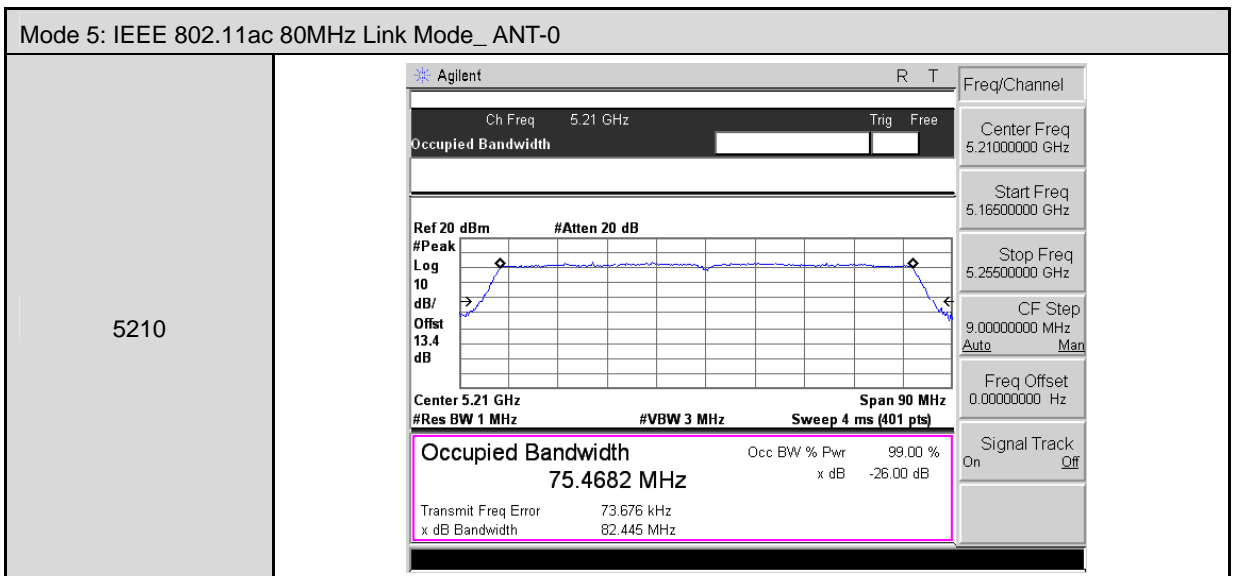
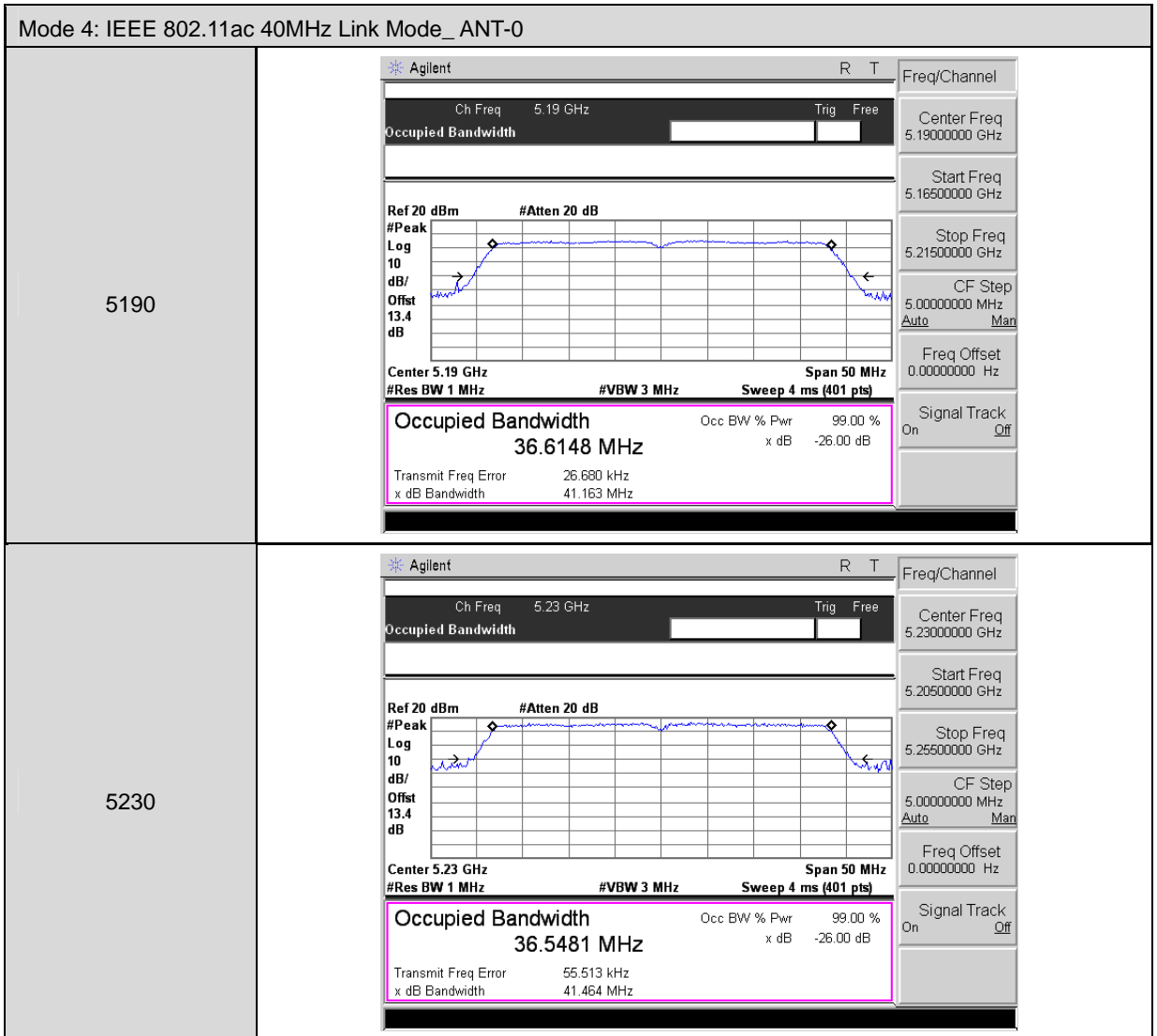

Mode 2: IEEE 802.11a Link Mode_ ANT-1	
5180	<p>Agilent R T</p> <p>Ch Freq 5.18 GHz Trng Free</p> <p>Occupied Bandwidth</p> <p>Ref 20 dBm #Atten 20 dB</p> <p>#Peak Log 10 dB/Offset 13.4 dB</p> <p>Center 5.18 GHz Span 25 MHz #Res BW 300 kHz #VBW 1 MHz Sweep 4 ms (401 pts)</p> <p><b>Occupied Bandwidth 16.8397 MHz</b></p> <p>Occ BW % Pwr 99.00 % x dB -26.00 dB</p> <p>Transmit Freq Error -2.855 kHz x dB Bandwidth 20.465 MHz</p> <p>Freq/Channel: Center Freq 5.18000000 GHz, Start Freq 5.16750000 GHz, Stop Freq 5.19250000 GHz, CF Step 2.50000000 MHz, Freq Offset 0.00000000 Hz, Signal Track On/Off</p>
5200	<p>Agilent R T</p> <p>Ch Freq 5.2 GHz Trng Free</p> <p>Occupied Bandwidth</p> <p>Ref 20 dBm #Atten 20 dB</p> <p>#Peak Log 10 dB/Offset 13.4 dB</p> <p>Center 5.2 GHz Span 25 MHz #Res BW 300 kHz #VBW 1 MHz Sweep 4 ms (401 pts)</p> <p><b>Occupied Bandwidth 16.7984 MHz</b></p> <p>Occ BW % Pwr 99.00 % x dB -26.00 dB</p> <p>Transmit Freq Error -15.957 kHz x dB Bandwidth 21.120 MHz</p> <p>Freq/Channel: Center Freq 5.20000000 GHz, Start Freq 5.18750000 GHz, Stop Freq 5.21250000 GHz, CF Step 2.50000000 MHz, Freq Offset 0.00000000 Hz, Signal Track On/Off</p>
5240	<p>Agilent R T</p> <p>Ch Freq 5.24 GHz Trng Free</p> <p>Occupied Bandwidth</p> <p>Ref 20 dBm #Atten 20 dB</p> <p>#Peak Log 10 dB/Offset 13.4 dB</p> <p>Center 5.24 GHz Span 25 MHz #Res BW 300 kHz #VBW 1 MHz Sweep 4 ms (401 pts)</p> <p><b>Occupied Bandwidth 16.7697 MHz</b></p> <p>Occ BW % Pwr 99.00 % x dB -26.00 dB</p> <p>Transmit Freq Error -7.095 kHz x dB Bandwidth 20.394 MHz</p> <p>Freq/Channel: Center Freq 5.24000000 GHz, Start Freq 5.22750000 GHz, Stop Freq 5.25250000 GHz, CF Step 2.50000000 MHz, Freq Offset 0.00000000 Hz, Signal Track On/Off</p>

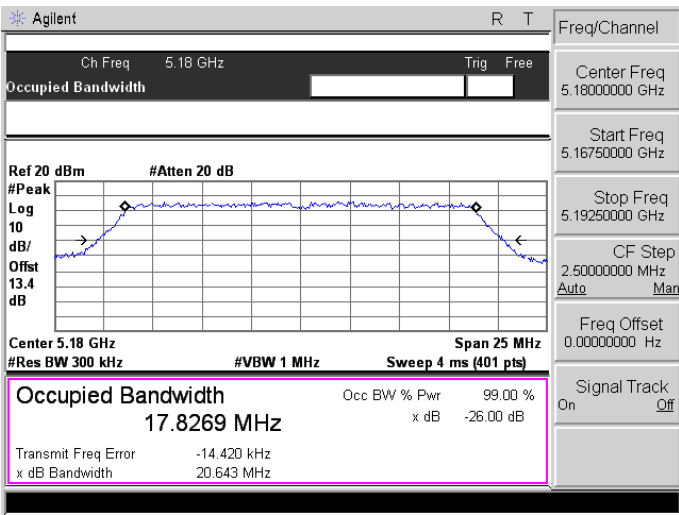
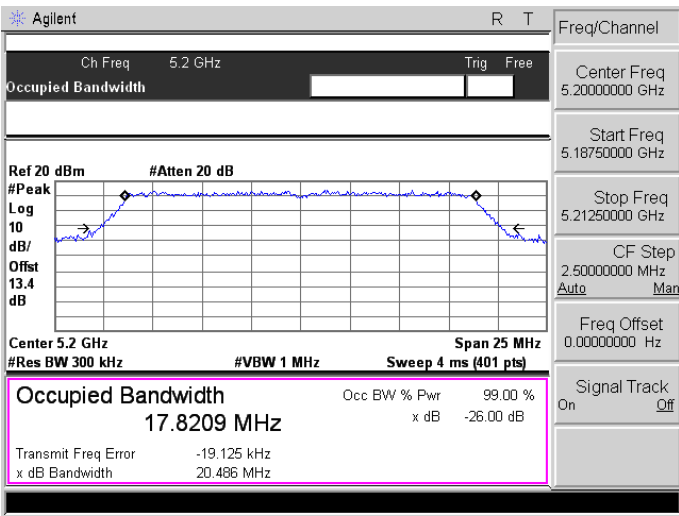
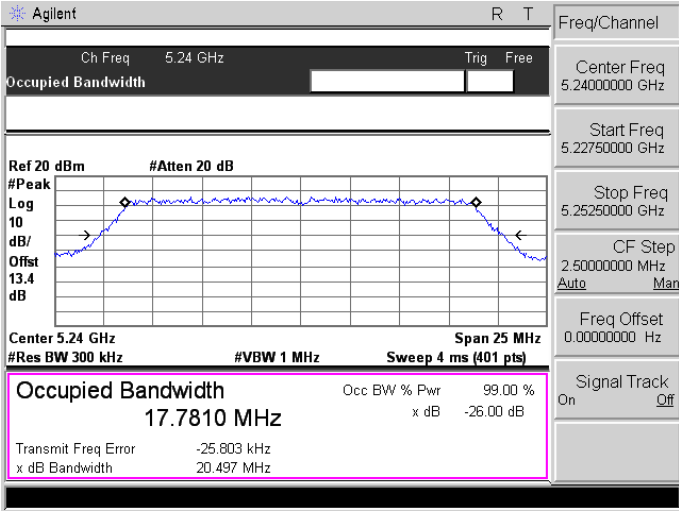
Mode 3: IEEE 802.11ac 20MHz Link Mode_ ANT-1	
5180	 <p>Agilent R T</p> <p>Ch Freq 5.18 GHz Trng Free</p> <p>Occupied Bandwidth</p> <p>Ref 20 dBm #Atten 20 dB</p> <p>#Peak</p> <p>Log 10 dB/Offset 13.4 dB</p> <p>Center 5.18 GHz Span 25 MHz</p> <p>#Res BW 300 kHz #VBW 1 MHz Sweep 4 ms (401 pts)</p> <p><b>Occupied Bandwidth 17.8269 MHz</b></p> <p>Occ BW % Pwr 99.00 % x dB -26.00 dB</p> <p>Transmit Freq Error -14.420 kHz</p> <p>x dB Bandwidth 20.643 MHz</p> <p>Freq/Channel</p> <p>Center Freq 5.18000000 GHz</p> <p>Start Freq 5.16750000 GHz</p> <p>Stop Freq 5.19250000 GHz</p> <p>CF Step 2.50000000 MHz Auto Man</p> <p>Freq Offset 0.00000000 Hz</p> <p>Signal Track On Off</p>
5200	 <p>Agilent R T</p> <p>Ch Freq 5.2 GHz Trng Free</p> <p>Occupied Bandwidth</p> <p>Ref 20 dBm #Atten 20 dB</p> <p>#Peak</p> <p>Log 10 dB/Offset 13.4 dB</p> <p>Center 5.2 GHz Span 25 MHz</p> <p>#Res BW 300 kHz #VBW 1 MHz Sweep 4 ms (401 pts)</p> <p><b>Occupied Bandwidth 17.8209 MHz</b></p> <p>Occ BW % Pwr 99.00 % x dB -26.00 dB</p> <p>Transmit Freq Error -19.125 kHz</p> <p>x dB Bandwidth 20.486 MHz</p> <p>Freq/Channel</p> <p>Center Freq 5.20000000 GHz</p> <p>Start Freq 5.18750000 GHz</p> <p>Stop Freq 5.21250000 GHz</p> <p>CF Step 2.50000000 MHz Auto Man</p> <p>Freq Offset 0.00000000 Hz</p> <p>Signal Track On Off</p>
5240	 <p>Agilent R T</p> <p>Ch Freq 5.24 GHz Trng Free</p> <p>Occupied Bandwidth</p> <p>Ref 20 dBm #Atten 20 dB</p> <p>#Peak</p> <p>Log 10 dB/Offset 13.4 dB</p> <p>Center 5.24 GHz Span 25 MHz</p> <p>#Res BW 300 kHz #VBW 1 MHz Sweep 4 ms (401 pts)</p> <p><b>Occupied Bandwidth 17.7810 MHz</b></p> <p>Occ BW % Pwr 99.00 % x dB -26.00 dB</p> <p>Transmit Freq Error -25.803 kHz</p> <p>x dB Bandwidth 20.497 MHz</p> <p>Freq/Channel</p> <p>Center Freq 5.24000000 GHz</p> <p>Start Freq 5.22750000 GHz</p> <p>Stop Freq 5.25250000 GHz</p> <p>CF Step 2.50000000 MHz Auto Man</p> <p>Freq Offset 0.00000000 Hz</p> <p>Signal Track On Off</p>

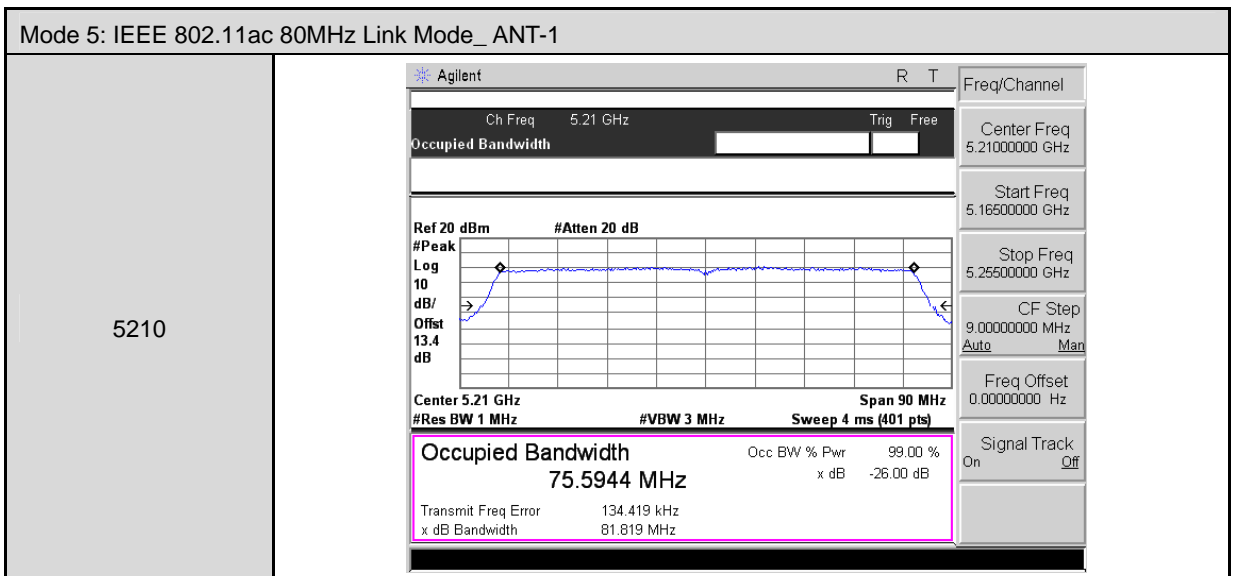
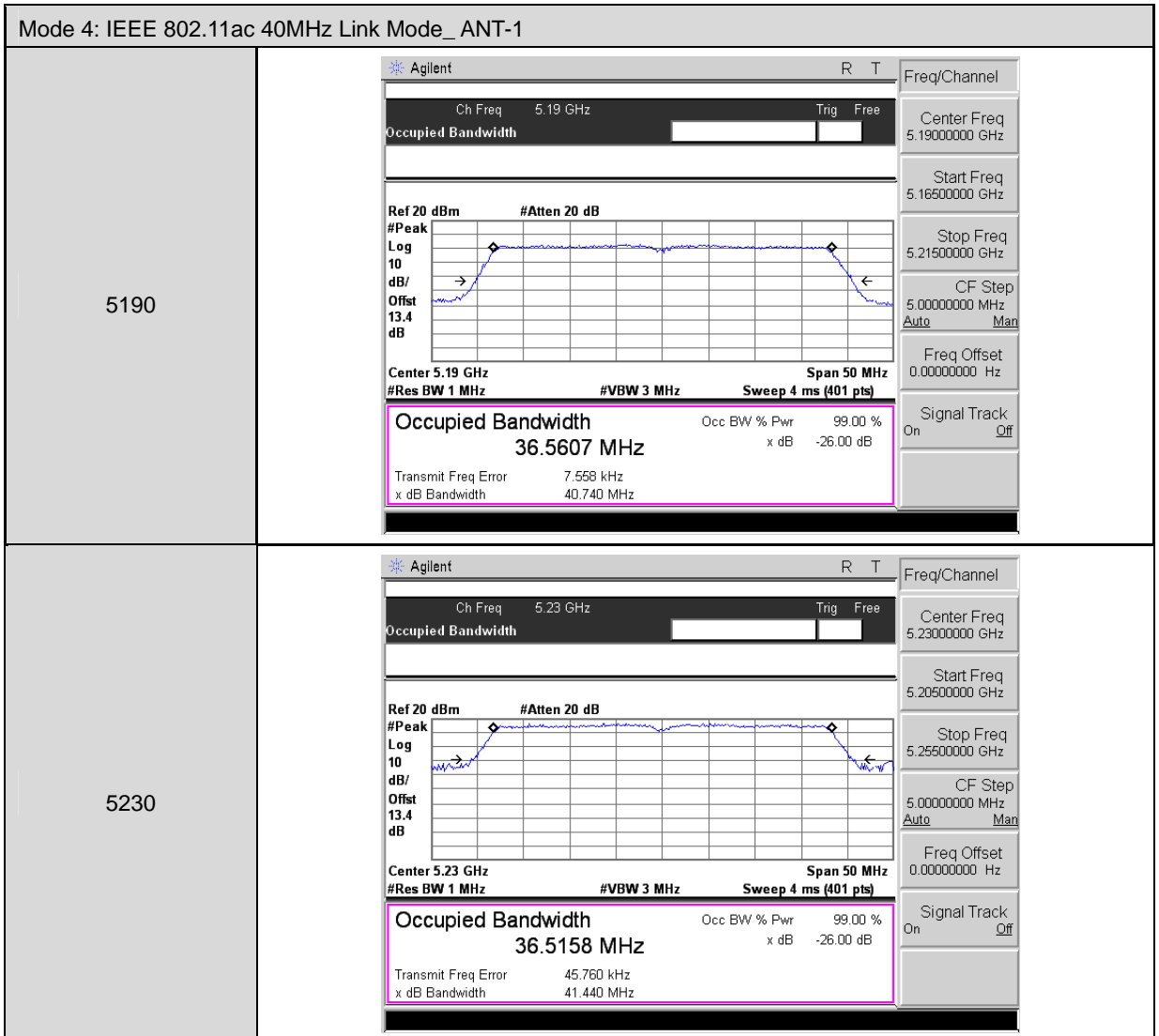

Mode 2: IEEE 802.11a Link Mode_ ANT-2	
5180	<p>Agilent R T</p> <p>Ch Freq 5.18 GHz Trng Free</p> <p>Occupied Bandwidth</p> <p>Ref 20 dBm #Atten 20 dB</p> <p>#Peak Log 10 dB/Offset 13.4 dB</p> <p>Center 5.18 GHz Span 25 MHz</p> <p>#Res BW 300 kHz #VBW 1 MHz Sweep 4 ms (401 pts)</p> <p><b>Occupied Bandwidth 16.7555 MHz</b></p> <p>Occ BW % Pwr 99.00 % x dB -26.00 dB</p> <p>Transmit Freq Error 11.465 kHz x dB Bandwidth 20.445 MHz</p> <p>Freq/Channel</p> <p>Center Freq 5.18000000 GHz</p> <p>Start Freq 5.16750000 GHz</p> <p>Stop Freq 5.19250000 GHz</p> <p>CF Step 2.50000000 MHz Auto Man</p> <p>Freq Offset 0.00000000 Hz</p> <p>Signal Track On Off</p>
5200	<p>Agilent R T</p> <p>Ch Freq 5.2 GHz Trng Free</p> <p>Occupied Bandwidth</p> <p>Ref 20 dBm #Atten 20 dB</p> <p>#Peak Log 10 dB/Offset 13.4 dB</p> <p>Center 5.2 GHz Span 25 MHz</p> <p>#Res BW 300 kHz #VBW 1 MHz Sweep 4 ms (401 pts)</p> <p><b>Occupied Bandwidth 16.7406 MHz</b></p> <p>Occ BW % Pwr 99.00 % x dB -26.00 dB</p> <p>Transmit Freq Error 18.284 kHz x dB Bandwidth 20.585 MHz</p> <p>Freq/Channel</p> <p>Center Freq 5.20000000 GHz</p> <p>Start Freq 5.18750000 GHz</p> <p>Stop Freq 5.21250000 GHz</p> <p>CF Step 2.50000000 MHz Auto Man</p> <p>Freq Offset 0.00000000 Hz</p> <p>Signal Track On Off</p>
5240	<p>Agilent R T</p> <p>Ch Freq 5.24 GHz Trng Free</p> <p>Occupied Bandwidth</p> <p>Ref 20 dBm #Atten 20 dB</p> <p>#Peak Log 10 dB/Offset 13.4 dB</p> <p>Center 5.24 GHz Span 25 MHz</p> <p>#Res BW 300 kHz #VBW 1 MHz Sweep 4 ms (401 pts)</p> <p><b>Occupied Bandwidth 16.7214 MHz</b></p> <p>Occ BW % Pwr 99.00 % x dB -26.00 dB</p> <p>Transmit Freq Error 33.264 kHz x dB Bandwidth 20.257 MHz</p> <p>Freq/Channel</p> <p>Center Freq 5.24000000 GHz</p> <p>Start Freq 5.22750000 GHz</p> <p>Stop Freq 5.25250000 GHz</p> <p>CF Step 2.50000000 MHz Auto Man</p> <p>Freq Offset 0.00000000 Hz</p> <p>Signal Track On Off</p>

Mode 3: IEEE 802.11ac 20MHz Link Mode_ ANT-2	
5180	<p>Agilent R T</p> <p>Ch Freq 5.18 GHz Trng Free</p> <p>Occupied Bandwidth</p> <p>Ref 20 dBm #Atten 20 dB</p> <p>#Peak Log 10 dB/Offset 13.4 dB</p> <p>Center 5.18 GHz Span 25 MHz</p> <p>#Res BW 300 kHz #VBW 1 MHz Sweep 4 ms (401 pts)</p> <p><b>Occupied Bandwidth 17.8316 MHz</b></p> <p>Occ BW % Pwr 99.00 % x dB -26.00 dB</p> <p>Transmit Freq Error -4.990 kHz x dB Bandwidth 20.666 MHz</p> <p>Freq/Channel</p> <p>Center Freq 5.1800000 GHz</p> <p>Start Freq 5.1675000 GHz</p> <p>Stop Freq 5.1925000 GHz</p> <p>CF Step 2.5000000 MHz Auto Man</p> <p>Freq Offset 0.0000000 Hz</p> <p>Signal Track On Off</p>
5200	<p>Agilent R T</p> <p>Ch Freq 5.2 GHz Trng Free</p> <p>Occupied Bandwidth</p> <p>Ref 20 dBm #Atten 20 dB</p> <p>#Peak Log 10 dB/Offset 13.4 dB</p> <p>Center 5.2 GHz Span 25 MHz</p> <p>#Res BW 300 kHz #VBW 1 MHz Sweep 4 ms (401 pts)</p> <p><b>Occupied Bandwidth 17.8370 MHz</b></p> <p>Occ BW % Pwr 99.00 % x dB -26.00 dB</p> <p>Transmit Freq Error -9.936 kHz x dB Bandwidth 20.903 MHz</p> <p>Freq/Channel</p> <p>Center Freq 5.2000000 GHz</p> <p>Start Freq 5.1875000 GHz</p> <p>Stop Freq 5.2125000 GHz</p> <p>CF Step 2.5000000 MHz Auto Man</p> <p>Freq Offset 0.0000000 Hz</p> <p>Signal Track On Off</p>
5240	<p>Agilent R T</p> <p>Ch Freq 5.24 GHz Trng Free</p> <p>Occupied Bandwidth</p> <p>Ref 20 dBm #Atten 20 dB</p> <p>#Peak Log 10 dB/Offset 13.4 dB</p> <p>Center 5.24 GHz Span 25 MHz</p> <p>#Res BW 300 kHz #VBW 1 MHz Sweep 4 ms (401 pts)</p> <p><b>Occupied Bandwidth 17.8058 MHz</b></p> <p>Occ BW % Pwr 99.00 % x dB -26.00 dB</p> <p>Transmit Freq Error -28.152 kHz x dB Bandwidth 20.550 MHz</p> <p>Freq/Channel</p> <p>Center Freq 5.2400000 GHz</p> <p>Start Freq 5.2275000 GHz</p> <p>Stop Freq 5.2525000 GHz</p> <p>CF Step 2.5000000 MHz Auto Man</p> <p>Freq Offset 0.0000000 Hz</p> <p>Signal Track On Off</p>

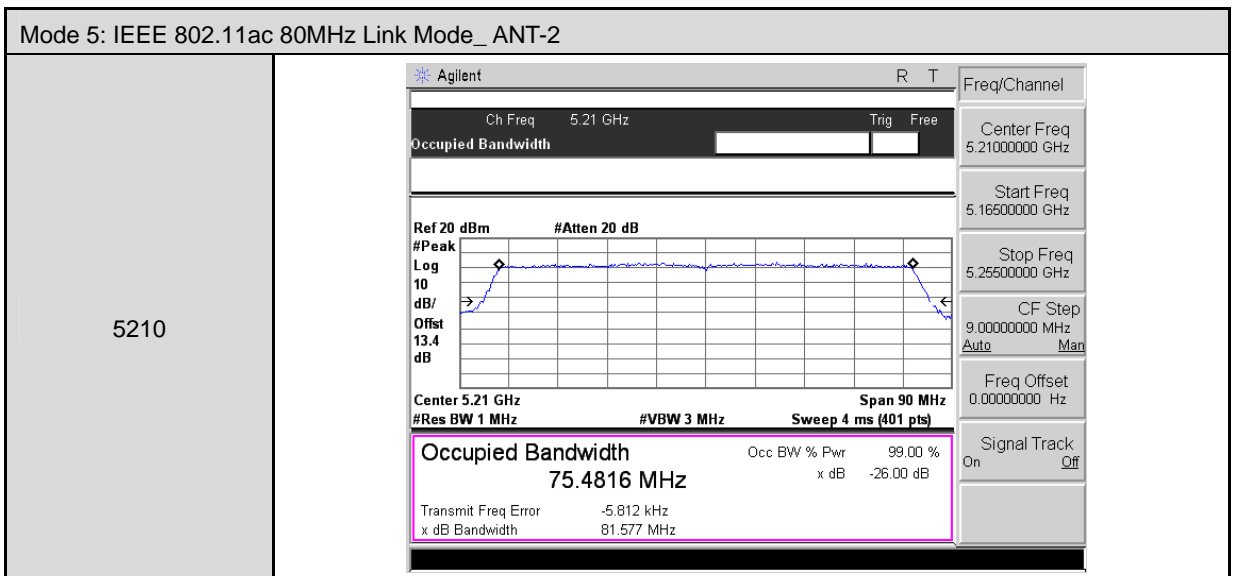
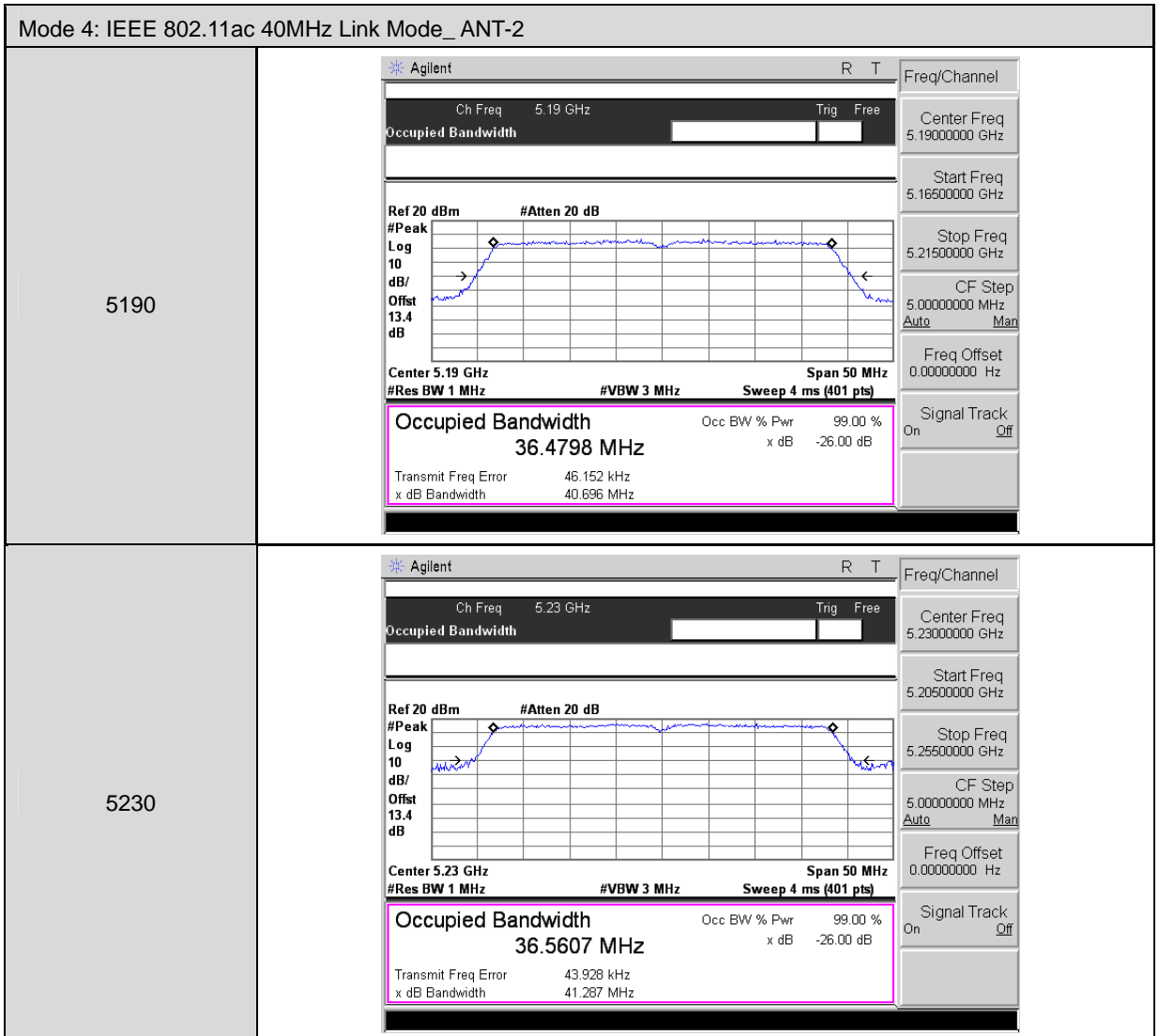

**Beamforming on**

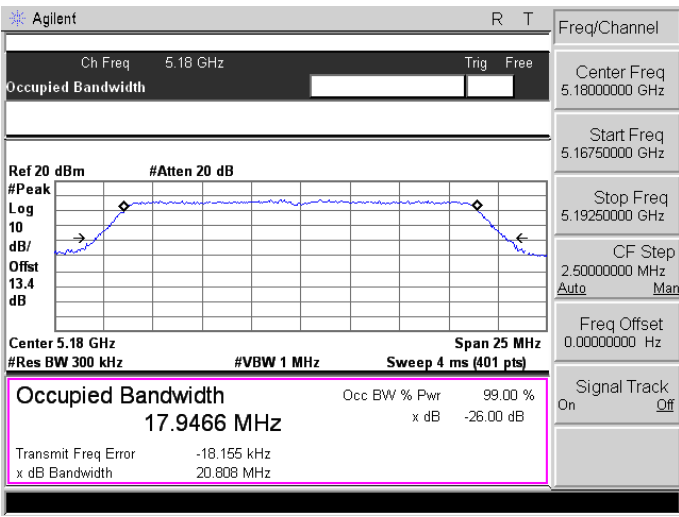
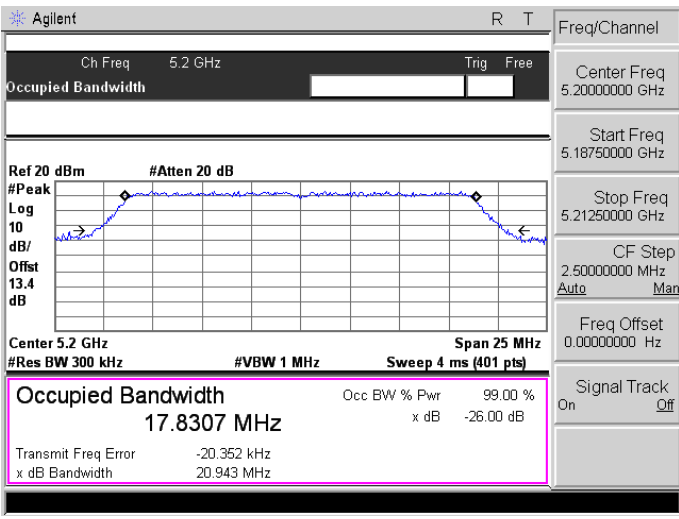
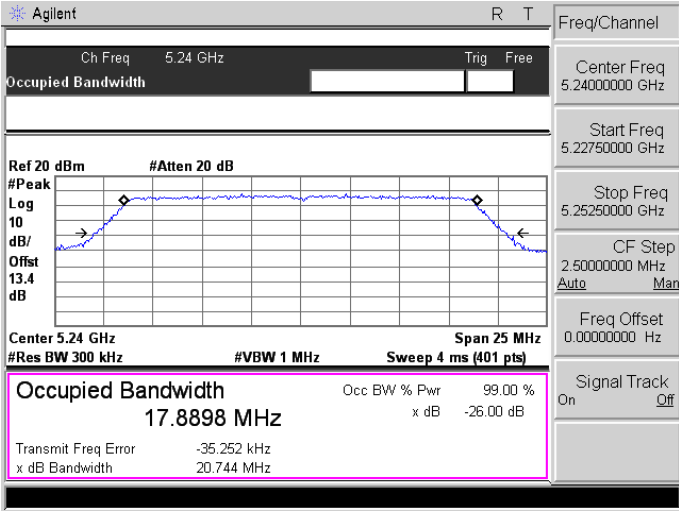
Mode 3: IEEE 802.11ac 20MHz Link Mode_ ANT-0	
5180	 <p>Agilent R T</p> <p>Ch Freq 5.18 GHz Trng Free</p> <p>Occupied Bandwidth</p> <p>Ref 20 dBm #Atten 20 dB</p> <p>#Peak Log 10 dB/Offset 13.4 dB</p> <p>Center 5.18 GHz Span 25 MHz</p> <p>#Res BW 300 kHz #VBW 1 MHz Sweep 4 ms (401 pts)</p> <p><b>Occupied Bandwidth 17.9466 MHz</b></p> <p>Occ BW % Pwr 99.00 % x dB -26.00 dB</p> <p>Transmit Freq Error -18.155 kHz</p> <p>x dB Bandwidth 20.808 MHz</p> <p>Freq/Channel</p> <p>Center Freq 5.18000000 GHz</p> <p>Start Freq 5.16750000 GHz</p> <p>Stop Freq 5.19250000 GHz</p> <p>CF Step 2.50000000 MHz Auto Man</p> <p>Freq Offset 0.00000000 Hz</p> <p>Signal Track On Off</p>
5200	 <p>Agilent R T</p> <p>Ch Freq 5.2 GHz Trng Free</p> <p>Occupied Bandwidth</p> <p>Ref 20 dBm #Atten 20 dB</p> <p>#Peak Log 10 dB/Offset 13.4 dB</p> <p>Center 5.2 GHz Span 25 MHz</p> <p>#Res BW 300 kHz #VBW 1 MHz Sweep 4 ms (401 pts)</p> <p><b>Occupied Bandwidth 17.8307 MHz</b></p> <p>Occ BW % Pwr 99.00 % x dB -26.00 dB</p> <p>Transmit Freq Error -20.352 kHz</p> <p>x dB Bandwidth 20.943 MHz</p> <p>Freq/Channel</p> <p>Center Freq 5.20000000 GHz</p> <p>Start Freq 5.18750000 GHz</p> <p>Stop Freq 5.21250000 GHz</p> <p>CF Step 2.50000000 MHz Auto Man</p> <p>Freq Offset 0.00000000 Hz</p> <p>Signal Track On Off</p>
5240	 <p>Agilent R T</p> <p>Ch Freq 5.24 GHz Trng Free</p> <p>Occupied Bandwidth</p> <p>Ref 20 dBm #Atten 20 dB</p> <p>#Peak Log 10 dB/Offset 13.4 dB</p> <p>Center 5.24 GHz Span 25 MHz</p> <p>#Res BW 300 kHz #VBW 1 MHz Sweep 4 ms (401 pts)</p> <p><b>Occupied Bandwidth 17.8898 MHz</b></p> <p>Occ BW % Pwr 99.00 % x dB -26.00 dB</p> <p>Transmit Freq Error -35.252 kHz</p> <p>x dB Bandwidth 20.744 MHz</p> <p>Freq/Channel</p> <p>Center Freq 5.24000000 GHz</p> <p>Start Freq 5.22750000 GHz</p> <p>Stop Freq 5.25250000 GHz</p> <p>CF Step 2.50000000 MHz Auto Man</p> <p>Freq Offset 0.00000000 Hz</p> <p>Signal Track On Off</p>



Mode 4: IEEE 802.11ac 40MHz Link Mode\_ ANT-0

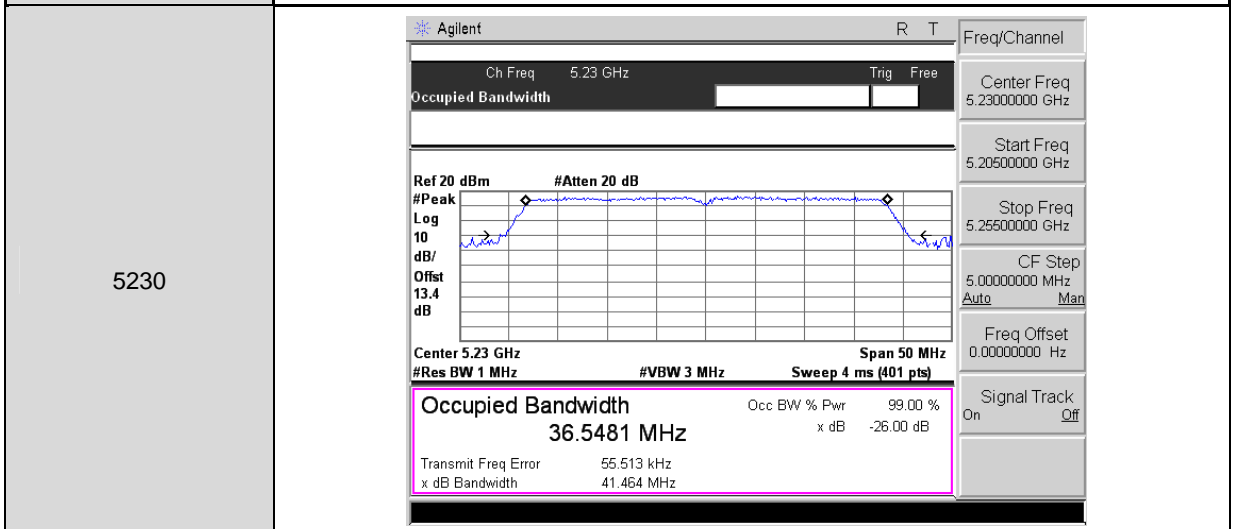
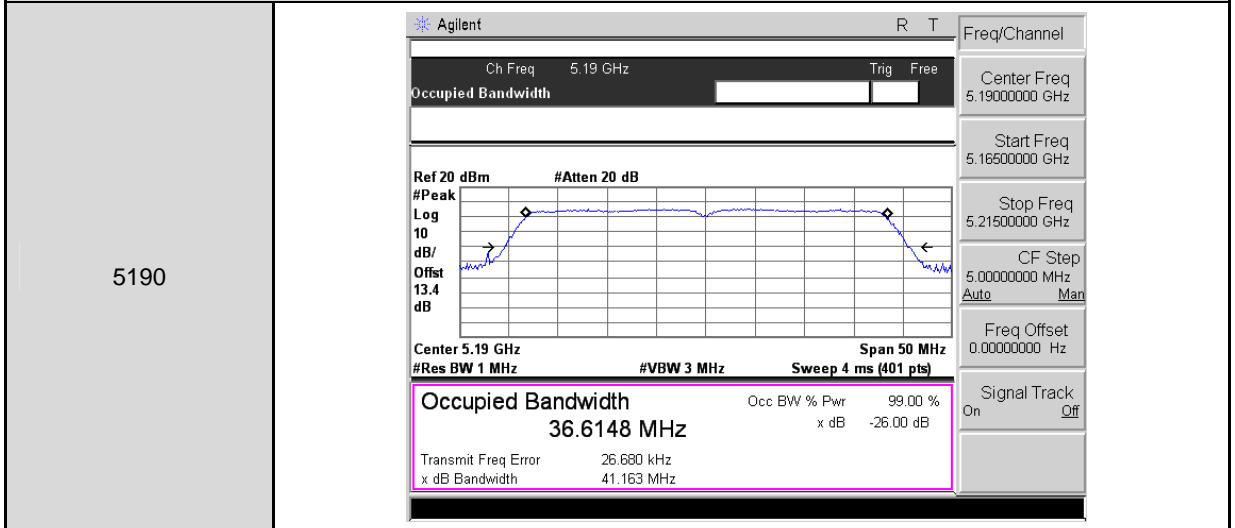

Mode 5: IEEE 802.11ac 80MHz Link Mode\_ ANT-0

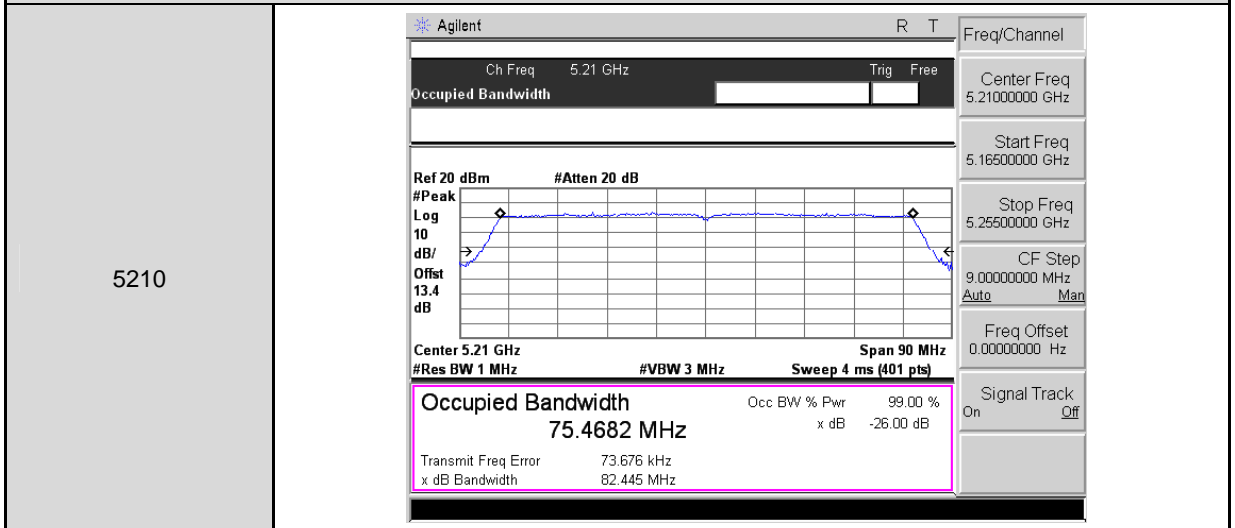

Mode 3: IEEE 802.11ac 20MHz Link Mode_ ANT-1	
5180	<p>Agilent R T</p> <p>Ch Freq 5.18 GHz Trng Free</p> <p>Occupied Bandwidth</p> <p>Ref 20 dBm #Atten 20 dB</p> <p>#Peak Log 10 dB/Offset 13.4 dB</p> <p>Center 5.18 GHz Span 25 MHz</p> <p>#Res BW 300 kHz #VBW 1 MHz Sweep 4 ms (401 pts)</p> <p><b>Occupied Bandwidth 17.8269 MHz</b></p> <p>Occ BW % Pwr 99.00 % x dB -26.00 dB</p> <p>Transmit Freq Error -14.420 kHz</p> <p>x dB Bandwidth 20.643 MHz</p> <p>Freq/Channel</p> <p>Center Freq 5.18000000 GHz</p> <p>Start Freq 5.16750000 GHz</p> <p>Stop Freq 5.19250000 GHz</p> <p>CF Step 2.50000000 MHz Auto Man</p> <p>Freq Offset 0.00000000 Hz</p> <p>Signal Track On Off</p>
5200	<p>Agilent R T</p> <p>Ch Freq 5.2 GHz Trng Free</p> <p>Occupied Bandwidth</p> <p>Ref 20 dBm #Atten 20 dB</p> <p>#Peak Log 10 dB/Offset 13.4 dB</p> <p>Center 5.2 GHz Span 25 MHz</p> <p>#Res BW 300 kHz #VBW 1 MHz Sweep 4 ms (401 pts)</p> <p><b>Occupied Bandwidth 17.8209 MHz</b></p> <p>Occ BW % Pwr 99.00 % x dB -26.00 dB</p> <p>Transmit Freq Error -19.125 kHz</p> <p>x dB Bandwidth 20.486 MHz</p> <p>Freq/Channel</p> <p>Center Freq 5.20000000 GHz</p> <p>Start Freq 5.18750000 GHz</p> <p>Stop Freq 5.21250000 GHz</p> <p>CF Step 2.50000000 MHz Auto Man</p> <p>Freq Offset 0.00000000 Hz</p> <p>Signal Track On Off</p>
5240	<p>Agilent R T</p> <p>Ch Freq 5.24 GHz Trng Free</p> <p>Occupied Bandwidth</p> <p>Ref 20 dBm #Atten 20 dB</p> <p>#Peak Log 10 dB/Offset 13.4 dB</p> <p>Center 5.24 GHz Span 25 MHz</p> <p>#Res BW 300 kHz #VBW 1 MHz Sweep 4 ms (401 pts)</p> <p><b>Occupied Bandwidth 17.7810 MHz</b></p> <p>Occ BW % Pwr 99.00 % x dB -26.00 dB</p> <p>Transmit Freq Error -25.803 kHz</p> <p>x dB Bandwidth 20.497 MHz</p> <p>Freq/Channel</p> <p>Center Freq 5.24000000 GHz</p> <p>Start Freq 5.22750000 GHz</p> <p>Stop Freq 5.25250000 GHz</p> <p>CF Step 2.50000000 MHz Auto Man</p> <p>Freq Offset 0.00000000 Hz</p> <p>Signal Track On Off</p>

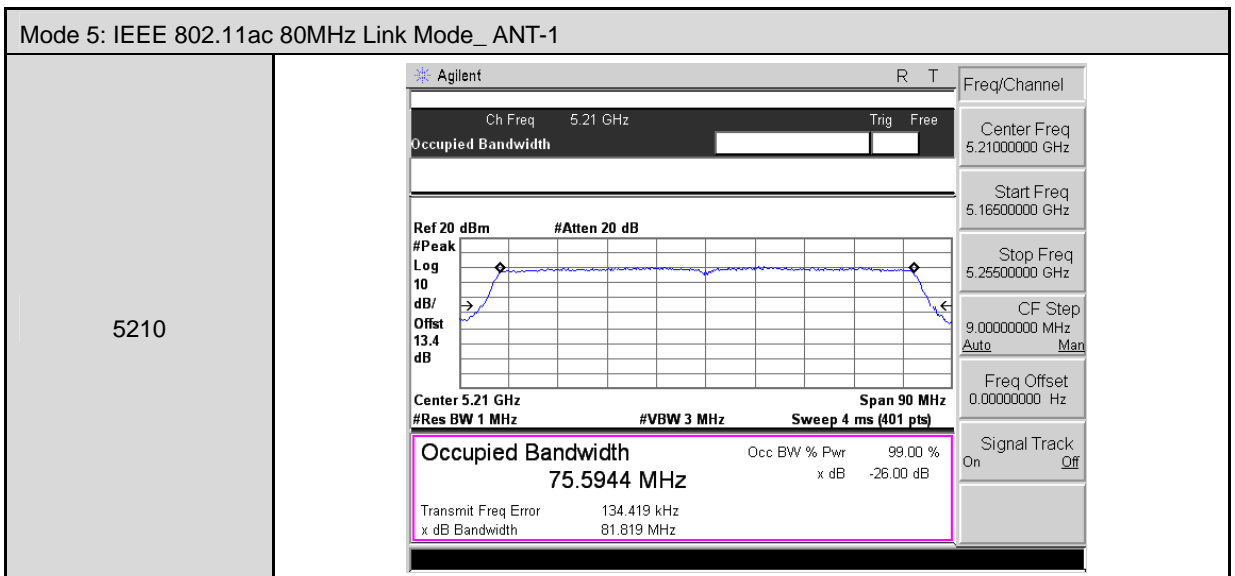
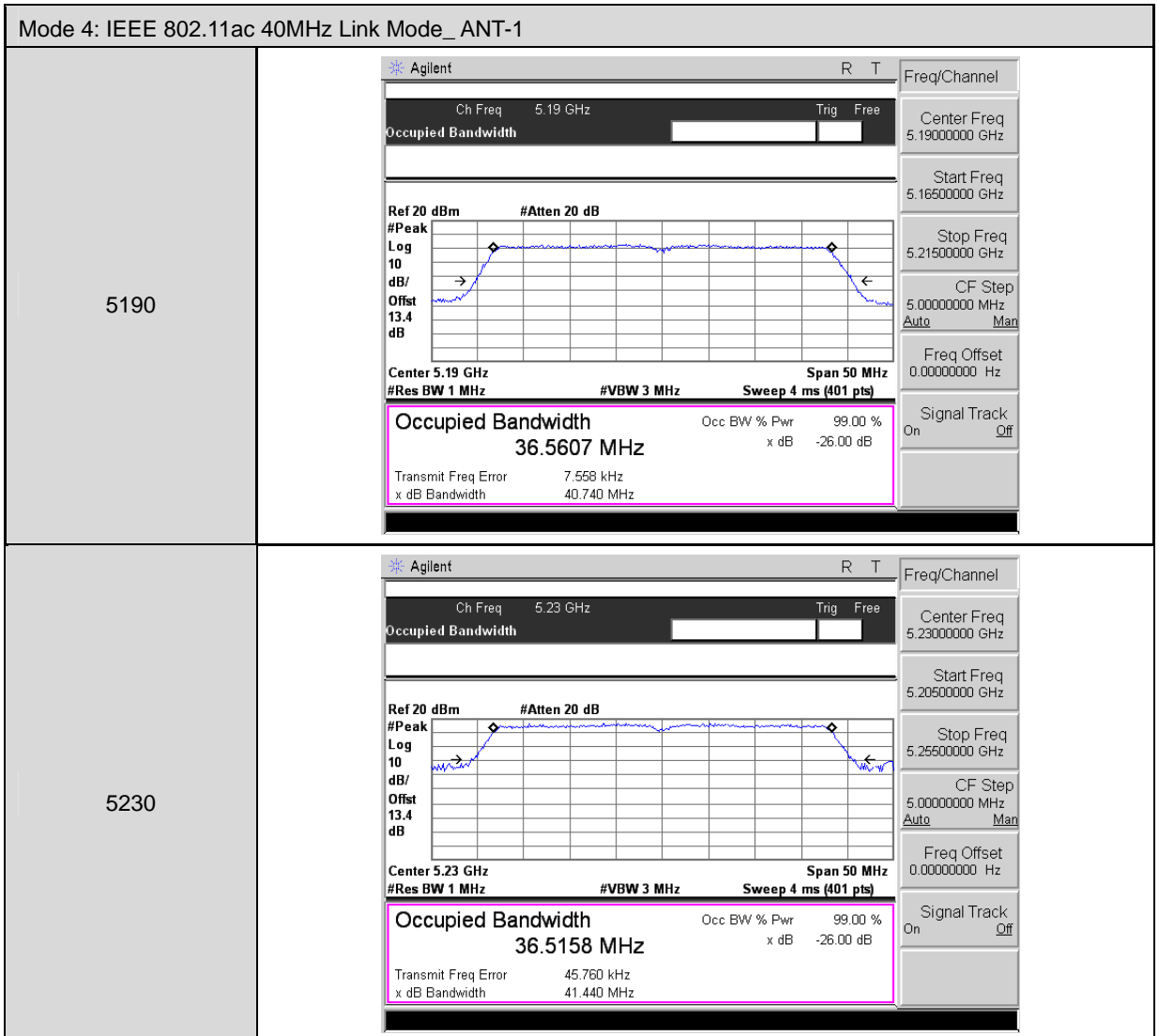

Mode 3: IEEE 802.11ac 20MHz Link Mode_ ANT-2	
5180	<p>Agilent R T</p> <p>Ch Freq 5.18 GHz Trng Free</p> <p>Occupied Bandwidth</p> <p>Ref 20 dBm #Atten 20 dB</p> <p>#Peak Log 10 dB/Offset 13.4 dB</p> <p>Center 5.18 GHz Span 25 MHz</p> <p>#Res BW 300 kHz #VBW 1 MHz Sweep 4 ms (401 pts)</p> <p><b>Occupied Bandwidth 17.8316 MHz</b></p> <p>Occ BW % Pwr 99.00 % x dB -26.00 dB</p> <p>Transmit Freq Error -4.990 kHz</p> <p>x dB Bandwidth 20.666 MHz</p> <p>Freq/Channel</p> <p>Center Freq 5.18000000 GHz</p> <p>Start Freq 5.16750000 GHz</p> <p>Stop Freq 5.19250000 GHz</p> <p>CF Step 2.50000000 MHz Auto Man</p> <p>Freq Offset 0.00000000 Hz</p> <p>Signal Track On Off</p>
5200	<p>Agilent R T</p> <p>Ch Freq 5.2 GHz Trng Free</p> <p>Occupied Bandwidth</p> <p>Ref 20 dBm #Atten 20 dB</p> <p>#Peak Log 10 dB/Offset 13.4 dB</p> <p>Center 5.2 GHz Span 25 MHz</p> <p>#Res BW 300 kHz #VBW 1 MHz Sweep 4 ms (401 pts)</p> <p><b>Occupied Bandwidth 17.8370 MHz</b></p> <p>Occ BW % Pwr 99.00 % x dB -26.00 dB</p> <p>Transmit Freq Error -9.936 kHz</p> <p>x dB Bandwidth 20.903 MHz</p> <p>Freq/Channel</p> <p>Center Freq 5.20000000 GHz</p> <p>Start Freq 5.18750000 GHz</p> <p>Stop Freq 5.21250000 GHz</p> <p>CF Step 2.50000000 MHz Auto Man</p> <p>Freq Offset 0.00000000 Hz</p> <p>Signal Track On Off</p>
5240	<p>Agilent R T</p> <p>Ch Freq 5.24 GHz Trng Free</p> <p>Occupied Bandwidth</p> <p>Ref 20 dBm #Atten 20 dB</p> <p>#Peak Log 10 dB/Offset 13.4 dB</p> <p>Center 5.24 GHz Span 25 MHz</p> <p>#Res BW 300 kHz #VBW 1 MHz Sweep 4 ms (401 pts)</p> <p><b>Occupied Bandwidth 17.8058 MHz</b></p> <p>Occ BW % Pwr 99.00 % x dB -26.00 dB</p> <p>Transmit Freq Error -28.152 kHz</p> <p>x dB Bandwidth 20.550 MHz</p> <p>Freq/Channel</p> <p>Center Freq 5.24000000 GHz</p> <p>Start Freq 5.22750000 GHz</p> <p>Stop Freq 5.25250000 GHz</p> <p>CF Step 2.50000000 MHz Auto Man</p> <p>Freq Offset 0.00000000 Hz</p> <p>Signal Track On Off</p>

Mode 4: IEEE 802.11ac 40MHz Link Mode\_ ANT-2

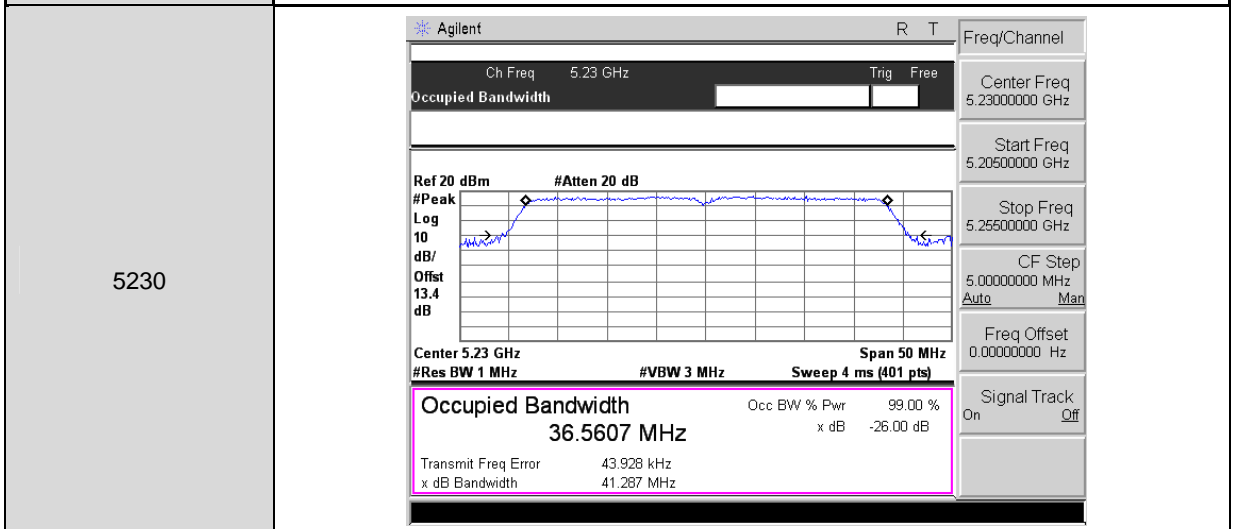
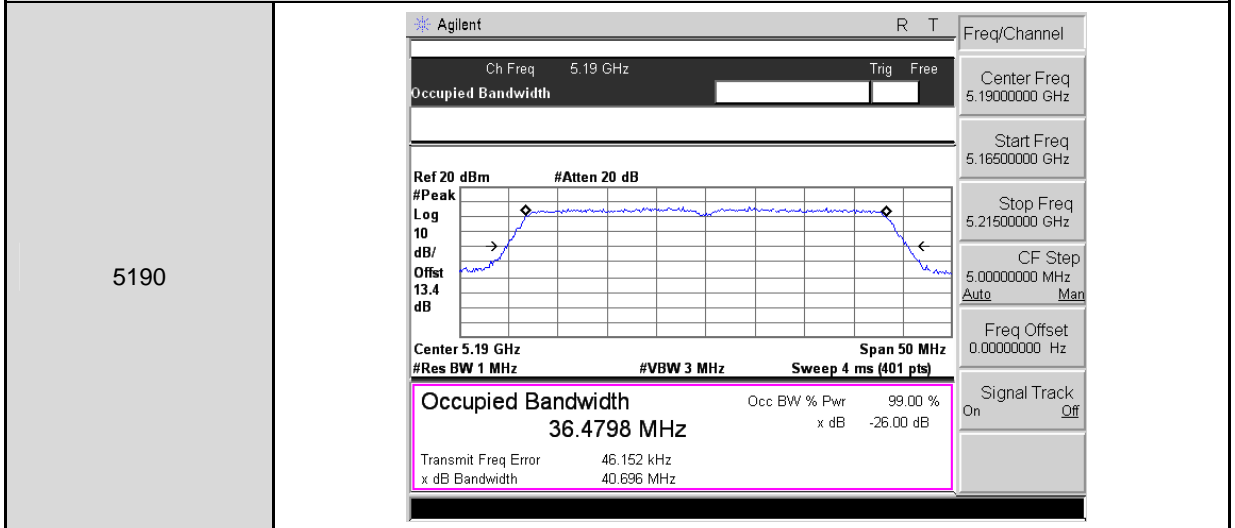

Mode 5: IEEE 802.11ac 80MHz Link Mode\_ ANT-2

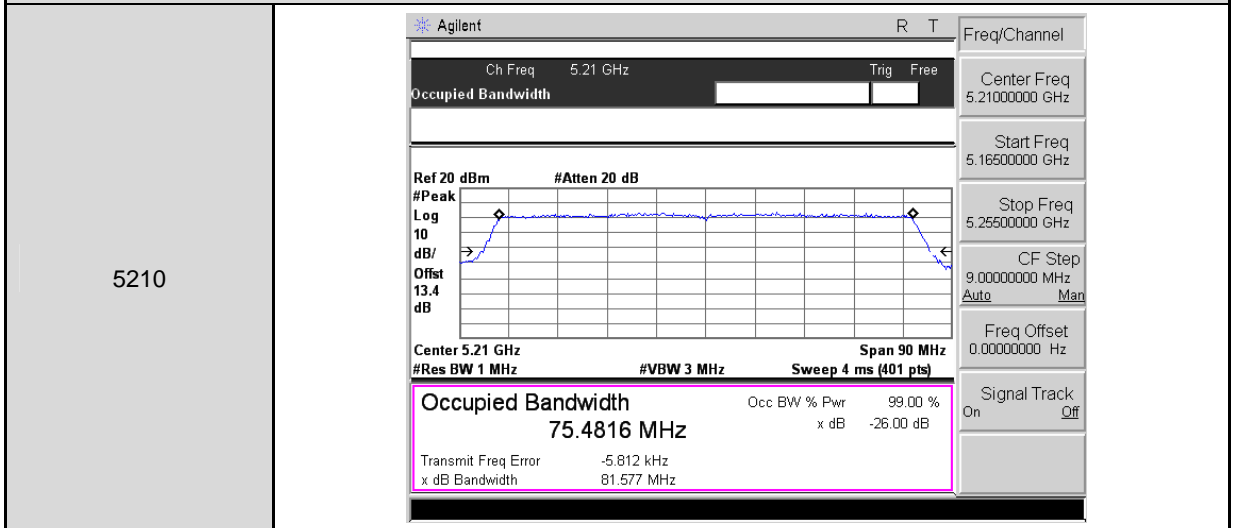

## 8 Peak Power Spectral Density Measurement

### 8.1. Limit

Conducted power spectral density

Frequency Range (MHz)	FCC Limit
5.150 ~ 5.250 GHz	17 dBm/MHz
5.250 ~ 5.350 GHz	11 dBm/MHz
5.470 ~ 5.725 GHz	11 dBm/MHz
5.725 ~ 5.850 GHz	30 dBm/500KHz

Note: Beamforming on Limit

$$5180 - 5240 \text{ MHz} : \text{Directional gain} = G_{ANT} + 10 \cdot \log(N_{ANT}/N_{SS}) = 6.77 \text{ dBi} > 6 \text{ dBi}$$

$$\text{Conducted power spectral density Limit} = 17 - (6.77 - 6) = 16.23 \text{ dBm/MHz}$$

### 8.2. Test Setup

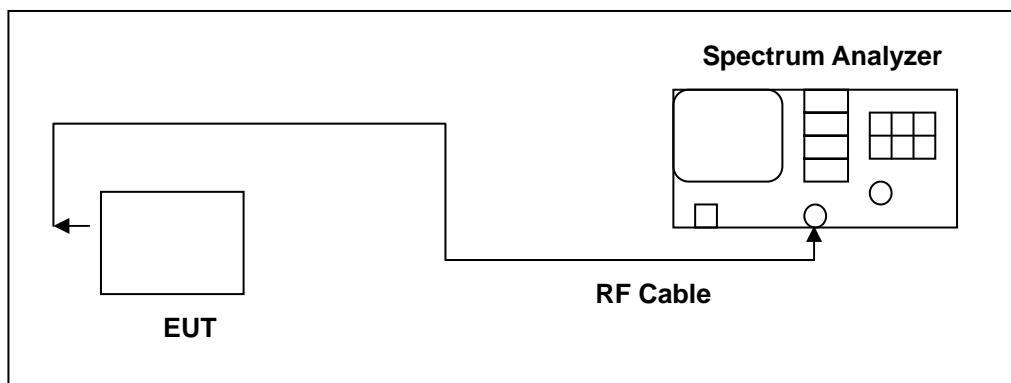

### 8.3. Test Instruments

Equipment	Manufacturer	Model Number	Serial Number	Cal. Date	Remark
Spectrum Analyzer	Agilent	E4445A	MY45300744	12/16/2014	(1)
Test Site	ATL	TE02	TE02	N.C.R.	-----

Remark: (1) Calibration period 1 year. (2) Calibration period 2 years.

Note: N.C.R. = No Calibration Request.

### 8.4. Test Procedure

The test is performed in accordance with KDB789033: D02 General UNII Test Procedures New Rules v01, Guidelines for Compliance Testing of Unlicensed National Information Infrastructure (U-NII) Devices - Part 15, Subpart E.

**8.5. Test Result**

Model Number	Touch P5					
Test Item	Conducted power spectral density					
Test Mode	Mode 2: IEEE 802.11a Link Mode					
Date of Test	08/15/2015			Test Site	TE02	
Frequency (MHz)	ANT-0		ANT-1			Limit (dBm/MHz)
	(dBm/MHz)		(dBm/MHz)			
5180	6.470		6.055			<17
5200	11.060		11.600			
5240	7.483		7.993			
Frequency (MHz)	ANT-2	ANT-0+1+2	Duty cycle	Duty Factor (dB)	Result (dBm/MHz)	Limit (dBm/MHz)
	(dBm/MHz)	(dBm/MHz)				
5180	5.824	11.049	0.965	0.153	11.202	<17
5200	10.190	15.913	0.965	0.153	16.066	
5240	7.235	12.506	0.965	0.153	12.660	

Model Number	Touch P5					
Test Item	Conducted power spectral density					
Test Mode	Mode 3: IEEE 802.11ac 20MHz Link Mode					
Date of Test	08/15/2015			Test Site	TE02	
Frequency (MHz)	ANT-0		ANT-1			Limit (dBm/MHz)
	(dBm/MHz)		(dBm/MHz)			
5180	5.876		5.603			<17
5200	10.420		10.600			
5240	9.045		9.449			
Frequency (MHz)	ANT-2	ANT-0+1+2	Duty cycle	Duty Factor (dB)	Result (dBm/MHz)	Limit (dBm/MHz)
	(dBm/MHz)	(dBm/MHz)				
5180	4.930	10.624	0.919	0.365	10.989	<17
5200	9.582	15.359	0.919	0.365	15.724	
5240	9.006	14.308	0.919	0.365	14.673	

Model Number	Touch P5					
Test Item	Conducted power spectral density					
Test Mode	Mode 4: IEEE 802.11ac 40MHz Link Mode					
Date of Test	08/15/2015			Test Site	TE02	
Frequency (MHz)	ANT-0		ANT-1			Limit (dBm/MHz)
	(dBm/MHz)		(dBm/MHz)			
5190	-1.072		1.988			<17
5230	8.150		7.825			
Frequency (MHz)	ANT-2	ANT-0+1+2	Duty cycle	Duty Factor (dB)	Result (dBm/MHz)	Limit (dBm/MHz)
	(dBm/MHz)	(dBm/MHz)				
5190	1.550	6.521	0.844	0.734	7.256	<17
5230	6.154	12.966	0.844	0.734	13.700	

Model Number	Touch P5					
Test Item	Conducted power spectral density					
Test Mode	Mode 5: IEEE 802.11ac 80MHz Link Mode					
Date of Test	08/15/2015			Test Site	TE02	
Frequency (MHz)	ANT-0		ANT-1			Limit (dBm/MHz)
	(dBm/MHz)		(dBm/MHz)			
5210	-2.184		-2.794			<17
Frequency (MHz)	ANT-2	ANT-0+1+2	Duty cycle	Duty Factor (dB)	Result (dBm/MHz)	Limit (dBm/MHz)
	(dBm/MHz)	(dBm/MHz)				
5210	-3.083	2.303	0.955	0.202	2.505	<17



Model Number	Touch P5					
Test Item	Conducted power spectral density					
Test Mode	Mode 3: IEEE 802.11ac 20MHz Link Mode					
Date of Test	08/15/2015			Test Site	TE02	
Beamforming on						
Frequency (MHz)	ANT-0		ANT-1			Limit (dBm/MHz)
	(dBm/MHz)		(dBm/MHz)			
5180	1.152		1.829			<16.23
5200	6.442		6.418			
5240	5.264		5.579			
Frequency (MHz)	ANT-2	ANT-0+1+2	Duty cycle	Duty Factor (dB)	Result (dBm/MHz)	Limit (dBm/MHz)
	(dBm/MHz)	(dBm/MHz)				
5180	0.763	6.407	0.919	0.365	6.772	<16.23
5200	5.307	11.223	0.919	0.365	11.589	
5240	5.383	10.547	0.919	0.365	10.912	

Model Number	Touch P5					
Test Item	Conducted power spectral density					
Test Mode	Mode 4: IEEE 802.11ac 40MHz Link Mode					
Date of Test	08/15/2015			Test Site	TE02	
Beamforming on						
Frequency (MHz)	ANT-0		ANT-1			Limit (dBm/MHz)
	(dBm/MHz)		(dBm/MHz)			
5190	-5.604		-2.205			<16.23
5230	3.779		4.181			
Frequency (MHz)	ANT-2	ANT-0+1+2	Duty cycle	Duty Factor (dB)	Result (dBm/MHz)	Limit (dBm/MHz)
	(dBm/MHz)	(dBm/MHz)				
5190	-3.104	2.090	0.844	0.734	2.824	<16.23
5230	1.822	8.882	0.844	0.734	9.616	

Model Number	Touch P5					
Test Item	Conducted power spectral density					
Test Mode	Mode 5: IEEE 802.11ac 80MHz Link Mode					
Date of Test	08/15/2015			Test Site	TE02	
Beamforming on						
Frequency (MHz)	ANT-0		ANT-1			Limit (dBm/MHz)
	(dBm/MHz)		(dBm/MHz)			
5210	-6.444		-6.283			<16.23
Frequency (MHz)	ANT-2	ANT-0+1+2	Duty cycle	Duty Factor (dB)	Result (dBm/MHz)	Limit (dBm/MHz)
	(dBm/MHz)	(dBm/MHz)				
5210	-7.014	-1.596	0.955	0.202	-1.394	<16.23

**8.6. Test Graphs**

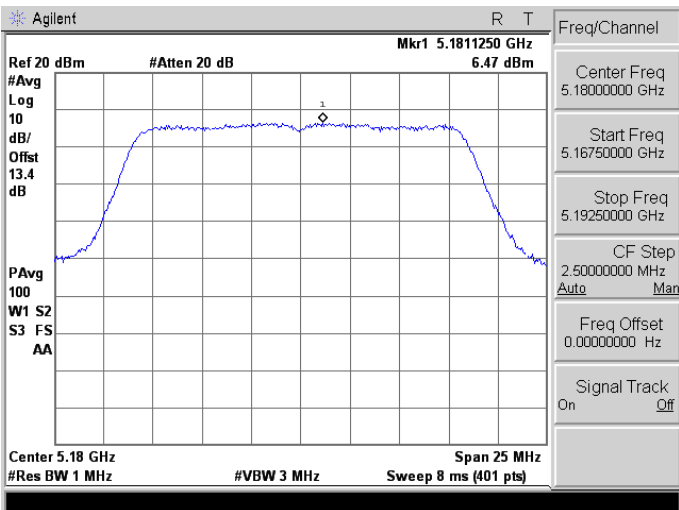
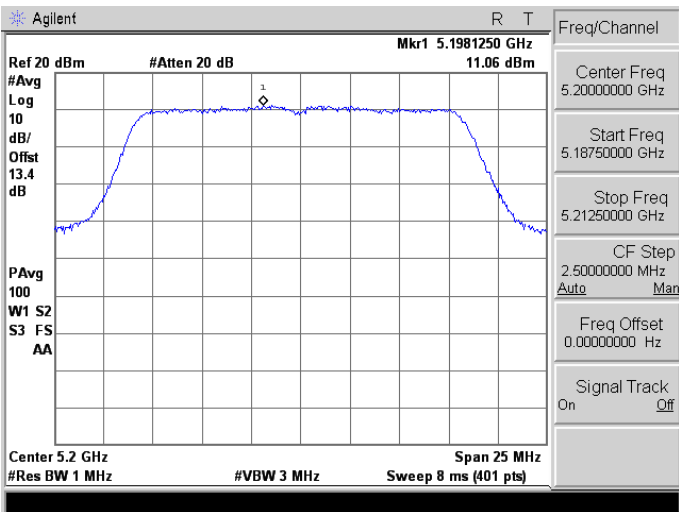
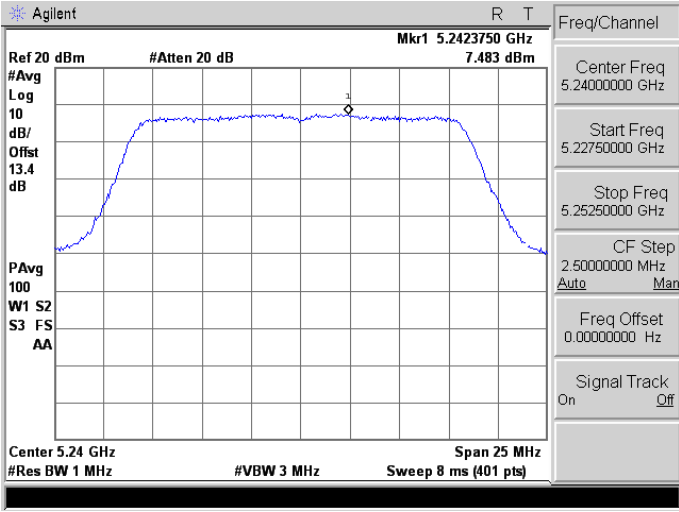
Mode 2: IEEE 802.11a Link Mode_ ANT-0	
5180	 <p>Agilent R T          Ref 20 dBm #Atten 20 dB Mkr1 5.1811250 GHz 6.47 dBm          #Avg Log          dB/ Offst 13.4 dB          PAvg 100          W1 S2          S3 FS          AA</p> <p>Center 5.18 GHz Span 25 MHz          #Res BW 1 MHz #VBW 3 MHz Sweep 8 ms (401 pts)</p> <p>Freq/Channel          Center Freq 5.18000000 GHz          Start Freq 5.16750000 GHz          Stop Freq 5.19250000 GHz          CF Step 2.50000000 MHz          Auto Man          Freq Offset 0.00000000 Hz          Signal Track On Off</p>
5200	 <p>Agilent R T          Ref 20 dBm #Atten 20 dB Mkr1 5.1981250 GHz 11.06 dBm          #Avg Log          dB/ Offst 13.4 dB          PAvg 100          W1 S2          S3 FS          AA</p> <p>Center 5.2 GHz Span 25 MHz          #Res BW 1 MHz #VBW 3 MHz Sweep 8 ms (401 pts)</p> <p>Freq/Channel          Center Freq 5.20000000 GHz          Start Freq 5.18750000 GHz          Stop Freq 5.21250000 GHz          CF Step 2.50000000 MHz          Auto Man          Freq Offset 0.00000000 Hz          Signal Track On Off</p>
5240	 <p>Agilent R T          Ref 20 dBm #Atten 20 dB Mkr1 5.2423750 GHz 7.483 dBm          #Avg Log          dB/ Offst 13.4 dB          PAvg 100          W1 S2          S3 FS          AA</p> <p>Center 5.24 GHz Span 25 MHz          #Res BW 1 MHz #VBW 3 MHz Sweep 8 ms (401 pts)</p> <p>Freq/Channel          Center Freq 5.24000000 GHz          Start Freq 5.22750000 GHz          Stop Freq 5.25250000 GHz          CF Step 2.50000000 MHz          Auto Man          Freq Offset 0.00000000 Hz          Signal Track On Off</p>

Mode 3: IEEE 802.11ac 20MHz Link Mode _ ANT-0	
5180	<p>Agilent R T          Ref 20 dBm #Atten 20 dB Mkr1 5.1791250 GHz 5.876 dBm          #Avg Log          dB/ Offst 13.4 dB          PAvg 100          W1 S2          S3 FS          AA</p> <p>Center 5.18 GHz Span 25 MHz          #Res BW 1 MHz #VBW 3 MHz Sweep 8 ms (401 pts)</p> <p>Freq/Channel          Center Freq 5.18000000 GHz          Start Freq 5.16750000 GHz          Stop Freq 5.19250000 GHz          CF Step 2.50000000 MHz Auto Man          Freq Offset 0.00000000 Hz          Signal Track On Off</p>
5200	<p>Agilent R T          Ref 20 dBm #Atten 20 dB Mkr1 5.1950625 GHz 10.42 dBm          #Avg Log          dB/ Offst 13.4 dB          PAvg 100          W1 S2          S3 FS          AA</p> <p>Center 5.2 GHz Span 25 MHz          #Res BW 1 MHz #VBW 3 MHz Sweep 8 ms (401 pts)</p> <p>Freq/Channel          Center Freq 5.20000000 GHz          Start Freq 5.18750000 GHz          Stop Freq 5.21250000 GHz          CF Step 2.50000000 MHz Auto Man          Freq Offset 0.00000000 Hz          Signal Track On Off</p>
5220	<p>Agilent R T          Ref 20 dBm #Atten 20 dB Mkr1 5.2413750 GHz 9.045 dBm          #Avg Log          dB/ Offst 13.4 dB          PAvg 100          W1 S2          S3 FS          AA</p> <p>Center 5.24 GHz Span 25 MHz          #Res BW 1 MHz #VBW 3 MHz Sweep 8 ms (401 pts)</p> <p>Freq/Channel          Center Freq 5.24000000 GHz          Start Freq 5.22750000 GHz          Stop Freq 5.25250000 GHz          CF Step 2.50000000 MHz Auto Man          Freq Offset 0.00000000 Hz          Signal Track On Off</p>

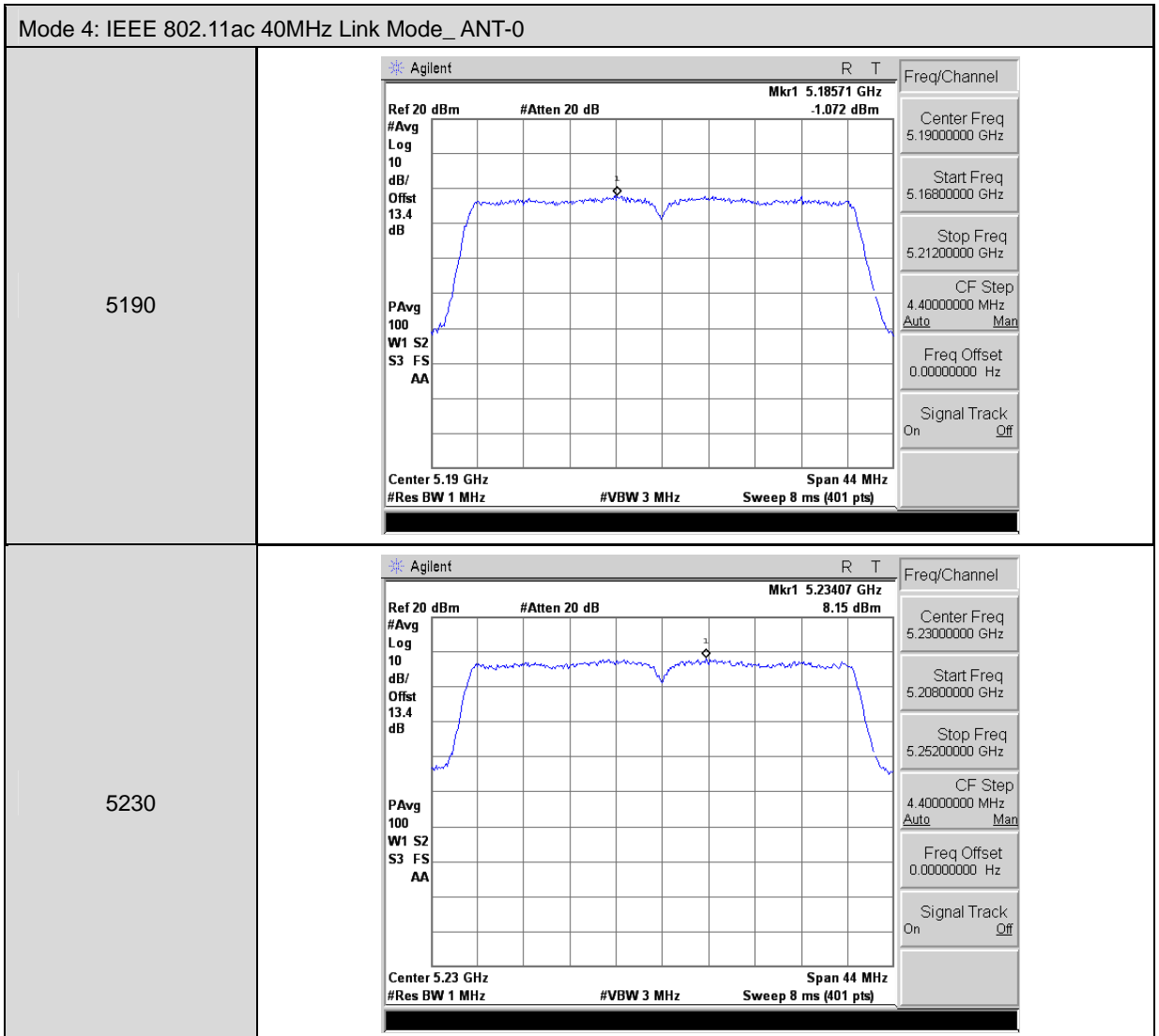

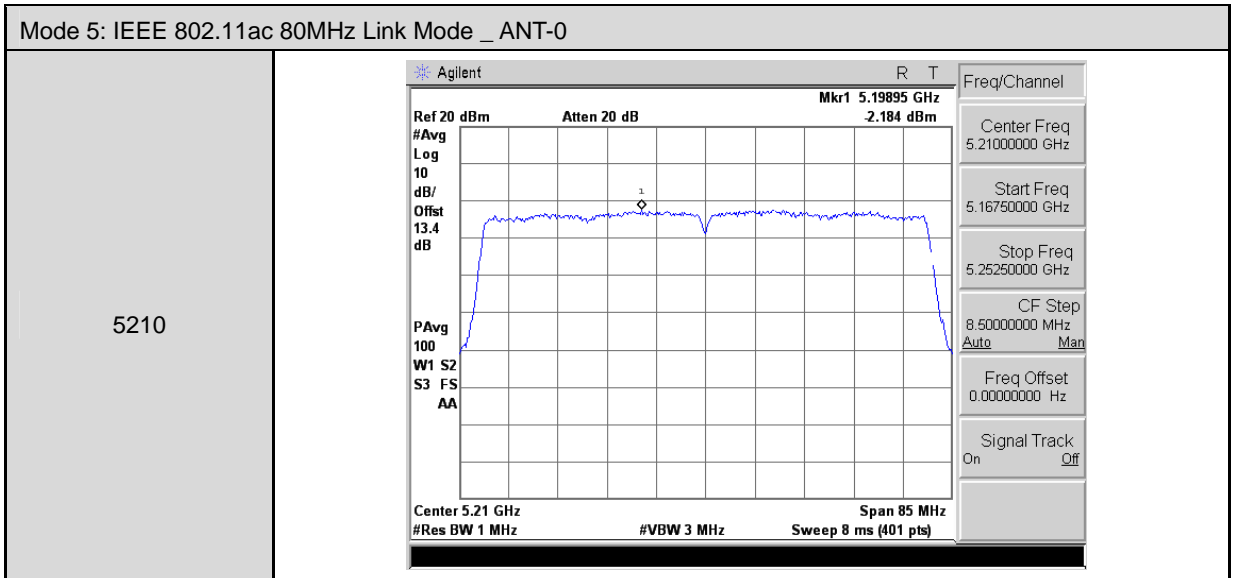

Mode 2: IEEE 802.11a Link Mode_ ANT-1	
5180	<p>Agilent R T</p> <p>Ref 20 dBm #Atten 20 dB Mkr1 5.1825625 GHz 6.055 dBm</p> <p>#Avg Log 10 dB/Offst 13.4 dB</p> <p>PAvg 100 W1 S2 S3 FS AA</p> <p>Center 5.18 GHz Span 25 MHz #Res BW 1 MHz #VBW 3 MHz Sweep 8 ms (401 pts)</p> <p>Freq/Channel: Center Freq 5.18000000 GHz, Start Freq 5.16750000 GHz, Stop Freq 5.19250000 GHz, CF Step 2.50000000 MHz, Freq Offset 0.00000000 Hz, Signal Track Off</p>
5200	<p>Agilent R T</p> <p>Ref 20 dBm #Atten 20 dB Mkr1 5.2013750 GHz 11.6 dBm</p> <p>#Avg Log 10 dB/Offst 13.4 dB</p> <p>PAvg 100 W1 S2 S3 FS AA</p> <p>Center 5.2 GHz Span 25 MHz #Res BW 1 MHz #VBW 3 MHz Sweep 8 ms (401 pts)</p> <p>Freq/Channel: Center Freq 5.20000000 GHz, Start Freq 5.18750000 GHz, Stop Freq 5.21250000 GHz, CF Step 2.50000000 MHz, Freq Offset 0.00000000 Hz, Signal Track Off</p>
5240	<p>Agilent R T</p> <p>Ref 20 dBm #Atten 20 dB Mkr1 5.2410000 GHz 7.993 dBm</p> <p>#Avg Log 10 dB/Offst 13.4 dB</p> <p>PAvg 100 W1 S2 S3 FS AA</p> <p>Center 5.24 GHz Span 25 MHz #Res BW 1 MHz #VBW 3 MHz Sweep 8 ms (401 pts)</p> <p>Freq/Channel: Center Freq 5.24000000 GHz, Start Freq 5.22750000 GHz, Stop Freq 5.25250000 GHz, CF Step 2.50000000 MHz, Freq Offset 0.00000000 Hz, Signal Track Off</p>

Mode 3: IEEE 802.11ac 20MHz Link Mode _ ANT-1	
5180	<p>Agilent R T            Ref 20 dBm #Atten 20 dB Mkr1 5.1788125 GHz 5.603 dBm            #Avg Log            dB/ Offst 13.4 dB            PAvg 100            W1 S2            S3 FS            AA</p> <p>Center 5.18 GHz Span 25 MHz            #Res BW 1 MHz #VBW 3 MHz Sweep 8 ms (401 pts)</p> <p>Freq/Channel            Center Freq 5.18000000 GHz            Start Freq 5.16750000 GHz            Stop Freq 5.19250000 GHz            CF Step 2.50000000 MHz Auto Man            Freq Offset 0.00000000 Hz            Signal Track On Off</p>
5200	<p>Agilent R T            Ref 20 dBm #Atten 20 dB Mkr1 5.1976250 GHz 10.6 dBm            #Avg Log            dB/ Offst 13.4 dB            PAvg 100            W1 S2            S3 FS            AA</p> <p>Center 5.2 GHz Span 25 MHz            #Res BW 1 MHz #VBW 3 MHz Sweep 8 ms (401 pts)</p> <p>Freq/Channel            Center Freq 5.20000000 GHz            Start Freq 5.18750000 GHz            Stop Freq 5.21250000 GHz            CF Step 2.50000000 MHz Auto Man            Freq Offset 0.00000000 Hz            Signal Track On Off</p>
5220	<p>Agilent R T            Ref 20 dBm #Atten 20 dB Mkr1 5.2413750 GHz 9.449 dBm            #Avg Log            dB/ Offst 13.4 dB            PAvg 100            W1 S2            S3 FS            AA</p> <p>Center 5.24 GHz Span 25 MHz            #Res BW 1 MHz #VBW 3 MHz Sweep 8 ms (401 pts)</p> <p>Freq/Channel            Center Freq 5.24000000 GHz            Start Freq 5.22750000 GHz            Stop Freq 5.25250000 GHz            CF Step 2.50000000 MHz Auto Man            Freq Offset 0.00000000 Hz            Signal Track On Off</p>



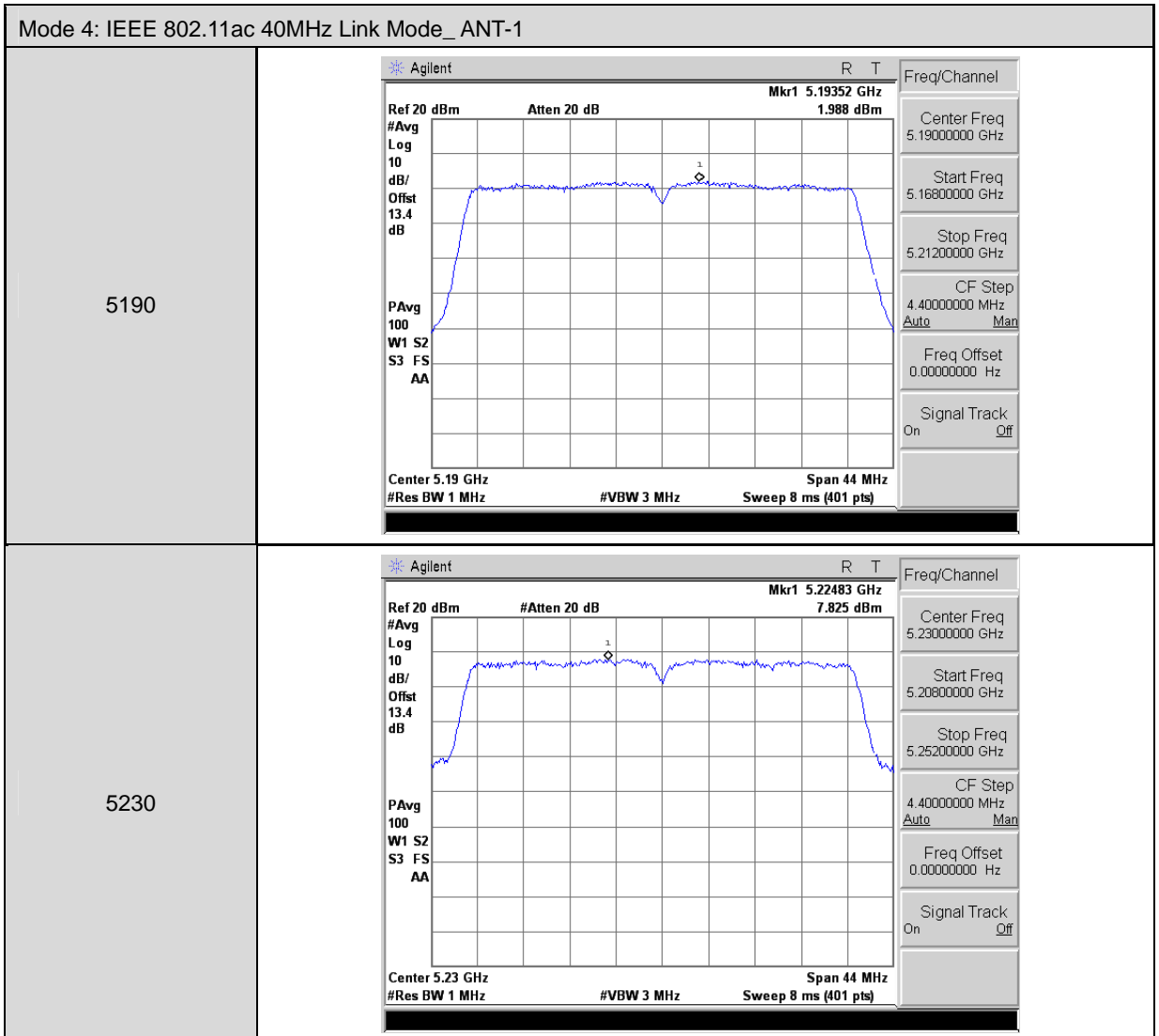

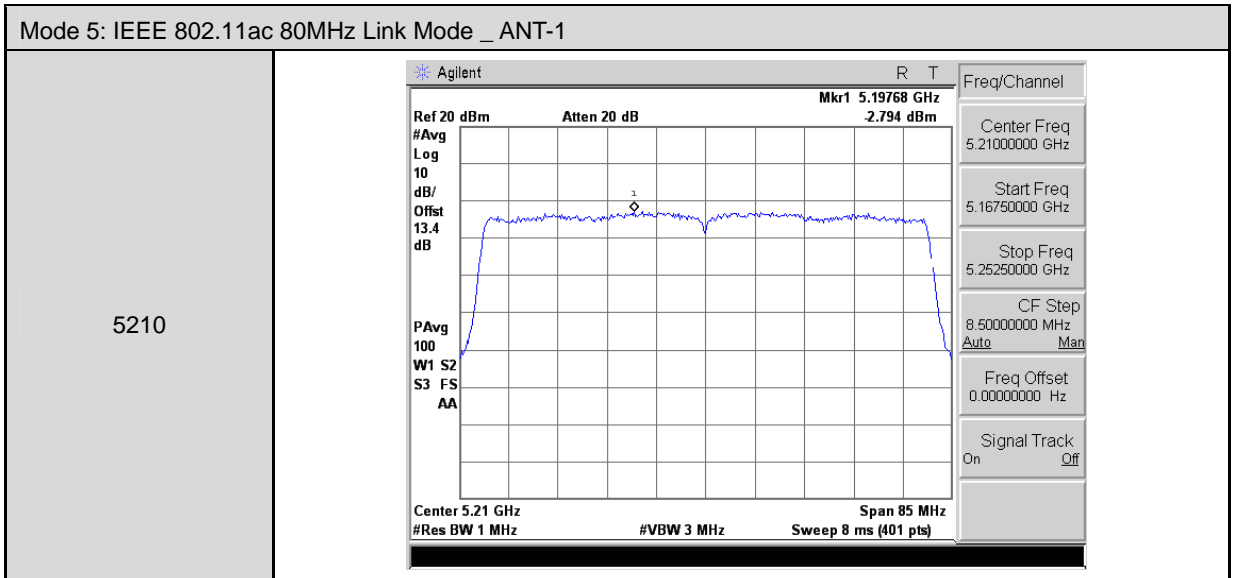

Mode 2: IEEE 802.11a Link Mode_ ANT-2	
5180	<p>Agilent R T            Ref 20 dBm #Atten 20 dB Mkr1 5.1780625 GHz 5.824 dBm            #Avg 10            Log            dB/Offst 13.4 dB            PAvg 100            W1 S2            S3 FS            AA            Center 5.18 GHz Span 25 MHz            #Res BW 1 MHz #VBW 3 MHz Sweep 8 ms (401 pts)</p> <p>Freq/Channel            Center Freq 5.18000000 GHz            Start Freq 5.16750000 GHz            Stop Freq 5.19250000 GHz            CF Step 2.50000000 MHz            Auto Man            Freq Offset 0.00000000 Hz            Signal Track On Off</p>
5200	<p>Agilent R T            Ref 20 dBm #Atten 20 dB Mkr1 5.1986250 GHz 10.19 dBm            #Avg 10            Log            dB/Offst 13.4 dB            PAvg 100            W1 S2            S3 FS            AA            Center 5.2 GHz Span 25 MHz            #Res BW 1 MHz #VBW 3 MHz Sweep 8 ms (401 pts)</p> <p>Freq/Channel            Center Freq 5.20000000 GHz            Start Freq 5.18750000 GHz            Stop Freq 5.21250000 GHz            CF Step 2.50000000 MHz            Auto Man            Freq Offset 0.00000000 Hz            Signal Track On Off</p>
5240	<p>Agilent R T            Ref 20 dBm #Atten 20 dB Mkr1 5.2410625 GHz 7.235 dBm            #Avg 10            Log            dB/Offst 13.4 dB            PAvg 100            W1 S2            S3 FS            AA            Center 5.24 GHz Span 25 MHz            #Res BW 1 MHz #VBW 3 MHz Sweep 8 ms (401 pts)</p> <p>Freq/Channel            Center Freq 5.24000000 GHz            Start Freq 5.22750000 GHz            Stop Freq 5.25250000 GHz            CF Step 2.50000000 MHz            Auto Man            Freq Offset 0.00000000 Hz            Signal Track On Off</p>

Mode 3: IEEE 802.11ac 20MHz Link Mode _ ANT-2	
5180	<p>Agilent R T          Ref 20 dBm #Atten 20 dB Mkr1 5.1787500 GHz          #Avg Log 10 dB/Offst 13.4 dB          PAvg 100 W1 S2 S3 FS AA          Center 5.18 GHz Span 25 MHz          #Res BW 1 MHz #VBW 3 MHz Sweep 8 ms (401 pts)</p> <p>Freq/Channel          Center Freq 5.18000000 GHz          Start Freq 5.16750000 GHz          Stop Freq 5.19250000 GHz          CF Step 2.50000000 MHz          Auto Man          Freq Offset 0.00000000 Hz          Signal Track On Off</p>
5200	<p>Agilent R T          Ref 20 dBm #Atten 20 dB Mkr1 5.2006875 GHz          #Avg Log 10 dB/Offst 13.4 dB          PAvg 100 W1 S2 S3 FS AA          Center 5.2 GHz Span 25 MHz          #Res BW 1 MHz #VBW 3 MHz Sweep 8 ms (401 pts)</p> <p>Freq/Channel          Center Freq 5.20000000 GHz          Start Freq 5.18750000 GHz          Stop Freq 5.21250000 GHz          CF Step 2.50000000 MHz          Auto Man          Freq Offset 0.00000000 Hz          Signal Track On Off</p>
5220	<p>Agilent R T          Ref 20 dBm #Atten 20 dB Mkr1 5.2407500 GHz          #Avg Log 10 dB/Offst 13.4 dB          PAvg 100 W1 S2 S3 FS AA          Center 5.24 GHz Span 25 MHz          #Res BW 1 MHz #VBW 3 MHz Sweep 8 ms (401 pts)</p> <p>Freq/Channel          Center Freq 5.24000000 GHz          Start Freq 5.22750000 GHz          Stop Freq 5.25250000 GHz          CF Step 2.50000000 MHz          Auto Man          Freq Offset 0.00000000 Hz          Signal Track On Off</p>

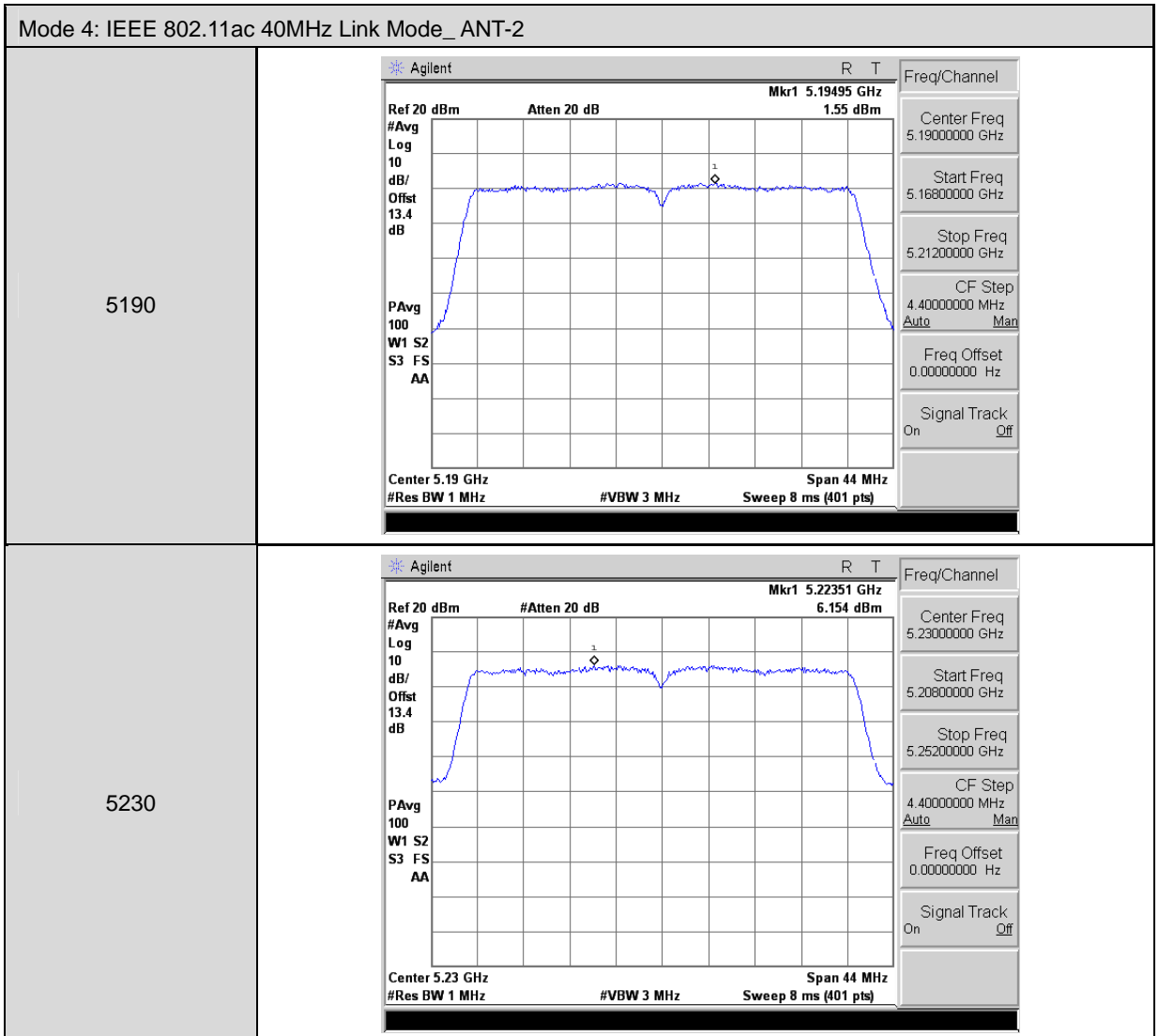

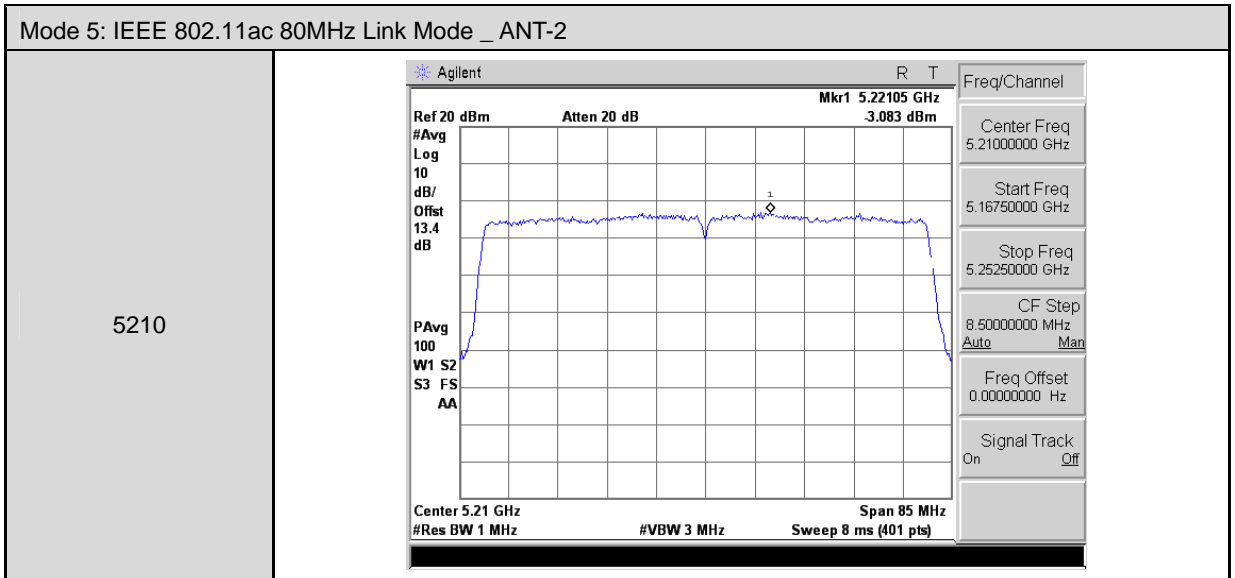

**Beamforming on**

Mode 3: IEEE 802.11ac 20MHz Link Mode _ ANT-0	
5180	
5200	
5220	

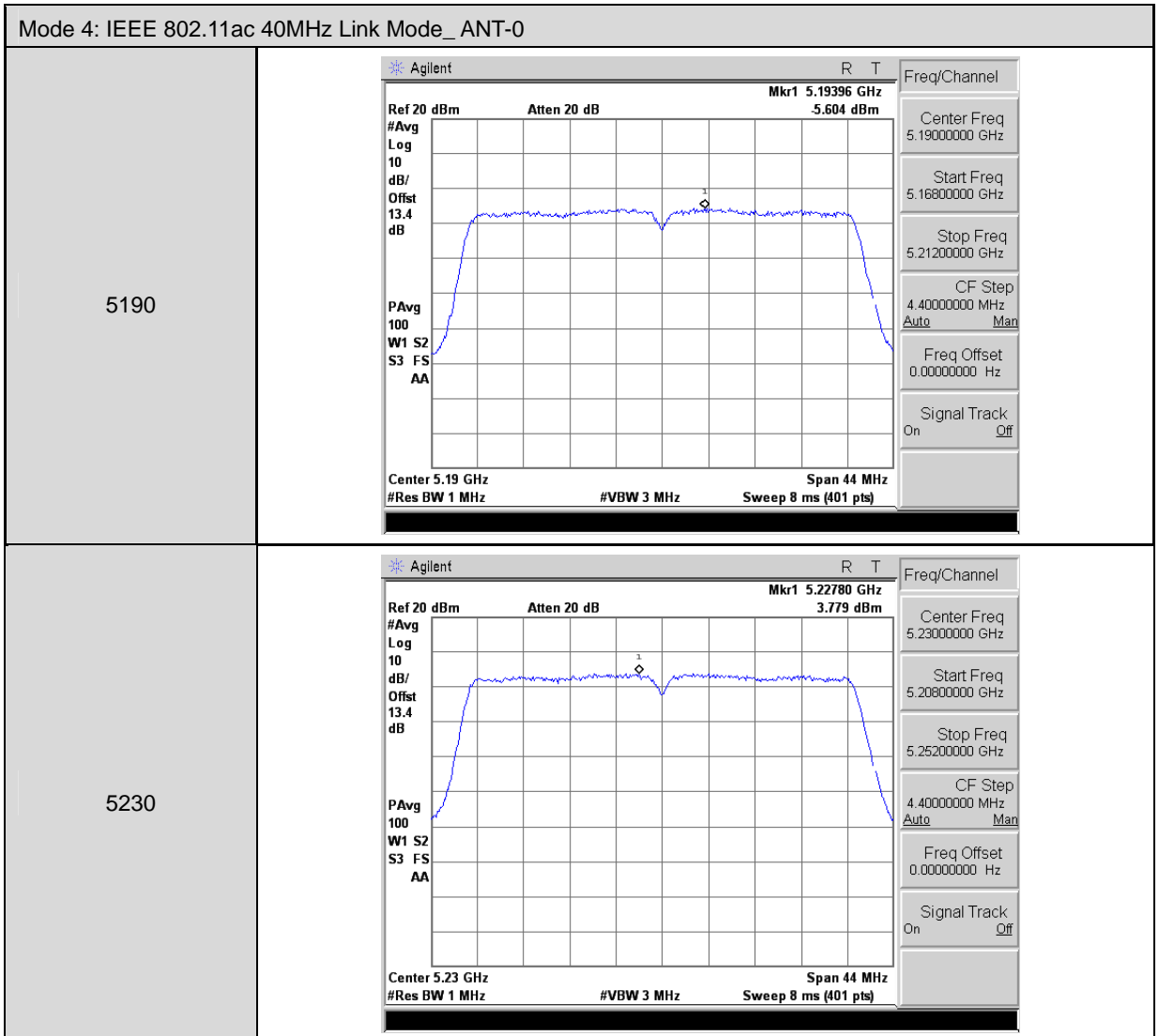



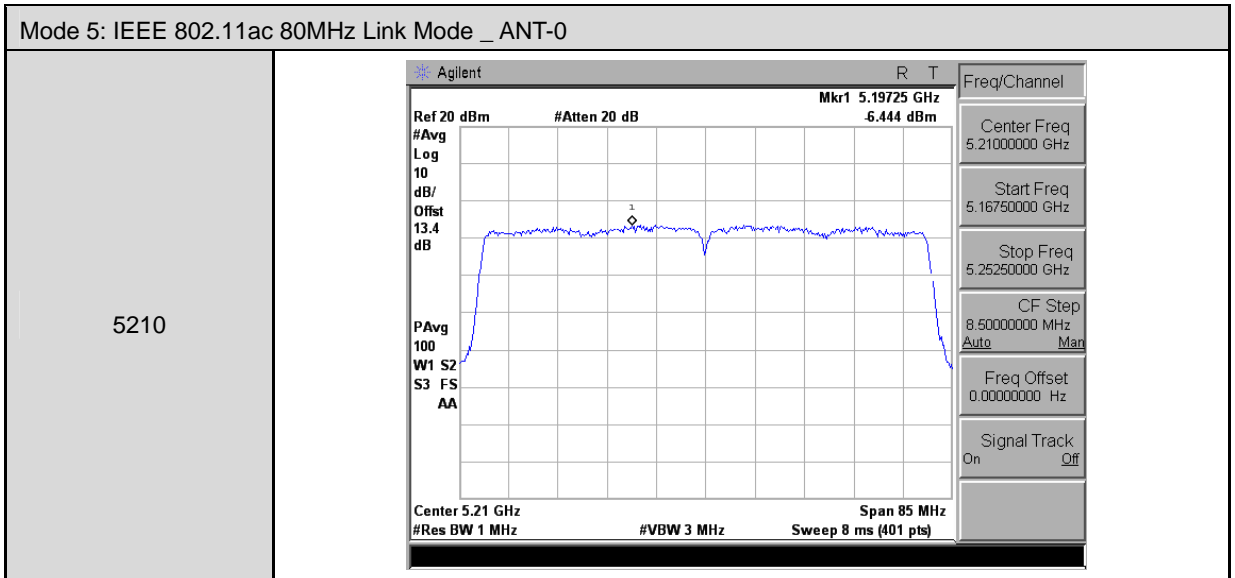

Mode 3: IEEE 802.11ac 20MHz Link Mode _ ANT-1	
5180	
5200	
5220	

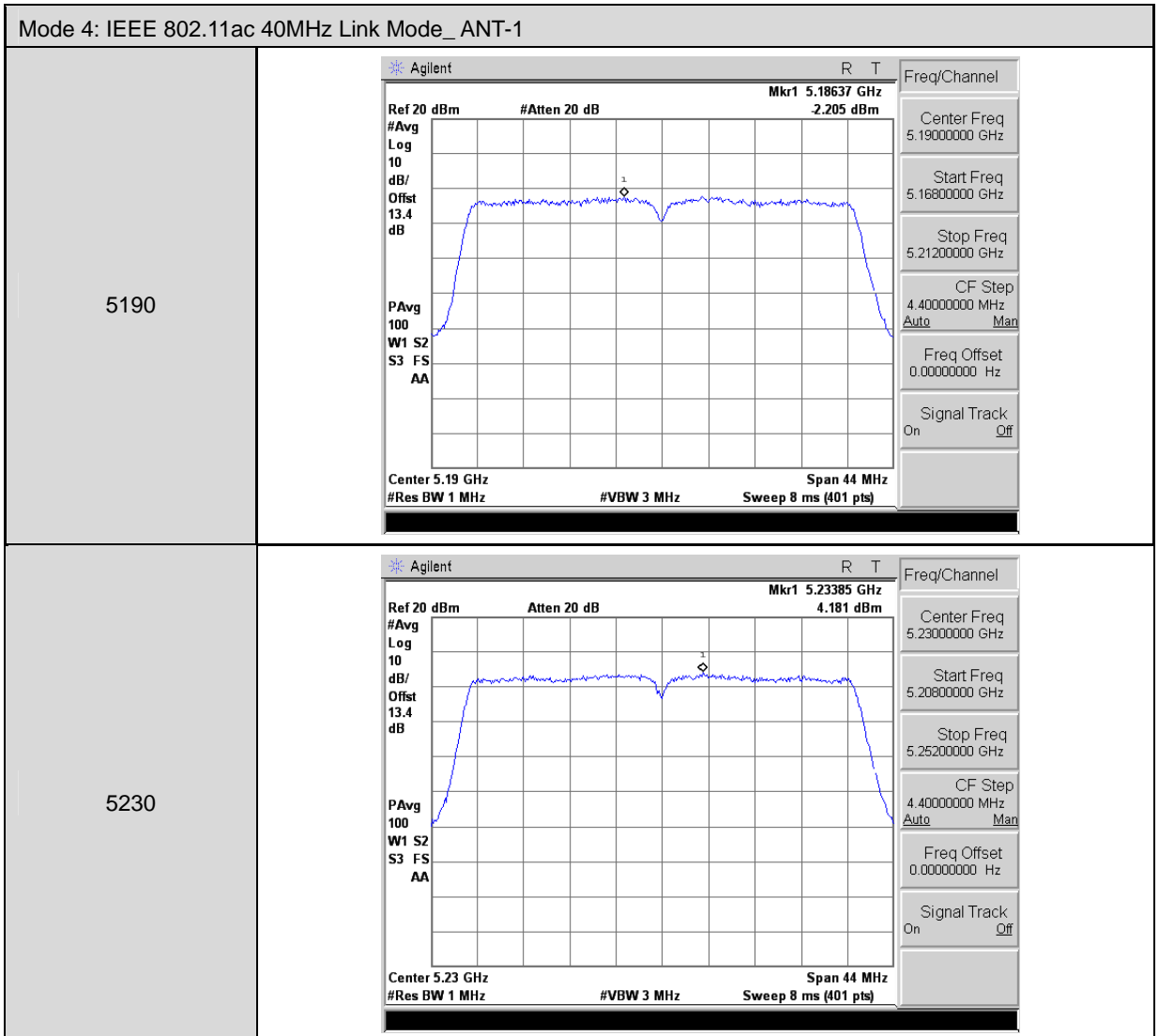

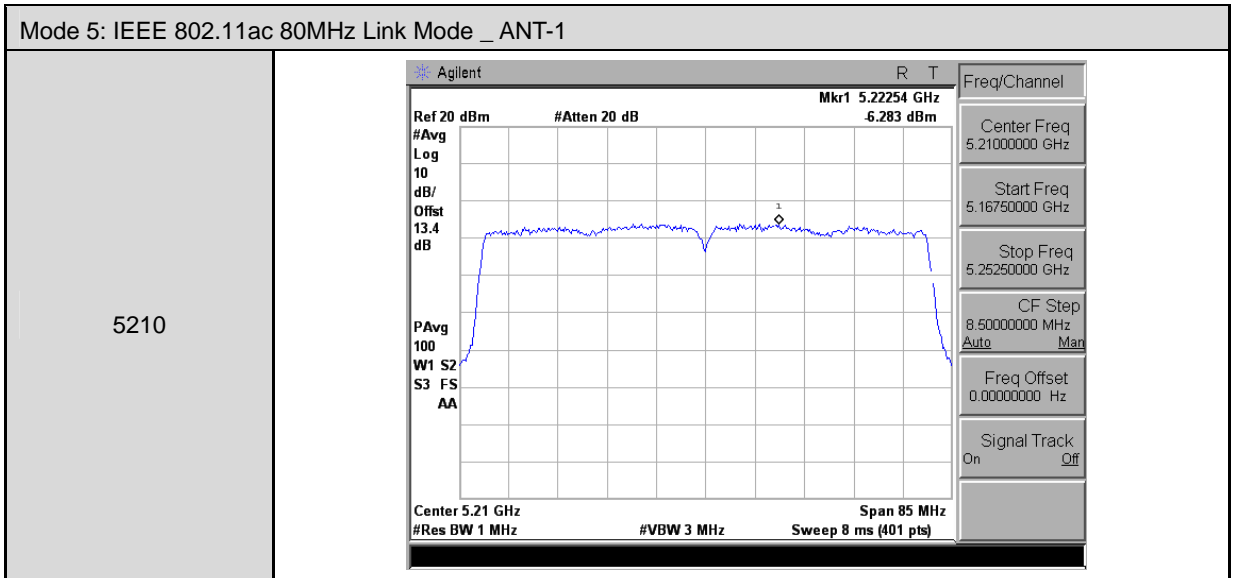

Mode 3: IEEE 802.11ac 20MHz Link Mode _ ANT-2	
5180	<p>Agilent R T          Ref 20 dBm Atten 20 dB Mkr1 5.1817500 GHz 0.763 dBm          #Avg 10          Log          dB/Offst 13.4 dB          PAvg 100          W1 S2          S3 FS          AA          Center 5.18 GHz Span 25 MHz          #Res BW 1 MHz #VBW 3 MHz Sweep 8 ms (401 pts)</p> <p>Freq/Channel          Center Freq 5.18000000 GHz          Start Freq 5.16750000 GHz          Stop Freq 5.19250000 GHz          CF Step 2.50000000 MHz          Auto Man          Freq Offset 0.00000000 Hz          Signal Track On Off</p>
5200	<p>Agilent R T          Ref 20 dBm Atten 20 dB Mkr1 5.2016875 GHz 5.307 dBm          #Avg 10          Log          dB/Offst 13.4 dB          PAvg 100          W1 S2          S3 FS          AA          Center 5.2 GHz Span 25 MHz          #Res BW 1 MHz #VBW 3 MHz Sweep 8 ms (401 pts)</p> <p>Freq/Channel          Center Freq 5.20000000 GHz          Start Freq 5.18750000 GHz          Stop Freq 5.21250000 GHz          CF Step 2.50000000 MHz          Auto Man          Freq Offset 0.00000000 Hz          Signal Track On Off</p>
5220	<p>Agilent R T          Ref 20 dBm Atten 20 dB Mkr1 5.2380625 GHz 5.383 dBm          #Avg 10          Log          dB/Offst 13.4 dB          PAvg 100          W1 S2          S3 FS          AA          Center 5.24 GHz Span 25 MHz          #Res BW 1 MHz #VBW 3 MHz Sweep 8 ms (401 pts)</p> <p>Freq/Channel          Center Freq 5.24000000 GHz          Start Freq 5.22750000 GHz          Stop Freq 5.25250000 GHz          CF Step 2.50000000 MHz          Auto Man          Freq Offset 0.00000000 Hz          Signal Track On Off</p>

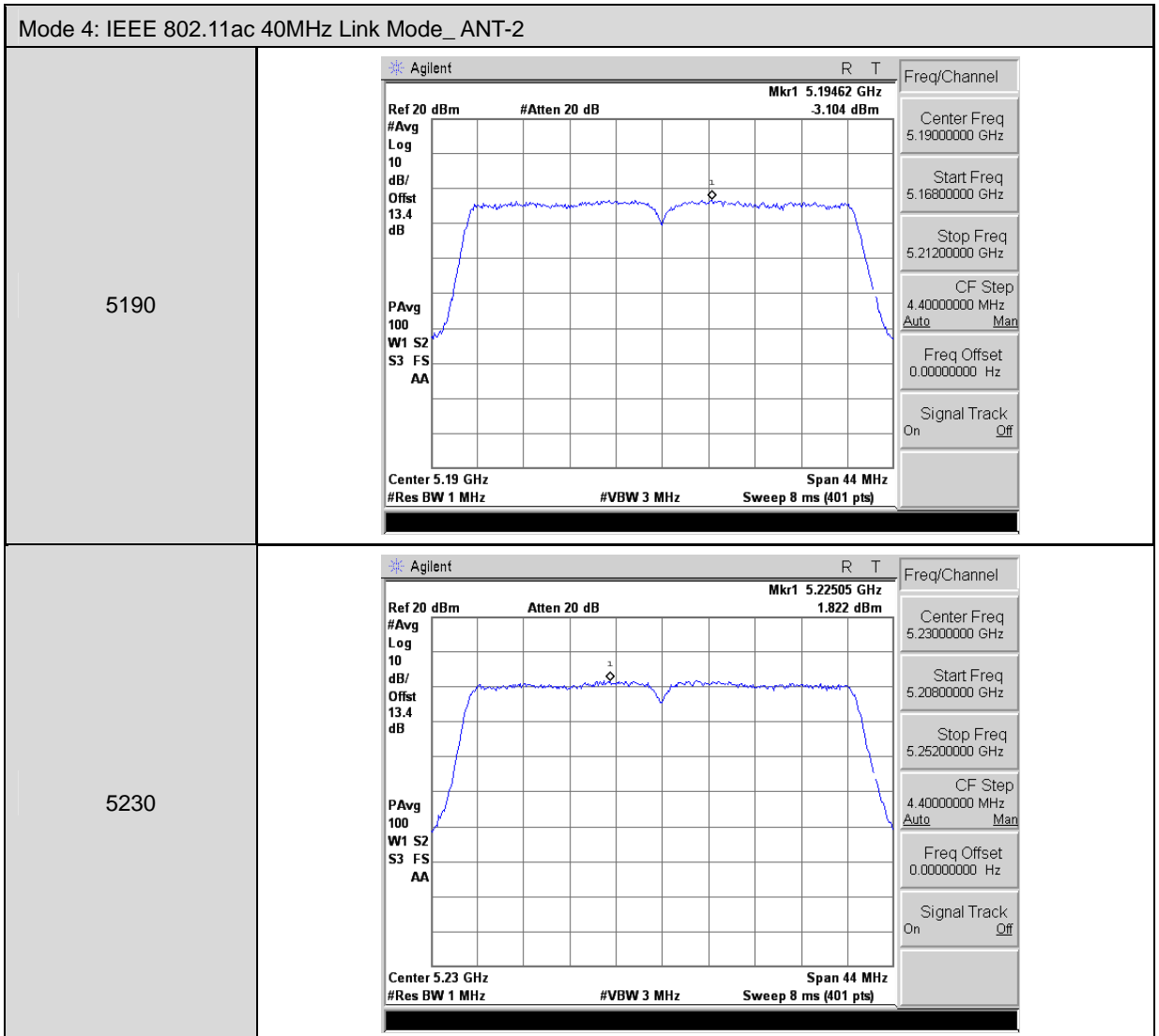

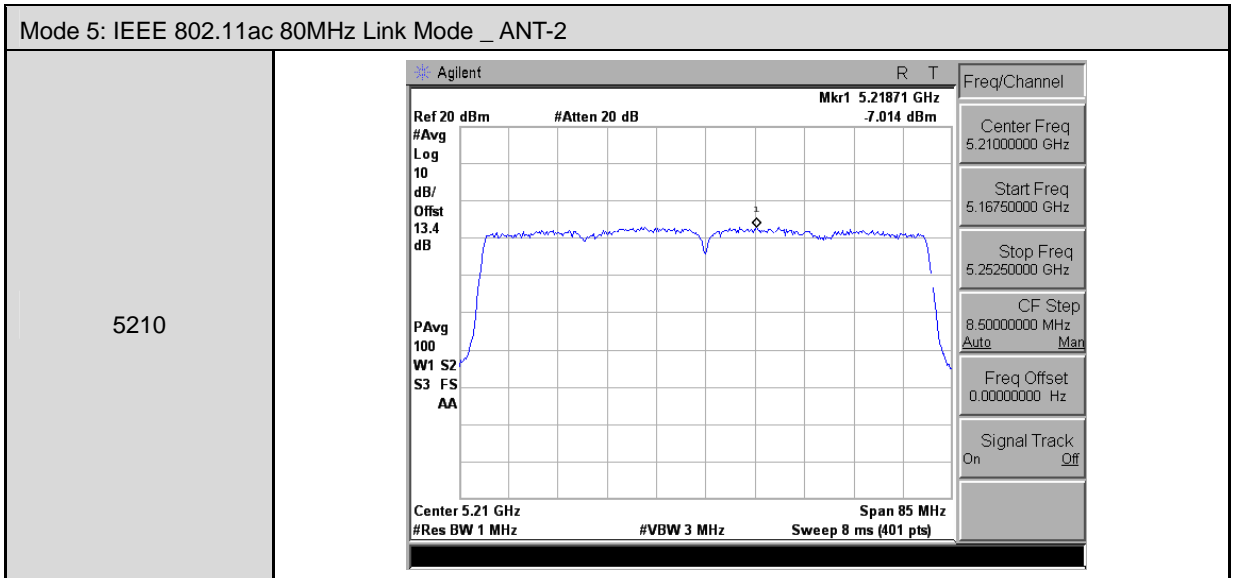

## 9 Frequency Stability Measurement

### 9.1. Limit

Manufacturers of U-NII devices are responsible for ensuring frequency stability such that an emission is maintained within the band of operation under all conditions of normal operation as specified in the users manual.

### 9.2. Test Setup

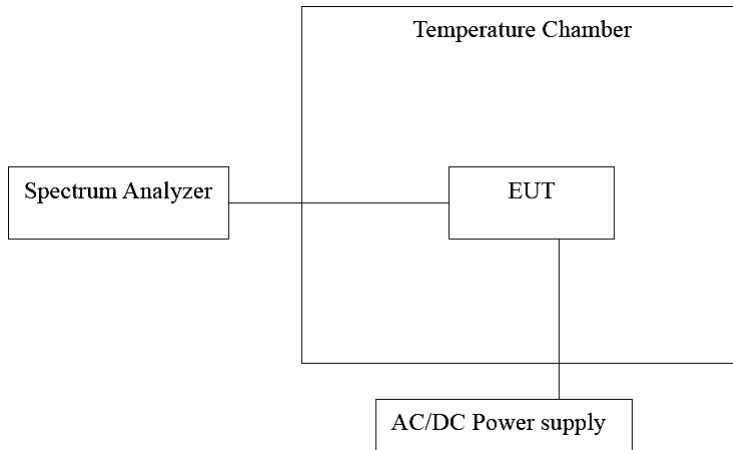

### 9.3. Test Instruments

Equipment	Manufacturer	Model Number	Serial Number	Cal. Date	Remark
Spectrum Analyzer	Agilent	E4408B	MY45107753	07/27/2015	(1)
Temperature & Humidity Chamber	TAICHY	MHU-225LA	980729	04/27/2015	(1)
Test Site	ATL	TE02	TE02	N.C.R.	-----

Remark: (1) Calibration period 1 year. (2) Calibration period 2 years.

Note: N.C.R. = No Calibration Request.



#### 9.4. Test Procedure

1. The EUT was placed inside the environmental test chamber and powered by nominal AC/DC voltage.
2. Turn the EUT on and couple its output to a spectrum analyzer.
3. Turn the EUT off and set the chamber to the highest temperature specified.
4. Allow sufficient time (approximately 30 min) for the temperature of the chamber to stabilize.
5. Repeat step 2 and 3 with the temperature chamber set to the lowest temperature.
6. The test chamber was allowed to stabilize at +20 degree C for a minimum of 30 minutes. The supply voltage was then adjusted on the EUT from 85% to 115% and the frequency record.

#### 9.5. Test Result

Model Number	Touch P5				
Test Mode	Mode 2				
Frequency	5200 MHz				
Date of Test	08/17/2015			Test Site	TE02
Temp. (°C)	Voltage (Vac)	Measured Frequency (MHz)	Delta Frequency (Hz)	Tolerance (ppm)	Result (Pass/Fail)
0	120	5200.0270	27000	5.192	Pass
10		5200.0210	21000	4.038	Pass
20		5200.0060	6000	1.154	Pass
30		5199.9080	-92000	-17.692	Pass
40		5199.9920	-8000	-1.538	Pass

Model Number	Touch P5				
Test Mode	Mode 2				
Frequency	5200 MHz				
Date of Test	08/17/2015			Test Site	TE02
Temp. (°C)	Voltage (Vac)	Measured Frequency (MHz)	Delta Frequency (Hz)	Tolerance (ppm)	Result (Pass/Fail)
20	138	5200.0900	90000	17.308	Pass
	120	5200.0060	6000	1.154	Pass
	102	5199.9810	-19000	-3.654	Pass

Model Number	Touch P5				
Test Mode	Mode 3				
Frequency	5200 MHz				
Date of Test	08/17/2015			Test Site	TE02
Temp. (°C)	Voltage (Vac)	Measured Frequency (MHz)	Delta Frequency (Hz)	Tolerance (ppm)	Result (Pass/Fail)
0	120	5200.0460	46000	8.846	Pass
10		5200.0580	58000	11.154	Pass
20		5200.0060	6000	1.154	Pass
30		5199.9010	-99000	-19.038	Pass
40		5199.9130	-87000	-16.731	Pass

Model Number	Touch P5				
Test Mode	Mode 3				
Frequency	5200 MHz				
Date of Test	08/17/2015			Test Site	TE02
Temp. (°C)	Voltage (Vdc)	Measured Frequency (MHz)	Delta Frequency (Hz)	Tolerance (ppm)	Result (Pass/Fail)
20	138	5200.0740	74000	14.231	Pass
	120	5200.0060	6000	1.154	Pass
	102	5199.9900	-10000	-1.923	Pass

Model Number	Touch P5				
Test Mode	Mode 4				
Frequency	5230 MHz				
Date of Test	08/17/2015			Test Site	TE02
Temp. (°C)	Voltage (Vac)	Measured Frequency (MHz)	Delta Frequency (Hz)	Tolerance (ppm)	Result (Pass/Fail)
0	120	5230.0570	57000	10.899	Pass
10		5230.0830	83000	15.870	Pass
20		5230.0040	4000	0.765	Pass
30		5229.9880	-12000	-2.294	Pass
40		5229.9230	-77000	-14.723	Pass

Model Number	Touch P5				
Test Mode	Mode 4				
Frequency	5230 MHz				
Date of Test	08/17/2015			Test Site	TE02
Temp. (°C)	Voltage (Vac)	Measured Frequency (MHz)	Delta Frequency (Hz)	Tolerance (ppm)	Result (Pass/Fail)
20	138	5230.0650	65000	12.428	Pass
	120	5230.0040	4000	0.765	Pass
	102	5229.9680	-32000	-6.119	Pass

Model Number	Touch P5				
Test Mode	Mode 5				
Frequency	5210 MHz				
Date of Test	08/17/2015			Test Site	TE02
Temp. (°C)	Voltage (Vac)	Measured Frequency (MHz)	Delta Frequency (Hz)	Tolerance (ppm)	Result (Pass/Fail)
0	120	5210.0330	33000	6.334	Pass
10		5210.0870	87000	16.699	Pass
20		5210.0040	4000	0.768	Pass
30		5209.9230	-77000	-14.779	Pass
40		5209.9720	-28000	-5.374	Pass

Model Number	Touch P5				
Test Mode	Mode 5				
Frequency	5210 MHz				
Date of Test	08/17/2015			Test Site	TE02
Temp. (°C)	Voltage (Vac)	Measured Frequency (MHz)	Delta Frequency (Hz)	Tolerance (ppm)	Result (Pass/Fail)
20	138	5210.0730	73000	14.012	Pass
	120	5210.0040	4000	0.768	Pass
	102	5209.9640	-36000	-6.910	Pass

## **10 Antenna Requirement**

### **10.1. Limit**

For intentional device, according to 15.203, an intentional radiator shall be designed to ensure that no antenna other than that furnished by the responsible party shall be used with the device.

And According to 15.407 (a), if transmitting antennas of directional gain greater than 6 dBi are used, the power shall be reduced by the amount in dB that the directional gain of the antenna exceeds 6dBi.

### **10.2. Antenna Connector Construction**

The antenna used in this product is Omni Directional Antenna. And the maximum Gain of this antenna is only 2 dBi.