

# FCC Radio Test Report

## FCC ID: TE7M9PLUSV22

The output power of UNII-3(Non Beamforming) & AC(VHT80) 5775MHz(Beamforming) and the worst case of radiated emissions above 1GHz have been re-evaluated by sample of FCC ID: TE7M9PLUSV22, model name: Deco M9 Plus. Meanwhile. The other test data were reissue from the FCC ID: TE7M9PLUSV2, model name: Deco M9 Plus. The test data of radiated emissions above 1GHz please see the Appendix A, the test data of output power please see the Appendix B. Product changes are as follows:

- The original Bluetooth chip CSR8811 (package is QFN40) is replaced by AC6368A/B (package is SOP8);
- The crystal of the original chip is 26MHz, while the crystal of the new chip is 24MHz;
- The Bluetooth antenna will not be changed;
- The software functions remain unchanged, and they are all used as on-boarding. In the new chip, the new driver is used.
- Change the circuit of Bluetooth part of PCB

### This report concerns: Original Grant

**Project No.** : 1908C067C  
**Equipment** : AC2200 Smart Home Mesh Wi-Fi System  
**Brand Name** : tp-link  
**Test Model** : Deco M9 Plus  
**Series Model** : N/A  
**Applicant** : TP-Link Technologies Co., Ltd.  
**Address** : Building 24(floors1,3,4,5) and 28(floors1-4) Central Science and Technology Park, Shennan Rd, Nanshan, Shenzhen, China  
**Manufacturer** : TP-Link Technologies Co., Ltd.  
**Address** : Building 24(floors1,3,4,5) and 28(floors1-4) Central Science and Technology Park, Shennan Rd, Nanshan, Shenzhen, China  
**Date of Receipt** : Jul. 01, 2021  
**Date of Test** : Jul. 02, 2021 ~ Mar. 04, 2022  
**Issued Date** : Mar. 17, 2022  
**Report Version** : R00  
**Test Sample** : Engineering Sample No.: DG2021070161  
**Standard(s)** : FCC CFR Title 47, Part 15, Subpart E  
FCC KDB 789033 D02 General UNII Test Procedures New Rules v02r01  
FCC KDB 662911 D01 Multiple Transmitter Output v02r01  
ANSI C63.10-2013

The above equipment has been tested and found compliance with the requirement of the relative standards by BTL Inc.



Prepared by : Antony Liang

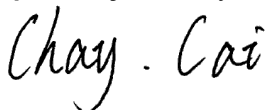

Approved by : Chay Cai



TESTING CERT #5123.02

Add: No. 3 Jinshagang 1st Rd. Shixia, Dalang Town Dongguan City, Guangdong 523792

People's Republic of China.

Tel: +86-769-8318-3000

Web: www.newbtl.com

**Declaration**

**BTL** represents to the client that testing is done in accordance with standard procedures as applicable and that test instruments used has been calibrated with standards traceable to international standard(s) and/or national standard(s).

**BTL's** reports apply only to the specific samples tested under conditions. It is manufacture's responsibility to ensure that additional production units of this model are manufactured with the identical electrical and mechanical components. **BTL** shall have no liability for any declarations, inferences or generalizations drawn by the client or others from **BTL** issued reports.

The report must not be used by the client to claim product certification, approval, or endorsement by NVLAP, NIST, A2LA, or any agency of the U.S. Government.

This report is the confidential property of the client. As a mutual protection to the clients, the public and ourselves, the test report shall not be reproduced, except in full, without our written approval.

**BTL's** laboratory quality assurance procedures are in compliance with the **ISO/IEC 17025** requirements, and accredited by the conformity assessment authorities listed in this test report.

**BTL** is not responsible for the sampling stage, so the results only apply to the sample as received.

The information, data and test plan are provided by manufacturer which may affect the validity of results, so it is manufacturer's responsibility to ensure that the apparatus meets the essential requirements of applied standards and in all the possible configurations as representative of its intended use.

**Limitation**

For the use of the authority's logo is limited unless the Test Standard(s)/Scope(s)/Item(s) mentioned in this test report is (are) included in the conformity assessment authorities acceptance respective.

Please note that the measurement uncertainty is provided for informational purpose only and are not use in determining the Pass/Fail results.

<b>Table of Contents</b>	<b>Page</b>
<b>REPORT ISSUED HISTORY</b>	<b>4</b>
<b>1 . SUMMARY OF TEST RESULTS</b>	<b>5</b>
1.1 TEST FACILITY	6
1.2 MEASUREMENT UNCERTAINTY	6
1.3 TEST ENVIRONMENT CONDITIONS	6
<b>2 . GENERAL INFORMATION</b>	<b>7</b>
2.1 GENERAL DESCRIPTION OF EUT	7
2.2 TEST MODES	10
2.3 PARAMETERS OF TEST SOFTWARE	11
2.4 BLOCK DIAGRAM SHOWING THE CONFIGURATION OF SYSTEM TESTED	11
2.5 SUPPORT UNITS	11
<b>3 . RADIATED EMISSIONS TEST</b>	<b>12</b>
3.1 LIMIT	12
3.2 TEST PROCEDURE	12
3.3 DEVIATION FROM TEST STANDARD	12
3.4 TEST SETUP	13
3.5 EUT OPERATION CONDITIONS	13
3.6 TEST RESULTS - ABOVE 1000 MHz	13
<b>4 . MAXIMUM OUTPUT POWER TEST</b>	<b>14</b>
4.1 LIMIT	14
4.2 TEST PROCEDURE	14
4.3 DEVIATION FROM STANDARD	14
4.4 TEST SETUP	14
4.5 EUT OPERATION CONDITIONS	14
4.6 TEST RESULTS	14
<b>5 . MEASUREMENT INSTRUMENTS LIST</b>	<b>15</b>
<b>6 . EUT TEST PHOTOS</b>	<b>16</b>
<b>APPENDIX A - RADIATED EMISSION - ABOVE 1000 MHZ</b>	<b>17</b>
<b>APPENDIX B - MAXIMUM OUTPUT POWER</b>	<b>22</b>

**REPORT ISSUED HISTORY**

Report Version	Description	Issued Date
R00	Original Issue.	Mar. 17, 2022

## 1. SUMMARY OF TEST RESULTS

Test procedures according to the technical standard(s):

FCC CFR Title 47, Part 15, Subpart C				
Standard(s) Section	Test Item	Test Result	Judgement	Remark
15.207 15.407(b)	AC Power Line Conducted Emissions	-----	PASS	-----
15.407(b) 15.205(a) 15.209(a)	Radiated Emissions	APPENDIX A	PASS	-----
15.407(a) 15.407(e)	Spectrum Bandwidth	-----	PASS	-----
15.407(a)	Maximum Output Power	APPENDIX B	PASS	-----
15.407(a)	Power Spectral Density	-----	PASS	-----
15.407(g)	Frequency Stability	-----	PASS	-----
15.203	Antenna Requirements	-----	PASS	Note(2)
15.407(c)	Automatically Discontinue Transmission	-----	PASS	Note(3)

Note:

- (1) "N/A" denotes test is not applicable in this test report.
- (2) The device what use a permanently attached antenna were considered sufficient to comply with the provisions of 15.203.
- (3) During no any information transmission, the EUT can automatically discontinue transmission and become standby mode for power saving. the EUT can detect the controlling signal of ACK message transmitting from remote device and verify whether it shall resend or discontinue transmission.
- (4) For UNII-1 this device was functioned as a  
 Access point device     Client device
- (5) Reissue from the FCC ID: TE7M9PLUSV2. Report: BTL-FCCP-4-1908C067.

### 1.1 TEST FACILITY

The test facilities used to collect the test data in this report is at the location of No. 3 Jinshagang 1st Rd. Shixia, Dalang Town Dongguan City, Guangdong 523792 People's Republic of China.

BTL's Registration Number for FCC: 357015  
 BTL's Designation Number for FCC: CN1240

### 1.2 MEASUREMENT UNCERTAINTY

ISO/IEC 17025 requires that an estimate of the measurement uncertainties associated with the emissions test results be included in the report. The measurement uncertainties given below are based on a 95% confidence level (based on a coverage factor (k=2))

The BTL measurement uncertainty as below table:

A. Radiated emissions test:

Test Site	Method	Measurement Frequency Range	U,(dB)
DG-CB03 (3m)	CISPR	1GHz ~ 6GHz	3.80
		6GHz ~ 18GHz	4.82

Test Site	Method	Measurement Frequency Range	U,(dB)
DG-CB03 (1m)	CISPR	18 ~ 26.5 GHz	3.62
		26.5 ~ 40 GHz	4.00

B. Other Measurement test:

Test Item	Uncertainty
Maximum Output Power	±0.95 dB
Temperature	±0.08 °C
Humidity	±1.5%

Note: Unless specifically mentioned, the uncertainty of measurement has not been taken into account to declare the compliance or non-compliance to the specification.

### 1.3 TEST ENVIRONMENT CONDITIONS

Test Item	Temperature	Humidity	Test Voltage	Tested By
Radiated Emissions-Above 1000 MHz	24°C	60%	AC 120V/60Hz	Chen Mo
Maximum Output Power	24°C	65%	AC 120V/60Hz	Longdage Feng

## 2. GENERAL INFORMATION

### 2.1 GENERAL DESCRIPTION OF EUT

Equipment	AC2200 Smart Home Mesh Wi-Fi System
Brand Name	tp-link
Test Model	Deco M9 Plus
Series Model	N/A
Model Difference(s)	N/A
Power Source	DC voltage supplied from AC/DC adapter. Model: T120200-2B4
Power Rating	I/P: 100-240V~ 50/60Hz 0.8A O/P: 12V --- 2A
Operation Frequency Bands	UNII-1: 5150 MHz~5250 MHz UNII-3: 5725 MHz~5850 MHz
Modulation Type	IEEE 802.11a/n/ac: OFDM
Bit Rate of Transmitter	IEEE 802.11a: 54/48/36/24/18/12/9/6 Mbps IEEE 802.11n: up to 300 Mbps IEEE 802.11ac: up to 866.7 Mbps
Maximum Output Power for UNII-3_Non Beamforming	IEEE 802.11a: 27.67 dBm (0.5848 W) IEEE 802.11n (HT20): 27.91 dBm (0.6180 W) IEEE 802.11n (HT40): 28.44 dBm (0.6892 W) IEEE 802.11ac (VHT20): 28.10 dBm (0.6457 W) IEEE 802.11ac (VHT40): 28.51 dBm (0.7096 W) IEEE 802.11ac (VHT80): 24.87 dBm (0.3069 W)
Maximum Output Power for UNII-3_Beamforming	IEEE 802.11ac (VHT80): 24.66 dBm (0.2924 W)

Note:

1. For a more detailed features description, please refer to the manufacturer's specifications or the user's manual.

## 2. Channel List:

IEEE 802.11a IEEE 802.11n (HT20) IEEE 802.11ac (VHT20)		IEEE 802.11n (HT40) IEEE 802.11ac (VHT40)		IEEE 802.11ac (VHT80)	
UNII-1		UNII-1		UNII-1	
Channel	Frequency (MHz)	Channel	Frequency (MHz)	Channel	Frequency (MHz)
36	5180	38	5190	42	5210
40	5200	46	5230		
44	5220				
48	5240				

IEEE 802.11a IEEE 802.11n (HT20) IEEE 802.11ac (VHT20)		IEEE 802.11n (HT40) IEEE 802.11ac (VHT40)		IEEE 802.11ac (VHT80)	
UNII-3		UNII-3		UNII-3	
Channel	Frequency (MHz)	Channel	Frequency (MHz)	Channel	Frequency (MHz)
149	5745	151	5755	155	5775
153	5765	159	5795		
157	5785				
161	5805				
165	5825				

## 3. Antenna Specification:

For UNII-1:

Ant.	Brand	P/N	Antenna Type	Connector	Gain (dBi)
1	tp-link	3101502551	Internal	I-PEX	0.80
2	tp-link	3101502551	Internal	I-PEX	0.80

Note: 1. This EUT supports CDD, and all antennas have the same gain,

 a. For Non Beamforming function, Directional gain =  $G_{ANT} + \text{Array Gain}$ ,

 For output power measurements, Array Gain = 0 ( $N_{ANT} \leq 4$ ), so, Directional gain = 0.8

 For power spectral density measurements, Array Gain =  $10 \log(N_{ANT}/N_{SS})$  Db

 Directional gain =  $0.8 + 10 \log(2/1) = 3.81$ .

 b. For Beamforming function, Beamforming gain: 3.0 dB, so Directional gain =  $3.0 + 0.8 = 3.80$ 

2. The antenna gain and beamforming gain are provided by the manufacturer.

For UNII-3:

Ant.	Brand	P/N	Antenna Type	Connector	Gain (dBi)
3	tp-link	3101502637	Internal	I-PEX	0.80
4	tp-link	3101502552	Internal	I-PEX	0.80

Note: 1. This EUT supports CDD, and all antennas have the same gain,

 a. For Non Beamforming function, Directional gain =  $G_{ANT} + \text{Array Gain}$ ,

 For output power measurements, Array Gain = 0 ( $N_{ANT} \leq 4$ ), so, Directional gain = 0.8

 For power spectral density measurements, Array Gain =  $10 \log(N_{ANT}/N_{SS})$  Db

 Directional gain =  $0.8 + 10 \log(2/1) = 3.81$ .

 b. For Beamforming function, Beamforming gain: 3.0 dB, so Directional gain =  $3.0 + 0.8 = 3.80$ 

2. The antenna gain and beamforming gain are provided by the manufacturer.



4. Table for Antenna Configuration:  
For Non Beamforming:

Operating Mode	TX Mode	2TX
IEEE 802.11a		V (Ant. 1 + Ant. 2)
IEEE 802.11n (HT20)		V (Ant. 1 + Ant. 2)
IEEE 802.11n (HT40)		V (Ant. 1 + Ant. 2)
IEEE 802.11ac (VHT20)		V (Ant. 1 + Ant. 2)
IEEE 802.11ac (VHT40)		V (Ant. 1 + Ant. 2)
IEEE 802.11ac (VHT80)		V (Ant. 1 + Ant. 2)

For Beamforming:

Operating Mode	TX Mode	2TX
IEEE 802.11n (HT20)		V (Ant. 1 + Ant. 2)
IEEE 802.11n (HT40)		V (Ant. 1 + Ant. 2)
IEEE 802.11ac (VHT20)		V (Ant. 1 + Ant. 2)
IEEE 802.11ac (VHT40)		V (Ant. 1 + Ant. 2)
IEEE 802.11ac (VHT80)		V (Ant. 1 + Ant. 2)

## 2.2 TEST MODES

The test system was pre-tested based on the consideration of all possible combinations of EUT operation mode.

Pretest Mode	Description
Mode 1	TX AC (VHT20) Mode / CH36 (UNII-1)
Mode 2	TX AC (VHT20) Mode / CH149 (UNII-3)
Mode 3	TX A Mode / CH149,CH157,CH165 (UNII-3)
Mode 4	TX N (HT20) Mode / CH149,CH157,CH165 (UNII-3)
Mode 5	TX N (HT40) Mode / CH151,CH159 (UNII-3)
Mode 6	TX AC (VHT20) Mode / CH149,CH157,CH165 (UNII-3)
Mode 7	TX AC (VHT40) Mode / CH151,CH159 (UNII-3)
Mode 8	TX AC (VHT80) Mode / CH155 (UNII-3)

Following mode(s) was (were) found to be the worst case(s) and selected for the final test.

Radiated emissions test - Above 1GHz	
Final Test Mode	Description
Mode 2	TX AC (VHT20) Mode / CH149 (UNII-3)

Radiated emissions test - Above 1GHz _Bandedge	
Final Test Mode	Description
Mode 1	TX AC (VHT20) Mode / CH36 (UNII-1)

Output Power _Non Beamforming	
Final Test Mode	Description
Mode 3	TX A Mode / CH149,CH157,CH165 (UNII-3)
Mode 4	TX N (HT20) Mode / CH149,CH157,CH165 (UNII-3)
Mode 5	TX N (HT40) Mode / CH151,CH159 (UNII-3)
Mode 6	TX AC (VHT20) Mode / CH149,CH157,CH165 (UNII-3)
Mode 7	TX AC (VHT40) Mode / CH151,CH159 (UNII-3)
Mode 8	TX AC (VHT80) Mode / CH155 (UNII-3)

Output Power _Beamforming	
Final Test Mode	Description
Mode 4	TX N (HT20) Mode / CH149,CH157,CH165 (UNII-3)
Mode 5	TX N (HT40) Mode / CH151,CH159 (UNII-3)
Mode 6	TX AC (VHT20) Mode / CH149,CH157,CH165 (UNII-3)
Mode 7	TX AC (VHT40) Mode / CH151,CH159 (UNII-3)
Mode 8	TX AC (VHT80) Mode / CH155 (UNII-3)

Note:

- (1) For radiated emission above 1 GHz test, 1GHz~26.5GHz and 26.5GHz~40GHz have been pre-tested and in this report only recorded the worst case. The remaining spurious points are all below the limit value of 20dB.
- (2) All the bit rate of transmitter have been tested and found the lowest rate is found to be the worst case and recorded.

### 2.3 PARAMETERS OF TEST SOFTWARE

Test Software	QRCT v3.0.187.0
---------------	-----------------

### 2.4 BLOCK DIAGRAM SHOWING THE CONFIGURATION OF SYSTEM TESTED

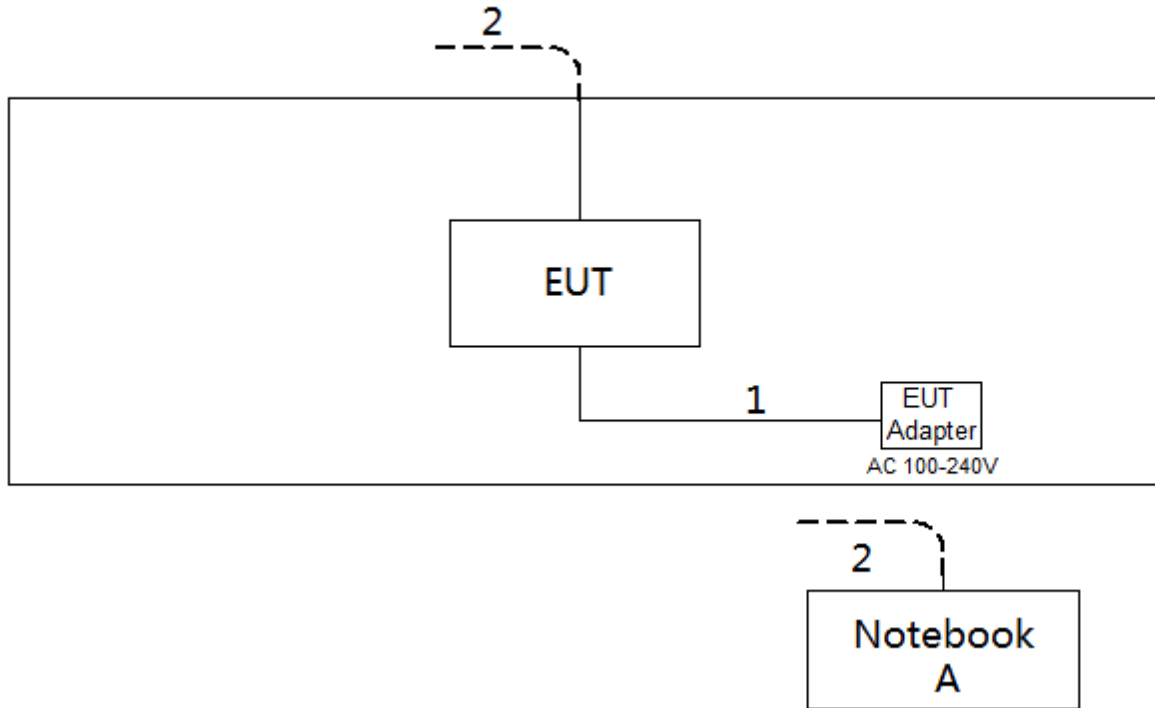

### 2.5 SUPPORT UNITS

Item	Equipment	Brand	Model No.	Series No.
A	Notebook	Dell	Inspiron 15-7559	N/A

Item	Cable Type	Shielded Type	Ferrite Core	Length
1	DC Cable	NO	NO	1.5m
2	RJ45 Cable	NO	NO	10m

### 3. RADIATED EMISSIONS TEST

#### 3.1 LIMIT

In case the emission fall within the restricted band specified on 15.205(a), then the 15.209(a) limit in the table below has to be followed.

#### LIMITS OF UNWANTED EMISSION OUT OF THE RESTRICTED BANDS

Frequency (MHz)	EIRP Limit (dBm/MHz)	Equivalent Field Strength at 3m (dBμV/m)
5150-5250	-27	68.3
5725-5850	-27 NOTE (2)	68.3
	10 NOTE (2)	105.3
	15.6 NOTE (2)	110.9
	27 NOTE (2)	122.3

#### NOTE:

(1) The following formula is used to convert the equipment isotropic radiated power (eirp) to field strength:

$$E = \frac{1000000\sqrt{30P}}{3} \mu\text{V/m, where P is the eirp (Watts)}$$

(2) According to 15.407(b)(4)(i), all emissions shall be limited to a level of -27 dBm/MHz at 75 MHz or more above or below the band edge increasing linearly to 10 dBm/MHz at 25 MHz above or below the bandedge, and from 25 MHz above or below the band edge increasing linearly to a level of 15.6 dBm/MHz at 5 MHz above or below the band edge, and from 5 MHz above or below the band edge increasing linearly to a level of 27 dBm/MHz at the band edge.

#### 3.2 TEST PROCEDURE

- a. The measuring distance of 3 m shall be used for measurements. The EUT was placed on the top of a rotating table 1.5 meter above the ground at a 3 meter semi-anechoic chamber. The table was rotated 360 degrees to determine the position of the highest radiation.(above 1GHz)
- b. The height of the equipment or of the substitution antenna shall be 0.8m or 1.5m; the height of the test antenna shall vary between 1 m to 4 m. Both horizontal and vertical polarizations of the antenna are set to make the measurement.
- c. For each suspected emission, the EUT was arranged to its worst case and then the antenna was tuned to heights find the maximum reading (used Bore sight function).
- d. The receiver system was set to peak and average detect function and specified bandwidth with maximum hold mode when the test frequency is above 1 GHz.
- e. The initial step in collecting radiated emission data is a receiver peak detector mode pre-scanning the measurement frequency range. Significant peaks are then marked and then Quasi Peak detector mode re-measured.
- f. All readings are Peak Mode value unless otherwise stated AVG in column of Note. If the Peak Mode Measured value compliance with the Peak Limits and lower than AVG Limits, the EUT shall be deemed to meet both Peak & AVG Limits and then only Peak Mode was measured, but AVG Mode didn't perform. (above 1 GHz)
- g. For the actual test configuration, please refer to the related Item –EUT Test Photos.

#### 3.3 DEVIATION FROM TEST STANDARD

No deviation

### 3.4 TEST SETUP

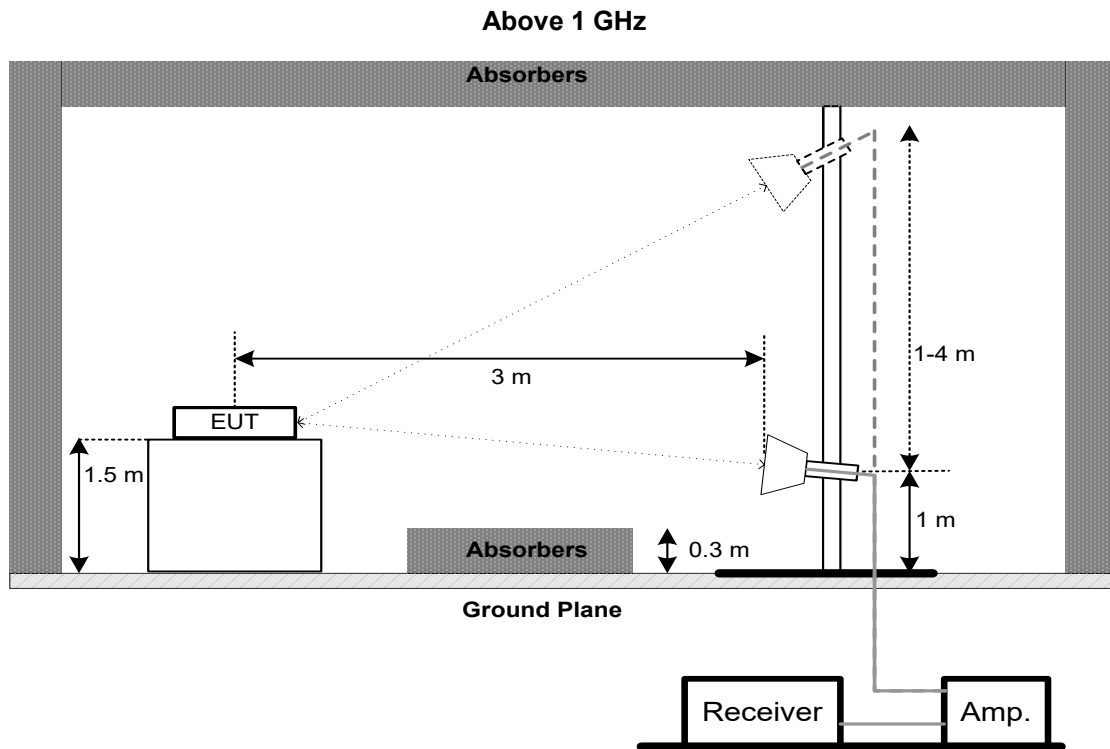

### 3.5 EUT OPERATION CONDITIONS

The EUT tested system was configured as the statements of 3.5 unless otherwise a special operating condition is specified in the follows during the testing.

### 3.6 TEST RESULTS - ABOVE 1000 MHz

Please refer to the APPENDIX A.

Remark:

- (1) No limit: This is fundamental signal, the judgment is not applicable.  
For fundamental signal judgment was referred to Peak output test.

## 4. MAXIMUM OUTPUT POWER TEST

### 4.1 LIMIT

Section	Test Item	Limit	Frequency Range (MHz)
FCC 15.407(a)	Maximum Output Power	AP device: 1 Watt (30 dBm) Client device: 250 mW (23.98 dBm)	5150-5250
		250 mW (23.98 dBm)	5250-5350
		250 mW (23.98 dBm)	5470-5725
		1 Watt (30dBm)	5725-5850

Note:

- a. For an indoor access point operating in the band 5.15-5.25 GHz, the maximum conducted output power over the frequency band of operation shall not exceed 1 W provided the maximum antenna gain does not exceed 6 dBi. In addition, the maximum power spectral density shall not exceed 17 dBm in any 1 megahertz band. If transmitting antennas of directional gain greater than 6 dBi are used, both the maximum conducted output power and the maximum power spectral density shall be reduced by the amount in dB that the directional gain of the antenna exceeds 6 dBi.

### 4.2 TEST PROCEDURE

- a. The EUT was directly connected to the power meter and antenna output port as show in the block diagram below.
- b. Test test was performed in accordance with method of FCC KDB 789033 D02 General UNII Test Procedures New Rules v02r01.

### 4.3 DEVIATION FROM STANDARD

No deviation.

### 4.4 TEST SETUP

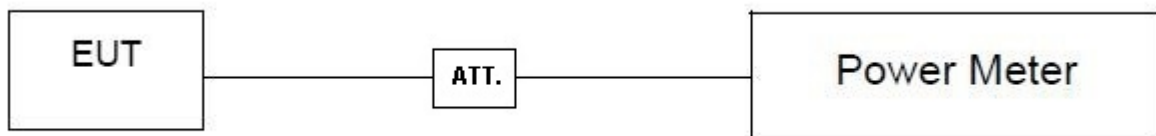

### 4.5 EUT OPERATION CONDITIONS

The EUT was programmed to be in continuously transmitting mode.

### 4.6 TEST RESULTS

Please refer to the APPENDIX B.

## 5. MEASUREMENT INSTRUMENTS LIST

Radiated Emissions - Above 1 GHz					
Item	Kind of Equipment	Manufacturer	Type No.	Serial No.	Calibrated until
1	Double Ridged Horn Antenna	ARA	DRG-118A	16554	Apr. 21, 2022
2	Broad-Band Horn Antenna	Schwarzbeck	BBHA 9170	9170319	Jun. 30, 2022
3	Amplifier	Agilent	8449B	3008A02584	Jul. 10, 2022
4	Controller	CT	SC100	N/A	N/A
5	Controller	MF	MF-7802	MF780208416	N/A
6	Receiver	Agilent	N9038A	MY52130039	Jan. 22, 2022 Jan. 22, 2023
7	EXA Spectrum Analyzer	Keysight	N9010A	MY56480488	Jan. 22, 2022 Jan. 22, 2023
8	Low Noise Amplifier	CONNPHY	CLN-18G40G-4330-K	619413	Jul. 16, 2022
9	Cable	N/A	A81-SMAMSMAM-12.5M	N/A	Oct. 15, 2022
10	Cable	Talent microwave	A40-2.92M2.92M-2.5M	N/A	Nov. 30, 2022
11*	Band Reject Filter	Micro-Tronics	BRC50703-01	7	Feb. 27, 2021 Feb. 27, 2024
12*	Band Reject Filter	Micro-Tronics	BRC50705-01	10	Feb. 27, 2021 Feb. 27, 2024
13	Measurement Software	Farad	EZ-EMC Ver.NB-03A1-01	N/A	N/A
14	966 Chamber Room	RM	9*6*6	N/A	Jul. 24, 2022

Maximum Output Power					
Item	Kind of Equipment	Manufacturer	Type No.	Serial No.	Calibrated until
1	Peak Power Analyzer	Keysight	8990B	MY51000506	Jul. 10, 2022
2	Wideband power sensor	Keysight	N1923A	MY58310004	Jul. 10, 2022
3	Attenuator	WOKEN	6SM3502	VAS1214NL	N/A
4	RF Cable	Tongkaichuan	N/A	N/A	N/A

Remark: "N/A" denotes no model name, serial no. or calibration specified.

"\*\*" calibration period of equipment list is three year.

Except \* item, all calibration period of equipment list is one year.

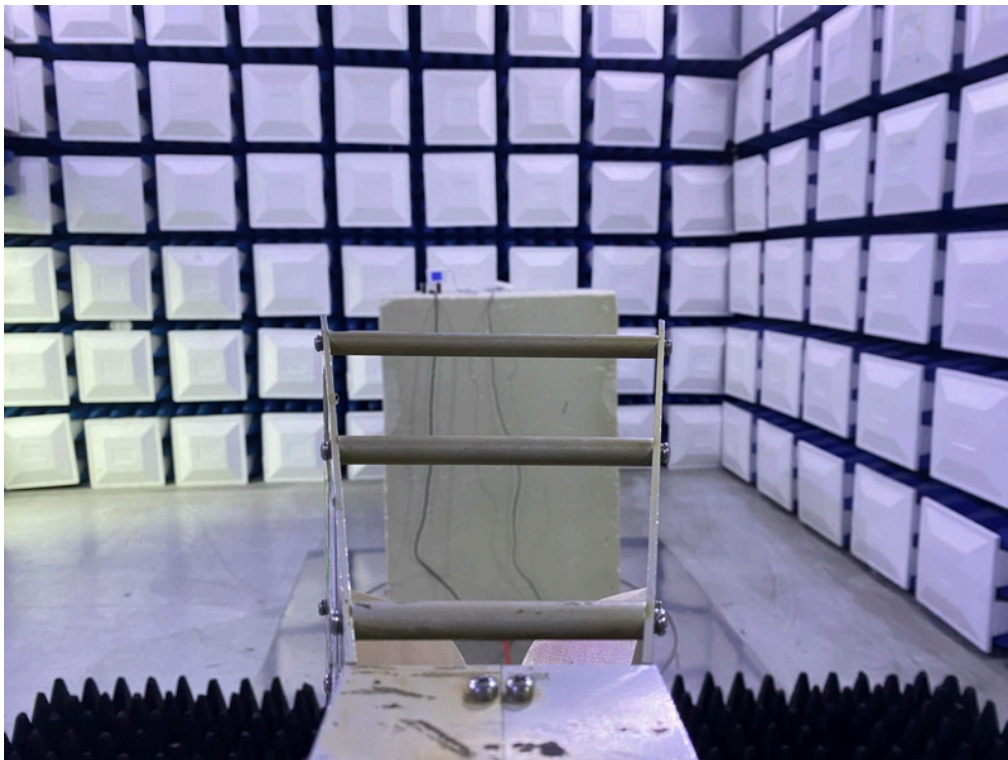
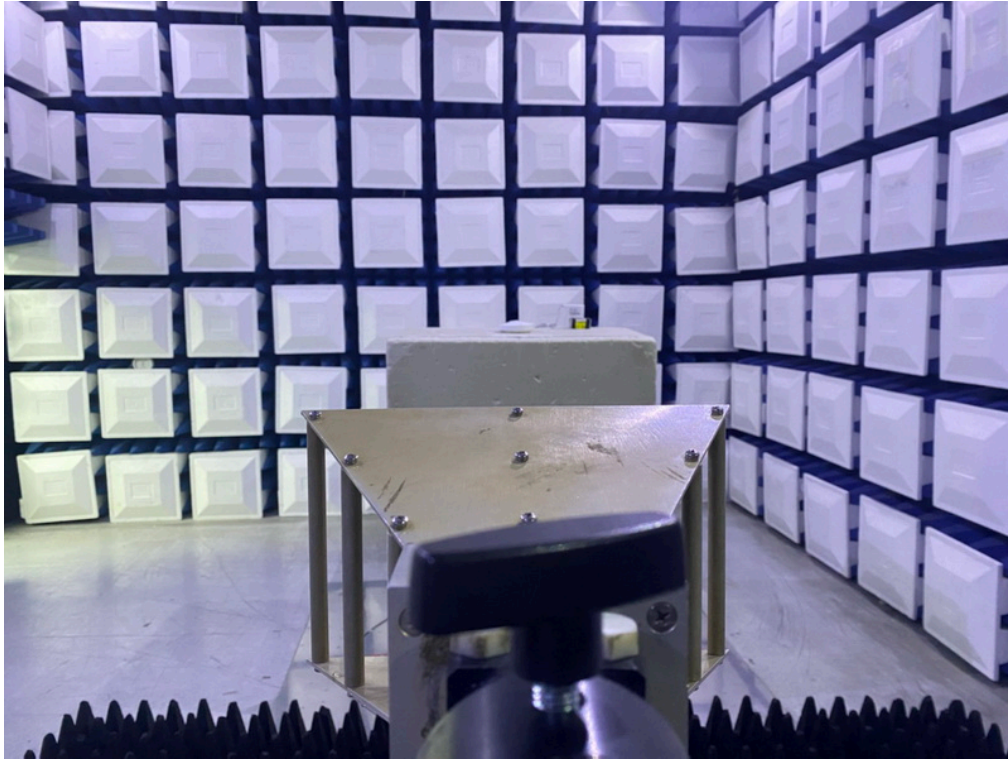
**6. EUT TEST PHOTOS****Radiated Emissions Test Photos****Above 1 GHz**



**APPENDIX A - RADIATED EMISSION - ABOVE 1000 MHZ**

Orthogonal Axis	X
Test Mode	UNII-1_TX AC(VHT20) Mode 5180 MHz

### Vertical

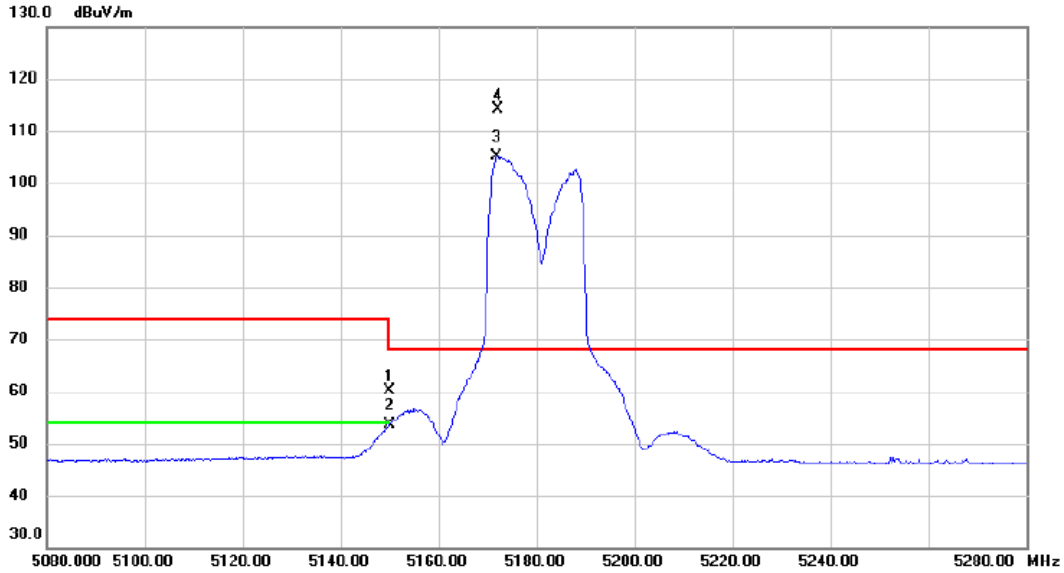

No.	Mk.	Freq. MHz	Reading Level dBuV	Correct Factor dB	Measure- ment dBuV/m	Limit dBuV/m	Margin dB	Detector	Comment
1		5150.000	42.28	17.91	60.19	74.00	-13.81	peak	
2		5150.000	35.60	17.91	53.51	54.00	-0.49	AVG	
3	X	5171.900	87.18	17.99	105.17	68.20	36.97	AVG	No Limit
4	*	5172.100	96.18	17.99	114.17	68.20	45.97	peak	No Limit

**REMARKS:**

- (1) Measurement Value = Reading Level + Correct Factor.
- (2) Margin Level = Measurement Value - Limit Value.

Orthogonal Axis	X
Test Mode	UNII-1_TX AC(VHT20) Mode 5180 MHz

### Horizontal

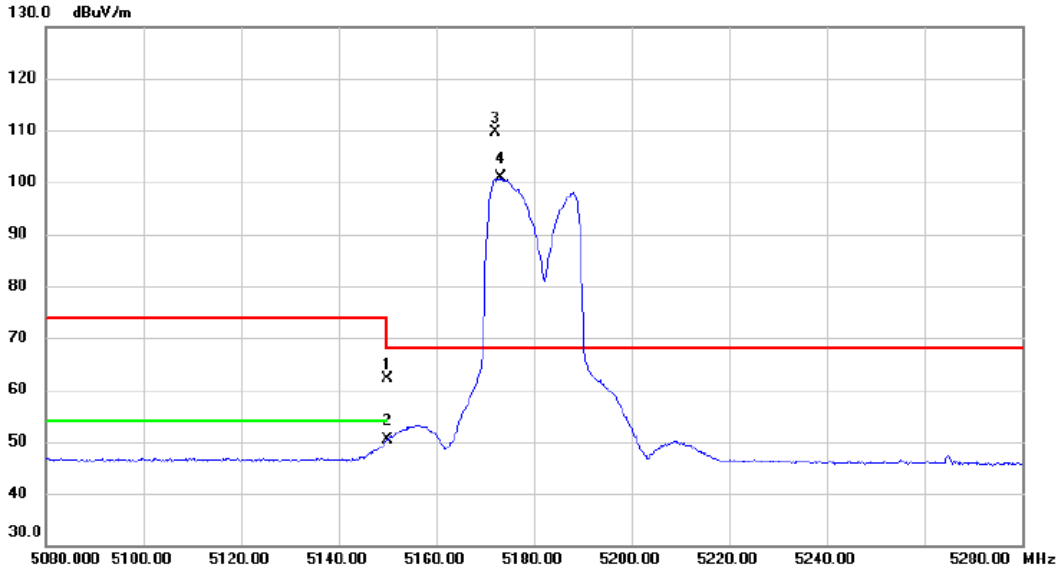

No.	Mk.	Freq.	Reading Level	Correct Factor	Measurement	Limit	Margin	Detector	Comment
		MHz	dBuV	dB	dBuV/m	dBuV/m	dB		
1		5150.000	44.26	17.91	62.17	74.00	-11.83	peak	
2		5150.000	32.42	17.91	50.33	54.00	-3.67	AVG	
3	*	5172.100	91.55	17.99	109.54	68.20	41.34	peak	No Limit
4	X	5173.100	82.85	17.99	100.84	68.20	32.64	AVG	No Limit

**REMARKS:**

- (1) Measurement Value = Reading Level + Correct Factor.
- (2) Margin Level = Measurement Value - Limit Value.

Orthogonal Axis	X
Test Mode	UNII-3_TX AC(VHT20) Mode 5745 MHz

### Vertical

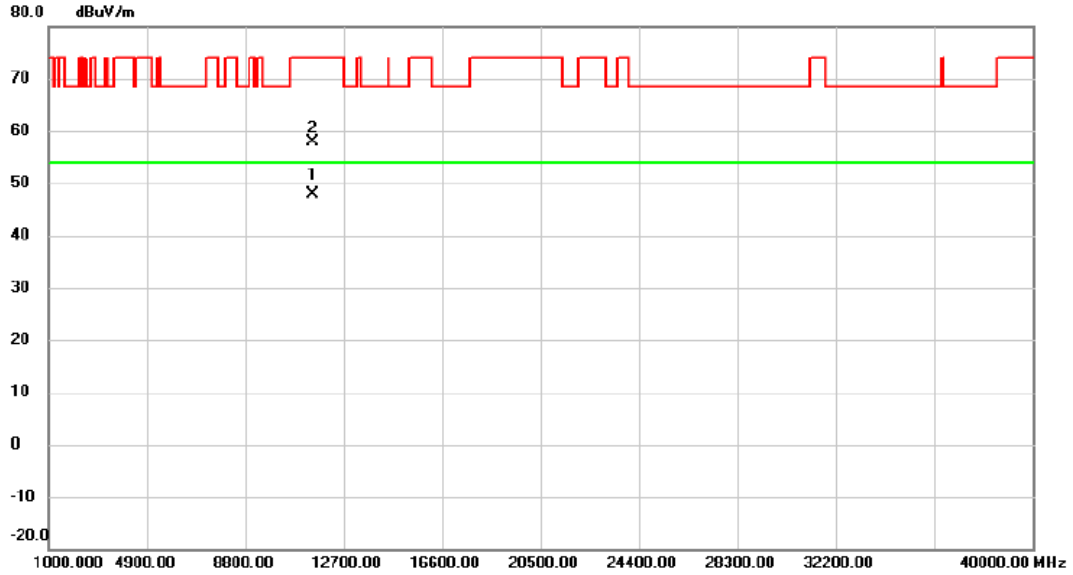

No.	Mk.	Freq. MHz	Reading Level dBuV	Correct Factor dB	Measure- ment dBuV/m	Limit dBuV/m	Margin dB	Detector	Comment
1	*	11495.350	31.31	16.66	47.97	54.00	-6.03	AVG	
2		11496.800	41.18	16.66	57.84	74.00	-16.16	peak	

**REMARKS:**

- (1) Measurement Value = Reading Level + Correct Factor.
- (2) Margin Level = Measurement Value - Limit Value.

Orthogonal Axis	X
Test Mode	UNII-3_TX AC(VHT20) Mode 5745 MHz

### Horizontal

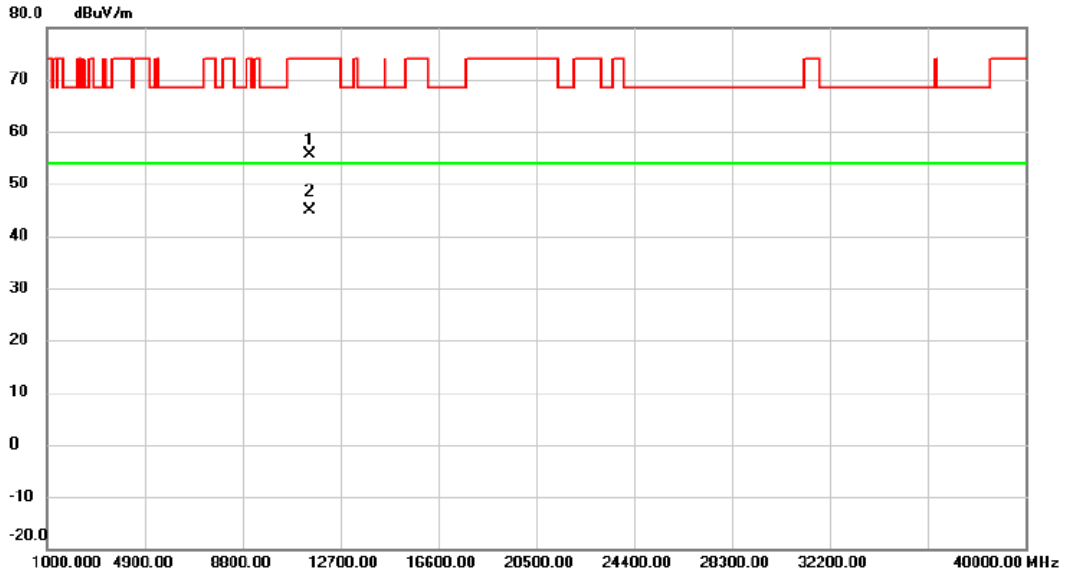

No.	Mk.	Freq. MHz	Reading Level dBuV	Correct Factor dB	Measure- ment dBuV/m	Limit dBuV/m	Margin dB	Detector	Comment
1		11481.775	39.08	16.64	55.72	74.00	-18.28	peak	
2	*	11496.900	28.18	16.66	44.84	54.00	-9.16	AVG	

**REMARKS:**

- (1) Measurement Value = Reading Level + Correct Factor.
- (2) Margin Level = Measurement Value - Limit Value.

## **APPENDIX B - MAXIMUM OUTPUT POWER**

**Non Beamforming**

Test Mode	UNII-3_TX A Mode_Ant. 1
-----------	-------------------------

Channel	Frequency (MHz)	Output Power (dBm)	Duty Factor	Output Power + Duty Factor (dBm)	Max. Limit (dBm)	Max. Limit (W)	Result
149	5745	23.93	0.17	24.10	30.00	1.00	Complies
157	5785	23.87	0.17	24.04	30.00	1.00	Complies
165	5825	24.62	0.17	24.79	30.00	1.00	Complies

Test Mode	UNII-3_TX A Mode_Ant. 2
-----------	-------------------------

Channel	Frequency (MHz)	Output Power (dBm)	Duty Factor	Output Power + Duty Factor (dBm)	Max. Limit (dBm)	Max. Limit (W)	Result
149	5745	23.43	0.17	23.60	30.00	1.00	Complies
157	5785	24.08	0.17	24.25	30.00	1.00	Complies
165	5825	24.35	0.17	24.52	30.00	1.00	Complies

Test Mode	UNII-3_TX A Mode_Total
-----------	------------------------

Channel	Frequency (MHz)	Output Power (dBm)	Max. Limit (dBm)	Max. Limit (W)	Result
149	5745	26.87	30.00	1.00	Complies
157	5785	27.15	30.00	1.00	Complies
165	5825	27.67	30.00	1.00	Complies

Test Mode	UNII-3_TX N (HT20) Mode_Ant. 1
-----------	--------------------------------

Channel	Frequency (MHz)	Output Power (dBm)	Duty Factor	Output Power + Duty Factor (dBm)	Max. Limit (dBm)	Max. Limit (W)	Result
149	5745	23.89	0.00	23.89	30.00	1.00	Complies
157	5785	24.26	0.00	24.26	30.00	1.00	Complies
165	5825	24.68	0.00	24.68	30.00	1.00	Complies

Test Mode	UNII-3_TX N (HT20) Mode_Ant. 2
-----------	--------------------------------

Channel	Frequency (MHz)	Output Power (dBm)	Duty Factor	Output Power + Duty Factor (dBm)	Max. Limit (dBm)	Max. Limit (W)	Result
149	5745	24.41	0.00	24.41	30.00	1.00	Complies
157	5785	24.48	0.00	24.48	30.00	1.00	Complies
165	5825	25.11	0.00	25.11	30.00	1.00	Complies

Test Mode	UNII-3_TX N (HT20) Mode_Total
-----------	-------------------------------

Channel	Frequency (MHz)	Output Power (dBm)	Max. Limit (dBm)	Max. Limit (W)	Result
149	5745	27.17	30.00	1.00	Complies
157	5785	27.38	30.00	1.00	Complies
165	5825	27.91	30.00	1.00	Complies



Test Mode	UNII-3_TX N (HT40) Mode_Ant. 1
-----------	--------------------------------

Channel	Frequency (MHz)	Output Power (dBm)	Duty Factor	Output Power + Duty Factor (dBm)	Max. Limit (dBm)	Max. Limit (W)	Result
151	5755	24.86	0.16	25.02	30.00	1.00	Complies
159	5795	25.17	0.16	25.33	30.00	1.00	Complies

Test Mode	UNII-3_TX N (HT40) Mode_Ant. 2
-----------	--------------------------------

Channel	Frequency (MHz)	Output Power (dBm)	Duty Factor	Output Power + Duty Factor (dBm)	Max. Limit (dBm)	Max. Limit (W)	Result
151	5755	25.12	0.16	25.28	30.00	1.00	Complies
159	5795	25.37	0.16	25.53	30.00	1.00	Complies

Test Mode	UNII-3_TX N (HT40) Mode_Total
-----------	-------------------------------

Channel	Frequency (MHz)	Output Power (dBm)	Max. Limit (dBm)	Max. Limit (W)	Result
151	5755	28.16	30.00	1.00	Complies
159	5795	28.44	30.00	1.00	Complies

Test Mode	UNII-3_TX AC (VHT20) Mode_Ant. 1
-----------	----------------------------------

Channel	Frequency (MHz)	Output Power (dBm)	Duty Factor	Output Power + Duty Factor (dBm)	Max. Limit (dBm)	Max. Limit (W)	Result
149	5745	23.92	0.00	23.92	30.00	1.00	Complies
157	5785	24.30	0.00	24.30	30.00	1.00	Complies
165	5825	24.95	0.00	24.95	30.00	1.00	Complies

Test Mode	UNII-3_TX AC (VHT20) Mode_Ant. 2
-----------	----------------------------------

Channel	Frequency (MHz)	Output Power (dBm)	Duty Factor	Output Power + Duty Factor (dBm)	Max. Limit (dBm)	Max. Limit (W)	Result
149	5745	24.62	0.00	24.62	30.00	1.00	Complies
157	5785	24.53	0.00	24.53	30.00	1.00	Complies
165	5825	25.23	0.00	25.23	30.00	1.00	Complies

Test Mode	UNII-3_TX AC (VHT20) Mode_Total
-----------	---------------------------------

Channel	Frequency (MHz)	Output Power (dBm)	Max. Limit (dBm)	Max. Limit (W)	Result
149	5745	27.29	30.00	1.00	Complies
157	5785	27.43	30.00	1.00	Complies
165	5825	28.10	30.00	1.00	Complies

Test Mode	UNII-3_TX AC (VHT40) Mode_Ant. 1
-----------	----------------------------------

Channel	Frequency (MHz)	Output Power (dBm)	Duty Factor	Output Power + Duty Factor (dBm)	Max. Limit (dBm)	Max. Limit (W)	Result
151	5755	24.91	0.14	25.07	30.00	1.00	Complies
159	5795	25.26	0.14	25.42	30.00	1.00	Complies

Test Mode	UNII-3_TX AC (VHT40) Mode_Ant. 2
-----------	----------------------------------

Channel	Frequency (MHz)	Output Power (dBm)	Duty Factor	Output Power + Duty Factor (dBm)	Max. Limit (dBm)	Max. Limit (W)	Result
151	5755	25.64	0.14	25.80	30.00	1.00	Complies
159	5795	25.46	0.14	25.62	30.00	1.00	Complies

Test Mode	UNII-3_TX AC (VHT40) Mode_Total
-----------	---------------------------------

Channel	Frequency (MHz)	Output Power (dBm)	Max. Limit (dBm)	Max. Limit (W)	Result
151	5755	28.44	30.00	1.00	Complies
159	5795	28.51	30.00	1.00	Complies

Test Mode	UNII-3_TX AC (VHT80) Mode_Ant. 1
-----------	----------------------------------

Channel	Frequency (MHz)	Output Power (dBm)	Duty Factor	Output Power + Duty Factor (dBm)	Max. Limit (dBm)	Max. Limit (W)	Result
155	5775	21.31	0.29	21.60	30.00	1.00	Complies

Test Mode	UNII-3_TX AC (VHT80) Mode_Ant. 2
-----------	----------------------------------

Channel	Frequency (MHz)	Output Power (dBm)	Duty Factor	Output Power + Duty Factor (dBm)	Max. Limit (dBm)	Max. Limit (W)	Result
155	5775	21.80	0.29	22.09	30.00	1.00	Complies

Test Mode	UNII-3_TX AC (VHT80) Mode_Total
-----------	---------------------------------

Channel	Frequency (MHz)	Output Power (dBm)	Max. Limit (dBm)	Max. Limit (W)	Result
155	5775	24.87	30.00	1.00	Complies

**Beamforming**

Test Mode	UNII-3_TX AC (VHT80) Mode_Ant. 1
-----------	----------------------------------

Channel	Frequency (MHz)	Output Power (dBm)	Duty Factor	Output Power + Duty Factor (dBm)	Max. Limit (dBm)	Max. Limit (W)	Result
155	5775	21.23	0.29	21.52	30.00	1.00	Complies

Test Mode	UNII-3_TX AC (VHT80) Mode_Ant. 2
-----------	----------------------------------

Channel	Frequency (MHz)	Output Power (dBm)	Duty Factor	Output Power + Duty Factor (dBm)	Max. Limit (dBm)	Max. Limit (W)	Result
155	5775	21.47	0.29	21.76	30.00	1.00	Complies

Test Mode	UNII-3_TX AC (VHT80) Mode_Total
-----------	---------------------------------

Channel	Frequency (MHz)	Output Power (dBm)	Max. Limit (dBm)	Max. Limit (W)	Result
155	5775	24.66	30.00	1.00	Complies

**End of Test Report**