

FCC Radio Test Report

FCC ID: TE7M9PLUSV22

The worst case of radiated emissions above 1GHz have been re-evaluated by sample of FCC ID: TE7M9PLUSV22, model name: Deco M9 Plus. Meanwhile. The other test data were reissue from the FCC ID: TE7M9PLUSV2, model name: Deco M9 Plus. The test data of radiated emissions above 1GHz please see the Appendix A. Product changes are as follows:

- a. The original Bluetooth chip CSR8811 (package is QFN40) is replaced by AC6368A/B (package is SOP8);
- b. The crystal of the original chip is 26MHz, while the crystal of the new chip is 24MHz;
- c. The Bluetooth antenna will not be changed;
- d. The software functions remain unchanged, and they are all used as on-boarding. In the new chip, the new driver is used.
- e. Change the circuit of Bluetooth part of PCB

This report concerns: Original Grant

Project No. : 1908C067C
Equipment : AC2200 Smart Home Mesh Wi-Fi System
Brand Name : tp-link
Test Model : Deco M9 Plus
Series Model : N/A
Applicant : TP-Link Technologies Co., Ltd.
Address : Building 24(floors 1,3,4,5) and 28(floors 1-4) Central Science and Technology Park, Shennan Rd, Nanshan, Shenzhen, China
Manufacturer : TP-Link Technologies Co., Ltd.
Address : Building 24(floors 1,3,4,5) and 28(floors 1-4) Central Science and Technology Park, Shennan Rd, Nanshan, Shenzhen, China
Date of Receipt : Jul. 01, 2021
Date of Test : Jul. 02, 2021 ~ Mar. 04, 2022
Issued Date : Mar. 17, 2022
Report Version : R00
Test Sample : Engineering Sample No.: DG2021070161
Standard(s) : FCC CFR Title 47, Part 15, Subpart C
FCC KDB 558074 D01 15.247 Meas Guidance v05r02
FCC KDB 662911 D01 Multiple Transmitter Output v02r01
ANSI C63.10-2013

The above equipment has been tested and found compliance with the requirement of the relative standards by BTL Inc.



Prepared by : Antony Liang

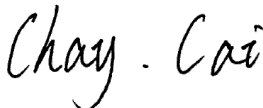

Approved by : Chay Cai



TESTING CERT #5123.02

Add: No. 3 Jinshagang 1st Rd. Shixia, Dalang Town Dongguan City, Guangdong 523792

People's Republic of China.

Tel: +86-769-8318-3000

Web: www.newbtl.com

Declaration

BTL represents to the client that testing is done in accordance with standard procedures as applicable and that test instruments used has been calibrated with standards traceable to international standard(s) and/or national standard(s).

BTL's reports apply only to the specific samples tested under conditions. It is manufacture's responsibility to ensure that additional production units of this model are manufactured with the identical electrical and mechanical components. **BTL** shall have no liability for any declarations, inferences or generalizations drawn by the client or others from **BTL** issued reports.

The report must not be used by the client to claim product certification, approval, or endorsement by NVLAP, NIST, A2LA, or any agency of the U.S. Government.

This report is the confidential property of the client. As a mutual protection to the clients, the public and ourselves, the test report shall not be reproduced, except in full, without our written approval.

BTL's laboratory quality assurance procedures are in compliance with the **ISO/IEC 17025** requirements, and accredited by the conformity assessment authorities listed in this test report.

BTL is not responsible for the sampling stage, so the results only apply to the sample as received.

The information, data and test plan are provided by manufacturer which may affect the validity of results, so it is manufacturer's responsibility to ensure that the apparatus meets the essential requirements of applied standards and in all the possible configurations as representative of its intended use.

Limitation

For the use of the authority's logo is limited unless the Test Standard(s)/Scope(s)/Item(s) mentioned in this test report is (are) included in the conformity assessment authorities acceptance respective.

Please note that the measurement uncertainty is provided for informational purpose only and are not use in determining the Pass/Fail results.

Table of Contents	Page
REPORT ISSUED HISTORY	4
1 . SUMMARY OF TEST RESULTS	5
1.1 TEST FACILITY	6
1.2 MEASUREMENT UNCERTAINTY	6
1.3 TEST ENVIRONMENT CONDITIONS	6
2 . GENERAL INFORMATION	7
2.1 GENERAL DESCRIPTION OF EUT	7
2.2 DESCRIPTION OF TEST MODES	9
2.3 PARAMETERS OF TEST SOFTWARE	9
2.4 BLOCK DIAGRAM SHOWING THE CONFIGURATION OF SYSTEM TESTED	10
2.5 SUPPORT UNITS	10
3 . RADIATED EMISSIONS TEST	11
3.1 LIMIT	11
3.2 TEST PROCEDURE	11
3.3 DEVIATION FROM TEST STANDARD	11
3.4 TEST SETUP	12
3.5 EUT OPERATION CONDITIONS	12
3.6 TEST RESULTS - ABOVE 1000 MHZ	12
4 . MEASUREMENT INSTRUMENTS LIST	13
5 . EUT TEST PHOTO	14
APPENDIX A - RADIATED EMISSION- ABOVE 1000 MHZ	15

REPORT ISSUED HISTORY

Report Version	Description	Issued Date
R00	Original Issue.	Mar. 17, 2022

1. SUMMARY OF TEST RESULTS

Test procedures according to the technical standard(s):

FCC CFR Title 47, Part 15, Subpart C				
Standard(s) Section	Test Item	Test Result	Judgment	Remark
15.207	AC Power Line Conducted Emissions	-----	PASS	-----
15.247(d) 15.205(a) 15.209(a)	Radiated Emissions	APPENDIX A	PASS	-----
15.247(a)(2)	Bandwidth	-----	PASS	-----
15.247(b)(3)	Maximum Output Power	-----	PASS	-----
15.247(d)	Conducted Spurious Emissions	-----	PASS	-----
15.247(e)	Power Spectral Density	-----	PASS	-----
15.203	Antenna Requirement	-----	PASS	Note(2)

Note:

- (1) "N/A" denotes test is not applicable to this device.
- (2) The device what use a permanently attached antenna were considered sufficient to comply with the provisions of 15.203.
- (3) Reissue from the FCC ID: TE7M9PLUSV2. Report: BTL-FCCP-3-1908C067.

1.1 TEST FACILITY

The test facilities used to collect the test data in this report is at the location of No. 3 Jinshagang 1st Rd. Shixia, Dalang Town Dongguan City, Guangdong 523792 People's Republic of China.
 BTL's Registration Number for FCC: 357015
 BTL's Designation Number for FCC: CN1240

1.2 MEASUREMENT UNCERTAINTY

ISO/IEC 17025 requires that an estimate of the measurement uncertainties associated with the emissions test results be included in the report. The measurement uncertainties given below are based on a 95% confidence level (based on a coverage factor (k=2))
 The BTL measurement uncertainty as below table:

A. Radiated emissions test:

Test Site	Method	Measurement Frequency Range	U,(dB)
DG-CB03 (3m)	CISPR	1GHz ~ 6GHz	3.80
		6GHz ~ 18GHz	4.82

Test Site	Method	Measurement Frequency Range	U,(dB)
DG-CB03 (1m)	CISPR	18 ~ 26.5 GHz	3.62
		26.5 ~ 40 GHz	4.00

Note: Unless specifically mentioned, the uncertainty of measurement has not been taken into account to declare the compliance or non-compliance to the specification.

1.3 TEST ENVIRONMENT CONDITIONS

Test Item	Temperature	Humidity	Test Voltage	Tested By
Radiated Emissions-Above 1000 MHz	20°C	55%	AC 120V/60Hz	Lang Chen

2. GENERAL INFORMATION

2.1 GENERAL DESCRIPTION OF EUT

Equipment	AC2200 Smart Home Mesh Wi-Fi System
Brand Name	tp-link
Test Model	Deco M9 Plus
Series Model	N/A
Model Difference(s)	N/A
Power Source	DC voltage supplied from AC/DC adapter. Model: T120200-2B4
Power Rating	I/P: 100-240V~ 50/60Hz 0.8A O/P: 12V --- 2A
Operation Frequency	2412 MHz ~ 2462 MHz
Modulation Type	IEEE 802.11b: DSSS IEEE 802.11g: OFDM IEEE 802.11n: OFDM
Bit Rate of Transmitter	IEEE 802.11b: 11/5.5/2/1 Mbps IEEE 802.11g: 54/48/36/24/18/12/9/6 Mbps IEEE 802.11n: up to 300 Mbps

Note:

1. For a more detailed features description, please refer to the manufacturer's specifications or the user's manual.

2. Channel List:

CH01 - CH11 for IEEE 802.11b, IEEE 802.11g, IEEE 802.11n (HT20) CH03 - CH09 for IEEE 802.11n (HT40)							
Channel	Frequency (MHz)	Channel	Frequency (MHz)	Channel	Frequency (MHz)	Channel	Frequency (MHz)
01	2412	04	2427	07	2442	10	2457
02	2417	05	2432	08	2447	11	2462
03	2422	06	2437	09	2452		

3. Antenna Specification:

Ant.	Brand	P/N	Antenna Type	Connector	Gain (dBi)
1	tp-link	3101502635	PCB	I-PEX	1.20
2	tp-link	3101502634	PCB	I-PEX	1.20

Note:

- (1) This EUT supports CDD, and all antennas have the same gain,
 - a. For Non Beamforming function, Directional gain= $G_{ANT} + \text{Array Gain}$,
For output power measurements, Array Gain=0 ($N_{ANT} \leq 4$), so, Directional gain=1.20
For power spectral density measurements, Array Gain= $10\log(N_{ANT}/N_{SS})$ dB,
so Directional gain= $1.20 + 10\log(2/1) = 4.21$
 - b. For Beamforming function, Beamforming Gain: 3.0 dB, so Directional gain= $3.0 + 1.20 = 4.20$
- (2) The antenna gain and beamforming gain are provided by the manufacturer.

4. The worst case for 2TX as follow:

For Non Beamforming:

Operating Mode	TX Mode	2TX
IEEE 802.11b		V (Ant. 1+ Ant. 2)
IEEE 802.11g		V (Ant. 1+ Ant. 2)
IEEE 802.11n(HT20)		V (Ant. 1+ Ant. 2)
IEEE 802.11n(HT40)		V (Ant. 1+ Ant. 2)

For Beamforming:

Operating Mode	TX Mode	2TX
IEEE 802.11n(HT20)		V (Ant. 1+ Ant. 2)
IEEE 802.11n(HT40)		V (Ant. 1+ Ant. 2)

2.2 DESCRIPTION OF TEST MODES

The test system was pre-tested based on the consideration of all possible combinations of EUT operation mode.

Pretest Mode	Description
Mode 1	TX B Mode Channel 01
Mode 2	TX N-20 MHz Mode Channel 11

Following mode(s) was (were) found to be the worst case(s) and selected for the final test.

Radiated emissions test - Above 1GHz	
Final Test Mode	Description
Mode 1	TX B Mode Channel 01

Radiated emissions test – Bandedge	
Final Test Mode	Description
Mode 2	TX N-20 MHz Mode Channel 11

NOTE:

- (1) The measurements are performed at the high, middle, low available channels.
- (2) For radiated emission below 1 GHz test, the IEEE 802.11b Channel 06 is found to be the worst case and recorded.
- (3) For radiated emission above 1 GHz test, 1GHz~26.5GHz have been pre-tested and in this report only recorded the worst case. The remaining spurious points are all below the limit value of 20dB.
- (4) All the bit rate of transmitter have been tested and found the lowest rate is found to be the worst case and recorded.

2.3 PARAMETERS OF TEST SOFTWARE

Test Software	QRCT v3.0.187.0
---------------	-----------------

2.4 BLOCK DIAGRAM SHOWING THE CONFIGURATION OF SYSTEM TESTED

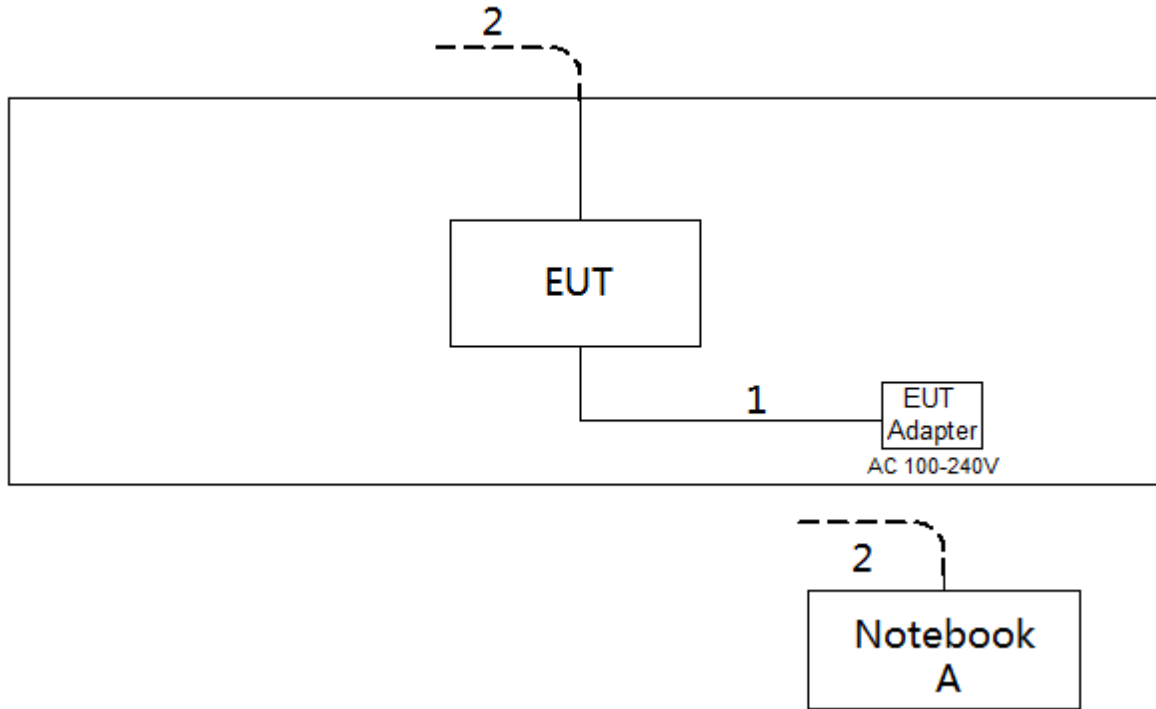

2.5 SUPPORT UNITS

Item	Equipment	Brand	Model No.	Series No.
A	Notebook	Dell	Inspiron 15-7559	N/A

Item	Cable Type	Shielded Type	Ferrite Core	Length
1	DC Cable	NO	NO	1.5m
2	RJ45 Cable	NO	NO	10m

3. RADIATED EMISSIONS TEST

3.1 LIMIT

In case the emission fall within the restricted band specified on 15.205(a), then the 15.209(a) limit in the table below has to be followed.

LIMITS OF RADIATED EMISSION MEASUREMENT (Above 1000 MHz)

Frequency (MHz)	(dBuV/m at 3 m)	
	Peak	Average
Above 1000	74	54

NOTE:

- (1) The limit for radiated test was performed according to FCC CFR Title 47, Part 15, Subpart C.
- (2) The tighter limit applies at the band edges.
- (3) Emission level (dBuV/m)=20log Emission level (uV/m).

3.2 TEST PROCEDURE

- a. The measuring distance of 3 m shall be used for measurements. The EUT was placed on the top of a rotating table 1.5 meter above the ground at a 3 meter semi-anechoic chamber. The table was rotated 360 degrees to determine the position of the highest radiation.(above 1 GHz)
- b. The height of the equipment or of the substitution antenna shall be 0.8m or 1.5m; the height of the test antenna shall vary between 1 m to 4 m. Both horizontal and vertical polarizations of the antenna are set to make the measurement.
- c. For each suspected emission, the EUT was arranged to its worst case and then the antenna was tuned to heights find the maximum reading (used Bore sight function).
- d. The receiver system was set to peak and average detect function and specified bandwidth with maximum hold mode when the test frequency is above 1 GHz.
- e. The initial step in collecting radiated emission data is a receiver peak detector mode pre-scanning the measurement frequency range. Significant peaks are then marked and then Quasi Peak detector mode re-measured.
- f. All readings are Peak Mode value unless otherwise stated AVG in column of Note. If the Peak Mode Measured value compliance with the Peak Limits and lower than AVG Limits, the EUT shall be deemed to meet both Peak & AVG Limits and then only Peak Mode was measured, but AVG Mode didn't perform. (above 1 GHz)
- g. For the actual test configuration, please refer to the related Item -EUT Test Photos.

3.3 DEVIATION FROM TEST STANDARD

No deviation

3.4 TEST SETUP

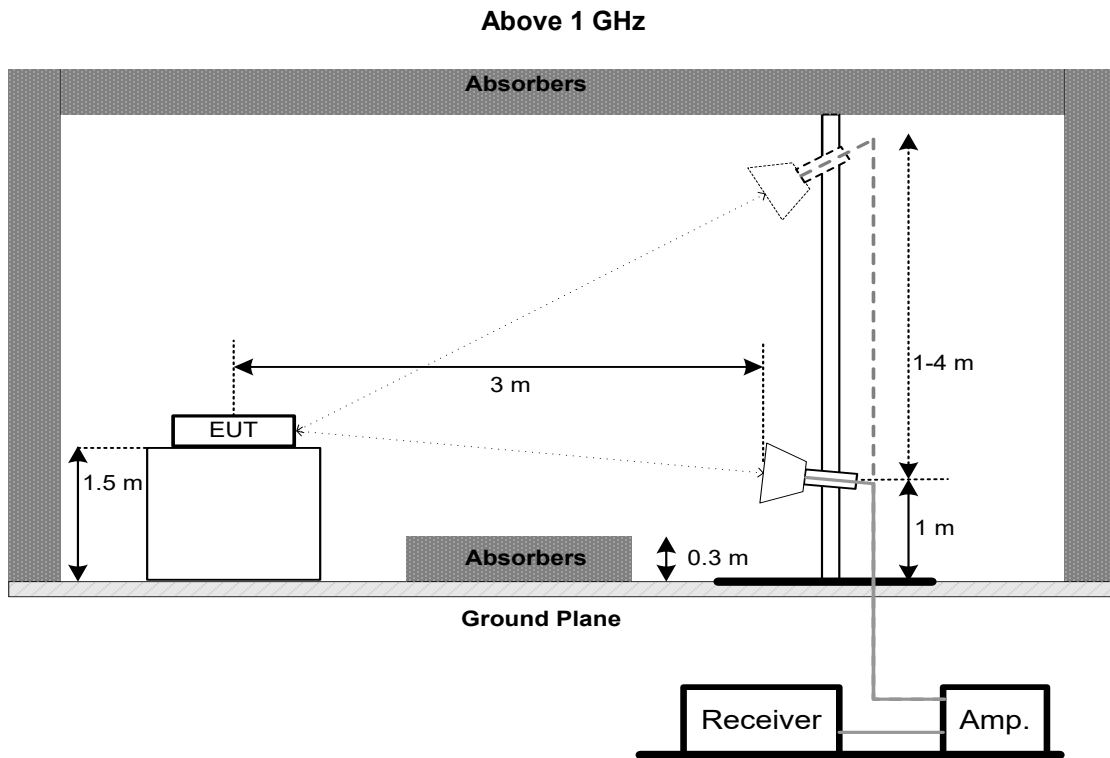

3.5 EUT OPERATION CONDITIONS

The EUT was programmed to be in continuously transmitting mode.

3.6 TEST RESULTS - ABOVE 1000 MHZ

Please refer to the APPENDIX A.

Remark:

- (1) No limit: This is fundamental signal, the judgment is not applicable.
For fundamental signal judgment was referred to Peak output test.

4. MEASUREMENT INSTRUMENTS LIST

Radiated Emissions - Above 1 GHz					
Item	Kind of Equipment	Manufacturer	Type No.	Serial No.	Calibrated until
1	Double Ridged Horn Antenna	ARA	DRG-118A	16554	Apr. 21, 2022
2	Broad-Band Horn Antenna	Schwarzbeck	BBHA 9170	9170319	Jun. 30, 2022
3	Amplifier	Agilent	8449B	3008A02584	Jul. 10, 2022
4	Controller	CT	SC100	N/A	N/A
5	Controller	MF	MF-7802	MF780208416	N/A
6	Receiver	Agilent	N9038A	MY52130039	Jan. 22, 2022 Jan. 22, 2023
7	EXA Spectrum Analyzer	Keysight	N9010A	MY56480488	Jan. 22, 2022 Jan. 22, 2023
8	Low Noise Amplifier	CONNPHY	CLN-18G40G-4330-K	619413	Jul. 16, 2022
9	Cable	N/A	A81-SMAMSMAM-12.5M	N/A	Oct. 15, 2022
10	Cable	Talent microwave	A40-2.92M2.92M-2.5M	N/A	Nov. 30, 2022
11	Filter	STI	STI15-9912	N/A	Jul. 10, 2022
12	Measurement Software	Farad	EZ-EMC Ver.NB-03A1-01	N/A	N/A
13	966 Chamber Room	RM	9*6*6	N/A	Jul. 24, 2022

Remark: "N/A" denotes no model name, serial no. or calibration specified.

All calibration period of equipment list is one year.

5. EUT TEST PHOTO

Radiated Emissions Test Photos

Above 1 GHz

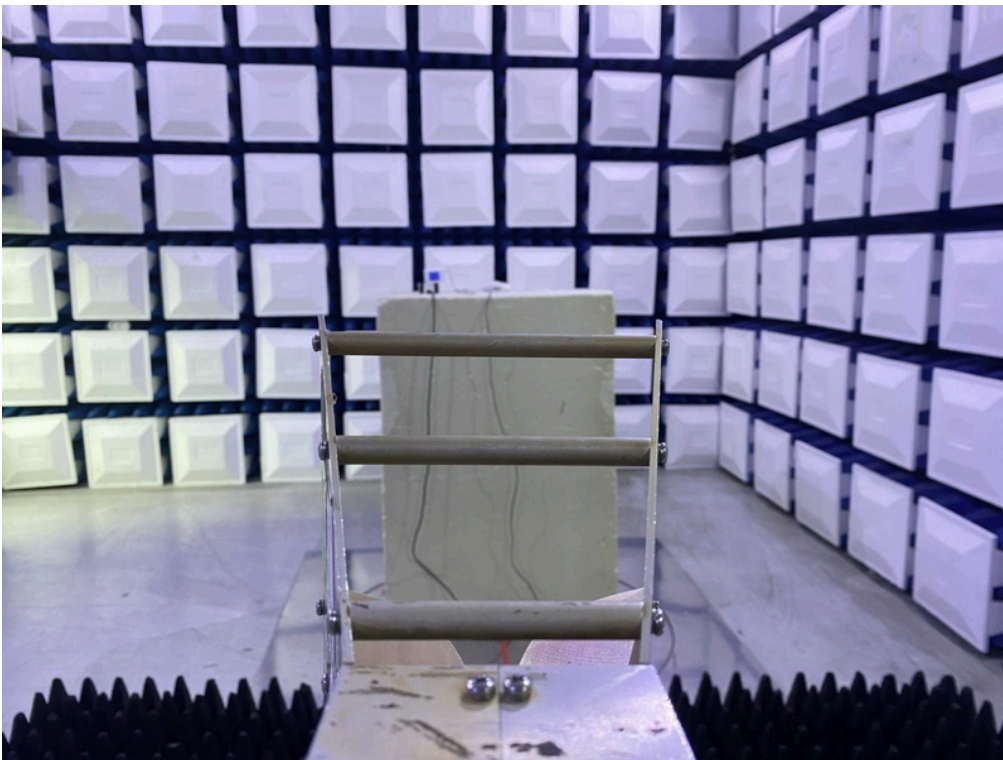
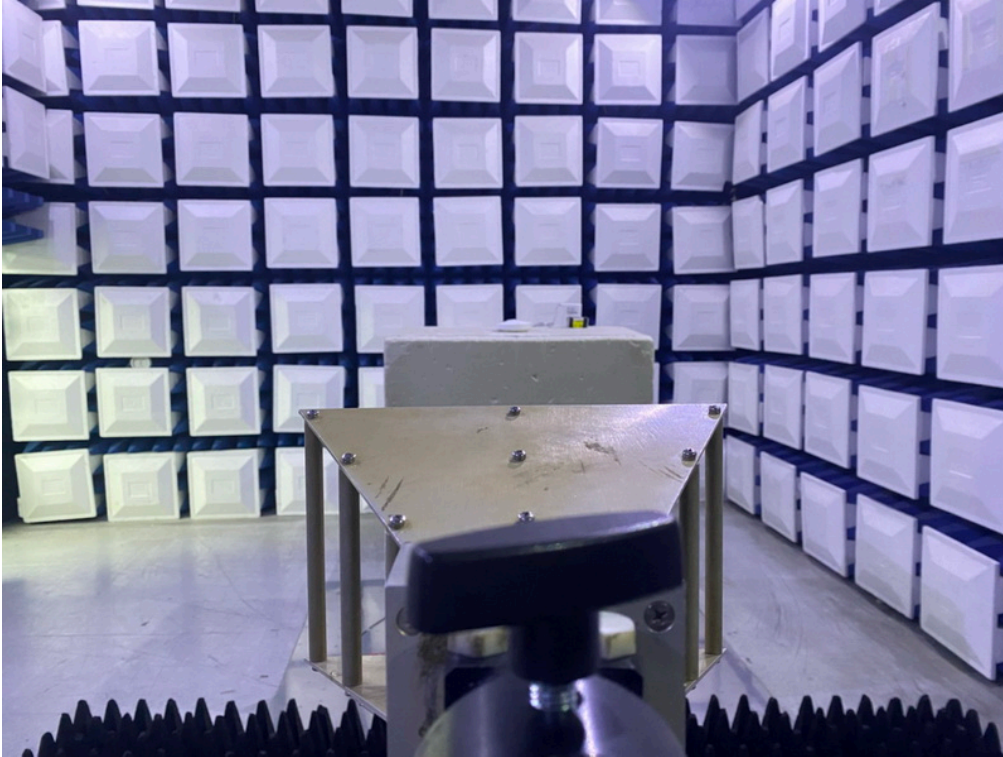

APPENDIX A - RADIATED EMISSION- ABOVE 1000 MHZ

Test Mode: TX N-20M Mode 2462 MHz

Vertical

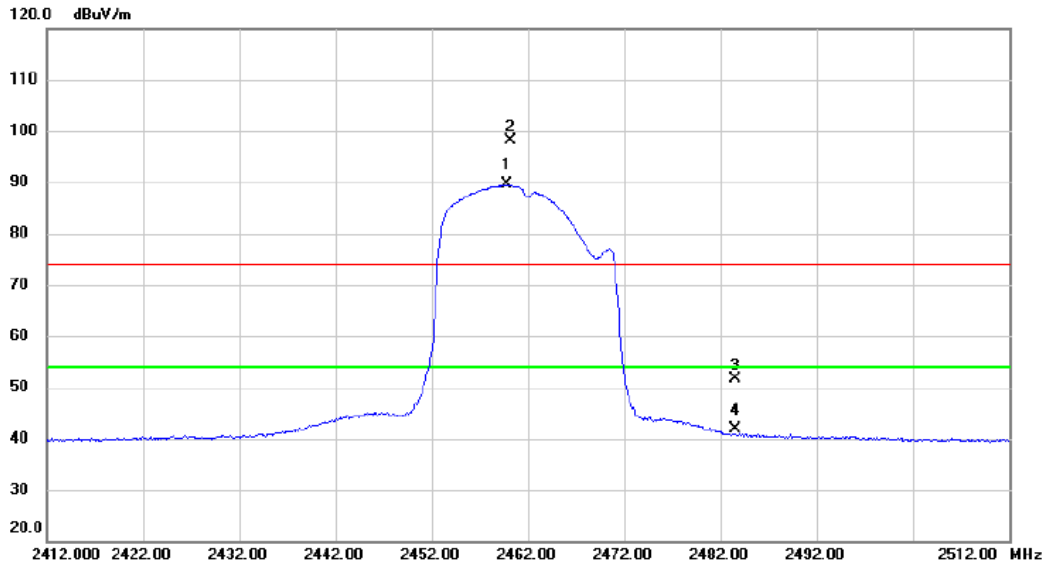

No.	Mk.	Freq. MHz	Reading Level dBuV	Correct Factor dB	Measure- ment dBuV/m	Limit dBuV/m	Margin dB	Detector	Comment
1	*	2459.800	81.12	8.40	89.52	54.00	35.52	AVG	No Limit
2	X	2460.250	89.69	8.40	98.09	74.00	24.09	peak	No Limit
3		2483.500	43.19	8.43	51.62	74.00	-22.38	peak	
4		2483.500	33.35	8.43	41.78	54.00	-12.22	AVG	

REMARKS:

- (1) Measurement Value = Reading Level + Correct Factor.
- (2) Margin Level = Measurement Value - Limit Value.

Test Mode: TX N-20M Mode 2462 MHz

Horizontal

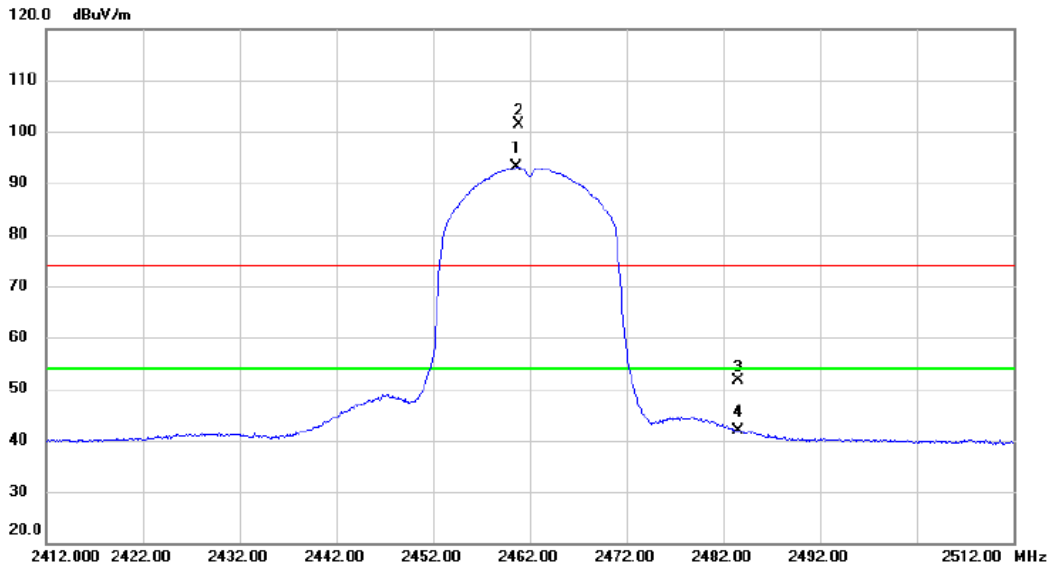

No. Mk.	Freq. MHz	Reading Level dBuV	Correct Factor dB	Measure- ment dBuV/m	Limit dBuV/m	Margin dB	Detector	Comment
1 *	2460.600	84.74	8.39	93.13	54.00	39.13	AVG	No Limit
2 X	2460.800	93.02	8.39	101.41	74.00	27.41	peak	No Limit
3	2483.500	43.22	8.43	51.65	74.00	-22.35	peak	
4	2483.500	33.57	8.43	42.00	54.00	-12.00	AVG	

REMARKS:

- (1) Measurement Value = Reading Level + Correct Factor.
- (2) Margin Level = Measurement Value - Limit Value.

Test Mode: TX B Mode 2412 MHz

Vertical

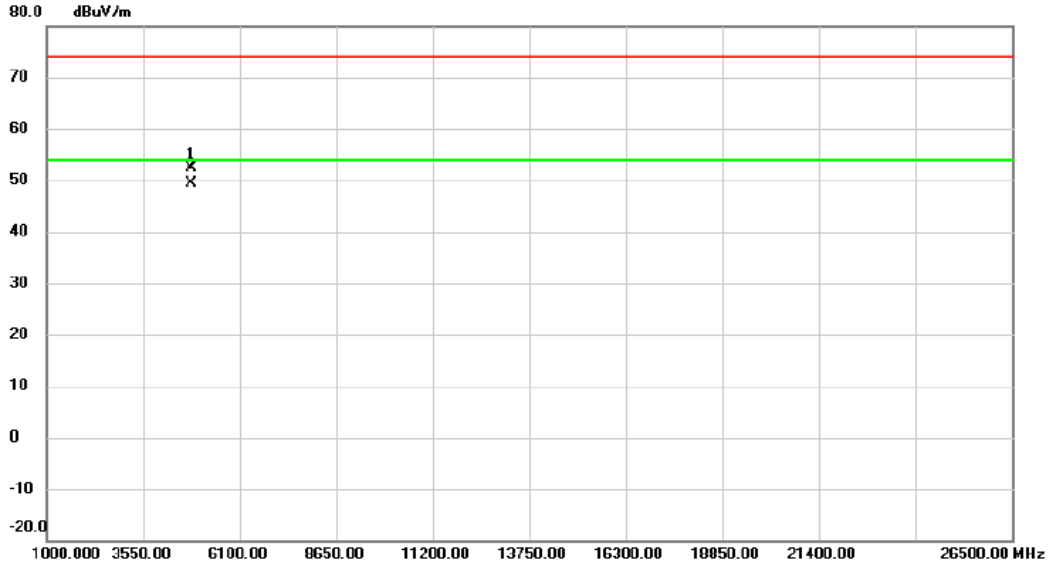

No. Mk.	Freq. MHz	Reading Level dBuV	Correct Factor dB	Measure- ment dBuV/m	Limit dBuV/m	Margin dB	Detector	Comment
1	4823.945	47.10	5.23	52.33	74.00	-21.67	peak	
2 *	4823.970	44.20	5.23	49.43	54.00	-4.57	AVG	

REMARKS:

- (1) Measurement Value = Reading Level + Correct Factor.
- (2) Margin Level = Measurement Value - Limit Value.

Test Mode: TX B Mode 2412 MHz

Horizontal

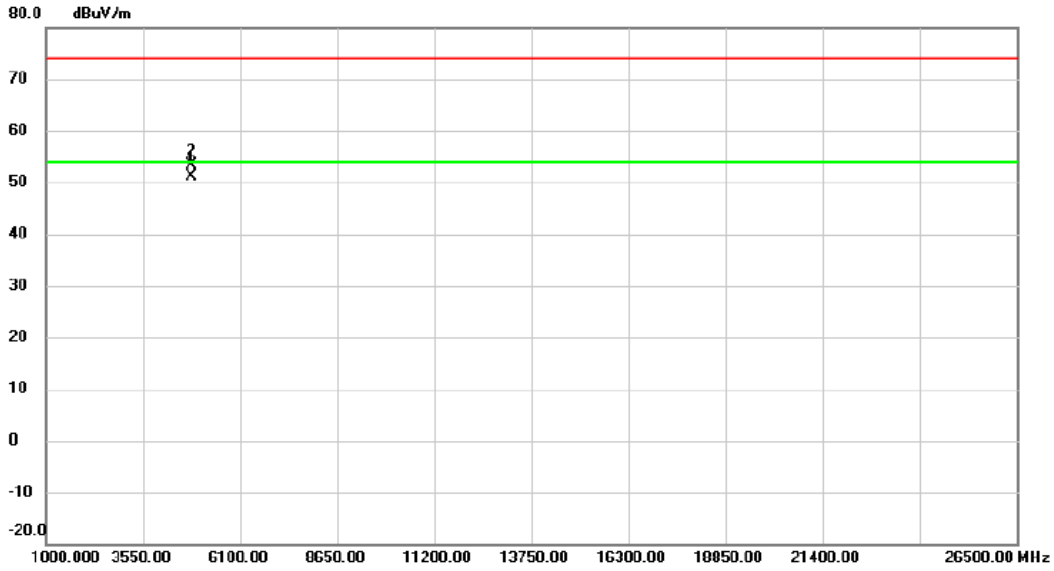

No. Mk.	Freq. MHz	Reading Level dBuV	Correct Factor dB	Measurement dBuV/m	Limit dBuV/m	Margin dB	Detector	Comment
1 *	4823.960	45.80	5.23	51.03	54.00	-2.97	AVG	
2	4823.965	48.17	5.23	53.40	74.00	-20.60	peak	

REMARKS:

- (1) Measurement Value = Reading Level + Correct Factor.
- (2) Margin Level = Measurement Value - Limit Value.

End of Test Report