

FCC Radio Test Report

FCC ID: TE7M9PLUSV2

This report concerns: Original Grant

Project No. : 1908C067
Equipment : AC2200 Smart Home Mesh Wi-Fi System
Brand Name : tp-link
Test Model : Deco M9 Plus
Series Model : N/A
Applicant : TP-Link Technologies Co., Ltd.
Address : Building 24(floors1,3,4,5) and 28(floors1-4) Central Science and Technology Park, Shennan Rd, Nanshan, Shenzhen, China
Manufacturer : TP-Link Technologies Co., Ltd.
Address : Building 24(floors1,3,4,5) and 28(floors1-4) Central Science and Technology Park, Shennan Rd, Nanshan, Shenzhen, China
Date of Receipt : Aug. 09, 2019
Date of Test : Aug. 09, 2019 ~ Nov. 09, 2019
Issued Date : Dec. 11, 2019
Report Version : R01
Test Sample : Engineering Sample No.: DG19081571 for conducted, DG19081572 for radiated.
Standard(s) : FCC Part15, Subpart E(15.407)
ANSI C63.10-2013
FCC KDB 789033 D02 General UNII Test Procedures New Rules v02r01
FCC KDB 662911 D01 Multiple Transmitter Output v02r01

The above equipment has been tested and found compliance with the requirement of the relative standards by BTL Inc.



Prepared by : Welly Zhou



Approved by : Ethan Ma



Certificate #5123.02

Add: No.3, Jinshagang 1st Road, Shixia, Dalang Town, Dongguan, Guangdong, China.

Tel: +86-769-8318-3000

Web: www.newbtl.com

Declaration

BTL represents to the client that testing is done in accordance with standard procedures as applicable and that test instruments used has been calibrated with standards traceable to international standard(s) and/or national standard(s).

BTL's reports apply only to the specific samples tested under conditions. It is manufacture's responsibility to ensure that additional production units of this model are manufactured with the identical electrical and mechanical components. **BTL** shall have no liability for any declarations, inferences or generalizations drawn by the client or others from **BTL** issued reports.

The report must not be used by the client to claim product certification, approval, or endorsement by NVLAP, NIST, A2LA, or any agency of the U.S. Government.

This report is the confidential property of the client. As a mutual protection to the clients, the public and ourselves, the test report shall not be reproduced, except in full, without our written approval.

BTL's laboratory quality assurance procedures are in compliance with the **ISO/IEC 17025** requirements, and accredited by the conformity assessment authorities listed in this test report.

BTL is not responsible for the sampling stage, so the results only apply to the sample as received.

The information, data and test plan are provided by manufacturer which may affect the validity of results, so it is manufacturer's responsibility to ensure that the apparatus meets the essential requirements of applied standards and in all the possible configurations as representative of its intended use.

Limitation

For the use of the authority's logo is limited unless the Test Standard(s)/Scope(s)/Item(s) mentioned in this test report is (are) included in the conformity assessment authorities acceptance respective.

Please note that the measurement uncertainty is provided for informational purpose only and are not use in determining the Pass/Fail results.

Table of Contents	Page
REPORT ISSUED HISTORY	6
1 . SUMMARY OF TEST RESULTS	7
1.1 TEST FACILITY	8
1.2 MEASUREMENT UNCERTAINTY	8
1.3 TEST ENVIRONMENT CONDITIONS	8
2 . GENERAL INFORMATION	9
2.1 GENERAL DESCRIPTION OF EUT	9
2.2 TEST MODES	12
2.3 PARAMETERS OF TEST SOFTWARE	15
2.4 DUTY CYCLE	17
2.5 BLOCK DIAGRAM SHOWING THE CONFIGURATION OF SYSTEM TESTED	19
2.6 SUPPORT UNITS	19
3 . AC POWER LINE CONDUCTED EMISSIONS TEST	20
3.1 LIMIT	20
3.2 TEST PROCEDURE	20
3.3 DEVIATION FROM TEST STANDARD	20
3.4 TEST SETUP	21
3.5 EUT OPERATION CONDITIONS	21
3.6 TEST RESULTS	21
4 . RADIATED EMISSIONS TEST	22
4.1 LIMIT	22
4.2 TEST PROCEDURE	23
4.3 DEVIATION FROM TEST STANDARD	23
4.4 TEST SETUP	24
4.5 EUT OPERATION CONDITIONS	25
4.6 TEST RESULTS - 9 KHZ to 30 MHZ	25
4.7 TEST RESULTS - 30 MHz TO 1000 MHz	25
4.8 TEST RESULTS - ABOVE 1000 MHz	25
5 . BANDWIDTH TEST	26
5.1 LIMIT	26
5.2 TEST PROCEDURE	26
5.3 TEST PROCEDURE	26

Table of Contents	Page
5.4 TEST SETUP	26
5.5 EUT OPERATION CONDITIONS	26
5.6 TEST RESULTS	26
6 . MAXIMUM OUTPUT POWER TEST	27
6.1 LIMIT	27
6.2 TEST PROCEDURE	27
6.3 DEVIATION FROM STANDARD	27
6.4 TEST SETUP	27
6.5 EUT OPERATION CONDITIONS	27
6.6 TEST RESULTS	27
7 . POWER SPECTRAL DENSITY TEST	28
7.1 LIMIT	28
7.2 TEST PROCEDURE	28
7.3 DEVIATION FROM STANDARD	28
7.4 TEST SETUP	28
7.5 EUT OPERATION CONDITIONS	28
7.6 TEST RESULTS	28
8 . FREQUENCY STABILITY MEASUREMENT	29
8.1 LIMIT	29
8.2 TEST PROCEDURE	29
8.3 DEVIATION FROM STANDARD	29
8.4 TEST SETUP	29
8.5 EUT OPERATION CONDITIONS	29
8.6 TEST RESULTS	29
9 . MEASUREMENT INSTRUMENTS LIST	30
10 . EUT TEST PHOTOS	32
APPENDIX A - AC POWER LINE CONDUCTED EMISSIONS	36
APPENDIX B - RADIATED EMISSION - 9 KHZ TO 30 MHZ	39
APPENDIX C - RADIATED EMISSION - 30 MHZ TO 1 GHZ	44
APPENDIX D - RADIATED EMISSION - ABOVE 1000 MHZ	47
APPENDIX E - BANDWIDTH	168
APPENDIX F - MAXIMUM OUTPUT POWER	187

Table of Contents**Page****APPENDIX G - POWER SPECTRAL DENSITY****210****APPENDIX H - FREQUENCY STABILITY****231**

REPORT ISSUED HISTORY

Report Version	Description	Issued Date
R00	Original Issue.	Nov. 25, 2019
R01	Revised report to address ACB's comments.	Dec. 11, 2019

1. SUMMARY OF TEST RESULTS

Test procedures according to the technical standard(s):

FCC Part15, Subpart E(15.407)				
Standard(s) Section	Test Item	Test Result	Judgement	Remark
15.207 15.407(b)	AC Power Line Conducted Emissions	APPENDIX A	PASS	-----
15.407(b) 15.205(a) 15.209(a)	Radiated Emissions	APPENDIX B APPENDIX C APPENDIX D	PASS	-----
15.407(a) 15.407(e)	Spectrum Bandwidth	APPENDIX E	PASS	-----
15.407(a)	Maximum Output Power	APPENDIX F	PASS	-----
15.407(a)	Power Spectral Density	APPENDIX G	PASS	-----
15.407(g)	Frequency Stability	APPENDIX H	PASS	-----
15.203	Antenna Requirements	-----	PASS	Note(2)
15.407(c)	Automatically Discontinue Transmission	-----	PASS	Note(3)

Note:

- (1) "N/A" denotes test is not applicable in this test report.
- (2) The device what use a permanently attached antenna were considered sufficient to comply with the provisions of 15.203.
- (3) During no any information transmission, the EUT can automatically discontinue transmission and become standby mode for power saving. the EUT can detect the controlling signal of ACK message transmitting from remote device and verify whether it shall resend or discontinue transmission.
- (4) For UNII-1 this device was functioned as a
 - Access point device Client device

1.1 TEST FACILITY

The test facilities used to collect the test data in this report is at the location of No.3,Jinshagang 1st Road, Shixia, Dalang Town, Dongguan, Guangdong, China.

BTL's Test Firm Registration Number for FCC: 357015

BTL's Designation Number for FCC: CN1240

1.2 MEASUREMENT UNCERTAINTY

ISO/IEC 17025 requires that an estimate of the measurement uncertainties associated with the emissions test results be included in the report. The measurement uncertainties given below are based on a 95% confidence level (based on a coverage factor (k=2))

The BTL measurement uncertainty as below table:

A. AC power line conducted emissions test:

Test Site	Method	Measurement Frequency Range	U, (dB)
DG-C02	CISPR	150kHz ~ 30MHz	2.60

B. Radiated emissions test:

Test Site	Method	Measurement Frequency Range	Ant. H / V	U, (dB)
DG-CB03	CISPR	9kHz ~ 30MHz	V	3.79
		9kHz ~ 30MHz	H	3.57
		30MHz ~ 200MHz	V	4.88
		30MHz ~ 200MHz	H	4.14
		200MHz ~ 1,000MHz	V	4.62
		200MHz ~ 1,000MHz	H	4.80
		1GHz ~ 6GHz	-	4.58
		6GHz ~ 18GHz	-	5.18
		18GHz ~ 26.5GHz	-	3.62
		26.5GHz ~ 40GHz	-	4.00

Note: Unless specifically mentioned, the uncertainty of measurement has not been taken into account to declare the compliance or non-compliance to the specification.

1.3 TEST ENVIRONMENT CONDITIONS

Test Item	Temperature	Humidity	Test Voltage	Tested By
AC Power Line Conducted Emissions	25°C	53%	AC 120V/60Hz	Laughing Zhang
Radiated Emissions-9K-30MHz	25°C	60%	AC 120V/60Hz	Damon Deng
Radiated Emissions-30 MHz to 1GHz	24°C	68%	AC 120V/60Hz	Laughing Zhang
Radiated Emissions-Above 1000 MHz	24°C	68%	AC 120V/60Hz	Laughing Zhang
Spectrum Bandwidth	24°C	65%	AC 120V/60Hz	Jonas Chen
Maximum Output Power	24°C	65%	AC 120V/60Hz	Jonas Chen
Power Spectral Density	24°C	65%	AC 120V/60Hz	Jonas Chen
Frequency Stability	Normal&Extreme	65%	Normal&Extreme	Jonas Chen

2. GENERAL INFORMATION

2.1 GENERAL DESCRIPTION OF EUT

Equipment	AC2200 Smart Home Mesh Wi-Fi System
Brand Name	tp-link
Test Model	Deco M9 Plus
Series Model	N/A
Model Difference(s)	N/A
Power Source	DC voltage supplied from AC/DC adapter. Model: T120200-2B4
Power Rating	I/P: 100-240V~ 50/60Hz 0.8A O/P: 12V --- 2A
Operation Frequency Bands	UNII-1: 5150 MHz~5250 MHz UNII-3: 5725 MHz~5850 MHz
Modulation Type	OFDM
Bit Rate of Transmitter	Up to 866.7 Mbps
Maximum Conducted Output Power for UNII-1_Non Beamforming	IEEE 802.11a: 28.64 dBm (0.7311 W) IEEE 802.11n (HT20): 28.46 dBm (0.7015 W) IEEE 802.11n (HT40): 26.31 dBm (0.4276 W) IEEE 802.11ac (VHT20): 28.40 dBm (0.6918 W) IEEE 802.11ac (VHT40): 26.22 dBm (0.4188 W) IEEE 802.11ac (VHT80): 19.69 dBm (0.0931 W)
Maximum Conducted Output Power for UNII-3_Non Beamforming	IEEE 802.11a: 28.75 dBm (0.7499 W) IEEE 802.11n (HT20): 28.83 dBm (0.7638 W) IEEE 802.11n (HT40): 29.04 dBm (0.8017 W) IEEE 802.11ac (VHT20): 28.79 dBm (0.7568 W) IEEE 802.11ac (VHT40): 28.79 dBm (0.7568 W) IEEE 802.11ac (VHT80): 25.10 dBm (0.3236 W)
Maximum Conducted Output Power for UNII-1_Beamforming	IEEE 802.11n (HT20): 26.58 dBm (0.4550 W) IEEE 802.11n (HT40): 26.55 dBm (0.4519 W) IEEE 802.11ac (VHT20): 26.61 dBm (0.4581 W) IEEE 802.11ac (VHT40): 26.58 dBm (0.4550 W) IEEE 802.11ac (VHT80): 23.60 dBm (0.2291 W)
Maximum Conducted Output Power for UNII-3_Beamforming	IEEE 802.11n (HT20): 26.51 dBm (0.4477 W) IEEE 802.11n (HT40): 26.75 dBm (0.4732 W) IEEE 802.11ac (VHT20): 26.63 dBm (0.4603 W) IEEE 802.11ac (VHT40): 26.86 dBm (0.4853 W) IEEE 802.11ac (VHT80): 25.52 dBm (0.3565 W)

Note:

- For a more detailed features description, please refer to the manufacturer's specifications or the user's manual.

2. Channel List:

IEEE 802.11a IEEE 802.11n (HT20) IEEE 802.11ac (VHT20)		IEEE 802.11n (HT40) IEEE 802.11ac (VHT40)		IEEE 802.11ac (VHT80)	
UNII-1		UNII-1		UNII-1	
Channel	Frequency (MHz)	Channel	Frequency (MHz)	Channel	Frequency (MHz)
36	5180	38	5190	42	5210
40	5200	46	5230		
44	5220				
48	5240				

IEEE 802.11a IEEE 802.11n (HT20) IEEE 802.11ac (VHT20)		IEEE 802.11n (HT40) IEEE 802.11ac (VHT40)		IEEE 802.11ac (VHT80)	
UNII-3		UNII-3		UNII-3	
Channel	Frequency (MHz)	Channel	Frequency (MHz)	Channel	Frequency (MHz)
149	5745	151	5755	155	5775
153	5765	159	5795		
157	5785				
161	5805				
165	5825				

3. Antenna Specification:

For UNII-1:

Ant.	Brand	P/N	Antenna Type	Connector	Gain (dBi)
1		3101502551	Internal	I-PEX	0.80
2		3101502551	Internal	I-PEX	0.80

Note: This EUT supports CDD, and all antennas have the same gain,

- (1) For Non Beamforming function, Directional gain= $G_{ANT} + \text{Array Gain}$,
 For output power measurements, Array Gain=0 ($N_{ANT} \leq 4$), so, Directional gain=0.8
 For power spectral density measurements, Array Gain= $10\log(N_{ANT}/N_{SS})$ dB
 Directional gain= $0.8 + 10\log(2/1) = 3.81$.

- (2) For Beamforming function, Beamforming gain: 3.0 dB, so Directional gain= $3.0 + 0.8 = 3.80$

For UNII-3:

Ant.	Brand	P/N	Antenna Type	Connector	Gain (dBi)
3		3101502637	Internal	I-PEX	0.80
4		3101502552	Internal	I-PEX	0.80

Note: This EUT supports CDD, and all antennas have the same gain,

- (1) For Non Beamforming function, Directional gain= $G_{ANT} + \text{Array Gain}$,
 For output power measurements, Array Gain=0 ($N_{ANT} \leq 4$), so, Directional gain=0.8
 For power spectral density measurements, Array Gain= $10\log(N_{ANT}/N_{SS})$ dB
 Directional gain= $0.8 + 10\log(2/1) = 3.81$.

- (2) For Beamforming function, Beamforming gain: 3.0 dB, so Directional gain= $3.0 + 0.8 = 3.80$

4. Table for Antenna Configuration:

For Non Beamforming:

Operating Mode	TX Mode	2TX
IEEE 802.11a		V (Ant. 1 + Ant. 2)
IEEE 802.11n (HT20)		V (Ant. 1 + Ant. 2)
IEEE 802.11n (HT40)		V (Ant. 1 + Ant. 2)
IEEE 802.11ac (VHT20)		V (Ant. 1 + Ant. 2)
IEEE 802.11ac (VHT40)		V (Ant. 1 + Ant. 2)
IEEE 802.11ac (VHT80)		V (Ant. 1 + Ant. 2)

For Beamforming:

Operating Mode	TX Mode	2TX
IEEE 802.11n (HT20)		V (Ant. 1 + Ant. 2)
IEEE 802.11n (HT40)		V (Ant. 1 + Ant. 2)
IEEE 802.11ac (VHT20)		V (Ant. 1 + Ant. 2)
IEEE 802.11ac (VHT40)		V (Ant. 1 + Ant. 2)
IEEE 802.11ac (VHT80)		V (Ant. 1 + Ant. 2)

2.2 TEST MODES

The test system was pre-tested based on the consideration of all possible combinations of EUT operation mode.

Pretest Mode	Description
Mode 1	TX A Mode / CH36, CH40, CH48 (UNII-1)
Mode 2	TX N (HT20) Mode / CH36, CH40, CH48 (UNII-1)
Mode 3	TX N (HT40) Mode / CH38, CH46 (UNII-1)
Mode 4	TX AC (VHT20) Mode / CH36, CH40, CH48 (UNII-1)
Mode 5	TX AC (VHT40) Mode / CH38, CH46 (UNII-1)
Mode 6	TX AC (VHT80) Mode / CH42 (UNII-1)
Mode 7	TX A Mode / CH149,CH157,CH165 (UNII-3)
Mode 8	TX N (HT20) Mode / CH149,CH157,CH165 (UNII-3)
Mode 9	TX N (HT40) Mode / CH151,CH159 (UNII-3)
Mode 10	TX AC (VHT20) Mode / CH149,CH157,CH165 (UNII-3)
Mode 11	TX AC (VHT40) Mode / CH151,CH159 (UNII-3)
Mode 12	TX AC (VHT80) Mode / CH155 (UNII-3)
Mode 13	TX N(HT40) Mode / CH151 (UNII-3)

Following mode(s) was (were) found to be the worst case(s) and selected for the final test.

AC power line conducted emissions test	
Final Test Mode	Description
Mode 13	TX N(HT40) Mode / CH151 (UNII-3)

Radiated emissions test - Below 1GHz	
Final Test Mode	Description
Mode 13	TX N(HT40) Mode / CH151 (UNII-3)

Radiated emissions test - Above 1GHz for Non Beamforming	
Final Test Mode	Description
Mode 1	TX A Mode / CH36, CH40, CH48 (UNII-1)
Mode 4	TX AC (VHT20) Mode / CH36, CH40, CH48 (UNII-1)
Mode 5	TX AC (VHT40) Mode / CH38, CH46 (UNII-1)
Mode 6	TX AC (VHT80) Mode / CH42 (UNII-1)
Mode 7	TX A Mode / CH149,CH157,CH165 (UNII-3)
Mode 10	TX AC (VHT20) Mode / CH149,CH157,CH165 (UNII-3)
Mode 11	TX AC (VHT40) Mode / CH151,CH159 (UNII-3)
Mode 12	TX AC (VHT80) Mode / CH155 (UNII-3)

Radiated emissions test - Above 1GHz for Beamforming	
Final Test Mode	Description
Mode 4	TX AC (VHT20) Mode / CH36, CH40, CH48 (UNII-1)
Mode 5	TX AC (VHT40) Mode / CH38, CH46 (UNII-1)
Mode 6	TX AC (VHT80) Mode / CH42 (UNII-1)
Mode 10	TX AC (VHT20) Mode / CH149,CH157,CH165 (UNII-3)
Mode 11	TX AC (VHT40) Mode / CH151,CH159 (UNII-3)
Mode 12	TX AC (VHT80) Mode / CH155 (UNII-3)

Conducted Output Power and Bandwidth test for Non Beamforming	
Final Test Mode	Description
Mode 1	TX A Mode / CH36, CH40, CH48 (UNII-1)
Mode 2	TX N (HT20) Mode / CH36, CH40, CH48 (UNII-1)
Mode 3	TX N (HT40) Mode / CH38, CH46 (UNII-1)
Mode 4	TX AC (VHT20) Mode / CH36, CH40, CH48 (UNII-1)
Mode 5	TX AC (VHT40) Mode / CH38, CH46 (UNII-1)
Mode 6	TX AC (VHT80) Mode / CH42 (UNII-1)
Mode 7	TX A Mode / CH149,CH157,CH165 (UNII-3)
Mode 8	TX N (HT20) Mode / CH149,CH157,CH165 (UNII-3)
Mode 9	TX N (HT40) Mode / CH151,CH159 (UNII-3)
Mode 10	TX AC (VHT20) Mode / CH149,CH157,CH165 (UNII-3)
Mode 11	TX AC (VHT40) Mode / CH151,CH159 (UNII-3)
Mode 12	TX AC (VHT80) Mode / CH155 (UNII-3)

Conducted Output Power and Bandwidth test for Beamforming	
Final Test Mode	Description
Mode 2	TX N (HT20) Mode / CH36, CH40, CH48 (UNII-1)
Mode 3	TX N (HT40) Mode / CH38, CH46 (UNII-1)
Mode 4	TX AC (VHT20) Mode / CH36, CH40, CH48 (UNII-1)
Mode 5	TX AC (VHT40) Mode / CH38, CH46 (UNII-1)
Mode 6	TX AC (VHT80) Mode / CH42 (UNII-1)
Mode 8	TX N (HT20) Mode / CH149,CH157,CH165 (UNII-3)
Mode 9	TX N (HT40) Mode / CH151,CH159 (UNII-3)
Mode 10	TX AC (VHT20) Mode / CH149,CH157,CH165 (UNII-3)
Mode 11	TX AC (VHT40) Mode / CH151,CH159 (UNII-3)
Mode 12	TX AC (VHT80) Mode / CH155 (UNII-3)

Other Conducted test for Non Beamforming	
Final Test Mode	Description
Mode 1	TX A Mode / CH36, CH40, CH48 (UNII-1)
Mode 4	TX AC (VHT20) Mode / CH36, CH40, CH48 (UNII-1)
Mode 5	TX AC (VHT40) Mode / CH38, CH46 (UNII-1)
Mode 6	TX AC (VHT80) Mode / CH42 (UNII-1)
Mode 7	TX A Mode / CH149,CH157,CH165 (UNII-3)
Mode 10	TX AC (VHT20) Mode / CH149,CH157,CH165 (UNII-3)
Mode 11	TX AC (VHT40) Mode / CH151,CH159 (UNII-3)
Mode 12	TX AC (VHT80) Mode / CH155 (UNII-3)

Other Conducted test for Beamforming	
Final Test Mode	Description
Mode 4	TX AC (VHT20) Mode / CH36, CH40, CH48 (UNII-1)
Mode 5	TX AC (VHT40) Mode / CH38, CH46 (UNII-1)
Mode 6	TX AC (VHT80) Mode / CH42 (UNII-1)
Mode 10	TX AC (VHT20) Mode / CH149,CH157,CH165 (UNII-3)
Mode 11	TX AC (VHT40) Mode / CH151,CH159 (UNII-3)
Mode 12	TX AC (VHT80) Mode / CH155 (UNII-3)

Note:

- (1) For radiated emission below 1 GHz test, the IEEE 802.11n40 channel 151 is found to be the worst case and recorded.
- (2) For radiated emission above 1 GHz test, 1GHz~26.5GHz and 26.5GHz~40GHz have been pre-tested and in this report only recorded the worst case. The remaining spurious points are all below the limit value of 20dB.
- (3) All the bit rate of transmitter have been tested and found the lowest rate is found to be the worst case and recorded.
- (4) The measurements for Power were tested, the non Beamforming and beamforming are recorded in the report. The worst case were IEEE 802.11a mode, IEEE 802.11ac(VHT20) mode, IEEE 802.11ac(VHT40) mode, IEEE 802.11ac(VHT80), only worst case were documented for other test items except Bandwidth.

2.3 PARAMETERS OF TEST SOFTWARE
Non Beamforming

UNII-1			
Test Software	QRCT v3.0.187.0		
Test Frequency (MHz)	5180	5200	5240
IEEE 802.11a	20.5	24.5	25
IEEE 802.11n (HT20)	20.5	24.5	25
IEEE 802.11ac (VHT20)	20	24.5	25
Test Frequency (MHz)	5190	5230	
IEEE 802.11n (HT40)	19	22.5	
IEEE 802.11ac (VHT40)	19	23	
Test Frequency (MHz)	5210		
IEEE 802.11ac (VHT80)	16		

UNII-3			
Test Software	QRCT v3.0.187.0		
Test Frequency (MHz)	5745	5785	5825
IEEE 802.11a	26	25	25
IEEE 802.11n (HT20)	26	26	26
IEEE 802.11ac (VHT20)	26	26	26
Test Frequency (MHz)	5755	5795	
IEEE 802.11n (HT40)	25	25	
IEEE 802.11ac (VHT40)	25	25	
Test Frequency (MHz)	5775		
IEEE 802.11ac (VHT80)	22		

Beamforming

UNII-1			
Test Software	QRCT v3.0.187.0		
Test Frequency (MHz)	5180	5200	5240
IEEE 802.11n (HT20)	20	23	23
IEEE 802.11ac (VHT20)	20	23	23
Test Frequency (MHz)	5190	5230	/
IEEE 802.11n (HT40)	17	23	/
IEEE 802.11ac (VHT40)	17	23	/
Test Frequency (MHz)	5210	/	/
IEEE 802.11ac (VHT80)	20	/	/

UNII-3			
Test Software	QRCT v3.0.187.0		
Test Frequency (MHz)	5745	5785	5825
IEEE 802.11n (HT20)	23	23	23
IEEE 802.11ac (VHT20)	23	23	23
Test Frequency (MHz)	5755	5795	/
IEEE 802.11n (HT40)	23	23	/
IEEE 802.11ac (VHT40)	23	23	/
Test Frequency (MHz)	5775	/	/
IEEE 802.11ac (VHT80)	22	/	/

2.4 DUTY CYCLE

If duty cycle is $\geq 98\%$, duty factor is not required.
 If duty cycle is $< 98\%$, duty factor shall be considered.
 The output power = measured power + duty factor.

IEEE 802.11a

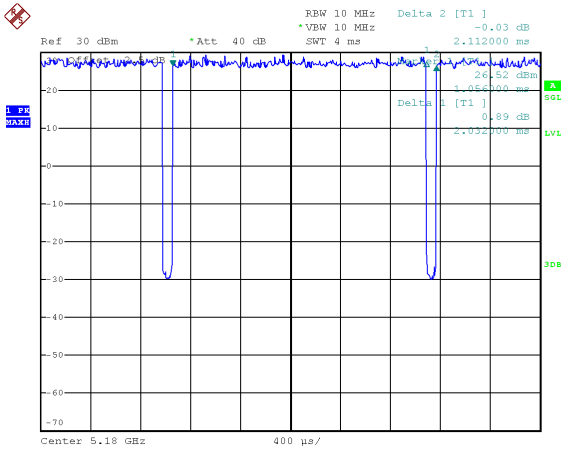

Date: 14.AUG.2019 20:10:13

Duty cycle = 2.032 ms / 2.112 ms = 96.21%
 Duty Factor = $10 \log(1 / \text{Duty cycle}) = 0.17$

IEEE 802.11n (HT20)

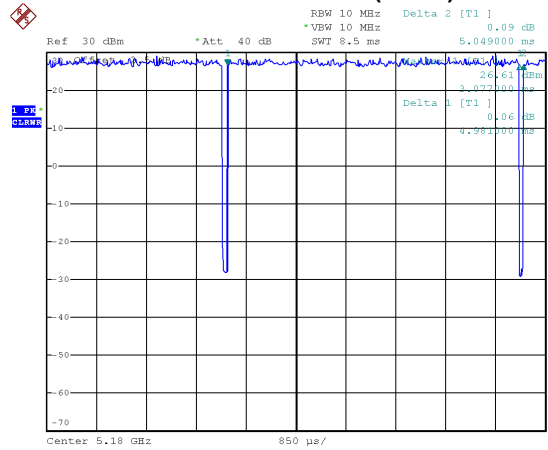

Date: 14.AUG.2019 20:10:35

Duty cycle = 4.981 ms / 5.049 ms = 98.65%
 Duty Factor = $10 \log(1 / \text{Duty cycle}) = 0.00$

IEEE 802.11n (HT40)

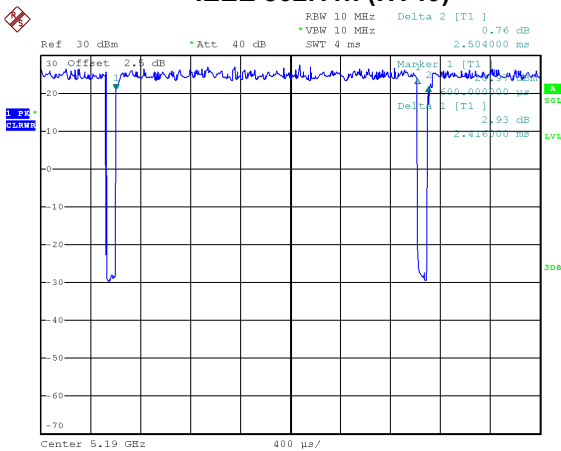

Date: 14.AUG.2019 20:11:23

Duty cycle = 2.416 ms / 2.504 ms = 96.49%
 Duty Factor = $10 \log(1 / \text{Duty cycle}) = 0.16$

IEEE 802.11ac (VHT20)

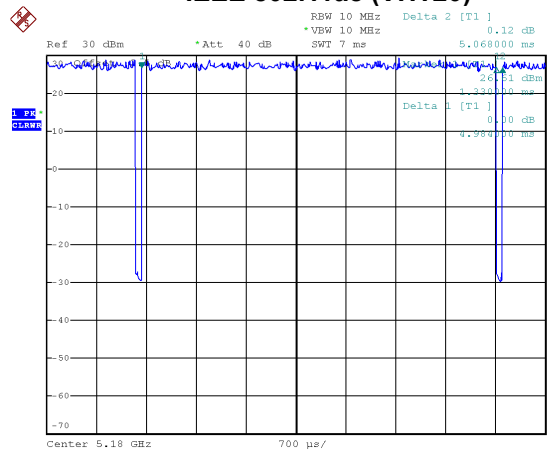

Date: 14.AUG.2019 20:11:00

Duty cycle = 4.984 ms / 5.068 ms = 98.34%
 Duty Factor = $10 \log(1 / \text{Duty cycle}) = 0.00$

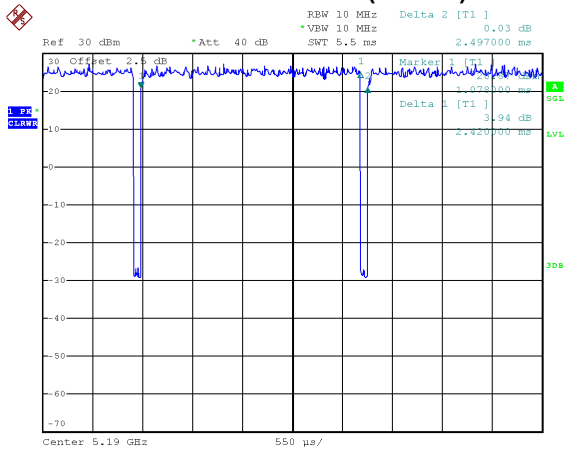
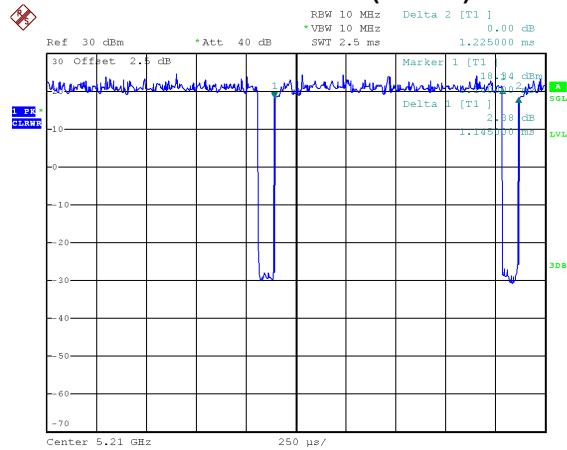
IEEE 802.11ac (VHT40)

IEEE 802.11ac (VHT80)

Date: 14.AUG.2019 20:11:43

Date: 14.AUG.2019 20:12:05

Duty cycle = 2.420 ms / 2.497 ms = 96.92%
 Duty Factor = $10 \log(1 / \text{Duty cycle}) = 0.14$

Duty cycle = 1.145 ms / 1.225 ms = 93.47%
 Duty Factor = $10 \log(1 / \text{Duty cycle}) = 0.29$

NOTE:

For IEEE 802.11a, IEEE 802.11n (HT20) and IEEE 802.11ac (VHT20):
 For radiated emissions frequency above 1 GHz, the resolution bandwidth of test receiver/spectrum analyzer is 1 MHz and the video bandwidth is 1 kHz (Duty cycle < 98%).

For IEEE 802.11n (HT40) and IEEE 802.11ac (VHT40):
 For radiated emissions frequency above 1 GHz, the resolution bandwidth of test receiver/spectrum analyzer is 1 MHz and the video bandwidth is 2 kHz (Duty cycle < 98%).

For IEEE 802.11ac (VHT80):
 For radiated emissions frequency above 1 GHz, the resolution bandwidth of test receiver/spectrum analyzer is 1 MHz and the video bandwidth is 3 kHz (Duty cycle < 98%).

2.5 BLOCK DIAGRAM SHOWING THE CONFIGURATION OF SYSTEM TESTED

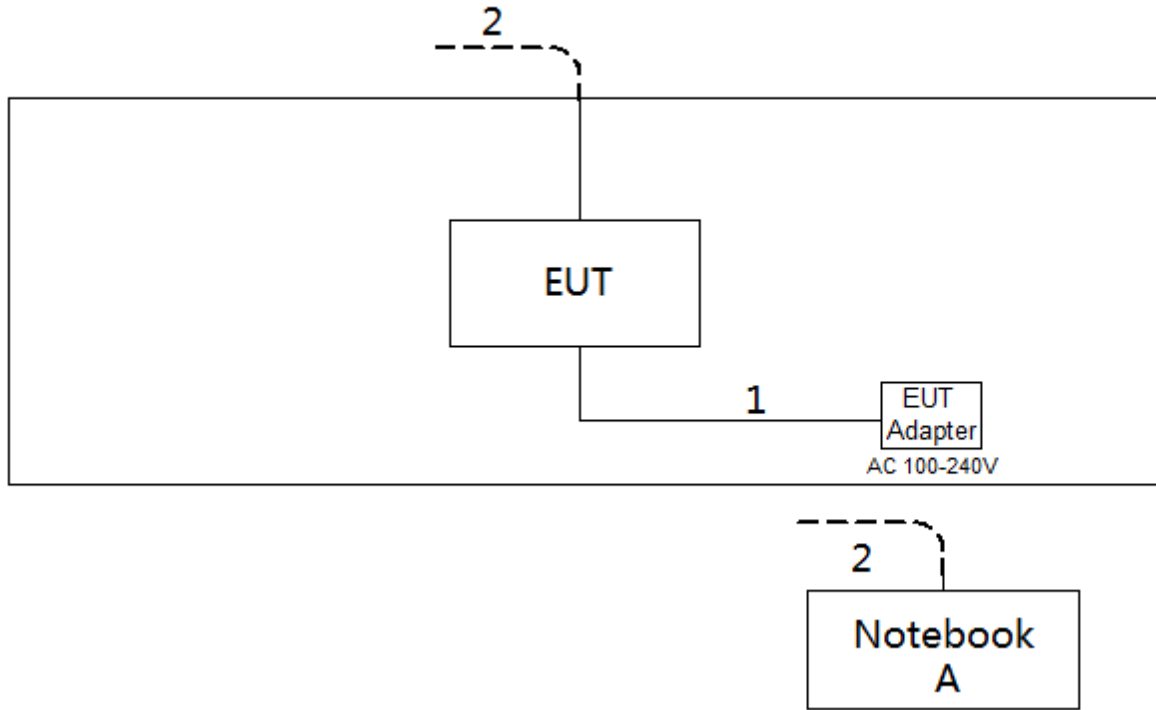

2.6 SUPPORT UNITS

Item	Equipment	Brand	Model No.	Series No.
A	Notebook	Dell	Inspiron 15-7559	N/A

Item	Cable Type	Shielded Type	Ferrite Core	Length
1	DC Cable	NO	NO	1.5m
2	RJ45 Cable	NO	NO	10m

3. AC POWER LINE CONDUCTED EMISSIONS TEST

3.1 LIMIT

Frequency (MHz)	Limit (dB μ V)	
	Quasi-peak	Average
0.15 - 0.50	66 to 56*	56 to 46*
0.50 - 5.0	56	46
5.0 - 30.0	60	50

NOTE:

- (1) The tighter limit applies at the band edges.
- (2) The limit of " * " marked band means the limitation decreases linearly with the logarithm of the frequency in the range.

The following table is the setting of the receiver

Receiver Parameter	Setting
Attenuation	10 dB
Start Frequency	0.15 MHz
Stop Frequency	30 MHz
IF Bandwidth	9 KHz

3.2 TEST PROCEDURE

- a. The EUT was placed 0.8 meters from the horizontal ground plane with EUT being connected to the power mains through a line impedance stabilization network (LISN). All other support equipment powered from additional LISN(s). The LISN provide 50 Ohm/ 50uH of coupling impedance for the measuring instrument.
- b. Interconnecting cables that hang closer than 40 cm to the ground plane shall be folded back and forth in the center forming a bundle 30 to 40 cm long.
- c. I/O cables that are not connected to a peripheral shall be bundled in the center. The end of the cable may be terminated, if required, using the correct terminating impedance. The overall length shall not exceed 1 m.
- d. LISN at least 80 cm from nearest part of EUT chassis.
- e. For the actual test configuration, please refer to the related Item -EUT Test Photos.

3.3 DEVIATION FROM TEST STANDARD

No deviation

3.4 TEST SETUP

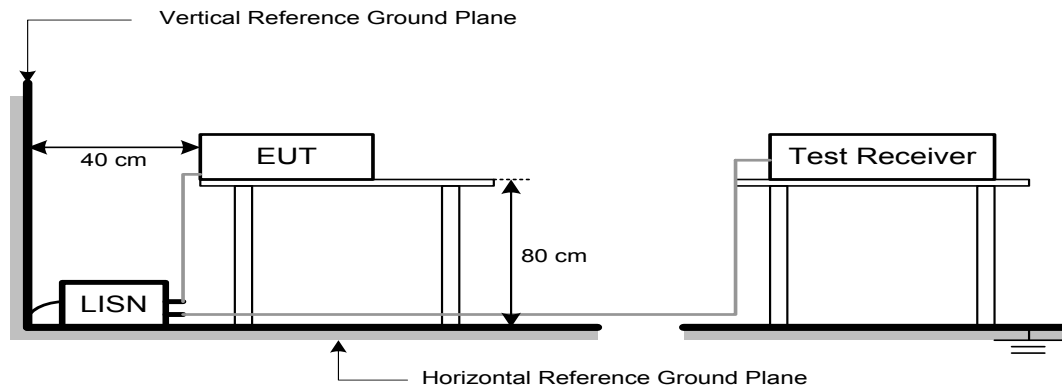

3.5 EUT OPERATION CONDITIONS

The EUT was configured for testing in a typical fashion (as a customer would normally use it). The EUT has been programmed to continuously transmit during test. This operating condition was tested and used to collect the included data.

The EUT was programmed to be in continuously transmitting/TX mode.

3.6 TEST RESULTS

Please refer to the APPENDIX A.

4. RADIATED EMISSIONS TEST

4.1 LIMIT

In case the emission fall within the restricted band specified on 15.205(a), then the 15.209(a) limit in the table below has to be followed.

LIMITS OF RADIATED EMISSIONS MEASUREMENT (9 kHz to 1000 MHz)

Frequency (MHz)	Field Strength (microvolts/meter)	Measurement Distance (meters)
0.009-0.490	2400/F(kHz)	300
0.490-1.705	24000/F(kHz)	30
1.705-30.0	30	30
30-88	100	3
88-216	150	3
216-960	200	3
Above 960	500	3

LIMITS OF UNWANTED EMISSION OUT OF THE RESTRICTED BANDS

Frequency (MHz)	EIRP Limit (dBm/MHz)	Equivalent Field Strength at 3m (dBμV/m)
5150-5250	-27	68.3
5725-5850	-27 NOTE (2)	68.3
	10 NOTE (2)	105.3
	15.6 NOTE (2)	110.9
	27 NOTE (2)	122.3

NOTE:

(1) The following formula is used to convert the equipment isotropic radiated power (eirp) to field strength:

$$E = \frac{1000000\sqrt{30P}}{3} \mu\text{V/m, where P is the eirp (Watts)}$$

(2) According to 15.407(b)(4)(i), all emissions shall be limited to a level of -27 dBm/MHz at 75 MHz or more above or below the band edge increasing linearly to 10 dBm/MHz at 25 MHz above or below the band edge, and from 25 MHz above or below the band edge increasing linearly to a level of 15.6 dBm/MHz at 5 MHz above or below the band edge, and from 5 MHz above or below the band edge increasing linearly to a level of 27 dBm/MHz at the band edge.

4.2 TEST PROCEDURE

- a. The measuring distance of 3 m shall be used for measurements. The EUT was placed on the top of a rotating table 0.8 meter above the ground at a 3 meter semi-anechoic chamber. The table was rotated 360 degrees to determine the position of the highest radiation.(below 1GHz)
- b. The measuring distance of 3 m shall be used for measurements. The EUT was placed on the top of a rotating table 1.5 meter above the ground at a 3 meter semi-anechoic chamber. The table was rotated 360 degrees to determine the position of the highest radiation.(above 1GHz)
- c. The height of the equipment or of the substitution antenna shall be 0.8m or 1.5m; the height of the test antenna shall vary between 1 m to 4 m. Both horizontal and vertical polarizations of the antenna are set to make the measurement.
- d. For each suspected emission, the EUT was arranged to its worst case and then the antenna was tuned to heights find the maximum reading (used Bore sight function).
- e. The receiver system was set to peak and average detect function and specified bandwidth with maximum hold mode when the test frequency is above 1 GHz.
- f. The initial step in collecting radiated emission data is a receiver peak detector mode pre-scanning the measurement frequency range. Significant peaks are then marked and then Quasi Peak detector mode re-measured.
- g. All readings are Peak unless otherwise stated QP in column of Note. Peak denotes that the Peak reading compliance with the QP Limits and then QP Mode measurement didn't perform. (below 1 GHz)
- h. All readings are Peak Mode value unless otherwise stated AVG in column of Note. If the Peak Mode Measured value compliance with the Peak Limits and lower than AVG Limits, the EUT shall be deemed to meet both Peak & AVG Limits and then only Peak Mode was measured, but AVG Mode didn't perform. (above 1 GHz)
- i. For the actual test configuration, please refer to the related Item –EUT Test Photos.

4.3 DEVIATION FROM TEST STANDARD

No deviation

4.4 TEST SETUP

9 kHz to 30 MHz

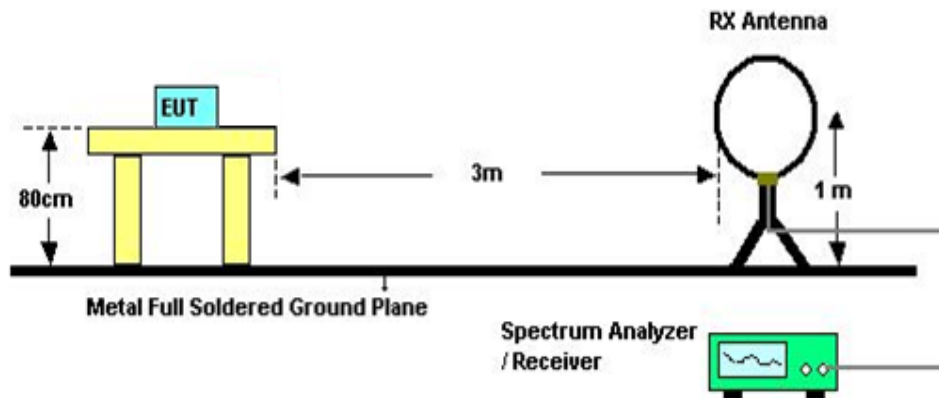

30 MHz to 1 GHz

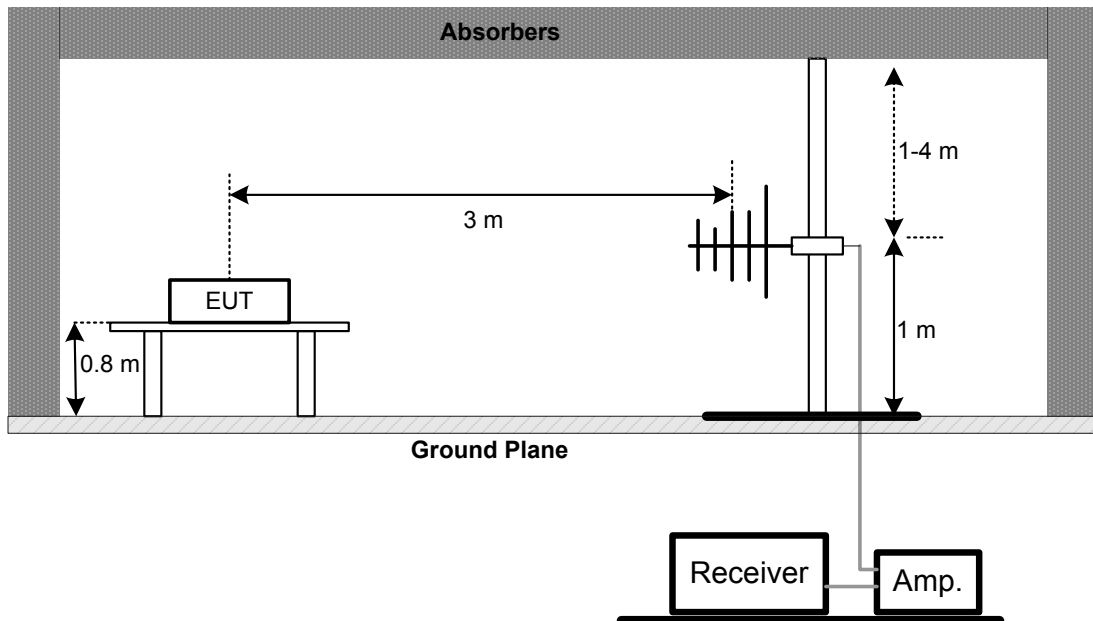

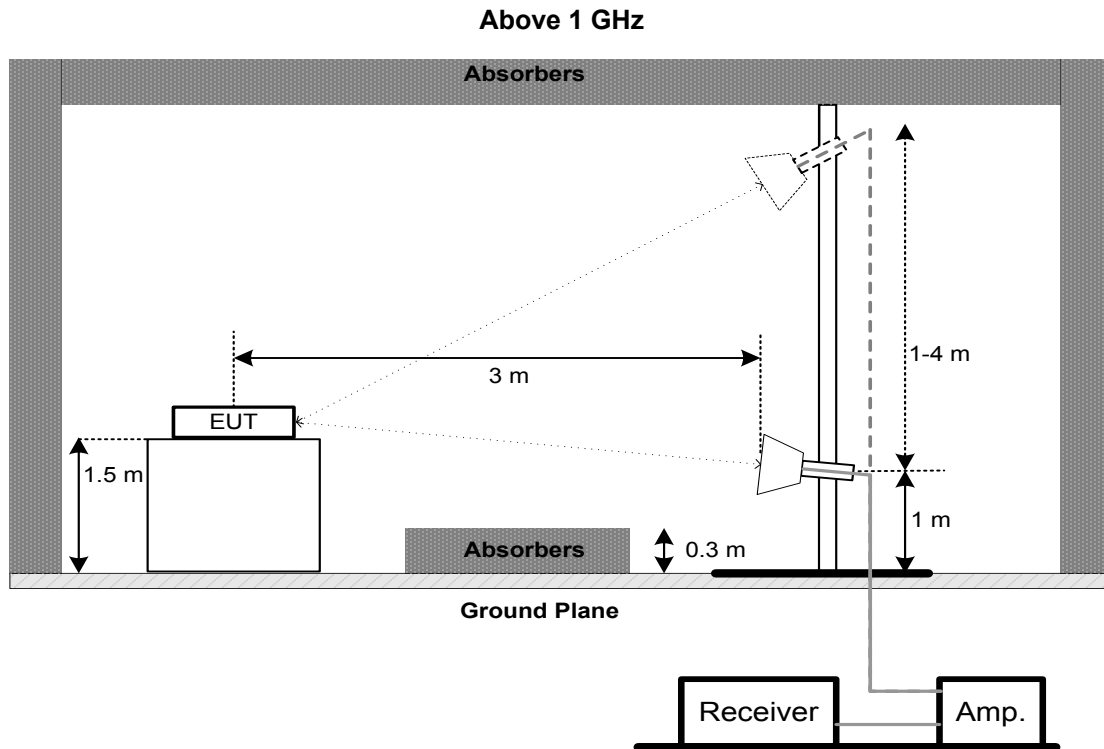

4.5 EUT OPERATION CONDITIONS

The EUT tested system was configured as the statements of 3.5 unless otherwise a special operating condition is specified in the follows during the testing.

4.6 TEST RESULTS - 9 KHZ to 30 MHZ

Please refer to the APPENDIX B

Remark:

- (1) Distance extrapolation factor = $40 \log (\text{specific distance} / \text{test distance})$ (dB).
- (2) Limit line = specific limits (dBuV) + distance extrapolation factor.

4.7 TEST RESULTS - 30 MHZ TO 1000 MHZ

Please refer to the APPENDIX C.

4.8 TEST RESULTS - ABOVE 1000 MHZ

Please refer to the APPENDIX D.

Remark:

- (1) No limit: This is fundamental signal, the judgment is not applicable.
For fundamental signal judgment was referred to Peak output test.

5. BANDWIDTH TEST

5.1 LIMIT

FCC Part15, Subpart E (15.407)			
Section	Test Item	Limit	Frequency Range (MHz)
15.407(a)	26 dB Bandwidth	-	5150-5250
15.407(e)	6 dB Bandwidth	Minimum 500 kHz	5725-5850

5.2 TEST PROCEDURE

a. The EUT was directly connected to the spectrum analyzer and antenna output port as show in the block diagram below

b. Spectrum Setting:

For UNII-1:

Spectrum Parameter	Setting
Attenuation	Auto
Span Frequency	> 26 dB Bandwidth
RBW	300 kHz (Bandwidth 20 MHz) 1 MHz (Bandwidth 40 MHz and 80 MHz)
VBW	1 MHz (Bandwidth 20 MHz) 3 MHz (Bandwidth 40 MHz and 80 MHz)
Detector	Peak
Trace	Max Hold
Sweep Time	Auto

For UNII-3:

Spectrum Parameter	Setting
Attenuation	Auto
Span Frequency	6 dB Bandwidth
RBW	100 kHz
VBW	300 kHz
Detector	Peak
Trace	Max Hold
Sweep Time	Auto

c. Measured the spectrum width with power higher than 26 dB / 6dB below carrier

5.3 TEST PROCEDURE

No deviation.

5.4 TEST SETUP



5.5 EUT OPERATION CONDITIONS

The EUT was programmed to be in continuously transmitting mode.

5.6 TEST RESULTS

Please refer to the APPENDIX E.

6. MAXIMUM OUTPUT POWER TEST

6.1 LIMIT

FCC Part15, Subpart E (15.407)			
Section	Test Item	Limit	Frequency Range (MHz)
15.407(a)	Maximum Output Power	AP device: 1 Watt (30 dBm)	5150-5250
		Client device: 250 mW (24 dBm)	5725-5850
		1 Watt (30dBm)	5725-5850

Note:

- a. For an indoor access point operating in the band 5.15-5.25 GHz, the maximum conducted output power over the frequency band of operation shall not exceed 1 W provided the maximum antenna gain does not exceed 6 dBi. In addition, the maximum power spectral density shall not exceed 17 dBm in any 1 megahertz band. If transmitting antennas of directional gain greater than 6 dBi are used, both the maximum conducted output power and the maximum power spectral density shall be reduced by the amount in dB that the directional gain of the antenna exceeds 6 dBi.

6.2 TEST PROCEDURE

- a. The EUT was directly connected to the power meter and antenna output port as show in the block diagram below.
- b. Test test was performed in accordance with method of FCC KDB 789033 D02 General UNII Test Procedures New Rules v02r01.

6.3 DEVIATION FROM STANDARD

No deviation.

6.4 TEST SETUP



6.5 EUT OPERATION CONDITIONS

The EUT was programmed to be in continuously transmitting mode.

6.6 TEST RESULTS

Please refer to the APPENDIX F.

7. POWER SPECTRAL DENSITY TEST

7.1 LIMIT

FCC Part15, Subpart E (15.407)			
Section	Test Item	Limit	Frequency Range (MHz)
15.407(a)	Power Spectral Density	AP device: 17 dBm/MHz	5150-5250
		Client device: 11 dBm/MHz	
		30 dBm/500 kHz	5725-5850

7.2 TEST PROCEDURE

- The EUT was directly connected to the spectrum analyzer and antenna output port as show in the block diagram below.
- Spectrum Setting

Spectrum Parameter	Setting
Attenuation	Auto
Span Frequency	Encompass the entire emissions bandwidth (EBW) of the signal
RBW	= 1 MHz.
VBW	≥ 3 MHz.
Detector	RMS
Trace average	100 trace
Sweep Time	Auto

Note:

- For UNII-3, according to KDB publication 789033 D02 General UNII Test Procedures New Rules v02r01, section II.F.5., it is acceptable to set RBW at 1 MHz and VBW at 3 MHz if the spectrum analyzer does not have 500 kHz RBW.
- The value measured with RBW=1 MHz is to be added with $10\log(500 \text{ kHz}/1 \text{ MHz})$ which is -3 dB. For example, if the measured value is +10dBm using RBW=1 MHz (that is +10 dBm/MHz), then the converted value will be +7dBm/500kHz.

7.3 DEVIATION FROM STANDARD

No deviation.

7.4 TEST SETUP



7.5 EUT OPERATION CONDITIONS

The EUT was programmed to be in continuously transmitting mode.

7.6 TEST RESULTS

Please refer to the APPENDIX G.

8. FREQUENCY STABILITY MEASUREMENT

8.1 LIMIT

FCC Part15, Subpart E (15.407)			
Section	Test Item	Limit	Frequency Range (MHz)
15.407(g)	Frequency Stability	An emission is maintained within the band of operation under all conditions of normal operation as specified in the users manual.	5150-5250
			5725-5850

8.2 TEST PROCEDURE

- The EUT was directly connected to the spectrum analyzer and antenna output port as show in the block diagram below.
- Spectrum Setting:

Spectrum Parameter	Setting
Attenuation	Auto
Span Frequency	Entire absence of modulation emissions bandwidth
RBW	10 kHz
VBW	10 kHz
Sweep Time	Auto

- The test extreme voltage is to change the primary supply voltage from 85 to 115 percent of the nominal value.
- User manual temperature is 0°C~40°C.

8.3 DEVIATION FROM STANDARD

No deviation.

8.4 TEST SETUP

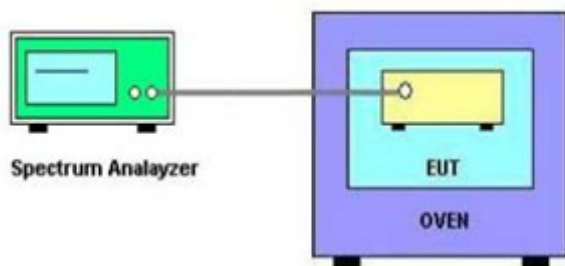

8.5 EUT OPERATION CONDITIONS

The EUT was programmed to be in continuously transmitting mode.

8.6 TEST RESULTS

Please refer to the APPENDIX H.

9. MEASUREMENT INSTRUMENTS LIST

AC Power Line Conducted Emissions					
Item	Kind of Equipment	Manufacturer	Type No.	Serial No.	Calibrated until
1	EMI Test Receiver	R&S	ESCI	100382	Mar. 10, 2020
2	LISN	EMCO	3816/2	52765	Mar. 10, 2020
3	50ohm Terminator	SHX	TF5-3	15041305	Mar. 10, 2020
4	Artificial-Mains Network	Schwarzbeck	NSLK 8127	8127685	Mar. 10, 2020
5	TRANSIENT LIMITER	EM	EM-7600	772	Mar. 10, 2020
6	Measurement Software	Farad	EZ-EMC Ver.NB-03A1-01	N/A	N/A
7	Cable	N/A	RG223	12m	Mar. 12, 2020

Radiated Emissions - 9 kHz to 30 MHz					
Item	Kind of Equipment	Manufacturer	Type No.	Serial No.	Calibrated until
1	Loop Antenna	EM	EM-6876-1	230	Jan. 15, 2020
2	Cable	N/A	RG 213/U	C-102	May 31, 2020
3	EMI Test Receiver	R&S	ESCI	100895	Mar. 10, 2020
4	Measurement Software	Farad	EZ-EMC Ver.NB-03A1-01	N/A	N/A

Radiated Emissions - 30 MHz to 1 GHz					
Item	Kind of Equipment	Manufacturer	Type No.	Serial No.	Calibrated until
1	Antenna	Schwarzbeck	VULB9160	9160-3232	Mar. 09, 2020
2*	Amplifier	HP	8447D	2944A09673	Aug. 11, 2021
3	Receiver	Agilent	N9038A	MY52130039	Aug. 03, 2020
4	Cable	emci	LMR-400(30MHz-1 GHz)(8m+5m)	N/A	May 24, 2020
5	Controller	CT	SC100	N/A	N/A
6	Controller	MF	MF-7802	MF780208416	N/A
7	Measurement Software	Farad	EZ-EMC Ver.NB-03A1-01	N/A	N/A

Radiated Emissions - Above 1 GHz					
Item	Kind of Equipment	Manufacturer	Type No.	Serial No.	Calibrated until
1	Double Ridged Guide Antenna	ETS	3115	75789	Mar. 09, 2020
2	Broad-Band Horn Antenna	Schwarzbeck	BBHA 9170	9170319	Jun. 23, 2020
3	Amplifier	Agilent	8449B	3008A02333	Mar. 10, 2020
4	Microwave Pre-amplifier With Adaptor	EMC INSTRUMENT	EMC2654045	980039 & HA01	Mar. 10, 2020
5	Receiver	Agilent	N9038A	MY52130039	Aug. 03, 2020
6	Controller	CT	SC100	N/A	N/A
7	Controller	MF	MF-7802	MF780208416	N/A
8	Cable	mitron	B10-01-01-12M	18072744	Jun. 29, 2020
9	Measurement Software	Farad	EZ-EMC Ver.NB-03A1-01	N/A	N/A

Bandwidth & Power Spectral Density					
Item	Kind of Equipment	Manufacturer	Type No.	Serial No.	Calibrated until
1	Spectrum Analyzer	R&S	FSP40	100185	Aug. 03, 2020

Conducted Output Power					
Item	Kind of Equipment	Manufacturer	Type No.	Serial No.	Calibrated until
1	Peak Power Analyzer	Keysight	8990B	MY51000506	Aug. 03, 2020
2	Wideband power sensor	Keysight	N1923A	MY58310004	Aug. 03, 2020

Frequency Stability					
Item	Kind of Equipment	Manufacturer	Type No.	Serial No.	Calibrated until
1	Spectrum Analyzer	R&S	FSP40	100185	Aug. 03, 2020
2	Precision Oven Tester	Bell	BTH-50C	20170306001	Mar. 10, 2020

Remark: "N/A" denotes no model name, serial no. or calibration specified.

"*" calibration period of equipment list is three year.

Except * item, all calibration period of equipment list is one year.

10. EUT TEST PHOTOS**AC Power Line Conducted Emissions Test Photos**

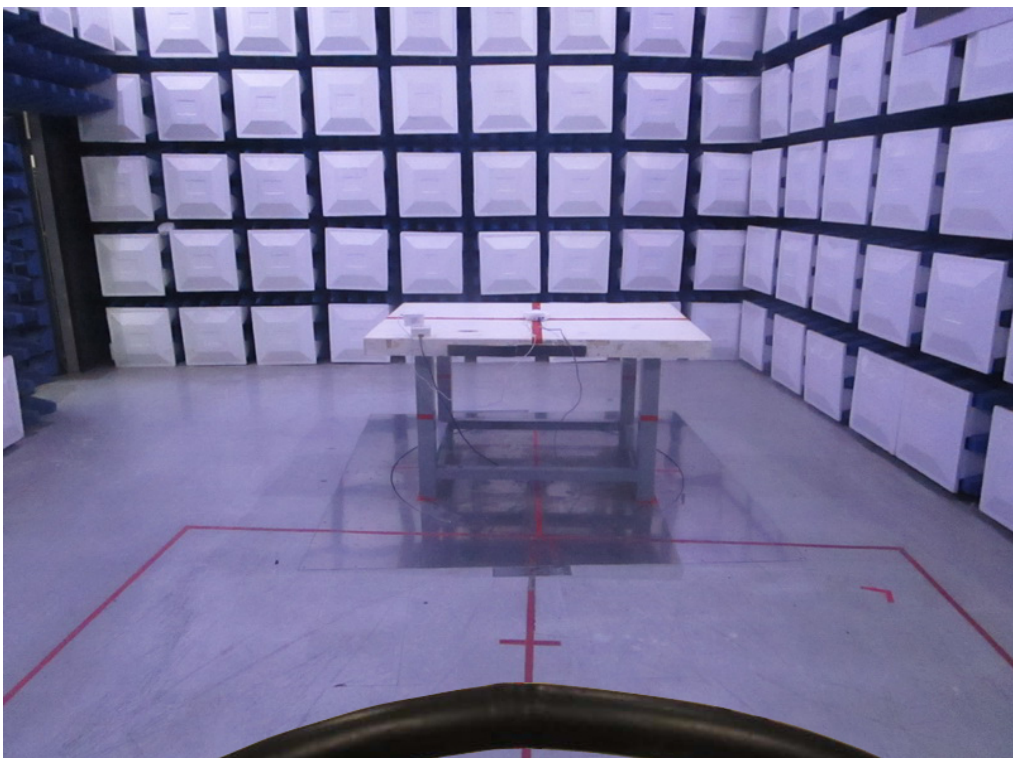
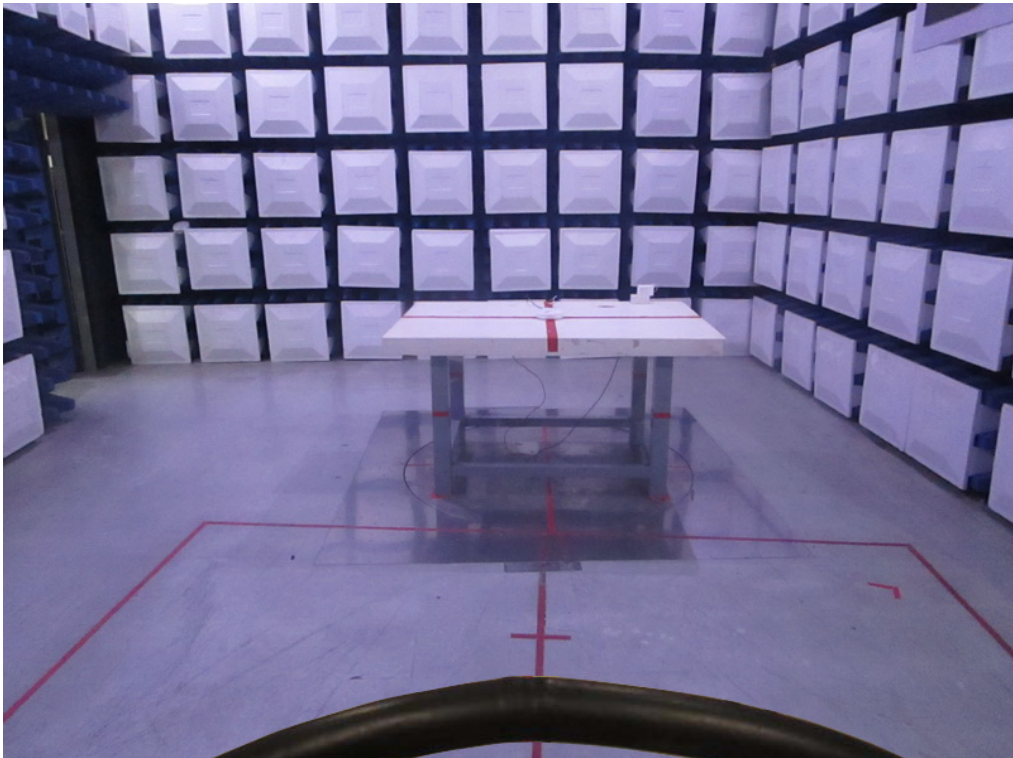
Radiated Emissions Test Photos**9 kHz to 30 MHz**

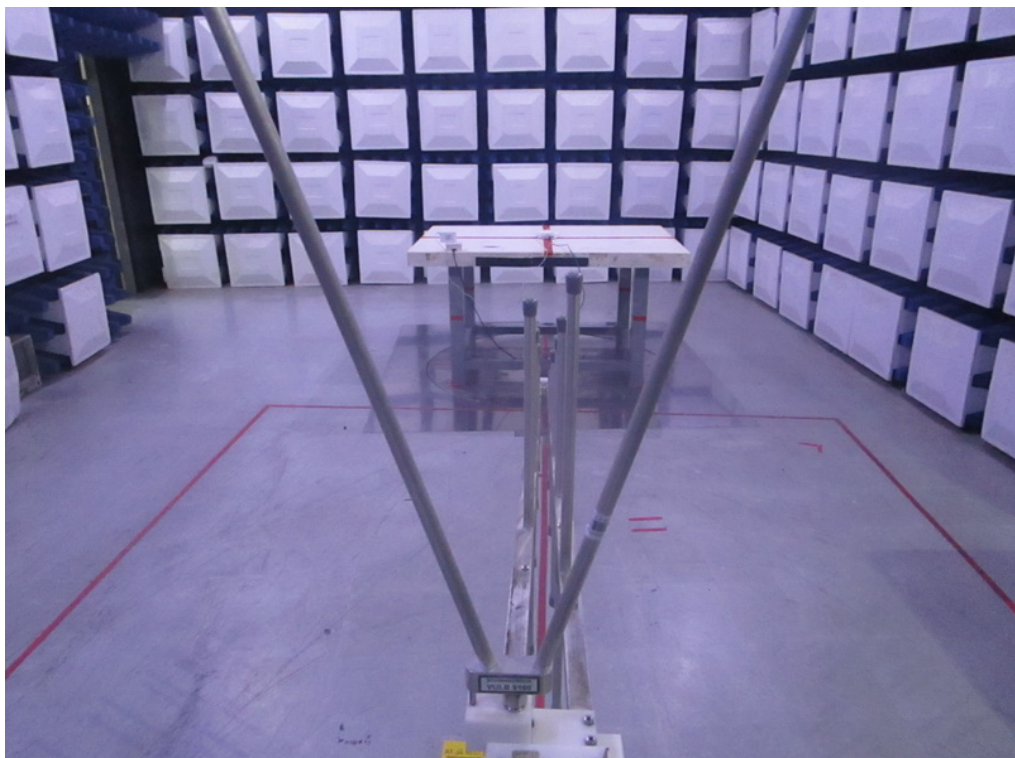
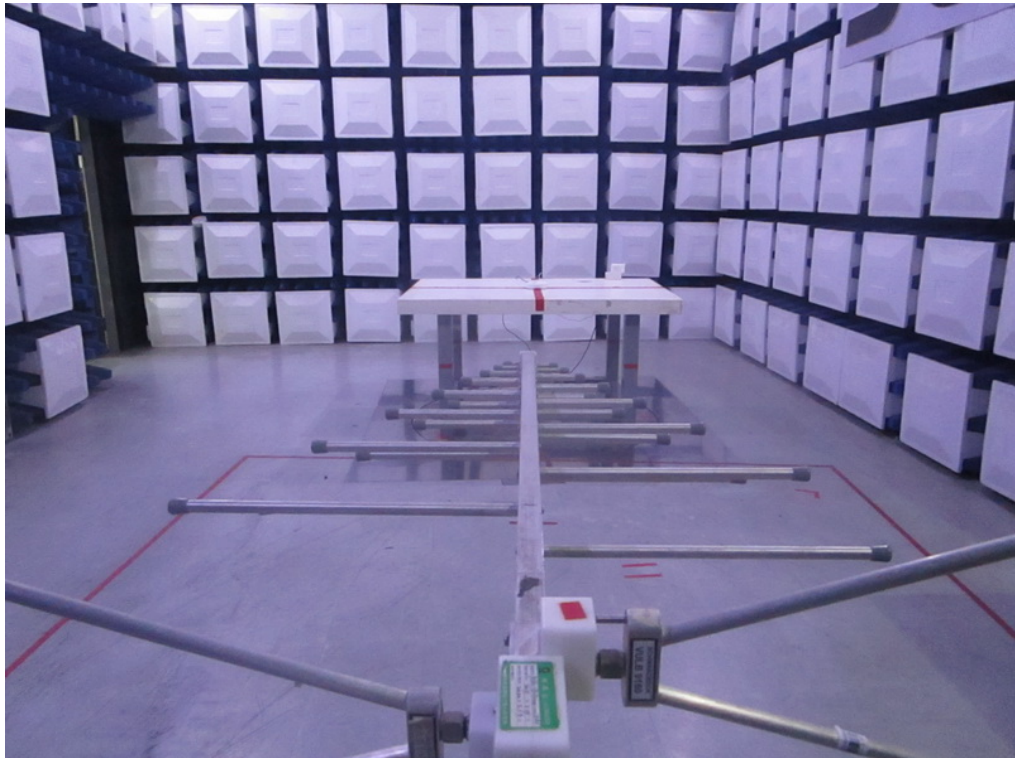
Radiated Emissions Test Photos**30 MHz to 1 GHz**

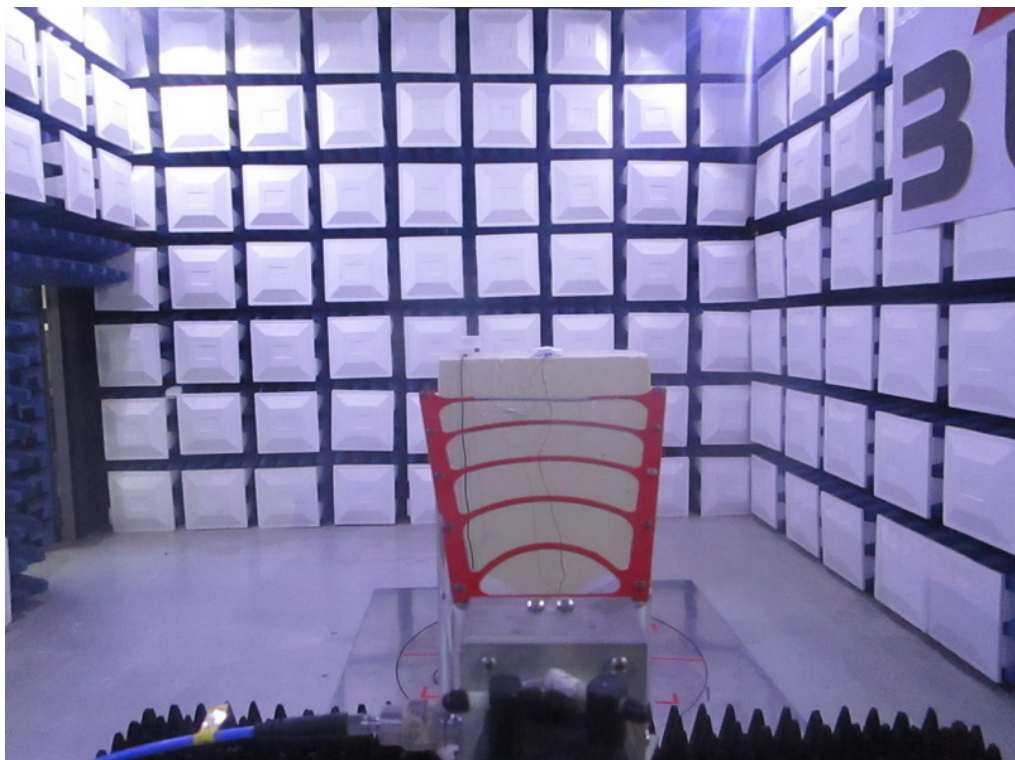
Radiated Emissions Test Photos**Above 1 GHz**

APPENDIX A - AC POWER LINE CONDUCTED EMISSIONS

Test Mode: TX N40 Mode Channel 151

Line

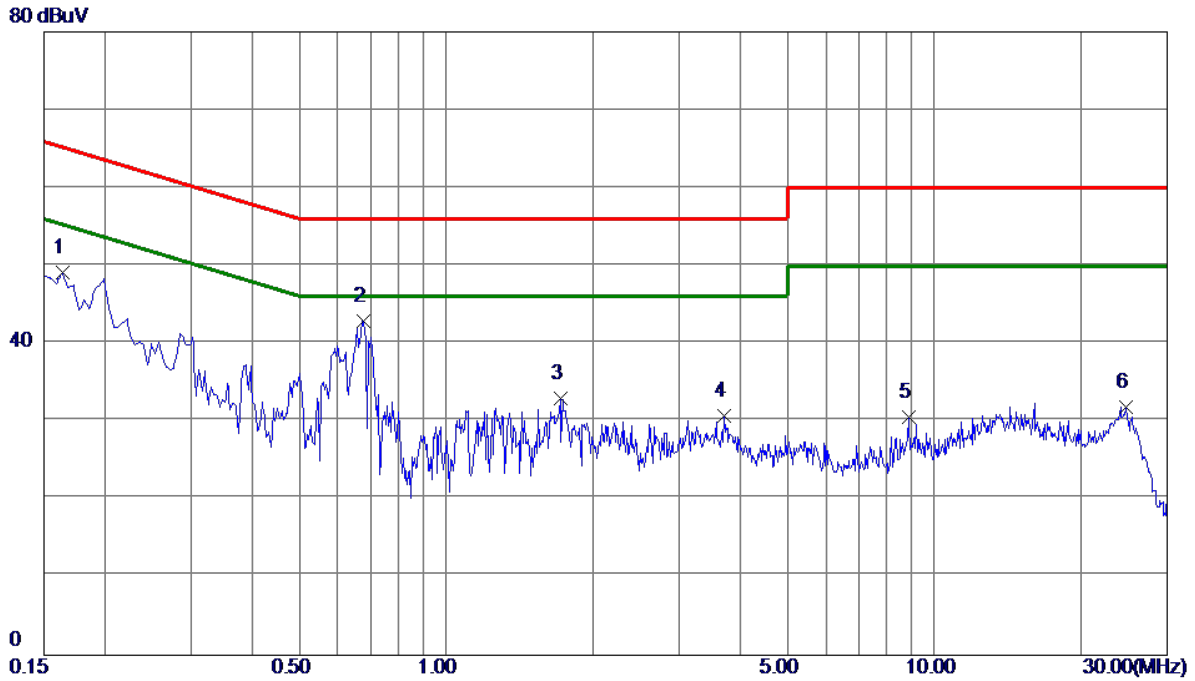

No.	Freq. MHz	Reading Level dBuV	Correct Factor dB	Measure ment dBuV	Limit dBuV	Margin dB	Detector	Comment
1	0.1635	39.34	9.82	49.16	65.28	-16.12	Peak	
2 *	0.6765	33.00	9.90	42.90	56.00	-13.10	Peak	
3	1.7115	22.99	9.97	32.96	56.00	-23.04	Peak	
4	3.7140	20.63	10.11	30.74	56.00	-25.26	Peak	
5	8.8530	20.09	10.43	30.52	60.00	-29.48	Peak	
6	24.6660	20.74	11.13	31.87	60.00	-28.13	Peak	

REMARKS:

- (1) Measurement Value = Reading Level + Correct Factor.
- (2) Margin Level = Measurement Value - Limit Value.
- (3) The test result has included the cable loss.

Test Mode: TX N40 Mode Channel 151

Neutral

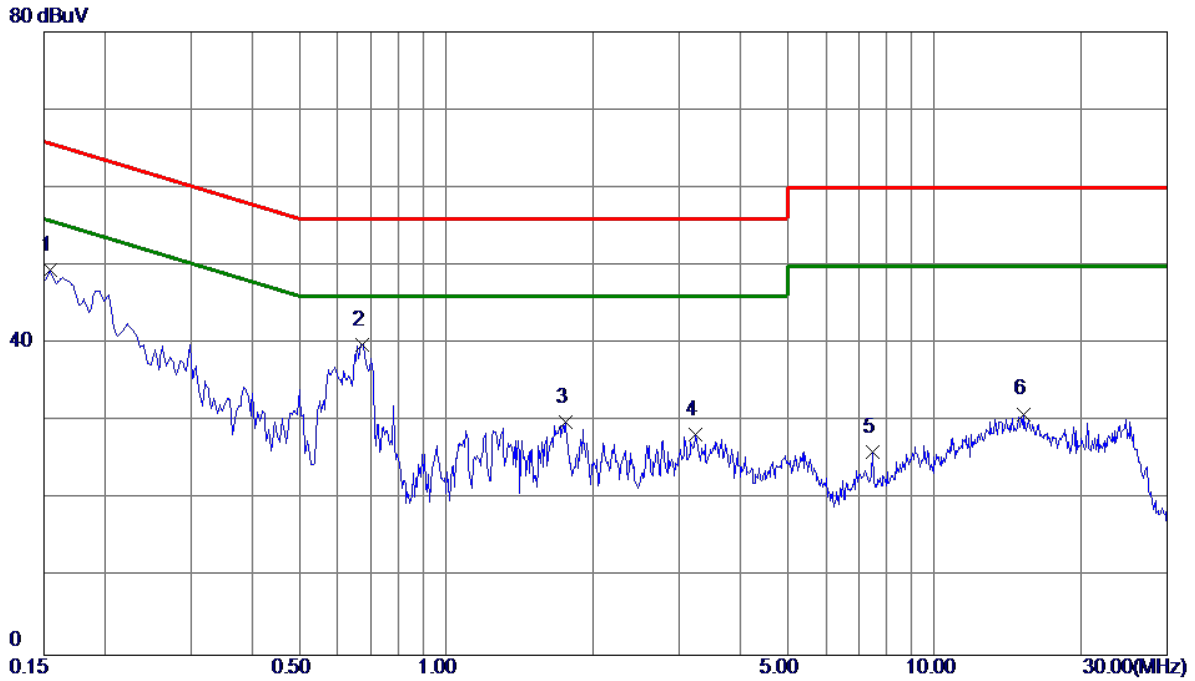

No.	Freq. MHz	Reading Level dBuV	Correct Factor dB	Measure ment dBuV	Limit dBuV	Margin dB	Detector	Comment
1	0.1544	39.51	9.91	49.42	65.76	-16.34	Peak	
2 *	0.6720	29.84	10.06	39.90	56.00	-16.10	Peak	
3	1.7565	19.73	10.17	29.90	56.00	-26.10	Peak	
4	3.2325	18.08	10.27	28.35	56.00	-27.65	Peak	
5	7.4805	15.47	10.61	26.08	60.00	-33.92	Peak	
6	15.2295	19.86	11.10	30.96	60.00	-29.04	Peak	

REMARKS:

- (1) Measurement Value = Reading Level + Correct Factor.
- (2) Margin Level = Measurement Value - Limit Value.
- (3) The test result has included the cable loss.

APPENDIX B - RADIATED EMISSION - 9 KHZ TO 30 MHZ

Test Mode: TX N40 Mode Channel 151

Ant 0°

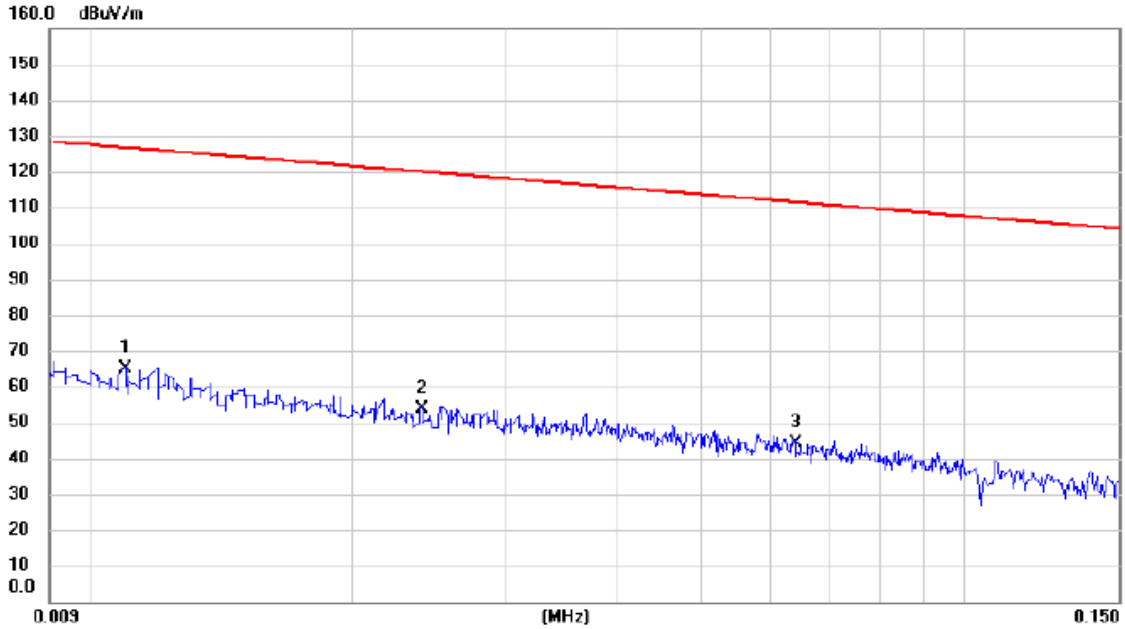

No.	Mk.	Freq.	Reading Level	Correct Factor	Measurement	Limit	Margin		
		MHz	dBuV	dB	dBuV/m	dBuV/m	dB	Detector	Comment
1	*	0.011	48.40	16.52	64.92	126.78	-61.86	AVG	
2		0.024	40.03	13.83	53.86	120.00	-66.14	AVG	
3		0.064	30.58	13.70	44.28	111.47	-67.19	AVG	

REMARKS:

- (1) Measurement Value = Reading Level + Correct Factor.
- (2) Margin Level = Measurement Value - Limit Value.

Test Mode: TX N40 Mode Channel 151

Ant 0°

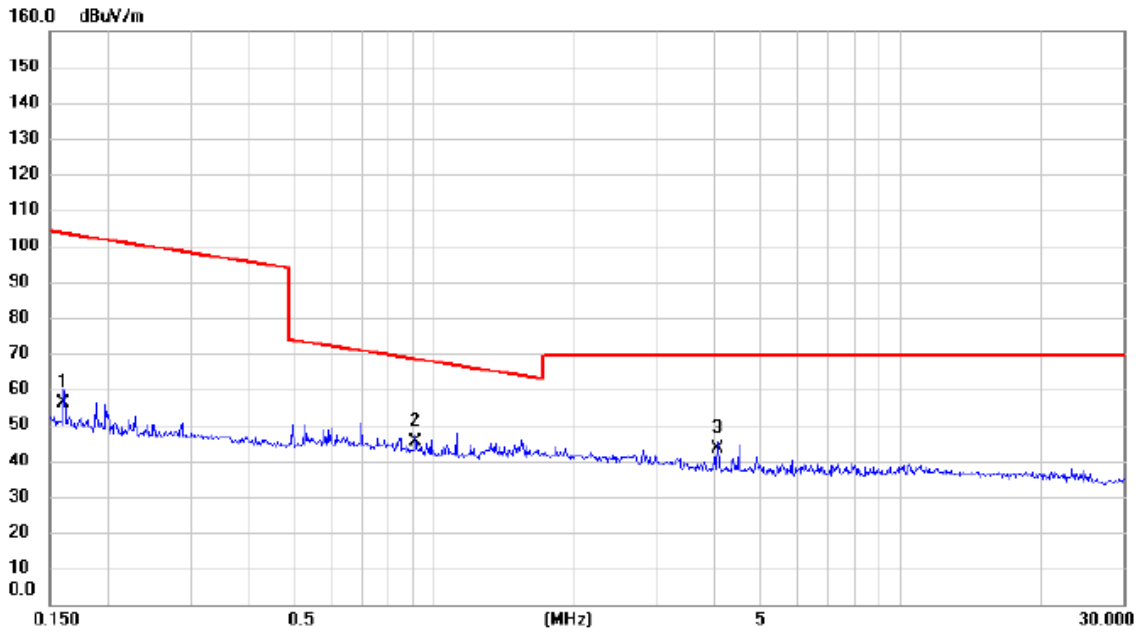

No.	Mk.	Freq.	Reading Level	Correct Factor	Measurement	Limit	Margin	Detector	Comment
		MHz	dBuV	dB	dBuV/m	dBuV/m	dB		
1		0.160	42.60	13.57	56.17	103.50	-47.33	AVG	
2	*	0.913	33.06	12.52	45.58	68.39	-22.81	QP	
3		4.049	32.40	10.95	43.35	69.54	-26.19	QP	

REMARKS:

- (1) Measurement Value = Reading Level + Correct Factor.
- (2) Margin Level = Measurement Value - Limit Value.

Test Mode: TX N40 Mode Channel 151

Ant 90°

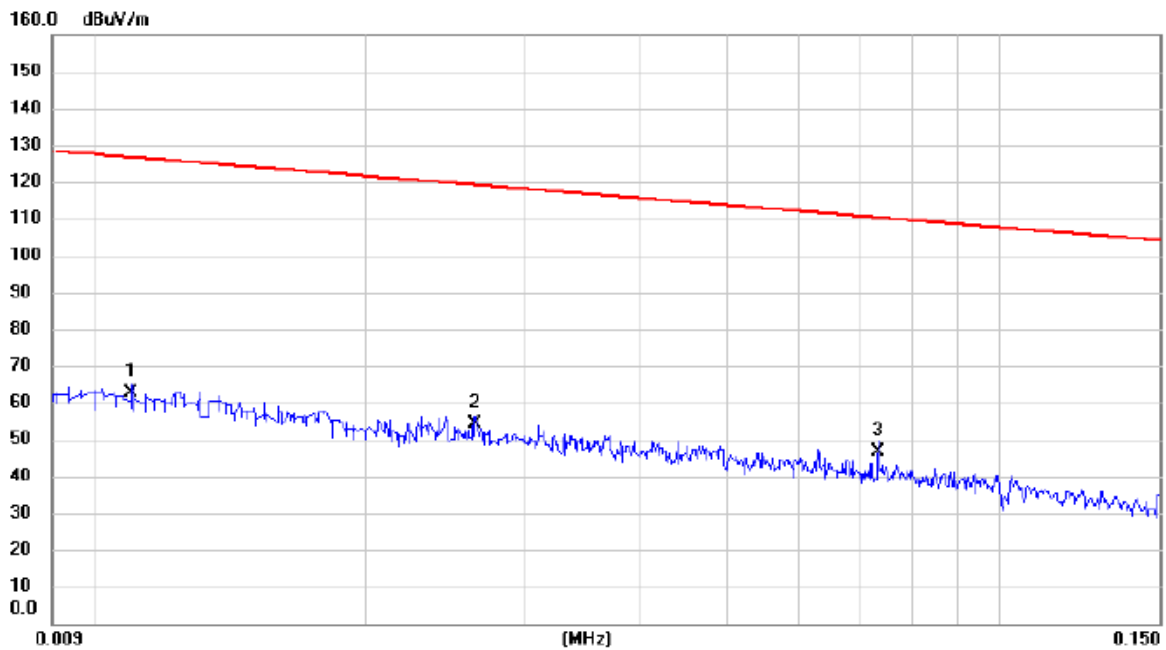

No.	Mk.	Freq. MHz	Reading Level dBuV	Correct Factor dB	Measure- ment dBuV/m	Limit dBuV/m	Margin dB	Detector	Comment
1		0.011	46.04	16.52	62.56	126.78	-64.22	AVG	
2		0.026	40.50	13.84	54.34	119.17	-64.83	AVG	
3	*	0.073	33.25	13.55	46.80	110.28	-63.48	AVG	

REMARKS:

(1) Measurement Value = Reading Level + Correct Factor.

(2) Margin Level = Measurement Value - Limit Value.

Test Mode: TX N40 Mode Channel 151

Ant 90°

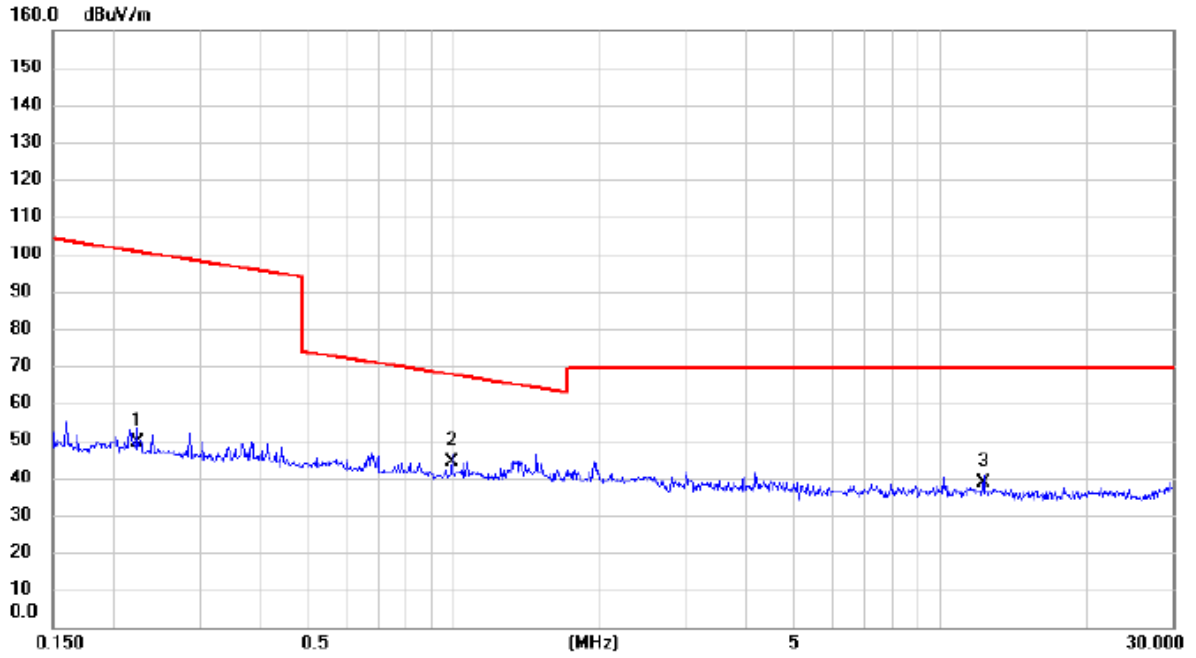

No.	Mk.	Freq. MHz	Reading Level dBuV	Correct Factor dB	Measure- ment dBuV/m	Limit dBuV/m	Margin dB	Detector	Comment
1		0.223	35.66	13.63	49.29	100.64	-51.35	AVG	
2	*	0.994	31.82	12.50	44.32	67.66	-23.34	QP	
3		12.253	27.13	11.60	38.73	69.54	-30.81	QP	

REMARKS:

- (1) Measurement Value = Reading Level + Correct Factor.
- (2) Margin Level = Measurement Value - Limit Value.

APPENDIX C - RADIATED EMISSION - 30 MHZ TO 1 GHZ

Test Mode: TX N40 Mode Channel 151

Vertical

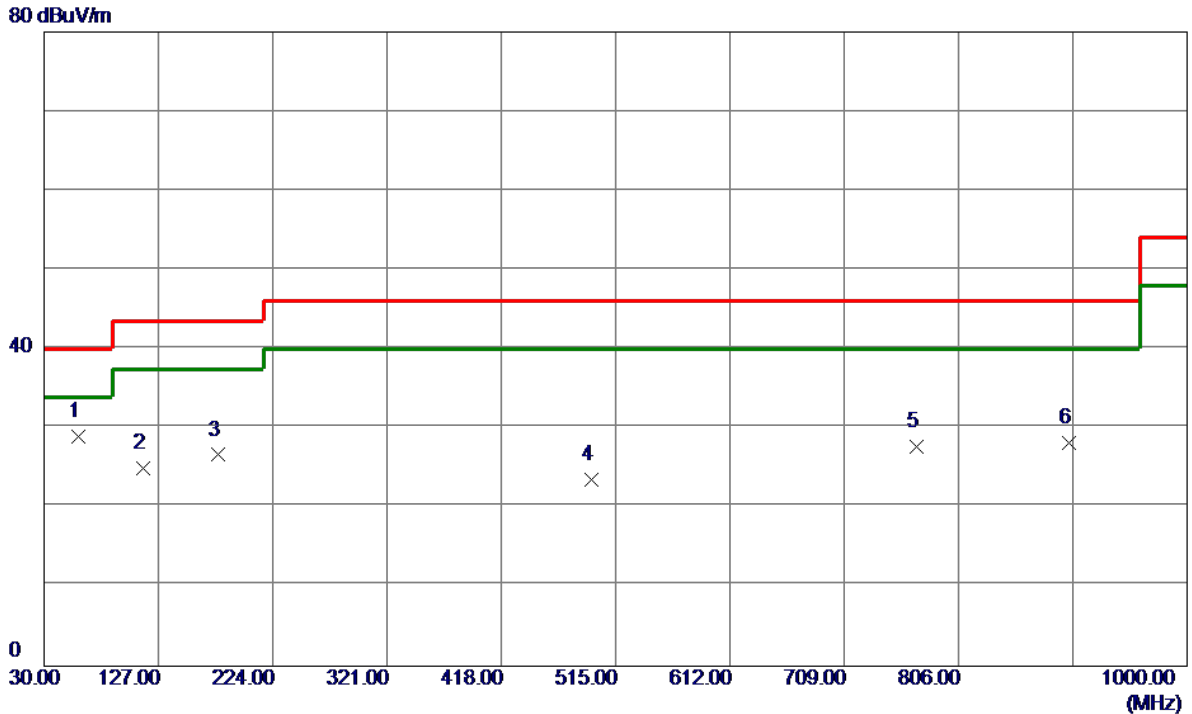

No.	Freq. MHz	Reading Level dBuV/m	Correct Factor dB	Measure ment dBuV/m	Limit dBuV/m	Margin dB	Detector	Comment
1 *	59.1000	43.74	-14.75	28.99	40.00	-11.01	Peak	
2	113.9050	38.92	-13.94	24.98	43.50	-18.52	Peak	
3	177.4400	39.60	-12.96	26.64	43.50	-16.86	Peak	
4	494.1450	31.25	-7.73	23.52	46.00	-22.48	Peak	
5	770.5949	31.13	-3.39	27.74	46.00	-18.26	Peak	
6	899.6050	30.01	-1.92	28.09	46.00	-17.91	Peak	

REMARKS:

- (1) Measurement Value = Reading Level + Correct Factor.
- (2) Margin Level = Measurement Value - Limit Value.

Test Mode: TX N40 Mode Channel 151

Horizontal

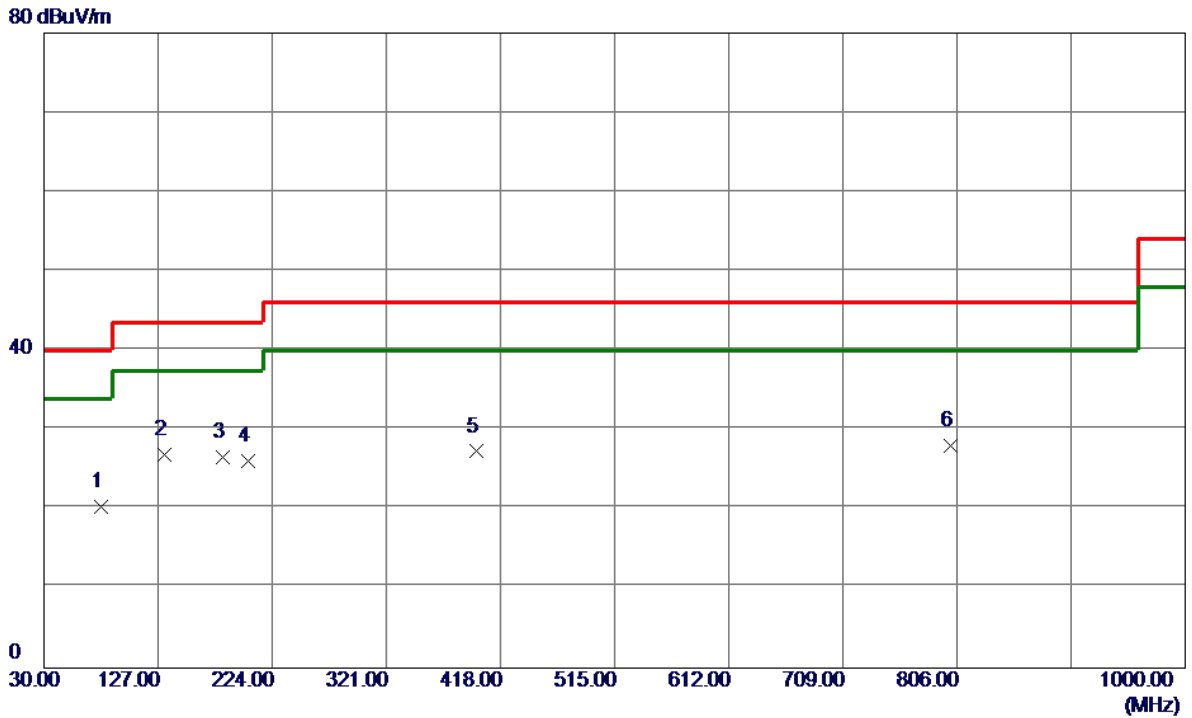

No.	Freq. MHz	Reading Level dBuV/m	Correct Factor dB	Measure ment dBuV/m	Limit dBuV/m	Margin dB	Detector	Comment
1	78.0150	37.97	-17.68	20.29	40.00	-19.71	Peak	
2 *	132.8200	39.91	-13.00	26.91	43.50	-16.59	Peak	
3	182.2899	40.07	-13.44	26.63	43.50	-16.87	Peak	
4	203.6300	41.39	-15.34	26.05	43.50	-17.45	Peak	
5	397.6300	36.80	-9.52	27.28	46.00	-18.72	Peak	
6	800.1800	31.03	-3.00	28.03	46.00	-17.97	Peak	

REMARKS:

- (1) Measurement Value = Reading Level + Correct Factor.
- (2) Margin Level = Measurement Value - Limit Value.

APPENDIX D - RADIATED EMISSION - ABOVE 1000 MHZ

Non Beamforming

Orthogonal Axis	X
Test Mode	UNII-1_TX A Mode 5180 MHz

Vertical

130 dBuV/m

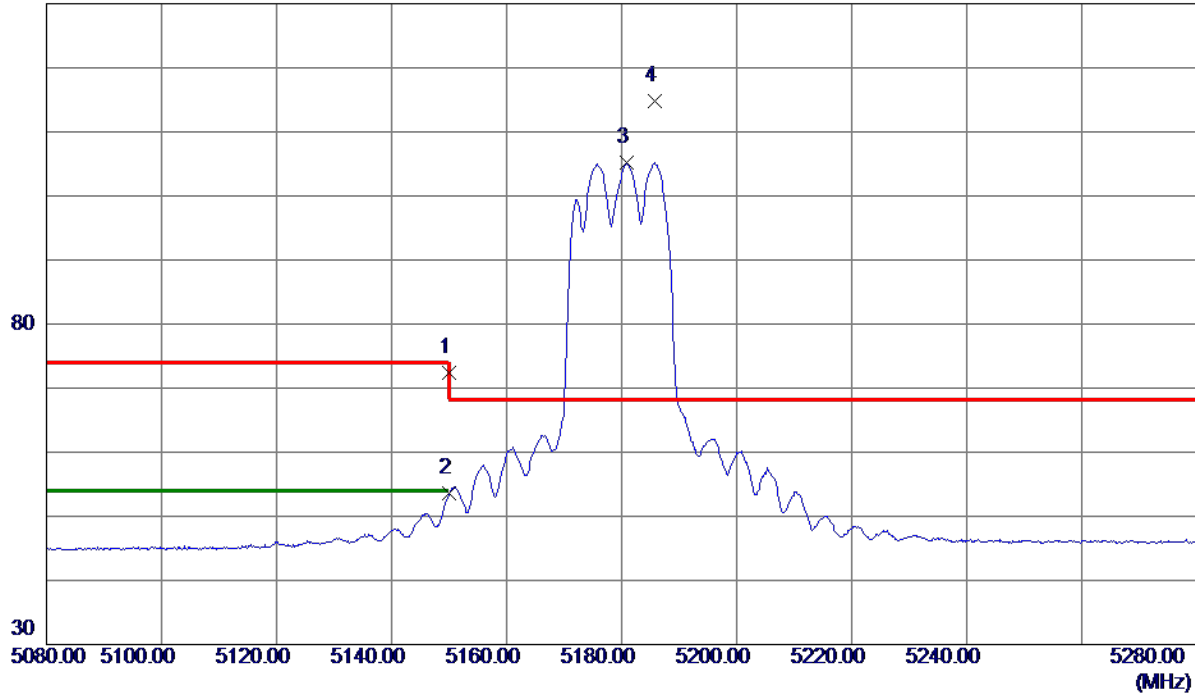

No.	Freq. MHz	Reading Level dBuV/m	Correct Factor dB	Measure ment dBuV/m	Limit dBuV/m	Margin dB	Detector	Comment
1	5150.0000	57.44	15.02	72.46	74.00	-1.54	Peak	
2	5150.0000	38.67	15.02	53.69	54.00	-0.31	AVG	
3	5180.9000	90.16	15.04	105.20	999.00	-893.80	AVG	No Limit
4 *	5185.7000	99.84	15.04	114.88	68.30	46.58	Peak	No Limit

REMARKS:

- (1) Measurement Value = Reading Level + Correct Factor.
- (2) Margin Level = Measurement Value - Limit Value.

Orthogonal Axis	X
Test Mode	UNII-1_TX A Mode 5180 MHz

Vertical

80 dBuV/m

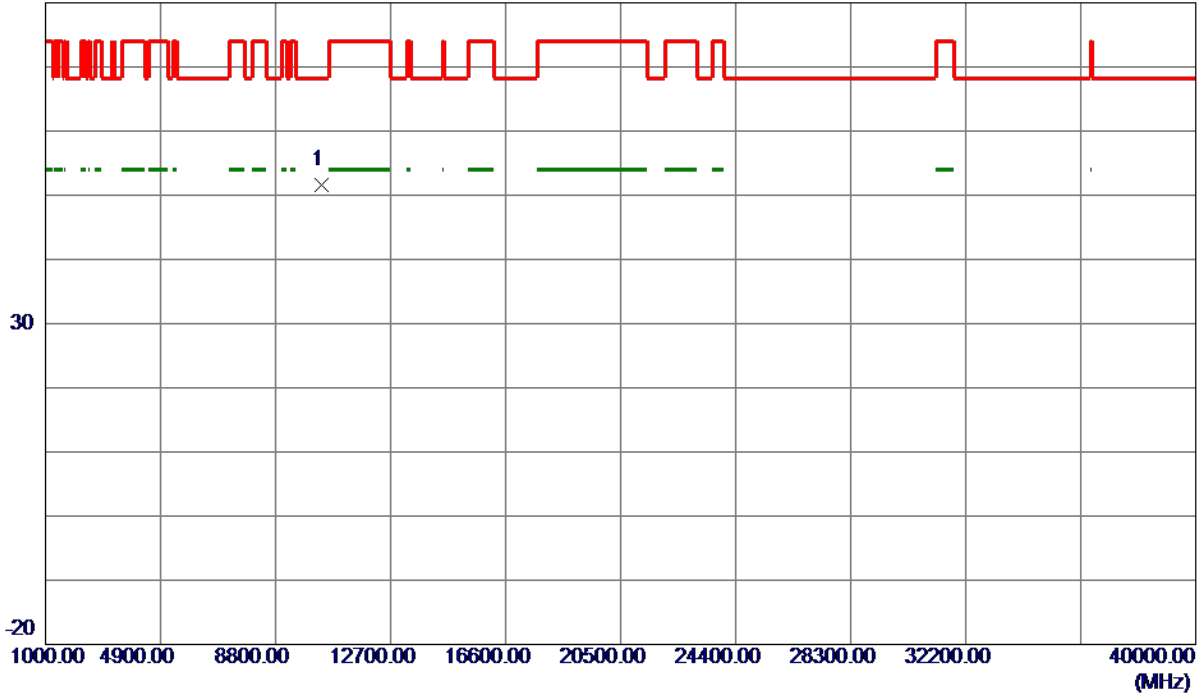

No.	Freq. MHz	Reading Level dBuV/m	Correct Factor dB	Measure ment dBuV/m	Limit dBuV/m	Margin dB	Detector	Comment
1 *	10361.7500	42.91	8.77	51.68	68.30	-16.62	Peak	

REMARKS:

- (1) Measurement Value = Reading Level + Correct Factor.
- (2) Margin Level = Measurement Value - Limit Value.

Orthogonal Axis	X
Test Mode	UNII-1_TX A Mode 5180 MHz

Horizontal

130 dBuV/m

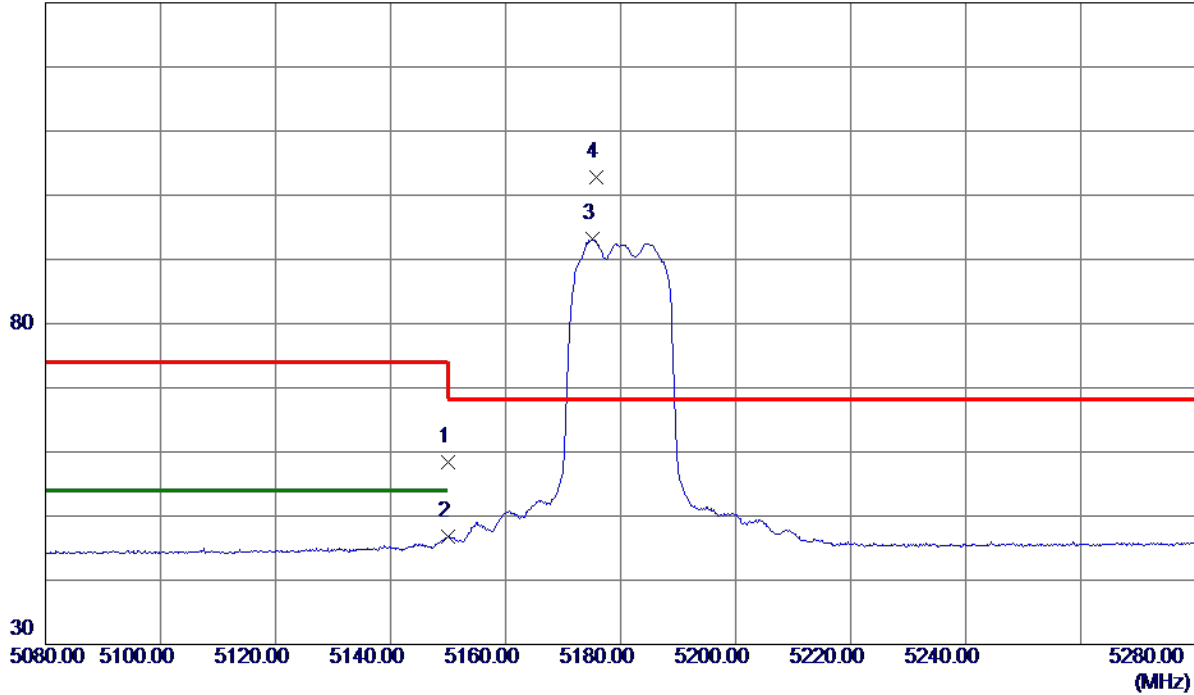

No.	Freq. MHz	Reading Level dBuV/m	Correct Factor dB	Measure ment dBuV/m	Limit dBuV/m	Margin dB	Detector	Comment
1	5150.0000	43.38	15.02	58.40	74.00	-15.60	Peak	
2	5150.0000	31.81	15.02	46.83	54.00	-7.17	AVG	
3	5175.2000	78.08	15.03	93.11	999.00	-905.89	AVG	No Limit
4 *	5175.8000	87.70	15.03	102.73	68.30	34.43	Peak	No Limit

REMARKS:

- (1) Measurement Value = Reading Level + Correct Factor.
- (2) Margin Level = Measurement Value - Limit Value.

Orthogonal Axis	X
Test Mode	UNII-1_TX A Mode 5180 MHz

Horizontal

80 dBuV/m

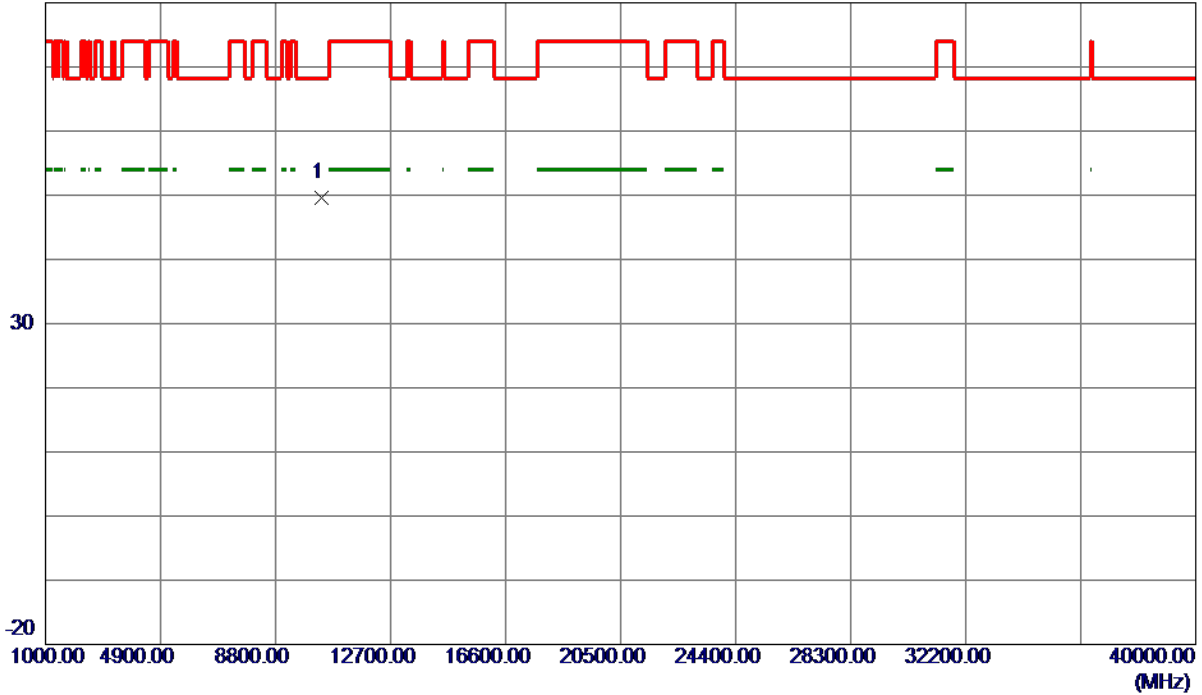

No.	Freq. MHz	Reading Level dBuV/m	Correct Factor dB	Measure ment dBuV/m	Limit dBuV/m	Margin dB	Detector	Comment
1 *	10360.2000	40.86	8.77	49.63	68.30	-18.67	Peak	

REMARKS:

- (1) Measurement Value = Reading Level + Correct Factor.
- (2) Margin Level = Measurement Value - Limit Value.

Orthogonal Axis	X
Test Mode	UNII-1_TX A Mode 5200 MHz

Vertical

130 dBuV/m

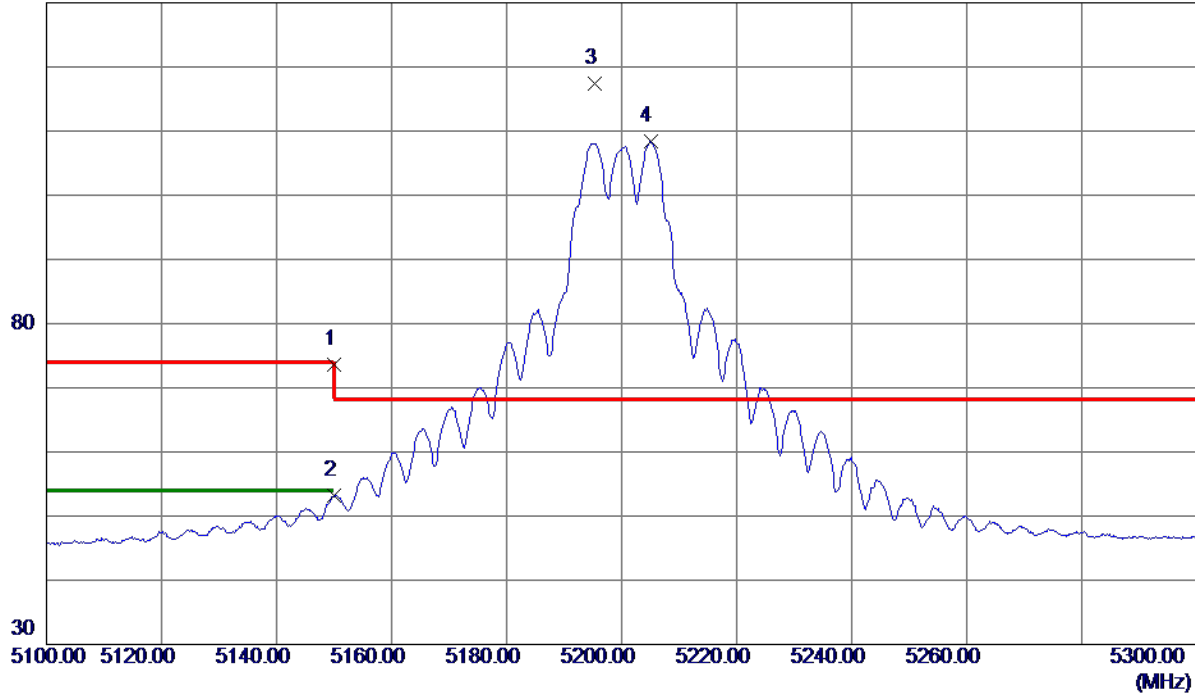

No.	Freq. MHz	Reading Level dBuV/m	Correct Factor dB	Measure ment dBuV/m	Limit dBuV/m	Margin dB	Detector	Comment
1	5150.0000	58.54	15.02	73.56	74.00	-0.44	Peak	
2	5150.0000	38.09	15.02	53.11	54.00	-0.89	AVG	
3 *	5195.3000	102.34	15.05	117.39	68.30	49.09	Peak	No Limit
4	5205.0000	93.33	15.05	108.38	999.00	-890.62	AVG	No Limit

REMARKS:

- (1) Measurement Value = Reading Level + Correct Factor.
- (2) Margin Level = Measurement Value - Limit Value.

Orthogonal Axis	X
Test Mode	UNII-1_TX A Mode 5200 MHz

Vertical

80 dBuV/m

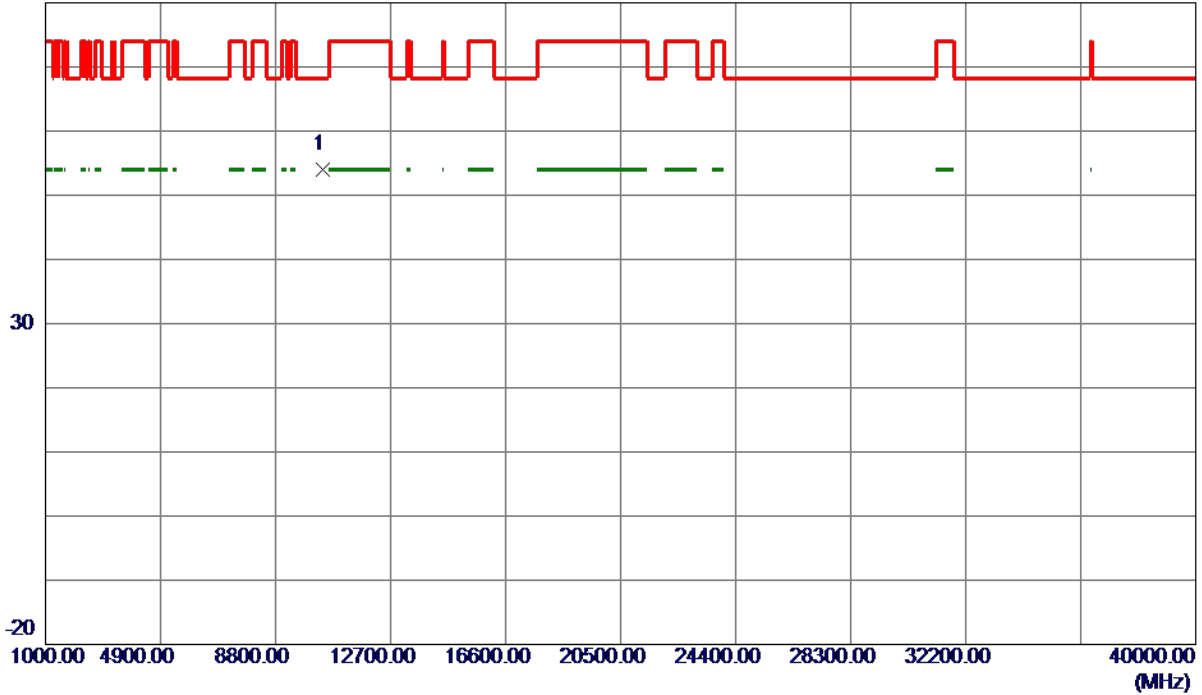

No.	Freq. MHz	Reading Level dBuV/m	Correct Factor dB	Measure ment dBuV/m	Limit dBuV/m	Margin dB	Detector	Comment
1 *	10401.3600	45.13	8.85	53.98	68.30	-14.32	Peak	

REMARKS:

- (1) Measurement Value = Reading Level + Correct Factor.
- (2) Margin Level = Measurement Value - Limit Value.

Orthogonal Axis	X
Test Mode	UNII-1_TX A Mode 5200 MHz

Horizontal

130 dBuV/m

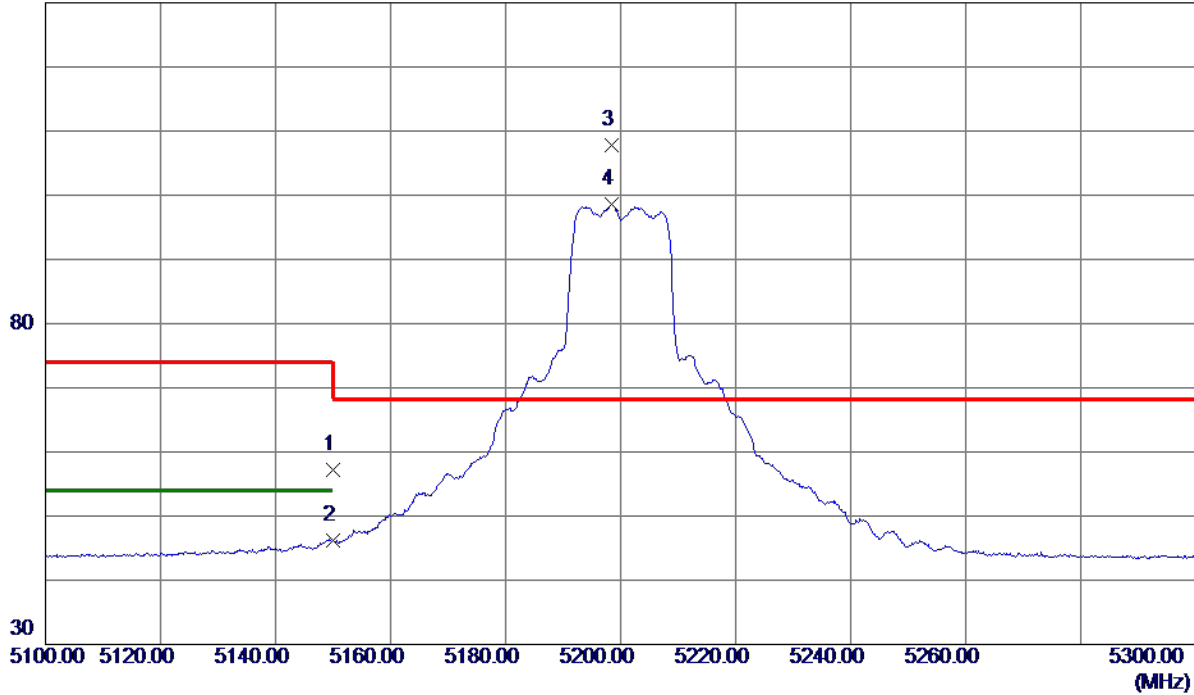

No.	Freq. MHz	Reading Level dBuV/m	Correct Factor dB	Measure ment dBuV/m	Limit dBuV/m	Margin dB	Detector	Comment
1	5150.0000	42.16	15.02	57.18	74.00	-16.82	Peak	
2	5150.0000	31.21	15.02	46.23	54.00	-7.77	AVG	
3 *	5198.4000	92.70	15.05	107.75	68.30	39.45	Peak	No Limit
4	5198.4000	83.56	15.05	98.61	999.00	-900.39	AVG	No Limit

REMARKS:

- (1) Measurement Value = Reading Level + Correct Factor.
- (2) Margin Level = Measurement Value - Limit Value.

Orthogonal Axis	X
Test Mode	UNII-1_TX A Mode 5200 MHz

Horizontal

80 dBuV/m

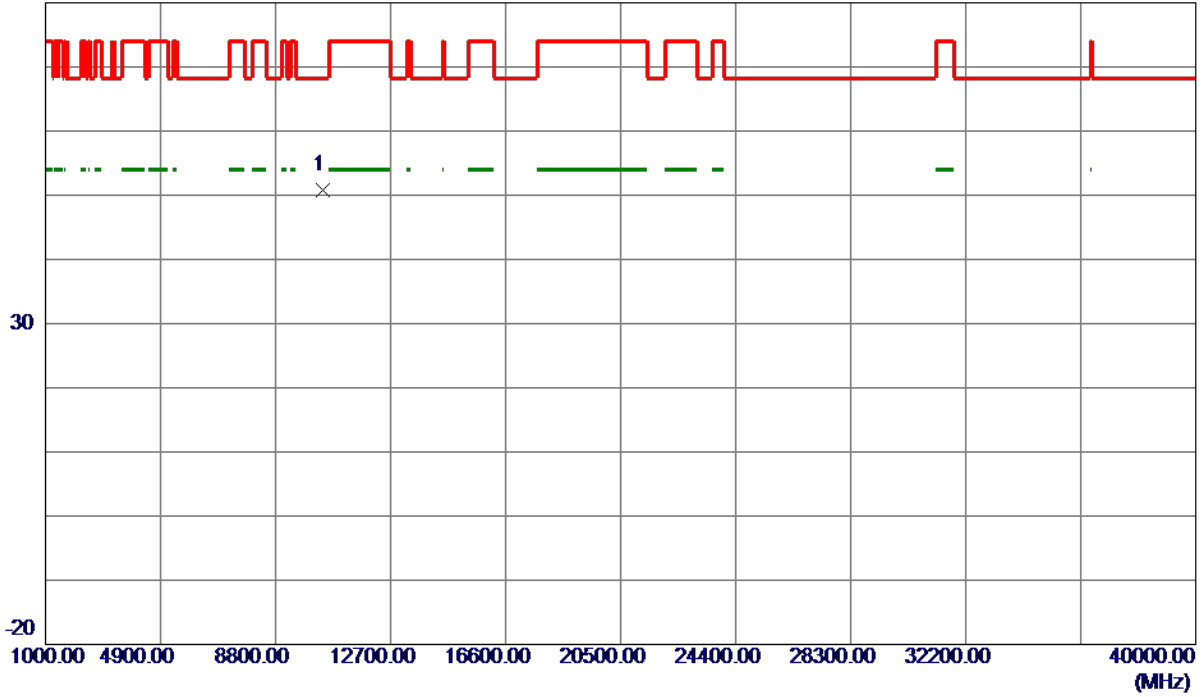

No.	Freq. MHz	Reading Level dBuV/m	Correct Factor dB	Measure ment dBuV/m	Limit dBuV/m	Margin dB	Detector	Comment
1 *	10400.0500	41.94	8.85	50.79	68.30	-17.51	Peak	

REMARKS:

- (1) Measurement Value = Reading Level + Correct Factor.
- (2) Margin Level = Measurement Value - Limit Value.

Orthogonal Axis	X
Test Mode	UNII-1_TX A Mode 5240 MHz

Vertical

130 dBuV/m

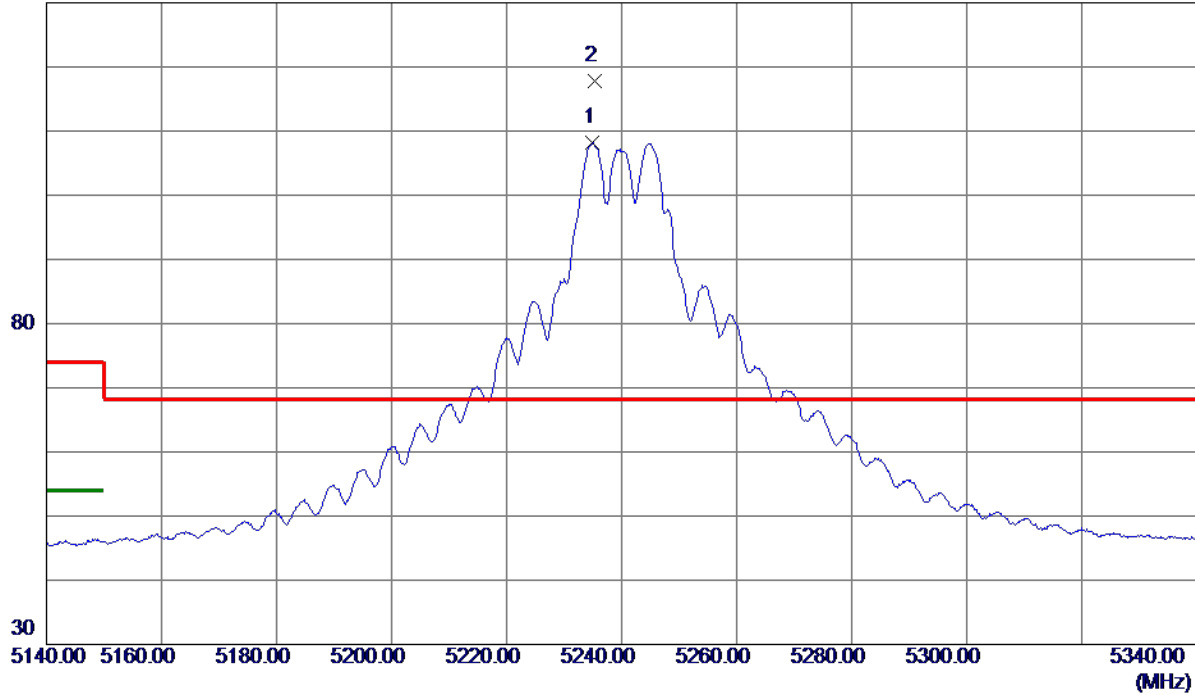

No.	Freq. MHz	Reading Level dBuV/m	Correct Factor dB	Measure ment dBuV/m	Limit dBuV/m	Margin dB	Detector	Comment
1	5235.0000	93.05	15.07	108.12	999.00	-890.88	AVG	No Limit
2 *	5235.3000	102.74	15.07	117.81	68.30	49.51	Peak	No Limit

REMARKS:

- (1) Measurement Value = Reading Level + Correct Factor.
- (2) Margin Level = Measurement Value - Limit Value.

Orthogonal Axis	X
Test Mode	UNII-1_TX A Mode 5240 MHz

Vertical

80 dBuV/m

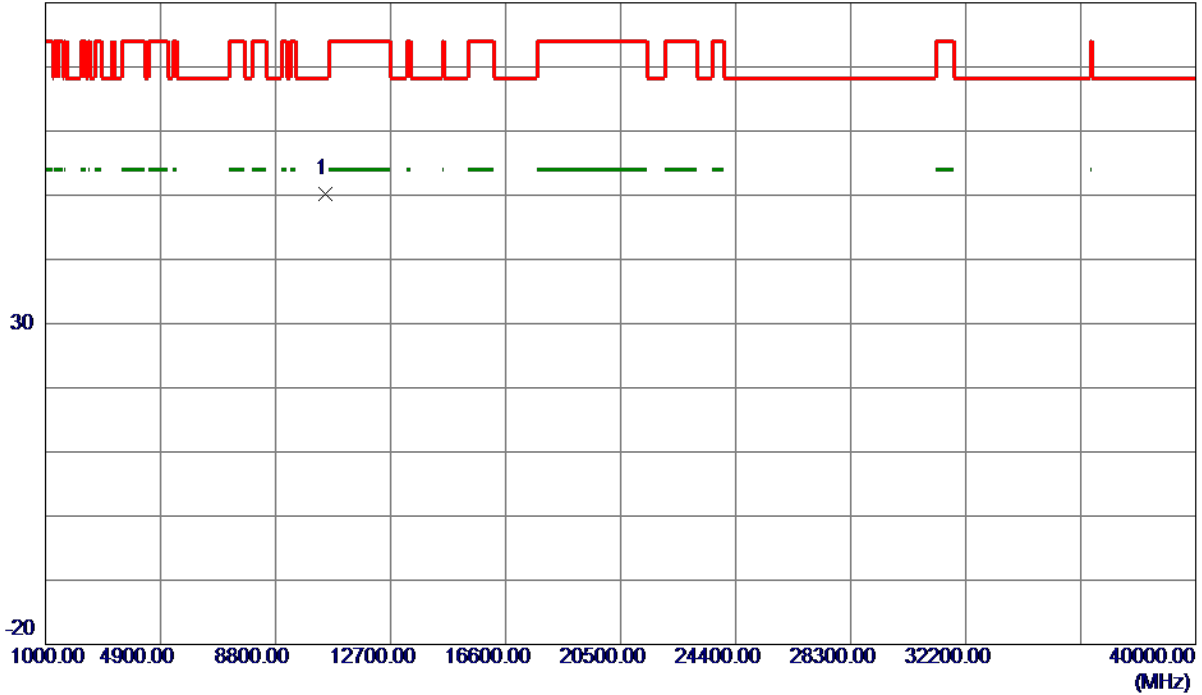

No.	Freq. MHz	Reading Level dBuV/m	Correct Factor dB	Measure ment dBuV/m	Limit dBuV/m	Margin dB	Detector	Comment
1 *	10482.3700	41.24	9.02	50.26	68.30	-18.04	Peak	

REMARKS:

- (1) Measurement Value = Reading Level + Correct Factor.
- (2) Margin Level = Measurement Value - Limit Value.

Orthogonal Axis	X
Test Mode	UNII-1_TX A Mode 5240 MHz

Horizontal

130 dBuV/m



No.	Freq. MHz	Reading Level dBuV/m	Correct Factor dB	Measure ment dBuV/m	Limit dBuV/m	Margin dB	Detector	Comment
1 *	5237.7000	94.35	15.08	109.43	68.30	41.13	Peak	No Limit
2	5247.1000	84.68	15.08	99.76	999.00	-899.24	AVG	No Limit

REMARKS:

- (1) Measurement Value = Reading Level + Correct Factor.
- (2) Margin Level = Measurement Value - Limit Value.

Orthogonal Axis	X
Test Mode	UNII-1_TX A Mode 5240 MHz

Horizontal

80 dBuV/m

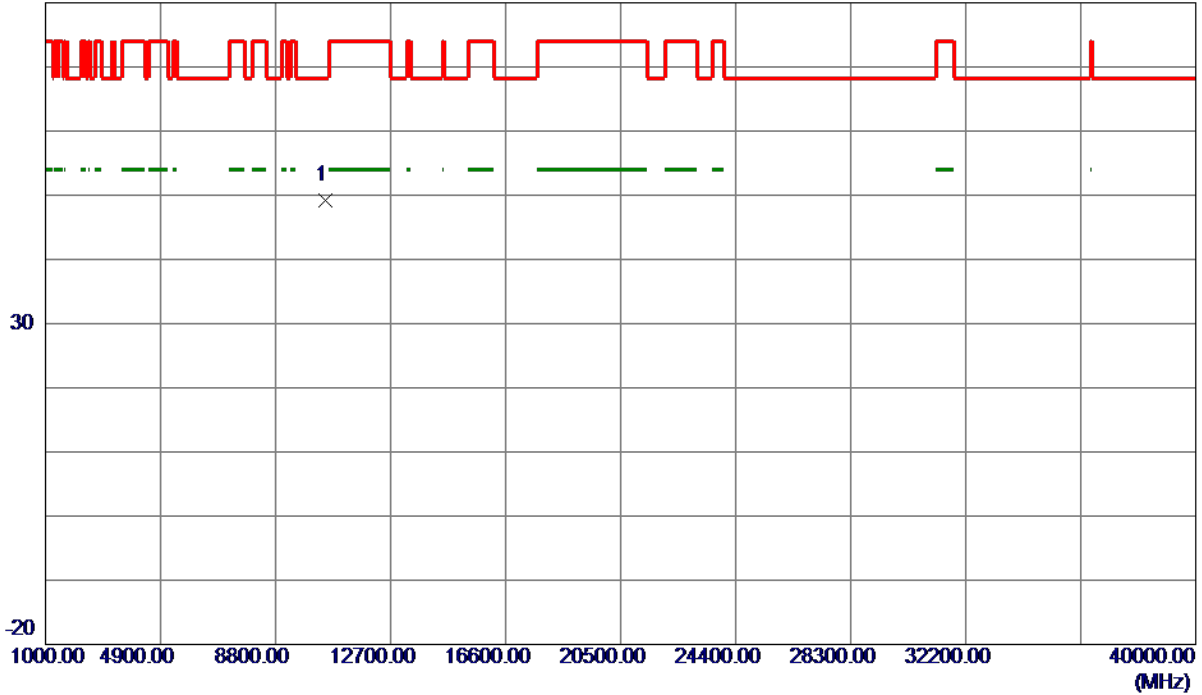

No.	Freq. MHz	Reading Level dBuV/m	Correct Factor dB	Measure ment dBuV/m	Limit dBuV/m	Margin dB	Detector	Comment
1 *	10481.4500	40.18	9.02	49.20	68.30	-19.10	Peak	

REMARKS:

- (1) Measurement Value = Reading Level + Correct Factor.
- (2) Margin Level = Measurement Value - Limit Value.

Orthogonal Axis	X
Test Mode	UNII-3_TX A Mode 5745 MHz

Vertical

130 dBuV/m

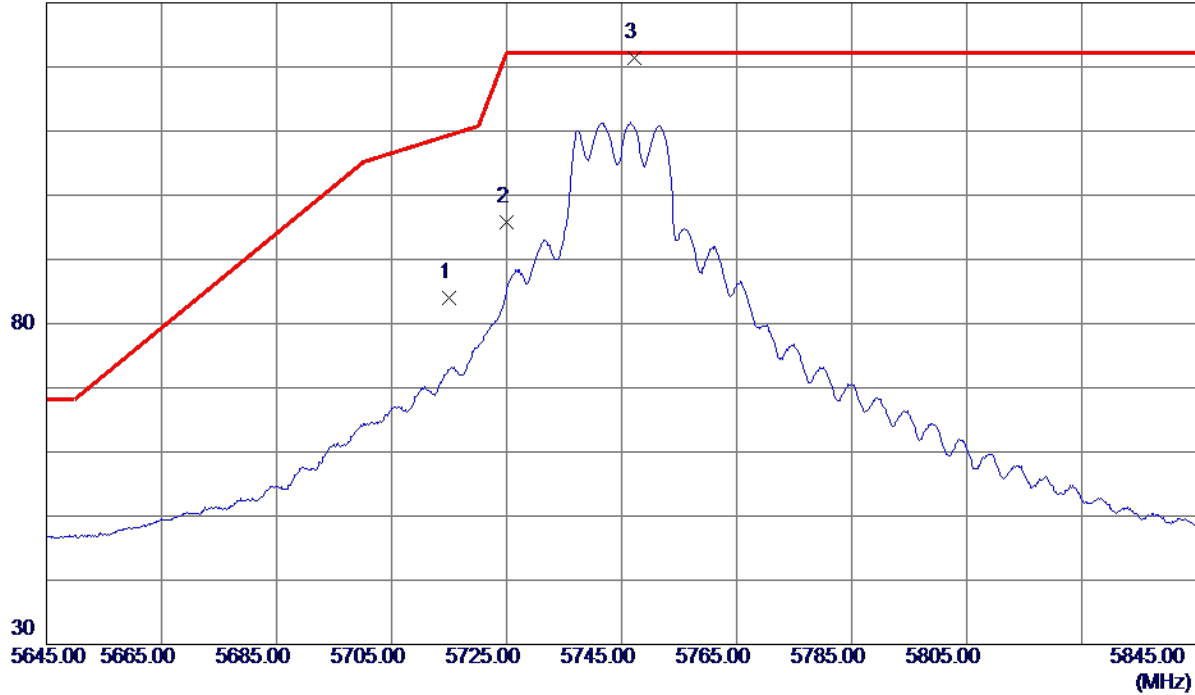

No.	Freq. MHz	Reading Level dBuV/m	Correct Factor dB	Measure ment dBuV/m	Limit dBuV/m	Margin dB	Detector	Comment
1	5715.0000	68.37	15.65	84.02	109.40	-25.38	Peak	
2	5725.0000	80.14	15.67	95.81	122.20	-26.39	Peak	
3 *	5747.2000	105.68	15.71	121.39	122.20	-0.81	Peak	No Limit

REMARKS:

- (1) Measurement Value = Reading Level + Correct Factor.
- (2) Margin Level = Measurement Value - Limit Value.

Orthogonal Axis	X
Test Mode	UNII-3_TX A Mode 5745 MHz

Vertical

80 dBuV/m

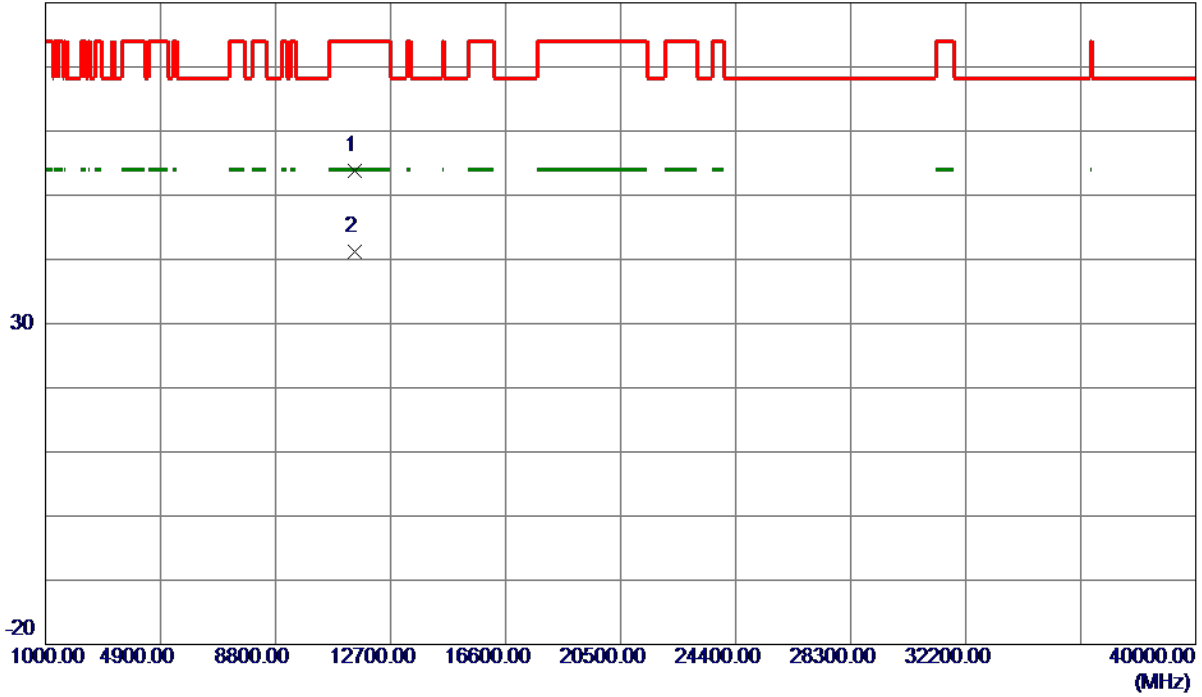

No.	Freq. MHz	Reading Level dBuV/m	Correct Factor dB	Measure ment dBuV/m	Limit dBuV/m	Margin dB	Detector	Comment
1	11483.6000	42.70	11.08	53.78	74.00	-20.22	Peak	
2 *	11488.2250	30.20	11.09	41.29	54.00	-12.71	AVG	

REMARKS:

- (1) Measurement Value = Reading Level + Correct Factor.
- (2) Margin Level = Measurement Value - Limit Value.

Orthogonal Axis	X
Test Mode	UNII-3_TX A Mode 5745 MHz

Horizontal

130 dBuV/m

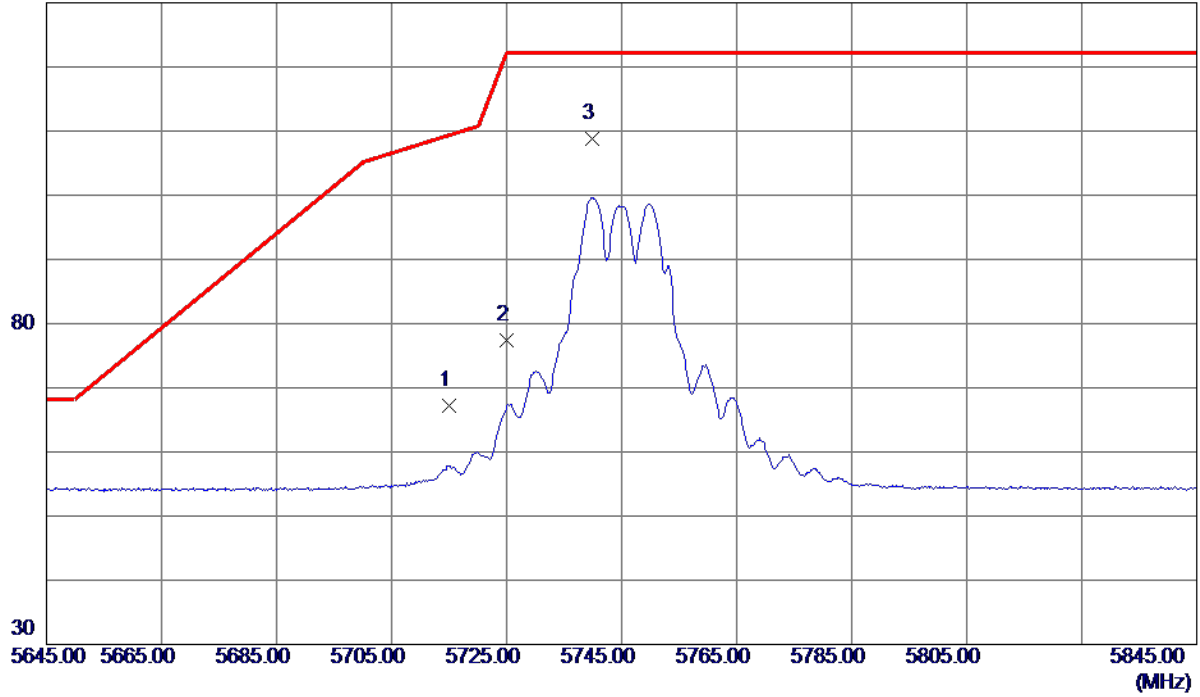

No.	Freq. MHz	Reading Level dBuV/m	Correct Factor dB	Measure ment dBuV/m	Limit dBuV/m	Margin dB	Detector	Comment
1	5715.0000	51.46	15.65	67.11	109.40	-42.29	Peak	
2	5725.0000	61.66	15.67	77.33	122.20	-44.87	Peak	
3 *	5739.8000	93.12	15.70	108.82	122.20	-13.38	Peak	No Limit

REMARKS:

- (1) Measurement Value = Reading Level + Correct Factor.
- (2) Margin Level = Measurement Value - Limit Value.

Orthogonal Axis	X
Test Mode	UNII-3_TX A Mode 5745 MHz

Horizontal

80 dBuV/m

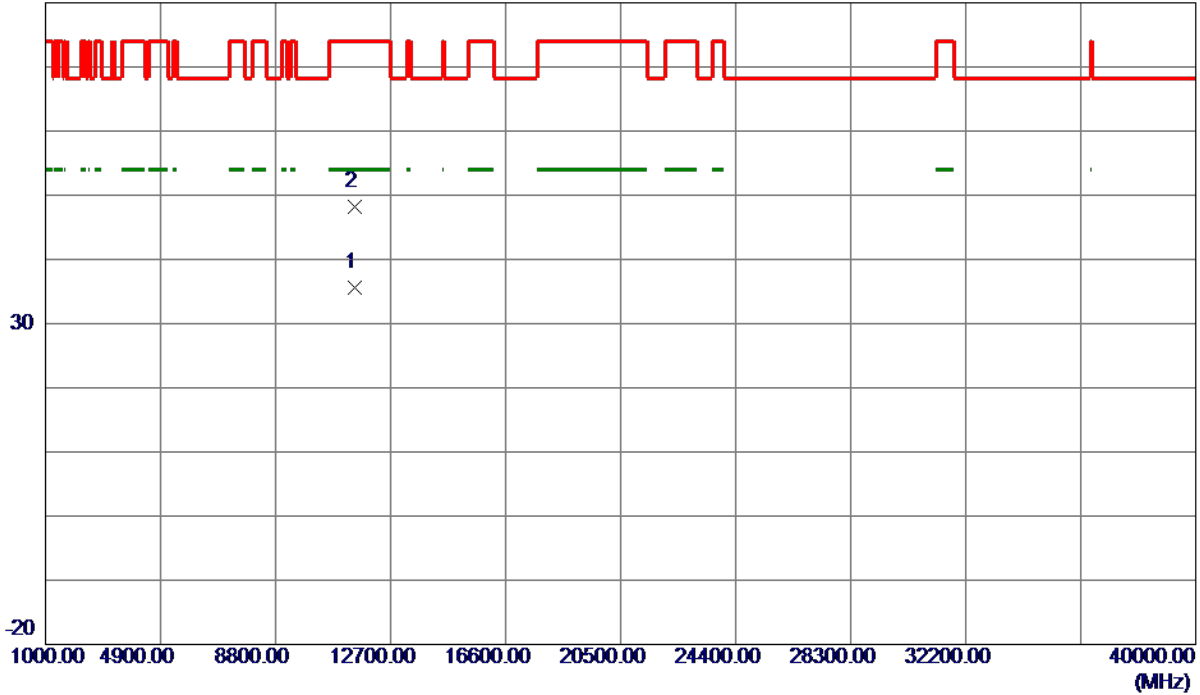

No.	Freq. MHz	Reading Level dBuV/m	Correct Factor dB	Measure ment dBuV/m	Limit dBuV/m	Margin dB	Detector	Comment
1 *	11489.2000	24.49	11.10	35.59	54.00	-18.41	AVG	
2	11494.0750	37.17	11.11	48.28	74.00	-25.72	Peak	

REMARKS:

- (1) Measurement Value = Reading Level + Correct Factor.
- (2) Margin Level = Measurement Value - Limit Value.

Orthogonal Axis	X
Test Mode	UNII-3_TX A Mode 5785 MHz

Vertical

130 dBuV/m

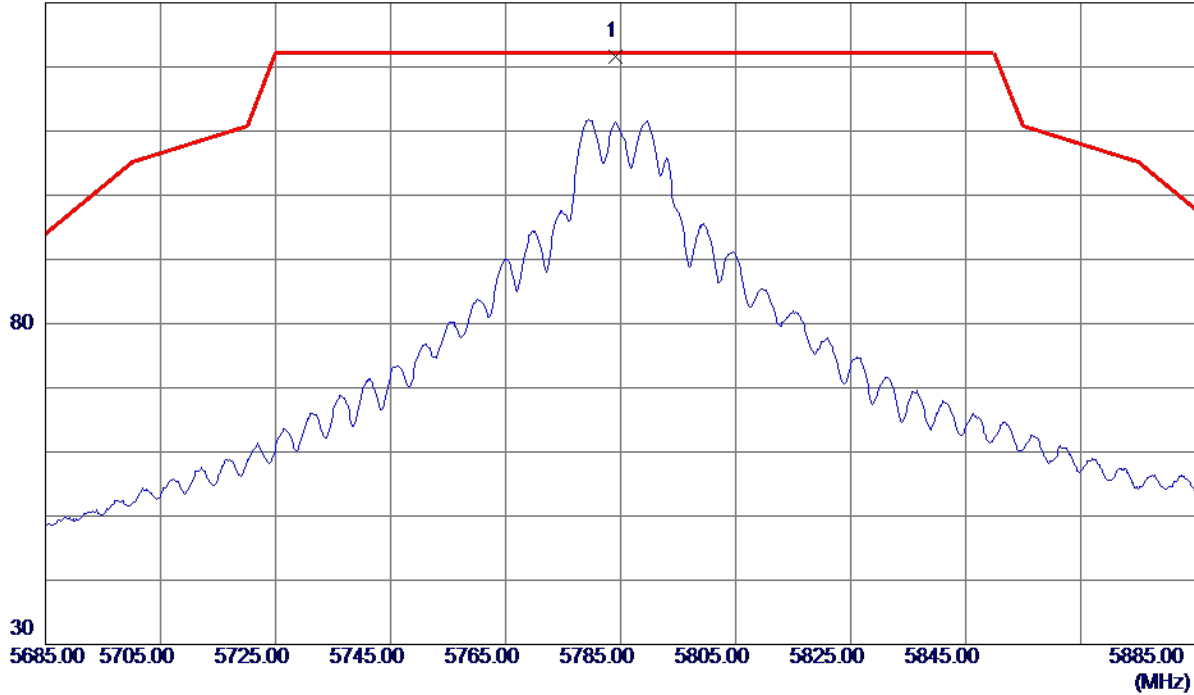

No.	Freq. MHz	Reading Level dBuV/m	Correct Factor dB	Measure ment dBuV/m	Limit dBuV/m	Margin dB	Detector	Comment
1 *	5784.1000	105.77	15.78	121.55	122.20	-0.65	Peak	No Limit

REMARKS:

- (1) Measurement Value = Reading Level + Correct Factor.
- (2) Margin Level = Measurement Value - Limit Value.

Orthogonal Axis	X
Test Mode	UNII-3_TX A Mode 5785 MHz

Vertical

80 dBuV/m

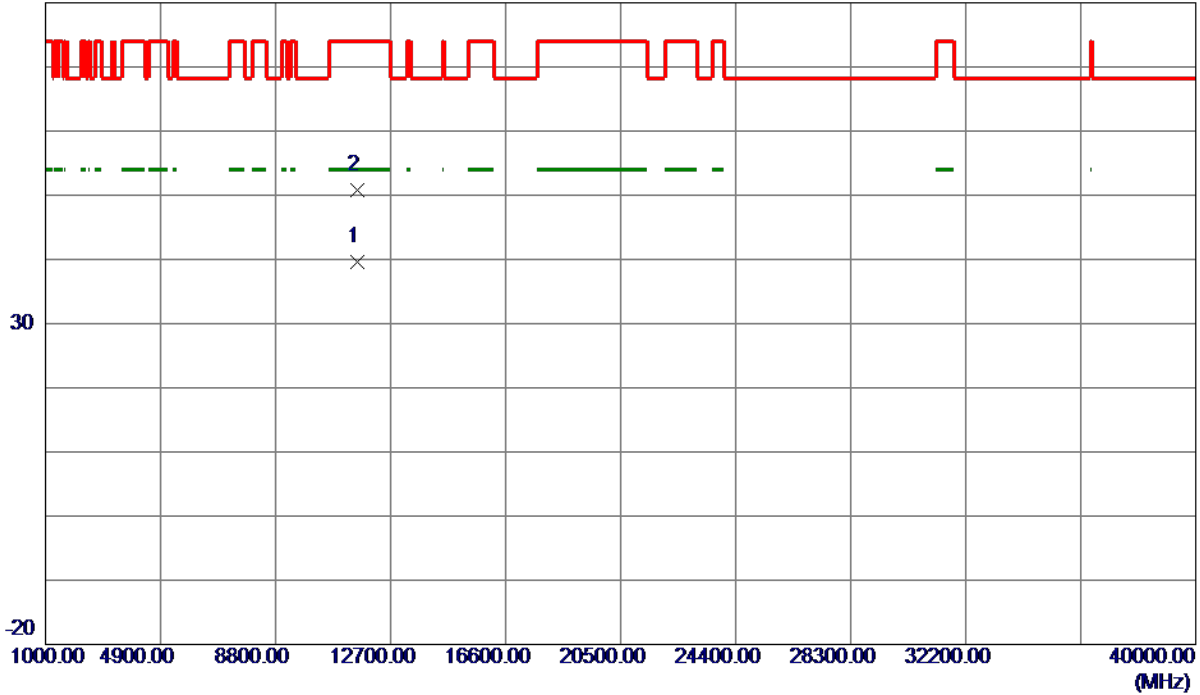

No.	Freq. MHz	Reading Level dBuV/m	Correct Factor dB	Measure ment dBuV/m	Limit dBuV/m	Margin dB	Detector	Comment
1 *	11570.2500	28.40	11.22	39.62	54.00	-14.38	AVG	
2	11575.9750	39.65	11.23	50.88	74.00	-23.12	Peak	

REMARKS:

- (1) Measurement Value = Reading Level + Correct Factor.
- (2) Margin Level = Measurement Value - Limit Value.

Orthogonal Axis	X
Test Mode	UNII-3_TX A Mode 5785 MHz

Horizontal

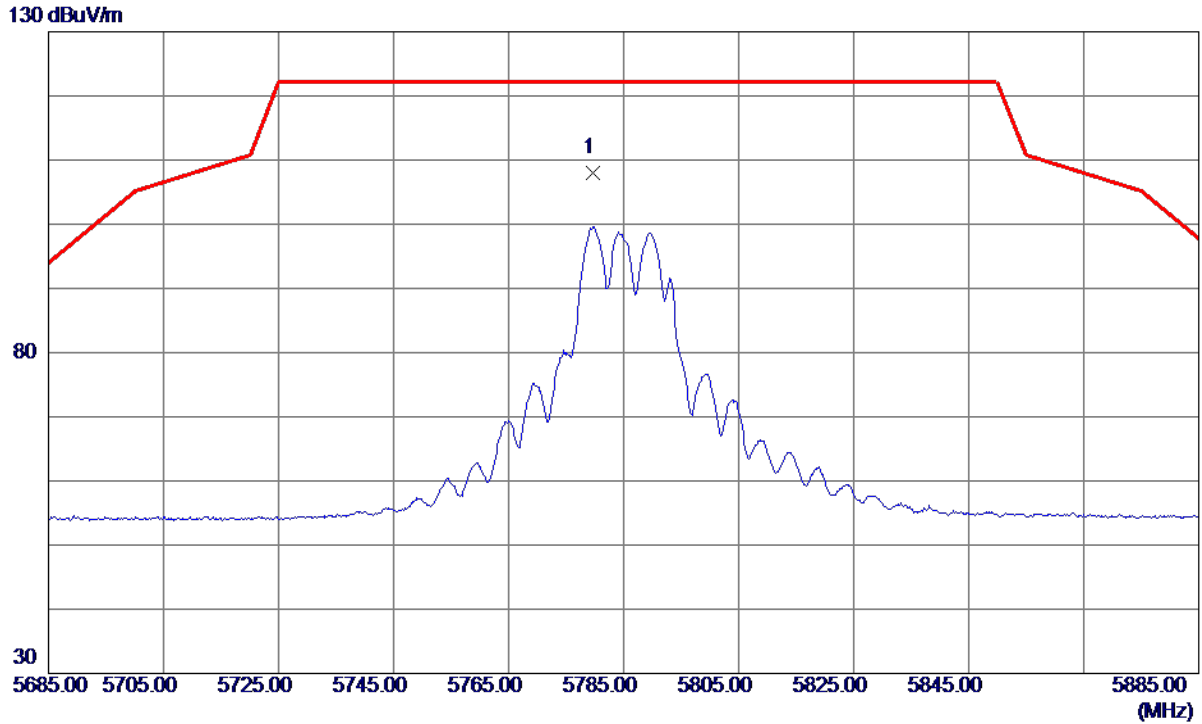

No.	Freq. MHz	Reading Level dBuV/m	Correct Factor dB	Measure ment dBuV/m	Limit dBuV/m	Margin dB	Detector	Comment
1 *	5779.7000	92.25	15.77	108.02	122.20	-14.18	Peak	No Limit

REMARKS:

- (1) Measurement Value = Reading Level + Correct Factor.
- (2) Margin Level = Measurement Value - Limit Value.

Orthogonal Axis	X
Test Mode	UNII-3_TX A Mode 5785 MHz

Horizontal

80 dBuV/m

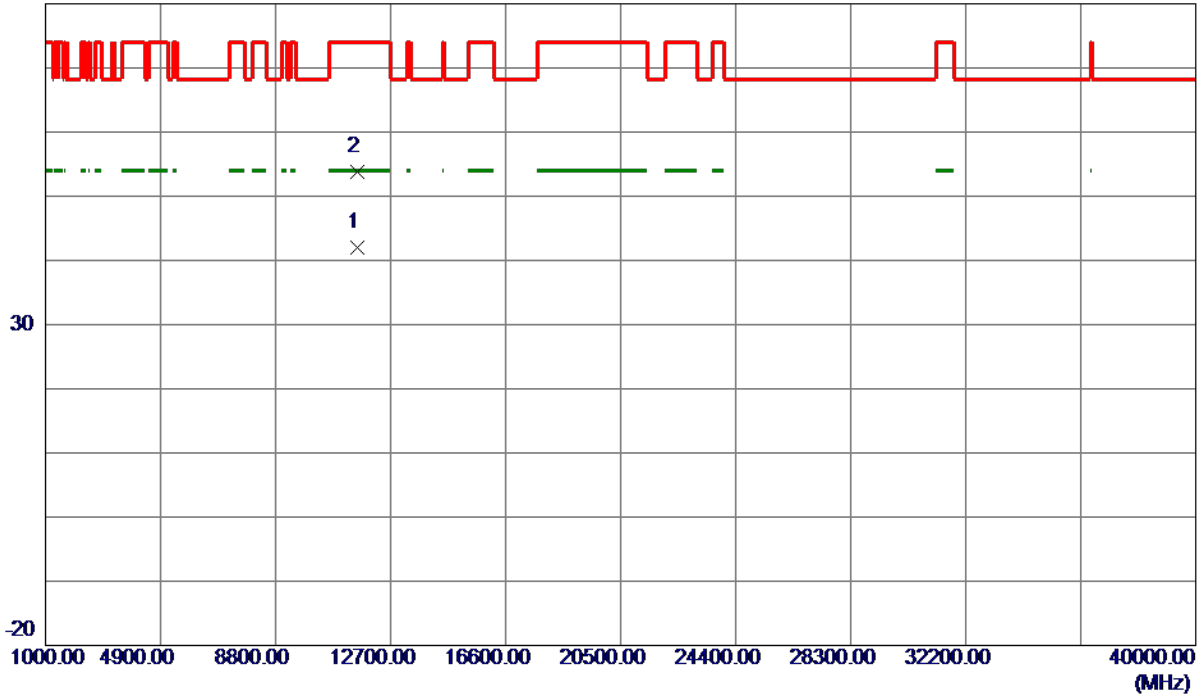

No.	Freq. MHz	Reading Level dBuV/m	Correct Factor dB	Measure ment dBuV/m	Limit dBuV/m	Margin dB	Detector	Comment
1 *	11575.0000	30.86	11.23	42.09	54.00	-11.91	AVG	
2	11579.2000	42.66	11.23	53.89	74.00	-20.11	Peak	

REMARKS:

- (1) Measurement Value = Reading Level + Correct Factor.
- (2) Margin Level = Measurement Value - Limit Value.

Orthogonal Axis	X
Test Mode	UNII-3_TX A Mode 5825 MHz

Vertical

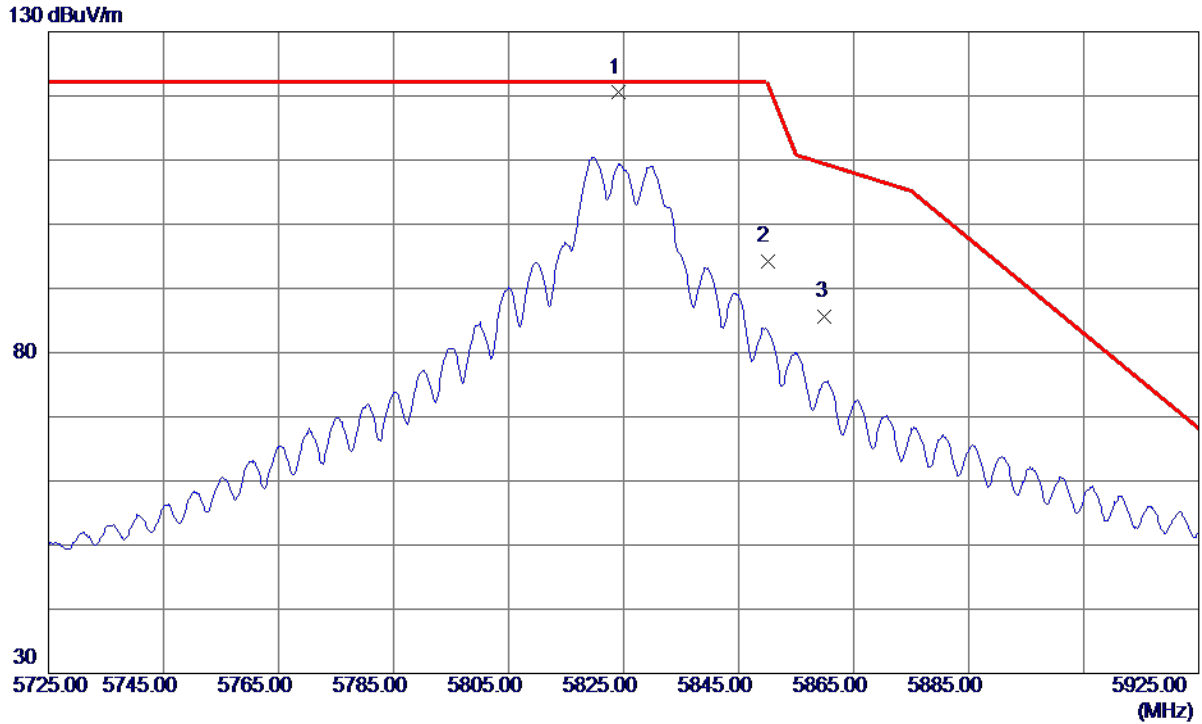

No.	Freq. MHz	Reading Level dBuV/m	Correct Factor dB	Measure ment dBuV/m	Limit dBuV/m	Margin dB	Detector	Comment
1 *	5824.1000	104.65	15.85	120.50	122.20	-1.70	Peak	No Limit
2	5850.0000	78.26	15.90	94.16	122.20	-28.04	Peak	
3	5860.0000	69.69	15.92	85.61	109.40	-23.79	Peak	

REMARKS:

- (1) Measurement Value = Reading Level + Correct Factor.
- (2) Margin Level = Measurement Value - Limit Value.

Orthogonal Axis	X
Test Mode	UNII-3_TX A Mode 5825 MHz

Vertical

80 dBuV/m

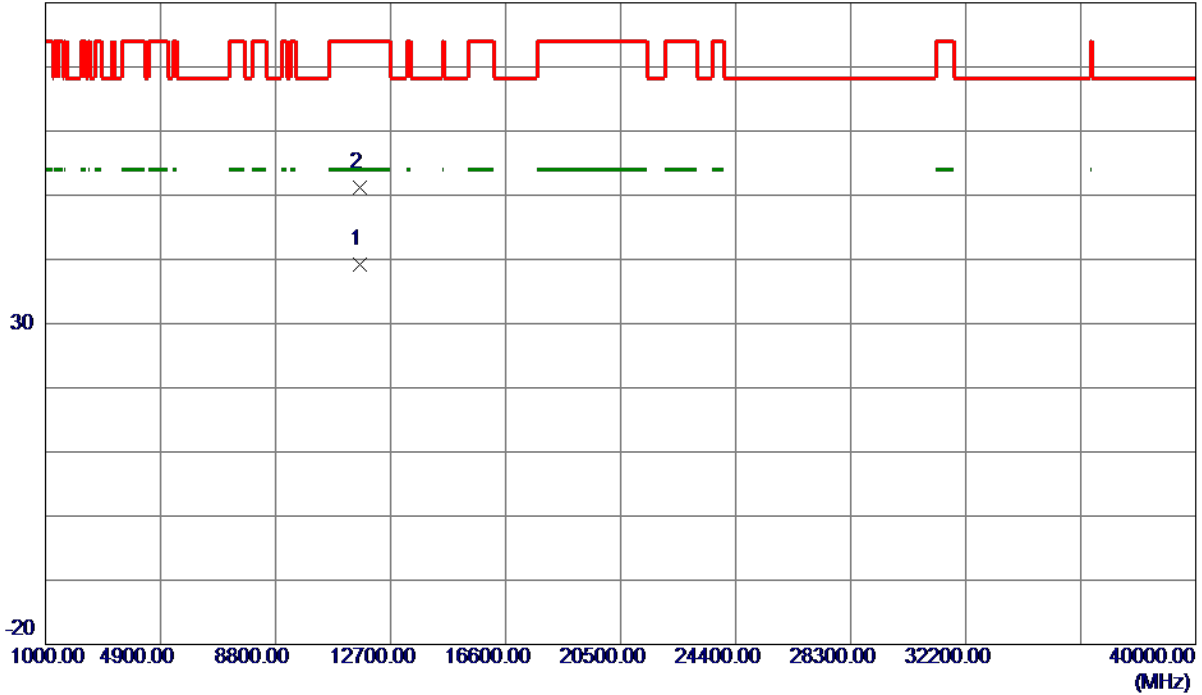

No.	Freq. MHz	Reading Level dBuV/m	Correct Factor dB	Measure ment dBuV/m	Limit dBuV/m	Margin dB	Detector	Comment
1 *	11646.1000	27.88	11.32	39.20	54.00	-14.80	AVG	
2	11651.2500	39.78	11.33	51.11	74.00	-22.89	Peak	

REMARKS:

- (1) Measurement Value = Reading Level + Correct Factor.
- (2) Margin Level = Measurement Value - Limit Value.

Orthogonal Axis	X
Test Mode	UNII-3_TX A Mode 5825 MHz

Horizontal

130 dBuV/m

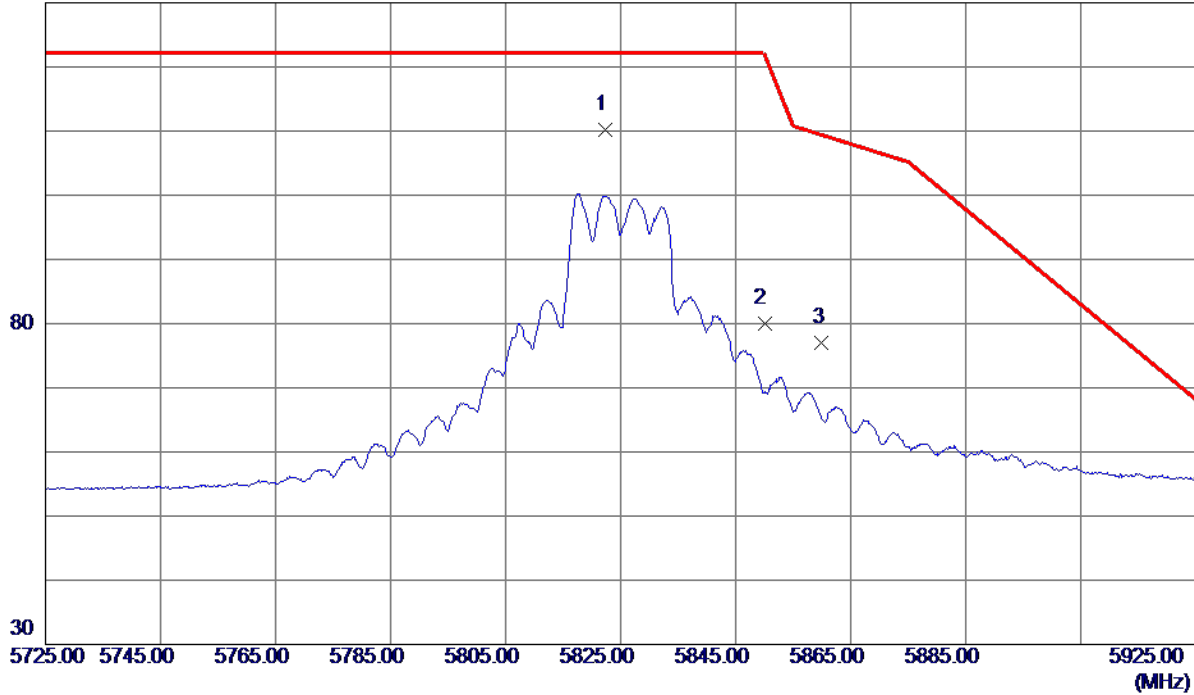

No.	Freq. MHz	Reading Level dBuV/m	Correct Factor dB	Measure ment dBuV/m	Limit dBuV/m	Margin dB	Detector	Comment
1 *	5822.4000	94.37	15.85	110.22	122.20	-11.98	Peak	No Limit
2	5850.0000	64.04	15.90	79.94	122.20	-42.26	Peak	
3	5860.0000	61.14	15.92	77.06	109.40	-32.34	Peak	

REMARKS:

- (1) Measurement Value = Reading Level + Correct Factor.
- (2) Margin Level = Measurement Value - Limit Value.

Orthogonal Axis	X
Test Mode	UNII-3_TX A Mode 5825 MHz

Horizontal

80 dBuV/m

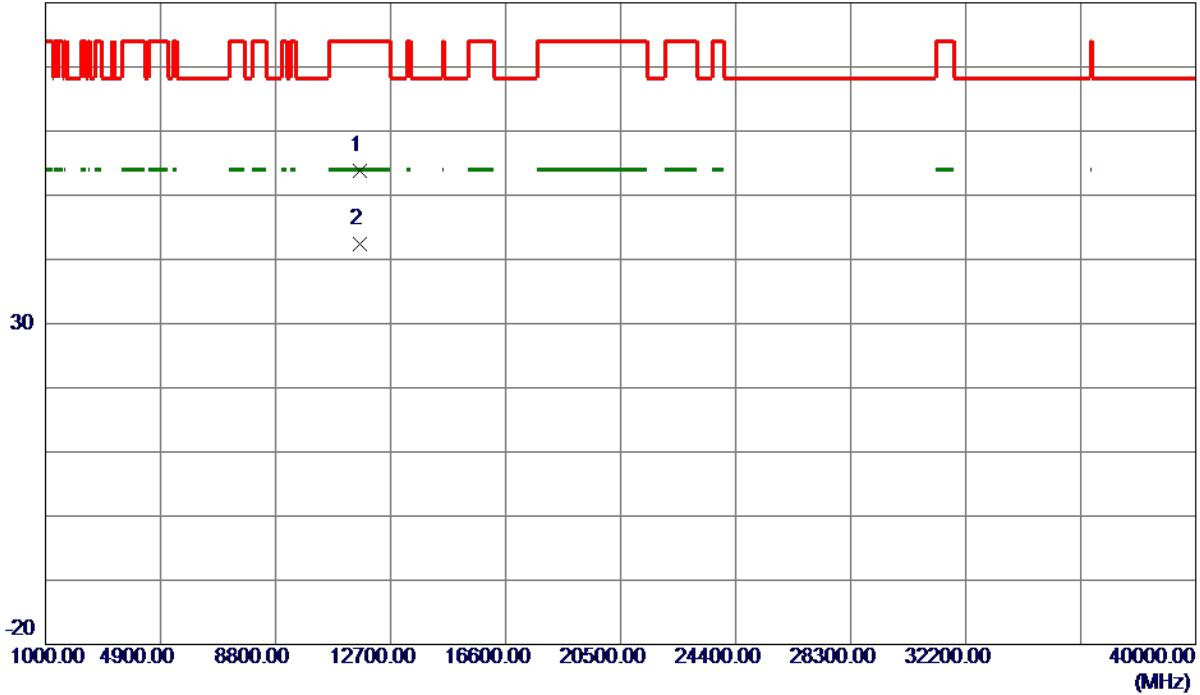

No.	Freq. MHz	Reading Level dBuV/m	Correct Factor dB	Measurement dBuV/m	Limit dBuV/m	Margin dB	Detector	Comment
1	11644.2000	42.41	11.32	53.73	74.00	-20.27	Peak	
2 *	11650.5500	31.03	11.33	42.36	54.00	-11.64	AVG	

REMARKS:

- (1) Measurement Value = Reading Level + Correct Factor.
- (2) Margin Level = Measurement Value - Limit Value.

Orthogonal Axis	X
Test Mode	UNII-1_TX AC (VHT20) Mode 5180 MHz

Vertical

130 dBuV/m

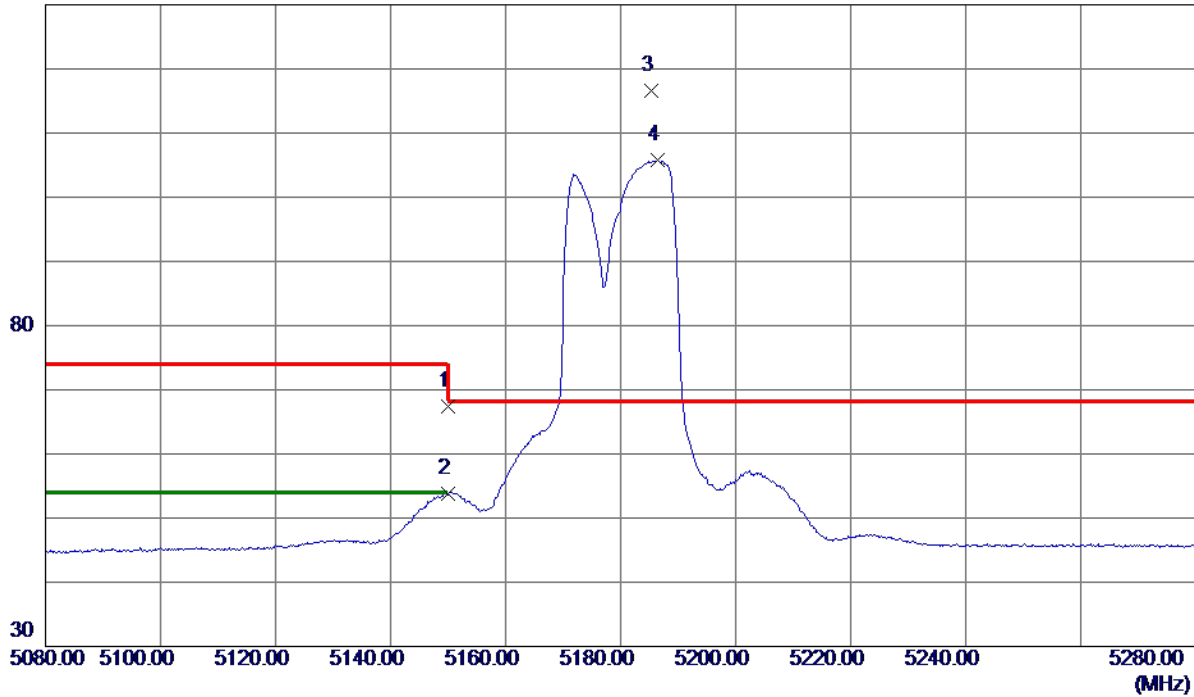

No.	Freq. MHz	Reading Level dBuV/m	Correct Factor dB	Measure ment dBuV/m	Limit dBuV/m	Margin dB	Detector	Comment
1	5150.0000	52.33	15.02	67.35	74.00	-6.65	Peak	
2	5150.0000	38.86	15.02	53.88	54.00	-0.12	AVG	
3 *	5185.4000	101.59	15.04	116.63	68.30	48.33	Peak	No Limit
4	5186.4000	90.70	15.04	105.74	999.00	-893.26	AVG	No Limit

REMARKS:

- (1) Measurement Value = Reading Level + Correct Factor.
- (2) Margin Level = Measurement Value - Limit Value.

Orthogonal Axis	X
Test Mode	UNII-1_TX AC (VHT20) Mode 5180 MHz

Vertical

80 dBuV/m

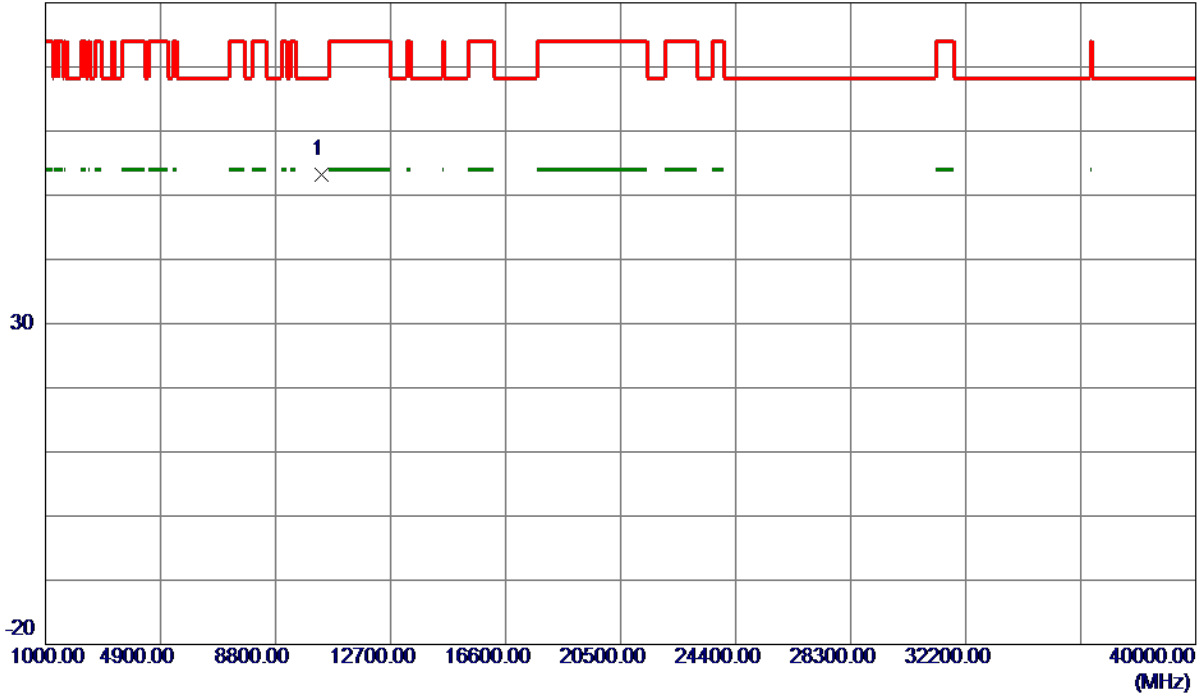

No.	Freq. MHz	Reading Level dBuV/m	Correct Factor dB	Measure ment dBuV/m	Limit dBuV/m	Margin dB	Detector	Comment
1 *	10361.7300	44.47	8.77	53.24	68.30	-15.06	Peak	

REMARKS:

- (1) Measurement Value = Reading Level + Correct Factor.
- (2) Margin Level = Measurement Value - Limit Value.

Orthogonal Axis	X
Test Mode	UNII-1_TX AC (VHT20) Mode 5180 MHz

Horizontal

130 dBuV/m

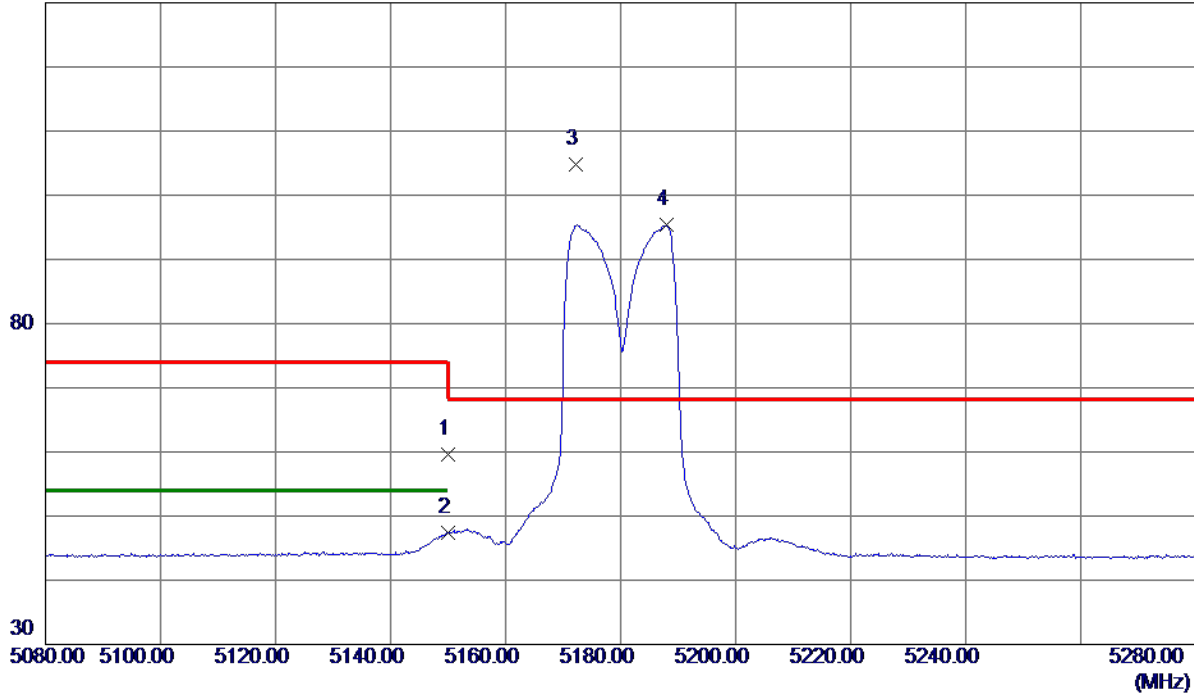

No.	Freq. MHz	Reading Level dBuV/m	Correct Factor dB	Measure ment dBuV/m	Limit dBuV/m	Margin dB	Detector	Comment
1	5150.0000	44.62	15.02	59.64	74.00	-14.36	Peak	
2	5150.0000	32.42	15.02	47.44	54.00	-6.56	AVG	
3 *	5172.2000	89.68	15.03	104.71	68.30	36.41	Peak	No Limit
4	5187.9000	80.42	15.04	95.46	999.00	-903.54	AVG	No Limit

REMARKS:

- (1) Measurement Value = Reading Level + Correct Factor.
- (2) Margin Level = Measurement Value - Limit Value.

Orthogonal Axis	X
Test Mode	UNII-1_TX AC (VHT20) Mode 5180 MHz

Horizontal

80 dBuV/m

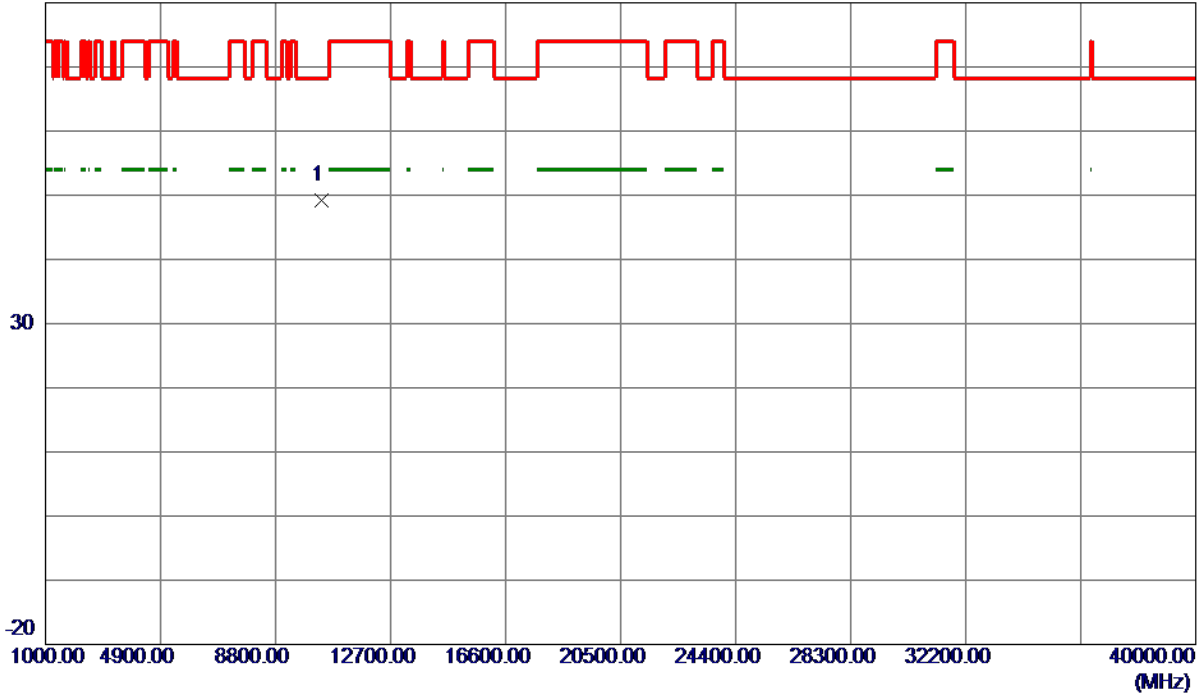

No.	Freq. MHz	Reading Level dBuV/m	Correct Factor dB	Measure ment dBuV/m	Limit dBuV/m	Margin dB	Detector	Comment
1 *	10356.8500	40.42	8.76	49.18	68.30	-19.12	Peak	

REMARKS:

- (1) Measurement Value = Reading Level + Correct Factor.
- (2) Margin Level = Measurement Value - Limit Value.

Orthogonal Axis	X
Test Mode	UNII-1_TX AC (VHT20) Mode 5200 MHz

Vertical

130 dBuV/m

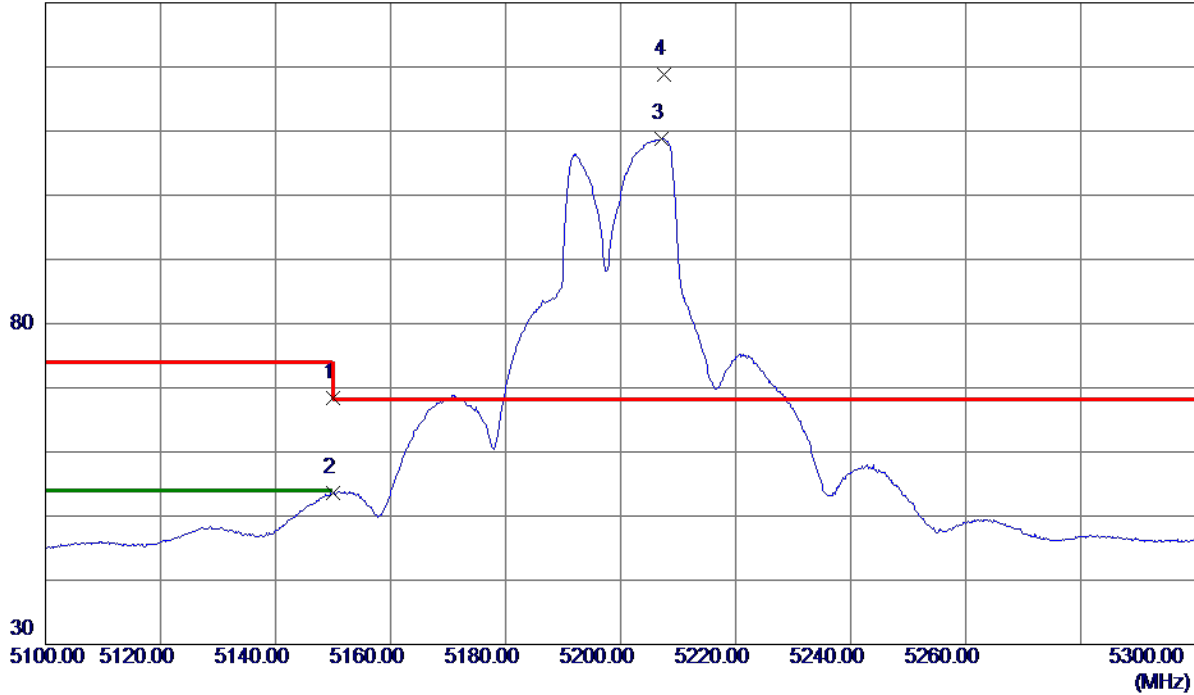

No.	Freq. MHz	Reading Level dBuV/m	Correct Factor dB	Measure ment dBuV/m	Limit dBuV/m	Margin dB	Detector	Comment
1	5150.0000	53.39	15.02	68.41	74.00	-5.59	Peak	
2	5150.0000	38.53	15.02	53.55	54.00	-0.45	AVG	
3	5207.2000	93.77	15.06	108.83	999.00	-890.17	AVG	No Limit
4 *	5207.5000	103.73	15.06	118.79	68.30	50.49	Peak	No Limit

REMARKS:

- (1) Measurement Value = Reading Level + Correct Factor.
- (2) Margin Level = Measurement Value - Limit Value.

Orthogonal Axis	X
Test Mode	UNII-1_TX AC (VHT20) Mode 5200 MHz

Vertical

80 dBuV/m

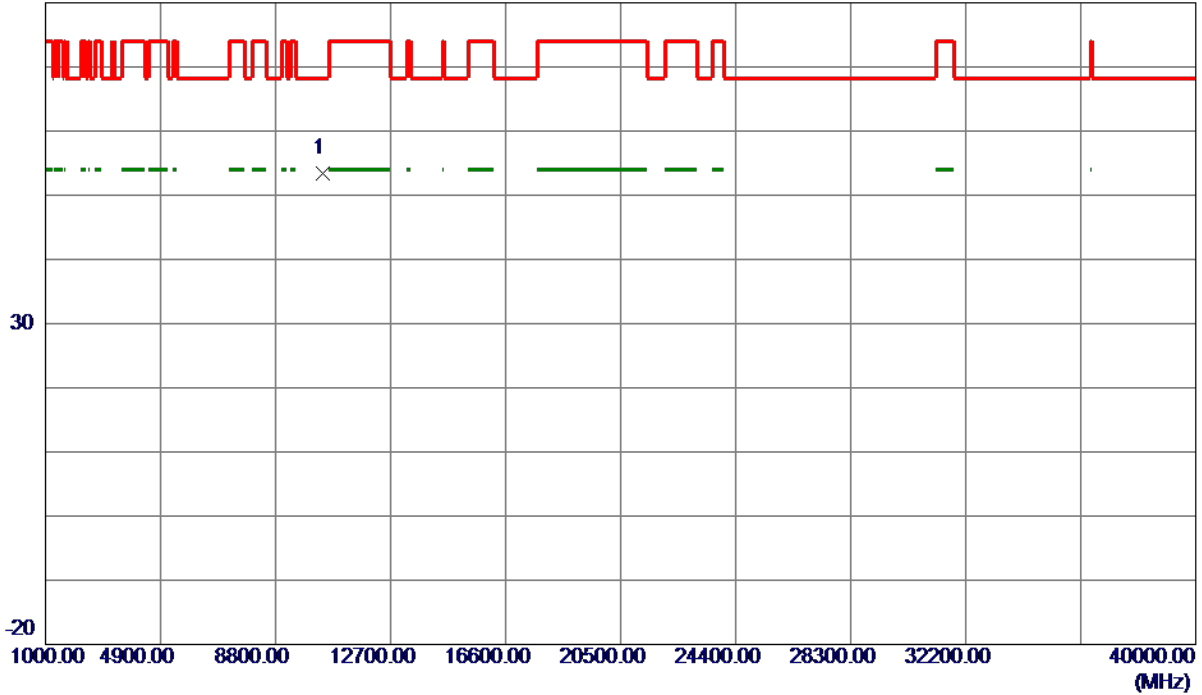

No.	Freq. MHz	Reading Level dBuV/m	Correct Factor dB	Measure ment dBuV/m	Limit dBuV/m	Margin dB	Detector	Comment
1 *	10404.5700	44.57	8.86	53.43	68.30	-14.87	Peak	

REMARKS:

- (1) Measurement Value = Reading Level + Correct Factor.
- (2) Margin Level = Measurement Value - Limit Value.

Orthogonal Axis	X
Test Mode	UNII-1_TX AC (VHT20) Mode 5200 MHz

Horizontal

130 dBuV/m

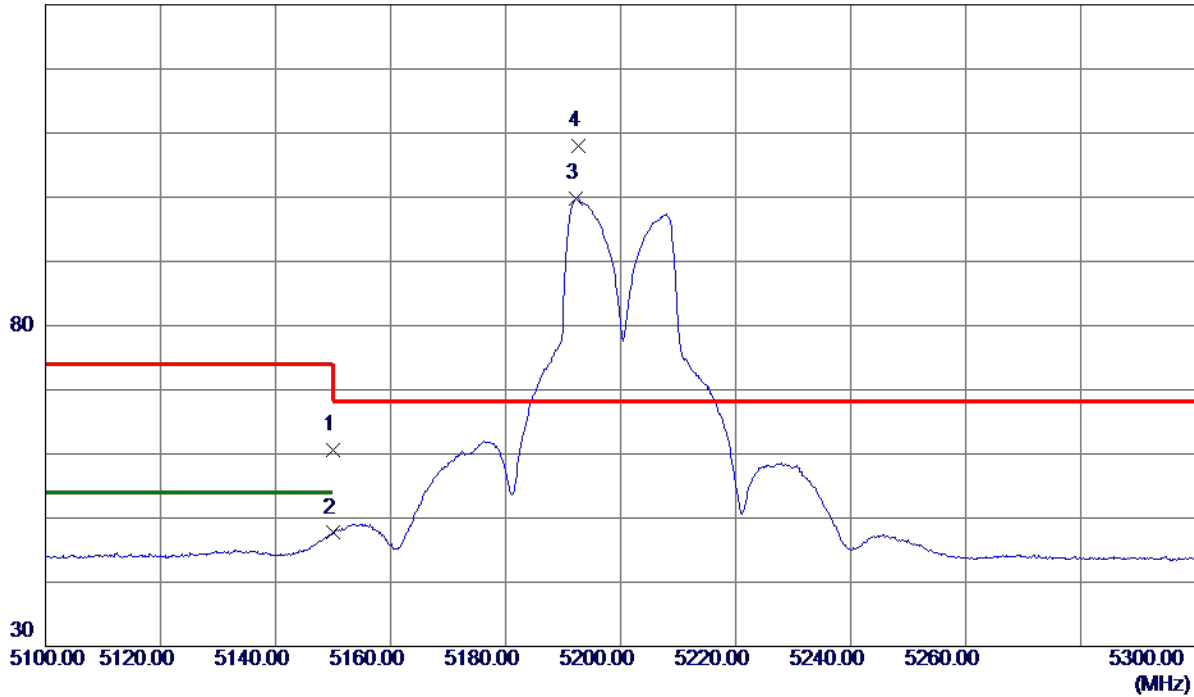

No.	Freq. MHz	Reading Level dBuV/m	Correct Factor dB	Measure ment dBuV/m	Limit dBuV/m	Margin dB	Detector	Comment
1	5150.0000	45.58	15.02	60.60	74.00	-13.40	Peak	
2	5150.0000	32.68	15.02	47.70	54.00	-6.30	AVG	
3	5192.3000	84.76	15.04	99.80	999.00	-899.20	AVG	No Limit
4 *	5192.6000	93.04	15.04	108.08	68.30	39.78	Peak	No Limit

REMARKS:

- (1) Measurement Value = Reading Level + Correct Factor.
- (2) Margin Level = Measurement Value - Limit Value.

Orthogonal Axis	X
Test Mode	UNII-1_TX AC (VHT20) Mode 5200 MHz

Horizontal

80 dBuV/m

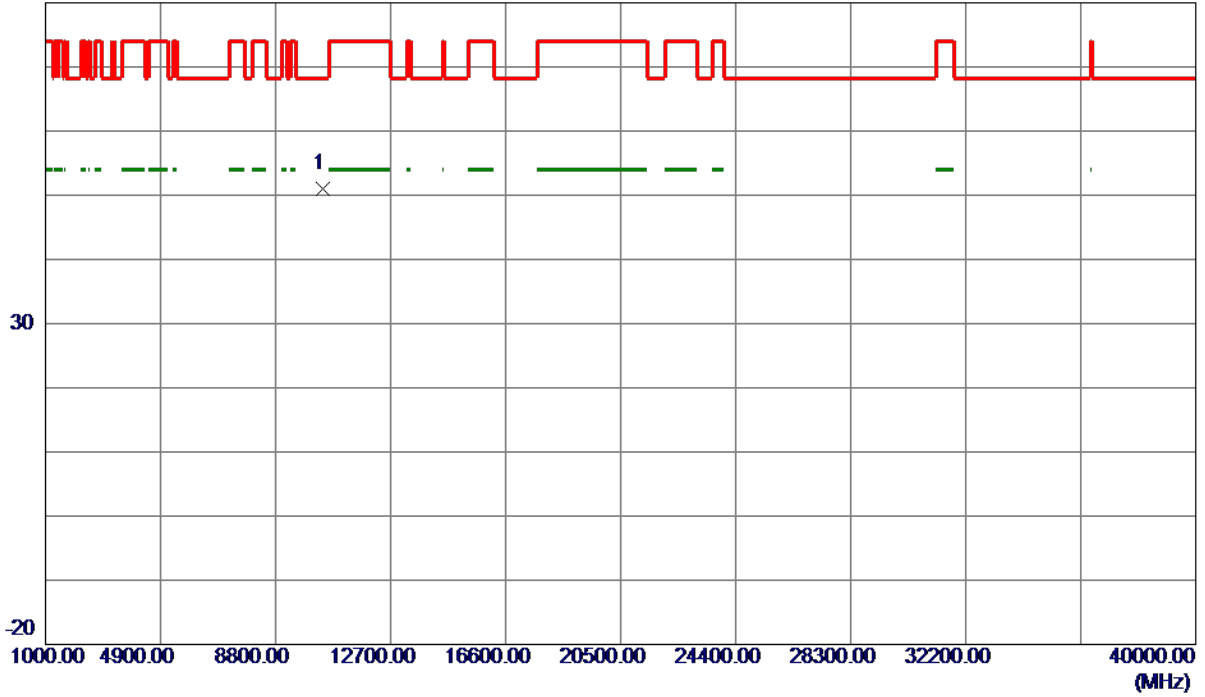

No.	Freq. MHz	Reading Level dBuV/m	Correct Factor dB	Measure ment dBuV/m	Limit dBuV/m	Margin dB	Detector	Comment
1 *	10398.2000	42.07	8.85	50.92	68.30	-17.38	Peak	

REMARKS:

- (1) Measurement Value = Reading Level + Correct Factor.
- (2) Margin Level = Measurement Value - Limit Value.

Orthogonal Axis	X
Test Mode	UNII-1_TX AC (VHT20) Mode 5240 MHz

Vertical

130 dBuV/m

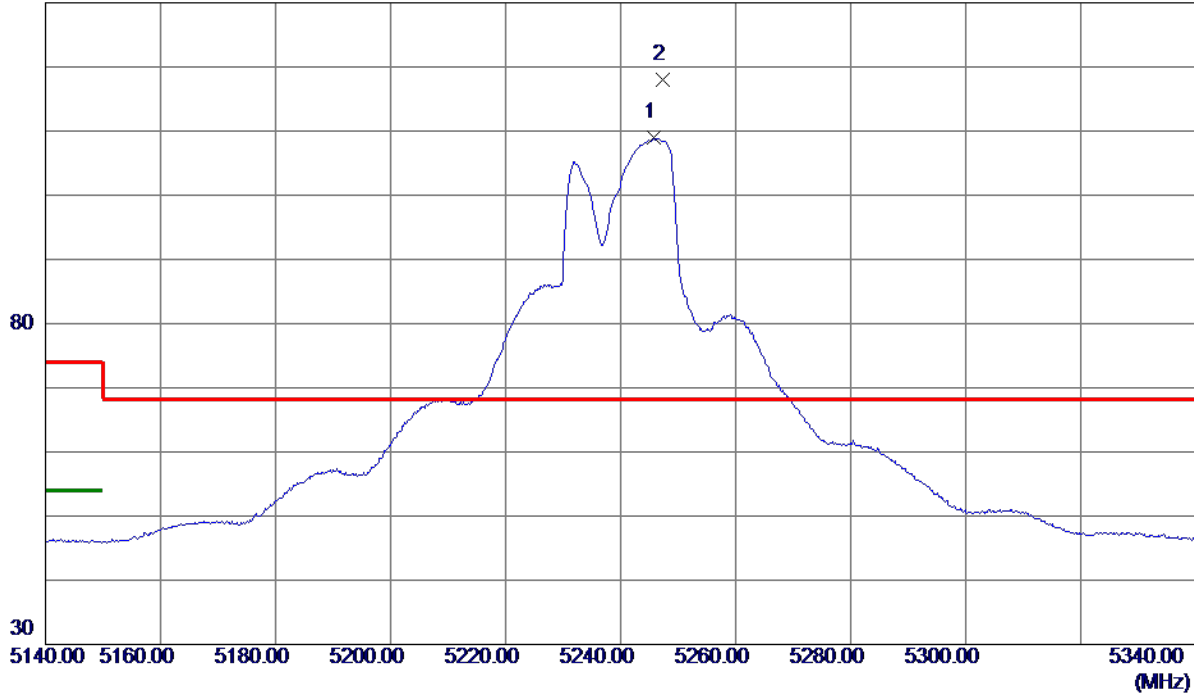

No.	Freq. MHz	Reading Level dBuV/m	Correct Factor dB	Measure ment dBuV/m	Limit dBuV/m	Margin dB	Detector	Comment
1	5245.8000	93.85	15.08	108.93	999.00	-890.07	AVG	No Limit
2 *	5247.3000	103.01	15.08	118.09	68.30	49.79	Peak	No Limit

REMARKS:

- (1) Measurement Value = Reading Level + Correct Factor.
- (2) Margin Level = Measurement Value - Limit Value.

Orthogonal Axis	X
Test Mode	UNII-1_TX AC (VHT20) Mode 5240 MHz

Vertical

80 dBuV/m

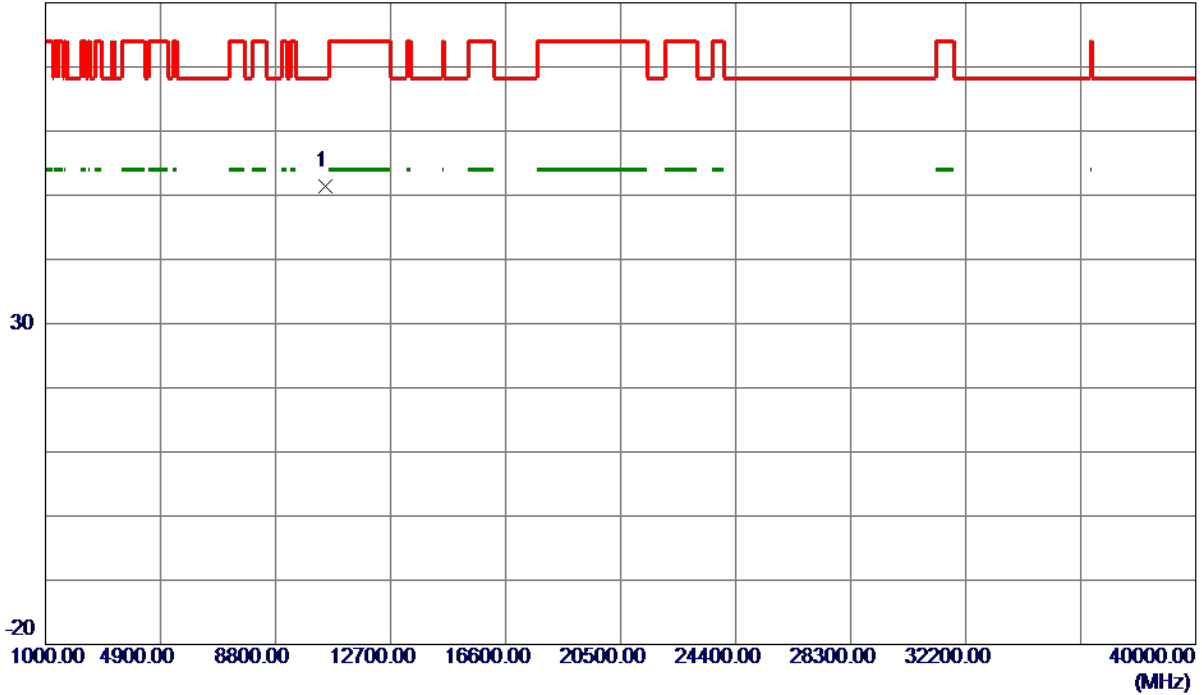

No.	Freq. MHz	Reading Level dBuV/m	Correct Factor dB	Measure ment dBuV/m	Limit dBuV/m	Margin dB	Detector	Comment
1 *	10470.0500	42.49	9.00	51.49	68.30	-16.81	Peak	

REMARKS:

- (1) Measurement Value = Reading Level + Correct Factor.
- (2) Margin Level = Measurement Value - Limit Value.

Orthogonal Axis	X
Test Mode	UNII-1_TX AC (VHT20) Mode 5240 MHz

Horizontal

130 dBuV/m

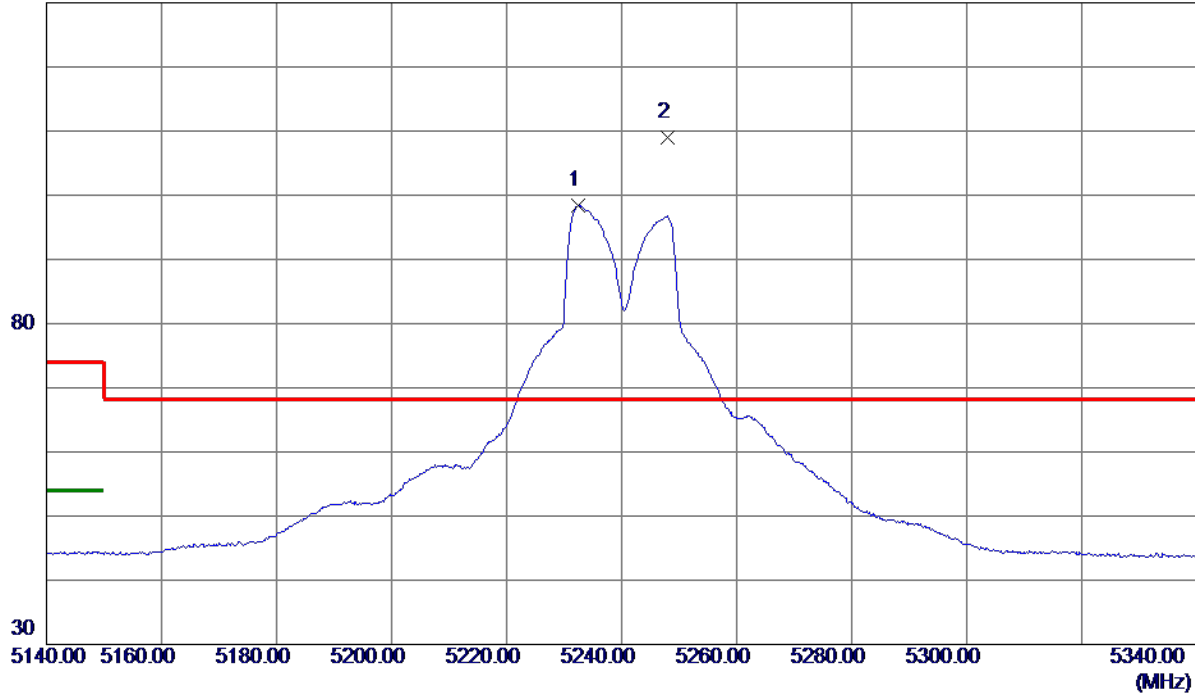

No.	Freq. MHz	Reading Level dBuV/m	Correct Factor dB	Measure ment dBuV/m	Limit dBuV/m	Margin dB	Detector	Comment
1	5232.5000	83.31	15.07	98.38	999.00	-900.62	AVG	No Limit
2 *	5248.0000	93.87	15.08	108.95	68.30	40.65	Peak	No Limit

REMARKS:

- (1) Measurement Value = Reading Level + Correct Factor.
- (2) Margin Level = Measurement Value - Limit Value.

Orthogonal Axis	X
Test Mode	UNII-1_TX AC (VHT20) Mode 5240 MHz

Horizontal

80 dBuV/m

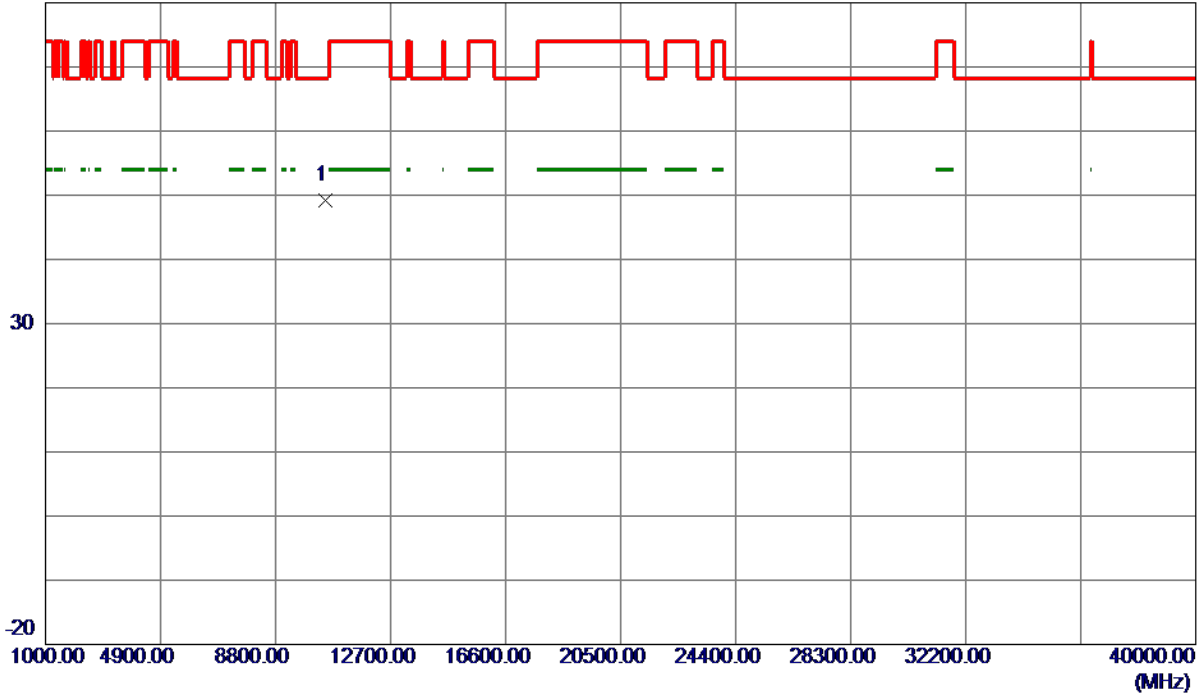

No.	Freq. MHz	Reading Level dBuV/m	Correct Factor dB	Measure ment dBuV/m	Limit dBuV/m	Margin dB	Detector	Comment
1 *	10480.8500	40.26	9.02	49.28	68.30	-19.02	Peak	

REMARKS:

- (1) Measurement Value = Reading Level + Correct Factor.
- (2) Margin Level = Measurement Value - Limit Value.

Orthogonal Axis	X
Test Mode	UNII-1_TX AC (VHT40) Mode 5190 MHz

Vertical

130 dBuV/m



No.	Freq. MHz	Reading Level dBuV/m	Correct Factor dB	Measure ment dBuV/m	Limit dBuV/m	Margin dB	Detector	Comment
1	5137.5000	50.73	15.01	65.74	74.00	-8.26	Peak	
2	5137.5000	38.55	15.01	53.56	54.00	-0.44	AVG	
3	5150.0000	46.27	15.02	61.29	74.00	-12.71	Peak	
4	5150.0000	38.49	15.02	53.51	54.00	-0.49	AVG	
5	5178.4000	87.90	15.03	102.93	999.00	-896.07	AVG	No Limit
6 *	5179.1000	98.00	15.04	113.04	68.30	44.74	Peak	No Limit

REMARKS:

- (1) Measurement Value = Reading Level + Correct Factor.
- (2) Margin Level = Measurement Value - Limit Value.

Orthogonal Axis	X
Test Mode	UNII-1_TX AC (VHT40) Mode 5190 MHz

Vertical

80 dBuV/m

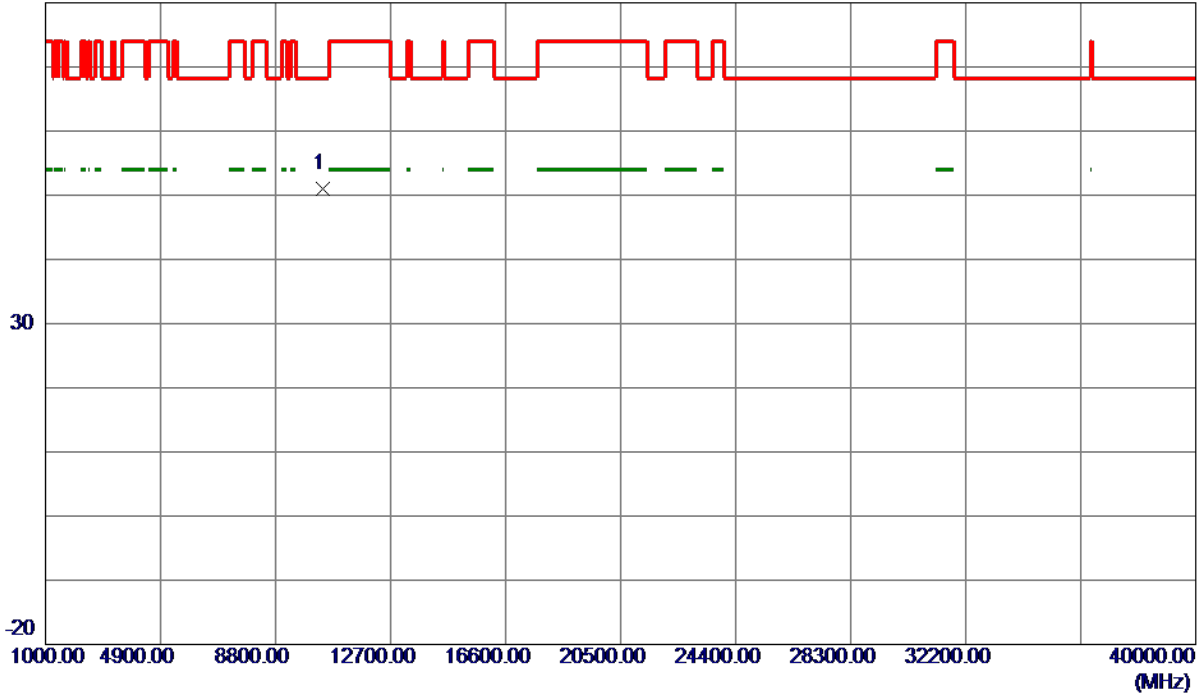

No.	Freq. MHz	Reading Level dBuV/m	Correct Factor dB	Measure ment dBuV/m	Limit dBuV/m	Margin dB	Detector	Comment
1 *	10386.8700	42.10	8.82	50.92	68.30	-17.38	Peak	

REMARKS:

- (1) Measurement Value = Reading Level + Correct Factor.
- (2) Margin Level = Measurement Value - Limit Value.

Orthogonal Axis	X
Test Mode	UNII-1_TX AC (VHT40) Mode 5190 MHz

Horizontal

130 dBuV/m



No.	Freq. MHz	Reading Level dBuV/m	Correct Factor dB	Measure ment dBuV/m	Limit dBuV/m	Margin dB	Detector	Comment
1	5150.0000	45.78	15.02	60.80	74.00	-13.20	Peak	
2	5150.0000	33.56	15.02	48.58	54.00	-5.42	AVG	
3	5187.7000	77.67	15.04	92.71	999.00	-906.29	AVG	No Limit
4 *	5188.6000	85.45	15.04	100.49	68.30	32.19	Peak	No Limit

REMARKS:

- (1) Measurement Value = Reading Level + Correct Factor.
- (2) Margin Level = Measurement Value - Limit Value.

Orthogonal Axis	X
Test Mode	UNII-1_TX AC (VHT40) Mode 5190 MHz

Horizontal

80 dBuV/m

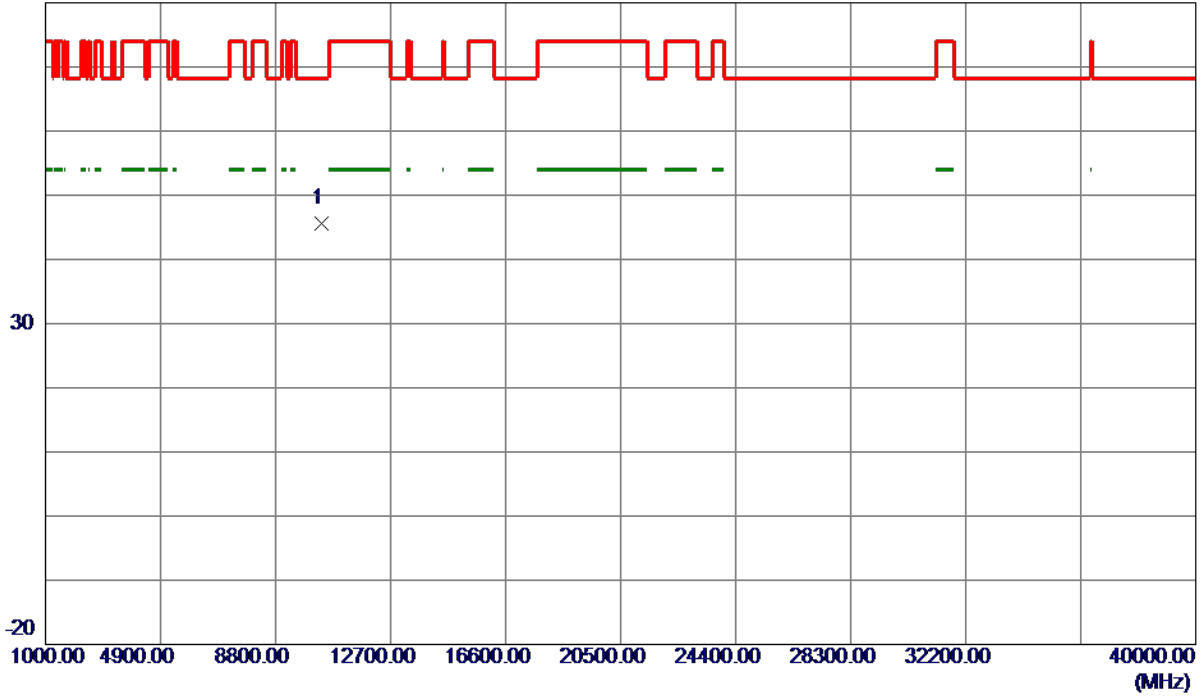

No.	Freq. MHz	Reading Level dBuV/m	Correct Factor dB	Measure ment dBuV/m	Limit dBuV/m	Margin dB	Detector	Comment
1 *	10373.7500	36.88	8.80	45.68	68.30	-22.62	Peak	

REMARKS:

- (1) Measurement Value = Reading Level + Correct Factor.
- (2) Margin Level = Measurement Value - Limit Value.

Orthogonal Axis	X
Test Mode	UNII-1_TX AC (VHT40) Mode 5230 MHz

Vertical

130 dBuV/m

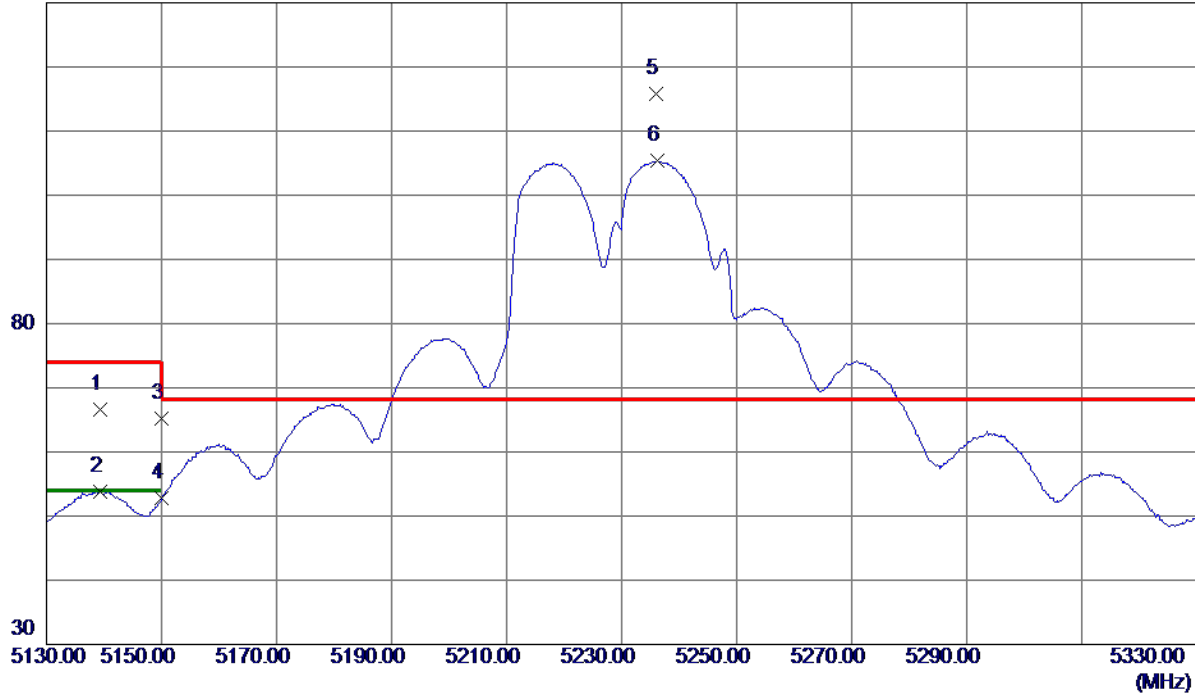

No.	Freq. MHz	Reading Level dBuV/m	Correct Factor dB	Measure ment dBuV/m	Limit dBuV/m	Margin dB	Detector	Comment
1	5139.4000	51.58	15.01	66.59	74.00	-7.41	Peak	
2	5139.4000	38.86	15.01	53.87	54.00	-0.13	AVG	
3	5150.0000	50.17	15.02	65.19	74.00	-8.81	Peak	
4	5150.0000	37.78	15.02	52.80	54.00	-1.20	AVG	
5 *	5236.1000	100.80	15.08	115.88	68.30	47.58	Peak	No Limit
6	5236.3000	90.32	15.08	105.40	999.00	-893.60	AVG	No Limit

REMARKS:

- (1) Measurement Value = Reading Level + Correct Factor.
- (2) Margin Level = Measurement Value - Limit Value.

Orthogonal Axis	X
Test Mode	UNII-1_TX AC (VHT40) Mode 5230 MHz

Vertical

80 dBuV/m

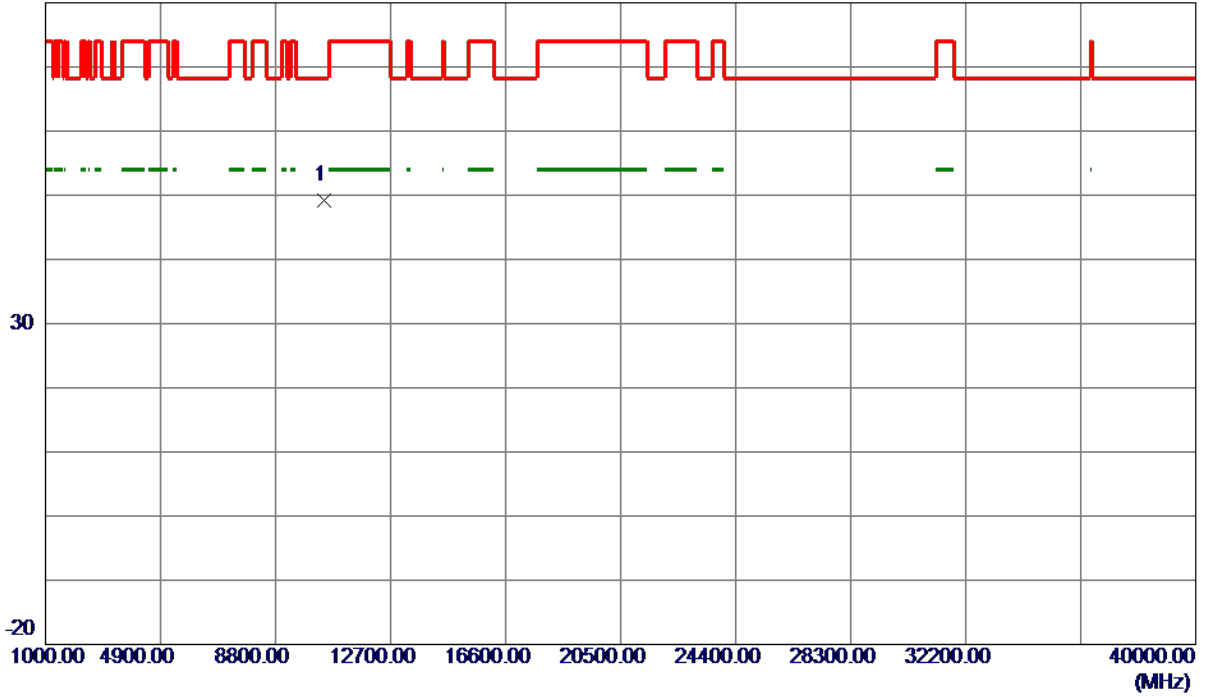

No.	Freq. MHz	Reading Level dBuV/m	Correct Factor dB	Measure ment dBuV/m	Limit dBuV/m	Margin dB	Detector	Comment
1 *	10462.0900	40.14	8.98	49.12	68.30	-19.18	Peak	

REMARKS:

- (1) Measurement Value = Reading Level + Correct Factor.
- (2) Margin Level = Measurement Value - Limit Value.

Orthogonal Axis	X
Test Mode	UNII-1_TX AC (VHT40) Mode 5230 MHz

Horizontal

130 dBuV/m

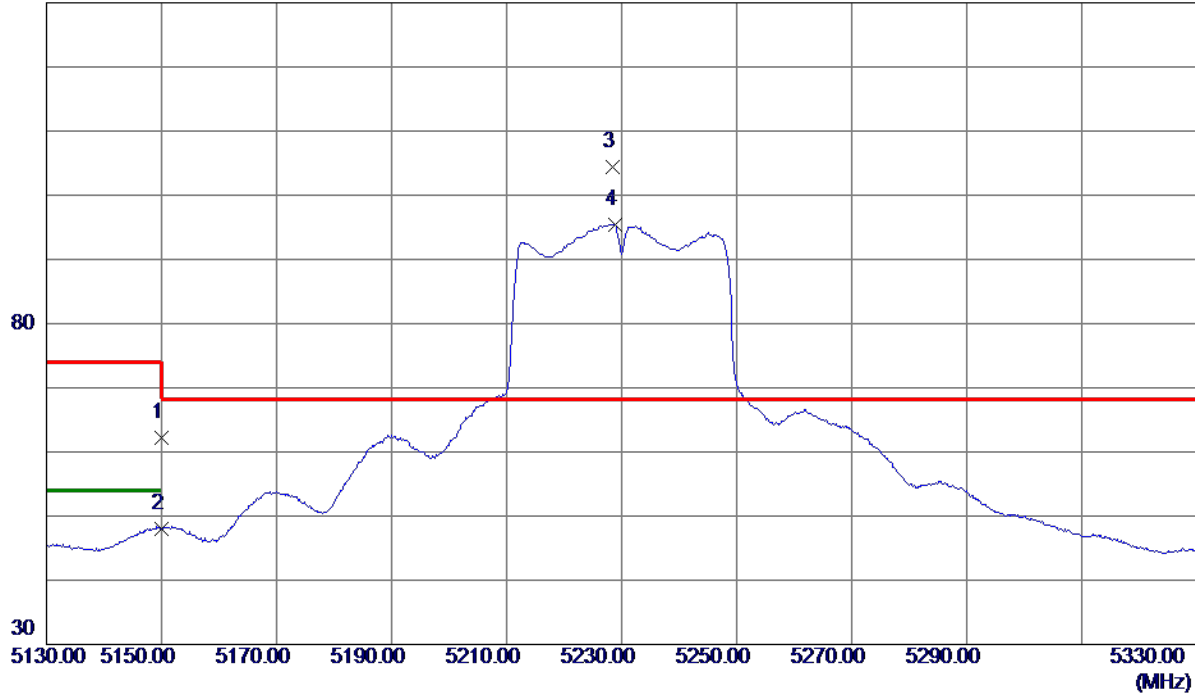

No.	Freq. MHz	Reading Level dBuV/m	Correct Factor dB	Measure ment dBuV/m	Limit dBuV/m	Margin dB	Detector	Comment
1	5150.0000	47.26	15.02	62.28	74.00	-11.72	Peak	
2	5150.0000	33.01	15.02	48.03	54.00	-5.97	AVG	
3 *	5228.4000	89.41	15.07	104.48	68.30	36.18	Peak	No Limit
4	5228.8000	80.41	15.07	95.48	999.00	-903.52	AVG	No Limit

REMARKS:

- (1) Measurement Value = Reading Level + Correct Factor.
- (2) Margin Level = Measurement Value - Limit Value.

Orthogonal Axis	X
Test Mode	UNII-1_TX AC (VHT40) Mode 5230 MHz

Horizontal

80 dBuV/m

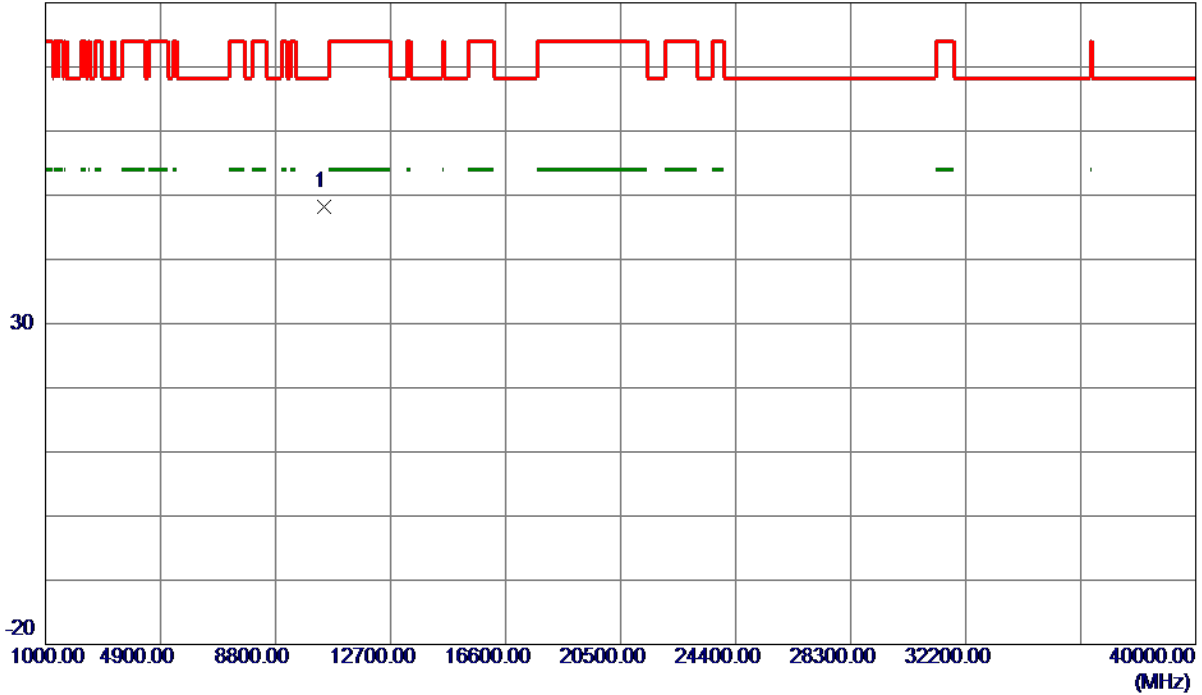

No.	Freq. MHz	Reading Level dBuV/m	Correct Factor dB	Measure ment dBuV/m	Limit dBuV/m	Margin dB	Detector	Comment
1 *	10461.5000	39.16	8.98	48.14	68.30	-20.16	Peak	

REMARKS:

- (1) Measurement Value = Reading Level + Correct Factor.
- (2) Margin Level = Measurement Value - Limit Value.

Orthogonal Axis	X
Test Mode	UNII-1_TX AC (VHT80) Mode 5210 MHz

Vertical

130 dBuV/m

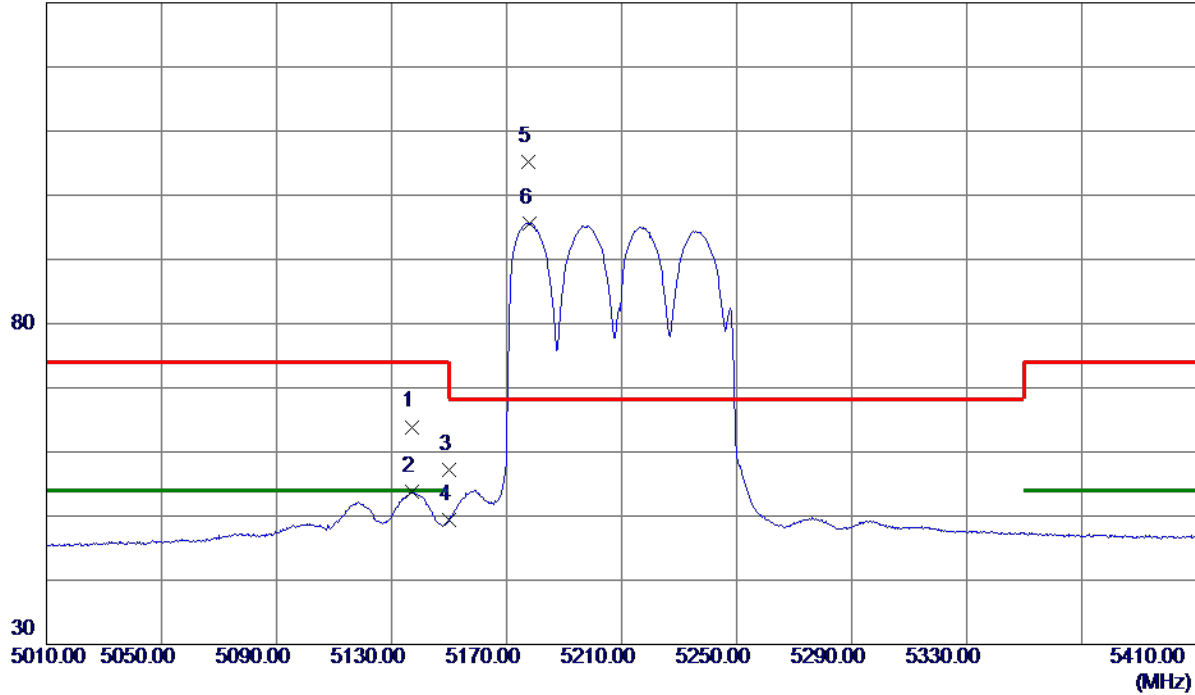

No.	Freq. MHz	Reading Level dBuV/m	Correct Factor dB	Measure ment dBuV/m	Limit dBuV/m	Margin dB	Detector	Comment
1	5137.0000	48.89	15.01	63.90	74.00	-10.10	Peak	
2	5137.0000	38.78	15.01	53.79	54.00	-0.21	AVG	
3	5150.0000	42.19	15.02	57.21	74.00	-16.79	Peak	
4	5150.0000	34.38	15.02	49.40	54.00	-4.60	AVG	
5 *	5177.6000	90.11	15.03	105.14	68.30	36.84	Peak	No Limit
6	5178.2000	80.65	15.03	95.68	999.00	-903.32	AVG	No Limit

REMARKS:

- (1) Measurement Value = Reading Level + Correct Factor.
- (2) Margin Level = Measurement Value - Limit Value.

Orthogonal Axis	X
Test Mode	UNII-1_TX AC (VHT80) Mode 5210 MHz

Vertical

80 dBuV/m

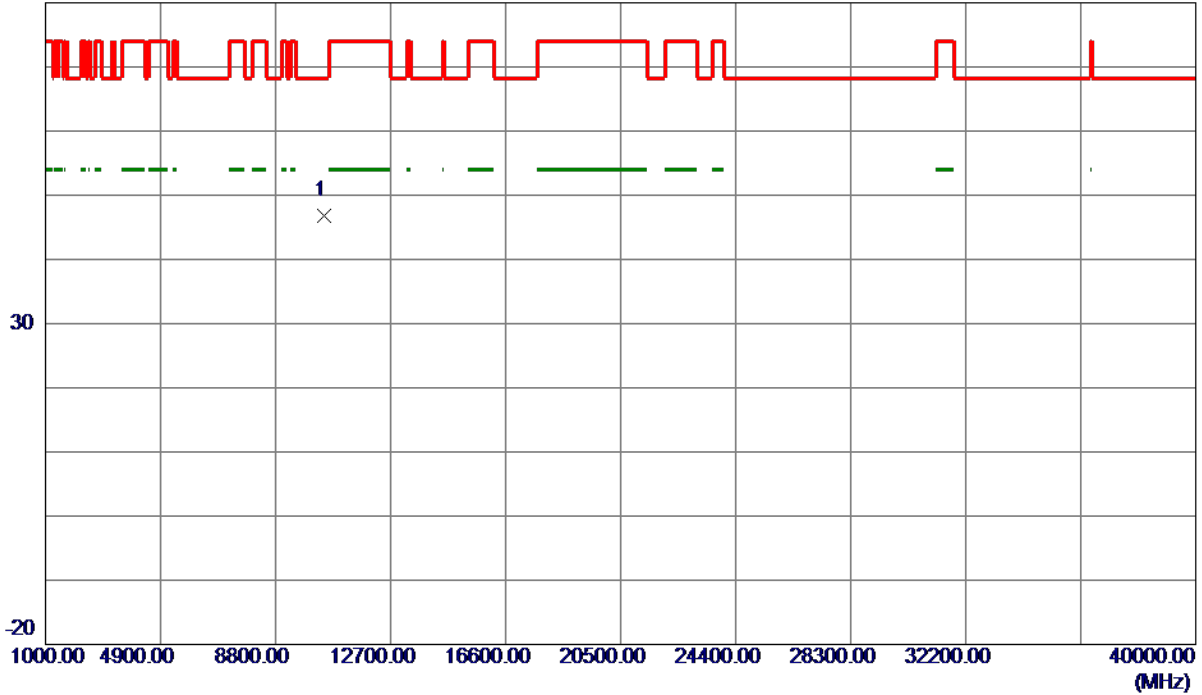

No.	Freq. MHz	Reading Level dBuV/m	Correct Factor dB	Measure ment dBuV/m	Limit dBuV/m	Margin dB	Detector	Comment
1 *	10427.8700	37.95	8.91	46.86	68.30	-21.44	Peak	

REMARKS:

- (1) Measurement Value = Reading Level + Correct Factor.
- (2) Margin Level = Measurement Value - Limit Value.

Orthogonal Axis	X
Test Mode	UNII-1_TX AC (VHT80) Mode 5210 MHz

Horizontal

130 dBuV/m

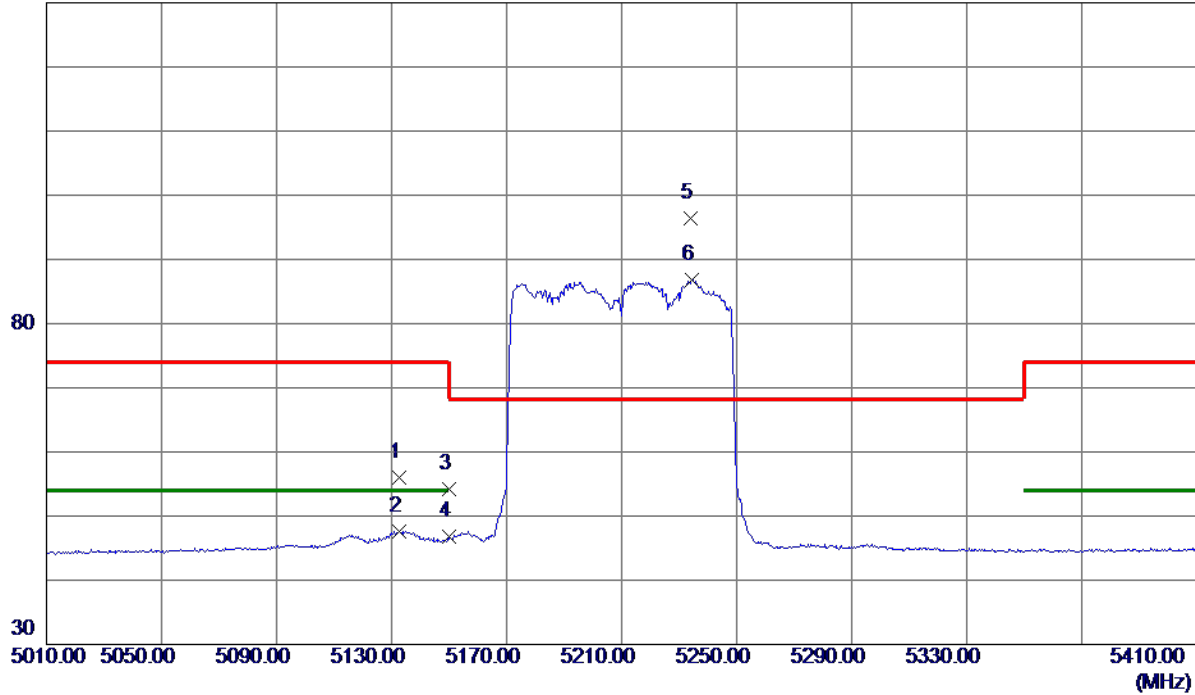

No.	Freq. MHz	Reading Level dBuV/m	Correct Factor dB	Measure ment dBuV/m	Limit dBuV/m	Margin dB	Detector	Comment
1	5132.8000	41.07	15.00	56.07	74.00	-17.93	Peak	
2	5132.8000	32.59	15.00	47.59	54.00	-6.41	AVG	
3	5150.0000	39.12	15.02	54.14	74.00	-19.86	Peak	
4	5150.0000	31.70	15.02	46.72	54.00	-7.28	AVG	
5 *	5234.2000	81.27	15.07	96.34	68.30	28.04	Peak	No Limit
6	5234.6000	71.67	15.07	86.74	999.00	-912.26	AVG	No Limit

REMARKS:

- (1) Measurement Value = Reading Level + Correct Factor.
- (2) Margin Level = Measurement Value - Limit Value.

Orthogonal Axis	X
Test Mode	UNII-1_TX AC (VHT80) Mode 5210 MHz

Horizontal

80 dBuV/m

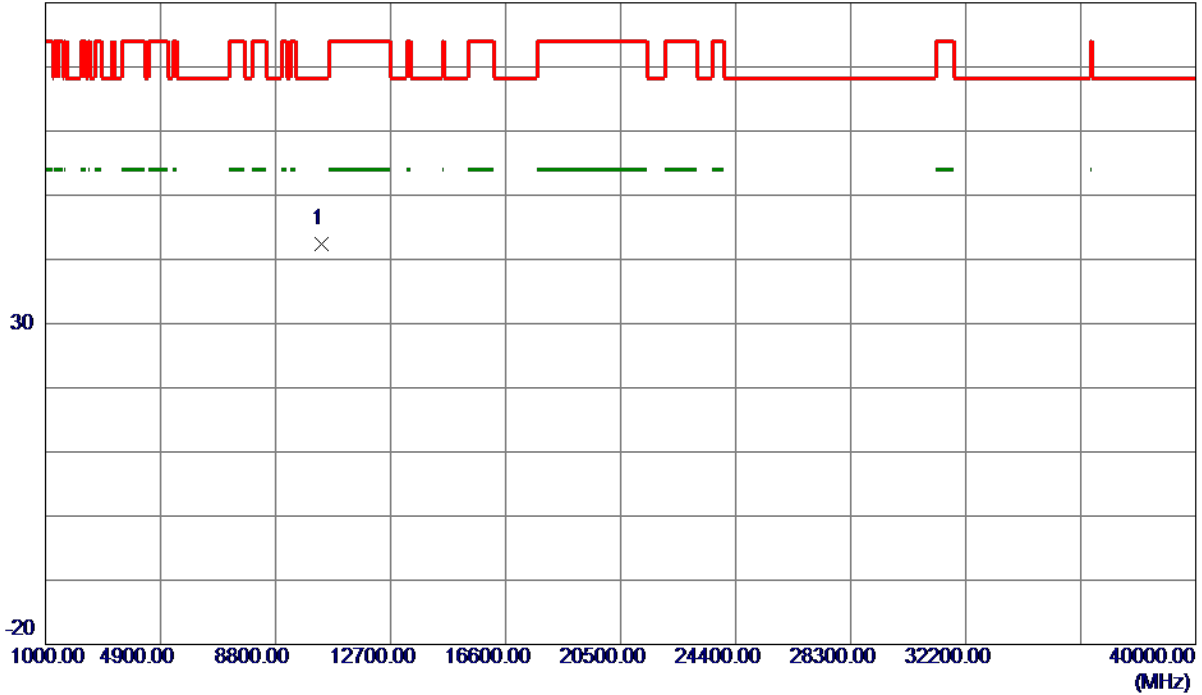

No.	Freq. MHz	Reading Level dBuV/m	Correct Factor dB	Measure ment dBuV/m	Limit dBuV/m	Margin dB	Detector	Comment
1 *	10381.1500	33.66	8.81	42.47	68.30	-25.83	Peak	

REMARKS:

- (1) Measurement Value = Reading Level + Correct Factor.
- (2) Margin Level = Measurement Value - Limit Value.

Orthogonal Axis	X
Test Mode	UNII-3_TX AC (VHT20) Mode 5745 MHz

Vertical

130 dBuV/m

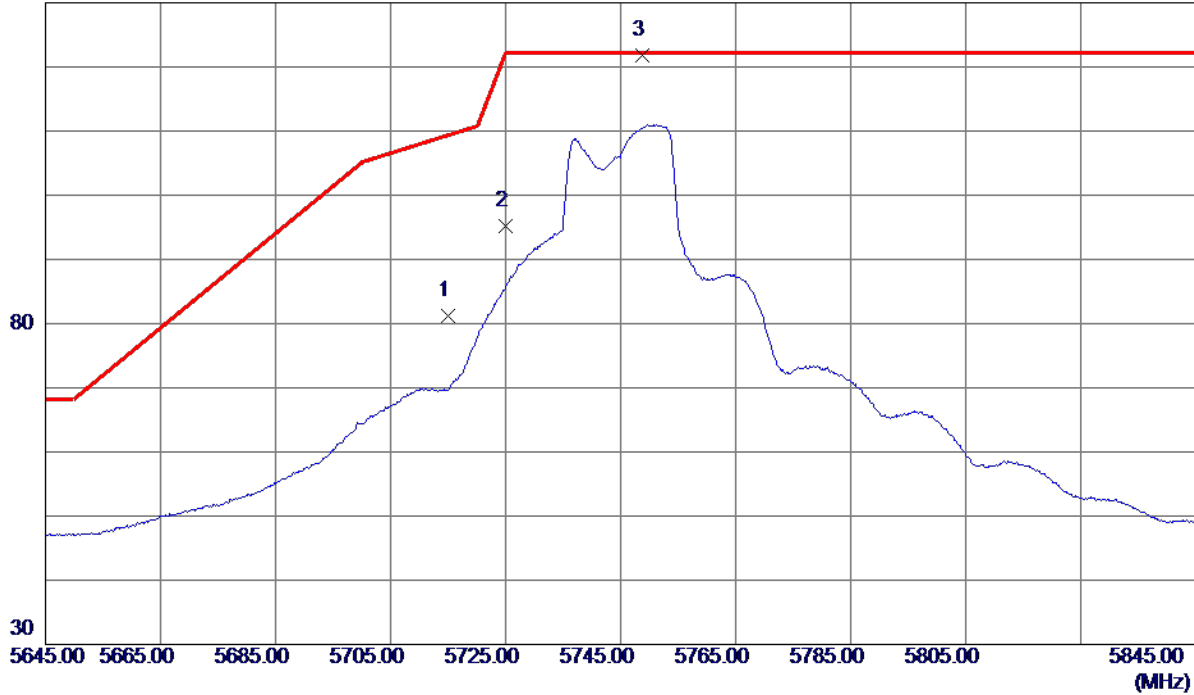

No.	Freq. MHz	Reading Level dBuV/m	Correct Factor dB	Measure ment dBuV/m	Limit dBuV/m	Margin dB	Detector	Comment
1	5715.0000	65.46	15.65	81.11	109.40	-28.29	Peak	
2	5725.0000	79.55	15.67	95.22	122.20	-26.98	Peak	
3 *	5748.7000	106.10	15.71	121.81	122.20	-0.39	Peak	No Limit

REMARKS:

- (1) Measurement Value = Reading Level + Correct Factor.
- (2) Margin Level = Measurement Value - Limit Value.

Orthogonal Axis	X
Test Mode	UNII-3_TX AC (VHT20) Mode 5745 MHz

Vertical

80 dBuV/m

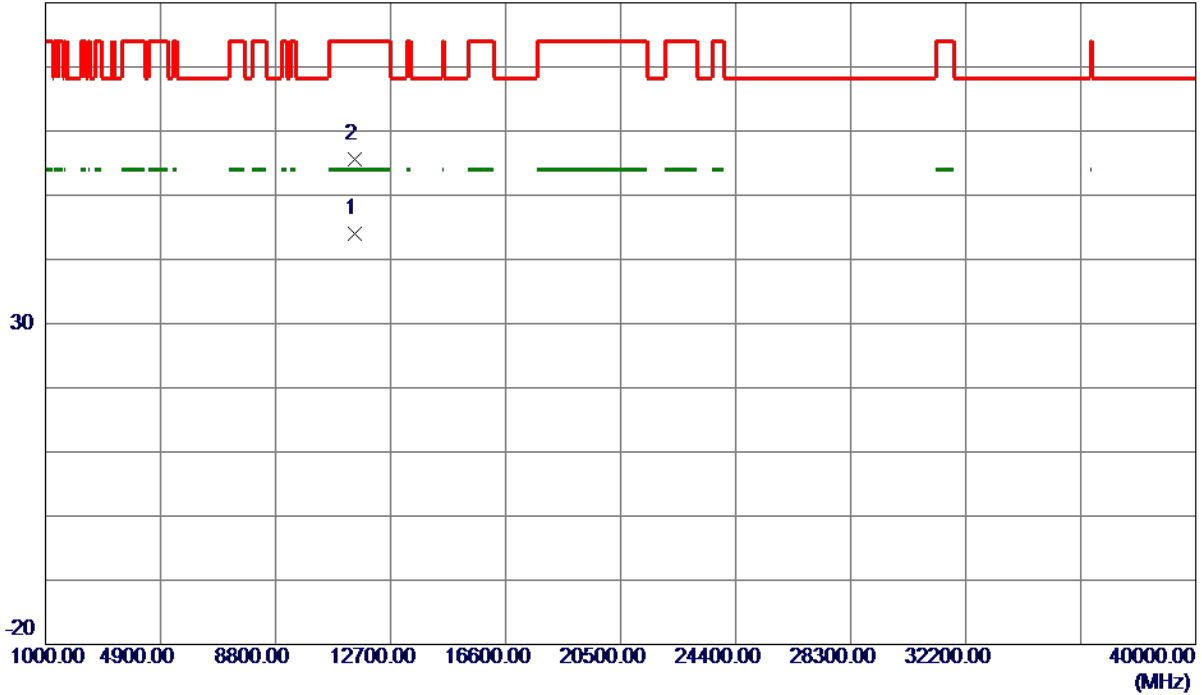

No.	Freq. MHz	Reading Level dBuV/m	Correct Factor dB	Measure ment dBuV/m	Limit dBuV/m	Margin dB	Detector	Comment
1 *	11487.0250	32.83	11.09	43.92	54.00	-10.08	AVG	
2	11491.5250	44.41	11.10	55.51	74.00	-18.49	Peak	

REMARKS:

- (1) Measurement Value = Reading Level + Correct Factor.
- (2) Margin Level = Measurement Value - Limit Value.

Orthogonal Axis	X
Test Mode	UNII-3_TX AC (VHT20) Mode 5745 MHz

Horizontal

130 dBuV/m

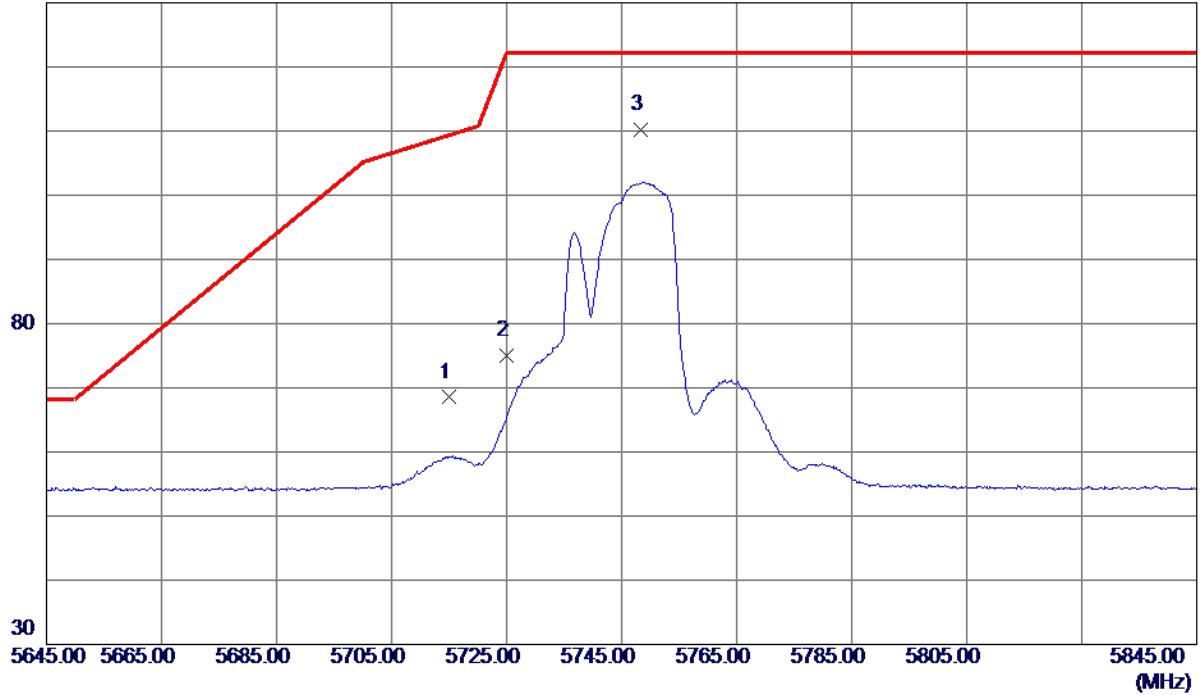

No.	Freq. MHz	Reading Level dBuV/m	Correct Factor dB	Measure ment dBuV/m	Limit dBuV/m	Margin dB	Detector	Comment
1	5715.0000	52.85	15.65	68.50	109.40	-40.90	Peak	
2	5725.0000	59.37	15.67	75.04	122.20	-47.16	Peak	
3 *	5748.3000	94.44	15.71	110.15	122.20	-12.05	Peak	No Limit

REMARKS:

- (1) Measurement Value = Reading Level + Correct Factor.
- (2) Margin Level = Measurement Value - Limit Value.

Orthogonal Axis	X
Test Mode	UNII-3_TX AC (VHT20) Mode 5745 MHz

Horizontal

80 dBuV/m

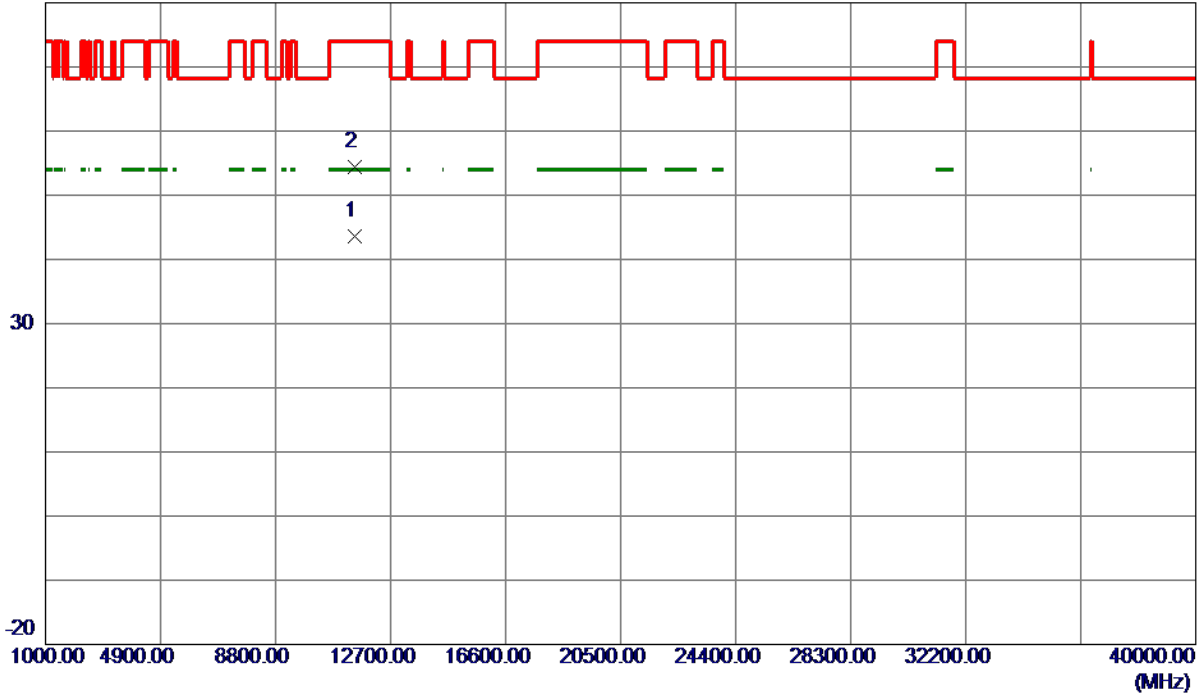

No.	Freq. MHz	Reading Level dBuV/m	Correct Factor dB	Measure ment dBuV/m	Limit dBuV/m	Margin dB	Detector	Comment
1 *	11492.7000	32.49	11.11	43.60	54.00	-10.40	AVG	
2	11494.2500	43.24	11.11	54.35	74.00	-19.65	Peak	

REMARKS:

- (1) Measurement Value = Reading Level + Correct Factor.
- (2) Margin Level = Measurement Value - Limit Value.

Orthogonal Axis	X
Test Mode	UNII-3_TX AC (VHT20) Mode 5785 MHz

Vertical

130 dBuV/m

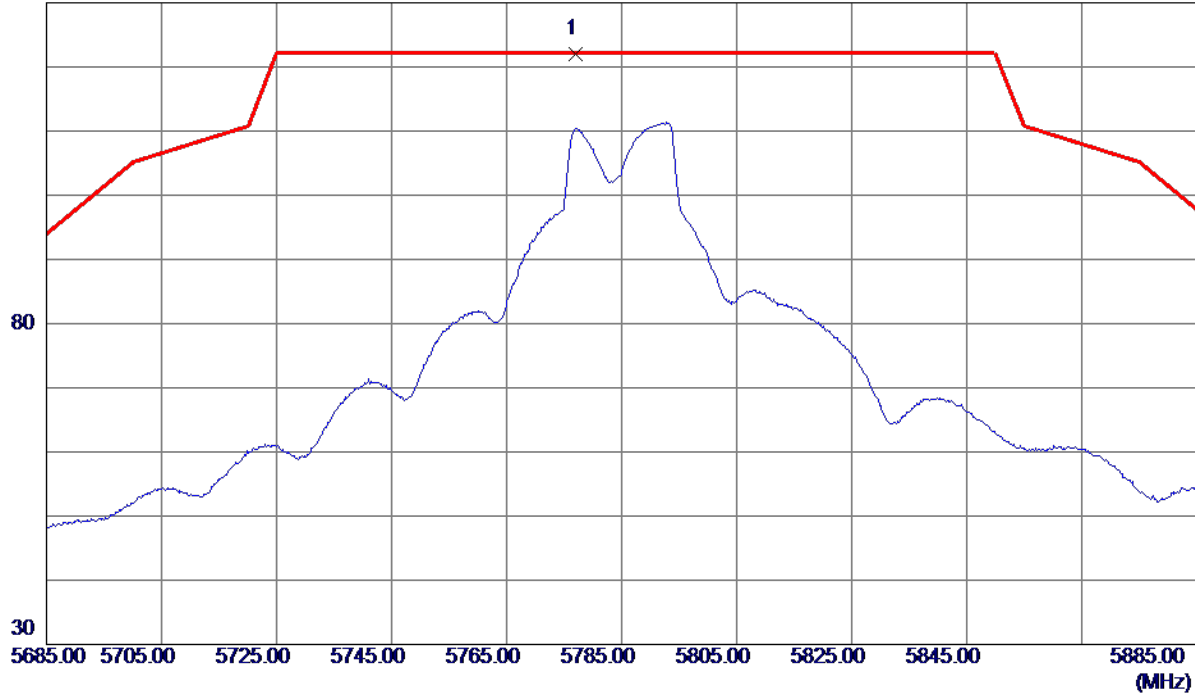

No.	Freq. MHz	Reading Level dBuV/m	Correct Factor dB	Measure ment dBuV/m	Limit dBuV/m	Margin dB	Detector	Comment
1 *	5777.1000	106.24	15.76	122.00	122.20	-0.20	Peak	No Limit

REMARKS:

- (1) Measurement Value = Reading Level + Correct Factor.
- (2) Margin Level = Measurement Value - Limit Value.

Orthogonal Axis	X
Test Mode	UNII-3_TX AC (VHT20) Mode 5785 MHz

Vertical

80 dBuV/m



No.	Freq. MHz	Reading Level dBuV/m	Correct Factor dB	Measure ment dBuV/m	Limit dBuV/m	Margin dB	Detector	Comment
1 *	11569.3750	27.54	11.22	38.76	54.00	-15.24	AVG	
2	11570.0750	39.92	11.22	51.14	74.00	-22.86	Peak	

REMARKS:

- (1) Measurement Value = Reading Level + Correct Factor.
- (2) Margin Level = Measurement Value - Limit Value.

Orthogonal Axis	X
Test Mode	UNII-3_TX AC (VHT20) Mode 5785 MHz

Horizontal

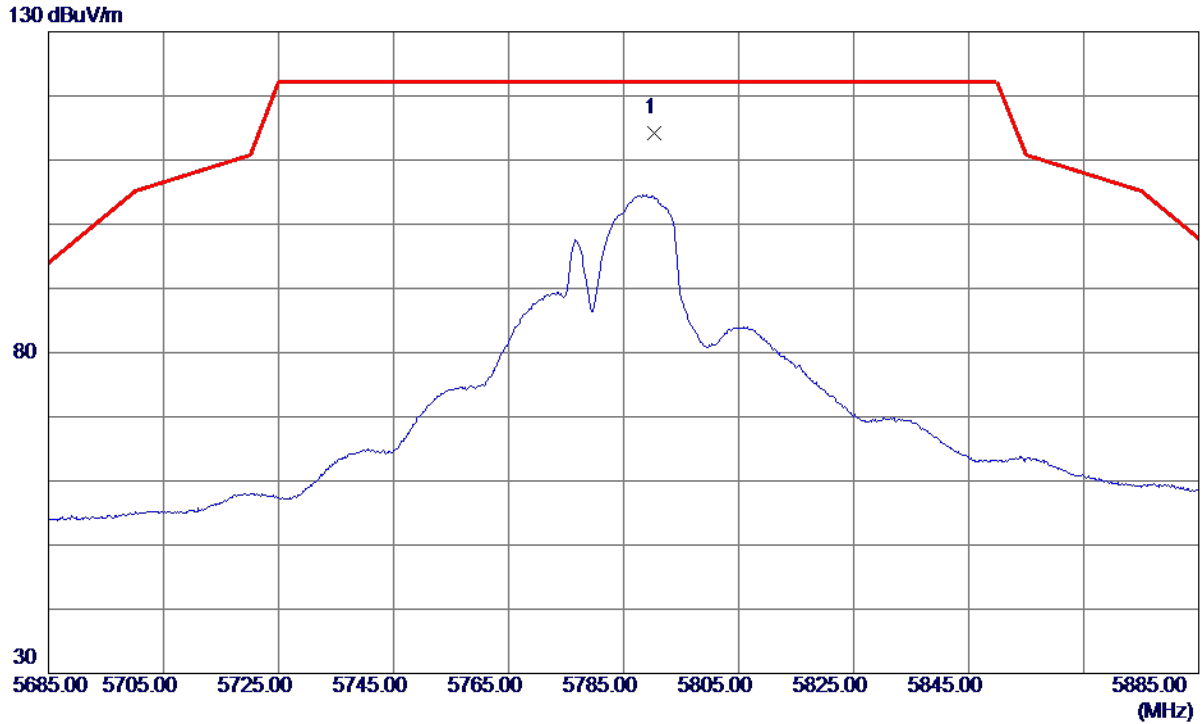

No.	Freq. MHz	Reading Level dBuV/m	Correct Factor dB	Measure ment dBuV/m	Limit dBuV/m	Margin dB	Detector	Comment
1 *	5790.3000	98.51	15.79	114.30	122.20	-7.90	Peak	No Limit

REMARKS:

- (1) Measurement Value = Reading Level + Correct Factor.
- (2) Margin Level = Measurement Value - Limit Value.

Orthogonal Axis	X
Test Mode	UNII-3_TX AC (VHT20) Mode 5785 MHz

Horizontal

80 dBuV/m

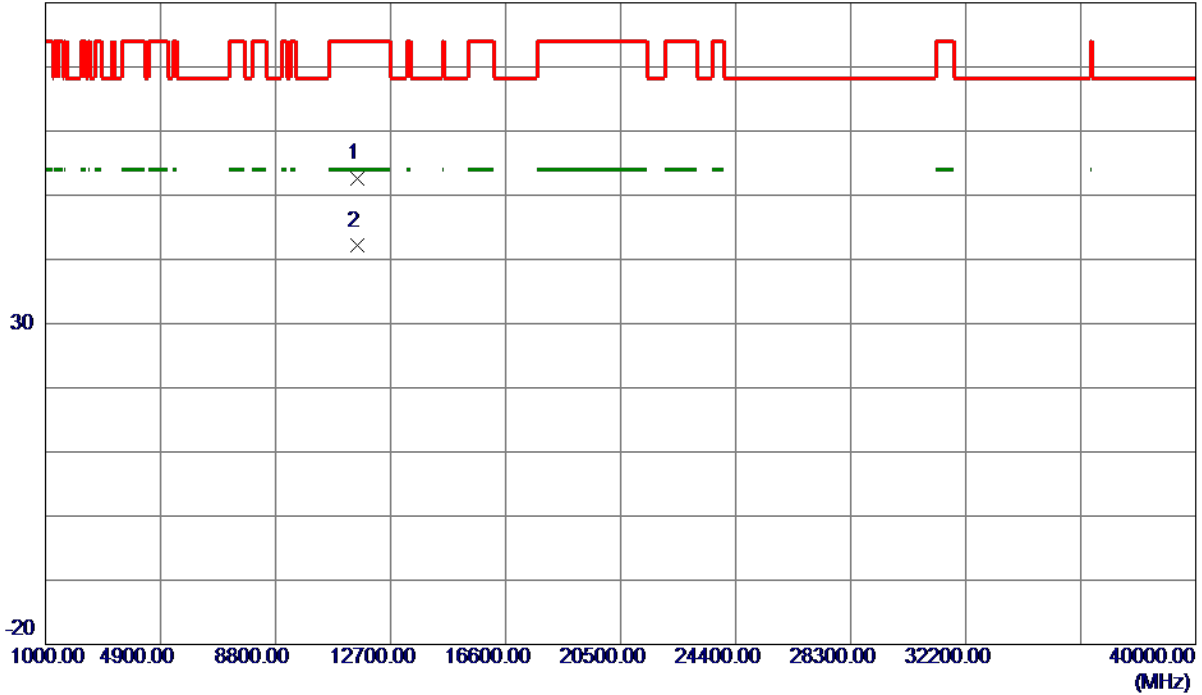

No.	Freq. MHz	Reading Level dBuV/m	Correct Factor dB	Measure ment dBuV/m	Limit dBuV/m	Margin dB	Detector	Comment
1	11564.1000	41.46	11.21	52.67	74.00	-21.33	Peak	
2 *	11566.9500	30.88	11.22	42.10	54.00	-11.90	AVG	

REMARKS:

- (1) Measurement Value = Reading Level + Correct Factor.
- (2) Margin Level = Measurement Value - Limit Value.

Orthogonal Axis	X
Test Mode	UNII-3_TX AC (VHT20) Mode 5825 MHz

Vertical

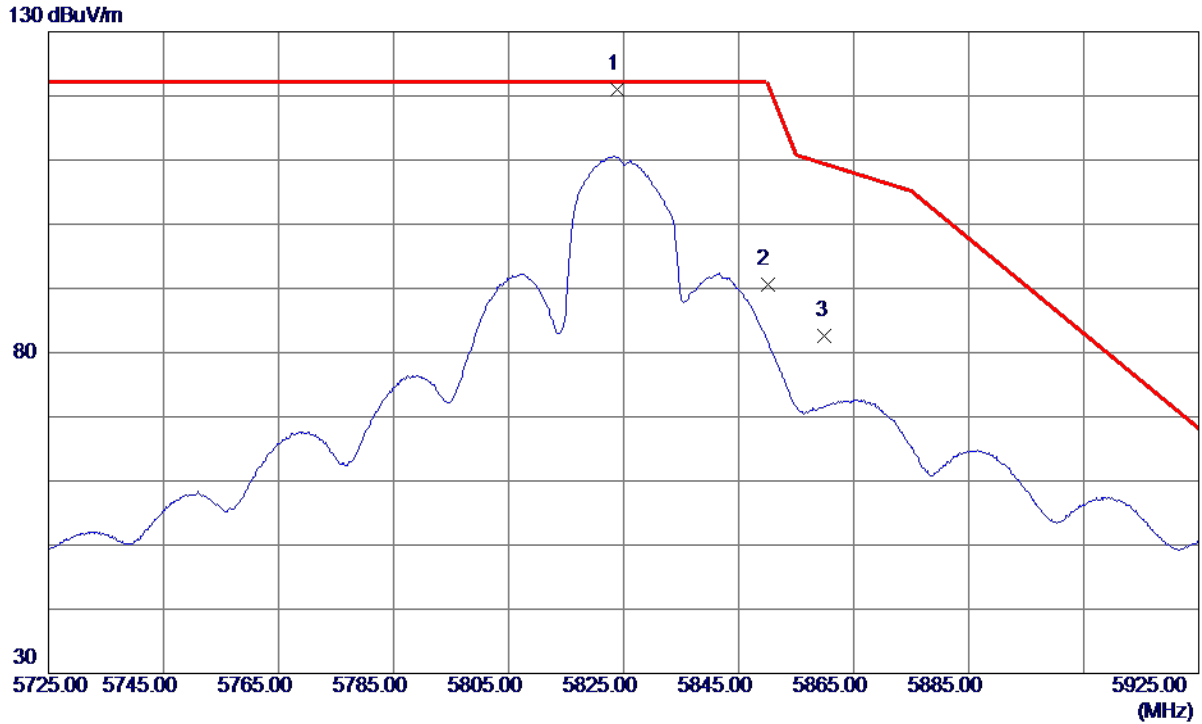

No.	Freq. MHz	Reading Level dBuV/m	Correct Factor dB	Measure ment dBuV/m	Limit dBuV/m	Margin dB	Detector	Comment
1 *	5823.8000	105.10	15.85	120.95	122.20	-1.25	Peak	No Limit
2	5850.0000	74.75	15.90	90.65	122.20	-31.55	Peak	
3	5860.0000	66.63	15.92	82.55	109.40	-26.85	Peak	

REMARKS:

- (1) Measurement Value = Reading Level + Correct Factor.
- (2) Margin Level = Measurement Value - Limit Value.

Orthogonal Axis	X
Test Mode	UNII-3_TX AC (VHT20) Mode 5825 MHz

Vertical

80 dBuV/m

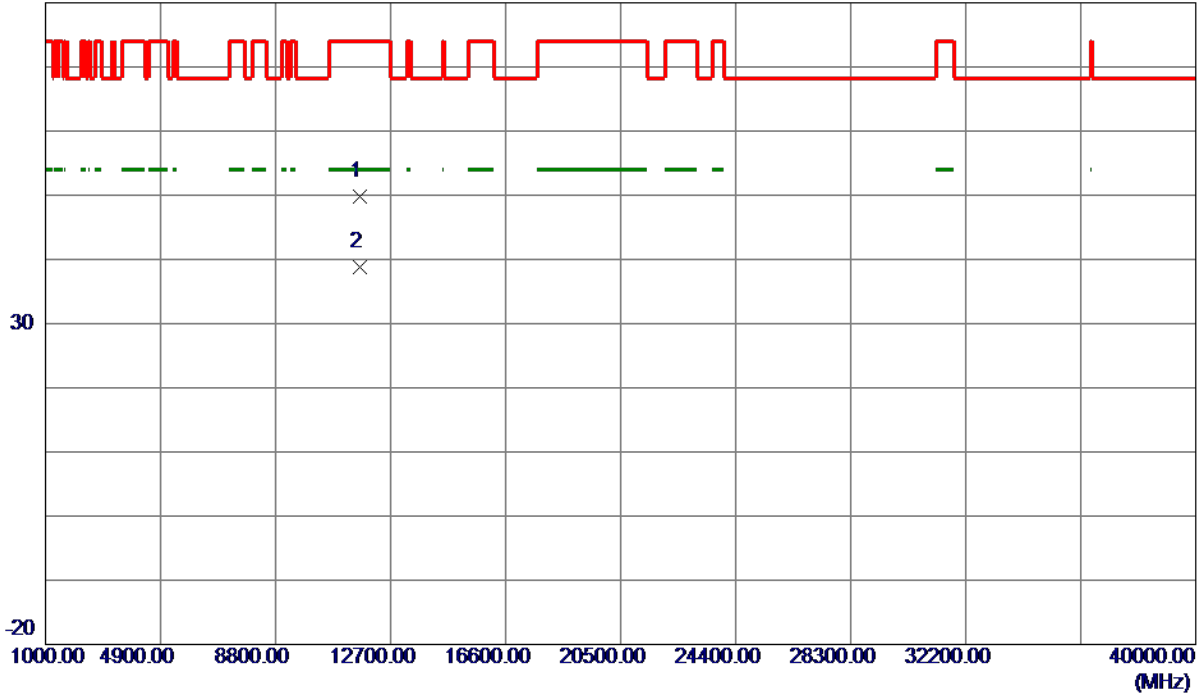

No.	Freq. MHz	Reading Level dBuV/m	Correct Factor dB	Measure ment dBuV/m	Limit dBuV/m	Margin dB	Detector	Comment
1	11652.6500	38.44	11.33	49.77	74.00	-24.23	Peak	
2 *	11654.3750	27.51	11.33	38.84	54.00	-15.16	AVG	

REMARKS:

- (1) Measurement Value = Reading Level + Correct Factor.
- (2) Margin Level = Measurement Value - Limit Value.

Orthogonal Axis	X
Test Mode	UNII-3_TX AC (VHT20) Mode 5825 MHz

Horizontal

130 dBuV/m

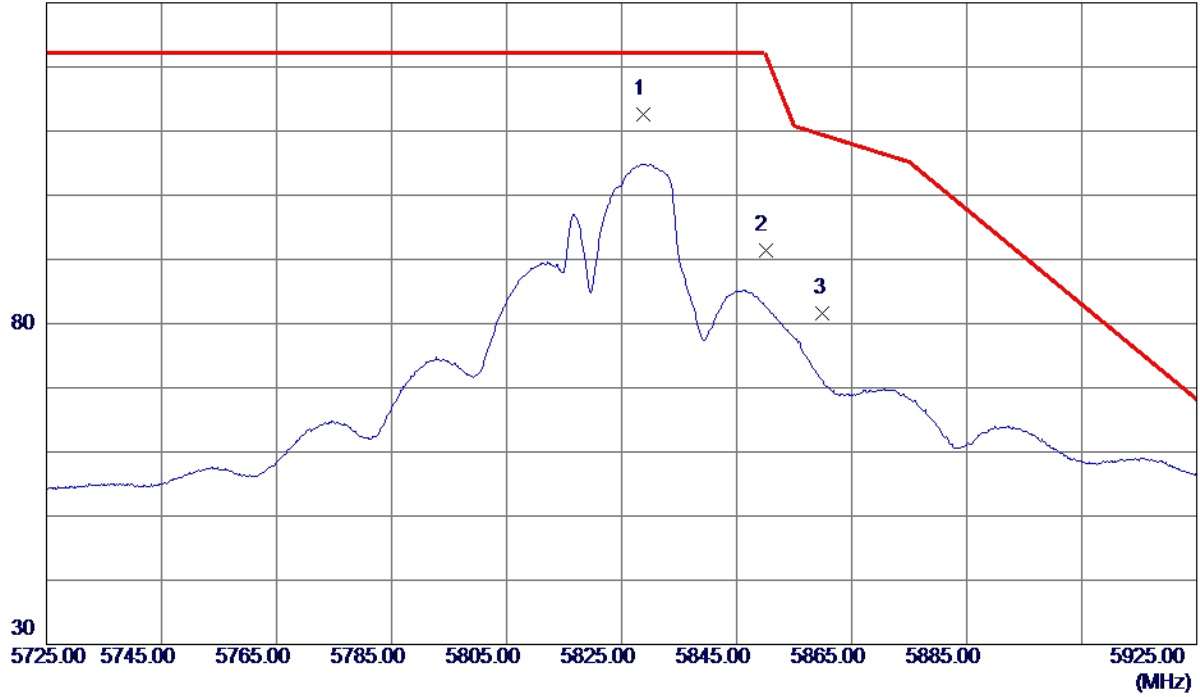

No.	Freq. MHz	Reading Level dBuV/m	Correct Factor dB	Measure ment dBuV/m	Limit dBuV/m	Margin dB	Detector	Comment
1 *	5828.7000	96.65	15.86	112.51	122.20	-9.69	Peak	No Limit
2	5850.0000	75.50	15.90	91.40	122.20	-30.80	Peak	
3	5860.0000	65.59	15.92	81.51	109.40	-27.89	Peak	

REMARKS:

- (1) Measurement Value = Reading Level + Correct Factor.
- (2) Margin Level = Measurement Value - Limit Value.

Orthogonal Axis	X
Test Mode	UNII-3_TX AC (VHT20) Mode 5825 MHz

Horizontal

80 dBuV/m

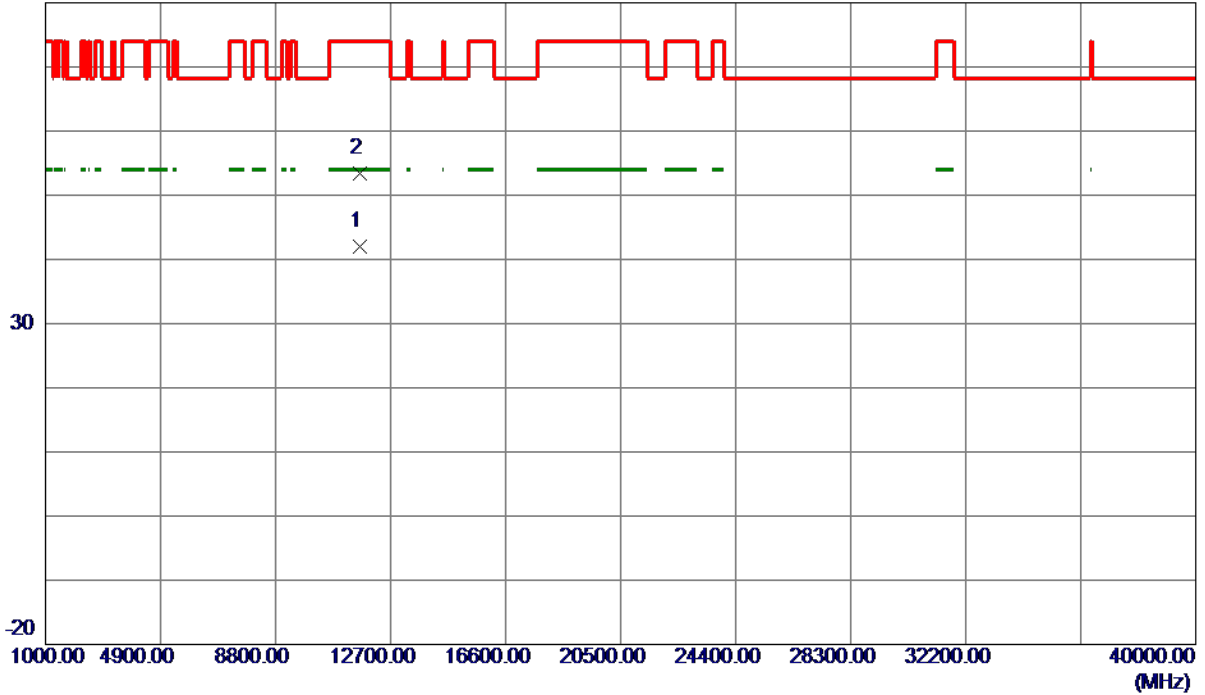

No.	Freq. MHz	Reading Level dBuV/m	Correct Factor dB	Measure ment dBuV/m	Limit dBuV/m	Margin dB	Detector	Comment
1 *	11652.7500	30.75	11.33	42.08	54.00	-11.92	AVG	
2	11654.2000	42.03	11.33	53.36	74.00	-20.64	Peak	

REMARKS:

- (1) Measurement Value = Reading Level + Correct Factor.
- (2) Margin Level = Measurement Value - Limit Value.

Orthogonal Axis	X
Test Mode	UNII-3_TX AC (VHT40) Mode 5755 MHz

Vertical

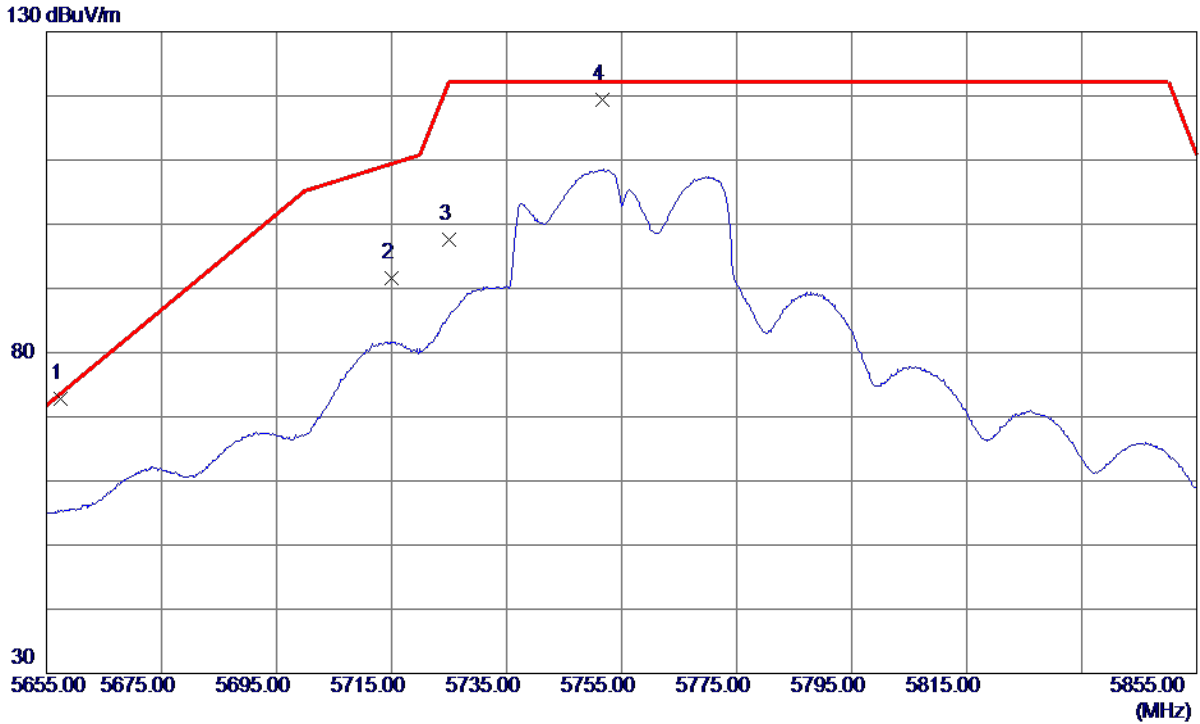

No.	Freq. MHz	Reading Level dBuV/m	Correct Factor dB	Measure ment dBuV/m	Limit dBuV/m	Margin dB	Detector	Comment
1 *	5657.4000	57.32	15.55	72.87	73.68	-0.81	Peak	
2	5715.0000	76.01	15.65	91.66	109.40	-17.74	Peak	
3	5725.0000	81.91	15.67	97.58	122.20	-24.62	Peak	
4	5751.7000	103.66	15.72	119.38	122.20	-2.82	Peak	No Limit

REMARKS:

- (1) Measurement Value = Reading Level + Correct Factor.
- (2) Margin Level = Measurement Value - Limit Value.

Orthogonal Axis	X
Test Mode	UNII-3_TX AC (VHT40) Mode 5755 MHz

Vertical

80 dBuV/m

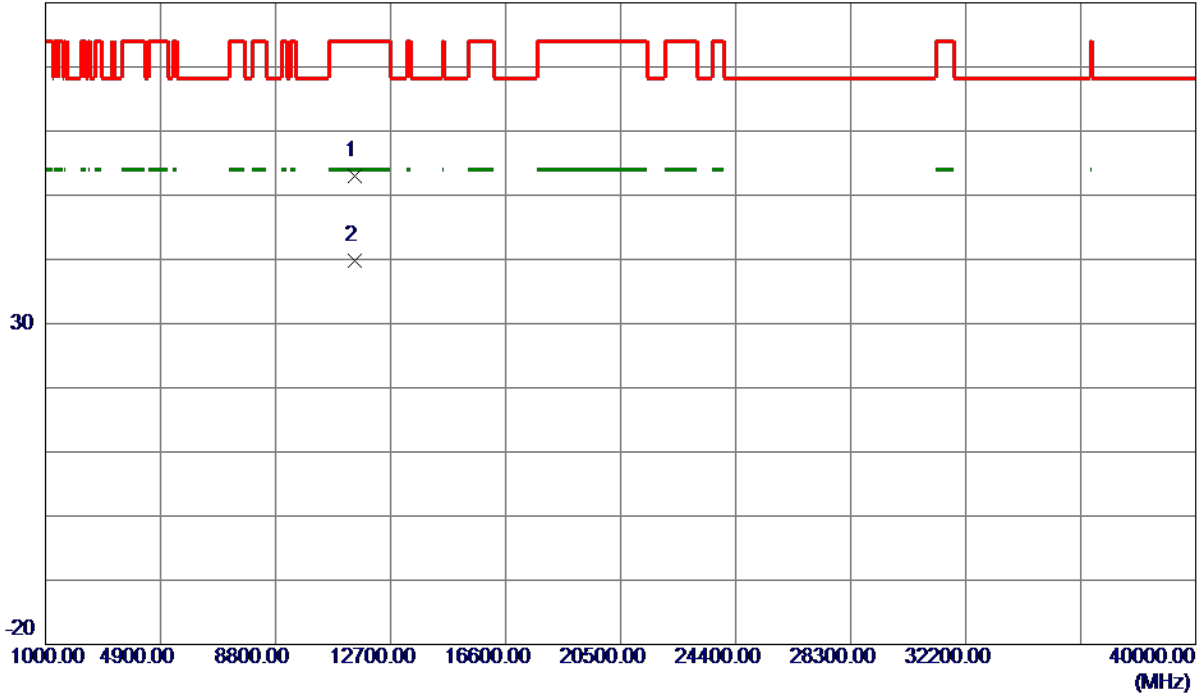

No.	Freq. MHz	Reading Level dBuV/m	Correct Factor dB	Measure ment dBuV/m	Limit dBuV/m	Margin dB	Detector	Comment
1	11492.7000	41.98	11.11	53.09	74.00	-20.91	Peak	
2 *	11504.2250	28.72	11.14	39.86	54.00	-14.14	AVG	

REMARKS:

- (1) Measurement Value = Reading Level + Correct Factor.
- (2) Margin Level = Measurement Value - Limit Value.

Orthogonal Axis	X
Test Mode	UNII-3_TX AC (VHT40) Mode 5755 MHz

Horizontal

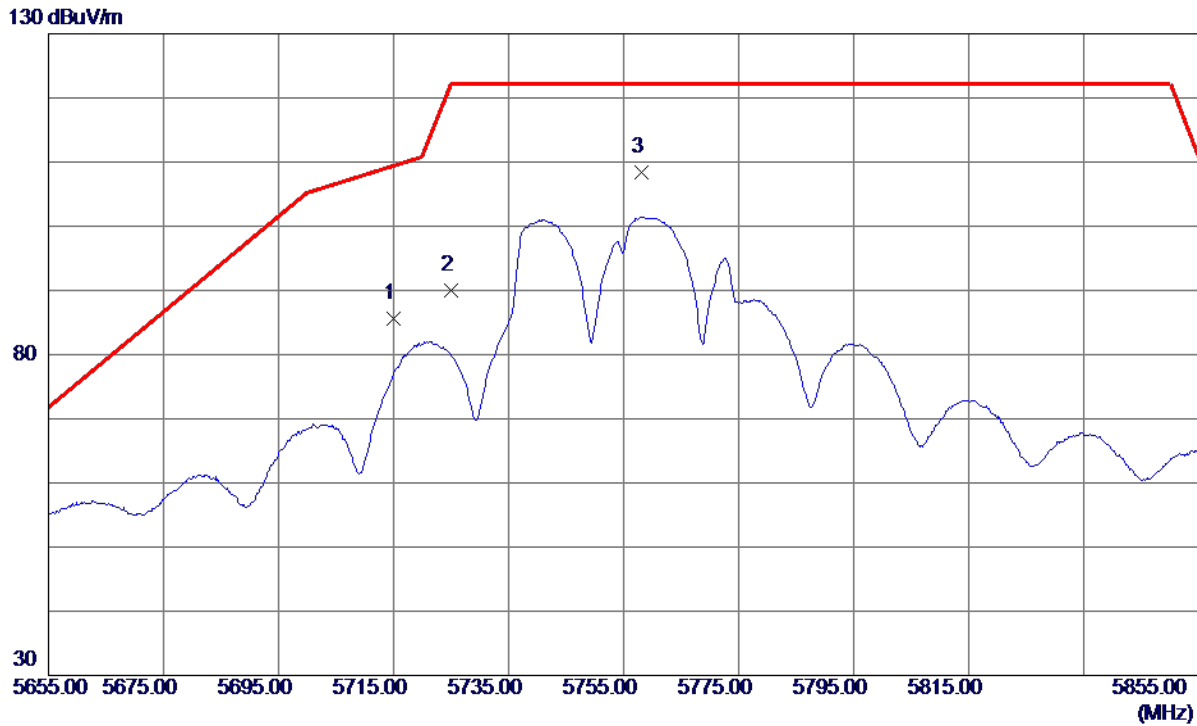

No.	Freq. MHz	Reading Level dBuV/m	Correct Factor dB	Measure ment dBuV/m	Limit dBuV/m	Margin dB	Detector	Comment
1	5715.0000	70.02	15.65	85.67	109.40	-23.73	Peak	
2	5725.0000	74.33	15.67	90.00	122.20	-32.20	Peak	
3 *	5758.2000	92.76	15.73	108.49	122.20	-13.71	Peak	No Limit

REMARKS:

- (1) Measurement Value = Reading Level + Correct Factor.
- (2) Margin Level = Measurement Value - Limit Value.

Orthogonal Axis	X
Test Mode	UNII-3_TX AC (VHT40) Mode 5755 MHz

Horizontal

80 dBuV/m

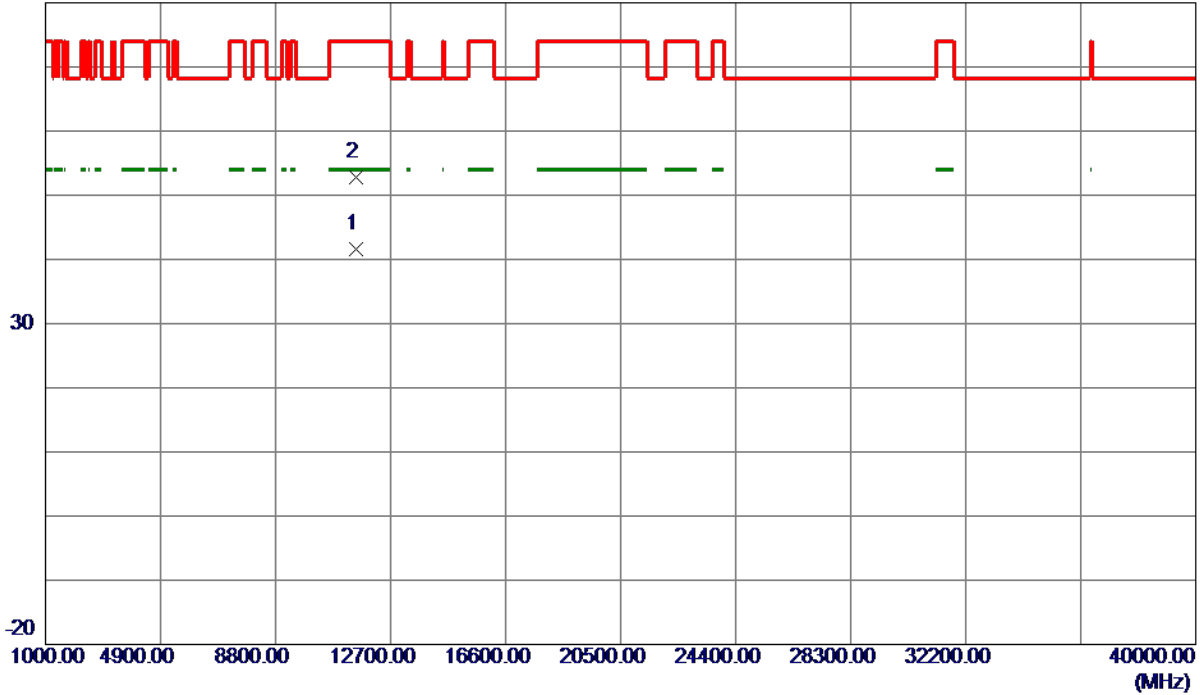

No.	Freq. MHz	Reading Level dBuV/m	Correct Factor dB	Measure ment dBuV/m	Limit dBuV/m	Margin dB	Detector	Comment
1 *	11511.1500	30.40	11.14	41.54	54.00	-12.46	AVG	
2	11512.1000	41.61	11.15	52.76	74.00	-21.24	Peak	

REMARKS:

- (1) Measurement Value = Reading Level + Correct Factor.
- (2) Margin Level = Measurement Value - Limit Value.

Orthogonal Axis	X
Test Mode	UNII-3_TX AC (VHT40) Mode 5795 MHz

Vertical

130 dBuV/m

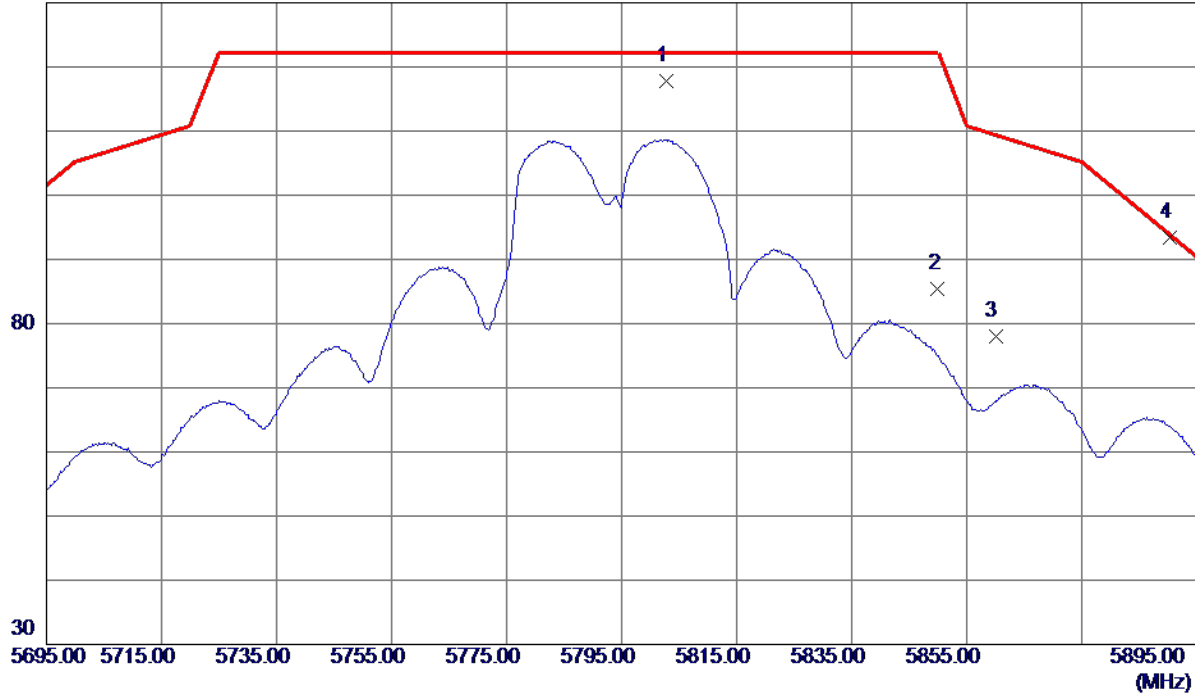

No.	Freq. MHz	Reading Level dBuV/m	Correct Factor dB	Measure ment dBuV/m	Limit dBuV/m	Margin dB	Detector	Comment
1	5802.7000	101.94	15.81	117.75	122.20	-4.45	Peak	No Limit
2	5850.0000	69.48	15.90	85.38	122.20	-36.82	Peak	
3	5860.0000	62.02	15.92	77.94	109.40	-31.46	Peak	
4 *	5890.3000	77.51	15.97	93.48	93.88	-0.40	Peak	

REMARKS:

- (1) Measurement Value = Reading Level + Correct Factor.
- (2) Margin Level = Measurement Value - Limit Value.

Orthogonal Axis	X
Test Mode	UNII-3_TX AC (VHT40) Mode 5795 MHz

Vertical

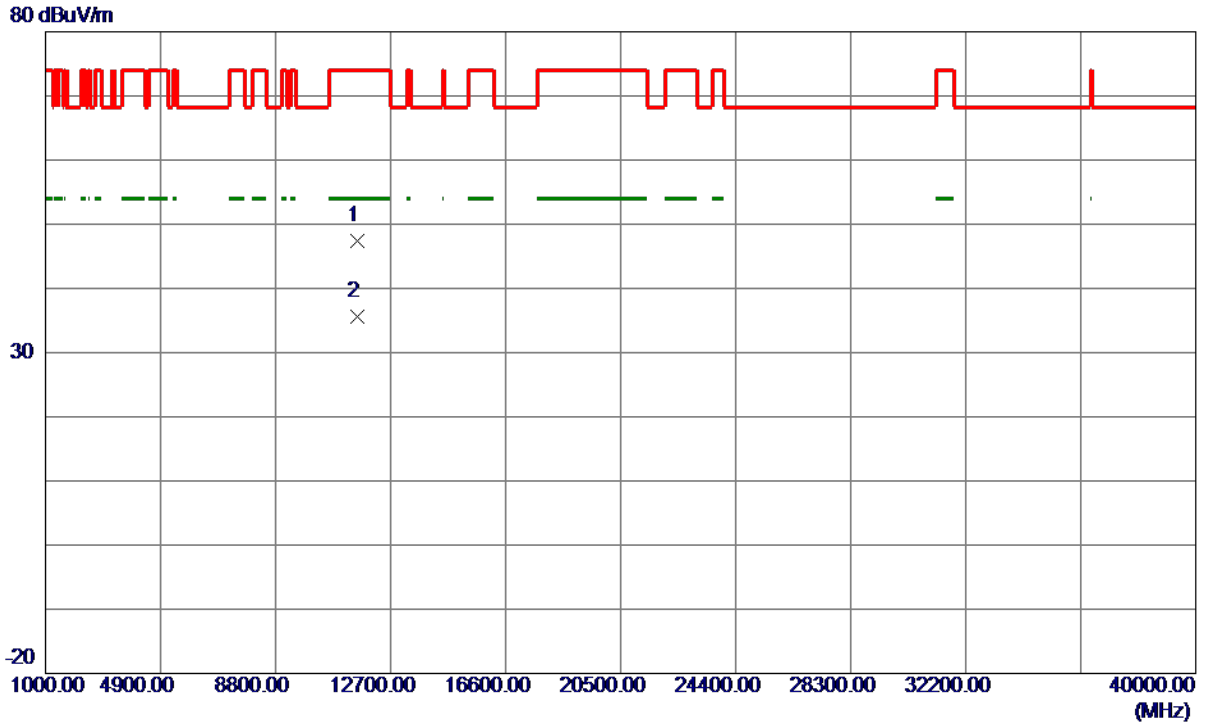

No.	Freq. MHz	Reading Level dBuV/m	Correct Factor dB	Measure ment dBuV/m	Limit dBuV/m	Margin dB	Detector	Comment
1	11589.5000	36.07	11.25	47.32	74.00	-26.68	Peak	
2 *	11590.7000	24.33	11.25	35.58	54.00	-18.42	AVG	

REMARKS:

- (1) Measurement Value = Reading Level + Correct Factor.
- (2) Margin Level = Measurement Value - Limit Value.

Orthogonal Axis	X
Test Mode	UNII-3_TX AC (VHT40) Mode 5795 MHz

Horizontal

130 dBuV/m

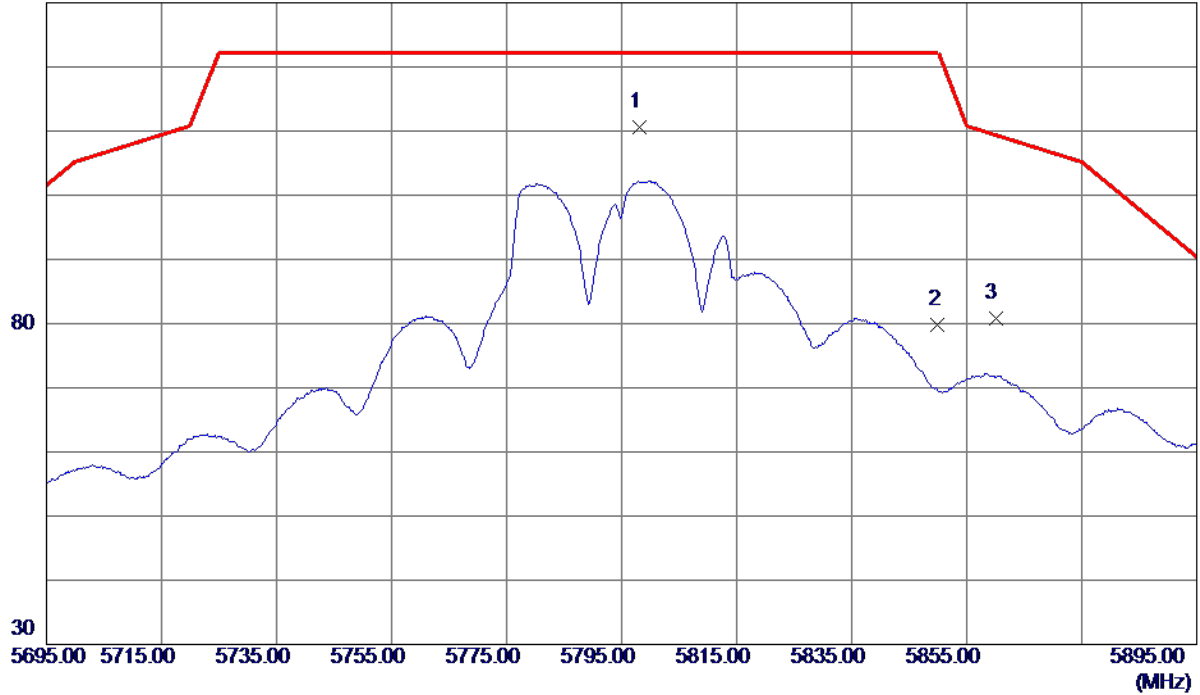

No.	Freq. MHz	Reading Level dBuV/m	Correct Factor dB	Measure ment dBuV/m	Limit dBuV/m	Margin dB	Detector	Comment
1 *	5798.2000	94.77	15.80	110.57	122.20	-11.63	Peak	No Limit
2	5850.0000	63.85	15.90	79.75	122.20	-42.45	Peak	
3	5860.0000	64.84	15.92	80.76	109.40	-28.64	Peak	

REMARKS:

- (1) Measurement Value = Reading Level + Correct Factor.
- (2) Margin Level = Measurement Value - Limit Value.

Orthogonal Axis	X
Test Mode	UNII-3_TX AC (VHT40) Mode 5795 MHz

Horizontal

80 dBuV/m

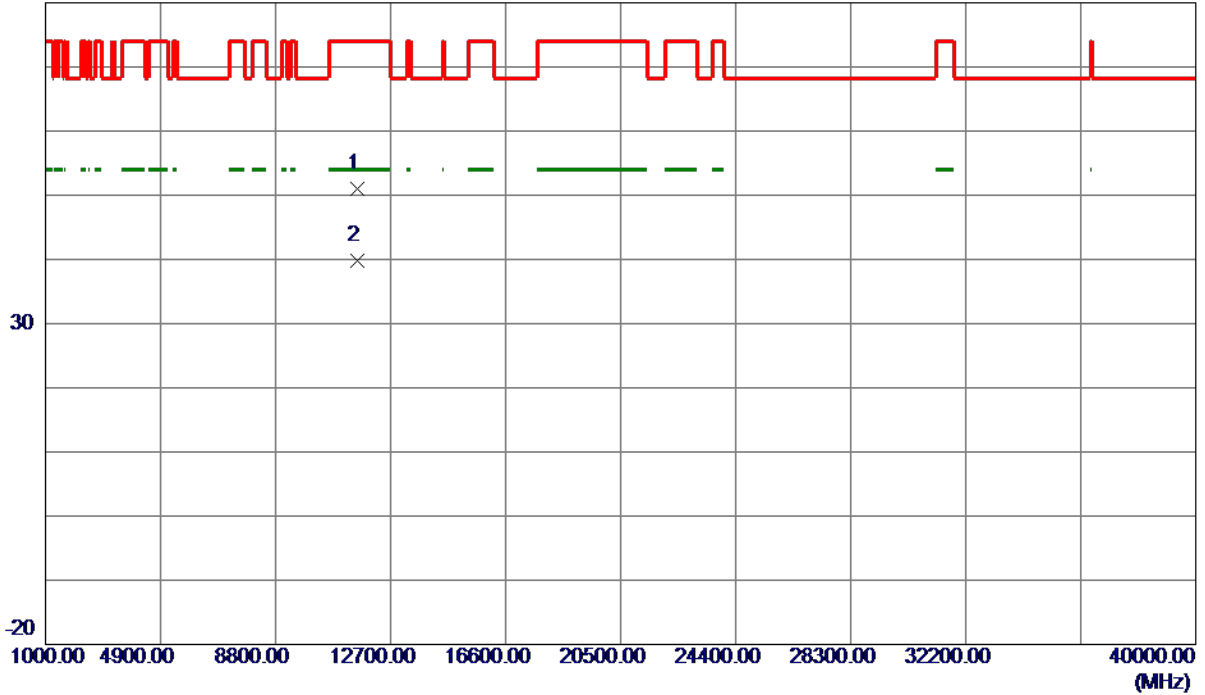

No.	Freq. MHz	Reading Level dBuV/m	Correct Factor dB	Measure ment dBuV/m	Limit dBuV/m	Margin dB	Detector	Comment
1	11585.3500	39.83	11.24	51.07	74.00	-22.93	Peak	
2 *	11589.2000	28.50	11.25	39.75	54.00	-14.25	AVG	

REMARKS:

- (1) Measurement Value = Reading Level + Correct Factor.
- (2) Margin Level = Measurement Value - Limit Value.

Orthogonal Axis	X
Test Mode	UNII-3_TX AC (VHT80) Mode 5775 MHz

Vertical

130 dBuV/m

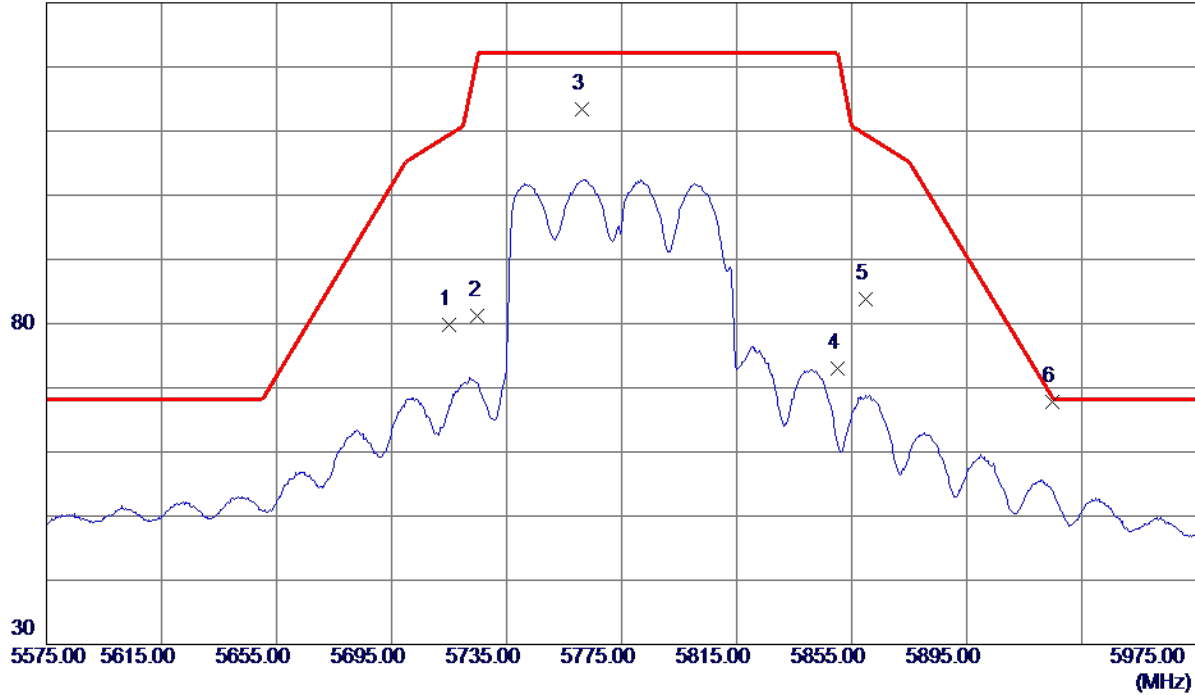

No.	Freq. MHz	Reading Level dBuV/m	Correct Factor dB	Measure ment dBuV/m	Limit dBuV/m	Margin dB	Detector	Comment
1	5715.0000	64.08	15.65	79.73	109.40	-29.67	Peak	
2	5725.0000	65.60	15.67	81.27	122.20	-40.93	Peak	
3	5761.2000	97.74	15.74	113.48	122.20	-8.72	Peak	No Limit
4	5850.0000	57.01	15.90	72.91	122.20	-49.29	Peak	
5	5860.0000	67.88	15.92	83.80	109.40	-25.60	Peak	
6 *	5924.8000	51.79	16.03	67.82	68.35	-0.53	Peak	

REMARKS:

- (1) Measurement Value = Reading Level + Correct Factor.
- (2) Margin Level = Measurement Value - Limit Value.

Orthogonal Axis	X
Test Mode	UNII-3_TX AC (VHT80) Mode 5775 MHz

Vertical

80 dBuV/m

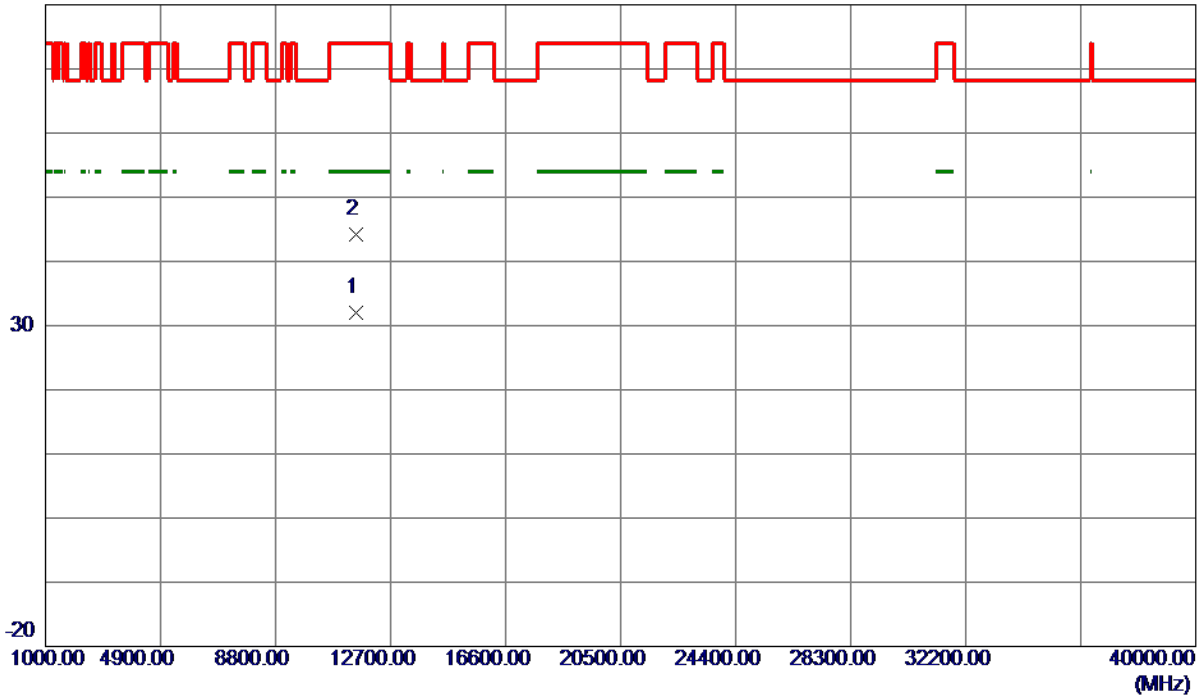

No.	Freq. MHz	Reading Level dBuV/m	Correct Factor dB	Measure ment dBuV/m	Limit dBuV/m	Margin dB	Detector	Comment
1 *	11523.9500	20.75	11.16	31.91	54.00	-22.09	AVG	
2	11528.4500	33.06	11.17	44.23	74.00	-29.77	Peak	

REMARKS:

- (1) Measurement Value = Reading Level + Correct Factor.
- (2) Margin Level = Measurement Value - Limit Value.

Orthogonal Axis	X
Test Mode	UNII-3_TX AC (VHT80) Mode 5775 MHz

Horizontal

130 dBuV/m

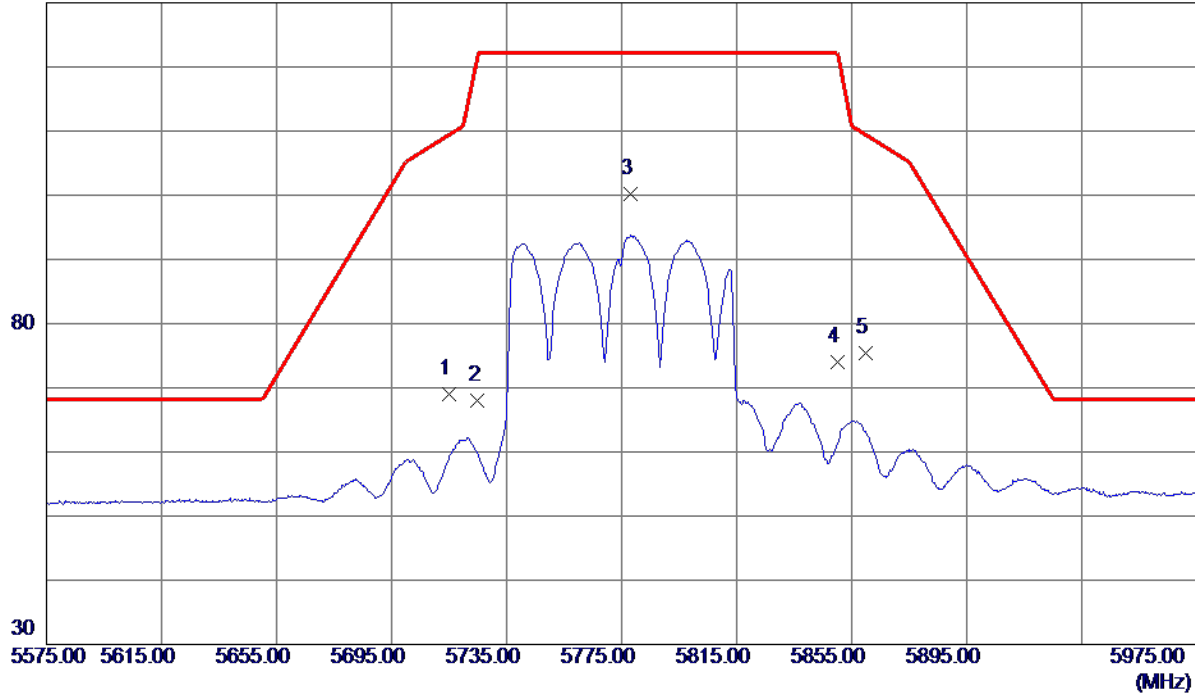

No.	Freq. MHz	Reading Level dBuV/m	Correct Factor dB	Measure ment dBuV/m	Limit dBuV/m	Margin dB	Detector	Comment
1	5715.0000	53.41	15.65	69.06	109.40	-40.34	Peak	
2	5725.0000	52.35	15.67	68.02	122.20	-54.18	Peak	
3 *	5778.2000	84.52	15.77	100.29	122.20	-21.91	Peak	No Limit
4	5850.0000	58.14	15.90	74.04	122.20	-48.16	Peak	
5	5860.0000	59.47	15.92	75.39	109.40	-34.01	Peak	

REMARKS:

- (1) Measurement Value = Reading Level + Correct Factor.
- (2) Margin Level = Measurement Value - Limit Value.

Orthogonal Axis	X
Test Mode	UNII-3_TX AC (VHT80) Mode 5775 MHz

Horizontal

80 dBuV/m

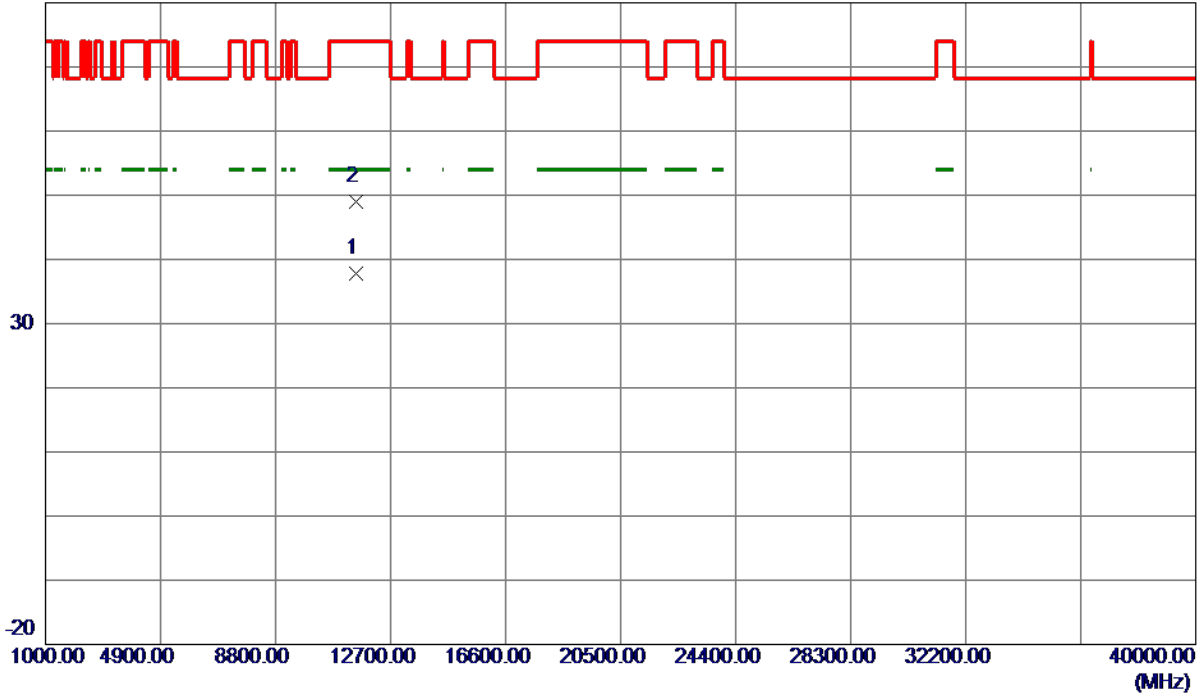

No.	Freq. MHz	Reading Level dBuV/m	Correct Factor dB	Measure ment dBuV/m	Limit dBuV/m	Margin dB	Detector	Comment
1 *	11515.2500	26.64	11.15	37.79	54.00	-16.21	AVG	
2	11531.8500	37.76	11.17	48.93	74.00	-25.07	Peak	

REMARKS:

- (1) Measurement Value = Reading Level + Correct Factor.
- (2) Margin Level = Measurement Value - Limit Value.

Beamforming

Orthogonal Axis	X
Test Mode	UNII-1_TX AC (VHT20) Mode 5180 MHz

Vertical

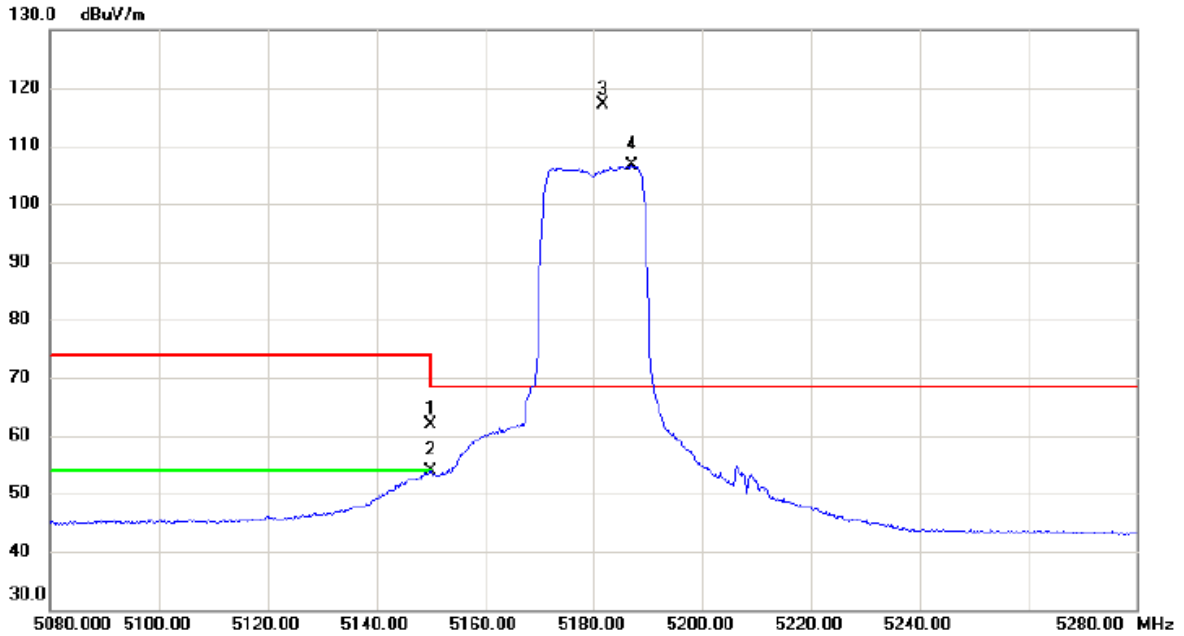

No.	Mk.	Freq. MHz	Reading Level dBuV	Correct Factor dB	Measure- ment dBuV/m	Limit dBuV/m	Margin dB	Detector	Comment
1		5150.000	46.84	15.02	61.86	74.00	-12.14	peak	
2		5150.000	38.83	15.02	53.85	54.00	-0.15	AVG	
3	*	5181.700	102.10	15.04	117.14	68.30	48.84	peak	No Limit
4	X	5187.100	91.55	15.04	106.59	68.30	38.29	AVG	No Limit

REMARKS:

- (1) Measurement Value = Reading Level + Correct Factor.
- (2) Margin Level = Measurement Value - Limit Value.

Orthogonal Axis	X
Test Mode	UNII-1_TX AC (VHT20) Mode 5180 MHz

Vertical

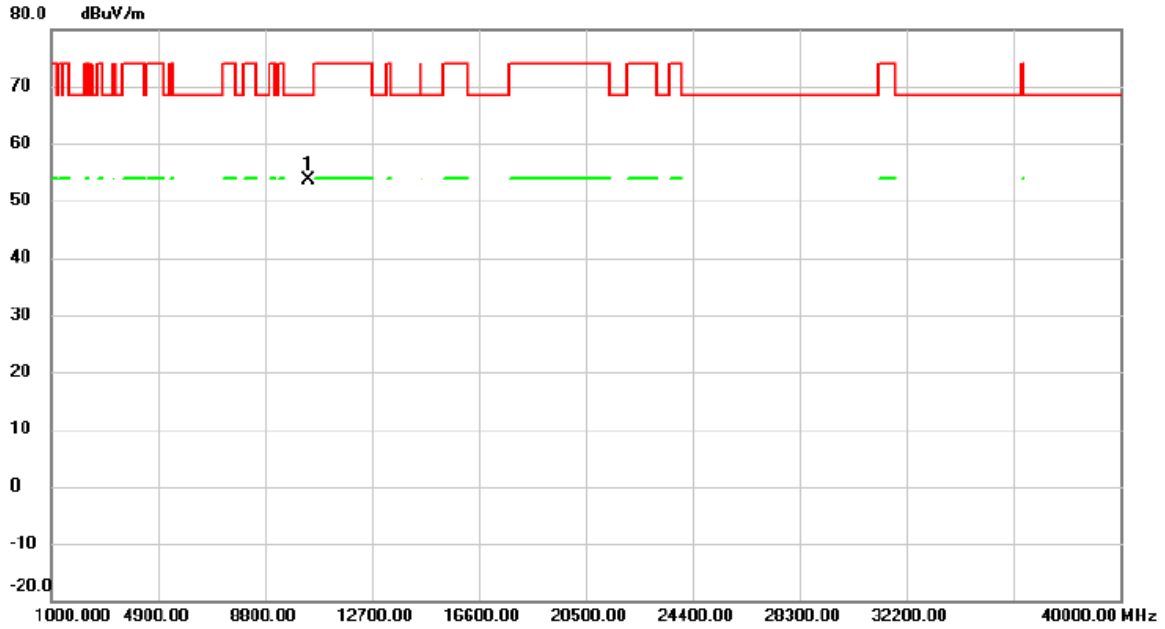

No.	Mk.	Freq. MHz	Reading Level dBuV	Correct Factor dB	Measure- ment dBuV/m	Limit dBuV/m	Margin dB	Detector	Comment
1	*	10361.823	44.93	8.77	53.70	68.30	-14.60	peak	

REMARKS:

- (1) Measurement Value = Reading Level + Correct Factor.
- (2) Margin Level = Measurement Value - Limit Value.

Orthogonal Axis	X
Test Mode	UNII-1_TX AC (VHT20) Mode 5180 MHz

Horizontal

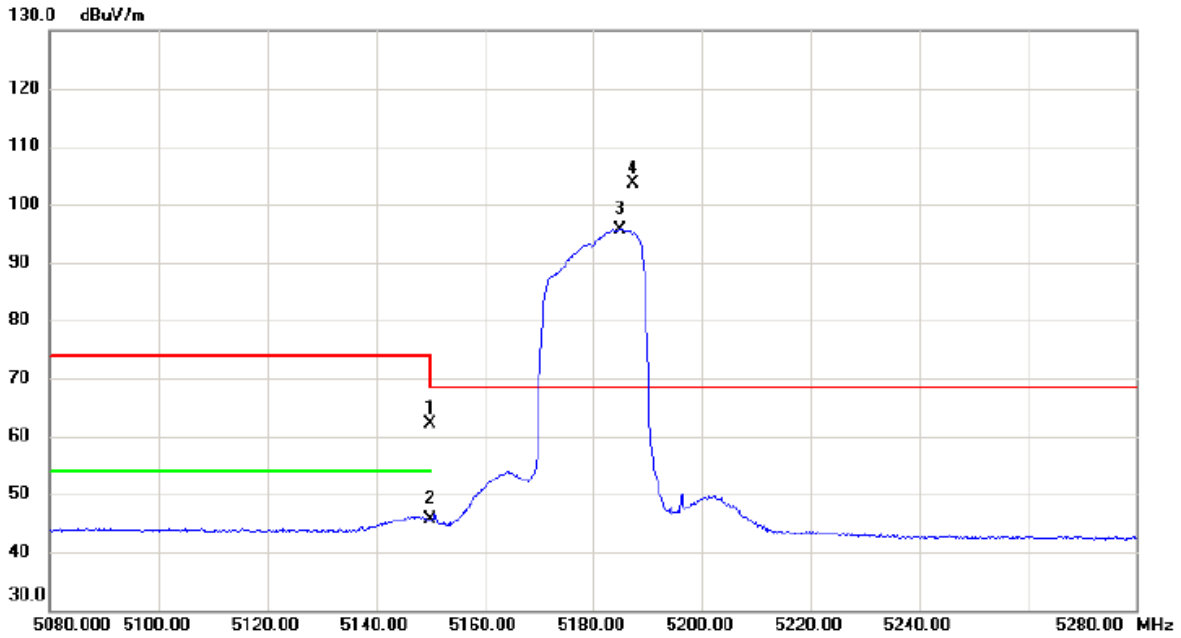

No.	Mk.	Freq. MHz	Reading Level dBuV	Correct Factor dB	Measure- ment dBuV/m	Limit dBuV/m	Margin dB	Detector	Comment
1		5150.000	47.23	15.02	62.25	74.00	-11.75	peak	
2		5150.000	30.58	15.02	45.60	54.00	-8.40	AVG	
3	X	5185.000	80.61	15.04	95.65	68.30	27.35	AVG	No Limit
4	*	5187.300	88.62	15.04	103.66	68.30	35.36	peak	No Limit

REMARKS:

- (1) Measurement Value = Reading Level + Correct Factor.
- (2) Margin Level = Measurement Value - Limit Value.

Orthogonal Axis	X
Test Mode	UNII-1_TX AC (VHT20) Mode 5180 MHz

Horizontal

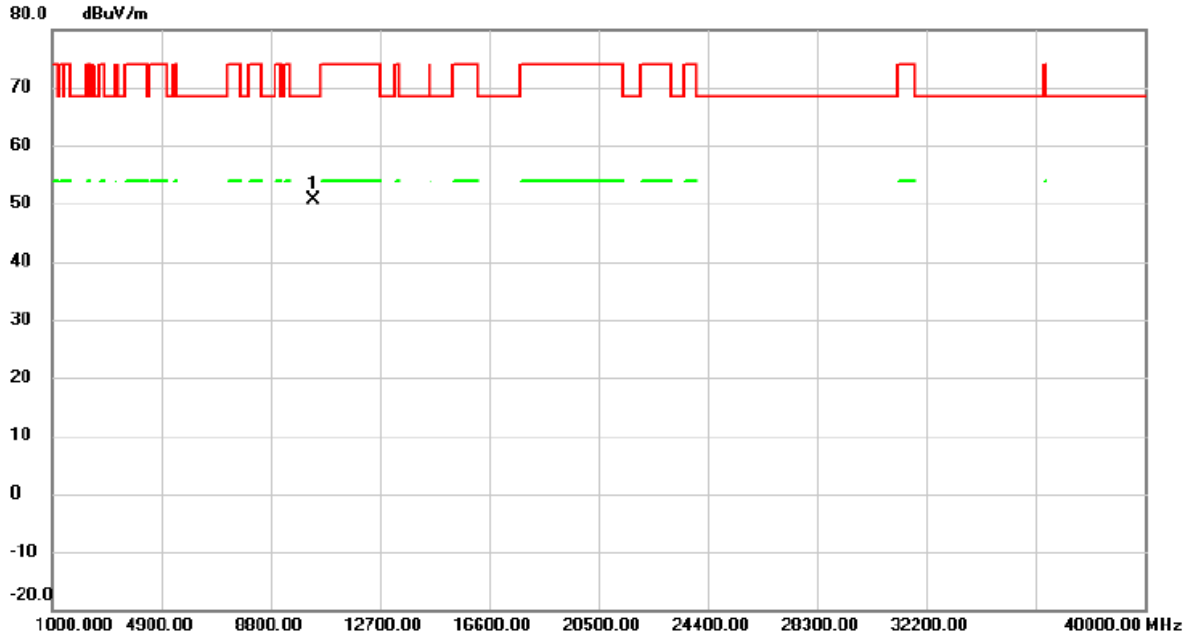

No.	Mk.	Freq. MHz	Reading Level dBuV	Correct Factor dB	Measure- ment dBuV/m	Limit dBuV/m	Margin dB	Detector	Comment
1	*	10355.822	41.93	8.75	50.68	68.30	-17.62	peak	

REMARKS:

- (1) Measurement Value = Reading Level + Correct Factor.
- (2) Margin Level = Measurement Value - Limit Value.

Orthogonal Axis	X
Test Mode	UNII-1_TX AC (VHT20) Mode 5200 MHz

Vertical

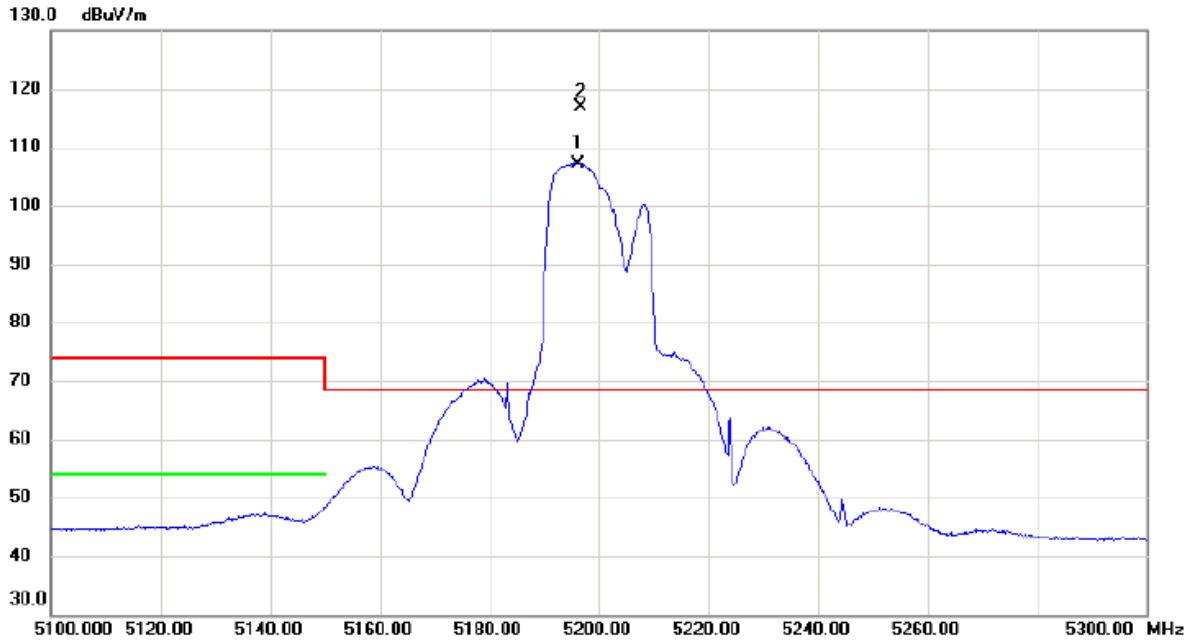

No.	Mk.	Freq. MHz	Reading Level dBuV	Correct Factor dB	Measure- ment dBuV/m	Limit dBuV/m	Margin dB	Detector	Comment
1	X	5196.000	92.10	15.05	107.15	68.30	38.85	AVG	No Limit
2	*	5196.700	101.93	15.05	116.98	68.30	48.68	peak	No Limit

REMARKS:

- (1) Measurement Value = Reading Level + Correct Factor.
- (2) Margin Level = Measurement Value - Limit Value.

Orthogonal Axis	X
Test Mode	UNII-1_TX AC (VHT20) Mode 5200 MHz

Vertical

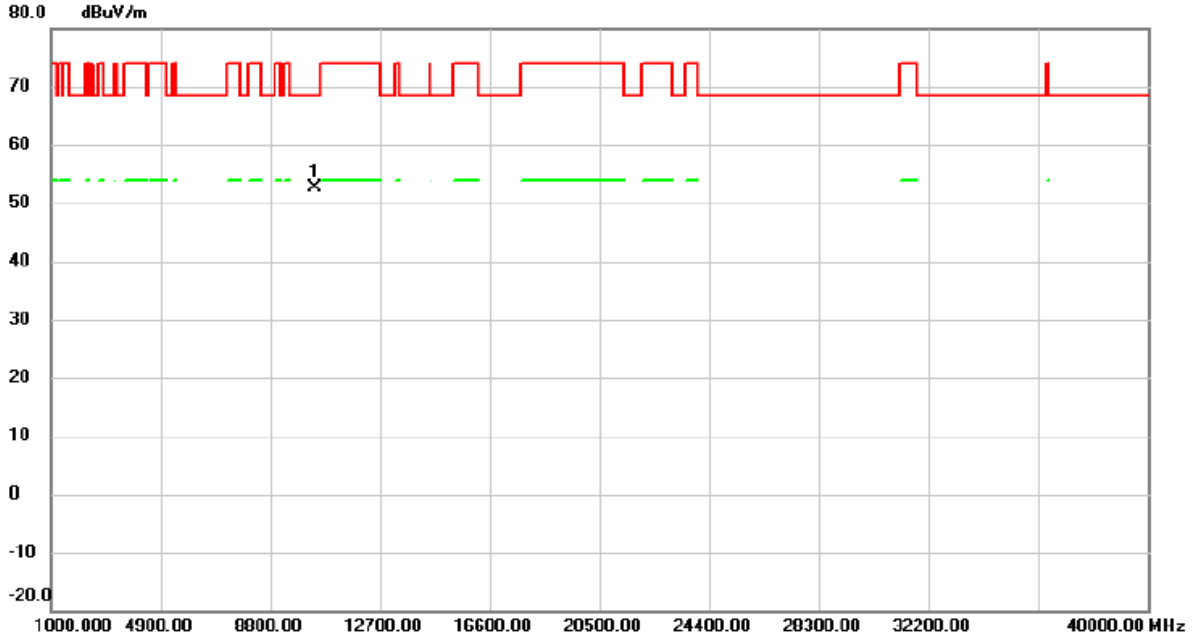

No.	Mk.	Freq. MHz	Reading Level dBuV	Correct Factor dB	Measure- ment dBuV/m	Limit dBuV/m	Margin dB	Detector	Comment
1	*	10403.820	43.82	8.85	52.67	68.30	-15.63	peak	

REMARKS:

- (1) Measurement Value = Reading Level + Correct Factor.
- (2) Margin Level = Measurement Value - Limit Value.

Orthogonal Axis	X
Test Mode	UNII-1_TX AC (VHT20) Mode 5200 MHz

Horizontal

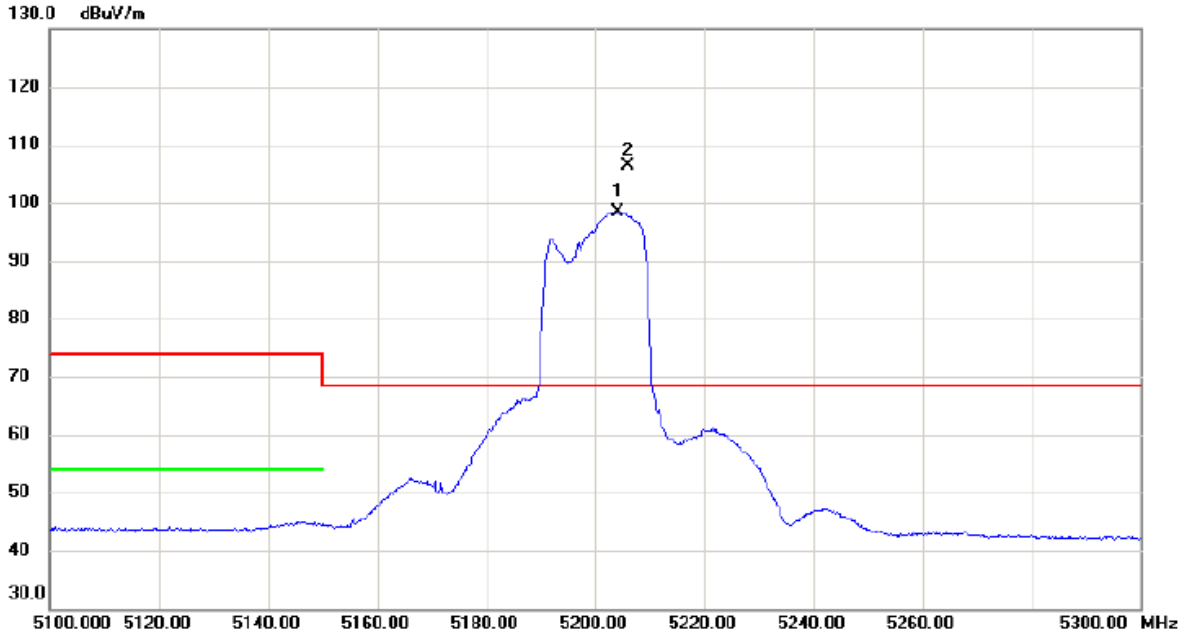

No.	Mk.	Freq. MHz	Reading Level dBuV	Correct Factor dB	Measure- ment dBuV/m	Limit dBuV/m	Margin dB	Detector	Comment
1	X	5204.200	83.39	15.05	98.44	68.30	30.14	AVG	No Limit
2	*	5206.000	91.41	15.05	106.46	68.30	38.16	peak	No Limit

REMARKS:

- (1) Measurement Value = Reading Level + Correct Factor.
- (2) Margin Level = Measurement Value - Limit Value.

Orthogonal Axis	X
Test Mode	UNII-1_TX AC (VHT20) Mode 5200 MHz

Horizontal

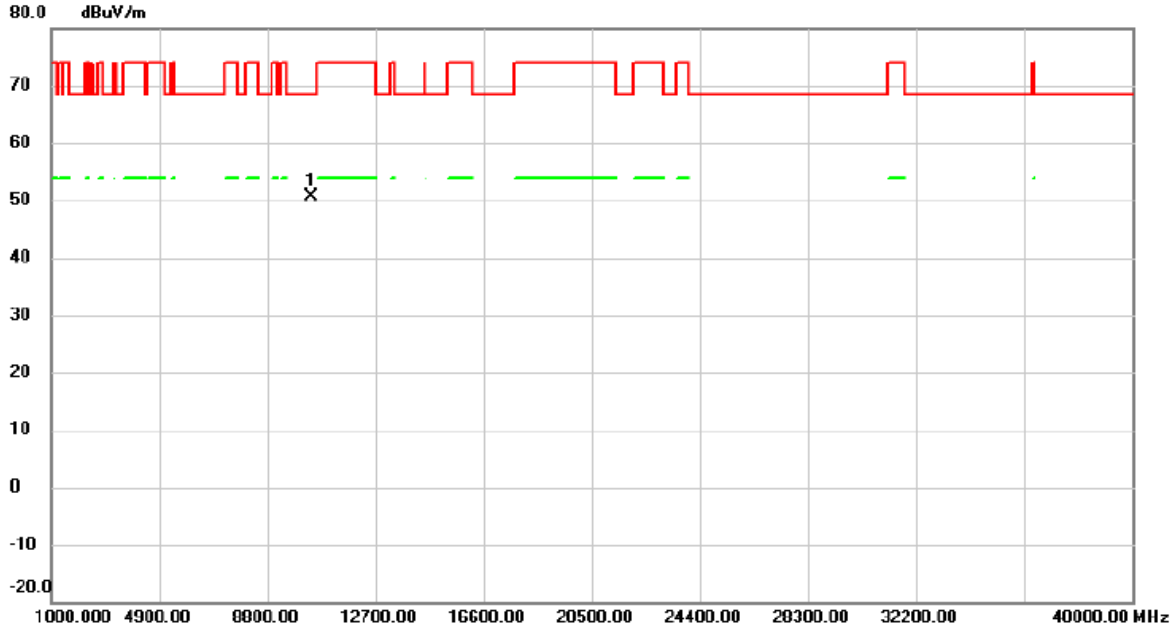

No.	Mk.	Freq. MHz	Reading Level dBuV	Correct Factor dB	Measure- ment dBuV/m	Limit dBuV/m	Margin dB	Detector	Comment
1	*	10397.324	41.81	8.85	50.66	68.30	-17.64	peak	

REMARKS:

- (1) Measurement Value = Reading Level + Correct Factor.
- (2) Margin Level = Measurement Value - Limit Value.

Orthogonal Axis	X
Test Mode	UNII-1_TX AC (VHT20) Mode 5240 MHz

Vertical

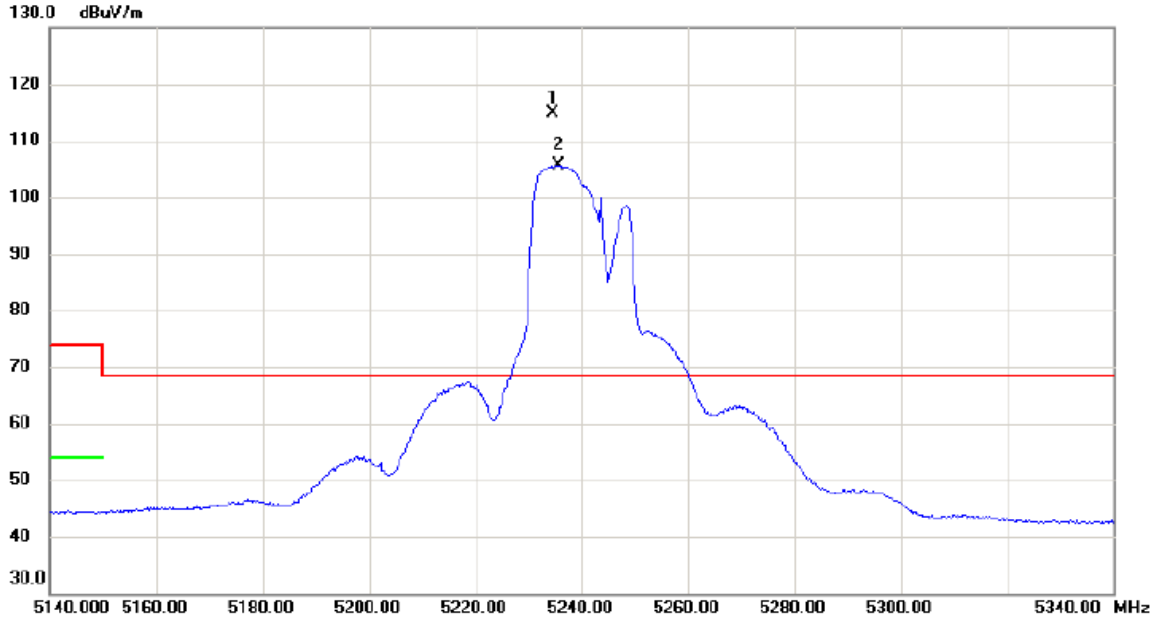

No.	Mk.	Freq. MHz	Reading Level dBuV	Correct Factor dB	Measure- ment dBuV/m	Limit dBuV/m	Margin dB	Detector	Comment
1	*	5234.500	99.70	15.07	114.77	68.30	46.47	peak	No Limit
2	X	5235.500	90.62	15.08	105.70	68.30	37.40	AVG	No Limit

REMARKS:

- (1) Measurement Value = Reading Level + Correct Factor.
- (2) Margin Level = Measurement Value - Limit Value.

Orthogonal Axis	X
Test Mode	UNII-1_TX AC (VHT20) Mode 5240 MHz

Vertical

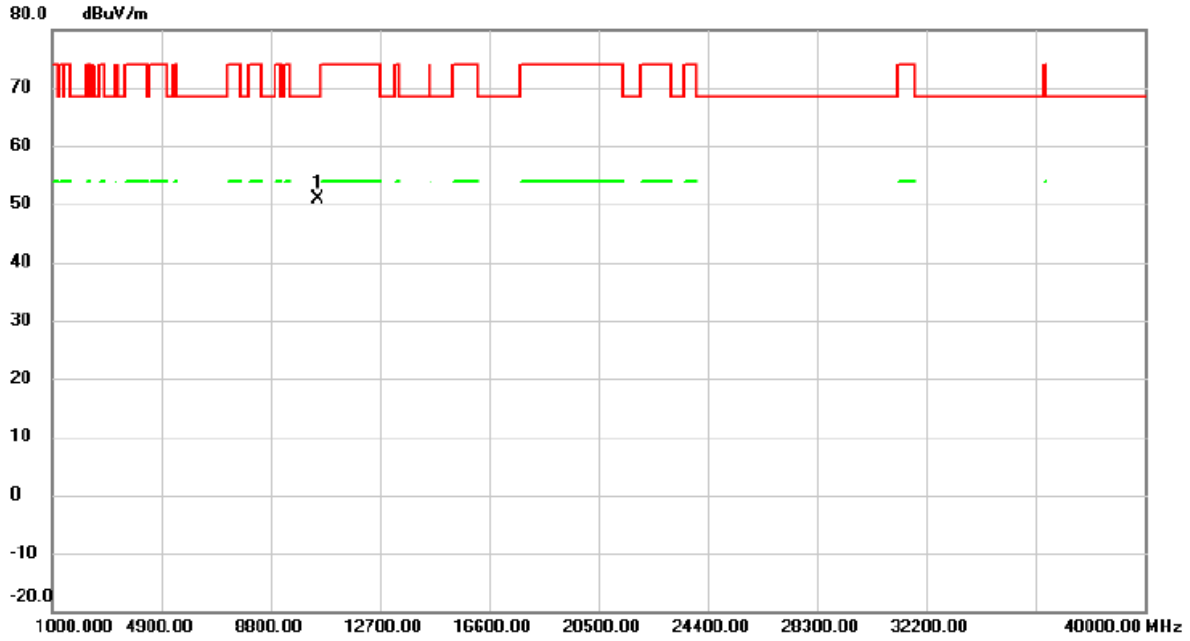

No.	Mk.	Freq. MHz	Reading Level dBuV	Correct Factor dB	Measure- ment dBuV/m	Limit dBuV/m	Margin dB	Detector	Comment
1	*	10471.824	41.84	9.01	50.85	68.30	-17.45	peak	

REMARKS:

- (1) Measurement Value = Reading Level + Correct Factor.
- (2) Margin Level = Measurement Value - Limit Value.

Orthogonal Axis	X
Test Mode	UNII-1_TX AC (VHT20) Mode 5240 MHz

Horizontal

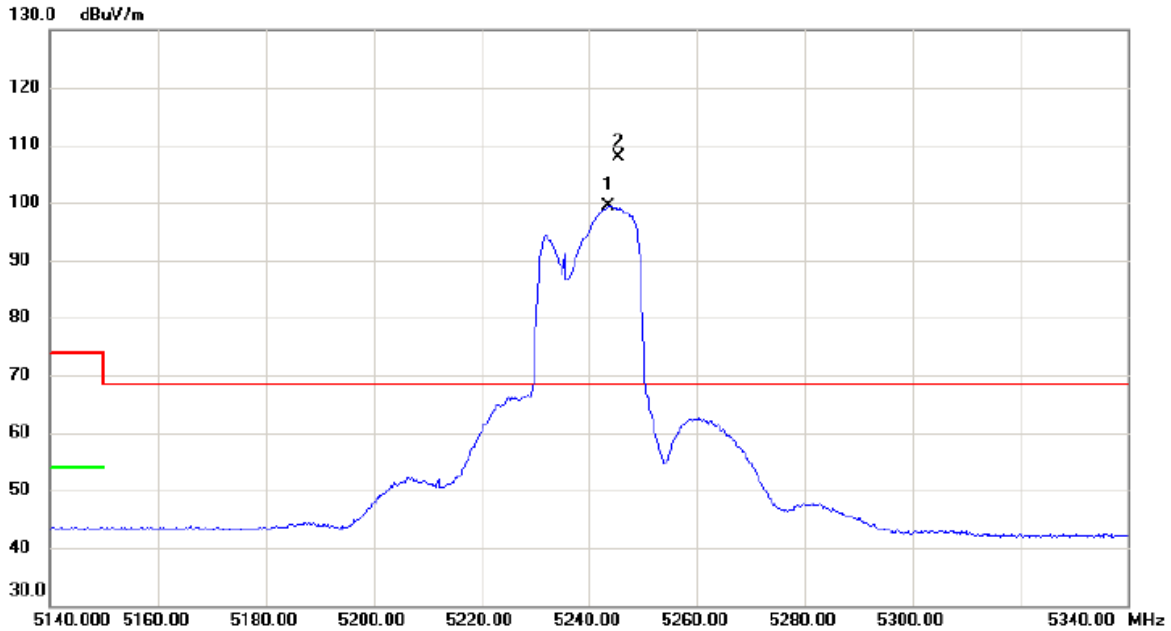

No.	Mk.	Freq. MHz	Reading Level dBuV	Correct Factor dB	Measure- ment dBuV/m	Limit dBuV/m	Margin dB	Detector	Comment
1	X	5243.600	84.32	15.08	99.40	68.30	31.10	AVG	No Limit
2	*	5245.500	92.82	15.09	107.91	68.30	39.61	peak	No Limit

REMARKS:

- (1) Measurement Value = Reading Level + Correct Factor.
- (2) Margin Level = Measurement Value - Limit Value.

Orthogonal Axis	X
Test Mode	UNII-1_TX AC (VHT20) Mode 5240 MHz

Horizontal

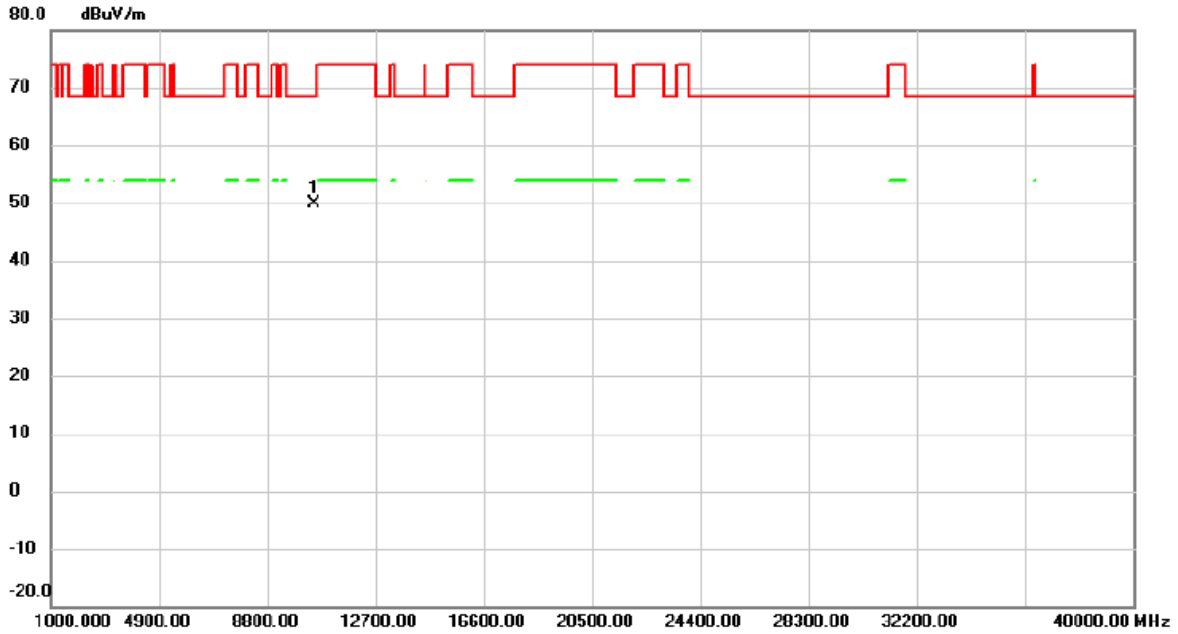

No.	Mk.	Freq. MHz	Reading Level dBuV	Correct Factor dB	Measure- ment dBuV/m	Limit dBuV/m	Margin dB	Detector	Comment
1	*	10481.723	40.83	9.03	49.86	68.30	-18.44	peak	

REMARKS:

- (1) Measurement Value = Reading Level + Correct Factor.
- (2) Margin Level = Measurement Value - Limit Value.

Orthogonal Axis	X
Test Mode	UNII-1_TX AC (VHT40) Mode 5190 MHz

Vertical

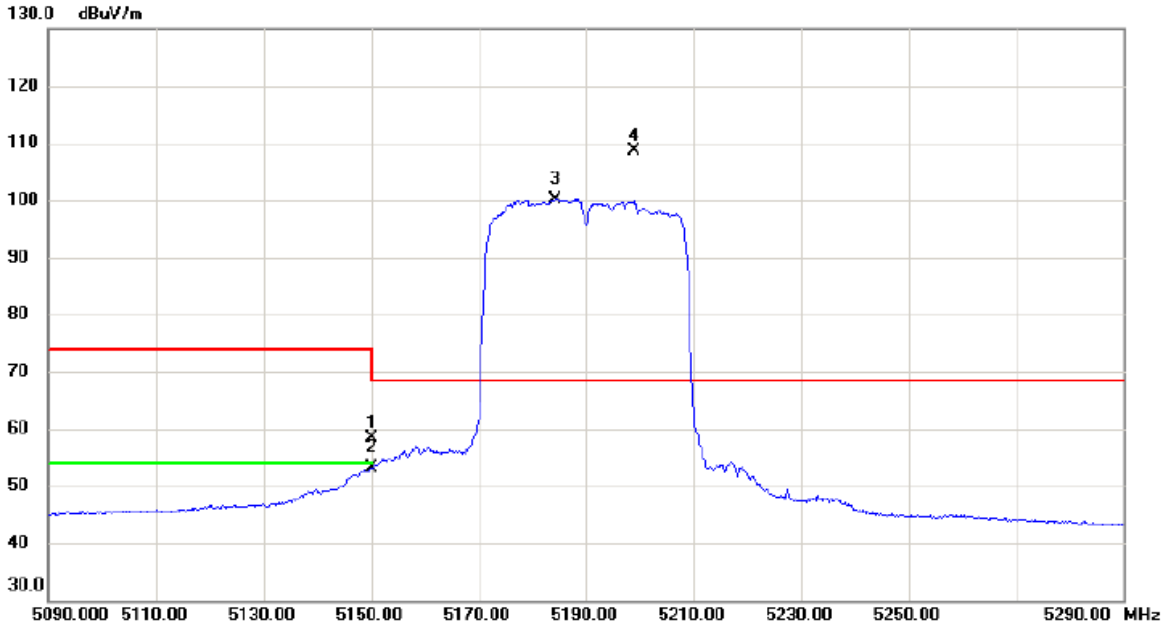

No.	Mk.	Freq. MHz	Reading Level dBuV	Correct Factor dB	Measure- ment dBuV/m	Limit dBuV/m	Margin dB	Detector	Comment
1		5150.000	43.43	15.02	58.45	74.00	-15.55	peak	
2		5150.000	38.04	15.02	53.06	54.00	-0.94	AVG	
3	X	5184.400	85.11	15.03	100.14	68.30	31.84	AVG	No Limit
4	*	5198.900	93.56	15.05	108.61	68.30	40.31	peak	No Limit

REMARKS:

- (1) Measurement Value = Reading Level + Correct Factor.
- (2) Margin Level = Measurement Value - Limit Value.

Orthogonal Axis	X
Test Mode	UNII-1_TX AC (VHT40) Mode 5190 MHz

Vertical

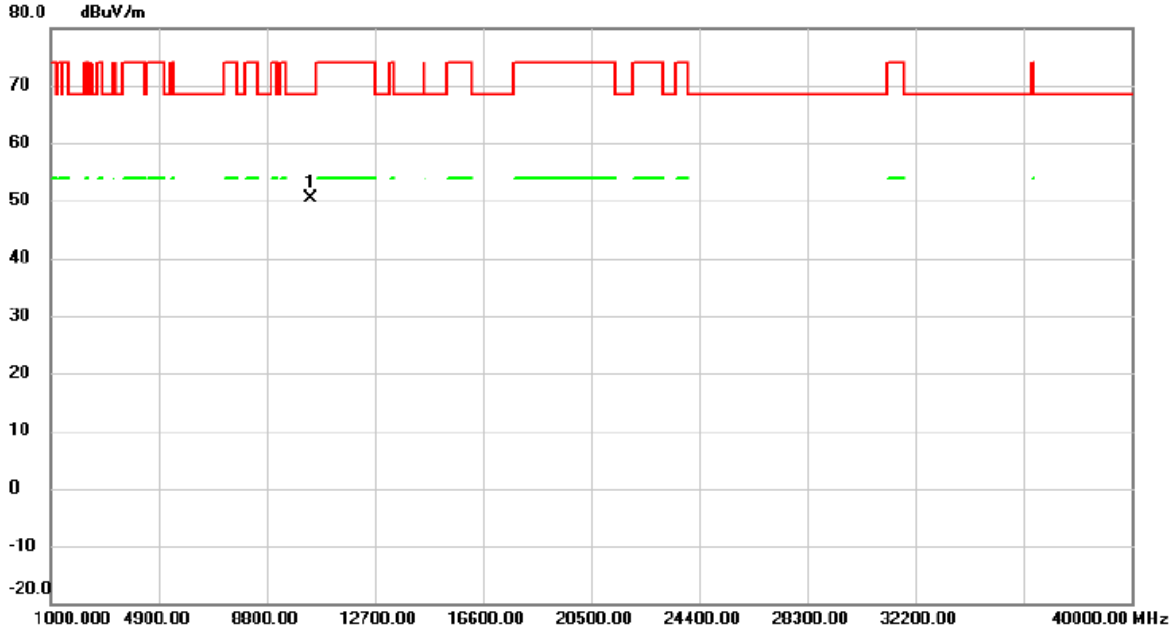

No.	Mk.	Freq. MHz	Reading Level dBuV	Correct Factor dB	Measure- ment dBuV/m	Limit dBuV/m	Margin dB	Detector	Comment
1	*	10385.876	41.55	8.83	50.38	68.30	-17.92	peak	

REMARKS:

- (1) Measurement Value = Reading Level + Correct Factor.
- (2) Margin Level = Measurement Value - Limit Value.

Orthogonal Axis	X
Test Mode	UNII-1_TX AC (VHT40) Mode 5190 MHz

Horizontal

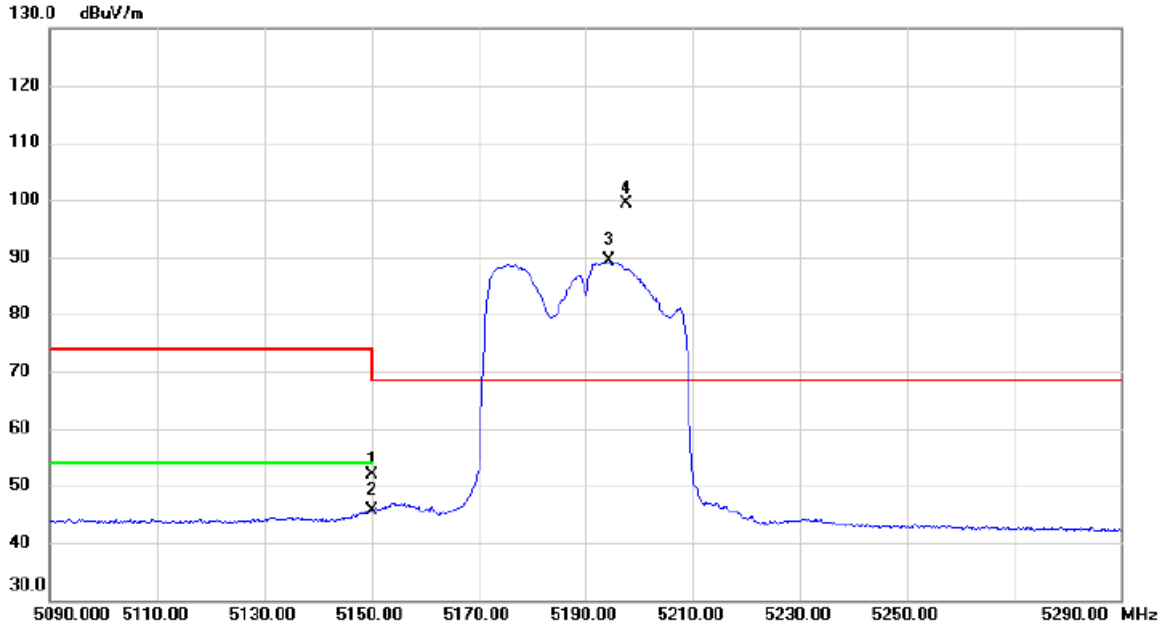

No.	Mk.	Freq. MHz	Reading Level dBuV	Correct Factor dB	Measure- ment dBuV/m	Limit dBuV/m	Margin dB	Detector	Comment
1		5150.000	36.90	15.02	51.92	74.00	-22.08	peak	
2		5150.000	30.53	15.02	45.55	54.00	-8.45	AVG	
3	X	5194.300	74.30	15.05	89.35	68.30	21.05	AVG	No Limit
4	*	5197.500	84.42	15.05	99.47	68.30	31.17	peak	No Limit

REMARKS:

- (1) Measurement Value = Reading Level + Correct Factor.
- (2) Margin Level = Measurement Value - Limit Value.

Orthogonal Axis	X
Test Mode	UNII-1_TX AC (VHT40) Mode 5190 MHz

Horizontal

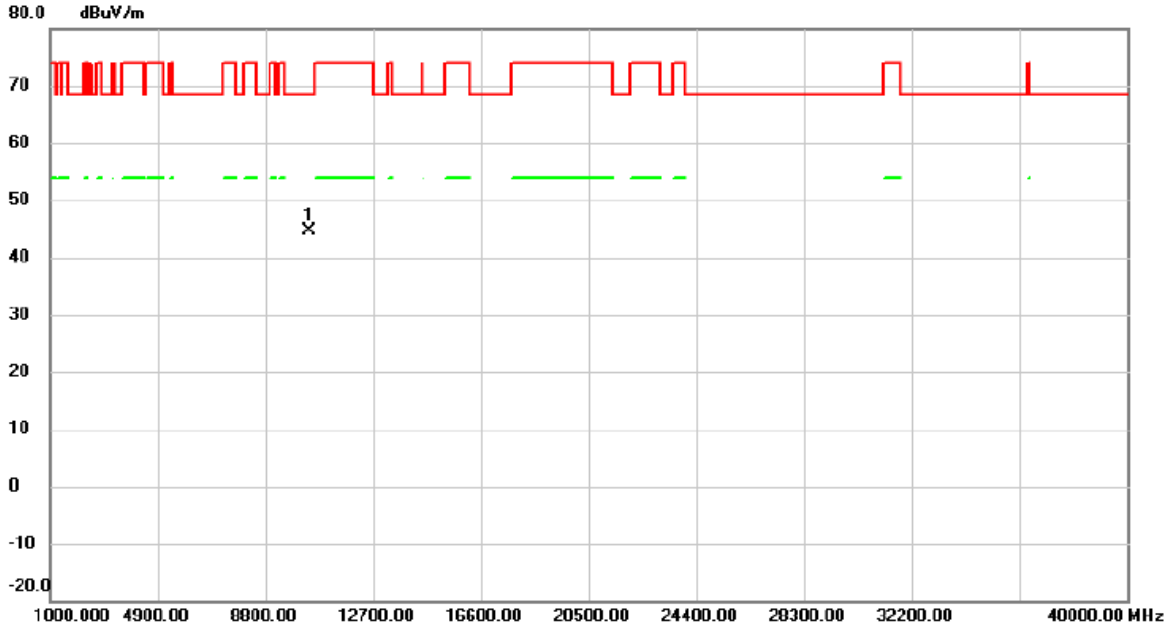

No.	Mk.	Freq. MHz	Reading Level dBuV	Correct Factor dB	Measure- ment dBuV/m	Limit dBuV/m	Margin dB	Detector	Comment
1	*	10372.950	35.74	8.80	44.54	68.30	-23.76	peak	

REMARKS:

- (1) Measurement Value = Reading Level + Correct Factor.
- (2) Margin Level = Measurement Value - Limit Value.

Orthogonal Axis	X
Test Mode	UNII-1_TX AC (VHT40) Mode 5230 MHz

Vertical

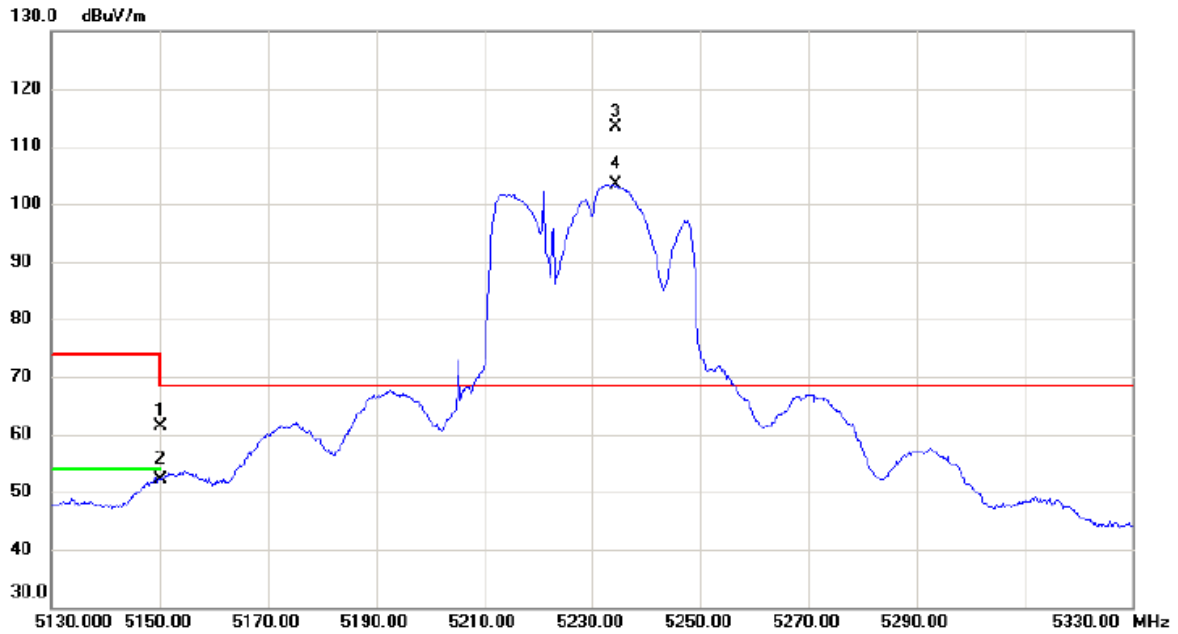

No.	Mk.	Freq. MHz	Reading Level dBuV	Correct Factor dB	Measure- ment dBuV/m	Limit dBuV/m	Margin dB	Detector	Comment
1		5150.000	46.27	15.02	61.29	74.00	-12.71	peak	
2		5150.000	37.10	15.02	52.12	54.00	-1.88	AVG	
3	*	5234.300	98.20	15.07	113.27	68.30	44.97	peak	No Limit
4	X	5234.400	88.38	15.07	103.45	68.30	35.15	AVG	No Limit

REMARKS:

- (1) Measurement Value = Reading Level + Correct Factor.
- (2) Margin Level = Measurement Value - Limit Value.

Orthogonal Axis	X
Test Mode	UNII-1_TX AC (VHT40) Mode 5230 MHz

Vertical

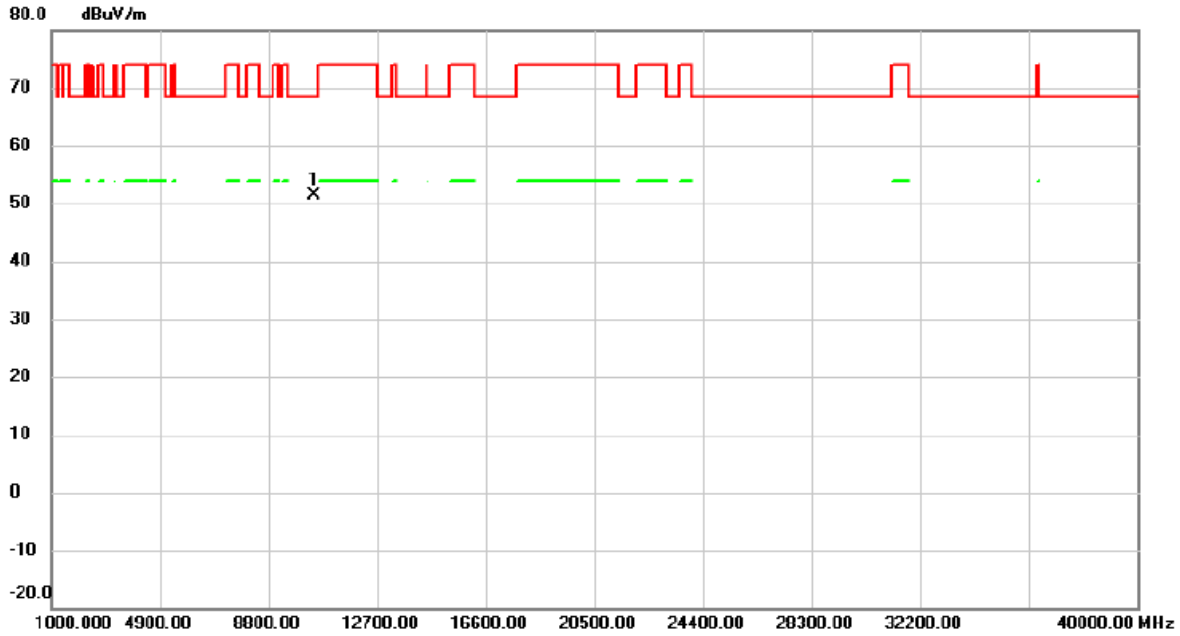

No.	Mk.	Freq. MHz	Reading Level dBuV	Correct Factor dB	Measure- ment dBuV/m	Limit dBuV/m	Margin dB	Detector	Comment
1	*	10461.442	42.42	8.98	51.40	68.30	-16.90	peak	

REMARKS:

- (1) Measurement Value = Reading Level + Correct Factor.
- (2) Margin Level = Measurement Value - Limit Value.

Orthogonal Axis	X
Test Mode	UNII-1_TX AC (VHT40) Mode 5230 MHz

Horizontal

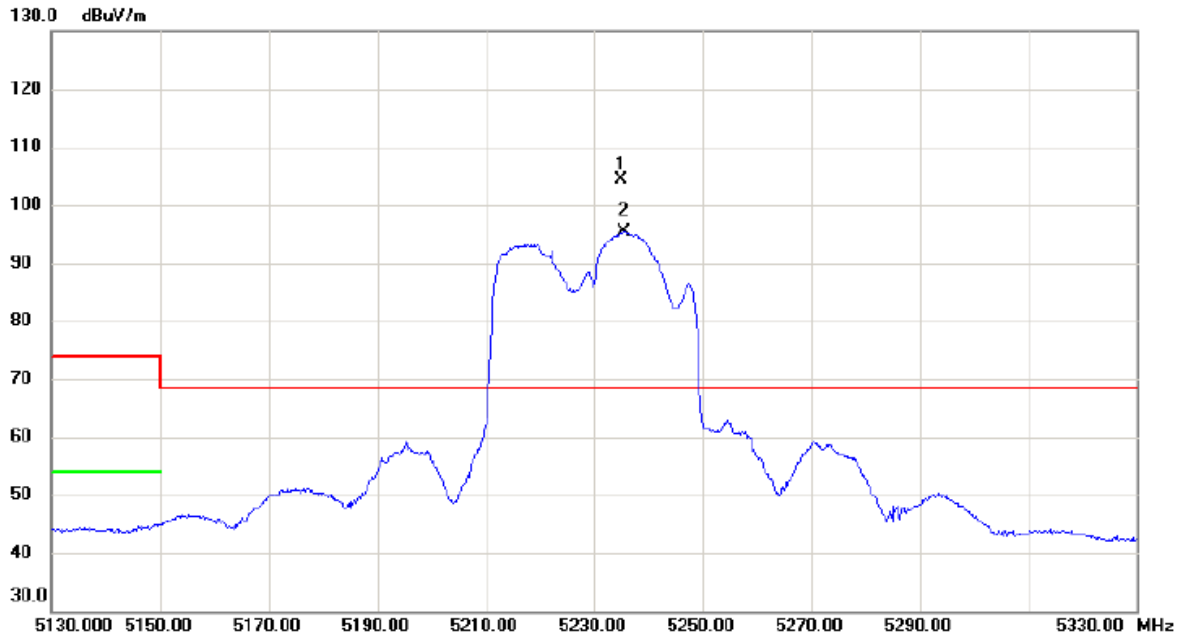

No.	Mk.	Freq. MHz	Reading Level dBuV	Correct Factor dB	Measure- ment dBuV/m	Limit dBuV/m	Margin dB	Detector	Comment
1	*	5234.800	89.22	15.07	104.29	68.30	35.99	peak	No Limit
2	X	5235.500	80.37	15.08	95.45	68.30	27.15	AVG	No Limit

REMARKS:

- (1) Measurement Value = Reading Level + Correct Factor.
- (2) Margin Level = Measurement Value - Limit Value.

Orthogonal Axis	X
Test Mode	UNII-1_TX AC (VHT40) Mode 5230 MHz

Horizontal

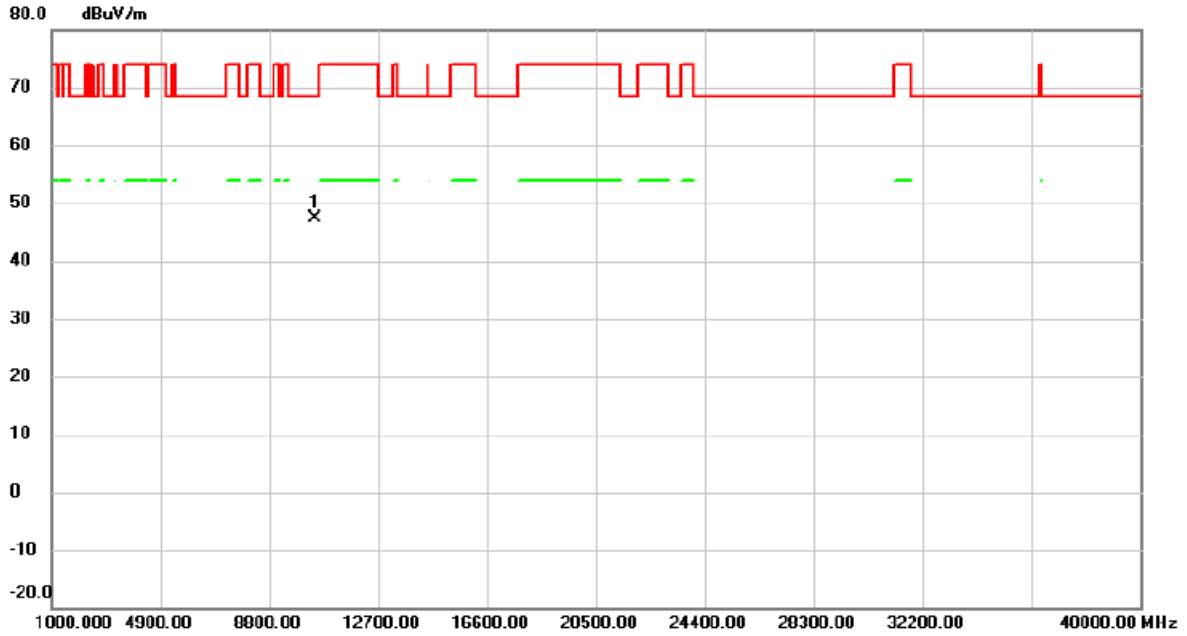

No.	Mk.	Freq. MHz	Reading Level dBuV	Correct Factor dB	Measure- ment dBuV/m	Limit dBuV/m	Margin dB	Detector	Comment
1	*	10461.630	38.45	8.98	47.43	68.30	-20.87	peak	

REMARKS:

- (1) Measurement Value = Reading Level + Correct Factor.
- (2) Margin Level = Measurement Value - Limit Value.

Orthogonal Axis	X
Test Mode	UNII-1_TX AC (VHT80) Mode 5210 MHz

Vertical

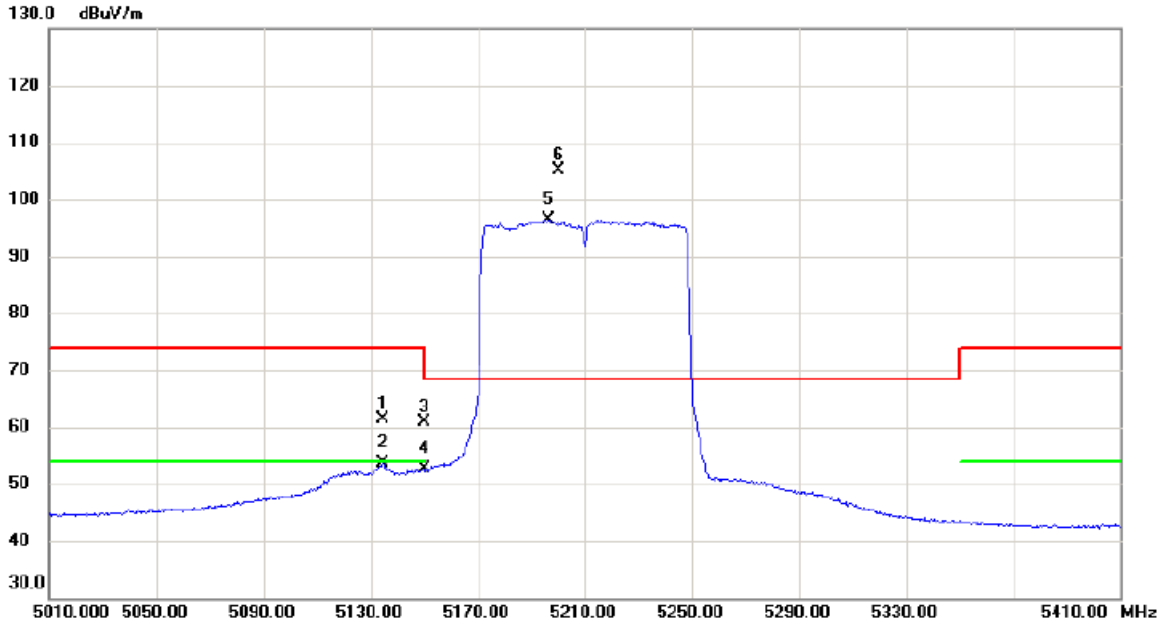

No.	Mk.	Freq. MHz	Reading Level dBuV	Correct Factor dB	Measure- ment dBuV/m	Limit dBuV/m	Margin dB	Detector	Comment
1		5134.600	46.39	15.00	61.39	74.00	-12.61	peak	
2		5134.600	38.55	15.00	53.55	54.00	-0.45	AVG	
3		5150.000	45.78	15.02	60.80	74.00	-13.20	peak	
4		5150.000	37.56	15.02	52.58	54.00	-1.42	AVG	
5	X	5196.600	81.38	15.05	96.43	68.30	28.13	AVG	No Limit
6	*	5200.000	90.12	15.05	105.17	68.30	36.87	peak	No Limit

REMARKS:

- (1) Measurement Value = Reading Level + Correct Factor.
- (2) Margin Level = Measurement Value - Limit Value.

Orthogonal Axis	X
Test Mode	UNII-1_TX AC (VHT80) Mode 5210 MHz

Vertical

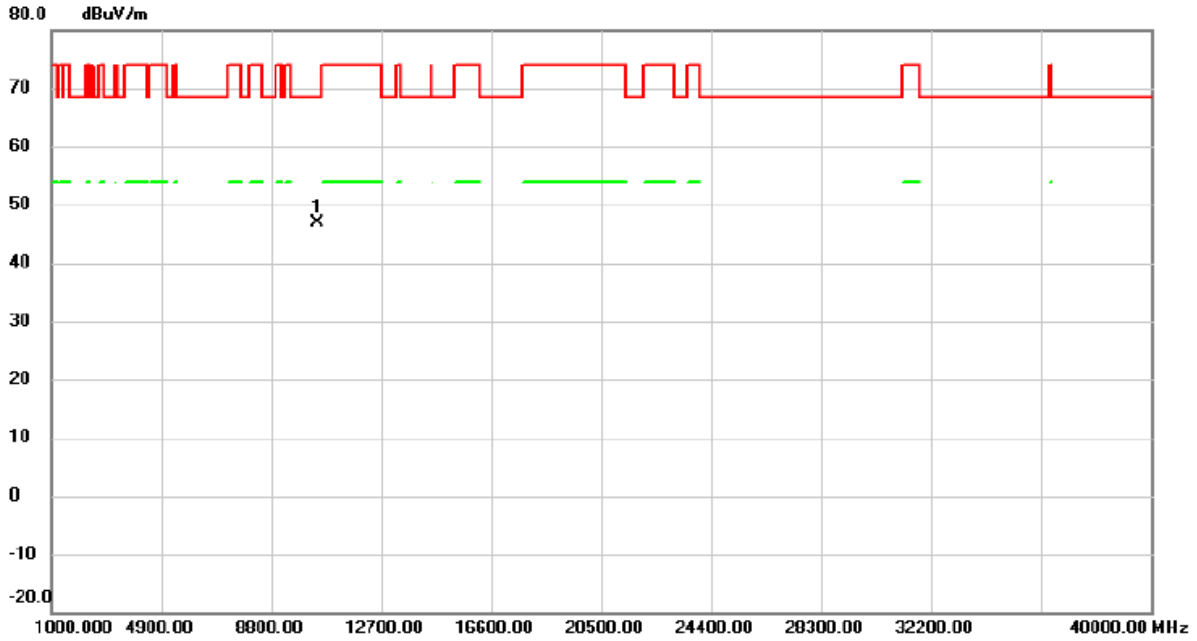

No.	Mk.	Freq.	Reading Level	Correct Factor	Measurement	Limit	Margin	Detector	Comment
		MHz	dBuV	dB	dBuV/m	dBuV/m	dB		
1	*	10427.452	37.94	8.91	46.85	68.30	-21.45	peak	

REMARKS:

- (1) Measurement Value = Reading Level + Correct Factor.
- (2) Margin Level = Measurement Value - Limit Value.

Orthogonal Axis	X
Test Mode	UNII-1_TX AC (VHT80) Mode 5210 MHz

Horizontal

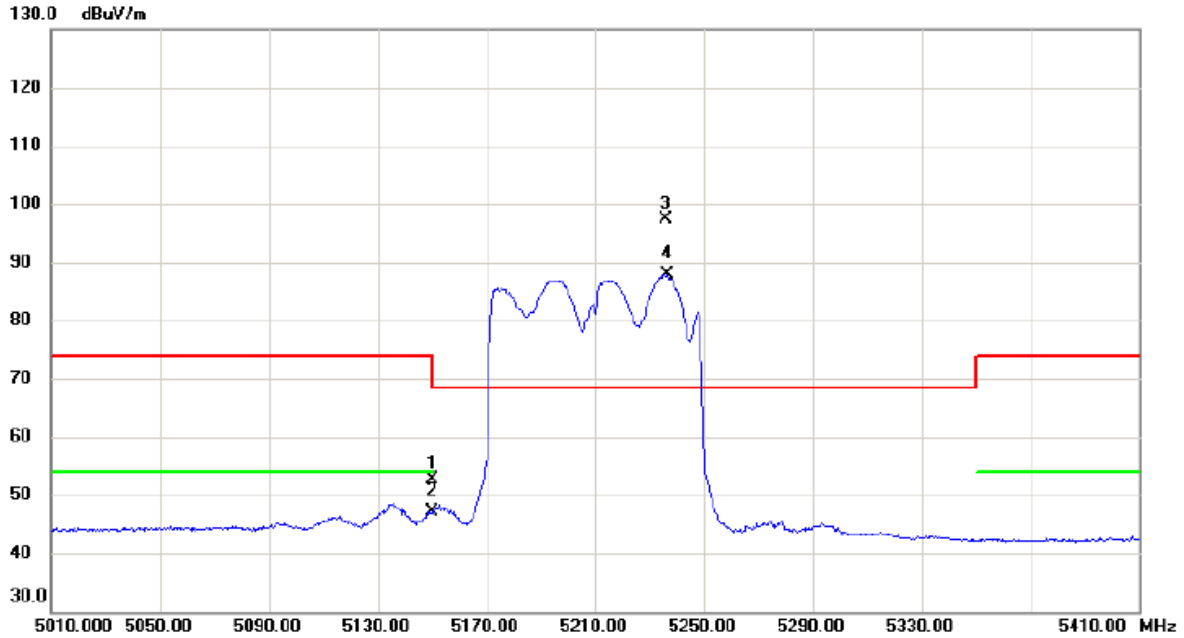

No.	Mk.	Freq. MHz	Reading Level dBuV	Correct Factor dB	Measure- ment dBuV/m	Limit dBuV/m	Margin dB	Detector	Comment
1		5150.000	37.56	15.02	52.58	74.00	-21.42	peak	
2		5150.000	32.08	15.02	47.10	54.00	-6.90	AVG	
3	*	5236.000	82.22	15.08	97.30	68.30	29.00	peak	No Limit
4	X	5236.200	72.89	15.08	87.97	68.30	19.67	AVG	No Limit

REMARKS:

- (1) Measurement Value = Reading Level + Correct Factor.
- (2) Margin Level = Measurement Value - Limit Value.

Orthogonal Axis	X
Test Mode	UNII-1_TX AC (VHT80) Mode 5210 MHz

Horizontal

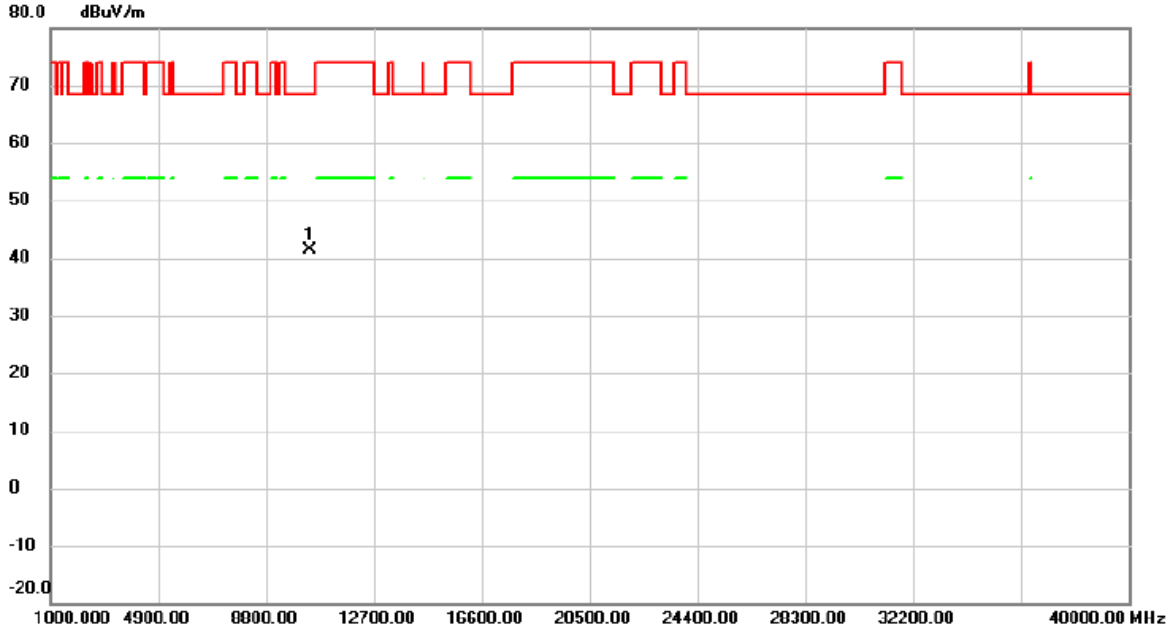

No.	Mk.	Freq. MHz	Reading Level dBuV	Correct Factor dB	Measure- ment dBuV/m	Limit dBuV/m	Margin dB	Detector	Comment
1	*	10381.824	32.56	8.82	41.38	68.30	-26.92	peak	

REMARKS:

- (1) Measurement Value = Reading Level + Correct Factor.
- (2) Margin Level = Measurement Value - Limit Value.

Orthogonal Axis	X
Test Mode	UNII-3_TX AC (VHT20) Mode 5745 MHz

Vertical

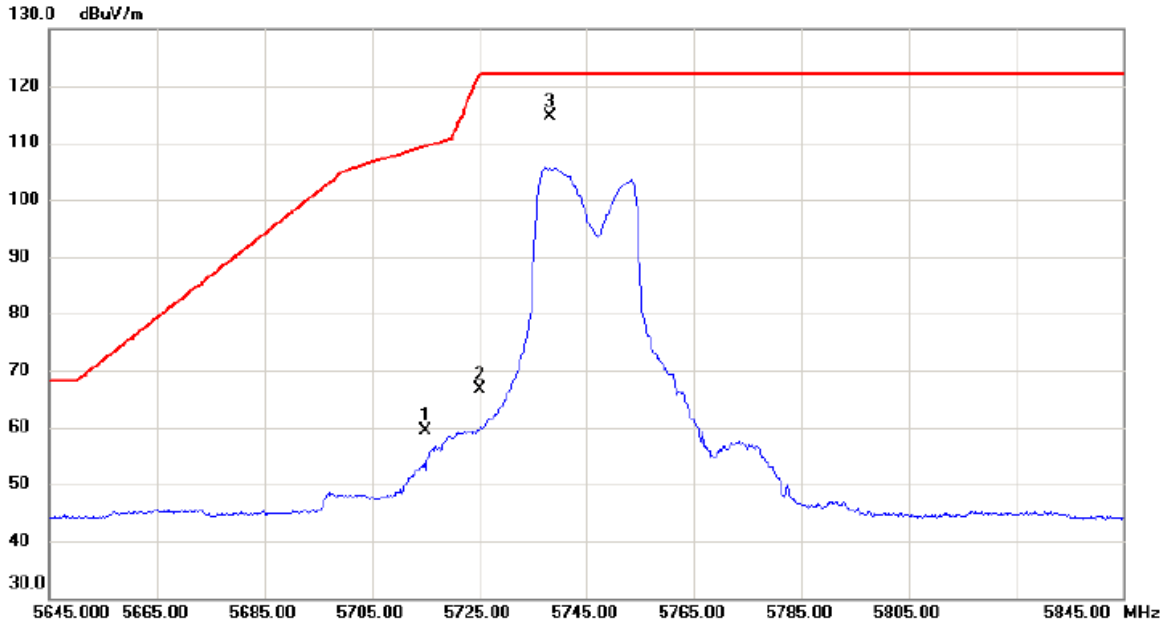

No.	Mk.	Freq.	Reading Level	Correct Factor	Measurement	Limit	Margin	Detector	Comment
		MHz	dBuV	dB	dBuV/m	dBuV/m	dB		
1		5715.000	43.66	15.66	59.32	109.40	-50.08	peak	
2		5725.000	51.02	15.67	66.69	122.20	-55.51	peak	
3 *		5738.100	98.85	15.70	114.55	122.20	-7.65	peak	No Limit

REMARKS:

- (1) Measurement Value = Reading Level + Correct Factor.
- (2) Margin Level = Measurement Value - Limit Value.

Orthogonal Axis	X
Test Mode	UNII-3_TX AC (VHT20) Mode 5745 MHz

Vertical

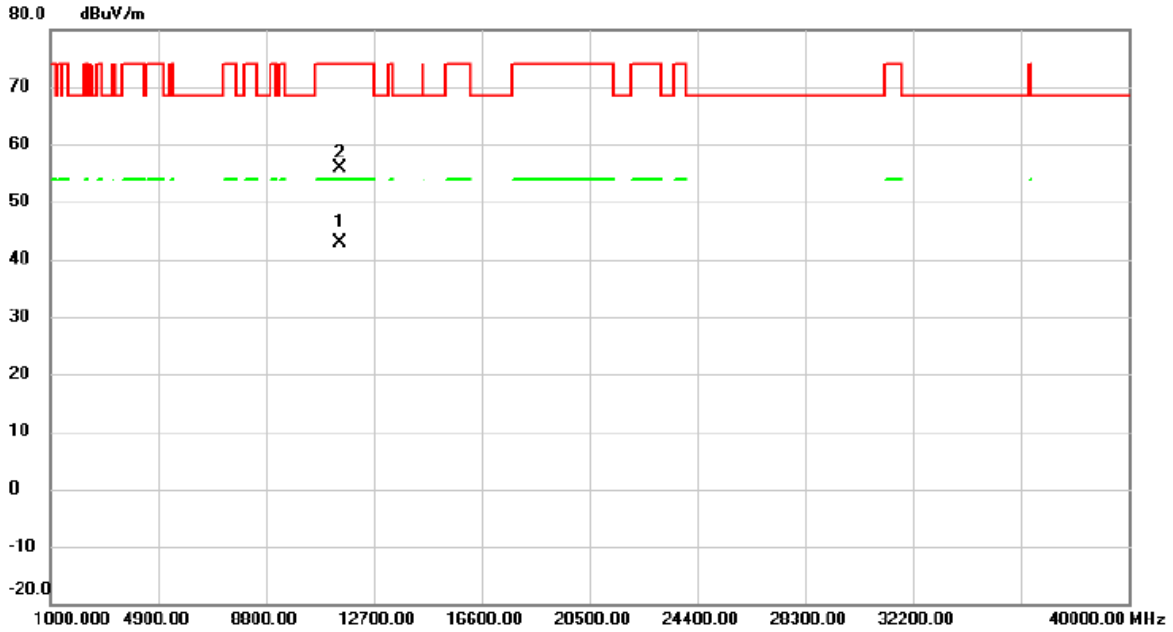

No.	Mk.	Freq. MHz	Reading Level dBuV	Correct Factor dB	Measure- ment dBuV/m	Limit dBuV/m	Margin dB	Detector	Comment
1	*	11486.721	31.87	11.10	42.97	54.00	-11.03	AVG	
2		11491.375	44.76	11.10	55.86	74.00	-18.14	peak	

REMARKS:

- (1) Measurement Value = Reading Level + Correct Factor.
- (2) Margin Level = Measurement Value - Limit Value.

Orthogonal Axis	X
Test Mode	UNII-3_TX AC (VHT20) Mode 5745 MHz

Horizontal

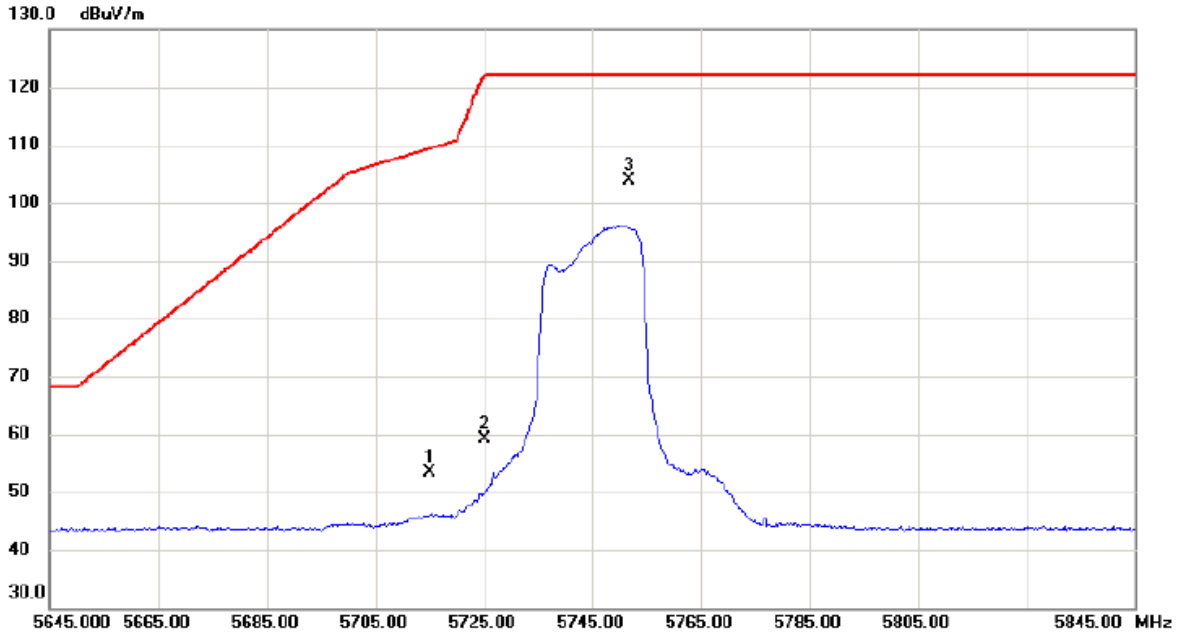

No.	Mk.	Freq. MHz	Reading Level dBuV	Correct Factor dB	Measure- ment dBuV/m	Limit dBuV/m	Margin dB	Detector	Comment
1		5715.000	37.60	15.66	53.26	109.40	-56.14	peak	
2		5725.000	43.49	15.67	59.16	122.20	-63.04	peak	
3	*	5751.700	88.11	15.71	103.82	122.20	-18.38	peak	No Limit

REMARKS:

- (1) Measurement Value = Reading Level + Correct Factor.
- (2) Margin Level = Measurement Value - Limit Value.

Orthogonal Axis	X
Test Mode	UNII-3_TX AC (VHT20) Mode 5745 MHz

Horizontal

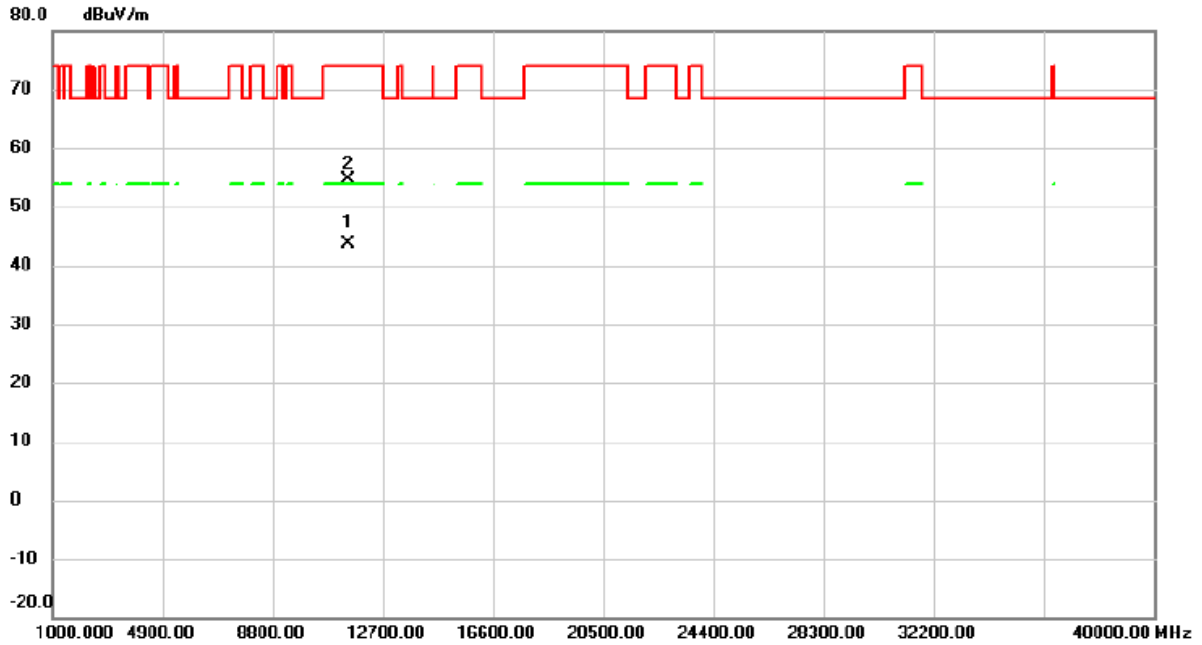

No.	Mk.	Freq. MHz	Reading Level dBuV	Correct Factor dB	Measure- ment dBuV/m	Limit dBuV/m	Margin dB	Detector	Comment
1	*	11491.985	32.47	11.11	43.58	54.00	-10.42	AVG	
2		11493.750	43.49	11.11	54.60	74.00	-19.40	peak	

REMARKS:

- (1) Measurement Value = Reading Level + Correct Factor.
- (2) Margin Level = Measurement Value - Limit Value.

Orthogonal Axis	X
Test Mode	UNII-3_TX AC (VHT20) Mode 5785 MHz

Vertical

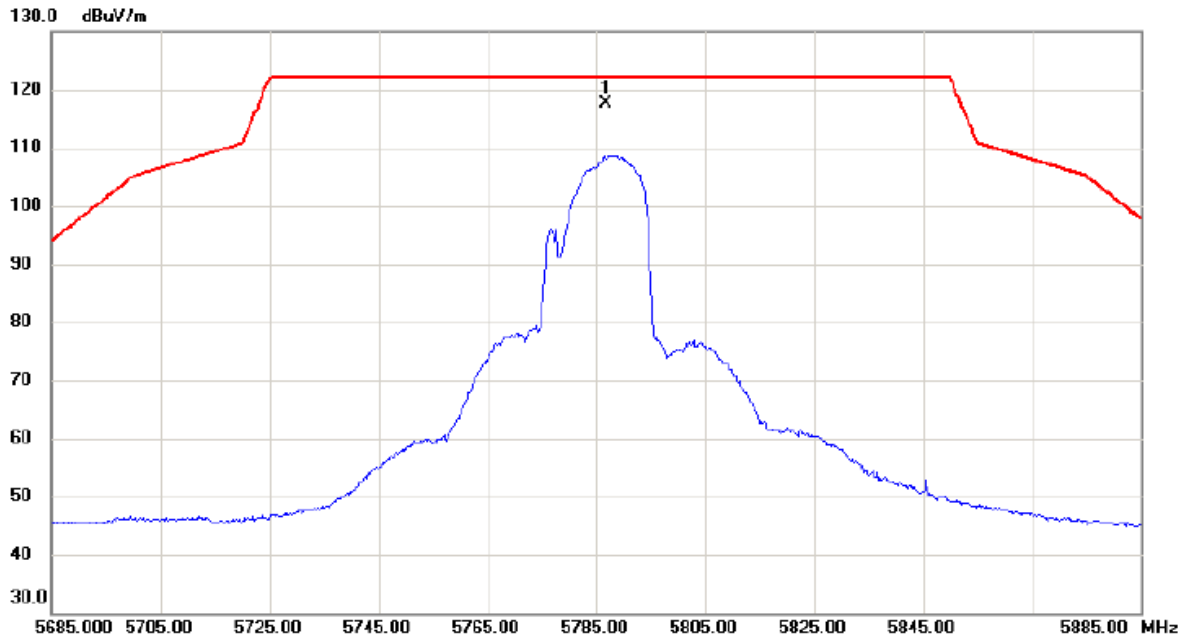

No.	Mk.	Freq. MHz	Reading Level dBuV	Correct Factor dB	Measure- ment dBuV/m	Limit dBuV/m	Margin dB	Detector	Comment
1	*	5786.600	101.87	15.78	117.65	122.20	-4.55	peak	No Limit

REMARKS:

- (1) Measurement Value = Reading Level + Correct Factor.
- (2) Margin Level = Measurement Value - Limit Value.

Orthogonal Axis	X
Test Mode	UNII-3_TX AC (VHT20) Mode 5785 MHz

Vertical

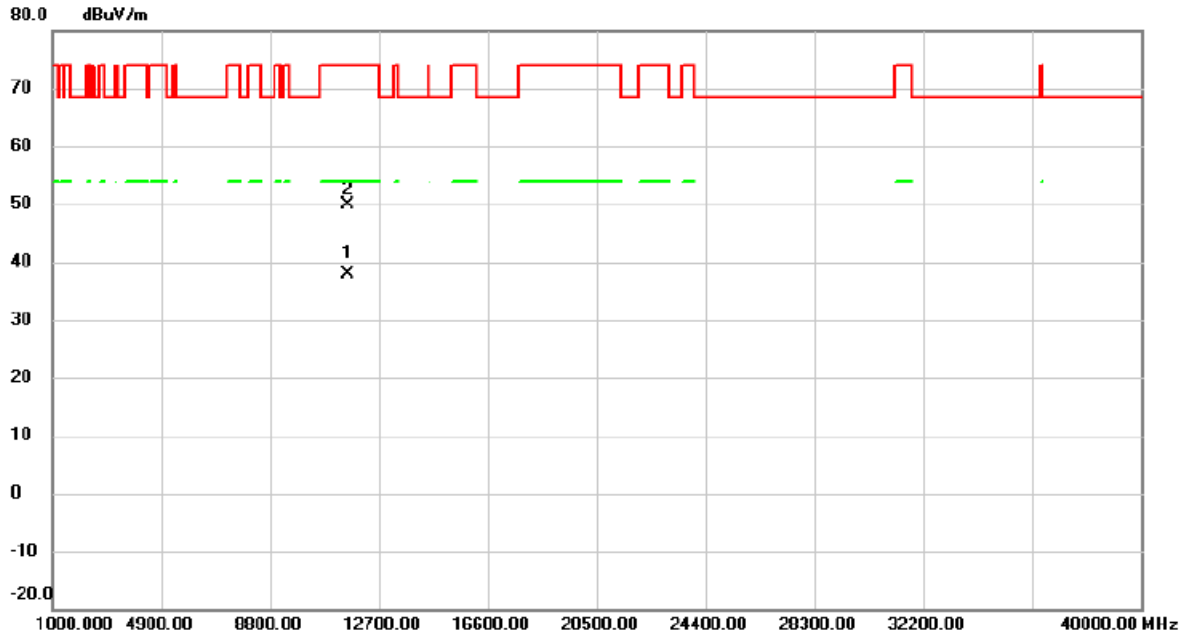

No.	Mk.	Freq. MHz	Reading Level dBuV	Correct Factor dB	Measure- ment dBuV/m	Limit dBuV/m	Margin dB	Detector	Comment
1	*	11568.460	26.75	11.22	37.97	54.00	-16.03	AVG	
2		11571.630	38.72	11.22	49.94	74.00	-24.06	peak	

REMARKS:

- (1) Measurement Value = Reading Level + Correct Factor.
- (2) Margin Level = Measurement Value - Limit Value.

Orthogonal Axis	X
Test Mode	UNII-3_TX AC (VHT20) Mode 5785 MHz

Horizontal

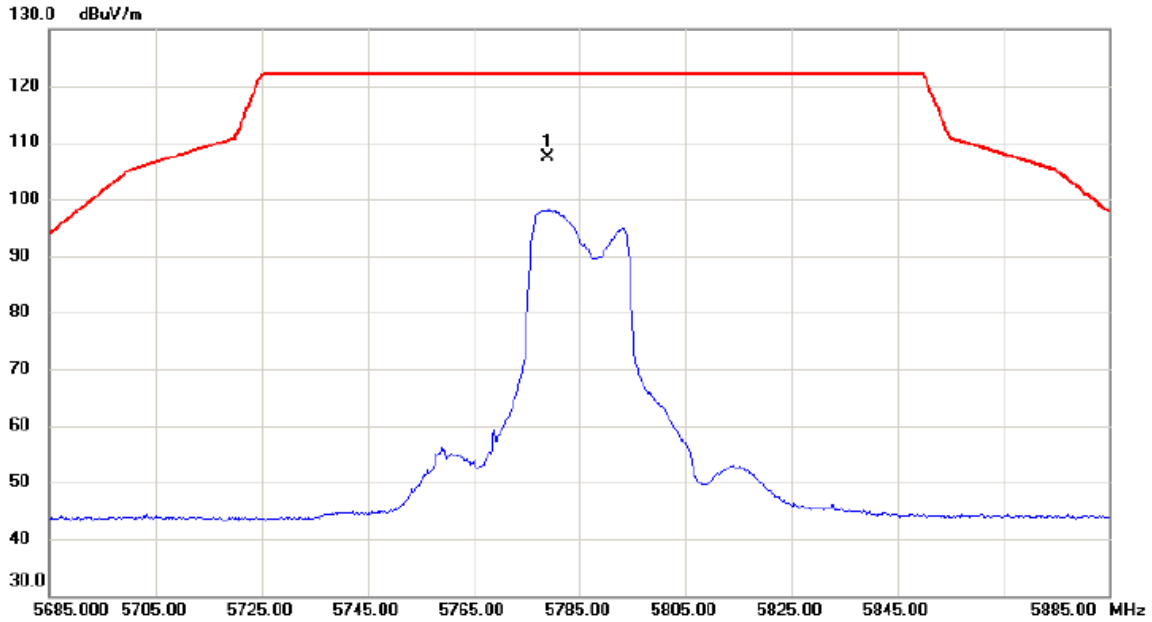

No.	Mk.	Freq.	Reading Level	Correct Factor	Measurement	Limit	Margin	Detector	Comment
		MHz	dBuV	dB	dBuV/m	dBuV/m	dB		
1	*	5779.100	91.53	15.77	107.30	122.20	-14.90	peak	No Limit

REMARKS:

- (1) Measurement Value = Reading Level + Correct Factor.
- (2) Margin Level = Measurement Value - Limit Value.

Orthogonal Axis	X
Test Mode	UNII-3_TX AC (VHT20) Mode 5785 MHz

Horizontal

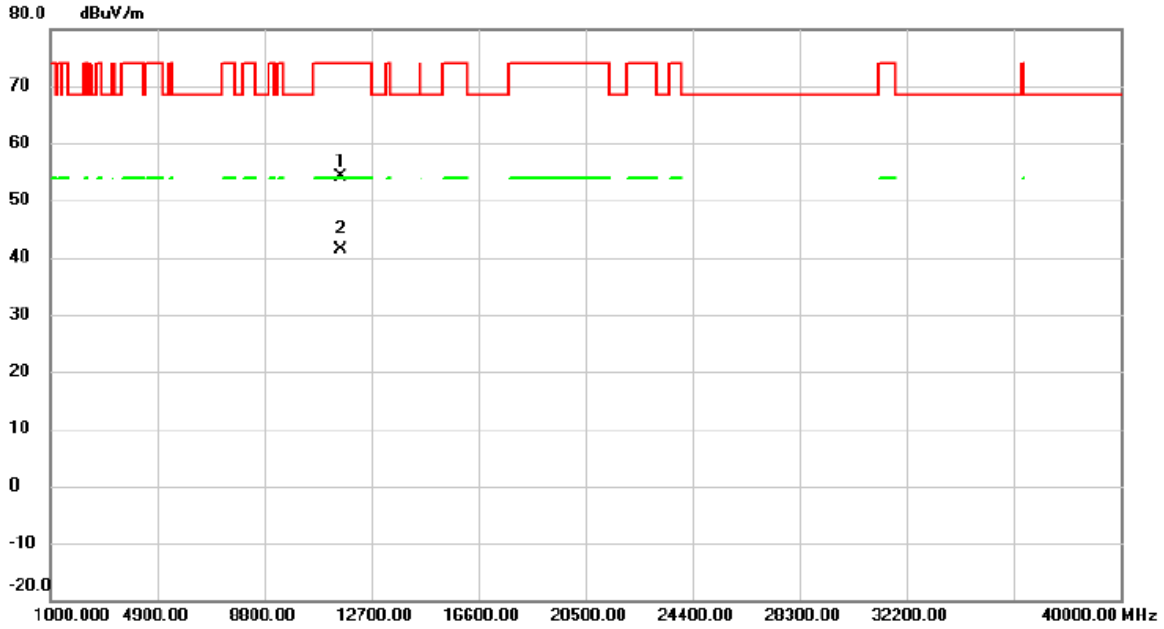

No.	Mk.	Freq. MHz	Reading Level dBuV	Correct Factor dB	Measure- ment dBuV/m	Limit dBuV/m	Margin dB	Detector	Comment
1		11563.850	42.80	11.22	54.02	74.00	-19.98	peak	
2	*	11565.720	30.21	11.22	41.43	54.00	-12.57	AVG	

REMARKS:

- (1) Measurement Value = Reading Level + Correct Factor.
- (2) Margin Level = Measurement Value - Limit Value.

Orthogonal Axis	X
Test Mode	UNII-3_TX AC (VHT20) Mode 5825 MHz

Vertical

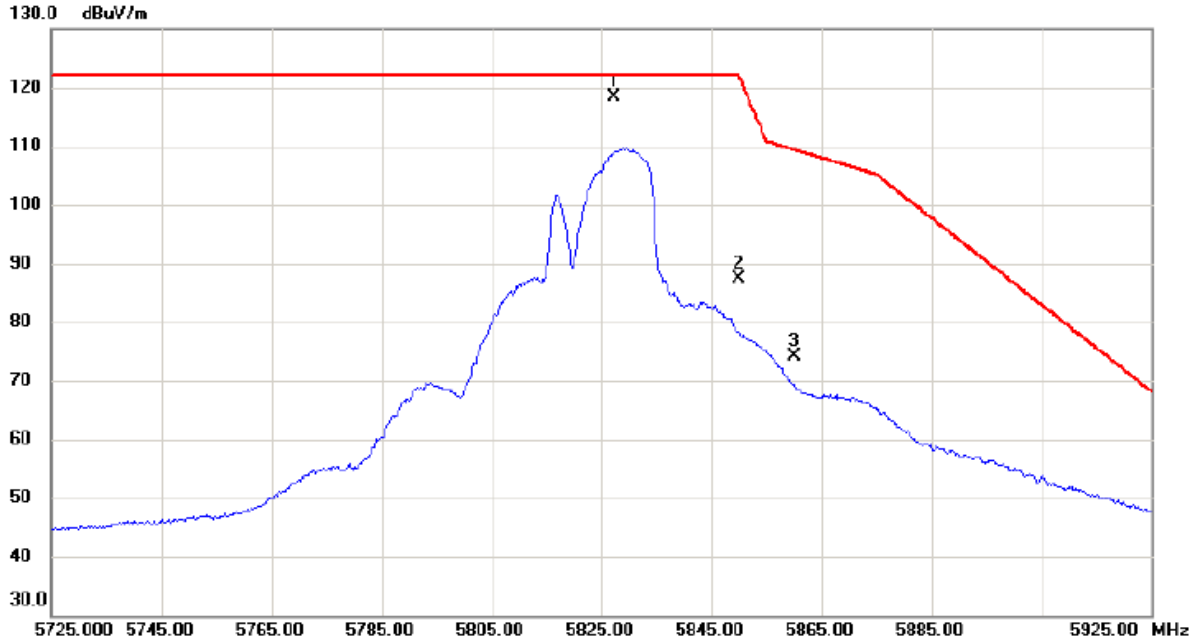

No.	Mk.	Freq. MHz	Reading Level dBuV	Correct Factor dB	Measure- ment dBuV/m	Limit dBuV/m	Margin dB	Detector	Comment
1	*	5827.200	102.63	15.86	118.49	122.20	-3.71	peak	No Limit
2		5850.000	71.36	15.90	87.26	122.20	-34.94	peak	
3		5860.000	58.22	15.92	74.14	109.40	-35.26	peak	

REMARKS:

- (1) Measurement Value = Reading Level + Correct Factor.
- (2) Margin Level = Measurement Value - Limit Value.

Orthogonal Axis	X
Test Mode	UNII-3_TX AC (VHT20) Mode 5825 MHz

Vertical

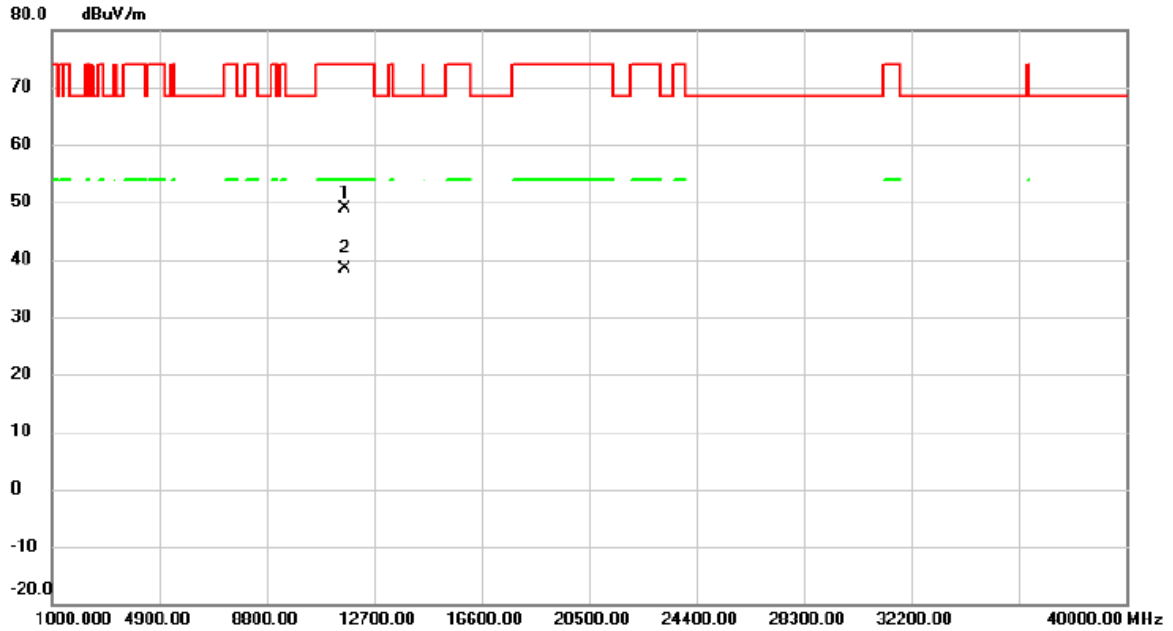

No.	Mk.	Freq. MHz	Reading Level dBuV	Correct Factor dB	Measure- ment dBuV/m	Limit dBuV/m	Margin dB	Detector	Comment
1		11653.426	37.45	11.33	48.78	74.00	-25.22	peak	
2	*	11653.850	27.12	11.33	38.45	54.00	-15.55	AVG	

REMARKS:

- (1) Measurement Value = Reading Level + Correct Factor.
- (2) Margin Level = Measurement Value - Limit Value.

Orthogonal Axis	X
Test Mode	UNII-3_TX AC (VHT20) Mode 5825 MHz

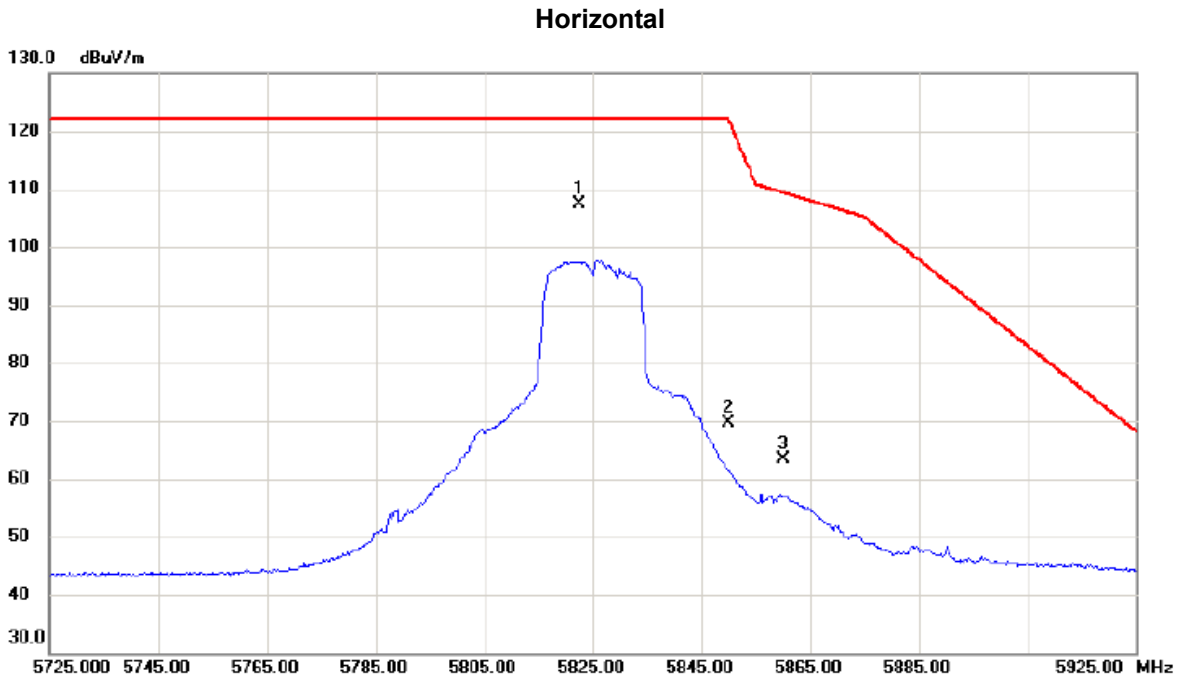

No.	Mk.	Freq. MHz	Reading Level dBuV	Correct Factor dB	Measure- ment dBuV/m	Limit dBuV/m	Margin dB	Detector	Comment
1	*	5822.500	91.49	15.84	107.33	122.20	-14.87	peak	No Limit
2		5850.000	53.67	15.90	69.57	122.20	-52.63	peak	
3		5860.000	47.38	15.92	63.30	109.40	-46.10	peak	

REMARKS:

- (1) Measurement Value = Reading Level + Correct Factor.
- (2) Margin Level = Measurement Value - Limit Value.

Orthogonal Axis	X
Test Mode	UNII-3_TX AC (VHT20) Mode 5825 MHz

Horizontal

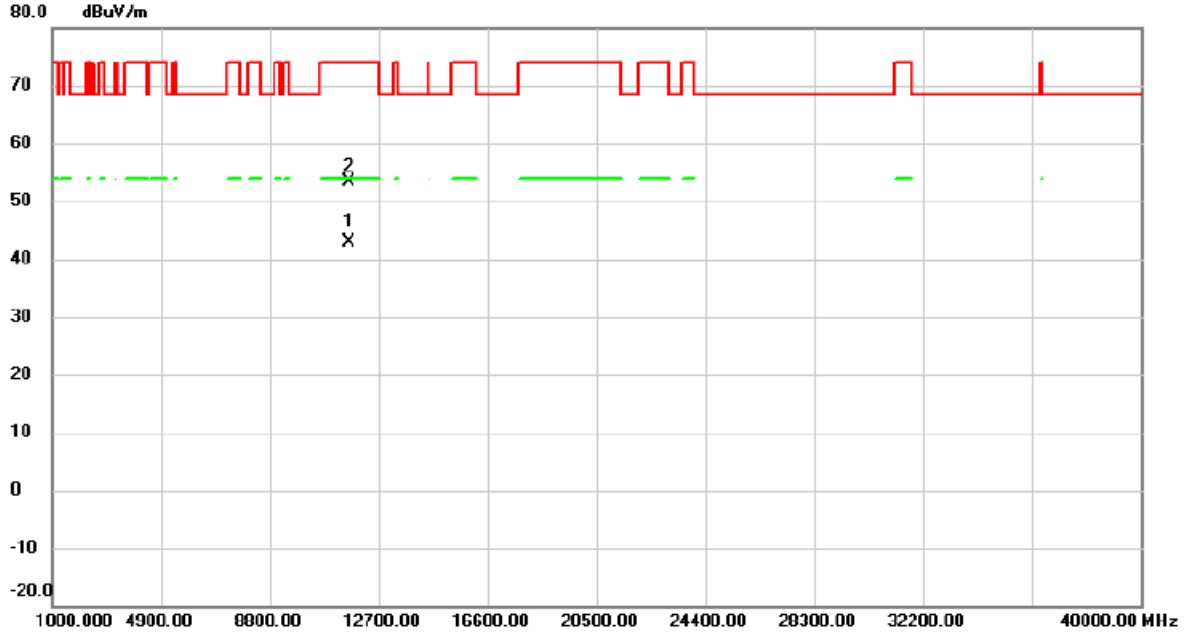

No.	Mk.	Freq.	Reading Level	Correct Factor	Measurement	Limit	Margin	Detector	Comment
		MHz	dBuV	dB	dBuV/m	dBuV/m	dB		
1	*	11652.950	31.47	11.33	42.80	54.00	-11.20	AVG	
2		11653.500	42.10	11.33	53.43	74.00	-20.57	peak	

REMARKS:

- (1) Measurement Value = Reading Level + Correct Factor.
- (2) Margin Level = Measurement Value - Limit Value.

Orthogonal Axis	X
Test Mode	UNII-3_TX AC (VHT40) Mode 5755 MHz

Vertical

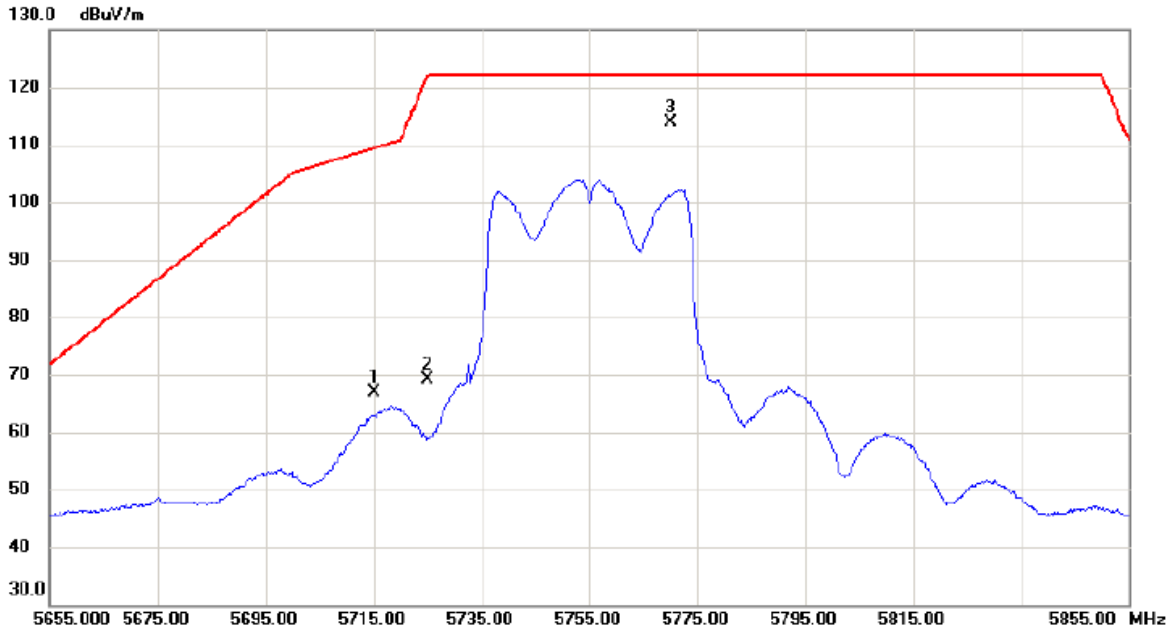

No.	Mk.	Freq. MHz	Reading Level dBuV	Correct Factor dB	Measure- ment dBuV/m	Limit dBuV/m	Margin dB	Detector	Comment
1		5715.000	51.26	15.66	66.92	109.40	-42.48	peak	
2		5725.000	53.42	15.67	69.09	122.20	-53.11	peak	
3	*	5770.000	98.03	15.76	113.79	122.20	-8.41	peak	No Limit

REMARKS:

- (1) Measurement Value = Reading Level + Correct Factor.
- (2) Margin Level = Measurement Value - Limit Value.

Orthogonal Axis	X
Test Mode	UNII-3_TX AC (VHT40) Mode 5755 MHz

Vertical

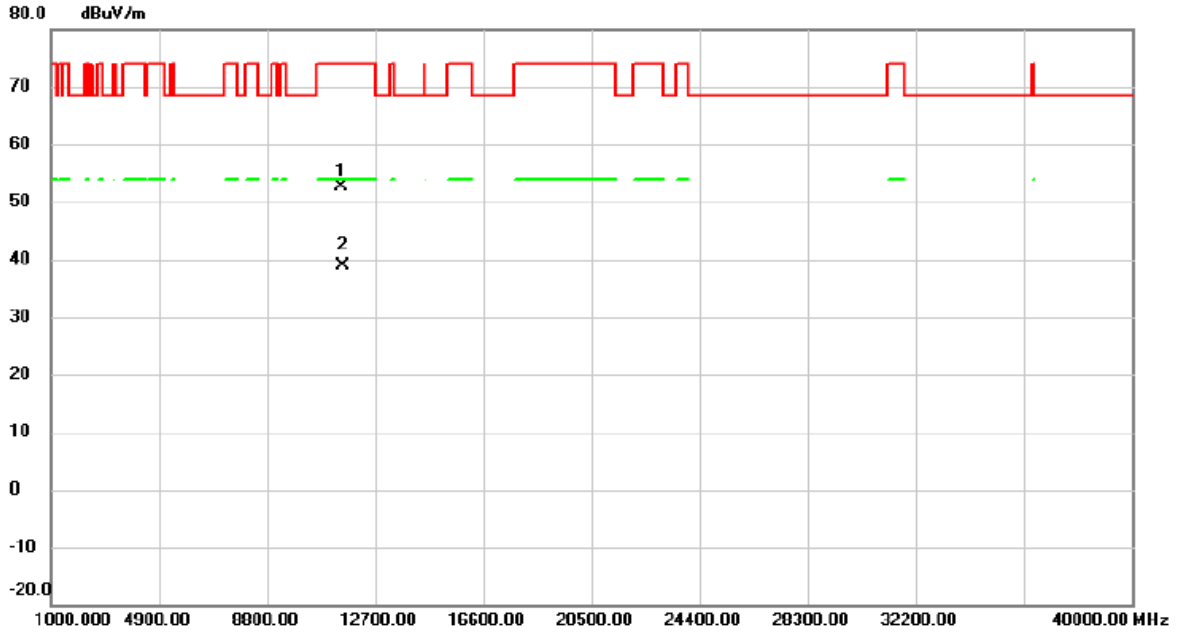

No.	Mk.	Freq. MHz	Reading Level dBuV	Correct Factor dB	Measure- ment dBuV/m	Limit dBuV/m	Margin dB	Detector	Comment
1		11492.683	41.56	11.11	52.67	74.00	-21.33	peak	
2	*	11505.425	27.75	11.13	38.88	54.00	-15.12	AVG	

REMARKS:

- (1) Measurement Value = Reading Level + Correct Factor.
- (2) Margin Level = Measurement Value - Limit Value.

Orthogonal Axis	X
Test Mode	UNII-3_TX AC (VHT40) Mode 5755 MHz

Horizontal

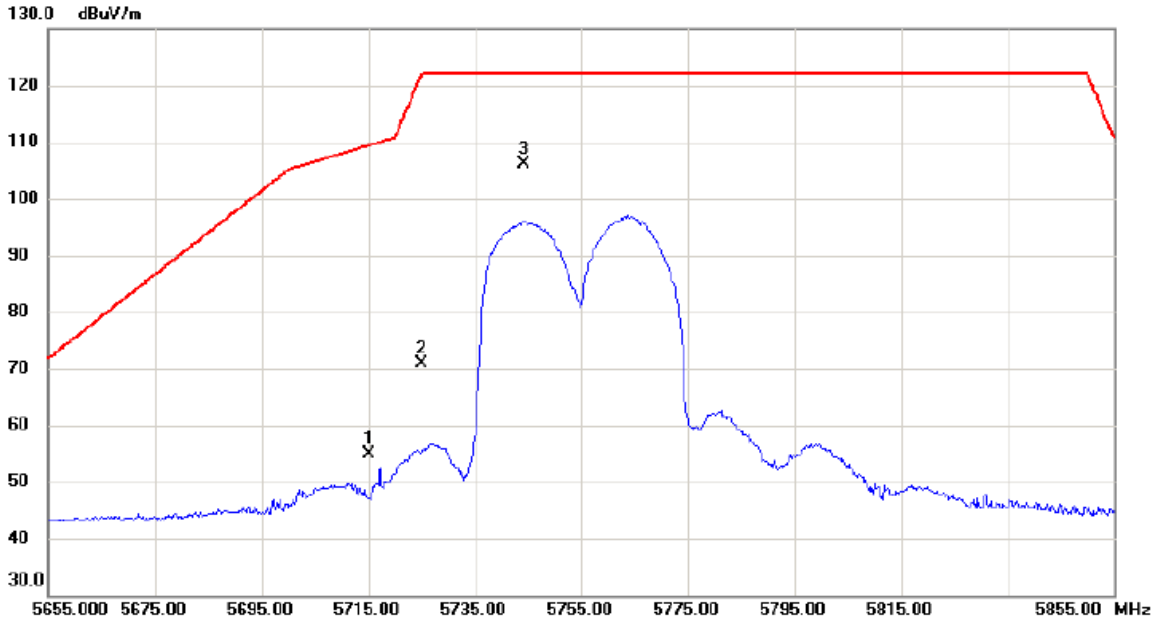

No.	Mk.	Freq. MHz	Reading Level dBuV	Correct Factor dB	Measure- ment dBuV/m	Limit dBuV/m	Margin dB	Detector	Comment
1		5715.000	39.30	15.66	54.96	109.40	-54.44	peak	
2		5725.000	55.31	15.67	70.98	122.20	-51.22	peak	
3	*	5744.100	90.45	15.71	106.16	122.20	-16.04	peak	No Limit

REMARKS:

- (1) Measurement Value = Reading Level + Correct Factor.
- (2) Margin Level = Measurement Value - Limit Value.

Orthogonal Axis	X
Test Mode	UNII-3_TX AC (VHT40) Mode 5755 MHz

Horizontal

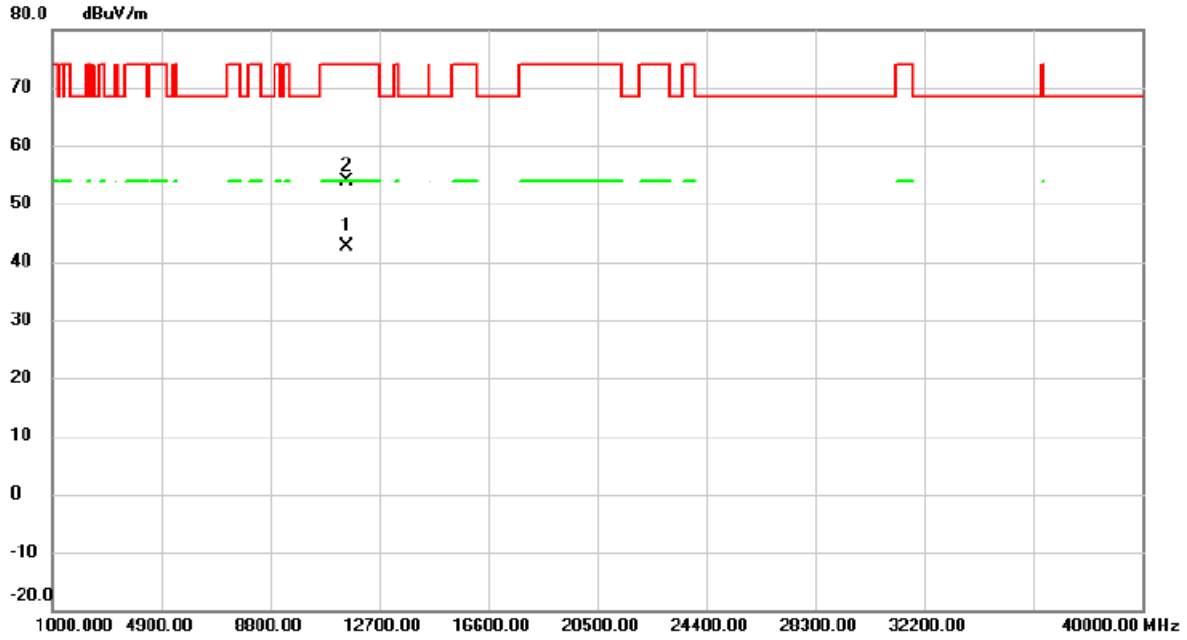

No.	Mk.	Freq. MHz	Reading Level dBuV	Correct Factor dB	Measure- ment dBuV/m	Limit dBuV/m	Margin dB	Detector	Comment
1	*	11511.470	31.41	11.14	42.55	54.00	-11.45	AVG	
2		11512.632	42.62	11.15	53.77	74.00	-20.23	peak	

REMARKS:

- (1) Measurement Value = Reading Level + Correct Factor.
- (2) Margin Level = Measurement Value - Limit Value.

Orthogonal Axis	X
Test Mode	UNII-3_TX AC (VHT40) Mode 5795 MHz

Vertical

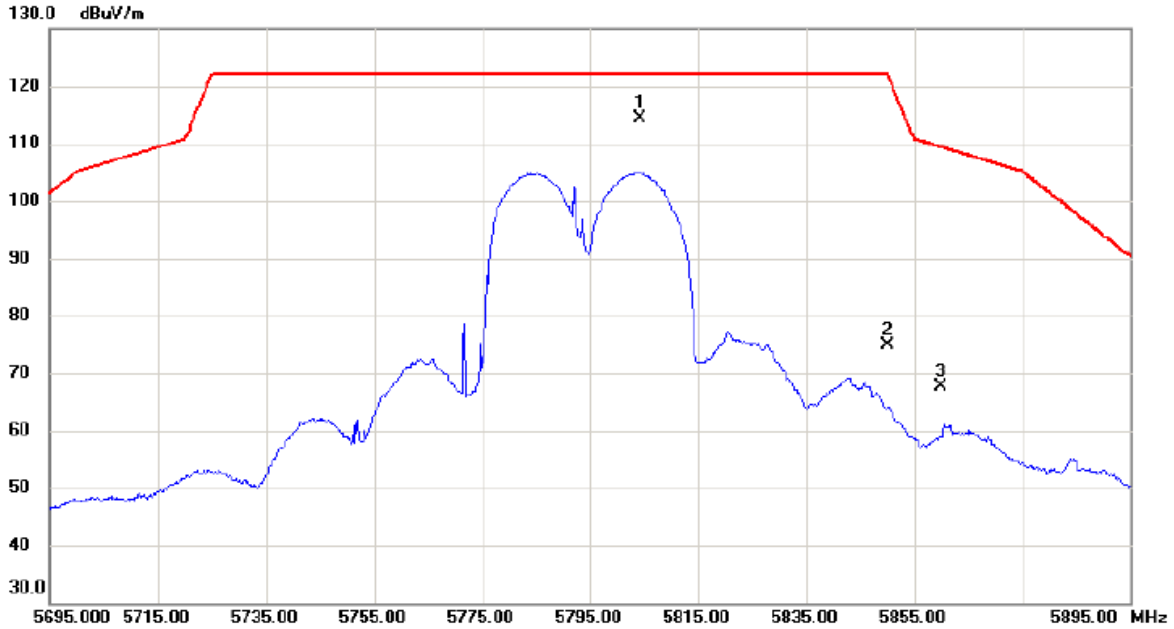

No. Mk.	Freq. MHz	Reading Level dBuV	Correct Factor dB	Measure- ment dBuV/m	Limit dBuV/m	Margin dB	Detector	Comment
1 *	5804.300	98.45	15.82	114.27	122.20	-7.93	peak	No Limit
2	5850.000	59.00	15.90	74.90	122.20	-47.30	peak	
3	5860.000	51.71	15.92	67.63	109.40	-41.77	peak	

REMARKS:

- (1) Measurement Value = Reading Level + Correct Factor.
- (2) Margin Level = Measurement Value - Limit Value.

Orthogonal Axis	X
Test Mode	UNII-3_TX AC (VHT40) Mode 5795 MHz

Vertical

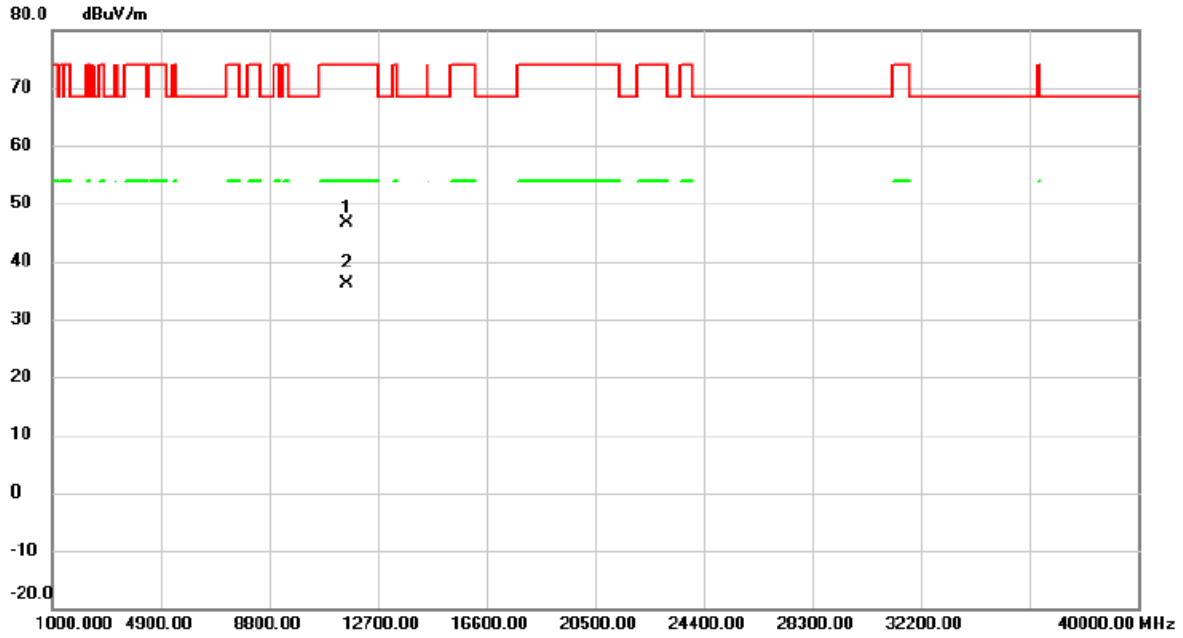

No.	Mk.	Freq. MHz	Reading Level dBuV	Correct Factor dB	Measure- ment dBuV/m	Limit dBuV/m	Margin dB	Detector	Comment
1		11589.475	35.42	11.25	46.67	74.00	-27.33	peak	
2	*	11590.682	24.95	11.25	36.20	54.00	-17.80	AVG	

REMARKS:

- (1) Measurement Value = Reading Level + Correct Factor.
- (2) Margin Level = Measurement Value - Limit Value.

Orthogonal Axis	X
Test Mode	UNII-3_TX AC (VHT40) Mode 5795 MHz

Horizontal

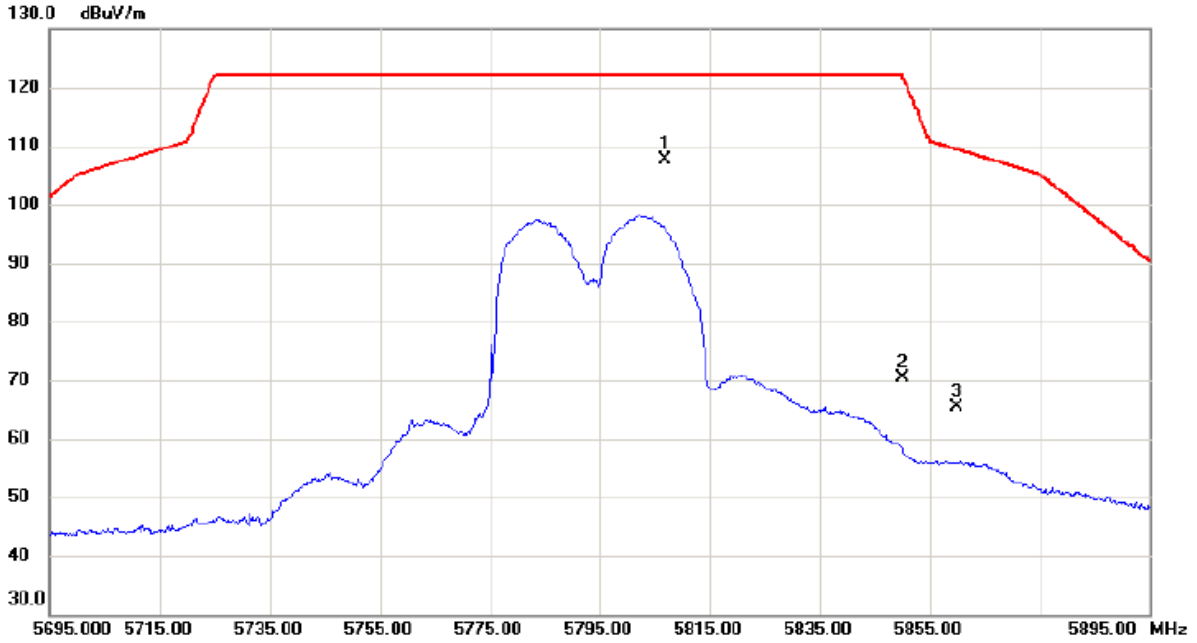

No.	Mk.	Freq. MHz	Reading Level dBuV	Correct Factor dB	Measure- ment dBuV/m	Limit dBuV/m	Margin dB	Detector	Comment
1	*	5806.900	91.92	15.82	107.74	122.20	-14.46	peak	No Limit
2		5850.000	54.38	15.90	70.28	122.20	-51.92	peak	
3		5860.000	49.58	15.92	65.50	109.40	-43.90	peak	

REMARKS:

- (1) Measurement Value = Reading Level + Correct Factor.
- (2) Margin Level = Measurement Value - Limit Value.

Orthogonal Axis	X
Test Mode	UNII-3_TX AC (VHT40) Mode 5795 MHz

Horizontal

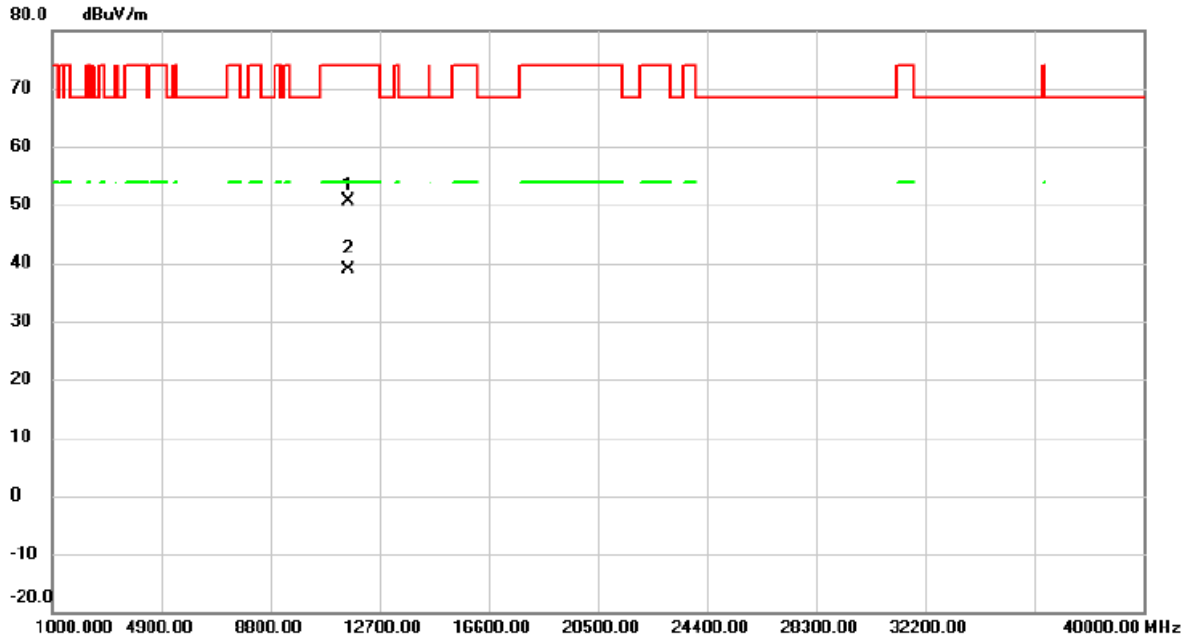

No.	Mk.	Freq. MHz	Reading Level dBuV	Correct Factor dB	Measure- ment dBuV/m	Limit dBuV/m	Margin dB	Detector	Comment
1		11585.415	39.45	11.24	50.69	74.00	-23.31	peak	
2	*	11589.470	27.68	11.25	38.93	54.00	-15.07	AVG	

REMARKS:

- (1) Measurement Value = Reading Level + Correct Factor.
- (2) Margin Level = Measurement Value - Limit Value.

Orthogonal Axis	X
Test Mode	UNII-3_TX AC (VHT80) Mode 5775 MHz

Vertical

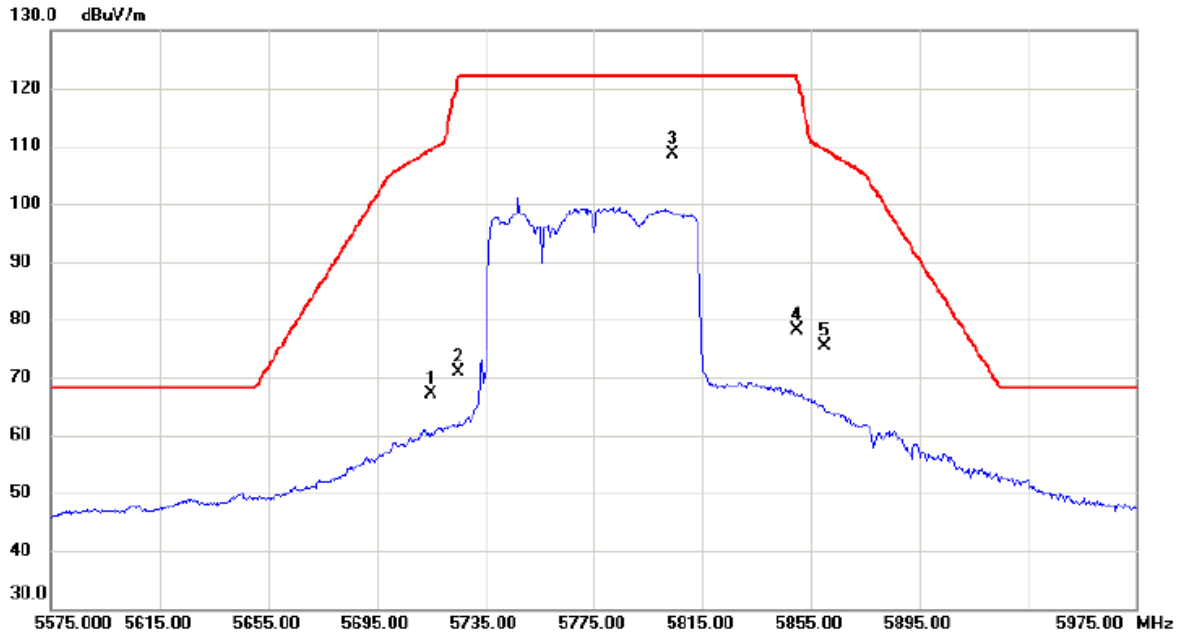

No.	Mk.	Freq. MHz	Reading Level dBuV	Correct Factor dB	Measure- ment dBuV/m	Limit dBuV/m	Margin dB	Detector	Comment
1		5715.000	51.44	15.66	67.10	109.40	-42.30	peak	
2		5725.000	55.14	15.67	70.81	122.20	-51.39	peak	
3	*	5804.200	92.88	15.82	108.70	122.20	-13.50	peak	No Limit
4		5850.000	62.25	15.90	78.15	122.20	-44.05	peak	
5		5860.000	59.40	15.92	75.32	109.40	-34.08	peak	

REMARKS:

- (1) Measurement Value = Reading Level + Correct Factor.
- (2) Margin Level = Measurement Value - Limit Value.

Orthogonal Axis	X
Test Mode	UNII-3_TX AC (VHT80) Mode 5775 MHz

Vertical

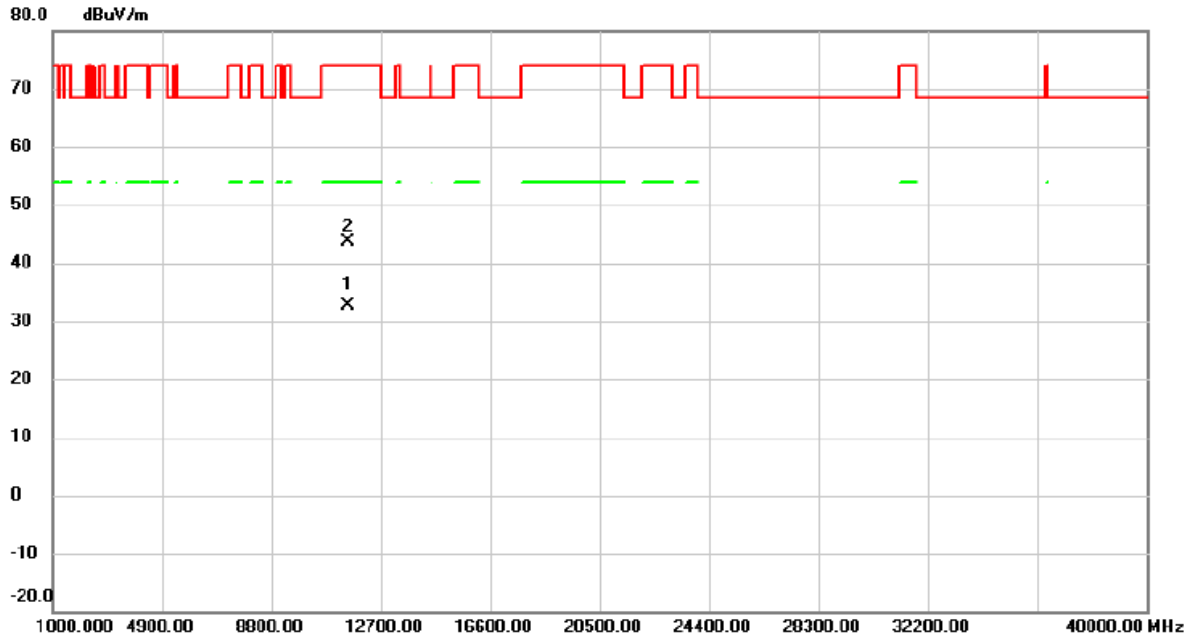

No.	Mk.	Freq. MHz	Reading Level dBuV	Correct Factor dB	Measure- ment dBuV/m	Limit dBuV/m	Margin dB	Detector	Comment
1	*	11523.824	21.40	11.16	32.56	54.00	-21.44	AVG	
2		11527.824	32.50	11.17	43.67	74.00	-30.33	peak	

REMARKS:

- (1) Measurement Value = Reading Level + Correct Factor.
- (2) Margin Level = Measurement Value - Limit Value.

Orthogonal Axis	X
Test Mode	UNII-3_TX AC (VHT80) Mode 5775 MHz

Horizontal

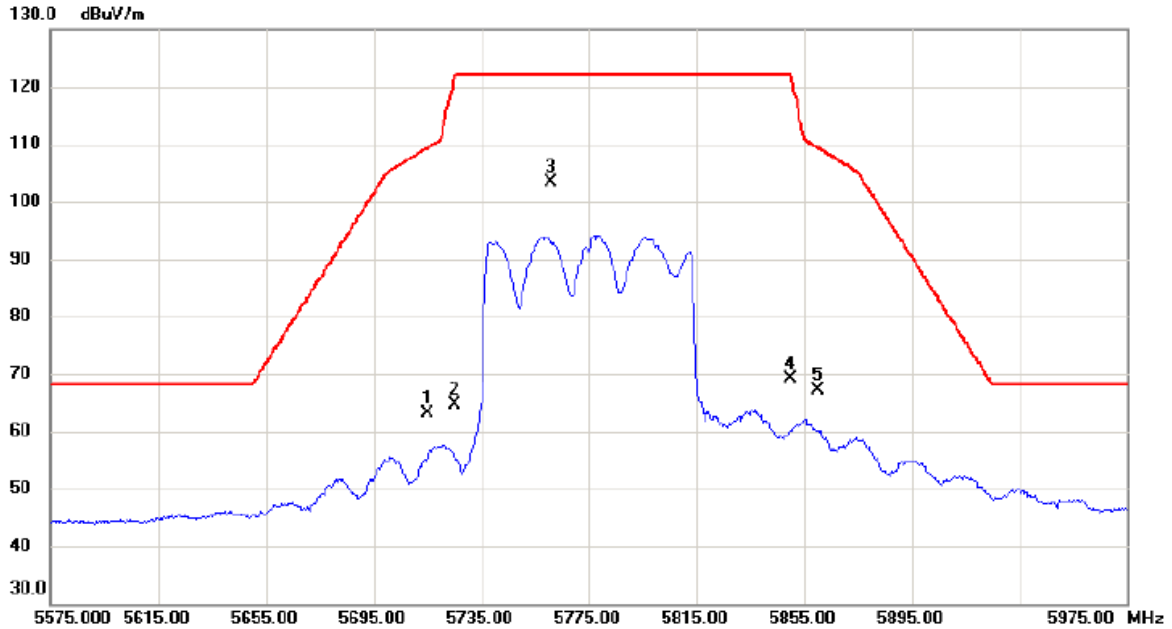

No.	Mk.	Freq. MHz	Reading Level dBuV	Correct Factor dB	Measure- ment dBuV/m	Limit dBuV/m	Margin dB	Detector	Comment
1		5715.000	47.44	15.66	63.10	109.40	-46.30	peak	
2		5725.000	48.96	15.67	64.63	122.20	-57.57	peak	
3	*	5760.600	87.66	15.74	103.40	122.20	-18.80	peak	No Limit
4		5850.000	53.33	15.90	69.23	122.20	-52.97	peak	
5		5860.000	51.18	15.92	67.10	109.40	-42.30	peak	

REMARKS:

- (1) Measurement Value = Reading Level + Correct Factor.
- (2) Margin Level = Measurement Value - Limit Value.

Orthogonal Axis	X
Test Mode	UNII-3_TX AC (VHT80) Mode 5775 MHz

Horizontal

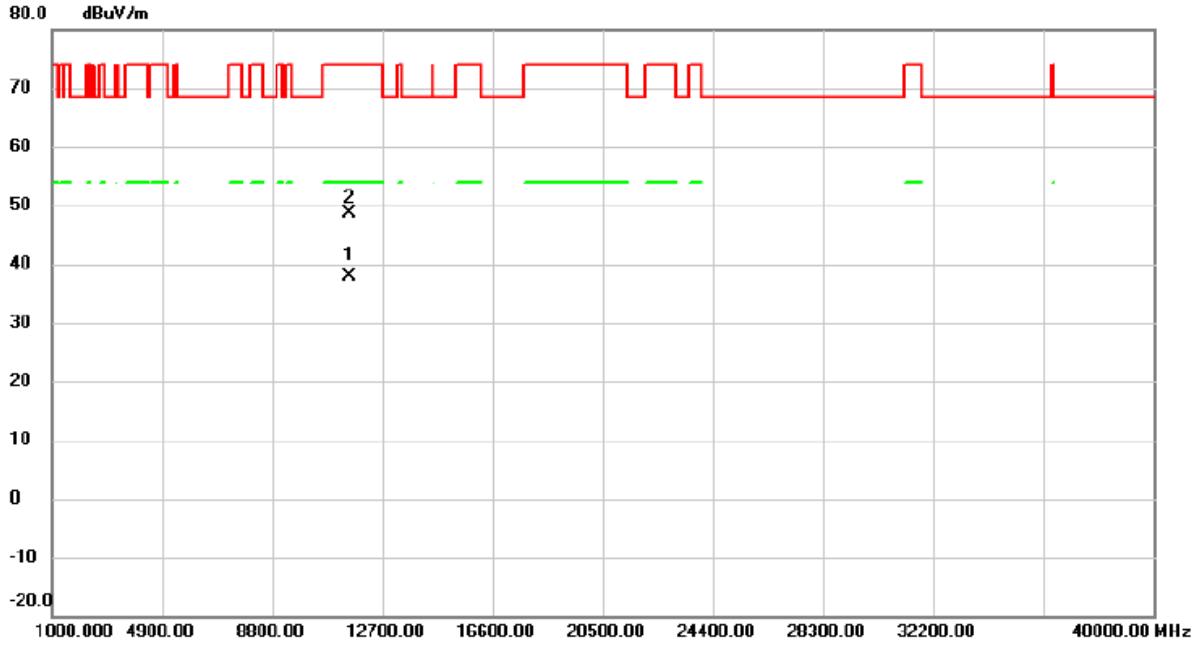

No.	Mk.	Freq. MHz	Reading Level dBuV	Correct Factor dB	Measure- ment dBuV/m	Limit dBuV/m	Margin dB	Detector	Comment
1	*	11514.432	26.83	11.15	37.98	54.00	-16.02	AVG	
2		11532.670	37.50	11.17	48.67	74.00	-25.33	peak	

REMARKS:

- (1) Measurement Value = Reading Level + Correct Factor.
- (2) Margin Level = Measurement Value - Limit Value.

APPENDIX E - BANDWIDTH

Non Beamforming

Test Mode	UNII-1_TX A Mode
-----------	------------------

Channel	Frequency (MHz)	26 dB Bandwidth (MHz)	99 % Emission Bandwidth (MHz)
36	5180	19.49	16.60
40	5200	20.30	16.70
48	5240	20.70	16.70

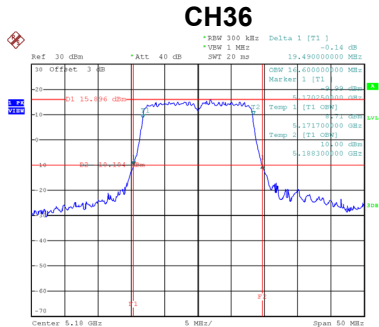

Date: 19_AUG.2019 21:32:57

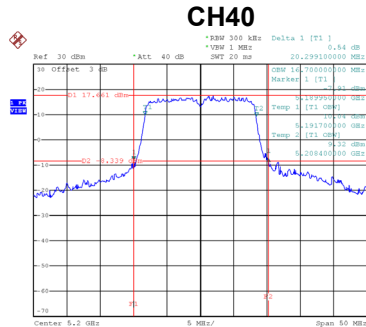

Date: 19_AUG.2019 22:13:26

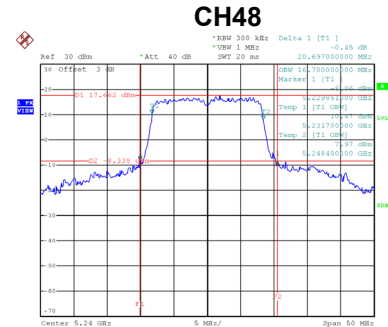

Date: 19_AUG.2019 22:16:43

Test Mode	UNII-1_TX N (HT20) Mode
-----------	-------------------------

Channel	Frequency (MHz)	26 dB Bandwidth (MHz)	99 % Emission Bandwidth (MHz)
36	5180	20.79	17.80
40	5200	22.09	17.90
48	5240	26.35	17.90

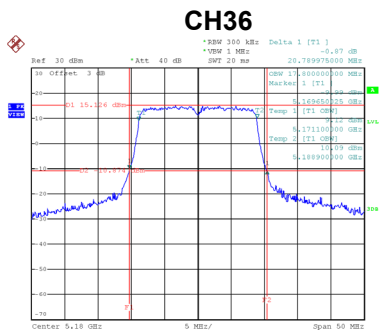

Date: 19_AUG.2019 22:26:48

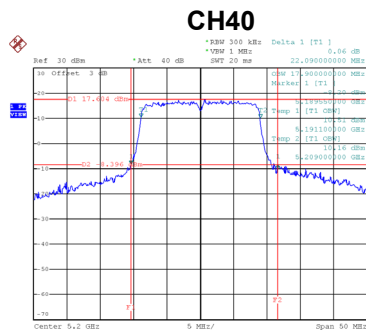

Date: 19_AUG.2019 22:30:10

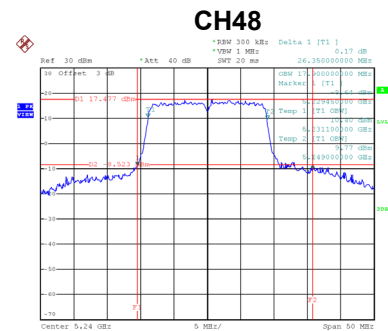

Date: 19_AUG.2019 22:31:51