

FCC Radio Test Report

FCC ID: TE7KC120V2

This report concerns: **Original Grant**

Project No. : 1907C185
Equipment : Kasa Cam
Brand Name : tp-link
Test Model : KC120
Series Model : N/A
Applicant : TP-Link Technologies Co., Ltd.
Address : Building 24(floors1,3,4,5) and 28(floors1-4) Central Science and Technology Park, Shennan Rd, Nanshan, Shenzhen, China
Manufacturer : TP-Link Technologies Co., Ltd.
Address : Building 24(floors1,3,4,5) and 28(floors1-4) Central Science and Technology Park, Shennan Rd, Nanshan, Shenzhen, China
Date of Receipt : Jul. 24, 2019
Date of Test : Jul. 25, 2019~Aug. 22, 2019
Issued Date : Sep. 06, 2019
Report Version : R00
Test Sample : Engineering Sample No.: DG19072543 for conducted, DG19072544 for radiated.
Standard(s) : FCC Part15, Subpart C (15.247)
ANSI C63.10-2013
KDB 558074 D01 15.247 Meas Guidance V05r02

The above equipment has been tested and found compliance with the requirement of the relative standards by BTL Inc.



Prepared by : Mandy Wang



Approved by : Ethan Ma



Certificate #5123.02

Add: No.3, Jinshagang 1st Road, Shixia, Dalang Town, Dongguan, Guangdong, China.

Tel: +86-769-8318-3000

Web: www.newbtl.com

Declaration

BTL represents to the client that testing is done in accordance with standard procedures as applicable and that test instruments used has been calibrated with standards traceable to international standard(s) and/or national standard(s).

BTL's reports apply only to the specific samples tested under conditions. It is manufacture's responsibility to ensure that additional production units of this model are manufactured with the identical electrical and mechanical components. **BTL** shall have no liability for any declarations, inferences or generalizations drawn by the client or others from **BTL** issued reports.

The report must not be used by the client to claim product certification, approval, or endorsement by NVLAP, NIST, A2LA, or any agency of the U.S. Government.

This report is the confidential property of the client. As a mutual protection to the clients, the public and ourselves, the test report shall not be reproduced, except in full, without our written approval.

BTL's laboratory quality assurance procedures are in compliance with the **ISO/IEC 17025** requirements, and accredited by the conformity assessment authorities listed in this test report.

BTL is not responsible for the sampling stage, so the results only apply to the sample as received.

The information, data and test plan are provided by manufacturer which may affect the validity of results, so it is manufacturer's responsibility to ensure that the apparatus meets the essential requirements of applied standards and in all the possible configurations as representative of its intended use.

Limitation

For the use of the authority's logo is limited unless the Test Standard(s)/Scope(s)/Item(s) mentioned in this test report is (are) included in the conformity assessment authorities acceptance respective.

Please note that the measurement uncertainty is provided for informational purpose only and are not use in determining the Pass/Fail results.

Table of Contents	Page
REPORT ISSUED HISTORY	6
1 . SUMMARY OF TEST RESULTS	7
1.1 TEST FACILITY	8
1.2 MEASUREMENT UNCERTAINTY	8
1.3 TEST ENVIRONMENT CONDITIONS	8
2 . GENERAL INFORMATION	9
2.1 GENERAL DESCRIPTION OF EUT	9
2.2 DESCRIPTION OF TEST MODES	10
2.3 PARAMETERS OF TEST SOFTWARE	11
2.4 DUTY CYCLE	12
2.5 BLOCK DIAGRAM SHOWING THE CONFIGURATION OF SYSTEM TESTED	13
2.6 SUPPORT UNITS	13
3 . AC POWER LINE CONDUCTED EMISSIONS TEST	14
3.1 LIMIT	14
3.2 TEST PROCEDURE	14
3.3 DEVIATION FROM TEST STANDARD	14
3.4 TEST SETUP	15
3.5 EUT OPERATION CONDITIONS	15
3.6 TEST RESULTS	15
4 . RADIATED EMISSIONS TEST	16
4.1 LIMIT	16
4.2 TEST PROCEDURE	17
4.3 DEVIATION FROM TEST STANDARD	17
4.4 TEST SETUP	18
4.5 EUT OPERATION CONDITIONS	19
4.6 TEST RESULTS - 9 KHZ TO 30 MHZ	19
4.7 TEST RESULTS - 30 MHZ TO 1000 MHZ	19
4.8 TEST RESULTS - ABOVE 1000 MHZ	19
5 . BANDWIDTH TEST	20
5.1 LIMIT	20
5.2 TEST PROCEDURE	20
5.3 DEVIATION FROM STANDARD	20

Table of Contents	Page
5.4 TEST SETUP	20
5.5 EUT OPERATION CONDITIONS	20
5.6 TEST RESULTS	20
6 . MAXIMUM AVERAGE OUTPUT POWER TEST	21
6.1 LIMIT	21
6.2 TEST PROCEDURE	21
6.3 DEVIATION FROM STANDARD	21
6.4 TEST SETUP	21
6.5 EUT OPERATION CONDITIONS	21
6.6 TEST RESULTS	21
7 . CONDUCTED SPURIOUS EMISSIONS	22
7.1 LIMIT	22
7.2 TEST PROCEDURE	22
7.3 DEVIATION FROM STANDARD	22
7.4 TEST SETUP	22
7.5 EUT OPERATION CONDITIONS	22
7.6 TEST RESULTS	22
8 . POWER SPECTRAL DENSITY TEST	23
8.1 LIMIT	23
8.2 TEST PROCEDURE	23
8.3 DEVIATION FROM STANDARD	23
8.4 TEST SETUP	23
8.5 EUT OPERATION CONDITIONS	23
8.6 TEST RESULTS	23
9 . MEASUREMENT INSTRUMENTS LIST	24
10 . EUT TEST PHOTO	26
APPENDIX A - AC POWER LINE CONDUCTED EMISSIONS	30
APPENDIX B - RADIATED EMISSION - 9 KHZ TO 30 MHZ	33
APPENDIX C - RADIATED EMISSION - 30 MHZ TO 1000 MHZ	38
APPENDIX D - RADIATED EMISSION- ABOVE 1000 MHZ	41
APPENDIX E - BANDWIDTH	122
APPENDIX F - MAXIMUM AVERAGE OUTPUT POWER	127

Table of Contents

Page

APPENDIX G - CONDUCTED SPURIOUS EMISSIONS

129

APPENDIX H - POWER SPECTRAL DENSITY

134

REPORT ISSUED HISTORY

Report Version	Description	Issued Date
R00	Original Issue.	Sep. 06, 2019

1. SUMMARY OF TEST RESULTS

Test procedures according to the technical standard(s):

FCC Part15, Subpart C (15.247)				
Standard(s) Section	Test Item	Test Result	Judgment	Remark
15.207	AC Power Line Conducted Emissions	APPENDIX A	PASS	-----
15.247(d) 15.205(a) 15.209(a)	Radiated Emissions	APPENDIX B APPENDIX C APPENDIX D	PASS	-----
15.247(a)(2)	Bandwidth	APPENDIX E	PASS	-----
15.247(b)(3)	Maximum Average Output Power	APPENDIX F	PASS	-----
15.247(d)	Conducted Spurious Emissions	APPENDIX G	PASS	-----
15.247(e)	Power Spectral Density	APPENDIX H	PASS	-----
15.203	Antenna Requirement	-----	PASS	Note(2)

Note:

- (1) "N/A" denotes test is not applicable in this test report.
- (2) The device what use a permanently attached antenna were considered sufficient to comply with the provisions of 15.203.

1.1 TEST FACILITY

The test facilities used to collect the test data in this report is at the location of No.3,Jinshagang 1st Road, Shixia, Dalang Town, Dongguan, Guangdong, China.

BTL's Test Firm Registration Number for FCC: 357015

BTL's Designation Number for FCC: CN1240

1.2 MEASUREMENT UNCERTAINTY

ISO/IEC 17025 requires that an estimate of the measurement uncertainties associated with the emissions test results be included in the report. The measurement uncertainties given below are based on a 95% confidence level (based on a coverage factor (k=2))

The BTL measurement uncertainty as below table:

A. AC power line conducted emissions test:

Test Site	Method	Measurement Frequency Range	U, (dB)
DG-C02	CISPR	150 kHz ~ 30 MHz	2.32

B. Radiated emissions test:

Test Site	Method	Measurement Frequency Range	Ant. H / V	U, (dB)
DG-CB03	CISPR	9kHz ~ 30MHz	V	3.79
		9kHz ~ 30MHz	H	3.57
		30MHz ~ 200MHz	V	4.88
		30MHz ~ 200MHz	H	4.14
		200MHz ~ 1,000MHz	V	4.62
		200MHz ~ 1,000MHz	H	4.80
		1GHz ~ 6GHz	-	4.58
		6GHz ~ 18GHz	-	5.18
		18GHz ~ 26.5GHz	-	3.80
26.5GHz ~ 40GHz	-	4.30		

Note: Unless specifically mentioned, the uncertainty of measurement has not been taken into account to declare the compliance or non-compliance to the specification.

1.3 TEST ENVIRONMENT CONDITIONS

Test Item	Temperature	Humidity	Test Voltage	Tested By
AC Power Line Conducted Emissions	25°C	53%	AC 120V/60Hz	Bert Xu
Radiated Emissions-9K-30MHz	25°C	60%	DC 5V	Bert Xu
Radiated Emissions-30 MHz to 1GHz	25°C	60%	DC 5V	Bert Xu
Radiated Emissions-Above 1000 MHz	25°C	60%	DC 5V	Sheldon Ou
Bandwidth	28°C	49%	DC 5V	Jonas Chen
Maximum Average output power	28°C	49%	DC 5V	Jonas Chen
Conducted Spurious Emissions	28°C	49%	DC 5V	Jonas Chen
Power Spectral Density	28°C	49%	DC 5V	Jonas Chen

2. GENERAL INFORMATION

2.1 GENERAL DESCRIPTION OF EUT

Equipment	Kasa Cam
Brand Name	tp-link
Test Model	KC120
Series Model	N/A
Model Difference(s)	N/A
Power Source	1# DC Voltage supplied from AC/DC adapter. Model: NBS05B050100VUU 2# Supplied from USB port.
Power Rating	1# I/P: 100-240~, 50/60Hz,0.2A 10-20VA O/P: 5.0V --- 1.0A 2# DC 5V
Operation Frequency	2412 MHz ~ 2462 MHz
Modulation Typ	IEEE 802.11b: DSSS IEEE 802.11g: OFDM IEEE 802.11n: OFDM
Bit Rate of Transmitter	IEEE 802.11b: 11/5.5/2/1 Mbps IEEE 802.11g: 54/48/36/24/18/12/9/6 Mbps IEEE 802.11n: up to 150 Mbps
Maximum Average Output Power	IEEE 802.11b: 18.28 dBm (0.0673 W) IEEE 802.11g: 19.67 dBm (0.0927 W) IEEE 802.11n (HT20): 19.24 dBm (0.0839 W) IEEE 802.11n (HT40): 19.77 dBm (0.0948W)

Note:

- For a more detailed features description, please refer to the manufacturer's specifications or the user's manual.

2. Channel List:

CH01 - CH11 for IEEE 802.11b, IEEE 802.11g, IEEE 802.11n (HT20) CH03 - CH09 for IEEE 802.11n (HT40)							
Channel	Frequency (MHz)	Channel	Frequency (MHz)	Channel	Frequency (MHz)	Channel	Frequency (MHz)
01	2412	04	2427	07	2442	10	2457
02	2417	05	2432	08	2447	11	2462
03	2422	06	2437	09	2452		

3. Antenna Specification:

Ant.	Brand	Model Name	Antenna Type	Connector	Gain (dBi)
1	TP-LINK®	N/A	PIFA	N/A	4.42

2.2 DESCRIPTION OF TEST MODES

The test system was pre-tested based on the consideration of all possible combinations of EUT operation mode.

Pretest Mode	Description
Mode 1	TX B Mode Channel 01/06/11
Mode 2	TX G Mode Channel 01/06/11
Mode 3	TX N-20 MHz Mode Channel 01/06/11
Mode 4	TX N-40 MHz Mode Channel 03/06/09
Mode 5	TX N-40 MHz Mode Channel 06
Mode 6	TX B Mode Channel 01/02/06/10/11
Mode 7	TX G Mode Channel 01/02/06/10/11
Mode 8	TX N-20 MHz Mode Channel 01/02/06/10/11
Mode 9	TX N-40 MHz Mode Channel 03/04/06/08/09

Following mode(s) as (were) found to be the worst case(s) and selected for the final test.

AC power line conducted emissions test	
Final Test Mode	Description
Mode 5	TX N-40 MHz Mode Channel 06

Radiated emissions test - Below 1GHz	
Final Test Mode	Description
Mode 5	TX N-40 MHz Mode Channel 06

Radiated emissions test- Above 1GHz	
Final Test Mode	Description
Mode 6	TX B Mode Channel 01/02/06/10/11
Mode 7	TX G Mode Channel 01/02/06/10/11
Mode 8	TX N-20 MHz Mode Channel 01/02/06/10/11
Mode 9	TX N-40 MHz Mode Channel 03/04/06/08/09

Conducted test	
Final Test Mode	Description
Mode 1	TX B Mode Channel 01/06/11
Mode 2	TX G Mode Channel 01/06/11
Mode 3	TX N-20 MHz Mode Channel 01/06/11
Mode 4	TX N-40 MHz Mode Channel 03/06/09

NOTE:

- (1) The measurements are performed at the high, middle, low available channels.
- (2) For radiated emission below 1 GHz test, the IEEE 802.11n (HT40) channel 06 is found to be the worst case and recorded.
- (3) All the bit rate of transmitter have been tested and found the lowest rate is found to be the worst case and recorded.
- (4) For radiated emission above 1 GHz test, 1GHz~26.5GHz have been pre-tested and in this report only recorded the worst case. The remaining spurious points are all below the limit value of 20dB.

2.3 PARAMETERS OF TEST SOFTWARE

Test Software	Win7_MP_Kit_RTL11n_8188FU_USB_v0.05_20190305		
Frequency (MHz)	2412	2437	2462
IEEE 802.11b	46	46	45
IEEE 802.11g	63	63	63
IEEE 802.11n (HT20)	62	63	63
Frequency (MHz)	2422	2437	2452
IEEE 802.11n (HT40)	59	63	60

2.4 DUTY CYCLE

If duty cycle is $\geq 98\%$, duty factor is not required.
 If duty cycle is $< 98\%$, duty factor shall be considered.
 The output power = measured power + duty factor.

IEEE 802.11b

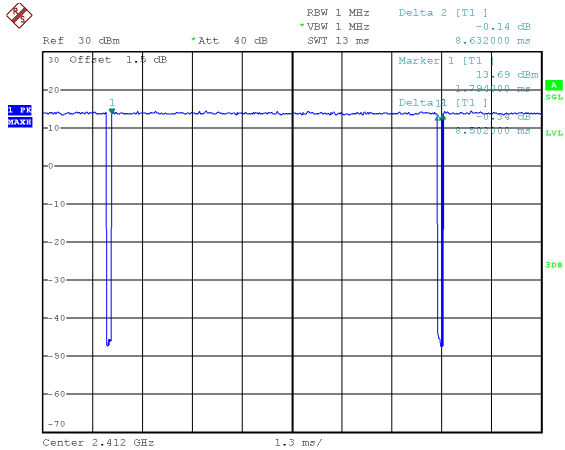

Date: 29.JUL.2019 00:29:00

Duty cycle = $8.502 \text{ ms} / 8.632 \text{ ms} = 98.49\%$
 Duty Factor = $10 \log(1/\text{Duty cycle}) = 0.00$
IEEE 802.11n (HT20)

IEEE 802.11g

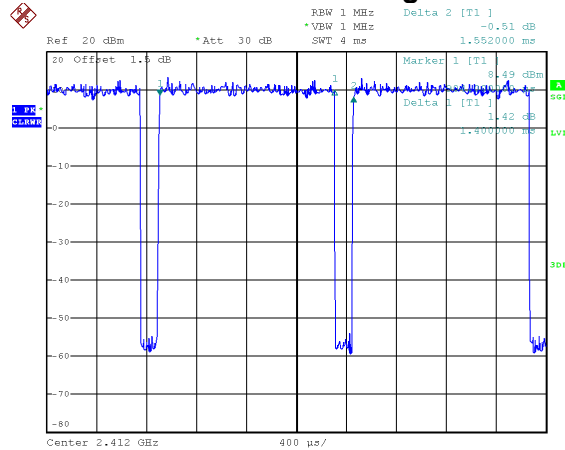

Date: 29.JUL.2019 00:45:27

Duty cycle = $1.400 \text{ ms} / 1.552 \text{ ms} = 90.21\%$
 Duty Factor = $10 \log(1/\text{Duty cycle}) = 0.45$
IEEE 802.11n (HT40)

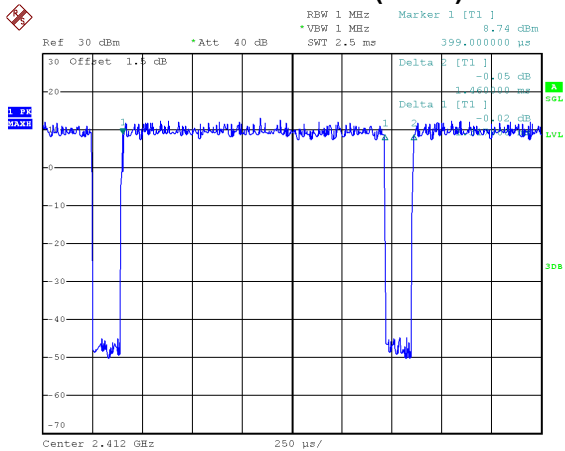

Date: 29.JUL.2019 01:00:16

Duty cycle = $1.317 \text{ ms} / 1.460 \text{ ms} = 90.21\%$
 Duty Factor = $10 \log(1/\text{Duty cycle}) = 0.45$

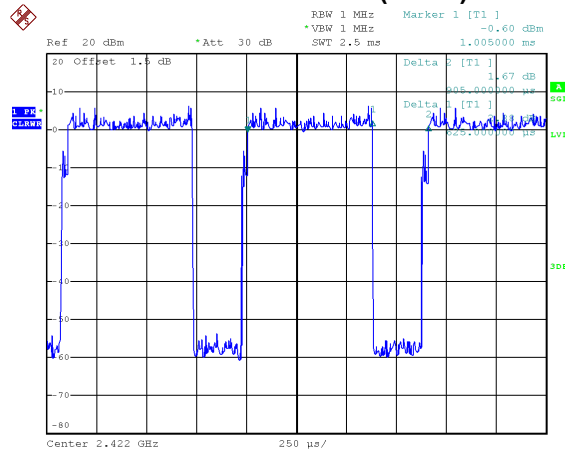

Date: 29.JUL.2019 01:14:52

Duty cycle = $0.625 \text{ ms} / 0.905 \text{ ms} = 69.06\%$
 Duty Factor = $10 \log(1/\text{Duty cycle}) = 1.61$

NOTE:

For IEEE 802.11g and IEEE 802.11n (HT20):
 For radiated emissions frequency above 1 GHz, the resolution bandwidth of test receiver/spectrum analyzer is 1 MHz and the video bandwidth is 1 kHz (Duty cycle $< 98\%$).

For IEEE 802.11n (HT40):
 For radiated emissions frequency above 1 GHz, the resolution bandwidth of test receiver/spectrum analyzer is 1 MHz and the video bandwidth is 2 kHz (Duty cycle $< 98\%$).

2.5 BLOCK DIAGRAM SHOWING THE CONFIGURATION OF SYSTEM TESTED

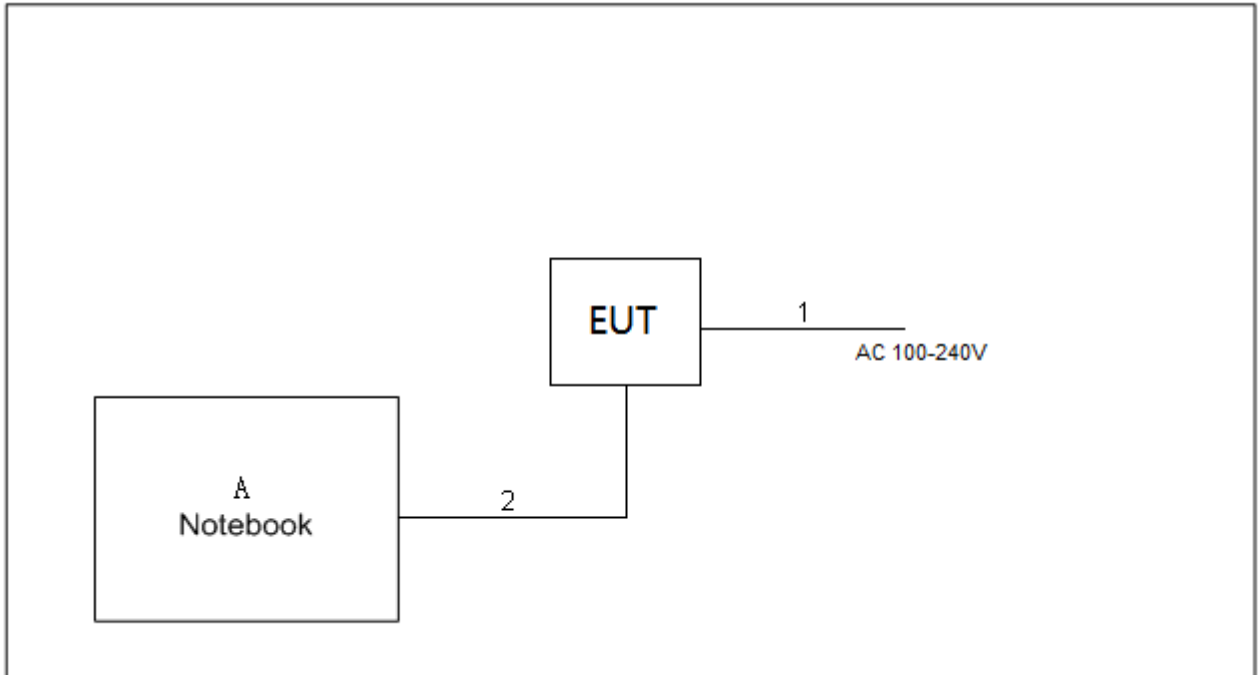

2.6 SUPPORT UNITS

Item	Equipment	Brand	Model No.	Series No.
A	Notebook	Dell	Inspiron 15-7559	N/A

Item	Cable Type	Shielded Type	Ferrite Core	Length
1	AC Cable	NO	NO	1.2m
2	USB Cable	NO	NO	0.8m

3. AC POWER LINE CONDUCTED EMISSIONS TEST

3.1 LIMIT

Frequency of Emission (MHz)	Limit (dB μ V)	
	Quasi-peak	Average
0.15 - 0.50	66 to 56*	56 to 46*
0.50 - 5.0	56	46
5.0 - 30.0	60	50

NOTE:

- (1) The tighter limit applies at the band edges.
- (2) The limit of " * " marked band means the limitation decreases linearly with the logarithm of the frequency in the range.

The following table is the setting of the receiver

Receiver Parameters	Setting
Attenuation	10 dB
Start Frequency	0.15 MHz
Stop Frequency	30 MHz
IF Bandwidth	9 kHz

3.2 TEST PROCEDURE

- a. The EUT was placed 0.8 meters from the horizontal ground plane with EUT being connected to the power mains through a line impedance stabilization network (LISN). All other support equipment powered from additional LISN(s). The LISN provide 50 Ohm/ 50uH of coupling impedance for the measuring instrument.
- b. Interconnecting cables that hang closer than 40 cm to the ground plane shall be folded back and forth in the center forming a bundle 30 to 40 cm long.
- c. I/O cables that are not connected to a peripheral shall be bundled in the center. The end of the cable may be terminated, if required, using the correct terminating impedance. The overall length shall not exceed 1 m.
- d. LISN at least 80 cm from nearest part of EUT chassis.
- e. For the actual test configuration, please refer to the related Item -EUT Test Photos.

3.3 DEVIATION FROM TEST STANDARD

No deviation

3.4 TEST SETUP

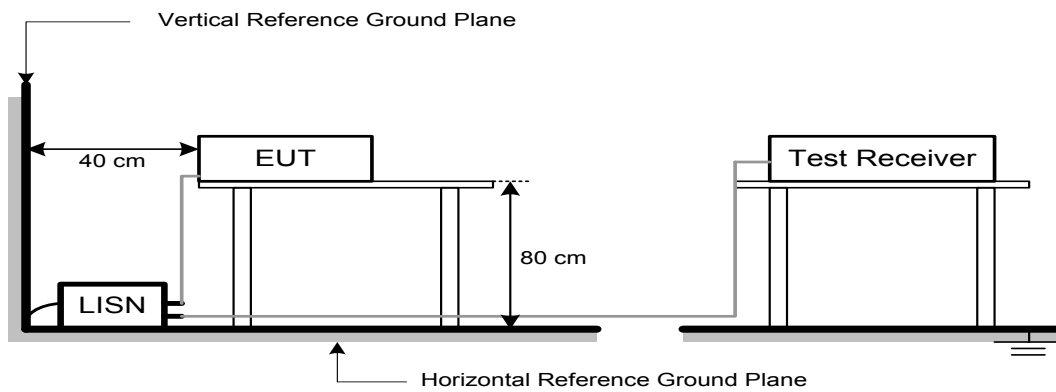

3.5 EUT OPERATION CONDITIONS

EUT was programmed to be in continuously transmitting mode.

3.6 TEST RESULTS

Please refer to the APPENDIX A.

4. RADIATED EMISSIONS TEST

4.1 LIMIT

In case the emission fall within the restricted band specified on 15.205(a), then the 15.209(a) limit in the table below has to be followed.

LIMITS OF RADIATED EMISSION MEASUREMENT (9 kHz-1000 MHz)

Frequency (MHz)	Field Strength (microvolts/meter)	Measurement Distance (meters)
0.009-0.490	2400/F(kHz)	300
0.490-1.705	24000/F(kHz)	30
1.705-30.0	30	30
30-88	100	3
88-216	150	3
216-960	200	3
Above 960	500	3

LIMITS OF RADIATED EMISSION MEASUREMENT (Above 1000 MHz)

Frequency (MHz)	(dBuV/m at 3 m)	
	Peak	Average
Above 1000	74	54

NOTE:

- (1) The limit for radiated test was performed according to FCC PART 15C.
- (2) The tighter limit applies at the band edges.
- (3) Emission level (dBuV/m)=20log Emission level (uV/m).

Spectrum Parameter	Setting
Attenuation	Auto
Start Frequency	1000 MHz
Stop Frequency	10th carrier harmonic
RBW / VBW (Emission in restricted band)	1 MHz / 3 MHz for Peak, 1 MHz / 1/T for Average

Receiver Parameter	Setting
Attenuation	Auto
Start ~ Stop Frequency	9 kHz~90 kHz for PK/AVG detector
Start ~ Stop Frequency	90 kHz~110 kHz for QP detector
Start ~ Stop Frequency	110 kHz~490 kHz for PK/AVG detector
Start ~ Stop Frequency	490 kHz~30 MHz for QP detector
Start ~ Stop Frequency	30 MHz~1000 MHz for QP detector

4.2 TEST PROCEDURE

- a. The measuring distance of 3 m shall be used for measurements. The EUT was placed on the top of a rotating table 0.8 meter above the ground at a 3 meter semi-anechoic chamber. The table was rotated 360 degrees to determine the position of the highest radiation.(below 1 GHz)
- b. The measuring distance of 3 m shall be used for measurements. The EUT was placed on the top of a rotating table 1.5 meter above the ground at a 3 meter semi-anechoic chamber. The table was rotated 360 degrees to determine the position of the highest radiation.(above 1 GHz)
- c. The height of the equipment or of the substitution antenna shall be 0.8m or 1.5m; the height of the test antenna shall vary between 1 m to 4 m. Both horizontal and vertical polarizations of the antenna are set to make the measurement.
- d. For each suspected emission, the EUT was arranged to its worst case and then the antenna was tuned to heights find the maximum reading (used Bore sight function).
- e. The receiver system was set to peak and average detect function and specified bandwidth with maximum hold mode when the test frequency is above 1 GHz.
- f. The initial step in collecting radiated emission data is a receiver peak detector mode pre-scanning the measurement frequency range. Significant peaks are then marked and then Quasi Peak detector mode re-measured.
- g. All readings are Peak unless otherwise stated QP in column of Note. Peak denotes that the Peak reading compliance with the QP Limits and then QP Mode measurement didn't perform. (below 1 GHz)
- h. All readings are Peak Mode value unless otherwise stated AVG in column of Note. If the Peak Mode Measured value compliance with the Peak Limits and lower than AVG Limits, the EUT shall be deemed to meet both Peak & AVG Limits and then only Peak Mode was measured, but AVG Mode didn't perform. (above 1 GHz)
- i. For the actual test configuration, please refer to the related Item -EUT Test Photos.

4.3 DEVIATION FROM TEST STANDARD

No deviation

4.4 TEST SETUP

9 kHz-30 MHz

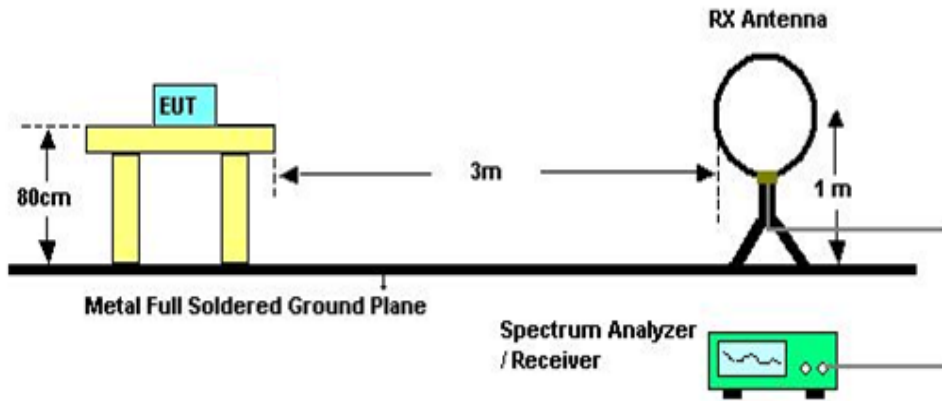

30 MHz to 1 GHz

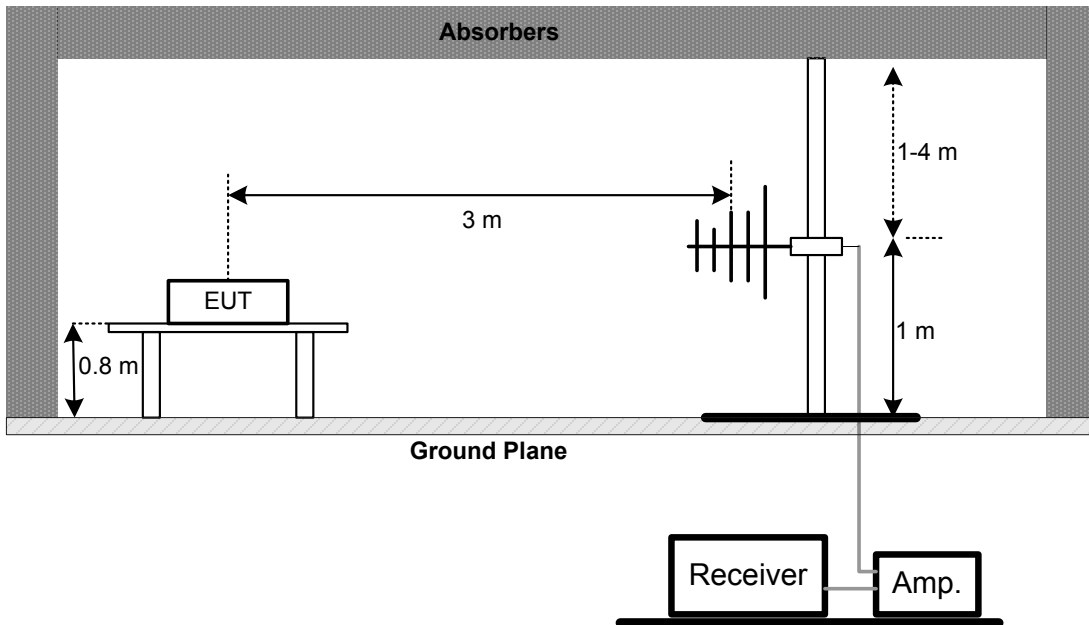

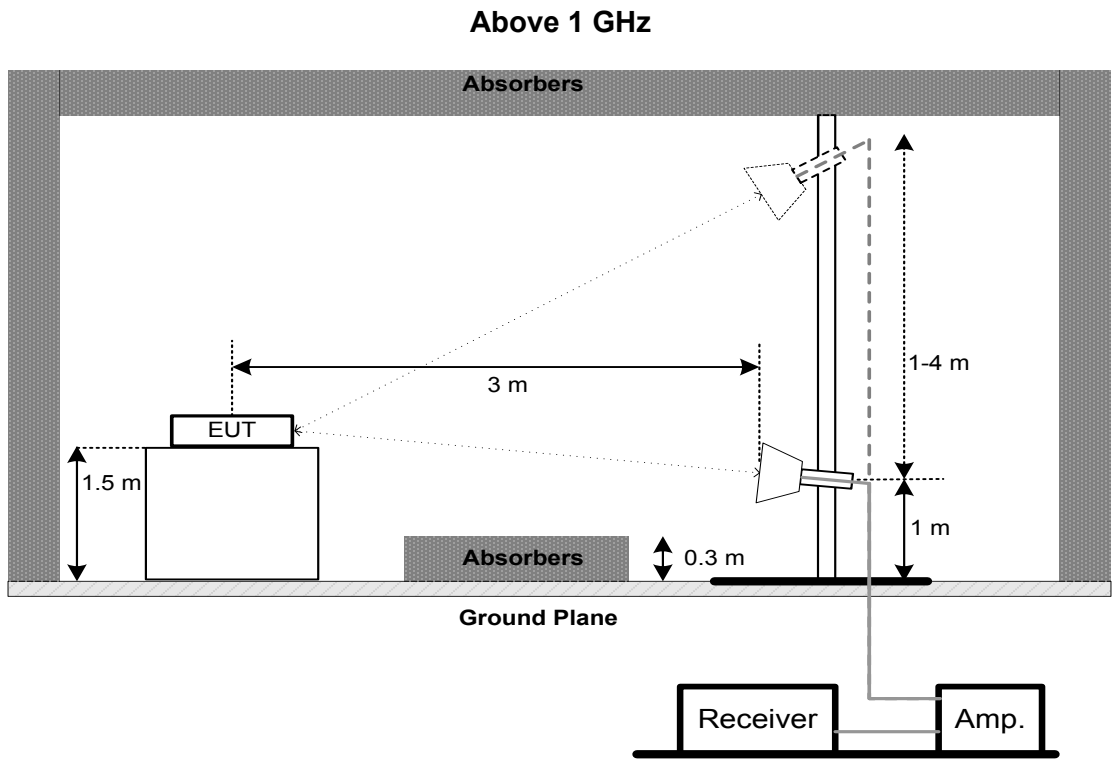

4.5 EUT OPERATION CONDITIONS

The EUT was programmed to be in continuously transmitting mode.

4.6 TEST RESULTS - 9 KHZ TO 30 MHZ

Please refer to the APPENDIX B

Remark:

- (1) Distance extrapolation factor = $40 \log(\text{specific distance} / \text{test distance})$ (dB).
- (2) Limit line = specific limits (dBuV) + distance extrapolation factor.

4.7 TEST RESULTS - 30 MHZ TO 1000 MHZ

Please refer to the APPENDIX C.

4.8 TEST RESULTS - ABOVE 1000 MHZ

Please refer to the APPENDIX D.

Remark:

- (1) No limit: This is fundamental signal, the judgment is not applicable.
For fundamental signal judgment was referred to Peak output test.

5. BANDWIDTH TEST**5.1 LIMIT**

FCC Part15, Subpart C (15.247)		
Section	Test Item	Limit
15.247(a)(2)	6 dB Bandwidth	Minimum 500 kHz
	99% Emission Bandwidth	-

5.2 TEST PROCEDURE

- The EUT was directly connected to the spectrum analyzer and antenna output port as show in the block diagram below.
- For 6dB Bandwidth Spectrum setting: RBW= 100KHz, VBW=300KHz, Sweep time = 2.5 ms.
For 99% OBW Spectrum Setting: For B,G,N20 mode: RBW= 300KHz, VBW=1MHz, For N40 mode: RBW= 1MHz, VBW=3MHz, Sweep time = 2.5 ms.
- The bandwidth was performed in accordance with method 11.8.1 of ANSI C63.10-2013.

5.3 DEVIATION FROM STANDARD

No deviation.

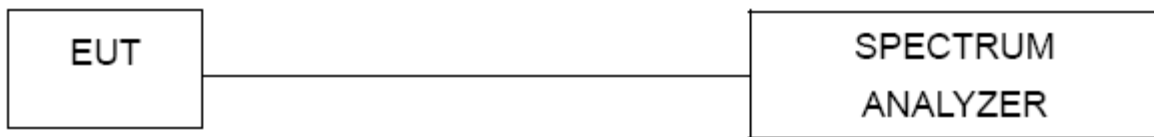
5.4 TEST SETUP**5.5 EUT OPERATION CONDITIONS**

The EUT was programmed to be in continuously transmitting mode.

5.6 TEST RESULTS

Please refer to the APPENDIX E.

6. MAXIMUM AVERAGE OUTPUT POWER TEST**6.1 LIMIT**

FCC Part15, Subpart C (15.247)		
Section	Test Item	Limit
15.247(b)(3)	Maximum Average Output Power	1 Watt or 30dBm

6.2 TEST PROCEDURE

- a. The EUT was directly connected to the power meter and antenna output port as show in the block diagram below.
- b. The maximum conducted output power was performed in accordance with method 11.9.2.3.1 of ANSI C63.10-2013 and FCC KDB 662911 D01 v02r01 Multiple Transmitter Output.

6.3 DEVIATION FROM STANDARD

No deviation.

6.4 TEST SETUP**6.5 EUT OPERATION CONDITIONS**

The EUT was programmed to be in continuously transmitting mode.

6.6 TEST RESULTS

Please refer to the APPENDIX F.

7. CONDUCTED SPURIOUS EMISSIONS

7.1 LIMIT

In any 100 kHz bandwidth outside the frequency band in which the spread spectrum or digitally modulated intentional radiator is operating, the radio frequency power that is produced by the intentional radiator shall be at least 20 dB below that in the 100 kHz bandwidth within the band that contains the highest level of the desired power, based on either an RF conducted or a radiated measurement, provided the transmitter demonstrates compliance with the peak Output Power limits. If the transmitter complies with the Output Power limits based on the use of RMS averaging over a time interval, as permitted under paragraph (b)(3) of this section, the attenuation required under this paragraph shall be 30 dB instead of 20 dB. Attenuation below the general limits specified in Section 15.209(a) is not required.

7.2 TEST PROCEDURE

- a. The EUT was directly connected to the spectrum analyzer and antenna output port as show in the block diagram below.
- b. Spectrum Setting: RBW= 100 kHz, VBW=300 kHz, Sweep time = Auto.

7.3 DEVIATION FROM STANDARD

No deviation.

7.4 TEST SETUP

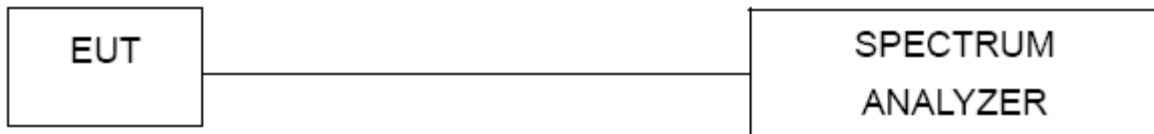

7.5 EUT OPERATION CONDITIONS

The EUT was programmed to be in continuously transmitting mode.

7.6 TEST RESULTS

Please refer to the APPENDIX G.

8. POWER SPECTRAL DENSITY TEST

8.1 LIMIT

FCC Part15, Subpart C (15.247)		
Section	Test Item	Limit
15.247(e)	Power Spectral Density	8 dBm (in any 3 kHz)

8.2 TEST PROCEDURE

- The EUT was directly connected to the spectrum analyzer and antenna output port as show in the block diagram below.
- Spectrum Setting: RBW=3 kHz, VBW=10 kHz, Sweep time = Auto.
- The Power Spectral Density was performed in accordance with method 11.10.2 of ANSI C63.10-2013.

8.3 DEVIATION FROM STANDARD

No deviation.

8.4 TEST SETUP

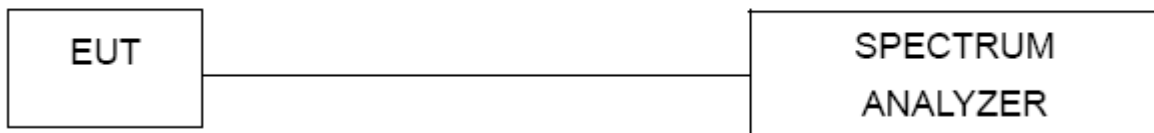

8.5 EUT OPERATION CONDITIONS

The EUT was programmed to be in continuously transmitting mode.

8.6 TEST RESULTS

Please refer to the APPENDIX H.

9. MEASUREMENT INSTRUMENTS LIST

AC Power Line Conducted Emissions					
Item	Kind of Equipment	Manufacturer	Type No.	Serial No.	Calibrated until
1	EMI Test Receiver	R&S	ESCI	100382	Mar. 10, 2020
2	LISN	EMCO	3816/2	52765	Mar. 10, 2020
3	50ohm Terminator	SHX	TF5-3	15041305	Mar. 10, 2020
4	Artificial-Mains Network	Schwarzbeck	NSLK 8127	8127685	Mar. 10, 2020
5	TRANSIENT LIMITER	EM	EM-7600	772	Mar. 10, 2020
6	Measurement Software	Farad	EZ-EMC Ver.NB-03A1-01	N/A	N/A
7	Cable	N/A	RG223	12m	Mar. 12, 2020

Radiated Emissions - 9 kHz to 30 MHz					
Item	Kind of Equipment	Manufacturer	Type No.	Serial No.	Calibrated until
1	Loop Antenna	EM	EM-6876-1	230	Jan. 15, 2020
2	Cable	N/A	RG 213/U	C-102	May 31, 2020
3	EMI Test Receiver	R&S	ESCI	100895	Mar. 10, 2020
4	Measurement Software	Farad	EZ-EMC Ver.NB-03A1-01	N/A	N/A

Radiated Emissions - 30 MHz to 1 GHz					
Item	Kind of Equipment	Manufacturer	Type No.	Serial No.	Calibrated until
1	Antenna	Schwarzbeck	VULB9160	9160-3232	Mar. 09, 2020
2*	Amplifier	HP	8447D	2944A09673	Aug. 11, 2021
3	Receiver	Agilent	N9038A	MY52130039	Aug. 03, 2020
4	Cable	emci	LMR-400(30MHz-1GHz)(8m+5m)	N/A	May 24, 2020
5	Controller	CT	SC100	N/A	N/A
6	Controller	MF	MF-7802	MF780208416	N/A
7	Measurement Software	Farad	EZ-EMC Ver.NB-03A1-01	N/A	N/A

Radiated Emissions - Above 1 GHz					
Item	Kind of Equipment	Manufacturer	Type No.	Serial No.	Calibrated until
1	Double Ridged Guide Antenna	ETS	3115	75789	Mar. 09, 2020
2	Broad-Band Horn Antenna	Schwarzbeck	BBHA 9170	9170319	Jun. 23, 2020
3	Amplifier	Agilent	8449B	3008A02333	Mar. 10, 2020
4	Microwave Preamplifier With Adaptor	EMC INSTRUMENT	EMC2654045	980039 & HA01	Mar. 10, 2020
5	Receiver	Agilent	N9038A	MY52130039	Aug. 03, 2020
6	Controller	CT	SC100	N/A	N/A
7	Controller	MF	MF-7802	MF780208416	N/A
8	Cable	mitron	B10-01-01-12M	18072744	Jun. 29, 2020
9	Measurement Software	Farad	EZ-EMC Ver.NB-03A1-01	N/A	N/A

**Bandwidth &
Antenna Conducted Spurious Emissions &
Power Spectral Density**

Item	Kind of Equipment	Manufacturer	Type No.	Serial No.	Calibrated until
1	Spectrum Analyzer	R&S	FSP40	100185	Aug. 03, 2020

Maximum Average Output Power

Item	Kind of Equipment	Manufacturer	Type No.	Serial No.	Calibrated until
1	Peak Power Analyzer	Keysight	8990B	MY51000506	Aug. 03, 2020
2	Wideband power sensor	Keysight	N1923A	MY58310004	Aug. 03, 2020

Remark: "N/A" denotes no model name, serial no. or calibration specified.

"*" calibration period of equipment list is three year.

Except * item, all calibration period of equipment list is one year.

10. EUT TEST PHOTO

AC Power Line Conducted Emissions Test Photos

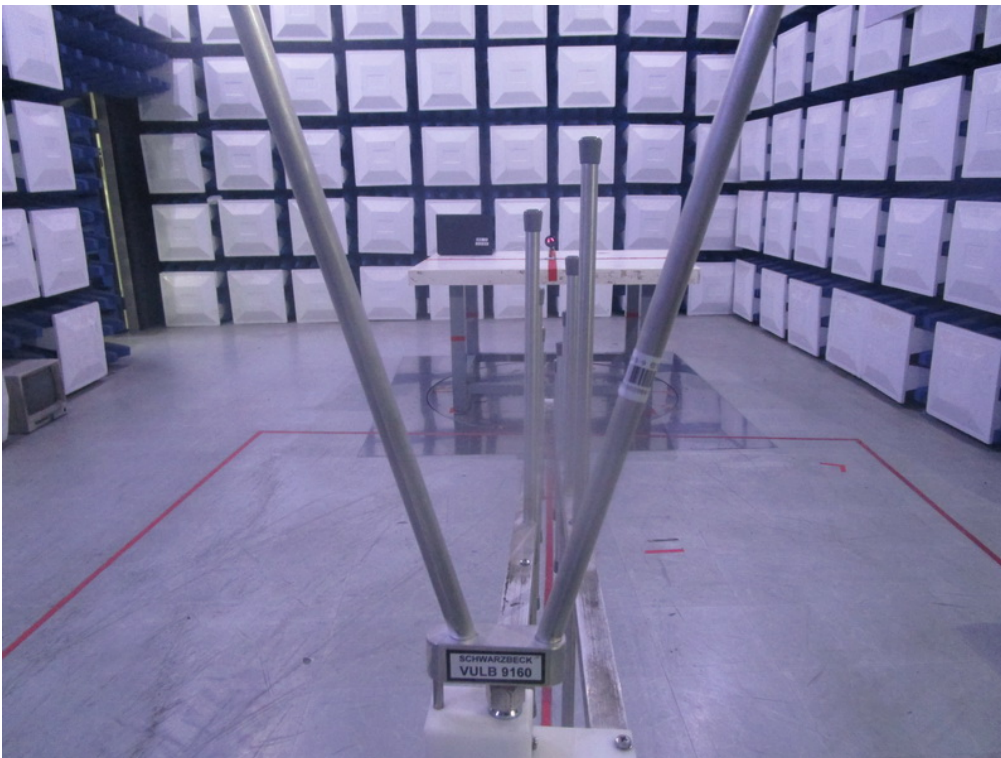
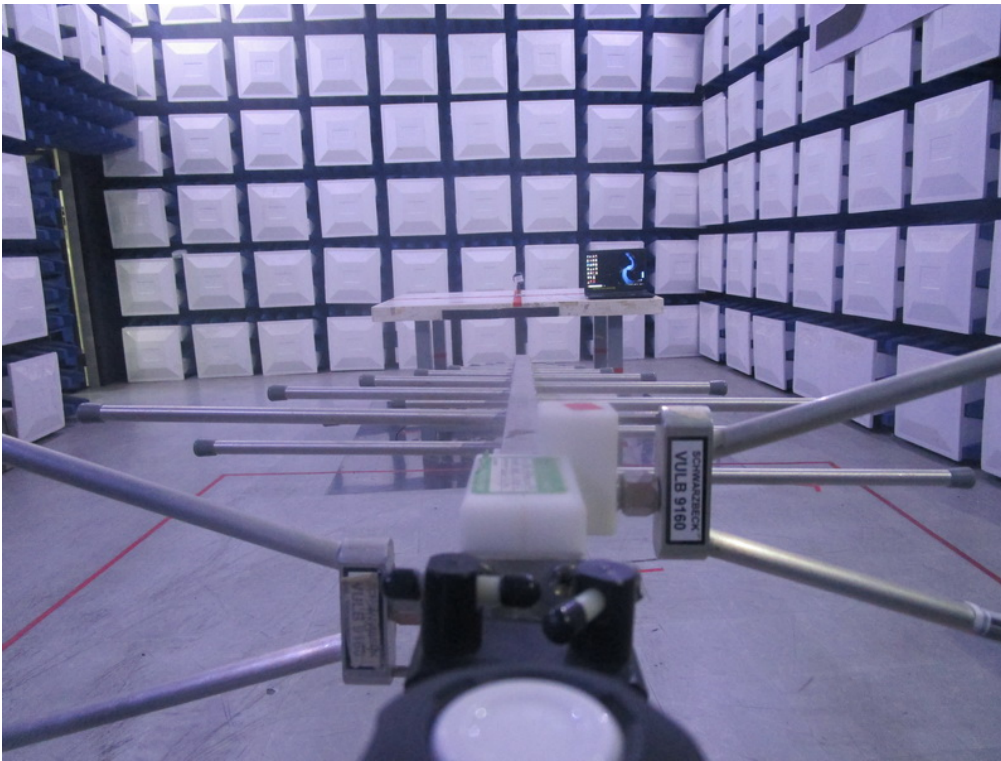

Radiated Emissions Test Photos**9 kHz to 30 MHz**

Radiated Emissions Test Photos**30 MHz to 1 GHz**

Radiated Emissions Test Photos

Above 1 GHz



APPENDIX A - AC POWER LINE CONDUCTED EMISSIONS

Test Mode: TX N-40MHz Mode Channel 06

Line

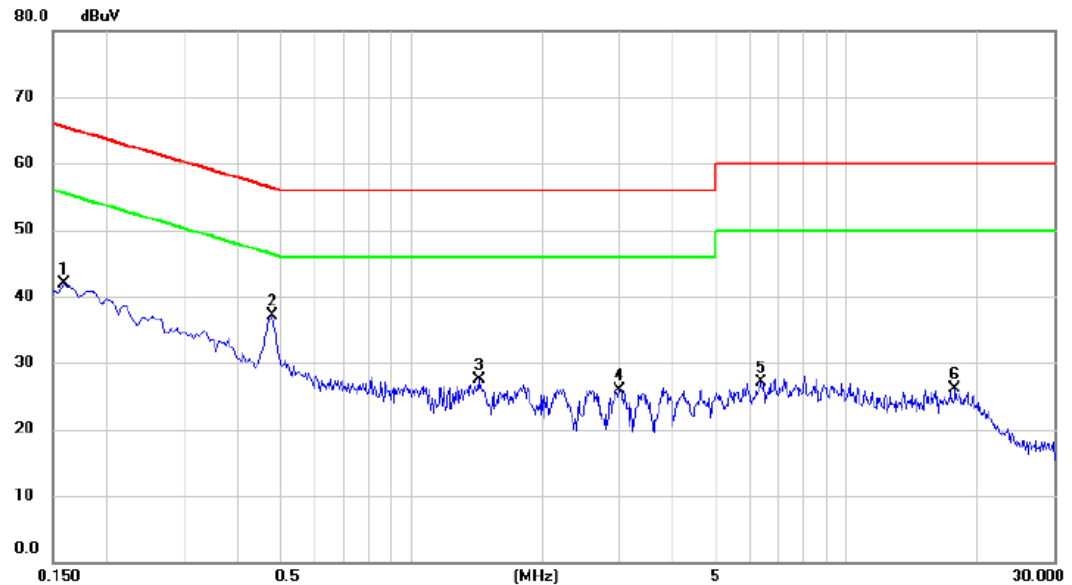

No.	Mk.	Freq. MHz	Reading Level dBuV	Correct Factor dB	Measure- ment dBuV	Limit dBuV	Margin dB	Detector	Comment
1		0.1590	32.04	9.82	41.86	65.52	-23.66	peak	
2	*	0.4785	27.13	9.88	37.01	56.37	-19.36	peak	
3		1.4325	17.54	9.95	27.49	56.00	-28.51	peak	
4		3.0030	15.75	10.06	25.81	56.00	-30.19	peak	
5		6.3510	16.88	10.29	27.17	60.00	-32.83	peak	
6		17.7585	15.13	10.99	26.12	60.00	-33.88	peak	

REMARKS:

- (1) Measurement Value = Reading Level + Correct Factor.
- (2) Margin Level = Measurement Value - Limit Value.

Test Mode: TX N-40MHz Mode Channel 06

Neutral

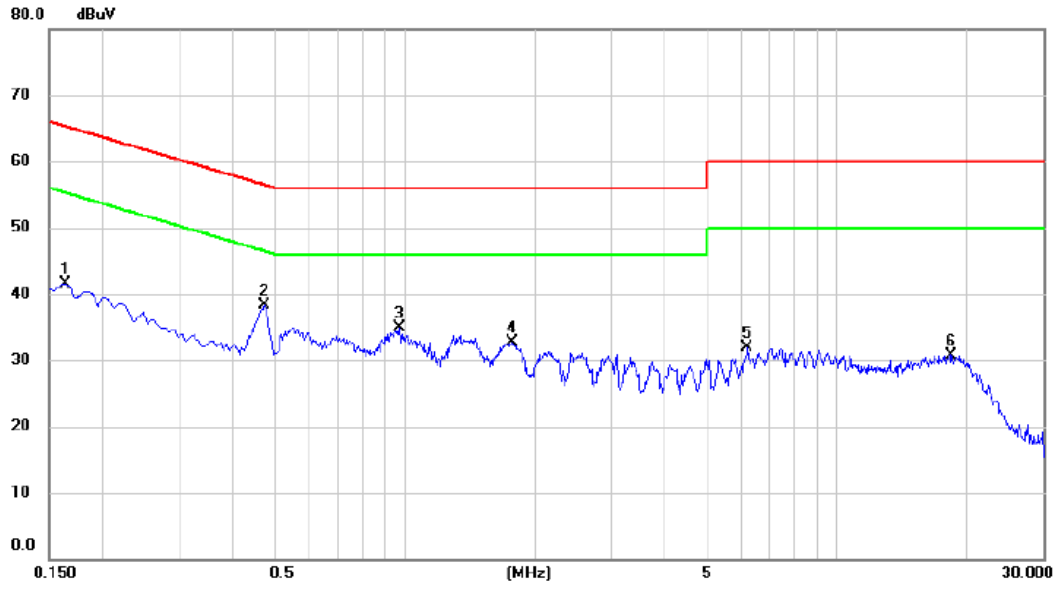

No.	Mk.	Freq. MHz	Reading Level dBuV	Correct Factor dB	Measure- ment dBuV	Limit dBuV	Margin dB	Detector	Comment
1		0.1635	31.61	9.91	41.52	65.28	-23.76	peak	
2	*	0.4740	28.27	10.03	38.30	56.44	-18.14	peak	
3		0.9690	24.75	10.11	34.86	56.00	-21.14	peak	
4		1.7745	22.44	10.17	32.61	56.00	-23.39	peak	
5		6.1980	21.31	10.51	31.82	60.00	-28.18	peak	
6		18.4200	19.44	11.36	30.80	60.00	-29.20	peak	

REMARKS:

- (1) Measurement Value = Reading Level + Correct Factor.
- (2) Margin Level = Measurement Value - Limit Value.

APPENDIX B - RADIATED EMISSION - 9 KHZ TO 30 MHZ

Test Mode: TX N-40MHz Mode Channel 06

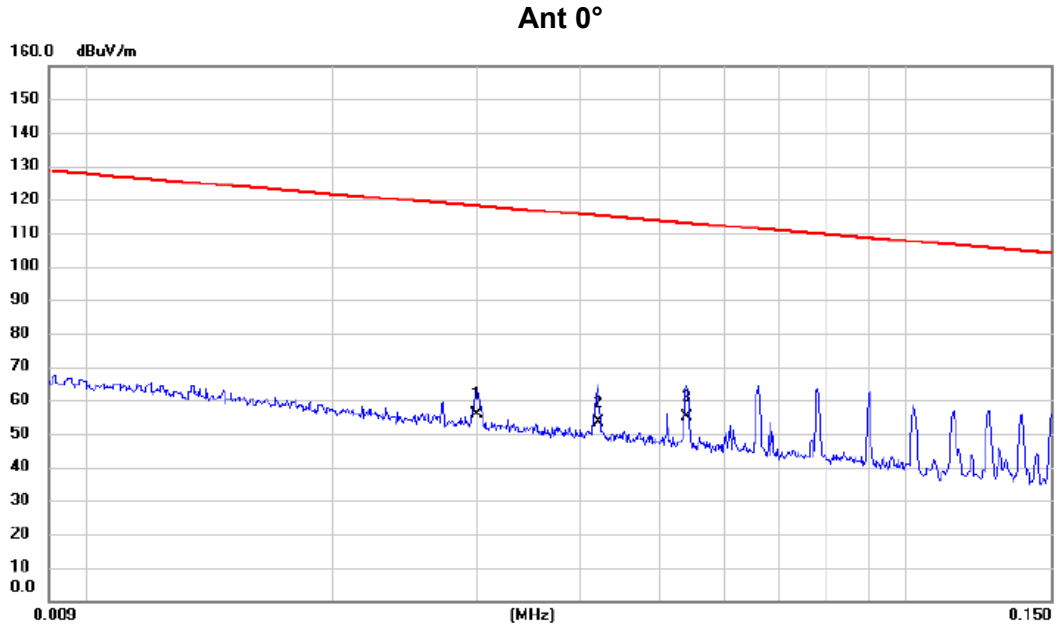

No.	Mk.	Freq. MHz	Reading Level dBuV	Correct Factor dB	Measure- ment dBuV/m	Limit dBuV/m	Margin dB	Detector	Comment
1		0.0300	41.81	13.85	55.66	118.06	-62.40	AVG	
2		0.0421	39.58	13.90	53.48	115.12	-61.64	AVG	
3	*	0.0540	41.25	13.87	55.12	112.96	-57.84	AVG	

REMARKS:

- (1) Measurement Value = Reading Level + Correct Factor.
- (2) Margin Level = Measurement Value - Limit Value.

Test Mode: TX N-40MHz Mode Channel 06

Ant 0°

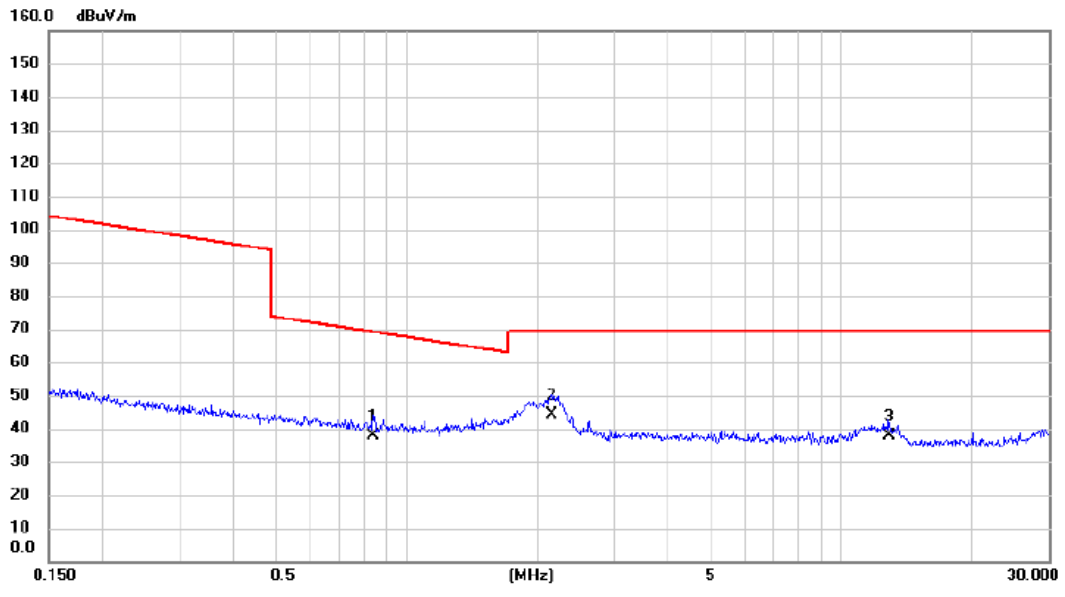

No.	Mk.	Freq. MHz	Reading Level dBuV	Correct Factor dB	Measure- ment dBuV/m	Limit dBuV/m	Margin dB	Detector	Comment
1		0.8393	25.16	12.55	37.71	69.13	-31.42	QP	
2	*	2.1552	32.36	11.73	44.09	69.54	-25.45	QP	
3		12.8516	26.09	11.60	37.69	69.54	-31.85	QP	

REMARKS:

- (1) Measurement Value = Reading Level + Correct Factor.
- (2) Margin Level = Measurement Value - Limit Value.

Test Mode: TX N-40MHz Mode Channel 06

Ant 90°

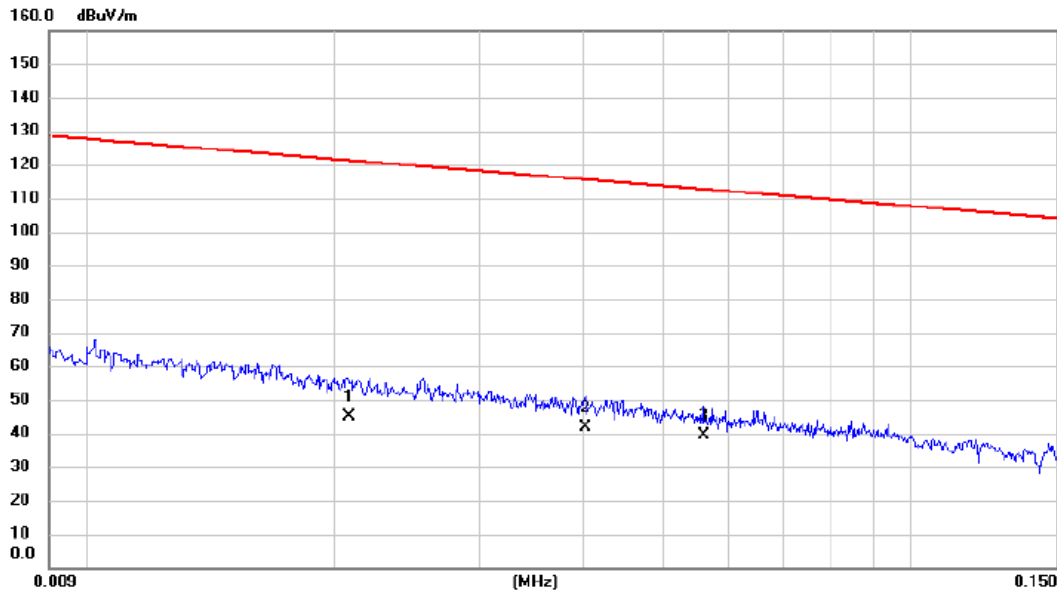

No.	Mk.	Freq.	Reading Level	Correct Factor	Measurement	Limit	Margin		
		MHz	dBuV	dB	dBuV/m	dBuV/m	dB	Detector	Comment
1		0.0208	31.36	13.82	45.18	121.24	-76.06	AVG	
2		0.0403	27.81	13.90	41.71	115.50	-73.79	AVG	
3	*	0.0560	25.69	13.83	39.52	112.64	-73.12	AVG	

REMARKS:

- (1) Measurement Value = Reading Level + Correct Factor.
- (2) Margin Level = Measurement Value - Limit Value.

Test Mode: TX N-40MHz Mode Channel 06

Ant 90°

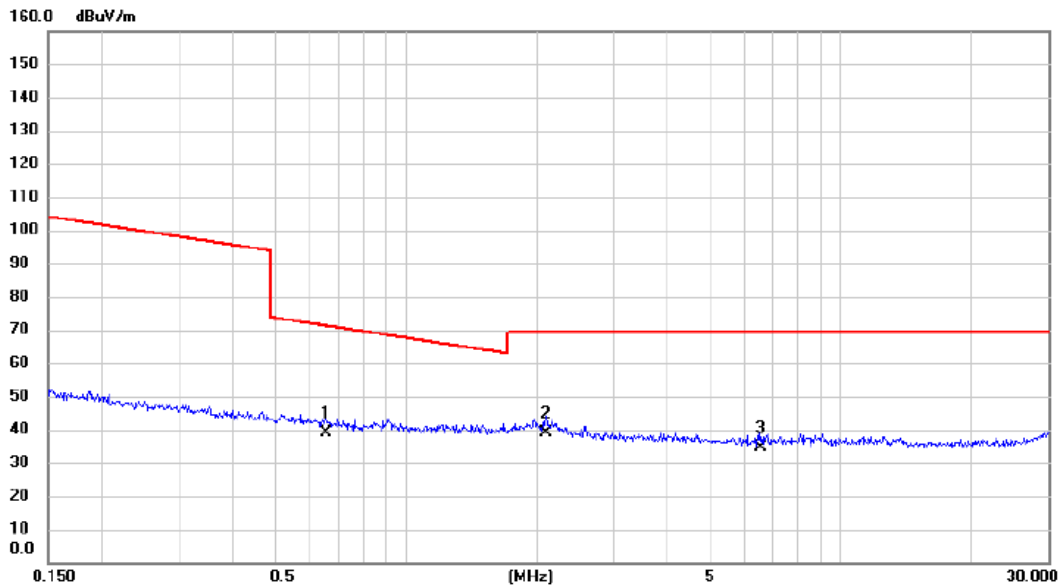

No.	Mk.	Freq. MHz	Reading Level dBuV	Correct Factor dB	Measure- ment dBuV/m	Limit dBuV/m	Margin dB	Detector	Comment
1		0.6543	26.31	12.76	39.07	71.29	-32.22	QP	
2	*	2.0990	27.13	11.76	38.89	69.54	-30.65	QP	
3		6.5227	23.57	11.09	34.66	69.54	-34.88	QP	

REMARKS:

- (1) Measurement Value = Reading Level + Correct Factor.
- (2) Margin Level = Measurement Value - Limit Value.

APPENDIX C - RADIATED EMISSION - 30 MHZ TO 1000 MHZ

Test Mode: TX N-40MHz Mode Channel 06

Vertical

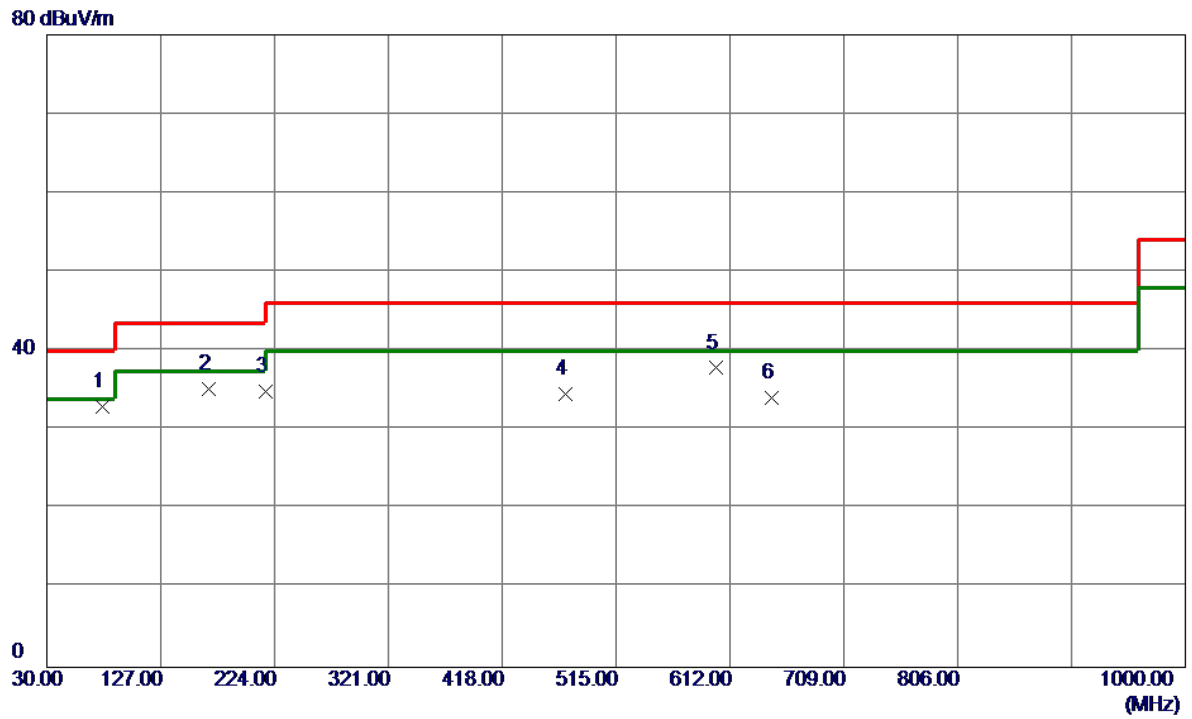

No.	Freq. MHz	Reading Level dBuV/m	Correct Factor dB	Measure ment dBuV/m	Limit dBuV/m	Margin dB	Detector	Comment
1 *	77.5300	50.49	-17.60	32.89	40.00	-7.11	Peak	
2	168.2250	47.38	-12.17	35.21	43.50	-8.29	Peak	
3	216.2400	49.93	-15.00	34.93	46.00	-11.07	Peak	
4	472.3200	42.51	-7.90	34.61	46.00	-11.39	Peak	
5	599.8750	43.58	-5.74	37.84	46.00	-8.16	Peak	
6	647.8900	38.78	-4.72	34.06	46.00	-11.94	Peak	

REMARKS:

- (1) Measurement Value = Reading Level + Correct Factor.
- (2) Margin Level = Measurement Value - Limit Value.

Test Mode: TX N-40MHz Mode Channel 06

Horizontal

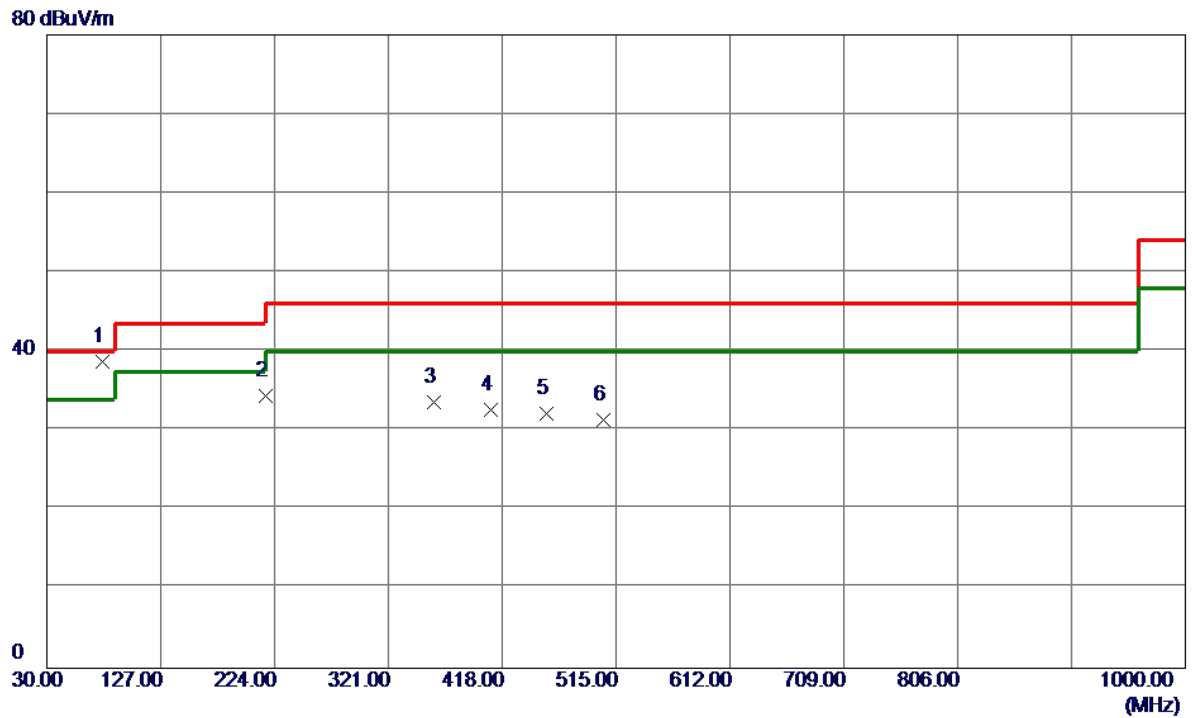

No.	Freq. MHz	Reading Level dBuV/m	Correct Factor dB	Measure ment dBuV/m	Limit dBuV/m	Margin dB	Detector	Comment
1 *	77.5300	56.25	-17.60	38.65	40.00	-1.35	Peak	
2	216.2400	49.39	-15.00	34.39	46.00	-11.61	Peak	
3	359.8000	44.08	-10.42	33.66	46.00	-12.34	Peak	
4	407.8150	41.96	-9.25	32.71	46.00	-13.29	Peak	
5	455.8300	40.14	-8.03	32.11	46.00	-13.89	Peak	
6	503.8450	39.08	-7.65	31.43	46.00	-14.57	Peak	

REMARKS:
 (1) Measurement Value = Reading Level + Correct Factor.
 (2) Margin Level = Measurement Value - Limit Value.

APPENDIX D - RADIATED EMISSION- ABOVE 1000 MHZ

Test Mode: TX B Mode 2412 MHz

Vertical

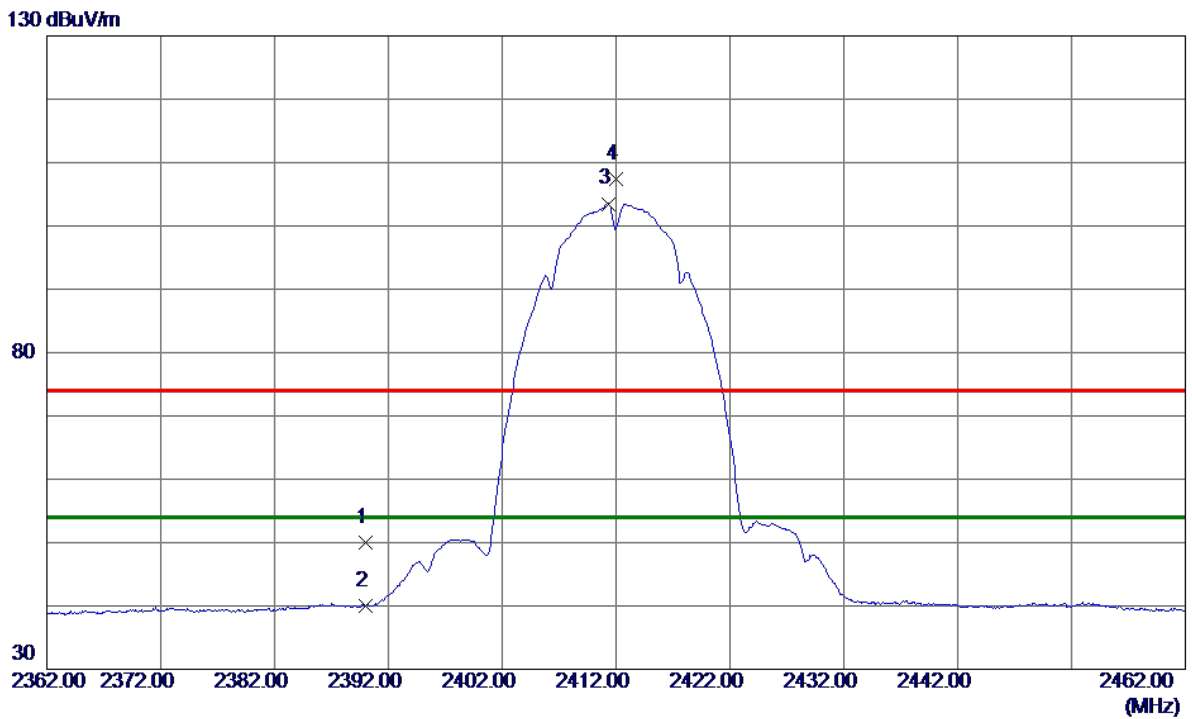

No.	Freq. MHz	Reading Level dBuV/m	Correct Factor dB	Measure ment dBuV/m	Limit dBuV/m	Margin dB	Detector	Comment
1	2390.0000	41.86	8.11	49.97	74.00	-24.03	Peak	
2	2390.0000	31.91	8.11	40.02	54.00	-13.98	AVG	
3 *	2411.3000	95.33	8.17	103.50	54.00	49.50	AVG	No Limit
4	2411.9500	99.23	8.17	107.40	74.00	33.40	Peak	No Limit

REMARKS:

- (1) Measurement Value = Reading Level + Correct Factor.
- (2) Margin Level = Measurement Value - Limit Value.

Test Mode: TX B Mode 2412 MHz

Vertical

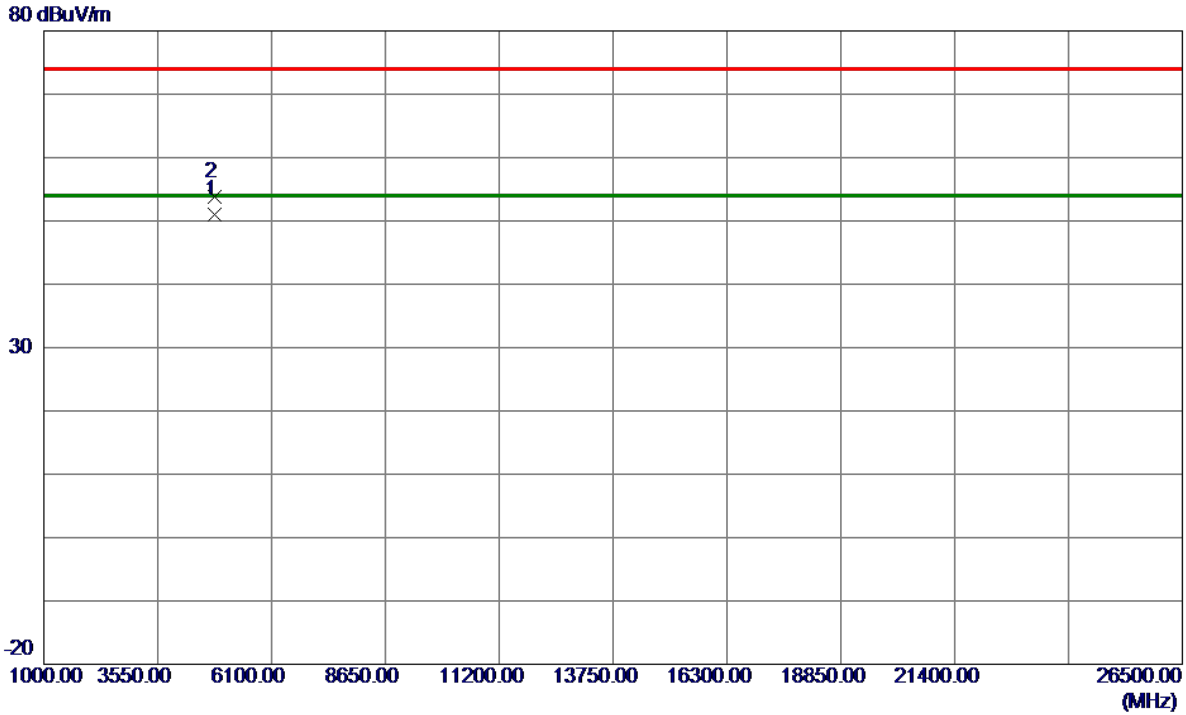

No.	Freq. MHz	Reading Level dBuV/m	Correct Factor dB	Measure ment dBuV/m	Limit dBuV/m	Margin dB	Detector	Comment
1 *	4823.9650	46.28	4.74	51.02	54.00	-2.98	AVG	
2	4824.1500	49.07	4.74	53.81	74.00	-20.19	Peak	

REMARKS:

- (1) Measurement Value = Reading Level + Correct Factor.
- (2) Margin Level = Measurement Value - Limit Value.

Test Mode: TX B Mode 2412 MHz

Horizontal

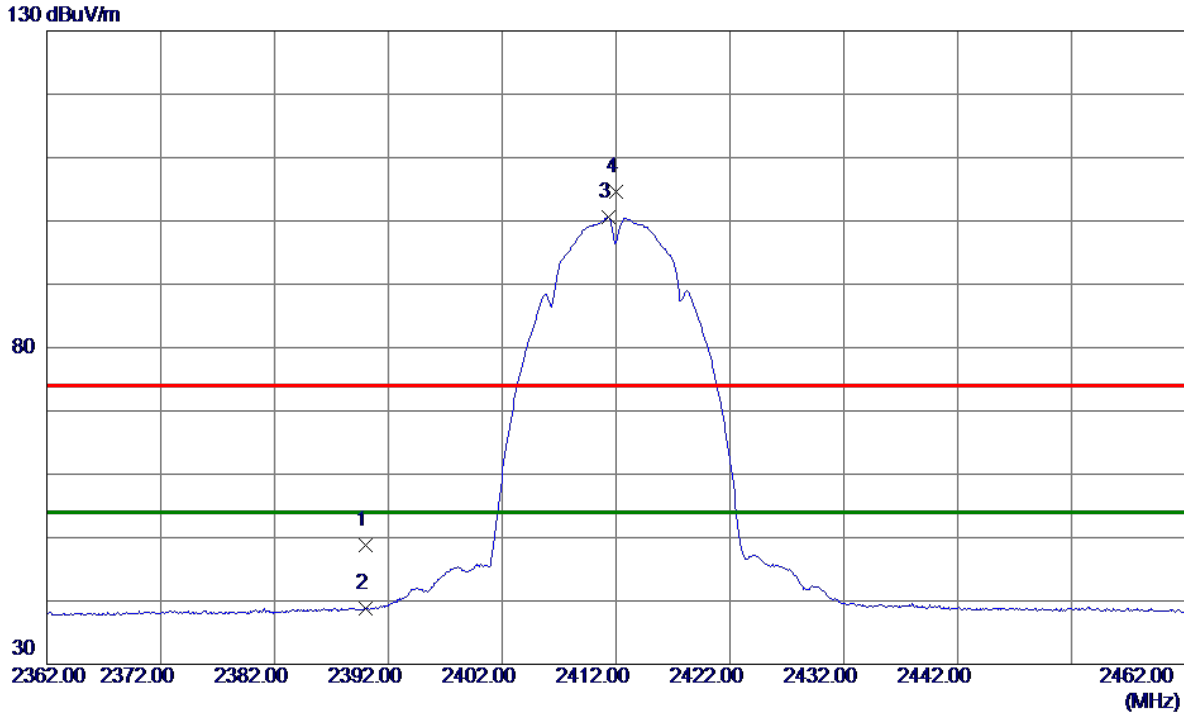

No.	Freq. MHz	Reading Level dBuV/m	Correct Factor dB	Measurement dBuV/m	Limit dBuV/m	Margin dB	Detector	Comment
1	2390.0000	41.25	7.56	48.81	74.00	-25.19	Peak	
2	2390.0000	31.23	7.56	38.79	54.00	-15.21	AVG	
3 *	2411.3000	92.98	7.64	100.62	54.00	46.62	AVG	No Limit
4	2412.0500	96.93	7.64	104.57	74.00	30.57	Peak	No Limit

REMARKS:

- (1) Measurement Value = Reading Level + Correct Factor.
- (2) Margin Level = Measurement Value - Limit Value.

Test Mode: TX B Mode 2412 MHz

Horizontal

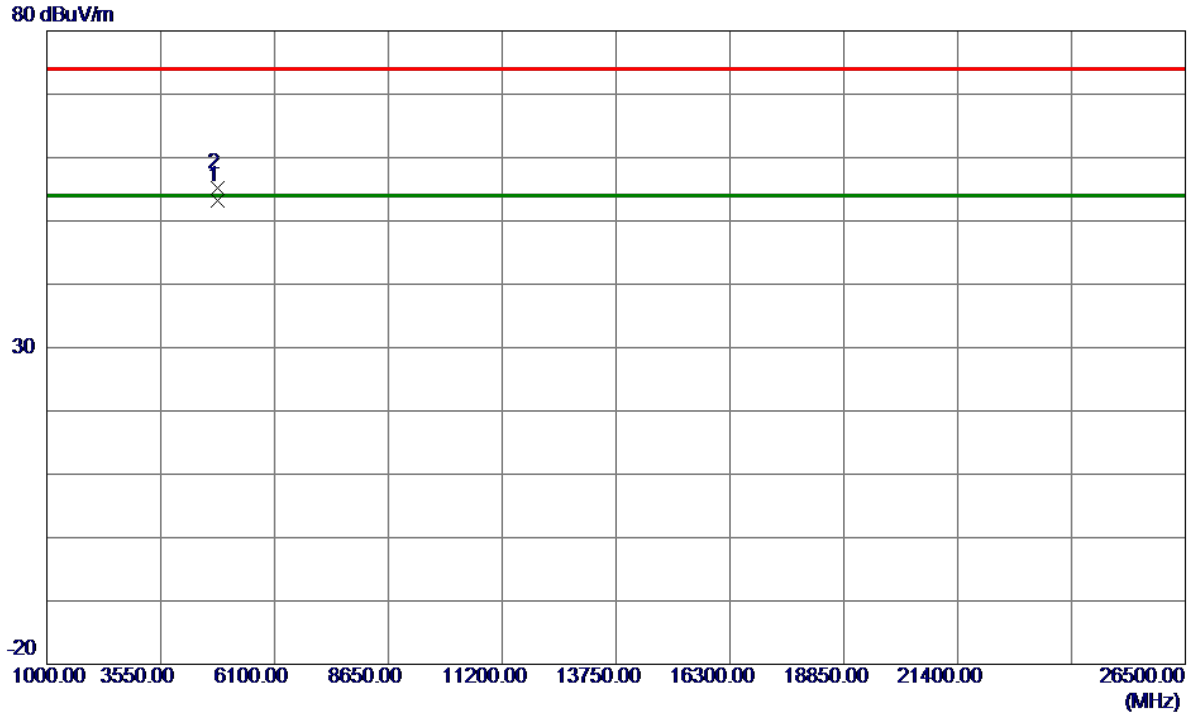

No.	Freq. MHz	Reading Level dBuV/m	Correct Factor dB	Measure ment dBuV/m	Limit dBuV/m	Margin dB	Detector	Comment
1 *	4823.9600	48.88	4.26	53.14	54.00	-0.86	AVG	
2	4824.0350	50.99	4.26	55.25	74.00	-18.75	Peak	

REMARKS:
 (1) Measurement Value = Reading Level + Correct Factor.
 (2) Margin Level = Measurement Value - Limit Value.

Test Mode: TX B Mode 2417 MHz

Vertical

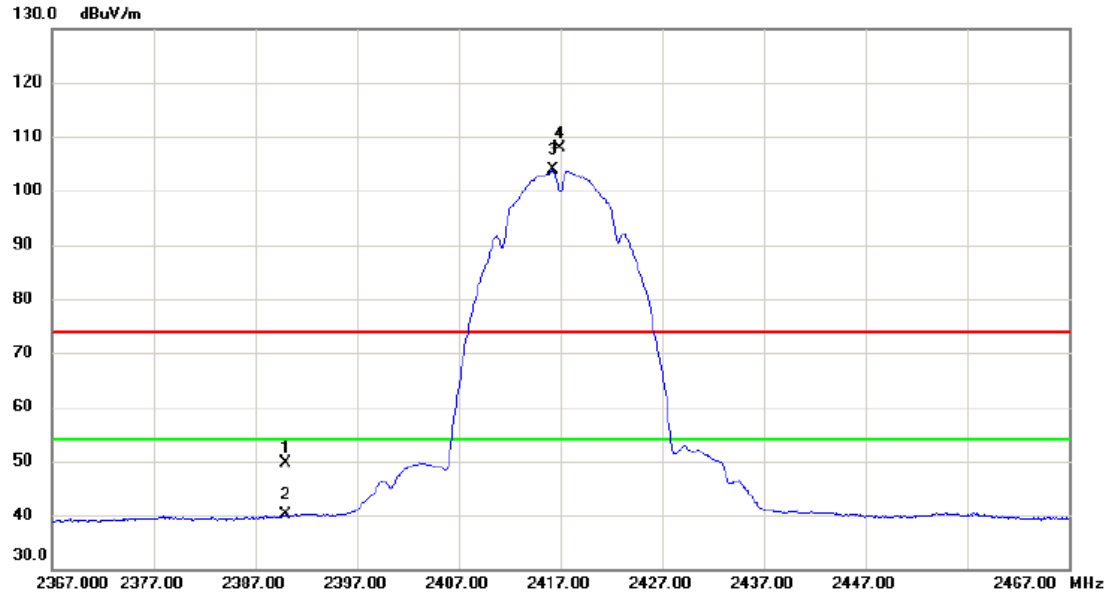

No.	Mk.	Freq.	Reading Level	Correct Factor	Measurement	Limit	Margin	Detector	Comment
		MHz	dBuV	dB	dBuV/m	dBuV/m	dB		
1		2390.000	41.43	8.11	49.54	74.00	-24.46	peak	
2		2390.000	31.95	8.11	40.06	54.00	-13.94	AVG	
3	*	2416.250	95.61	8.19	103.80	54.00	49.80	AVG	No Limit
4	X	2416.950	99.72	8.19	107.91	74.00	33.91	peak	No Limit

REMARKS:

- (1) Measurement Value = Reading Level + Correct Factor.
- (2) Margin Level = Measurement Value - Limit Value.

Test Mode: TX B Mode 2417 MHz

Vertical

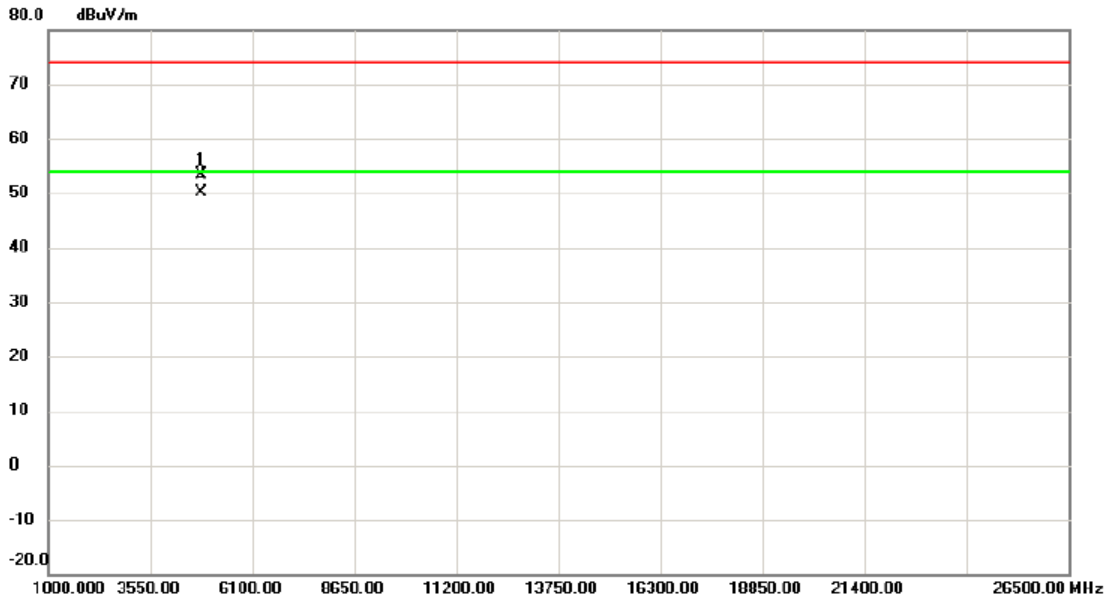

No.	Mk.	Freq. MHz	Reading Level dBuV	Correct Factor dB	Measure- ment dBuV/m	Limit dBuV/m	Margin dB	Detector	Comment
1		4833.983	48.69	4.80	53.49	74.00	-20.51	peak	
2	*	4834.033	45.42	4.80	50.22	54.00	-3.78	AVG	

REMARKS:

- (1) Measurement Value = Reading Level + Correct Factor.
- (2) Margin Level = Measurement Value - Limit Value.

Test Mode: TX B Mode 2417 MHz

Horizontal

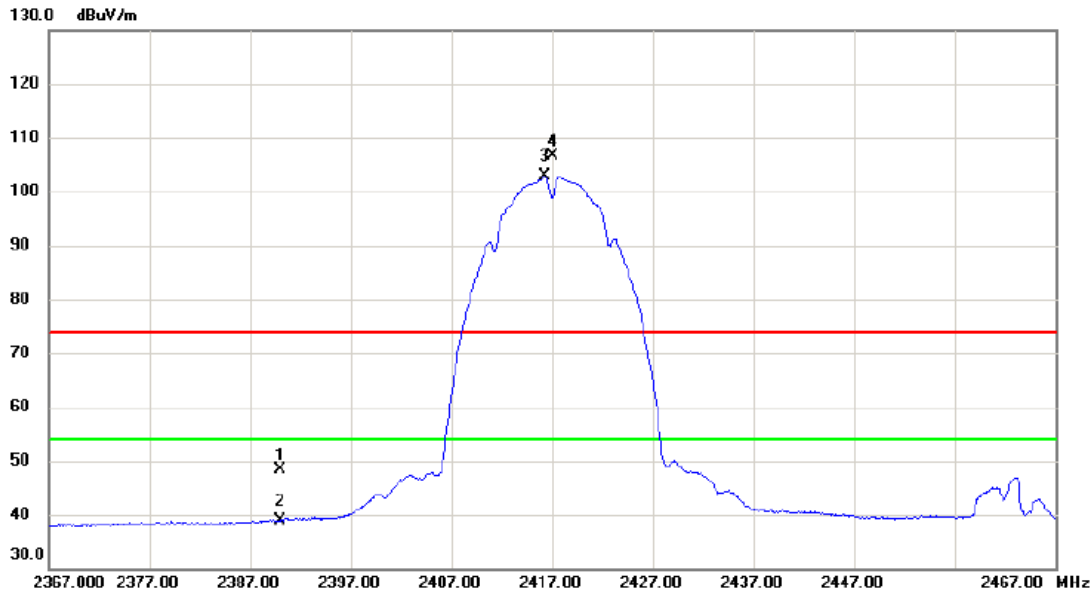

No.	Mk.	Freq. MHz	Reading Level dBuV	Correct Factor dB	Measure- ment dBuV/m	Limit dBuV/m	Margin dB	Detector	Comment
1		2390.000	40.90	7.57	48.47	74.00	-25.53	peak	
2		2390.000	31.43	7.57	39.00	54.00	-15.00	AVG	
3	*	2416.300	95.14	7.66	102.80	54.00	48.80	AVG	No Limit
4	X	2417.000	98.95	7.66	106.61	74.00	32.61	peak	No Limit

REMARKS:

- (1) Measurement Value = Reading Level + Correct Factor.
- (2) Margin Level = Measurement Value - Limit Value.

Test Mode: TX B Mode 2417 MHz

Horizontal

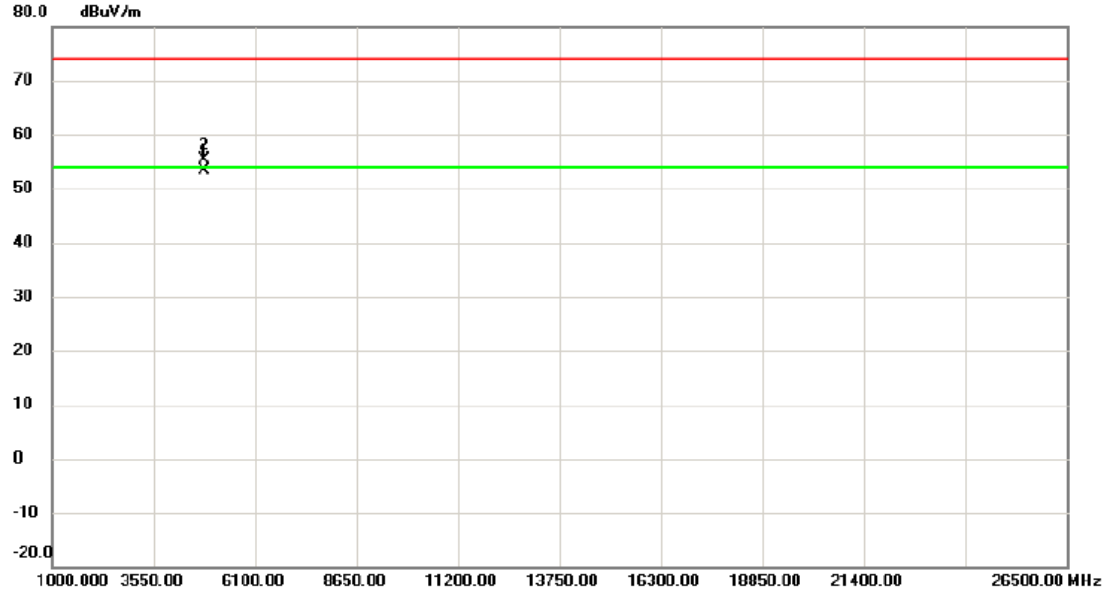

No.	Mk.	Freq. MHz	Reading Level dBuV	Correct Factor dB	Measure- ment dBuV/m	Limit dBuV/m	Margin dB	Detector	Comment
1	*	4833.986	49.08	4.29	53.37	54.00	-0.63	AVG	
2		4834.040	51.14	4.29	55.43	74.00	-18.57	peak	

REMARKS:
 (1) Measurement Value = Reading Level + Correct Factor.
 (2) Margin Level = Measurement Value - Limit Value.

Test Mode: TX B Mode 2437 MHz

Vertical

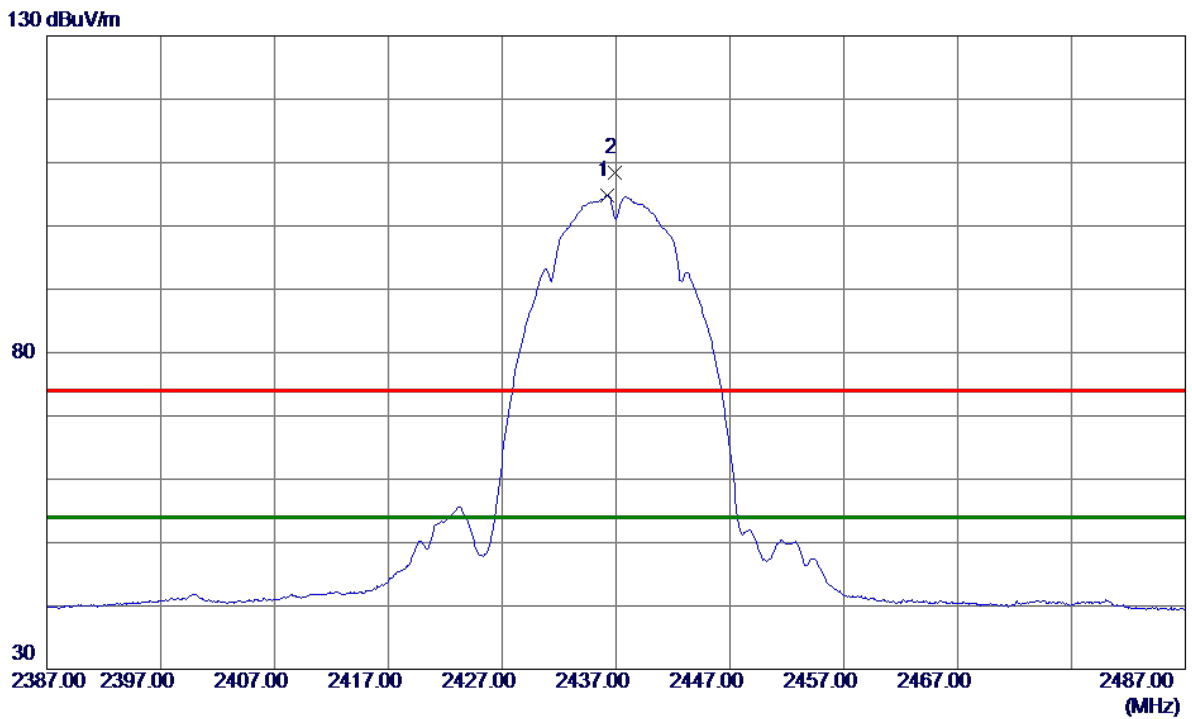

No.	Freq. MHz	Reading Level dBuV/m	Correct Factor dB	Measure ment dBuV/m	Limit dBuV/m	Margin dB	Detector	Comment
1 *	2436.2500	96.60	8.24	104.84	54.00	50.84	AVG	No Limit
2	2436.9000	100.20	8.25	108.45	74.00	34.45	Peak	No Limit

REMARKS:

- (1) Measurement Value = Reading Level + Correct Factor.
- (2) Margin Level = Measurement Value - Limit Value.

Test Mode: TX B Mode 2437 MHz

Vertical

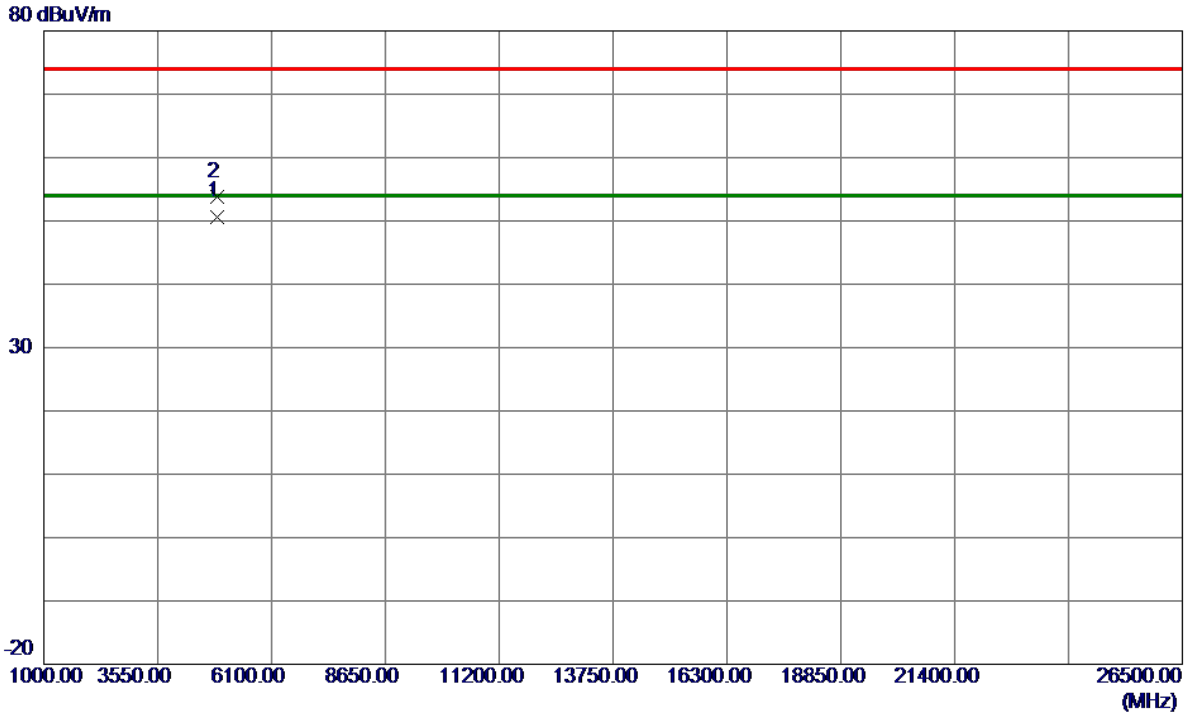

No.	Freq. MHz	Reading Level dBuV/m	Correct Factor dB	Measure ment dBuV/m	Limit dBuV/m	Margin dB	Detector	Comment
1 *	4874.0099	45.71	4.99	50.70	54.00	-3.30	AVG	
2	4874.0470	48.83	4.99	53.82	74.00	-20.18	Peak	

REMARKS:

- (1) Measurement Value = Reading Level + Correct Factor.
- (2) Margin Level = Measurement Value - Limit Value.

Test Mode: TX B Mode 2437 MHz

Horizontal

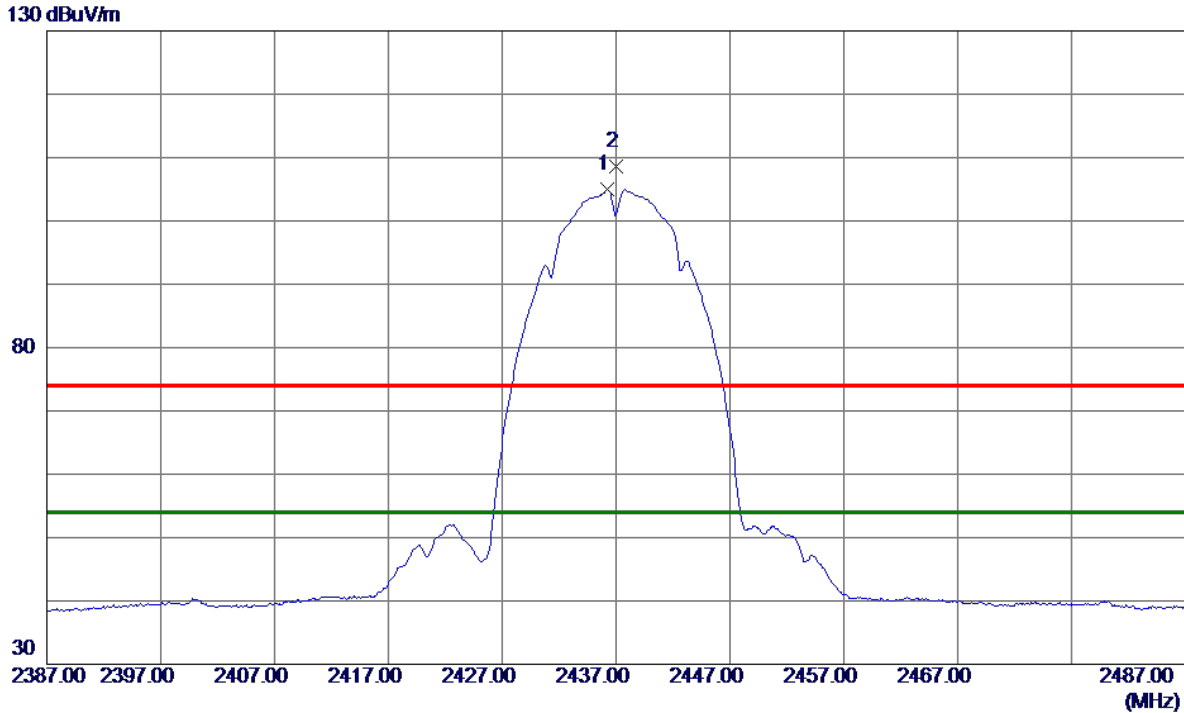

No.	Freq. MHz	Reading Level dBuV/m	Correct Factor dB	Measure ment dBuV/m	Limit dBuV/m	Margin dB	Detector	Comment
1 *	2436.2500	97.21	7.72	104.93	54.00	50.93	AVG	No Limit
2	2437.0000	100.97	7.72	108.69	74.00	34.69	Peak	No Limit

REMARKS:

- (1) Measurement Value = Reading Level + Correct Factor.
- (2) Margin Level = Measurement Value - Limit Value.

Test Mode: TX B Mode 2437 MHz

Horizontal

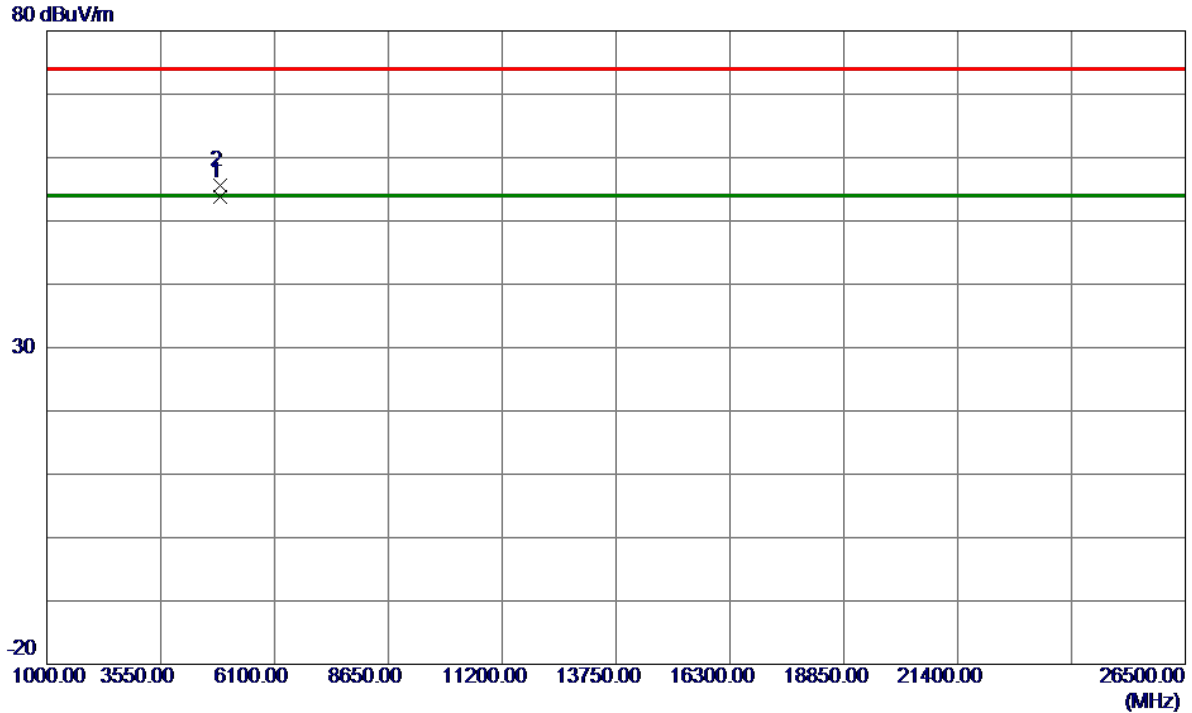

No.	Freq. MHz	Reading Level dBuV/m	Correct Factor dB	Measure ment dBuV/m	Limit dBuV/m	Margin dB	Detector	Comment
1 *	4873.9820	49.45	4.44	53.89	54.00	-0.11	AVG	
2	4874.0760	51.24	4.44	55.68	74.00	-18.32	Peak	

REMARKS:
 (1) Measurement Value = Reading Level + Correct Factor.
 (2) Margin Level = Measurement Value - Limit Value.

Test Mode: TX B Mode 2457 MHz

Vertical

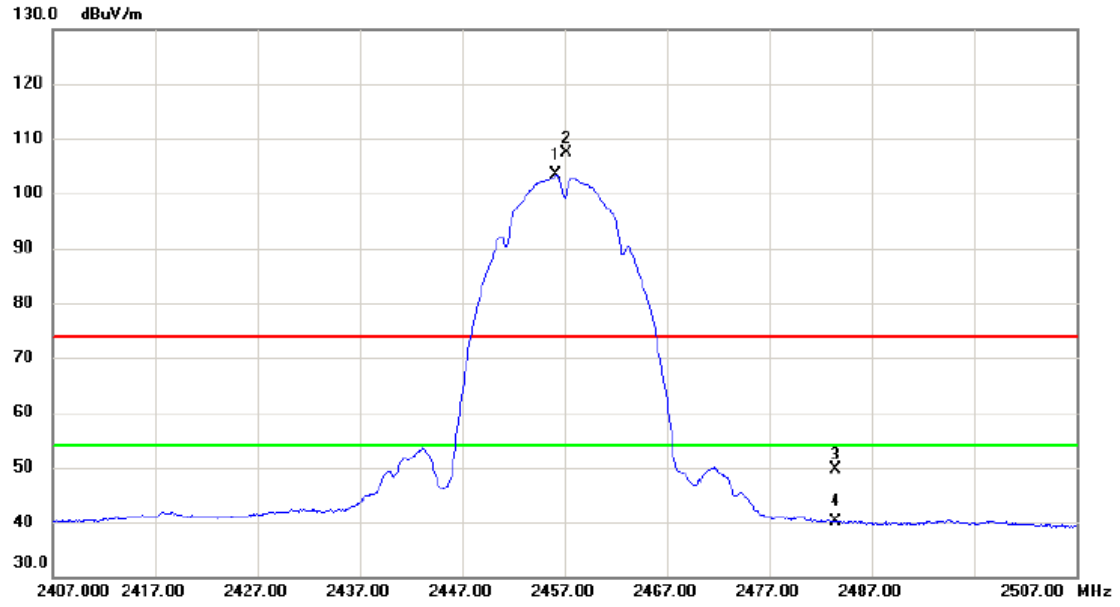

No.	Mk.	Freq. MHz	Reading Level dBuV	Correct Factor dB	Measure- ment dBuV/m	Limit dBuV/m	Margin dB	Detector	Comment
1	*	2456.200	95.06	8.30	103.36	54.00	49.36	AVG	No Limit
2	X	2457.150	99.17	8.30	107.47	74.00	33.47	peak	No Limit
3		2483.500	41.17	8.38	49.55	74.00	-24.45	peak	
4		2483.500	31.84	8.38	40.22	54.00	-13.78	AVG	

REMARKS:

- (1) Measurement Value = Reading Level + Correct Factor.
- (2) Margin Level = Measurement Value - Limit Value.

Test Mode: TX B Mode 2457 MHz

Vertical

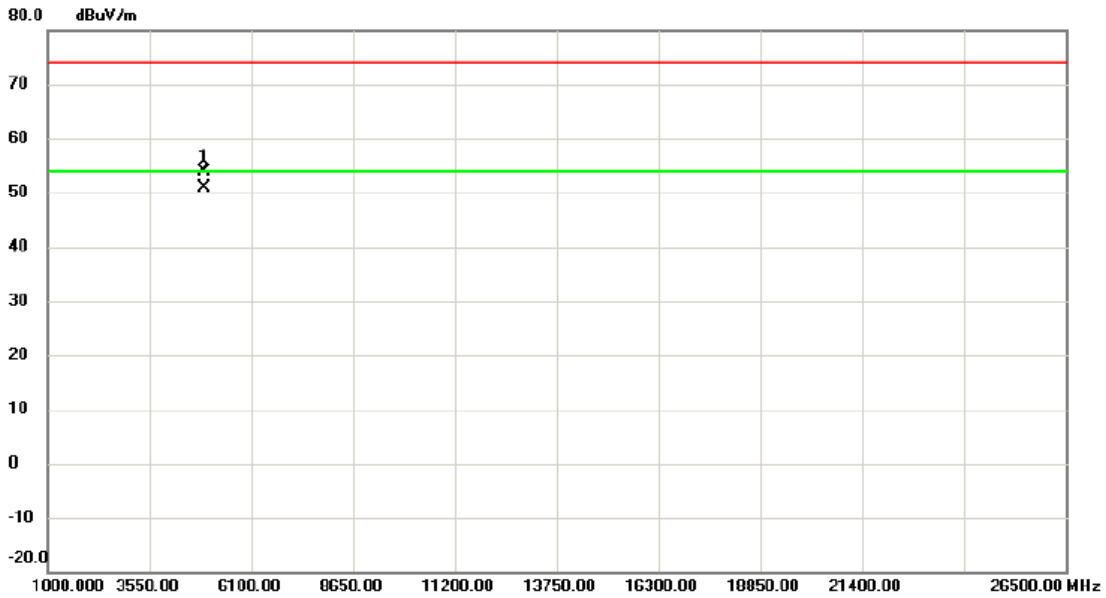

No.	Mk.	Freq. MHz	Reading Level dBuV	Correct Factor dB	Measure- ment dBuV/m	Limit dBuV/m	Margin dB	Detector	Comment
1		4913.905	48.70	5.18	53.88	74.00	-20.12	peak	
2	*	4914.055	45.62	5.18	50.80	54.00	-3.20	AVG	

REMARKS:

- (1) Measurement Value = Reading Level + Correct Factor.
- (2) Margin Level = Measurement Value - Limit Value.

Test Mode: TX B Mode 2457 MHz

Horizontal

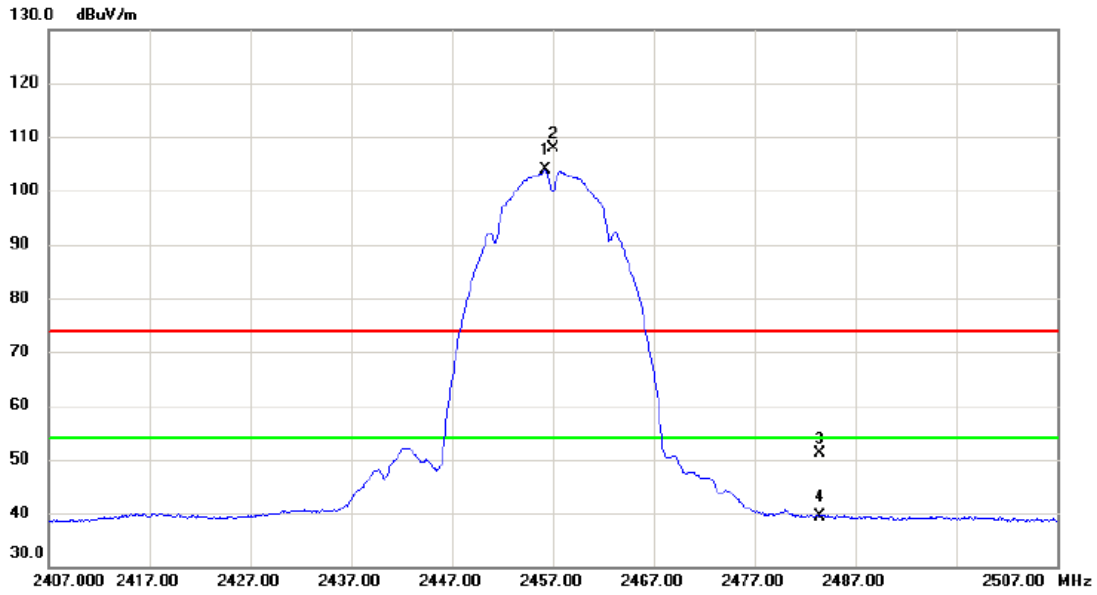

No.	Mk.	Freq.	Reading Level	Correct Factor	Measurement	Limit	Margin		
		MHz	dBuV	dB	dBuV/m	dBuV/m	dB	Detector	Comment
1	*	2456.250	96.01	7.78	103.79	54.00	49.79	AVG	No Limit
2	X	2457.000	100.09	7.79	107.88	74.00	33.88	peak	No Limit
3		2483.500	43.34	7.87	51.21	74.00	-22.79	peak	
4		2483.500	31.53	7.87	39.40	54.00	-14.60	AVG	

REMARKS:

- (1) Measurement Value = Reading Level + Correct Factor.
- (2) Margin Level = Measurement Value - Limit Value.

Test Mode: TX B Mode 2457 MHz

Horizontal

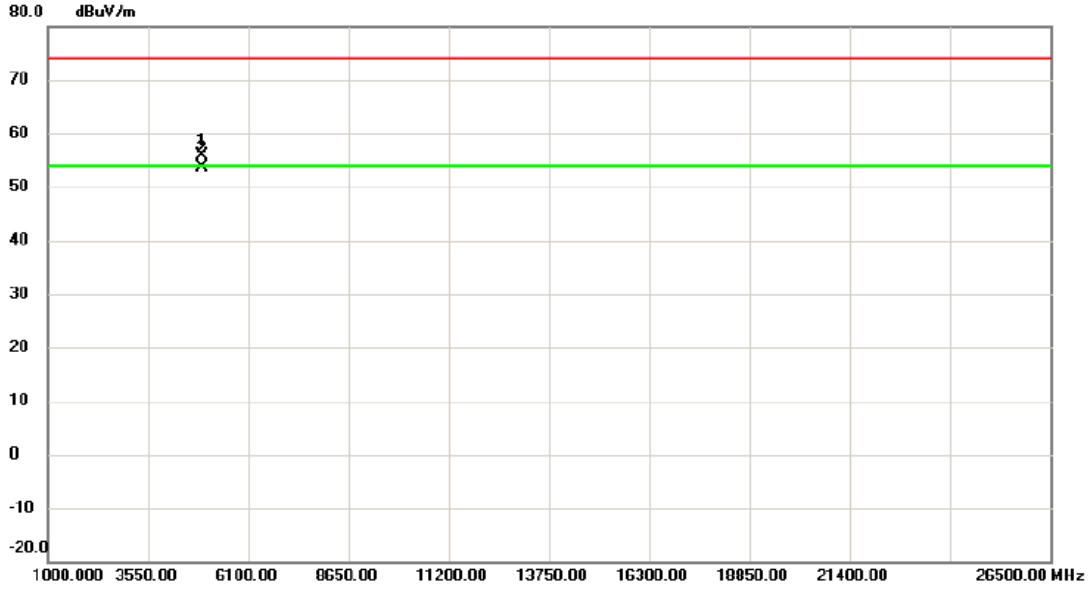

No.	Mk.	Freq.	Reading Level	Correct Factor	Measurement	Limit	Margin	Detector	Comment
		MHz	dBuV	dB	dBuV/m	dBuV/m	dB		
1		4913.903	51.21	4.58	55.79	74.00	-18.21	peak	
2	*	4913.983	49.02	4.58	53.60	54.00	-0.40	AVG	

REMARKS:

- (1) Measurement Value = Reading Level + Correct Factor.
- (2) Margin Level = Measurement Value - Limit Value.

Test Mode: TX B Mode 2462 MHz

Vertical

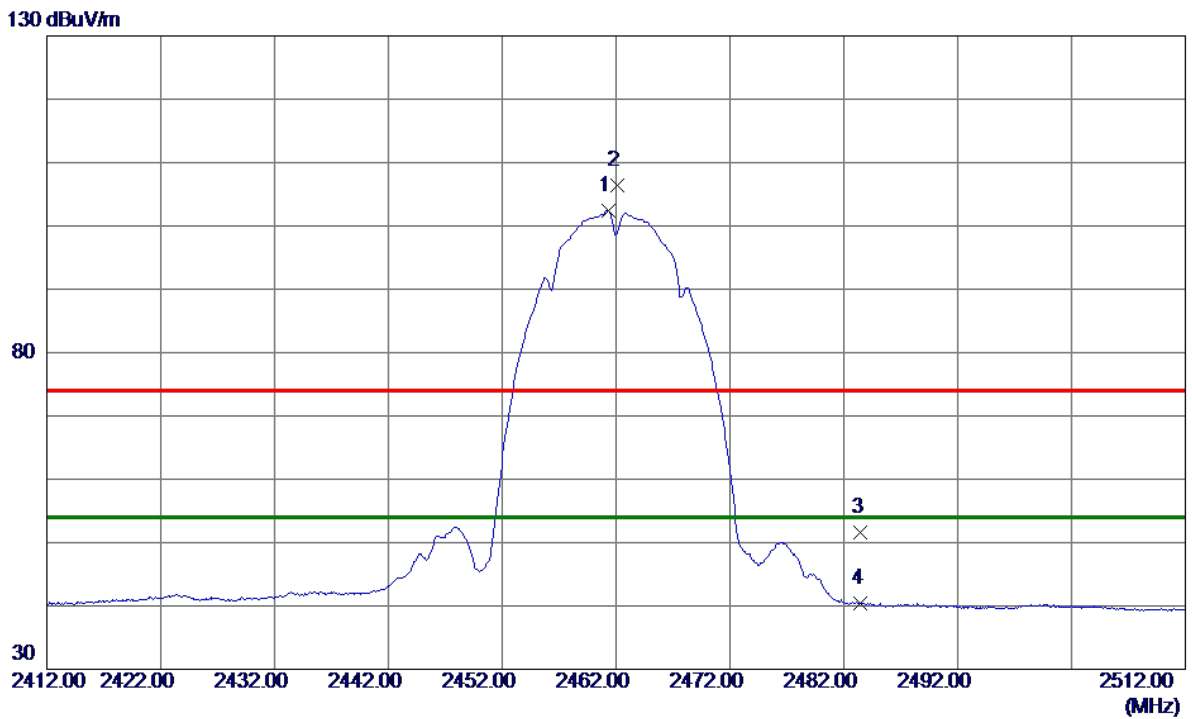

No.	Freq. MHz	Reading Level dBuV/m	Correct Factor dB	Measure ment dBuV/m	Limit dBuV/m	Margin dB	Detector	Comment
1 *	2461.3000	94.08	8.32	102.40	54.00	48.40	AVG	No Limit
2	2462.1500	98.16	8.32	106.48	74.00	32.48	Peak	No Limit
3	2483.5000	43.27	8.38	51.65	74.00	-22.35	Peak	
4	2483.5000	31.97	8.38	40.35	54.00	-13.65	AVG	

REMARKS:

- (1) Measurement Value = Reading Level + Correct Factor.
- (2) Margin Level = Measurement Value - Limit Value.

Test Mode: TX B Mode 2462 MHz

Vertical

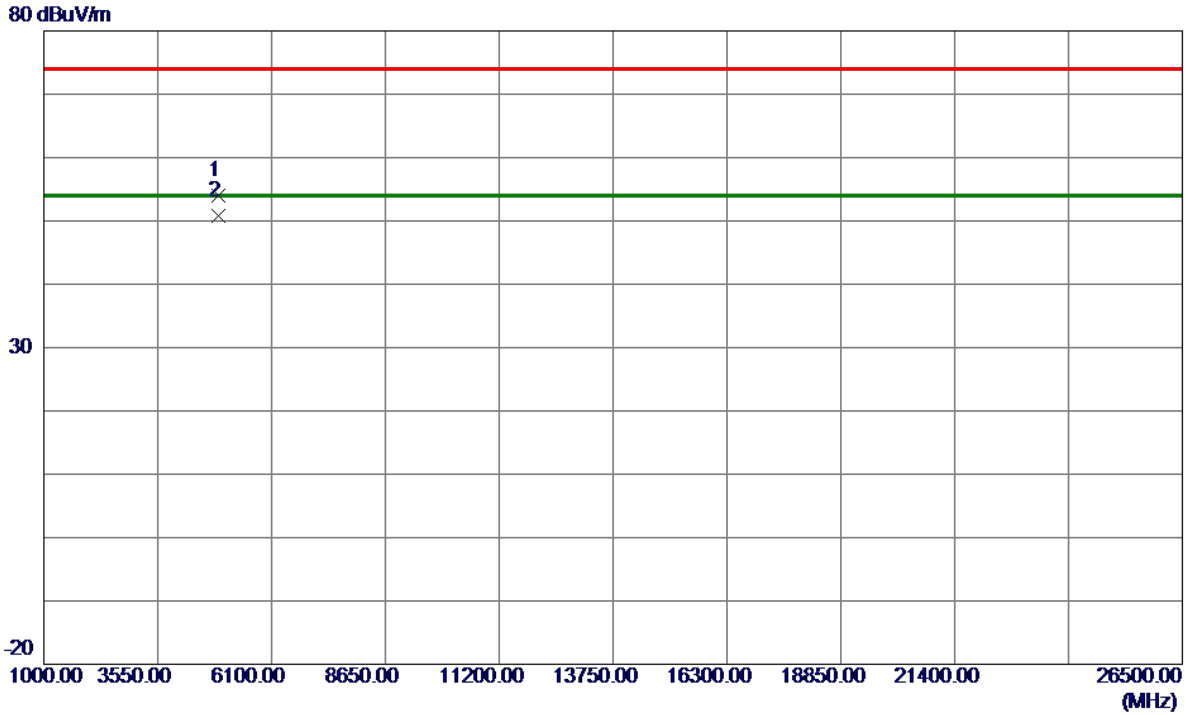

No.	Freq. MHz	Reading Level dBuV/m	Correct Factor dB	Measure ment dBuV/m	Limit dBuV/m	Margin dB	Detector	Comment
1	4923.7960	48.80	5.23	54.03	74.00	-19.97	Peak	
2 *	4924.0150	45.52	5.24	50.76	54.00	-3.24	AVG	

REMARKS:

- (1) Measurement Value = Reading Level + Correct Factor.
- (2) Margin Level = Measurement Value - Limit Value.

Test Mode: TX B Mode 2462 MHz

Horizontal

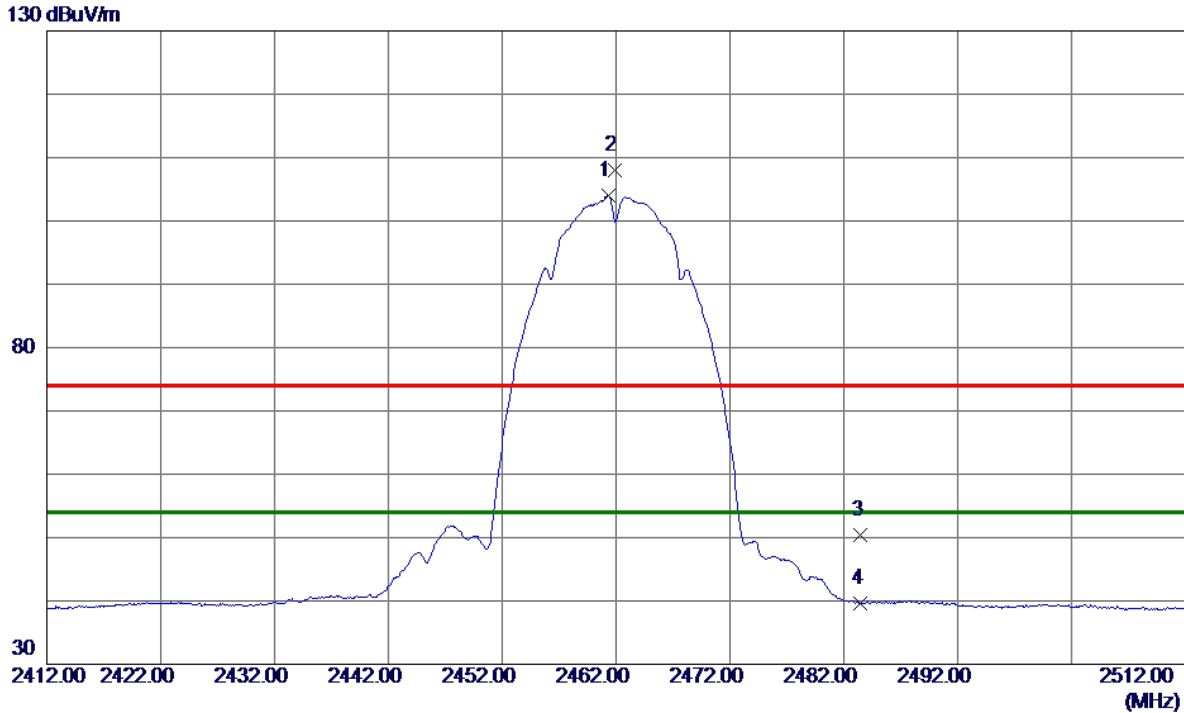

No.	Freq. MHz	Reading Level dBuV/m	Correct Factor dB	Measure ment dBuV/m	Limit dBuV/m	Margin dB	Detector	Comment
1 *	2461.3000	96.14	7.80	103.94	54.00	49.94	AVG	No Limit
2	2461.9000	100.10	7.80	107.90	74.00	33.90	Peak	No Limit
3	2483.5000	42.50	7.88	50.38	74.00	-23.62	Peak	
4	2483.5000	31.76	7.88	39.64	54.00	-14.36	AVG	

REMARKS:

- (1) Measurement Value = Reading Level + Correct Factor.
- (2) Margin Level = Measurement Value - Limit Value.

Test Mode: TX B Mode 2462 MHz

Horizontal

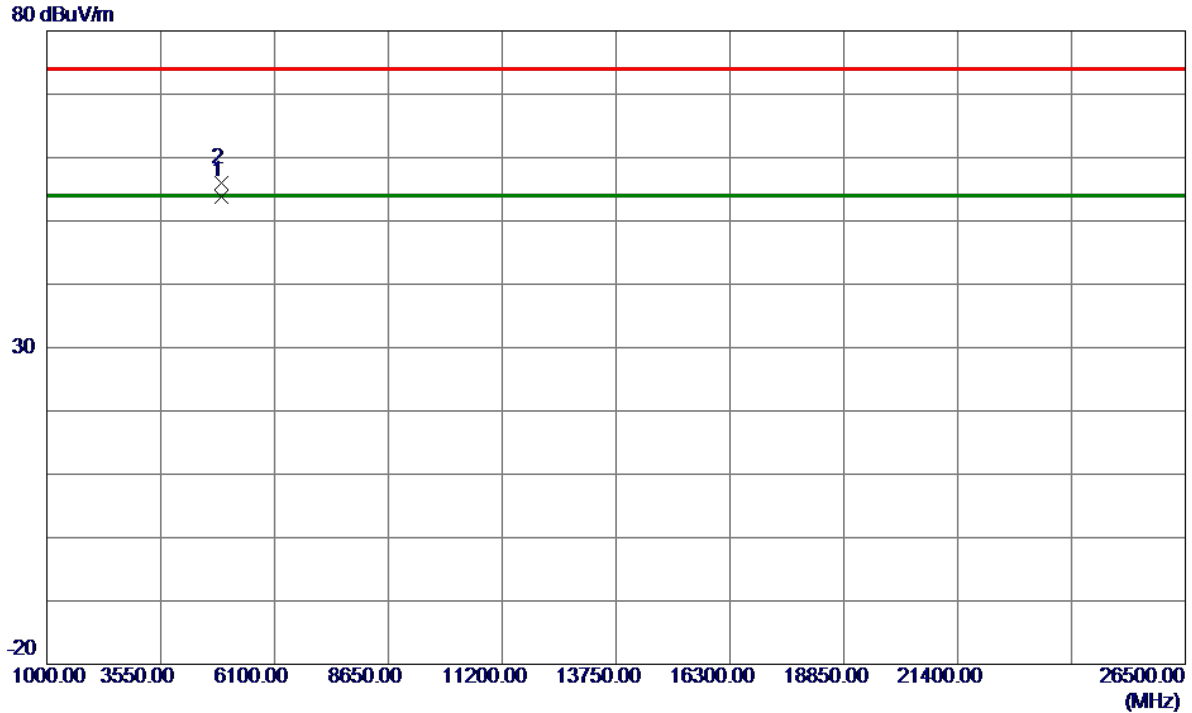

No.	Freq. MHz	Reading Level dBuV/m	Correct Factor dB	Measure ment dBuV/m	Limit dBuV/m	Margin dB	Detector	Comment
1 *	4923.9890	49.27	4.63	53.90	54.00	-0.10	AVG	
2	4924.1260	51.46	4.63	56.09	74.00	-17.91	Peak	

REMARKS:
 (1) Measurement Value = Reading Level + Correct Factor.
 (2) Margin Level = Measurement Value - Limit Value.

Test Mode: TX G Mode 2412 MHz

Vertical

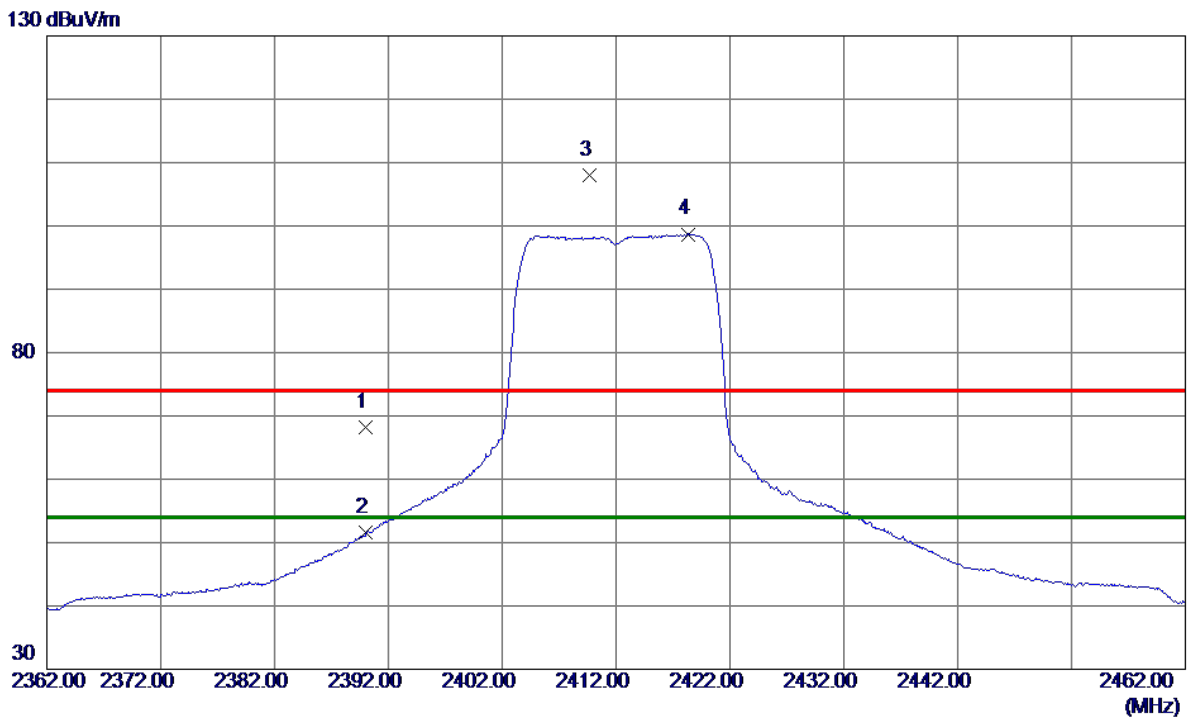

No.	Freq. MHz	Reading Level dBuV/m	Correct Factor dB	Measure ment dBuV/m	Limit dBuV/m	Margin dB	Detector	Comment
1	2390.0000	60.16	8.11	68.27	74.00	-5.73	Peak	
2	2390.0000	43.44	8.11	51.55	54.00	-2.45	AVG	
3	2409.6500	99.93	8.17	108.10	74.00	34.10	Peak	No Limit
4 *	2418.3000	90.51	8.19	98.70	54.00	44.70	AVG	No Limit

REMARKS:
 (1) Measurement Value = Reading Level + Correct Factor.
 (2) Margin Level = Measurement Value - Limit Value.

Test Mode: TX G Mode 2412 MHz

Vertical

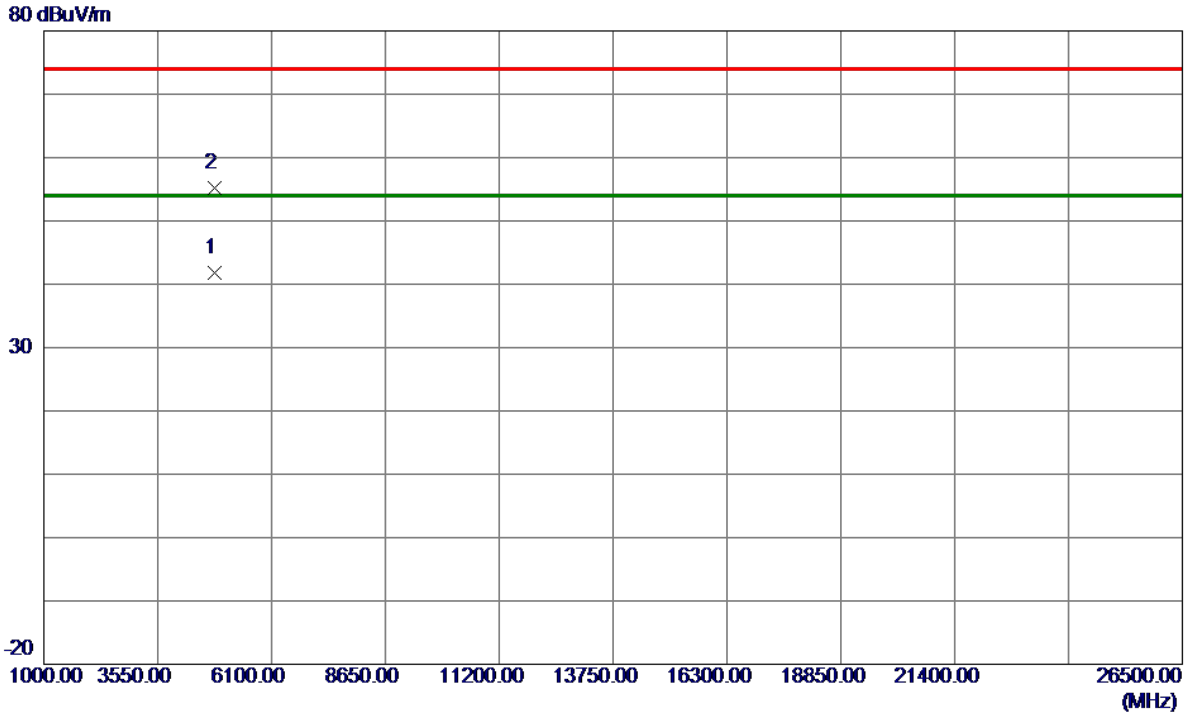

No.	Freq. MHz	Reading Level dBuV/m	Correct Factor dB	Measure ment dBuV/m	Limit dBuV/m	Margin dB	Detector	Comment
1 *	4823.2000	37.13	4.74	41.87	54.00	-12.13	AVG	
2	4825.5750	50.54	4.75	55.29	74.00	-18.71	Peak	

REMARKS:

- (1) Measurement Value = Reading Level + Correct Factor.
- (2) Margin Level = Measurement Value - Limit Value.

Test Mode: TX G Mode 2412 MHz

Horizontal

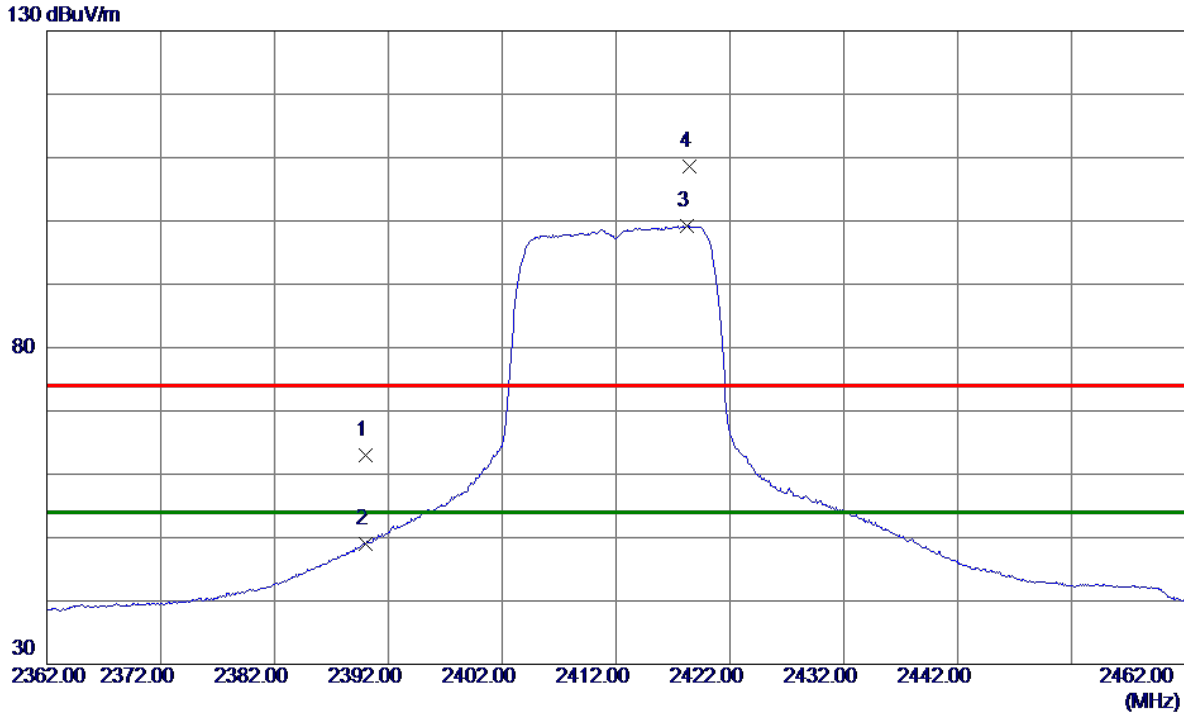

No.	Freq. MHz	Reading Level dBuV/m	Correct Factor dB	Measure ment dBuV/m	Limit dBuV/m	Margin dB	Detector	Comment
1	2390.0000	55.47	7.56	63.03	74.00	-10.97	Peak	
2	2390.0000	41.51	7.56	49.07	54.00	-4.93	AVG	
3 *	2418.2000	91.59	7.66	99.25	54.00	45.25	AVG	No Limit
4	2418.4500	100.97	7.66	108.63	74.00	34.63	Peak	No Limit

REMARKS:

- (1) Measurement Value = Reading Level + Correct Factor.
- (2) Margin Level = Measurement Value - Limit Value.

Test Mode: TX G Mode 2412 MHz

Horizontal

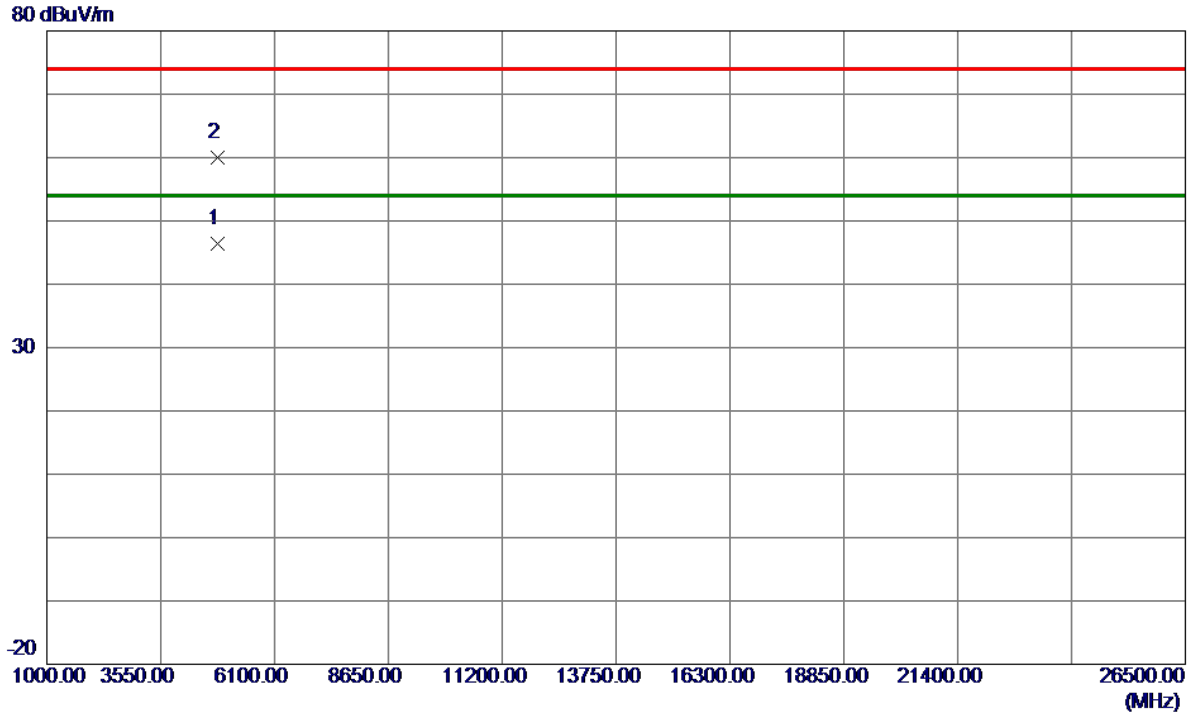

No.	Freq. MHz	Reading Level dBuV/m	Correct Factor dB	Measure ment dBuV/m	Limit dBuV/m	Margin dB	Detector	Comment
1 *	4822.8750	41.64	4.74	46.38	54.00	-7.62	AVG	
2	4828.3000	55.23	4.77	60.00	74.00	-14.00	Peak	

REMARKS:
 (1) Measurement Value = Reading Level + Correct Factor.
 (2) Margin Level = Measurement Value - Limit Value.

Test Mode: TX G Mode 2417 MHz

Vertical

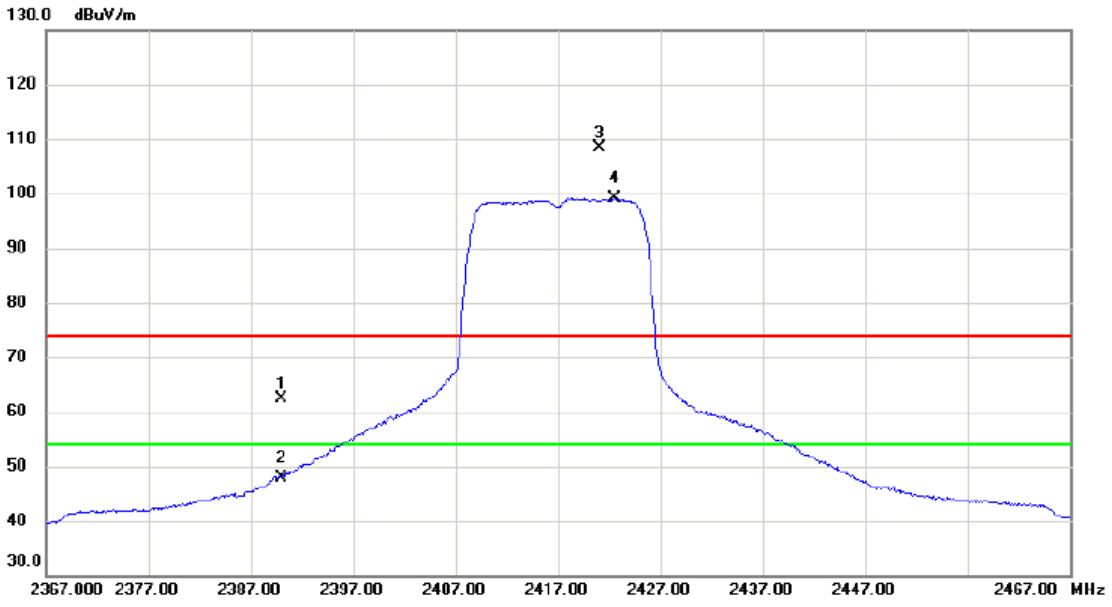

No.	Mk.	Freq. MHz	Reading Level dBuV	Correct Factor dB	Measure- ment dBuV/m	Limit dBuV/m	Margin dB	Detector	Comment
1		2390.000	54.35	8.11	62.46	74.00	-11.54	peak	
2		2390.000	39.74	8.11	47.85	54.00	-6.15	AVG	
3	X	2421.100	100.07	8.20	108.27	74.00	34.27	peak	No Limit
4	*	2422.550	90.85	8.20	99.05	54.00	45.05	AVG	No Limit

REMARKS:

- (1) Measurement Value = Reading Level + Correct Factor.
- (2) Margin Level = Measurement Value - Limit Value.

Test Mode: TX G Mode 2417 MHz

Vertical

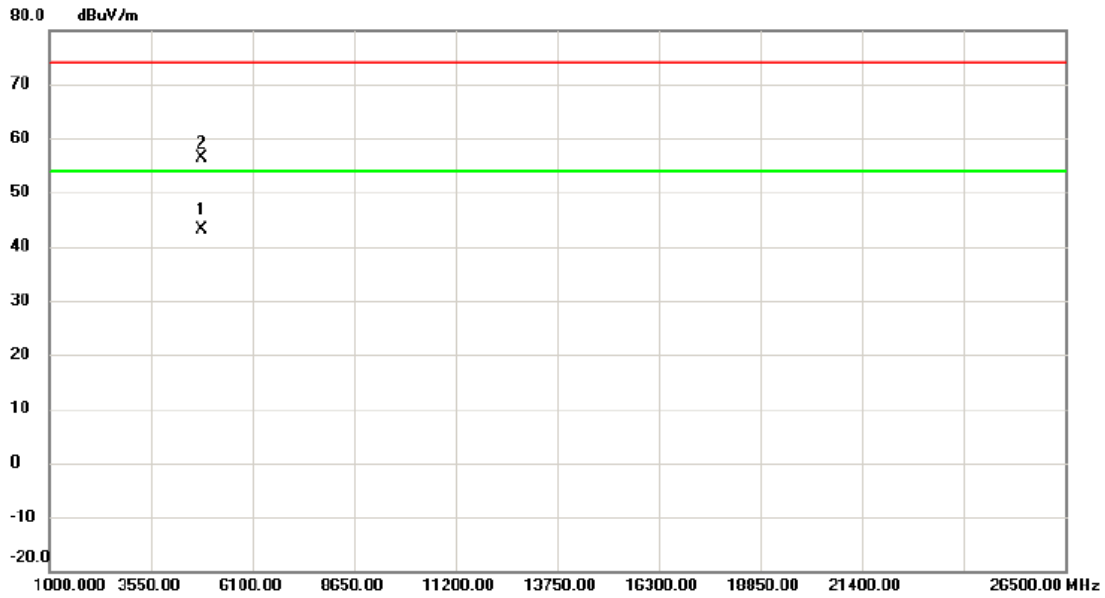

No.	Mk.	Freq.	Reading Level	Correct Factor	Measurement	Limit	Margin	Detector	Comment
		MHz	dBuV	dB	dBuV/m	dBuV/m	dB		
1	*	4834.250	38.24	4.80	43.04	54.00	-10.96	AVG	
2		4838.125	51.55	4.81	56.36	74.00	-17.64	peak	

REMARKS:

- (1) Measurement Value = Reading Level + Correct Factor.
- (2) Margin Level = Measurement Value - Limit Value.

Test Mode: TX G Mode 2417 MHz

Horizontal

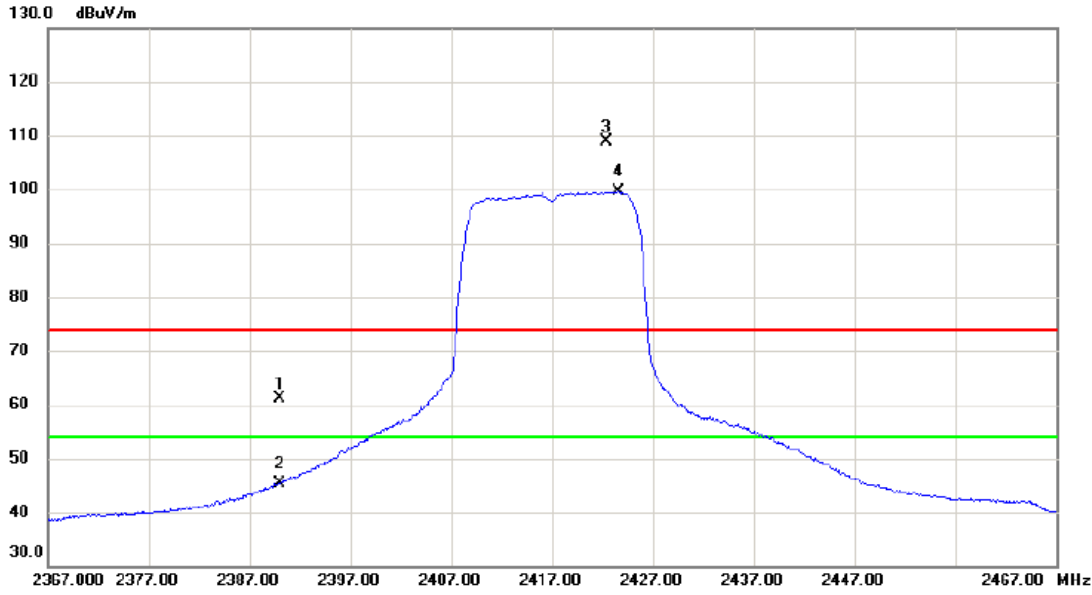

No.	Mk.	Freq. MHz	Reading Level dBuV	Correct Factor dB	Measure- ment dBuV/m	Limit dBuV/m	Margin dB	Detector	Comment
1		2390.000	53.58	7.57	61.15	74.00	-12.85	peak	
2		2390.000	37.78	7.57	45.35	54.00	-8.65	AVG	
3	X	2422.350	101.22	7.67	108.89	74.00	34.89	peak	No Limit
4	*	2423.650	91.85	7.68	99.53	54.00	45.53	AVG	No Limit

REMARKS:

- (1) Measurement Value = Reading Level + Correct Factor.
- (2) Margin Level = Measurement Value - Limit Value.

Test Mode: TX G Mode 2417 MHz

Horizontal

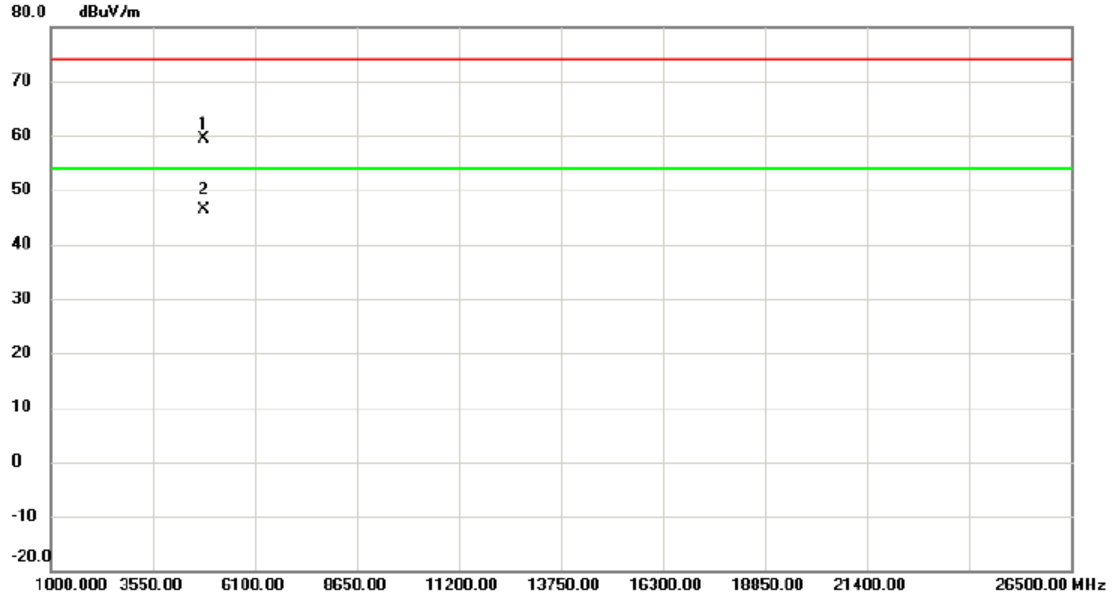

No.	Mk.	Freq. MHz	Reading Level dBuV	Correct Factor dB	Measure- ment dBuV/m	Limit dBuV/m	Margin dB	Detector	Comment
1		4827.575	54.72	4.77	59.49	74.00	-14.51	peak	
2	*	4834.400	41.62	4.80	46.42	54.00	-7.58	AVG	

REMARKS:
 (1) Measurement Value = Reading Level + Correct Factor.
 (2) Margin Level = Measurement Value - Limit Value.

Test Mode: TX G Mode 2437 MHz

Vertical

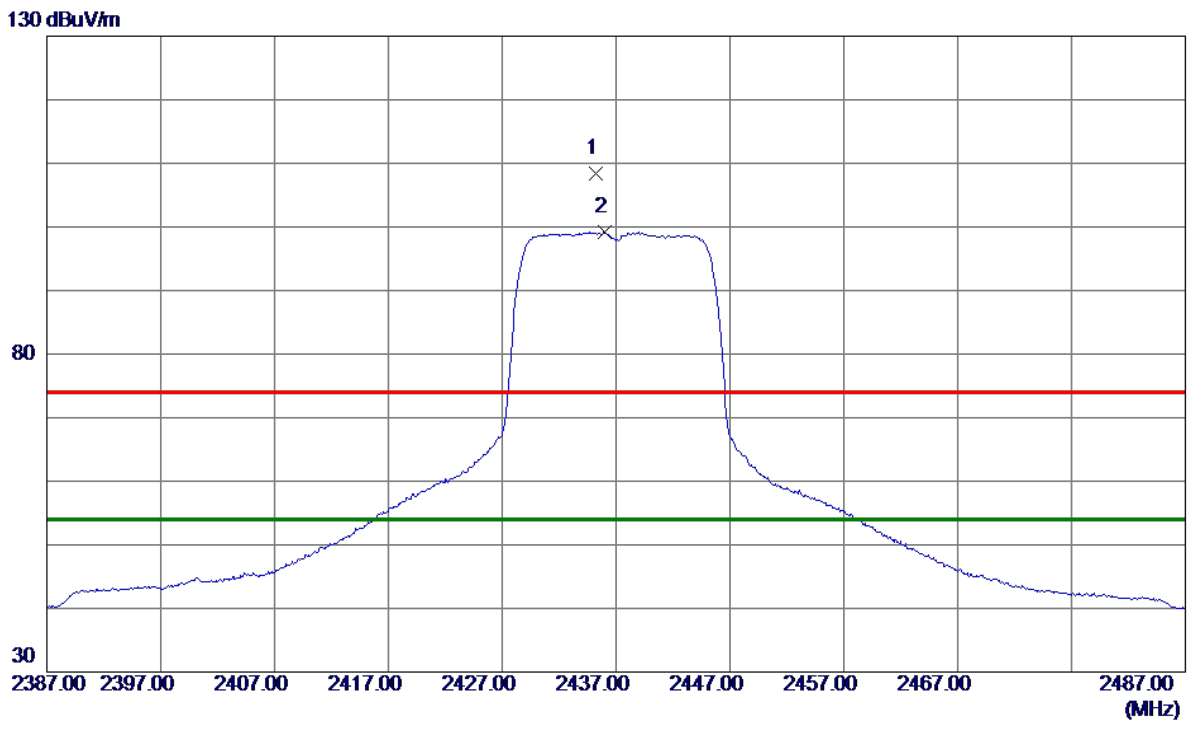

No.	Freq. MHz	Reading Level dBuV/m	Correct Factor dB	Measure ment dBuV/m	Limit dBuV/m	Margin dB	Detector	Comment
1	2435.2500	100.14	8.24	108.38	74.00	34.38	Peak	No Limit
2 *	2435.9500	90.92	8.24	99.16	54.00	45.16	AVG	No Limit

REMARKS:

- (1) Measurement Value = Reading Level + Correct Factor.
- (2) Margin Level = Measurement Value - Limit Value.

Test Mode: TX G Mode 2437 MHz

Vertical

80 dBuV/m

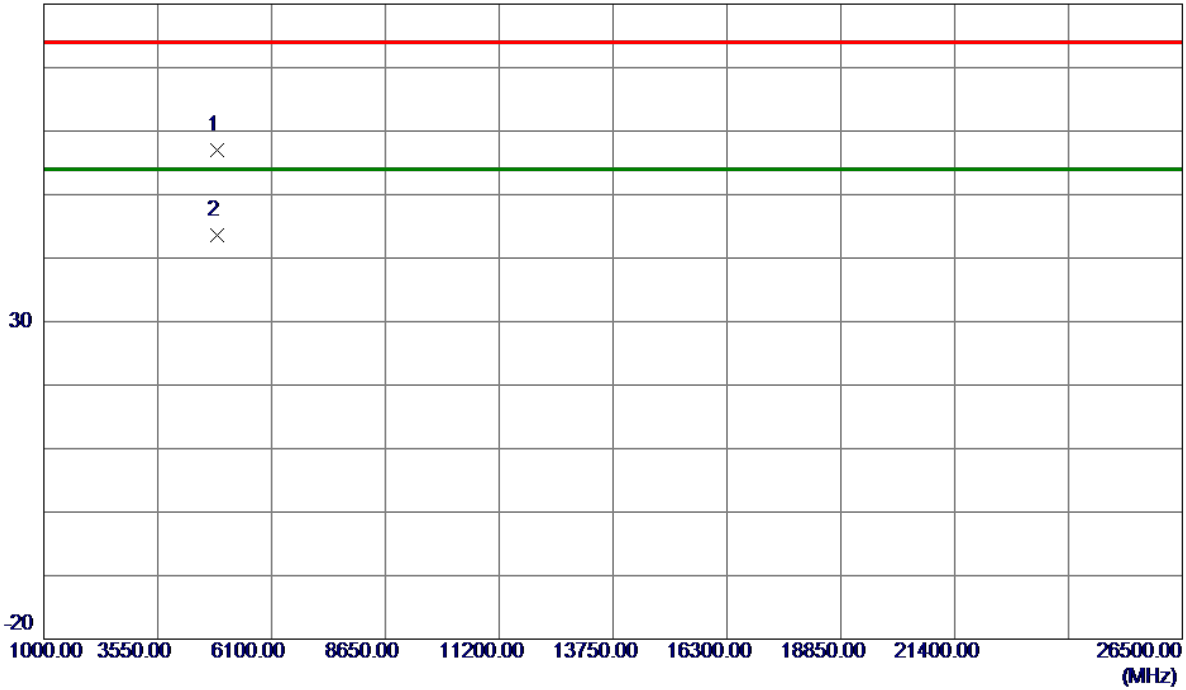

No.	Freq. MHz	Reading Level dBuV/m	Correct Factor dB	Measure ment dBuV/m	Limit dBuV/m	Margin dB	Detector	Comment
1	4869.8750	51.97	4.97	56.94	74.00	-17.06	Peak	
2 *	4876.4750	38.66	5.00	43.66	54.00	-10.34	AVG	

REMARKS:

- (1) Measurement Value = Reading Level + Correct Factor.
- (2) Margin Level = Measurement Value - Limit Value.

Test Mode: TX G Mode 2437 MHz

Horizontal

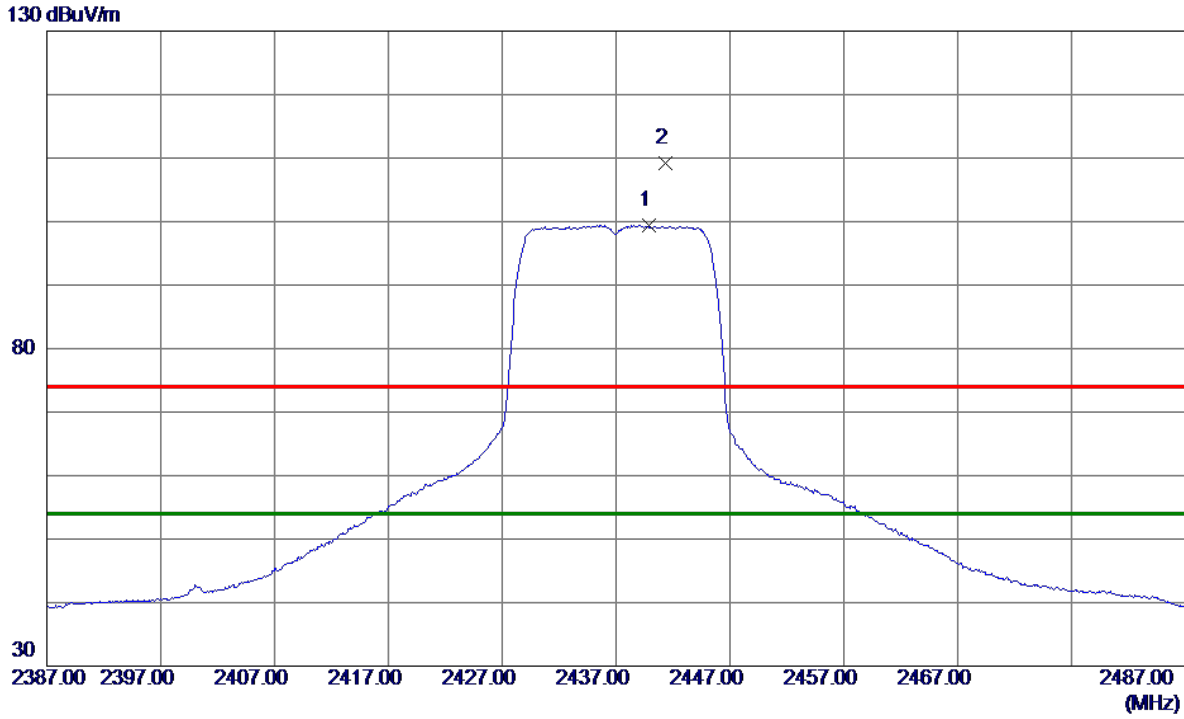

No.	Freq. MHz	Reading Level dBuV/m	Correct Factor dB	Measure ment dBuV/m	Limit dBuV/m	Margin dB	Detector	Comment
1 *	2439.8500	91.69	7.73	99.42	54.00	45.42	AVG	No Limit
2	2441.3500	101.47	7.74	109.21	74.00	35.21	Peak	No Limit

REMARKS:
 (1) Measurement Value = Reading Level + Correct Factor.
 (2) Margin Level = Measurement Value - Limit Value.

Test Mode: TX G Mode 2437 MHz

Horizontal

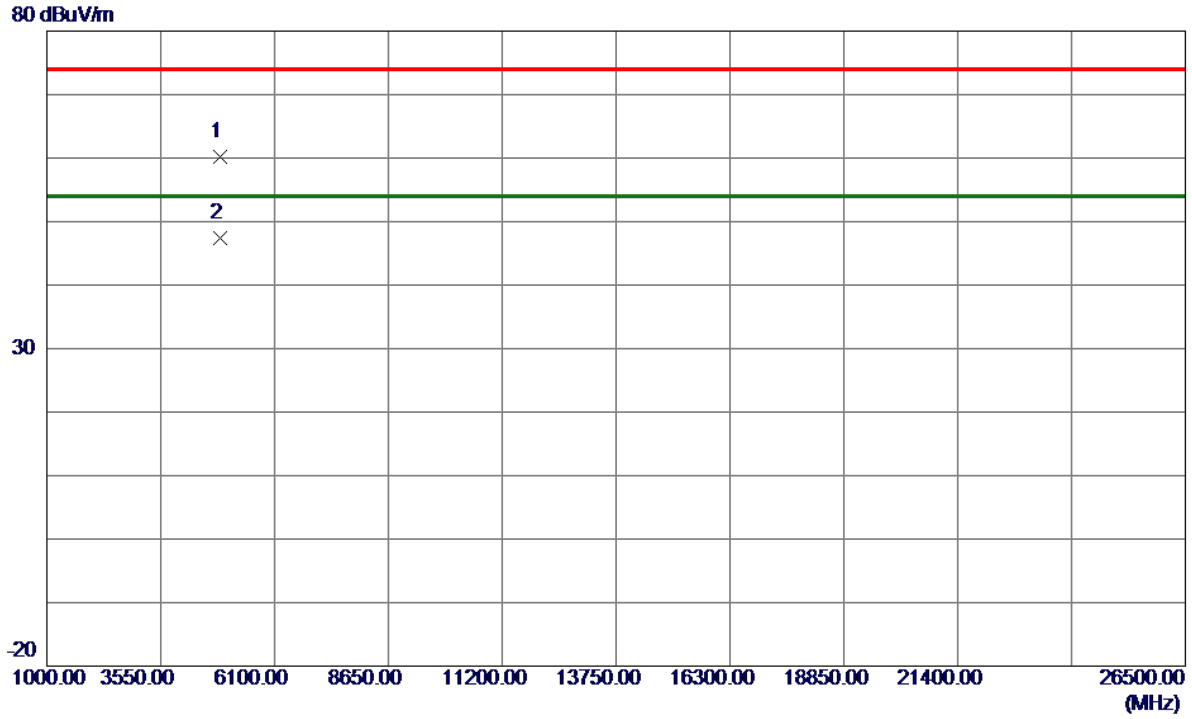

No.	Freq. MHz	Reading Level dBuV/m	Correct Factor dB	Measure ment dBuV/m	Limit dBuV/m	Margin dB	Detector	Comment
1	4874.4250	55.14	4.99	60.13	74.00	-13.87	Peak	
2 *	4874.8500	42.44	4.99	47.43	54.00	-6.57	AVG	

REMARKS:
 (1) Measurement Value = Reading Level + Correct Factor.
 (2) Margin Level = Measurement Value - Limit Value.

Test Mode: TX G Mode 2457 MHz

Vertical

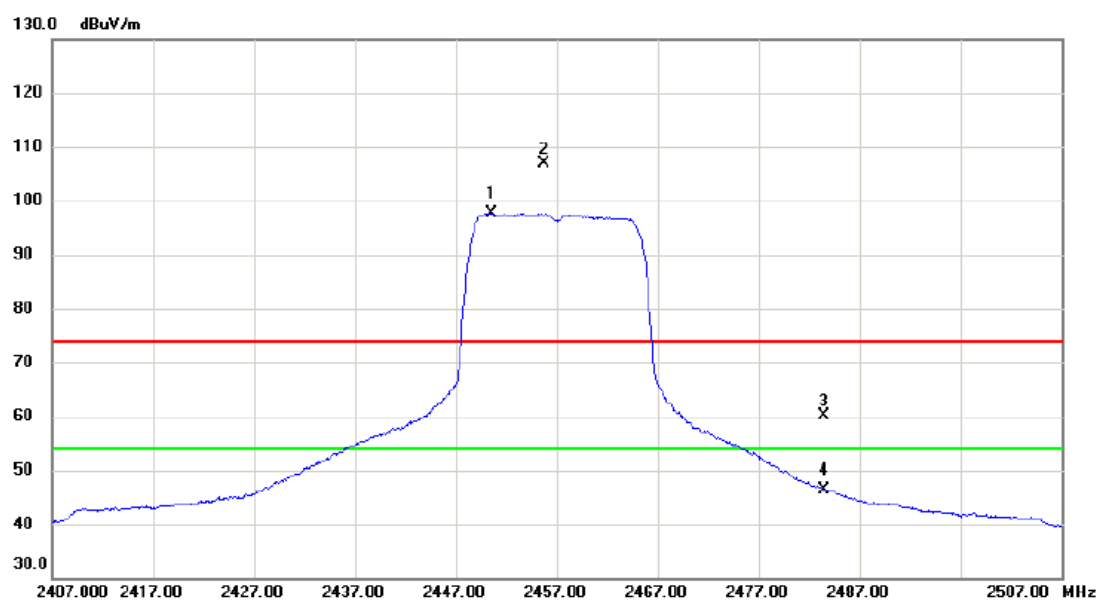

No.	Mk.	Freq.	Reading Level	Correct Factor	Measurement	Limit	Margin		
		MHz	dBuV	dB	dBuV/m	dBuV/m	dB	Detector	Comment
1	*	2450.600	89.41	8.28	97.69	54.00	43.69	AVG	No Limit
2	X	2455.700	98.61	8.30	106.91	74.00	32.91	peak	No Limit
3		2483.500	51.68	8.38	60.06	74.00	-13.94	peak	
4		2483.500	38.02	8.38	46.40	54.00	-7.60	AVG	

REMARKS:
 (1) Measurement Value = Reading Level + Correct Factor.
 (2) Margin Level = Measurement Value - Limit Value.

Test Mode: TX G Mode 2457 MHz

Vertical

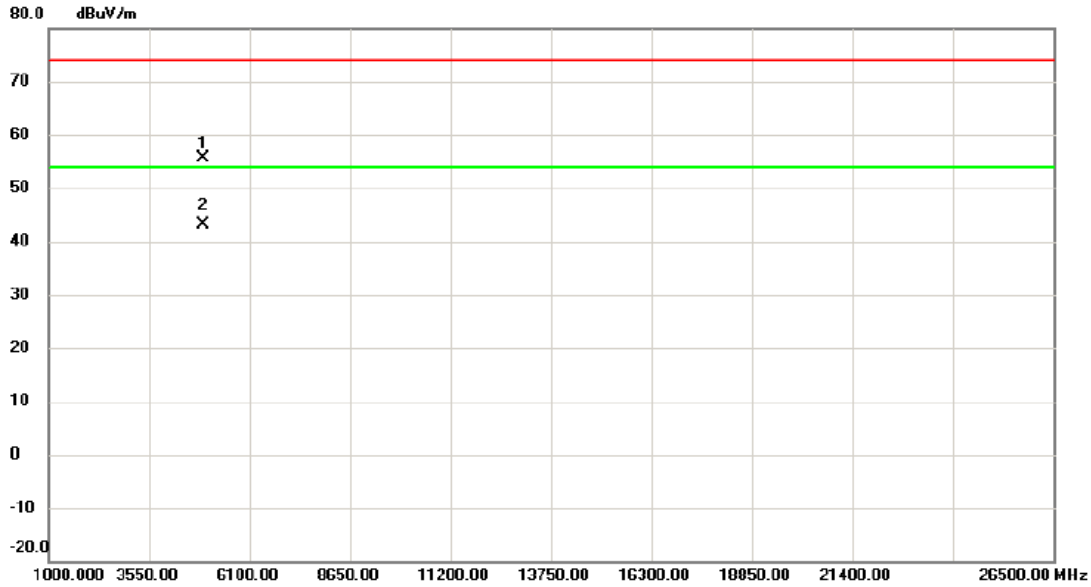

No.	Mk.	Freq.	Reading Level	Correct Factor	Measurement	Limit	Margin	Detector	Comment
		MHz	dBuV	dB	dBuV/m	dBuV/m	dB		
1		4914.200	50.34	5.18	55.52	74.00	-18.48	peak	
2	*	4914.200	37.98	5.18	43.16	54.00	-10.84	AVG	

REMARKS:

- (1) Measurement Value = Reading Level + Correct Factor.
- (2) Margin Level = Measurement Value - Limit Value.

Test Mode: TX G Mode 2457 MHz

Horizontal

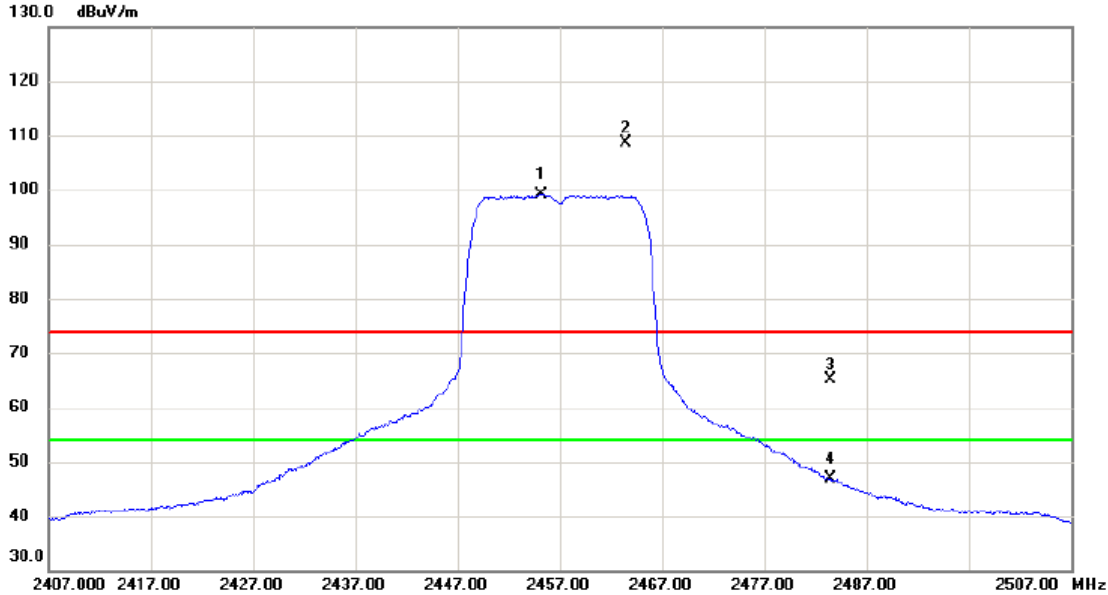

No.	Mk.	Freq. MHz	Reading Level dBuV	Correct Factor dB	Measure- ment dBuV/m	Limit dBuV/m	Margin dB	Detector	Comment
1	*	2455.150	91.33	7.78	99.11	54.00	45.11	AVG	No Limit
2	X	2463.450	100.78	7.81	108.59	74.00	34.59	peak	No Limit
3		2483.500	57.38	7.87	65.25	74.00	-8.75	peak	
4		2483.500	39.07	7.87	46.94	54.00	-7.06	AVG	

REMARKS:

- (1) Measurement Value = Reading Level + Correct Factor.
- (2) Margin Level = Measurement Value - Limit Value.

Test Mode: TX G Mode 2457 MHz

Horizontal

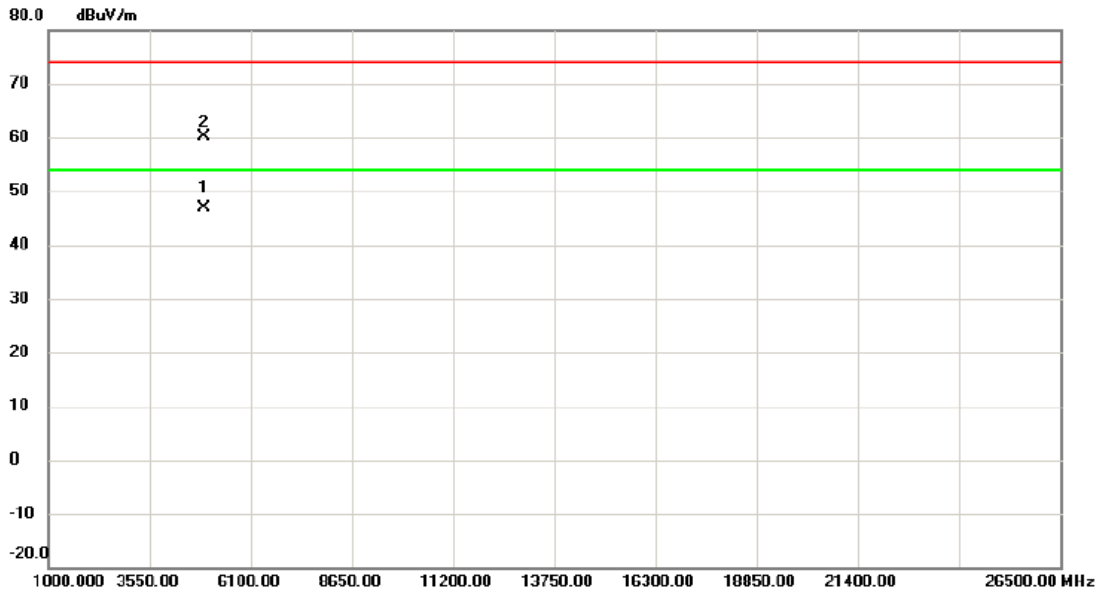

No.	Mk.	Freq.	Reading Level	Correct Factor	Measurement	Limit	Margin	Detector	Comment
		MHz	dBuV	dB	dBuV/m	dBuV/m	dB		
1	*	4914.225	41.80	5.18	46.98	54.00	-7.02	AVG	
2		4918.625	55.03	5.21	60.24	74.00	-13.76	peak	

REMARKS:

- (1) Measurement Value = Reading Level + Correct Factor.
- (2) Margin Level = Measurement Value - Limit Value.

Test Mode: TX G Mode 2462 MHz

Vertical

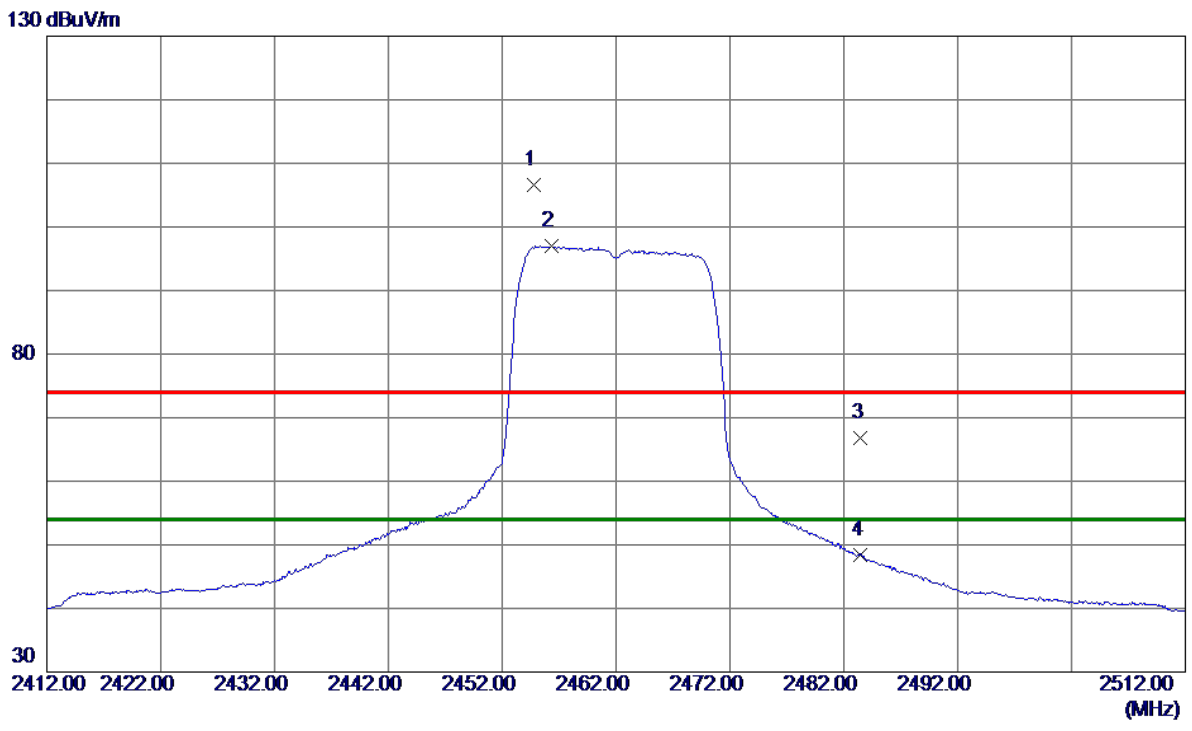

No.	Freq. MHz	Reading Level dBuV/m	Correct Factor dB	Measure ment dBuV/m	Limit dBuV/m	Margin dB	Detector	Comment
1	2454.8000	98.33	8.30	106.63	74.00	32.63	Peak	No Limit
2 *	2456.3500	88.69	8.30	96.99	54.00	42.99	AVG	No Limit
3	2483.5000	58.37	8.38	66.75	74.00	-7.25	Peak	
4	2483.5000	40.00	8.38	48.38	54.00	-5.62	AVG	

REMARKS:
 (1) Measurement Value = Reading Level + Correct Factor.
 (2) Margin Level = Measurement Value - Limit Value.

Test Mode: TX G Mode 2462 MHz

Vertical

80 dBuV/m

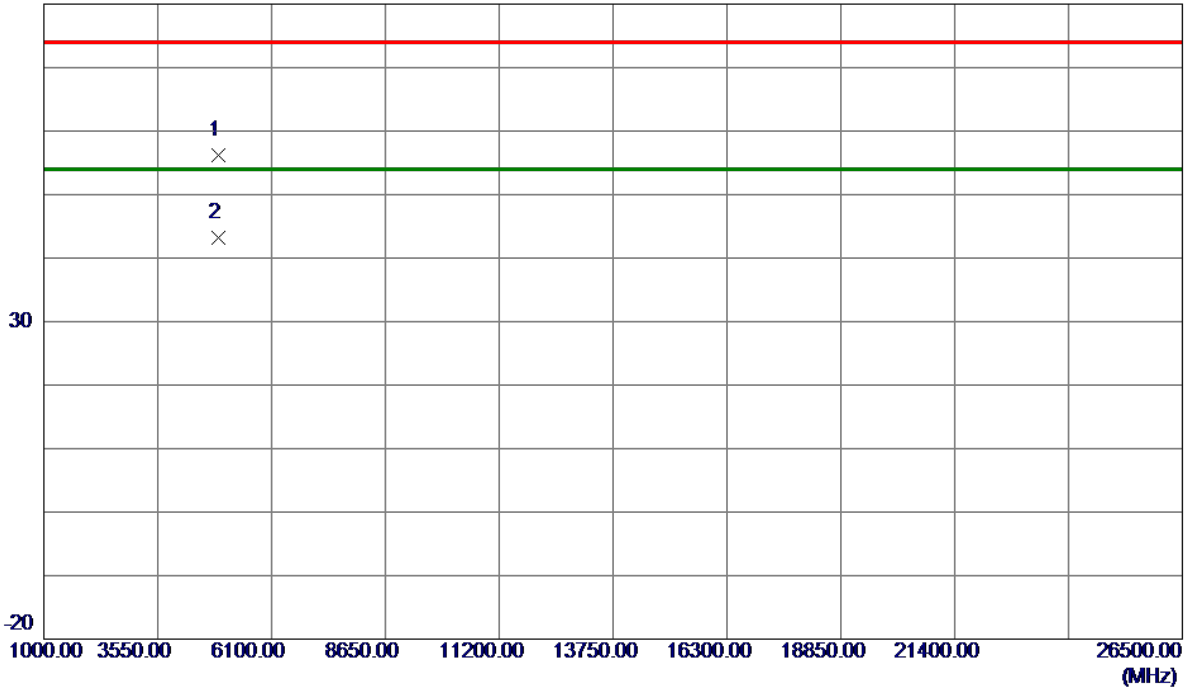

No.	Freq. MHz	Reading Level dBuV/m	Correct Factor dB	Measure ment dBuV/m	Limit dBuV/m	Margin dB	Detector	Comment
1	4917.5500	50.93	5.20	56.13	74.00	-17.87	Peak	
2 *	4923.0750	38.06	5.23	43.29	54.00	-10.71	AVG	

REMARKS:

- (1) Measurement Value = Reading Level + Correct Factor.
- (2) Margin Level = Measurement Value - Limit Value.

Test Mode: TX G Mode 2462 MHz

Horizontal

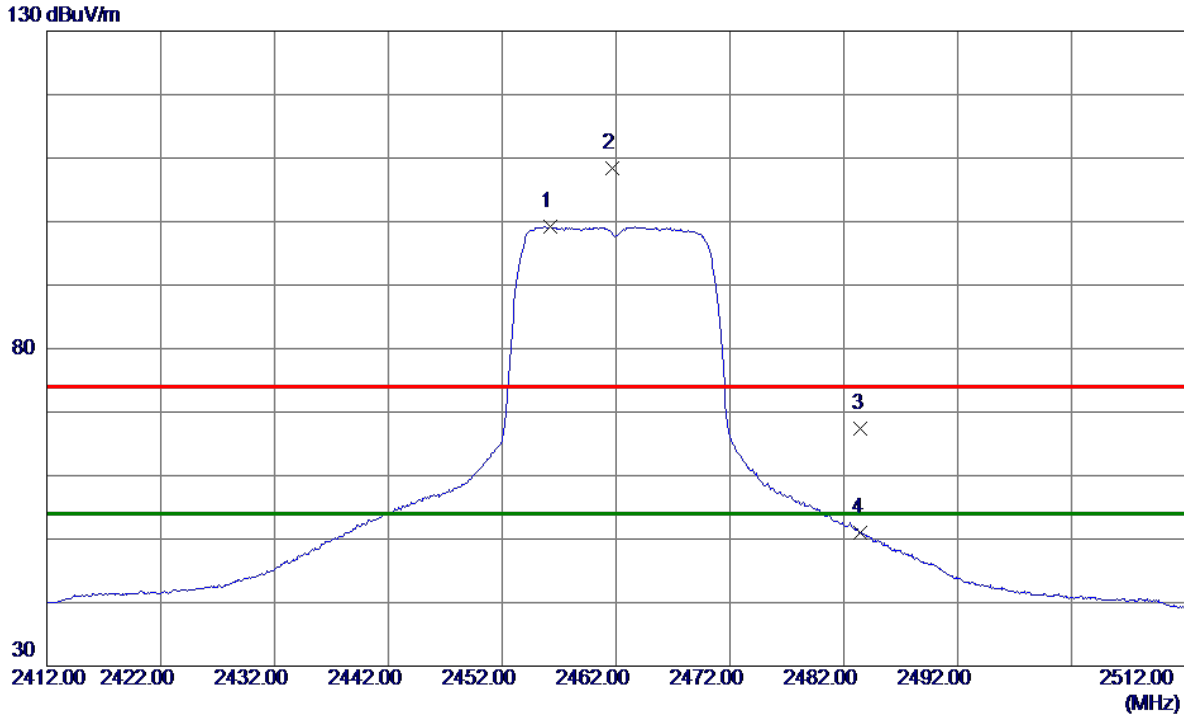

No.	Freq. MHz	Reading Level dBuV/m	Correct Factor dB	Measure ment dBuV/m	Limit dBuV/m	Margin dB	Detector	Comment
1 *	2456.2500	91.47	7.78	99.25	54.00	45.25	AVG	No Limit
2	2461.6500	100.67	7.80	108.47	74.00	34.47	Peak	No Limit
3	2483.5000	59.57	7.88	67.45	74.00	-6.55	Peak	
4	2483.5000	43.06	7.88	50.94	54.00	-3.06	AVG	

REMARKS:
 (1) Measurement Value = Reading Level + Correct Factor.
 (2) Margin Level = Measurement Value - Limit Value.

Test Mode: TX G Mode 2462 MHz

Horizontal

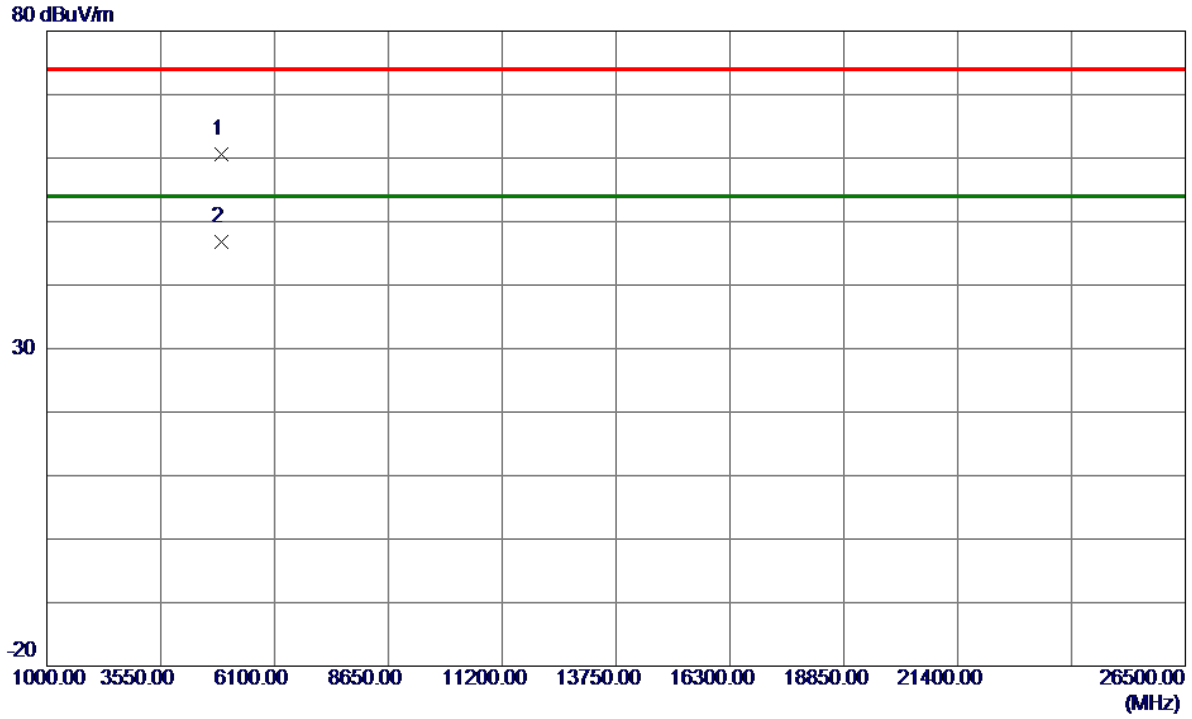

No.	Freq. MHz	Reading Level dBuV/m	Correct Factor dB	Measure ment dBuV/m	Limit dBuV/m	Margin dB	Detector	Comment
1	4923.3750	55.33	5.23	60.56	74.00	-13.44	Peak	
2 *	4924.0250	41.54	5.24	46.78	54.00	-7.22	AVG	

REMARKS:
 (1) Measurement Value = Reading Level + Correct Factor.
 (2) Margin Level = Measurement Value - Limit Value.

Test Mode: TX N-20M Mode 2412 MHz

Vertical

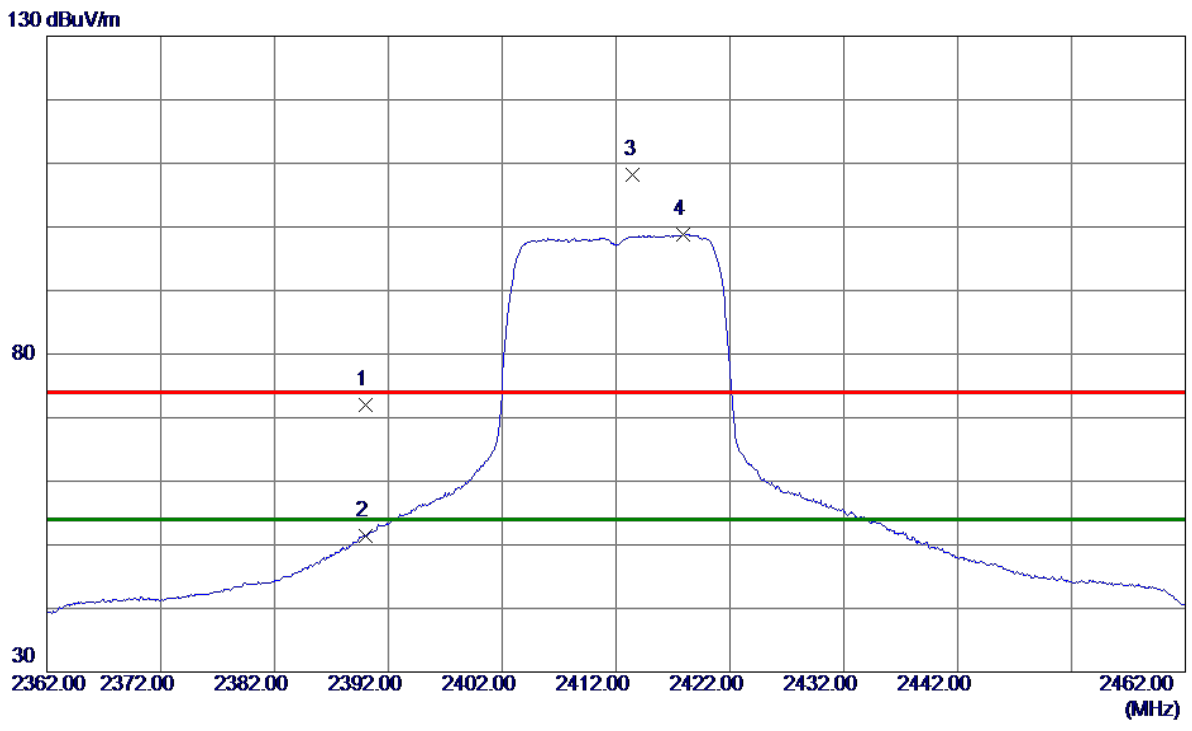

No.	Freq. MHz	Reading Level dBuV/m	Correct Factor dB	Measure ment dBuV/m	Limit dBuV/m	Margin dB	Detector	Comment
1	2390.0000	63.97	8.11	72.08	74.00	-1.92	Peak	
2	2390.0000	43.28	8.11	51.39	54.00	-2.61	AVG	
3	2413.5000	100.07	8.18	108.25	74.00	34.25	Peak	No Limit
4 *	2417.9000	90.62	8.19	98.81	54.00	44.81	AVG	No Limit

REMARKS:

- (1) Measurement Value = Reading Level + Correct Factor.
- (2) Margin Level = Measurement Value - Limit Value.

Test Mode: TX N-20M Mode 2412 MHz

Vertical

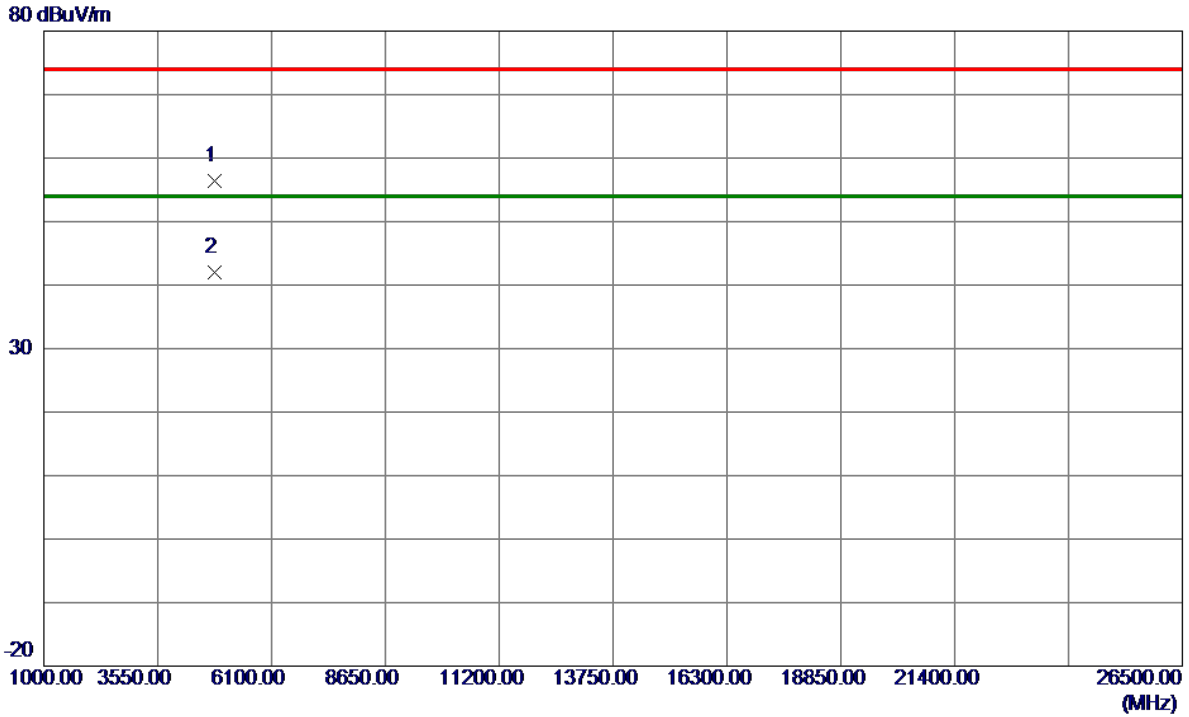

No.	Freq. MHz	Reading Level dBuV/m	Correct Factor dB	Measure ment dBuV/m	Limit dBuV/m	Margin dB	Detector	Comment
1	4819.9750	51.60	4.72	56.32	74.00	-17.68	Peak	
2 *	4823.8750	37.27	4.74	42.01	54.00	-11.99	AVG	

REMARKS:

- (1) Measurement Value = Reading Level + Correct Factor.
- (2) Margin Level = Measurement Value - Limit Value.

Test Mode: TX N-20M Mode 2412 MHz

Horizontal

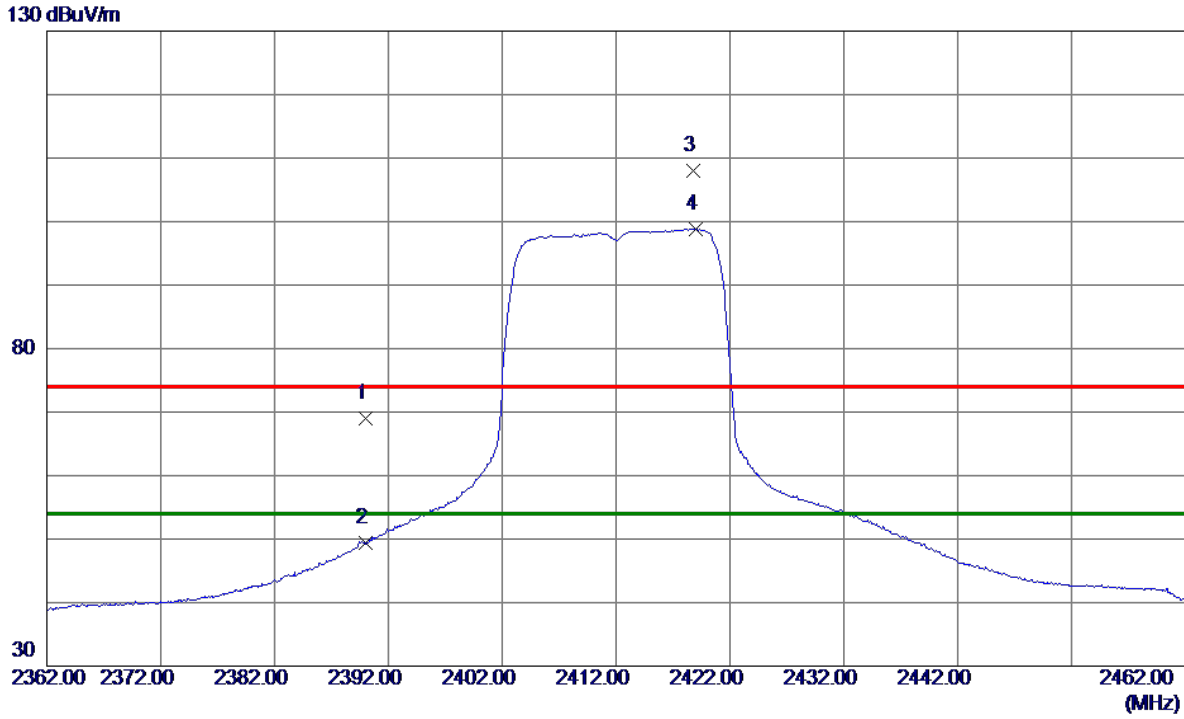

No.	Freq. MHz	Reading Level dBuV/m	Correct Factor dB	Measure ment dBuV/m	Limit dBuV/m	Margin dB	Detector	Comment
1	2390.0000	61.52	7.56	69.08	74.00	-4.92	Peak	
2	2390.0000	41.90	7.56	49.46	54.00	-4.54	AVG	
3	2418.7500	100.25	7.66	107.91	74.00	33.91	Peak	No Limit
4 *	2419.0500	91.18	7.66	98.84	54.00	44.84	AVG	No Limit

REMARKS:
 (1) Measurement Value = Reading Level + Correct Factor.
 (2) Margin Level = Measurement Value - Limit Value.

Test Mode: TX N-20M Mode 2412 MHz

Horizontal

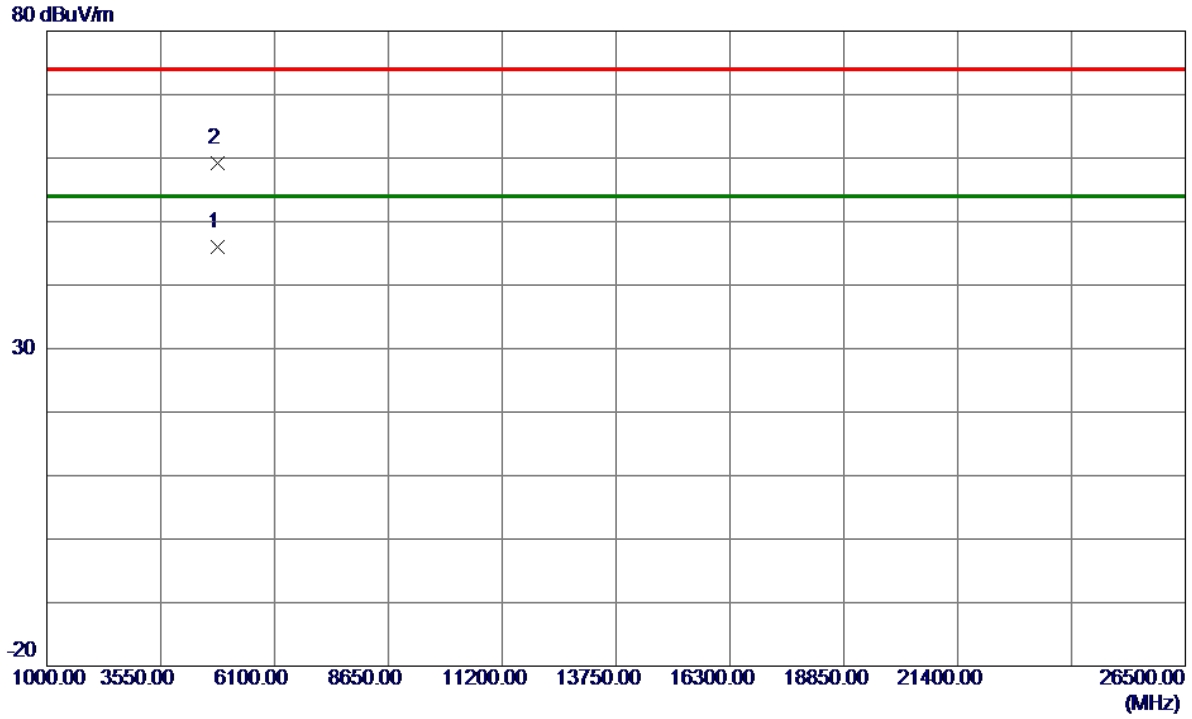

No.	Freq. MHz	Reading Level dBuV/m	Correct Factor dB	Measure ment dBuV/m	Limit dBuV/m	Margin dB	Detector	Comment
1 *	4823.2250	41.20	4.74	45.94	54.00	-8.06	AVG	
2	4824.1250	54.39	4.74	59.13	74.00	-14.87	Peak	

REMARKS:
 (1) Measurement Value = Reading Level + Correct Factor.
 (2) Margin Level = Measurement Value - Limit Value.

Test Mode: TX N-20M Mode 2417 MHz

Vertical

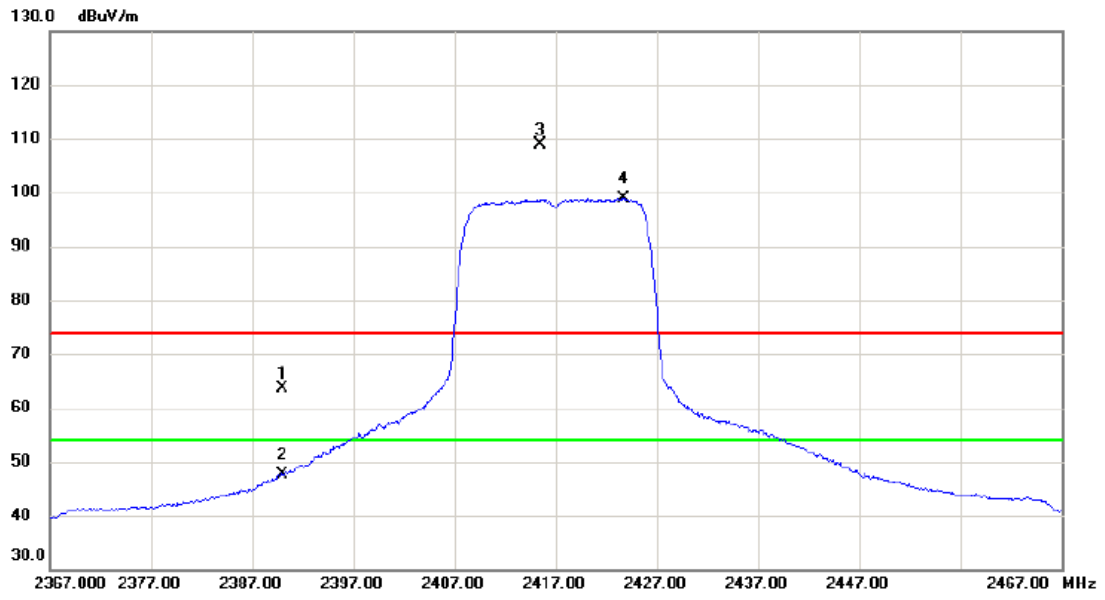

No.	Mk.	Freq. MHz	Reading Level dBuV	Correct Factor dB	Measure- ment dBuV/m	Limit dBuV/m	Margin dB	Detector	Comment
1		2390.000	55.50	8.11	63.61	74.00	-10.39	peak	
2		2390.000	39.45	8.11	47.56	54.00	-6.44	AVG	
3	X	2415.400	100.66	8.19	108.85	74.00	34.85	peak	No Limit
4	*	2423.750	90.60	8.21	98.81	54.00	44.81	AVG	No Limit

REMARKS:

- (1) Measurement Value = Reading Level + Correct Factor.
- (2) Margin Level = Measurement Value - Limit Value.

Test Mode: TX N-20M Mode 2417 MHz

Vertical

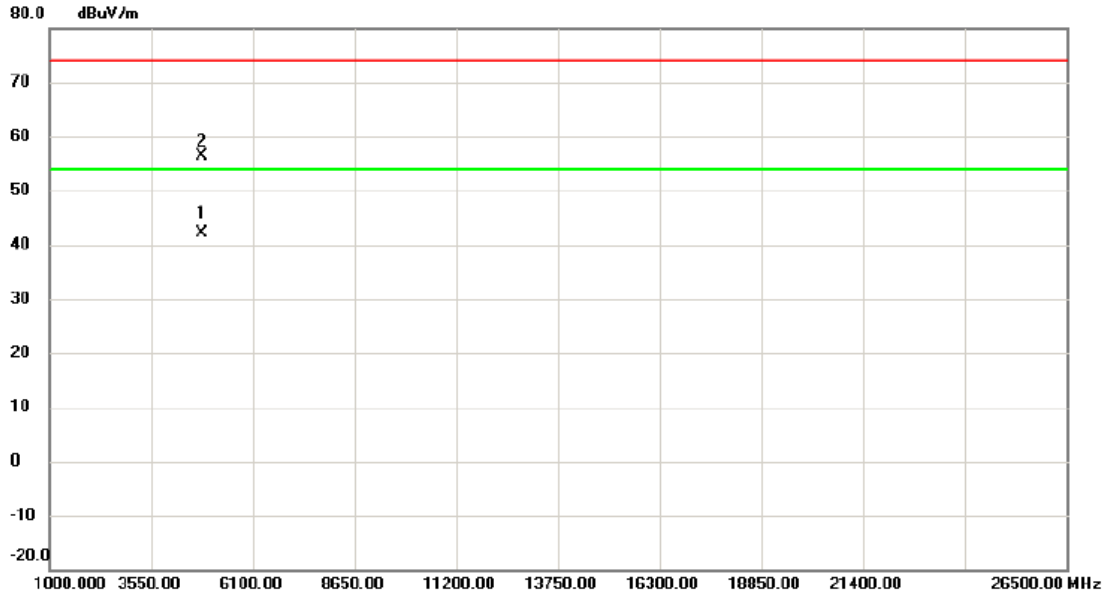

No. Mk.	Freq. MHz	Reading Level dBuV	Correct Factor dB	Measurement dBuV/m	Limit dBuV/m	Margin dB	Detector	Comment
1 *	4834.925	37.39	4.80	42.19	54.00	-11.81	AVG	
2	4837.125	51.48	4.80	56.28	74.00	-17.72	peak	

REMARKS:

- (1) Measurement Value = Reading Level + Correct Factor.
- (2) Margin Level = Measurement Value - Limit Value.

Test Mode: TX N-20M Mode 2417 MHz

Horizontal

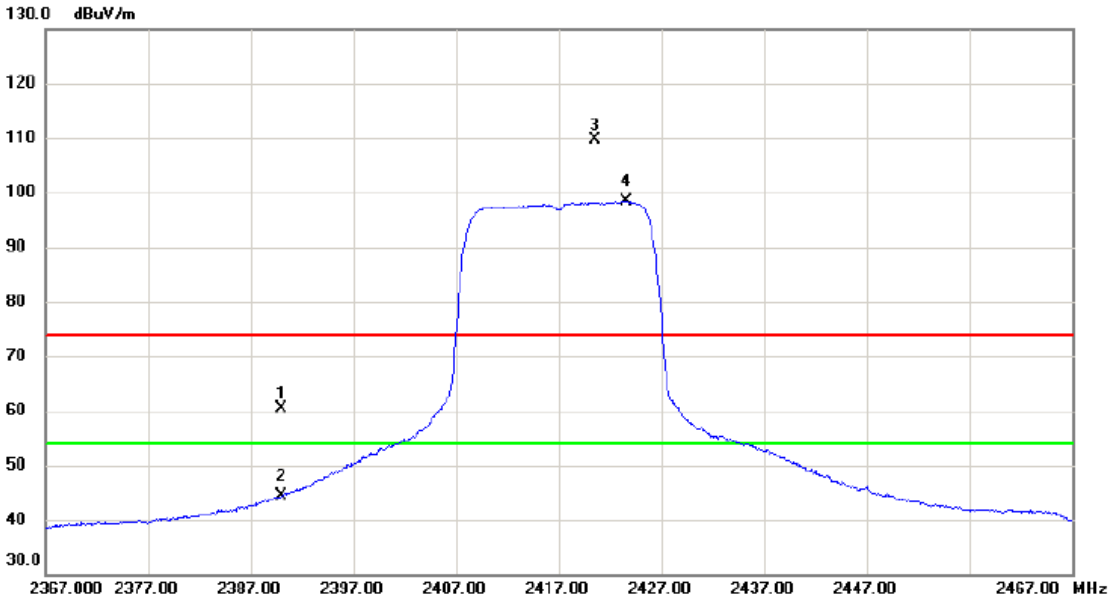

No.	Mk.	Freq. MHz	Reading Level dBuV	Correct Factor dB	Measure- ment dBuV/m	Limit dBuV/m	Margin dB	Detector	Comment
1		2390.000	52.78	7.57	60.35	74.00	-13.65	peak	
2		2390.000	36.76	7.57	44.33	54.00	-9.67	AVG	
3	X	2420.500	101.85	7.67	109.52	74.00	35.52	peak	No Limit
4	*	2423.600	90.76	7.67	98.43	54.00	44.43	AVG	No Limit

REMARKS:
 (1) Measurement Value = Reading Level + Correct Factor.
 (2) Margin Level = Measurement Value - Limit Value.

Test Mode: TX N-20M Mode 2417 MHz

Horizontal

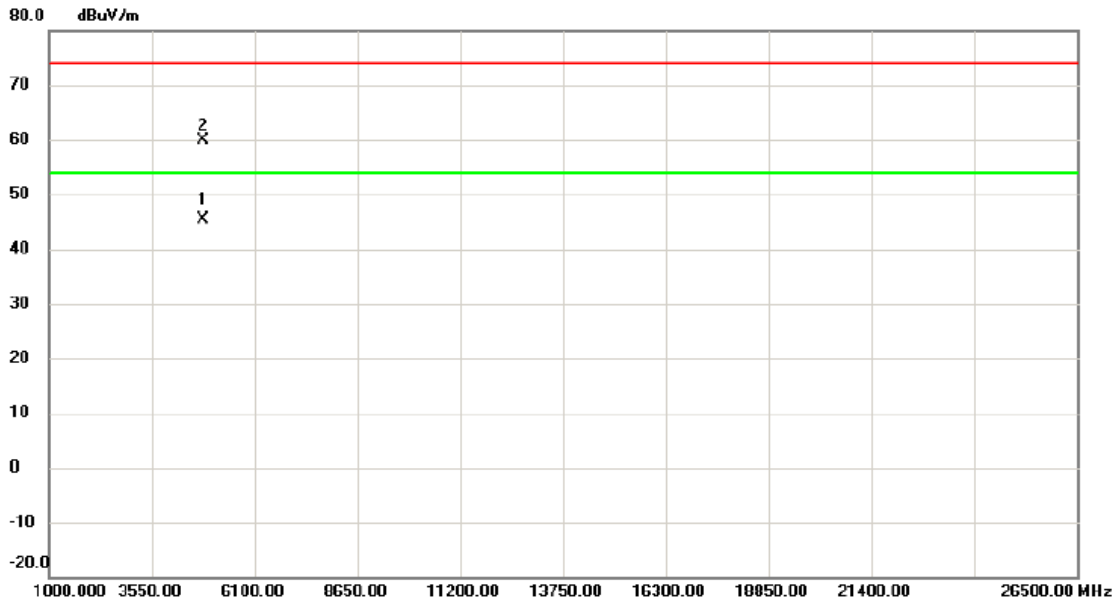

No. Mk.	Freq. MHz	Reading Level dBuV	Correct Factor dB	Measurement dBuV/m	Limit dBuV/m	Margin dB	Detector	Comment
1 *	4834.050	40.59	4.80	45.39	54.00	-8.61	AVG	
2	4836.675	55.15	4.80	59.95	74.00	-14.05	peak	

REMARKS:
 (1) Measurement Value = Reading Level + Correct Factor.
 (2) Margin Level = Measurement Value - Limit Value.

Test Mode: TX N-20M Mode 2437 MHz

Vertical

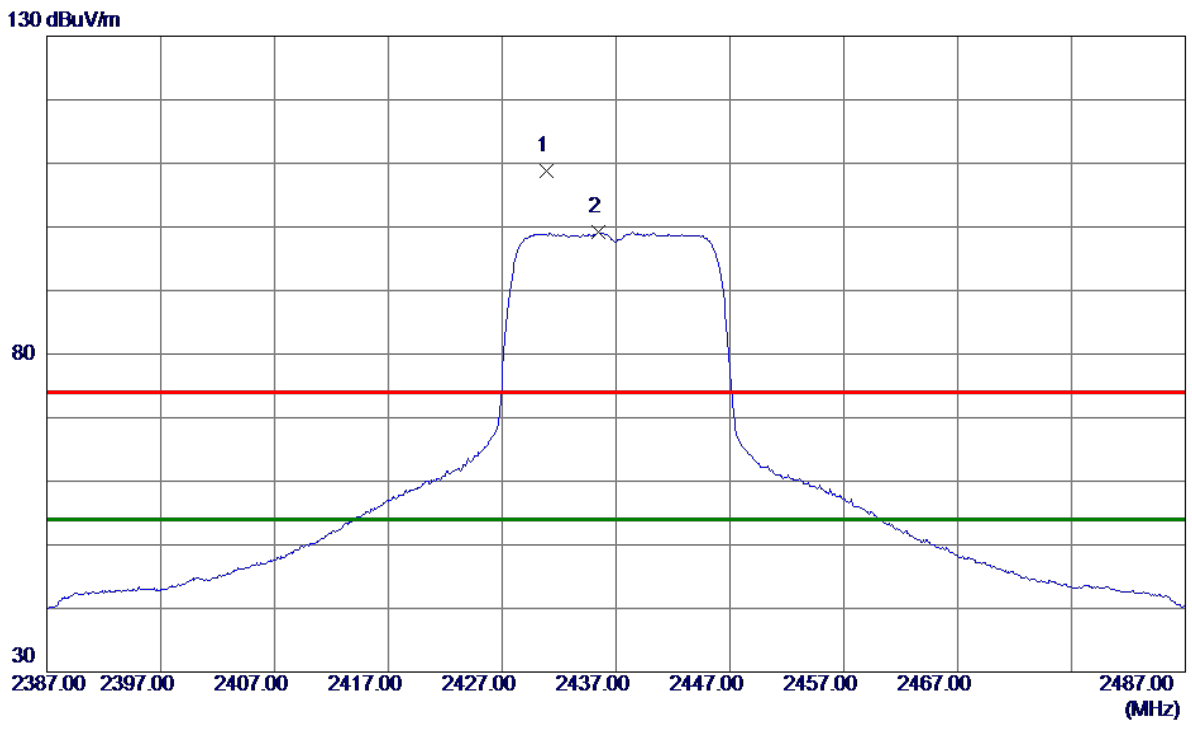

No.	Freq. MHz	Reading Level dBuV/m	Correct Factor dB	Measure ment dBuV/m	Limit dBuV/m	Margin dB	Detector	Comment
1	2430.9000	100.55	8.23	108.78	74.00	34.78	Peak	No Limit
2 *	2435.4500	90.90	8.24	99.14	54.00	45.14	AVG	No Limit

REMARKS:

- (1) Measurement Value = Reading Level + Correct Factor.
- (2) Margin Level = Measurement Value - Limit Value.

Test Mode: TX N-20M Mode 2437 MHz

Vertical

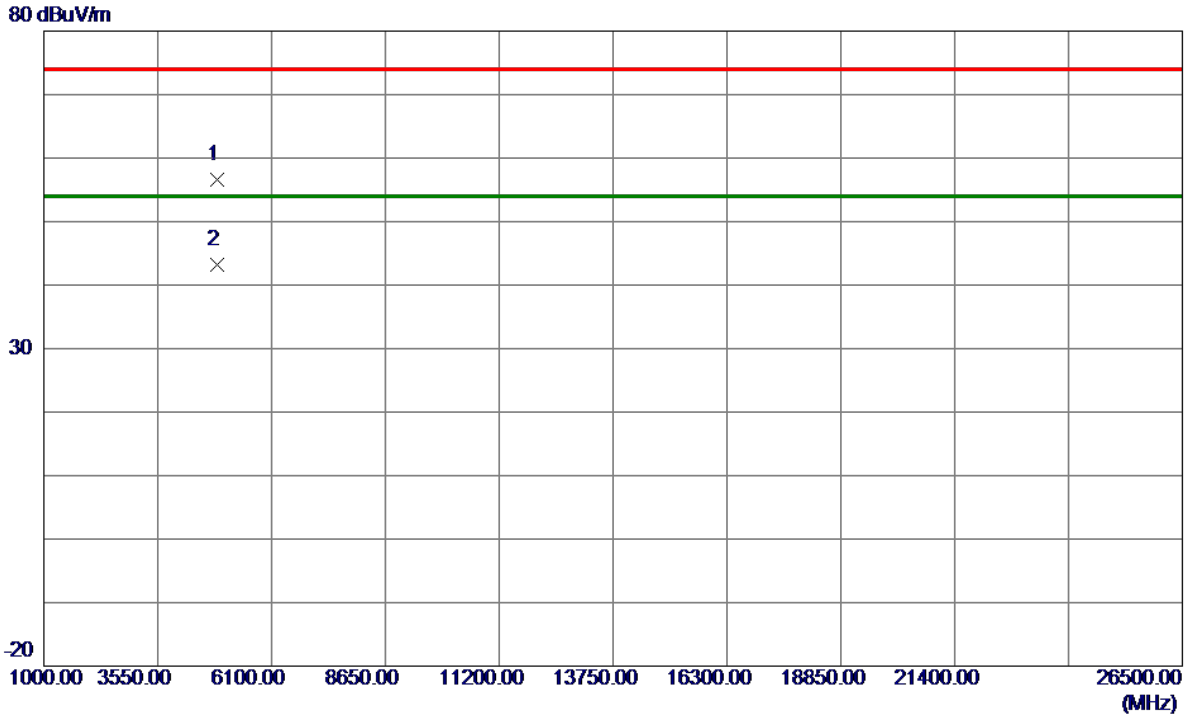

No.	Freq. MHz	Reading Level dBuV/m	Correct Factor dB	Measure ment dBuV/m	Limit dBuV/m	Margin dB	Detector	Comment
1	4870.0000	51.71	4.97	56.68	74.00	-17.32	Peak	
2 *	4873.5750	38.18	4.99	43.17	54.00	-10.83	AVG	

REMARKS:

- (1) Measurement Value = Reading Level + Correct Factor.
- (2) Margin Level = Measurement Value - Limit Value.

Test Mode: TX N-20M Mode 2437 MHz

Horizontal

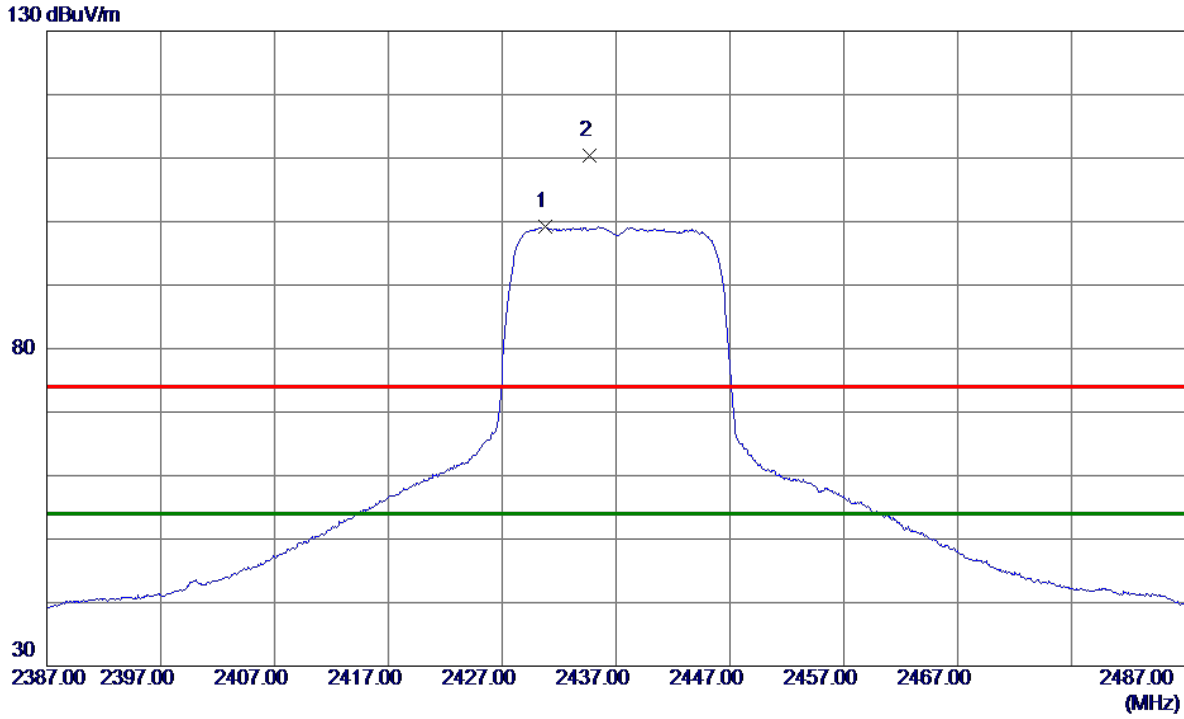

No.	Freq. MHz	Reading Level dBuV/m	Correct Factor dB	Measure ment dBuV/m	Limit dBuV/m	Margin dB	Detector	Comment
1 *	2430.8000	91.52	7.70	99.22	54.00	45.22	AVG	No Limit
2	2434.7000	102.74	7.71	110.45	74.00	36.45	Peak	No Limit

REMARKS:
 (1) Measurement Value = Reading Level + Correct Factor.
 (2) Margin Level = Measurement Value - Limit Value.

Test Mode: TX N-20M Mode 2437 MHz

Horizontal



No.	Freq. MHz	Reading Level dBuV/m	Correct Factor dB	Measure ment dBuV/m	Limit dBuV/m	Margin dB	Detector	Comment
1	4869.8750	56.06	4.97	61.03	74.00	-12.97	Peak	
2 *	4873.6250	42.04	4.99	47.03	54.00	-6.97	AVG	

REMARKS:
 (1) Measurement Value = Reading Level + Correct Factor.
 (2) Margin Level = Measurement Value - Limit Value.

Test Mode: TX N-20M Mode 2457 MHz

Vertical

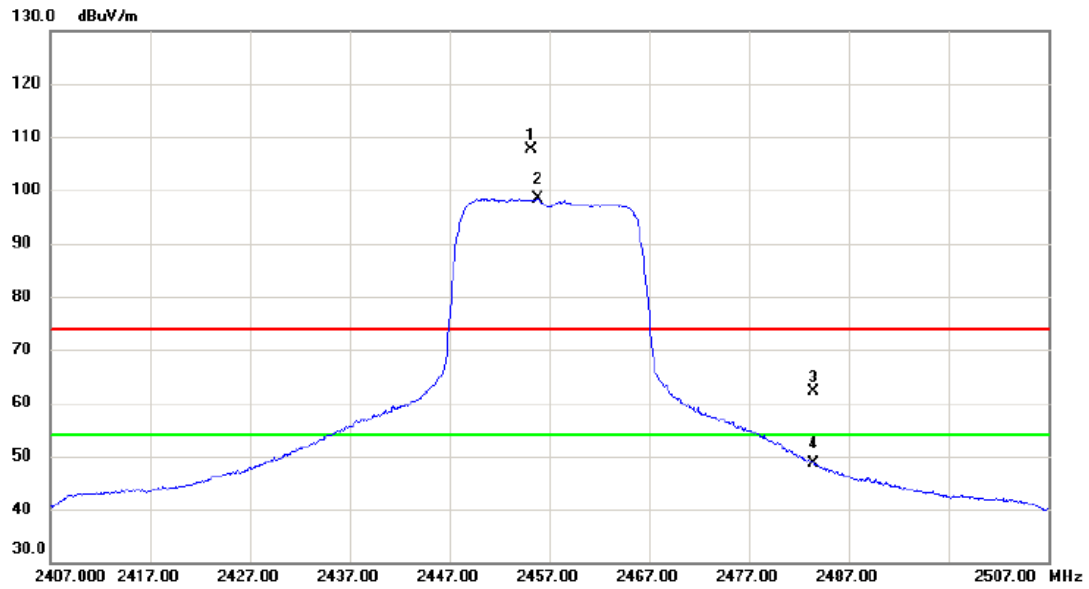

No.	Mk.	Freq. MHz	Reading Level dBuV	Correct Factor dB	Measure- ment dBuV/m	Limit dBuV/m	Margin dB	Detector	Comment
1	X	2455.150	99.29	8.30	107.59	74.00	33.59	peak	No Limit
2	*	2455.800	90.16	8.30	98.46	54.00	44.46	AVG	No Limit
3		2483.500	53.78	8.38	62.16	74.00	-11.84	peak	
4		2483.500	40.35	8.38	48.73	54.00	-5.27	AVG	

REMARKS:

- (1) Measurement Value = Reading Level + Correct Factor.
- (2) Margin Level = Measurement Value - Limit Value.

Test Mode: TX N-20M Mode 2457 MHz

Vertical

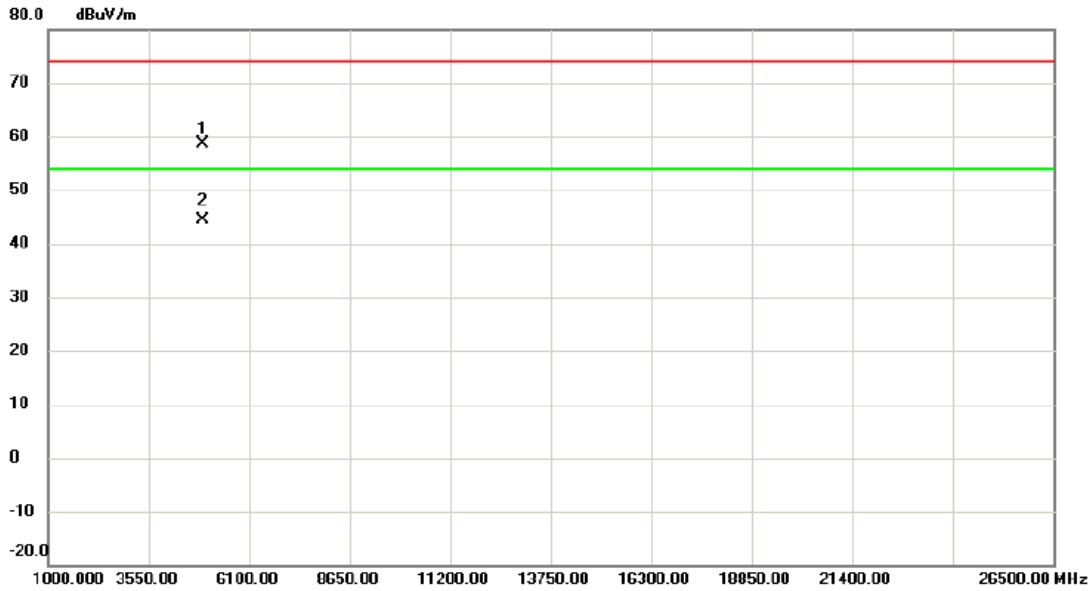

No.	Mk.	Freq. MHz	Reading Level dBuV	Correct Factor dB	Measure- ment dBuV/m	Limit dBuV/m	Margin dB	Detector	Comment
1		4910.125	53.34	5.17	58.51	74.00	-15.49	peak	
2	*	4912.925	39.20	5.18	44.38	54.00	-9.62	AVG	

REMARKS:

(1) Measurement Value = Reading Level + Correct Factor.

(2) Margin Level = Measurement Value - Limit Value.

Test Mode: TX N-20M Mode 2457 MHz

Horizontal

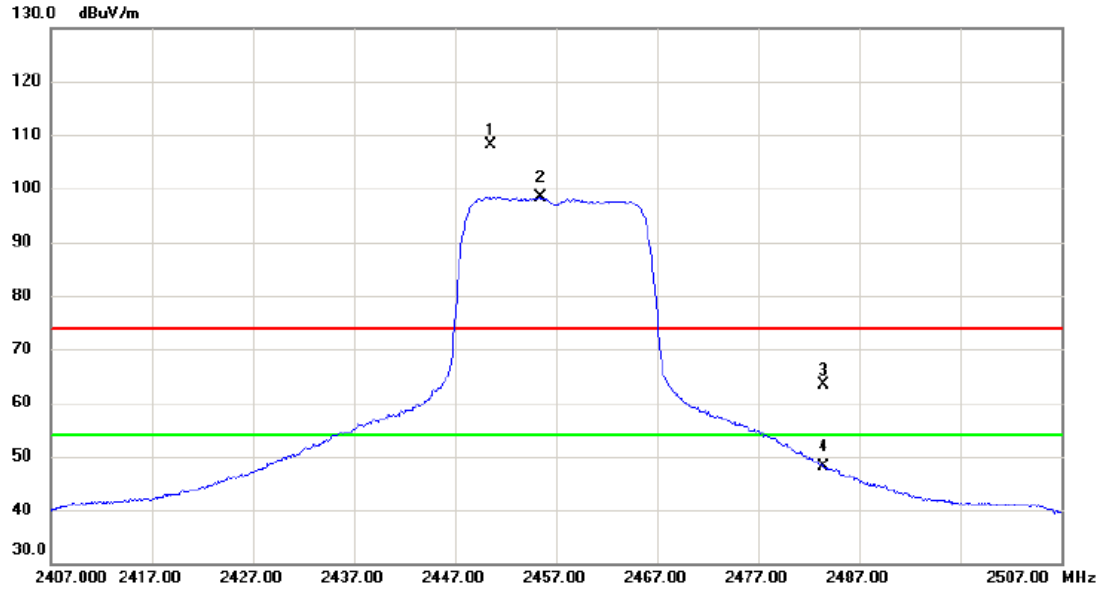

No.	Mk.	Freq. MHz	Reading Level dBuV	Correct Factor dB	Measure- ment dBuV/m	Limit dBuV/m	Margin dB	Detector	Comment
1	X	2450.500	100.39	7.76	108.15	74.00	34.15	peak	No Limit
2	*	2455.400	90.69	7.78	98.47	54.00	44.47	AVG	No Limit
3		2483.500	55.39	7.87	63.26	74.00	-10.74	peak	
4		2483.500	40.19	7.87	48.06	54.00	-5.94	AVG	

REMARKS:

(1) Measurement Value = Reading Level + Correct Factor.

(2) Margin Level = Measurement Value - Limit Value.

Test Mode: TX N-20M Mode 2457 MHz

Horizontal

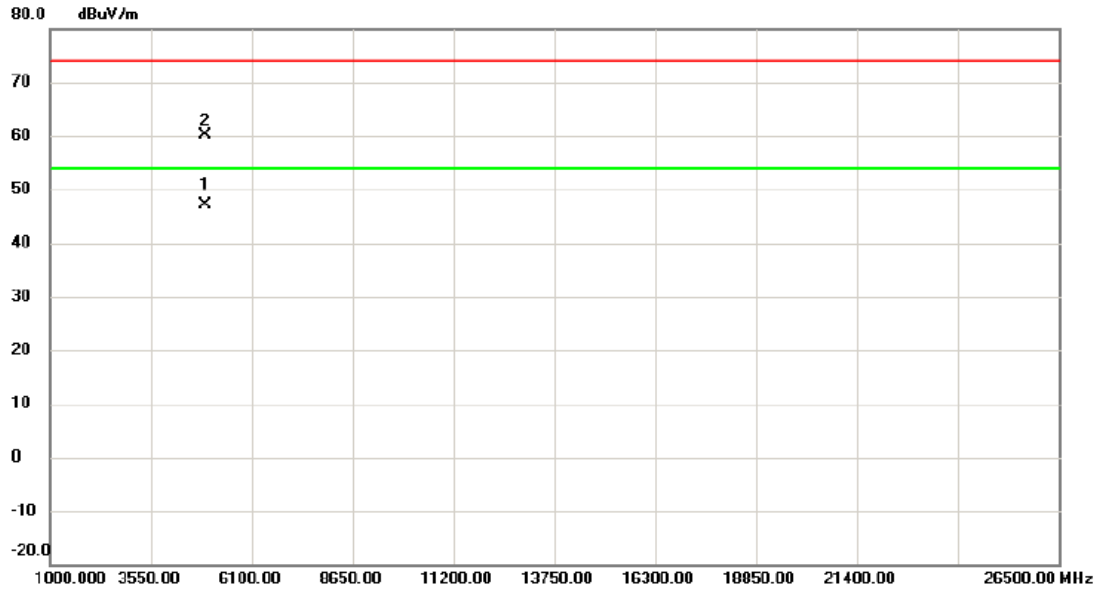

No.	Mk.	Freq. MHz	Reading Level dBuV	Correct Factor dB	Measure- ment dBuV/m	Limit dBuV/m	Margin dB	Detector	Comment
1	*	4914.600	41.98	5.18	47.16	54.00	-6.84	AVG	
2		4915.525	55.06	5.19	60.25	74.00	-13.75	peak	

REMARKS:
 (1) Measurement Value = Reading Level + Correct Factor.
 (2) Margin Level = Measurement Value - Limit Value.

Test Mode: TX N-20M Mode 2462 MHz

Vertical

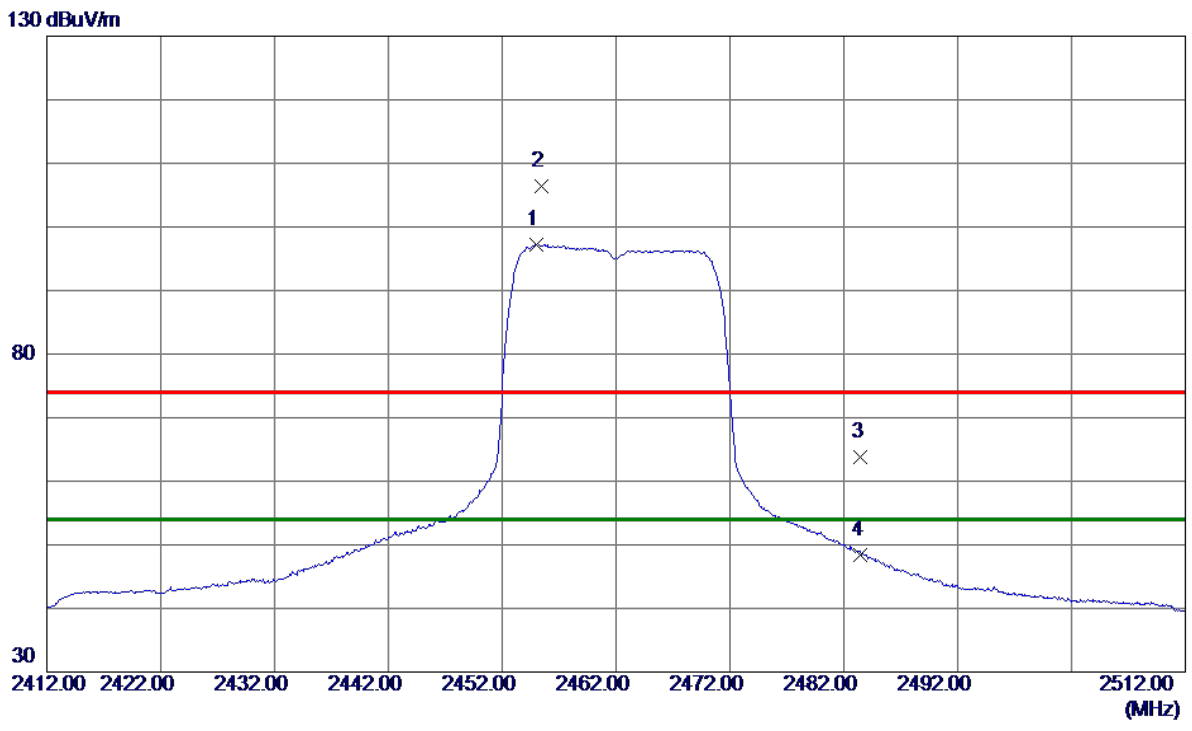

No.	Freq. MHz	Reading Level dBuV/m	Correct Factor dB	Measure ment dBuV/m	Limit dBuV/m	Margin dB	Detector	Comment
1 *	2454.9500	88.97	8.30	97.27	54.00	43.27	AVG	No Limit
2	2455.4500	98.16	8.30	106.46	74.00	32.46	Peak	No Limit
3	2483.5000	55.33	8.38	63.71	74.00	-10.29	Peak	
4	2483.5000	40.07	8.38	48.45	54.00	-5.55	AVG	

REMARKS:

- (1) Measurement Value = Reading Level + Correct Factor.
- (2) Margin Level = Measurement Value - Limit Value.

Test Mode: TX N-20M Mode 2462 MHz

Vertical

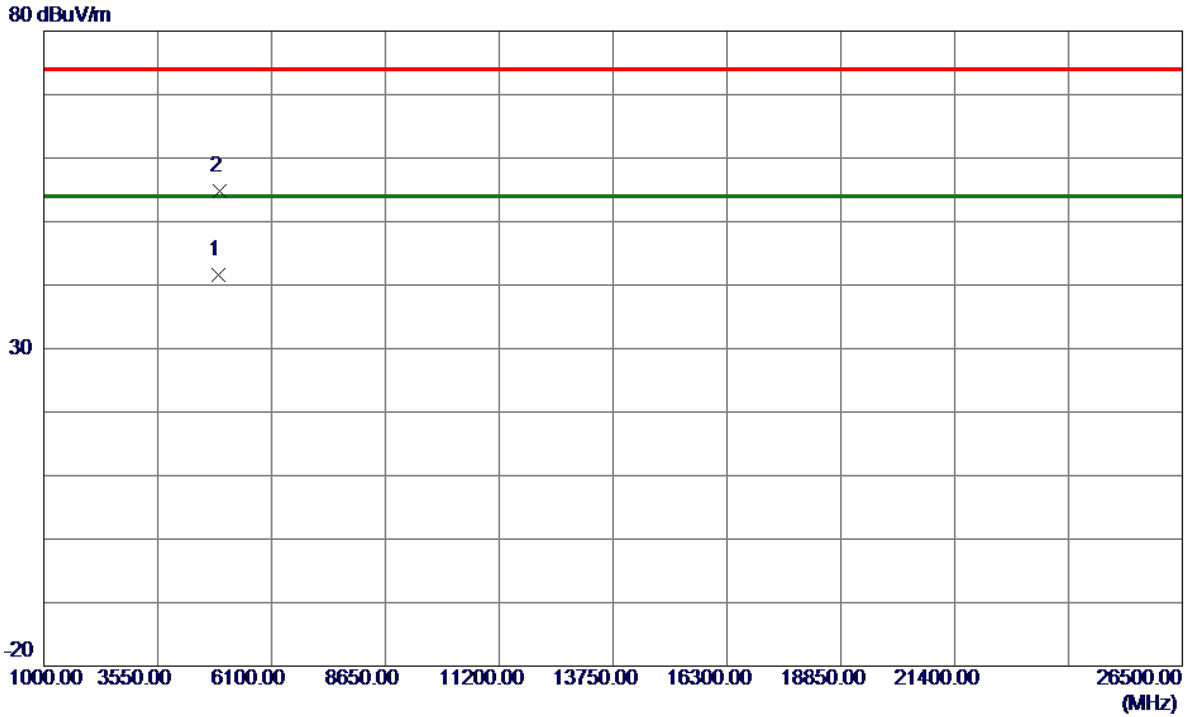

No.	Freq. MHz	Reading Level dBuV/m	Correct Factor dB	Measure ment dBuV/m	Limit dBuV/m	Margin dB	Detector	Comment
1 *	4923.4750	36.45	5.23	41.68	54.00	-12.32	AVG	
2	4926.4500	49.47	5.25	54.72	74.00	-19.28	Peak	

REMARKS:

- (1) Measurement Value = Reading Level + Correct Factor.
- (2) Margin Level = Measurement Value - Limit Value.

Test Mode: TX N-20M Mode 2462 MHz

Horizontal

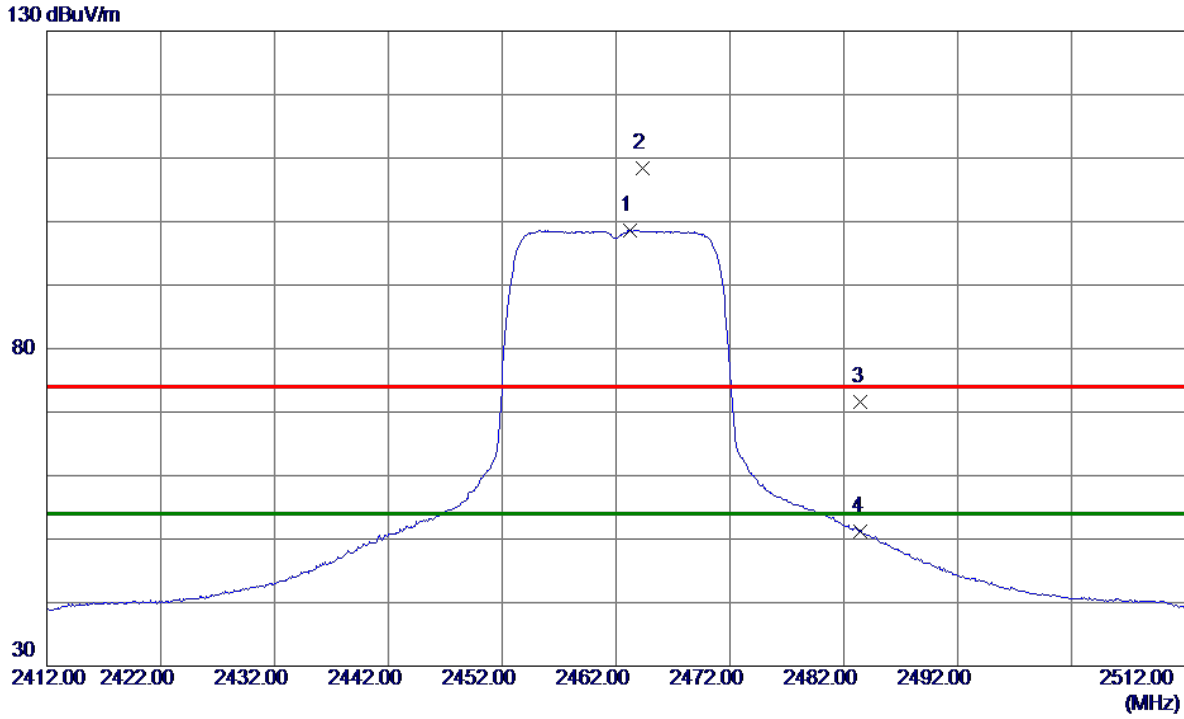

No.	Freq. MHz	Reading Level dBuV/m	Correct Factor dB	Measure ment dBuV/m	Limit dBuV/m	Margin dB	Detector	Comment
1 *	2463.2500	90.81	7.81	98.62	54.00	44.62	AVG	No Limit
2	2464.3000	100.55	7.81	108.36	74.00	34.36	Peak	No Limit
3	2483.5000	63.73	7.88	71.61	74.00	-2.39	Peak	
4	2483.5000	43.27	7.88	51.15	54.00	-2.85	AVG	

REMARKS:
 (1) Measurement Value = Reading Level + Correct Factor.
 (2) Margin Level = Measurement Value - Limit Value.

Test Mode: TX N-20M Mode 2462 MHz

Horizontal

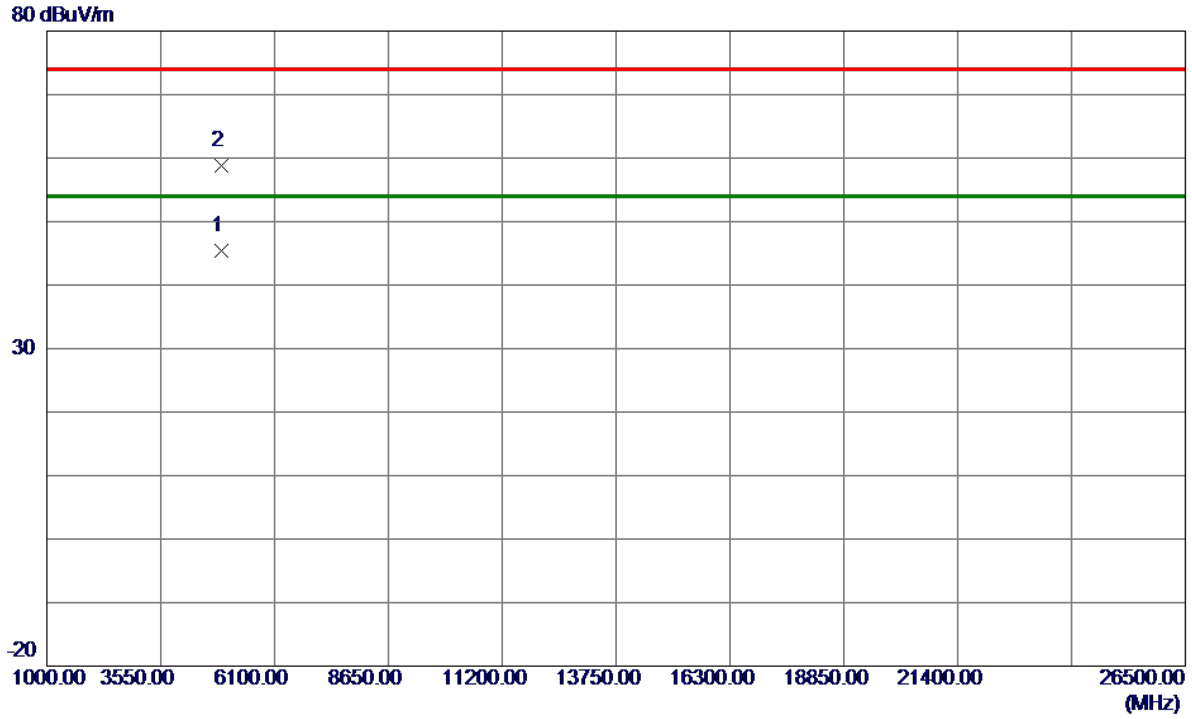

No.	Freq. MHz	Reading Level dBuV/m	Correct Factor dB	Measure ment dBuV/m	Limit dBuV/m	Margin dB	Detector	Comment
1 *	4923.8000	40.16	5.24	45.40	54.00	-8.60	AVG	
2	4923.9750	53.51	5.24	58.75	74.00	-15.25	Peak	

REMARKS:
 (1) Measurement Value = Reading Level + Correct Factor.
 (2) Margin Level = Measurement Value - Limit Value.

Test Mode: TX N-40M Mode 2422 MHz

Vertical

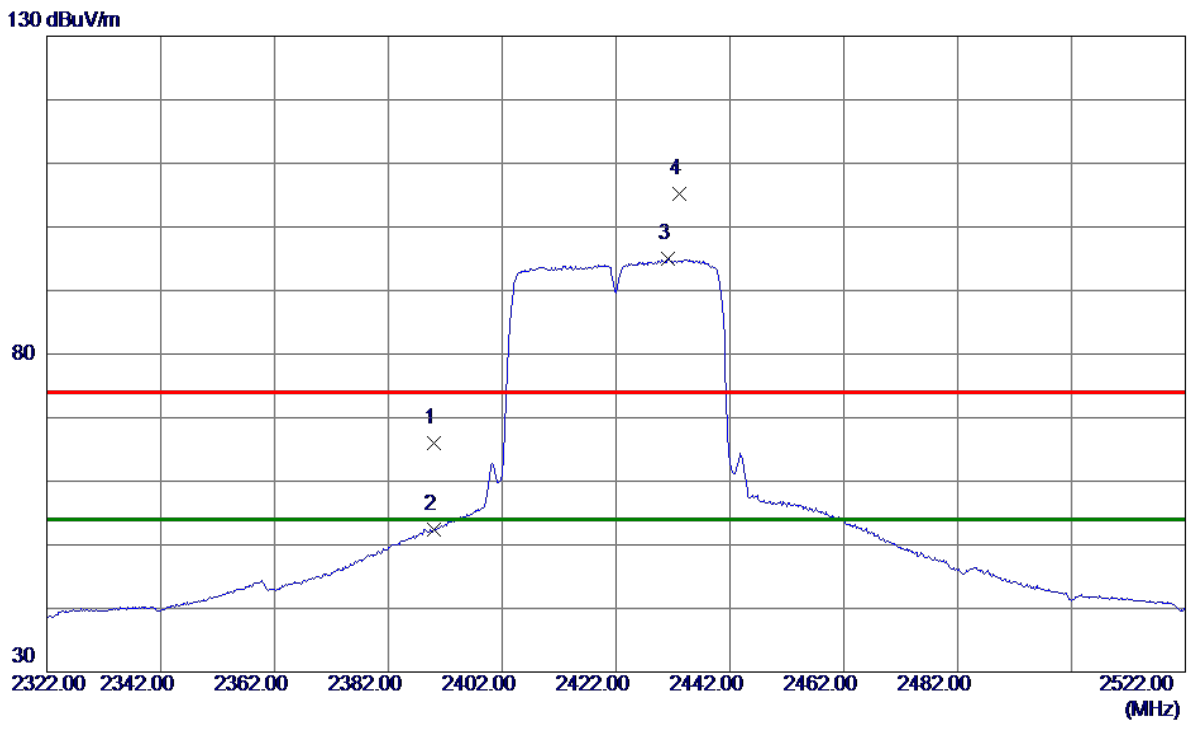

No.	Freq. MHz	Reading Level dBuV/m	Correct Factor dB	Measure ment dBuV/m	Limit dBuV/m	Margin dB	Detector	Comment
1	2390.0000	57.93	8.11	66.04	74.00	-7.96	Peak	
2	2390.0000	44.30	8.11	52.41	54.00	-1.59	AVG	
3 *	2431.1000	86.76	8.23	94.99	54.00	40.99	AVG	No Limit
4	2433.1000	97.06	8.23	105.29	74.00	31.29	Peak	No Limit

REMARKS:

- (1) Measurement Value = Reading Level + Correct Factor.
- (2) Margin Level = Measurement Value - Limit Value.

Test Mode: TX N-40M Mode 2422 MHz

Vertical

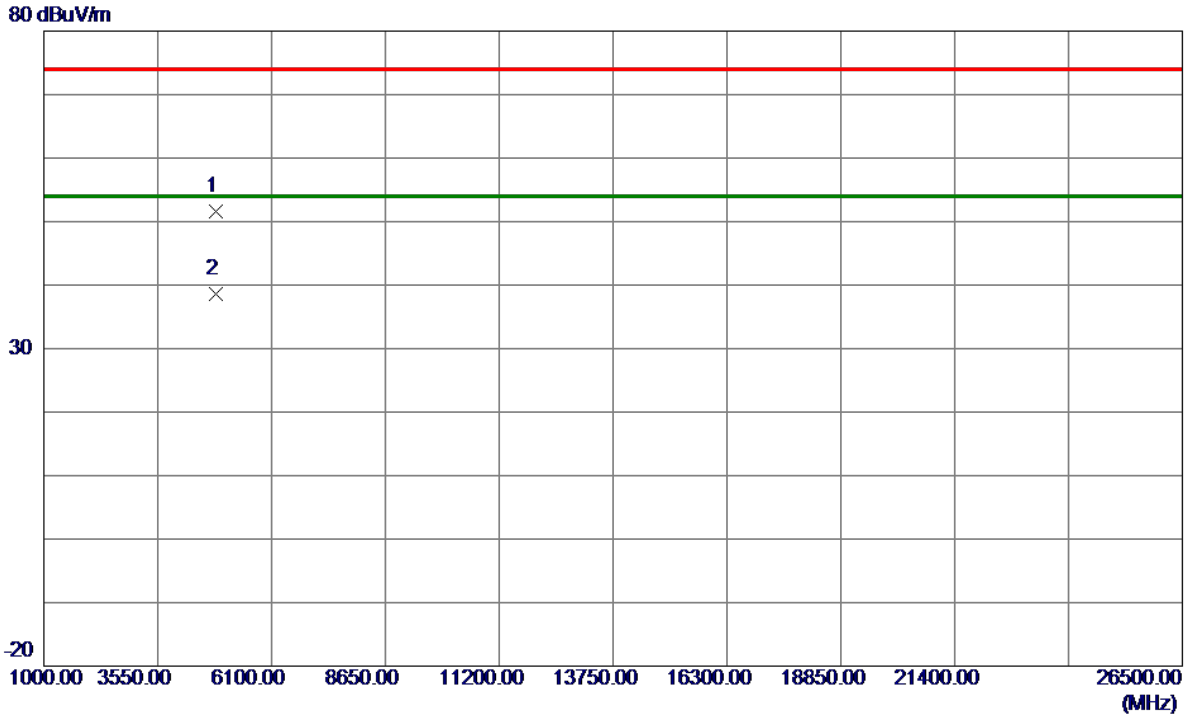

No.	Freq. MHz	Reading Level dBuV/m	Correct Factor dB	Measure ment dBuV/m	Limit dBuV/m	Margin dB	Detector	Comment
1	4842.9500	46.80	4.84	51.64	74.00	-22.36	Peak	
2 *	4844.6500	33.83	4.85	38.68	54.00	-15.32	AVG	

REMARKS:

- (1) Measurement Value = Reading Level + Correct Factor.
- (2) Margin Level = Measurement Value - Limit Value.

Test Mode: TX N-40M Mode 2422 MHz

Horizontal

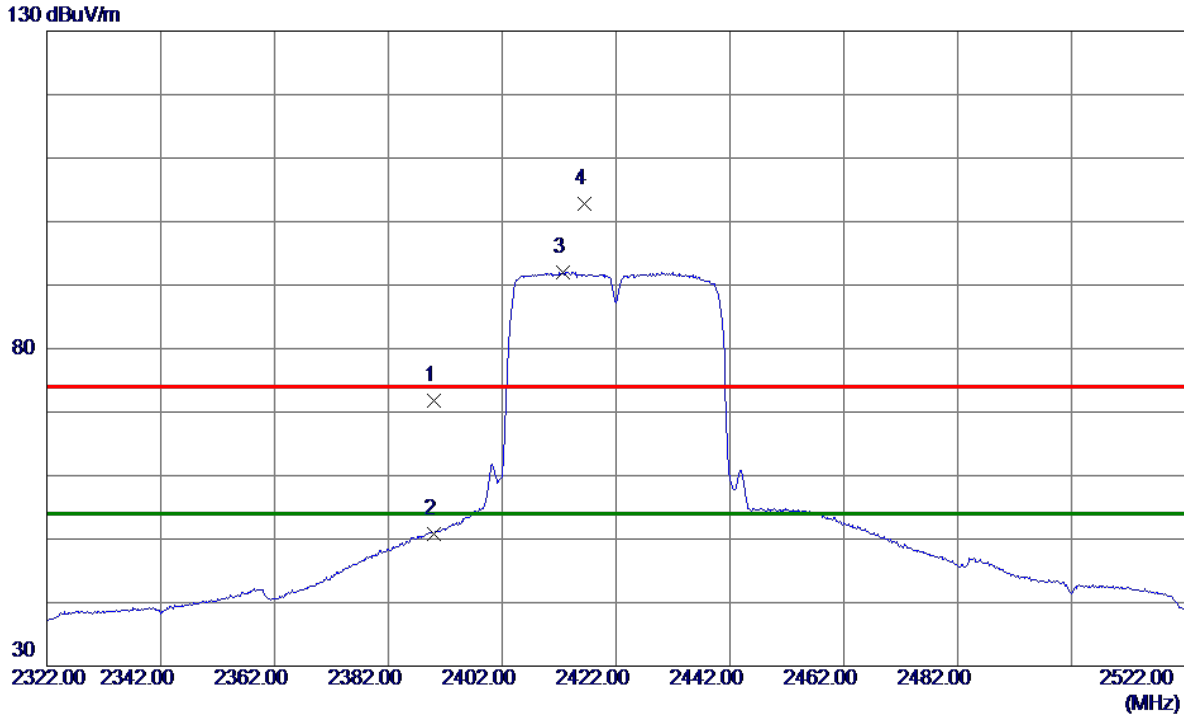

No.	Freq. MHz	Reading Level dBuV/m	Correct Factor dB	Measure ment dBuV/m	Limit dBuV/m	Margin dB	Detector	Comment
1	2390.0000	64.33	7.56	71.89	74.00	-2.11	Peak	
2	2390.0000	43.33	7.56	50.89	54.00	-3.11	AVG	
3 *	2412.7000	84.42	7.64	92.06	54.00	38.06	AVG	No Limit
4	2416.4000	95.15	7.65	102.80	74.00	28.80	Peak	No Limit

REMARKS:
 (1) Measurement Value = Reading Level + Correct Factor.
 (2) Margin Level = Measurement Value - Limit Value.

Test Mode: TX N-40M Mode 2422 MHz

Horizontal

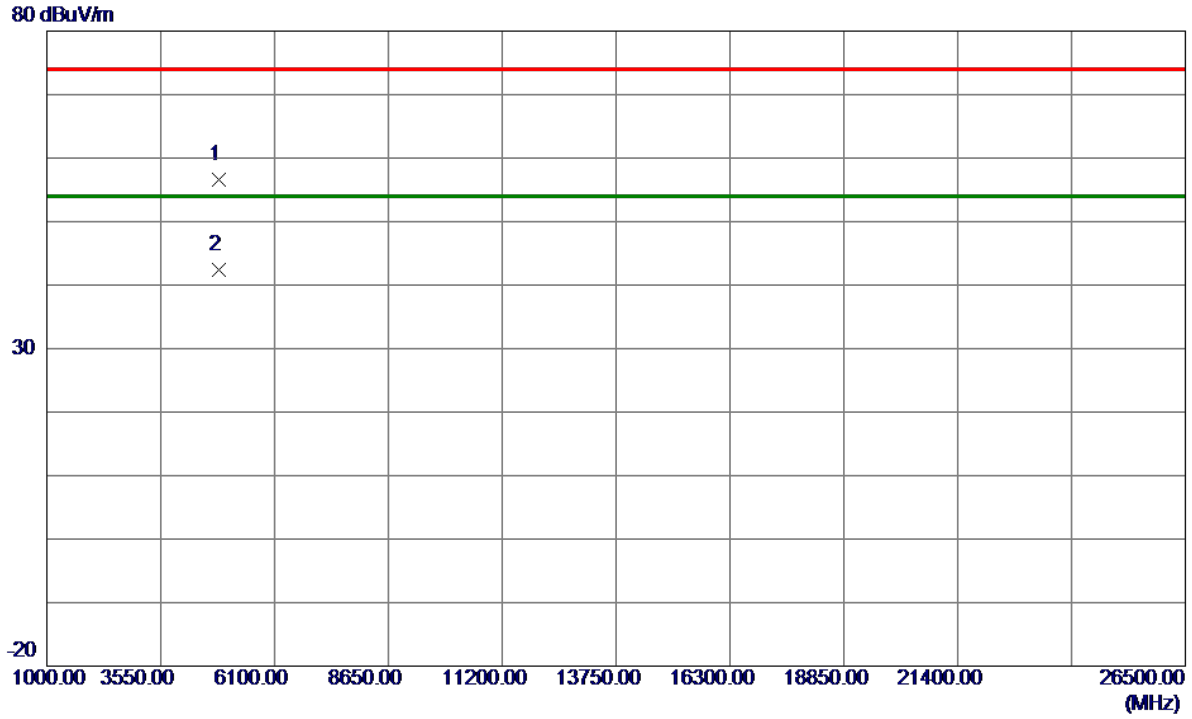

No.	Freq. MHz	Reading Level dBuV/m	Correct Factor dB	Measure ment dBuV/m	Limit dBuV/m	Margin dB	Detector	Comment
1	4842.8500	51.85	4.84	56.69	74.00	-17.31	Peak	
2 *	4847.1500	37.56	4.86	42.42	54.00	-11.58	AVG	

REMARKS:
 (1) Measurement Value = Reading Level + Correct Factor.
 (2) Margin Level = Measurement Value - Limit Value.

Test Mode: TX N-40M Mode 2427 MHz

Vertical

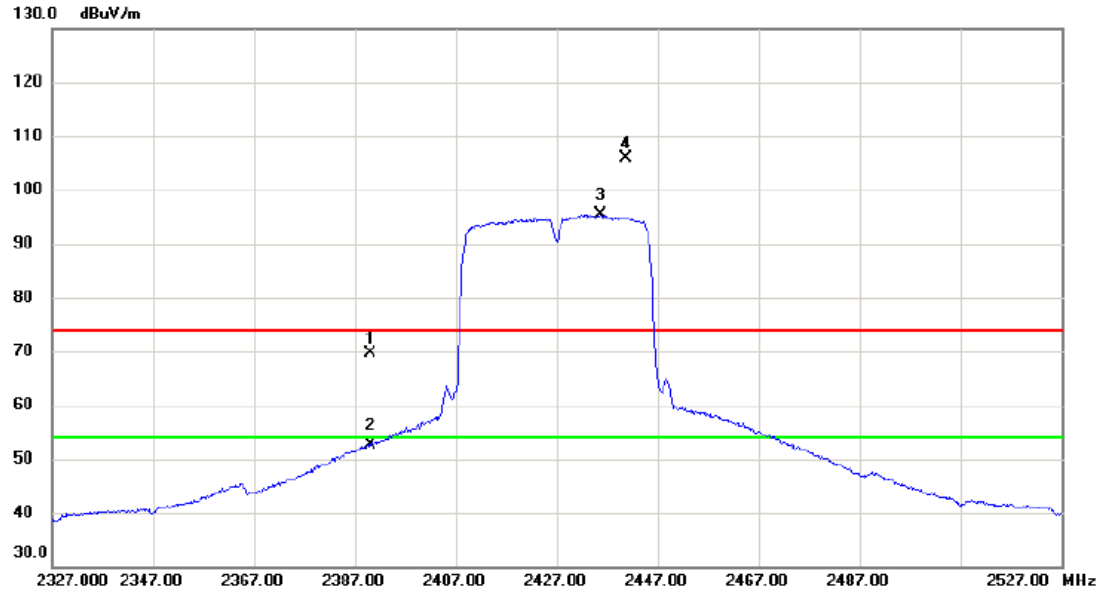

No.	Mk.	Freq. MHz	Reading Level dBuV	Correct Factor dB	Measure- ment dBuV/m	Limit dBuV/m	Margin dB	Detector	Comment
1		2390.000	61.45	8.11	69.56	74.00	-4.44	peak	
2		2390.000	44.48	8.11	52.59	54.00	-1.41	AVG	
3	*	2435.700	87.13	8.23	95.36	54.00	41.36	AVG	No Limit
4	X	2440.800	97.54	8.26	105.80	74.00	31.80	peak	No Limit

REMARKS:

- (1) Measurement Value = Reading Level + Correct Factor.
- (2) Margin Level = Measurement Value - Limit Value.

Test Mode: TX N-40M Mode 2427 MHz

Vertical

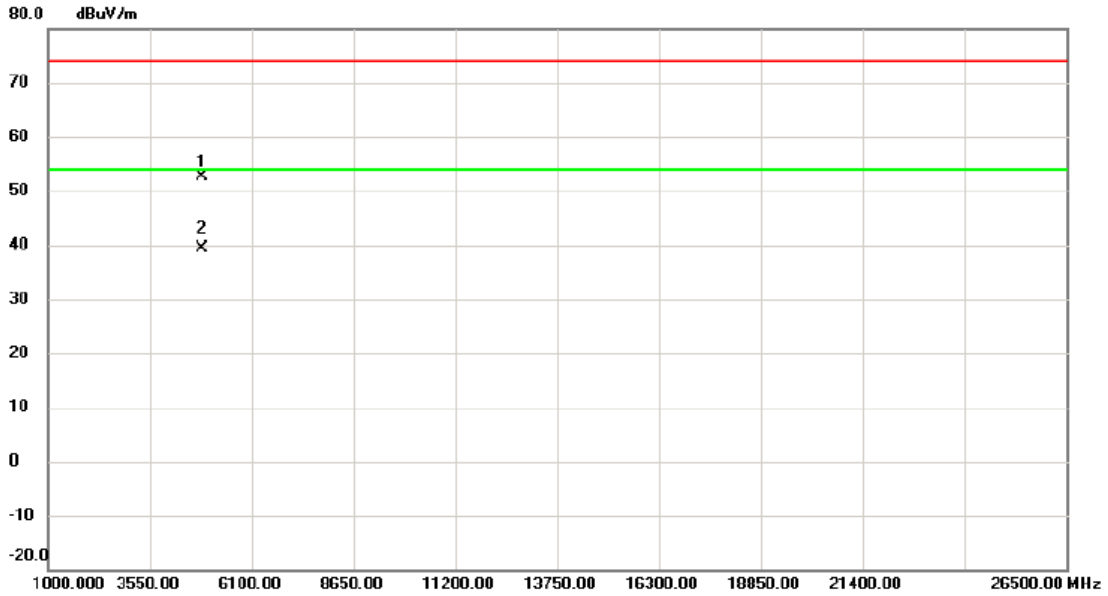

No.	Mk.	Freq.	Reading Level	Correct Factor	Measurement	Limit	Margin	Detector	Comment
		MHz	dBuV	dB	dBuV/m	dBuV/m	dB		
1		4852.950	47.85	4.89	52.74	74.00	-21.26	peak	
2	*	4854.000	34.42	4.89	39.31	54.00	-14.69	AVG	

REMARKS:

(1) Measurement Value = Reading Level + Correct Factor.

(2) Margin Level = Measurement Value - Limit Value.

Test Mode: TX N-40M Mode 2427 MHz

Horizontal

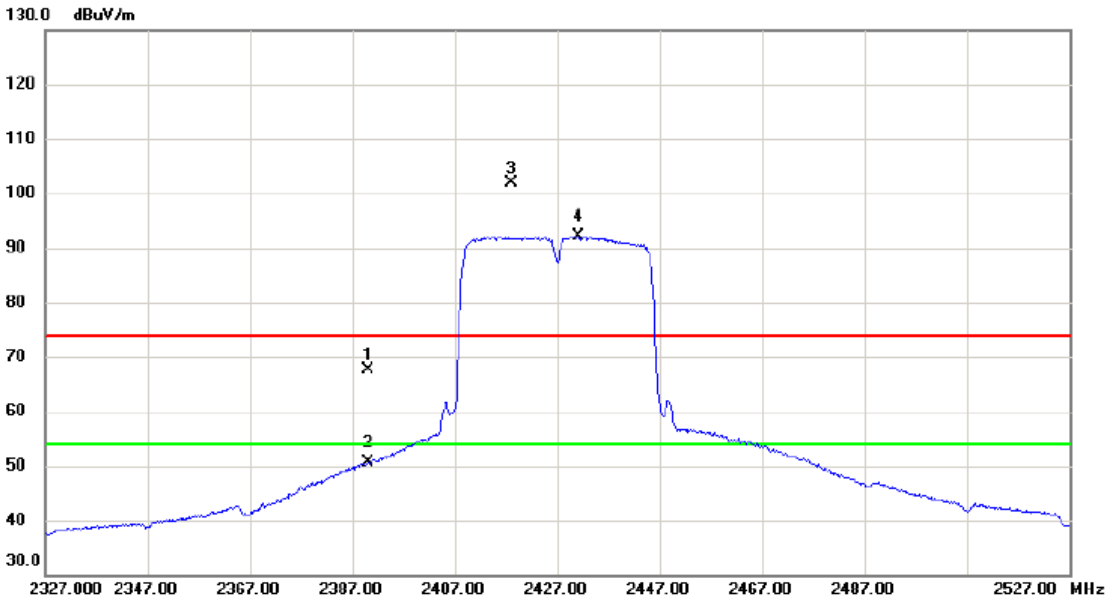

No.	Mk.	Freq. MHz	Reading Level dBuV	Correct Factor dB	Measure- ment dBuV/m	Limit dBuV/m	Margin dB	Detector	Comment
1		2390.000	60.09	7.57	67.66	74.00	-6.34	peak	
2		2390.000	43.05	7.57	50.62	54.00	-3.38	AVG	
3	X	2418.100	94.25	7.66	101.91	74.00	27.91	peak	No Limit
4	*	2431.100	84.31	7.70	92.01	54.00	38.01	AVG	No Limit

REMARKS:

- (1) Measurement Value = Reading Level + Correct Factor.
- (2) Margin Level = Measurement Value - Limit Value.

Test Mode: TX N-40M Mode 2427 MHz

Horizontal

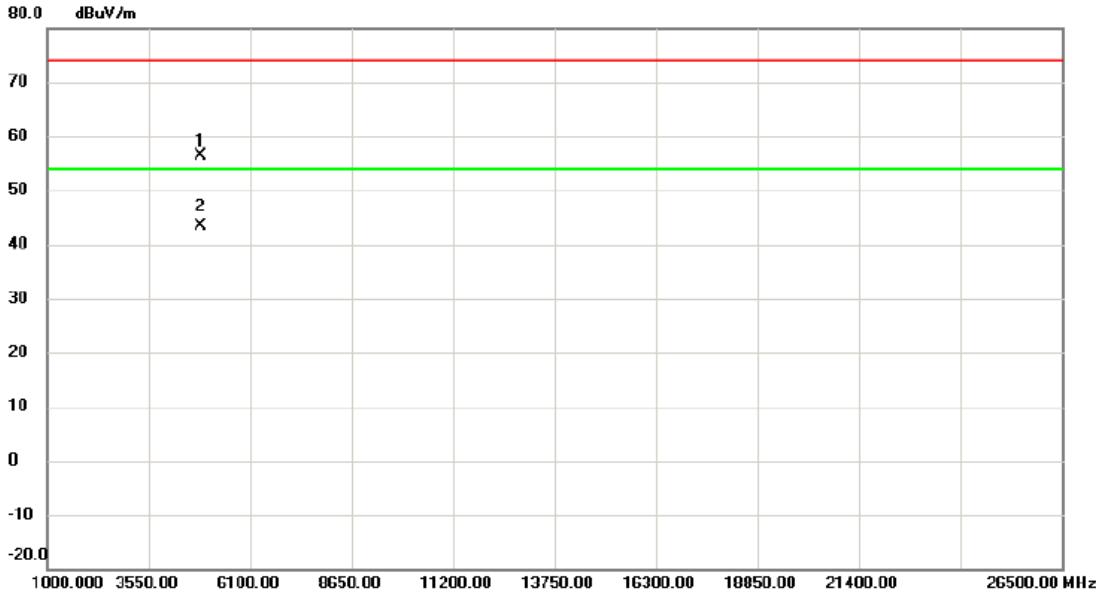

No. Mk.	Freq. MHz	Reading Level dBuV	Correct Factor dB	Measurement dBuV/m	Limit dBuV/m	Margin dB	Detector	Comment
1	4851.650	51.54	4.88	56.42	74.00	-17.58	peak	
2 *	4856.100	38.55	4.91	43.46	54.00	-10.54	AVG	

REMARKS:

- (1) Measurement Value = Reading Level + Correct Factor.
- (2) Margin Level = Measurement Value - Limit Value.

Test Mode: TX N-40M Mode 2437 MHz

Vertical

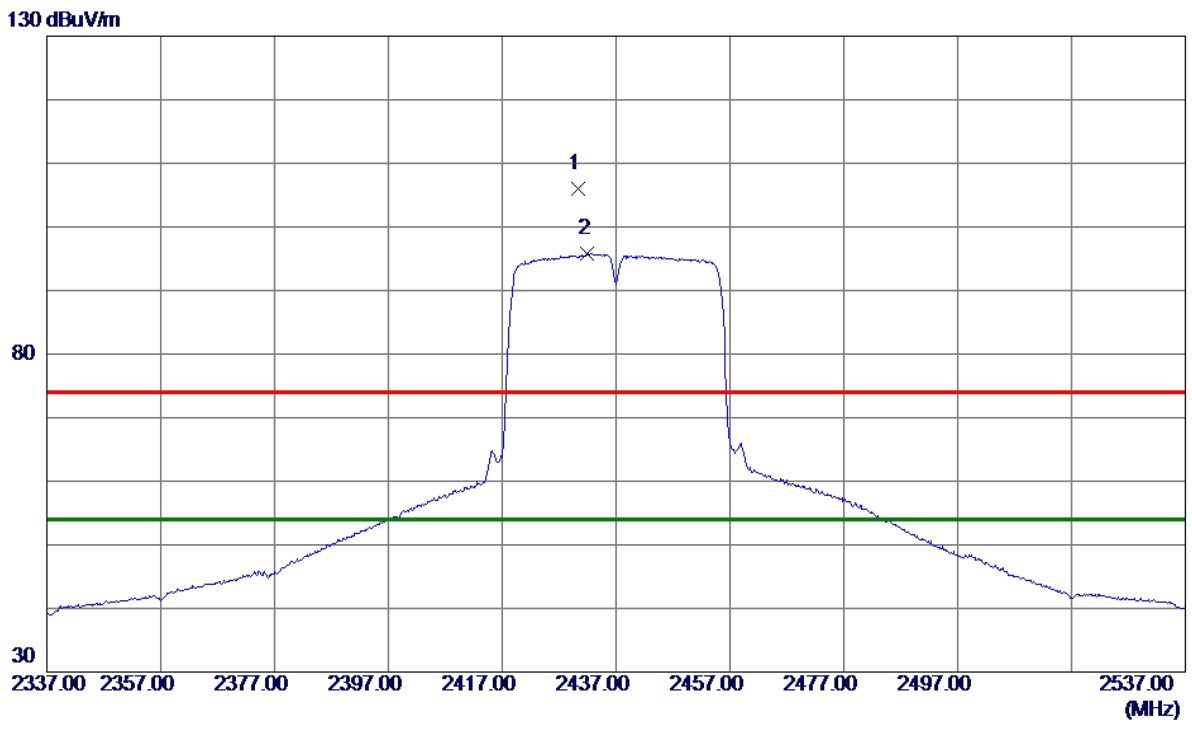

No.	Freq. MHz	Reading Level dBuV/m	Correct Factor dB	Measure ment dBuV/m	Limit dBuV/m	Margin dB	Detector	Comment
1	2430.4000	97.74	8.23	105.97	74.00	31.97	Peak	No Limit
2 *	2432.0000	87.60	8.23	95.83	54.00	41.83	AVG	No Limit

REMARKS:

- (1) Measurement Value = Reading Level + Correct Factor.
- (2) Margin Level = Measurement Value - Limit Value.

Test Mode: TX N-40M Mode 2437 MHz

Vertical

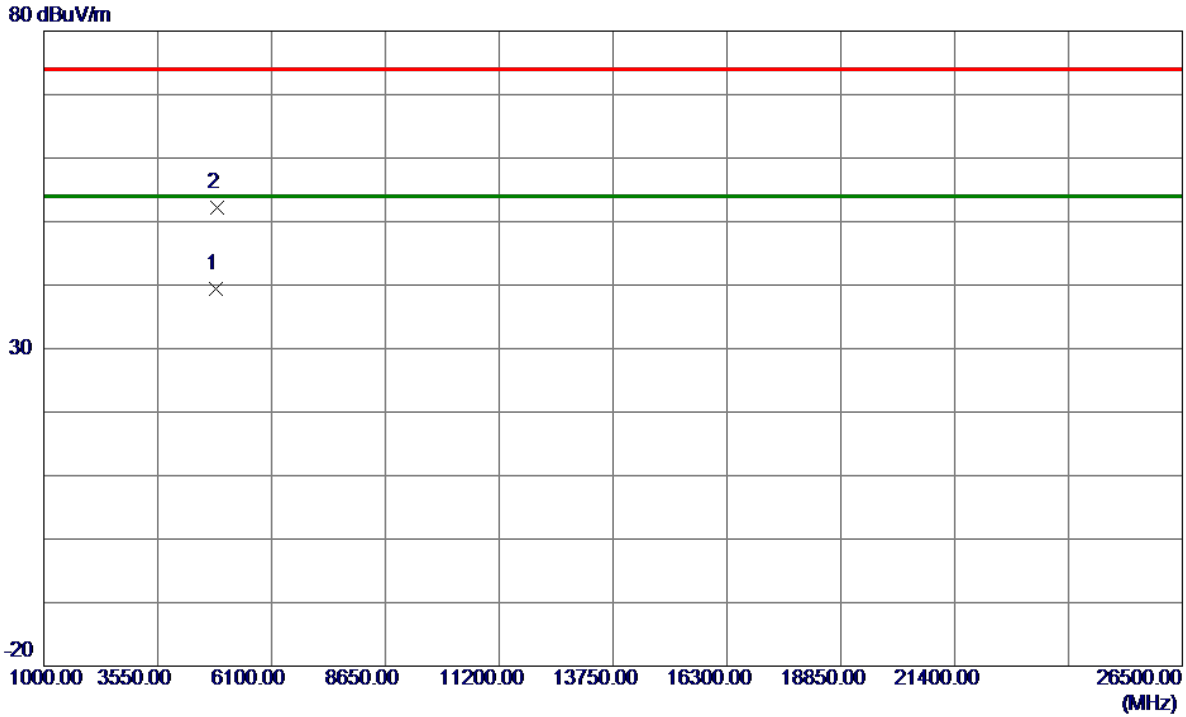

No.	Freq. MHz	Reading Level dBuV/m	Correct Factor dB	Measure ment dBuV/m	Limit dBuV/m	Margin dB	Detector	Comment
1 *	4867.4500	34.37	4.96	39.33	54.00	-14.67	AVG	
2	4872.5500	47.29	4.98	52.27	74.00	-21.73	Peak	

REMARKS:

- (1) Measurement Value = Reading Level + Correct Factor.
- (2) Margin Level = Measurement Value - Limit Value.

Test Mode: TX N-40M Mode 2437 MHz

Horizontal

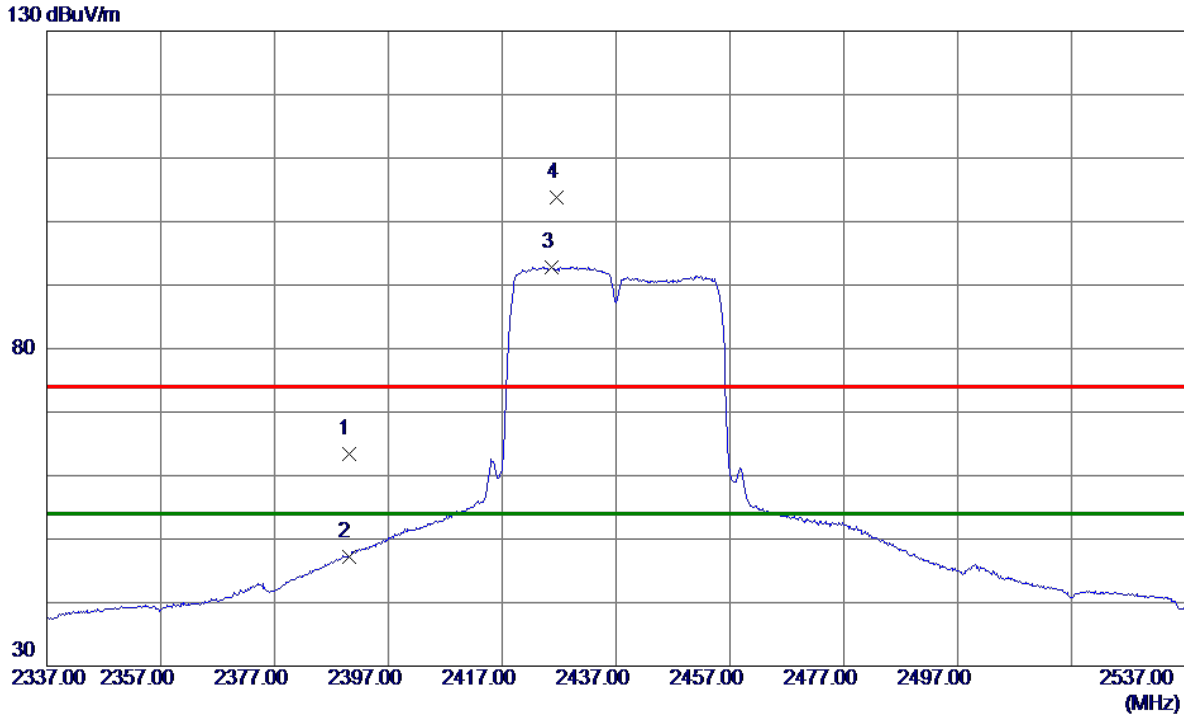

No.	Freq. MHz	Reading Level dBuV/m	Correct Factor dB	Measure ment dBuV/m	Limit dBuV/m	Margin dB	Detector	Comment
1	2390.0000	55.75	7.56	63.31	74.00	-10.69	Peak	
2	2390.0000	39.68	7.56	47.24	54.00	-6.76	AVG	
3 *	2425.7000	85.14	7.68	92.82	54.00	38.82	AVG	No Limit
4	2426.5000	96.12	7.69	103.81	74.00	29.81	Peak	No Limit

REMARKS:
 (1) Measurement Value = Reading Level + Correct Factor.
 (2) Margin Level = Measurement Value - Limit Value.

Test Mode: TX N-40M Mode 2437 MHz

Horizontal

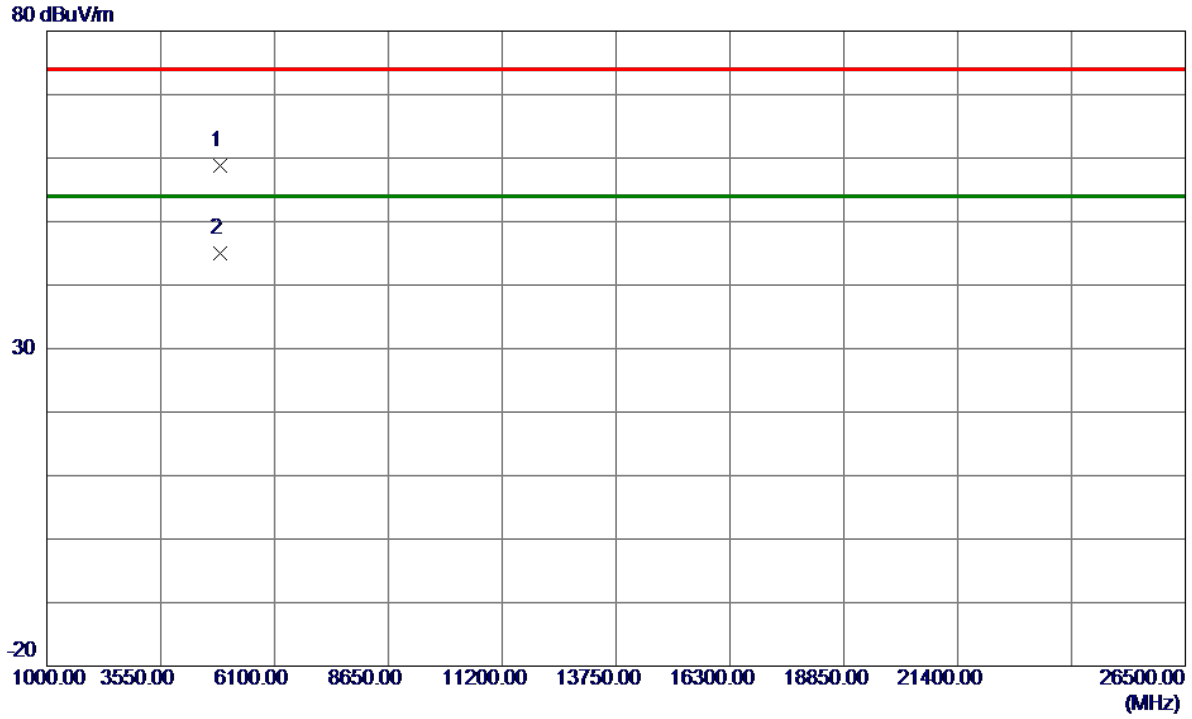

No.	Freq. MHz	Reading Level dBuV/m	Correct Factor dB	Measure ment dBuV/m	Limit dBuV/m	Margin dB	Detector	Comment
1	4873.0000	53.78	4.99	58.77	74.00	-15.23	Peak	
2 *	4874.2500	39.95	4.99	44.94	54.00	-9.06	AVG	

REMARKS:
 (1) Measurement Value = Reading Level + Correct Factor.
 (2) Margin Level = Measurement Value - Limit Value.

Test Mode: TX N-40M Mode 2447 MHz

Vertical

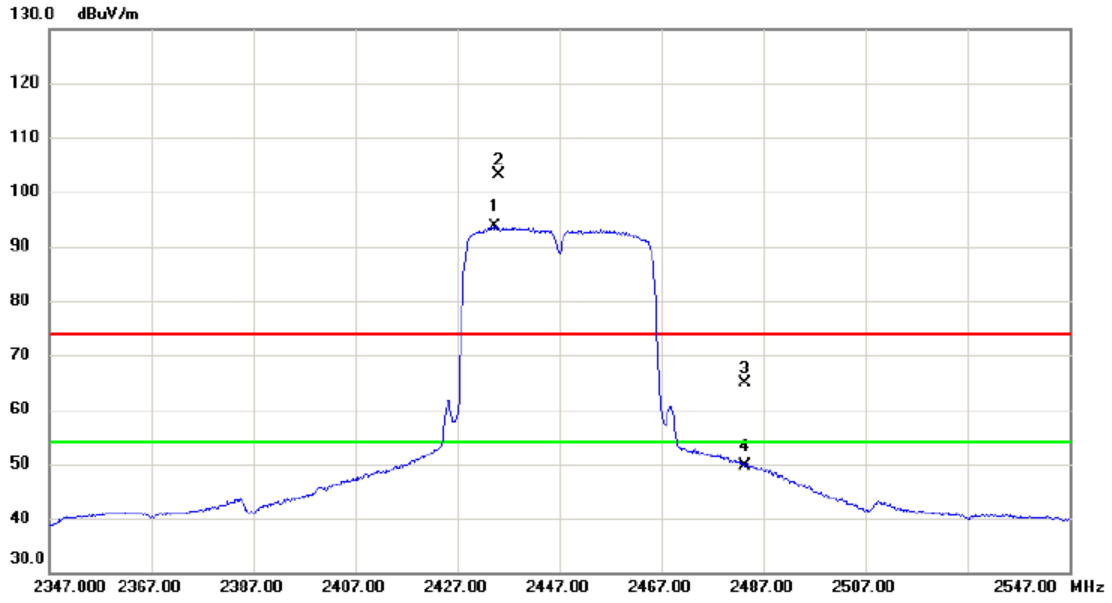

No.	Mk.	Freq.	Reading Level	Correct Factor	Measurement	Limit	Margin		
		MHz	dBuV	dB	dBuV/m	dBuV/m	dB	Detector	Comment
1	*	2434.300	85.30	8.23	93.53	54.00	39.53	AVG	No Limit
2	X	2435.100	94.99	8.23	103.22	74.00	29.22	peak	No Limit
3		2483.500	56.51	8.38	64.89	74.00	-9.11	peak	
4		2483.500	41.37	8.38	49.75	54.00	-4.25	AVG	

REMARKS:

- (1) Measurement Value = Reading Level + Correct Factor.
- (2) Margin Level = Measurement Value - Limit Value.

Test Mode: TX N-40M Mode 2447 MHz

Vertical

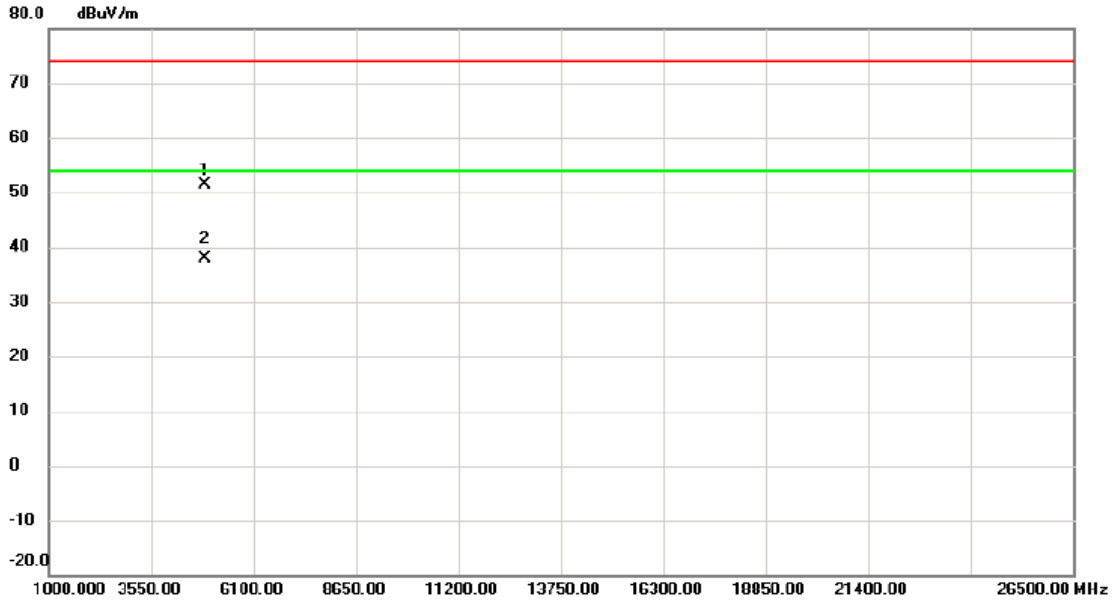

No.	Mk.	Freq. MHz	Reading Level dBuV	Correct Factor dB	Measure- ment dBuV/m	Limit dBuV/m	Margin dB	Detector	Comment
1		4892.650	46.23	5.08	51.31	74.00	-22.69	peak	
2	*	4893.700	32.87	5.09	37.96	54.00	-16.04	AVG	

REMARKS:

(1) Measurement Value = Reading Level + Correct Factor.

(2) Margin Level = Measurement Value - Limit Value.

Test Mode: TX N-40M Mode 2447 MHz

Horizontal

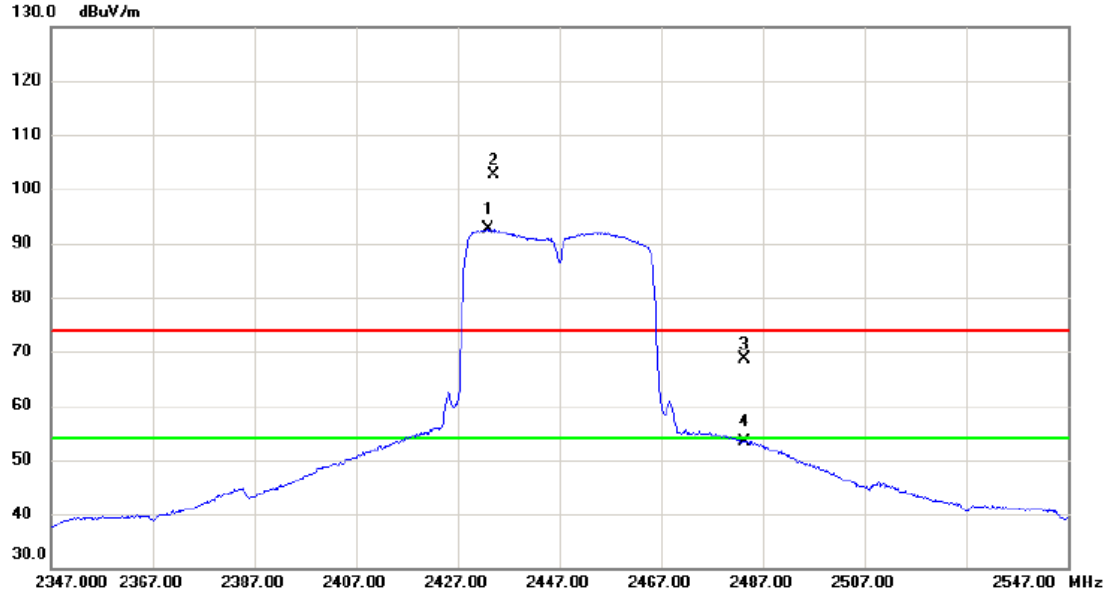

No. Mk.	Freq. MHz	Reading Level dBuV	Correct Factor dB	Measure- ment dBuV/m	Limit dBuV/m	Margin dB	Detector	Comment
1 *	2432.900	84.96	7.70	92.66	54.00	38.66	AVG	No Limit
2 X	2434.000	94.81	7.70	102.51	74.00	28.51	peak	No Limit
3	2483.500	60.86	7.87	68.73	74.00	-5.27	peak	
4	2483.500	45.50	7.87	53.37	54.00	-0.63	AVG	

REMARKS:

- (1) Measurement Value = Reading Level + Correct Factor.
- (2) Margin Level = Measurement Value - Limit Value.

Test Mode: TX N-40M Mode 2447 MHz

Horizontal

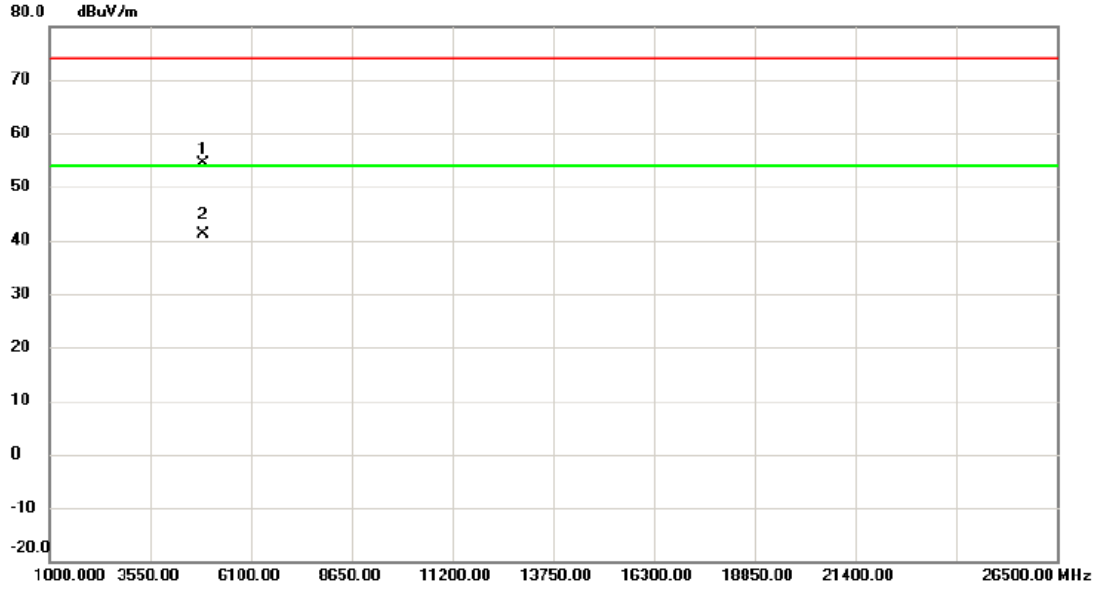

No.	Mk.	Freq. MHz	Reading Level dBuV	Correct Factor dB	Measure- ment dBuV/m	Limit dBuV/m	Margin dB	Detector	Comment
1		4893.500	49.36	5.09	54.45	74.00	-19.55	peak	
2	*	4893.850	35.95	5.09	41.04	54.00	-12.96	AVG	

REMARKS:

- (1) Measurement Value = Reading Level + Correct Factor.
- (2) Margin Level = Measurement Value - Limit Value.

Test Mode: TX N-40M Mode 2452 MHz

Vertical

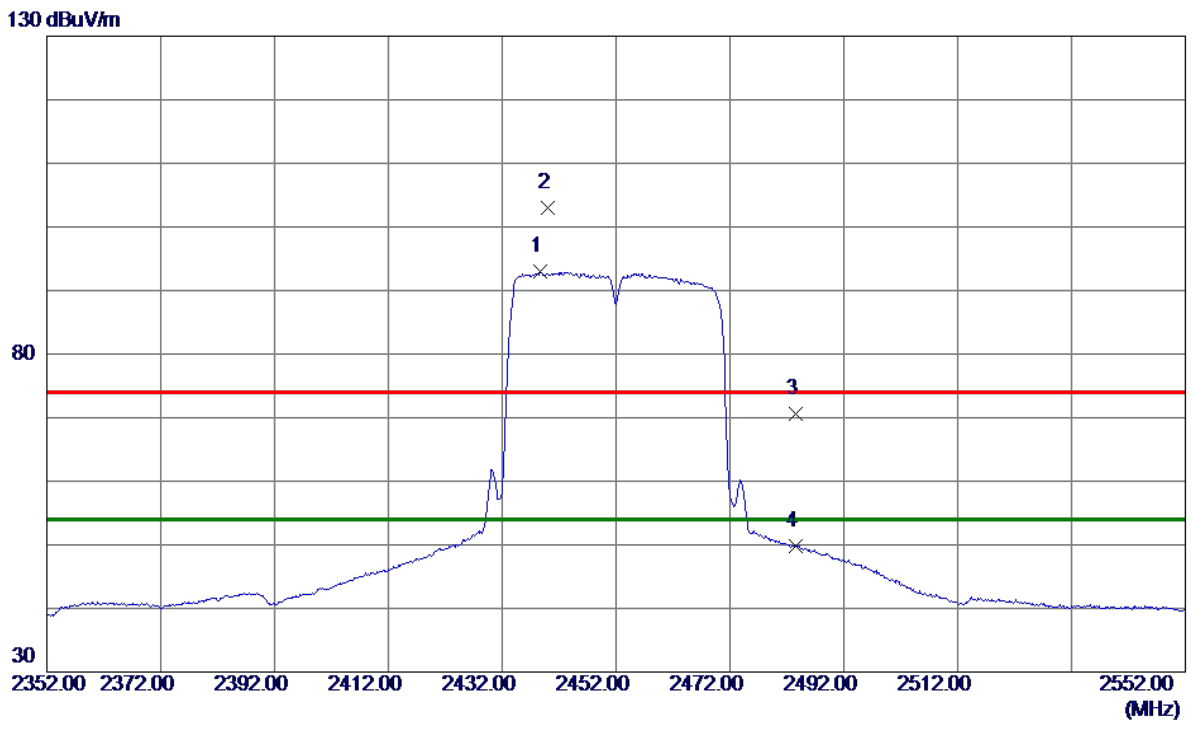

No.	Freq. MHz	Reading Level dBuV/m	Correct Factor dB	Measure ment dBuV/m	Limit dBuV/m	Margin dB	Detector	Comment
1 *	2438.7000	84.67	8.25	92.92	54.00	38.92	AVG	No Limit
2	2440.0000	94.75	8.25	103.00	74.00	29.00	Peak	No Limit
3	2483.5000	62.18	8.38	70.56	74.00	-3.44	Peak	
4	2483.5000	41.35	8.38	49.73	54.00	-4.27	AVG	

REMARKS:

- (1) Measurement Value = Reading Level + Correct Factor.
- (2) Margin Level = Measurement Value - Limit Value.

Test Mode: TX N-40M Mode 2452 MHz

Vertical

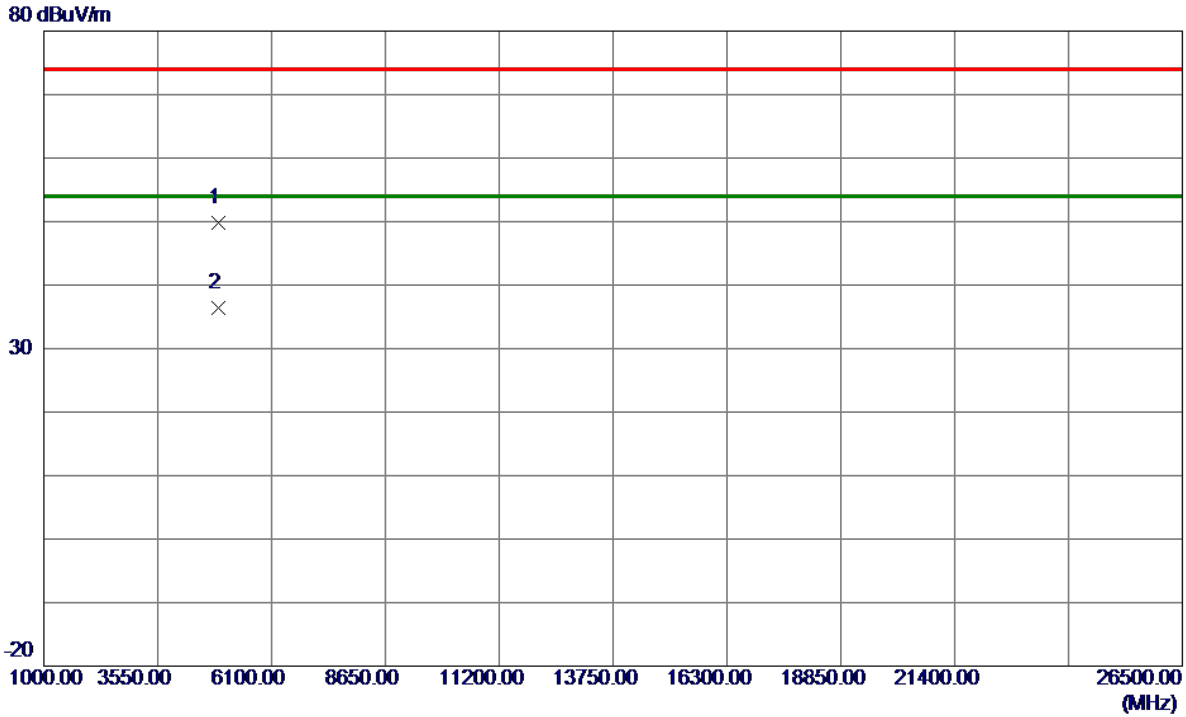

No.	Freq. MHz	Reading Level dBuV/m	Correct Factor dB	Measure ment dBuV/m	Limit dBuV/m	Margin dB	Detector	Comment
1	4902.3500	44.64	5.13	49.77	74.00	-24.23	Peak	
2 *	4904.4000	31.18	5.14	36.32	54.00	-17.68	AVG	

REMARKS:

- (1) Measurement Value = Reading Level + Correct Factor.
- (2) Margin Level = Measurement Value - Limit Value.

Test Mode: TX N-40M Mode 2452 MHz

Horizontal

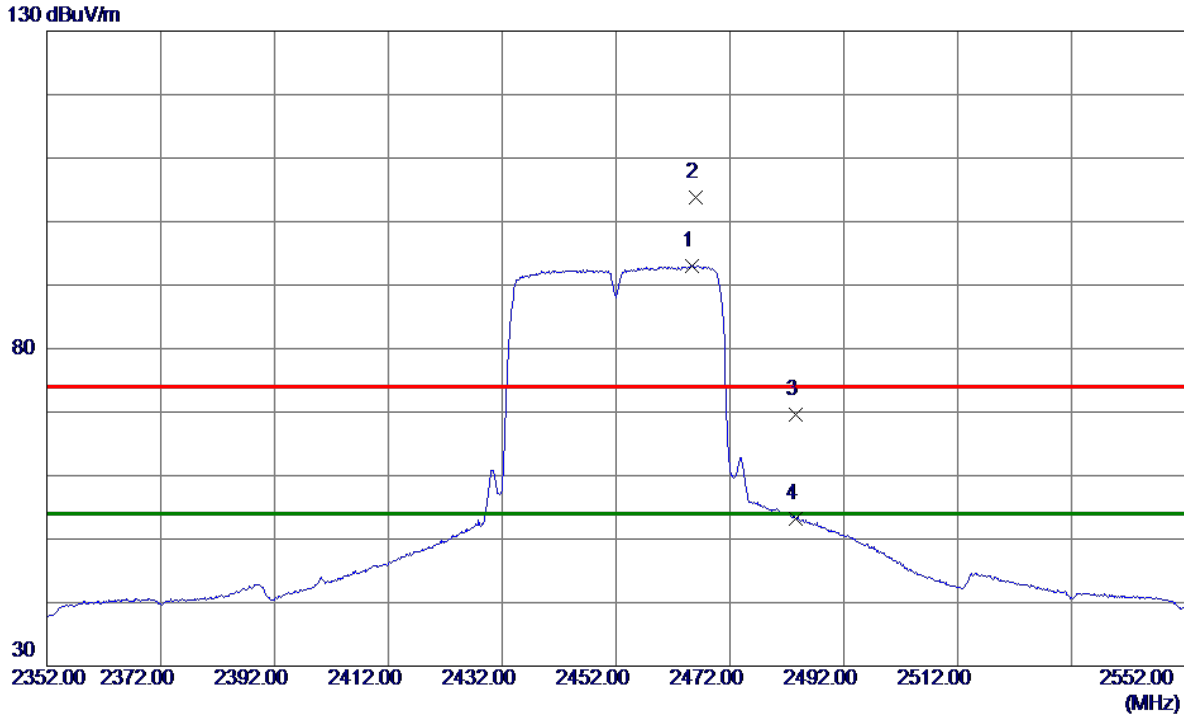

No.	Freq. MHz	Reading Level dBuV/m	Correct Factor dB	Measure ment dBuV/m	Limit dBuV/m	Margin dB	Detector	Comment
1 *	2465.4000	85.25	7.82	93.07	54.00	39.07	AVG	No Limit
2	2465.9000	95.98	7.82	103.80	74.00	29.80	Peak	No Limit
3	2483.5000	61.71	7.88	69.59	74.00	-4.41	Peak	
4	2483.5000	45.35	7.88	53.23	54.00	-0.77	AVG	

REMARKS:
 (1) Measurement Value = Reading Level + Correct Factor.
 (2) Margin Level = Measurement Value - Limit Value.

Test Mode: TX N-40M Mode 2452 MHz

Horizontal

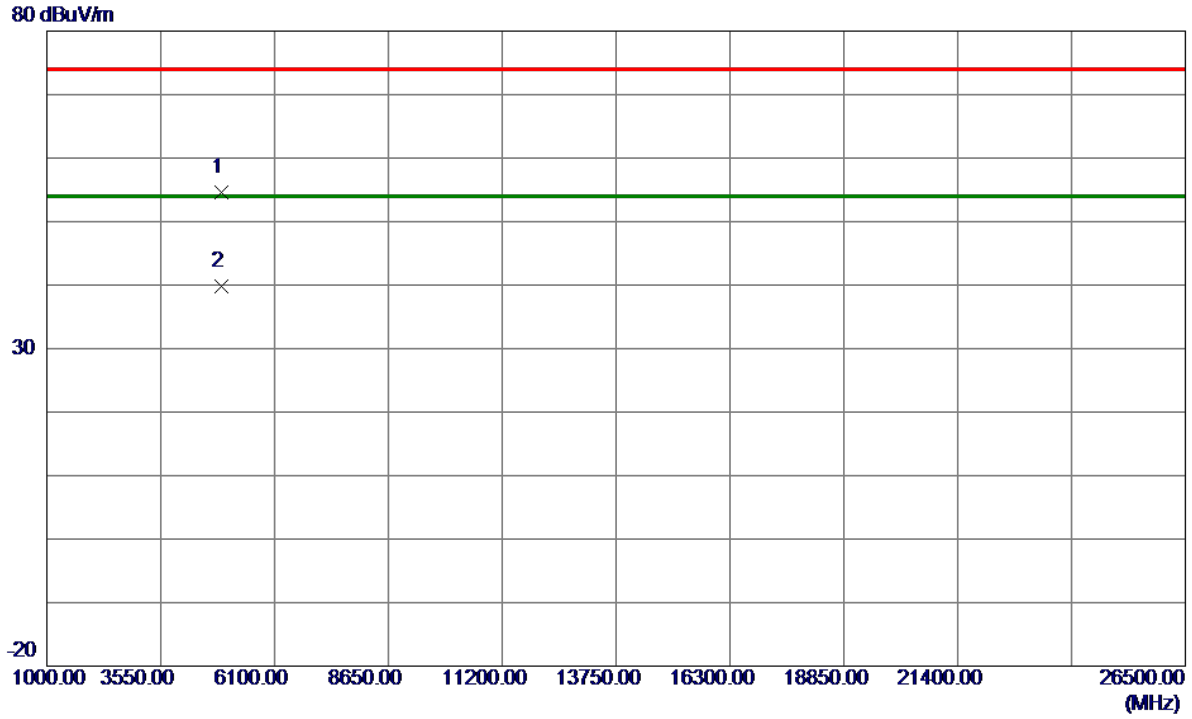

No.	Freq. MHz	Reading Level dBuV/m	Correct Factor dB	Measure ment dBuV/m	Limit dBuV/m	Margin dB	Detector	Comment
1	4902.9000	49.53	5.13	54.66	74.00	-19.34	Peak	
2 *	4904.0000	34.75	5.14	39.89	54.00	-14.11	AVG	

REMARKS:
 (1) Measurement Value = Reading Level + Correct Factor.
 (2) Margin Level = Measurement Value - Limit Value.

APPENDIX E - BANDWIDTH

Test Mode	TX B Mode
-----------	-----------

Channel	Frequency (MHz)	6 dB Bandwidth (MHz)	6 dB Bandwidth Min. Limit (kHz)	Result
01	2412	9.07	500	Complies
06	2437	9.10	500	Complies
11	2462	9.06	500	Complies

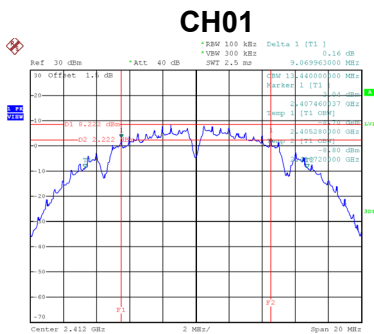

Date: 20_AUG.2019 16:45:40

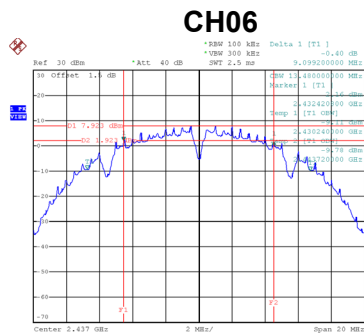

Date: 20_AUG.2019 16:47:44

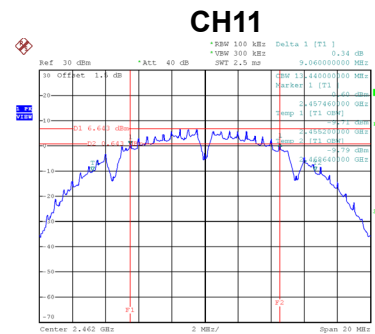

Date: 20_AUG.2019 16:49:36

Channel	Frequency (MHz)	99 % Emission Bandwidth (MHz)	Result
01	2412	13.50	Complies
06	2437	13.50	Complies
11	2462	13.50	Complies

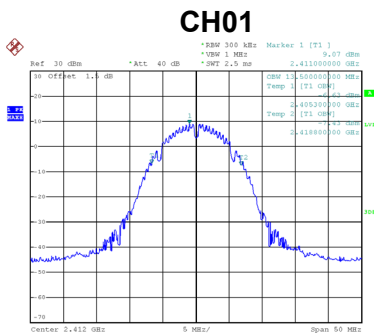

Date: 20_AUG.2019 17:19:54

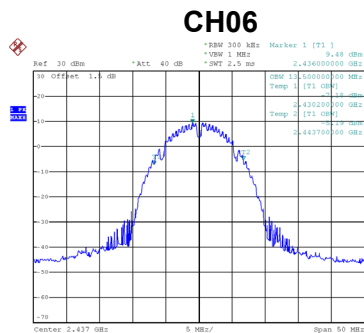

Date: 20_AUG.2019 17:22:26

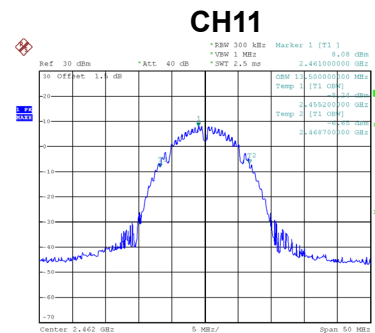

Date: 20_AUG.2019 17:23:05

Test Mode	TX G Mode
-----------	-----------

Channel	Frequency (MHz)	6 dB Bandwidth (MHz)	6 dB Bandwidth Min. Limit (kHz)	Result
01	2412	16.43	500	Complies
06	2437	16.42	500	Complies
11	2462	16.40	500	Complies

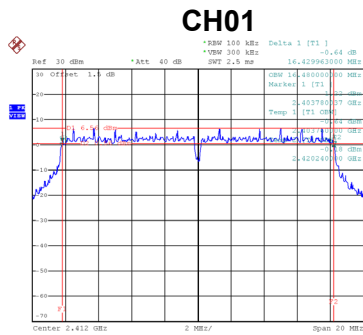

Date: 20.AUG.2019 16:51:12

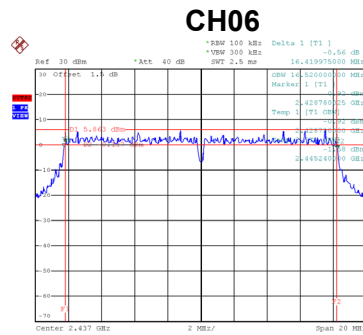

Date: 20.AUG.2019 16:52:34

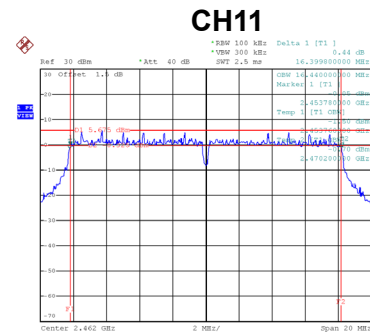

Date: 20.AUG.2019 16:54:21

Channel	Frequency (MHz)	99 % Emission Bandwidth (MHz)	Result
01	2412	17.20	Complies
06	2437	17.20	Complies
11	2462	17.10	Complies

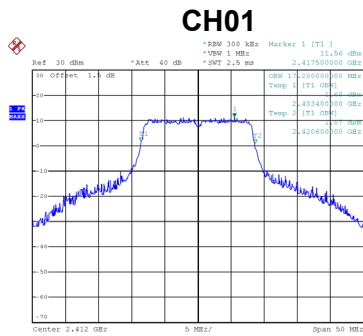

Date: 20.AUG.2019 17:24:21

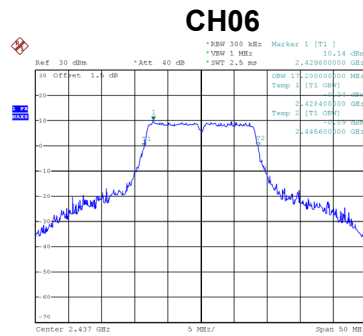

Date: 20.AUG.2019 17:24:50

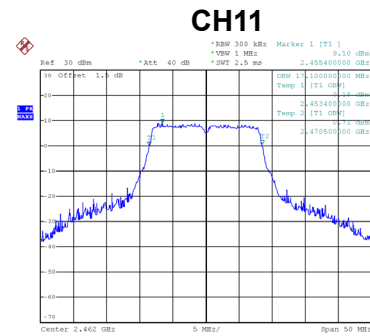

Date: 20.AUG.2019 17:25:21

Test Mode	TX N-20M Mode
-----------	---------------

Channel	Frequency (MHz)	6 dB Bandwidth (MHz)	6 dB Bandwidth Min. Limit (kHz)	Result
01	2412	17.64	500	Complies
06	2437	17.35	500	Complies
11	2462	17.59	500	Complies

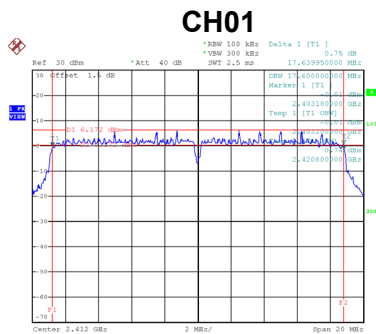

Date: 20.AUG.2019 16:55:52

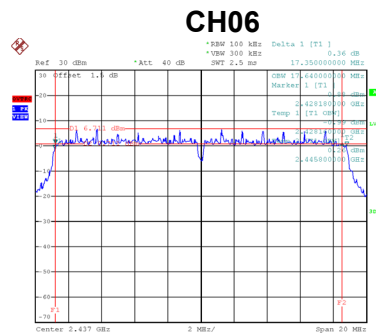

Date: 20.AUG.2019 16:57:19

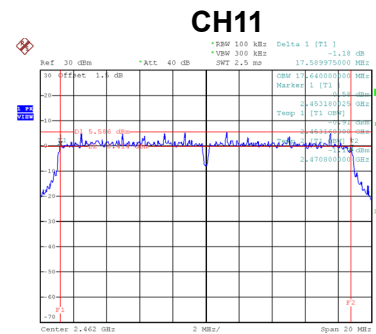

Date: 20.AUG.2019 16:58:55

Channel	Frequency (MHz)	99 % Emission Bandwidth (MHz)	Result
01	2412	18.10	Complies
06	2437	18.10	Complies
11	2462	18.10	Complies

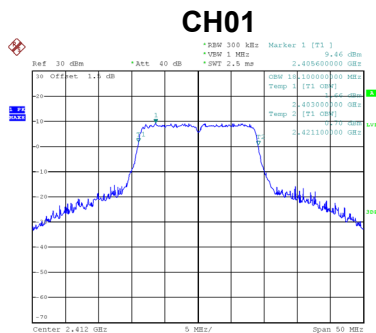

Date: 20.AUG.2019 17:27:30

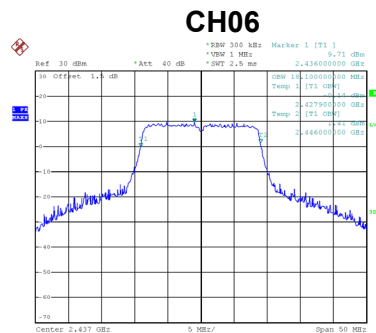

Date: 20.AUG.2019 17:26:47

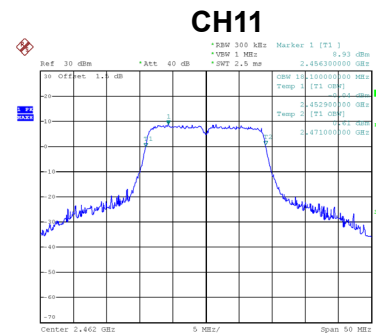

Date: 20.AUG.2019 17:26:07

Test Mode	TX N-40M Mode
-----------	---------------

Channel	Frequency (MHz)	6 dB Bandwidth (MHz)	6 dB Bandwidth Min. Limit (kHz)	Result
03	2422	36.07	500	Complies
06	2437	35.88	500	Complies
09	2452	35.99	500	Complies

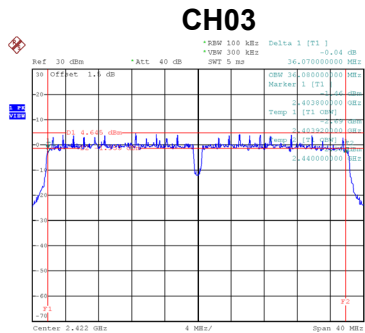

Date: 20.AUG.2019 17:00:33

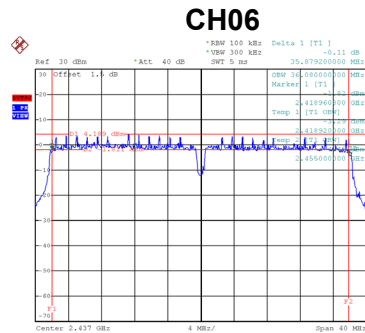

Date: 20.AUG.2019 17:03:01

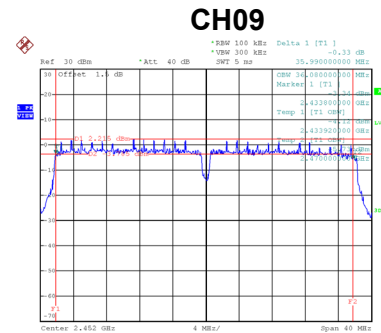

Date: 20.AUG.2019 17:04:47

Channel	Frequency (MHz)	99 % Emission Bandwidth (MHz)	Result
03	2422	37.40	Complies
06	2437	37.40	Complies
09	2452	37.00	Complies

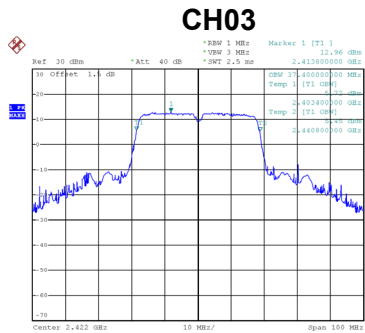

Date: 20.AUG.2019 17:29:08

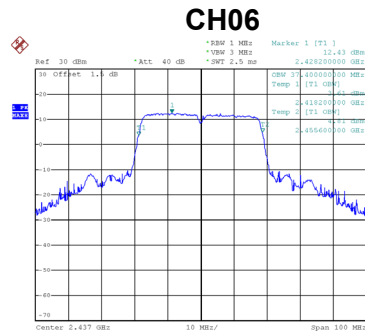

Date: 20.AUG.2019 17:30:03

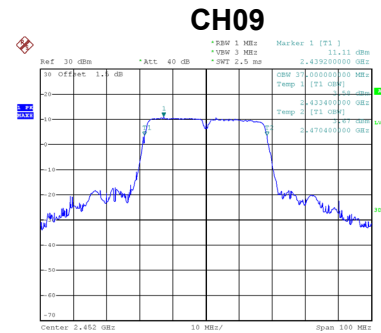

Date: 20.AUG.2019 17:30:44

APPENDIX F - MAXIMUM AVERAGE OUTPUT POWER

Test Mode	TX B Mode
-----------	-----------

Channel	Frequency (MHz)	Average Output Power (dBm)	Duty Factor	Average Output Power + Duty Factor (dBm)	Max. Limit (dBm)	Max. Limit (W)	Result
01	2412	18.20	0.00	18.20	30.00	1.0000	Complies
06	2437	18.28	0.00	18.28	30.00	1.0000	Complies
11	2462	17.33	0.00	17.33	30.00	1.0000	Complies

Test Mode	TX G Mode
-----------	-----------

Channel	Frequency (MHz)	Average Output Power (dBm)	Duty Factor	Average Output Power + Duty Factor (dBm)	Max. Limit (dBm)	Max. Limit (W)	Result
01	2412	19.05	0.45	19.50	30.00	1.0000	Complies
06	2437	19.22	0.45	19.67	30.00	1.0000	Complies
11	2462	17.47	0.45	17.92	30.00	1.0000	Complies

Test Mode	TX N-20M Mode
-----------	---------------

Channel	Frequency (MHz)	Average Output Power (dBm)	Duty Factor	Average Output Power + Duty Factor (dBm)	Max. Limit (dBm)	Max. Limit (W)	Result
01	2412	18.48	0.45	18.93	30.00	1.0000	Complies
06	2437	18.79	0.45	19.24	30.00	1.0000	Complies
11	2462	17.64	0.45	18.09	30.00	1.0000	Complies

Test Mode	TX N-40M Mode
-----------	---------------

Channel	Frequency (MHz)	Average Output Power (dBm)	Duty Factor	Average Output Power + Duty Factor (dBm)	Max. Limit (dBm)	Max. Limit (W)	Result
03	2422	17.91	1.61	19.52	30.00	1.0000	Complies
06	2437	18.16	1.61	19.77	30.00	1.0000	Complies
09	2452	16.85	1.61	18.46	30.00	1.0000	Complies

APPENDIX G - CONDUCTED SPURIOUS EMISSIONS