



# User Guide

## Kasa Spot Pan Tilt

# Contents

About This Guide .....	1
Introduction .....	2
Appearance .....	3
Set Up Your Camera .....	4
Use Your Camera .....	5
Authentication .....	7

# About This Guide

This guide provides a brief introduction to the Kasa Spot and the Kasa Smart app, as well as regulatory information.

Please note that features of the product may vary slightly depending on the model and software version you have, and on your location, language and internet service provider. All images, parameters and descriptions documented in this guide are used for demonstration only.

## Conventions

In this guide, the following convention is used:

Convention	Description
Teal	Key information appears in teal, including management page text such as menus, items, buttons and so on.
<u>Underline</u>	Hyperlinks are in teal and underlined. You can click to redirect to a website.

## More Info

- Specifications can be found on the product page at <https://www.tp-link.com>.
- Our Technical Support and troubleshooting information can be found at <https://www.tp-link.com/support>.
- Frequently Asked Questions (FAQs) can be found at <https://www.tp-link.com/support/faq>.

# Introduction

With the Kasa Spot Pan Tilt connected to your home network, you can get the full picture of any space in your apartment, dorm or home. With a 360° horizontal view and 118° vertical view, the Pan Tilt has everything covered. With Motion Tracking and Patrol Mode, track activity from beginning to end and set multiple distinct viewpoints for your camera to monitor at set intervals.

- **Simple Setup** - Easily connects your camera to your home network and place it almost anywhere.
- **Crystal Clear Video** – Sharp and clear 1080p full-HD provides high-quality video right in the palm of your hand.
- **Pan and Tilt** – Swipe up, down, left and right on your phone to rotate and set the camera's point of view.
- **Motion Tracking** – When motion activity is detected, Kasa Spot Pan Tilt tracks and follows the subject to keep it within the camera's field of view.
- **Cloud Storage Plans** – Upgrade your Kasa Care subscription plan and enjoy full video recordings for up to 30 days.
- **Night Vision** – Even at night, the camera will detect activity 30 ft. away with night vision.
- **Patrol Mode** – Set multiple distinct viewpoints and program your pan tilt camera to keep an eye on each region at intervals of your choosing.
- **Two-Way Audio** - Use crisp two-way audio to communicate with nosy roommates, family or even mischievous pets.



# Appearance

Kasa Spot Pan Tilt has a system LED that changes color according to its status, a microphone, a speaker, a micro USB port, and a RESET button. Refer below for details.

## System LED

- **Solid amber:**  
Rebooting
- **Alternating amber and green:**  
SoftAP Mode
- **Flashing red:**  
Connecting to Wi-Fi
- **Flashing green:**  
Connected to Wi-Fi
- **Solid green:**  
Bound to Cloud
- **Flashing amber:**  
Resetting to SoftAP/Factory mode

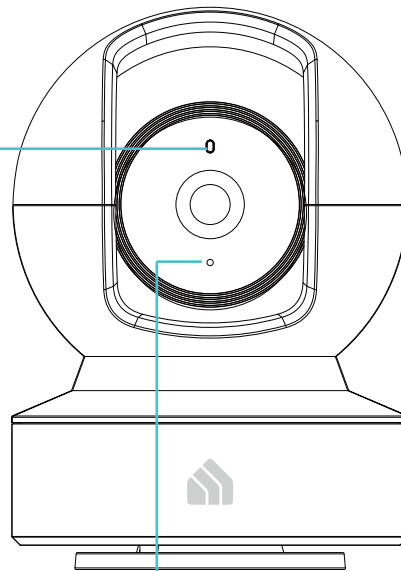

## Microphone

Built-in internal microphone.  
Note: Do NOT insert objects into the hole.

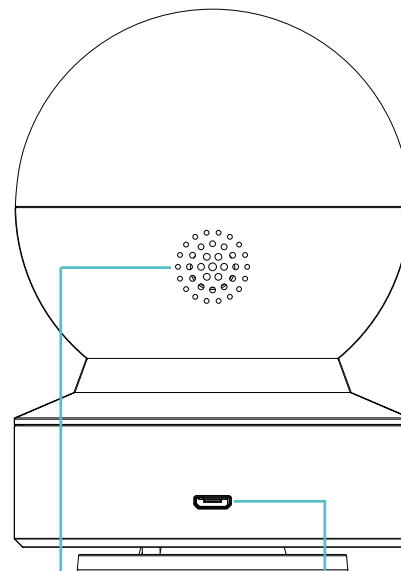

## Speaker

The sound comes out of the camera.

## Micro USB Port

Connect the power cord provided.

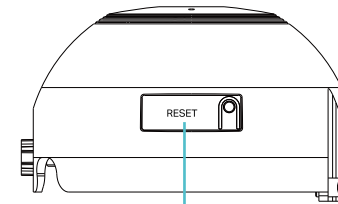

## RESET Button

- **Press and hold for 3 to 15 seconds:**  
Reset to SoftAP mode
- **Press and hold for over 15 seconds:**  
Reset to Factory mode

# Set Up Your Camera

Follow the steps below to get started with your new camera.

## Step 1. Download Kasa

Get the [Kasa Smart](#) app from the Apple App Store or Google Play, or by scanning the QR code below.



## Step 2. Log In

Open the app, and log in with your TP-Link ID. If you don't have an account, create one first.

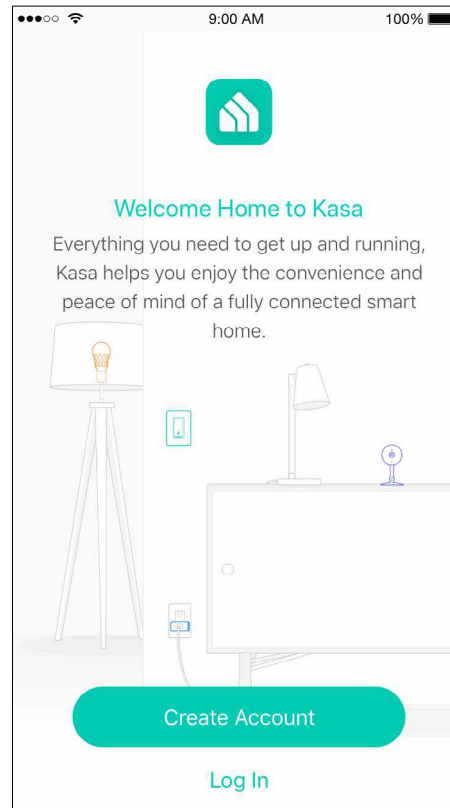

## Step 3. Start Setup

Tap the ⊕ button in the Kasa app and select [Kasa Spot Pan Tilt](#).

# Use Your Camera

After initial setup is complete, you can view and manage your camera with the Kasa app.

## View the Live Video

You can view your camera from anywhere at any time with your phone.

Go to the [Devices](#) page, then tap a camera to view the live video.

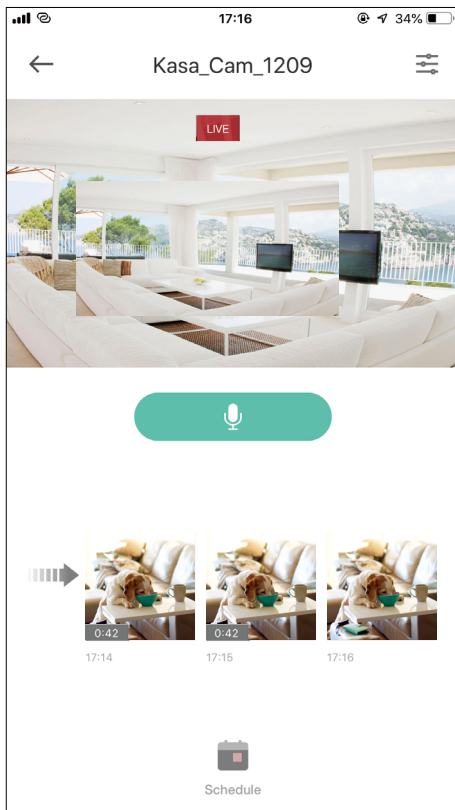

## Change Camera Settings

You can change the settings of your camera to meet various needs.

Go to the [Devices](#) page, tap a camera, then tap  to view and change camera settings.

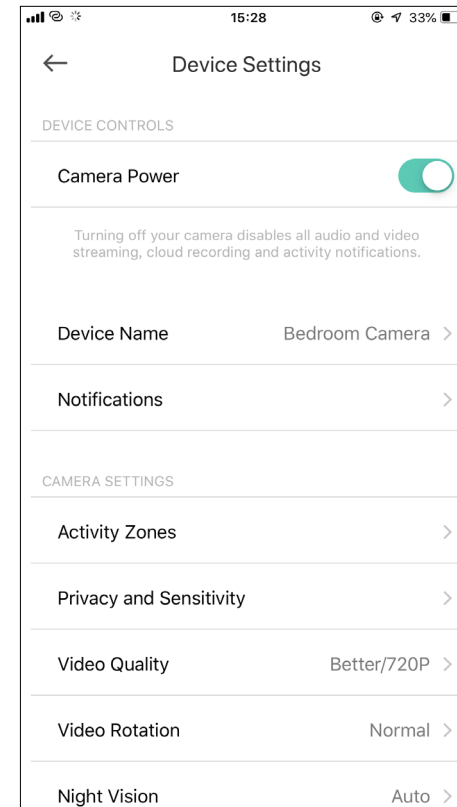

## Check Activity Notifications

When you receive an instant alert you can view live video immediately or check recordings anytime.

Go to the [Activity](#) page to view activity notifications on each date. You can tap  for notification settings.

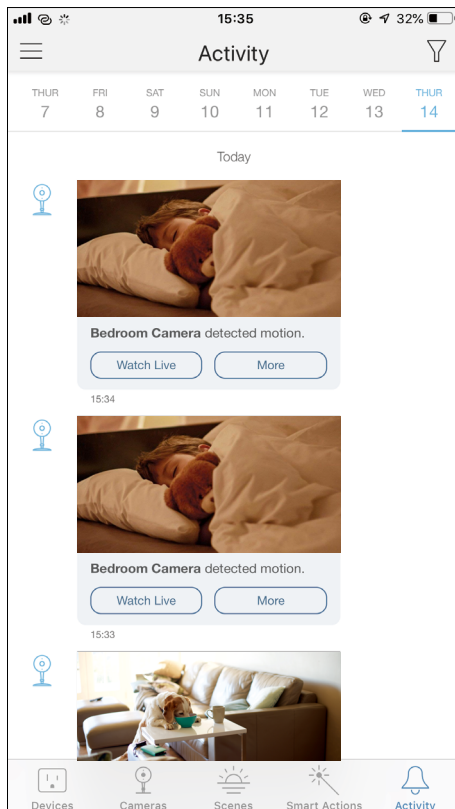

## Control Your Camera Smartly

You can easily control your camera together with other smart home devices. With Kasa Smart, your home is never more than a few taps away.

For more information, go to the Kasa Smart app.

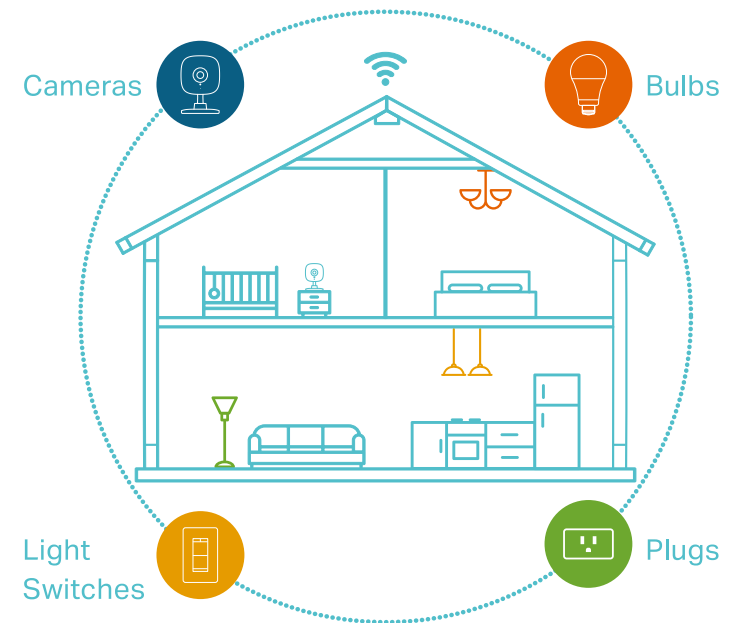



# Authentication

## COPYRIGHT & TRADEMARKS

Specifications are subject to change without notice.  tp-link is a registered trademark of TP-Link Technologies Co., Ltd. Other brands and product names are trademarks or registered trademarks of their respective holders.

No part of the specifications may be reproduced in any form or by any means or used to make any derivative such as translation, transformation, or adaptation without permission from TP-Link Technologies Co., Ltd. Copyright © 2019 TP-Link Technologies Co., Ltd. All rights reserved.

**FCC compliance information statement**



**Product Name: Kasa Spot Pan Tilt**

**Model Number: KC110**

Component Name	Model	FCC Identifier number
AC ADAPTER	NBS05B050100VUU	NA

**Responsible Party:**

**TP-Link USA Corporation, d/b/a TP-Link North America, Inc.**

Address: 145 South State College Blvd. Suite 400, Brea, CA 92821

Website: <http://www.tp-link.com/us/>

Tel: +1 626 333 0234

Fax: +1 909 527 6803

E-mail: [sales.usa@tp-link.com](mailto:sales.usa@tp-link.com)

This equipment has been tested and found to comply with the limits for a Class B digital device, pursuant to part 15 of the FCC Rules. These limits are designed to provide reasonable protection against harmful interference in a residential installation. This equipment generates, uses and can radiate radio frequency energy and, if not installed and used in accordance with the instructions, may cause harmful interference to radio communications. However, there is no guarantee that interference will not occur in a particular installation. If this equipment does cause harmful interference to radio or television reception, which can be determined by turning the equipment off and on, the user is encouraged to try to correct the interference by one or more of the following measures:

- Increase the separation between the equipment and receiver.
- Connect the equipment into an outlet on a circuit different from that to which the receiver is connected.
- Consult the dealer or an experienced radio/ TV technician for help.

This device complies with part 15 of the FCC Rules. Operation is subject to the following two conditions:

1. This device may not cause harmful interference.
2. This device must accept any interference received, including interference that may cause undesired operation.

Any changes or modifications not expressly approved by the party responsible for compliance could void the user's authority to operate the equipment.

Note: The manufacturer is not responsible for any radio or TV interference caused by unauthorized modifications to this equipment. Such modifications could void the user's authority to operate the equipment.

### **FCC RF Radiation Exposure Statement**

This equipment complies with FCC RF radiation exposure limits set forth for an uncontrolled environment. This device and its antenna must not be co-located or operating in conjunction with any other antenna or transmitter.

"To comply with FCC RF exposure compliance requirements, this grant is applicable to only Mobile Configurations. The antennas used for this transmitter must be installed to provide a separation distance of at least 20 cm from all persons and must not be co-located or operating in conjunction with any other antenna or transmitter."

We, **TP-Link USA Corporation**, has determined that the equipment shown as above has been shown to comply with the applicable technical standards, FCC part 15. There is no unauthorized change is made in the equipment and the equipment is properly maintained and operated.

**Issue Date: 2019-04-08**

**FCC compliance information statement**

**Product Name: AC ADAPTER**

**Model Number: NBS05B050100VUU**

**Responsible Party:**

**TP-Link USA Corporation, d/b/a TP-Link North America, Inc.**

Address: 145 South State College Blvd. Suite 400, Brea, CA 92821

Website: <http://www.tp-link.com/us/>

Tel: +1 626 333 0234

Fax: +1 909 527 6803

E-mail: [sales.usa@tp-link.com](mailto:sales.usa@tp-link.com)

This equipment has been tested and found to comply with the limits for a Class B digital device, pursuant to part 15 of the FCC Rules. These limits are designed to provide reasonable protection against harmful interference in a residential installation. This equipment generates, uses and can radiate radio frequency energy and, if not installed and used in accordance with the instructions, may cause harmful interference to radio communications. However, there is no guarantee that interference will not occur in a particular installation. If this equipment does cause harmful interference to radio or television reception, which can be determined by turning the equipment off and on, the user is encouraged to try to correct the interference by one or more of the following measures:

- Increase the separation between the equipment and receiver.
- Connect the equipment into an outlet on a circuit different from that to which the receiver is connected.
- Consult the dealer or an experienced radio/ TV technician for help.

This device complies with part 15 of the FCC Rules. Operation is subject to the following two conditions:

1. This device may not cause harmful interference.
2. This device must accept any interference received, including interference that may cause undesired operation.

Any changes or modifications not expressly approved by the party responsible for compliance could void the user's authority to operate the equipment.

We, **TP-Link USA Corporation**, has determined that the equipment shown as above has been shown to comply with the applicable technical standards, FCC part 15. There is no unauthorized change is made in the equipment and the equipment is properly maintained and operated.

**Issue Date: 2019-04-08**

## CE Mark Warning



This is a class B product. In a domestic environment, this product may cause radio interference, in which case the user may be required to take adequate measures.

## OPERATING FREQUENCY (the maximum transmitted power)

2412MHz—2472MHz (20dBm)

## EU Declaration of Conformity

TP-Link hereby declares that the device is in compliance with the essential requirements and other relevant provisions of directives 2014/53/EU, 2009/125/EC and 2011/65/EU.

The original EU declaration of conformity may be found at <https://www.tp-link.com/en/ce>

## RF Exposure Information

This device meets the EU requirements (2014/53/EU Article 3.1a) on the limitation of exposure of the general public to electromagnetic fields by way of health protection.

The device complies with RF specifications when the device used at 20 cm from your body.

Restricted to indoor use.

## Canadian Compliance Statement

This device contains licence-exempt transmitter(s)/receiver(s) that comply with Innovation, Science and Economic Development Canada's licence-exempt RSS(s). Operation is subject to the following two conditions:

1. This device may not cause interference, and
2. This device must accept any interference, including interference that may cause undesired operation of the device.

L'émetteur/récepteur exempt de licence contenu dans le présent appareil est conforme aux CNR d'Innovation, Sciences et Développement économique Canada applicables aux appareils radio exempts de licence. L'exploitation est autorisée aux deux conditions suivantes :

1. l'appareil ne doit pas produire de brouillage;
2. l'utilisateur de l'appareil doit accepter tout brouillage radioélectrique subi, même si le brouillage est susceptible d'en compromettre le fonctionnement

## **Radiation Exposure Statement:**

This equipment complies with IC radiation exposure limits set forth for an uncontrolled environment. This equipment should be installed and operated with minimum distance 20cm between the radiator & your body.

## **Déclaration d'exposition aux radiations:**

Cet équipement est conforme aux limites d'exposition aux rayonnements IC établies pour un environnement non contrôlé. Cet équipement doit être installé et utilisé avec un minimum de 20 cm de distance entre la source de rayonnement et votre corps.

## **Industry Canada Statement**

CAN ICES-3 (B)/NMB-3(B)

## **Korea Warning Statements:**

당해 무선설비는 운용중 전파혼신 가능성이 있음.

## **NCC Notice & BSMI Notice:**

### **注意!**

依據 低功率電波輻射性電機管理辦法

第十二條 經型式認證合格之低功率射頻電機，非經許可，公司、商號或使用者均不得擅自變更頻率、加大功率或變更原設計之特性或功能。

第十四條 低功率射頻電機之使用不得影響飛航安全及干擾合法通行；經發現有干擾現象時，應立即停用，並改善至無干擾時方得繼續使用。前項合法通信，指依電信規定作業之無線電信。低功率射頻電機需忍受合法通信或工業、科學以及醫療用電波輻射性電機設備之干擾。

### **安全諮詢及注意事項**

- 請使用原裝電源供應器或只能按照本產品注明的電源類型使用本產品。
- 清潔本產品之前請先拔掉電源線。請勿使用液體、噴霧清潔劑或濕布進行清潔。
- 注意防潮，請勿將水或其他液體潑灑到本產品上。
- 插槽與開口供通風使用，以確保本產品的操作可靠並防止過熱，請勿堵塞或覆蓋開口。
- 請勿將本產品置放於靠近熱源的地方。除非有正常的通風，否則不可放在密閉位置中。
- 請不要私自打開機殼，不要嘗試自行維修本產品，請由授權的專業人士進行此項工作。

## 限用物質含有情況標示聲明書

產品元件名稱	限用物質及其化學符號					
	鉛 Pb	鎘 Cd	汞 Hg	六價鉻 CrVI	多溴聯苯 PBB	多溴二苯醚 PBDE
PCB	○	○	○	○	○	○
外殼	○	○	○	○	○	○
電源適配器	—	○	○	○	○	○
備考 1. "超出 0.1 wt %" 及 "超出 0.01 wt %" 系指限用物質之百分比含量超出百分比含量基準值。 備考 2. "○" 系指該項限用物質之百分比含量未超出百分比含量基準值。 備考 3. "—" 系指該項限用物質為排除項目。						



Продукт сертифіковано згідно с правилами системи УкрСЕПРО на відповідність вимогам нормативних документів та вимогам, що передбачені чинними законодавчими актами України.





### Safety Information

- Keep the device away from water, fire, humidity or hot environments.
- Do not attempt to disassemble, repair, or modify the device.
- Do not use damaged charger or USB cable to charge the device.
- Do not use any other chargers than those recommended
- Do not use the device where wireless devices are not allowed.
- Adapter shall be installed near the equipment and shall be easily accessible.

-  Use only power supplies which are provided by manufacturer and in the original packing of this product. If you have any questions, please don't hesitate to contact us.

Please read and follow the above safety information when operating the device. We cannot guarantee that no accidents or damage will occur due to improper use of the device. Please use this product with care and operate at your own risk.

### Explanation of the symbols on the product label

Symbol	Explanation
	DC voltage
	Indoor use only
	<p>RECYCLING</p> <p>This product bears the selective sorting symbol for Waste electrical and electronic equipment (WEEE). This means that this product must be handled pursuant to European directive 2012/19/EU in order to be recycled or dismantled to minimize its impact on the environment.</p> <p>User has the choice to give his product to a competent recycling organization or to the retailer when he buys a new electrical or electronic equipment.</p>