

FCC Radio Test Report

FCC ID: TE7EC330G5U

This report concerns (check one): Original Grant Class I Change Class II Change

Project No. : 1808C222
Equipment : AC1900 Wireless Dual Band Gigabit Router
Test Model : EC330-G5u
Series Model : N/A
Applicant : TP-Link Technologies Co., Ltd.
Address : Building 24 (floors 1,3,4,5) and 28 (floors1-4), Central Science and Technology Park, Nanshan Shenzhen, 518057 China

Date of Receipt : Aug. 27, 2018
Date of Test : Aug. 28, 2018~Nov. 14, 2018
Issued Date : Dec. 18, 2018
Tested by : BTL Inc.

Testing Engineer : Welly Zhou
(Welly Zhou)

Technical Manager : David Mao
(David Mao)

Authorized Signatory : Steven Lu
(Steven Lu)

B T L I N C .

No.3, Jinshagang 1st Road, Shixia, Dalang Town, Dongguan,
Guangdong, China.

TEL: +86-769-8318-3000 FAX: +86-769-8319-6000



Certificate #5123.02

Declaration

BTL represents to the client that testing is done in accordance with standard procedures as applicable and that test instruments used has been calibrated with standards traceable to international standard(s) and/or national standard(s).

BTL's reports apply only to the specific samples tested under conditions. It is manufacture's responsibility to ensure that additional production units of this model are manufactured with the identical electrical and mechanical components. **BTL** shall have no liability for any declarations, inferences or generalizations drawn by the client or others from **BTL** issued reports.

The report must not be used by the client to claim product certification, approval, or endorsement by NVLAP, NIST, A2LA or any agency of the U.S. Government.

This report is the confidential property of the client. As a mutual protection to the clients, the public and ourselves, the test report shall not be reproduced, except in full, without our written approval.

BTL's laboratory quality assurance procedures are in compliance with the **ISO/IEC 17025** requirements, and accredited by the conformity assessment authorities listed in this test report.

BTL is not responsible for the sampling stage, so the results only apply to the sample as received.

The information, data and test plan are provided by manufacturer, so it is manufacturer's responsibility to ensure that the apparatus meets the essential requirements in all the possible configurations as representative of its intended use.

Limitation

For the use of the authority's logo is limited unless the Test Standard(s)/Scope(s)/Item(s) mentioned in this test report is (are) included in the conformity assessment authorities acceptance respective.

Table of Contents

Page

1 . GENERAL SUMMARY	6
2 . SUMMARY OF TEST RESULTS	7
2.1 TEST FACILITY	8
2.2 MEASUREMENT UNCERTAINTY	8
3 . GENERAL INFORMATION	9
3.1 GENERAL DESCRIPTION OF EUT	9
3.2 DESCRIPTION OF TEST MODES	11
3.3 TABLE OF PARAMETERS OF TEXT SOFTWARE SETTING	14
3.4 BLOCK DIAGRAM SHOWING THE CONFIGURATION OF SYSTEM TESTED	15
3.5 DESCRIPTION OF SUPPORT UNITS	15
4 . EMC EMISSION TEST	16
4.1 CONDUCTED EMISSION MEASUREMENT	16
4.1.1 POWER LINE CONDUCTED EMISSION LIMITS	16
4.1.2 TEST PROCEDURE	16
4.1.3 DEVIATION FROM TEST STANDARD	16
4.1.4 TEST SETUP	17
4.1.5 EUT OPERATING CONDITIONS	17
4.1.6 EUT TEST CONDITIONS	17
4.1.7 TEST RESULTS	17
4.2 RADIATED EMISSION MEASUREMENT	18
4.2.1 RADIATED EMISSION LIMITS	18
4.2.2 TEST PROCEDURE	19
4.2.3 DEVIATION FROM TEST STANDARD	19
4.2.4 TEST SETUP	20
4.2.5 EUT OPERATING CONDITIONS	21
4.2.6 EUT TEST CONDITIONS	21
4.2.7 TEST RESULTS (9 KHZ TO 30 MHZ)	21
4.2.8 TEST RESULTS (30 MHZ TO 1000 MHZ)	21
4.2.9 TEST RESULTS (ABOVE 1000 MHZ)	21
5 . BANDWIDTH TEST	22
5.1 APPLIED PROCEDURES	22
5.1.1 TEST PROCEDURE	22
5.1.2 DEVIATION FROM STANDARD	22
5.1.3 TEST SETUP	22
5.1.4 EUT OPERATION CONDITIONS	22
5.1.5 EUT TEST CONDITIONS	22
5.1.6 TEST RESULTS	22

Table of Contents	Page
6 . MAXIMUM AVERAGE POWER TEST	23
6.1 APPLIED PROCEDURES / LIMIT	23
6.1.1 TEST PROCEDURE	23
6.1.2 DEVIATION FROM STANDARD	23
6.1.3 TEST SETUP	23
6.1.4 EUT OPERATION CONDITIONS	23
6.1.5 EUT TEST CONDITIONS	23
6.1.6 TEST RESULTS	23
7 . ANTENNA CONDUCTED SPURIOUS EMISSION	24
7.1 APPLIED PROCEDURES / LIMIT	24
7.1.1 TEST PROCEDURE	24
7.1.2 DEVIATION FROM STANDARD	24
7.1.3 TEST SETUP	24
7.1.4 EUT OPERATION CONDITIONS	24
7.1.5 EUT TEST CONDITIONS	24
7.1.6 TEST RESULTS	24
8 . POWER SPECTRAL DENSITY TEST	25
8.1 APPLIED PROCEDURES / LIMIT	25
8.1.1 TEST PROCEDURE	25
8.1.2 DEVIATION FROM STANDARD	25
8.1.3 TEST SETUP	25
8.1.4 EUT OPERATION CONDITIONS	25
8.1.5 EUT TEST CONDITIONS	25
8.1.6 TEST RESULTS	25
9 . MEASUREMENT INSTRUMENTS LIST	26
10 . EUT TEST PHOTO	28
APPENDIX B - RADIATED EMISSION (9 KHZ TO 30 MHZ)	35
APPENDIX C - RADIATED EMISSION (30 MHZ TO 1000 MHZ)	40
APPENDIX D - RADIATED EMISSION (ABOVE 1000 MHZ)	47
APPENDIX E - BANDWIDTH	174
APPENDIX F - MAXIMUM AVERAGE OUTPUT POWER	199
APPENDIX G - ANTENNA CONDUCTED SPURIOUS EMISSION	206
APPENDIX H - POWER SPECTRAL DENSITY	351

REPORT ISSUED HISTORY

Report Version	Description	Issued Date
R00	Original Issue.	Dec. 18, 2018

1. GENERAL SUMMARY

Equipment : AC1900 Wireless Dual Band Gigabit Router
Brand Name : tp-link
Test Model : EC330-G5u
Series Model : N/A
Applicant : TP-Link Technologies Co., Ltd.
Manufacturer : TP-Link Technologies Co., Ltd.
Address : Building 24 (floors 1,3,4,5) and 28 (floors1-4), Central Science and Technology Park, Nanshan Shenzhen, 518057 China
Date of Test : Aug. 28, 2018~Nov. 14, 2018
Test Sample : Engineering Sample No.: D180807220
Standard(s) : FCC Part15, Subpart C (15.247) / ANSI C63.10-2013

The above equipment has been tested and found compliance with the requirement of the relative standards by BTL Inc.

The test data, data evaluation, and equipment configuration contained in our test report (Ref No. BTL-FCCP-1-1808C222) were obtained utilizing the test procedures, test instruments, test sites that has been accredited by the Authority of A2LA according to the ISO/IEC 17025 quality assessment standard and technical standard(s).

2. SUMMARY OF TEST RESULTS

Test procedures according to the technical standard(s):

Applied Standard(s): FCC Part15 (15.247) , Subpart C			
Standard(s) Section	Test Item	Judgment	Remark
15.207	Conducted Emission	PASS	
15.247(d)	Antenna conducted Spurious Emission	PASS	
15.247(a)(2)	Bandwidth	PASS	
15.247(b)(3)	Average output power	PASS	
15.247(e)	Power Spectral Density	PASS	
15.203	Antenna Requirement	PASS	
15.247(d)/ 15.205/ 15.209	Transmitter Radiated Emissions	PASS	

Note:

(1) "N/A" denotes test is not applicable in this test report.

2.1 TEST FACILITY

The test facilities used to collect the test data in this report is at the location of No.3,Jinshagang 1st Road, Shixia, Dalang Town, Dongguan, Guangdong, China.

BTL's test firm number for FCC: 854385

BTL's designation number for FCC: CN5020

2.2 MEASUREMENT UNCERTAINTY

The measurement uncertainty figures shall be calculated according the methods described in the ETSI TR 100 028 and shall correspond to an expansion factor (coverage factor) $k=1.96$ or $k=2$ (which provide confidence levels of respectively 90% and 95.45% in the case where the distributions characterizing the actual measurement uncertainties are normal (Gaussian)). Measurement Uncertainty for a Level of Confidence of 95 %, $U=2xUc(y)$.

The BTL measurement uncertainty as below table:

A. Conducted Measurement:

Test Site	Method	Measurement Frequency Range	U, (dB)
DG-C02	CISPR	150 kHz ~ 30 MHz	2.32

B. Radiated Measurement:

Test Site	Method	Measurement Frequency Range	Ant. H / V	U, (dB)
DG-CB03	CISPR	9 KHz~30 MHz	V	3.79
		9 KHz~30 MHz	H	3.57
		30 MHz~200 MHz	V	3.82
		30 MH~200 MHz	H	3.78
		200 MHz~1,000 MHz	V	4.10
		200 MHz~1,000 MHz	H	4.06
		1 GHz~18 GHz	V	3.12
		1 GHz~18 GHz	H	3.68
		18 GHz~40 GHz	V	4.15
		18 GHz~40 GHz	H	4.14

Note: Unless specifically mentioned, the uncertainty of measurement has not been taken into account to declare the compliance or non-compliance to the specification.

3. GENERAL INFORMATION

3.1 GENERAL DESCRIPTION OF EUT

Equipment	AC1900 Wireless Dual Band Gigabit Router	
Brand Name	tp-link	
Test Model	EC330-G5u	
Series Model	N/A	
Model Difference(s)	N/A	
Product Description	Operation Frequency	2412 MHz ~2462 MHz
	Modulation Technology	802.11b:DSSS 802.11g:OFDM 802.11n:OFDM vht:256QAM
	Bit Rate of Transmitter	802.11b: 11/5.5/2/1 Mbps 802.11g: 54/48/36/24/18/12/9/6 Mbps 802.11n: up to 600 Mbps vht: up to 800 Mbps
	Average Output Power (Max.)	802.11b: 25.87 dBm 802.11g: 25.72 dBm 802.11n(20 MHz):25.77dBm 802.11n(40 MHz): 21.39dBm vht(20 MHz): 25.75dBm vht(40 MHz): 21.49dBm
Power Source	DC voltage supplied from AC/DC adapter. Brand / Model:Amc / EUSA+24120-2000	
Power Rating	I/P:100-240V~ 50/60Hz 0.6A O/P:12V---2A	

Note:

1. For a more detailed features description, please refer to the manufacturer's specifications or the user's manual.

2. Channel List:

CH01 - CH11 for 802.11b, 802.11g, 802.11n(20 MHz), vht(20 MHz) CH03 - CH09 for 802.11n(40 MHz), vht(40 MHz)							
Channel	Frequency (MHz)	Channel	Frequency (MHz)	Channel	Frequency (MHz)	Channel	Frequency (MHz)
01	2412	04	2427	07	2442	10	2457
02	2417	05	2432	08	2447	11	2462
03	2422	06	2437	09	2452		

3. Table for Filed Antenna

Ant.	Brand	P/N	Antenna Type	Connector	Gain (dBi)
1		3101501579	Dipole	I-PEX	1.98
2		3101501578	Dipole	I-PEX	1.98
3		3101501578	Dipole	I-PEX	1.98
4		3101501724	PCB	IPEX	1.95

Note: This EUT supports MIMO 4X4, any transmit signals are correlated with each other,
 so Directional gain = $10\log[(10^{G1/20} + 10^{G2/20} + \dots + 10^{GN/20})^2 / N]$ dBi,
 that is Directional gain = $10\log[(10^{1.98/20} + 10^{1.98/20} + 10^{1.98/20} + 10^{1.95/20})^2 / 4]$ dBi = 7.99.
 So, the average output power limit is $30 - 7.99 + 6 = 28.01$,
 the power density limit is $8 - 7.99 + 6 = 6.01$.

4. The worst case for 4TX as follow:

Operating Mode	TX Mode	4TX
802.11b		V (ANT 1+ANT 2+ ANT 3+ANT 4)
802.11g		V (ANT 1+ANT 2+ ANT 3+ANT 4)
802.11n(20 MHz)		V (ANT 1+ANT 2+ ANT 3+ANT 4)
802.11n(40 MHz)		V (ANT 1+ANT 2+ ANT 3+ANT 4)
vht(20 MHz)		V (ANT 1+ANT 2+ ANT 3+ANT 4)
vht(40 MHz)		V (ANT 1+ANT 2+ ANT 3+ANT 4)

3.2 DESCRIPTION OF TEST MODES

To investigate the maximum EMI emission characteristics generates from EUT, the test system was pre-scanning tested base on the consideration of following EUT operation mode or test configuration mode which possible have effect on EMI emission level. Each of these EUT operation mode(s) or test configuration mode(s) mentioned above was evaluated respectively.

Pretest Mode	Description
Mode 1	TX B Mode Channel 01/06/11
Mode 2	TX G Mode Channel 01/06/11
Mode 3	TX N-20 MHz Mode Channel 01/06/11
Mode 4	TX N-40 MHz Mode Channel 03/06/09
Mode 5	TX VHT-20 MHz Mode Channel 01/06/11
Mode 6	TX VHT-40 MHz Mode Channel 03/06/09
Mode 7	TX Mode
Mode 8	TX B Mode Channel 01/02/06/10/11
Mode 9	TX G Mode Channel 01/02/06/10/11
Mode 10	TX N-20 MHz Mode Channel 01/02/06/10/11
Mode 11	TX N-40 MHz Mode Channel 03/04/06/08/09
Mode 12	TX VHT-20 MHz Mode Channel 01/02/06/10/11
Mode 13	TX VHT-40 MHz Mode Channel 03/04/06/08/09

The EUT system operated these modes were found to be the worst case during the pre-scanning test as following:

For Conducted Test	
Final Test Mode:	Description
Mode 7	TX Mode

For Radiated Test	
Final Test Mode:	Description
Mode 1	TX B Mode Channel 01/06/11
Mode 2	TX G Mode Channel 01/06/11
Mode 3	TX N-20 MHz Mode Channel 01/06/11
Mode 4	TX N-40 MHz Mode Channel 03/06/09
Mode 5	TX VHT-20 MHz Mode Channel 01/06/11
Mode 6	TX VHT-40 MHz Mode Channel 03/06/09

For Band Edge Test	
Final Test Mode:	Description
Mode 8	TX B Mode Channel 01/02/06/10/11
Mode 9	TX G Mode Channel 01/02/06/10/11
Mode 10	TX N-20 MHz Mode Channel 01/02/06/10/11
Mode 11	TX N-40 MHz Mode Channel 03/04/06/08/09
Mode 12	TX VHT-20 MHz Mode Channel 01/02/06/10/11
Mode 13	TX VHT-40 MHz Mode Channel 03/04/06/08/09

Spectrum Bandwidth	
Final Test Mode:	Description
Mode 1	TX B Mode Channel 01/06/11
Mode 2	TX G Mode Channel 01/06/11
Mode 3	TX N-20 MHz Mode Channel 01/06/11
Mode 4	TX N-40 MHz Mode Channel 03/06/09
Mode 5	TX VHT-20 MHz Mode Channel 01/06/11
Mode 6	TX VHT-40 MHz Mode Channel 03/06/09

Maximum Average Output Power	
Final Test Mode:	Description
Mode 1	TX B Mode Channel 01/06/11
Mode 2	TX G Mode Channel 01/06/11
Mode 3	TX N-20 MHz Mode Channel 01/06/11
Mode 4	TX N-40 MHz Mode Channel 03/06/09
Mode 5	TX VHT-20 MHz Mode Channel 01/06/11
Mode 6	TX VHT-40 MHz Mode Channel 03/06/09

Power Spectral Density	
Final Test Mode:	Description
Mode 1	TX B Mode Channel 01/06/11
Mode 2	TX G Mode Channel 01/06/11
Mode 3	TX N-20 MHz Mode Channel 01/06/11
Mode 4	TX N-40 MHz Mode Channel 03/06/09
Mode 5	TX VHT-20 MHz Mode Channel 01/06/11
Mode 6	TX VHT-40 MHz Mode Channel 03/06/09

Note:

- (1) The measurements are performed at the high, middle, low available channels.
- (2) 802.11b mode: DBPSK (1 Mbps)
 802.11g mode: OFDM (6 Mbps)
 802.11n HT20 mode : BPSK (6.5 Mbps)
 802.11n HT40 mode : BPSK (13.5 Mbps)
 vht20 mode : BPSK (6.5 Mbps)
 vht40 mode : BPSK (13.5 Mbps)
 For radiated emission tests, the highest output powers were set for final test.
- (3) For radiated 30 MHz to 1000 MHz test, the 802.11b is found to be the worst case and recorded.

3.3 TABLE OF PARAMETERS OF TEXT SOFTWARE SETTING

During testing, channel & power controlling software provided by the customer was used to control the operating channel as well as the output power level. The RF output power selection is for the setting of RF output power expected by the customer and is going to be fixed on the firmware of the final end product power parameters of WLAN

Test software version	N/A		
Frequency (MHz)	2412	2437	2462
802.11b	1F	24	20
802.11g	16	2A	19
802.11n (20 MHz)	16	29	1C
vht (20 MHz)	1A	2A	1C
Frequency (MHz)	2422	2437	2452
802.11n (40 MHz)	15	1D	18
vht (40 MHz)	15	1D	17

3.4 BLOCK DIAGRAM SHOWING THE CONFIGURATION OF SYSTEM TESTED

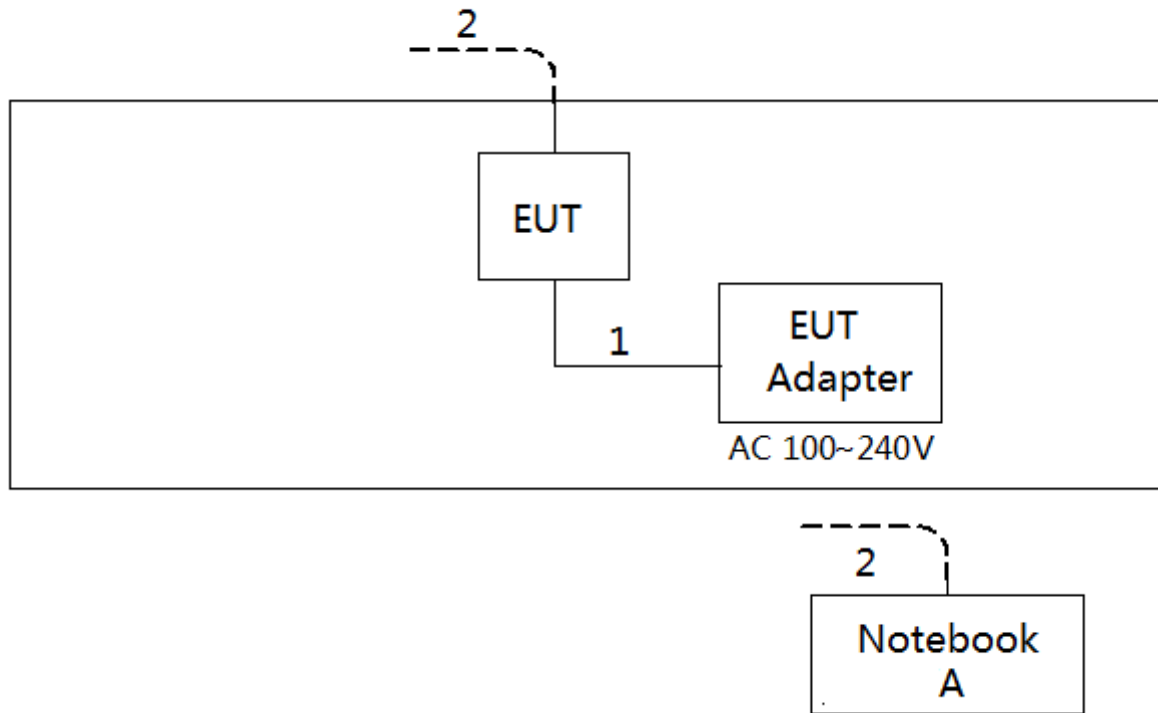

3.5 DESCRIPTION OF SUPPORT UNITS

The EUT has been tested as an independent unit together with other necessary accessories or support units. The following support units or accessories were used to form a representative test configuration during the tests.

Item	Equipment	Mfr/Brand	Model/Type No.	FCC ID	Series No.
A	Notebook	Lenovo	G410	N/A	N/A

Item	Shielded Type	Ferrite Core	Length	Note
1	NO	NO	1.5m	DC Cable
2	NO	NO	10m	RJ45 Cable

4. EMC EMISSION TEST

4.1 CONDUCTED EMISSION MEASUREMENT

4.1.1 POWER LINE CONDUCTED EMISSION LIMITS (Frequency Range 150 kHz-30 MHz)

Frequency of Emission (MHz)	Conducted Limit (dB μ V)	
	Quasi-peak	Average
0.15 - 0.50	66 to 56*	56 to 46*
0.50 - 5.0	56	46
5.0 - 30.0	60	50

Note:

- (1) The limit of " * " decreases with the logarithm of the frequency
- (2) The test result calculated as following:
 Measurement Value = Reading Level + Correct Factor
 Correct Factor = Insertion Loss + Cable Loss + Attenuator Factor(if use)
 Margin Level = Measurement Value - Limit Value

The following table is the setting of the receiver

Receiver Parameters	Setting
Attenuation	10 dB
Start Frequency	0.15 MHz
Stop Frequency	30 MHz
IF Bandwidth	9 kHz

4.1.2 TEST PROCEDURE

- a. The EUT was placed 0.8 meters from the horizontal ground plane with EUT being connected to the power mains through a line impedance stabilization network (LISN). All other support equipment powered from additional LISN(s). The LISN provide 50 Ohm/ 50uH of coupling impedance for the measuring instrument.
- b. Interconnecting cables that hang closer than 40 cm to the ground plane shall be folded back and forth in the center forming a bundle 30 to 40 cm long.
- c. I/O cables that are not connected to a peripheral shall be bundled in the center. The end of the cable may be terminated, if required, using the correct terminating impedance. The overall length shall not exceed 1 m.
- d. LISN at least 80 cm from nearest part of EUT chassis.
- e. For the actual test configuration, please refer to the related Item -EUT Test Photos.

4.1.3 DEVIATION FROM TEST STANDARD

No deviation

4.1.4 TEST SETUP

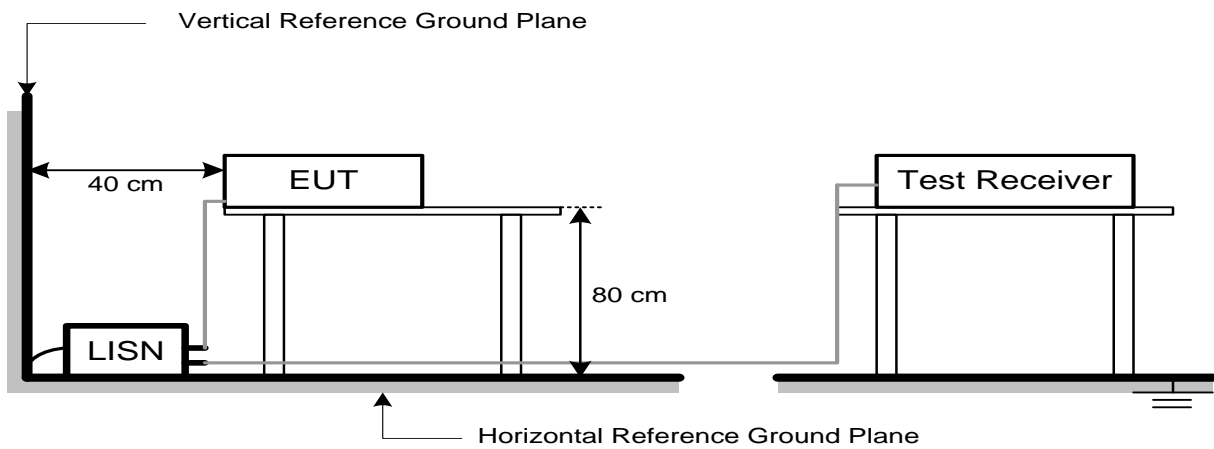

4.1.5 EUT OPERATING CONDITIONS

The EUT was placed on the test table and programmed in normal function.

4.1.6 EUT TEST CONDITIONS

Temperature: 25°C Relative Humidity: 53% Test Voltage: AC 120V/60Hz

4.1.7 TEST RESULTS

Please refer to the Appendix A.

4.2 RADIATED EMISSION MEASUREMENT

4.2.1 RADIATED EMISSION LIMITS

In case the emission fall within the restricted band specified on 15.205(a), then the 15.209(a) limit in the table below has to be followed.

LIMITS OF RADIATED EMISSION MEASUREMENT (9 kHz-1000 MHz)

Frequency (MHz)	Field Strength (microvolts/meter)	Measurement Distance (meters)
0.009~0.490	2400/F(kHz)	300
0.490~1.705	24000/F(kHz)	30
1.705~30.0	30	30
30~88	100	3
88~216	150	3
216~960	200	3
960~1000	500	3

LIMITS OF RADIATED EMISSION MEASUREMENT (Above 1000 MHz)

Frequency (MHz)	(dBuV/m) (at 3 meters)	
	Peak	Average
Above 1000	74	54

Note:

- (1) The limit for radiated test was performed according to FCC PART 15C.
- (2) The tighter limit applies at the band edges.
- (3) Emission level (dBuV/m)=20log Emission level (uV/m).
- (4) The test result calculated as following:
 Measurement Value = Reading Level + Correct Factor
 Correct Factor = Antenna Factor + Cable Loss - Amplifier Gain(if use)
 Margin Level = Measurement Value - Limit Value

Spectrum Parameter	Setting
Attenuation	Auto
Start Frequency	1000 MHz
Stop Frequency	10th carrier harmonic
RBW / VBW (Emission in restricted band)	1 MHz / 3 MHz for Peak, 1 MHz / 1/T for Average

Receiver Parameter	Setting
Attenuation	Auto
Start ~ Stop Frequency	9 kHz~90 kHz for PK/AVG detector
Start ~ Stop Frequency	90 kHz~110 kHz for QP detector
Start ~ Stop Frequency	110 kHz~490 kHz for PK/AVG detector
Start ~ Stop Frequency	490 kHz~30 MHz for QP detector
Start ~ Stop Frequency	30 MHz~1000 MHz for QP detector

4.2.2 TEST PROCEDURE

- a. The measuring distance of 3 m shall be used for measurements. The EUT was placed on the top of a rotating table 0.8 meter above the ground at a 3 meter semi-anechoic chamber. The table was rotated 360 degrees to determine the position of the highest radiation.(below 1 GHz)
- b. The measuring distance of 3 m shall be used for measurements. The EUT was placed on the top of a rotating table 1.5 meter above the ground at a 3 meter semi-anechoic chamber. The table was rotated 360 degrees to determine the position of the highest radiation.(above 1 GHz)
- c. The height of the equipment or of the substitution antenna shall be 0.8m or 1.5m; the height of the test antenna shall vary between 1 m to 4 m. Both horizontal and vertical polarizations of the antenna are set to make the measurement.
- d. For each suspected emission, the EUT was arranged to its worst case and then the antenna was tuned to heights find the maximum reading (used Bore sight function).
- e. The receiver system was set to peak and average detect function and specified bandwidth with maximum hold mode when the test frequency is above 1 GHz.
- f. The initial step in collecting radiated emission data is a receiver peak detector mode pre-scanning the measurement frequency range. Significant peaks are then marked and then Quasi Peak detector mode re-measured.
- g. All readings are Peak unless otherwise stated QP in column of Note. Peak denotes that the Peak reading compliance with the QP Limits and then QP Mode measurement didn't perform. (below 1 GHz)
- h. All readings are Peak Mode value unless otherwise stated AVG in column of Note. If the Peak Mode Measured value compliance with the Peak Limits and lower than AVG Limits, the EUT shall be deemed to meet both Peak & AVG Limits and then only Peak Mode was measured, but AVG Mode didn't perform. (above 1 GHz)
- i. For the actual test configuration, please refer to the related Item -EUT Test Photos.

4.2.3 DEVIATION FROM TEST STANDARD

No deviation

4.2.4 TEST SETUP

(A) Radiated Emission Test Set-Up Frequency 30 MHz-1000 MHz

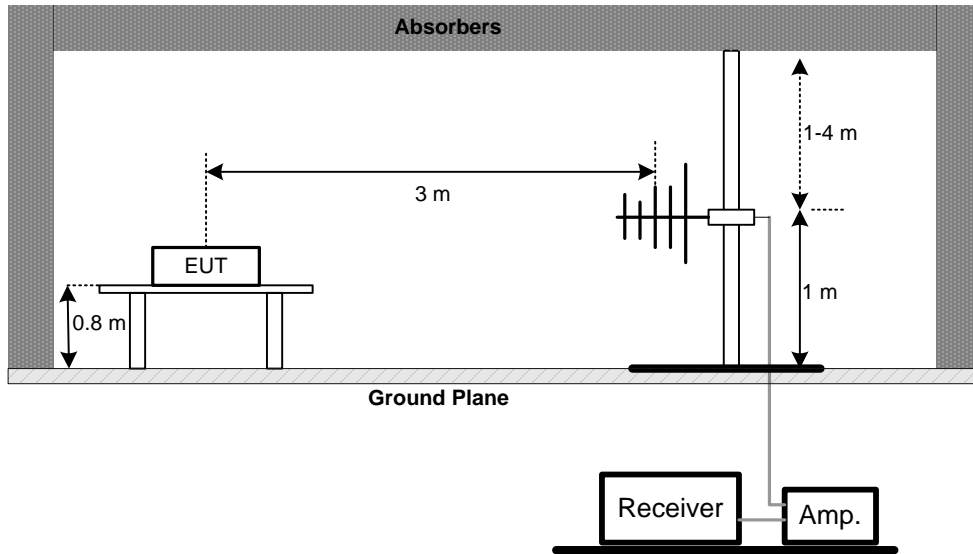

(B) Radiated Emission Test Set-Up Frequency Above 1 GHz

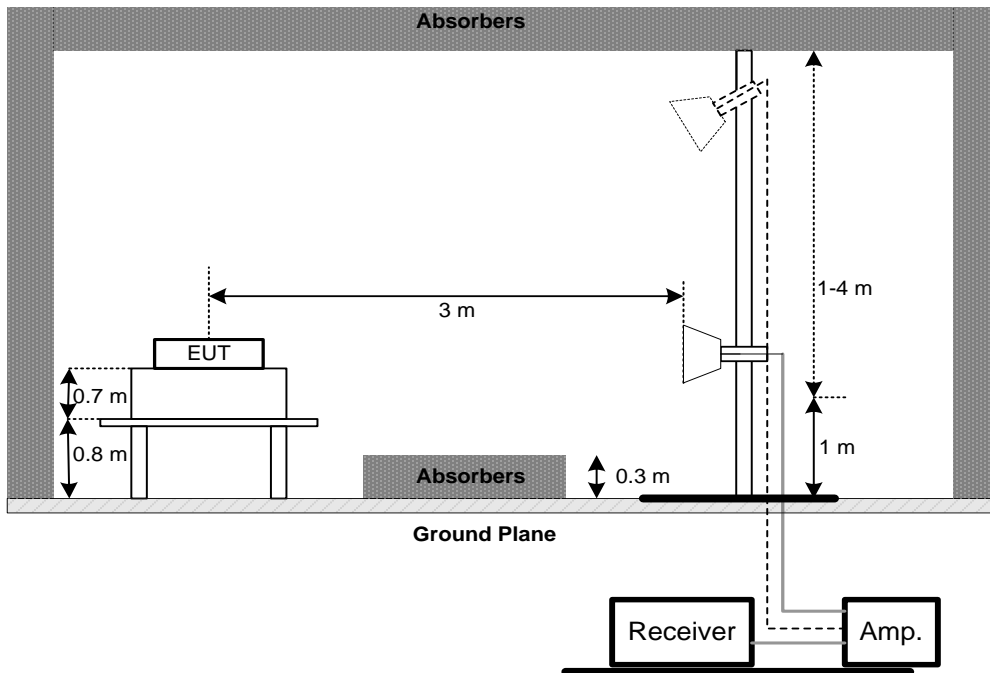

(C) For Radiated Emissions 9 kHz-30 MHz

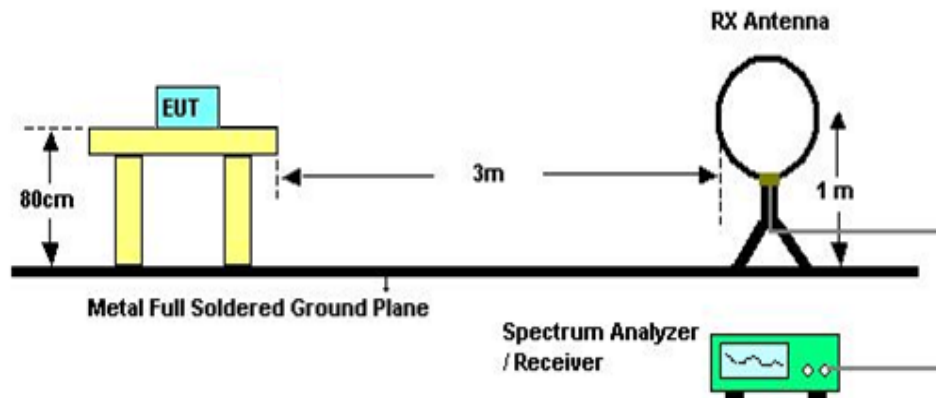

4.2.5 EUT OPERATING CONDITIONS

The EUT was programmed to be in continuously transmitting mode.

4.2.6 EUT TEST CONDITIONS

Temperature: 25°C Relative Humidity: 60% Test Voltage: AC 120V/60Hz

4.2.7 TEST RESULTS (9 kHz TO 30 MHz)

Please refer to the Appendix B

Remark:

- (1) The amplitude of spurious emissions which are attenuated by more than 20 dB below the permissible value has no need to be reported.
- (2) Distance extrapolation factor = $40 \log (\text{specific distance} / \text{test distance})$ (dB).
- (3) Limit line = specific limits (dBuV) + distance extrapolation factor.

4.2.8 TEST RESULTS (30 MHz TO 1000 MHz)

Please refer to the Appendix C.

4.2.9 TEST RESULTS (ABOVE 1000 MHz)

Please refer to the Appendix D.

Remark:

- (1) No limit: This is fundamental signal, the judgment is not applicable.
For fundamental signal judgment was referred to Peak output test.

5. BANDWIDTH TEST

5.1 APPLIED PROCEDURES

FCC Part15 (15.247) , Subpart C			
Section	Test Item	Frequency Range (MHz)	Result
15.247(a)(2)	6dB Bandwidth	2400-2483.5	PASS
	99% OBW		

5.1.1 TEST PROCEDURE

- a. The EUT was directly connected to the spectrum analyzer and antenna output port as show in the block diagram below.
- b. The bandwidth was performed in accordance with method 11.8 of ANSI C63.10-2013.
- c. For 6dB Bandwidth Spectrum setting: RBW= 100KHz, VBW=300KHz, Sweep time = 2.5 ms.
For 99% OBW Spectrum Setting: For B,G.N20 mode: RBW= 300KHz, VBW=1MHz,For N40 mode: RBW= 1MHz, VBW=3MHz Sweep time = 2.5 ms.

5.1.2 DEVIATION FROM STANDARD

No deviation.

5.1.3 TEST SETUP

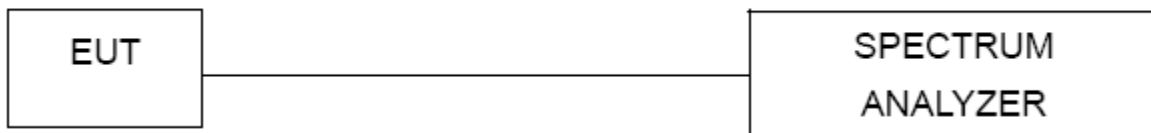

5.1.4 EUT OPERATION CONDITIONS

The EUT was programmed to be in continuously transmitting mode.

5.1.5 EUT TEST CONDITIONS

Temperature: 26°C Relative Humidity: 62% Test Voltage: AC 120V/60Hz

5.1.6 TEST RESULTS

Please refer to the Appendix E.

6. MAXIMUM AVERAGE POWER TEST

6.1 APPLIED PROCEDURES / LIMIT

FCC Part15 (15.247) , Subpart C				
Section	Test Item	Limit	Frequency Range (MHz)	Result
15.247(b)(3)	Average Output Power	1 Watt or 30 dBm	2400-2483.5	PASS

6.1.1 TEST PROCEDURE

- a. The EUT was directly connected to the power meter and antenna output port as show in the block diagram below.
- b. The maximum Average output power was performed in accordance with method 8.3.2.3 of FCC KDB 558074 D01 v05 DTS Meas Guidance and 11.9.2.3 of ANSI C63.10-2013.

6.1.2 DEVIATION FROM STANDARD

No deviation.

6.1.3 TEST SETUP



6.1.4 EUT OPERATION CONDITIONS

The EUT was programmed to be in continuously transmitting mode.

6.1.5 EUT TEST CONDITIONS

Temperature: 26°C Relative Humidity: 62% Test Voltage: AC 120V/60Hz

6.1.6 TEST RESULTS

Please refer to the Appendix F.

7. ANTENNA CONDUCTED SPURIOUS EMISSION

7.1 APPLIED PROCEDURES / LIMIT

In any 100 kHz bandwidth outside the frequency band in which the spread spectrum or digitally modulated intentional radiator is operating, the radio frequency power that is produced by the intentional radiator shall be at least 20 dB below that in the 100 kHz bandwidth within the band that contains the highest level of the desired power, based on either an RF conducted or a radiated measurement, provided the transmitter demonstrates compliance with the peak Output Power limits. If the transmitter complies with the Output Power limits based on the use of RMS averaging over a time interval, as permitted under paragraph (b)(3) of this section, the attenuation required under this paragraph shall be 30 dB instead of 20 dB. Attenuation below the general limits specified in Section 15.209(a) is not required. In addition, radiated emissions which fall in the restricted bands, as defined in Section 15.205(a), must also comply with the radiated emission limits specified in Section 15.209(a) (see Section 15.205(c)).

7.1.1 TEST PROCEDURE

- a. The EUT was directly connected to the spectrum analyzer and antenna output port as show in the block diagram below.
- b. Spectrum Setting: RBW= 100 kHz, VBW=300 kHz, Sweep time = Auto.
- c. Offset=antenna gain+cable loss

7.1.2 DEVIATION FROM STANDARD

No deviation.

7.1.3 TEST SETUP

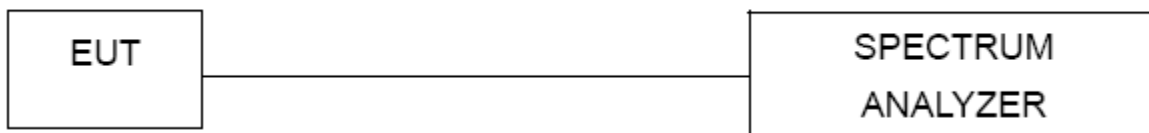

7.1.4 EUT OPERATION CONDITIONS

The EUT was programmed to be in continuously transmitting mode.

7.1.5 EUT TEST CONDITIONS

Temperature: 26°C Relative Humidity: 62% Test Voltage: AC 120V/60Hz

7.1.6 TEST RESULTS

Please refer to the Appendix G.

8. POWER SPECTRAL DENSITY TEST

8.1 APPLIED PROCEDURES / LIMIT

FCC Part15 (15.247) , Subpart C				
Section	Test Item	Limit	Frequency Range (MHz)	Result
15.247(e)	Power Spectral Density	8 dBm (in any 3 kHz)	2400-2483.5	PASS

8.1.1 TEST PROCEDURE

- The EUT was directly connected to the spectrum analyzer and antenna output port as show in the block diagram below.
- The Power Spectral Density was performed in accordance with method 8.4 of FCC KDB 558074 D01 v05 DTS Meas Guidance and 11.10.2 of ANSI C63.10-2013.
- Spectrum Setting: RBW=3 kHz, VBW=10 kHz, Sweep time = Auto.

8.1.2 DEVIATION FROM STANDARD

No deviation.

8.1.3 TEST SETUP



8.1.4 EUT OPERATION CONDITIONS

The EUT was programmed to be in continuously transmitting mode.

8.1.5 EUT TEST CONDITIONS

Temperature: 26°C Relative Humidity: 62% Test Voltage: AC 120V/60Hz

8.1.6 TEST RESULTS

Please refer to the Appendix H.

9. MEASUREMENT INSTRUMENTS LIST

Conducted Emission Measurement					
Item	Kind of Equipment	Manufacturer	Type No.	Serial No.	Calibrated until
1	EMI Test Receiver	R&S	ESCI	100382	Mar. 11, 2019
2	LISN	EMCO	3816/2	52765	Mar. 11, 2019
3	50Ω Terminator	SHX	TF2-3G-A	8122901	Mar. 11, 2019
4	TWO-LINE V-NETWORK	R&S	ENV216	101447	Mar. 11, 2019
5	Measurement Software	Farad	EZ-EMC Ver.NB-03A1-01	N/A	N/A
6	Cable	N/A	RG223	12m	Mar. 23, 2019

Radiated Emission Measurement-9 kHz TO 30 MHz					
Item	Kind of Equipment	Manufacturer	Type No.	Serial No.	Calibrated until
1	Loop Antenna	EM	EM-6876-1	230	Feb. 07, 2019
2	Cable	N/A	RG 213/U	C-102	Jun. 01, 2019
3	EMI Test Receiver	R&S	ESCI	100382	Mar. 11, 2019
4	Measurement Software	Farad	EZ-EMC Ver.NB-03A1-01	N/A	N/A

Radiated Emission Measurement-30 MHz TO 1000 MHz					
Item	Kind of Equipment	Manufacturer	Type No.	Serial No.	Calibrated until
1	Antenna	Schwarbeck	VULB9160	9160-3232	Mar. 11, 2019
2	Amplifier	HP	8447D	2944A09673	Aug. 11, 2019
3	Receiver	Agilent	N9038A	MY52130039	Aug. 11, 2019
4	Cable	emci	LMR-400(30MHz-1 GHz)(8m+5m)	N/A	May 25, 2019
5	Controller	CT	SC100	N/A	N/A
6	Controller	MF	MF-7802	MF780208416	N/A
7	Measurement Software	Farad	EZ-EMC Ver.NB-03A1-01	N/A	N/A

Radiated Emission Measurement - Above 1GHz

Item	Kind of Equipment	Manufacturer	Type No.	Serial No.	Calibrated until
1	Double Ridged Guide Antenna	ETS	3115	75789	Mar. 11, 2019
2	Broad-Band Horn Antenna	Schwarzbeck	BBHA 9170	9170319	Jun. 30, 2019
3	Amplifier	Agilent	8449B	3008A02274	Mar. 11, 2019
4	Microwave Preamplifier With Adaptor	EMC INSTRUMENT	EMC2654045	980039 & HA01	Mar. 11, 2019
5	Receiver	Agilent	N9038A	MY52130039	Aug. 11, 2019
6	Controller	CT	SC100	N/A	N/A
7	Controller	MF	MF-7802	MF780208416	N/A
8	Cable	mitron	B10-01-01-12M	18072744	Jul. 30, 2019
9	Measurement Software	Farad	EZ-EMC Ver.NB-03A1-01	N/A	N/A

Bandwidth

Item	Kind of Equipment	Manufacturer	Type No.	Serial No.	Calibrated until
1	Spectrum Analyzer	R&S	FSP40	100185	Aug. 11, 2019

Average output power

Item	Kind of Equipment	Manufacturer	Type No.	Serial No.	Calibrated until
1	Power Meter	ANRITSU	ML2495A	1128009	Mar. 11, 2019

Antenna Conducted Spurious Emission

Item	Kind of Equipment	Manufacturer	Type No.	Serial No.	Calibrated until
1	Spectrum Analyzer	R&S	FSP40	100185	Aug. 11, 2019

Power Spectral Density

Item	Kind of Equipment	Manufacturer	Type No.	Serial No.	Calibrated until
1	Spectrum Analyzer	R&S	FSP40	100185	Aug. 11, 2019

Remark: "N/A" denotes no model name, serial no. or calibration specified.
All calibration period of equipment list is one year.

10. EUT TEST PHOTO

Conducted Measurement Photos



Radiated Measurement Photos

9 kHz to 30 MHz

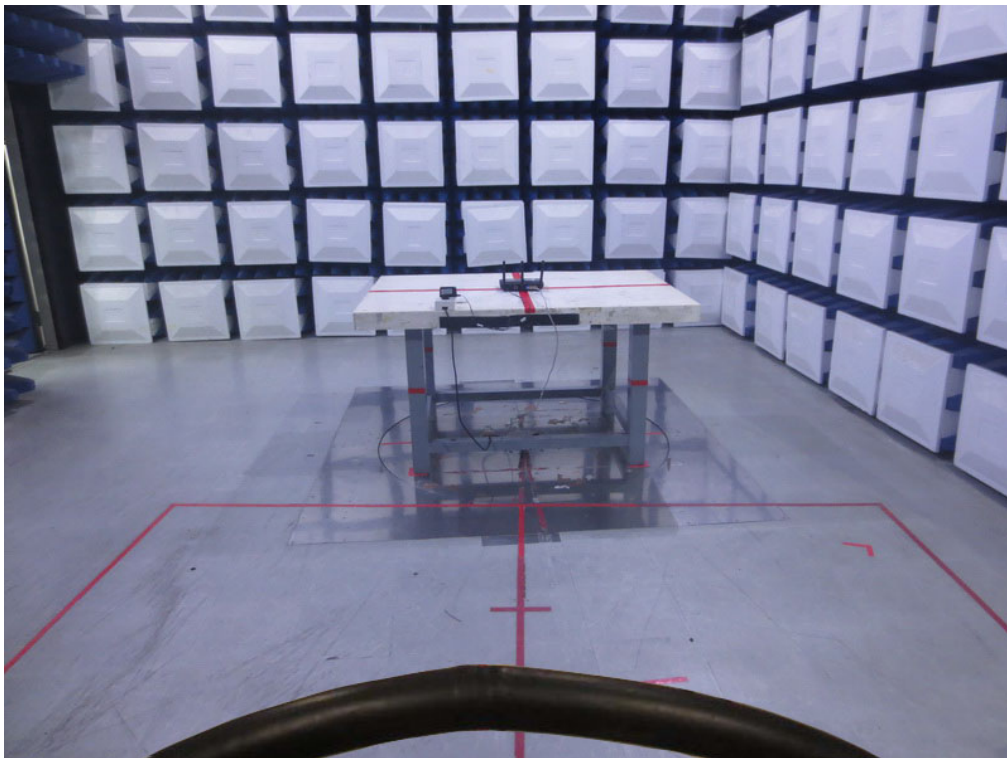
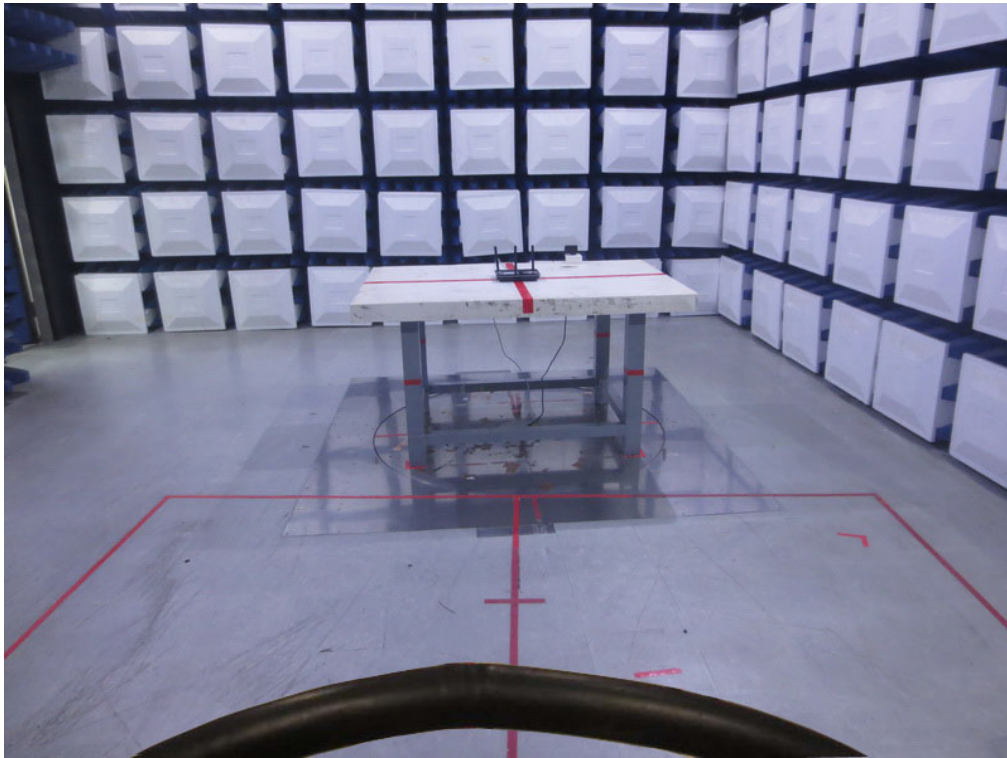

Radiated Measurement Photos

30 MHz to 1000 MHz

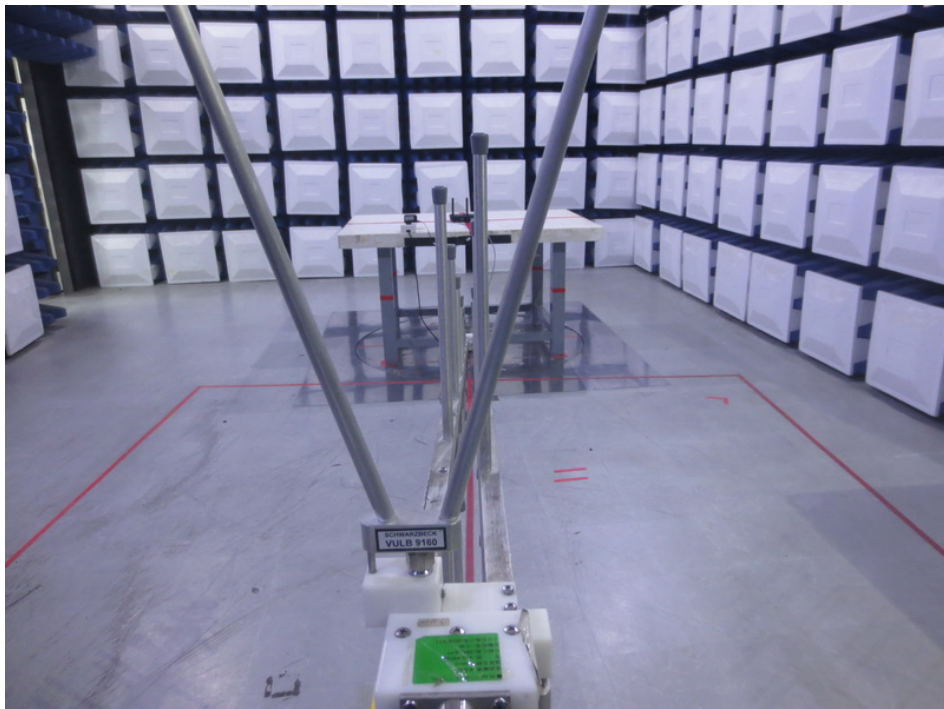
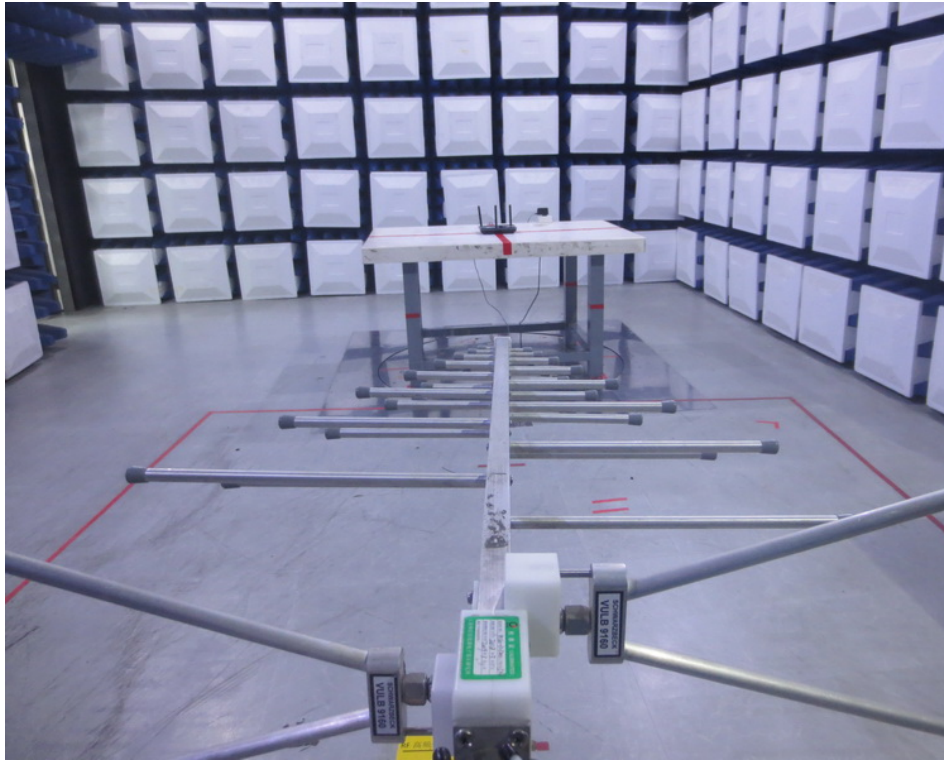

Radiated Measurement Photos

Above 1000 MHz

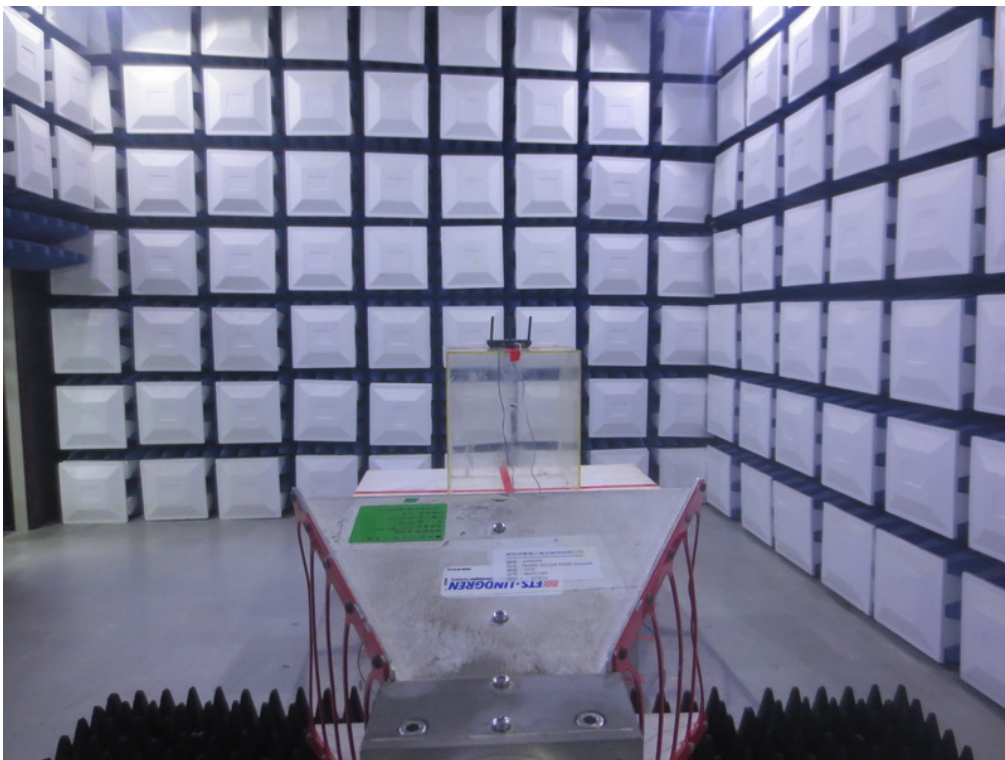
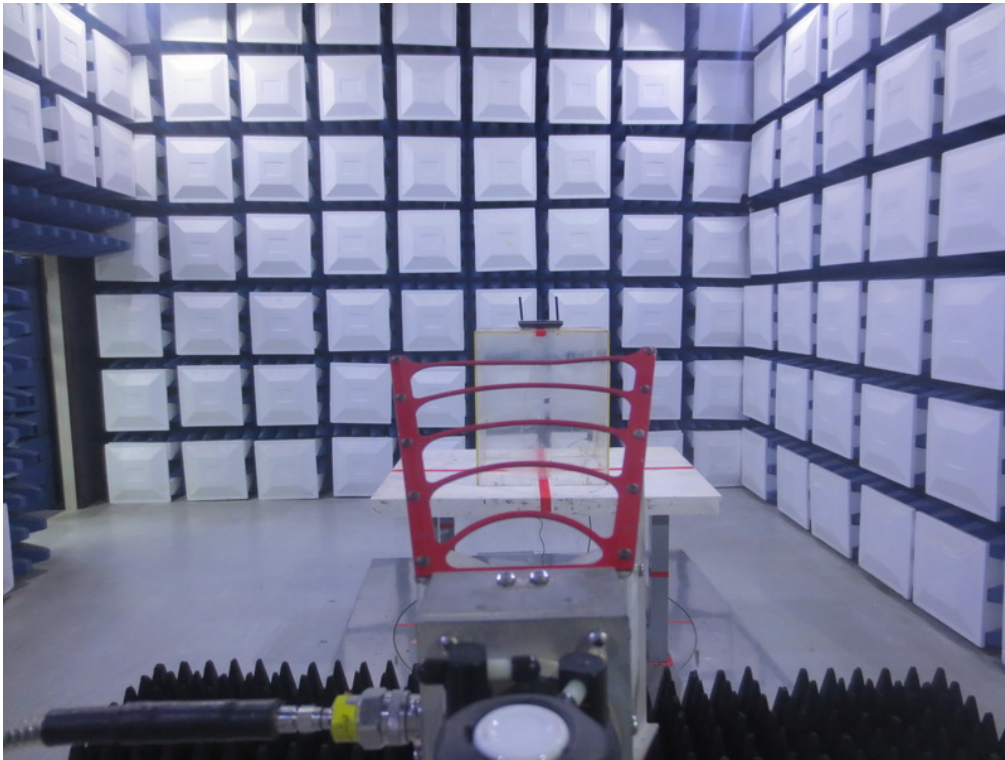

APPENDIX A - CONDUCTED EMISSION

Test Mode: TX Mode

Line

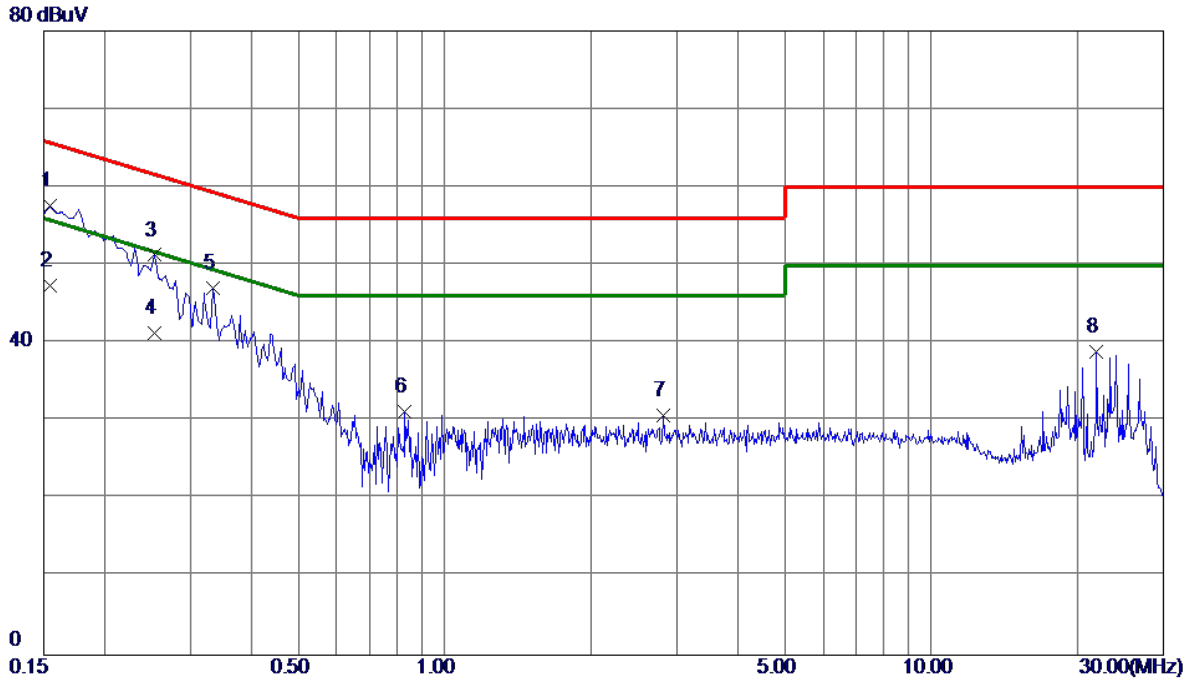

No.	Freq. MHz	Reading Level dBuV	Correct Factor dB	Measure ment dBuV	Limit dBuV	Margin dB	Detector	Comment
1 *	0.1545	47.72	9.82	57.54	65.75	-8.21	Peak	
2	0.1545	37.50	9.82	47.32	55.75	-8.43	AVG	
3	0.2535	41.46	9.82	51.28	61.64	-10.36	Peak	
4	0.2535	31.50	9.82	41.32	51.64	-10.32	AVG	
5	0.3345	37.24	9.81	47.05	59.34	-12.29	Peak	
6	0.8294	21.32	9.91	31.23	56.00	-24.77	Peak	
7	2.8140	20.72	10.04	30.76	56.00	-25.24	Peak	
8	21.8895	27.72	11.17	38.89	60.00	-21.11	Peak	

Test Mode: TX Mode

Neutral

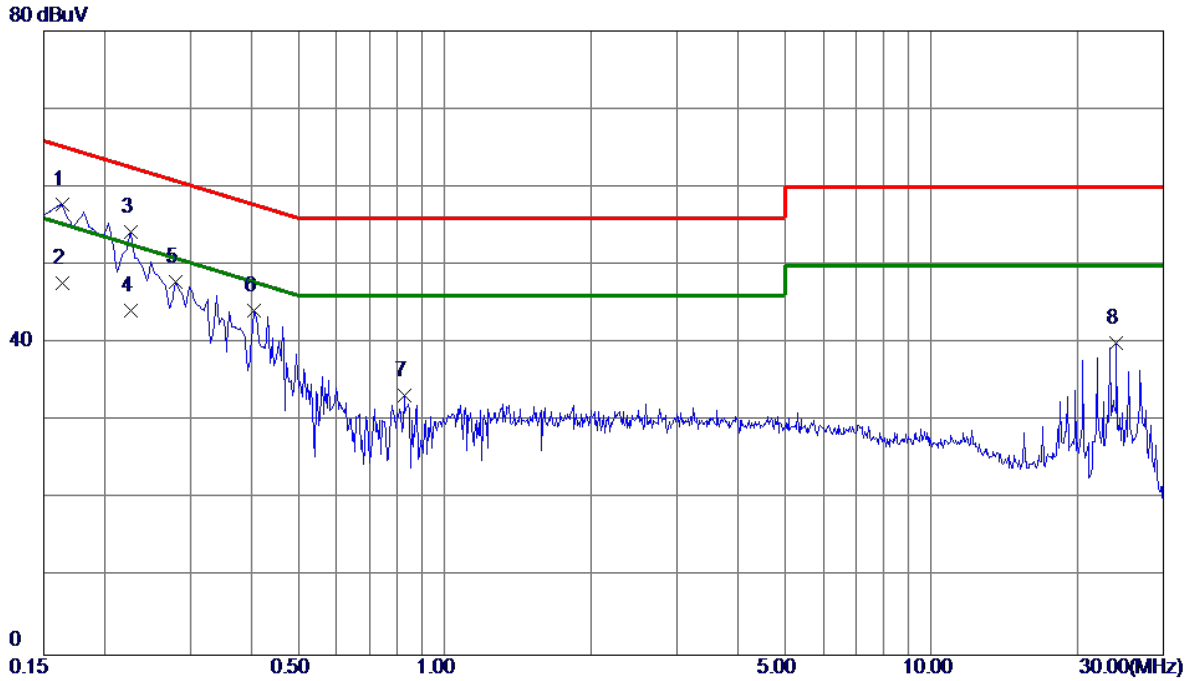

No.	Freq. MHz	Reading Level dBuV	Correct Factor dB	Measure ment dBuV	Limit dBuV	Margin dB	Detector	Comment
1 *	0.1635	47.90	9.91	57.81	65.28	-7.47	Peak	
2	0.1635	37.80	9.91	47.71	55.28	-7.57	AVG	
3	0.2265	44.33	9.92	54.25	62.58	-8.33	Peak	
4	0.2265	34.29	9.92	44.21	52.58	-8.37	AVG	
5	0.2805	37.93	9.93	47.86	60.80	-12.94	Peak	
6	0.4063	34.20	9.95	44.15	57.72	-13.57	Peak	
7	0.8250	23.23	10.09	33.32	56.00	-22.68	Peak	
8	24.0315	28.47	11.48	39.95	60.00	-20.05	Peak	

APPENDIX B - RADIATED EMISSION (9 KHZ TO 30 MHZ)

Test Mode: TX Mode

Ant 0°

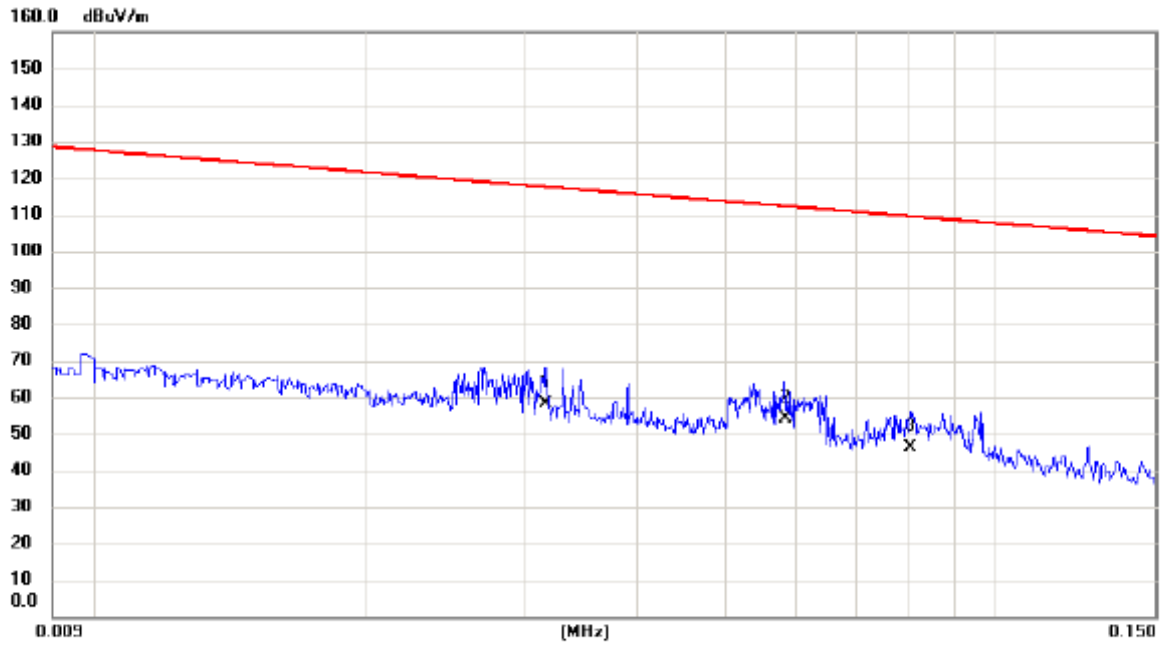

No.	Mk.	Freq.	Reading Level	Correct Factor	Measurement	Limit	Margin	Detector	Comment
		MHz	dBuV	dB	dBuV/m	dBuV/m	dB		
1		0.0317	38.50	19.82	58.32	117.58	-59.26	AVG	
2	*	0.0583	34.70	19.36	54.06	112.29	-58.23	AVG	
3		0.0803	27.40	18.90	46.30	109.51	-63.21	AVG	

Test Mode: TX Mode

Ant 0°

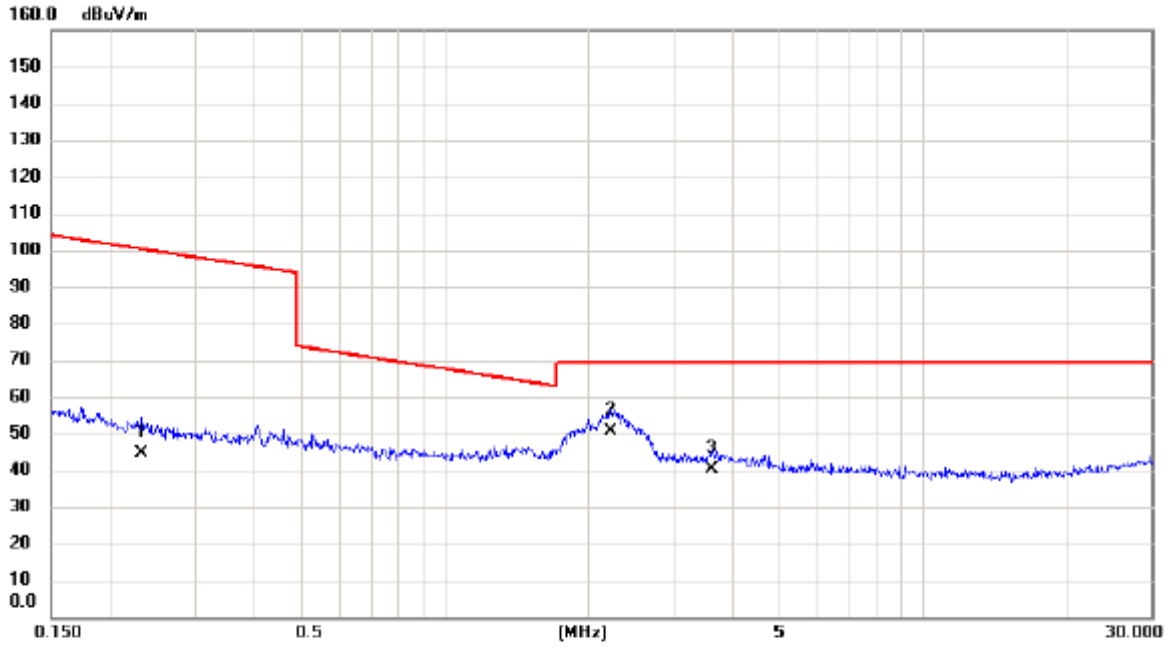

No.	Mk.	Freq. MHz	Reading Level dBuV	Correct Factor dB	Measure- ment dBuV/m	Limit dBuV/m	Margin dB	Detector	Comment
1		0.2316	27.50	17.09	44.59	100.31	-55.72	AVG	
2	*	2.2132	33.70	16.98	50.68	69.54	-18.86	QP	
3		3.6034	24.20	16.06	40.26	69.54	-29.28	QP	

Test Mode: TX Mode

Ant 90°

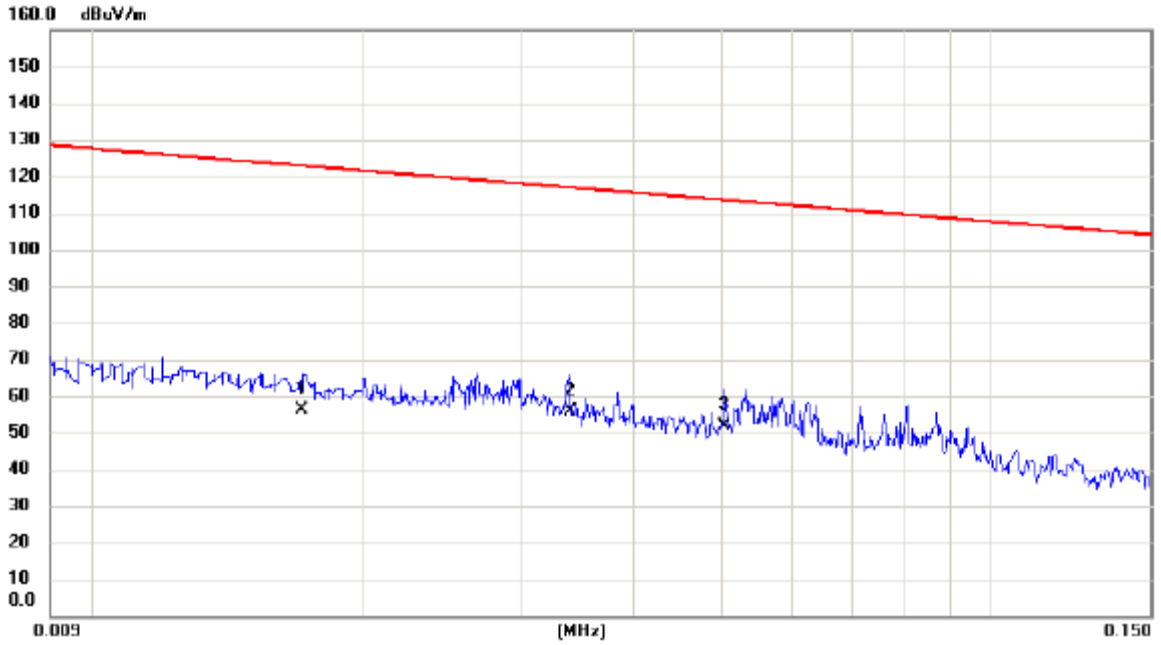

No.	Mk.	Freq.	Reading Level	Correct Factor	Measurement	Limit	Margin	Detector	Comment
		MHz	dBuV	dB	dBuV/m	dBuV/m	dB		
1		0.0171	35.70	20.43	56.13	122.94	-66.81	AVG	
2	*	0.0340	35.90	19.79	55.69	116.98	-61.29	AVG	
3		0.0505	32.30	19.51	51.81	113.54	-61.73	AVG	

Test Mode: TX Mode

Ant 90°

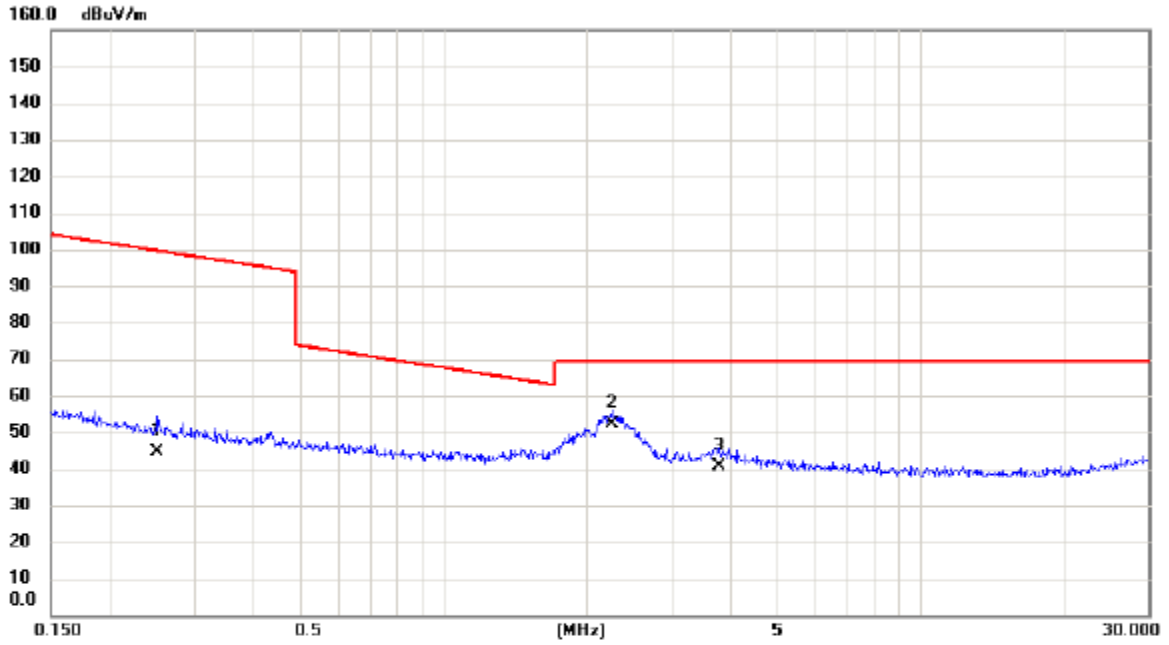

No.	Mk.	Freq. MHz	Reading Level dBuV	Correct Factor dB	Measure- ment dBuV/m	Limit dBuV/m	Margin dB	Detector	Comment
1		0.2508	27.70	17.06	44.76	99.62	-54.86	AVG	
2	*	2.2486	35.40	16.96	52.36	69.54	-17.18	QP	
3		3.7794	24.80	15.93	40.73	69.54	-28.81	QP	

APPENDIX C - RADIATED EMISSION (30 MHZ TO 1000 MHZ)

Test Mode: TX B Mode Channel 01

Vertical

80 dBuV/m

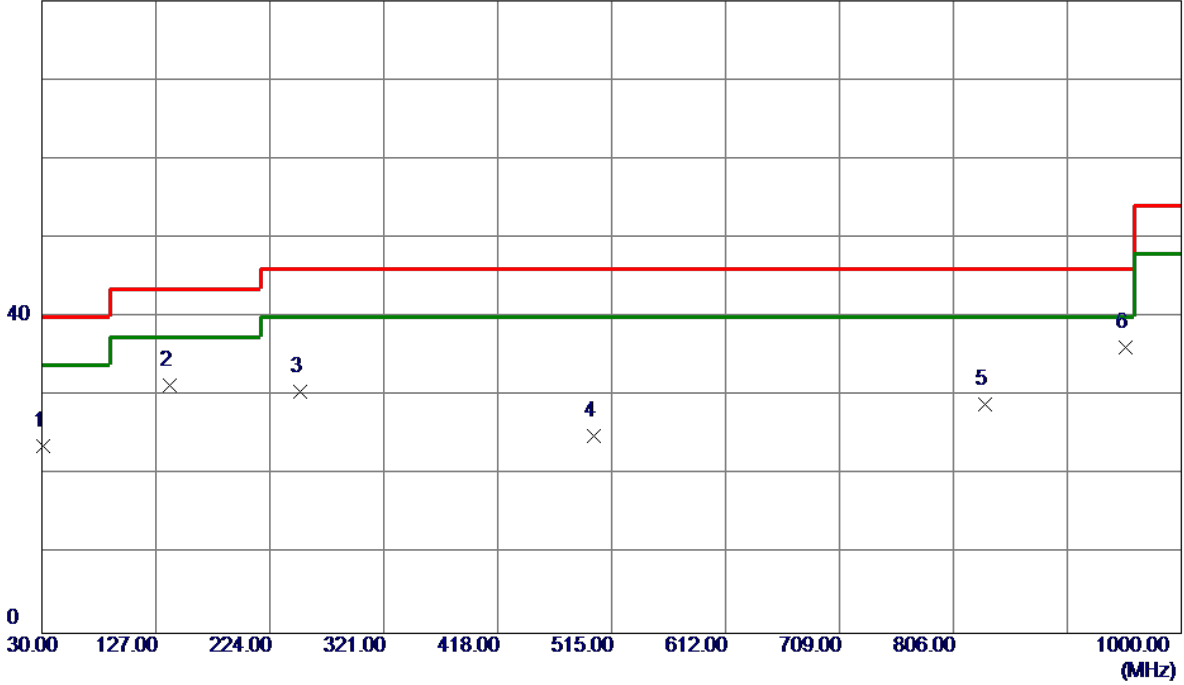

No.	Freq. MHz	Reading Level dBuV/m	Correct Factor dB	Measure ment dBuV/m	Limit dBuV/m	Margin dB	Detector	Comment
1	31.4550	38.64	-15.02	23.62	40.00	-16.38	Peak	
2	139.1250	43.51	-12.21	31.30	43.50	-12.20	Peak	
3	250.1900	44.85	-14.28	30.57	46.00	-15.43	Peak	
4	499.9650	33.56	-8.53	25.03	46.00	-20.97	Peak	
5	832.6750	30.51	-1.55	28.96	46.00	-17.04	Peak	
6 *	952.9550	34.88	1.34	36.22	46.00	-9.78	Peak	

Test Mode: TX B Mode Channel 01

Horizontal

80 dBuV/m

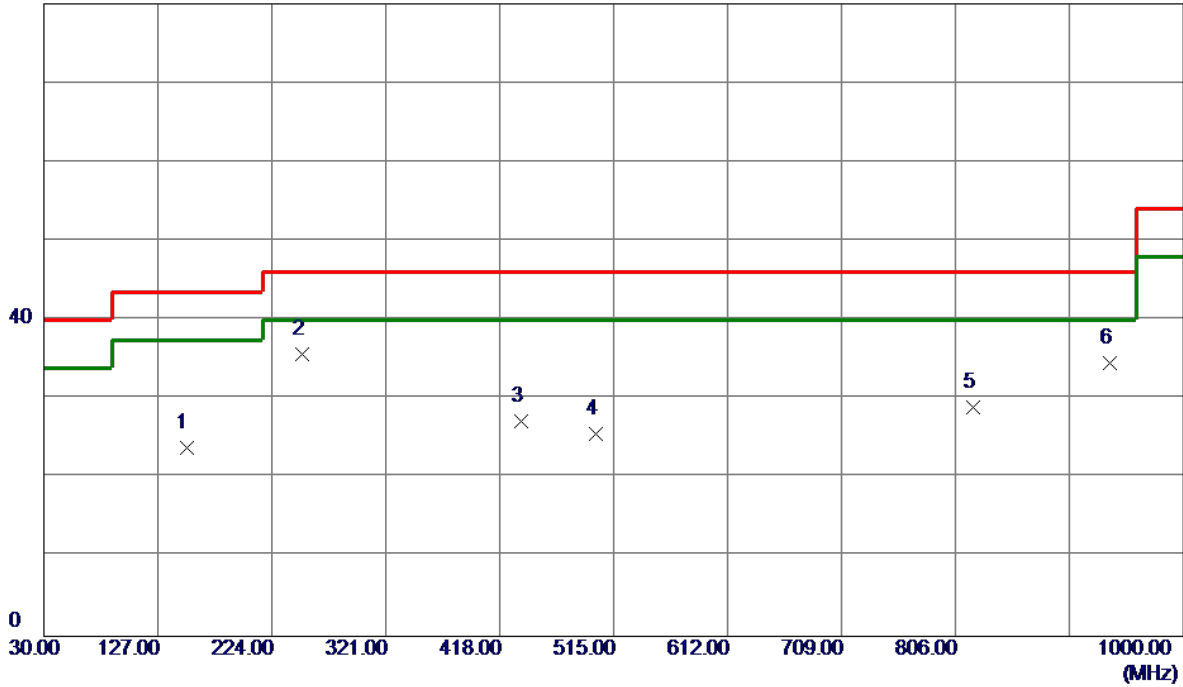

No.	Freq. MHz	Reading Level dBuV/m	Correct Factor dB	Measure ment dBuV/m	Limit dBuV/m	Margin dB	Detector	Comment
1	151.2500	35.22	-11.38	23.84	43.50	-19.66	Peak	
2 *	250.1900	49.95	-14.28	35.67	46.00	-10.33	Peak	
3	435.9450	35.14	-7.96	27.18	46.00	-18.82	Peak	
4	499.9650	34.13	-8.53	25.60	46.00	-20.40	Peak	
5	821.0349	30.39	-1.37	29.02	46.00	-16.98	Peak	
6	936.9500	33.61	0.89	34.50	46.00	-11.50	Peak	

Test Mode: TX B Mode Channel 06

Vertical

80 dBuV/m

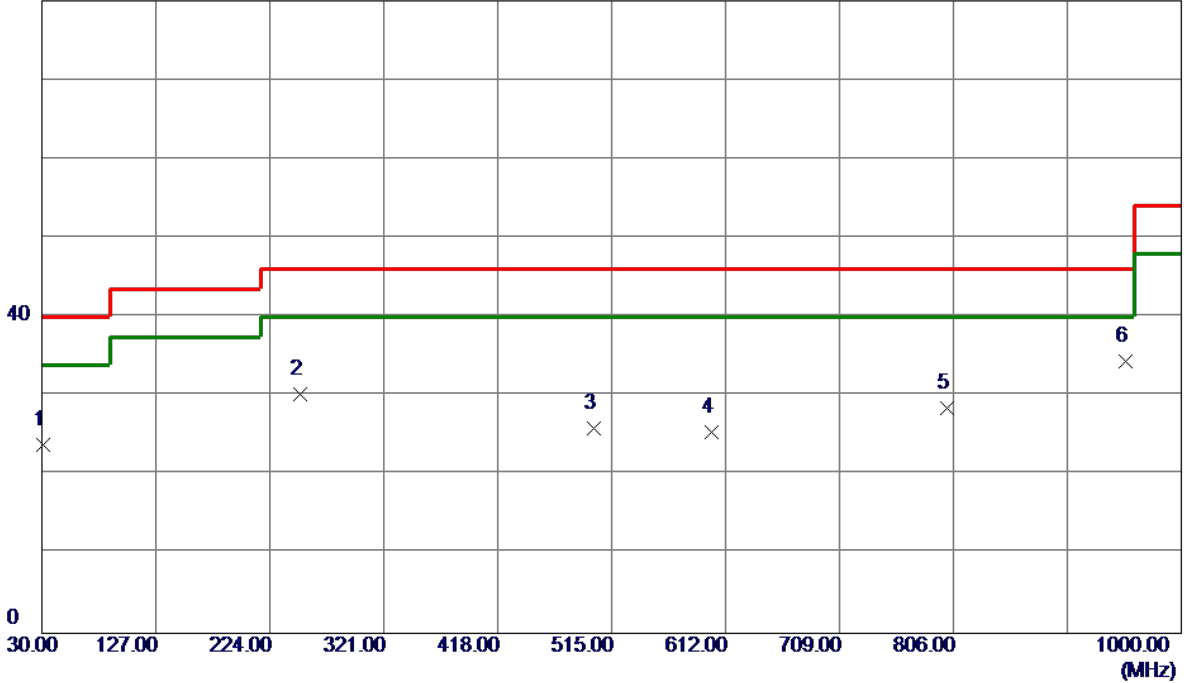

No.	Freq. MHz	Reading Level dBuV/m	Correct Factor dB	Measure ment dBuV/m	Limit dBuV/m	Margin dB	Detector	Comment
1	31.4550	38.79	-15.02	23.77	40.00	-16.23	Peak	
2	250.1900	44.49	-14.28	30.21	46.00	-15.79	Peak	
3	499.9650	34.42	-8.53	25.89	46.00	-20.11	Peak	
4	599.8750	31.81	-6.30	25.51	46.00	-20.49	Peak	
5	800.1800	29.57	-1.04	28.53	46.00	-17.47	Peak	
6 *	952.9550	33.04	1.34	34.38	46.00	-11.62	Peak	

Test Mode: TX B Mode Channel 06

Horizontal

80 dBuV/m

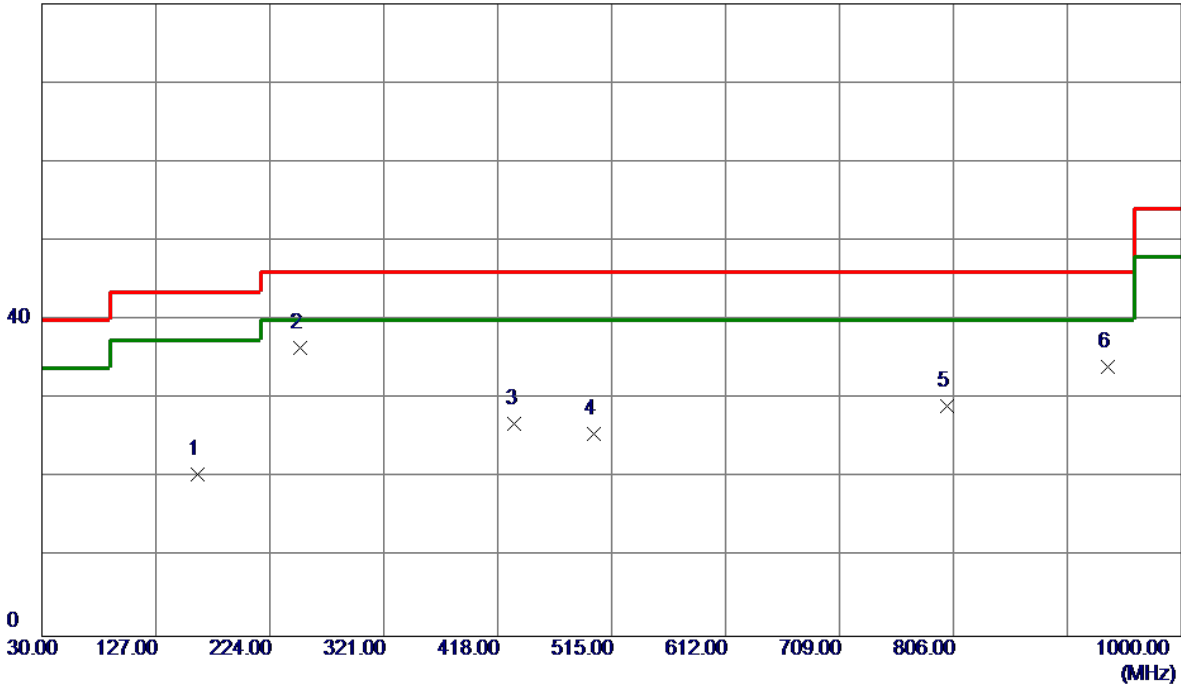

No.	Freq. MHz	Reading Level dBuV/m	Correct Factor dB	Measure ment dBuV/m	Limit dBuV/m	Margin dB	Detector	Comment
1	162.4050	31.19	-10.74	20.45	43.50	-23.05	Peak	
2 *	250.1900	50.69	-14.28	36.41	46.00	-9.59	Peak	
3	432.5500	35.03	-8.10	26.93	46.00	-19.07	Peak	
4	499.9650	34.06	-8.53	25.53	46.00	-20.47	Peak	
5	800.1800	30.22	-1.04	29.18	46.00	-16.82	Peak	
6	936.9500	33.24	0.89	34.13	46.00	-11.87	Peak	

Test Mode: TX B Mode Channel 11

Vertical

80 dBuV/m

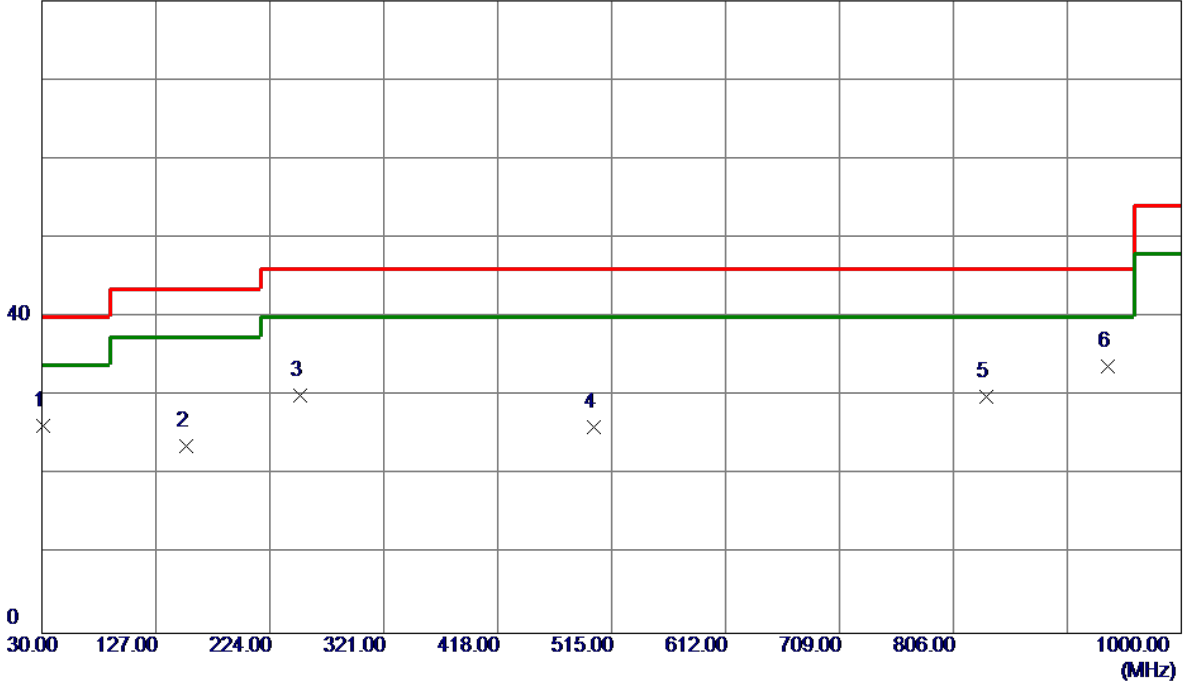

No.	Freq. MHz	Reading Level dBuV/m	Correct Factor dB	Measure ment dBuV/m	Limit dBuV/m	Margin dB	Detector	Comment
1	31.4550	41.23	-15.02	26.21	40.00	-13.79	Peak	
2	152.7050	34.86	-11.25	23.61	43.50	-19.89	Peak	
3	250.1900	44.32	-14.28	30.04	46.00	-15.96	Peak	
4	499.9650	34.61	-8.53	26.08	46.00	-19.92	Peak	
5	833.6450	31.53	-1.56	29.97	46.00	-16.03	Peak	
6 *	936.9500	32.80	0.89	33.69	46.00	-12.31	Peak	

Test Mode: TX B Mode Channel 11

Horizontal

80 dBuV/m

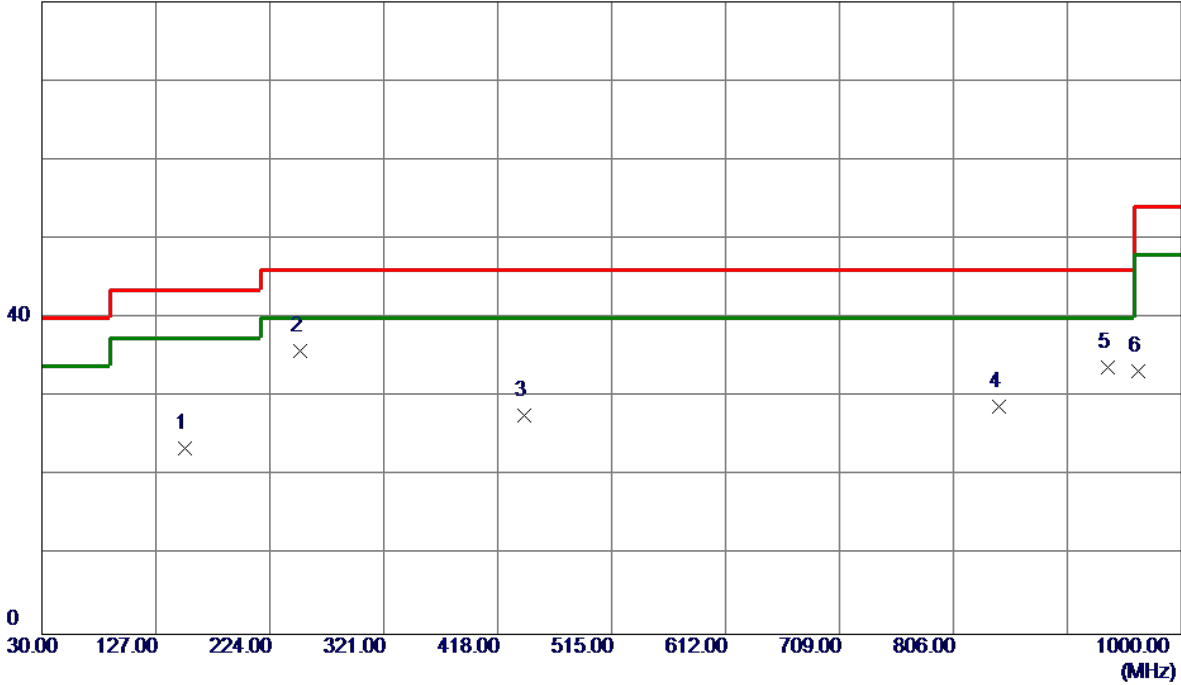

No.	Freq. MHz	Reading Level dBuV/m	Correct Factor dB	Measure ment dBuV/m	Limit dBuV/m	Margin dB	Detector	Comment
1	151.7350	34.81	-11.34	23.47	43.50	-20.03	Peak	
2 *	250.1900	50.15	-14.28	35.87	46.00	-10.13	Peak	
3	440.7950	35.45	-7.77	27.68	46.00	-18.32	Peak	
4	844.3150	30.50	-1.73	28.77	46.00	-17.23	Peak	
5	936.9500	32.90	0.89	33.79	46.00	-12.21	Peak	
6	963.6250	32.25	1.09	33.34	54.00	-20.66	Peak	

APPENDIX D - RADIATED EMISSION (ABOVE 1000 MHZ)

Orthogonal Axis	X
Test Mode:	TX B Mode 2412 MHz

Vertical

130 dBuV/m

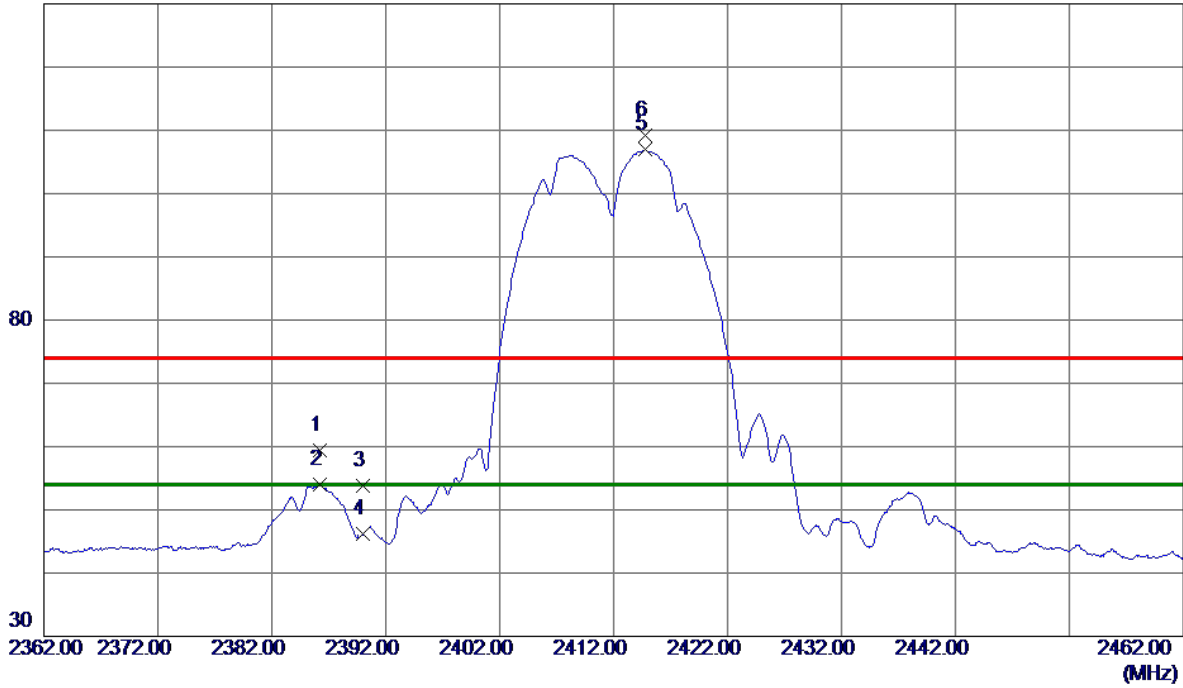

No.	Freq. MHz	Reading Level dBuV/m	Correct Factor dB	Measure ment dBuV/m	Limit dBuV/m	Margin dB	Detector	Comment
1	2386.2000	52.72	6.62	59.34	74.00	-14.66	Peak	
2	2386.2000	47.35	6.62	53.97	54.00	-0.03	AVG	
3	2390.0000	47.19	6.62	53.81	74.00	-20.19	Peak	
4	2390.0000	39.65	6.62	46.27	54.00	-7.73	AVG	
5 *	2414.7500	100.29	6.62	106.91	54.00	52.91	AVG	No Limit
6	2414.8000	102.66	6.62	109.28	74.00	35.28	Peak	No Limit

Orthogonal Axis	X
Test Mode:	TX B Mode 2412 MHz

Vertical

80 dBuV/m

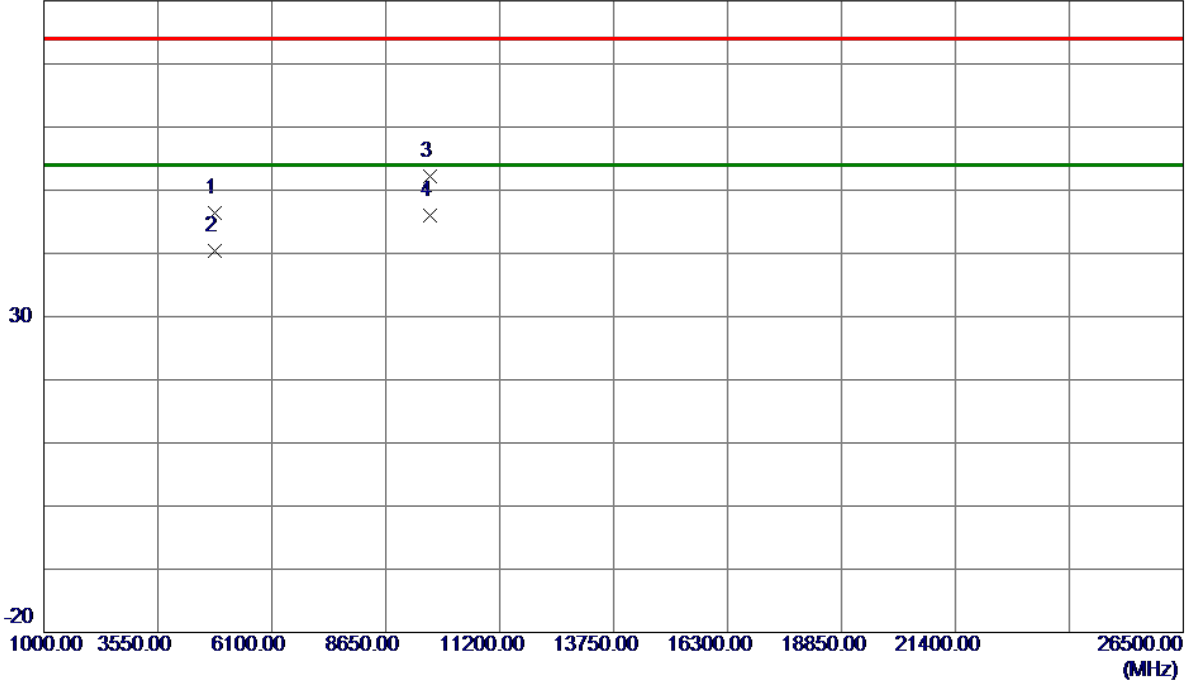

No.	Freq. MHz	Reading Level dBuV/m	Correct Factor dB	Measure ment dBuV/m	Limit dBuV/m	Margin dB	Detector	Comment
1	4823.9690	42.85	3.57	46.42	74.00	-27.58	Peak	
2	4823.9990	36.80	3.57	40.37	54.00	-13.63	AVG	
3	9647.8540	41.23	11.03	52.26	74.00	-21.74	Peak	
4 *	9648.0210	34.90	11.03	45.93	54.00	-8.07	AVG	

Orthogonal Axis	X
Test Mode:	TX B Mode 2412 MHz

Horizontal

130 dBuV/m

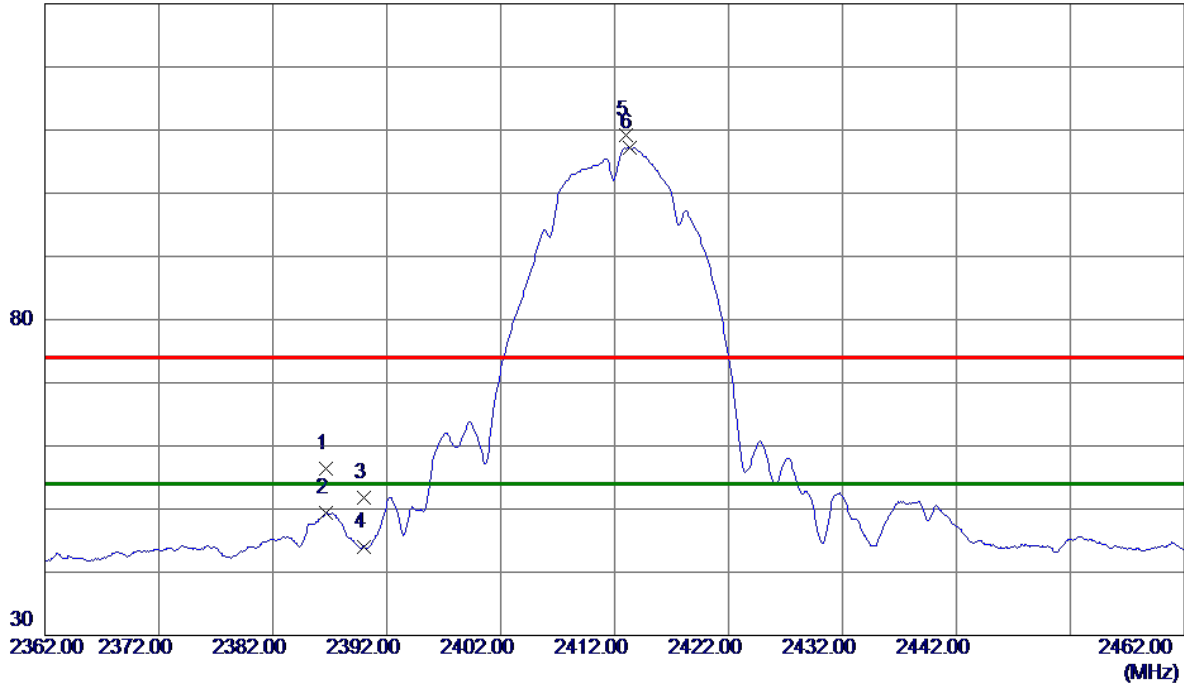

No.	Freq. MHz	Reading Level dBuV/m	Correct Factor dB	Measure ment dBuV/m	Limit dBuV/m	Margin dB	Detector	Comment
1	2386.7000	49.83	6.62	56.45	74.00	-17.55	Peak	
2	2386.7000	42.70	6.62	49.32	54.00	-4.68	AVG	
3	2390.0000	45.27	6.62	51.89	74.00	-22.11	Peak	
4	2390.0000	37.44	6.62	44.06	54.00	-9.94	AVG	
5	2412.9500	102.49	6.62	109.11	74.00	35.11	Peak	No Limit
6 *	2413.3000	100.56	6.62	107.18	54.00	53.18	AVG	No Limit

Orthogonal Axis	X
Test Mode:	TX B Mode 2412 MHz

Horizontal

80 dBuV/m

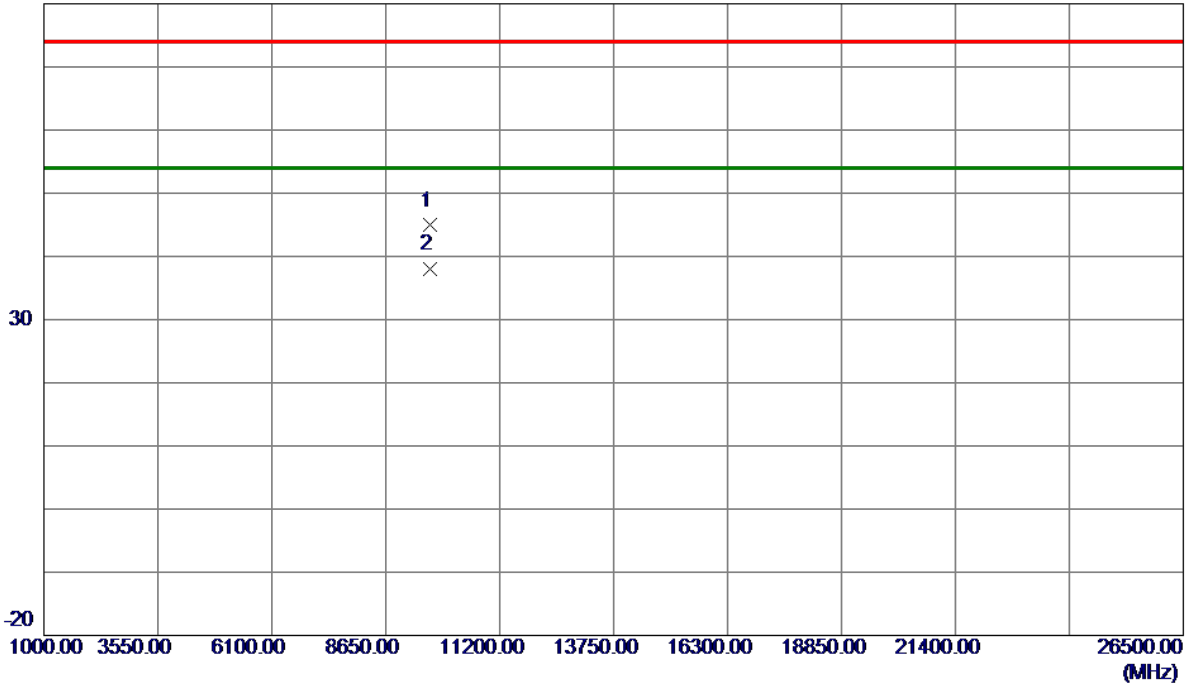

No.	Freq. MHz	Reading Level dBuV/m	Correct Factor dB	Measure ment dBuV/m	Limit dBuV/m	Margin dB	Detector	Comment
1	9647.9700	33.87	11.03	44.90	74.00	-29.10	Peak	
2 *	9648.0039	26.97	11.03	38.00	54.00	-16.00	AVG	

Orthogonal Axis :	X
Test Mode :	TX B MODE 2417MHz

Vertical

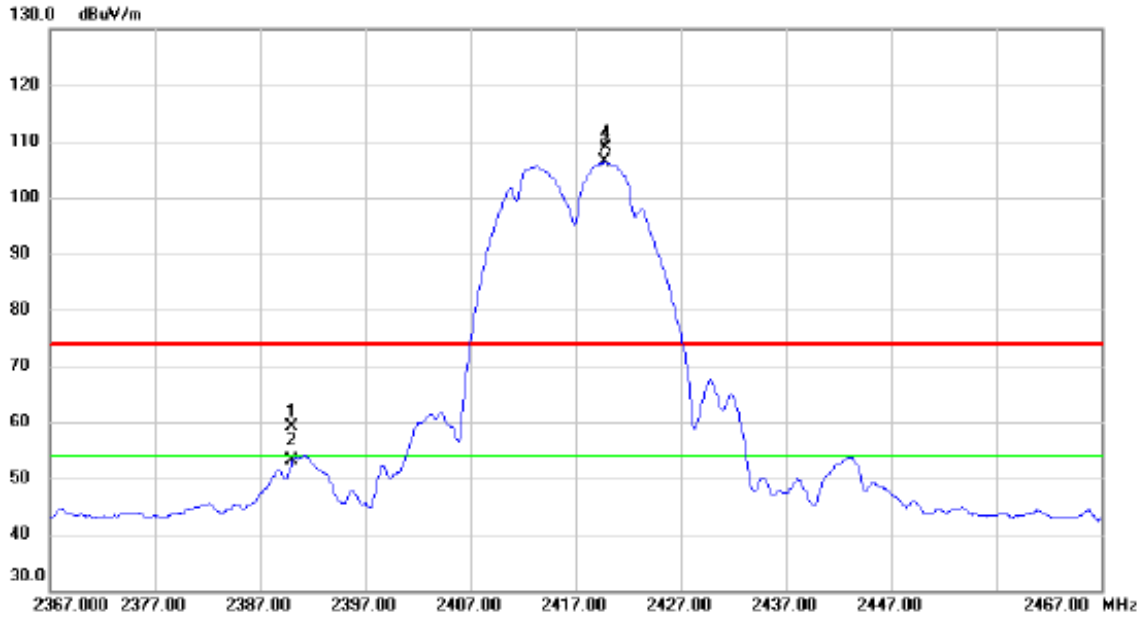

No.	Mk.	Freq. MHz	Reading Level dBuV	Correct Factor dB	Measure- ment dBuV/m	Limit dBuV/m	Margin dB	Detector	Comment
1		2390.000	52.50	6.62	59.12	74.00	-14.88	peak	
2		2390.000	46.50	6.62	53.12	54.00	-0.88	AVG	
3	*	2419.750	99.77	6.62	106.39	54.00	52.39	AVG	No Limit
4	X	2419.800	102.15	6.62	108.77	74.00	34.77	peak	No Limit

Orthogonal Axis :	X
Test Mode :	TX B MODE 2417MHz

Vertical

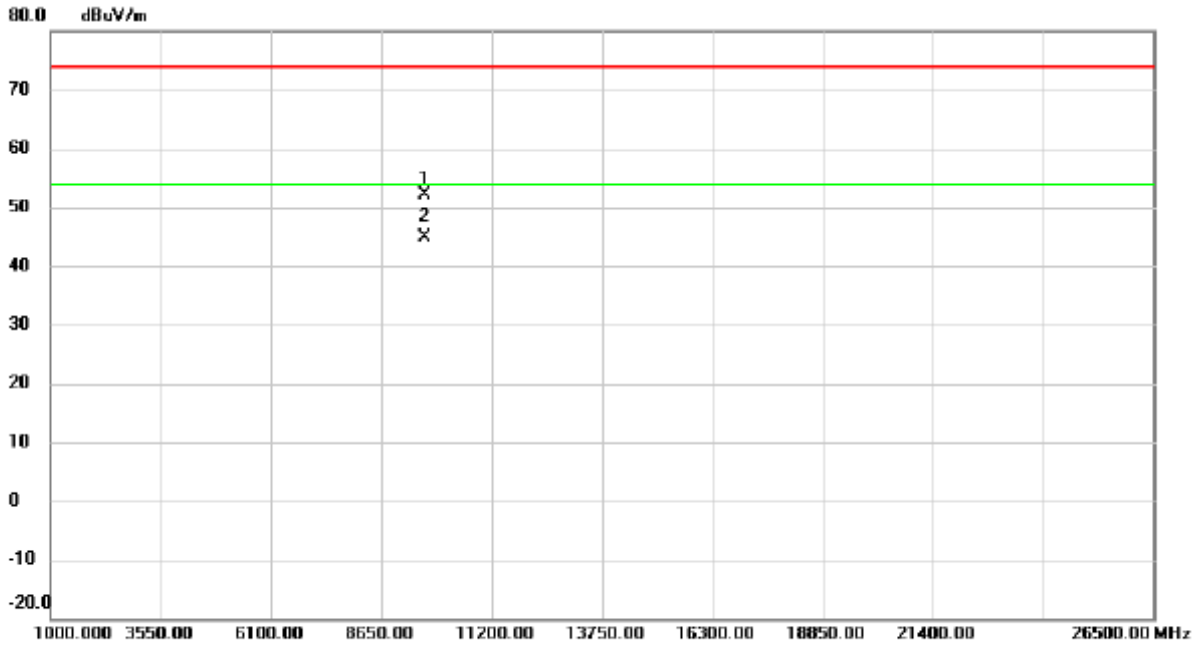

No.	Mk.	Freq. MHz	Reading Level dBuV	Correct Factor dB	Measure- ment dBuV/m	Limit dBuV/m	Margin dB	Detector	Comment
1		9667.906	41.06	11.03	52.09	74.00	-21.91	peak	
2	*	9668.005	33.97	11.03	45.00	54.00	-9.00	AVG	

Orthogonal Axis :	X
Test Mode :	TX B MODE 2417MHz

Horizontal

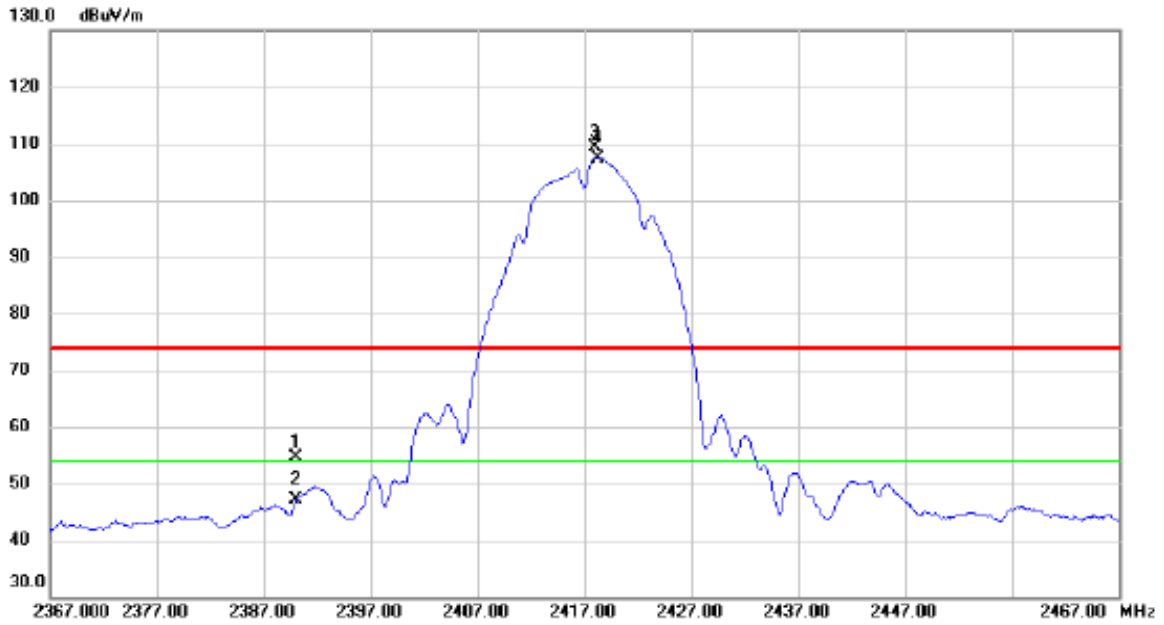

No.	Mk.	Freq. MHz	Reading Level dBuV	Correct Factor dB	Measure- ment dBuV/m	Limit dBuV/m	Margin dB	Detector	Comment
1		2390.000	48.02	6.62	54.64	74.00	-19.36	peak	
2		2390.000	40.60	6.62	47.22	54.00	-6.78	AVG	
3	X	2418.000	102.70	6.61	109.31	74.00	35.31	peak	No Limit
4	*	2418.250	100.77	6.61	107.38	54.00	53.38	AVG	No Limit

Orthogonal Axis :	X
Test Mode :	TX B MODE 2417MHz

Horizontal

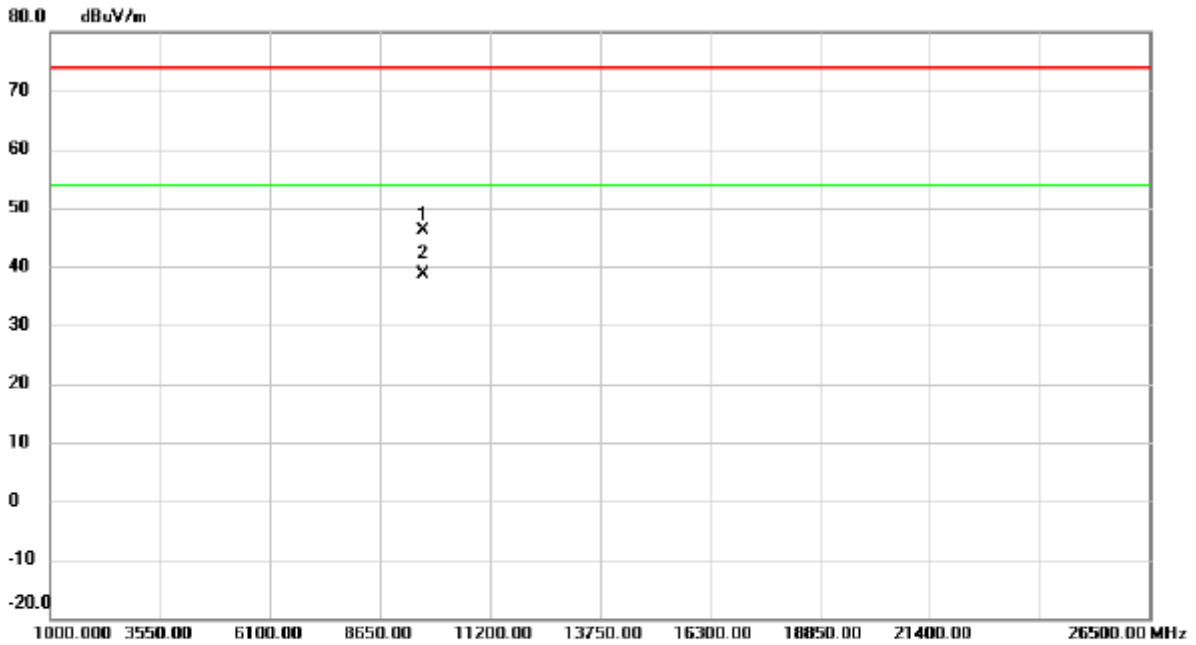

No.	Mk.	Freq.	Reading Level	Correct Factor	Measurement	Limit	Margin	Detector	Comment
		MHz	dBuV	dB	dBuV/m	dBuV/m	dB		
1		9667.511	35.21	11.03	46.24	74.00	-27.76	peak	
2	*	9668.013	27.67	11.03	38.70	54.00	-15.30	AVG	

Orthogonal Axis	X
Test Mode:	TX B Mode 2437 MHz

Vertical

130 dBuV/m

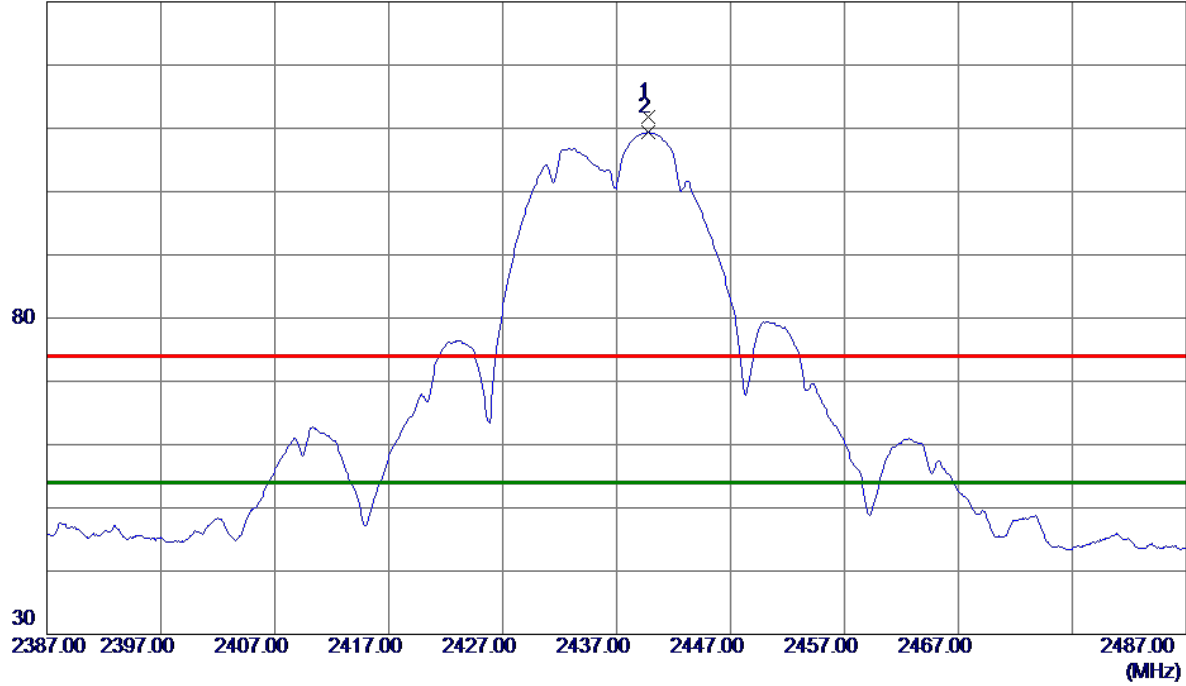

No.	Freq. MHz	Reading Level dBuV/m	Correct Factor dB	Measure ment dBuV/m	Limit dBuV/m	Margin dB	Detector	Comment
1	2439.7500	105.16	6.61	111.77	74.00	37.77	Peak	No Limit
2 *	2439.7500	102.86	6.61	109.47	54.00	55.47	AVG	No Limit

Orthogonal Axis	X
Test Mode:	TX B Mode 2437 MHz

Vertical

80 dBuV/m

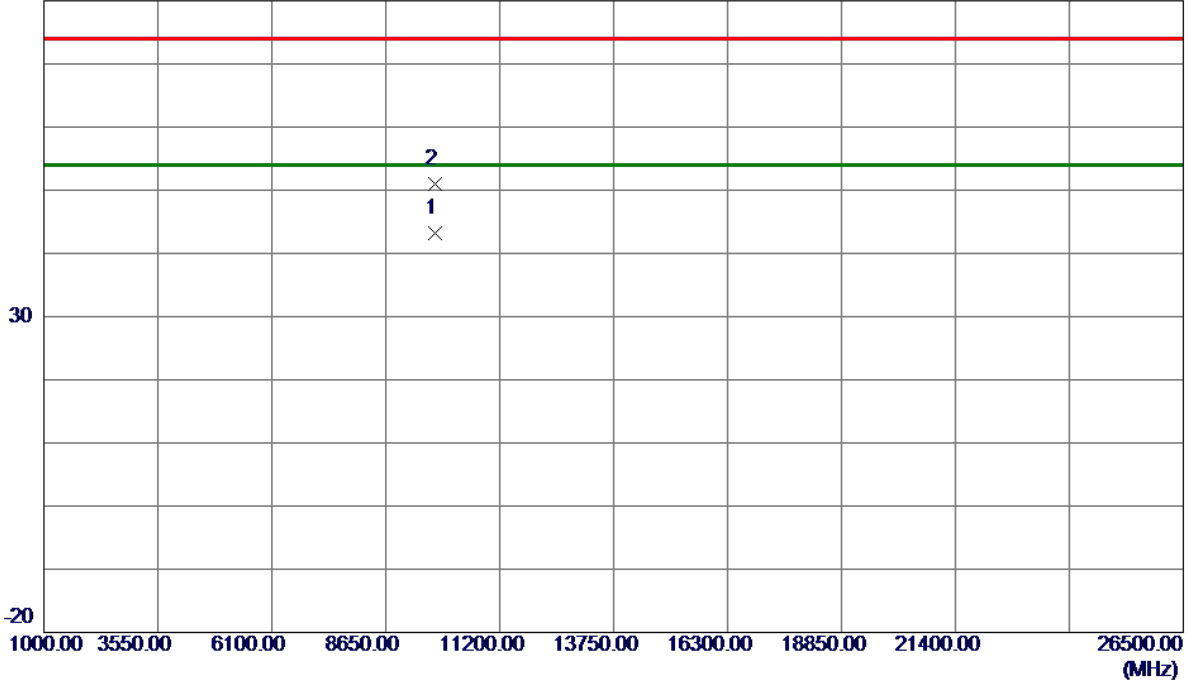

No.	Freq. MHz	Reading Level dBuV/m	Correct Factor dB	Measure ment dBuV/m	Limit dBuV/m	Margin dB	Detector	Comment
1 *	9747.9670	32.20	11.05	43.25	54.00	-10.75	AVG	
2	9748.0910	40.00	11.05	51.05	74.00	-22.95	Peak	

Orthogonal Axis	X
Test Mode:	TX B Mode 2437 MHz

Horizontal

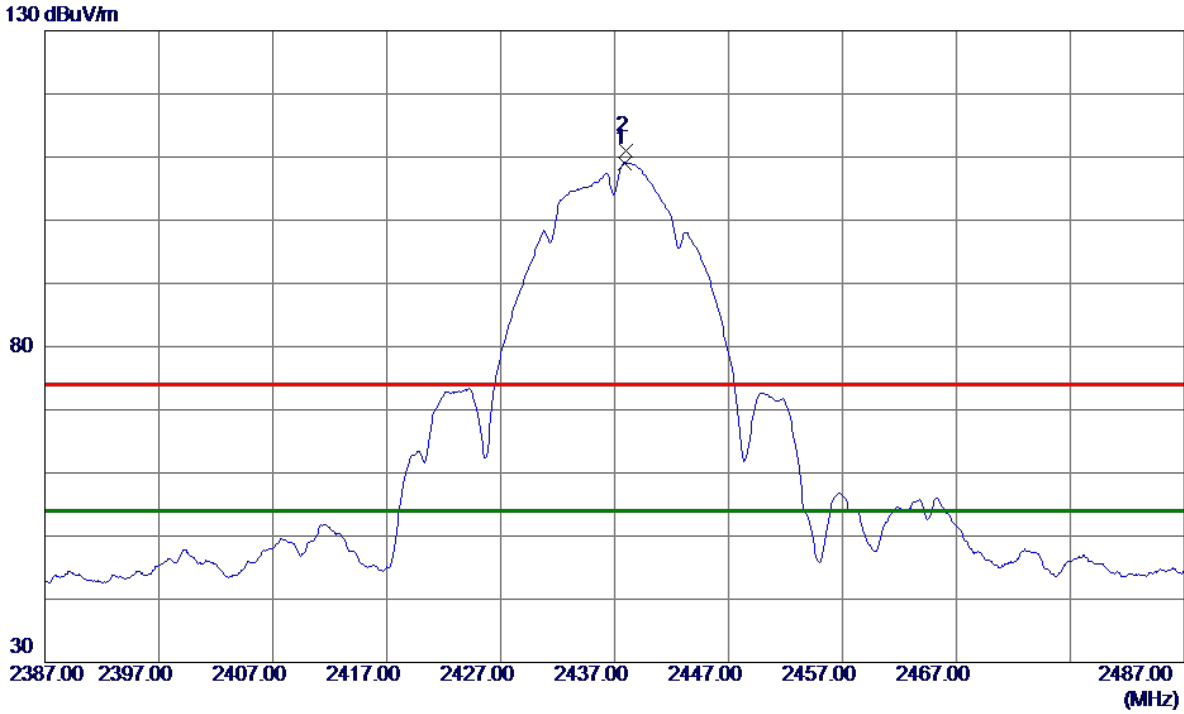

No.	Freq. MHz	Reading Level dBuV/m	Correct Factor dB	Measure ment dBuV/m	Limit dBuV/m	Margin dB	Detector	Comment
1 *	2437.8500	102.49	6.61	109.10	54.00	55.10	AVG	No Limit
2	2437.9500	104.43	6.61	111.04	74.00	37.04	Peak	No Limit

Orthogonal Axis	X
Test Mode:	TX B Mode 2437 MHz

Horizontal

80 dBuV/m

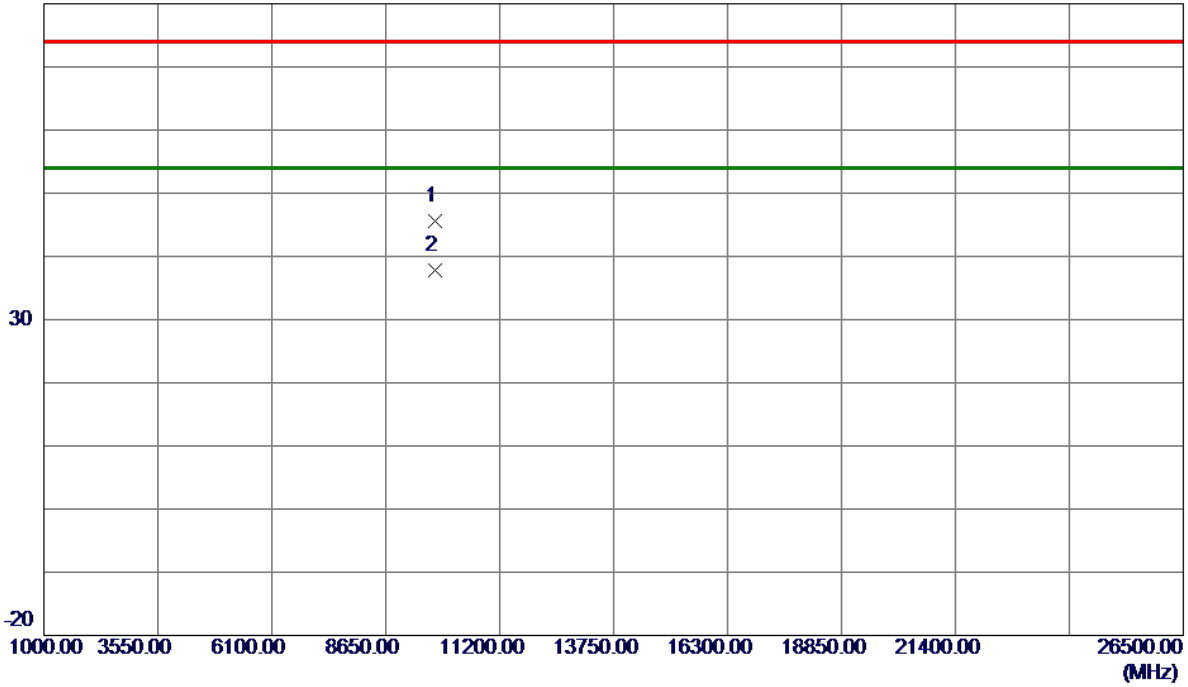

No.	Freq. MHz	Reading Level dBuV/m	Correct Factor dB	Measure ment dBuV/m	Limit dBuV/m	Margin dB	Detector	Comment
1	9747.8820	34.49	11.05	45.54	74.00	-28.46	Peak	
2 *	9748.0170	26.75	11.05	37.80	54.00	-16.20	AVG	

Orthogonal Axis :	X
Test Mode :	TX B MODE 2457MHz

Vertical

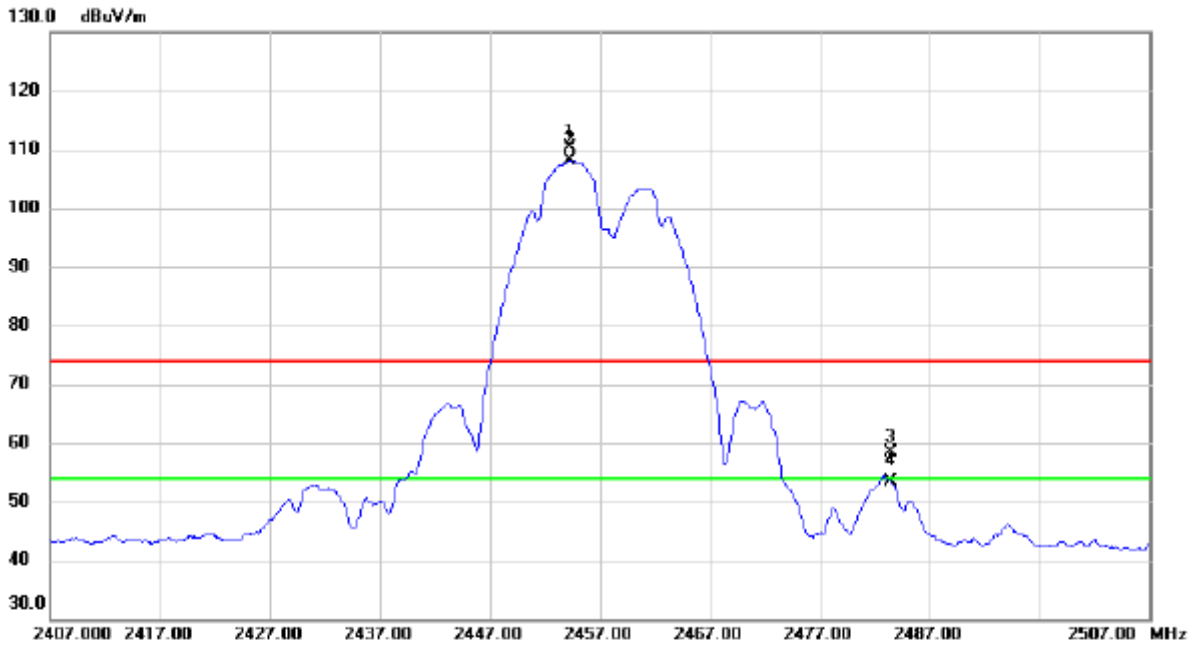

No.	Mk.	Freq. MHz	Reading Level dBuV	Correct Factor dB	Measure- ment dBuV/m	Limit dBuV/m	Margin dB	Detector	Comment
1	X	2454.250	103.82	6.60	110.42	74.00	36.42	peak	No Limit
2	*	2454.300	101.57	6.60	108.17	54.00	54.17	AVG	No Limit
3		2483.500	51.85	6.61	58.46	74.00	-15.54	peak	
4		2483.500	46.70	6.61	53.31	54.00	-0.69	AVG	

Orthogonal Axis :	X
Test Mode :	TX B MODE 2457MHz

Vertical

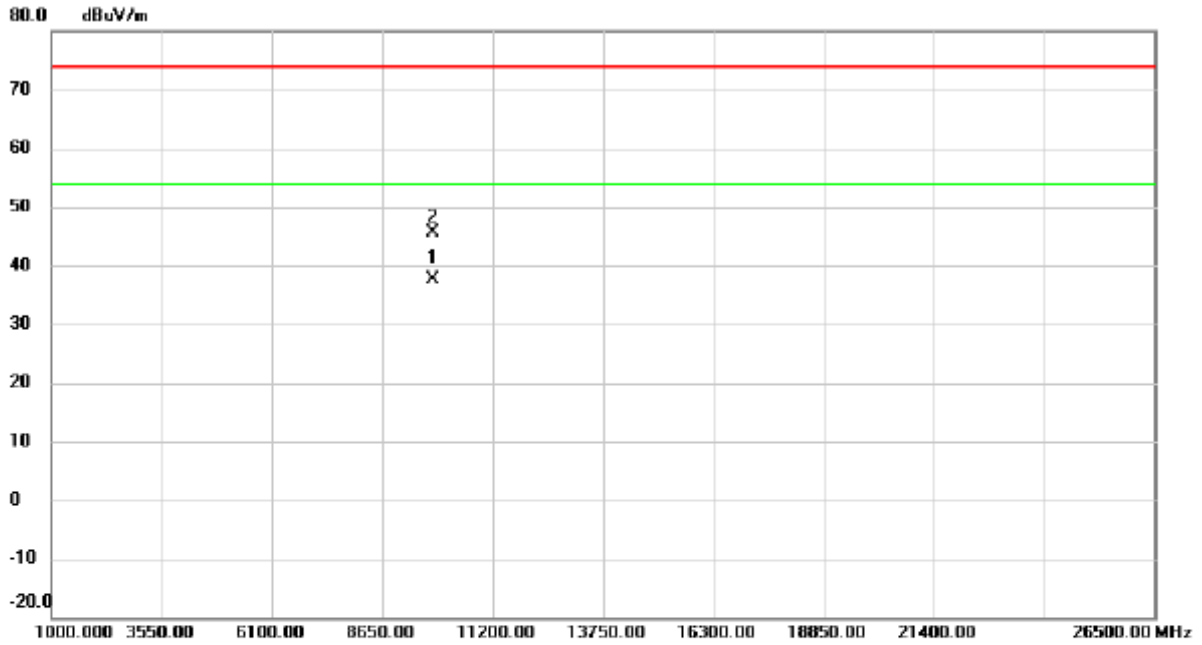

No.	Mk.	Freq. MHz	Reading Level dBuV	Correct Factor dB	Measure- ment dBuV/m	Limit dBuV/m	Margin dB	Detector	Comment
1	*	9827.998	26.52	11.06	37.58	54.00	-16.42	AVG	
2		9828.177	34.56	11.06	45.62	74.00	-28.38	peak	

Orthogonal Axis :	X
Test Mode :	TX B MODE 2457MHz

Horizontal

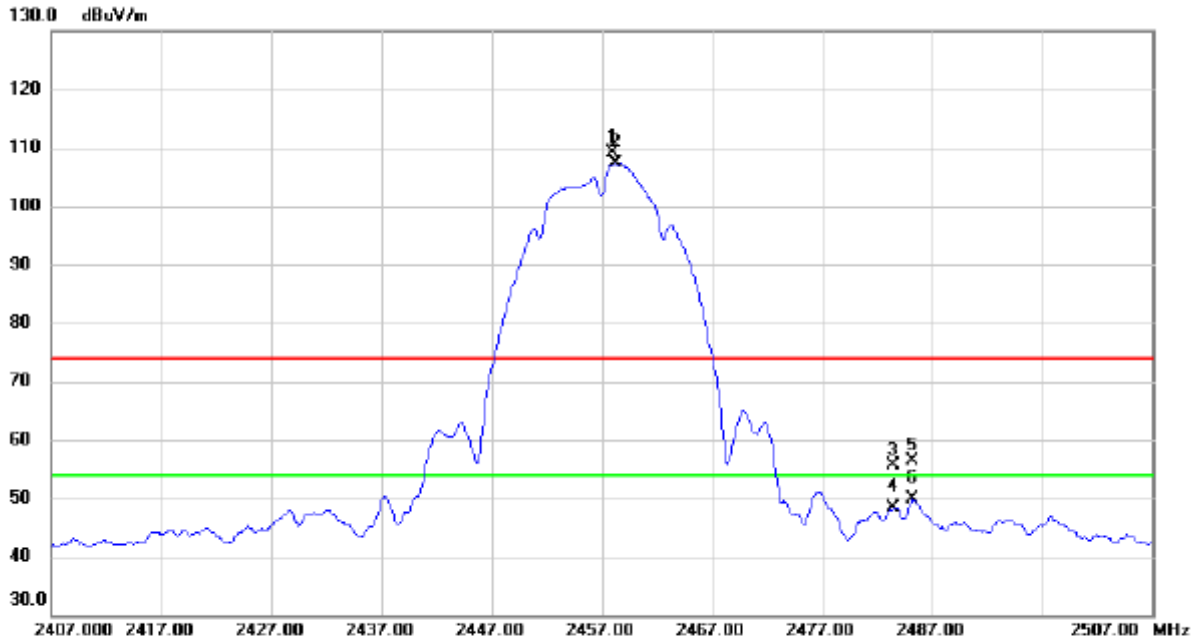

No.	Mk.	Freq. MHz	Reading Level dBuV	Correct Factor dB	Measure- ment dBuV/m	Limit dBuV/m	Margin dB	Detector	Comment
1	X	2457.950	102.58	6.62	109.20	74.00	35.20	peak	No Limit
2	*	2458.300	100.71	6.62	107.33	54.00	53.33	AVG	No Limit
3		2483.500	49.05	6.61	55.66	74.00	-18.34	peak	
4		2483.500	41.67	6.61	48.28	54.00	-5.72	AVG	
5		2485.250	49.71	6.61	56.32	74.00	-17.68	peak	
6		2485.250	43.19	6.61	49.80	54.00	-4.20	AVG	

Orthogonal Axis :	X
Test Mode :	TX B MODE 2457MHz

Horizontal

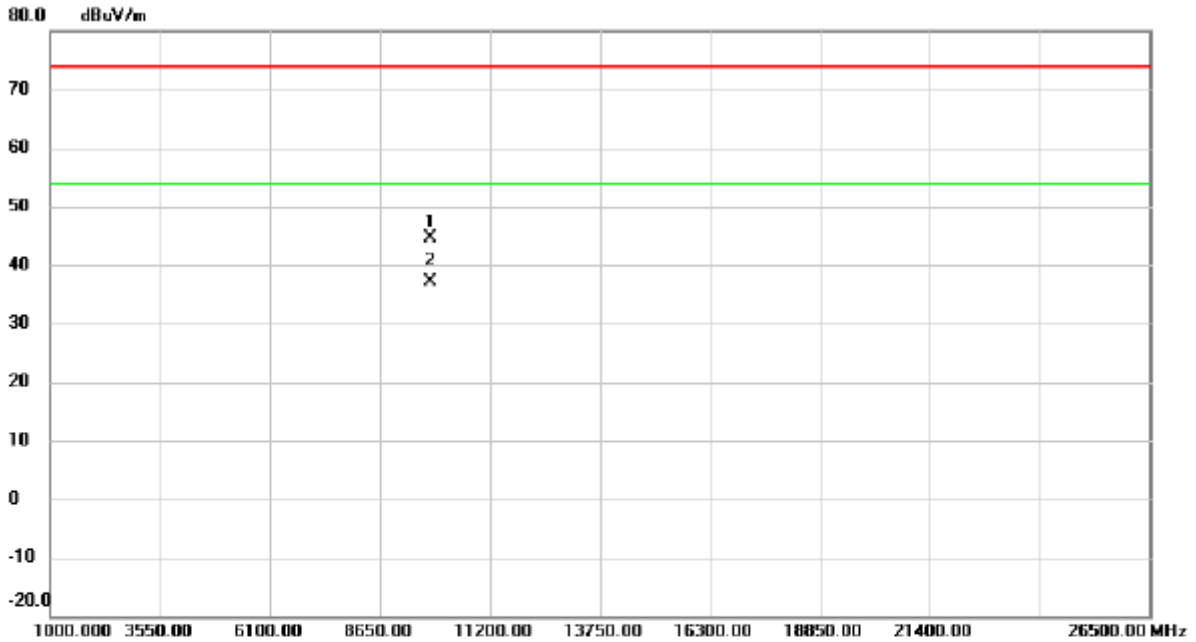

No.	Mk.	Freq. MHz	Reading Level dBuV	Correct Factor dB	Measure- ment dBuV/m	Limit dBuV/m	Margin dB	Detector	Comment
1		9827.895	33.68	11.06	44.74	74.00	-29.26	peak	
2	*	9828.153	26.02	11.06	37.08	54.00	-16.92	AVG	

Orthogonal Axis	X
Test Mode:	TX B Mode 2462 MHz

Vertical

130 dBuV/m

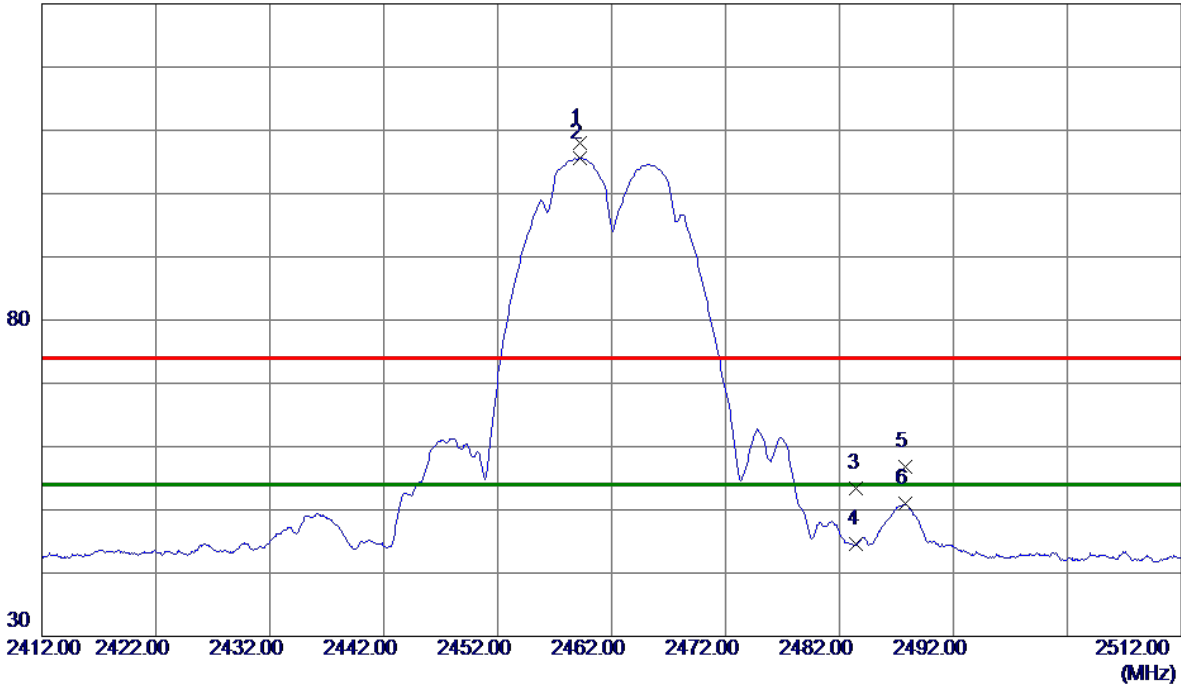

No.	Freq. MHz	Reading Level dBuV/m	Correct Factor dB	Measure ment dBuV/m	Limit dBuV/m	Margin dB	Detector	Comment
1	2459.2500	101.31	6.61	107.92	74.00	33.92	Peak	No Limit
2 *	2459.2500	99.05	6.61	105.66	54.00	51.66	AVG	No Limit
3	2483.5000	46.75	6.61	53.36	74.00	-20.64	Peak	
4	2483.5000	37.92	6.61	44.53	54.00	-9.47	AVG	
5	2487.7500	50.21	6.61	56.82	74.00	-17.18	Peak	
6	2487.7500	44.37	6.61	50.98	54.00	-3.02	AVG	

Orthogonal Axis	X
Test Mode:	TX B Mode 2462 MHz

Vertical

80 dBuV/m

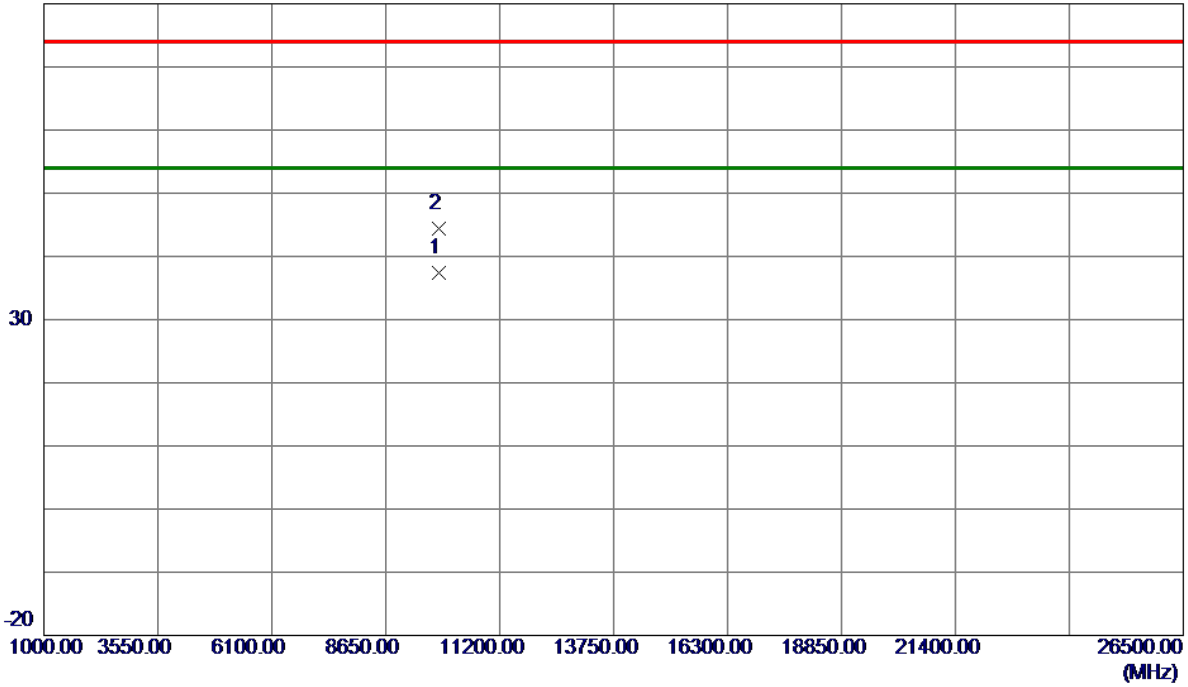

No.	Freq. MHz	Reading Level dBuV/m	Correct Factor dB	Measure ment dBuV/m	Limit dBuV/m	Margin dB	Detector	Comment
1 *	9848.0940	26.42	11.06	37.48	54.00	-16.52	AVG	
2	9848.2390	33.26	11.06	44.32	74.00	-29.68	Peak	

Orthogonal Axis	X
Test Mode:	TX B Mode 2462 MHz

Horizontal

130 dBuV/m

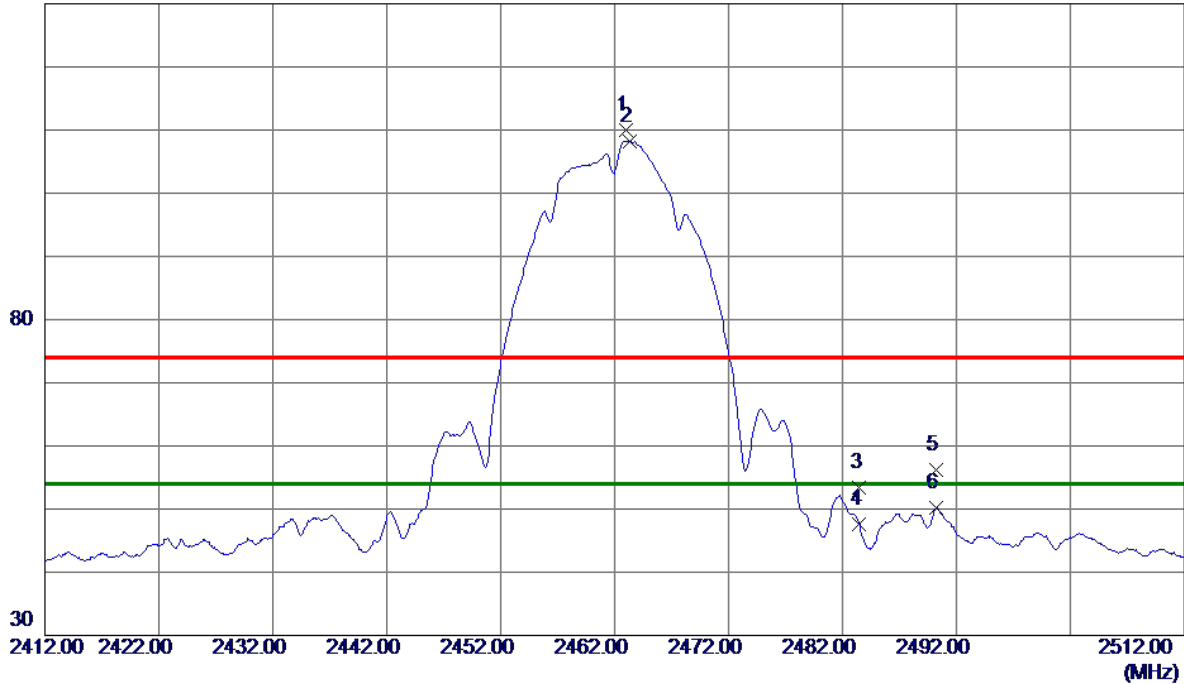

No.	Freq. MHz	Reading Level dBuV/m	Correct Factor dB	Measure ment dBuV/m	Limit dBuV/m	Margin dB	Detector	Comment
1	2462.9500	103.36	6.61	109.97	74.00	35.97	Peak	No Limit
2 *	2463.3000	101.64	6.61	108.25	54.00	54.25	AVG	No Limit
3	2483.5000	46.77	6.61	53.38	74.00	-20.62	Peak	
4	2483.5000	40.99	6.61	47.60	54.00	-6.40	AVG	
5	2490.2500	49.62	6.61	56.23	74.00	-17.77	Peak	
6	2490.2500	43.67	6.61	50.28	54.00	-3.72	AVG	

Orthogonal Axis	X
Test Mode:	TX B Mode 2462 MHz

Horizontal

80 dBuV/m

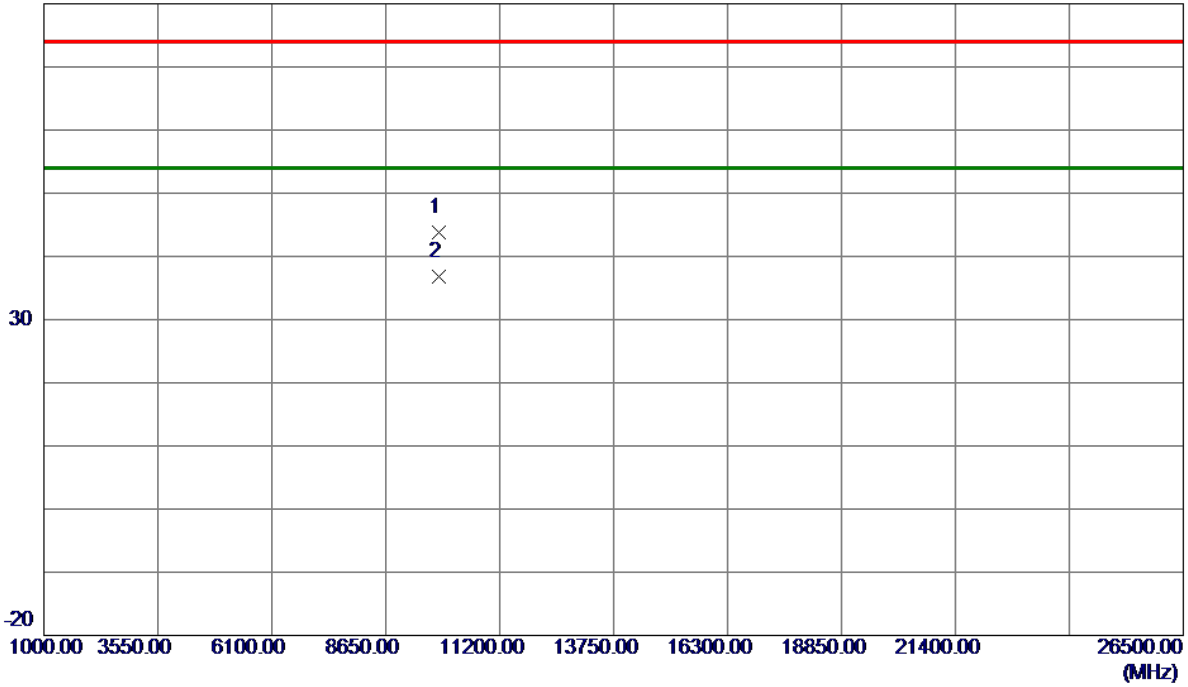

No.	Freq. MHz	Reading Level dBuV/m	Correct Factor dB	Measure ment dBuV/m	Limit dBuV/m	Margin dB	Detector	Comment
1	9847.7320	32.66	11.06	43.72	74.00	-30.28	Peak	
2 *	9847.9530	25.70	11.06	36.76	54.00	-17.24	AVG	

Orthogonal Axis	X
Test Mode:	TX G Mode 2412 MHz

Vertical

130 dBuV/m

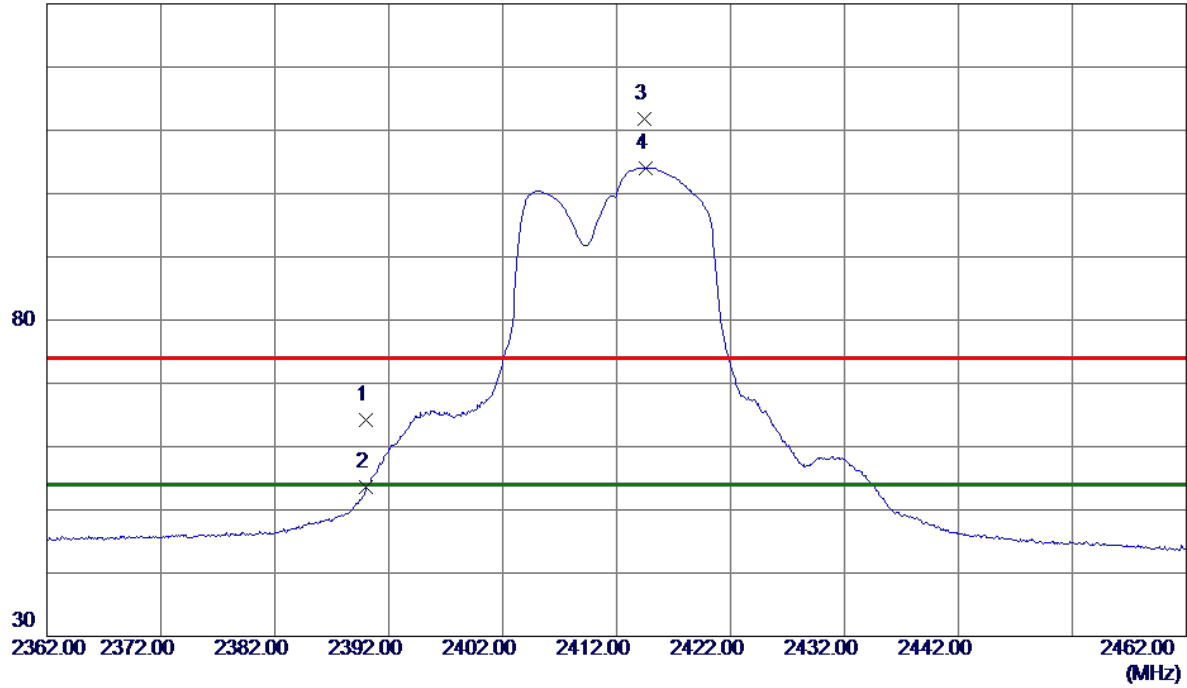

No.	Freq. MHz	Reading Level dBuV/m	Correct Factor dB	Measure ment dBuV/m	Limit dBuV/m	Margin dB	Detector	Comment
1	2390.0000	57.51	6.62	64.13	74.00	-9.87	Peak	
2	2390.0000	46.97	6.62	53.59	54.00	-0.41	AVG	
3	2414.4500	105.24	6.62	111.86	74.00	37.86	Peak	No Limit
4 *	2414.5500	97.48	6.62	104.10	54.00	50.10	AVG	No Limit

Orthogonal Axis	X
Test Mode:	TX G Mode 2412 MHz

Vertical

80 dBuV/m

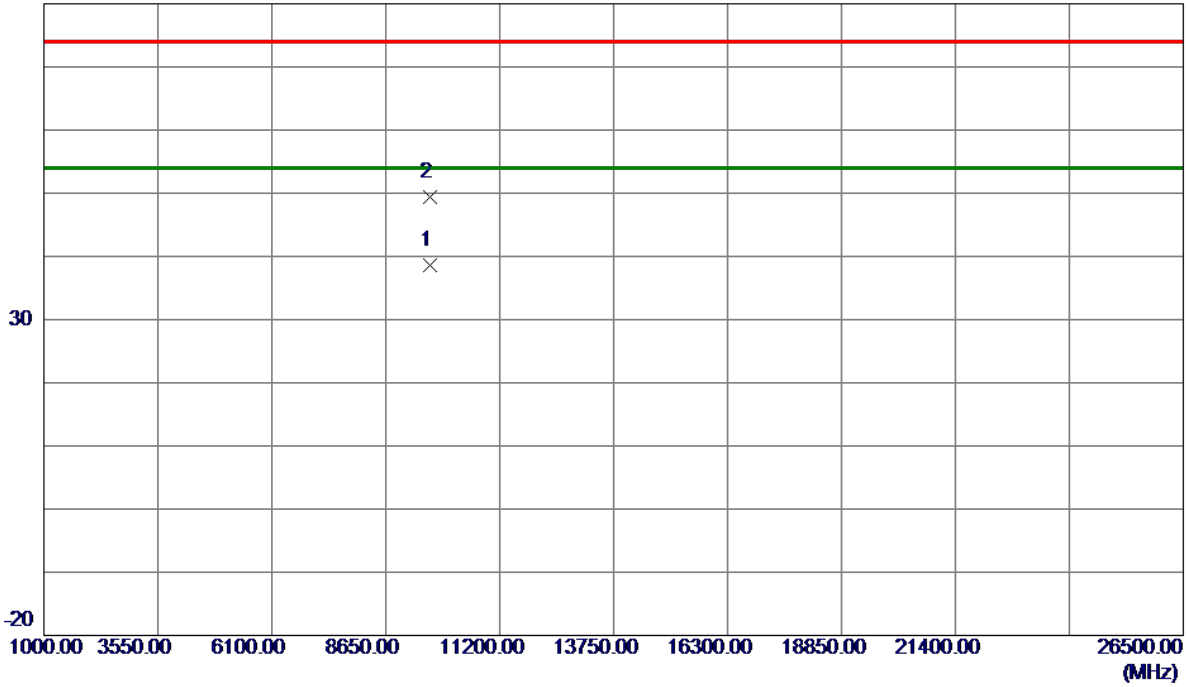

No.	Freq. MHz	Reading Level dBuV/m	Correct Factor dB	Measure ment dBuV/m	Limit dBuV/m	Margin dB	Detector	Comment
1 *	9647.9610	27.64	11.03	38.67	54.00	-15.33	AVG	
2	9647.9620	38.31	11.03	49.34	74.00	-24.66	Peak	

Orthogonal Axis	X
Test Mode:	TX G Mode 2412 MHz

Horizontal

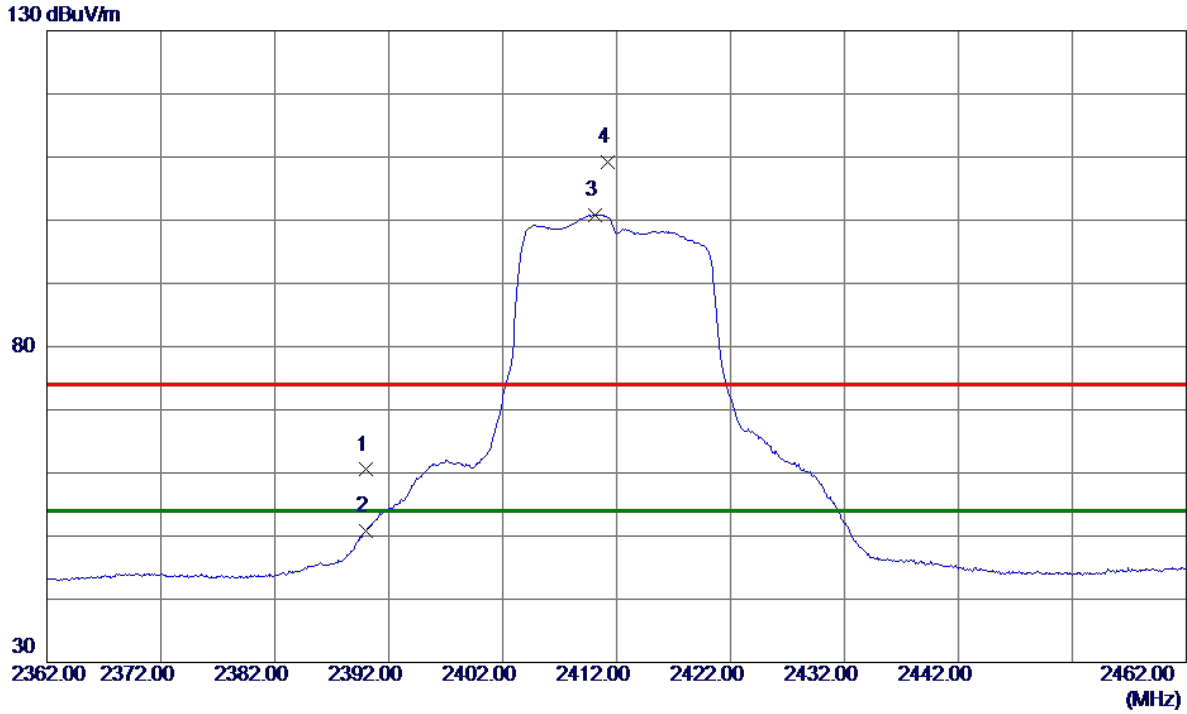

No.	Freq. MHz	Reading Level dBuV/m	Correct Factor dB	Measure ment dBuV/m	Limit dBuV/m	Margin dB	Detector	Comment
1	2390.0000	53.88	6.62	60.50	74.00	-13.50	Peak	
2	2390.0000	44.23	6.62	50.85	54.00	-3.15	AVG	
3 *	2410.1500	94.24	6.62	100.86	54.00	46.86	AVG	No Limit
4	2411.2000	102.64	6.62	109.26	74.00	35.26	Peak	No Limit

Orthogonal Axis	X
Test Mode:	TX G Mode 2412 MHz

Horizontal

80 dBuV/m

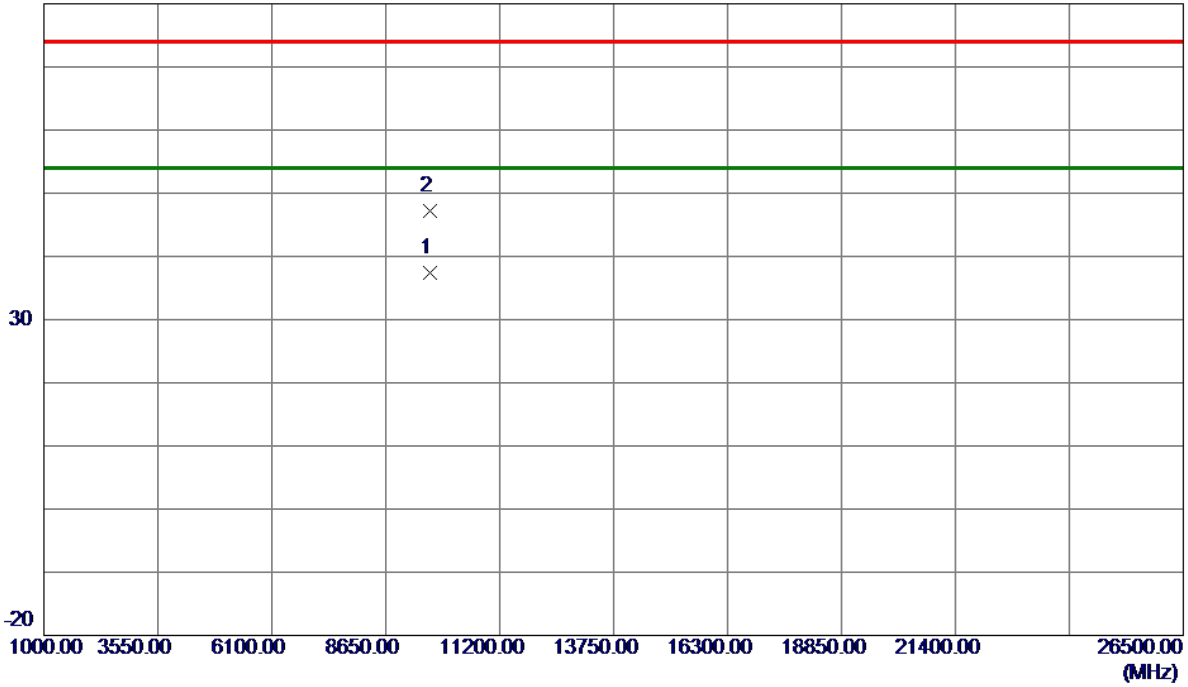

No.	Freq. MHz	Reading Level dBuV/m	Correct Factor dB	Measure ment dBuV/m	Limit dBuV/m	Margin dB	Detector	Comment
1 *	9648.1240	26.39	11.03	37.42	54.00	-16.58	AVG	
2	9648.5910	36.12	11.03	47.15	74.00	-26.85	Peak	

Orthogonal Axis :	X
Test Mode :	TX G MODE 2417MHz

Vertical

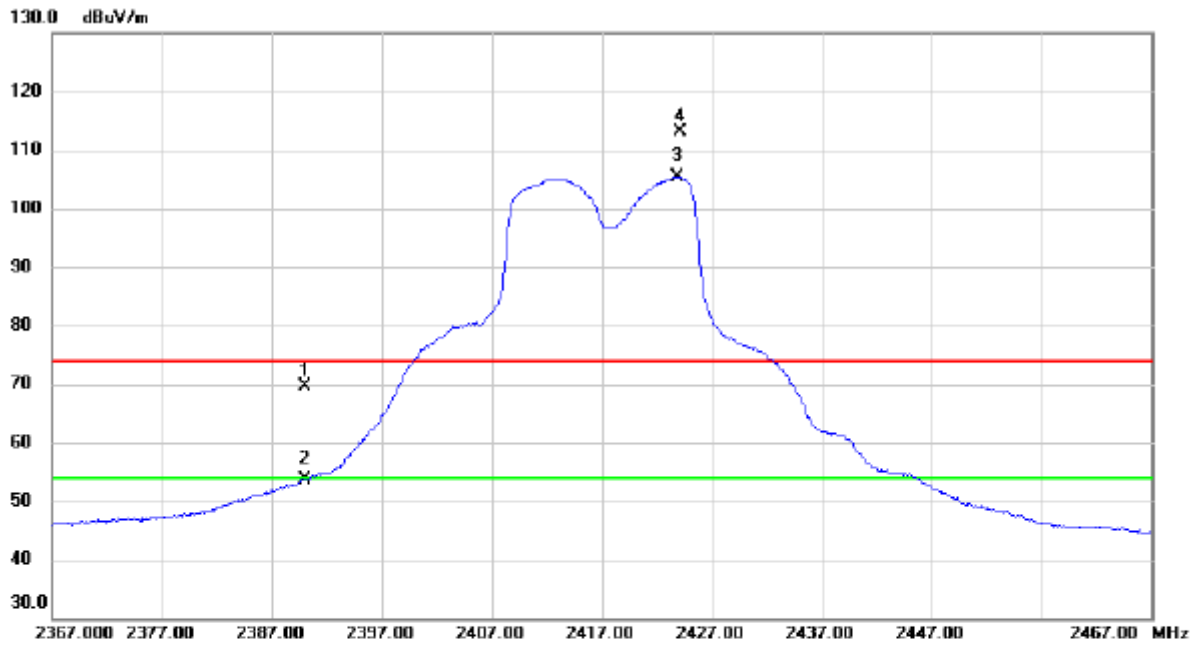

No.	Mk.	Freq. MHz	Reading Level dBuV	Correct Factor dB	Measure- ment dBuV/m	Limit dBuV/m	Margin dB	Detector	Comment
1		2390.000	62.96	6.62	69.58	74.00	-4.42	peak	
2		2390.000	47.05	6.62	53.67	54.00	-0.33	AVG	
3	*	2423.900	98.80	6.62	105.42	54.00	51.42	AVG	No Limit
4	X	2424.200	106.62	6.62	113.24	74.00	39.24	peak	No Limit

Orthogonal Axis :	X
Test Mode :	TX G MODE 2417MHz

Vertical

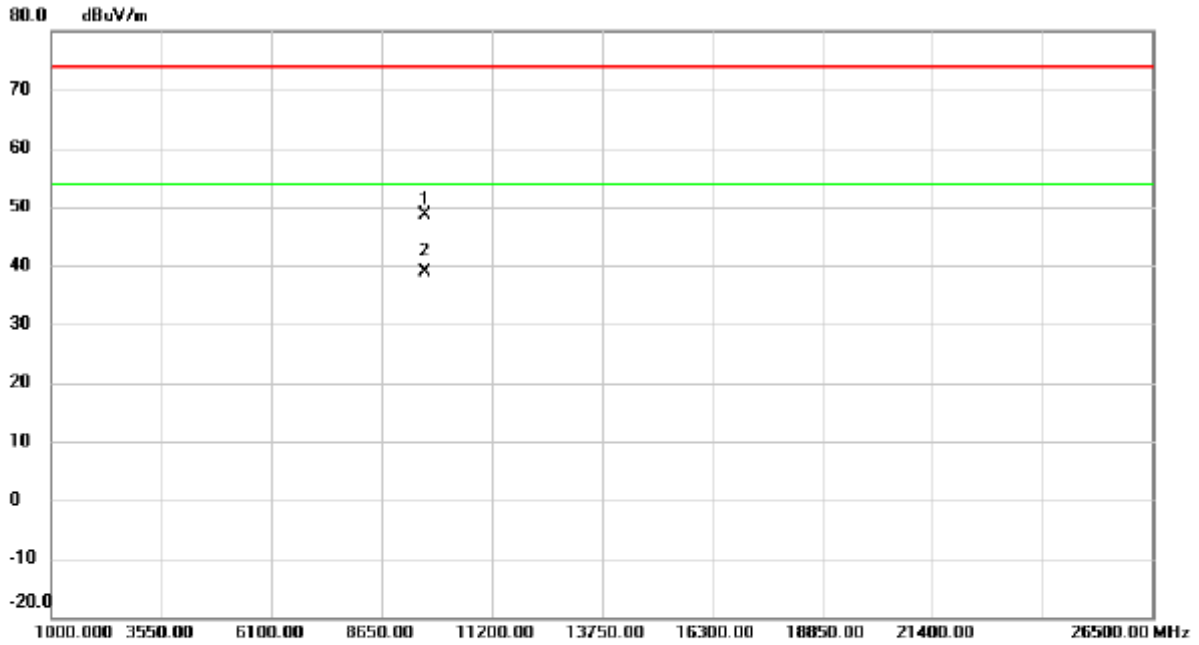

No.	Mk.	Freq. MHz	Reading Level dBuV	Correct Factor dB	Measure- ment dBuV/m	Limit dBuV/m	Margin dB	Detector	Comment
1		9667.858	37.58	11.03	48.61	74.00	-25.39	peak	
2	*	9668.008	27.84	11.03	38.87	54.00	-15.13	AVG	

Orthogonal Axis :	X
Test Mode :	TX G MODE 2417MHz

Horizontal

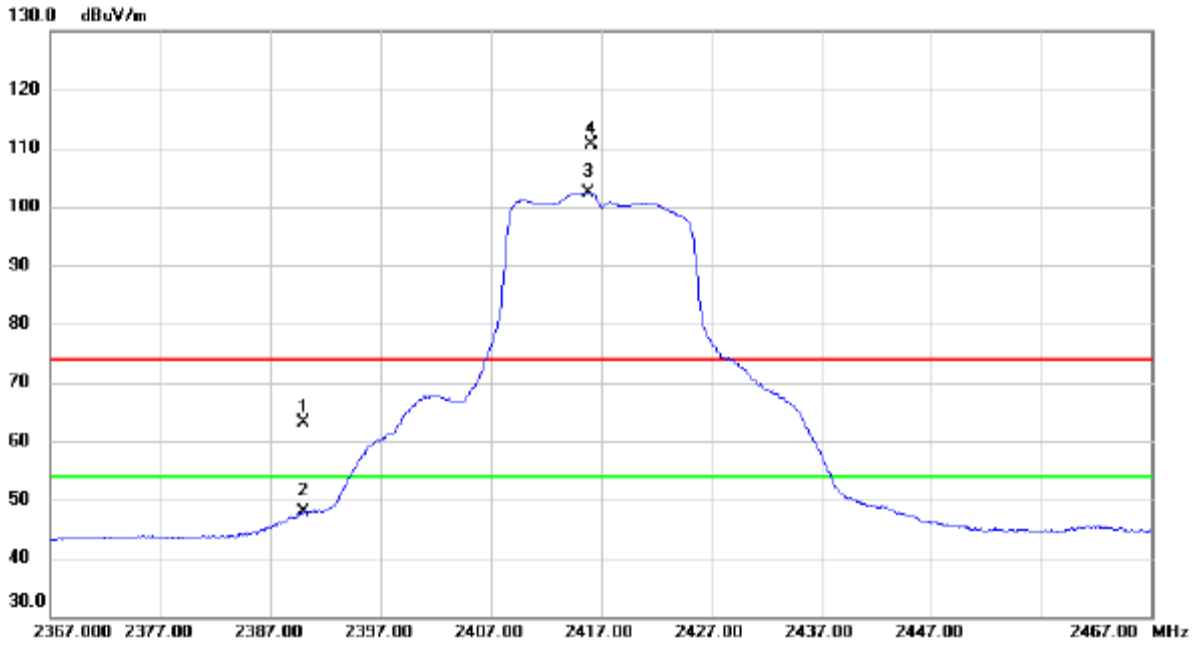

No.	Mk.	Freq. MHz	Reading Level dBuV	Correct Factor dB	Measure- ment dBuV/m	Limit dBuV/m	Margin dB	Detector	Comment
1		2390.000	56.54	6.62	63.16	74.00	-10.84	peak	
2		2390.000	41.23	6.62	47.85	54.00	-6.15	AVG	
3	*	2415.900	95.88	6.62	102.50	54.00	48.50	AVG	No Limit
4	X	2416.200	103.95	6.62	110.57	74.00	36.57	peak	No Limit

Orthogonal Axis :	X
Test Mode :	TX G MODE 2417MHz

Horizontal

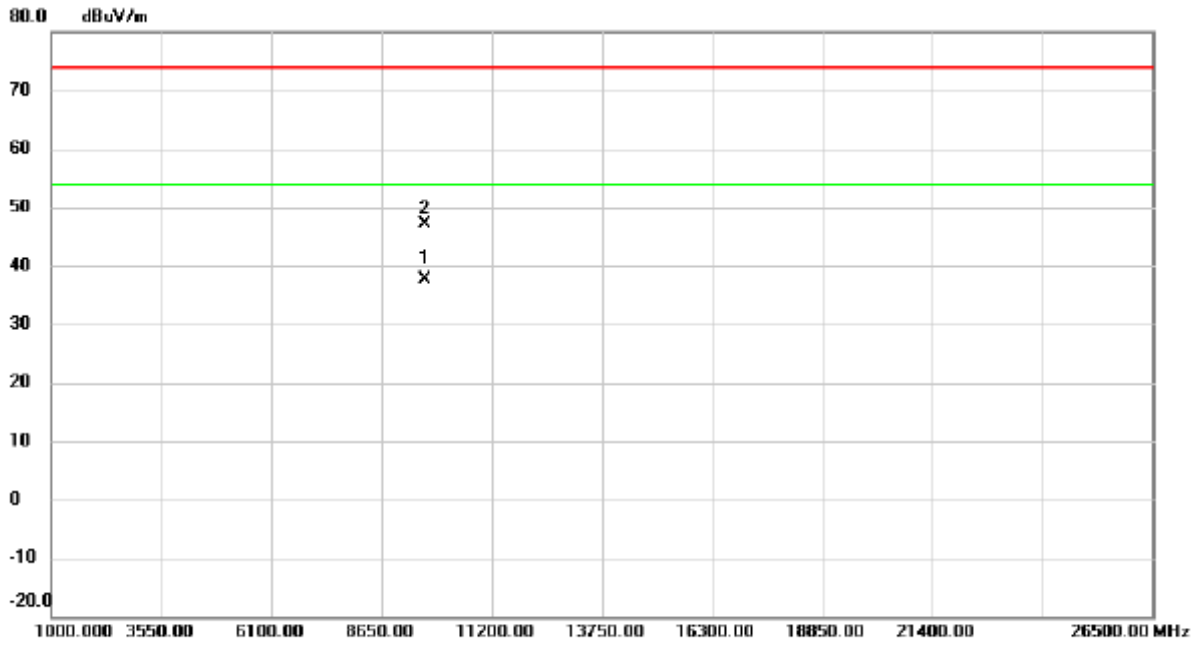

No.	Mk.	Freq.	Reading Level	Correct Factor	Measurement	Limit	Margin	Detector	Comment
		MHz	dBuV	dB	dBuV/m	dBuV/m	dB		
1	*	9667.916	26.71	11.03	37.74	54.00	-16.26	AVG	
2		9668.418	36.20	11.03	47.23	74.00	-26.77	peak	

Orthogonal Axis	X
Test Mode:	TX G Mode 2437 MHz

Vertical

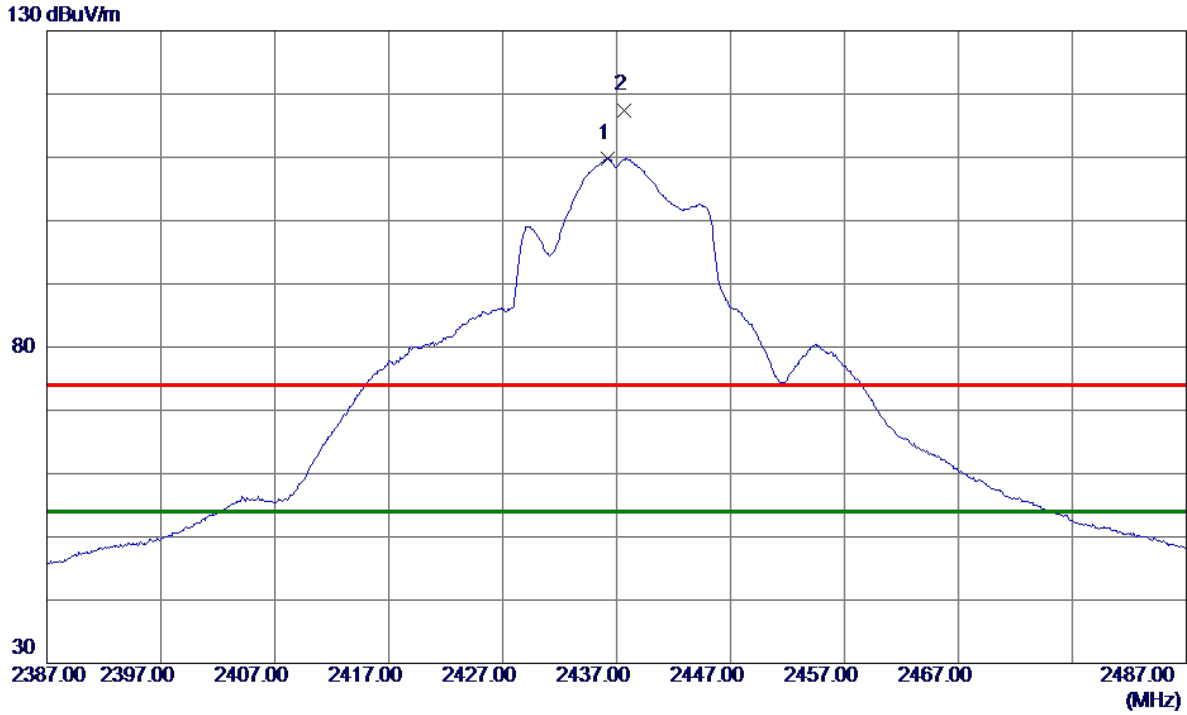

No.	Freq. MHz	Reading Level dBuV/m	Correct Factor dB	Measure ment dBuV/m	Limit dBuV/m	Margin dB	Detector	Comment
1 *	2436.2500	103.14	6.61	109.75	54.00	55.75	AVG	No Limit
2	2437.7000	110.89	6.61	117.50	74.00	43.50	Peak	No Limit

Orthogonal Axis	X
Test Mode:	TX G Mode 2437 MHz

Vertical

80 dBuV/m

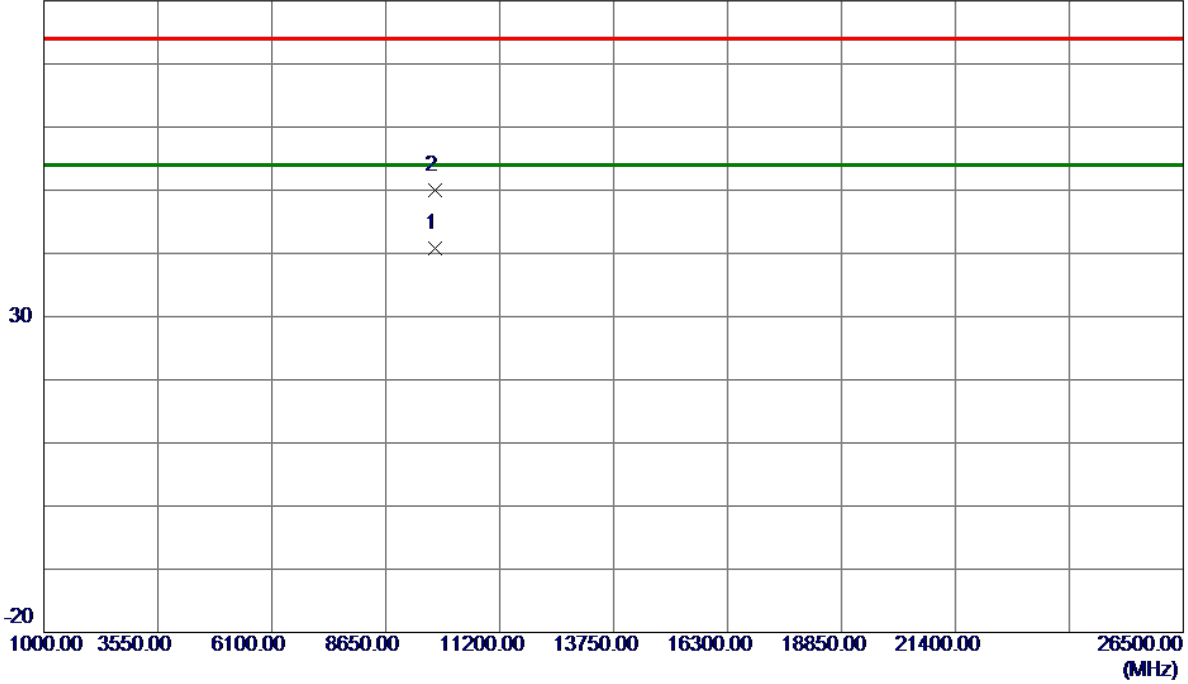

No.	Freq. MHz	Reading Level dBuV/m	Correct Factor dB	Measure ment dBuV/m	Limit dBuV/m	Margin dB	Detector	Comment
1 *	9747.9140	29.76	11.05	40.81	54.00	-13.19	AVG	
2	9747.9660	38.91	11.05	49.96	74.00	-24.04	Peak	

Orthogonal Axis	X
Test Mode:	TX G Mode 2437 MHz

Horizontal

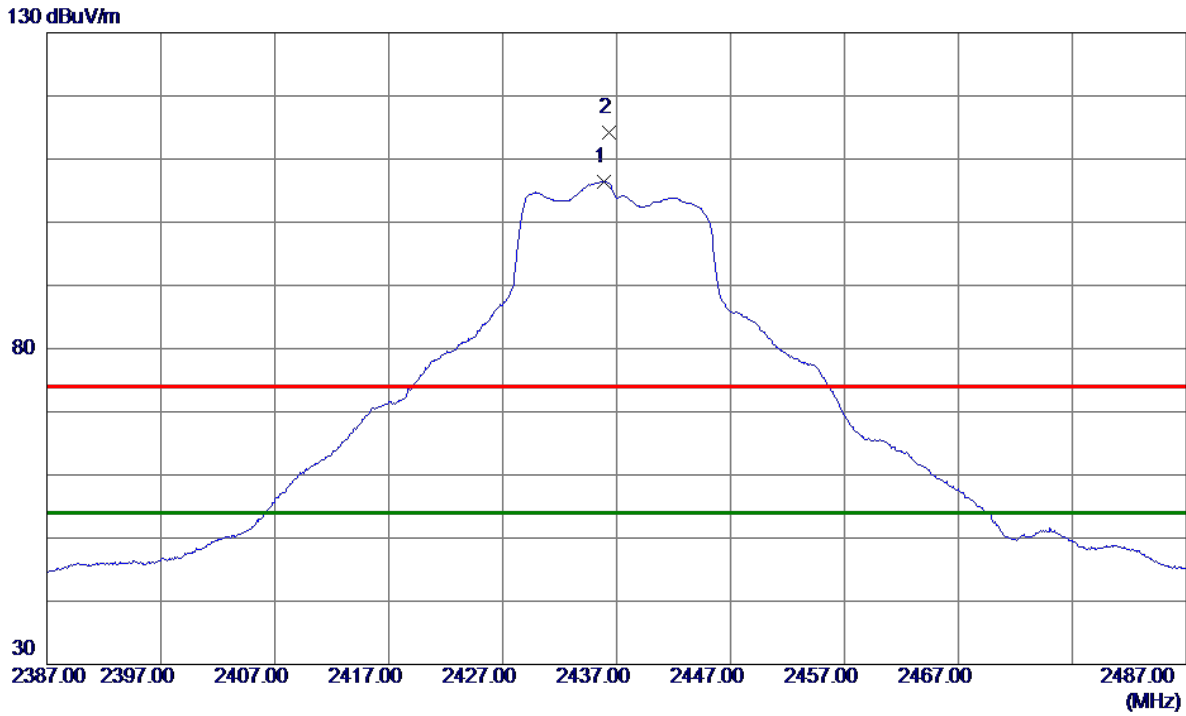

No.	Freq. MHz	Reading Level dBuV/m	Correct Factor dB	Measure ment dBuV/m	Limit dBuV/m	Margin dB	Detector	Comment
1 *	2435.9000	99.84	6.61	106.45	54.00	52.45	AVG	No Limit
2	2436.3000	107.68	6.61	114.29	74.00	40.29	Peak	No Limit

Orthogonal Axis	X
Test Mode:	TX G Mode 2437 MHz

Horizontal

80 dBuV/m

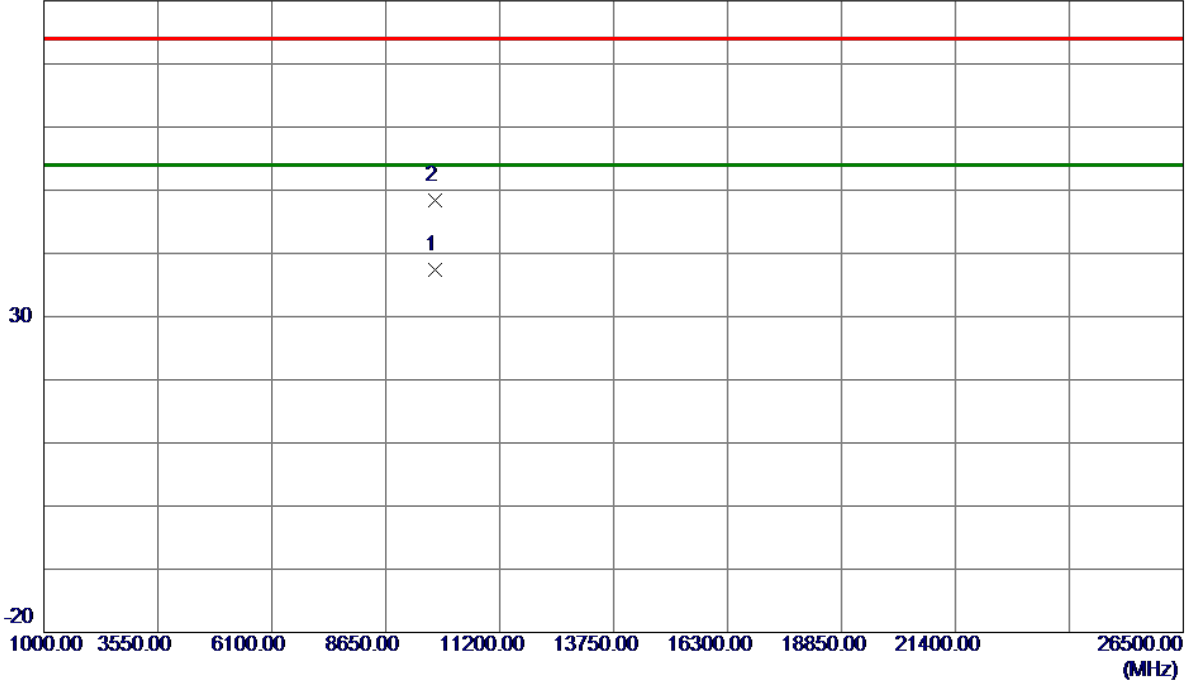

No.	Freq. MHz	Reading Level dBuV/m	Correct Factor dB	Measure ment dBuV/m	Limit dBuV/m	Margin dB	Detector	Comment
1 *	9747.9000	26.42	11.05	37.47	54.00	-16.53	AVG	
2	9748.2779	37.30	11.05	48.35	74.00	-25.65	Peak	

Orthogonal Axis :	X
Test Mode :	TX G MODE 2457MHz

Vertical

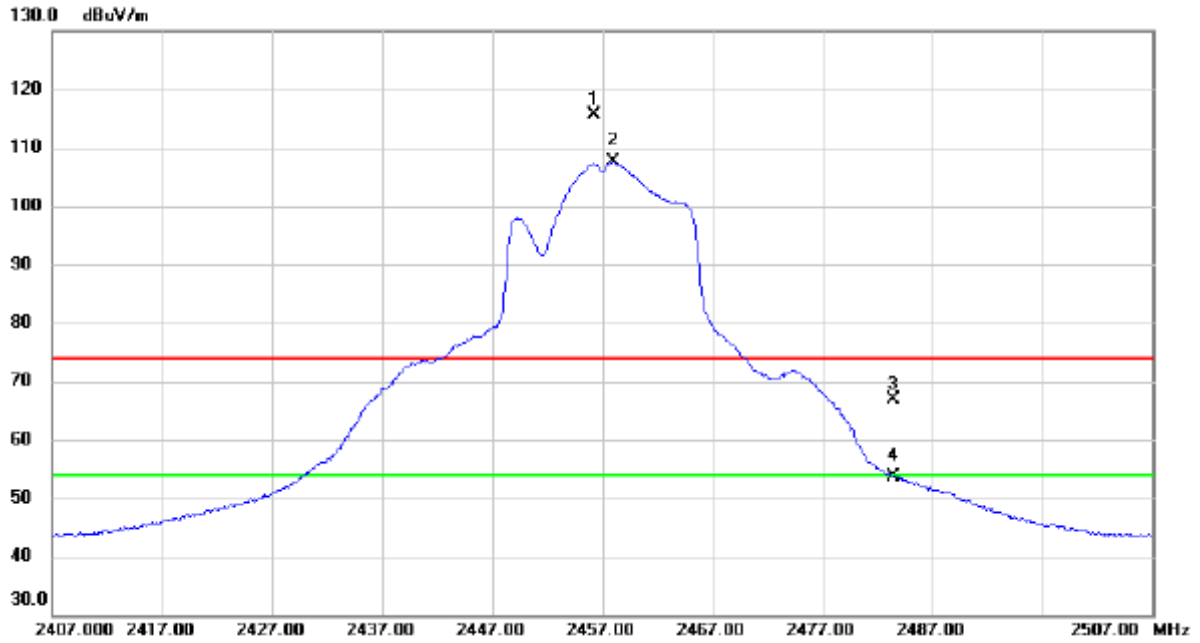

No.	Mk.	Freq. MHz	Reading Level dBuV	Correct Factor dB	Measure- ment dBuV/m	Limit dBuV/m	Margin dB	Detector	Comment
1	X	2456.300	109.13	6.62	115.75	74.00	41.75	peak	No Limit
2	*	2458.050	100.96	6.62	107.58	54.00	53.58	AVG	No Limit
3		2483.500	60.21	6.61	66.82	74.00	-7.18	peak	
4		2483.500	46.96	6.61	53.57	54.00	-0.43	AVG	

Orthogonal Axis :	X
Test Mode :	TX G MODE 2457MHz

Vertical

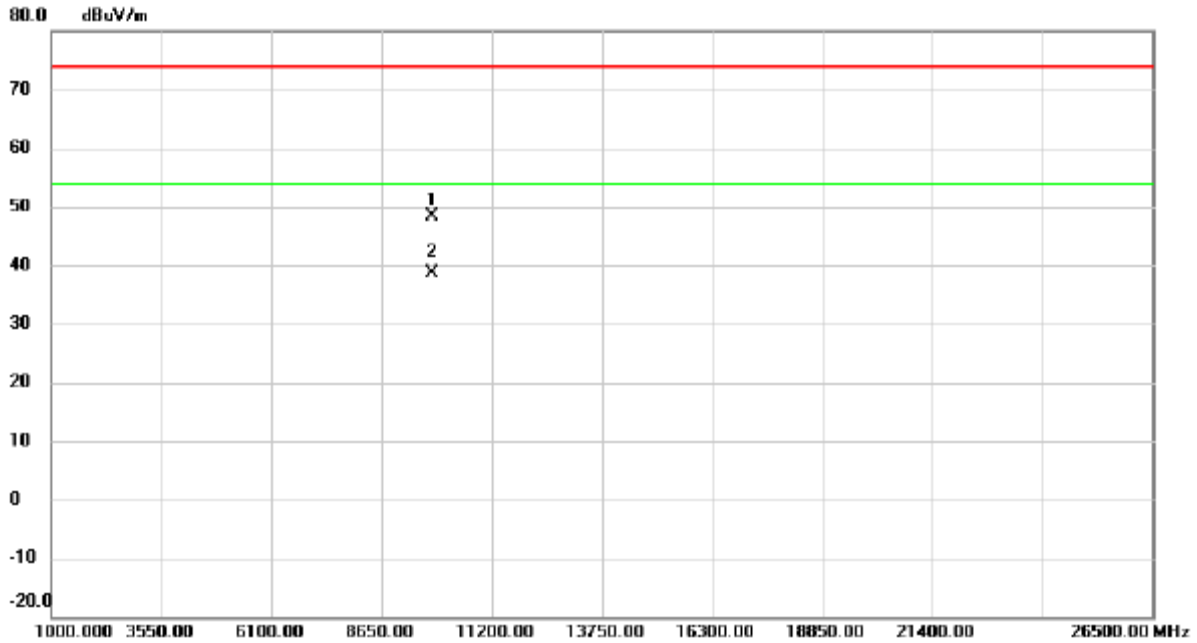

No.	Mk.	Freq. MHz	Reading Level dBuV	Correct Factor dB	Measure- ment dBuV/m	Limit dBuV/m	Margin dB	Detector	Comment
1		9827.849	37.38	11.06	48.44	74.00	-25.56	peak	
2	*	9827.957	27.52	11.06	38.58	54.00	-15.42	AVG	

Orthogonal Axis :	X
Test Mode :	TX G MODE 2457MHz

Horizontal

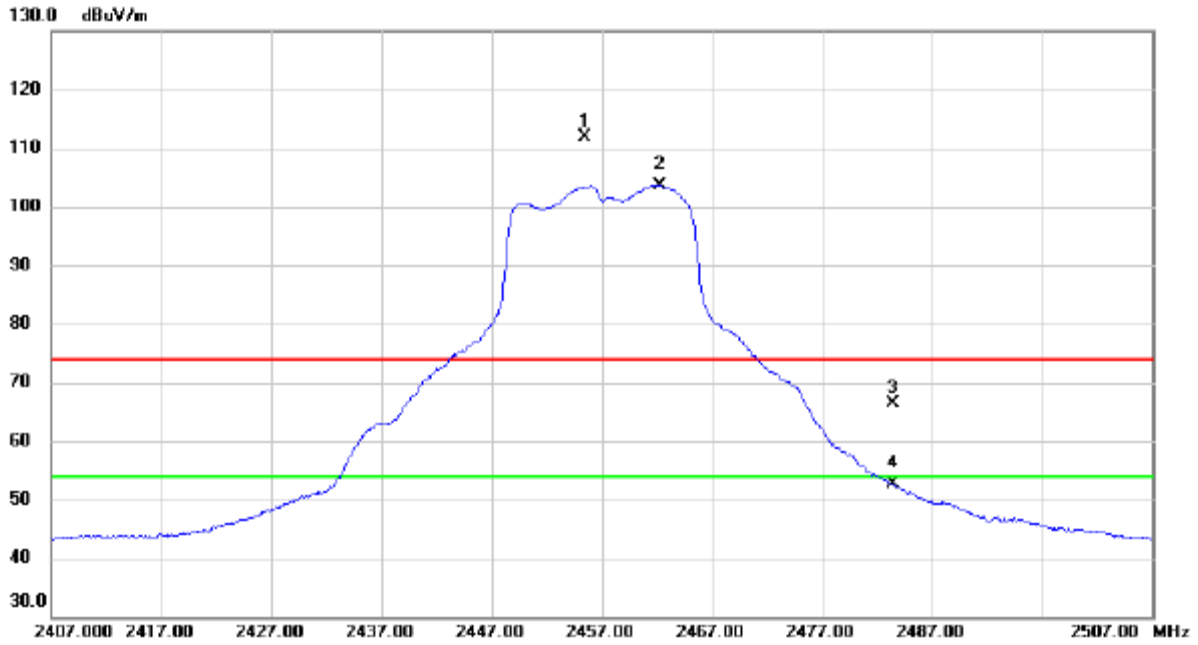

No.	Mk.	Freq. MHz	Reading Level dBuV	Correct Factor dB	Measure- ment dBuV/m	Limit dBuV/m	Margin dB	Detector	Comment
1	X	2455.400	105.21	6.60	111.81	74.00	37.81	peak	No Limit
2	*	2462.250	97.13	6.61	103.74	54.00	49.74	AVG	No Limit
3		2483.500	59.67	6.61	66.28	74.00	-7.72	peak	
4		2483.500	45.97	6.61	52.58	54.00	-1.42	AVG	

Orthogonal Axis :	X
Test Mode :	TX G MODE 2457MHz

Horizontal

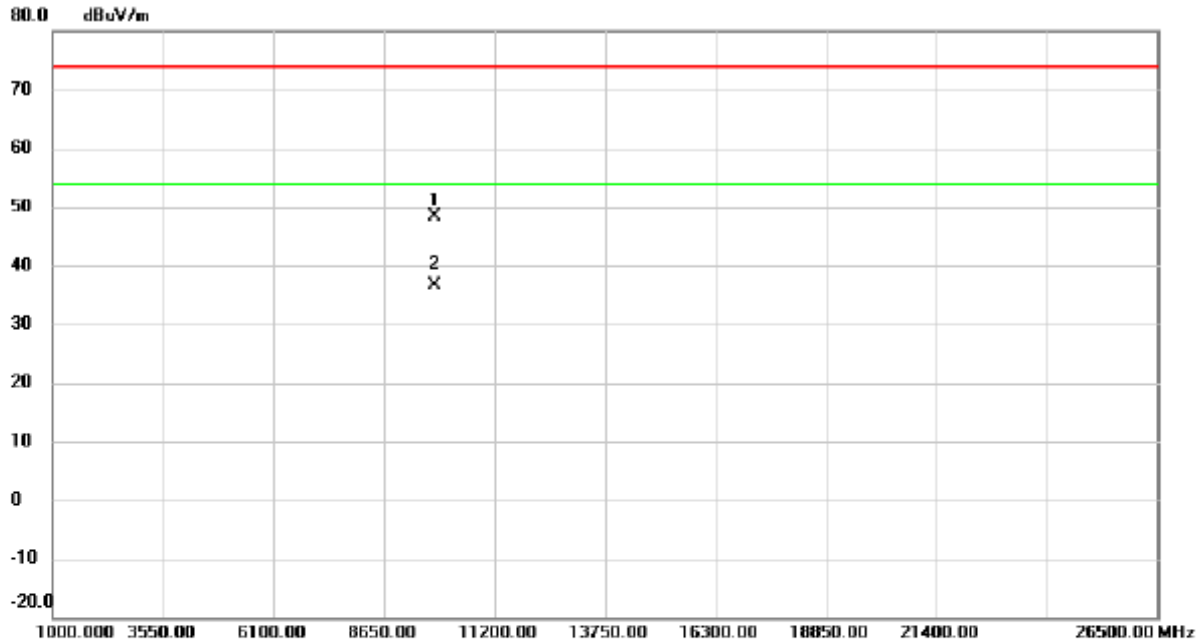

No.	Mk.	Freq.	Reading Level	Correct Factor	Measurement	Limit	Margin	Detector	Comment
		MHz	dBuV	dB	dBuV/m	dBuV/m	dB		
1		9827.810	37.39	11.06	48.45	74.00	-25.55	peak	
2	*	9828.146	25.61	11.06	36.67	54.00	-17.33	AVG	

Orthogonal Axis	X
Test Mode:	TX G Mode 2462 MHz

Vertical

130 dBuV/m

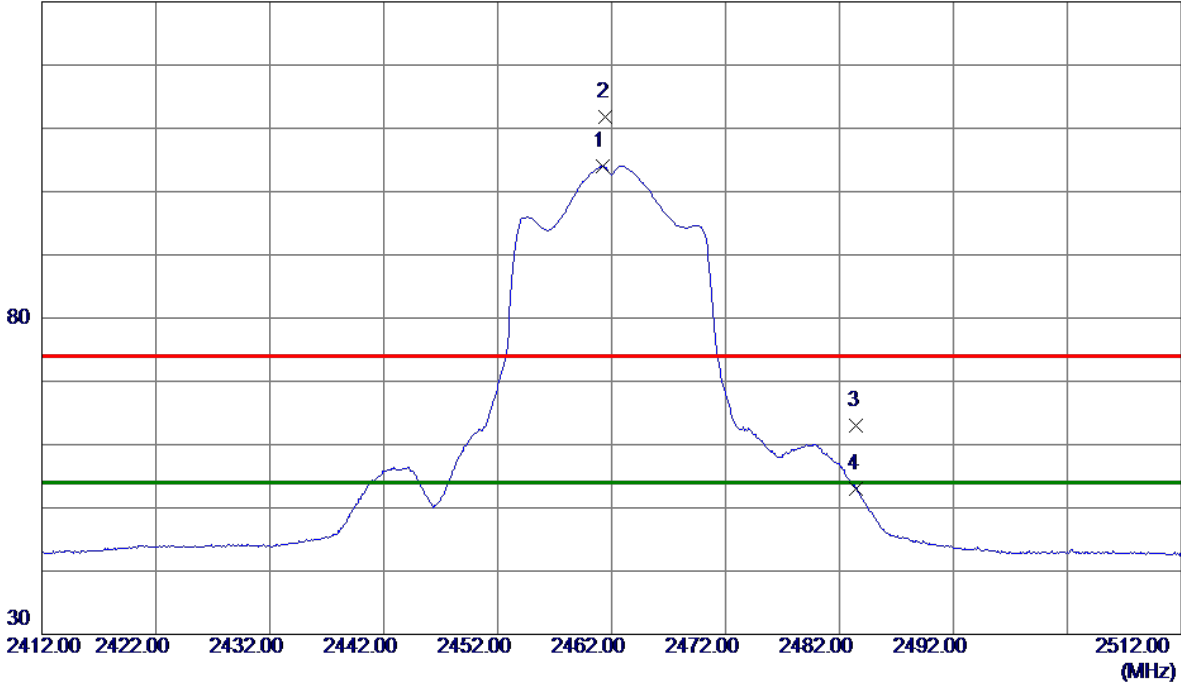

No.	Freq. MHz	Reading Level dBuV/m	Correct Factor dB	Measure ment dBuV/m	Limit dBuV/m	Margin dB	Detector	Comment
1 *	2461.2000	97.39	6.61	104.00	54.00	50.00	AVG	No Limit
2	2461.5000	105.22	6.61	111.83	74.00	37.83	Peak	No Limit
3	2483.5000	56.39	6.61	63.00	74.00	-11.00	Peak	
4	2483.5000	46.30	6.61	52.91	54.00	-1.09	AVG	

Orthogonal Axis	X
Test Mode:	TX G Mode 2462 MHz

Vertical

80 dBuV/m

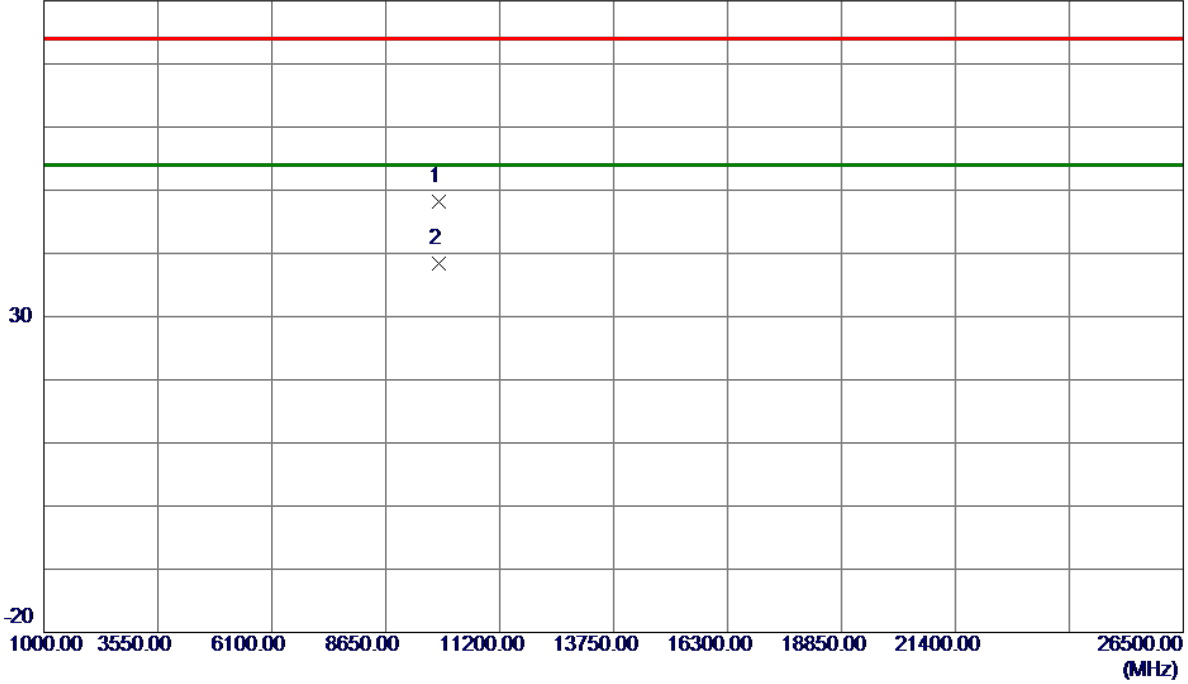

No.	Freq. MHz	Reading Level dBuV/m	Correct Factor dB	Measure ment dBuV/m	Limit dBuV/m	Margin dB	Detector	Comment
1	9847.8430	37.19	11.06	48.25	74.00	-25.75	Peak	
2 *	9848.0450	27.35	11.06	38.41	54.00	-15.59	AVG	

Orthogonal Axis	X
Test Mode:	TX G Mode 2462 MHz

Horizontal

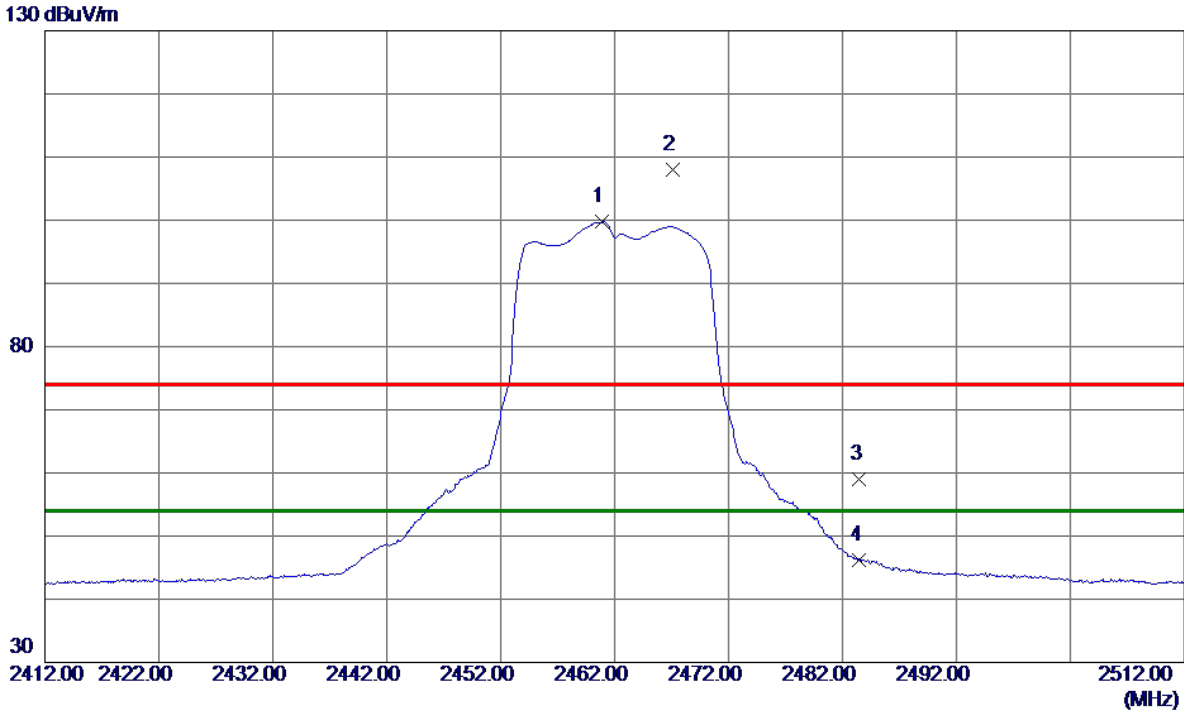

No.	Freq. MHz	Reading Level dBuV/m	Correct Factor dB	Measure ment dBuV/m	Limit dBuV/m	Margin dB	Detector	Comment
1 *	2460.9000	93.14	6.61	99.75	54.00	45.75	AVG	No Limit
2	2467.1500	101.35	6.61	107.96	74.00	33.96	Peak	No Limit
3	2483.5000	52.32	6.61	58.93	74.00	-15.07	Peak	
4	2483.5000	39.61	6.61	46.22	54.00	-7.78	AVG	

Orthogonal Axis	X
Test Mode:	TX G Mode 2462 MHz

Horizontal

80 dBuV/m

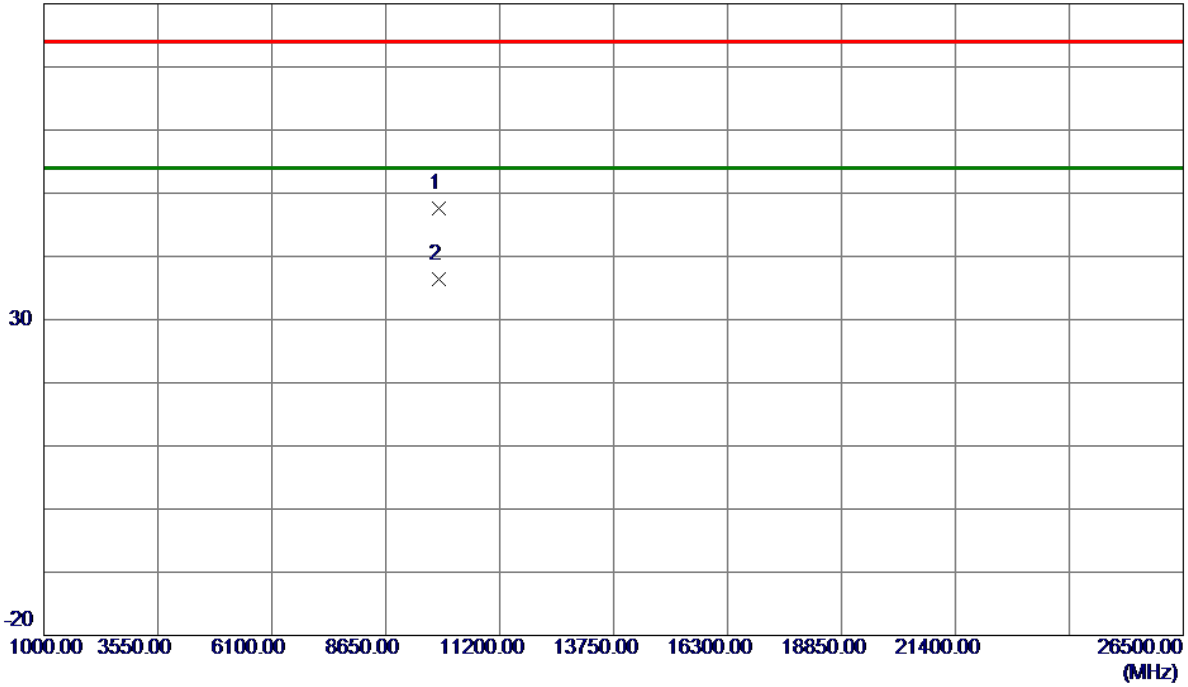

No.	Freq. MHz	Reading Level dBuV/m	Correct Factor dB	Measure ment dBuV/m	Limit dBuV/m	Margin dB	Detector	Comment
1	9848.4900	36.57	11.06	47.63	74.00	-26.37	Peak	
2 *	9849.6700	25.42	11.06	36.48	54.00	-17.52	AVG	

Orthogonal Axis	X
Test Mode:	TX N-20M Mode 2412 MHz

Vertical

130 dBuV/m

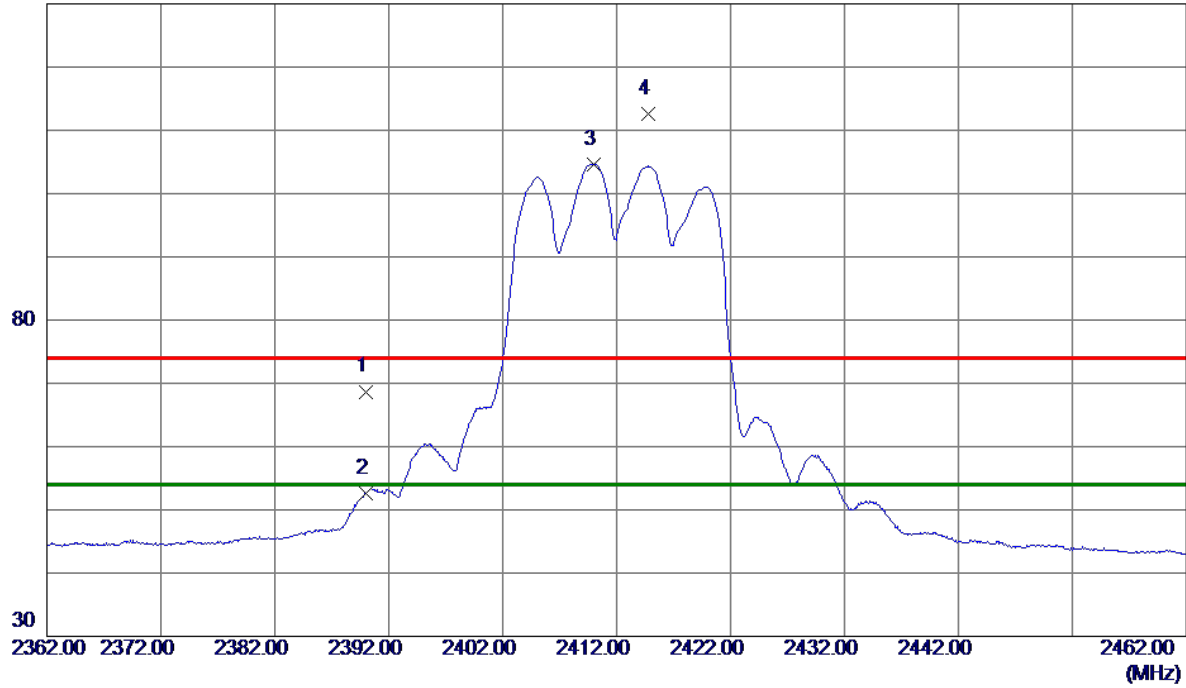

No.	Freq. MHz	Reading Level dBuV/m	Correct Factor dB	Measure ment dBuV/m	Limit dBuV/m	Margin dB	Detector	Comment
1	2390.0000	62.08	6.62	68.70	74.00	-5.30	Peak	
2	2390.0000	46.03	6.62	52.65	54.00	-1.35	AVG	
3 *	2409.9500	98.06	6.62	104.68	54.00	50.68	AVG	No Limit
4	2414.8000	105.97	6.62	112.59	74.00	38.59	Peak	No Limit

Orthogonal Axis	X
Test Mode:	TX N-20M Mode 2412 MHz

Vertical

80 dBuV/m

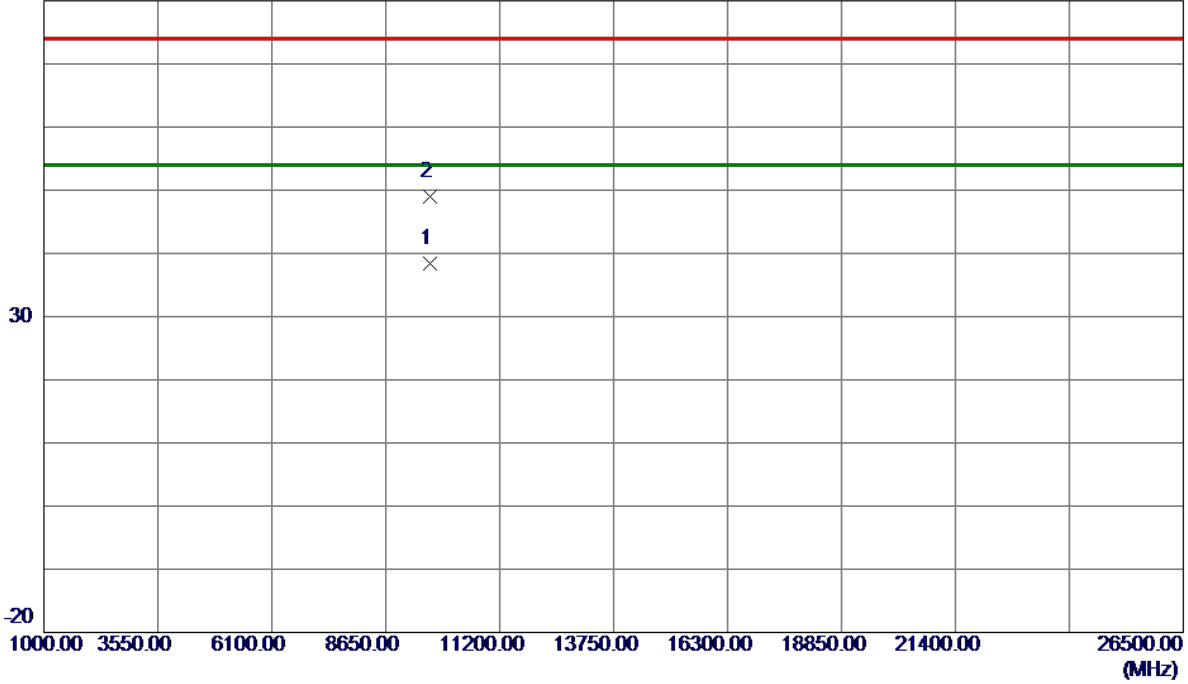

No.	Freq. MHz	Reading Level dBuV/m	Correct Factor dB	Measure ment dBuV/m	Limit dBuV/m	Margin dB	Detector	Comment
1 *	9647.9910	27.33	11.03	38.36	54.00	-15.64	AVG	
2	9648.1110	37.94	11.03	48.97	74.00	-25.03	Peak	

Orthogonal Axis	X
Test Mode:	TX N-20M Mode 2412 MHz

Horizontal

130 dBuV/m

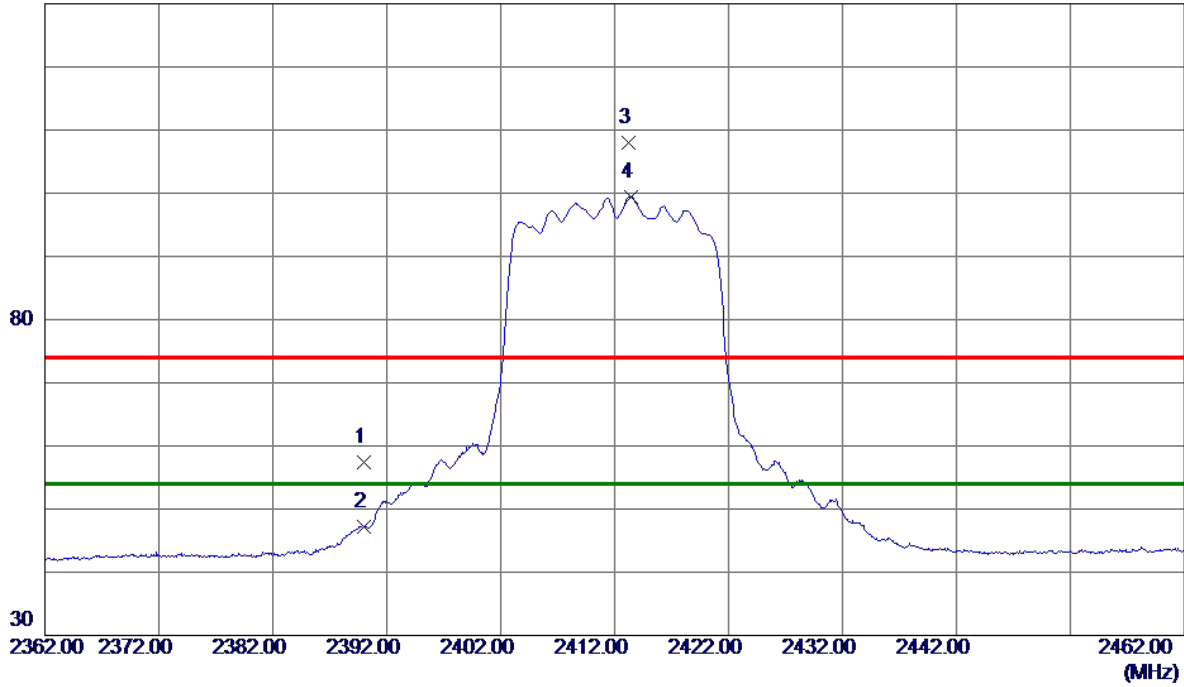

No.	Freq. MHz	Reading Level dBuV/m	Correct Factor dB	Measure ment dBuV/m	Limit dBuV/m	Margin dB	Detector	Comment
1	2390.0000	50.83	6.62	57.45	74.00	-16.55	Peak	
2	2390.0000	40.56	6.62	47.18	54.00	-6.82	AVG	
3	2413.2500	101.42	6.62	108.04	74.00	34.04	Peak	No Limit
4 *	2413.4000	92.87	6.62	99.49	54.00	45.49	AVG	No Limit

Orthogonal Axis	X
Test Mode:	TX N-20M Mode 2412 MHz

Horizontal

80 dBuV/m

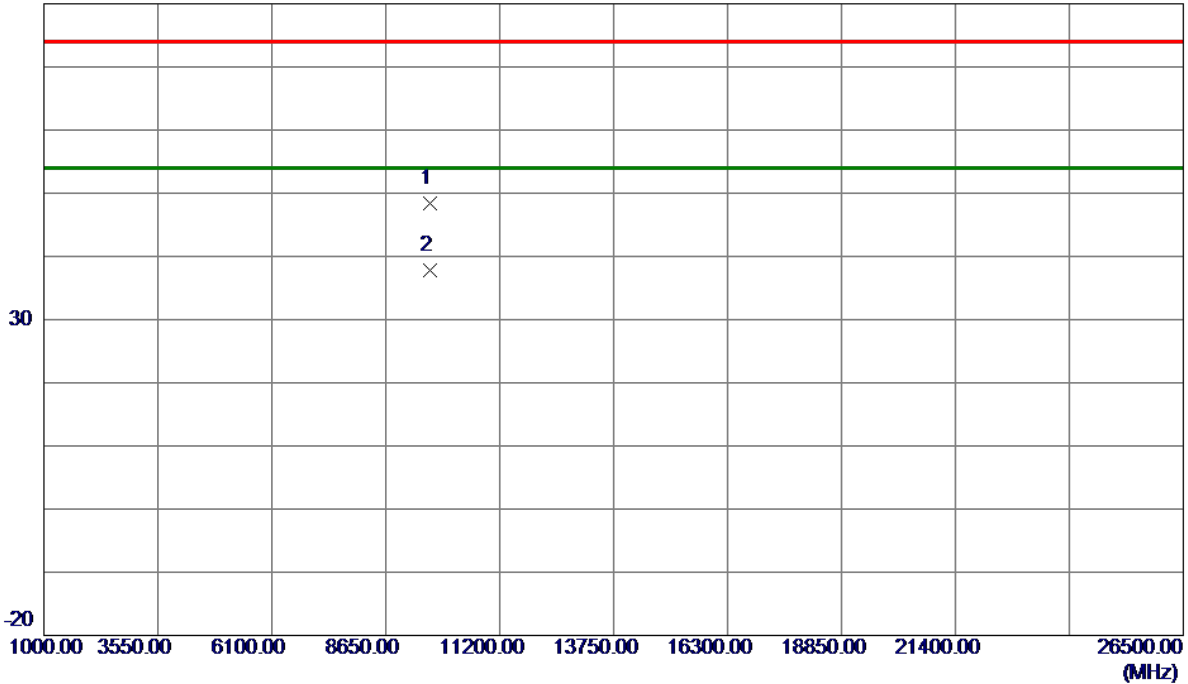

No.	Freq. MHz	Reading Level dBuV/m	Correct Factor dB	Measure ment dBuV/m	Limit dBuV/m	Margin dB	Detector	Comment
1	9647.8070	37.38	11.03	48.41	74.00	-25.59	Peak	
2 *	9648.1230	26.69	11.03	37.72	54.00	-16.28	AVG	

Orthogonal Axis :	X
Test Mode :	TX N-20M MODE 2417MHz

Vertical

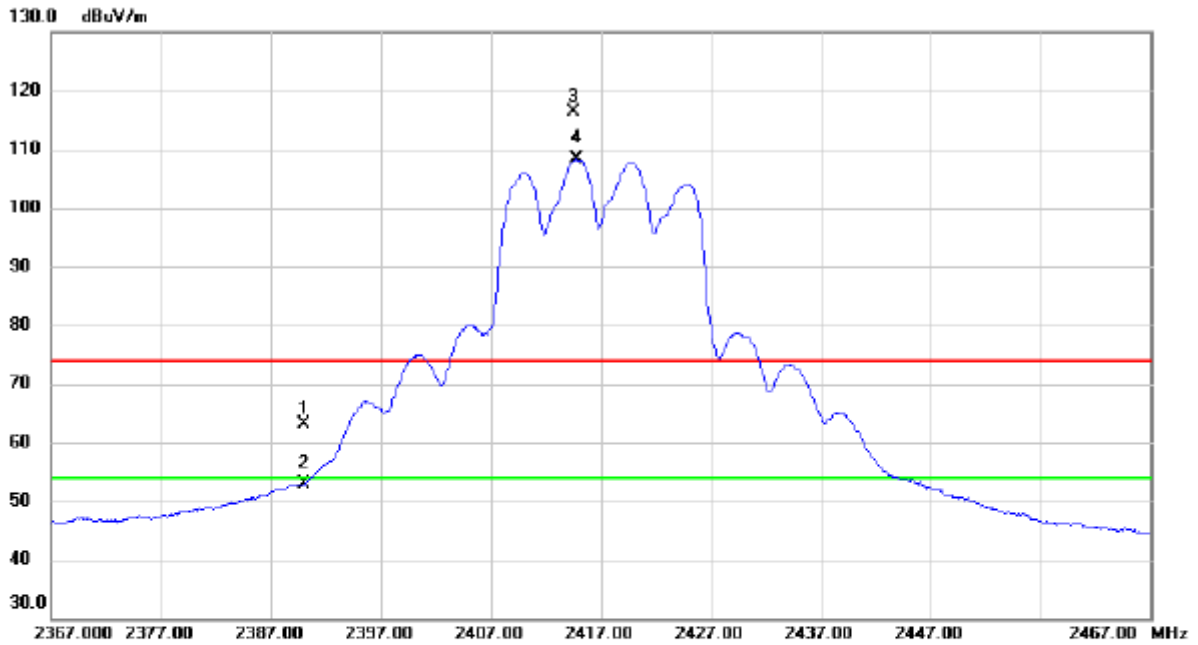

No.	Mk.	Freq. MHz	Reading Level dBuV	Correct Factor dB	Measure- ment dBuV/m	Limit dBuV/m	Margin dB	Detector	Comment
1		2390.000	56.53	6.62	63.15	74.00	-10.85	peak	
2		2390.000	46.27	6.62	52.89	54.00	-1.11	AVG	
3	X	2414.600	109.78	6.62	116.40	74.00	42.40	peak	No Limit
4	*	2414.850	101.66	6.62	108.28	54.00	54.28	AVG	No Limit

Orthogonal Axis :	X
Test Mode :	TX N-20M MODE 2417MHz

Vertical

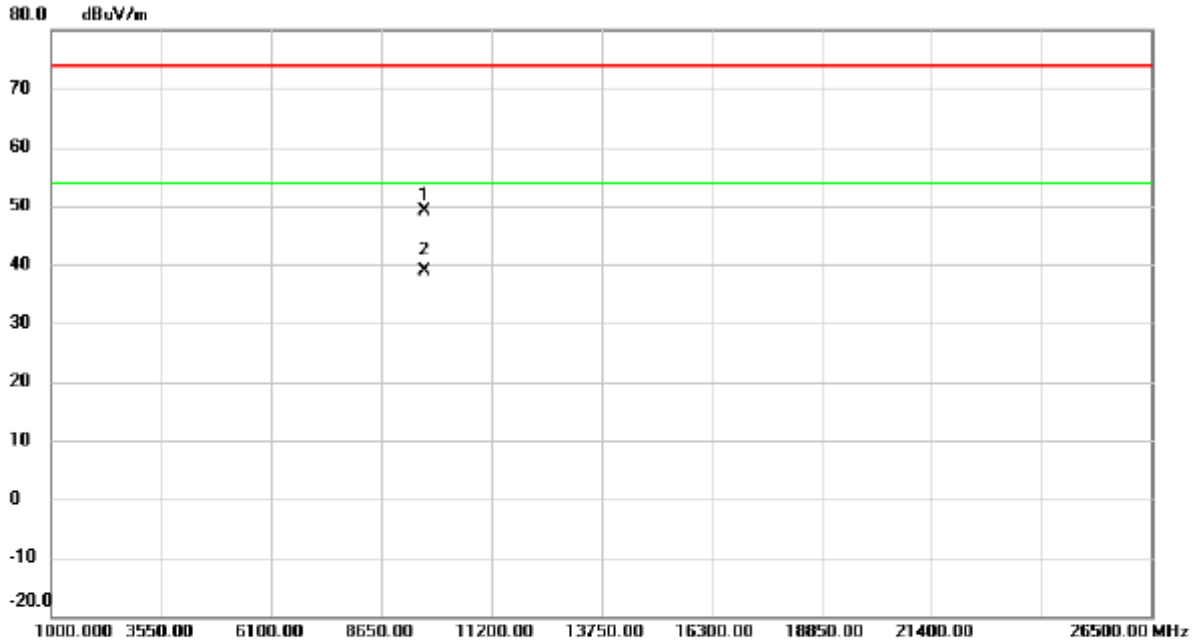

No.	Mk.	Freq.	Reading Level	Correct Factor	Measurement	Limit	Margin	Detector	Comment
		MHz	dBuV	dB	dBuV/m	dBuV/m	dB		
1		9667.555	38.13	11.03	49.16	74.00	-24.84	peak	
2	*	9667.936	27.83	11.03	38.86	54.00	-15.14	AVG	

Orthogonal Axis :	X
Test Mode :	TX N-20M MODE 2417MHz

Horizontal

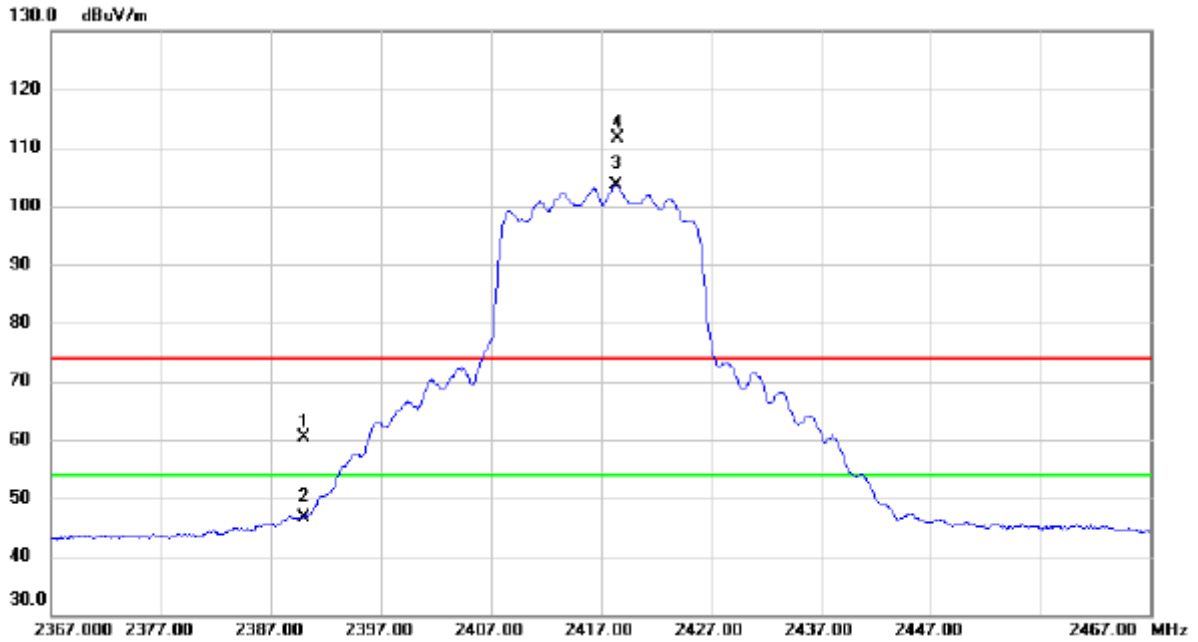

No.	Mk.	Freq. MHz	Reading Level dBuV	Correct Factor dB	Measure- ment dBuV/m	Limit dBuV/m	Margin dB	Detector	Comment
1		2390.000	53.83	6.62	60.45	74.00	-13.55	peak	
2		2390.000	39.94	6.62	46.56	54.00	-7.44	AVG	
3	*	2418.450	96.93	6.61	103.54	54.00	49.54	AVG	No Limit
4	X	2418.600	105.04	6.61	111.65	74.00	37.65	peak	No Limit

Orthogonal Axis :	X
Test Mode :	TX N-20M MODE 2417MHz

Horizontal

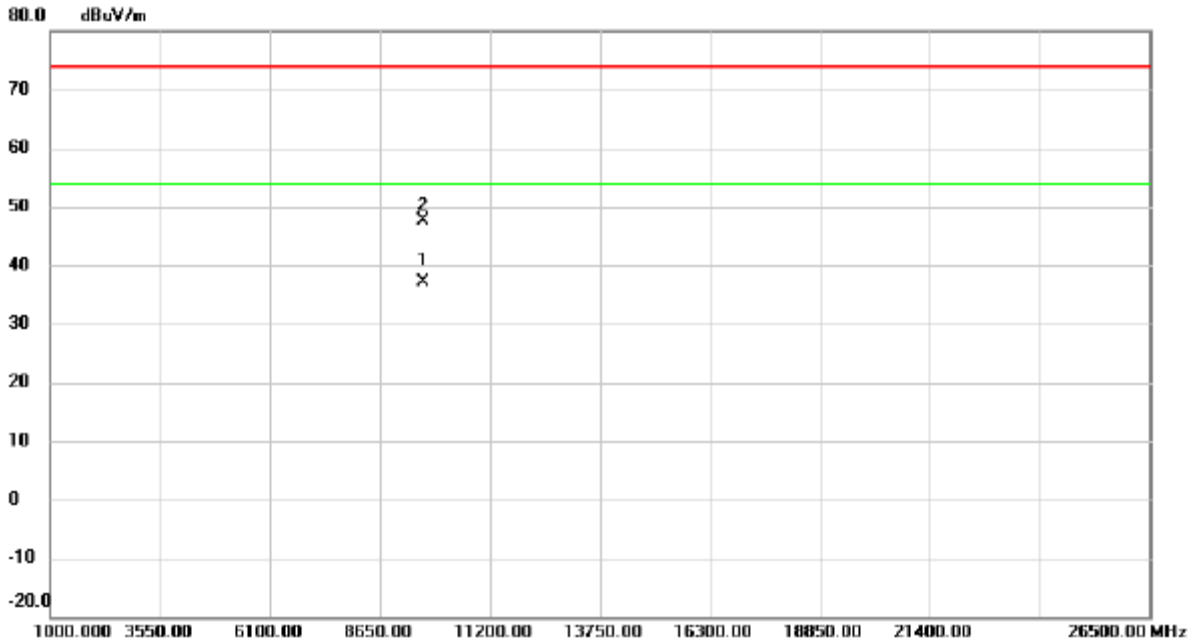

No.	Mk.	Freq. MHz	Reading Level dBuV	Correct Factor dB	Measure- ment dBuV/m	Limit dBuV/m	Margin dB	Detector	Comment
1	*	9667.857	26.04	11.03	37.07	54.00	-16.93	AVG	
2		9667.867	36.51	11.03	47.54	74.00	-26.46	peak	

Orthogonal Axis	X
Test Mode:	TX N-20M Mode 2437 MHz

Vertical

130 dBuV/m

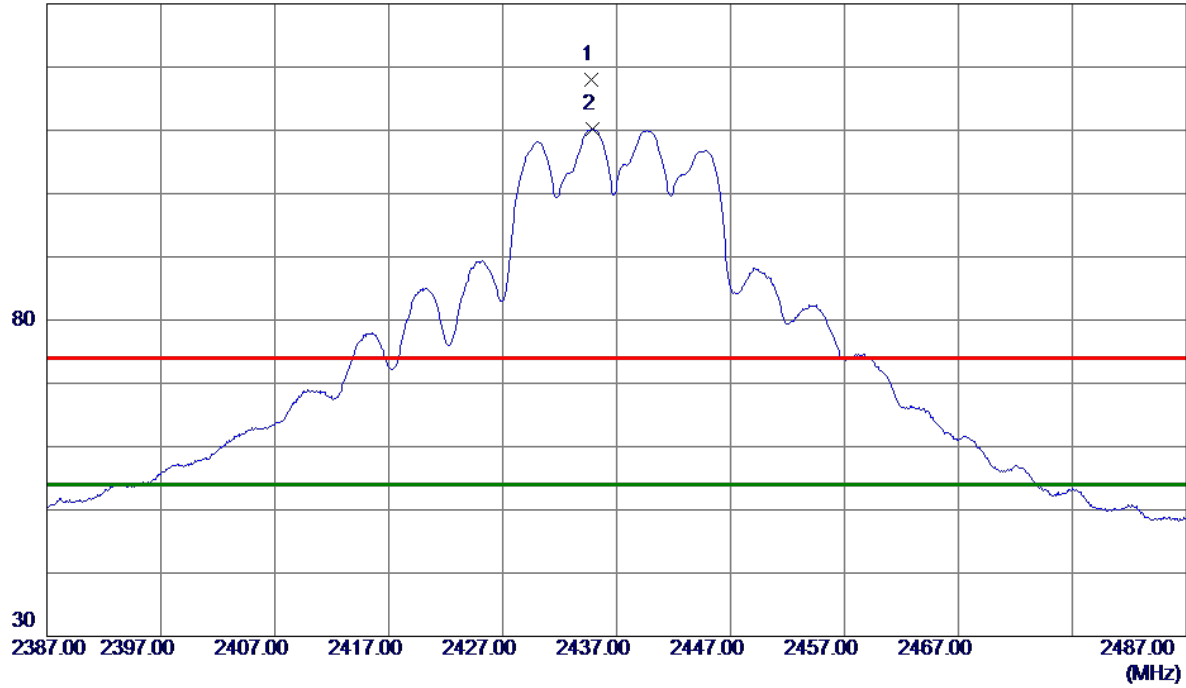

No.	Freq. MHz	Reading Level dBuV/m	Correct Factor dB	Measure ment dBuV/m	Limit dBuV/m	Margin dB	Detector	Comment
1	2434.7500	111.45	6.61	118.06	74.00	44.06	Peak	No Limit
2 *	2434.8500	103.61	6.61	110.22	54.00	56.22	AVG	No Limit

Orthogonal Axis	X
Test Mode:	TX N-20M Mode 2437 MHz

Vertical

80 dBuV/m

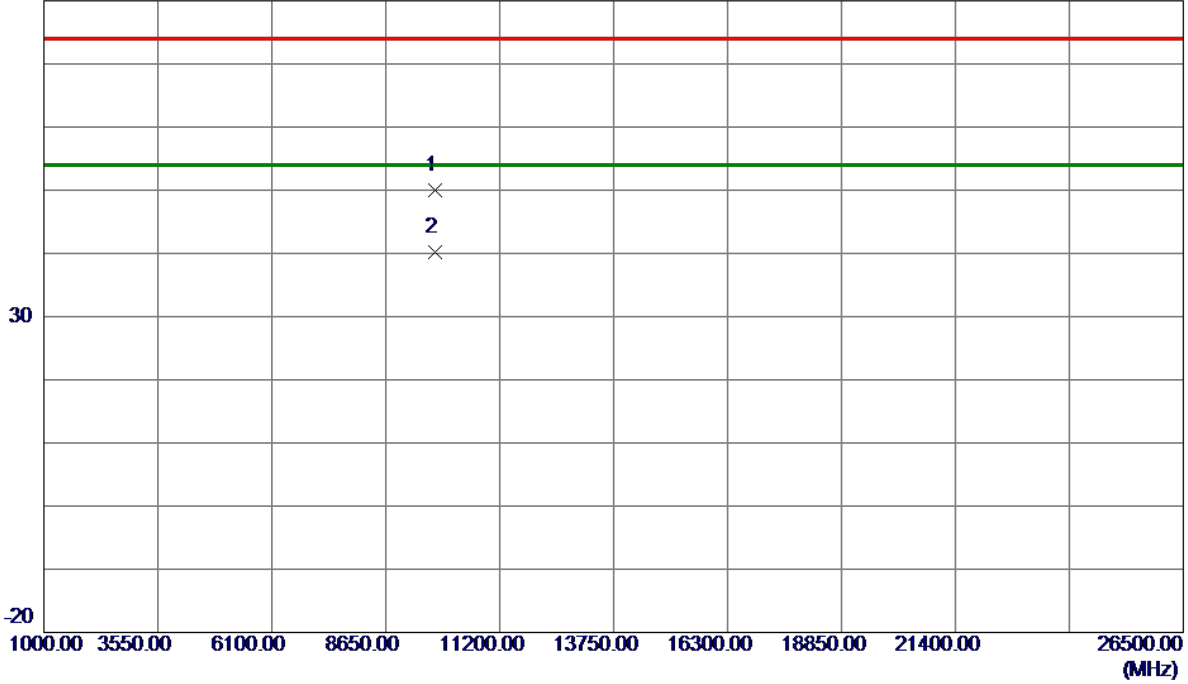

No.	Freq. MHz	Reading Level dBuV/m	Correct Factor dB	Measure ment dBuV/m	Limit dBuV/m	Margin dB	Detector	Comment
1	9747.1560	38.94	11.05	49.99	74.00	-24.01	Peak	
2 *	9747.9360	29.24	11.05	40.29	54.00	-13.71	AVG	

Orthogonal Axis	X
Test Mode:	TX N-20M Mode 2437 MHz

Horizontal

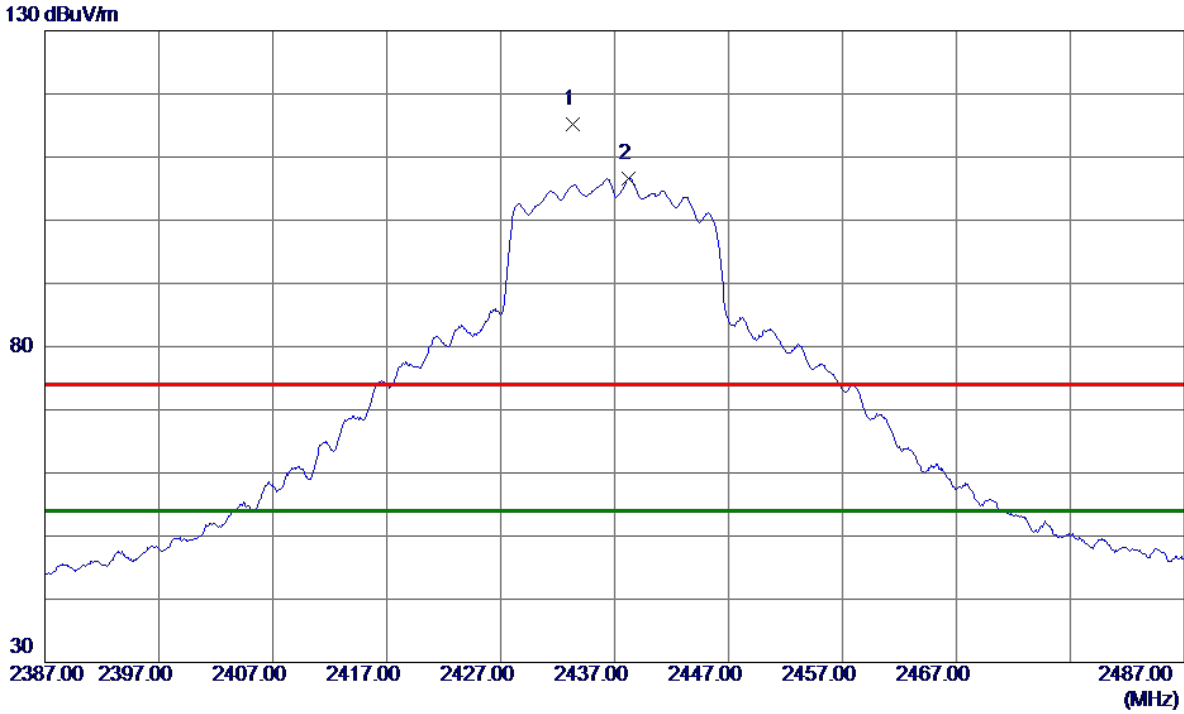

No.	Freq. MHz	Reading Level dBuV/m	Correct Factor dB	Measure ment dBuV/m	Limit dBuV/m	Margin dB	Detector	Comment
1	2433.3500	108.52	6.62	115.14	74.00	41.14	Peak	No Limit
2 *	2438.2500	99.99	6.61	106.60	54.00	52.60	AVG	No Limit

Orthogonal Axis	X
Test Mode:	TX N-20M Mode 2437 MHz

Horizontal

80 dBuV/m

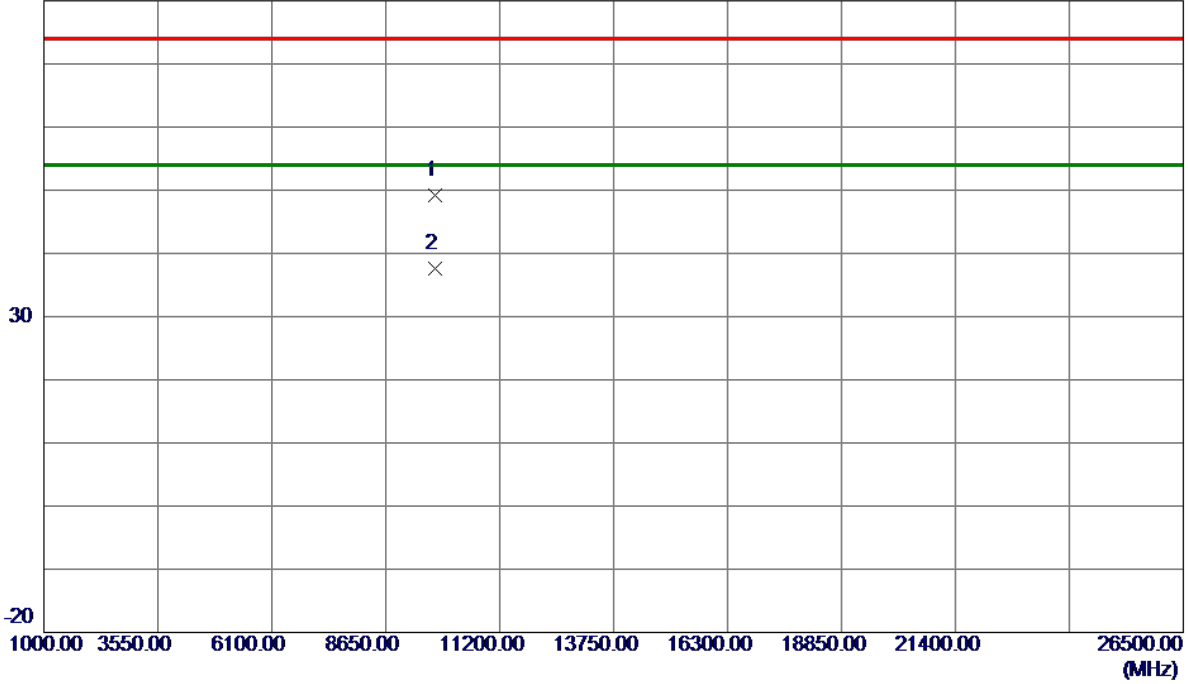

No.	Freq. MHz	Reading Level dBuV/m	Correct Factor dB	Measure ment dBuV/m	Limit dBuV/m	Margin dB	Detector	Comment
1	9747.8330	38.16	11.05	49.21	74.00	-24.79	Peak	
2 *	9748.1100	26.48	11.05	37.53	54.00	-16.47	AVG	

Orthogonal Axis :	X
Test Mode :	TX N-20M MODE 2457MHz

Vertical

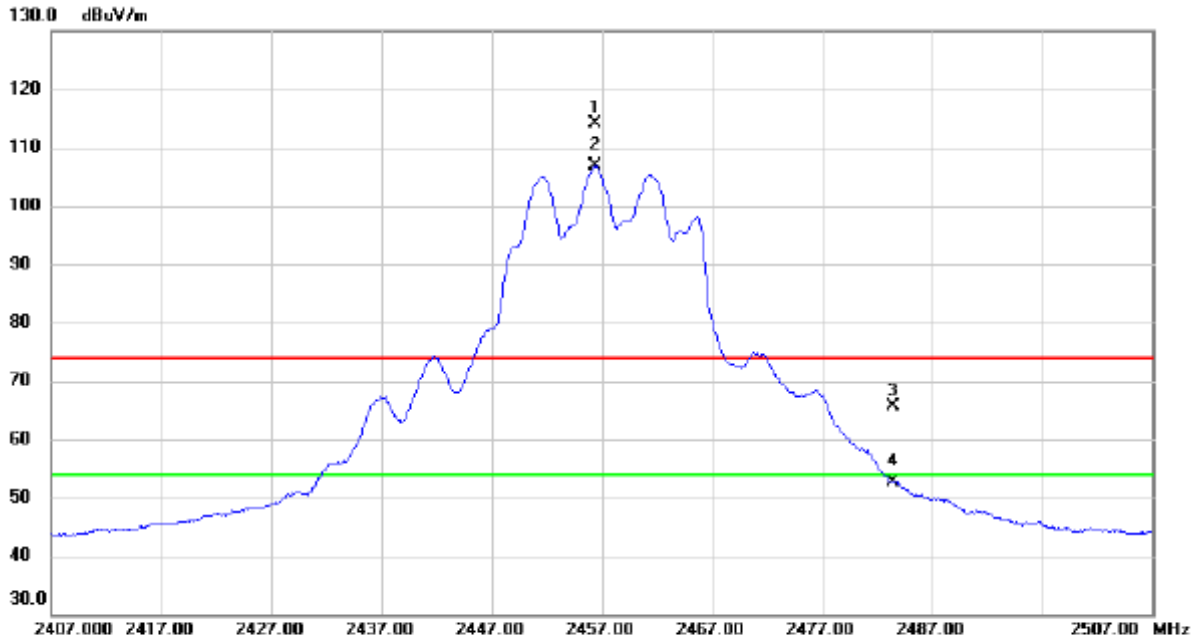

No.	Mk.	Freq. MHz	Reading Level dBuV	Correct Factor dB	Measure- ment dBuV/m	Limit dBuV/m	Margin dB	Detector	Comment
1	X	2456.400	107.63	6.62	114.25	74.00	40.25	peak	No Limit
2	*	2456.450	100.17	6.62	106.79	54.00	52.79	AVG	No Limit
3		2483.500	59.02	6.61	65.63	74.00	-8.37	peak	
4		2483.500	46.04	6.61	52.65	54.00	-1.35	AVG	

Orthogonal Axis :	X
Test Mode :	TX N-20M MODE 2457MHz

Vertical

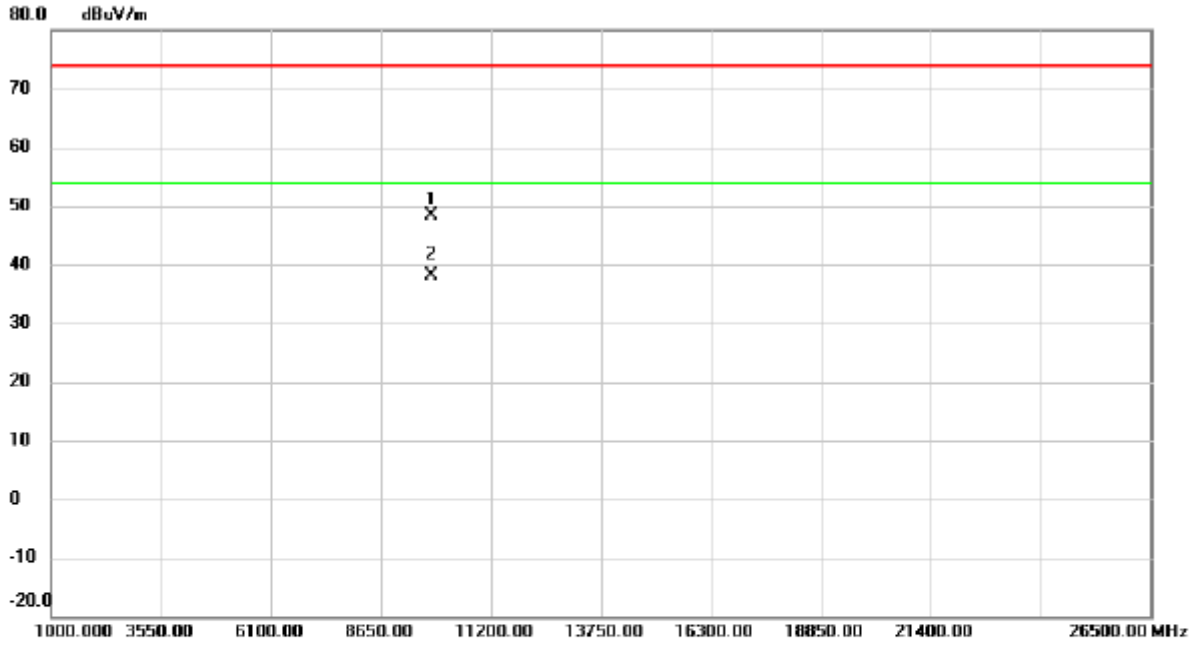

No.	Mk.	Freq. MHz	Reading Level dBuV	Correct Factor dB	Measure- ment dBuV/m	Limit dBuV/m	Margin dB	Detector	Comment
1		9827.654	37.23	11.06	48.29	74.00	-25.71	peak	
2	*	9828.035	27.14	11.06	38.20	54.00	-15.80	AVG	

Orthogonal Axis :	X
Test Mode :	TX N-20M MODE 2457MHz

Horizontal

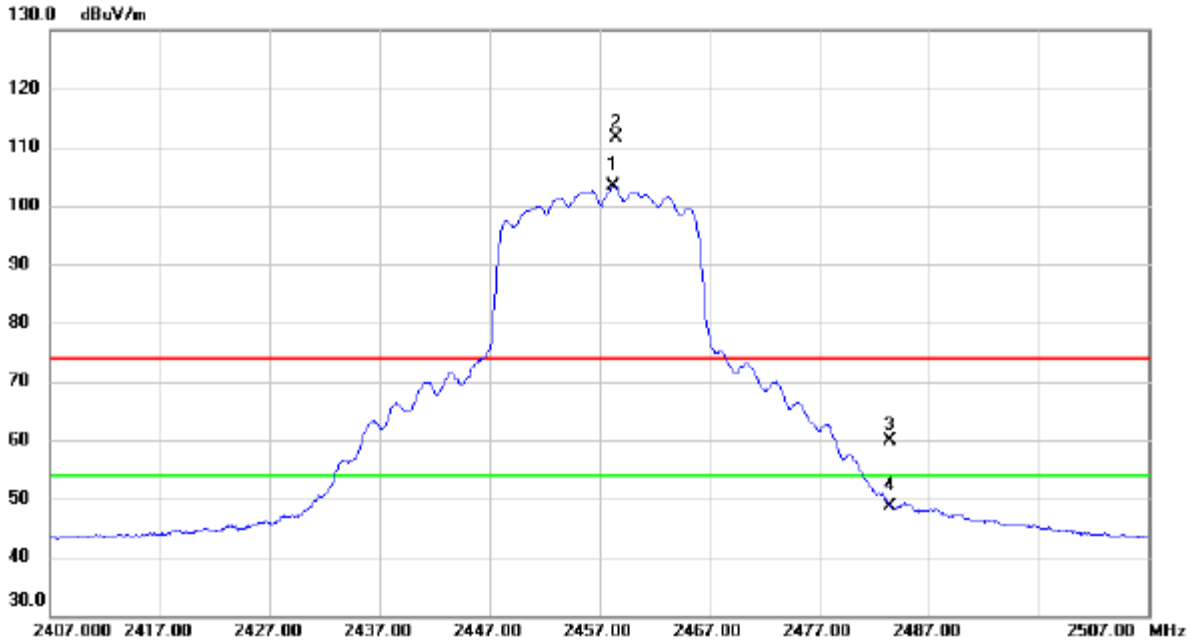

No.	Mk.	Freq. MHz	Reading Level dBuV	Correct Factor dB	Measure- ment dBuV/m	Limit dBuV/m	Margin dB	Detector	Comment
1	*	2458.300	96.69	6.62	103.31	54.00	49.31	AVG	No Limit
2	X	2458.500	104.90	6.62	111.52	74.00	37.52	peak	No Limit
3		2483.500	53.20	6.61	59.81	74.00	-14.19	peak	
4		2483.500	42.10	6.61	48.71	54.00	-5.29	AVG	

Orthogonal Axis :	X
Test Mode :	TX N-20M MODE 2457MHz

Horizontal

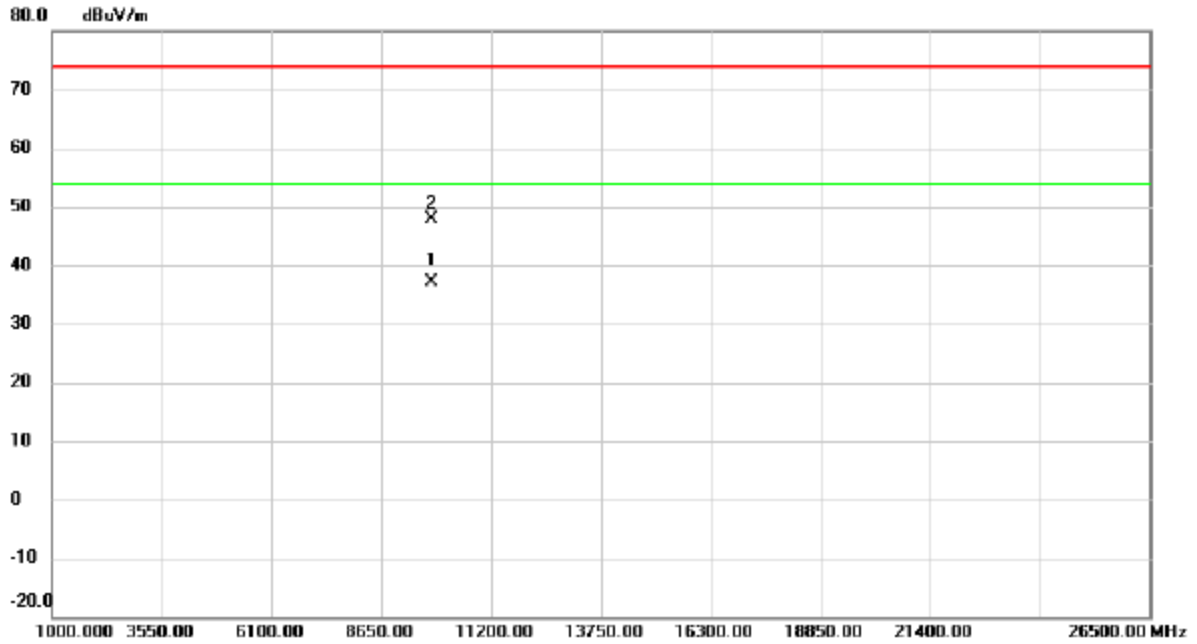

No. Mk.	Freq. MHz	Reading Level dBuV	Correct Factor dB	Measure- ment dBuV/m	Limit dBuV/m	Margin dB	Detector	Comment
1 *	9827.934	25.96	11.06	37.02	54.00	-16.98	AVG	
2	9828.746	36.91	11.06	47.97	74.00	-26.03	peak	

Orthogonal Axis	X
Test Mode:	TX N-20M Mode 2462 MHz

Vertical

130 dBuV/m

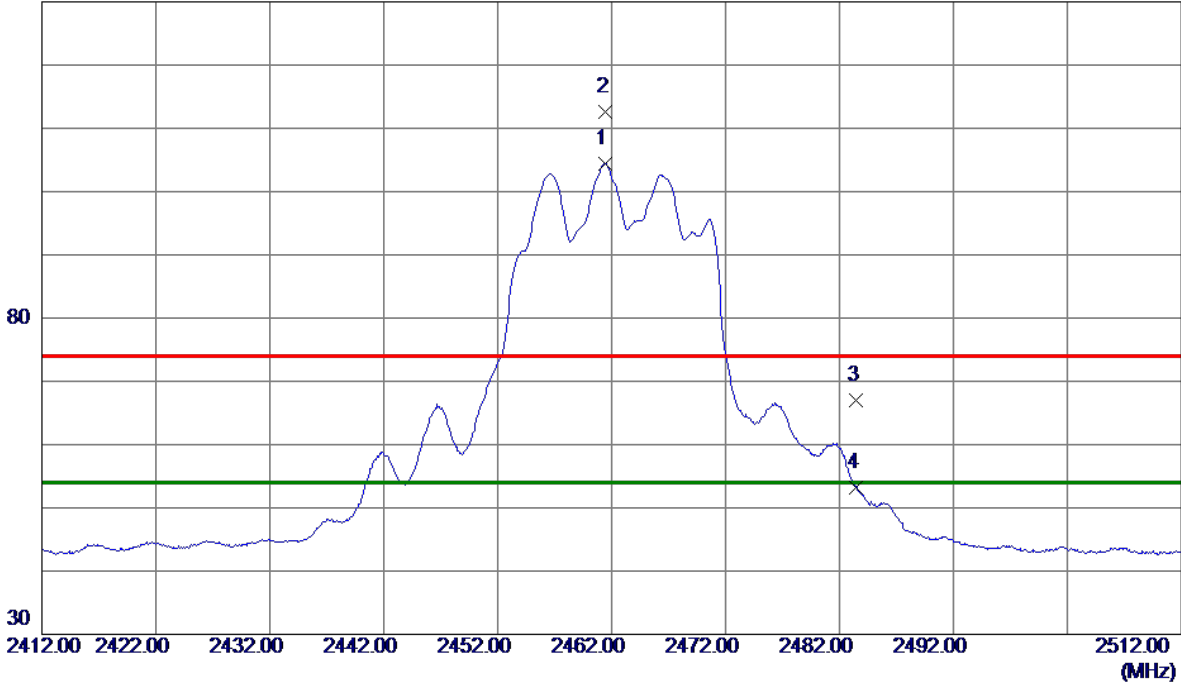

No.	Freq. MHz	Reading Level dBuV/m	Correct Factor dB	Measure ment dBuV/m	Limit dBuV/m	Margin dB	Detector	Comment
1 *	2461.4500	97.86	6.61	104.47	54.00	50.47	AVG	No Limit
2	2461.5000	105.92	6.61	112.53	74.00	38.53	Peak	No Limit
3	2483.5000	60.37	6.61	66.98	74.00	-7.02	Peak	
4	2483.5000	46.67	6.61	53.28	54.00	-0.72	AVG	

Orthogonal Axis	X
Test Mode:	TX N-20M Mode 2462 MHz

Vertical

80 dBuV/m

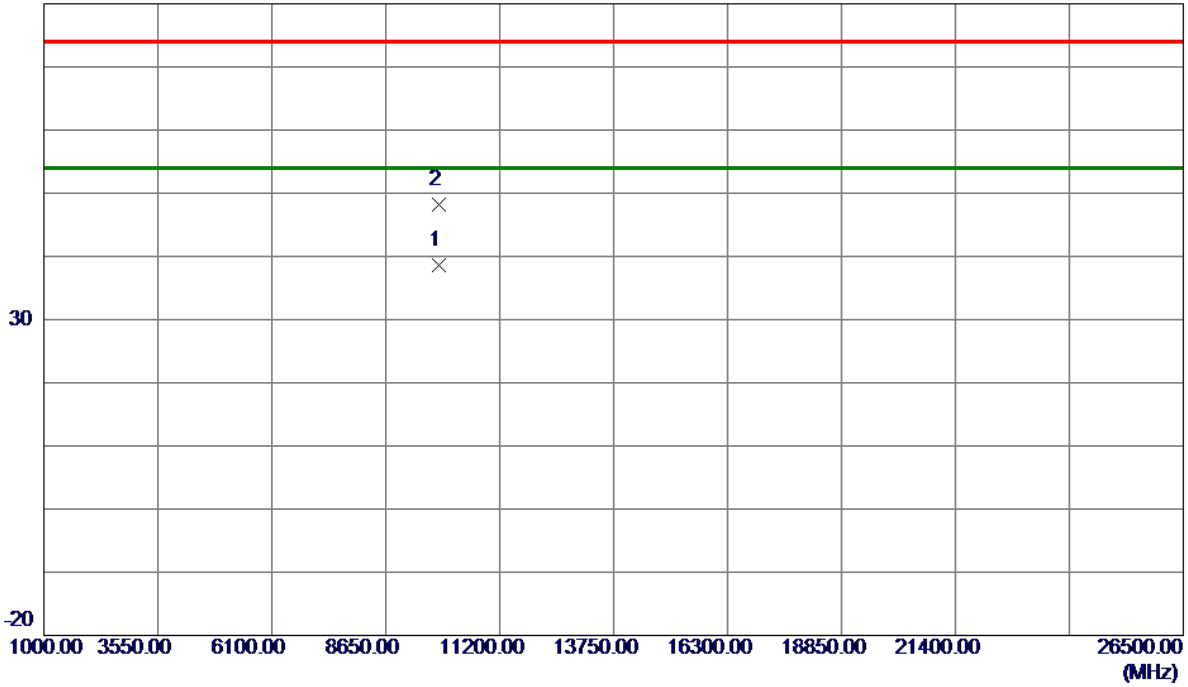

No.	Freq. MHz	Reading Level dBuV/m	Correct Factor dB	Measure ment dBuV/m	Limit dBuV/m	Margin dB	Detector	Comment
1 *	9848.0710	27.53	11.06	38.59	54.00	-15.41	AVG	
2	9848.1940	37.15	11.06	48.21	74.00	-25.79	Peak	

Orthogonal Axis	X
Test Mode:	TX N-20M Mode 2462 MHz

Horizontal

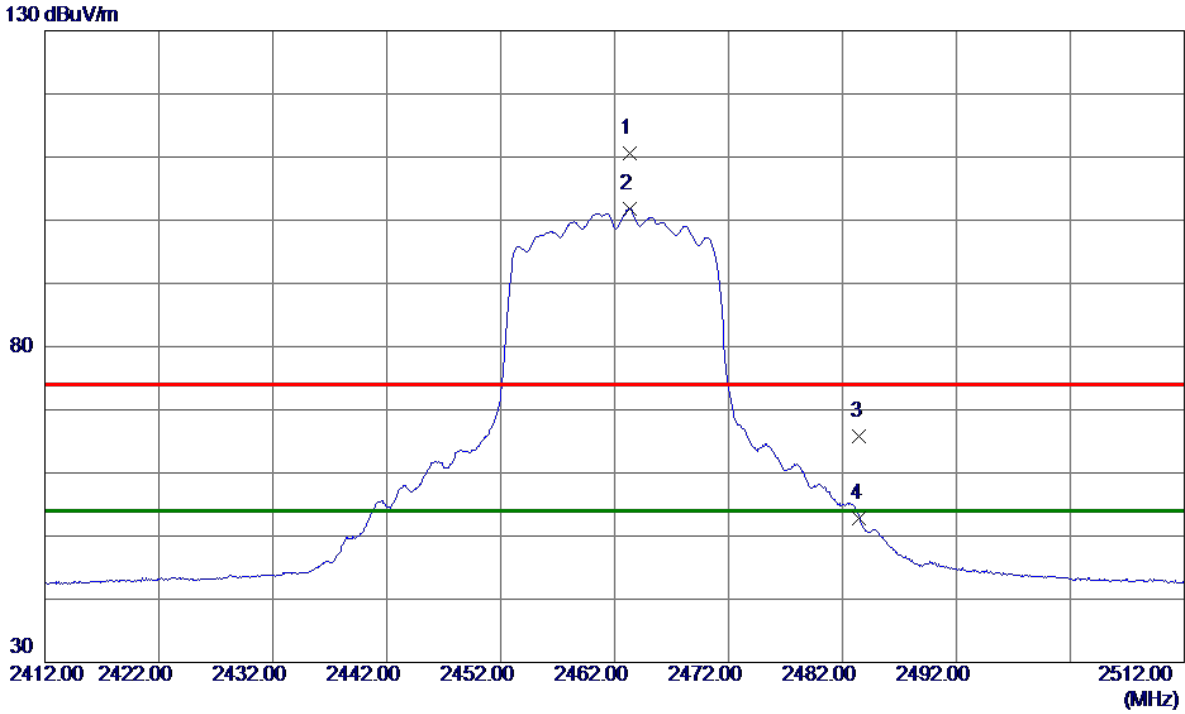

No.	Freq. MHz	Reading Level dBuV/m	Correct Factor dB	Measure ment dBuV/m	Limit dBuV/m	Margin dB	Detector	Comment
1	2463.3000	104.07	6.61	110.68	74.00	36.68	Peak	No Limit
2 *	2463.3500	95.16	6.61	101.77	54.00	47.77	AVG	No Limit
3	2483.5000	59.24	6.61	65.85	74.00	-8.15	Peak	
4	2483.5000	46.19	6.61	52.80	54.00	-1.20	AVG	

Orthogonal Axis	X
Test Mode:	TX N-20M Mode 2462 MHz

Horizontal

80 dBuV/m

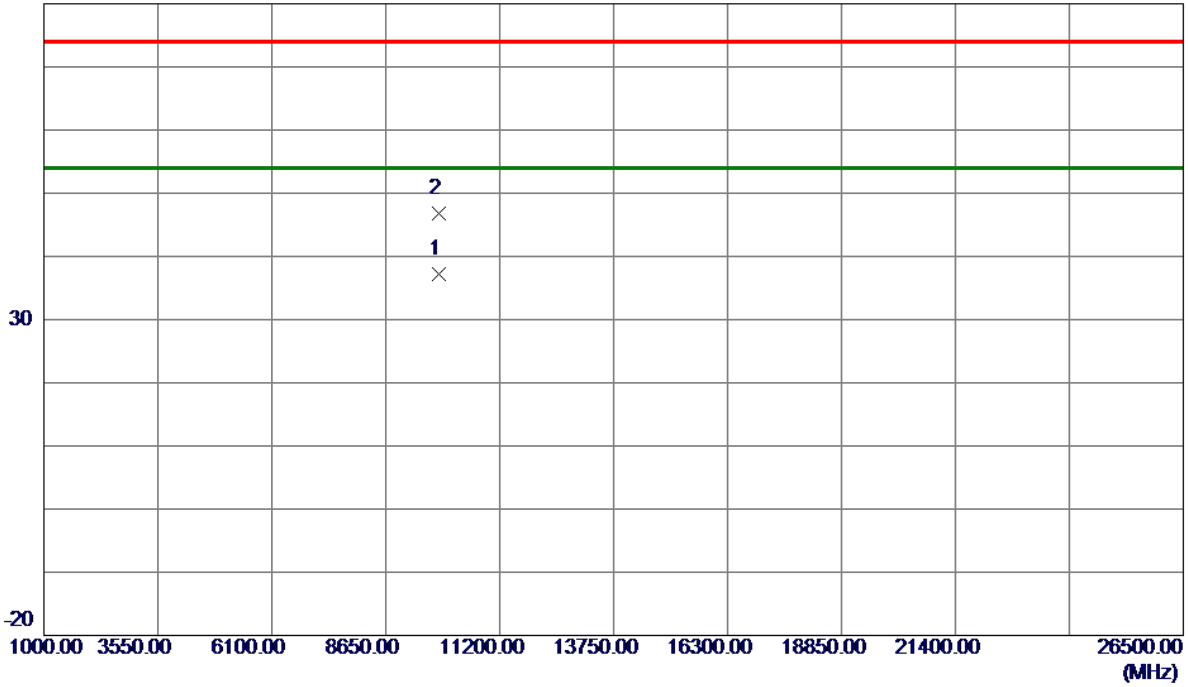

No.	Freq. MHz	Reading Level dBuV/m	Correct Factor dB	Measure ment dBuV/m	Limit dBuV/m	Margin dB	Detector	Comment
1 *	9847.9300	26.14	11.06	37.20	54.00	-16.80	AVG	
2	9848.6929	35.66	11.06	46.72	74.00	-27.28	Peak	

Orthogonal Axis	X
Test Mode:	TX N-40M Mode 2422MHz

Vertical

130 dBuV/m

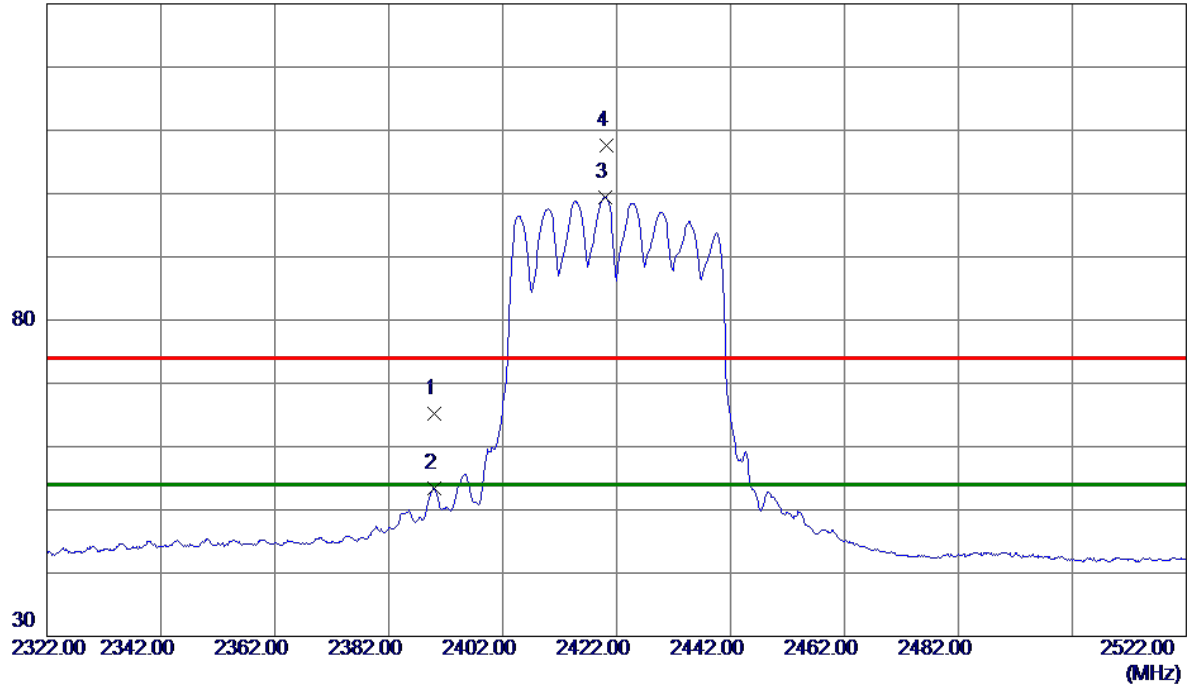

No.	Freq. MHz	Reading Level dBuV/m	Correct Factor dB	Measure ment dBuV/m	Limit dBuV/m	Margin dB	Detector	Comment
1	2390.0000	58.53	6.62	65.15	74.00	-8.85	Peak	
2	2390.0000	46.76	6.62	53.38	54.00	-0.62	AVG	
3 *	2420.0000	92.83	6.62	99.45	54.00	45.45	AVG	No Limit
4	2420.2000	100.94	6.62	107.56	74.00	33.56	Peak	No Limit

Orthogonal Axis	X
Test Mode:	TX N-40M Mode 2422MHz

Vertical

80 dBuV/m

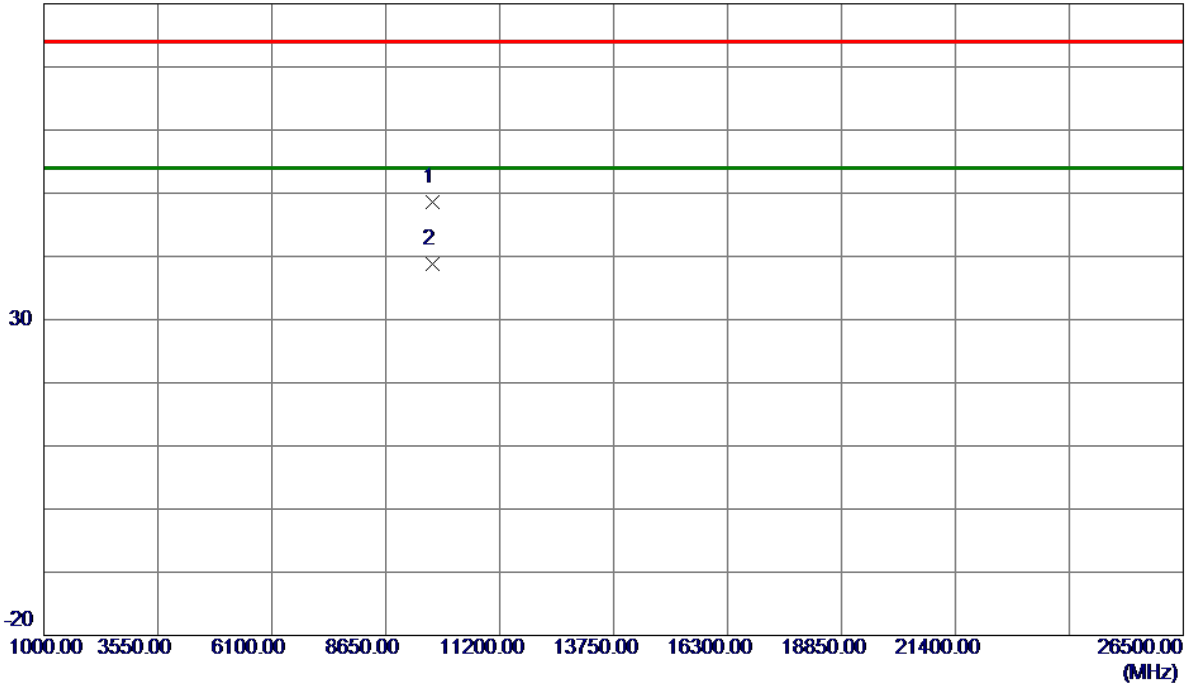

No.	Freq. MHz	Reading Level dBuV/m	Correct Factor dB	Measure ment dBuV/m	Limit dBuV/m	Margin dB	Detector	Comment
1	9687.8200	37.60	11.04	48.64	74.00	-25.36	Peak	
2 *	9687.9660	27.83	11.04	38.87	54.00	-15.13	AVG	

Orthogonal Axis	X
Test Mode:	TX N-40M Mode 2422MHz

Horizontal

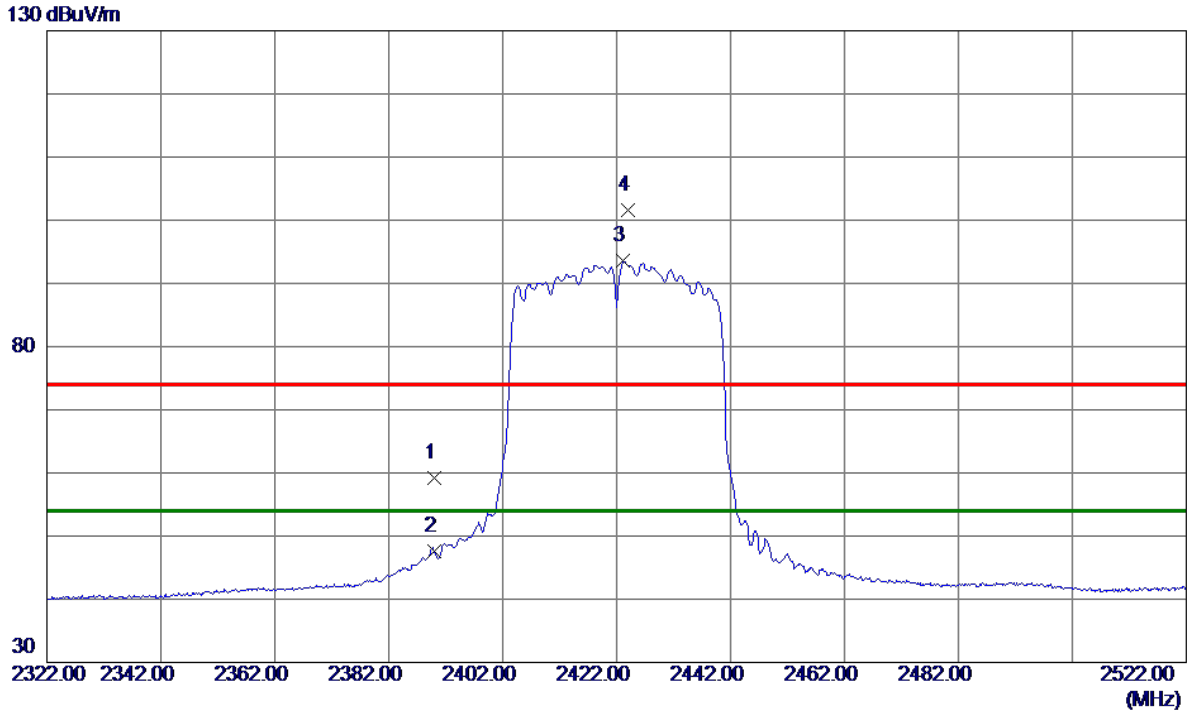

No.	Freq. MHz	Reading Level dBuV/m	Correct Factor dB	Measure ment dBuV/m	Limit dBuV/m	Margin dB	Detector	Comment
1	2390.0000	52.66	6.62	59.28	74.00	-14.72	Peak	
2	2390.0000	41.04	6.62	47.66	54.00	-6.34	AVG	
3 *	2423.2000	86.90	6.62	93.52	54.00	39.52	AVG	No Limit
4	2424.1000	94.95	6.62	101.57	74.00	27.57	Peak	No Limit

Orthogonal Axis	X
Test Mode:	TX N-40M Mode 2422MHz

Horizontal

80 dBuV/m

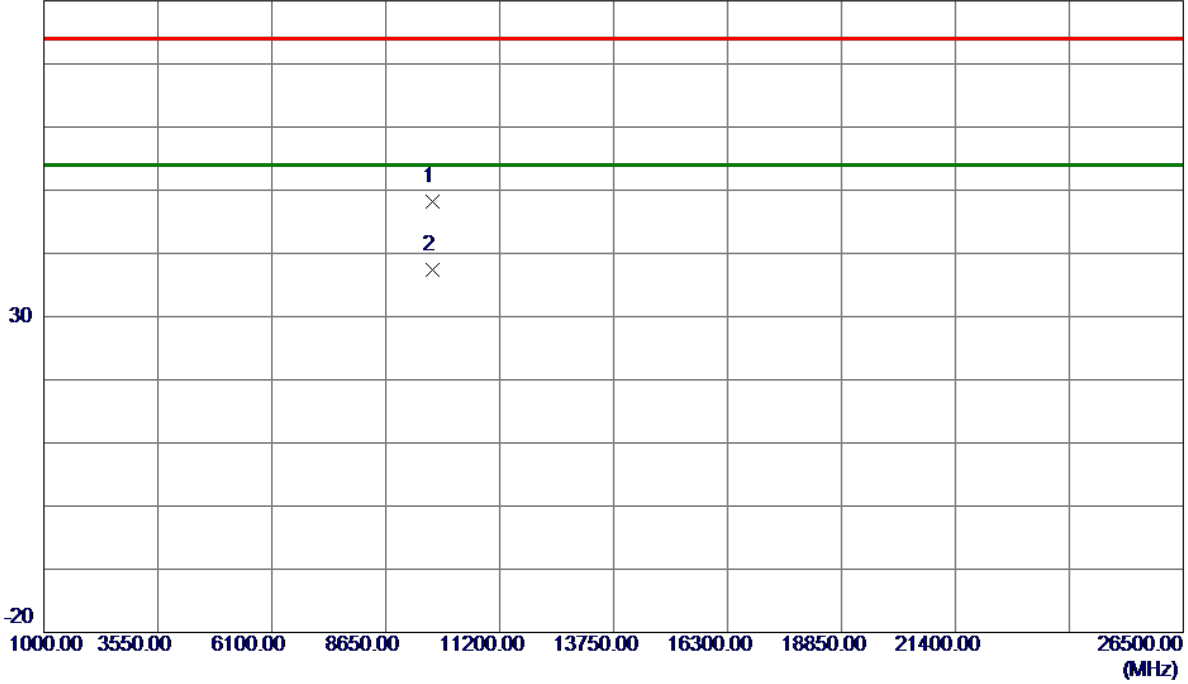

No.	Freq. MHz	Reading Level dBuV/m	Correct Factor dB	Measure ment dBuV/m	Limit dBuV/m	Margin dB	Detector	Comment
1	9687.5070	37.18	11.04	48.22	74.00	-25.78	Peak	
2 *	9687.9730	26.34	11.04	37.38	54.00	-16.62	AVG	

Orthogonal Axis :	X
Test Mode :	TX N-40M MODE 2427MHz

Vertical

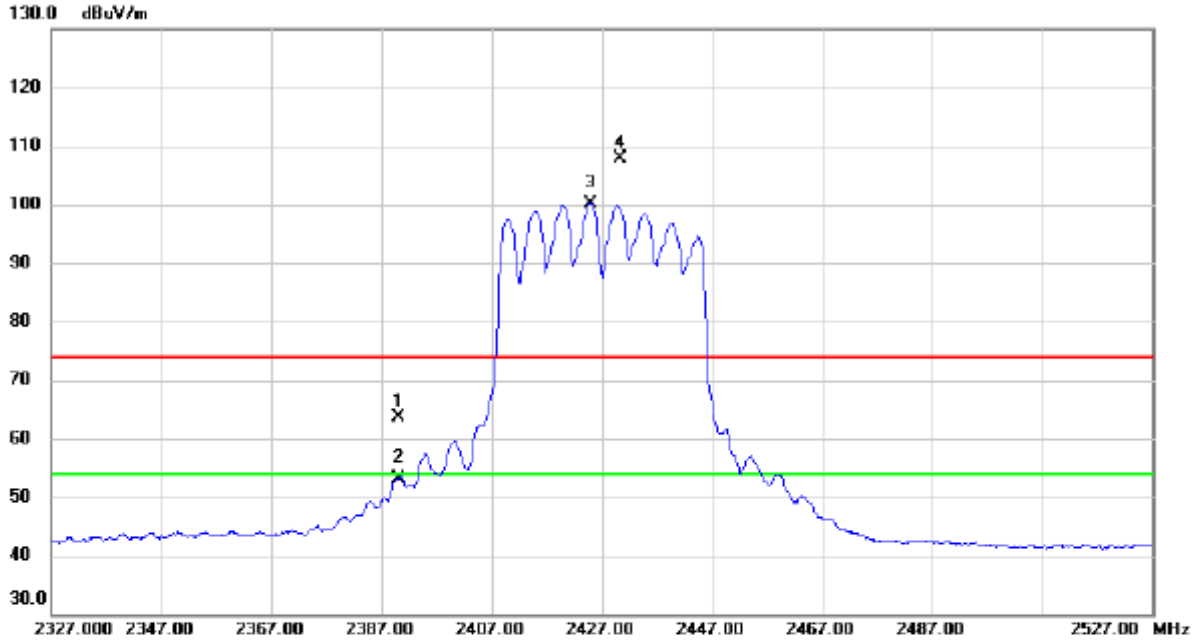

No.	Mk.	Freq. MHz	Reading Level dBuV	Correct Factor dB	Measure- ment dBuV/m	Limit dBuV/m	Margin dB	Detector	Comment
1		2390.000	57.04	6.62	63.66	74.00	-10.34	peak	
2		2390.000	46.54	6.62	53.16	54.00	-0.84	AVG	
3	*	2424.900	93.52	6.62	100.14	54.00	46.14	AVG	No Limit
4	X	2430.300	101.15	6.61	107.76	74.00	33.76	peak	No Limit

Orthogonal Axis :	X
Test Mode :	TX N-40M MODE 2427MHz

Vertical

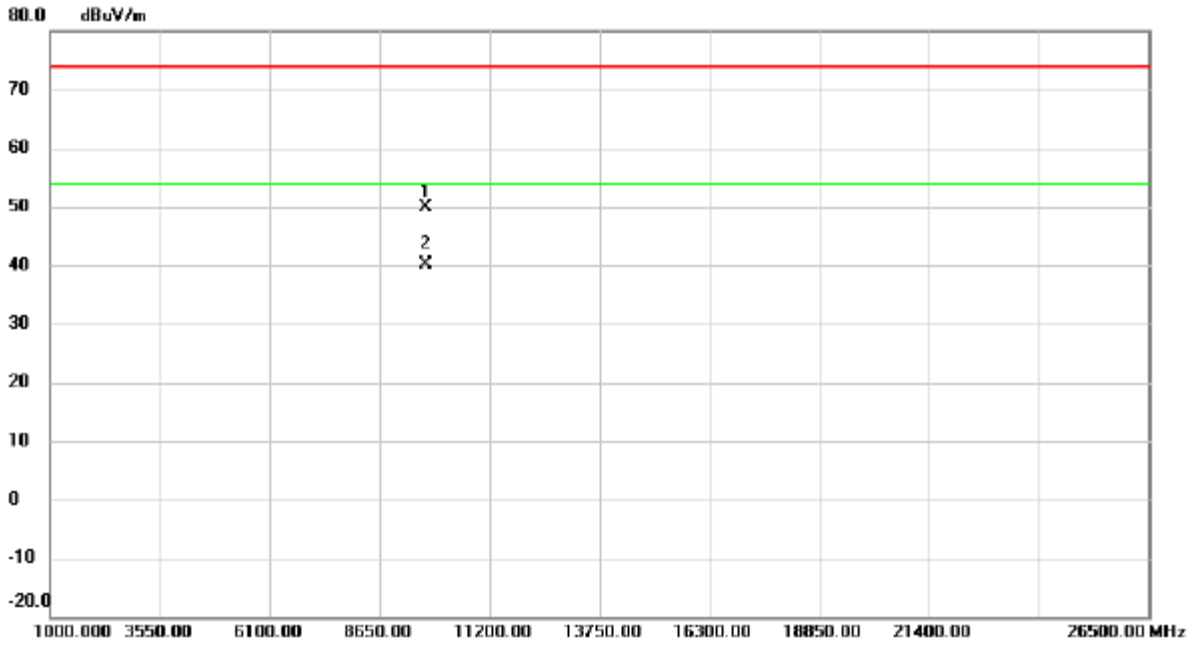

No.	Mk.	Freq.	Reading Level	Correct Factor	Measurement	Limit	Margin	Detector	Comment
		MHz	dBuV	dB	dBuV/m	dBuV/m	dB		
1		9707.940	38.72	11.04	49.76	74.00	-24.24	peak	
2	*	9707.973	29.07	11.04	40.11	54.00	-13.89	AVG	

Orthogonal Axis :	X
Test Mode :	TX N-40M MODE 2427MHz

Horizontal

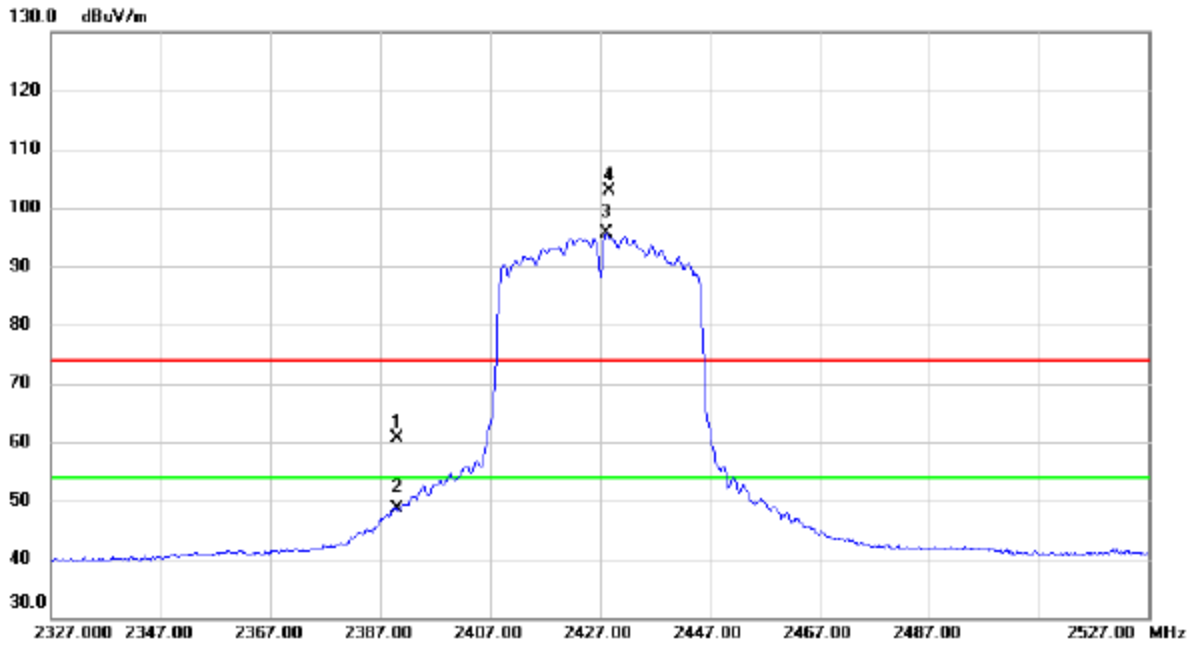

No.	Mk.	Freq. MHz	Reading Level dBuV	Correct Factor dB	Measure- ment dBuV/m	Limit dBuV/m	Margin dB	Detector	Comment
1		2390.000	53.99	6.62	60.61	74.00	-13.39	peak	
2		2390.000	42.08	6.62	48.70	54.00	-5.30	AVG	
3	*	2428.200	88.98	6.61	95.59	54.00	41.59	AVG	No Limit
4	X	2428.800	96.29	6.61	102.90	74.00	28.90	peak	No Limit

Orthogonal Axis :	X
Test Mode :	TX N-40M MODE 2427MHz

Horizontal

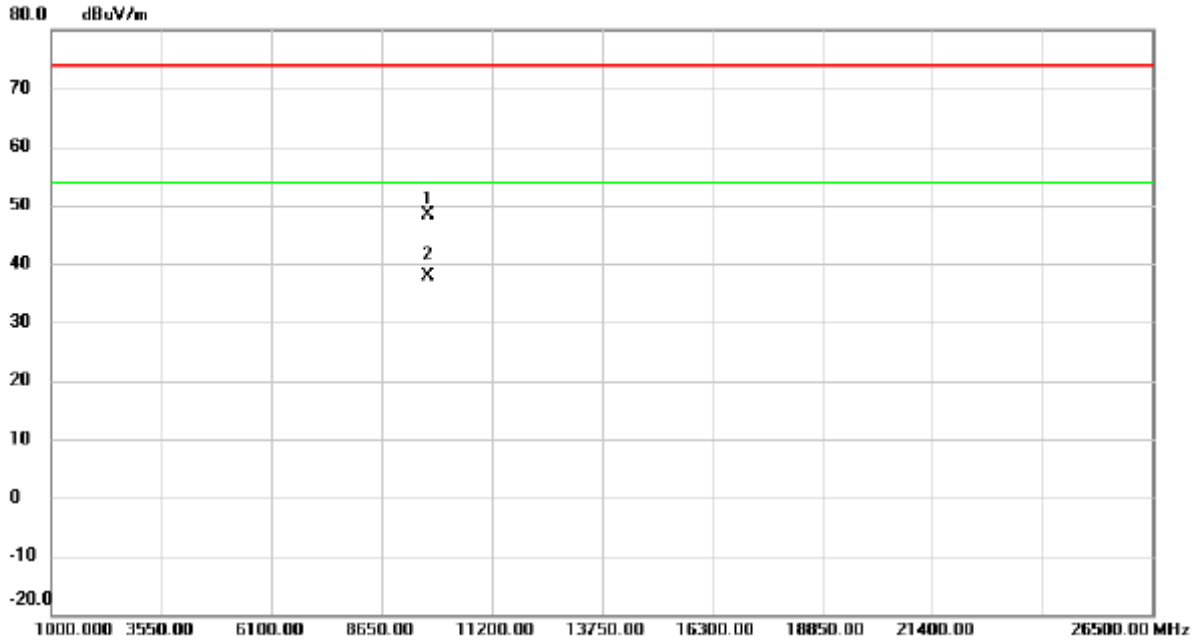

No.	Mk.	Freq. MHz	Reading Level dBuV	Correct Factor dB	Measure- ment dBuV/m	Limit dBuV/m	Margin dB	Detector	Comment
1		9707.329	37.39	11.04	48.43	74.00	-25.57	peak	
2	*	9707.907	26.73	11.04	37.77	54.00	-16.23	AVG	

Orthogonal Axis	X
Test Mode:	TX N-40M Mode 2437 MHz

Vertical

130 dBuV/m

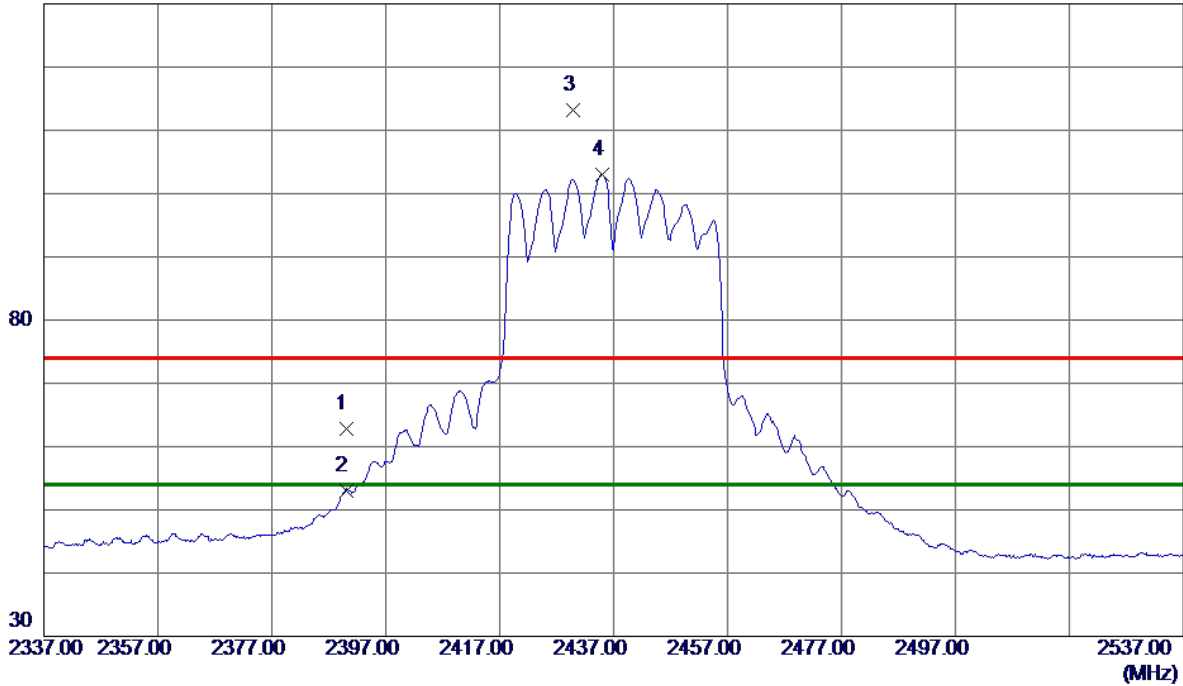

No.	Freq. MHz	Reading Level dBuV/m	Correct Factor dB	Measure ment dBuV/m	Limit dBuV/m	Margin dB	Detector	Comment
1	2390.0000	56.20	6.62	62.82	74.00	-11.18	Peak	
2	2390.0000	46.42	6.62	53.04	54.00	-0.96	AVG	
3	2429.9000	106.49	6.62	113.11	74.00	39.11	Peak	No Limit
4 *	2434.9000	96.33	6.61	102.94	54.00	48.94	AVG	No Limit

Orthogonal Axis	X
Test Mode:	TX N-40M Mode 2437 MHz

Vertical

80 dBuV/m

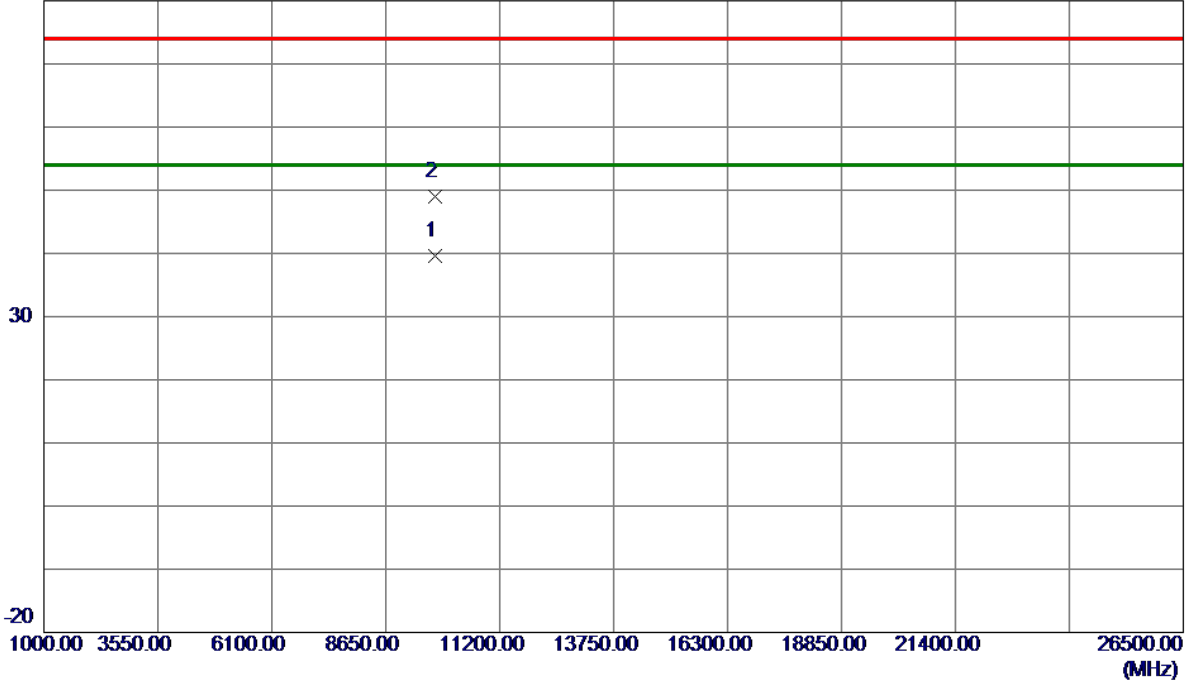

No.	Freq. MHz	Reading Level dBuV/m	Correct Factor dB	Measure ment dBuV/m	Limit dBuV/m	Margin dB	Detector	Comment
1 *	9748.0220	28.59	11.05	39.64	54.00	-14.36	AVG	
2	9748.0519	37.91	11.05	48.96	74.00	-25.04	Peak	

Orthogonal Axis	X
Test Mode:	TX N-40M Mode 2437 MHz

Horizontal

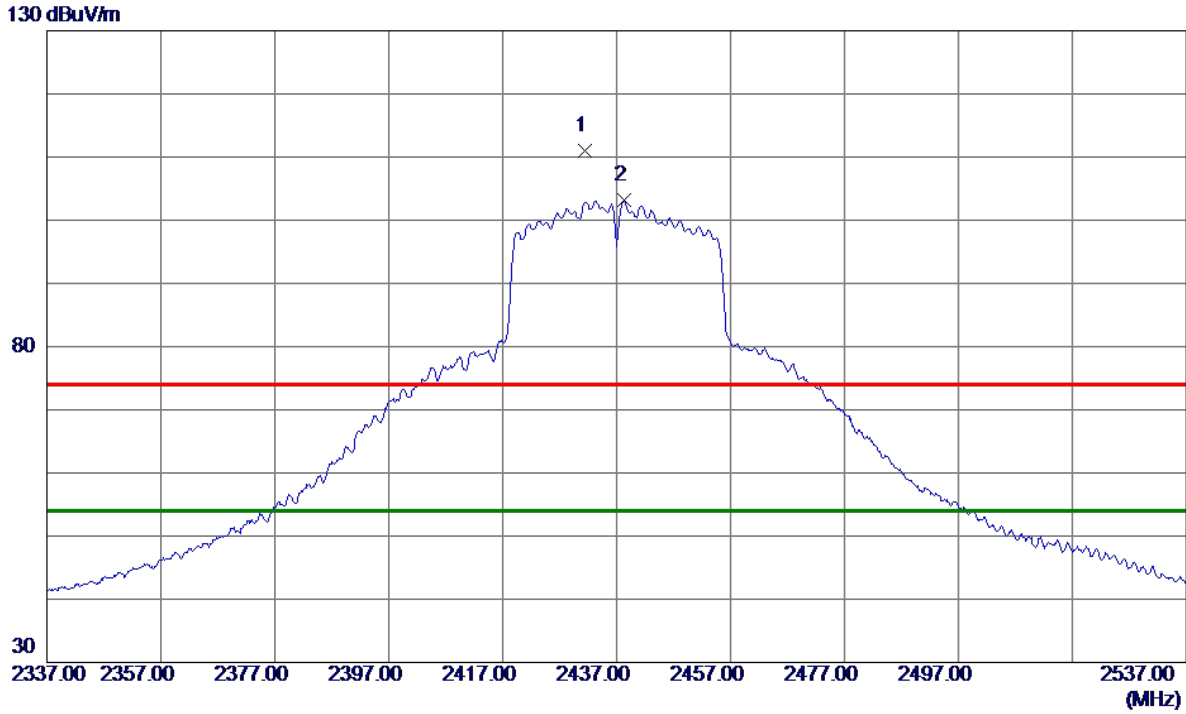

No.	Freq. MHz	Reading Level dBuV/m	Correct Factor dB	Measure ment dBuV/m	Limit dBuV/m	Margin dB	Detector	Comment
1	2431.5000	104.31	6.62	110.93	74.00	36.93	Peak	No Limit
2 *	2438.4000	96.57	6.61	103.18	54.00	49.18	AVG	No Limit

Orthogonal Axis	X
Test Mode:	TX N-40M Mode 2437 MHz

Horizontal

80 dBuV/m

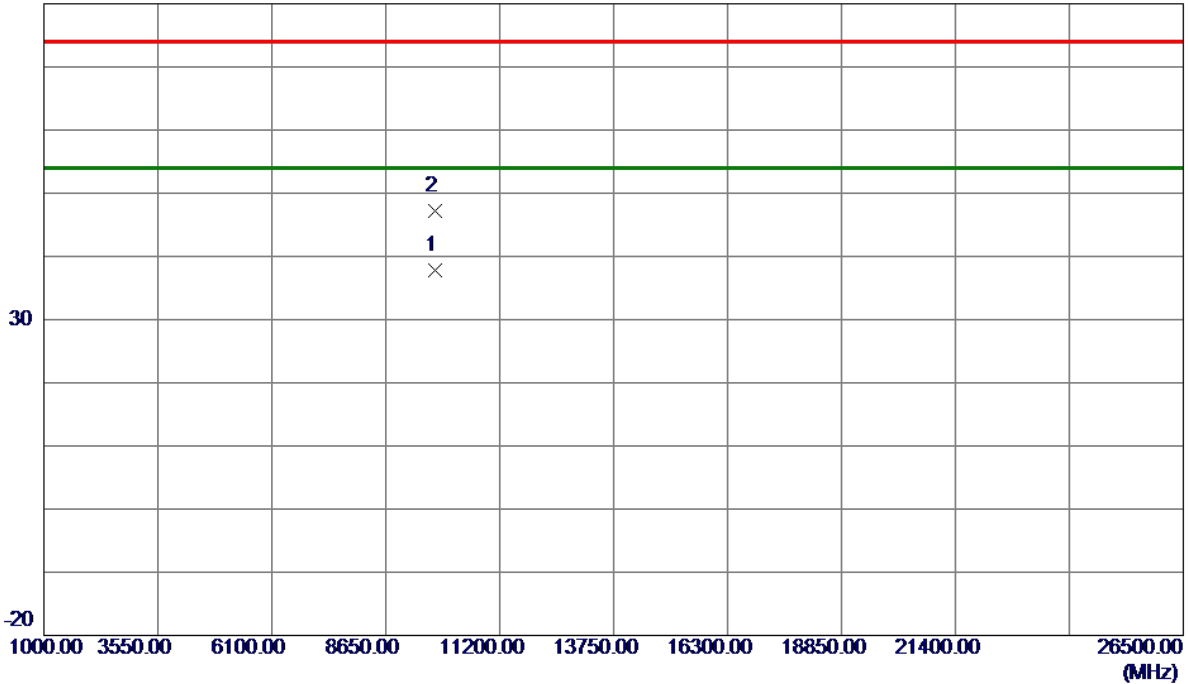

No.	Freq. MHz	Reading Level dBuV/m	Correct Factor dB	Measure ment dBuV/m	Limit dBuV/m	Margin dB	Detector	Comment
1 *	9747.9589	26.69	11.05	37.74	54.00	-16.26	AVG	
2	9748.5070	36.11	11.05	47.16	74.00	-26.84	Peak	

Orthogonal Axis :	X
Test Mode :	TX N-40M MODE 2447MHz

Vertical

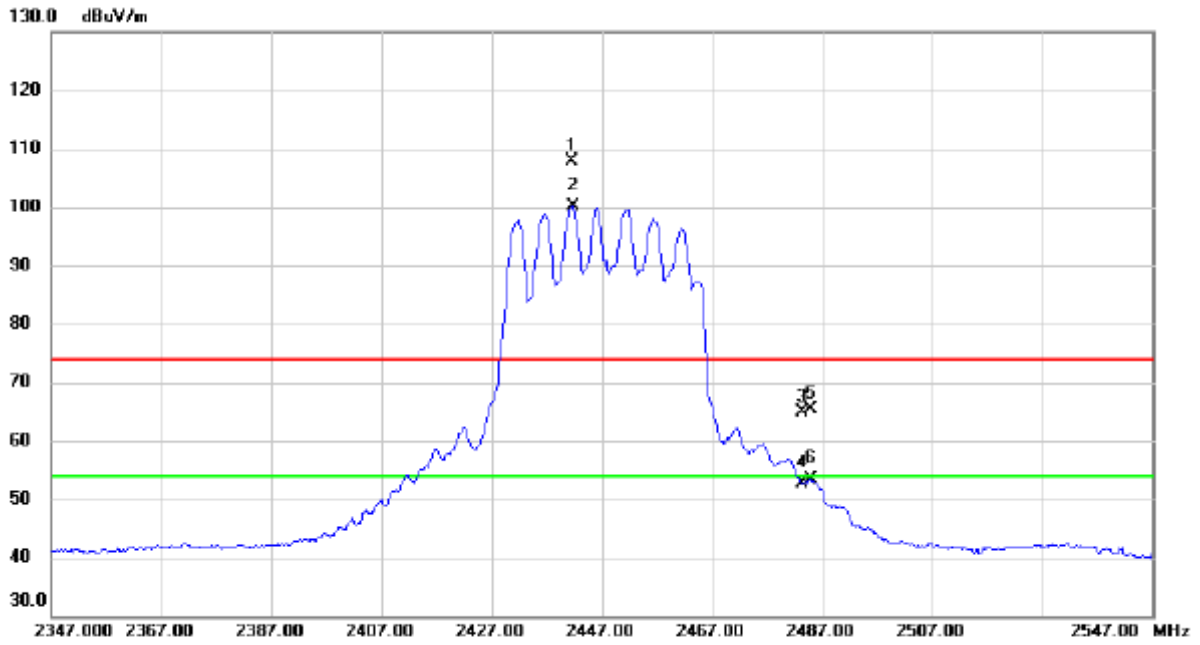

No.	Mk.	Freq. MHz	Reading Level dBuV	Correct Factor dB	Measure- ment dBuV/m	Limit dBuV/m	Margin dB	Detector	Comment
1	X	2441.600	101.28	6.61	107.89	74.00	33.89	peak	No Limit
2	*	2441.700	93.43	6.61	100.04	54.00	46.04	AVG	No Limit
3		2483.500	58.33	6.61	64.94	74.00	-9.06	peak	
4		2483.500	46.14	6.61	52.75	54.00	-1.25	AVG	
5		2484.900	58.89	6.61	65.50	74.00	-8.50	peak	
6		2484.900	46.75	6.61	53.36	54.00	-0.64	AVG	

Orthogonal Axis :	X
Test Mode :	TX N-40M MODE 2447MHz

Vertical

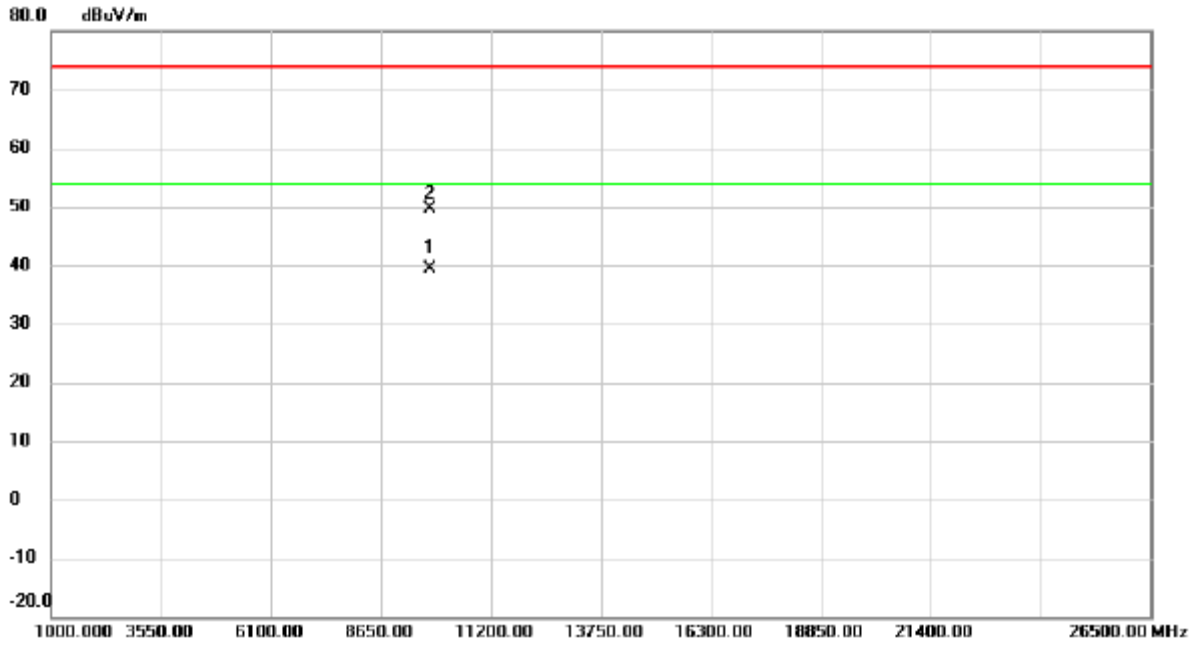

No.	Mk.	Freq. MHz	Reading Level dBuV	Correct Factor dB	Measure- ment dBuV/m	Limit dBuV/m	Margin dB	Detector	Comment
1	*	9788.033	28.32	11.05	39.37	54.00	-14.63	AVG	
2		9788.135	38.46	11.05	49.51	74.00	-24.49	peak	

Orthogonal Axis :	X
Test Mode :	TX N-40M MODE 2447MHz

Horizontal

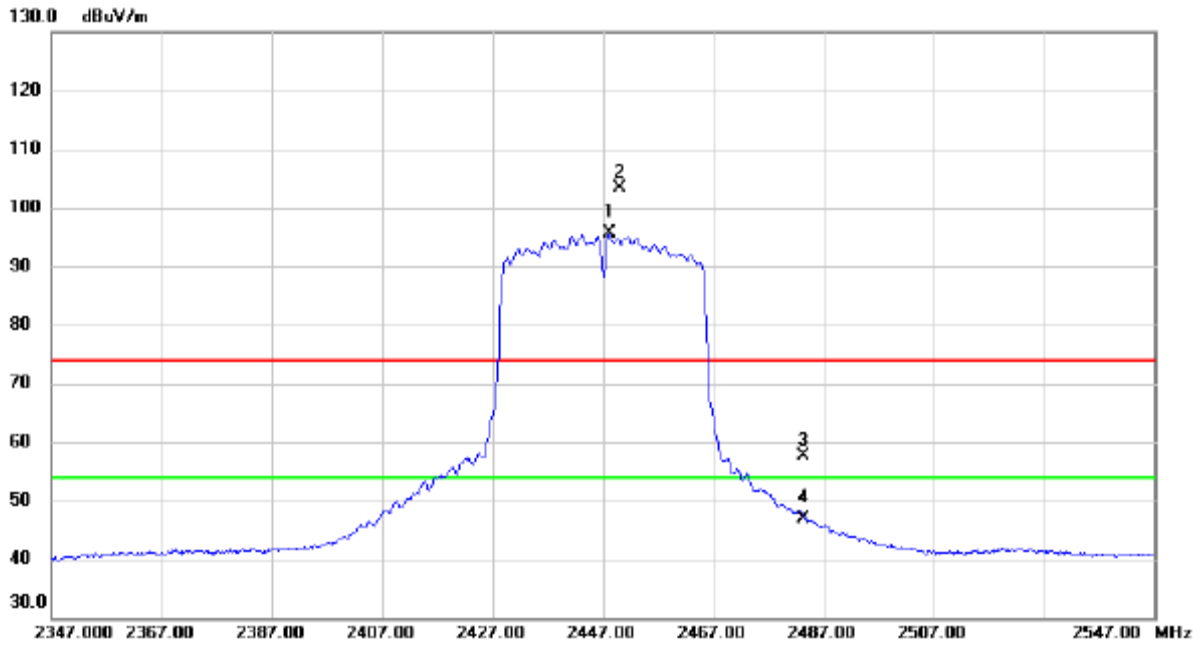

No.	Mk.	Freq. MHz	Reading Level dBuV	Correct Factor dB	Measure- ment dBuV/m	Limit dBuV/m	Margin dB	Detector	Comment
1	*	2448.300	88.99	6.61	95.60	54.00	41.60	AVG	No Limit
2	X	2450.200	96.72	6.61	103.33	74.00	29.33	peak	No Limit
3		2483.500	50.97	6.61	57.58	74.00	-16.42	peak	
4		2483.500	40.25	6.61	46.86	54.00	-7.14	AVG	

Orthogonal Axis :	X
Test Mode :	TX N-40M MODE 2447MHz

Horizontal

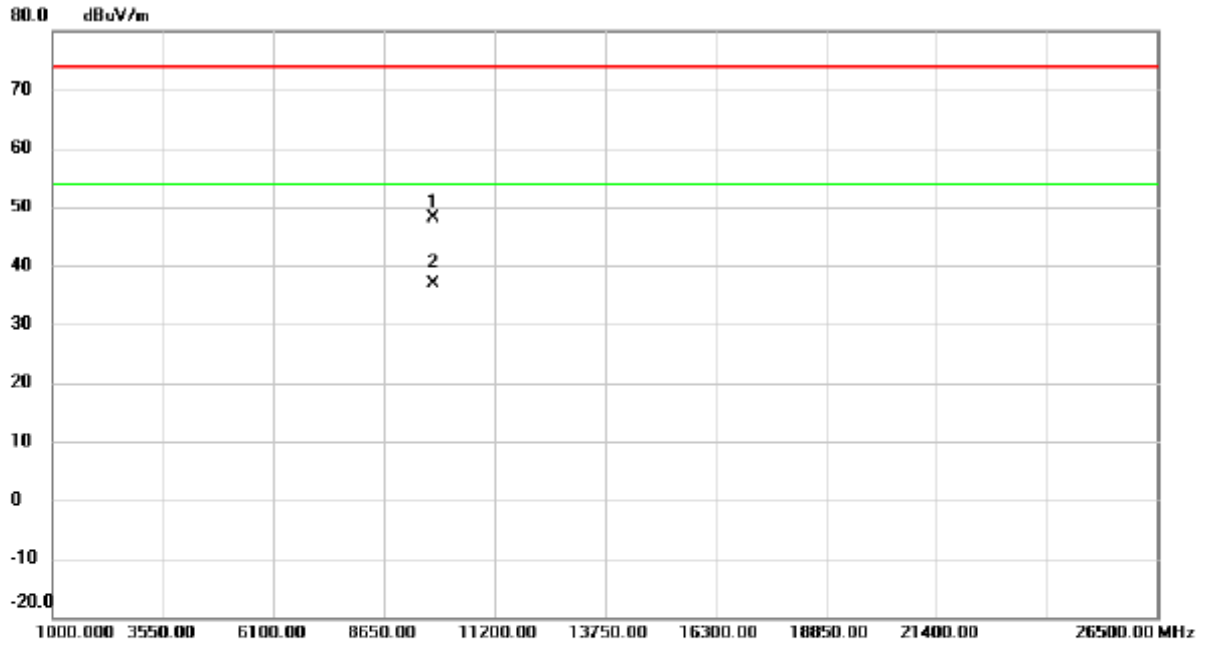

No.	Mk.	Freq. MHz	Reading Level dBuV	Correct Factor dB	Measure- ment dBuV/m	Limit dBuV/m	Margin dB	Detector	Comment
1		9787.698	37.09	11.05	48.14	74.00	-25.86	peak	
2	*	9788.067	25.86	11.05	36.91	54.00	-17.09	AVG	

Orthogonal Axis	X
Test Mode:	TX N-40M Mode 2452MHz

Vertical

130 dBuV/m

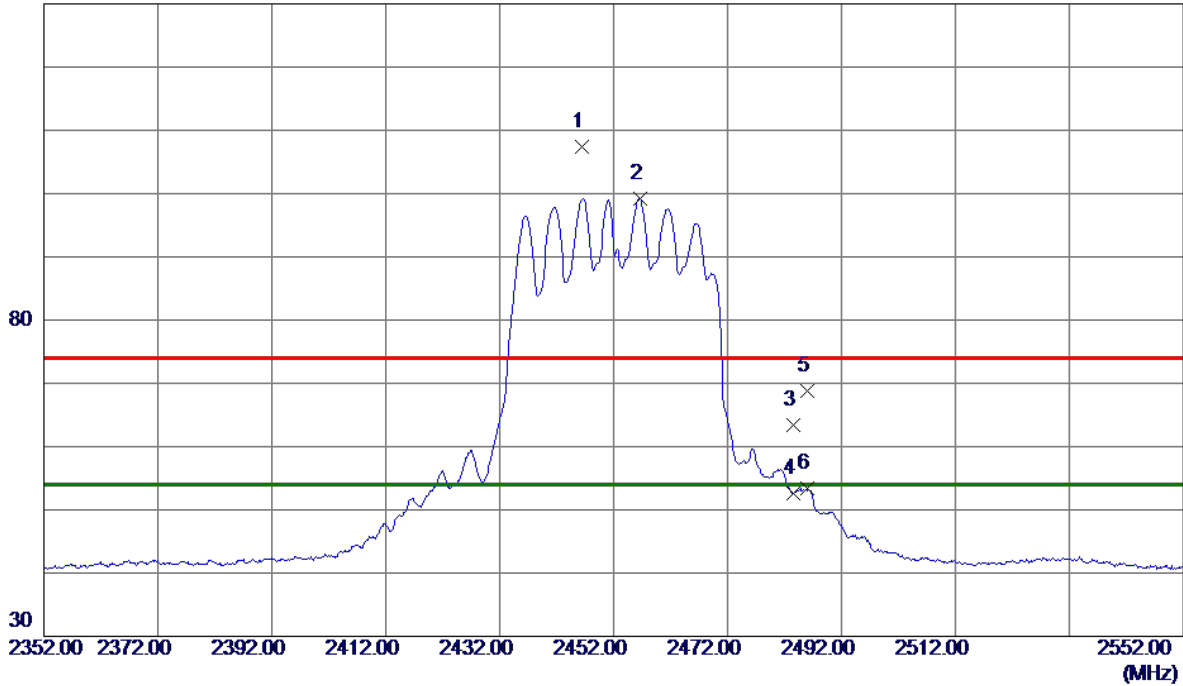

No.	Freq. MHz	Reading Level dBuV/m	Correct Factor dB	Measure ment dBuV/m	Limit dBuV/m	Margin dB	Detector	Comment
1	2446.5000	100.84	6.61	107.45	74.00	33.45	Peak	No Limit
2 *	2456.6000	92.60	6.61	99.21	54.00	45.21	AVG	No Limit
3	2483.5000	56.81	6.61	63.42	74.00	-10.58	Peak	
4	2483.5000	46.05	6.61	52.66	54.00	-1.34	AVG	
5	2486.1000	62.17	6.61	68.78	74.00	-5.22	Peak	
6	2486.1000	46.82	6.61	53.43	54.00	-0.57	AVG	

Orthogonal Axis	X
Test Mode:	TX N-40M Mode 2452MHz

Vertical

80 dBuV/m

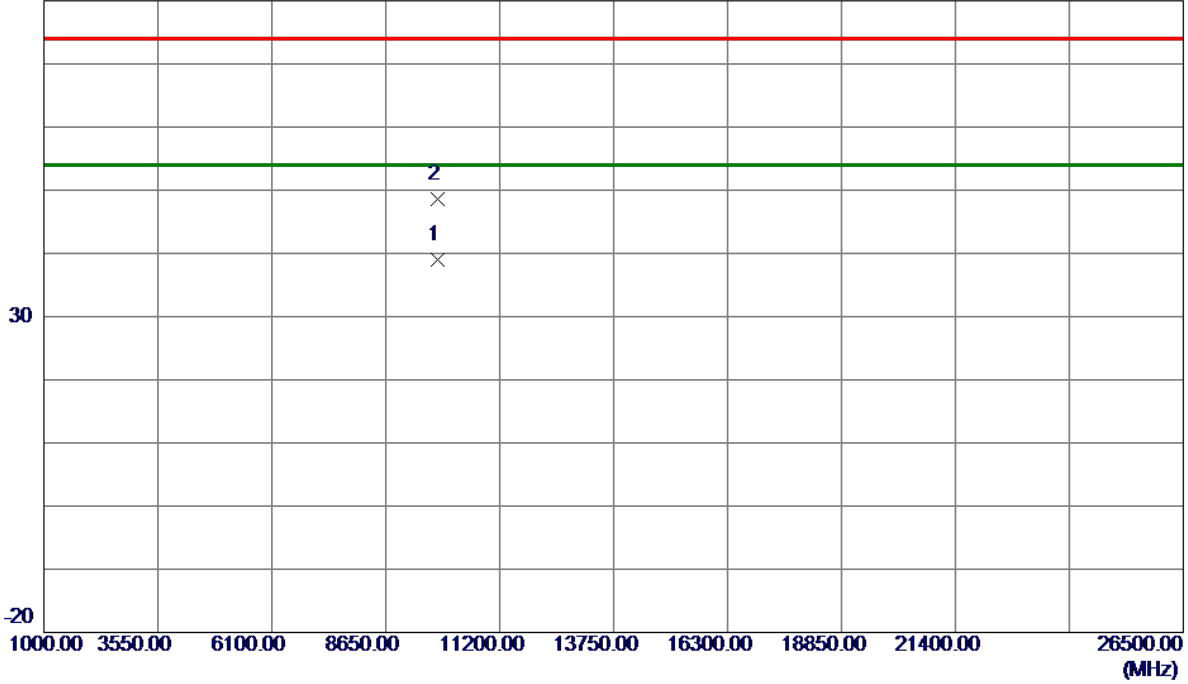

No.	Freq. MHz	Reading Level dBuV/m	Correct Factor dB	Measure ment dBuV/m	Limit dBuV/m	Margin dB	Detector	Comment
1 *	9808.0290	27.93	11.06	38.99	54.00	-15.01	AVG	
2	9808.2720	37.61	11.06	48.67	74.00	-25.33	Peak	

Orthogonal Axis	X
Test Mode:	TX N-40M Mode 2452MHz

Horizontal

130 dBuV/m

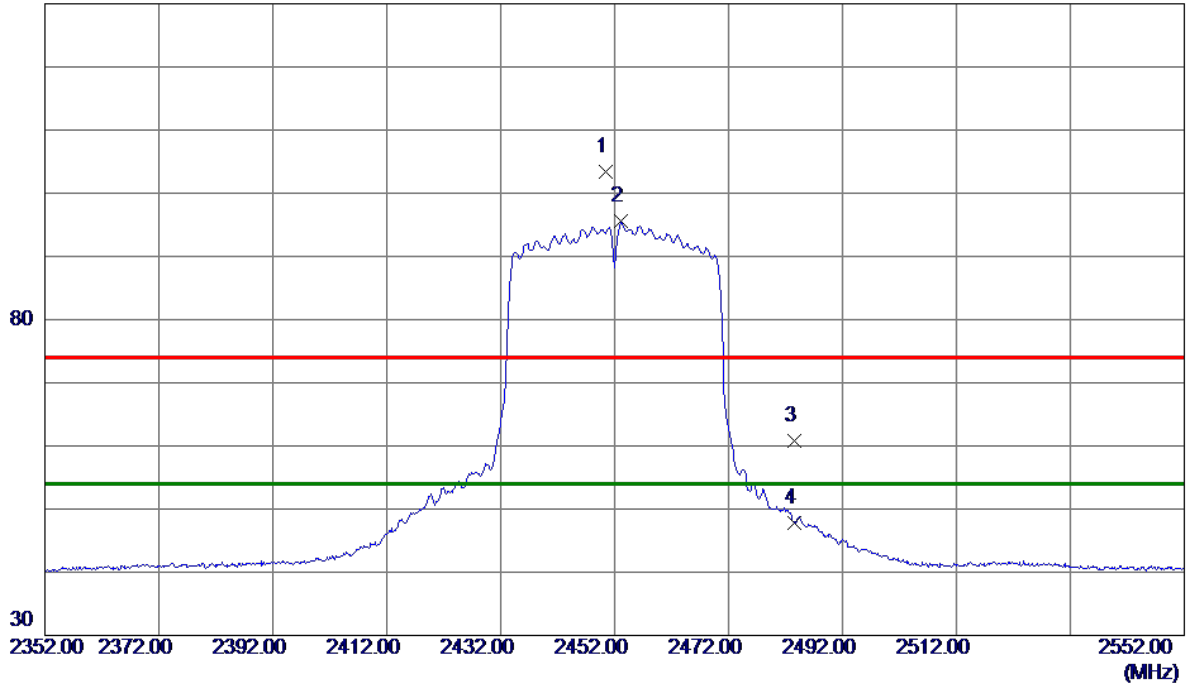

No.	Freq. MHz	Reading Level dBuV/m	Correct Factor dB	Measure ment dBuV/m	Limit dBuV/m	Margin dB	Detector	Comment
1	2450.4000	96.83	6.61	103.44	74.00	29.44	Peak	No Limit
2 *	2453.2000	88.93	6.61	95.54	54.00	41.54	AVG	No Limit
3	2483.5000	54.10	6.61	60.71	74.00	-13.29	Peak	
4	2483.5000	41.27	6.61	47.88	54.00	-6.12	AVG	

Orthogonal Axis	X
Test Mode:	TX N-40M Mode 2452MHz

Horizontal

80 dBuV/m

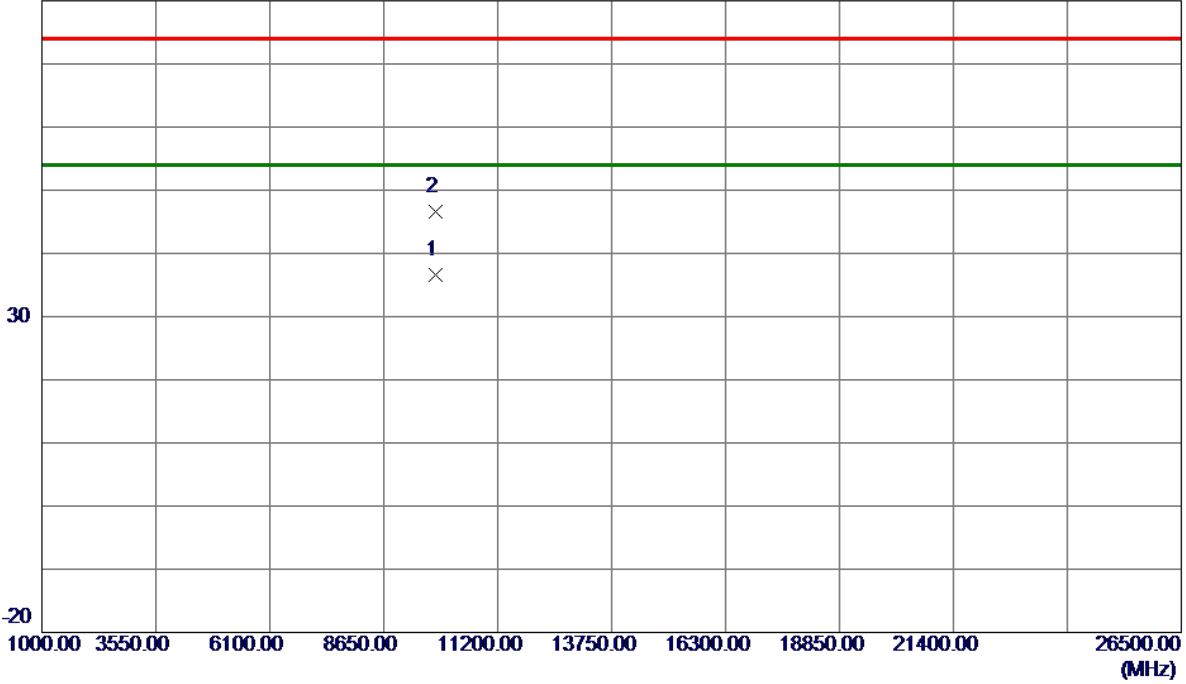

No.	Freq. MHz	Reading Level dBuV/m	Correct Factor dB	Measure ment dBuV/m	Limit dBuV/m	Margin dB	Detector	Comment
1 *	9807.9280	25.61	11.06	36.67	54.00	-17.33	AVG	
2	9808.7000	35.56	11.06	46.62	74.00	-27.38	Peak	

Orthogonal Axis	X
Test Mode:	TX VHT-20M Mode 2412 MHz

Vertical

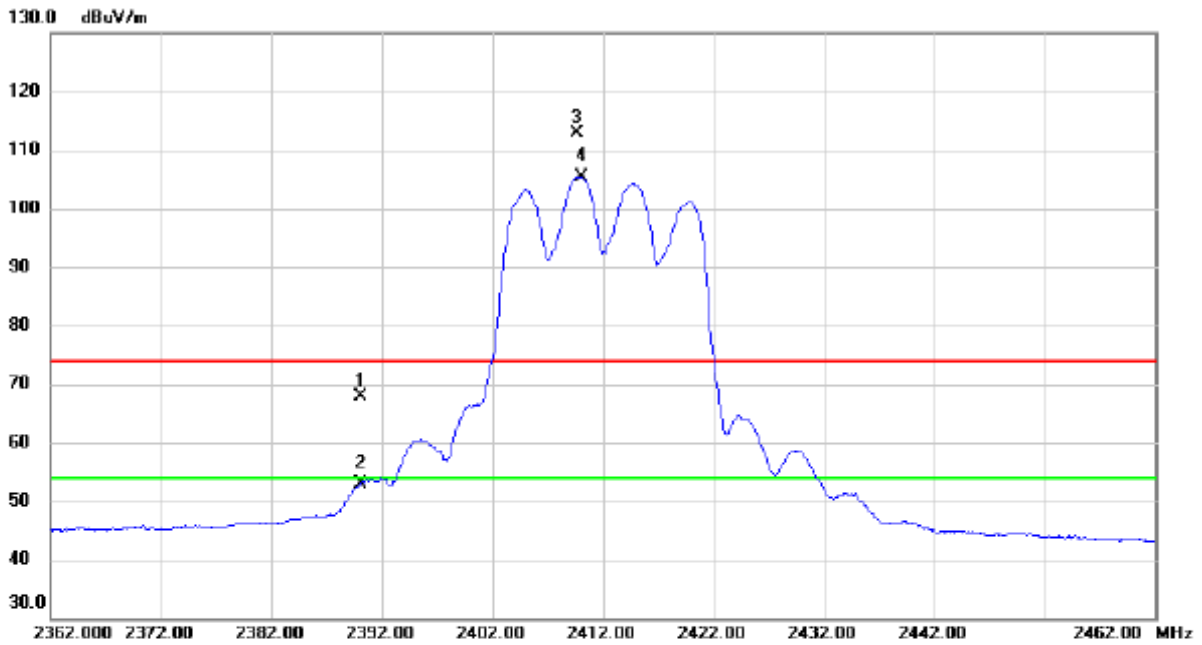

No.	Mk.	Freq. MHz	Reading Level dBuV	Correct Factor dB	Measure- ment dBuV/m	Limit dBuV/m	Margin dB	Detector	Comment
1		2390.000	61.27	6.62	67.89	74.00	-6.11	peak	
2		2390.000	46.26	6.62	52.88	54.00	-1.12	AVG	
3	X	2409.650	106.15	6.62	112.77	74.00	38.77	peak	No Limit
4	*	2410.000	98.83	6.62	105.45	54.00	51.45	AVG	No Limit

Orthogonal Axis	X
Test Mode:	TX VHT-20M Mode 2412 MHz

Vertical

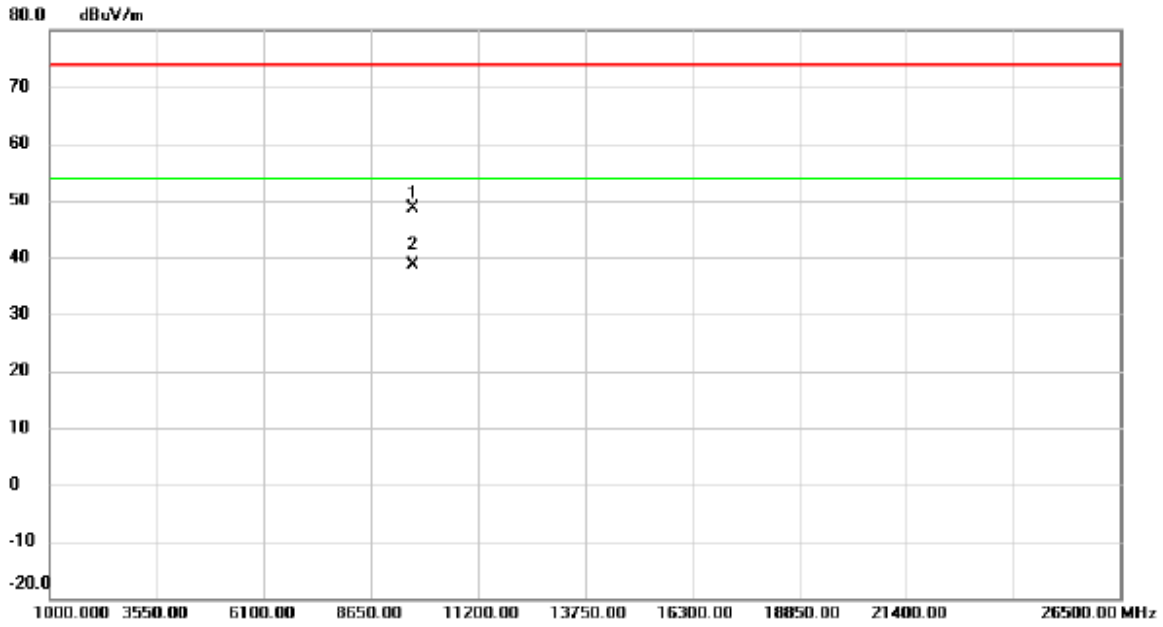

No.	Mk.	Freq. MHz	Reading Level dBuV	Correct Factor dB	Measure- ment dBuV/m	Limit dBuV/m	Margin dB	Detector	Comment
1		9648.012	37.63	11.03	48.66	74.00	-25.34	peak	
2	*	9648.021	27.66	11.03	38.69	54.00	-15.31	AVG	

Orthogonal Axis	X
Test Mode:	TX VHT-20M Mode 2412 MHz

Horizontal

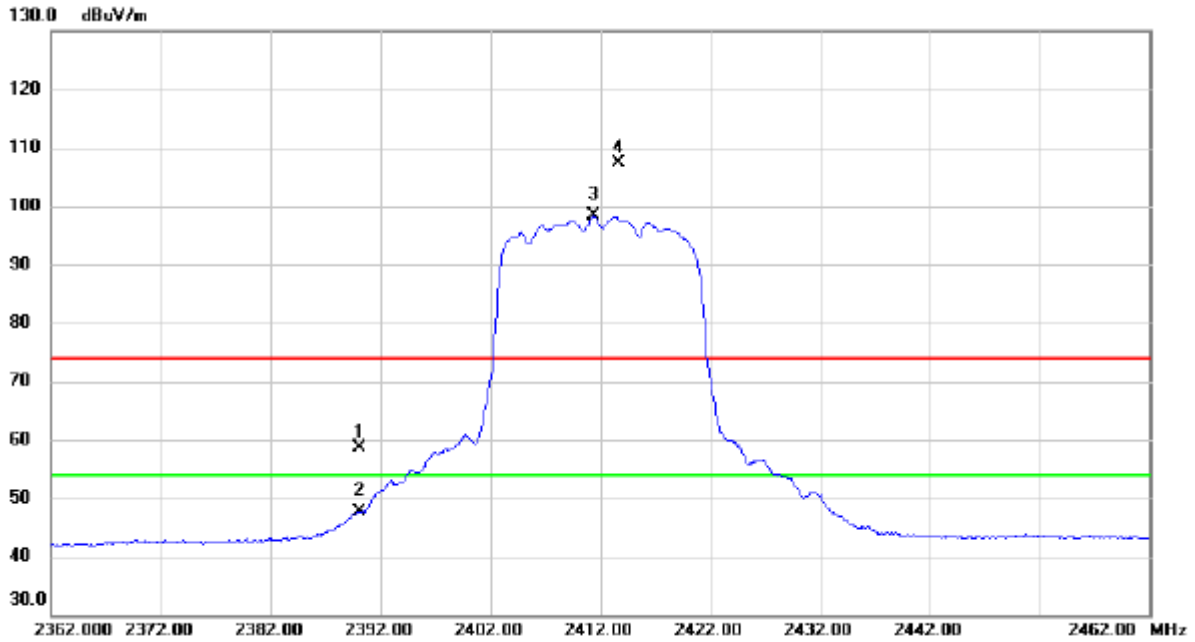

No.	Mk.	Freq. MHz	Reading Level dBuV	Correct Factor dB	Measure- ment dBuV/m	Limit dBuV/m	Margin dB	Detector	Comment
1		2390.000	51.90	6.62	58.52	74.00	-15.48	peak	
2		2390.000	40.98	6.62	47.60	54.00	-6.40	AVG	
3	*	2411.400	91.67	6.62	98.29	54.00	44.29	AVG	No Limit
4	X	2413.700	100.76	6.62	107.38	74.00	33.38	peak	No Limit

Orthogonal Axis	X
Test Mode:	TX VHT-20M Mode 2412 MHz

Horizontal

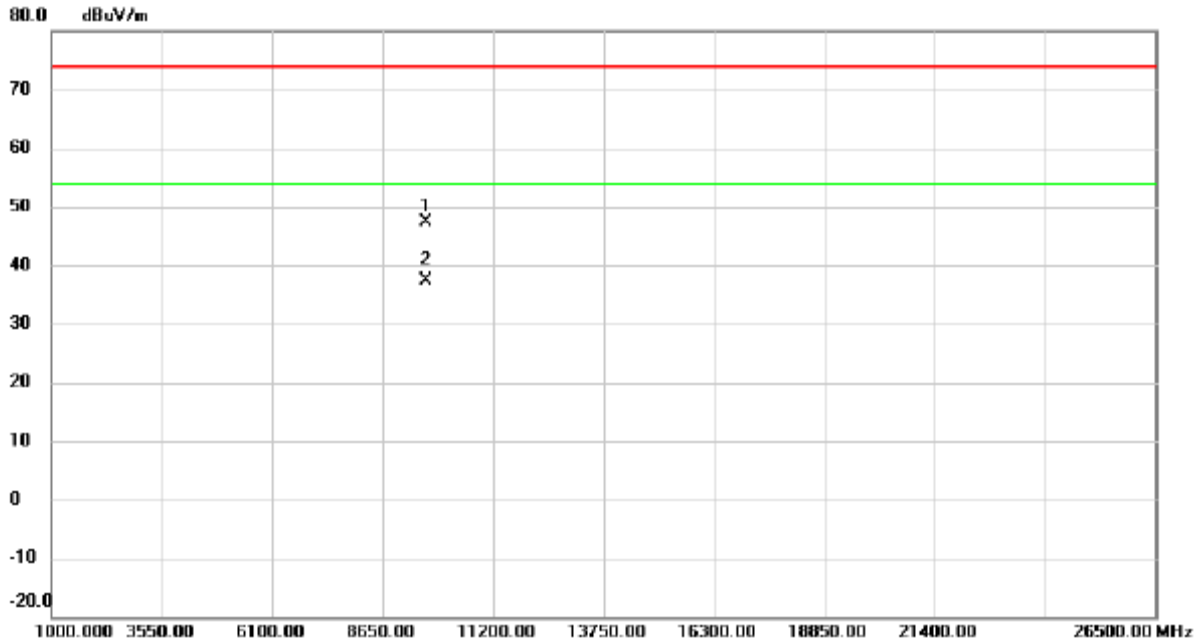

No. Mk.	Freq. MHz	Reading Level dBuV	Correct Factor dB	Measure- ment dBuV/m	Limit dBuV/m	Margin dB	Detector	Comment
1	9647.461	36.42	11.03	47.45	74.00	-26.55	peak	
2 *	9647.982	26.43	11.03	37.46	54.00	-16.54	AVG	

Orthogonal Axis	X
Test Mode:	TX VHT-20M Mode 2417 MHz

Vertical

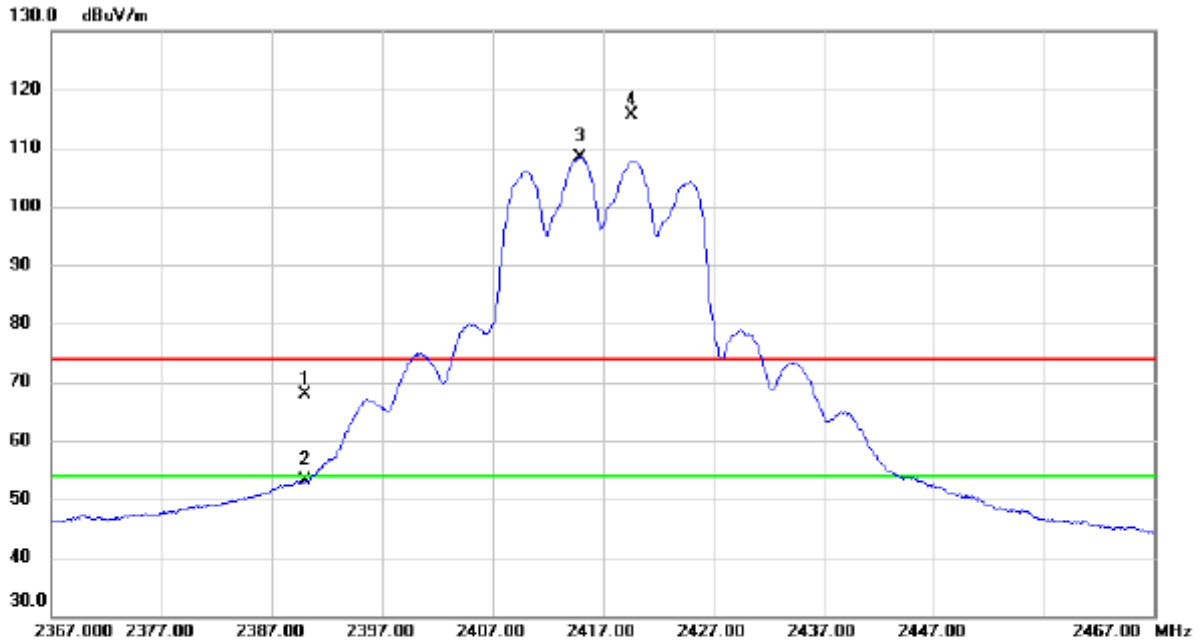

No.	Mk.	Freq. MHz	Reading Level dBuV	Correct Factor dB	Measure- ment dBuV/m	Limit dBuV/m	Margin dB	Detector	Comment
1		2390.000	61.25	6.62	67.87	74.00	-6.13	peak	
2		2390.000	46.47	6.62	53.09	54.00	-0.91	AVG	
3	*	2414.950	101.78	6.62	108.40	54.00	54.40	AVG	No Limit
4	X	2419.600	109.07	6.62	115.69	74.00	41.69	peak	No Limit

Orthogonal Axis	X
Test Mode:	TX VHT-20M Mode 2417 MHz

Vertical

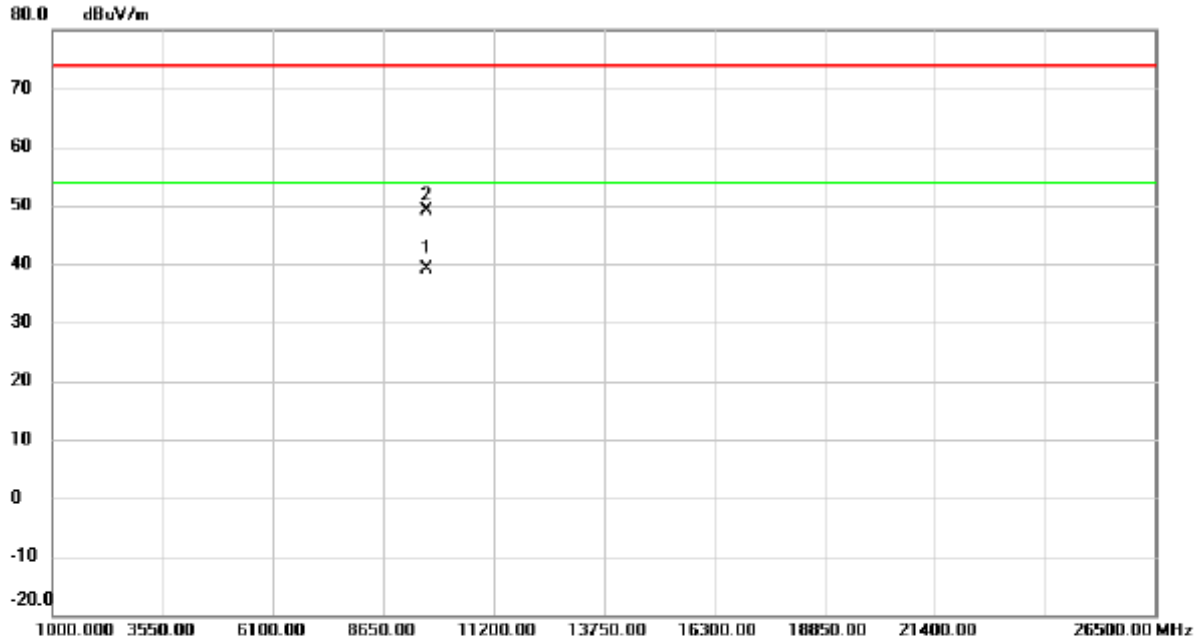

No.	Mk.	Freq. MHz	Reading Level dBuV	Correct Factor dB	Measure- ment dBuV/m	Limit dBuV/m	Margin dB	Detector	Comment
1	*	9667.983	28.05	11.03	39.08	54.00	-14.92	AVG	
2		9668.053	38.12	11.03	49.15	74.00	-24.85	peak	

Orthogonal Axis	X
Test Mode:	TX VHT-20M Mode 2417 MHz

Horizontal

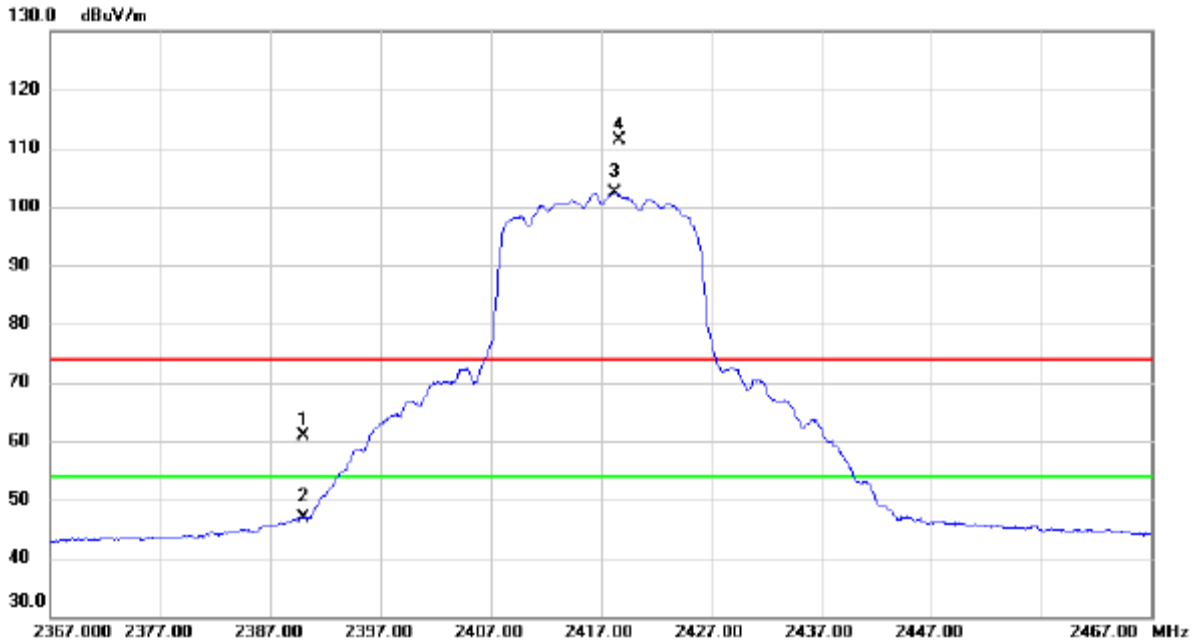

No.	Mk.	Freq. MHz	Reading Level dBuV	Correct Factor dB	Measure- ment dBuV/m	Limit dBuV/m	Margin dB	Detector	Comment
1		2390.000	54.19	6.62	60.81	74.00	-13.19	peak	
2		2390.000	40.29	6.62	46.91	54.00	-7.09	AVG	
3	*	2418.300	95.81	6.61	102.42	54.00	48.42	AVG	No Limit
4	X	2418.700	104.68	6.61	111.29	74.00	37.29	peak	No Limit

Orthogonal Axis	X
Test Mode:	TX VHT-20M Mode 2417 MHz

Horizontal

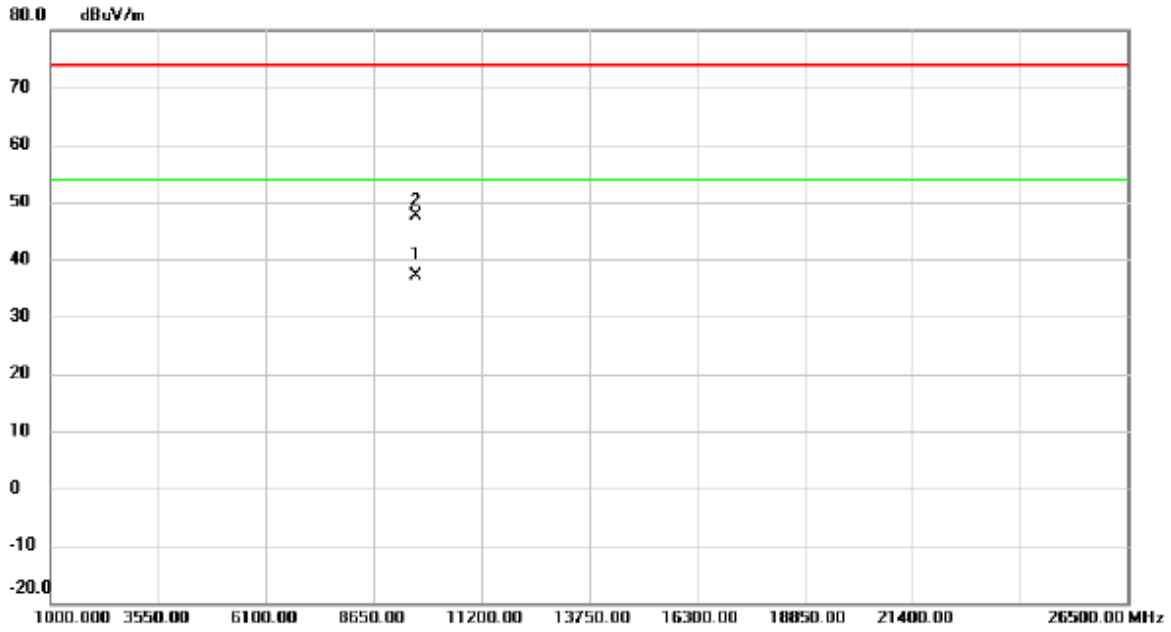

No.	Mk.	Freq. MHz	Reading Level dBuV	Correct Factor dB	Measure- ment dBuV/m	Limit dBuV/m	Margin dB	Detector	Comment
1	*	9668.017	26.19	11.03	37.22	54.00	-16.78	AVG	
2		9668.454	36.52	11.03	47.55	74.00	-26.45	peak	

Orthogonal Axis	X
Test Mode:	TX VHT-20M Mode 2437 MHz

Vertical

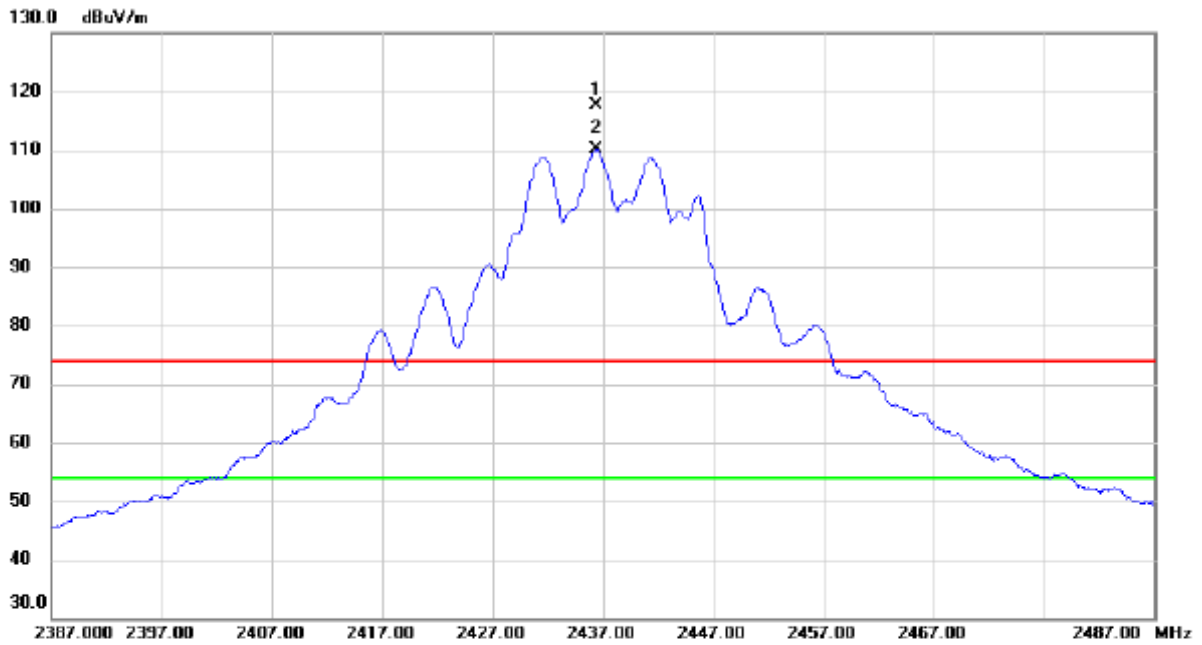

No.	Mk.	Freq. MHz	Reading Level dBuV	Correct Factor dB	Measure- ment dBuV/m	Limit dBuV/m	Margin dB	Detector	Comment
1	X	2436.350	111.04	6.62	117.66	74.00	43.66	peak	No Limit
2	*	2436.400	103.44	6.62	110.06	54.00	56.06	AVG	No Limit

Orthogonal Axis	X
Test Mode:	TX VHT-20M Mode 2437 MHz

Vertical

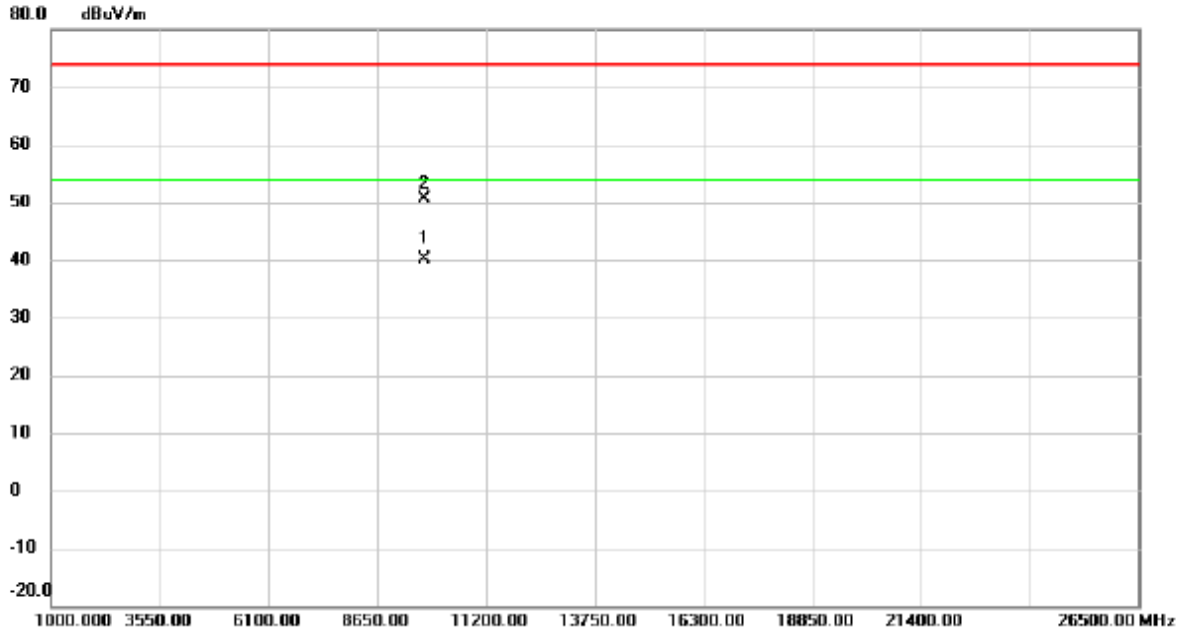

No.	Mk.	Freq. MHz	Reading Level dBuV	Correct Factor dB	Measure- ment dBuV/m	Limit dBuV/m	Margin dB	Detector	Comment
1	*	9748.015	29.20	11.04	40.24	54.00	-13.76	AVG	
2		9748.811	39.48	11.04	50.52	74.00	-23.48	peak	

Orthogonal Axis	X
Test Mode:	TX VHT-20M Mode 2437 MHz

Horizontal

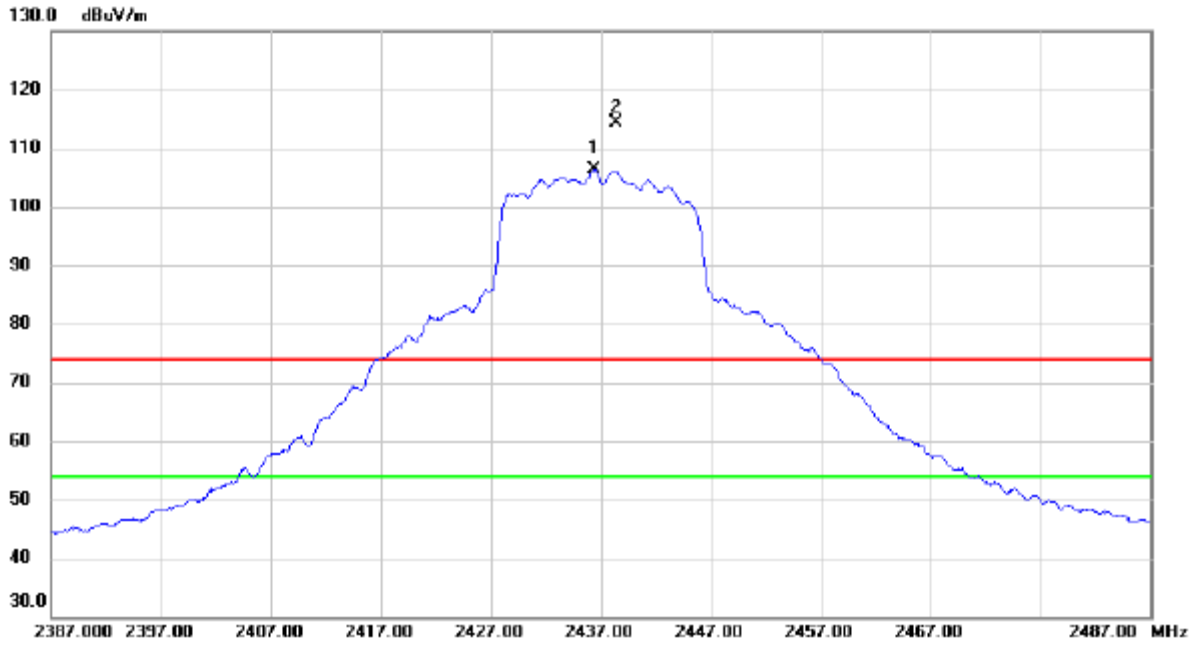

No.	Mk.	Freq. MHz	Reading Level dBuV	Correct Factor dB	Measure- ment dBuV/m	Limit dBuV/m	Margin dB	Detector	Comment
1	*	2436.400	99.70	6.62	106.32	54.00	52.32	AVG	No Limit
2	X	2438.400	107.67	6.62	114.29	74.00	40.29	peak	No Limit

Orthogonal Axis	X
Test Mode:	TX VHT-20M Mode 2437 MHz

Horizontal

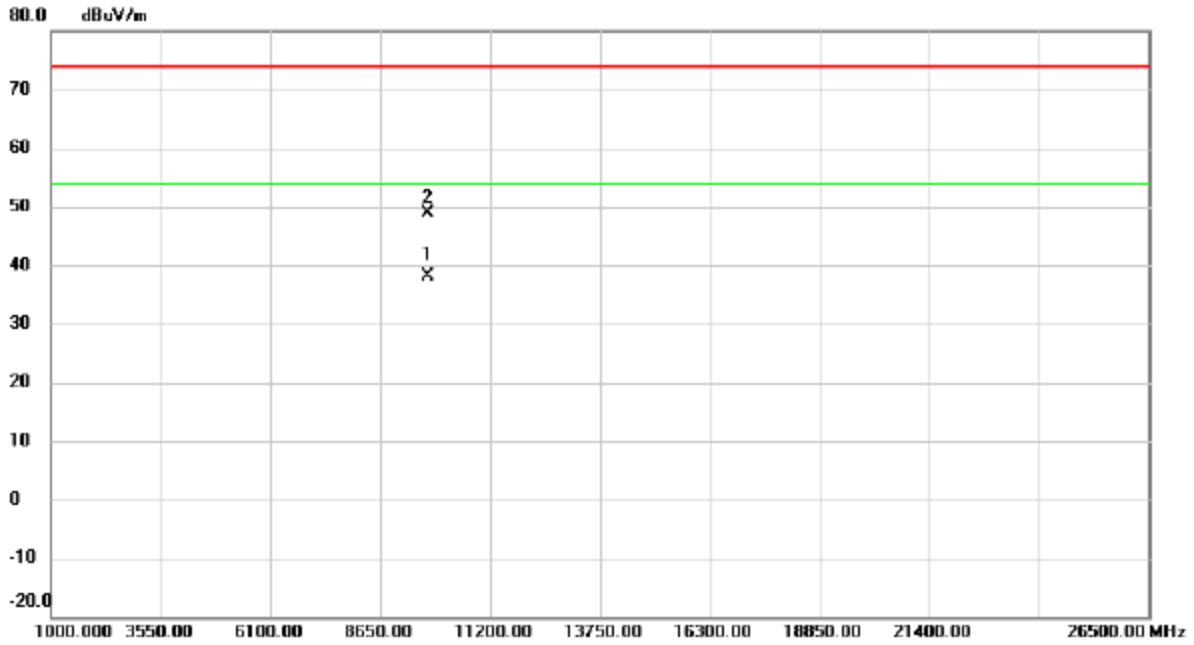

No.	Mk.	Freq. MHz	Reading Level dBuV	Correct Factor dB	Measure- ment dBuV/m	Limit dBuV/m	Margin dB	Detector	Comment
1	*	9748.023	27.02	11.04	38.06	54.00	-15.94	AVG	
2		9748.994	37.72	11.04	48.76	74.00	-25.24	peak	

Orthogonal Axis	X
Test Mode:	TX VHT-20M Mode 2457 MHz

Vertical

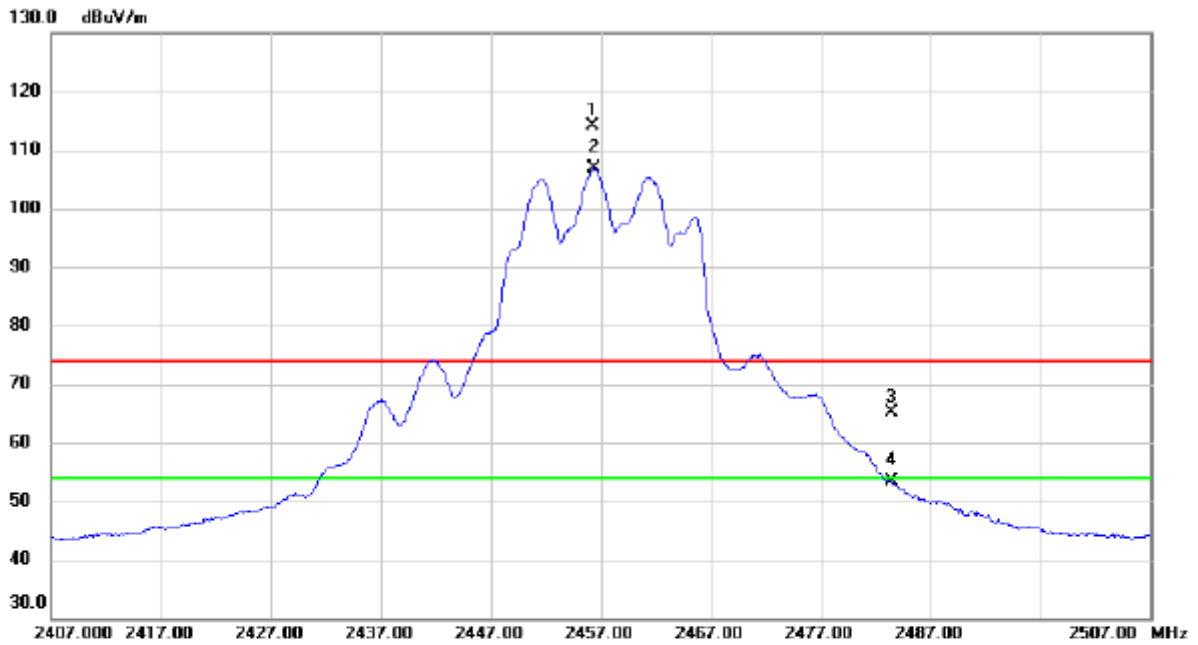

No.	Mk.	Freq. MHz	Reading Level dBuV	Correct Factor dB	Measure- ment dBuV/m	Limit dBuV/m	Margin dB	Detector	Comment
1	X	2456.250	107.47	6.61	114.08	74.00	40.08	peak	No Limit
2	*	2456.450	100.17	6.62	106.79	54.00	52.79	AVG	No Limit
3		2483.500	58.59	6.61	65.20	74.00	-8.80	peak	
4		2483.500	46.65	6.61	53.26	54.00	-0.74	AVG	

Orthogonal Axis	X
Test Mode:	TX VHT-20M Mode 2457 MHz

Vertical

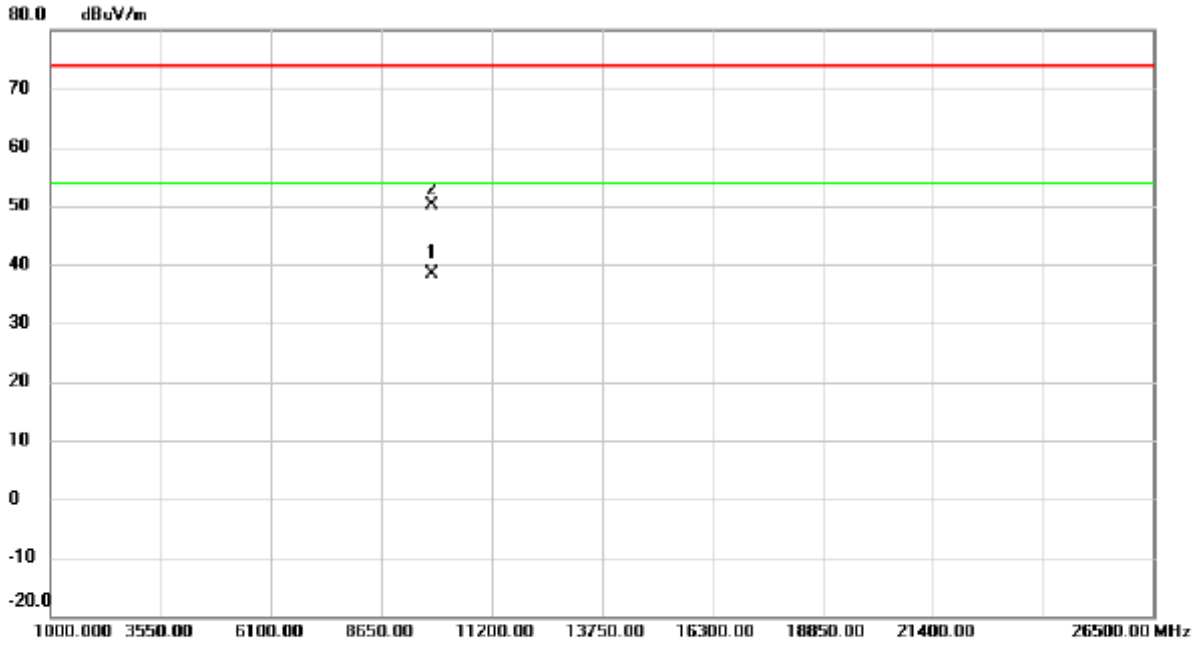

No.	Mk.	Freq. MHz	Reading Level dBuV	Correct Factor dB	Measure- ment dBuV/m	Limit dBuV/m	Margin dB	Detector	Comment
1	*	9827.897	27.31	11.06	38.37	54.00	-15.63	AVG	
2		9827.937	39.15	11.06	50.21	74.00	-23.79	peak	

Orthogonal Axis	X
Test Mode:	TX VHT-20M Mode 2457 MHz

Horizontal

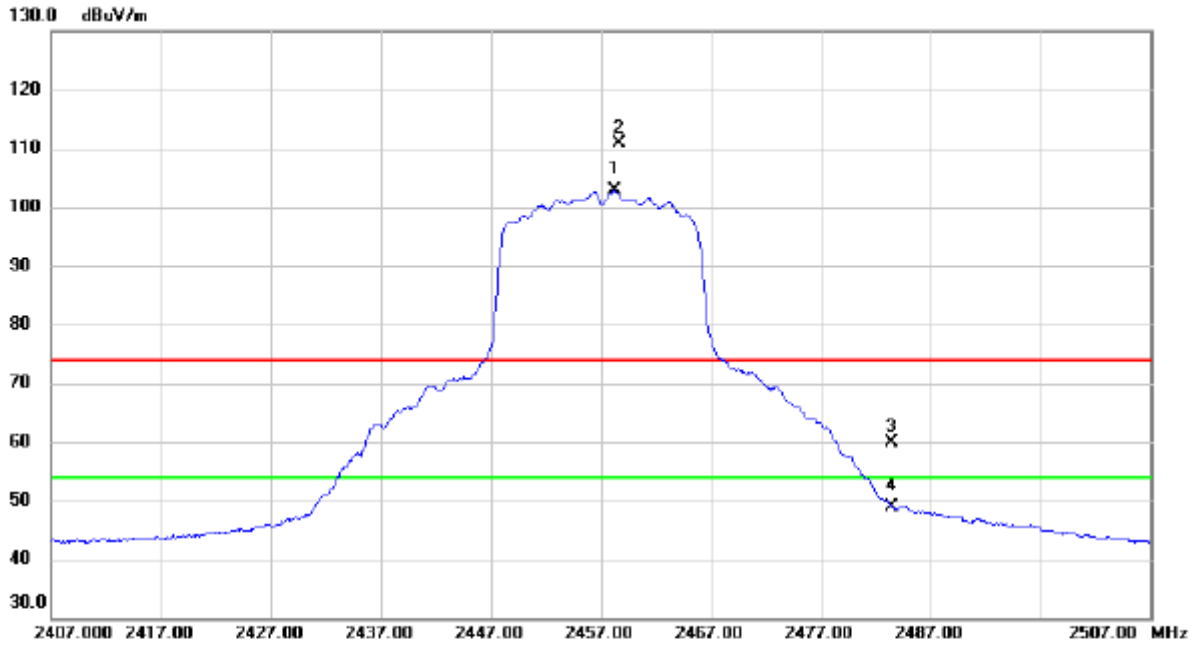

No.	Mk.	Freq. MHz	Reading Level dBuV	Correct Factor dB	Measure- ment dBuV/m	Limit dBuV/m	Margin dB	Detector	Comment
1	*	2458.300	96.14	6.62	102.76	54.00	48.76	AVG	No Limit
2	X	2458.700	104.22	6.62	110.84	74.00	36.84	peak	No Limit
3		2483.500	53.29	6.61	59.90	74.00	-14.10	peak	
4		2483.500	42.31	6.61	48.92	54.00	-5.08	AVG	

Orthogonal Axis	X
Test Mode:	TX VHT-20M Mode 2457 MHz

Horizontal

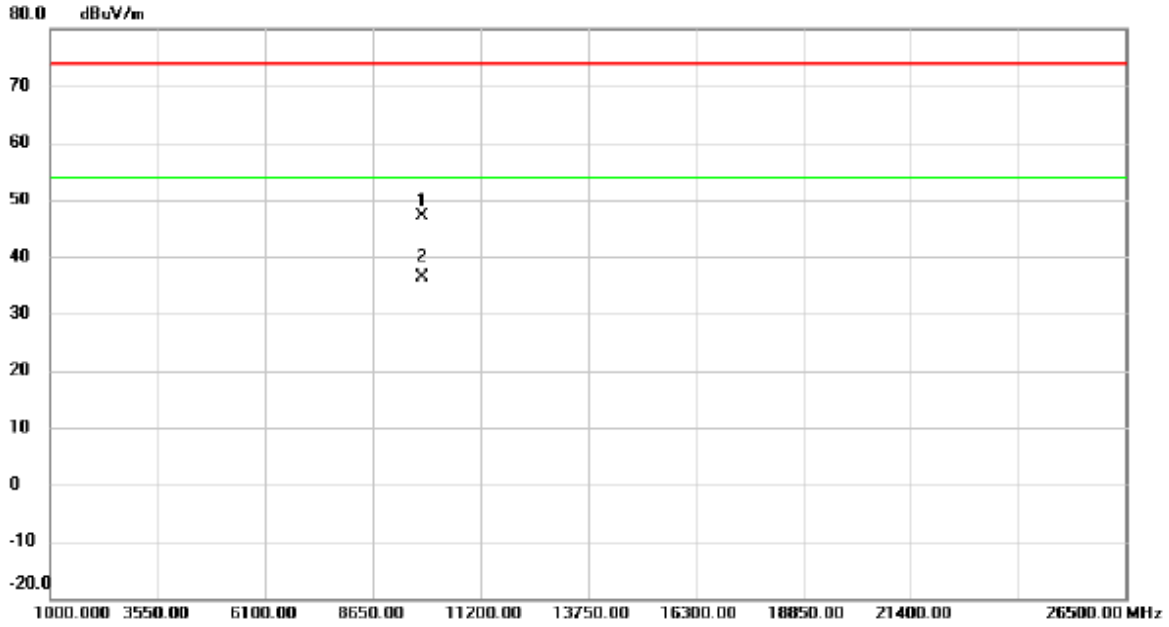

No.	Mk.	Freq. MHz	Reading Level dBuV	Correct Factor dB	Measure- ment dBuV/m	Limit dBuV/m	Margin dB	Detector	Comment
1		9827.172	36.14	11.06	47.20	74.00	-26.80	peak	
2	*	9828.593	25.23	11.06	36.29	54.00	-17.71	AVG	

Orthogonal Axis	X
Test Mode:	TX VHT-20M Mode 2462 MHz

Vertical

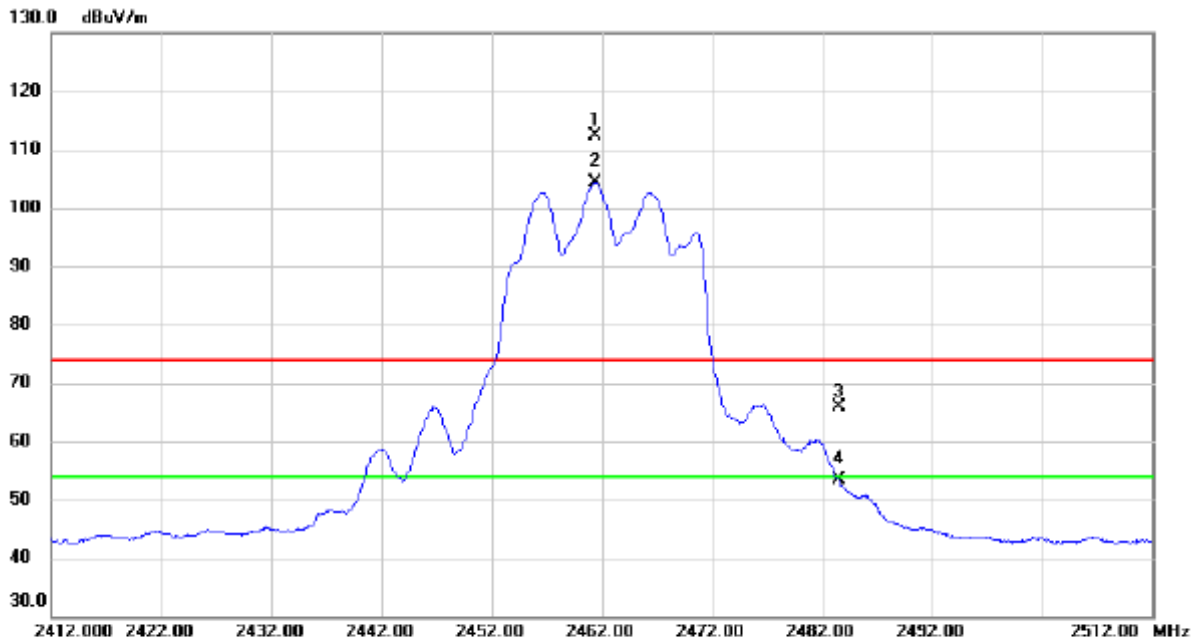

No.	Mk.	Freq. MHz	Reading Level dBuV	Correct Factor dB	Measure- ment dBuV/m	Limit dBuV/m	Margin dB	Detector	Comment
1	X	2461.400	105.89	6.61	112.50	74.00	38.50	peak	No Limit
2	*	2461.450	97.88	6.61	104.49	54.00	50.49	AVG	No Limit
3		2483.500	59.35	6.61	65.96	74.00	-8.04	peak	
4		2483.500	46.68	6.61	53.29	54.00	-0.71	AVG	

Orthogonal Axis	X
Test Mode:	TX VHT-20M Mode 2462 MHz

Vertical

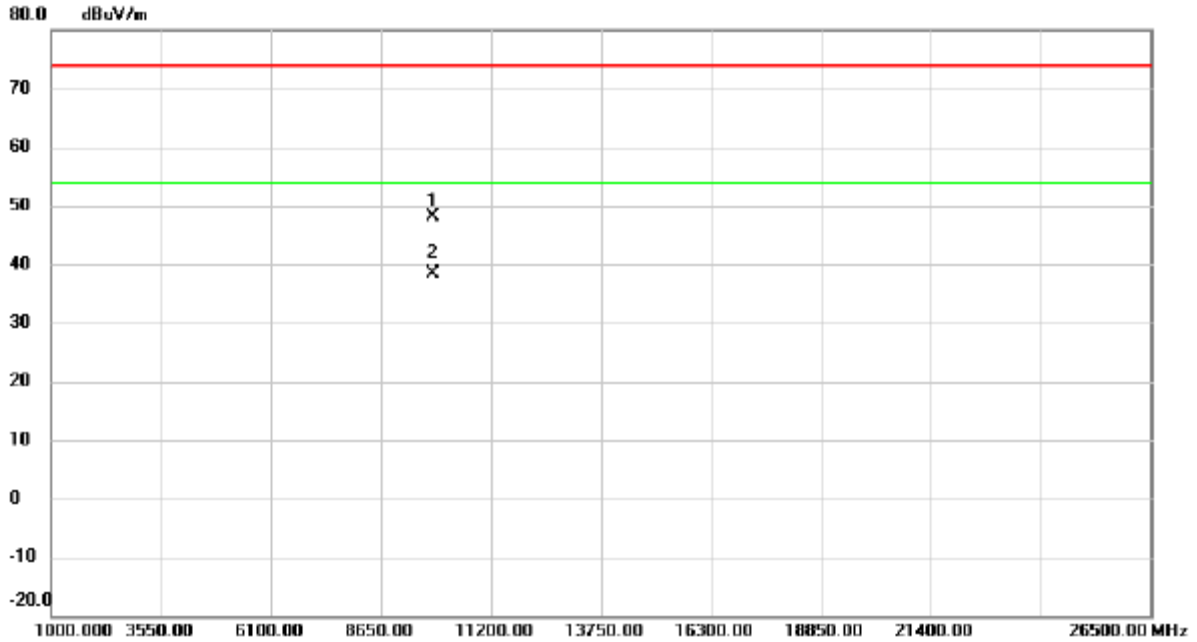

No.	Mk.	Freq. MHz	Reading Level dBuV	Correct Factor dB	Measure- ment dBuV/m	Limit dBuV/m	Margin dB	Detector	Comment
1		9847.669	37.18	11.07	48.25	74.00	-25.75	peak	
2	*	9847.988	27.43	11.07	38.50	54.00	-15.50	AVG	

Orthogonal Axis	X
Test Mode:	TX VHT-20M Mode 2462 MHz

Horizontal

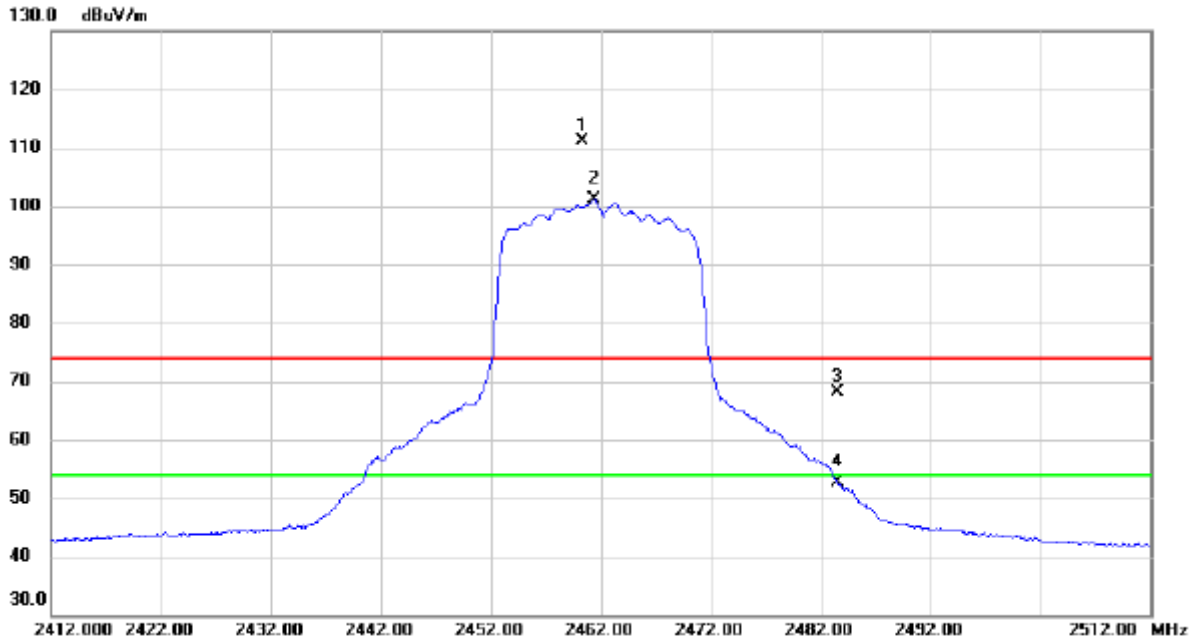

No.	Mk.	Freq. MHz	Reading Level dBuV	Correct Factor dB	Measure- ment dBuV/m	Limit dBuV/m	Margin dB	Detector	Comment
1	X	2460.350	104.51	6.62	111.13	74.00	37.13	peak	No Limit
2	*	2461.400	94.44	6.61	101.05	54.00	47.05	AVG	No Limit
3		2483.500	61.50	6.61	68.11	74.00	-5.89	peak	
4		2483.500	45.95	6.61	52.56	54.00	-1.44	AVG	

Orthogonal Axis	X
Test Mode:	TX VHT-20M Mode 2462 MHz

Horizontal

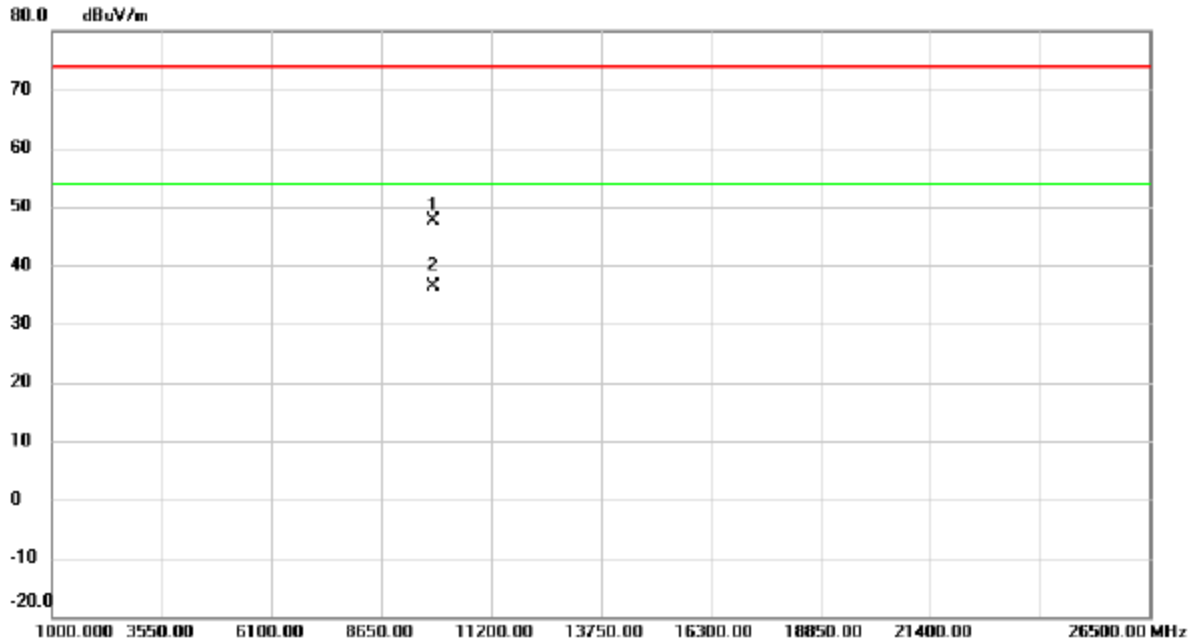

No.	Mk.	Freq.	Reading Level	Correct Factor	Measurement	Limit	Margin	Detector	Comment
		MHz	dBuV	dB	dBuV/m	dBuV/m	dB		
1		9848.149	36.63	11.07	47.70	74.00	-26.30	peak	
2	*	9848.199	25.34	11.07	36.41	54.00	-17.59	AVG	

Orthogonal Axis	X
Test Mode:	TX VHT-40M Mode 2422MHz

Vertical

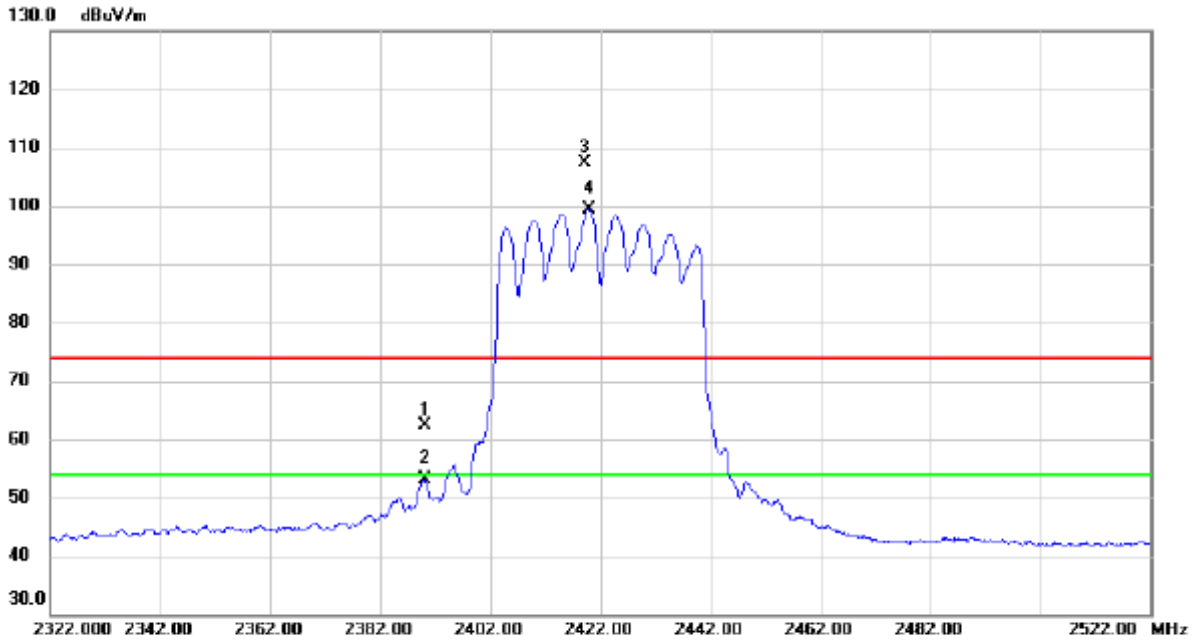

No.	Mk.	Freq. MHz	Reading Level dBuV	Correct Factor dB	Measure- ment dBuV/m	Limit dBuV/m	Margin dB	Detector	Comment
1		2390.000	55.82	6.62	62.44	74.00	-11.56	peak	
2		2390.000	46.62	6.62	53.24	54.00	-0.76	AVG	
3	X	2419.200	100.77	6.62	107.39	74.00	33.39	peak	No Limit
4	*	2419.900	92.69	6.62	99.31	54.00	45.31	AVG	No Limit

Orthogonal Axis	X
Test Mode:	TX VHT-40M Mode 2422MHz

Vertical

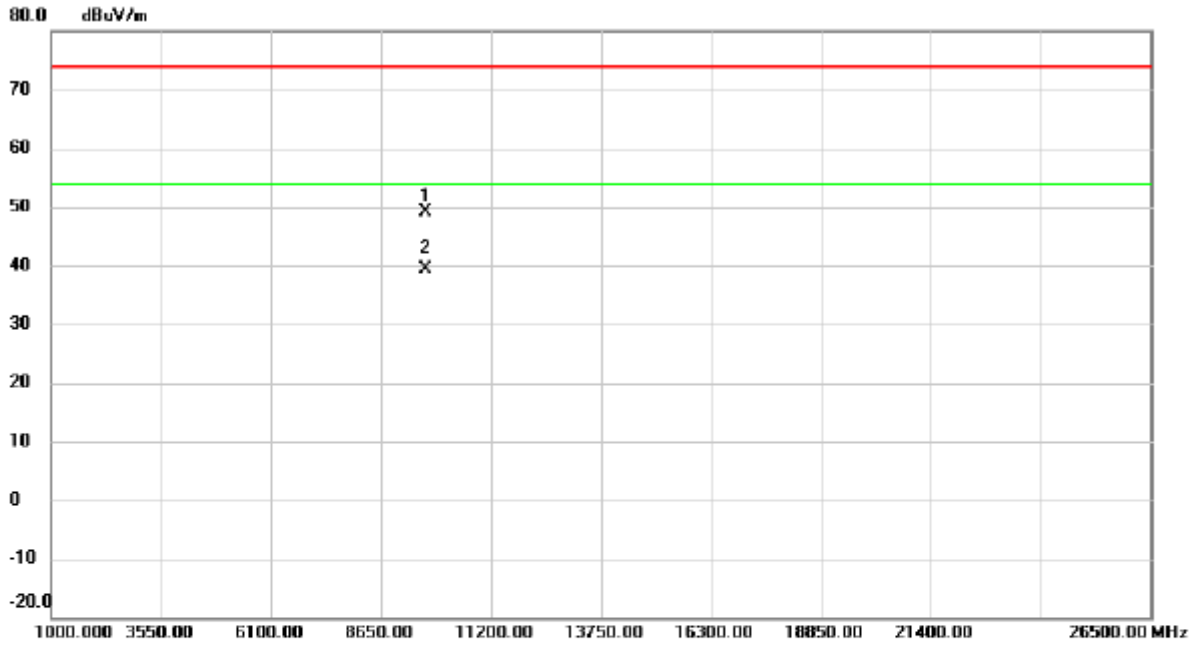

No.	Mk.	Freq. MHz	Reading Level dBuV	Correct Factor dB	Measure- ment dBuV/m	Limit dBuV/m	Margin dB	Detector	Comment
1		9687.716	38.15	11.04	49.19	74.00	-24.81	peak	
2	*	9687.917	28.26	11.04	39.30	54.00	-14.70	AVG	

Orthogonal Axis	X
Test Mode:	TX VHT-40M Mode 2422MHz

Horizontal

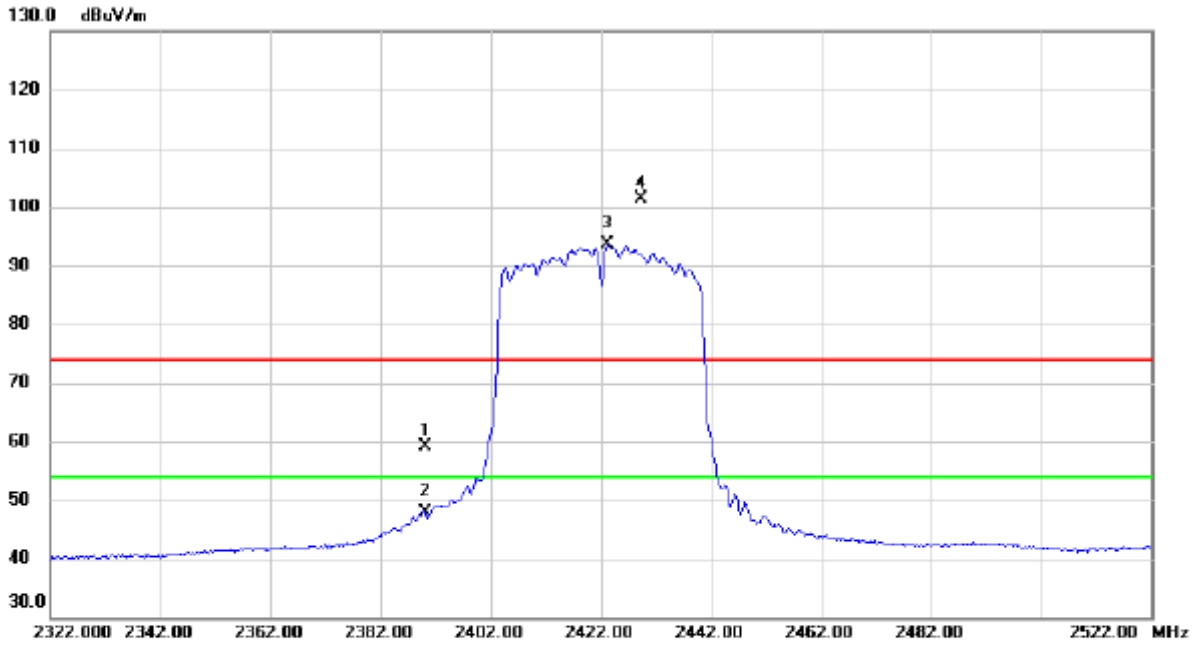

No.	Mk.	Freq. MHz	Reading Level dBuV	Correct Factor dB	Measure- ment dBuV/m	Limit dBuV/m	Margin dB	Detector	Comment
1		2390.000	52.61	6.62	59.23	74.00	-14.77	peak	
2		2390.000	41.33	6.62	47.95	54.00	-6.05	AVG	
3	*	2423.300	87.11	6.62	93.73	54.00	39.73	AVG	No Limit
4	X	2429.300	94.87	6.61	101.48	74.00	27.48	peak	No Limit

Orthogonal Axis	X
Test Mode:	TX VHT-40M Mode 2422MHz

Horizontal

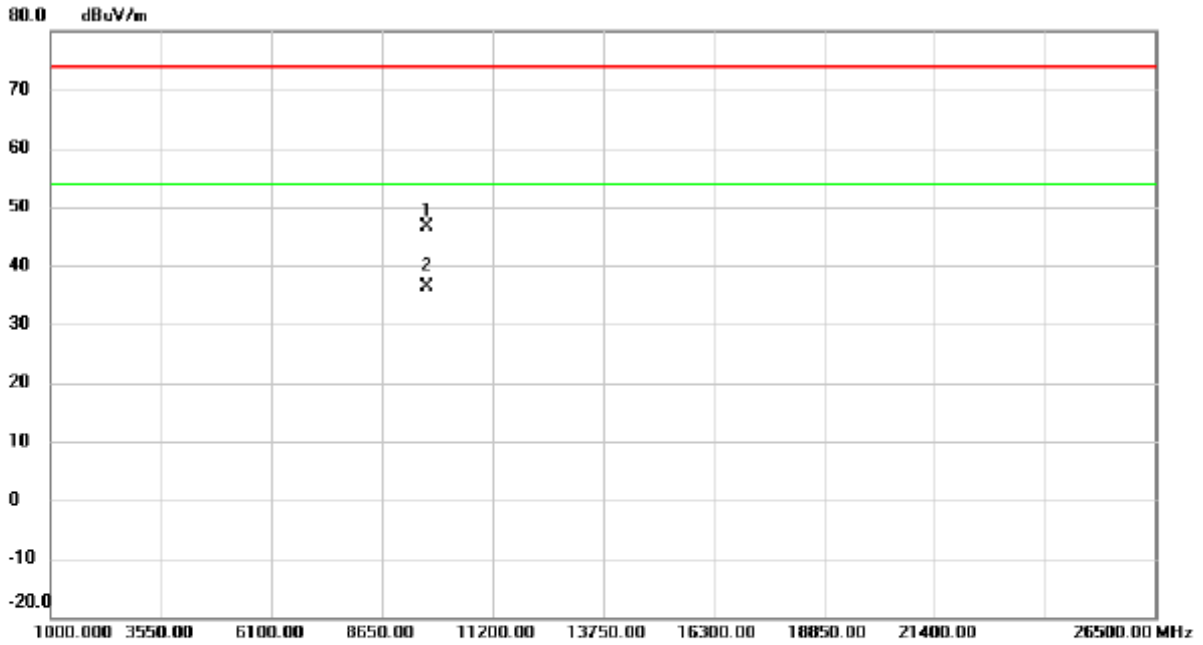

No.	Mk.	Freq. MHz	Reading Level dBuV	Correct Factor dB	Measure- ment dBuV/m	Limit dBuV/m	Margin dB	Detector	Comment
1		9688.560	35.49	11.04	46.53	74.00	-27.47	peak	
2	*	9688.888	25.35	11.04	36.39	54.00	-17.61	AVG	

Orthogonal Axis	X
Test Mode:	TX VHT-40M Mode 2427MHz

Vertical

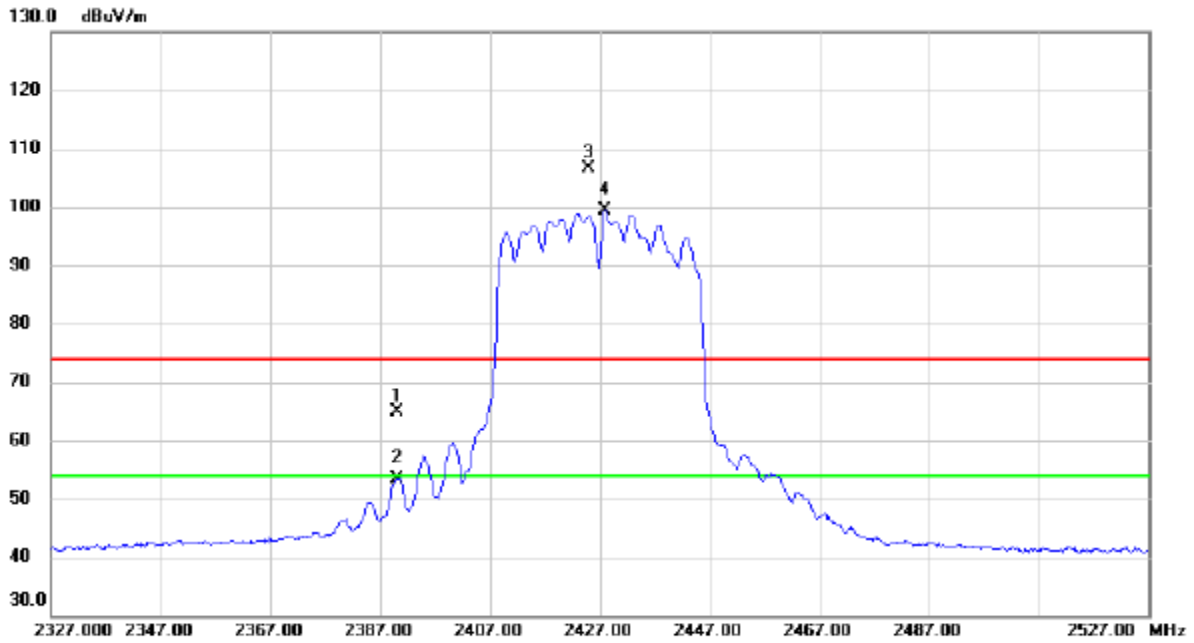

No.	Mk.	Freq. MHz	Reading Level dBuV	Correct Factor dB	Measure- ment dBuV/m	Limit dBuV/m	Margin dB	Detector	Comment
1		2390.000	58.24	6.62	64.86	74.00	-9.14	peak	
2		2390.000	46.86	6.62	53.48	54.00	-0.52	AVG	
3	X	2425.100	99.93	6.61	106.54	74.00	32.54	peak	No Limit
4	*	2428.000	92.89	6.61	99.50	54.00	45.50	AVG	No Limit

Orthogonal Axis	X
Test Mode:	TX VHT-40M Mode 2427MHz

Vertical

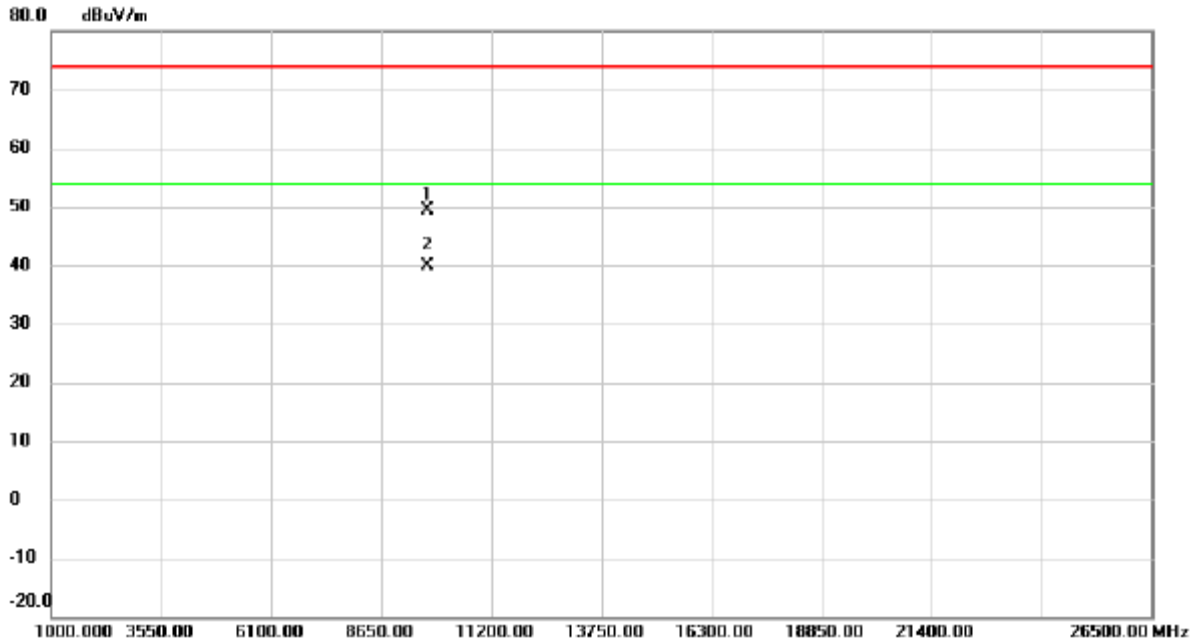

No.	Mk.	Freq. MHz	Reading Level dBuV	Correct Factor dB	Measure- ment dBuV/m	Limit dBuV/m	Margin dB	Detector	Comment
1		9707.604	38.30	11.04	49.34	74.00	-24.66	peak	
2	*	9708.005	28.80	11.04	39.84	54.00	-14.16	AVG	

Orthogonal Axis	X
Test Mode:	TX VHT-40M Mode 2427MHz

Horizontal

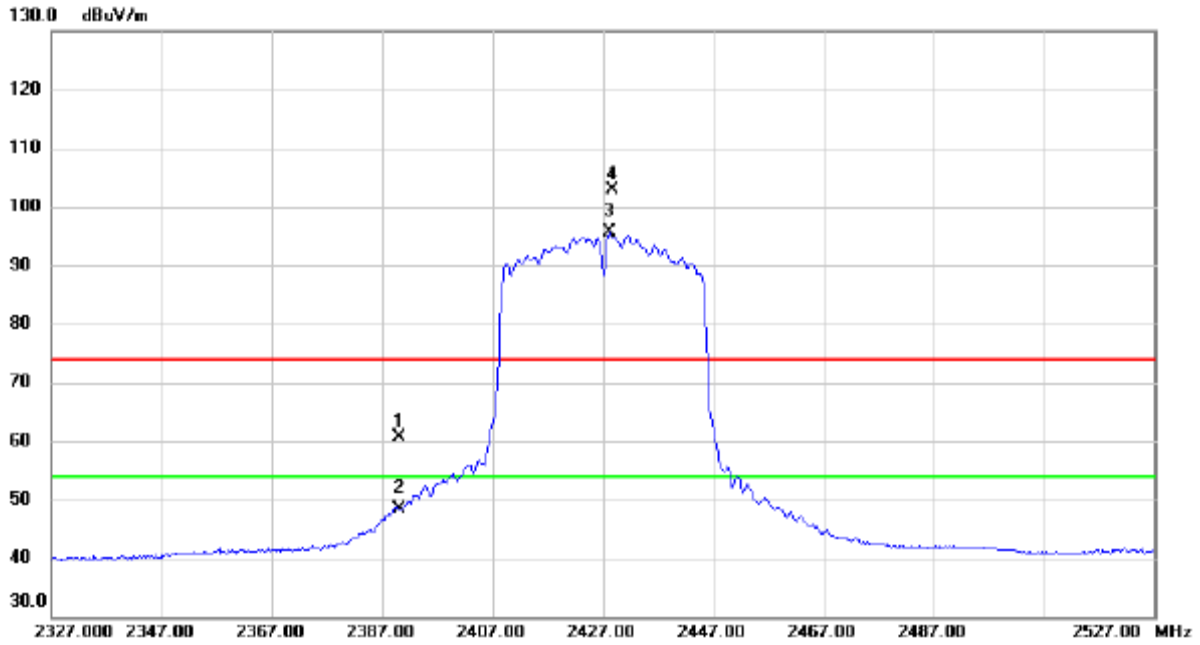

No.	Mk.	Freq. MHz	Reading Level dBuV	Correct Factor dB	Measure- ment dBuV/m	Limit dBuV/m	Margin dB	Detector	Comment
1		2390.000	53.93	6.62	60.55	74.00	-13.45	peak	
2		2390.000	41.69	6.62	48.31	54.00	-5.69	AVG	
3	*	2428.300	88.99	6.61	95.60	54.00	41.60	AVG	No Limit
4	X	2428.700	96.25	6.61	102.86	74.00	28.86	peak	No Limit

Orthogonal Axis	X
Test Mode:	TX VHT-40M Mode 2427MHz

Horizontal

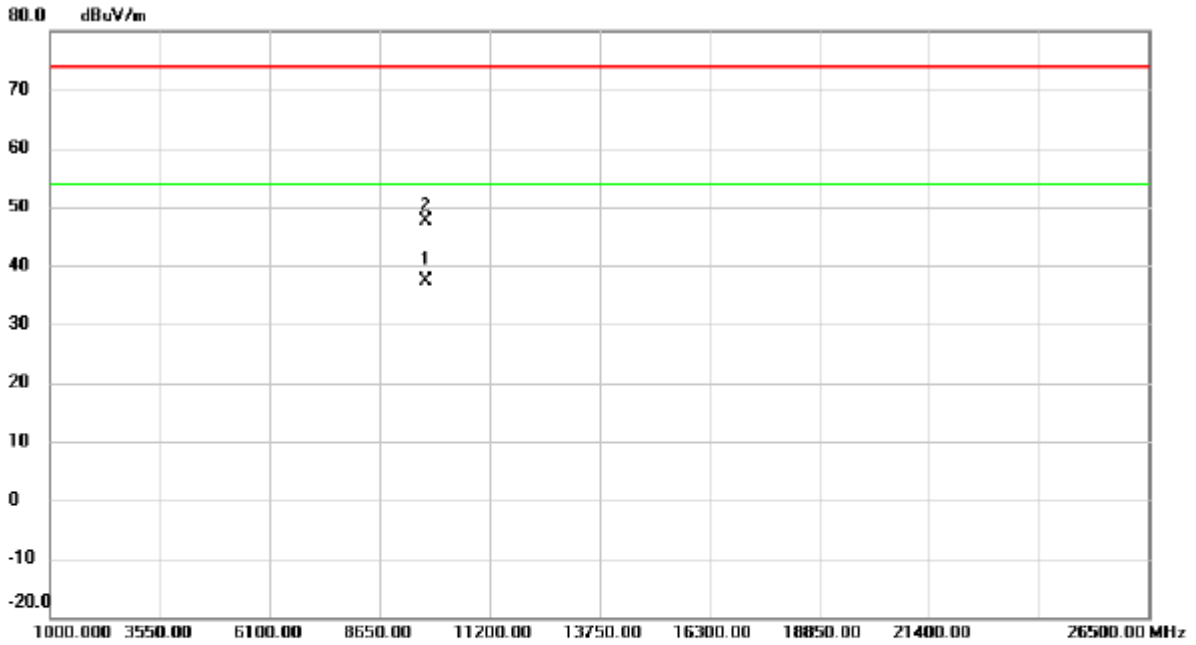

No.	Mk.	Freq.	Reading Level	Correct Factor	Measurement	Limit	Margin	Detector	Comment
		MHz	dBuV	dB	dBuV/m	dBuV/m	dB		
1	*	9707.962	26.36	11.04	37.40	54.00	-16.60	AVG	
2		9708.757	36.54	11.04	47.58	74.00	-26.42	peak	

Orthogonal Axis	X
Test Mode:	TX VHT-40M Mode 2437 MHz

Vertical

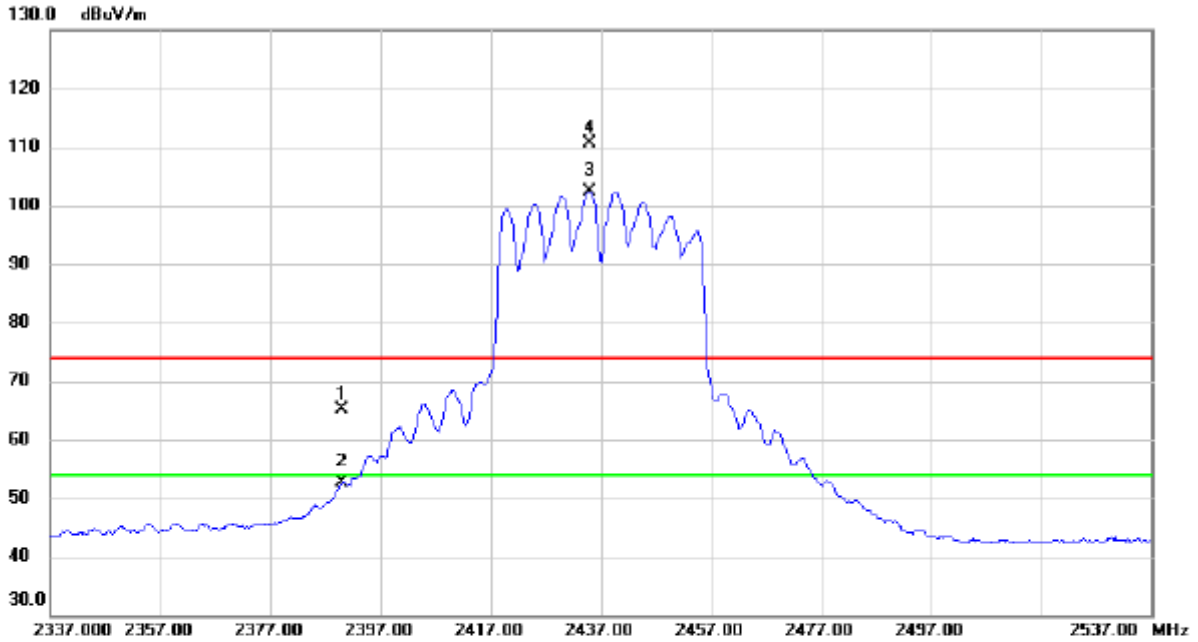

No.	Mk.	Freq. MHz	Reading Level dBuV	Correct Factor dB	Measure- ment dBuV/m	Limit dBuV/m	Margin dB	Detector	Comment
1		2390.000	58.54	6.62	65.16	74.00	-8.84	peak	
2		2390.000	45.92	6.62	52.54	54.00	-1.46	AVG	
3	*	2434.900	95.82	6.62	102.44	54.00	48.44	AVG	No Limit
4	X	2435.100	103.92	6.62	110.54	74.00	36.54	peak	No Limit

Orthogonal Axis	X
Test Mode:	TX VHT-40M Mode 2437 MHz

Vertical

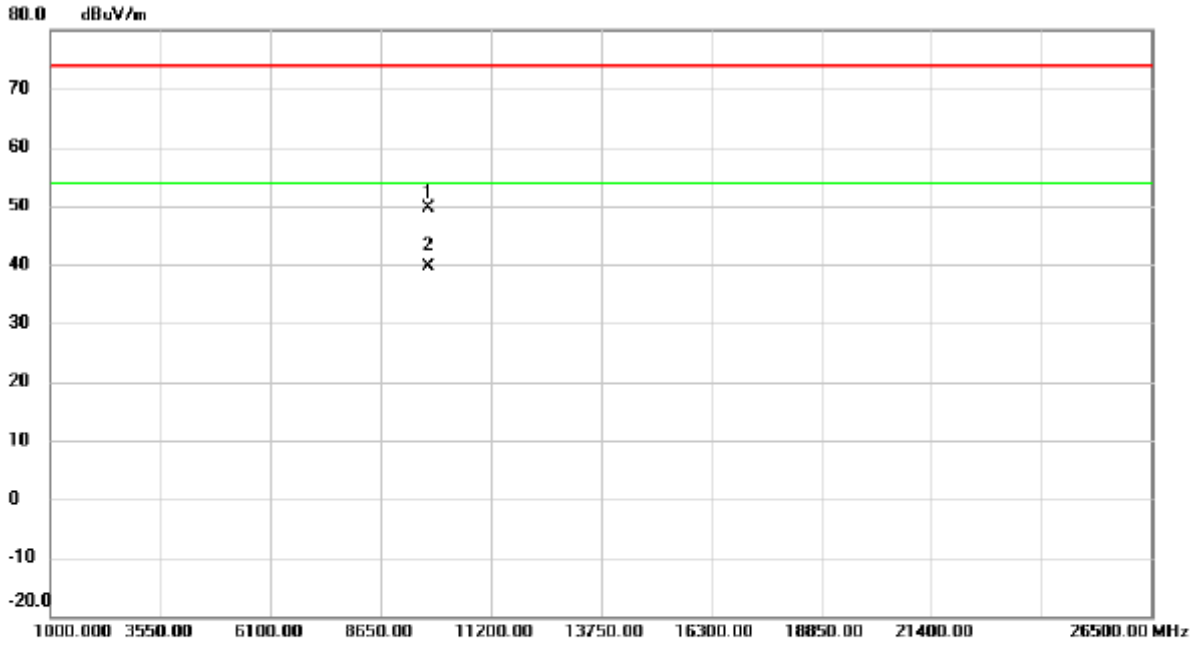

No.	Mk.	Freq. MHz	Reading Level dBuV	Correct Factor dB	Measure- ment dBuV/m	Limit dBuV/m	Margin dB	Detector	Comment
1		9747.824	38.70	11.04	49.74	74.00	-24.26	peak	
2	*	9747.864	28.60	11.04	39.64	54.00	-14.36	AVG	

Orthogonal Axis	X
Test Mode:	TX VHT-40M Mode 2437 MHz

Horizontal

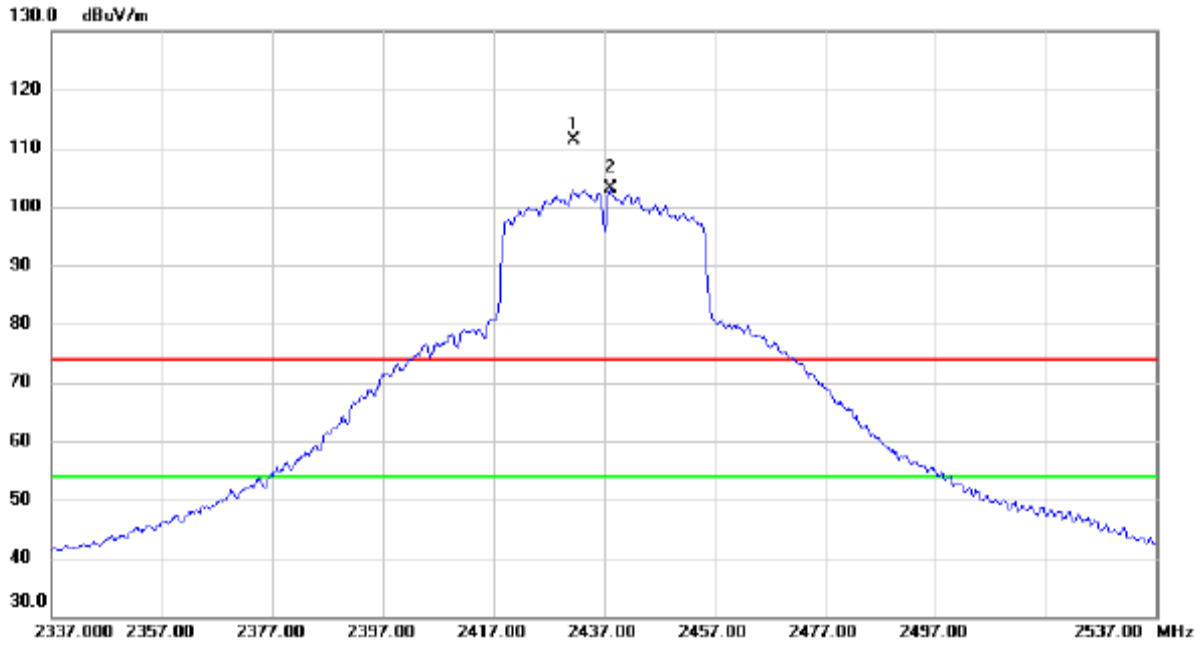

No.	Mk.	Freq. MHz	Reading Level dBuV	Correct Factor dB	Measure- ment dBuV/m	Limit dBuV/m	Margin dB	Detector	Comment
1	X	2431.500	104.72	6.62	111.34	74.00	37.34	peak	No Limit
2	*	2438.300	96.51	6.62	103.13	54.00	49.13	AVG	No Limit

Orthogonal Axis	X
Test Mode:	TX VHT-40M Mode 2437 MHz

Horizontal

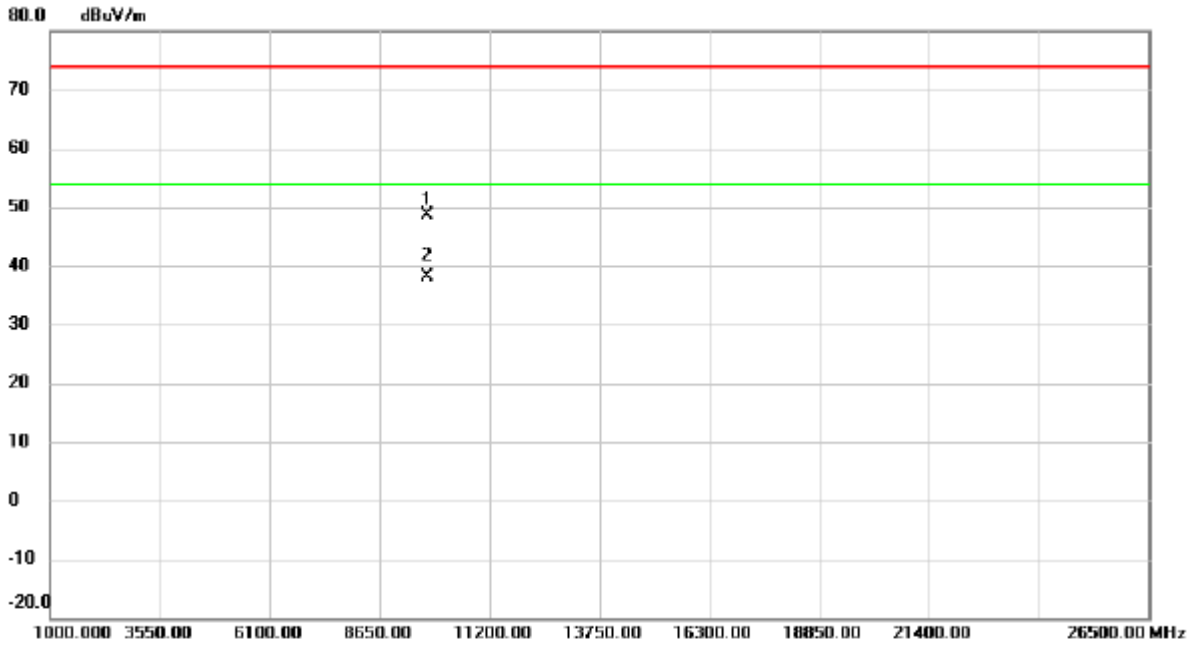

No.	Mk.	Freq. MHz	Reading Level dBuV	Correct Factor dB	Measure- ment dBuV/m	Limit dBuV/m	Margin dB	Detector	Comment
1		9747.671	37.64	11.04	48.68	74.00	-25.32	peak	
2	*	9747.993	27.14	11.04	38.18	54.00	-15.82	AVG	

Orthogonal Axis	X
Test Mode:	TX VHT-40M Mode 2447MHz

Vertical

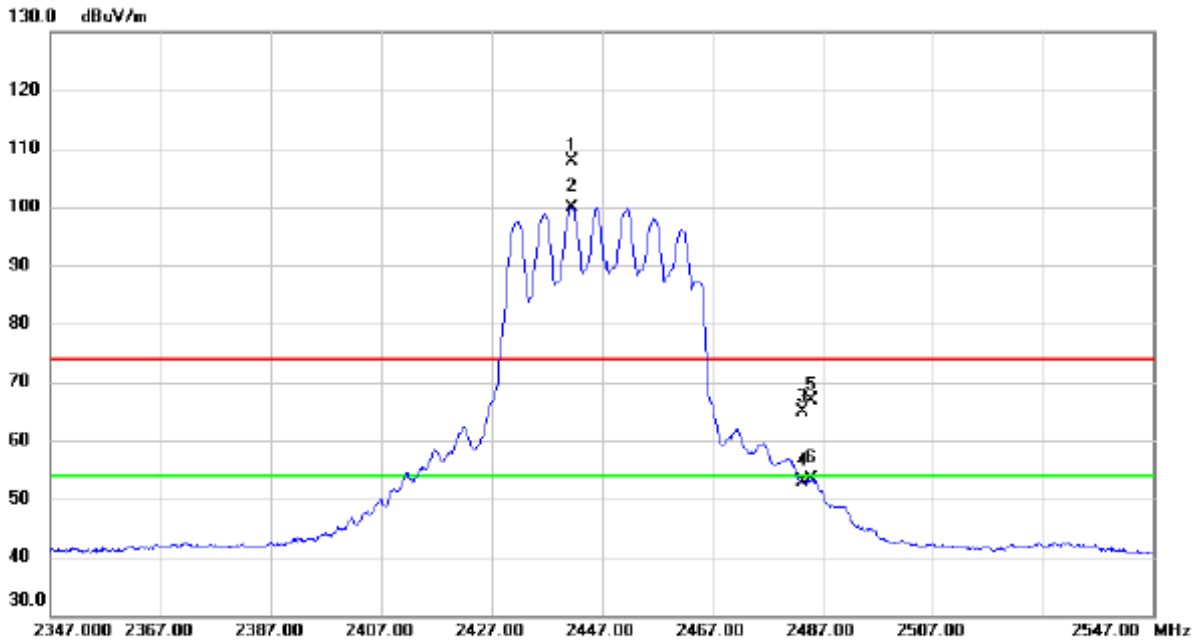

No.	Mk.	Freq. MHz	Reading Level dBuV	Correct Factor dB	Measure- ment dBuV/m	Limit dBuV/m	Margin dB	Detector	Comment
1	X	2441.400	101.17	6.61	107.78	74.00	33.78	peak	No Limit
2	*	2441.500	93.39	6.61	100.00	54.00	46.00	AVG	No Limit
3		2483.500	58.31	6.61	64.92	74.00	-9.08	peak	
4		2483.500	46.19	6.61	52.80	54.00	-1.20	AVG	
5		2485.100	60.37	6.61	66.98	74.00	-7.02	peak	
6		2485.100	46.77	6.61	53.38	54.00	-0.62	AVG	

Orthogonal Axis	X
Test Mode:	TX VHT-40M Mode 2447MHz

Vertical

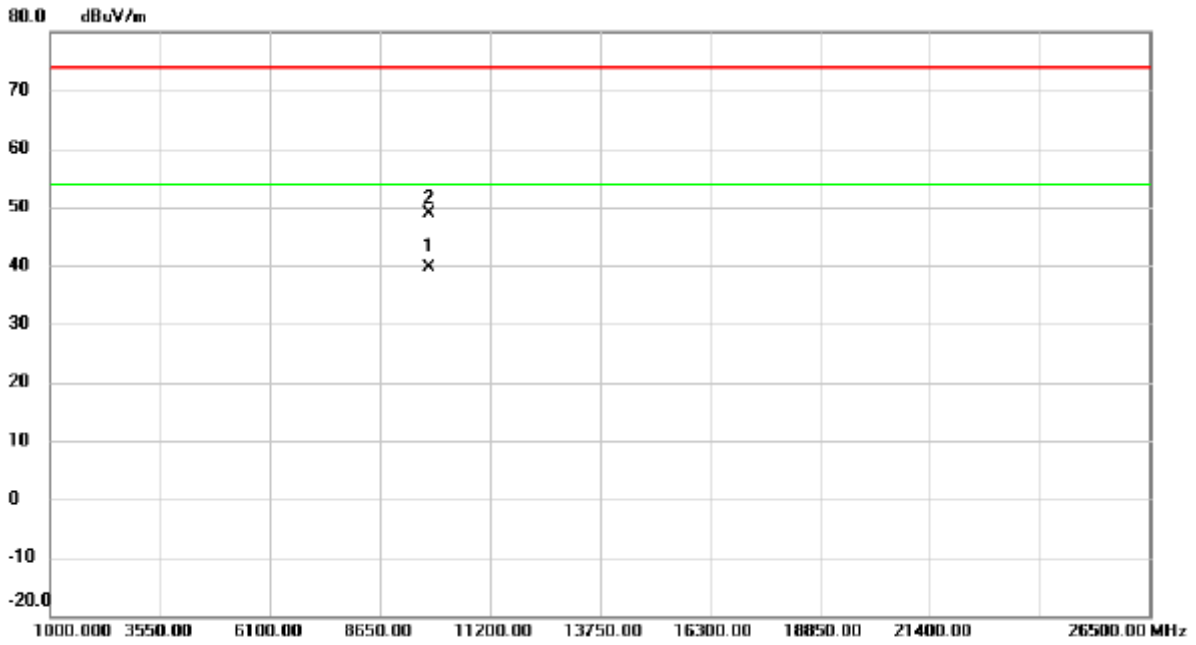

No.	Mk.	Freq.	Reading Level	Correct Factor	Measurement	Limit	Margin	Detector	Comment
		MHz	dBuV	dB	dBuV/m	dBuV/m	dB		
1	*	9787.976	28.56	11.05	39.61	54.00	-14.39	AVG	
2		9787.990	37.84	11.05	48.89	74.00	-25.11	peak	

Orthogonal Axis	X
Test Mode:	TX VHT-40M Mode 2447MHz

Horizontal

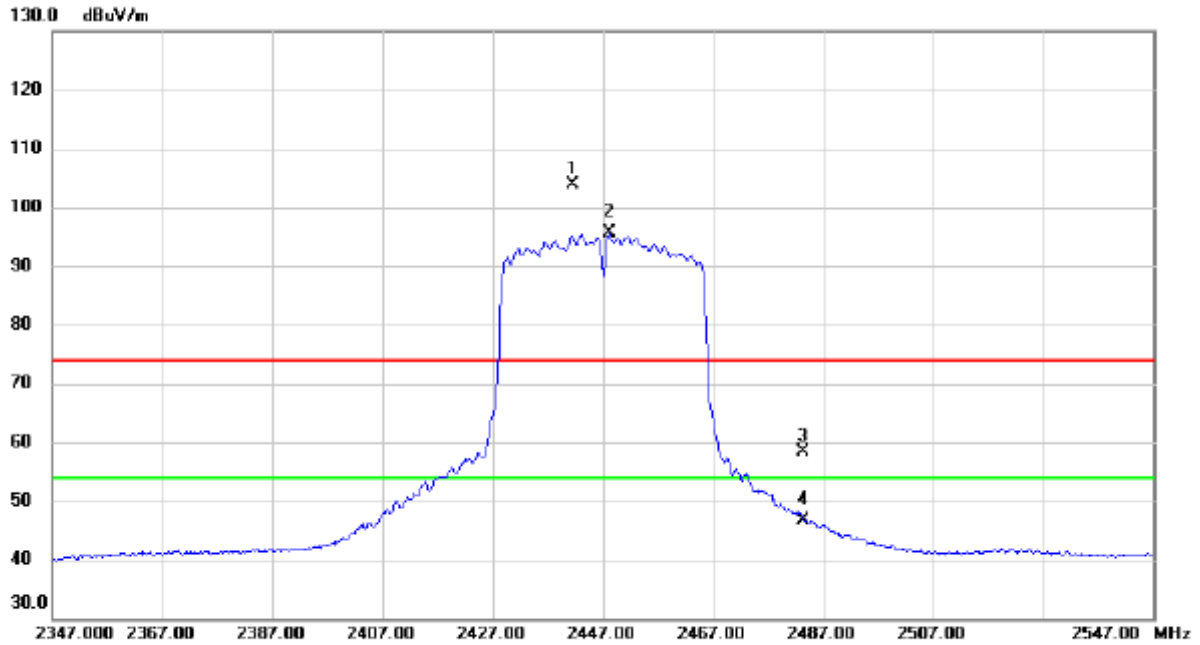

No.	Mk.	Freq. MHz	Reading Level dBuV	Correct Factor dB	Measure- ment dBuV/m	Limit dBuV/m	Margin dB	Detector	Comment
1	X	2441.500	97.22	6.61	103.83	74.00	29.83	peak	No Limit
2	*	2448.200	89.03	6.61	95.64	54.00	41.64	AVG	No Limit
3		2483.500	51.85	6.61	58.46	74.00	-15.54	peak	
4		2483.500	40.07	6.61	46.68	54.00	-7.32	AVG	

Orthogonal Axis	X
Test Mode:	TX VHT-40M Mode 2447MHz

Horizontal

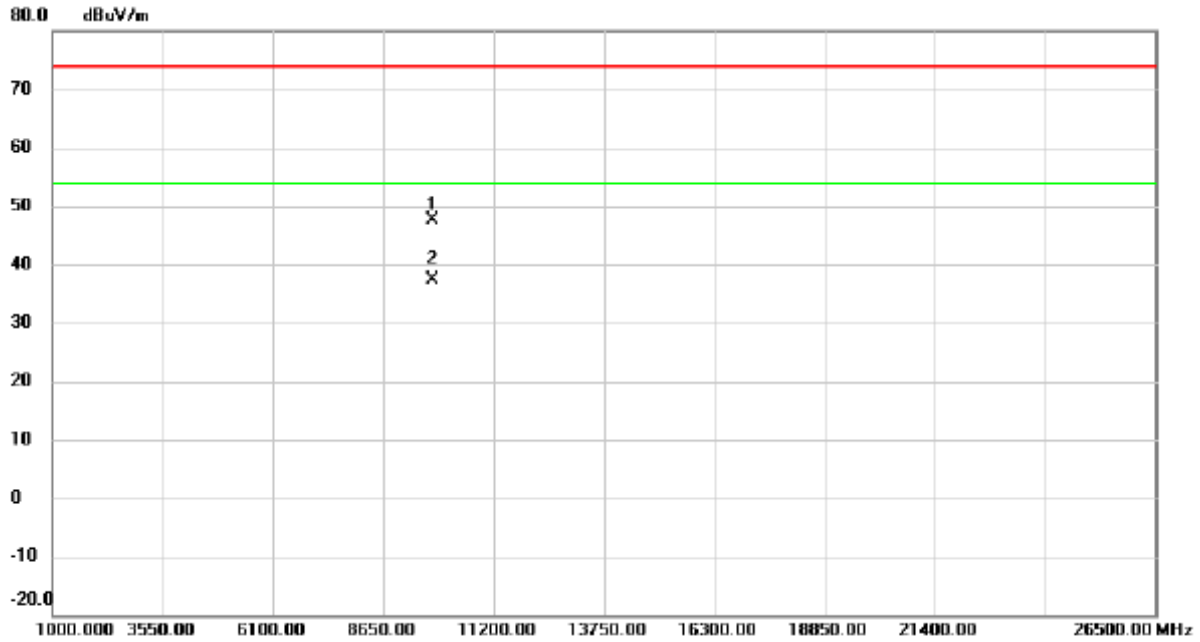

No.	Mk.	Freq. MHz	Reading Level dBuV	Correct Factor dB	Measure- ment dBuV/m	Limit dBuV/m	Margin dB	Detector	Comment
1		9788.017	36.54	11.05	47.59	74.00	-26.41	peak	
2	*	9788.087	26.36	11.05	37.41	54.00	-16.59	AVG	

Orthogonal Axis	X
Test Mode:	TX VHT-40M Mode 2452MHz

Vertical

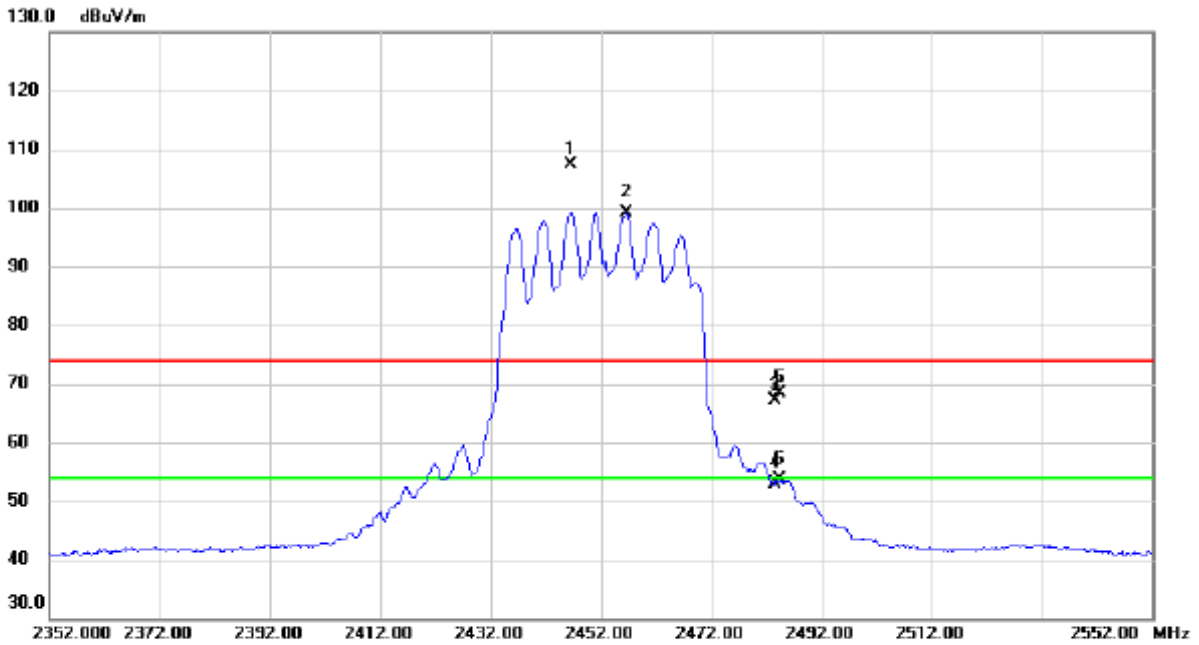

No.	Mk.	Freq. MHz	Reading Level dBuV	Correct Factor dB	Measure- ment dBuV/m	Limit dBuV/m	Margin dB	Detector	Comment
1	X	2446.500	100.89	6.61	107.50	74.00	33.50	peak	No Limit
2	*	2456.600	92.56	6.62	99.18	54.00	45.18	AVG	No Limit
3		2483.500	60.42	6.61	67.03	74.00	-6.97	peak	
4		2483.500	46.28	6.61	52.89	54.00	-1.11	AVG	
5		2484.500	61.76	6.61	68.37	74.00	-5.63	peak	
6		2484.500	46.98	6.61	53.59	54.00	-0.41	AVG	

Orthogonal Axis	X
Test Mode:	TX VHT-40M Mode 2452MHz

Vertical

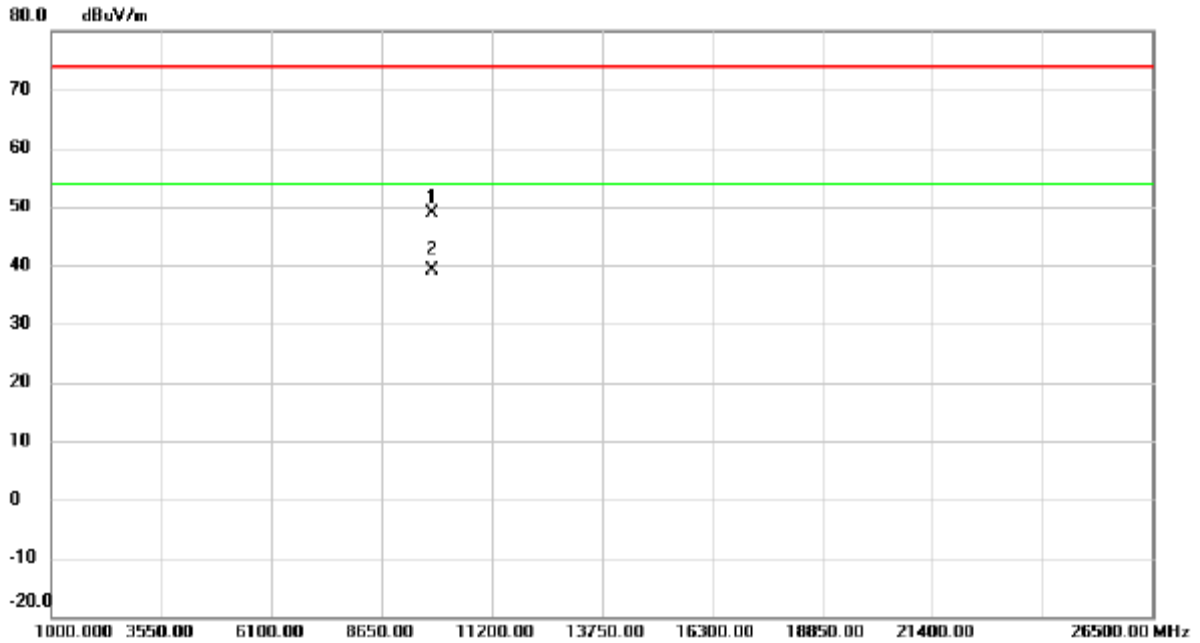

No.	Mk.	Freq. MHz	Reading Level dBuV	Correct Factor dB	Measure- ment dBuV/m	Limit dBuV/m	Margin dB	Detector	Comment
1		9807.935	37.81	11.06	48.87	74.00	-25.13	peak	
2	*	9808.053	28.03	11.06	39.09	54.00	-14.91	AVG	

Orthogonal Axis	X
Test Mode:	TX VHT-40M Mode 2452MHz

Horizontal

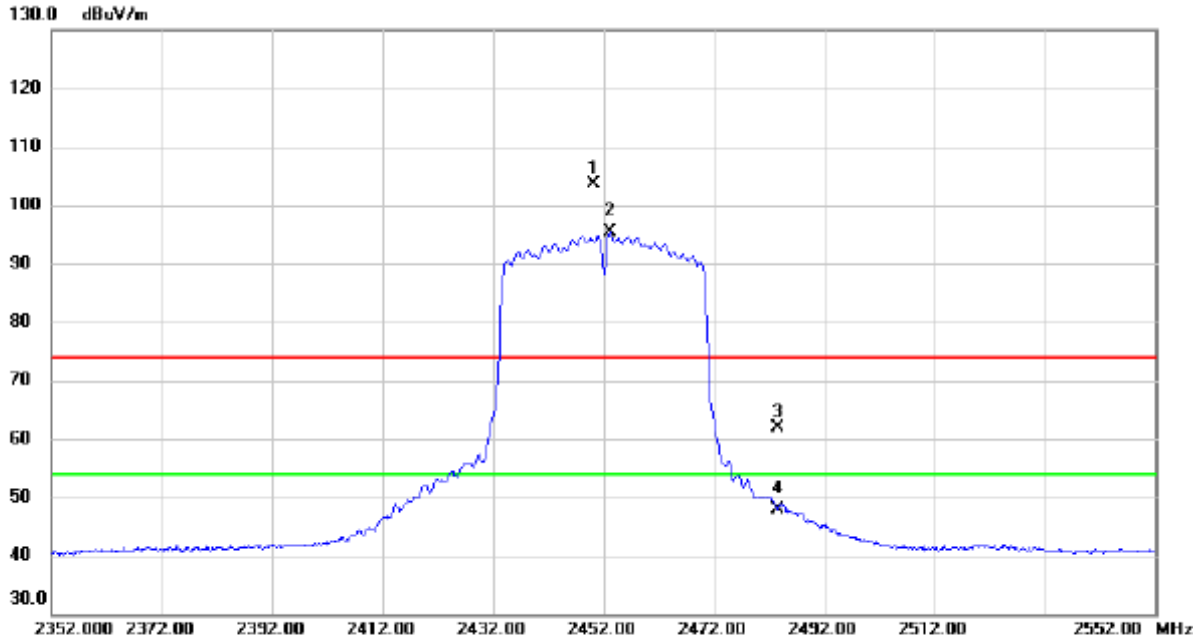

No.	Mk.	Freq. MHz	Reading Level dBuV	Correct Factor dB	Measure- ment dBuV/m	Limit dBuV/m	Margin dB	Detector	Comment
1	X	2450.200	96.98	6.61	103.59	74.00	29.59	peak	No Limit
2	*	2453.200	88.89	6.61	95.50	54.00	41.50	AVG	No Limit
3		2483.500	55.33	6.61	61.94	74.00	-12.06	peak	
4		2483.500	41.28	6.61	47.89	54.00	-6.11	AVG	

Orthogonal Axis	X
Test Mode:	TX VHT-40M Mode 2452MHz

Horizontal

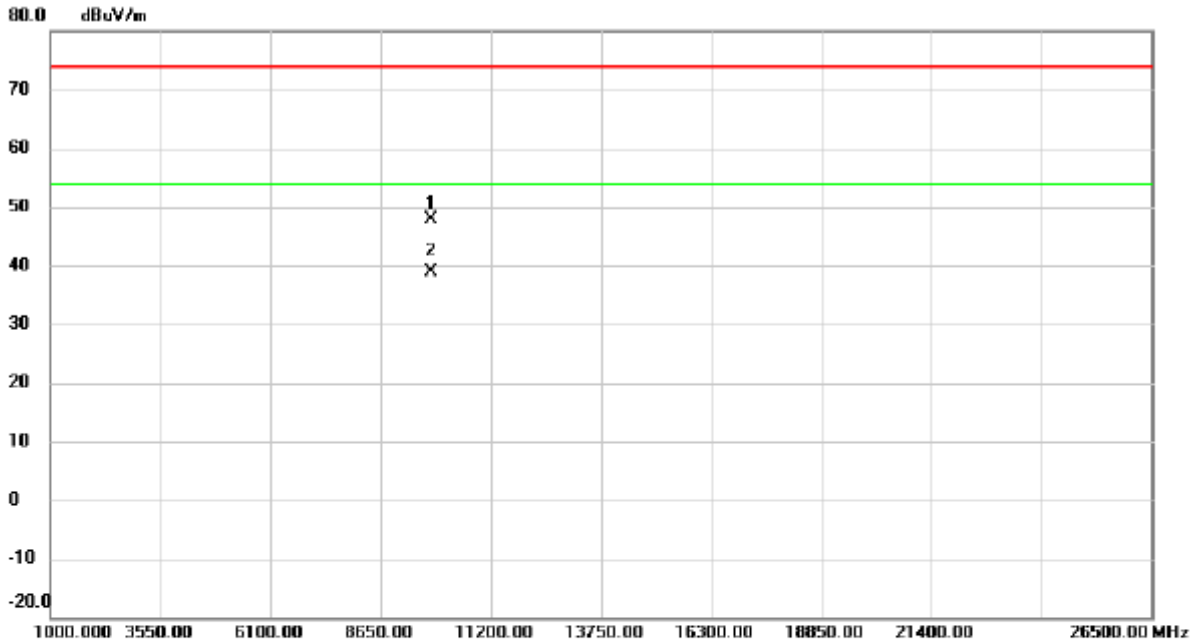

No.	Mk.	Freq. MHz	Reading Level dBuV	Correct Factor dB	Measure- ment dBuV/m	Limit dBuV/m	Margin dB	Detector	Comment
1		9807.911	36.86	11.06	47.92	74.00	-26.08	peak	
2	*	9808.099	27.85	11.06	38.91	54.00	-15.09	AVG	

TX B Mode_DUTY CYCLE

Duty cycle: TX 2412 MHz

Duty cycle = T_{ON} / T_{Total}

T_{ON} : 8.441 msec

T_{Total} : 8.487 msec

Duty cycle: 99.46%

Duty Factor = $10 \log(1/Duty\ cycle)$

Duty Factor = 0.00

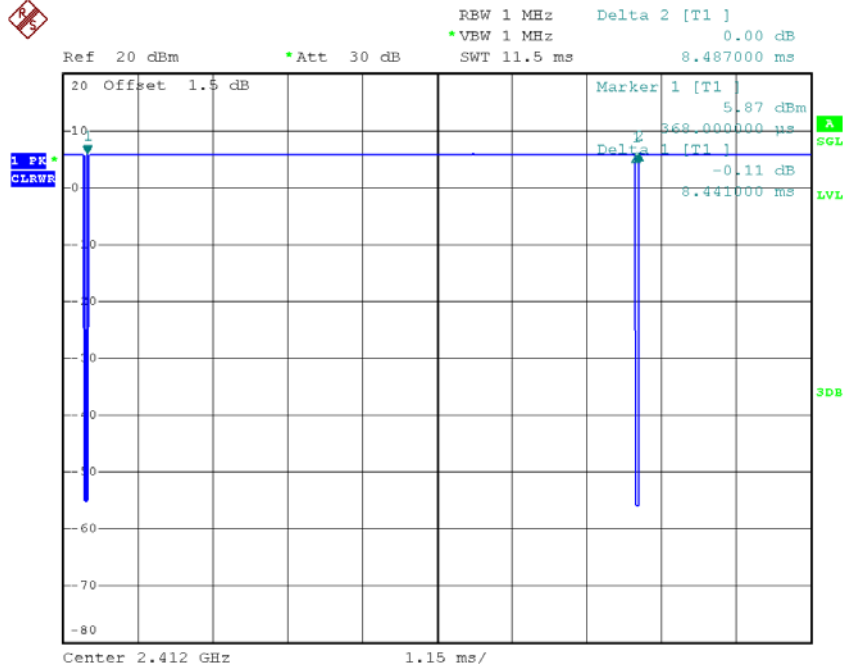

Date: 12.SEP.2018 19:13:22

Note: The duty cycle is $\geq 98\%$ no need to calculated as Duty Factor.

TX G Mode_DUTY CYCLE

Duty cycle: TX 2412 MHz

$$\text{Duty cycle} = T_{\text{ON}} / T_{\text{Total}}$$

T_{ON} : 8.440 msec

T_{Total} : 8.500 msec

Duty cycle: 99.29 %

$$\text{Duty Factor} = 10 \log(1/\text{Duty cycle})$$

Duty Factor = 0.00

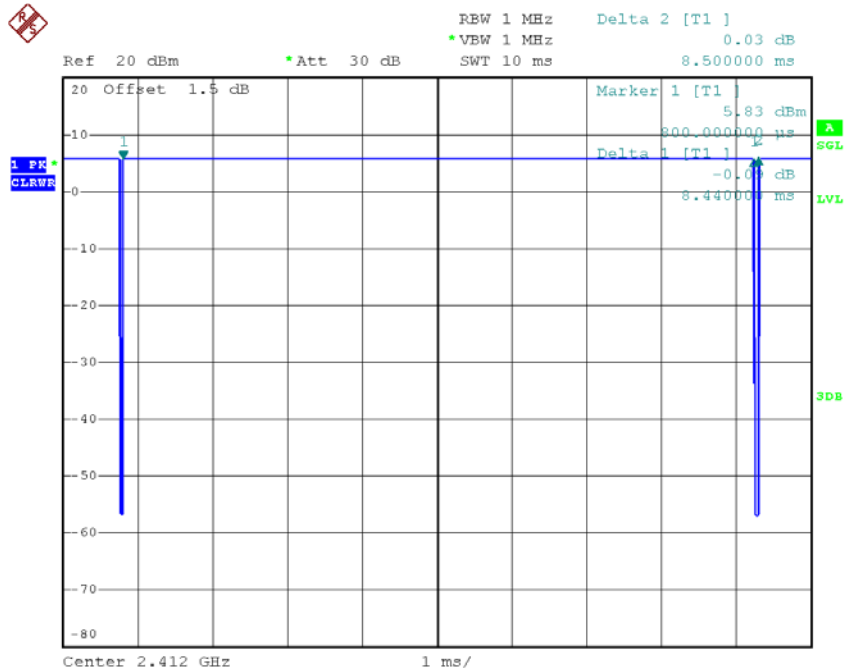

Date: 12.SEP.2018 19:13:43

Note: The duty cycle is ≥ 98 % no need to calculated as Duty Factor.

TX N20 Mode_DUTY CYCLE

Duty cycle: TX 2412 MHz

$$\text{Duty cycle} = T_{\text{ON}} / T_{\text{Total}}$$

T_{ON} : 1.310 msec

T_{Total} : 1.370 msec

Duty cycle: 95.62%

$$\text{Duty Factor} = 10 \log(1/\text{Duty cycle})$$

$$\text{Duty Factor} = 0.19$$

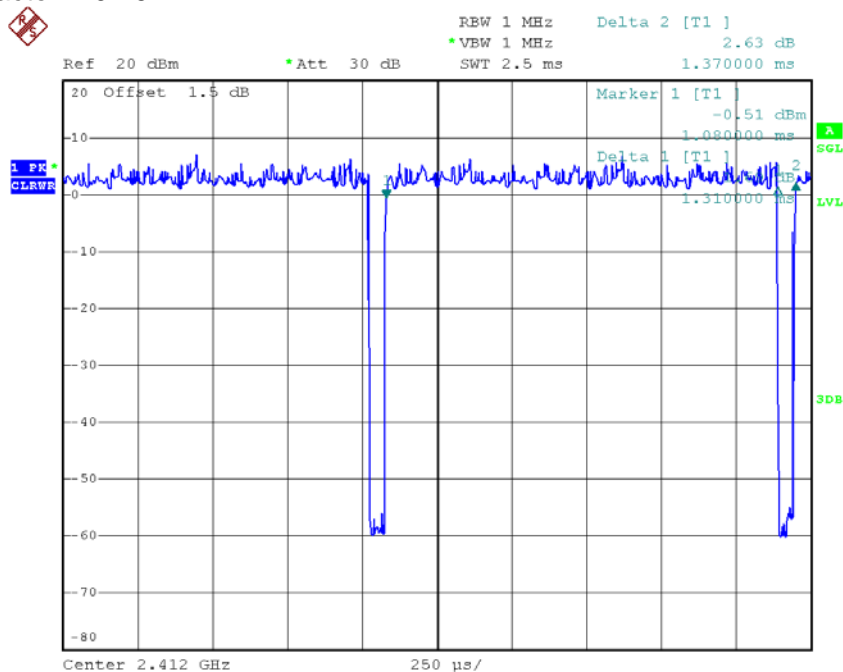

Date: 12.SEP.2018 19:14:08

Note: The EUT was programmed to be in continually transmitting mode and the transmit duty cycle < 98 %, so, the output power and power density should be calculated as

$$\text{Output Power} = \text{Measured power} + \text{Duty factor}$$

$$\text{Power Spectral Density} = \text{Measured density} + \text{Duty factor}$$

TX N40 Mode_DUTY CYCLE

Duty cycle: TX 2422MHz

$$\text{Duty cycle} = T_{\text{ON}} / T_{\text{Total}}$$

T_{ON} : 0.635 msec

T_{Total} : 0.720msec

Duty cycle: 88.19%

$$\text{Duty Factor} = 10 \log(1/\text{Duty cycle})$$

Duty Factor = 0.55

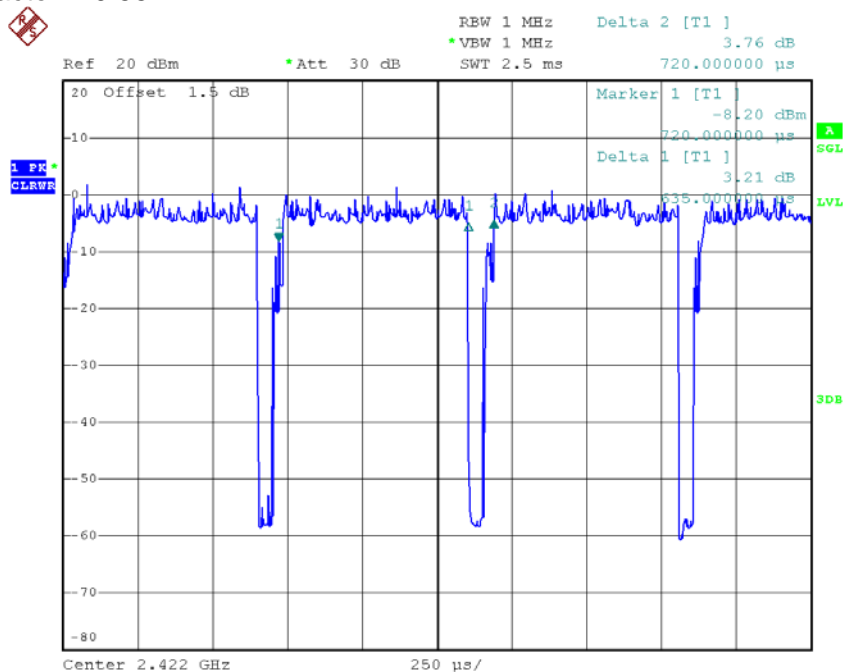

Date: 12.SEP.2018 19:14:26

Note: The EUT was programmed to be in continually transmitting mode and the transmit duty cycle < 98 %, so, the output power and power density should be calculated as

$$\text{Output Power} = \text{Measured power} + \text{Duty factor}$$

$$\text{Power Spectral Density} = \text{Measured density} + \text{Duty factor}$$

TX VHT20 Mode_DUTY CYCLE

Duty cycle: TX 2412 MHz

Duty cycle = T_{ON} / T_{Total}

T_{ON} : 0.132 msec

T_{Total} : 0.138 msec

Duty cycle: 95.65%

Duty Factor = $10 \log(1/\text{Duty cycle})$

Duty Factor = 0.19

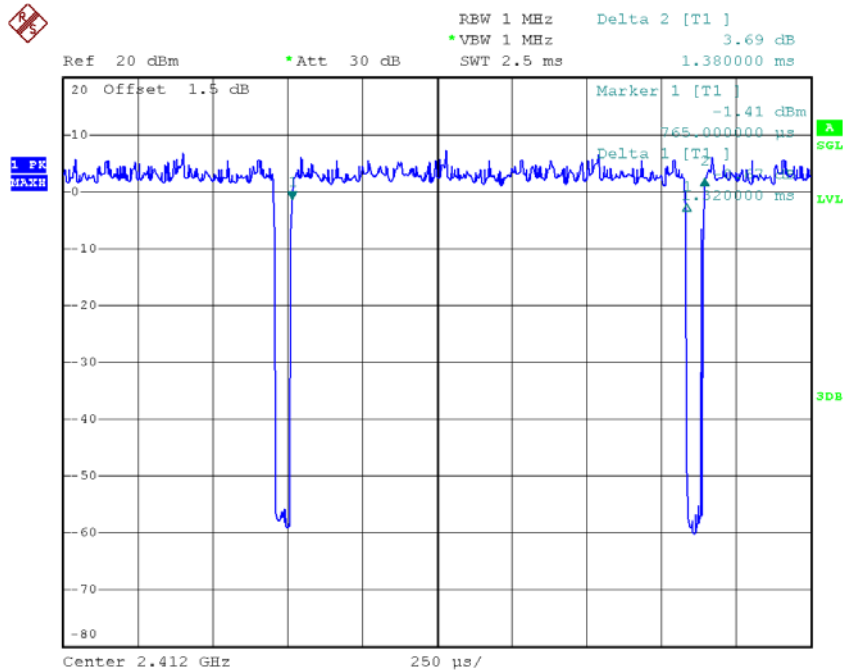

Date: 12.SEP.2018 19:17:59

Note: The EUT was programmed to be in continually transmitting mode and the transmit duty cycle < 98 %, so, the output power and power density should be calculated as

Output Power = Measured power + Duty factor

Power Spectral Density = Measured density + Duty factor

TX VHT40 Mode_DUTY CYCLE

Duty cycle: TX 2422MHz

$$\text{Duty cycle} = T_{\text{ON}} / T_{\text{Total}}$$

T_{ON} : 0.630 msec

T_{Total} : 0.715 msec

Duty cycle: 88.11%

$$\text{Duty Factor} = 10 \log(1/\text{Duty cycle})$$

Duty Factor = 0.55

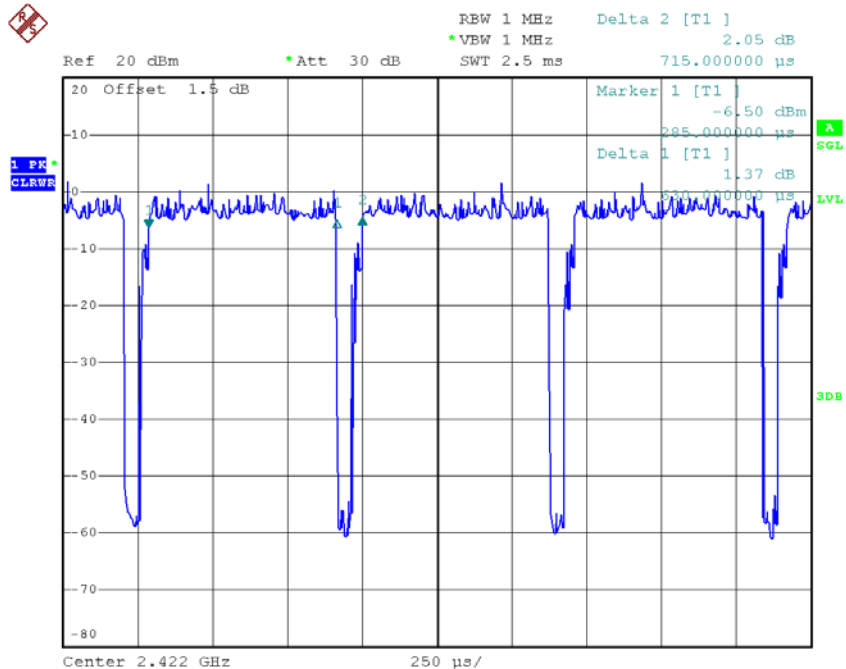

Date: 12.SEP.2018 19:18:24

Note: The EUT was programmed to be in continually transmitting mode and the transmit duty cycle < 98 %, so, the output power and power density should be calculated as

$$\text{Output Power} = \text{Measured power} + \text{Duty factor}$$

$$\text{Power Spectral Density} = \text{Measured density} + \text{Duty factor}$$

APPENDIX E - BANDWIDTH

Test Mode : TX B Mode_CH01/06/11

Frequency (MHz)	6dB Bandwidth (MHz)	Min. Limit (kHz)	Test Result
2412	10.12	500	Complies
2437	10.17	500	Complies
2462	10.14	500	Complies

TX CH01

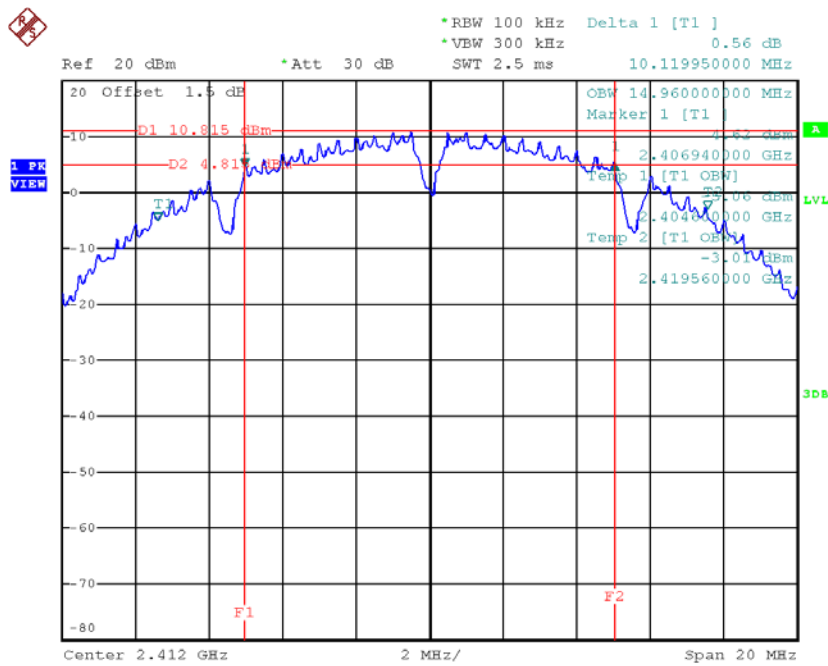

Date: 30.OCT.2018 14:51:33

TX CH06

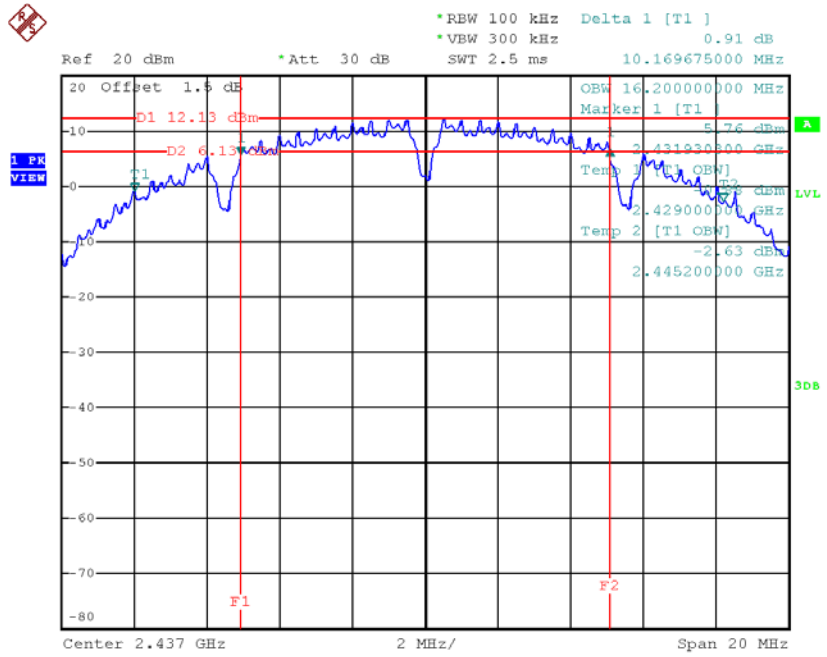

Date: 30.OCT.2018 14:54:43

TX CH11

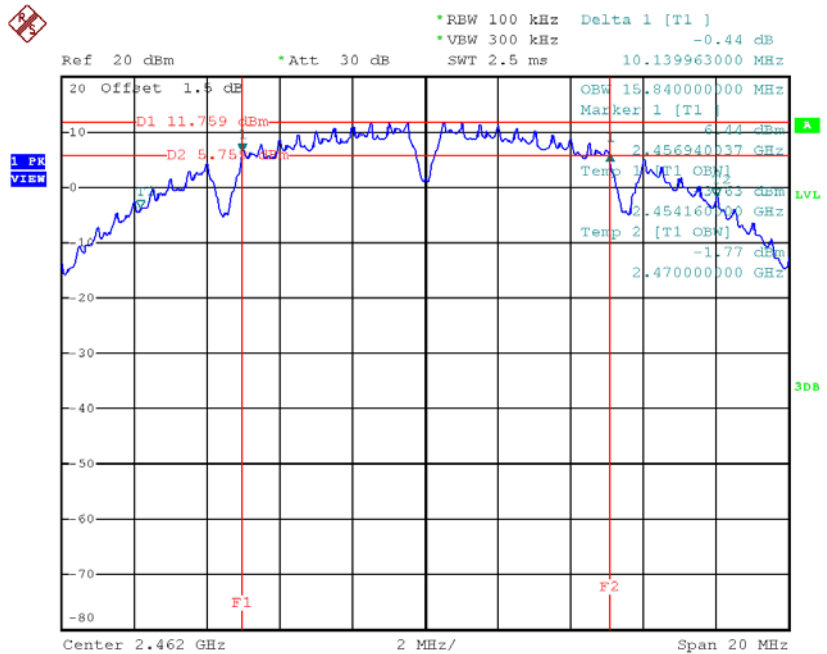

Date: 30.OCT.2018 15:33:25