

## FCC 47 CFR PART 15 SUBPART E

Applicant : TP-Link Technologies Co., Ltd.

Product Type : AC1900 Wireless Dual Band DOCSIS 3.0 Cable Modem Router

Trade Name : TP-Link

Model Number : CR1900

Test Specification : FCC 47 CFR PART 15 SUBPART E  
ANSI C63.10:2013

Receive Date : Mar. 02, 2017

Test Period : Mar. 09 ~ Jul. 04, 2017

Issue Date : Aug. 08, 2017

### Issue by

A Test Lab Techno Corp.  
No. 140-1, Changan Street, Bade District,  
Taoyuan City 33465, Taiwan (R.O.C)  
Tel : +86-3-2710188 / Fax : +86-3-2710190



Taiwan Accreditation Foundation accreditation number: 1330  
Test Firm MRA designation number: TW0010

**Note:** This report shall not be reproduced except in full, without the written approval of A Test Lab Techno Corp. This document may be altered or revised by A Test Lab Techno Corp. personnel only, and shall be noted in the revision section of the document. The client should not use it to claim product endorsement by TAF, or any government agencies. The test results in the report only apply to the tested sample.



### **Revision History**

Rev.	Issue Date	Revisions	Revised By
00	Jul. 17, 2017	Initial Issue	Nina Lin
01	Jul. 27, 2017	Revised report information.	Nina Lin
02	Aug. 08, 2017	Revised report information.	Nina Lin



## Verification of Compliance

Issued Date: Aug. 08, 2017

Applicant : TP-Link Technologies Co., Ltd.  
Product Type : AC1900 Wireless Daul Band DOSIS 3.0 Cable Modem Router  
Trade Name : TP-Link  
Model Number : CR1900  
FCC ID : TE7CR1900  
EUT Rated Voltage : DC 12V, 4.2A  
Test Voltage : 120 Vac / 60 Hz  
Applicable Standard : FCC 47 CFR PART 15 SUBPART E  
ANSI C63.10:2013  
Test Result : Complied  
Performing Lab. : A Test Lab Techno Corp.

No. 140-1, Changan Street, Bade District,  
Taoyuan City 33465, Taiwan (R.O.C)

Tel : +86-3-2710188 / Fax : +86-3-2710190

Taiwan Accreditation Foundation accreditation number: 1330

<http://www.atl-lab.com.tw/e-index.htm>



A Test Lab Techno Corp. tested the above equipment in accordance with the requirements set forth in the above standards. All indications of Pass/Fail in this report are opinions expressed by A Test Lab Techno Corp. based on interpretations and/or observations of test results. Measurement Uncertainties were not taken into account and are published for informational purposes only. The test results show that the equipment tested is capable of demonstrating compliance with the requirements as documented in this report.

Approved By : Fly Lu Reviewed By : Eric Ou Yang  
(Manager) (Fly Lu) (Testing Engineer) (Eric Ou Yang)



## TABLE OF CONTENTS

<b>1</b>	<b>General Information.....</b>	<b>5</b>
1.1.	Summary of Test Result .....	5
1.2.	Measurement Uncertainty .....	5
<b>2</b>	<b>EUT Description.....</b>	<b>6</b>
<b>3</b>	<b>Test Methodology .....</b>	<b>8</b>
3.1.	Mode of Operation .....	8
3.2.	EUT Exercise Software .....	17
3.3.	Configuration of Test System Details .....	17
3.4.	Test Site Environment .....	18
<b>4</b>	<b>Test Results .....</b>	<b>19</b>
4.1.	AC Power Conducted Emission Measurement .....	19
4.2.	Test Procedure .....	20
4.3.	Transmitter Radiated Emissions Measurement.....	23
4.4.	Maximum Conducted Output Power Measurement .....	182
4.5.	26dB RF Bandwidth & 99 % Occupied Bandwidth Measurement .....	193
4.6.	6dB RF Bandwidth Measurement .....	213
4.7.	Peak Power Spectral Density Measurement .....	231
4.8.	Frequency Stability Measurement .....	283
4.9.	Antenna Requirement .....	286



# 1 General Information

## 1.1. Summary of Test Result

Standard	Item	Result	Remark
FCC			
15.407(b)(6) 15.207	AC Power Conducted Emission	PASS	---
15.407(b) 15.205 / 15.209	Transmitter Radiated Emissions	PASS	---
15.407(a)	Maximum Conducted Output Power	PASS	---
15.407(a)	26dB RF Bandwidth	Reference	---
15.407(e)	6dB RF Bandwidth	PASS	----
15.407(a)	Peak Power Spectral Density	PASS	---
15.407(g)	Frequency Stability	PASS	---
15.407(a) 15.203	Antenna Requirement	PASS	---

The test results of this report relate only to the tested sample(s) identified in this report. Manufacturer or whom it may concern should recognize the pass or fail of the test result.

## 1.2. Measurement Uncertainty

Test Item	Frequency Range	Uncertainty (dB)
Conducted Emission	9kHz ~ 150KHz	2.7
	150kHz ~ 30MHz	2.7
Radiated Emission	9kHz ~ 30MHz	1.7
	30MHz ~ 1000MHz	5.7
	1000MHz ~ 18000MHz	5.5
	18000MHz ~ 26500MHz	4.8
	26500MHz ~ 40000MHz	4.8
Conducted Output Power		+0.27 dB / -0.28 dB
RF Bandwidth		4.96%
Power Spectral Density		+0.71 dB / -0.77 dB
Frequency Stability		+ 2.212 x 10 <sup>-7</sup> % / - 2.170 x 10 <sup>-7</sup>
Duty Cycle		1.06%
Time Occupancy		1.40%



## 2 EUT Description

Applicant	TP-Link Technologies Co., Ltd. Building 24 (floors 1,3,4,5) and 28 (floors1-4), Central Science and Technology Park, Nanshan, Shenzhen, China 518057			
Manufacturer	TP-Link Technologies Co., Ltd. Building 24 (floors 1,3,4,5) and 28 (floors1-4), Central Science and Technology Park, Nanshan, Shenzhen, China 518057			
Product Type	AC1900 Wireless Dual Band DOSIS 3.0 Cable Modem Router			
Trade Name	TP-Link			
Model No.	CR1900			
FCC ID	TE7CR1900			
Operate Frequency	Frequency Band		Frequency Range (MHz)	Number of Channels
	IEEE 802.11a	U-NII Band I	5180 – 5240	4
		U-NII Band III	5745 – 5825	5
	IEEE 802.11n 5GHz 20 MHz / IEEE 802.11ac 20 MHz	U-NII Band I	5180 – 5240	4
		U-NII Band III	5745 – 5825	5
	IEEE 802.11n 5GHz 40 MHz / IEEE 802.11ac 40 MHz	U-NII Band I	5190 – 5230	2
		U-NII Band III	5755 – 5795	2
	IEEE 802.11ac 80 MHz	U-NII Band I	5210	1
U-NII Band III		5775	1	
Modulation Type	OFDM			
Equipment Type	Master			
Antenna information	Antenna	Model	Type	Max. Gain (dBi)
	ANT-0	3101501223	Internal Antenna	2.88
	ANT-1	3101501222	Internal Antenna	2.93
	ANT-2	3101501221	Internal Antenna	2.90
Antenna Delivery	Reference section 3.1			
Frequency stability specification	± 20 ppm			
Operate Temp. Range	0 ~ 40 °C			



Frequency Band		RF Output Power (W)
IEEE 802.11a	U-NII Band I	0.472
	U-NII Band III	0.976
IEEE 802.11ac 20 MHz	U-NII Band I	0.477
	U-NII Band III	0.999
IEEE 802.11ac 40 MHz	U-NII Band I	0.659
	U-NII Band III	0.982
IEEE 802.11ac 80 MHz	U-NII Band I	0.079
	U-NII Band III	0.692
Beamforming on		
IEEE 802.11ac 20 MHz	U-NII Band I	0.541
	U-NII Band III	0.678
IEEE 802.11ac 40 MHz	U-NII Band I	0.650
	U-NII Band III	0.654
IEEE 802.11ac 80 MHz	U-NII Band I	0.049
	U-NII Band III	0.634

### 3 Test Methodology

#### 3.1. Mode of Operation

Decision of Test ATL has verified the construction and function in typical operation. All the test modes were carried out with the EUT in normal operation, which was shown in this test report and defined as:

Test Mode
Mode 1: Transmit mode
Mode 2: IEEE 802.11a Continuous TX mode
Mode 3: IEEE 802.11ac 20MHz Continuous TX mode
Mode 4: IEEE 802.11ac 40MHz Continuous TX mode
Mode 5: IEEE 802.11ac 80MHz Continuous TX mode

Software used to control the EUT for staying in continuous transmitting mode was programmed.

After verification, all tests were carried out with the worst case test modes as shown below except radiated spurious emission below 1GHz and power line conducted emissions below 30MHz, which worst case was in normal link mode only.

Equipment Type	
Outdoor access point	---
Indoor access point	V
Fixed point-to-point access points	---
Client devices	---

Test Mode	ANT-0	ANT-1	ANT-2	ANT-0+1+2
Mode 2	V	V	V	V
Mode 3	V	V	V	V
Mode 4	V	V	V	V
Mode 5	V	V	V	V

Test Mode	Antenna Delivery	Data Rate	Band	Test Channel
Mode 2	3TX / 3RX (CDD)	6M	U-NII Band I	36, 40, 48
			U-NII Band III	149, 157, 165
Mode 3	3TX / 3RX (CDD/Beamforming on)	19.5M	U-NII Band I	36, 40, 48
			U-NII Band III	149, 157, 165
Mode 4	3TX / 3RX (CDD/Beamforming on)	40.5M	U-NII Band I	38, 46
			U-NII Band III	151,159
Mode 5	3TX / 3RX (CDD/Beamforming on)	87.9M	U-NII Band I	42
			U-NII Band III	155





**Duty cycle**

Test Mode	Frequency (MHz)	on time (ms)	on+off time (ms)	Duty cycle	Duty Factor (dB)	1/T Minimum VBW (kHz)
Mode 2	5180.0	2.080	2.170	0.959	0.184	0.481
Mode 3	5180.0	0.690	0.775	0.890	0.505	1.449
Mode 4	5190.0	0.365	0.450	0.811	0.909	2.740
Mode 5	5210.0	0.468	0.486	0.963	0.164	2.137

**Beamforming on**

Test Mode	Frequency (MHz)	on time (ms)	on+off time (ms)	Duty cycle	Duty Factor (dB)	1/T Minimum VBW (kHz)
Mode 3	5180.0	1.720	2.140	0.804	0.949	0.581
Mode 4	5190.0	0.400	0.725	0.552	2.583	2.500
Mode 5	5210.0	0.196	0.486	0.403	3.944	5.102



### Duty Cycle Graphs





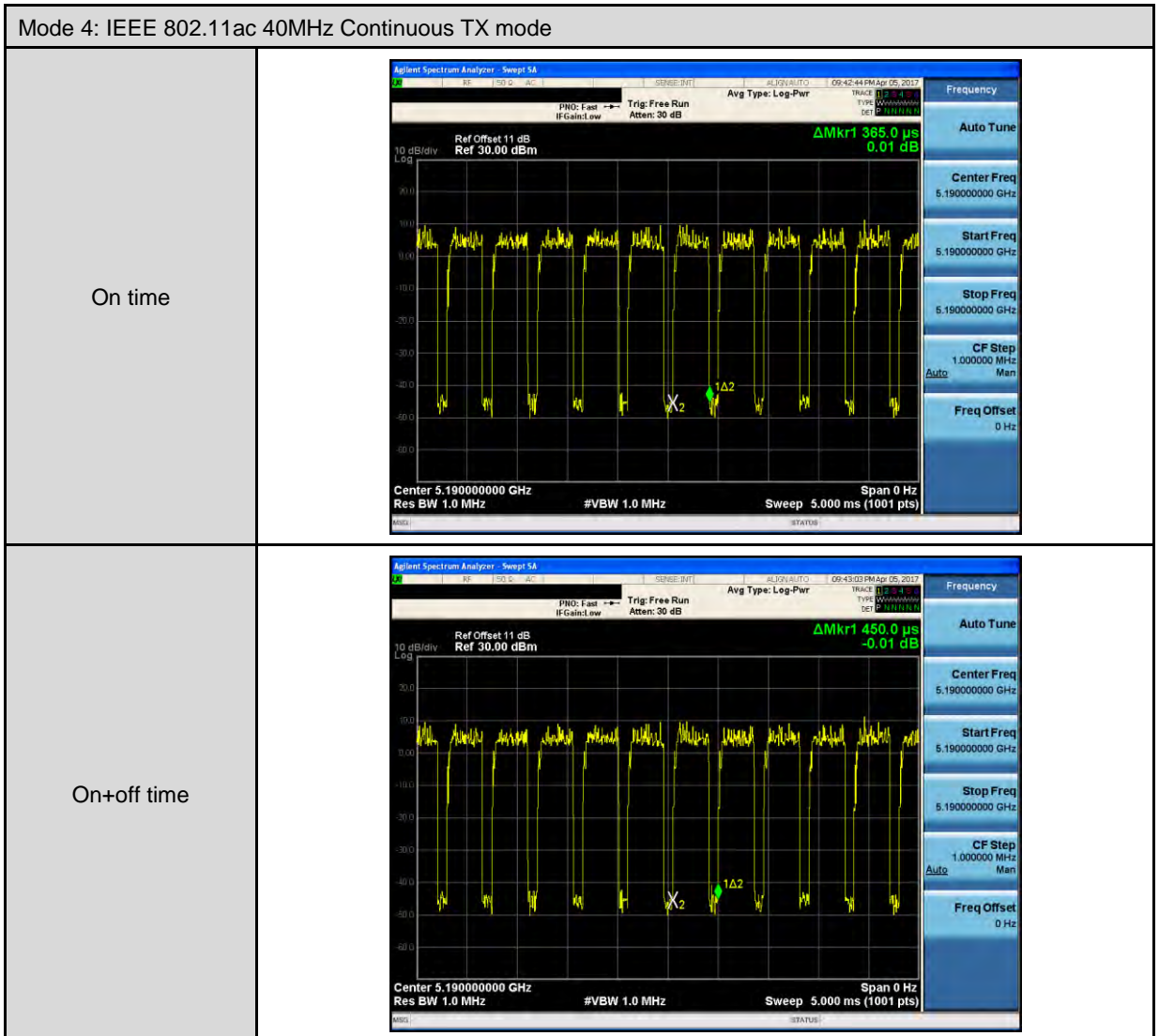

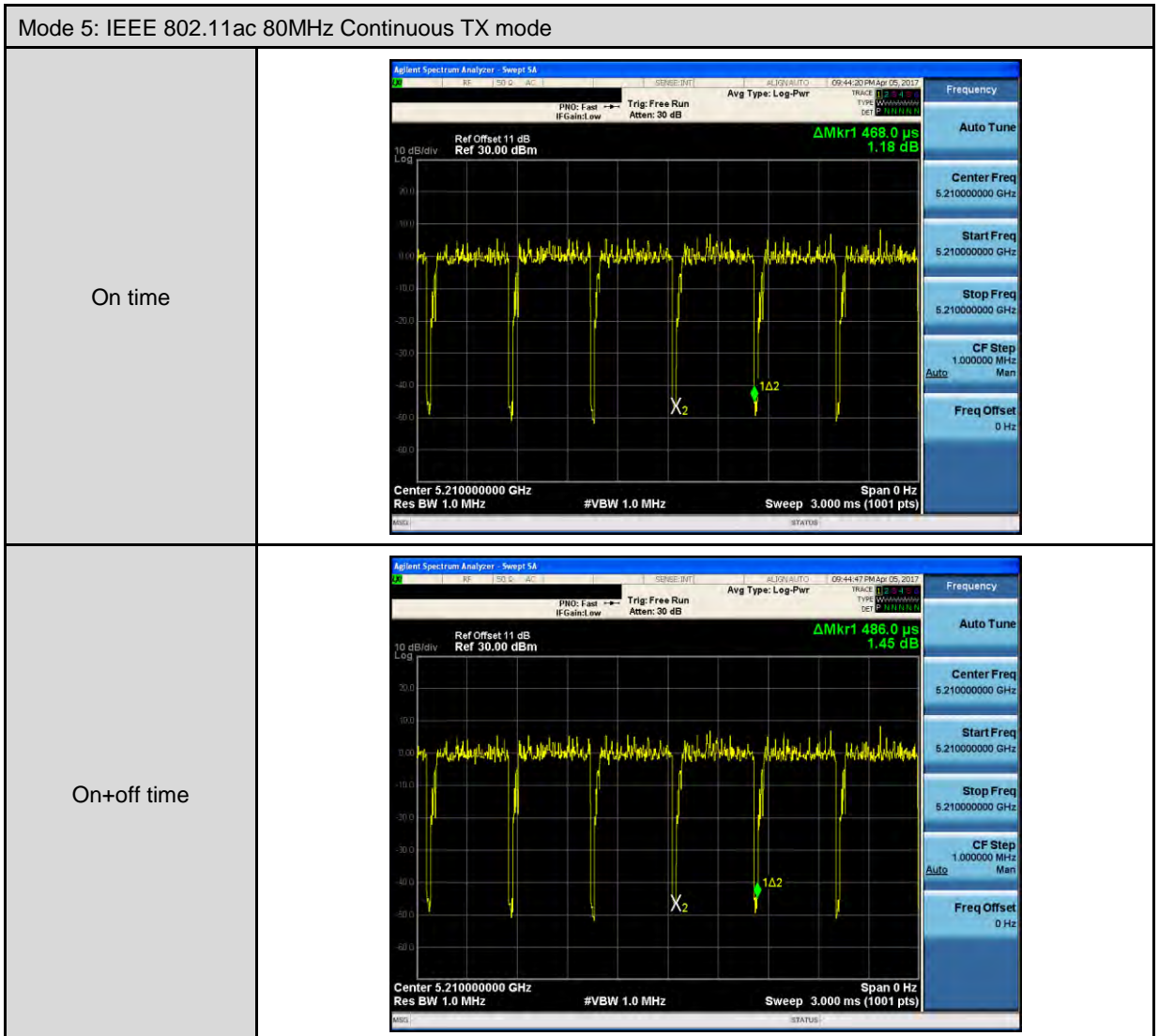



Beamforming on

Mode 3: IEEE 802.11ac 20MHz Continuous TX mode

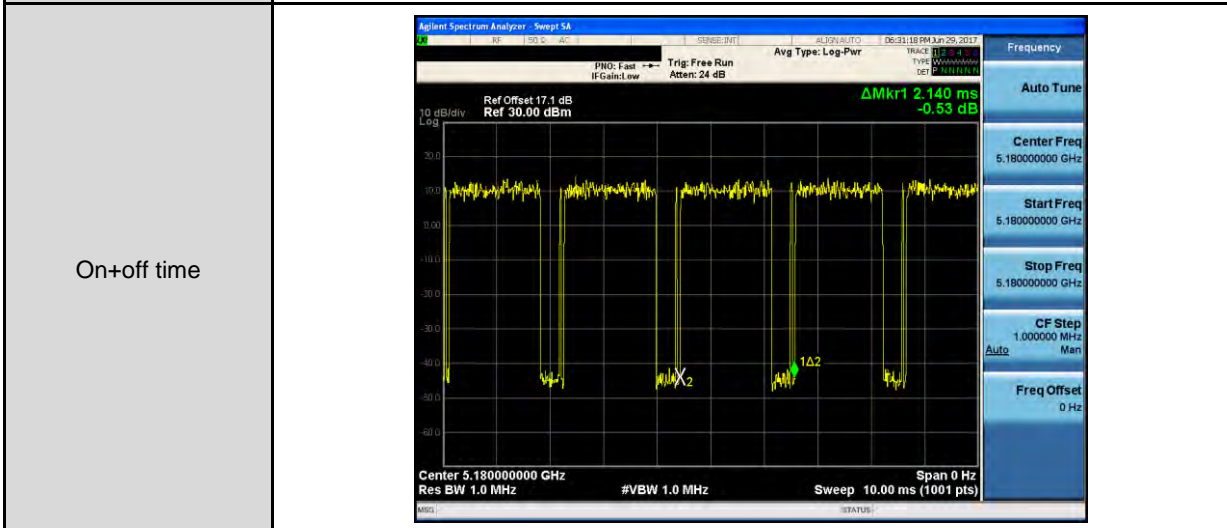
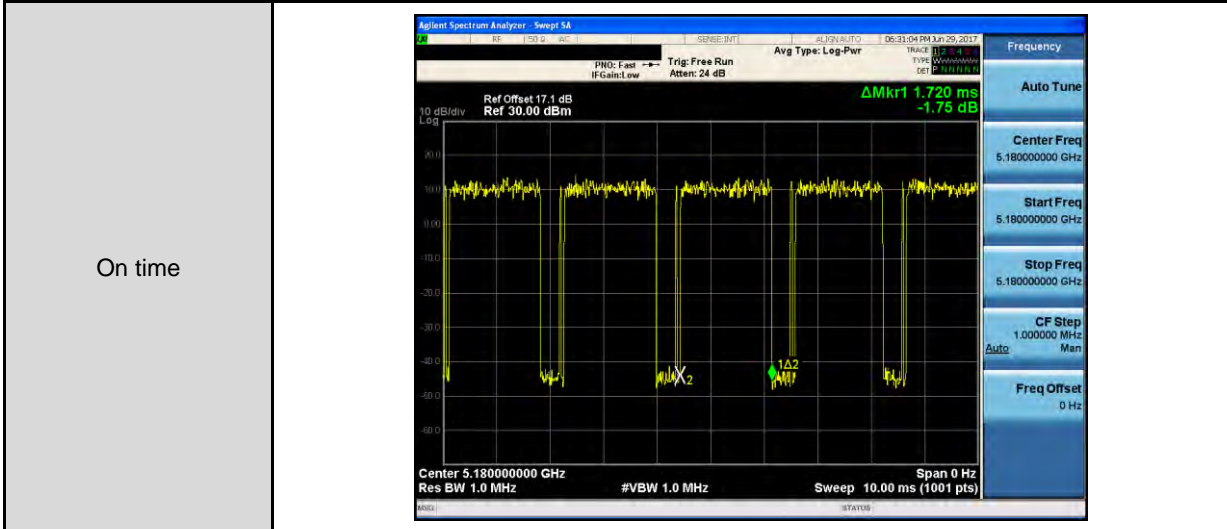



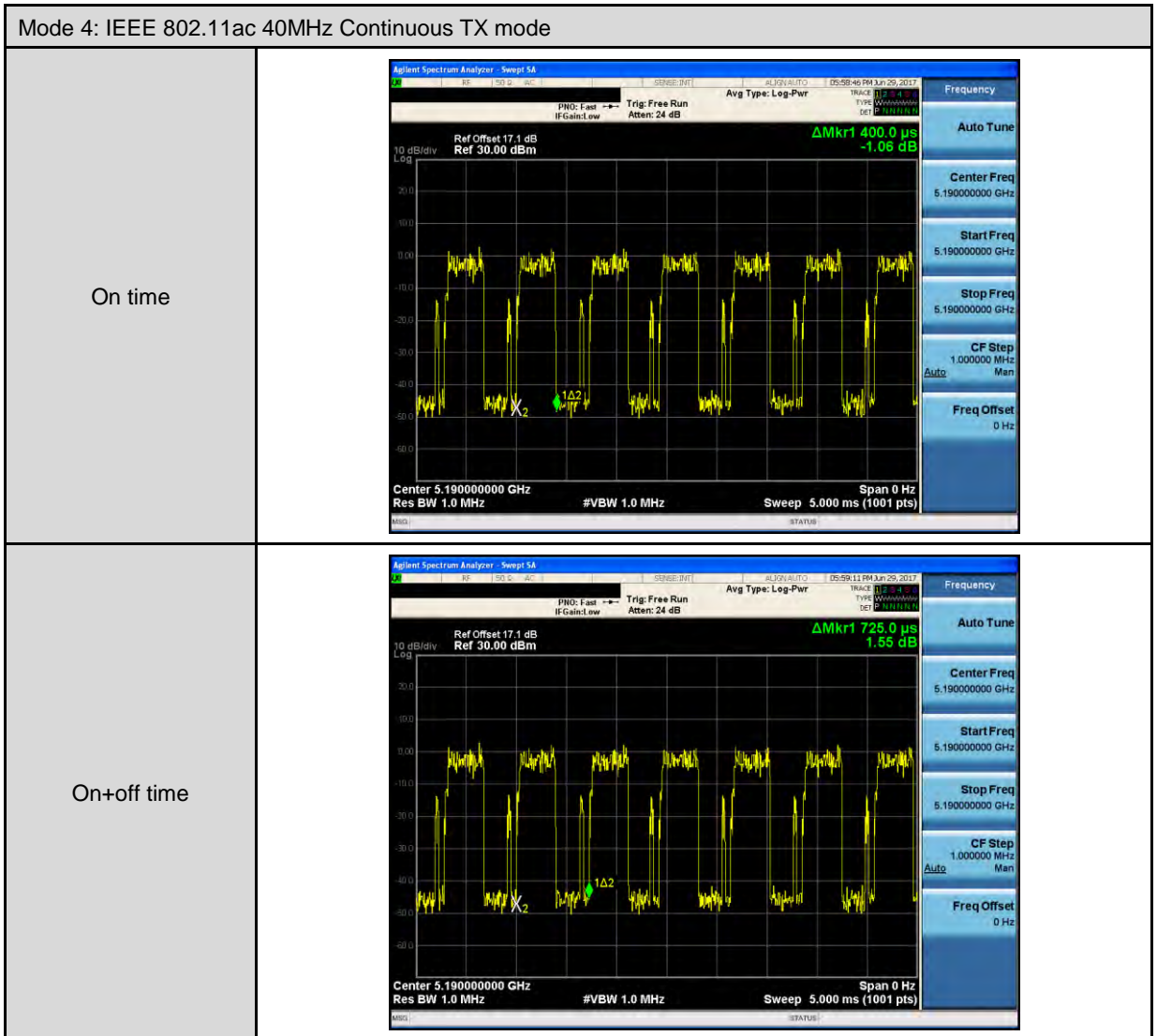

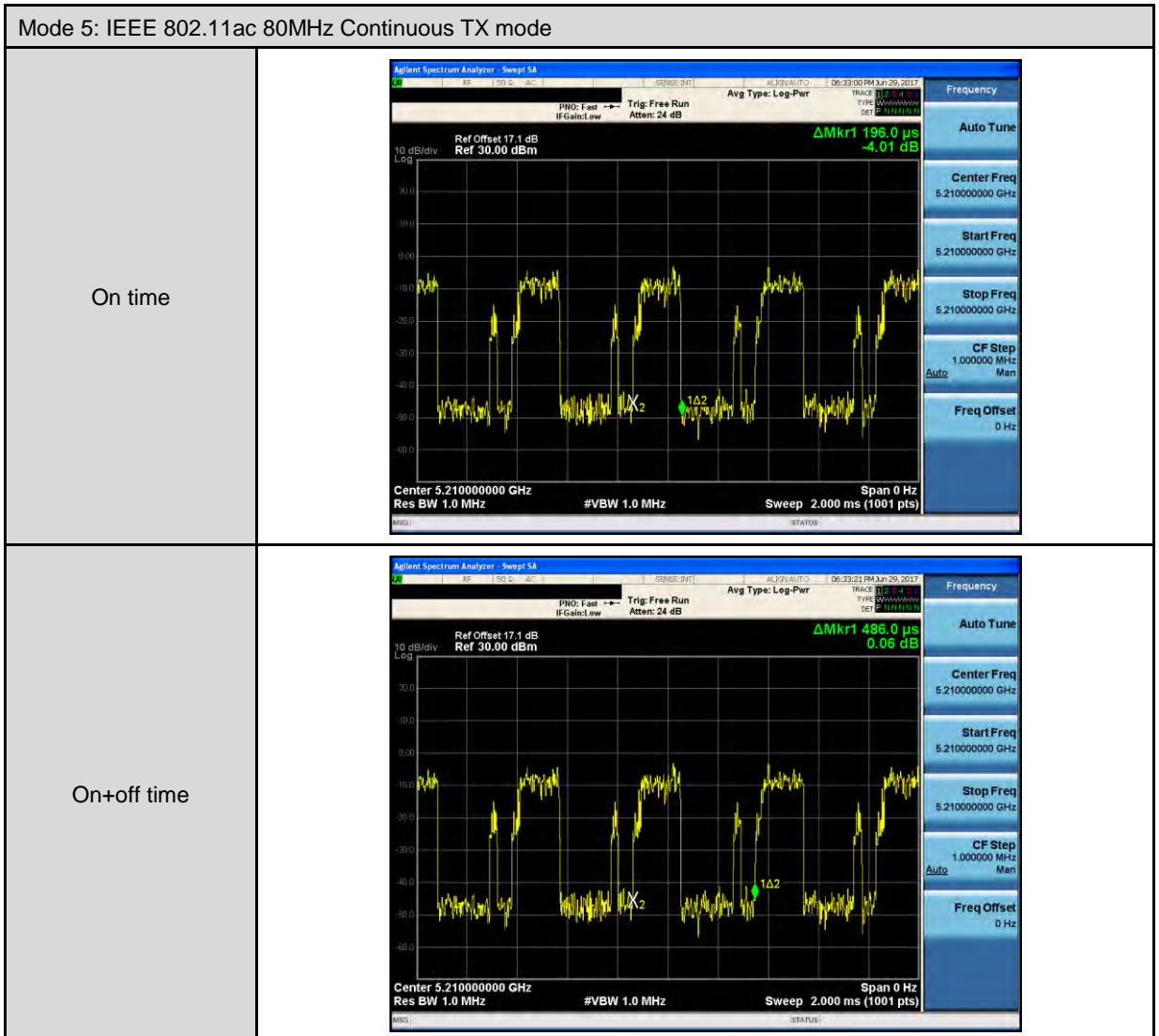



### 3.2. EUT Exercise Software

The EUT is operated in the engineering mode to fix the TX frequency for the purposes of measurement. According to its specifications, the EUT must comply with the requirements of Section 15.407 under the FCC Rules Part 15 Subpart E.

1.	Setup the EUT shown on 3.3.
2.	Turn on the power of all equipment.
3.	EUT run test program.

Measurement Software	
1	EZ-EMC Ver. ATL-03A1-1
2	EZ-EMC Ver ATL-ITC-3A1-1

### 3.3. Configuration of Test System Details

Conducted Emission

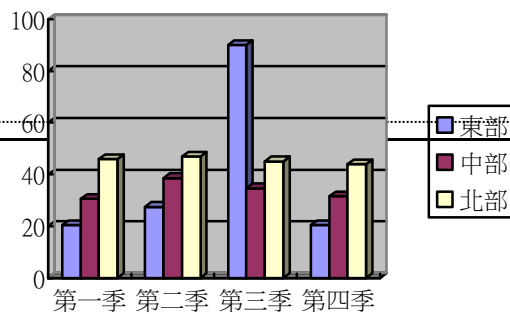
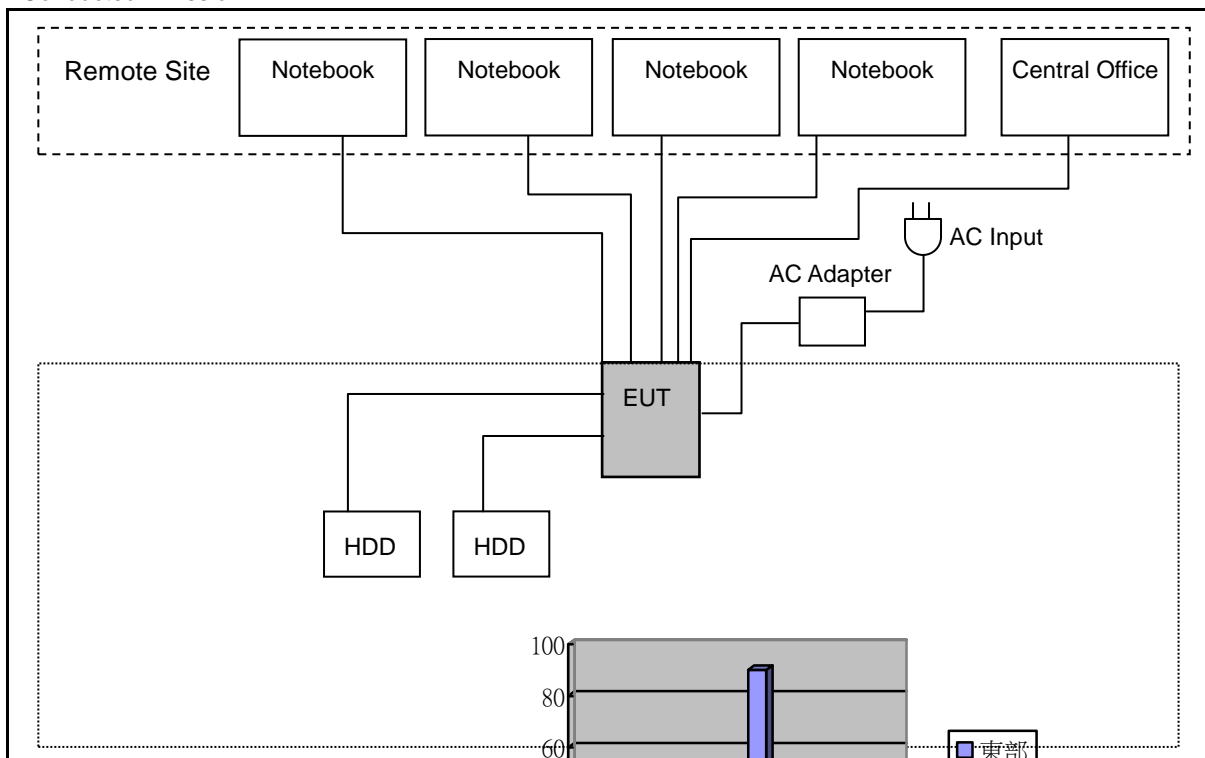

Radiated Emission

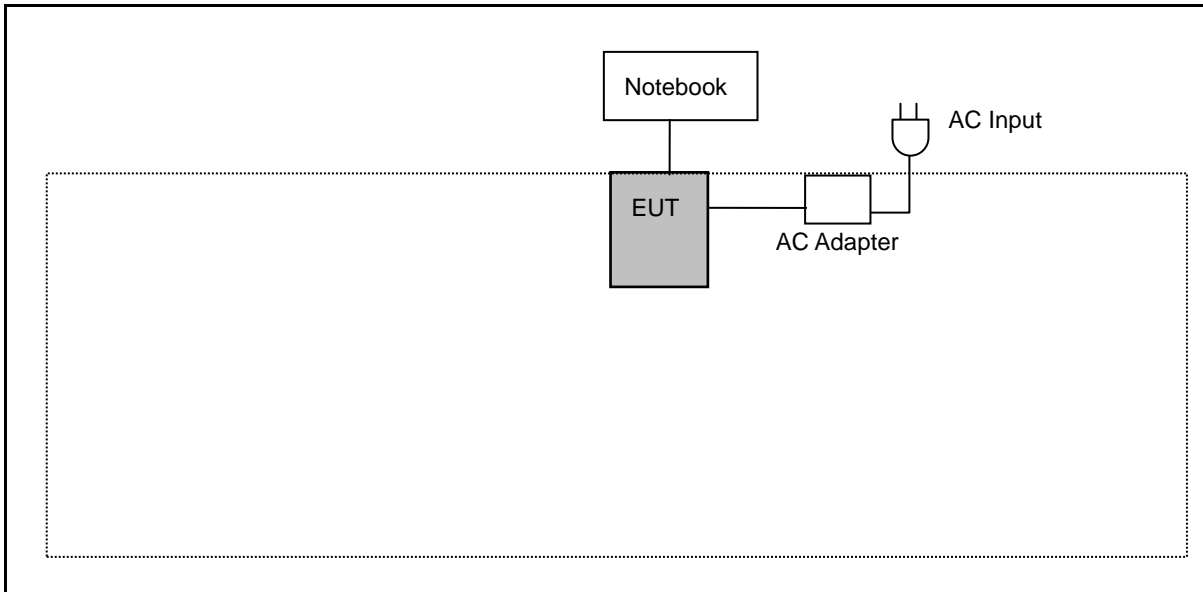

### 3.4. Test Site Environment

Items	Required (IEC 60068-1)	Actual
Temperature (°C)	15-35	26
Humidity (%RH)	25-75	60
Barometric pressure (mbar)	860-1060	950

## 4 Test Results

### 4.1. AC Power Conducted Emission Measurement

#### ■ Limit

Frequency (MHz)	Quasi-peak	Average
0.15 - 0.5	66 to 56	56 to 46
0.50 - 5.0	56	46
5.0 - 30.0	60	50

#### ■ Test Instruments

Describe	Manufacturer	Model Number	Serial Number	Cal. Date	Remark
Test Receiver	R&S	ESCI	100367	05/18/2017	1 year
LISN	R&S	ENV216	101040	04/01/2017	1 year
LISN	R&S	ENV216	101041	03/15/2017	1 year
RF Cable	Woken	00100D1380194M	TE-02-02	05/19/2017	1 year
Test Site	ATL	TE02	TE02	N.C.R.	-----

Note: N.C.R. = No Calibration Request.

#### ■ Test Setup

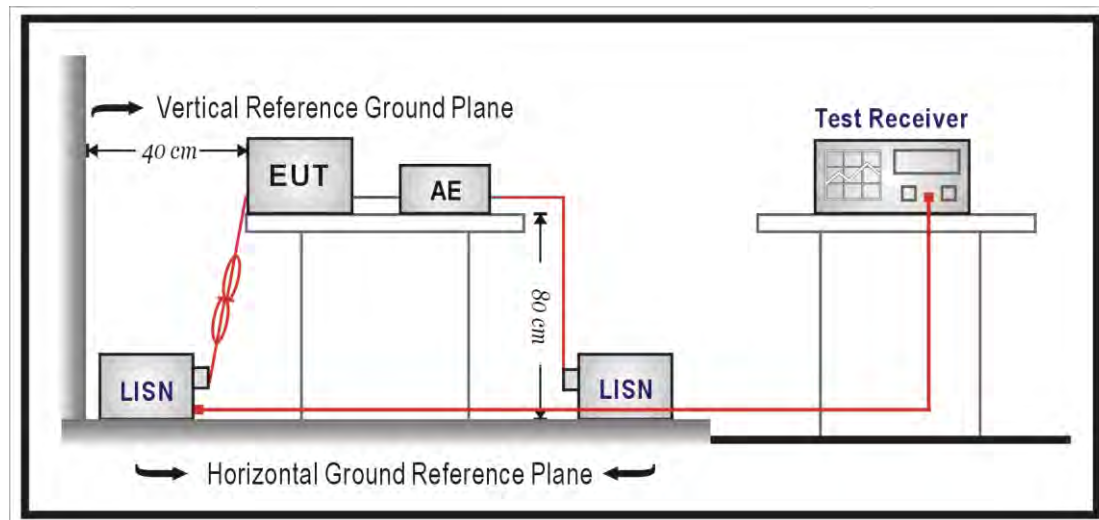

## 4.2. Test Procedure

The EUT and simulators are connected to the main power through a line impedance stabilization network (L.I.S.N.). This provides a  $50\Omega//50\mu\text{H}$  coupling impedance for the measuring equipment. The peripheral devices are also connected to the main power through a LISN that provides a  $50\Omega//50\mu\text{H}$  coupling impedance with 50ohm termination.

Tabletop device shall be placed on a non-conducting platform, of nominal size 1 m by 1.5 m, raised 80 cm above the reference ground plane. The wall of screened room shall be located 40cm to the rear of the EUT. Other surfaces of tabletop or floor standing EUT shall be at least 80cm from any other ground conducting surface including one or more LISNs. For floor-standing device shall be placed under the EUT with a 12mm insulating material.

Conducted emissions were investigated over the frequency range from 0.15 MHz to 30 MHz using a resolution bandwidth of 9 kHz. The equipment under test (EUT) shall be meet the limits in section 4.1, as applicable, including the average limit and the quasi-peak limit when using respectively, an average detector and quasi-peak detector measured in accordance with the methods described of related standard. When all of peak value were complied with quasi-peak and average limit from 150kHz to 30MHz then quasi-peak and average measurement was unnecessary.

The AMN shall be placed 0,8 m from the boundary of the unit under test and bonded to a ground reference plane for AMNs mounted on top of the ground reference plane. This distance is between the closest points of the AMN and the EUT. All other units of the EUT and associated equipment shall be at least 0,8 m from the AMN. If the mains power cable is longer than 1m then the cable shall be folded back and forth at the centre of the lead to form a bundle no longer than 0.4m. All of interconnecting cables that hang closer than 40cm to the ground plane shall be folded back and forth in the center forming a bundle 30 cm to 40 cm long. All of EUT and AE shall be separate place more than 0.1m. All  $50\Omega$  ports of the LISN shall be resistively terminated into  $50\Omega$  loads when not connected to the measuring instrument.

If the reading of the measuring receiver shows fluctuations close to the limit, the reading shall be observed for at least 15 s at each measurement frequency; the higher reading shall be recorded with the exception of any brief isolated high reading which shall be ignored.

■ **Test Result**

Standard:	FCC Part 15.407	Line:	L1
Test item:	Conducted Emission	Power:	AC 120V/60Hz
Test Mode:	Mode 1	Temp.(°C)/Hum.(%RH):	26(°C)/60%RH
		Date:	03/09/2017
Description:			

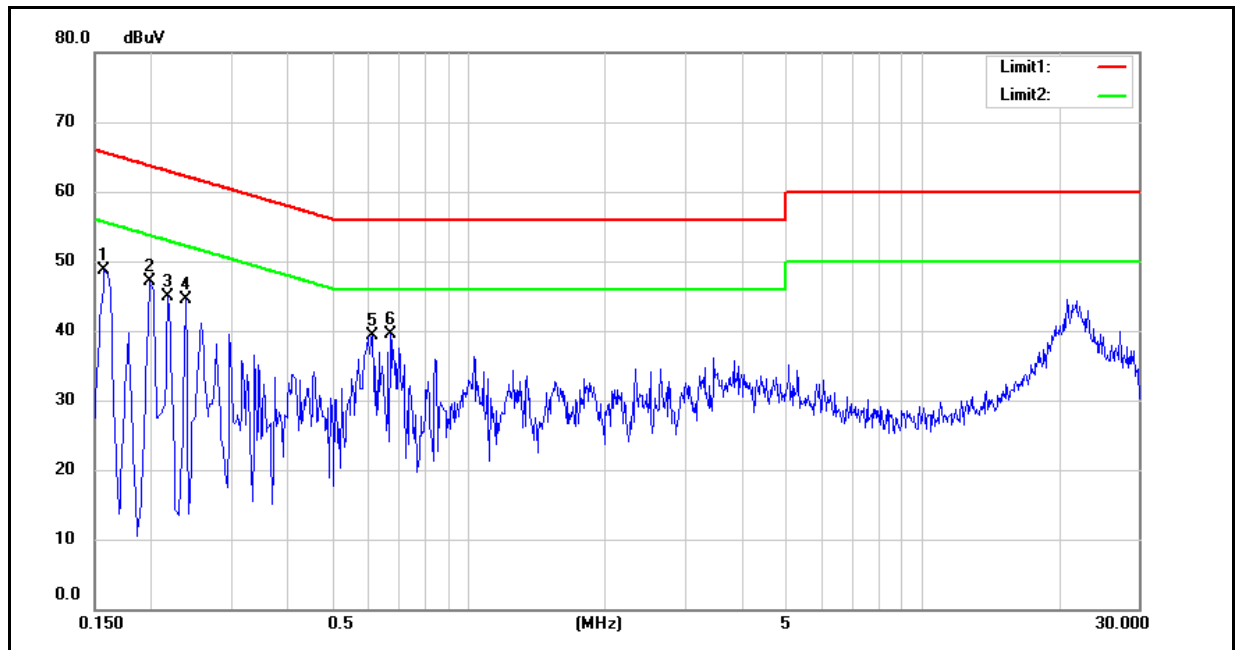

No.	Frequency (MHz)	QP reading (dBuV)	AVG reading (dBuV)	Correction factor (dB)	QP result (dBuV)	AVG result (dBuV)	QP limit (dBuV)	AVG limit (dBuV)	QP margin (dB)	AVG margin (dB)	Remark
1	0.1580	40.19	21.34	9.64	49.83	30.98	65.57	55.57	-15.74	-24.59	Pass
2	0.1980	34.11	14.48	9.64	43.75	24.12	63.69	53.69	-19.94	-29.57	Pass
3	0.2180	31.54	10.88	9.64	41.18	20.52	62.89	52.89	-21.71	-32.37	Pass
4	0.2380	27.91	4.60	9.64	37.55	14.24	62.17	52.17	-24.62	-37.93	Pass
5	0.6140	28.21	16.79	9.68	37.89	26.47	56.00	46.00	-18.11	-19.53	Pass
6	0.6740	26.59	13.57	9.68	36.27	23.25	56.00	46.00	-19.73	-22.75	Pass

Note: 1. Result = Correction factor + Reading

2. Correction factor = Antenna Factor + Cable loss – Pre-Amplifier gain.



Standard:	FCC Part 15.407	Line:	N
Test item:	Conducted Emission	Power:	AC 120V/60Hz
Test Mode:	Mode 1	Temp.(°C)/Hum.(%RH):	26(°C)/60%RH
		Date:	03/09/2017
Description:			

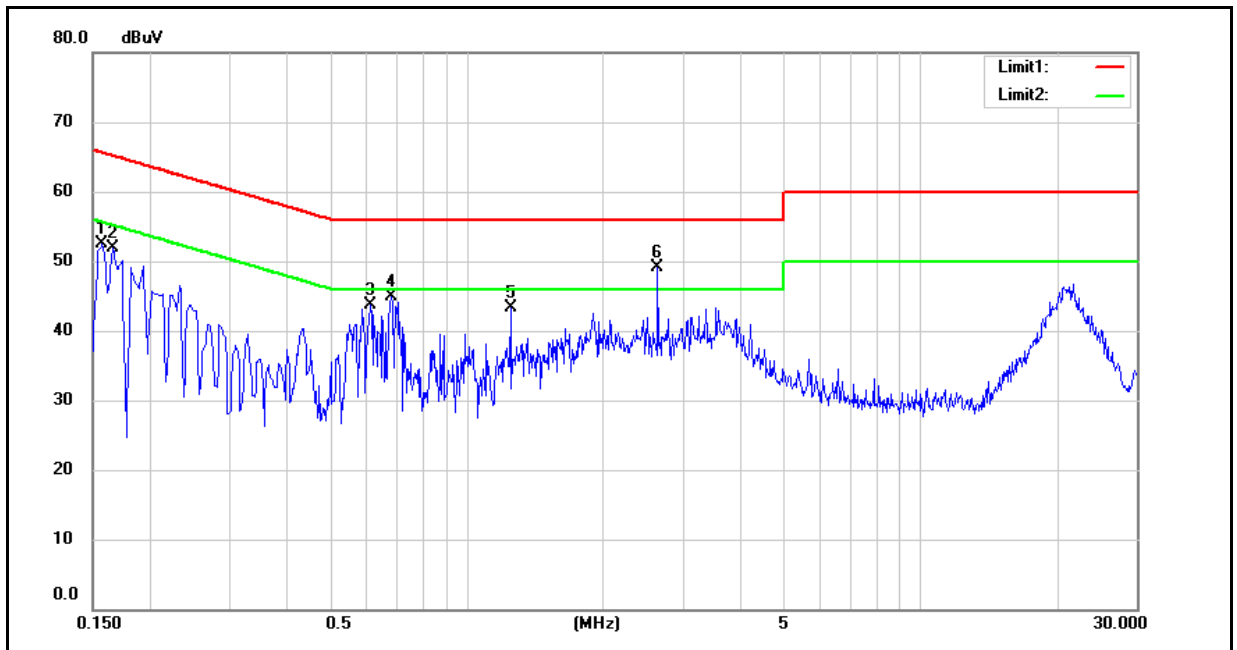

No.	Frequency (MHz)	QP reading (dBuV)	AVG reading (dBuV)	Correction factor (dB)	QP result (dBuV)	AVG result (dBuV)	QP limit (dBuV)	AVG limit (dBuV)	QP margin (dB)	AVG margin (dB)	Remark
1	0.1580	36.69	11.50	9.63	46.32	21.13	65.57	55.57	-19.25	-34.44	Pass
2	0.1660	36.42	13.61	9.64	46.06	23.25	65.16	55.16	-19.10	-31.91	Pass
3	0.6140	32.28	17.85	9.68	41.96	27.53	56.00	46.00	-14.04	-18.47	Pass
4	0.6860	31.15	16.92	9.68	40.83	26.60	56.00	46.00	-15.17	-19.40	Pass
5	1.2500	23.02	9.64	9.71	32.73	19.35	56.00	46.00	-23.27	-26.65	Pass
6	2.6420	24.98	16.39	9.78	34.76	26.17	56.00	46.00	-21.24	-19.83	Pass

Note: 1. Result = Correction factor + Reading  
 2. Correction factor = Antenna Factor + Cable loss – Pre-Amplifier gain.

### 4.3. Transmitter Radiated Emissions Measurement

#### ■ Limit

(1) Undesirable emission limits. Except as shown in paragraph (b)(7) of this section, the maximum emissions outside of the frequency bands of operation shall be attenuated in accordance with the following limits:

- (a) For transmitters operating in the 5.15-5.25 GHz band: All emissions outside of the 5.15-5.35 GHz band shall not exceed an e.i.r.p. of -27 dBm/MHz.
- (b) For transmitters operating in the 5.25-5.35 GHz band: All emissions outside of the 5.15-5.35 GHz band shall not exceed an e.i.r.p. of -27 dBm/MHz.
- (c) For transmitters operating in the 5.47-5.725 GHz band: All emissions outside of the 5.47-5.725 GHz band shall not exceed an e.i.r.p. of -27 dBm/MHz.
- (d) For transmitters operating in the 5.725-5.85 GHz band:
  - (i) All emissions shall be limited to a level of -27 dBm/MHz at 75 MHz or more above or below the band edge increasing linearly to 10 dBm/MHz at 25 MHz above or below the band edge, and from 25 MHz above or below the band edge increasing linearly to a level of 15.6 dBm/MHz at 5 MHz above or below the band edge, and from 5 MHz above or below the band edge increasing linearly to a level of 27 dBm/MHz at the band edge.

(2) Limits of Radiated Emission Measurement

Emissions radiated outside of the specified bands, shall be according to the general radiated limits in 15.209 as following:

Frequency Range (MHz)	Field Strength (microvolts/meter)	Measurement Distance (meters)
0.009 ~ 0.490	2400/F(kHz)	300
0.490 ~ 1.705	24000/F(kHz)	30
1.705 ~ 30.0	30	30
30 ~ 88	10	3
88 ~ 216	150	3
216 ~ 960	200	3
Above 960	500	3

- Note:
1. The lower limit shall apply at the transition frequencies.
  2. Emission level (dBuV/m) = 20 log Emission level (uV/m).
  3. As shown in 15.35(b), for frequencies above 1000MHz, the field strength limits are based on average detector, however, the peak field strength of any emission shall not exceed the maximum permitted average limits, specified above by more than 20dB under any condition of modulation.

**■ Test Instruments**

3 Meter Chamber					
Equipment	Manufacturer	Model Number	Serial Number	Cal. Date	Remark
RF Pre-selector	Agilent	N9039A	MY46520256	06/22/2016	1 year
Spectrum Analyzer	Agilent	E4446A	MY46180578	06/22/2016	1 year
Pre Amplifier	Agilent	8449B	3008A02237	10/11/2016	1 year
Pre Amplifier	Agilent	8447D	2944A11119	01/12/2017	1 year
Broadband Antenna	Schwarzbeck	VULB9168	416	10/13/2016	1 year
Horn Antenna (1~18GHz)	SCHWARZBECK MESS-ELEKTRONIK	BBHA9120D	9120D-550	06/06/2016	1 year
Horn Antenna (18~40GHz)	ETS	3116	86467	09/05/2016	1 year
Loop Antenna	COM-POWER CORPORATION	AL-130	121014	01/26/2017	1 year
Microwave Cable	EMCI	EMC102-KM-KM-1 4000	151001	02/20/2017	1 year
Microwave Cable	EMCI	EMC-104-SM-SM- 14000	140202	02/20/2017	1 year
Microwave Cable	EMCI	EMC104-SM-SM-6 00	140301	02/20/2017	1 year
Preamplifier	Amplifier	EMC2654045	980028	08/15/2016	1 year
Test Site	ATL	TE01	888001	08/29/2016	1 year

Note: N.C.R. = No Calibration Request.

**■ Setup**

9kHz ~ 30MHz

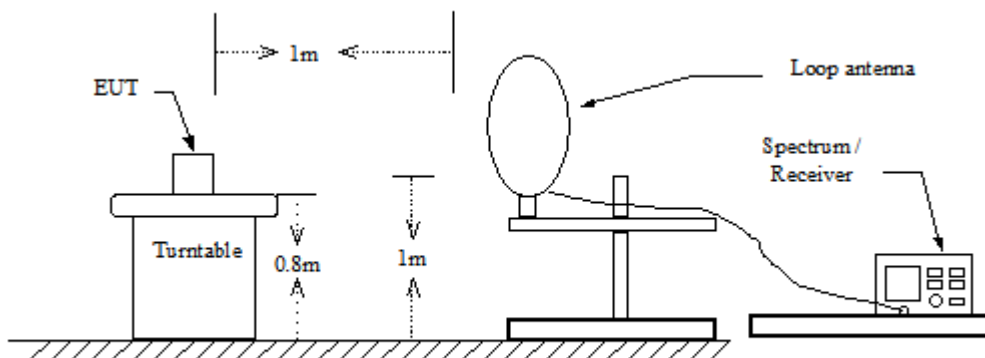



30MHz ~ 1GHz

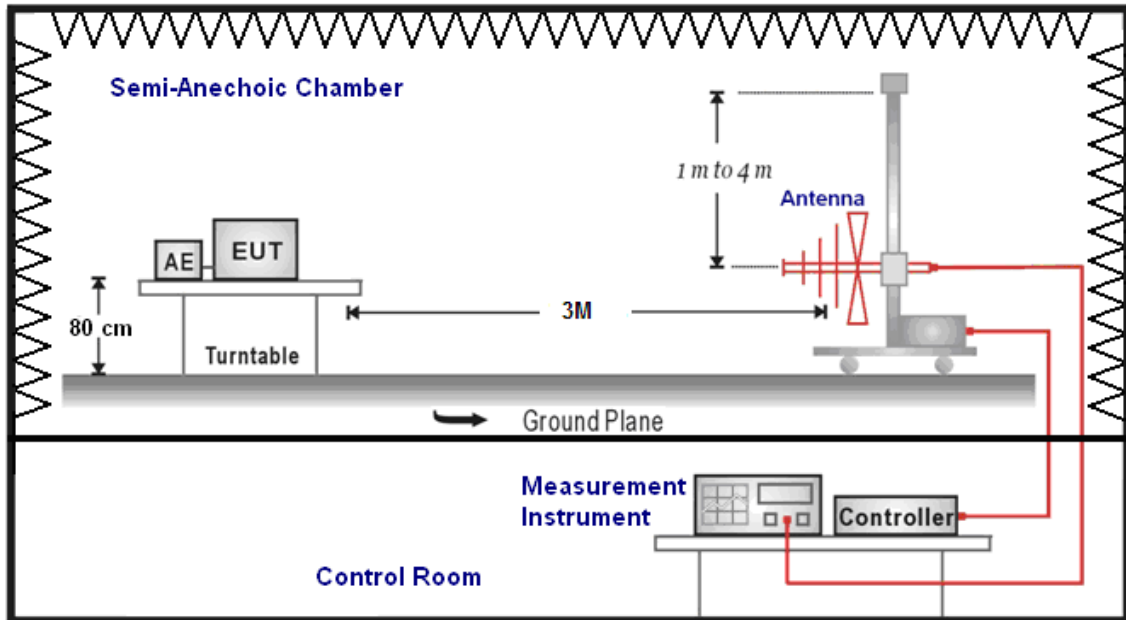

Above 1GHz

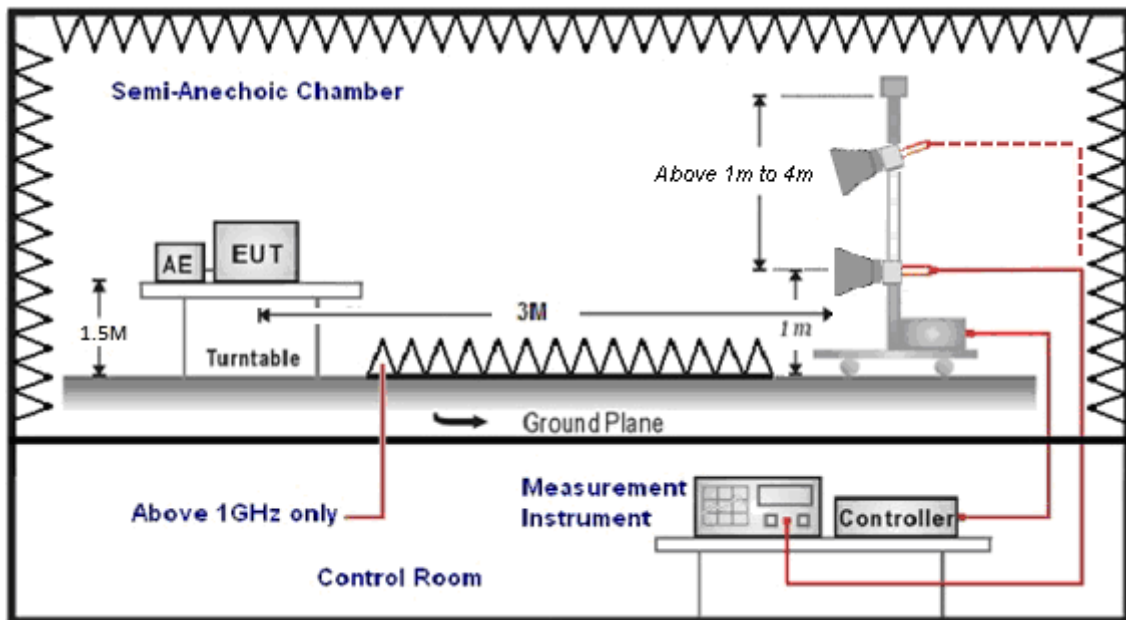

### ■ Test Procedure

Final radiation measurements were made on a three-meter, Semi Anechoic Chamber. The EUT system was placed on a nonconductive turntable which is 0.8 or 1.5 meters height (below 1GHz use 0.8m turntable / above 1GHz use 1.5m turntable), top surface 1.0 x 1.5 meter. The spectrum was examined from 250 MHz to 2.5 GHz in order to cover the whole spectrum below 10th harmonic which could generate from the EUT. During the test, EUT was set to transmit continuously & Measurements spectrum range from 9 kHz to 40 GHz is investigated.

For measurements below 1 GHz the resolution bandwidth is set to 100 kHz for peak detection measurements or 120 kHz for quasi-peak detection measurements. Peak detection is used unless otherwise noted as quasi-peak.

For restricted measurements above 1 GHz the resolution bandwidth is set to 1 MHz, and then the video bandwidth is set to 3 MHz for peak measurements and 10 Hz for average measurements when Duty cycle > 0.98 / 1/T for average measurements when Duty cycle < 0.98.

For out of band measurements above 1 GHz the resolution bandwidth is set to 1 MHz, and then the video bandwidth is set to 3 MHz for peak measurements.

A nonconductive material surrounded the EUT to supporting the EUT for standing on three orthogonal planes. At each condition, the EUT was rotated 360 degrees, and the antenna was raised and lowered from one to four meters to find the maximum emission levels. Measurements were taken using both horizontal and vertical antenna polarization.

SCHWARZBECK MESS-ELEKTRONIK Trilog-Broadband Antenna at 3 Meter and the ETS-Lindgren Double-Ridged Waveguide Horn antenna Schwarzbeck Mess-Elektronik Broadband Horn Antenna was used in frequencies 1 – 40 GHz at a distance of 3 meter. The antenna at an angle toward the source of the emission. All test results were extrapolated to equivalent signal at 3 meters utilizing an inverse linear distance extrapolation Factor (20dB/decade).

For testing above 1GHz, the emission level of the EUT in peak mode was 20dB lower than average limit (that means the emission level in peak mode also complies with the limit in average mode), then testing will be stopped and peak values of EUT will be reported, otherwise, the emissions will be measured in average mode again and reported.

Appropriate preamplifiers were used for improving sensitivity and precautions were taken to avoid overloading or desensitizing the spectrum analyzer. No post – detector video filters were used in the test.

The spectrum analyzer's 6 dB bandwidth was set to 1 MHz, and the analyzer was operated in the peak detection mode, for frequencies both below and up 1 GHz. The average levels were obtained by subtracting the duty cycle correction factor from the peak readings.

The following procedures were used to convert the emission levels measured in decibels referenced to 1 microvolt (dBuV) into field intensity in micro volts per meter (uV/m).

The actual field intensity in decibels referenced to 1 microvolt in to field intensity in micro volts per meter (dBuV/m).



The actual field intensity in referenced to 1 microvolt per meter (dBuV/m) is determined by algebraically adding the measured reading in dBuV, the antenna factor (dB), and cable loss (dB) and Subtracting the gain of preamplifier (dB) is auto calculate in spectrum analyzer.

(1)  $\text{Amplitude (dBuV/m)} = \text{FI (dBuV)} + \text{AF (dBuV)} + \text{CL (dBuV)} - \text{Gain (dB)}$

FI= Reading of the field intensity.

AF= Antenna factor.

CL= Cable loss.

P.S Amplitude is auto calculate in spectrum analyzer.

(2)  $\text{Actual Amplitude (dBuV/m)} = \text{Amplitude (dBuV)} - \text{Dis(dB)}$

The FCC specified emission limits were calculated according the EUT operating frequency and by following linear interpolation equations:

(a) For fundamental frequency : Transmitter Output < +30dBm

(b) For spurious frequency : Spurious emission limits = fundamental emission limit /10

### Measuring Instruments and setting

The following table is the setting of spectrum analyzer and receiver.

Spectrum Parameter	Setting
Attenuation	Auto
Start Frequency	1000MHz
Stop Frequency	40GHz
RBW/VBW(Emission in restricted band)	1MHz / 3MHz for Peak 1MHz / (1/T) for Average
RBW/VBW(Emission in non-restricted band)	1MHz / 3MHz for Peak



■ Test Result

Below 1GHz

Standard:	FCC Part 15.407	Test Distance:	3m
Test item:	Radiated Emission	Power:	AC 120V/60Hz
Test Mode:	Mode 1	Temp.(°C)/Hum.(%RH):	26(°C)/60%RH
Description:		Date:	04/17/2017

Frequency (MHz)	Reading (dBuV)	Correct Factor (dB/m)	Result (dBuV/m)	Limit (dBuV/m)	Margin (dB)	Remark	Ant.Polar. H / V
93.0500	47.68	-11.59	36.09	43.50	-7.41	QP	H
116.3300	39.90	-8.06	31.84	43.50	-11.66	QP	H
499.4800	40.57	0.73	41.30	46.00	-4.70	QP	H
514.0300	37.00	0.94	37.94	46.00	-8.06	QP	H
624.6100	31.36	3.40	34.76	46.00	-11.24	QP	H
874.8700	29.02	8.07	37.09	46.00	-8.91	QP	H
93.0500	53.83	-11.59	42.24	43.50	-1.26	QP	V
120.2100	44.45	-7.66	36.79	43.50	-6.71	QP	V
530.5200	36.22	1.19	37.41	46.00	-8.59	QP	V
624.6100	31.49	3.40	34.89	46.00	-11.11	QP	V
822.4900	28.71	7.06	35.77	46.00	-10.23	QP	V
931.1300	27.08	9.26	36.34	46.00	-9.66	QP	V

Note:1.Result (dBuV/m) = Correct Factor (dB/m) + Reading(dBuV).

2.Correction factor (dB/m) = Antenna Factor (dB/m) + Cable loss (dB) – Pre-Amplifier gain (dB).

3. When the peak results are less than average limit, so not need to evaluate the average.



Above 1GHz

Standard:	FCC Part 15.407	Test Distance:	3m
Test item:	Harmonic	Power:	AC 120V/60Hz
Frequency:	5180MHz	Temp.(°C)/Hum.(%RH):	26(°C)/60%RH
Mode:	Mode 2	Date:	04/06/2017
Ant.Polar.:	Horizontal		

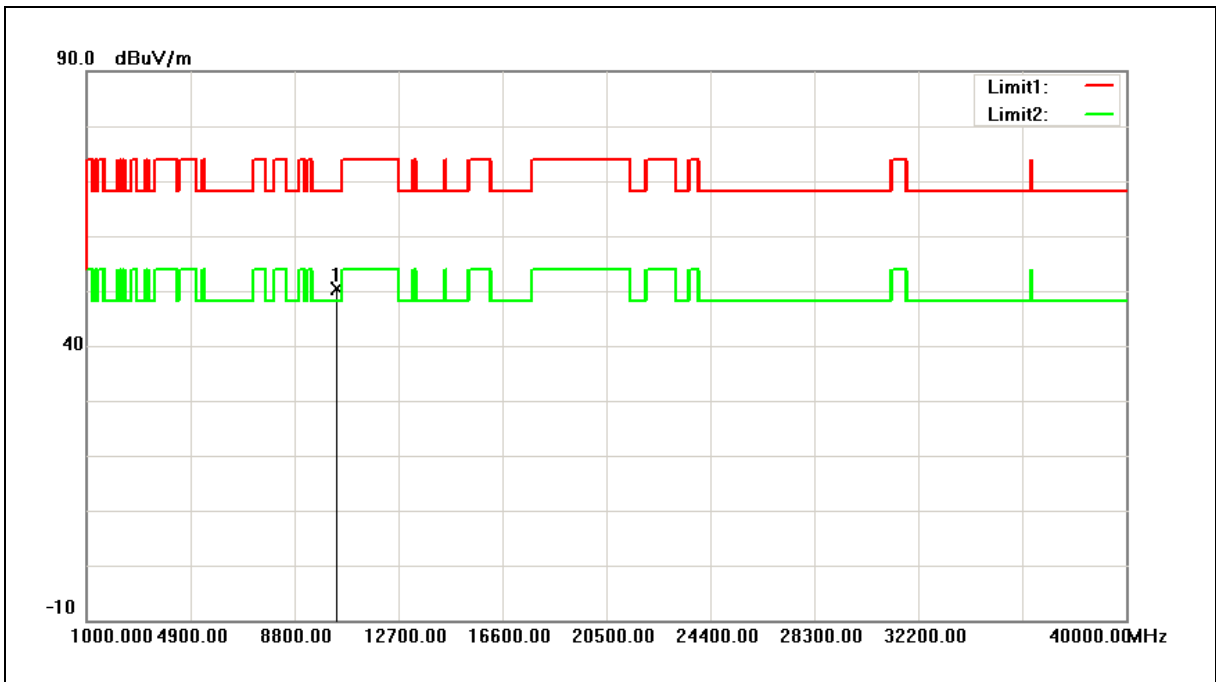

No.	Frequency (MHz)	Reading (dBuV)	Correct Factor (dB/m)	Result (dBuV/m)	Limit (dBuV/m)	Margin (dB)	Remark
1	10360.000	44.92	5.36	50.28	68.20	-17.92	peak

Note:1.Result (dBuV/m) = Correct Factor (dB/m) + Reading(dBuV).

2.Correction factor (dB/m) = Antenna Factor (dB/m) + Cable loss (dB) – Pre-Amplifier gain (dB).

3. When the peak results are less than average limit, so not need to evaluate the average.



Standard:	FCC Part 15.407	Test Distance:	3m
Test item:	Harmonic	Power:	AC 120V/60Hz
Frequency:	5180MHz	Temp.(°C)/Hum.(%RH):	26(°C)/60%RH
Mode:	Mode 2	Date:	04/06/2017
Ant.Polar.:	Vertical		

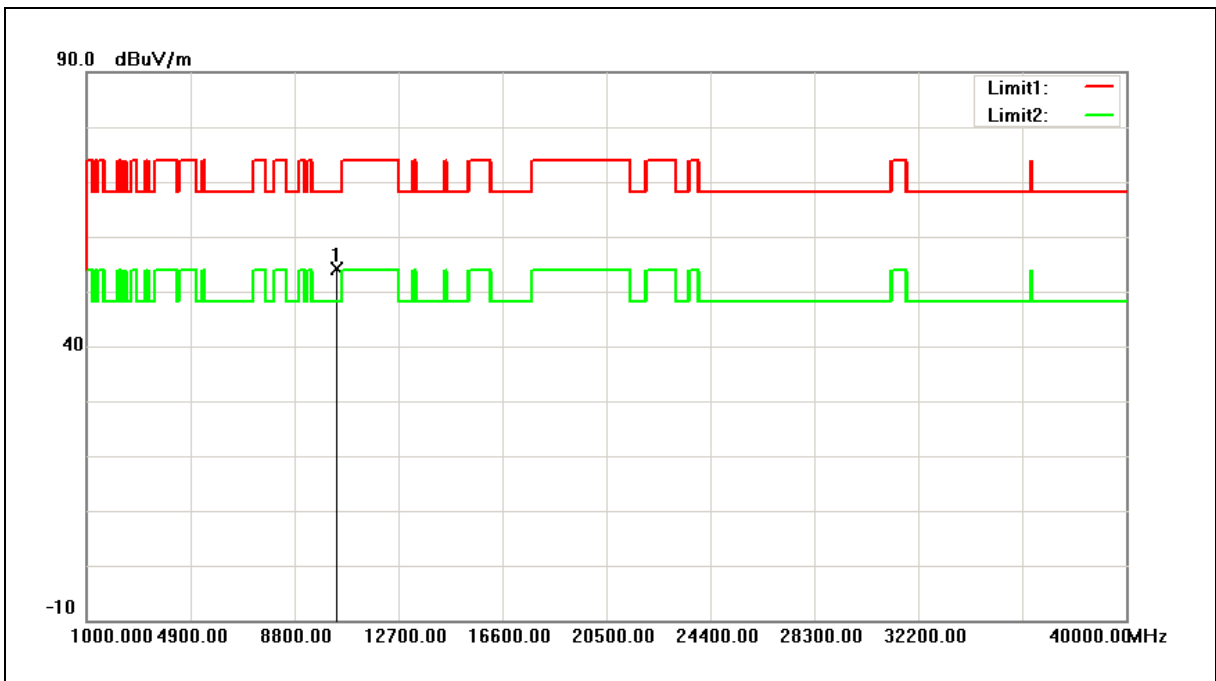

No.	Frequency (MHz)	Reading (dBuV)	Correct Factor (dB/m)	Result (dBuV/m)	Limit (dBuV/m)	Margin (dB)	Remark
1	10360.000	48.76	5.36	54.12	68.20	-14.08	peak

Note:1.Result (dBuV/m) = Correct Factor (dB/m) + Reading(dBuV).

2.Correction factor (dB/m) = Antenna Factor (dB/m) + Cable loss (dB) – Pre-Amplifier gain (dB).

3. When the peak results are less than average limit, so not need to evaluate the average.



Standard:	FCC Part 15.407	Test Distance:	3m
Test item:	Harmonic	Power:	AC 120V/60Hz
Frequency:	5200MHz	Temp.(°C)/Hum.(%RH):	26(°C)/60%RH
Mode:	Mode 2	Date:	04/06/2017
Ant.Polar.:	Horizontal		

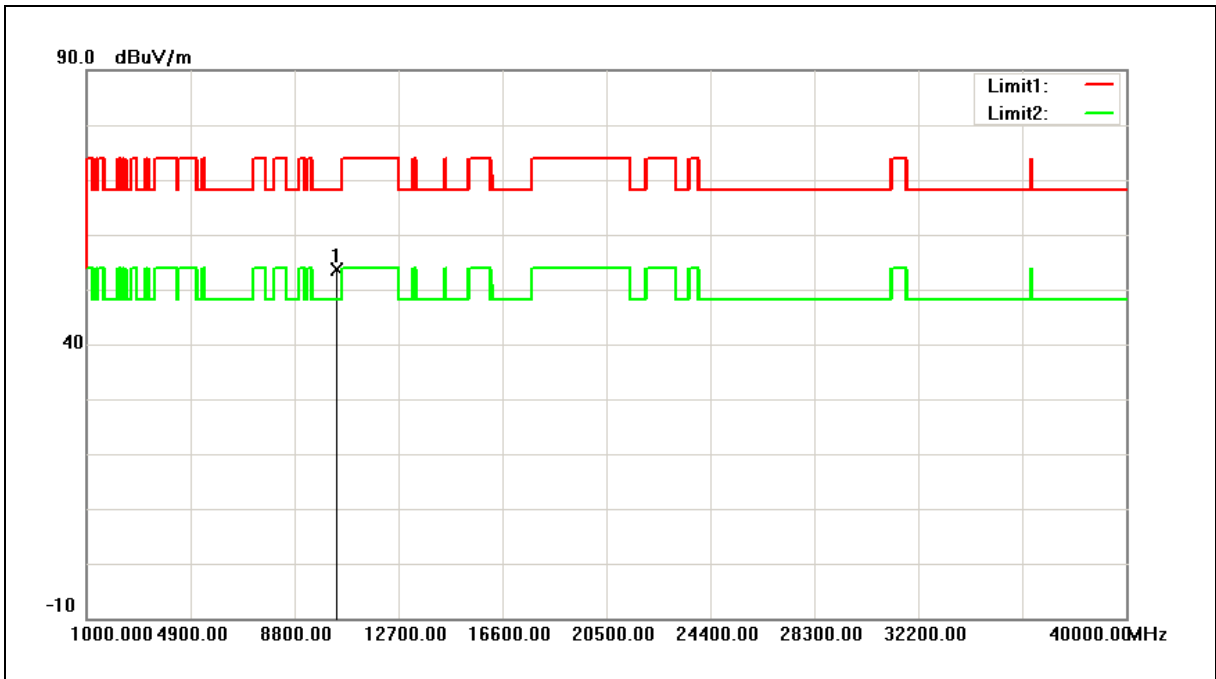

No.	Frequency (MHz)	Reading (dBuV)	Correct Factor (dB/m)	Result (dBuV/m)	Limit (dBuV/m)	Margin (dB)	Remark
1	10400.000	48.20	5.45	53.65	68.20	-14.55	peak

Note:1.Result (dBuV/m) = Correct Factor (dB/m) + Reading(dBuV).

2.Correction factor (dB/m) = Antenna Factor (dB/m) + Cable loss (dB) – Pre-Amplifier gain (dB).

3. When the peak results are less than average limit, so not need to evaluate the average.



Standard:	FCC Part 15.407	Test Distance:	3m
Test item:	Harmonic	Power:	AC 120V/60Hz
Frequency:	5200MHz	Temp.(°C)/Hum.(%RH):	26(°C)/60%RH
Mode:	Mode 2	Date:	04/06/2017
Ant.Polar.:	Vertical		

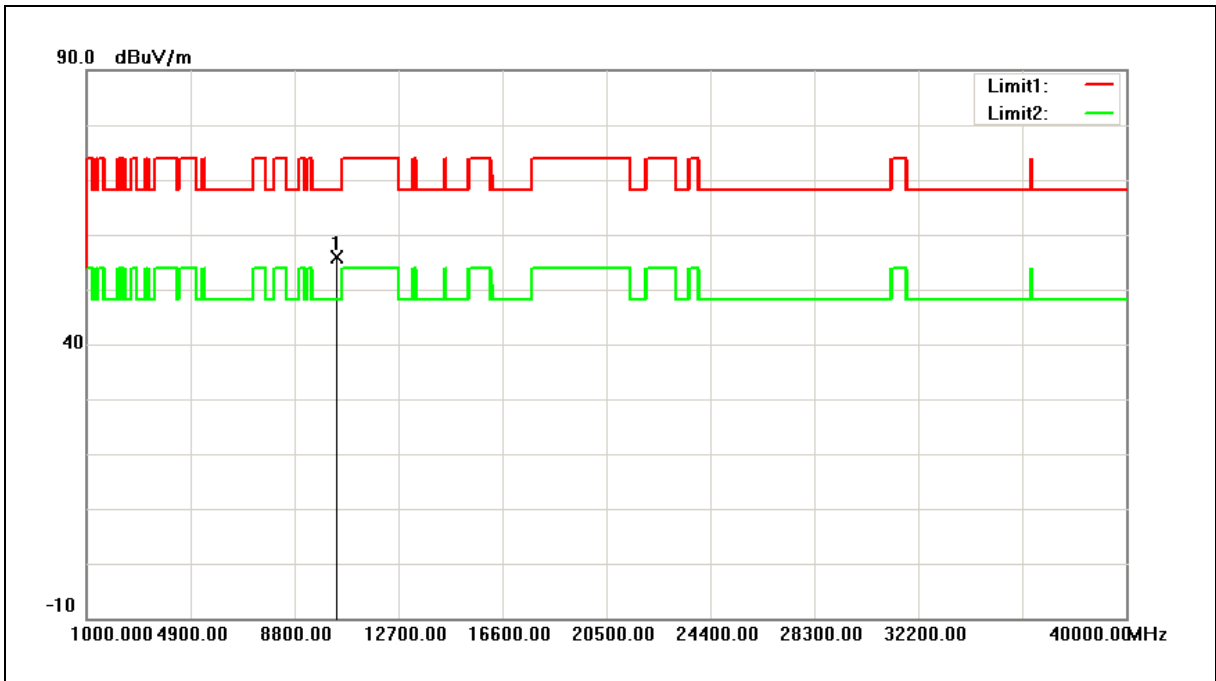

No.	Frequency (MHz)	Reading (dBuV)	Correct Factor (dB/m)	Result (dBuV/m)	Limit (dBuV/m)	Margin (dB)	Remark
1	10400.000	50.33	5.45	55.78	68.20	-12.42	peak

Note:1.Result (dBuV/m) = Correct Factor (dB/m) + Reading(dBuV).

2.Correction factor (dB/m) = Antenna Factor (dB/m) + Cable loss (dB) – Pre-Amplifier gain (dB).

3. When the peak results are less than average limit, so not need to evaluate the average.





Standard:	FCC Part 15.407	Test Distance:	3m
Test item:	Harmonic	Power:	AC 120V/60Hz
Frequency:	5240MHz	Temp.(°C)/Hum.(%RH):	26(°C)/60%RH
Mode:	Mode 2	Date:	04/06/2017
Ant.Polar.:	Horizontal		

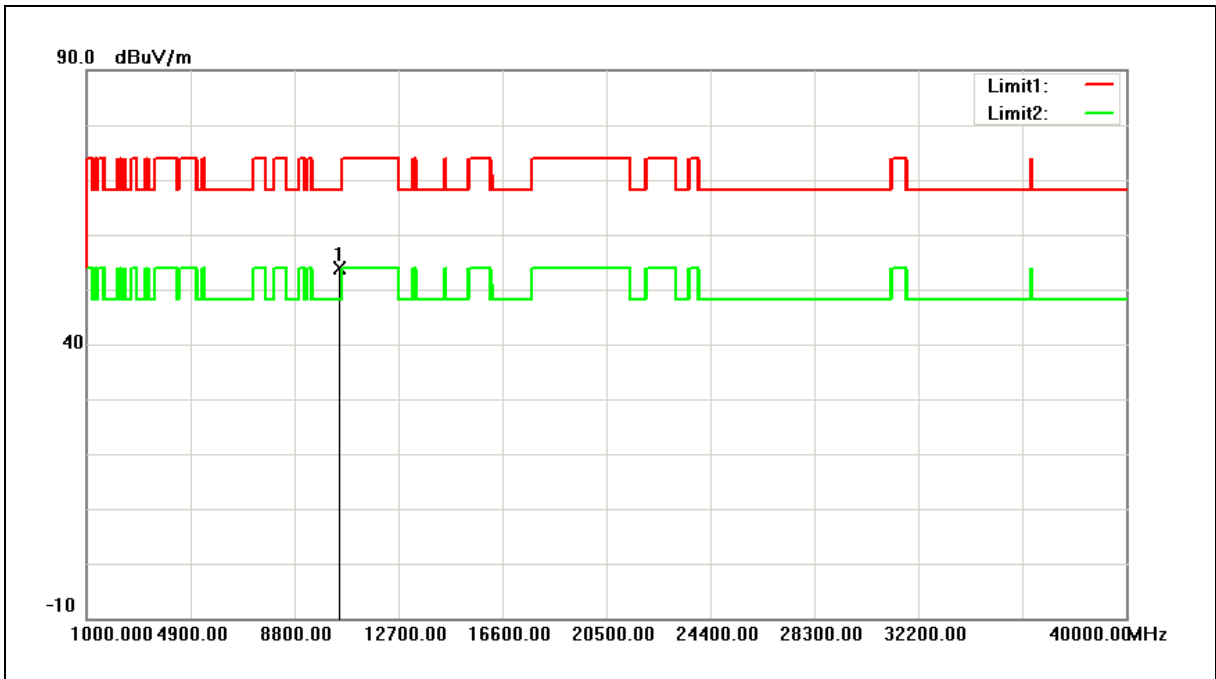

No.	Frequency (MHz)	Reading (dBuV)	Correct Factor (dB/m)	Result (dBuV/m)	Limit (dBuV/m)	Margin (dB)	Remark
1	10480.000	48.31	5.63	53.94	68.20	-14.26	peak

Note:1.Result (dBuV/m) = Correct Factor (dB/m) + Reading(dBuV).

2.Correction factor (dB/m) = Antenna Factor (dB/m) + Cable loss (dB) – Pre-Amplifier gain (dB).

3. When the peak results are less than average limit, so not need to evaluate the average.



Standard:	FCC Part 15.407	Test Distance:	3m
Test item:	Harmonic	Power:	AC 120V/60Hz
Frequency:	5240MHz	Temp.(°C)/Hum.(%RH):	26(°C)/60%RH
Mode:	Mode 2	Date:	04/06/2017
Ant.Polar.:	Vertical		

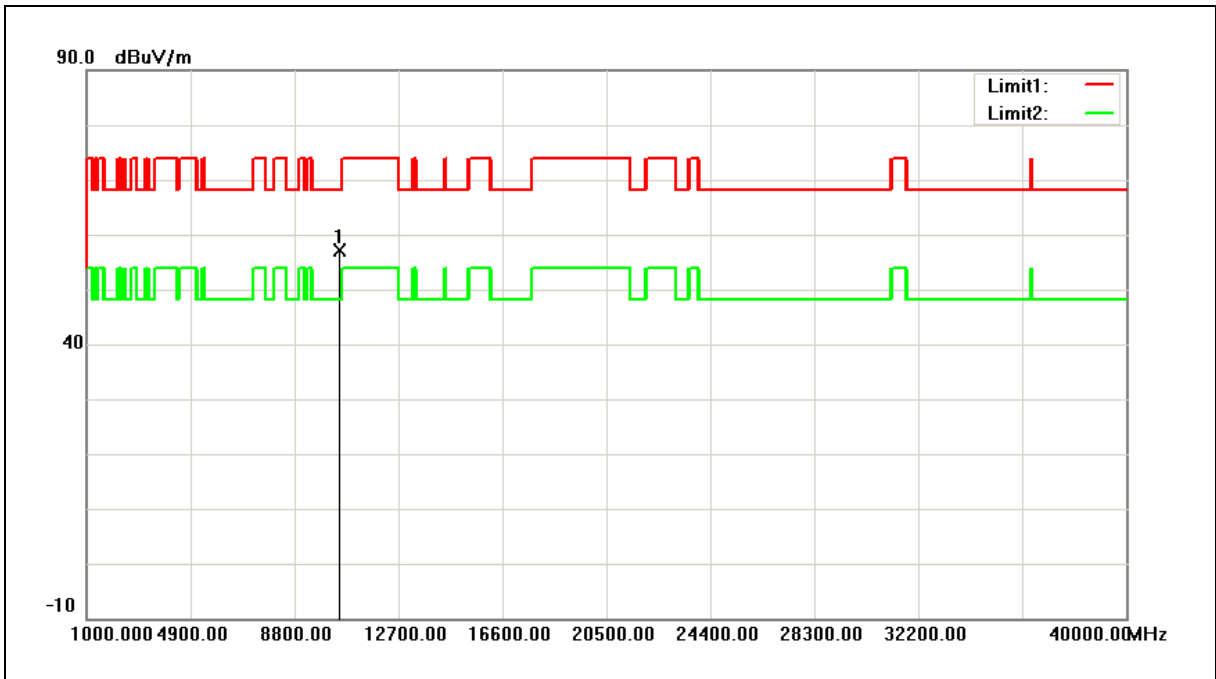

No.	Frequency (MHz)	Reading (dBuV)	Correct Factor (dB/m)	Result (dBuV/m)	Limit (dBuV/m)	Margin (dB)	Remark
1	10480.000	51.43	5.63	57.06	68.20	-11.14	peak

Note:1.Result (dBuV/m) = Correct Factor (dB/m) + Reading(dBuV).

2.Correction factor (dB/m) = Antenna Factor (dB/m) + Cable loss (dB) – Pre-Amplifier gain (dB).

3. When the peak results are less than average limit, so not need to evaluate the average.



Standard:	FCC Part 15.407	Test Distance:	3m
Test item:	Harmonic	Power:	AC 120V/60Hz
Frequency:	5745MHz	Temp.(°C)/Hum.(%RH):	26(°C)/60%RH
Mode:	Mode 2	Date:	04/07/2017
Ant.Polar.:	Horizontal		

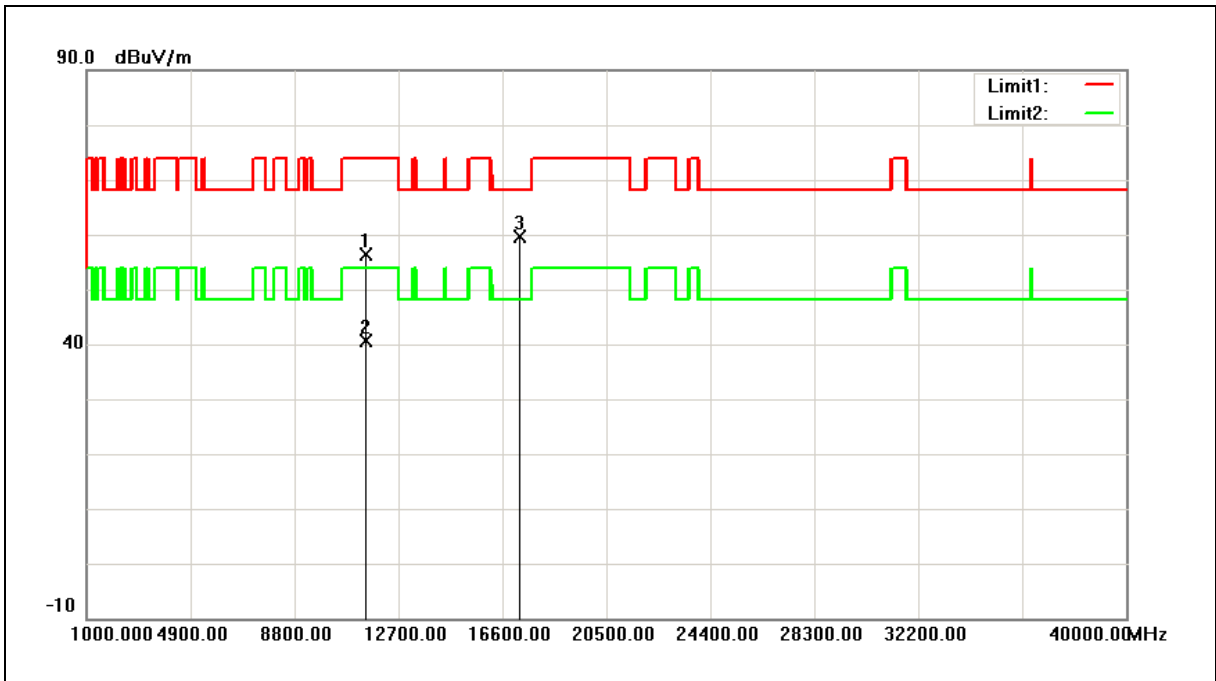

No.	Frequency (MHz)	Reading (dBuV)	Correct Factor (dB/m)	Result (dBuV/m)	Limit (dBuV/m)	Margin (dB)	Remark
1	11490.000	49.74	6.61	56.35	74.00	-17.65	peak
2	11490.000	34.04	6.61	40.65	54.00	-13.35	AVG
3	17235.000	48.84	10.87	59.71	68.20	-8.49	peak

Note:1.Result (dBuV/m) = Correct Factor (dB/m) + Reading(dBuV).

2.Correction factor (dB/m) = Antenna Factor (dB/m) + Cable loss (dB) – Pre-Amplifier gain (dB).

3. When the peak results are less than average limit, so not need to evaluate the average.



Standard:	FCC Part 15.407	Test Distance:	3m
Test item:	Harmonic	Power:	AC 120V/60Hz
Frequency:	5745MHz	Temp.(°C)/Hum.(%RH):	26(°C)/60%RH
Mode:	Mode 2	Date:	04/07/2017
Ant.Polar.:	Vertical		

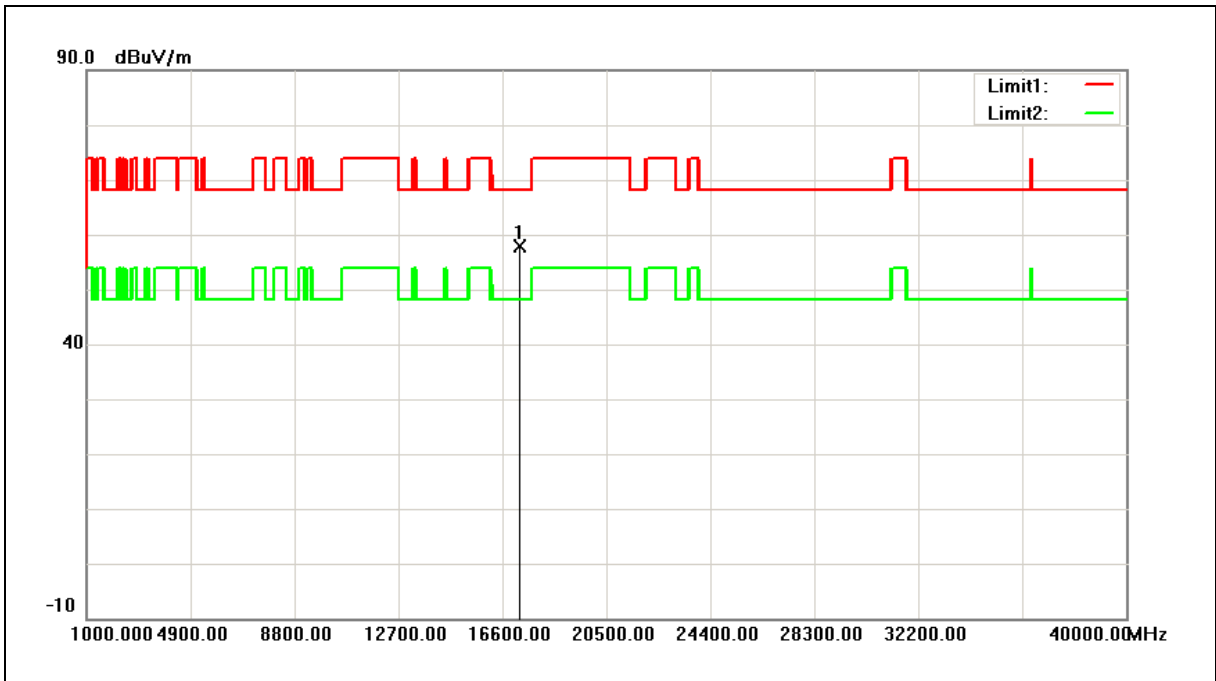

No.	Frequency (MHz)	Reading (dBuV)	Correct Factor (dB/m)	Result (dBuV/m)	Limit (dBuV/m)	Margin (dB)	Remark
1	17235.000	47.10	10.87	57.97	68.20	-10.23	peak

Note:1.Result (dBuV/m) = Correct Factor (dB/m) + Reading(dBuV).

2.Correction factor (dB/m) = Antenna Factor (dB/m) + Cable loss (dB) – Pre-Amplifier gain (dB).

3. When the peak results are less than average limit, so not need to evaluate the average.



Standard:	FCC Part 15.407	Test Distance:	3m
Test item:	Harmonic	Power:	AC 120V/60Hz
Frequency:	5785MHz	Temp.(°C)/Hum.(%RH):	26(°C)/60%RH
Mode:	Mode 2	Date:	04/07/2017
Ant.Polar.:	Horizontal		

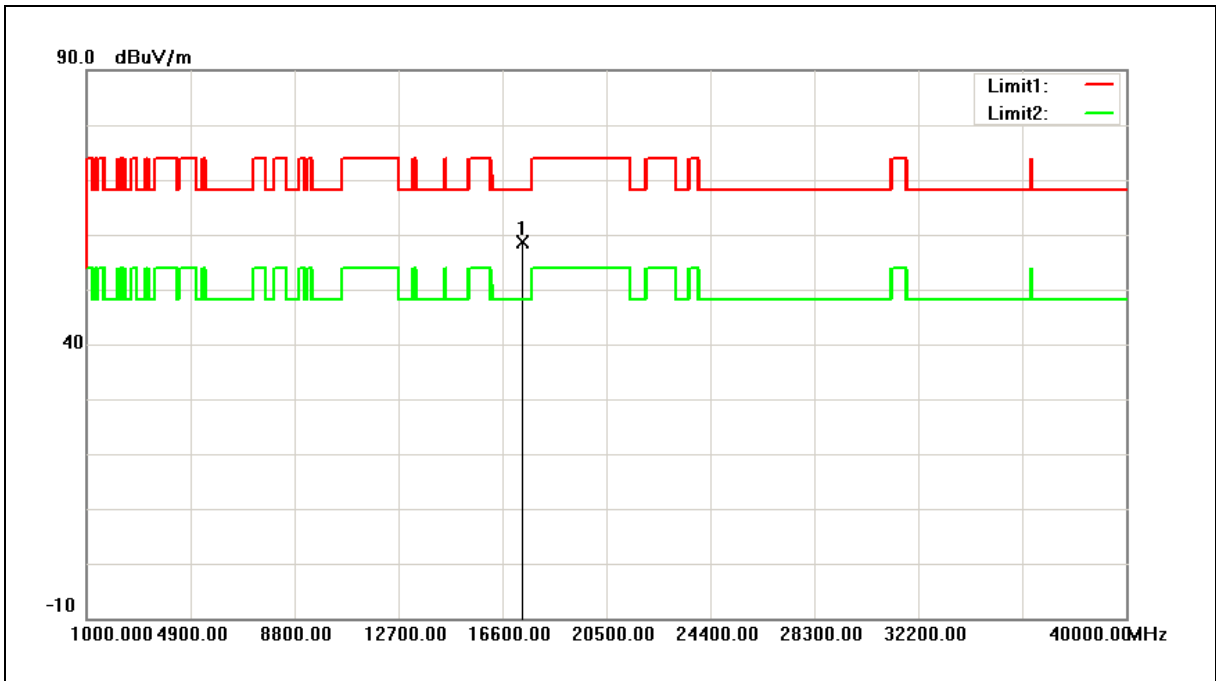

No.	Frequency (MHz)	Reading (dBuV)	Correct Factor (dB/m)	Result (dBuV/m)	Limit (dBuV/m)	Margin (dB)	Remark
1	17355.000	47.06	11.52	58.58	68.20	-9.62	peak

Note:1.Result (dBuV/m) = Correct Factor (dB/m) + Reading(dBuV).

2.Correction factor (dB/m) = Antenna Factor (dB/m) + Cable loss (dB) – Pre-Amplifier gain (dB).

3. When the peak results are less than average limit, so not need to evaluate the average.



Standard:	FCC Part 15.407	Test Distance:	3m
Test item:	Harmonic	Power:	AC 120V/60Hz
Frequency:	5785MHz	Temp.(°C)/Hum.(%RH):	26(°C)/60%RH
Mode:	Mode 2	Date:	04/07/2017
Ant.Polar.:	Vertical		

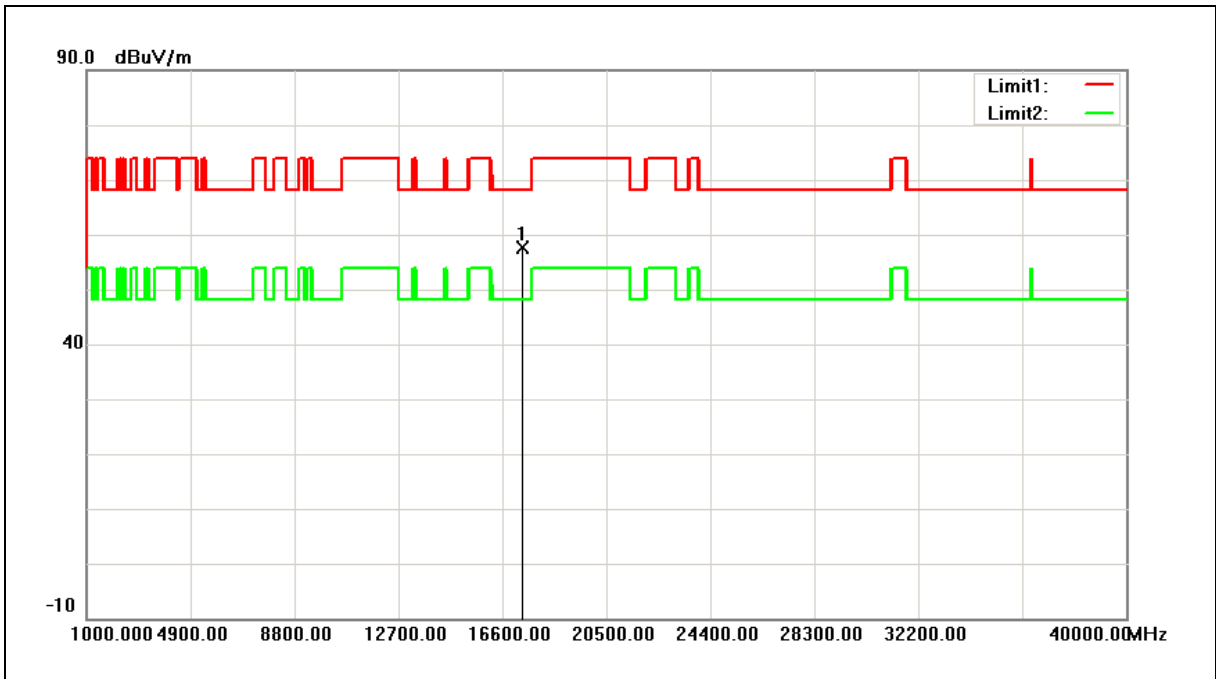

No.	Frequency (MHz)	Reading (dBuV)	Correct Factor (dB/m)	Result (dBuV/m)	Limit (dBuV/m)	Margin (dB)	Remark
1	17355.000	46.05	11.52	57.57	68.20	-10.63	peak

Note:1.Result (dBuV/m) = Correct Factor (dB/m) + Reading(dBuV).

2.Correction factor (dB/m) = Antenna Factor (dB/m) + Cable loss (dB) – Pre-Amplifier gain (dB).

3. When the peak results are less than average limit, so not need to evaluate the average.



Standard:	FCC Part 15.407	Test Distance:	3m
Test item:	Harmonic	Power:	AC 120V/60Hz
Frequency:	5825MHz	Temp.(°C)/Hum.(%RH):	26(°C)/60%RH
Mode:	Mode 2	Date:	04/07/2017
Ant.Polar.:	Horizontal		

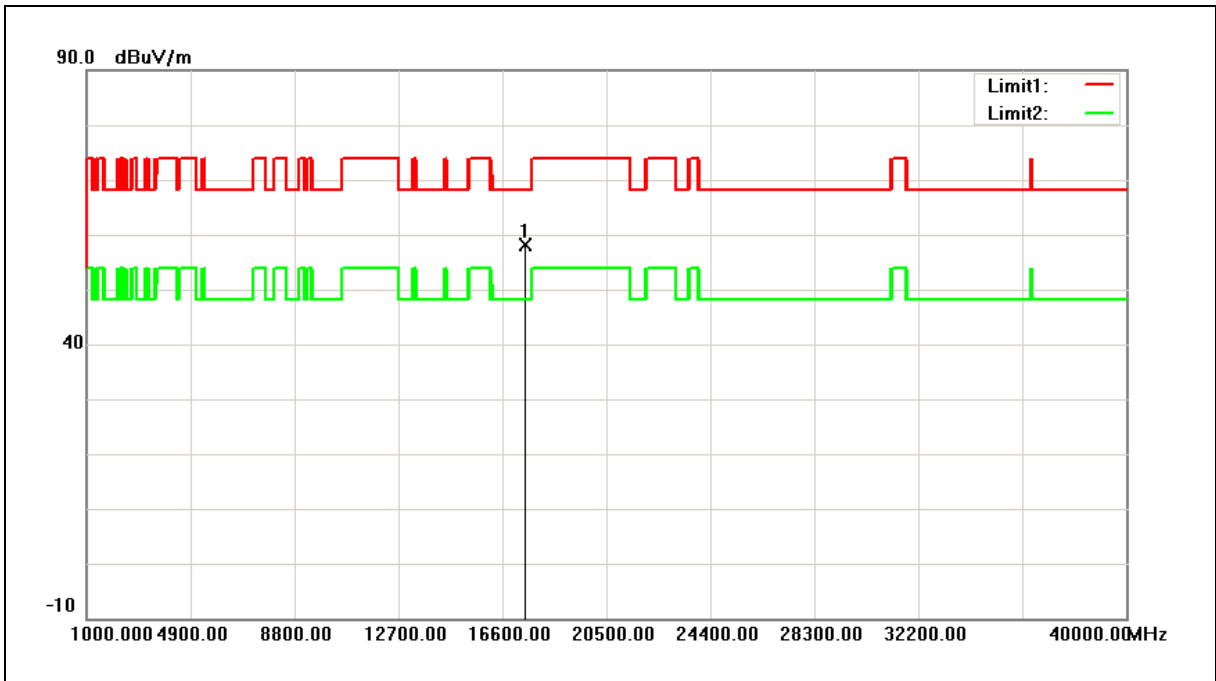

No.	Frequency (MHz)	Reading (dBuV)	Correct Factor (dB/m)	Result (dBuV/m)	Limit (dBuV/m)	Margin (dB)	Remark
1	17475.000	46.01	12.17	58.18	68.20	-10.02	peak

Note:1.Result (dBuV/m) = Correct Factor (dB/m) + Reading(dBuV).

2.Correction factor (dB/m) = Antenna Factor (dB/m) + Cable loss (dB) – Pre-Amplifier gain (dB).

3. When the peak results are less than average limit, so not need to evaluate the average.



Standard:	FCC Part 15.407	Test Distance:	3m
Test item:	Harmonic	Power:	AC 120V/60Hz
Frequency:	5825MHz	Temp.(°C)/Hum.(%RH):	26(°C)/60%RH
Mode:	Mode 2	Date:	04/07/2017
Ant.Polar.:	Vertical		

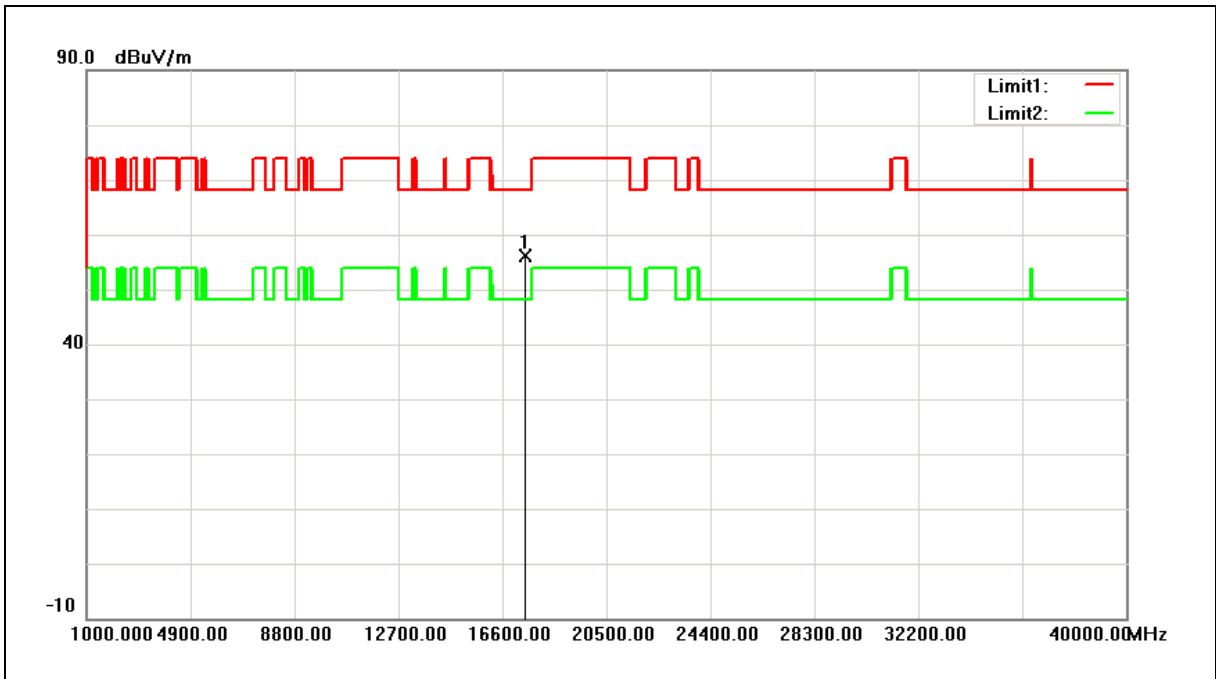

No.	Frequency (MHz)	Reading (dBuV)	Correct Factor (dB/m)	Result (dBuV/m)	Limit (dBuV/m)	Margin (dB)	Remark
1	17475.000	43.98	12.17	56.15	68.20	-12.05	peak

Note:1.Result (dBuV/m) = Correct Factor (dB/m) + Reading(dBuV).

2.Correction factor (dB/m) = Antenna Factor (dB/m) + Cable loss (dB) – Pre-Amplifier gain (dB).

3. When the peak results are less than average limit, so not need to evaluate the average.





Standard:	FCC Part 15.407	Test Distance:	3m
Test item:	Harmonic	Power:	AC 120V/60Hz
Frequency:	5180MHz	Temp.(°C)/Hum.(%RH):	26(°C)/60%RH
Mode:	Mode 3	Date:	04/06/2017
Ant.Polar.:	Horizontal		

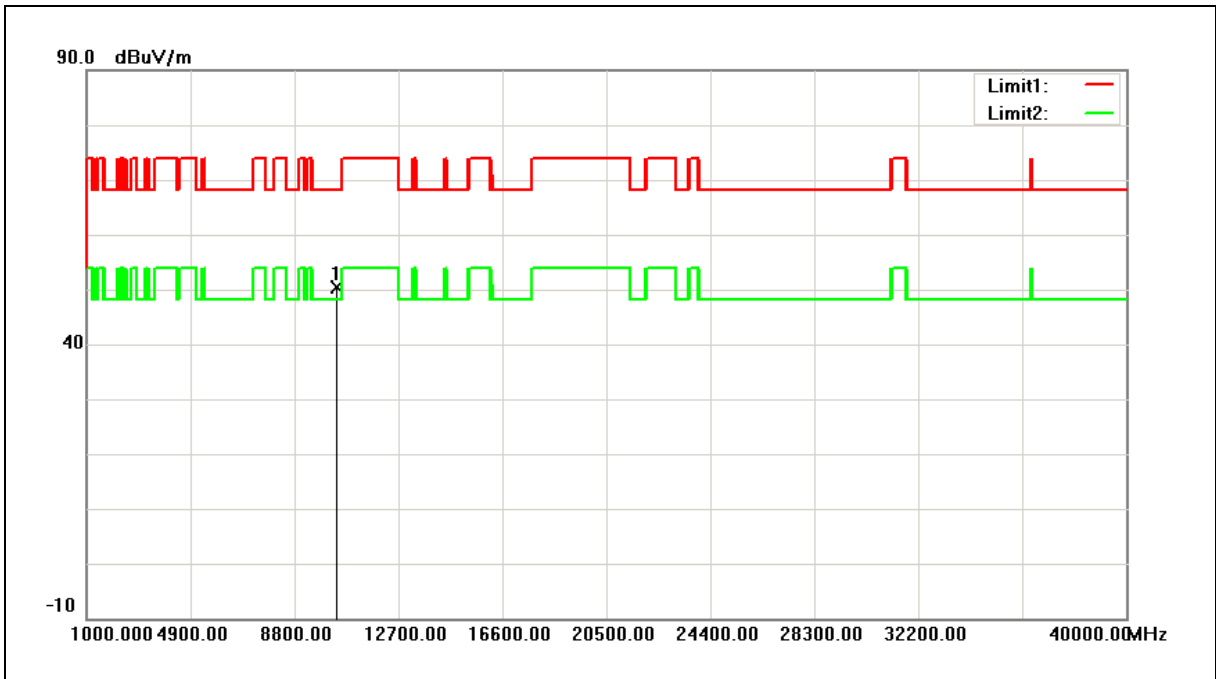

No.	Frequency (MHz)	Reading (dBuV)	Correct Factor (dB/m)	Result (dBuV/m)	Limit (dBuV/m)	Margin (dB)	Remark
1	10360.000	45.03	5.36	50.39	68.20	-17.81	peak

Note:1.Result (dBuV/m) = Correct Factor (dB/m) + Reading(dBuV).

2.Correction factor (dB/m) = Antenna Factor (dB/m) + Cable loss (dB) – Pre-Amplifier gain (dB).

3. When the peak results are less than average limit, so not need to evaluate the average.



Standard:	FCC Part 15.407	Test Distance:	3m
Test item:	Harmonic	Power:	AC 120V/60Hz
Frequency:	5180MHz	Temp.(°C)/Hum.(%RH):	26(°C)/60%RH
Mode:	Mode 3	Date:	04/06/2017
Ant.Polar.:	Vertical		

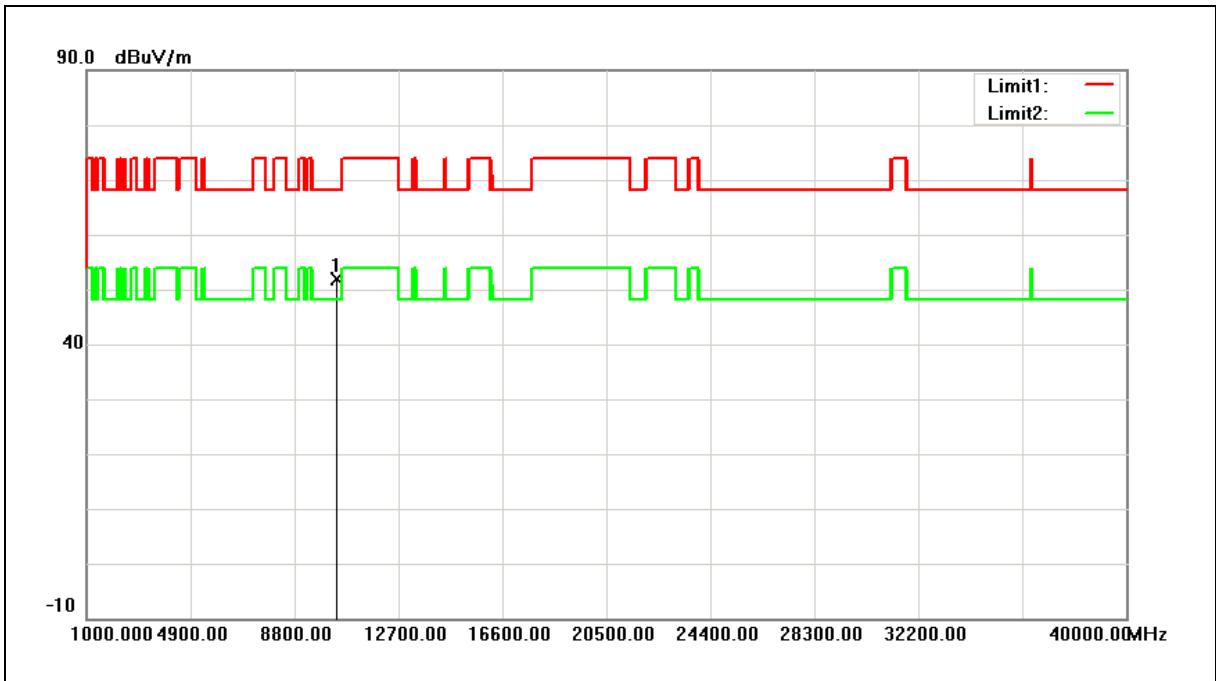

No.	Frequency (MHz)	Reading (dBuV)	Correct Factor (dB/m)	Result (dBuV/m)	Limit (dBuV/m)	Margin (dB)	Remark
1	10360.000	46.61	5.36	51.97	68.20	-16.23	peak

Note:1.Result (dBuV/m) = Correct Factor (dB/m) + Reading(dBuV).

2.Correction factor (dB/m) = Antenna Factor (dB/m) + Cable loss (dB) – Pre-Amplifier gain (dB).

3. When the peak results are less than average limit, so not need to evaluate the average.



Standard:	FCC Part 15.407	Test Distance:	3m
Test item:	Harmonic	Power:	AC 120V/60Hz
Frequency:	5200MHz	Temp.(°C)/Hum.(%RH):	26(°C)/60%RH
Mode:	Mode 3	Date:	04/06/2017
Ant.Polar.:	Horizontal		

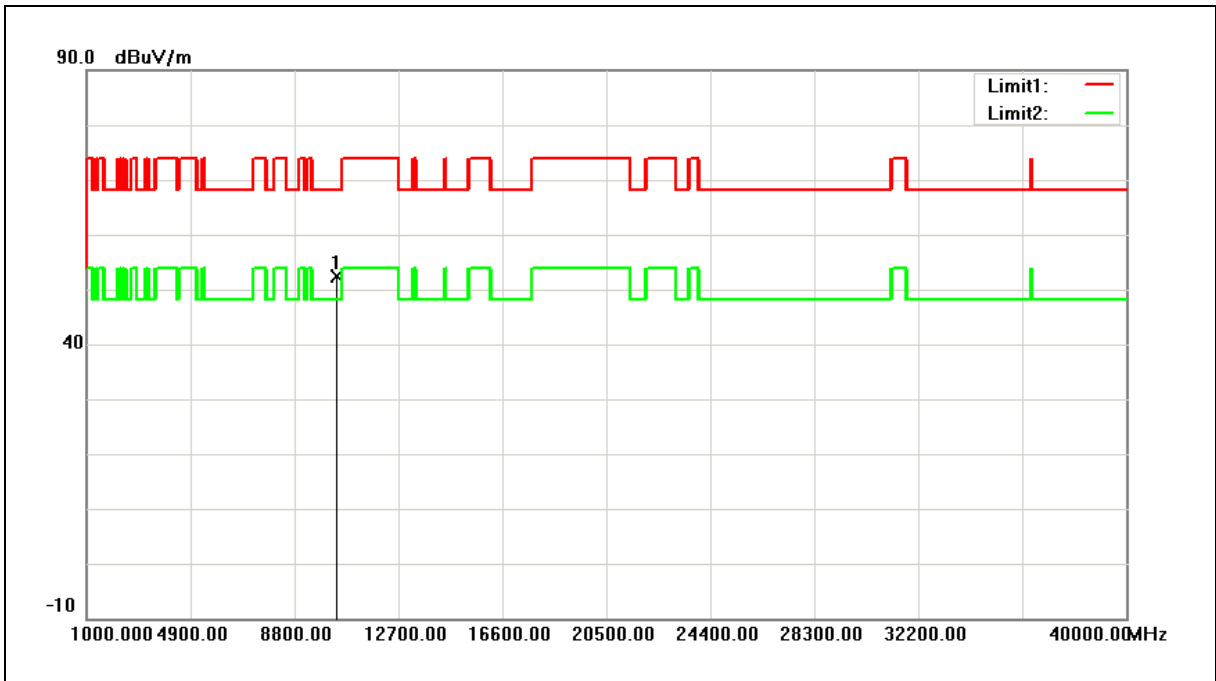

No.	Frequency (MHz)	Reading (dBuV)	Correct Factor (dB/m)	Result (dBuV/m)	Limit (dBuV/m)	Margin (dB)	Remark
1	10400.000	46.94	5.45	52.39	68.20	-15.81	peak

Note:1.Result (dBuV/m) = Correct Factor (dB/m) + Reading(dBuV).

2.Correction factor (dB/m) = Antenna Factor (dB/m) + Cable loss (dB) – Pre-Amplifier gain (dB).

3. When the peak results are less than average limit, so not need to evaluate the average.



Standard:	FCC Part 15.407	Test Distance:	3m
Test item:	Harmonic	Power:	AC 120V/60Hz
Frequency:	5200MHz	Temp.(°C)/Hum.(%RH):	26(°C)/60%RH
Mode:	Mode 3	Date:	04/06/2017
Ant.Polar.:	Vertical		

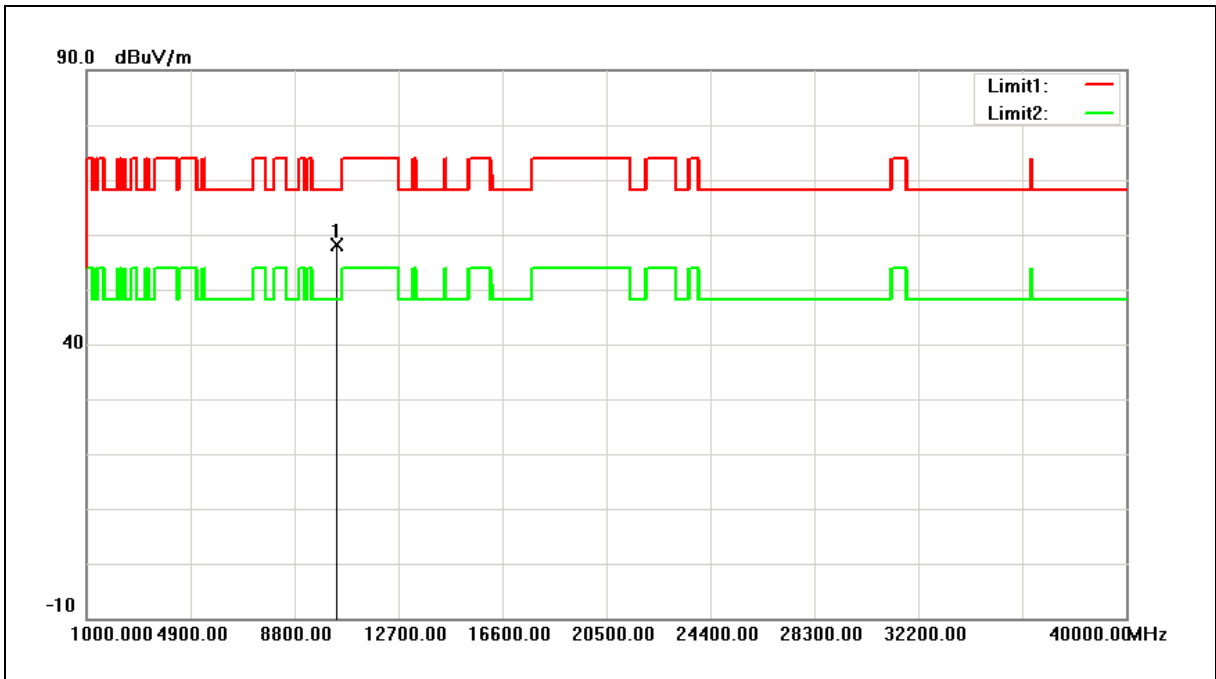

No.	Frequency (MHz)	Reading (dBuV)	Correct Factor (dB/m)	Result (dBuV/m)	Limit (dBuV/m)	Margin (dB)	Remark
1	10400.000	52.80	5.45	58.25	68.20	-9.95	peak

Note:1.Result (dBuV/m) = Correct Factor (dB/m) + Reading(dBuV).

2.Correction factor (dB/m) = Antenna Factor (dB/m) + Cable loss (dB) – Pre-Amplifier gain (dB).

3. When the peak results are less than average limit, so not need to evaluate the average.



Standard:	FCC Part 15.407	Test Distance:	3m
Test item:	Harmonic	Power:	AC 120V/60Hz
Frequency:	5240MHz	Temp.(°C)/Hum.(%RH):	26(°C)/60%RH
Mode:	Mode 3	Date:	04/06/2017
Ant.Polar.:	Horizontal		

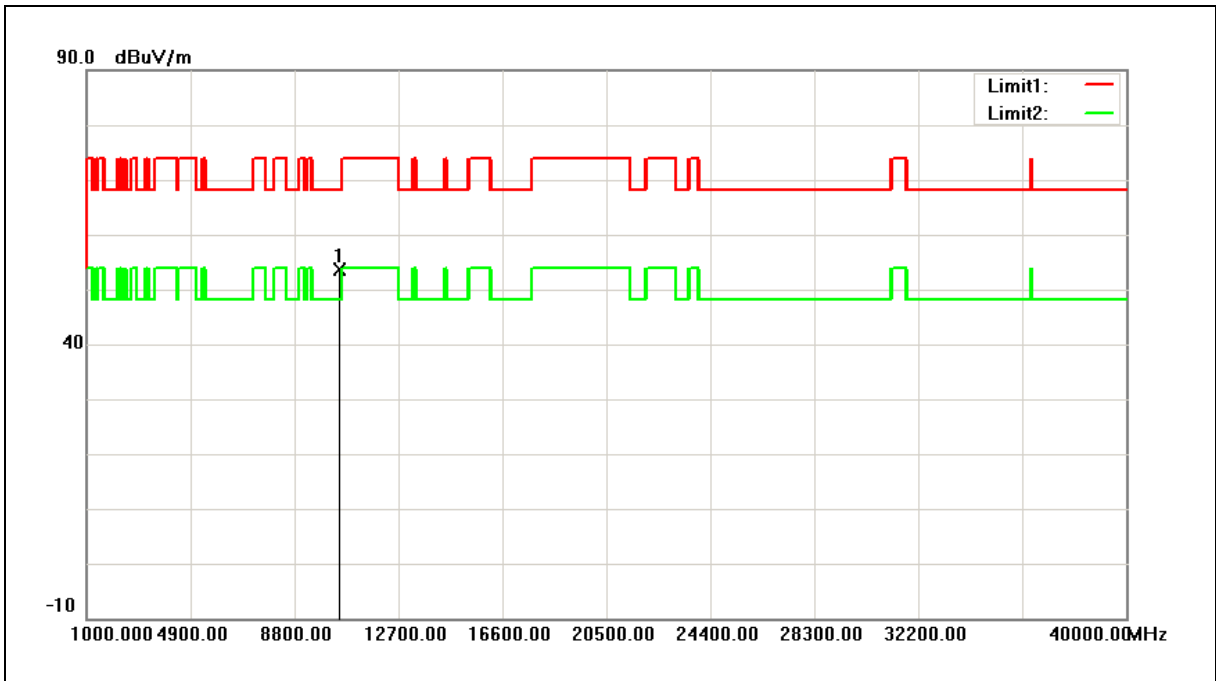

No.	Frequency (MHz)	Reading (dBuV)	Correct Factor (dB/m)	Result (dBuV/m)	Limit (dBuV/m)	Margin (dB)	Remark
1	10480.000	47.97	5.63	53.60	68.20	-14.60	peak

Note:1.Result (dBuV/m) = Correct Factor (dB/m) + Reading(dBuV).

2.Correction factor (dB/m) = Antenna Factor (dB/m) + Cable loss (dB) – Pre-Amplifier gain (dB).

3. When the peak results are less than average limit, so not need to evaluate the average.



Standard:	FCC Part 15.407	Test Distance:	3m
Test item:	Harmonic	Power:	AC 120V/60Hz
Frequency:	5240MHz	Temp.(°C)/Hum.(%RH):	26(°C)/60%RH
Mode:	Mode 3	Date:	04/06/2017
Ant.Polar.:	Vertical		

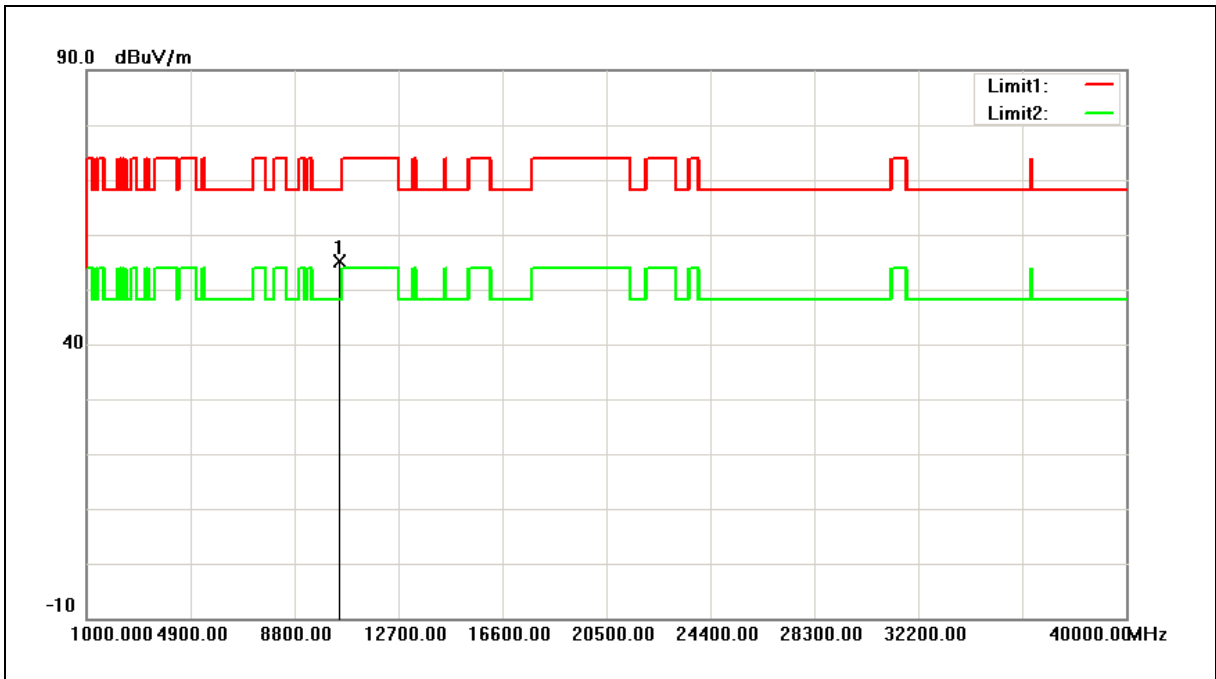

No.	Frequency (MHz)	Reading (dBuV)	Correct Factor (dB/m)	Result (dBuV/m)	Limit (dBuV/m)	Margin (dB)	Remark
1	10480.000	49.55	5.63	55.18	68.20	-13.02	peak

Note:1.Result (dBuV/m) = Correct Factor (dB/m) + Reading(dBuV).

2.Correction factor (dB/m) = Antenna Factor (dB/m) + Cable loss (dB) – Pre-Amplifier gain (dB).

3. When the peak results are less than average limit, so not need to evaluate the average.



Standard:	FCC Part 15.407	Test Distance:	3m
Test item:	Harmonic	Power:	AC 120V/60Hz
Frequency:	5745MHz	Temp.(°C)/Hum.(%RH):	26(°C)/60%RH
Mode:	Mode 3	Date:	04/07/2017
Ant.Polar.:	Horizontal		

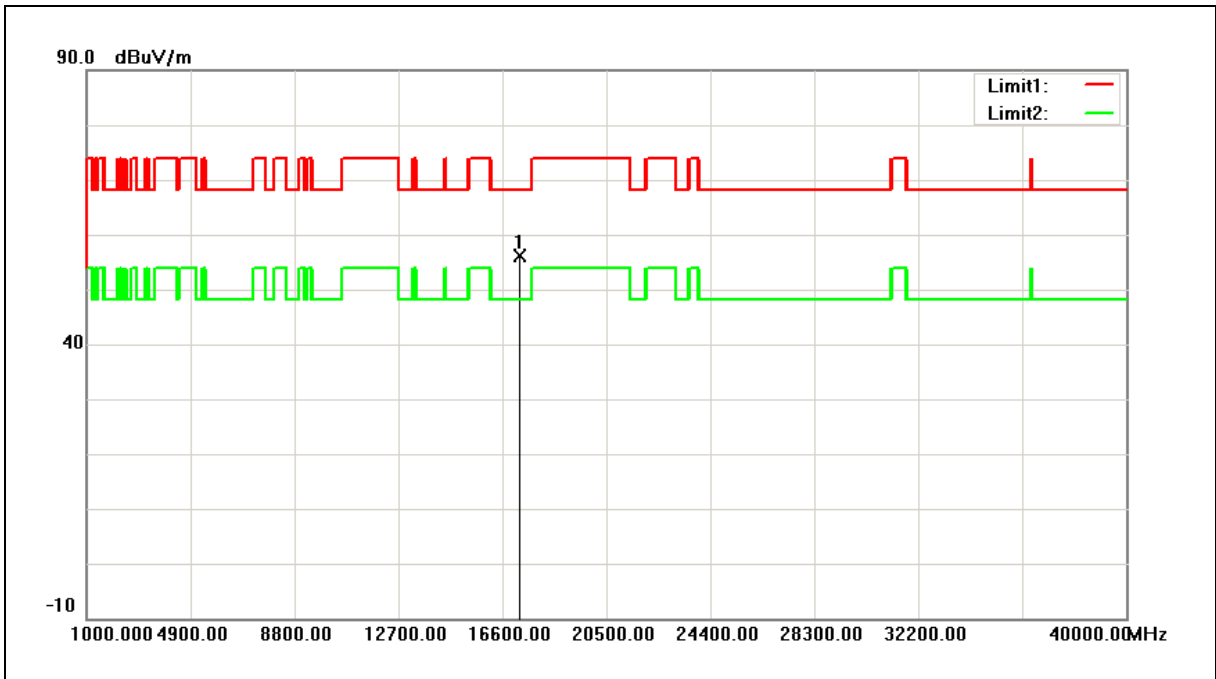

No.	Frequency (MHz)	Reading (dBuV)	Correct Factor (dB/m)	Result (dBuV/m)	Limit (dBuV/m)	Margin (dB)	Remark
1	17235.000	45.19	10.87	56.06	68.20	-12.14	peak

Note:1.Result (dBuV/m) = Correct Factor (dB/m) + Reading(dBuV).

2.Correction factor (dB/m) = Antenna Factor (dB/m) + Cable loss (dB) – Pre-Amplifier gain (dB).

3. When the peak results are less than average limit, so not need to evaluate the average.



Standard:	FCC Part 15.407	Test Distance:	3m
Test item:	Harmonic	Power:	AC 120V/60Hz
Frequency:	5745MHz	Temp.(°C)/Hum.(%RH):	26(°C)/60%RH
Mode:	Mode 3	Date:	04/07/2017
Ant.Polar.:	Vertical		

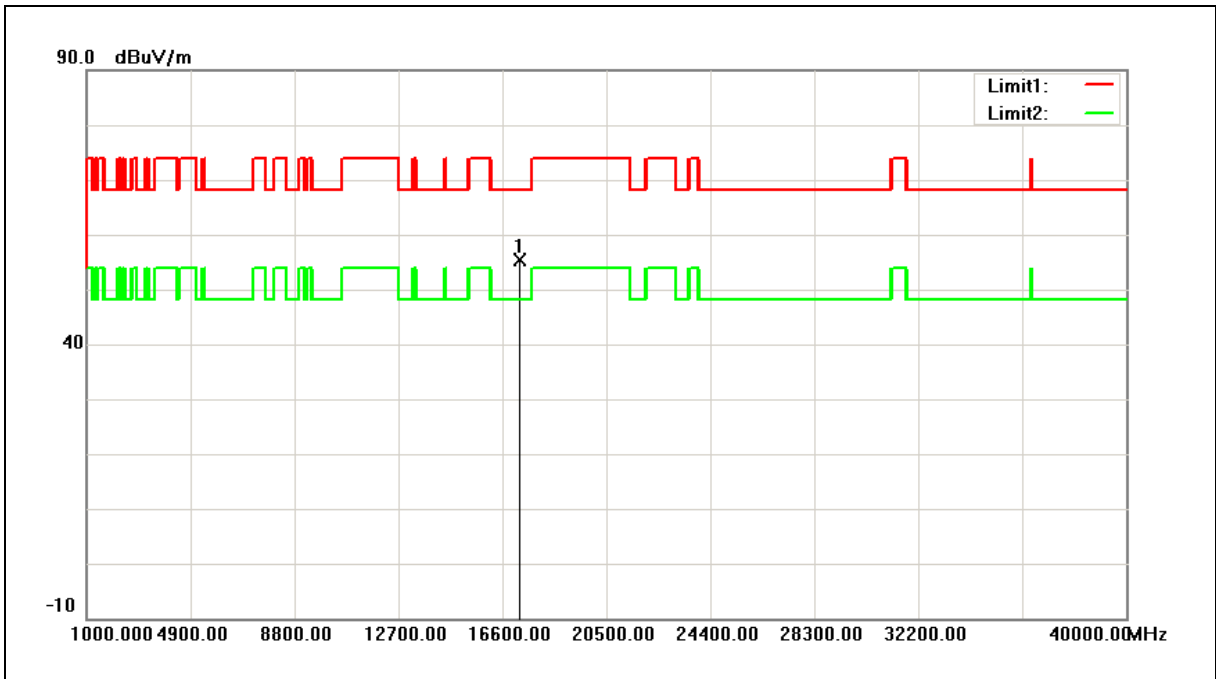

No.	Frequency (MHz)	Reading (dBuV)	Correct Factor (dB/m)	Result (dBuV/m)	Limit (dBuV/m)	Margin (dB)	Remark
1	17235.000	44.51	10.87	55.38	68.20	-12.82	peak

Note:1.Result (dBuV/m) = Correct Factor (dB/m) + Reading(dBuV).

2.Correction factor (dB/m) = Antenna Factor (dB/m) + Cable loss (dB) – Pre-Amplifier gain (dB).

3. When the peak results are less than average limit, so not need to evaluate the average.





Standard:	FCC Part 15.407	Test Distance:	3m
Test item:	Harmonic	Power:	AC 120V/60Hz
Frequency:	5785MHz	Temp.(°C)/Hum.(%RH):	26(°C)/60%RH
Mode:	Mode 3	Date:	04/07/2017
Ant.Polar.:	Horizontal		

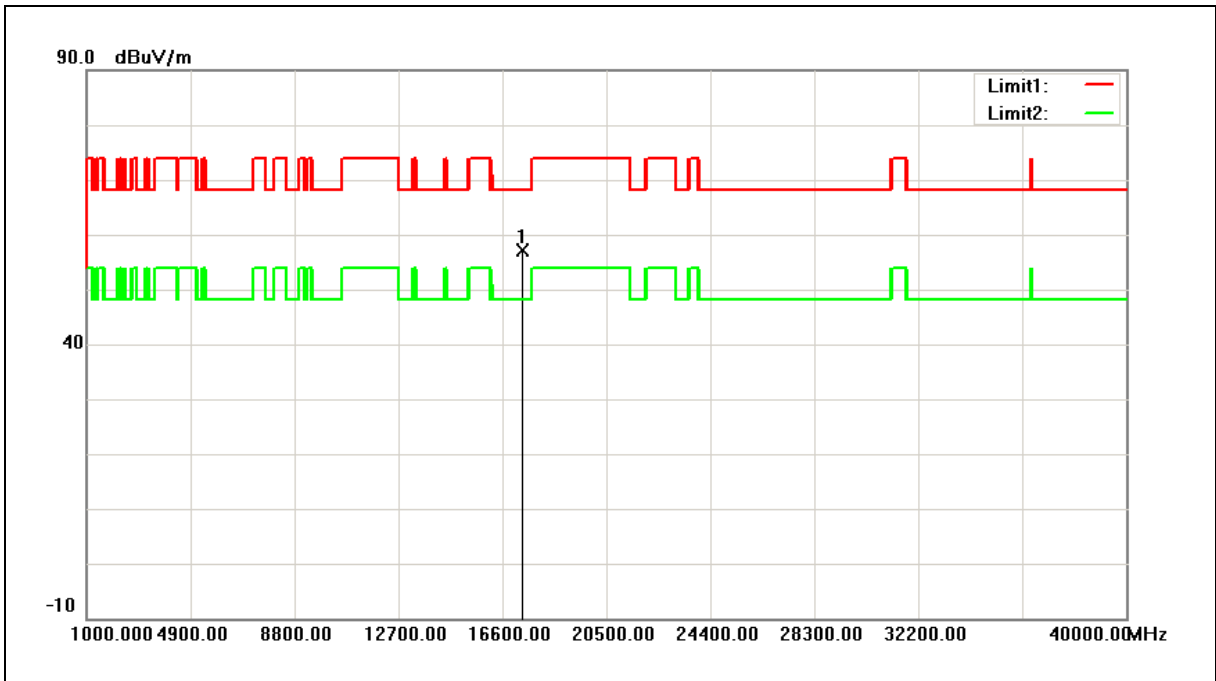

No.	Frequency (MHz)	Reading (dBuV)	Correct Factor (dB/m)	Result (dBuV/m)	Limit (dBuV/m)	Margin (dB)	Remark
1	17355.000	45.49	11.52	57.01	68.20	-11.19	peak

Note:1.Result (dBuV/m) = Correct Factor (dB/m) + Reading(dBuV).

2.Correction factor (dB/m) = Antenna Factor (dB/m) + Cable loss (dB) – Pre-Amplifier gain (dB).

3. When the peak results are less than average limit, so not need to evaluate the average.



Standard:	FCC Part 15.407	Test Distance:	3m
Test item:	Harmonic	Power:	AC 120V/60Hz
Frequency:	5785MHz	Temp.(°C)/Hum.(%RH):	26(°C)/60%RH
Mode:	Mode 3	Date:	04/07/2017
Ant.Polar.:	Vertical		

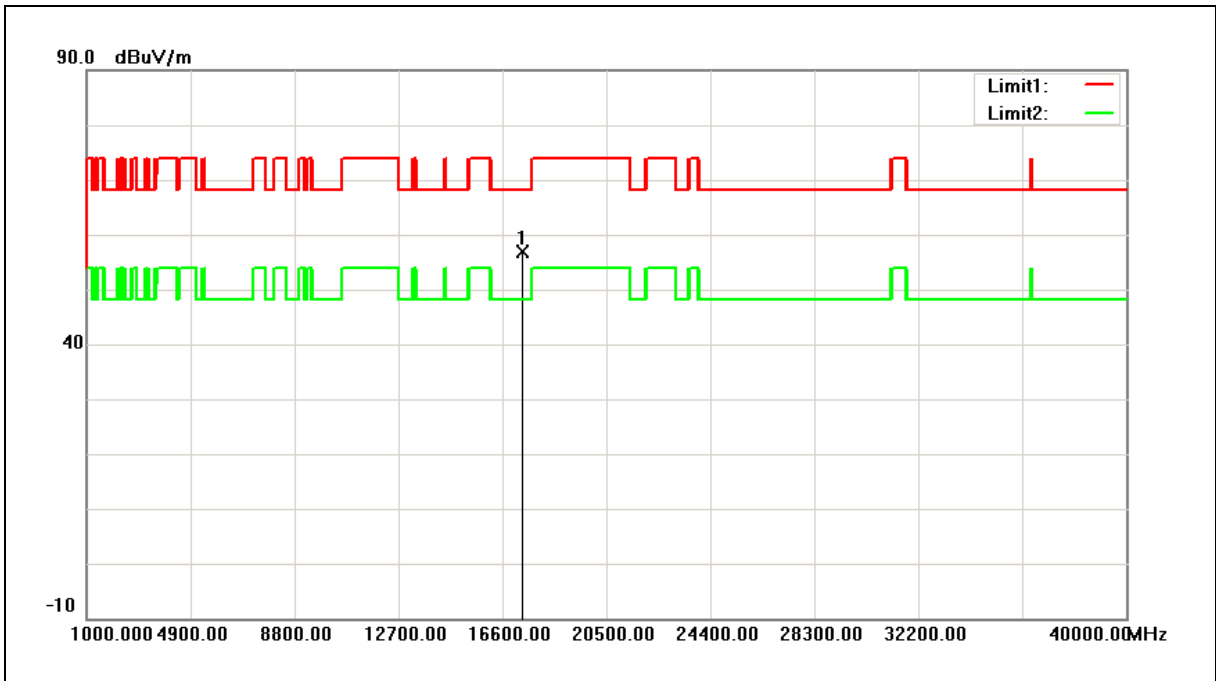

No.	Frequency (MHz)	Reading (dBuV)	Correct Factor (dB/m)	Result (dBuV/m)	Limit (dBuV/m)	Margin (dB)	Remark
1	17355.000	45.29	11.52	56.81	68.20	-11.39	peak

Note:1.Result (dBuV/m) = Correct Factor (dB/m) + Reading(dBuV).

2.Correction factor (dB/m) = Antenna Factor (dB/m) + Cable loss (dB) – Pre-Amplifier gain (dB).

3. When the peak results are less than average limit, so not need to evaluate the average.



Standard:	FCC Part 15.407	Test Distance:	3m
Test item:	Harmonic	Power:	AC 120V/60Hz
Frequency:	5825MHz	Temp.(°C)/Hum.(%RH):	26(°C)/60%RH
Mode:	Mode 3	Date:	04/07/2017
Ant.Polar.:	Horizontal		

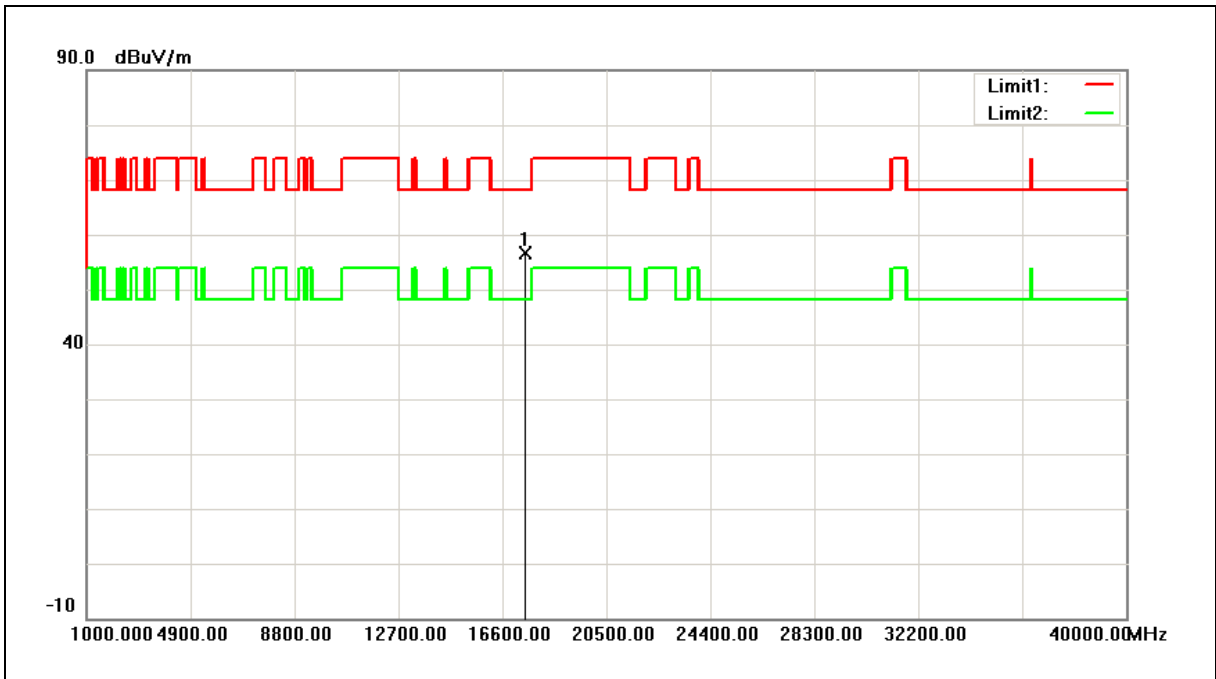

No.	Frequency (MHz)	Reading (dBuV)	Correct Factor (dB/m)	Result (dBuV/m)	Limit (dBuV/m)	Margin (dB)	Remark
1	17475.000	44.54	12.17	56.71	68.20	-11.49	peak

Note:1.Result (dBuV/m) = Correct Factor (dB/m) + Reading(dBuV).

2.Correction factor (dB/m) = Antenna Factor (dB/m) + Cable loss (dB) – Pre-Amplifier gain (dB).

3. When the peak results are less than average limit, so not need to evaluate the average.



Standard:	FCC Part 15.407	Test Distance:	3m
Test item:	Harmonic	Power:	AC 120V/60Hz
Frequency:	5825MHz	Temp.(°C)/Hum.(%RH):	26(°C)/60%RH
Mode:	Mode 3	Date:	04/07/2017
Ant.Polar.:	Vertical		

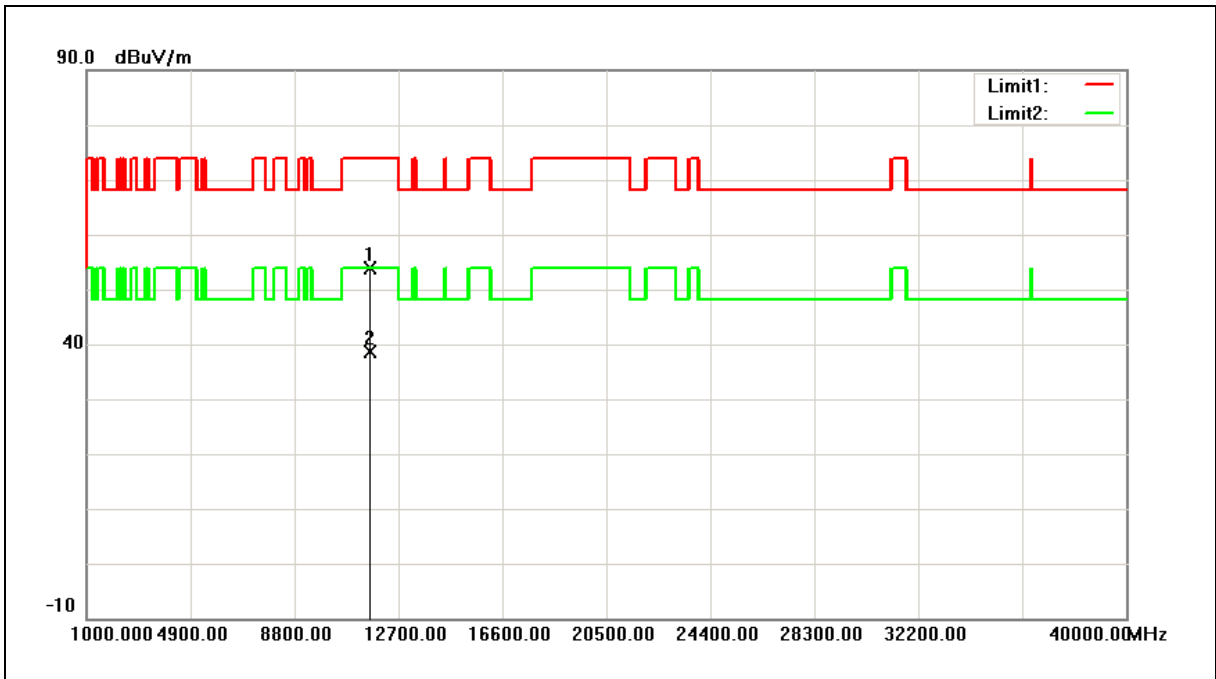

No.	Frequency (MHz)	Reading (dBuV)	Correct Factor (dB/m)	Result (dBuV/m)	Limit (dBuV/m)	Margin (dB)	Remark
1	11650.000	46.93	7.01	53.94	74.00	-20.06	peak
2	11650.000	31.60	7.01	38.61	54.00	-15.39	AVG

Note:1.Result (dBuV/m) = Correct Factor (dB/m) + Reading(dBuV).

2.Correction factor (dB/m) = Antenna Factor (dB/m) + Cable loss (dB) – Pre-Amplifier gain (dB).

3. When the peak results are less than average limit, so not need to evaluate the average.



Standard:	FCC Part 15.407	Test Distance:	3m
Test item:	Harmonic	Power:	AC 120V/60Hz
Frequency:	5190MHz	Temp.(°C)/Hum.(%RH):	26(°C)/60%RH
Mode:	Mode 4	Date:	04/06/2017
Ant.Polar.:	Horizontal		

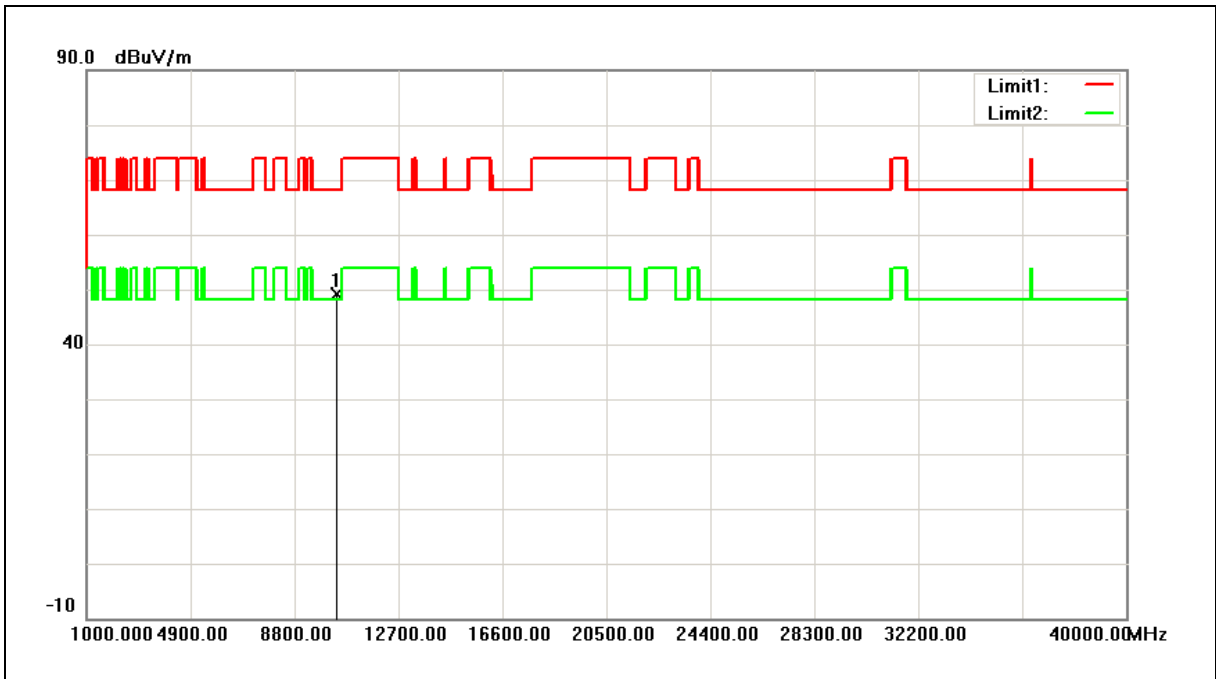

No.	Frequency (MHz)	Reading (dBuV)	Correct Factor (dB/m)	Result (dBuV/m)	Limit (dBuV/m)	Margin (dB)	Remark
1	10380.000	43.69	5.39	49.08	68.20	-19.12	peak

Note:1.Result (dBuV/m) = Correct Factor (dB/m) + Reading(dBuV).

2.Correction factor (dB/m) = Antenna Factor (dB/m) + Cable loss (dB) – Pre-Amplifier gain (dB).

3. When the peak results are less than average limit, so not need to evaluate the average.



Standard:	FCC Part 15.407	Test Distance:	3m
Test item:	Harmonic	Power:	AC 120V/60Hz
Frequency:	5190MHz	Temp.(°C)/Hum.(%RH):	26(°C)/60%RH
Mode:	Mode 4	Date:	04/06/2017
Ant.Polar.:	Vertical		

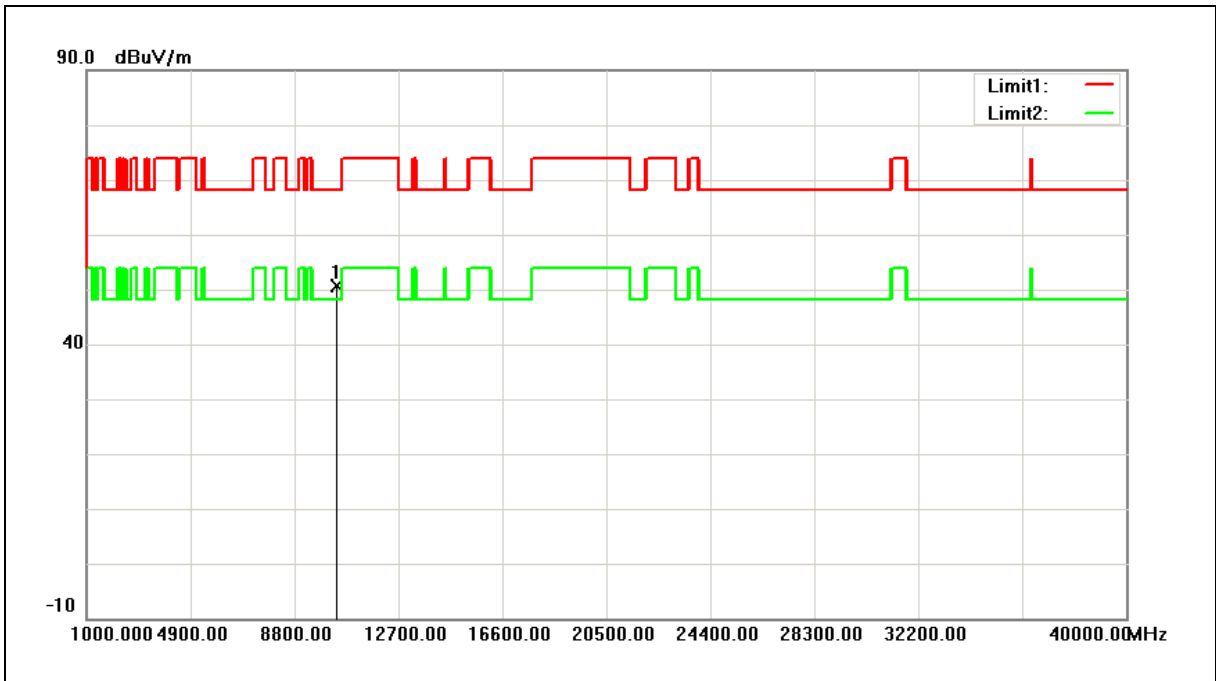

No.	Frequency (MHz)	Reading (dBuV)	Correct Factor (dB/m)	Result (dBuV/m)	Limit (dBuV/m)	Margin (dB)	Remark
1	10380.000	45.21	5.39	50.60	68.20	-17.60	peak

Note:1.Result (dBuV/m) = Correct Factor (dB/m) + Reading(dBuV).

2.Correction factor (dB/m) = Antenna Factor (dB/m) + Cable loss (dB) – Pre-Amplifier gain (dB).

3. When the peak results are less than average limit, so not need to evaluate the average.



Standard:	FCC Part 15.407	Test Distance:	3m
Test item:	Harmonic	Power:	AC 120V/60Hz
Frequency:	5230MHz	Temp.(°C)/Hum.(%RH):	26(°C)/60%RH
Mode:	Mode 4	Date:	04/06/2017
Ant.Polar.:	Horizontal		

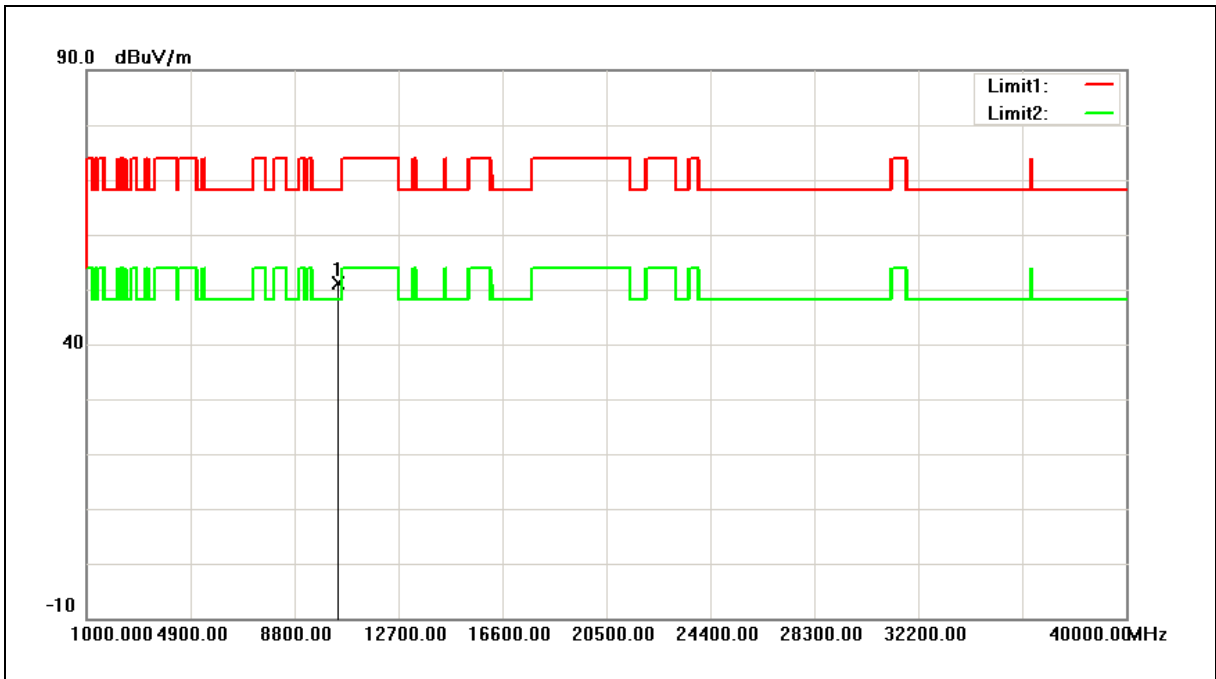

No.	Frequency (MHz)	Reading (dBuV)	Correct Factor (dB/m)	Result (dBuV/m)	Limit (dBuV/m)	Margin (dB)	Remark
1	10460.000	45.44	5.59	51.03	68.20	-17.17	peak

Note:1.Result (dBuV/m) = Correct Factor (dB/m) + Reading(dBuV).

2.Correction factor (dB/m) = Antenna Factor (dB/m) + Cable loss (dB) – Pre-Amplifier gain (dB).

3. When the peak results are less than average limit, so not need to evaluate the average.



Standard:	FCC Part 15.407	Test Distance:	3m
Test item:	Harmonic	Power:	AC 120V/60Hz
Frequency:	5230MHz	Temp.(°C)/Hum.(%RH):	26(°C)/60%RH
Mode:	Mode 4	Date:	04/06/2017
Ant.Polar.:	Vertical		

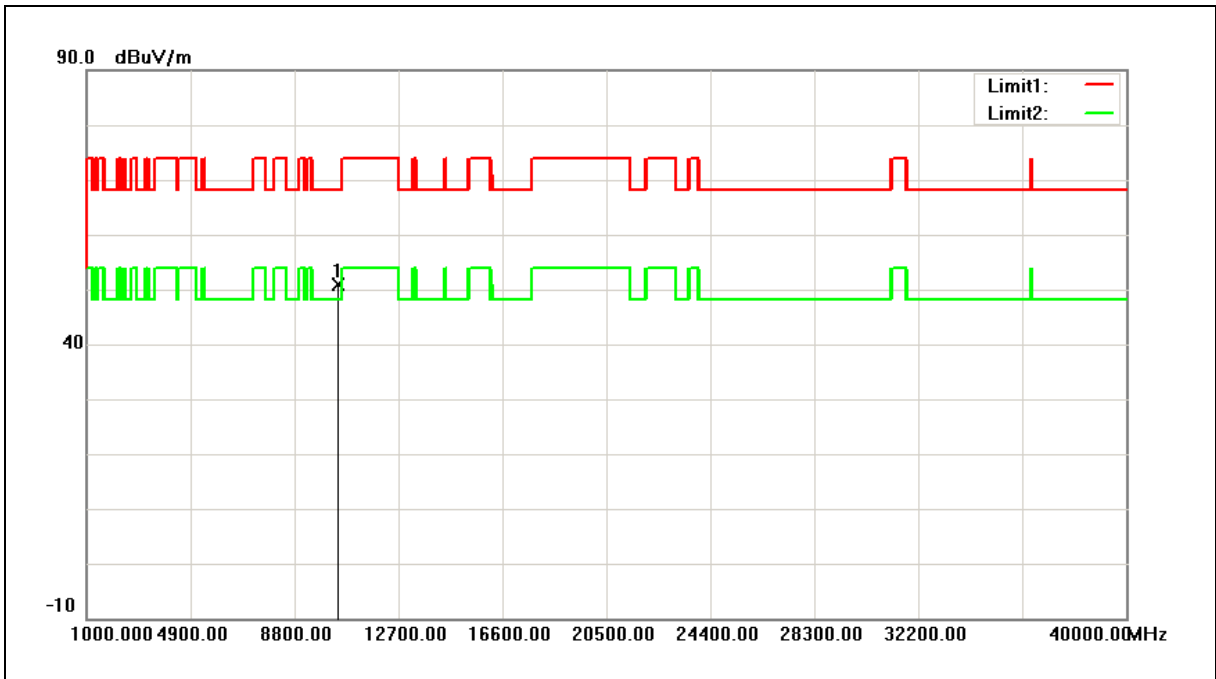

No.	Frequency (MHz)	Reading (dBuV)	Correct Factor (dB/m)	Result (dBuV/m)	Limit (dBuV/m)	Margin (dB)	Remark
1	10460.000	45.24	5.59	50.83	68.20	-17.37	peak

Note:1.Result (dBuV/m) = Correct Factor (dB/m) + Reading(dBuV).

2.Correction factor (dB/m) = Antenna Factor (dB/m) + Cable loss (dB) – Pre-Amplifier gain (dB).

3. When the peak results are less than average limit, so not need to evaluate the average.





Standard:	FCC Part 15.407	Test Distance:	3m
Test item:	Harmonic	Power:	AC 120V/60Hz
Frequency:	5755MHz	Temp.(°C)/Hum.(%RH):	26(°C)/60%RH
Mode:	Mode 4	Date:	04/07/2017
Ant.Polar.:	Horizontal		

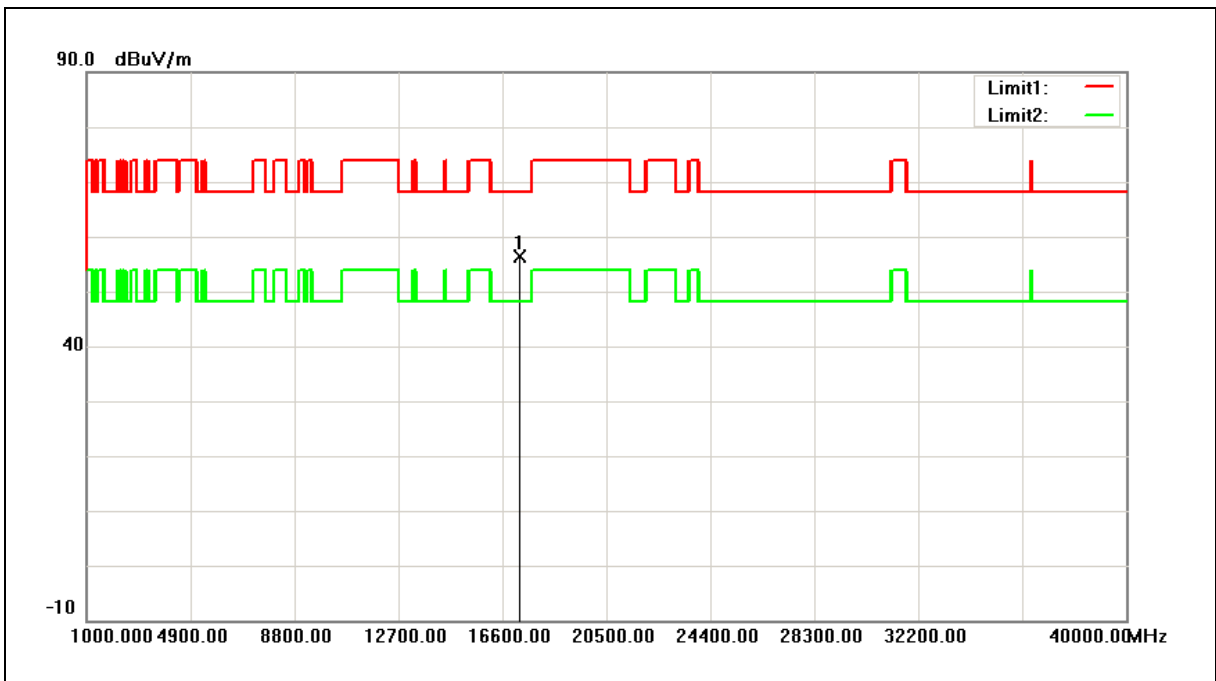

No.	Frequency (MHz)	Reading (dBuV)	Correct Factor (dB/m)	Result (dBuV/m)	Limit (dBuV/m)	Margin (dB)	Remark
1	17265.000	45.47	11.03	56.50	68.20	-11.70	peak

Note:1.Result (dBuV/m) = Correct Factor (dB/m) + Reading(dBuV).

2.Correction factor (dB/m) = Antenna Factor (dB/m) + Cable loss (dB) – Pre-Amplifier gain (dB).

3. When the peak results are less than average limit, so not need to evaluate the average.



Standard:	FCC Part 15.407	Test Distance:	3m
Test item:	Harmonic	Power:	AC 120V/60Hz
Frequency:	5755MHz	Temp.(°C)/Hum.(%RH):	26(°C)/60%RH
Mode:	Mode 4	Date:	04/07/2017
Ant.Polar.:	Vertical		

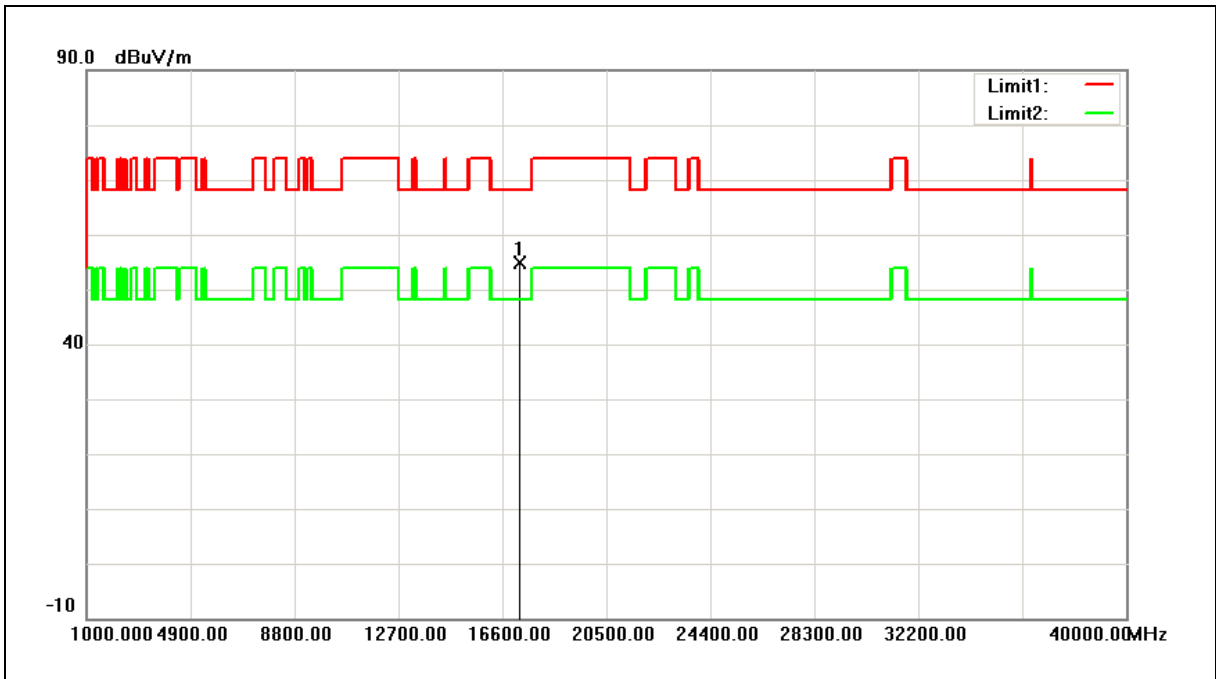

No.	Frequency (MHz)	Reading (dBuV)	Correct Factor (dB/m)	Result (dBuV/m)	Limit (dBuV/m)	Margin (dB)	Remark
1	17265.000	43.82	11.03	54.85	68.20	-13.35	peak

Note:1.Result (dBuV/m) = Correct Factor (dB/m) + Reading(dBuV).

2.Correction factor (dB/m) = Antenna Factor (dB/m) + Cable loss (dB) – Pre-Amplifier gain (dB).

3. When the peak results are less than average limit, so not need to evaluate the average.



Standard:	FCC Part 15.407	Test Distance:	3m
Test item:	Harmonic	Power:	AC 120V/60Hz
Frequency:	5795MHz	Temp.(°C)/Hum.(%RH):	26(°C)/60%RH
Mode:	Mode 4	Date:	04/07/2017
Ant.Polar.:	Horizontal		

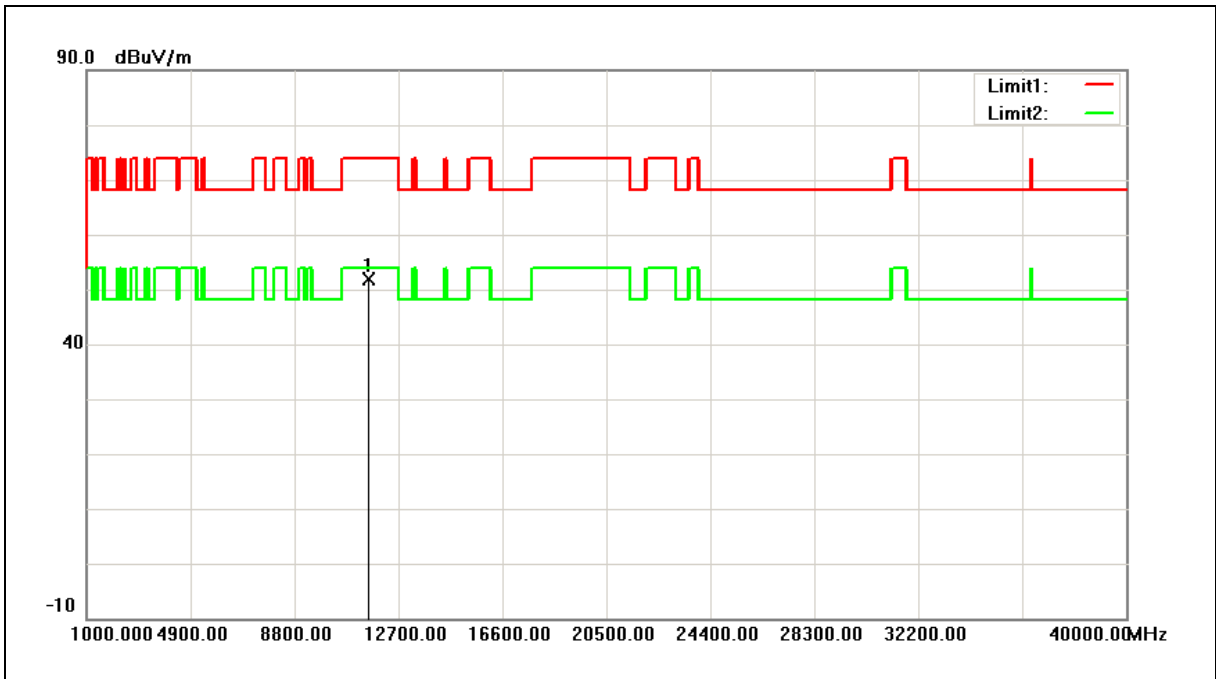

No.	Frequency (MHz)	Reading (dBuV)	Correct Factor (dB/m)	Result (dBuV/m)	Limit (dBuV/m)	Margin (dB)	Remark
1	11590.000	44.98	6.86	51.84	74.00	-22.16	peak

Note:1.Result (dBuV/m) = Correct Factor (dB/m) + Reading(dBuV).

2.Correction factor (dB/m) = Antenna Factor (dB/m) + Cable loss (dB) – Pre-Amplifier gain (dB).

3. When the peak results are less than average limit, so not need to evaluate the average.



Standard:	FCC Part 15.407	Test Distance:	3m
Test item:	Harmonic	Power:	AC 120V/60Hz
Frequency:	5795MHz	Temp.(°C)/Hum.(%RH):	26(°C)/60%RH
Mode:	Mode 4	Date:	04/07/2017
Ant.Polar.:	Vertical		

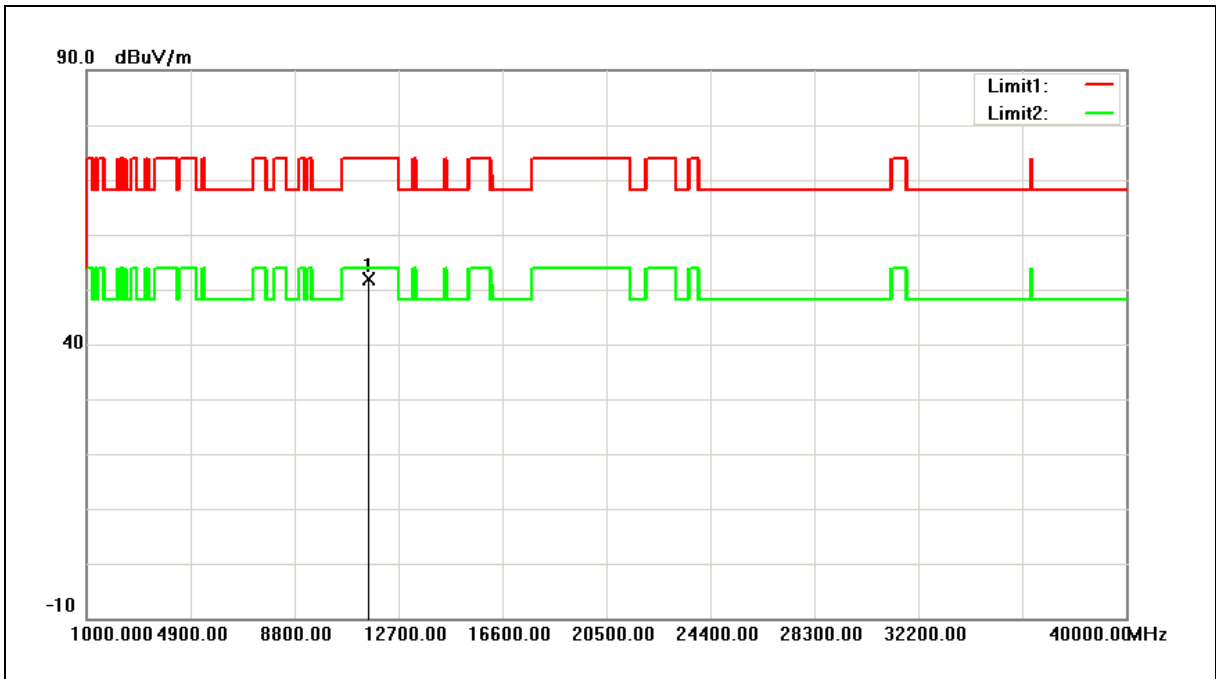

No.	Frequency (MHz)	Reading (dBuV)	Correct Factor (dB/m)	Result (dBuV/m)	Limit (dBuV/m)	Margin (dB)	Remark
1	11590.000	45.02	6.86	51.88	74.00	-22.12	peak

Note:1.Result (dBuV/m) = Correct Factor (dB/m) + Reading(dBuV).

2.Correction factor (dB/m) = Antenna Factor (dB/m) + Cable loss (dB) – Pre-Amplifier gain (dB).

3. When the peak results are less than average limit, so not need to evaluate the average.



Standard:	FCC Part 15.407	Test Distance:	3m
Test item:	Harmonic	Power:	AC 120V/60Hz
Frequency:	5210MHz	Temp.(°C)/Hum.(%RH):	26(°C)/60%RH
Mode:	Mode 5	Date:	04/06/2017
Ant.Polar.:	Horizontal		

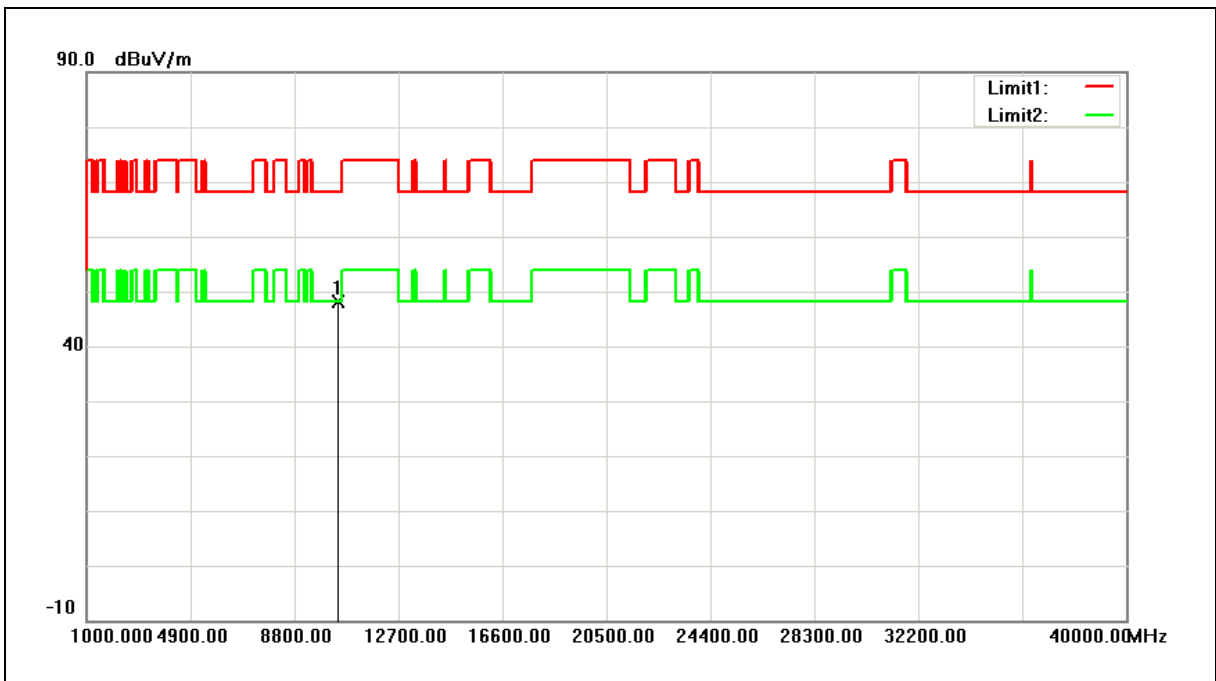

No.	Frequency (MHz)	Reading (dBuV)	Correct Factor (dB/m)	Result (dBuV/m)	Limit (dBuV/m)	Margin (dB)	Remark
1	10420.000	42.75	5.49	48.24	68.20	-19.96	peak

Note:1.Result (dBuV/m) = Correct Factor (dB/m) + Reading(dBuV).

2.Correction factor (dB/m) = Antenna Factor (dB/m) + Cable loss (dB) – Pre-Amplifier gain (dB).

3. When the peak results are less than average limit, so not need to evaluate the average.



Standard:	FCC Part 15.407	Test Distance:	3m
Test item:	Harmonic	Power:	AC 120V/60Hz
Frequency:	5210MHz	Temp.(°C)/Hum.(%RH):	26(°C)/60%RH
Mode:	Mode 5	Date:	04/06/2017
Ant.Polar.:	Vertical		

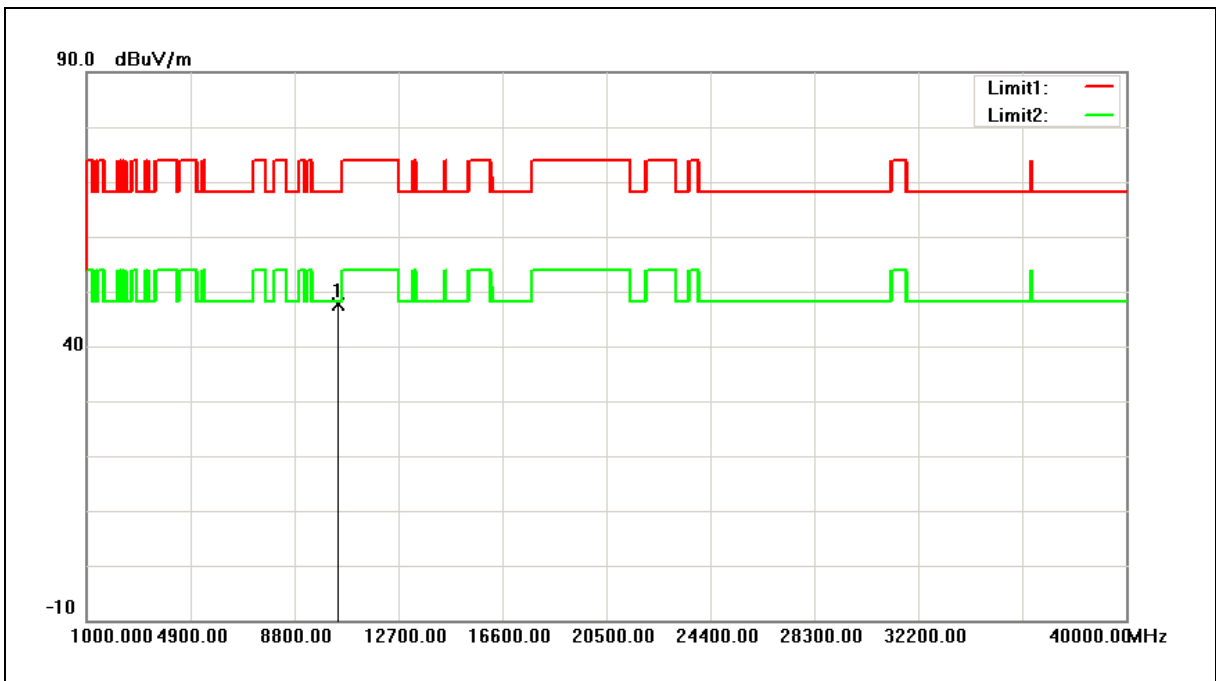

No.	Frequency (MHz)	Reading (dBuV)	Correct Factor (dB/m)	Result (dBuV/m)	Limit (dBuV/m)	Margin (dB)	Remark
1	10420.000	42.26	5.49	47.75	68.20	-20.45	peak

Note:1.Result (dBuV/m) = Correct Factor (dB/m) + Reading(dBuV).

2.Correction factor (dB/m) = Antenna Factor (dB/m) + Cable loss (dB) – Pre-Amplifier gain (dB).

3. When the peak results are less than average limit, so not need to evaluate the average.



Standard:	FCC Part 15.407	Test Distance:	3m
Test item:	Harmonic	Power:	AC 120V/60Hz
Frequency:	5775MHz	Temp.(°C)/Hum.(%RH):	26(°C)/60%RH
Mode:	Mode 5	Date:	04/07/2017
Ant.Polar.:	Horizontal		

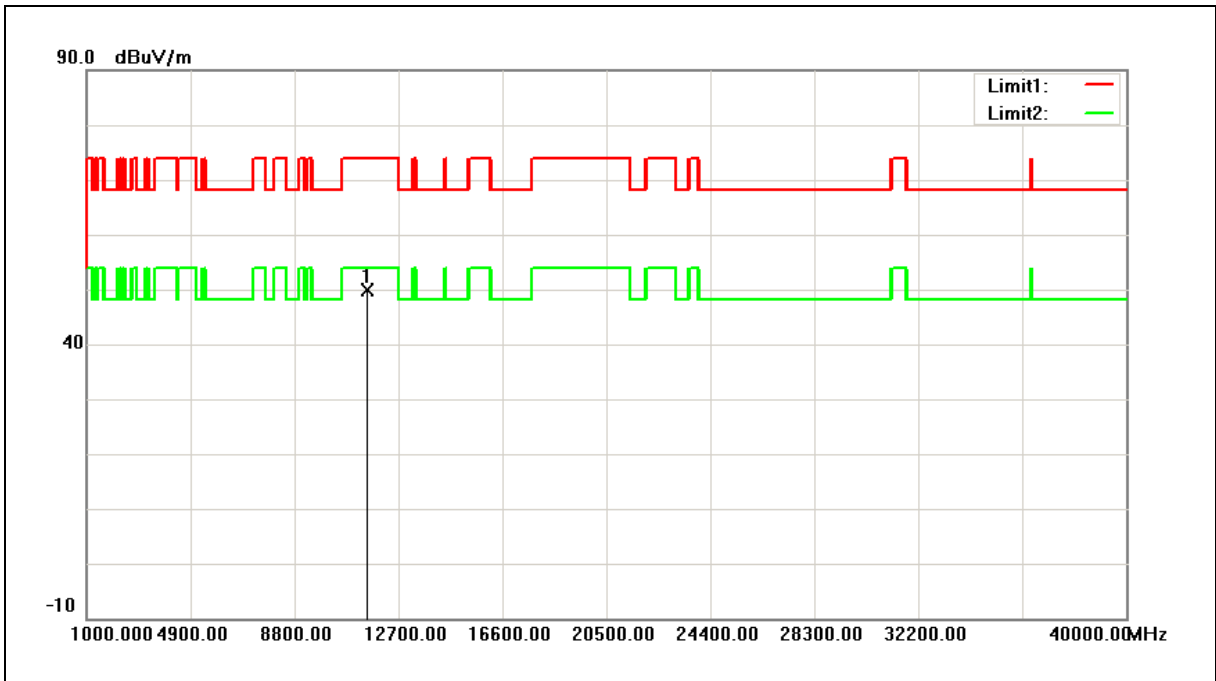

No.	Frequency (MHz)	Reading (dBuV)	Correct Factor (dB/m)	Result (dBuV/m)	Limit (dBuV/m)	Margin (dB)	Remark
1	11550.000	43.19	6.75	49.94	74.00	-24.06	peak

Note:1.Result (dBuV/m) = Correct Factor (dB/m) + Reading(dBuV).

2.Correction factor (dB/m) = Antenna Factor (dB/m) + Cable loss (dB) – Pre-Amplifier gain (dB).

3. When the peak results are less than average limit, so not need to evaluate the average.



Standard:	FCC Part 15.407	Test Distance:	3m
Test item:	Harmonic	Power:	AC 120V/60Hz
Frequency:	5775MHz	Temp.(°C)/Hum.(%RH):	26(°C)/60%RH
Mode:	Mode 5	Date:	04/07/2017
Ant.Polar.:	Vertical		

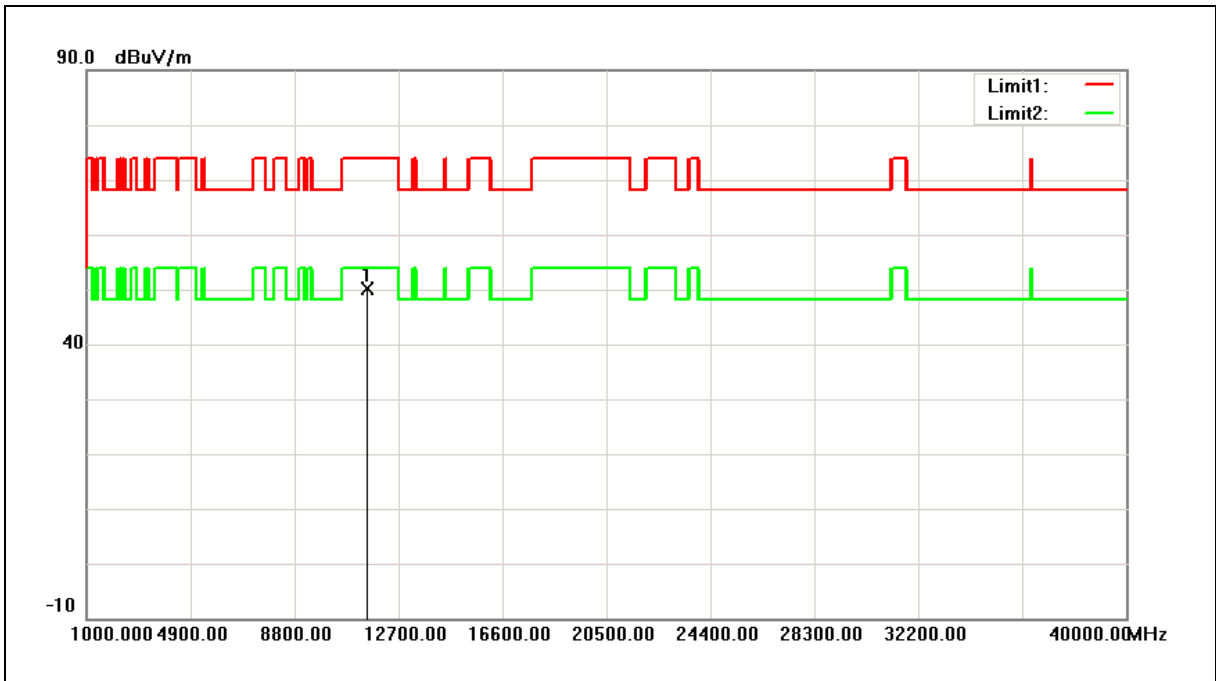

No.	Frequency (MHz)	Reading (dBuV)	Correct Factor (dB/m)	Result (dBuV/m)	Limit (dBuV/m)	Margin (dB)	Remark
1	11550.000	43.27	6.75	50.02	74.00	-23.98	peak

Note:1.Result (dBuV/m) = Correct Factor (dB/m) + Reading(dBuV).

2.Correction factor (dB/m) = Antenna Factor (dB/m) + Cable loss (dB) – Pre-Amplifier gain (dB).

3. When the peak results are less than average limit, so not need to evaluate the average.





Standard:	FCC Part 15.407	Test Distance:	3m
Test item:	Transmitter Unwanted Emissions	Power:	AC 120V/60Hz
Test Mode:	Simultaneous Transmitting (DTS+NII)	Temp.(°C)/Hum.(%RH):	26(°C)/60%RH
Ant.Polar.:	Horizontal	Date:	04/06/2017

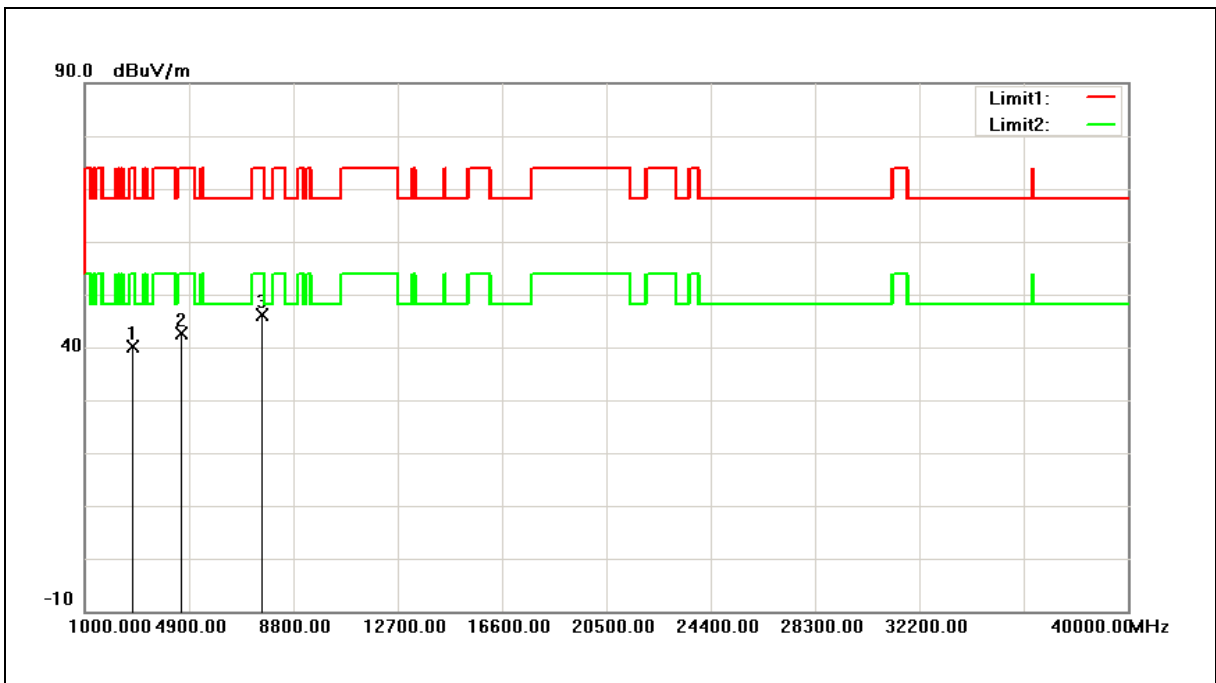

No.	Frequency (MHz)	Reading (dBuV)	Correct Factor (dB/m)	Result (dBuV/m)	Limit (dBuV/m)	Margin (dB)	Remark
1	2785.000	53.03	-12.85	40.18	74.00	-33.82	peak
2	4621.000	50.46	-7.71	42.75	74.00	-31.25	peak
3	7647.000	45.29	0.91	46.20	74.00	-27.80	peak

Note:1.Result (dBuV/m) = Correct Factor (dB/m) + Reading(dBuV).

2.Correction factor (dB/m) = Antenna Factor (dB/m) + Cable loss (dB) – Pre-Amplifier gain (dB).

3. When the peak results are less than average limit, so not need to evaluate the average.



Standard:	FCC Part 15.407	Test Distance:	3m
Test item:	Transmitter Unwanted Emissions	Power:	AC 120V/60Hz
Test Mode:	Simultaneous Transmitting (DTS+NII)	Temp.(°C)/Hum.(%RH):	26(°C)/60%RH
Ant.Polar.:	Vertical	Date:	04/06/2017

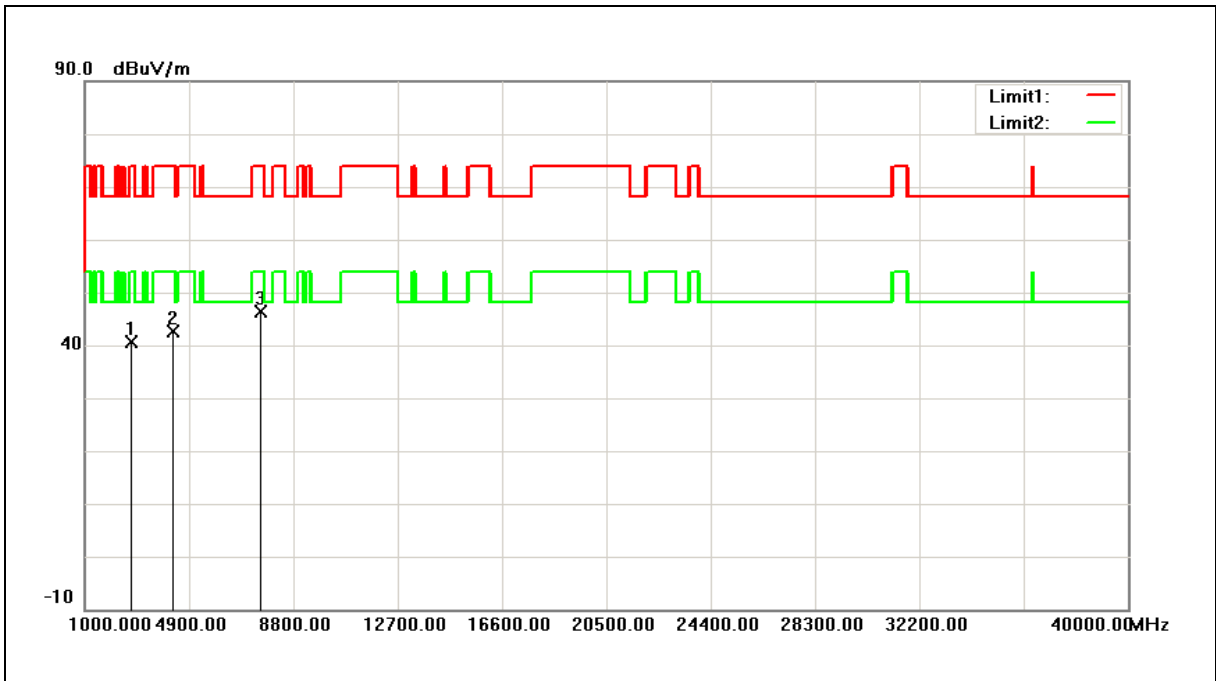

No.	Frequency (MHz)	Reading (dBuV)	Correct Factor (dB/m)	Result (dBuV/m)	Limit (dBuV/m)	Margin (dB)	Remark
1	2751.000	53.62	-12.93	40.69	74.00	-33.31	peak
2	4298.000	51.23	-8.60	42.63	74.00	-31.37	peak
3	7562.000	45.68	0.68	46.36	74.00	-27.64	peak

Note:1.Result (dBuV/m) = Correct Factor (dB/m) + Reading(dBuV).

2.Correction factor (dB/m) = Antenna Factor (dB/m) + Cable loss (dB) – Pre-Amplifier gain (dB).

3. When the peak results are less than average limit, so not need to evaluate the average.



**Band Edge**

Standard:	FCC Part 15.407	Test Distance:	3m
Test item:	Band edge	Power:	AC 120V/60Hz
Frequency:	5180MHz	Temp.(°C)/Hum.(%RH):	26(°C)/60%RH
Mode:	Mode 1	Date:	04/06/2017
Ant.Polar.:	Horizontal		

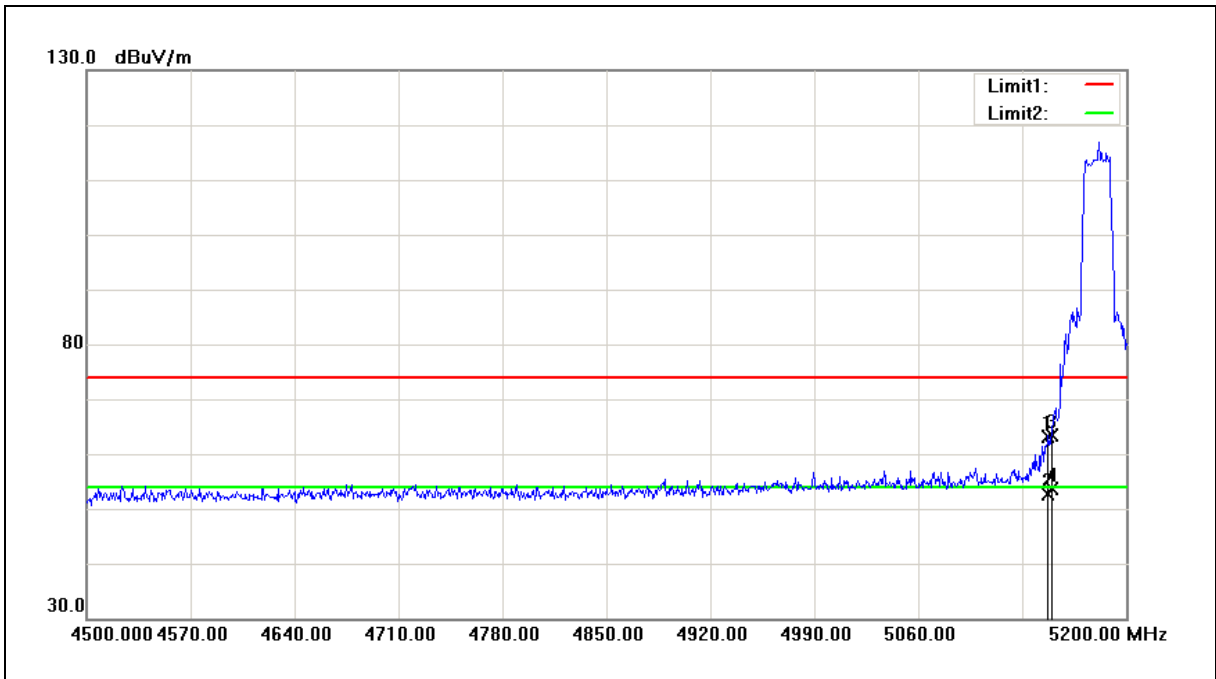

No.	Frequency (MHz)	Reading (dBuV)	Correct Factor (dB/m)	Result (dBuV/m)	Limit (dBuV/m)	Margin (dB)	Remark
1	5147.500	55.01	8.24	63.25	74.00	-10.75	peak
2	5147.500	44.34	8.24	52.58	54.00	-1.42	AVG
3	5150.000	55.20	8.25	63.45	74.00	-10.55	peak
4	5150.000	45.40	8.25	53.65	54.00	-0.35	AVG

Note:1.Result (dBuV/m) = Correct Factor (dB/m) + Reading(dBuV).

2.Correction factor (dB/m) = Antenna Factor (dB/m) + Cable loss (dB) – Pre-Amplifier gain (dB).

3. When the peak results are less than average limit, so not need to evaluate the average.



Standard:	FCC Part 15.407	Test Distance:	3m
Test item:	Band edge	Power:	AC 120V/60Hz
Frequency:	5180MHz	Temp.(°C)/Hum.(%RH):	26(°C)/60%RH
Mode:	Mode 1	Date:	04/06/2017
Ant.Polar.:	Vertical		

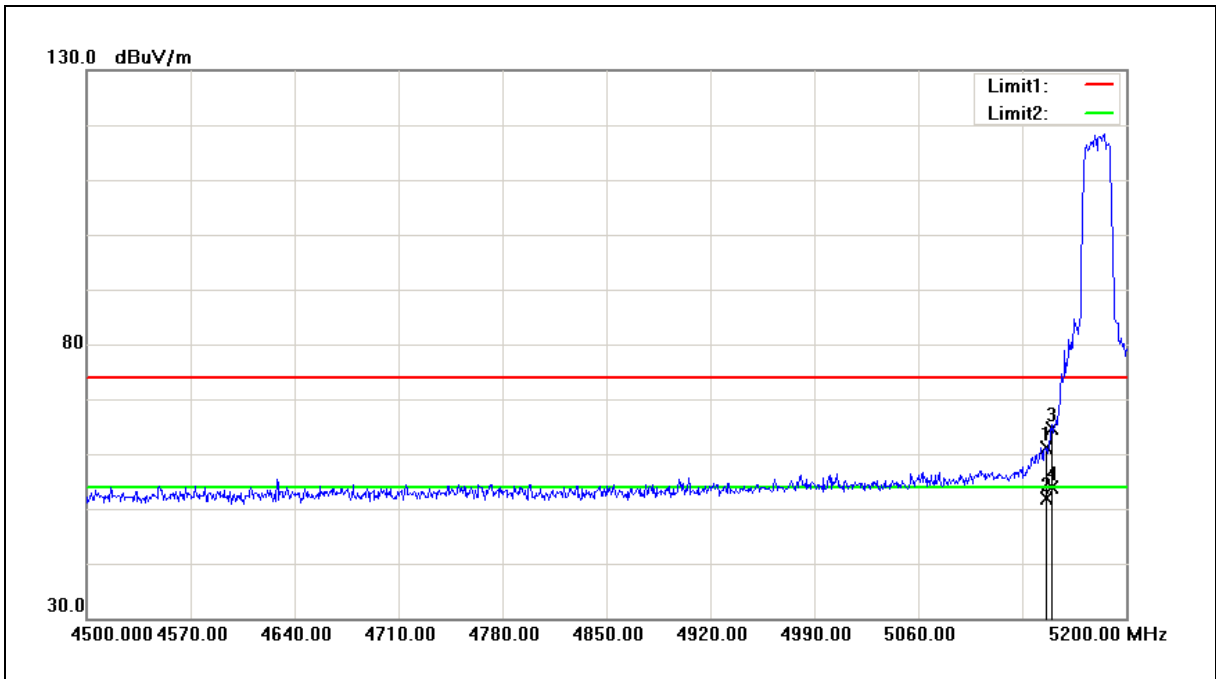

No.	Frequency (MHz)	Reading (dBuV)	Correct Factor (dB/m)	Result (dBuV/m)	Limit (dBuV/m)	Margin (dB)	Remark
1	5146.100	52.94	8.24	61.18	74.00	-12.82	peak
2	5146.100	43.76	8.24	52.00	54.00	-2.00	AVG
3	5150.000	56.27	8.25	64.52	74.00	-9.48	peak
4	5150.000	45.51	8.25	53.76	54.00	-0.24	AVG

Note:1.Result (dBuV/m) = Correct Factor (dB/m) + Reading(dBuV).

2.Correction factor (dB/m) = Antenna Factor (dB/m) + Cable loss (dB) – Pre-Amplifier gain (dB).

3. When the peak results are less than average limit, so not need to evaluate the average.



Standard:	FCC Part 15.407	Test Distance:	3m
Test item:	Band edge	Power:	AC 120V/60Hz
Frequency:	5200MHz	Temp.(°C)/Hum.(%RH):	26(°C)/60%RH
Mode:	Mode 1	Date:	04/06/2017
Ant.Polar.:	Horizontal		

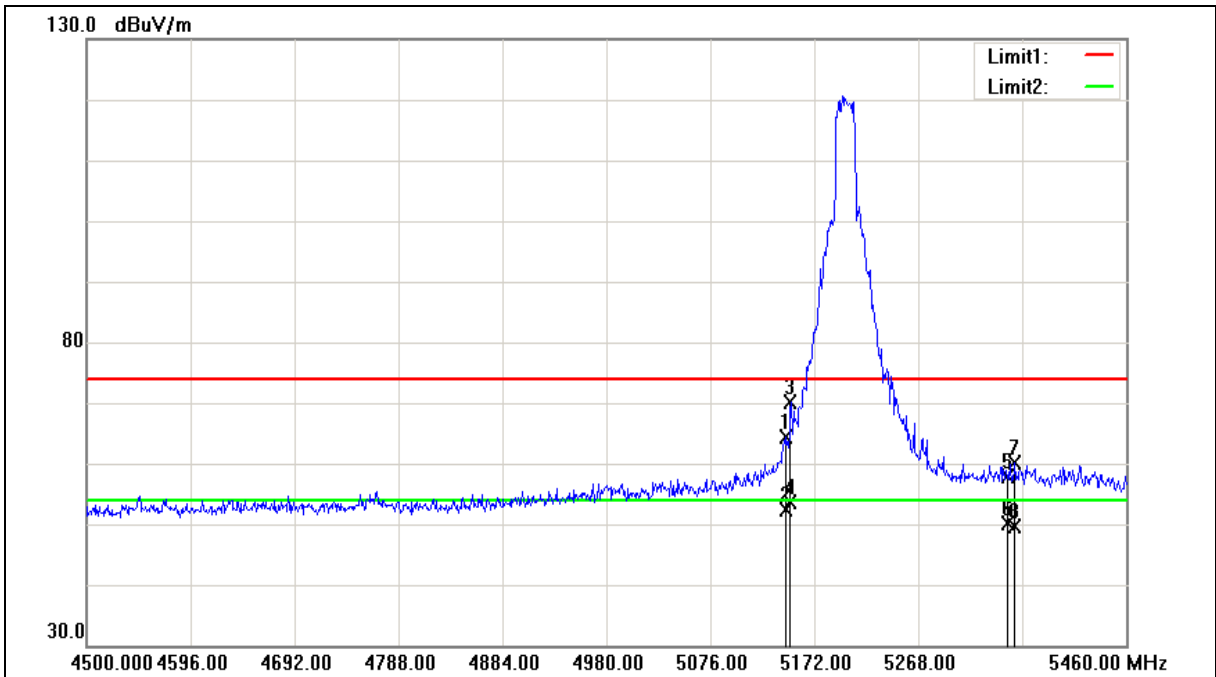



Standard:	FCC Part 15.407	Test Distance:	3m
Test item:	Band edge	Power:	AC 120V/60Hz
Frequency:	5200MHz	Temp.(°C)/Hum.(%RH):	26(°C)/60%RH
Mode:	Mode 1	Date:	04/06/2017
Ant.Polar.:	Horizontal		

No.	Frequency (MHz)	Reading (dBuV)	Correct Factor (dB/m)	Result (dBuV/m)	Limit (dBuV/m)	Margin (dB)	Remark
1	5145.120	56.21	8.24	64.45	74.00	-9.55	peak
2	5145.120	44.24	8.24	52.48	54.00	-1.52	AVG
3	5150.000	61.85	8.25	70.10	74.00	-3.90	peak
4	5150.000	45.39	8.25	53.64	54.00	-0.36	AVG
5	5350.000	49.59	8.41	58.00	74.00	-16.00	peak
6	5350.000	41.60	8.41	50.01	54.00	-3.99	AVG
7	5357.280	51.65	8.42	60.07	74.00	-13.93	peak
8	5357.280	41.28	8.42	49.70	54.00	-4.30	AVG

Note:1.Result (dBuV/m) = Correct Factor (dB/m) + Reading(dBuV).

2.Correction factor (dB/m) = Antenna Factor (dB/m) + Cable loss (dB) – Pre-Amplifier gain (dB).

3. When the peak results are less than average limit, so not need to evaluate the average.



Standard:	FCC Part 15.407	Test Distance:	3m
Test item:	Band edge	Power:	AC 120V/60Hz
Frequency:	5200MHz	Temp.(°C)/Hum.(%RH):	26(°C)/60%RH
Mode:	Mode 1	Date:	04/06/2017
Ant.Polar.:	Vertical		

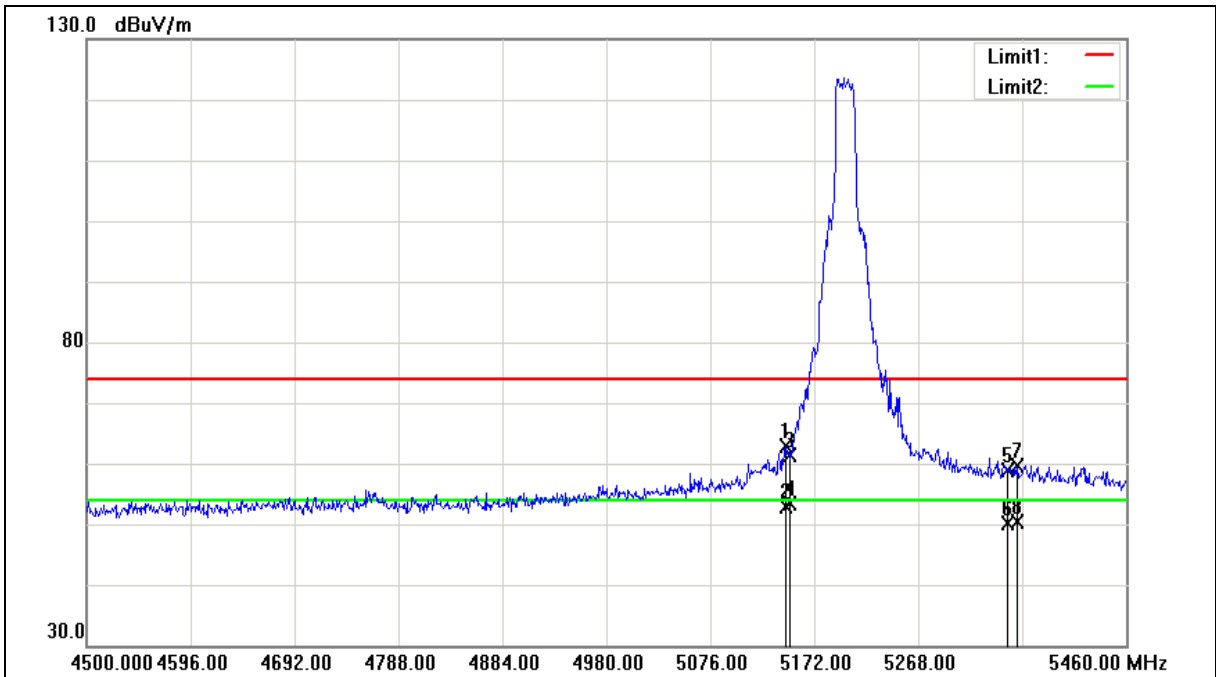



Standard:	FCC Part 15.407	Test Distance:	3m
Test item:	Band edge	Power:	AC 120V/60Hz
Frequency:	5200MHz	Temp.(°C)/Hum.(%RH):	26(°C)/60%RH
Mode:	Mode 1	Date:	04/06/2017
Ant.Polar.:	Vertical		

No.	Frequency (MHz)	Reading (dBuV)	Correct Factor (dB/m)	Result (dBuV/m)	Limit (dBuV/m)	Margin (dB)	Remark
1	5145.120	54.53	8.24	62.77	74.00	-11.23	peak
2	5145.120	44.64	8.24	52.88	54.00	-1.12	AVG
3	5150.000	53.17	8.25	61.42	74.00	-12.58	peak
4	5150.000	45.11	8.25	53.36	54.00	-0.64	AVG
5	5350.000	50.50	8.41	58.91	74.00	-15.09	peak
6	5350.000	41.80	8.41	50.21	54.00	-3.79	AVG
7	5359.200	51.30	8.42	59.72	74.00	-14.28	peak
8	5359.200	42.03	8.42	50.45	54.00	-3.55	AVG

Note:1.Result (dBuV/m) = Correct Factor (dB/m) + Reading(dBuV).

2.Correction factor (dB/m) = Antenna Factor (dB/m) + Cable loss (dB) – Pre-Amplifier gain (dB).

3. When the peak results are less than average limit, so not need to evaluate the average.





Standard:	FCC Part 15.407	Test Distance:	3m
Test item:	Band edge	Power:	AC 120V/60Hz
Frequency:	5240MHz	Temp.(°C)/Hum.(%RH):	26(°C)/60%RH
Mode:	Mode 1	Date:	04/06/2017
Ant.Polar.:	Horizontal		

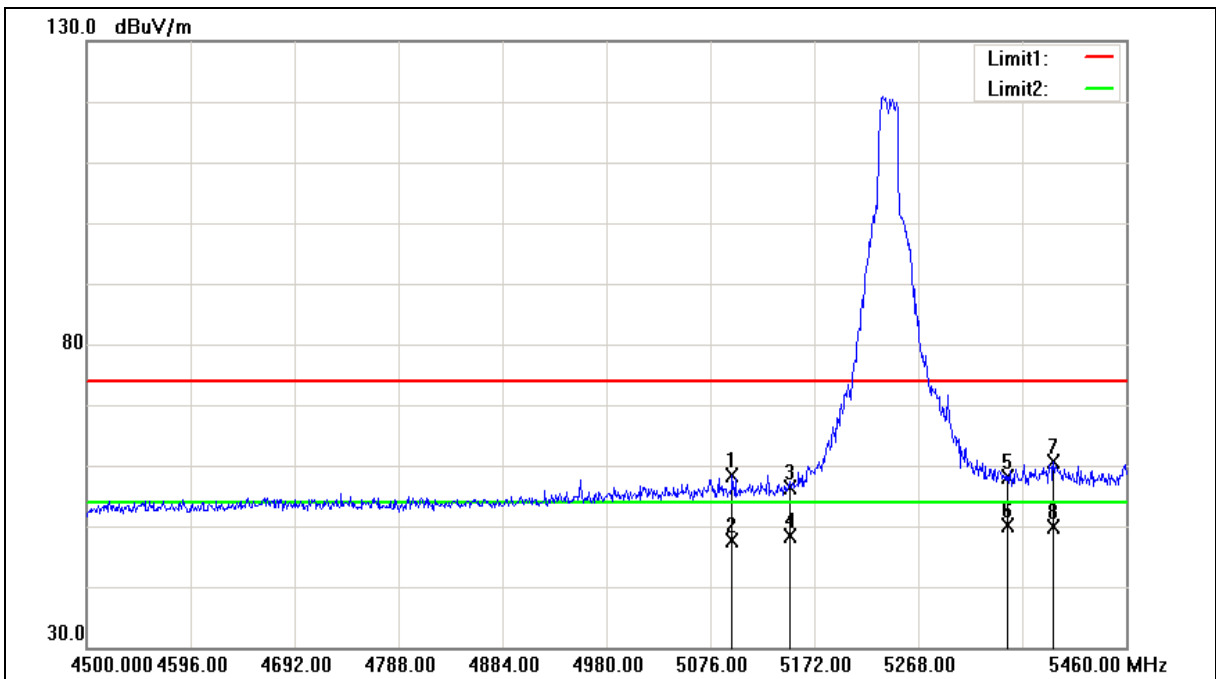



Standard:	FCC Part 15.407	Test Distance:	3m
Test item:	Band edge	Power:	AC 120V/60Hz
Frequency:	5240MHz	Temp.(°C)/Hum.(%RH):	26(°C)/60%RH
Mode:	Mode 1	Date:	04/06/2017
Ant.Polar.:	Horizontal		

No.	Frequency (MHz)	Reading (dBuV)	Correct Factor (dB/m)	Result (dBuV/m)	Limit (dBuV/m)	Margin (dB)	Remark
1	5096.160	50.10	8.19	58.29	74.00	-15.71	peak
2	5096.160	39.56	8.19	47.75	54.00	-6.25	AVG
3	5150.000	48.08	8.25	56.33	74.00	-17.67	peak
4	5150.000	40.16	8.25	48.41	54.00	-5.59	AVG
5	5350.000	49.78	8.41	58.19	74.00	-15.81	peak
6	5350.000	41.73	8.41	50.14	54.00	-3.86	AVG
7	5392.800	52.16	8.46	60.62	74.00	-13.38	peak
8	5392.800	41.52	8.46	49.98	54.00	-4.02	AVG

Note:1.Result (dBuV/m) = Correct Factor (dB/m) + Reading(dBuV).

2.Correction factor (dB/m) = Antenna Factor (dB/m) + Cable loss (dB) – Pre-Amplifier gain (dB).

3. When the peak results are less than average limit, so not need to evaluate the average.



Standard:	FCC Part 15.407	Test Distance:	3m
Test item:	Band edge	Power:	AC 120V/60Hz
Frequency:	5240MHz	Temp.(°C)/Hum.(%RH):	26(°C)/60%RH
Mode:	Mode 1	Date:	04/06/2017
Ant.Polar.:	Vertical		

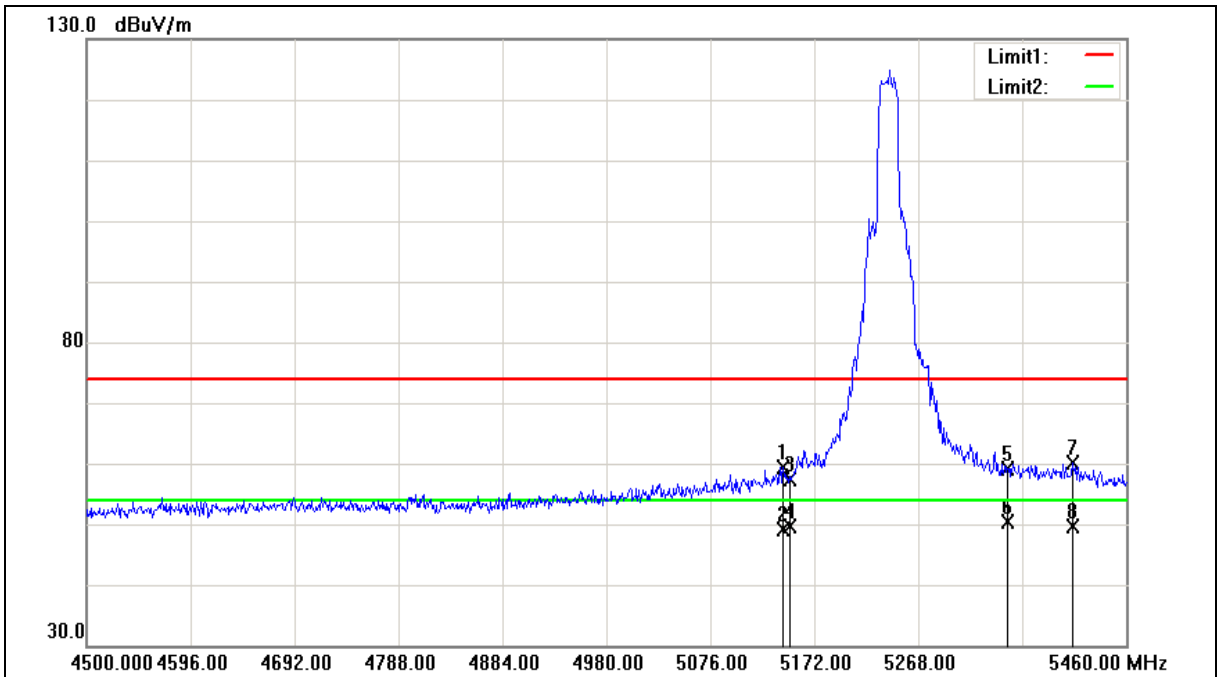



Standard:	FCC Part 15.407	Test Distance:	3m
Test item:	Band edge	Power:	AC 120V/60Hz
Frequency:	5240MHz	Temp.(°C)/Hum.(%RH):	26(°C)/60%RH
Mode:	Mode 1	Date:	04/06/2017
Ant.Polar.:	Vertical		

No.	Frequency (MHz)	Reading (dBuV)	Correct Factor (dB/m)	Result (dBuV/m)	Limit (dBuV/m)	Margin (dB)	Remark
1	5143.200	51.19	8.24	59.43	74.00	-14.57	peak
2	5143.200	40.96	8.24	49.20	54.00	-4.80	AVG
3	5150.000	49.05	8.25	57.30	74.00	-16.70	peak
4	5150.000	41.28	8.25	49.53	54.00	-4.47	AVG
5	5350.000	50.65	8.41	59.06	74.00	-14.94	peak
6	5350.000	42.06	8.41	50.47	54.00	-3.53	AVG
7	5410.080	51.59	8.47	60.06	74.00	-13.94	peak
8	5410.080	41.05	8.47	49.52	54.00	-4.48	AVG

Note:1.Result (dBuV/m) = Correct Factor (dB/m) + Reading(dBuV).

2.Correction factor (dB/m) = Antenna Factor (dB/m) + Cable loss (dB) – Pre-Amplifier gain (dB).

3. When the peak results are less than average limit, so not need to evaluate the average.



Standard:	FCC Part 15.407	Test Distance:	3m
Test item:	Band edge	Power:	AC 120V/60Hz
Frequency:	5745MHz	Temp.(°C)/Hum.(%RH):	26(°C)/60%RH
Mode:	Mode 1	Date:	04/06/2017
Ant.Polar.:	Horizontal		

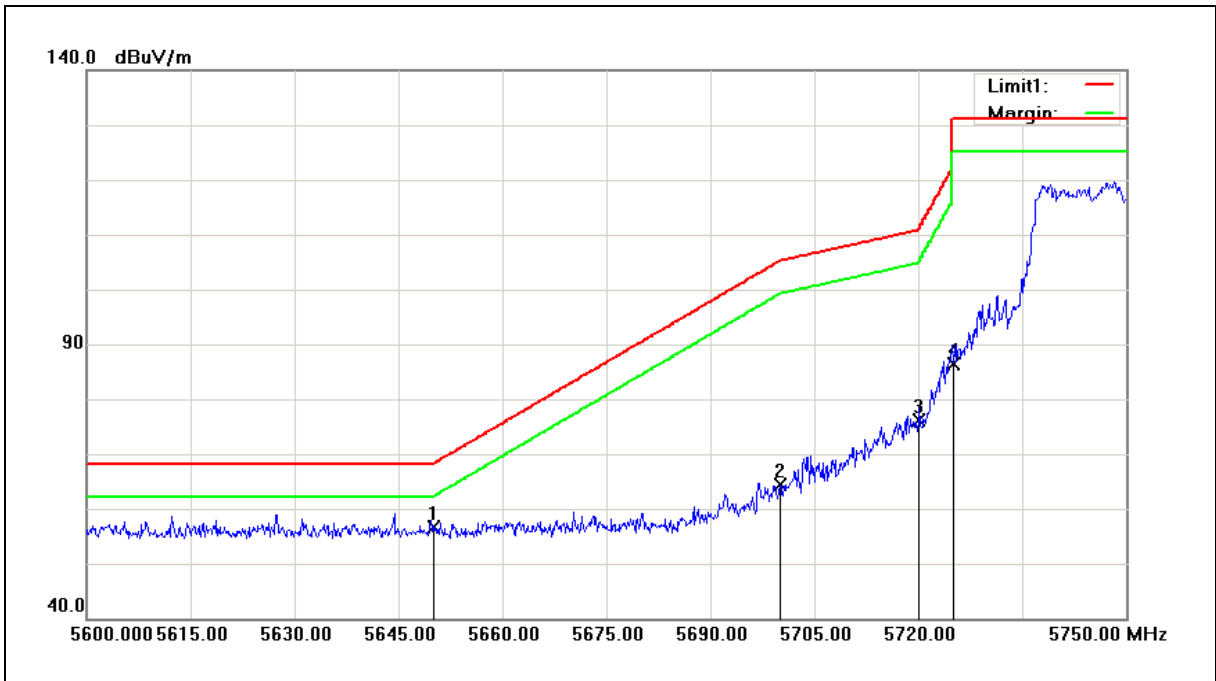

No.	Frequency (MHz)	Reading (dBuV)	Correct Factor (dB/m)	Result (dBuV/m)	Limit (dBuV/m)	Margin (dB)	Remark
1	5650.000	47.72	8.93	56.65	68.20	-11.55	peak
2	5700.000	55.38	9.05	64.43	105.20	-40.77	peak
3	5720.000	67.12	9.09	76.21	110.80	-34.59	peak
4	5725.000	77.39	9.11	86.50	122.20	-35.70	peak

Note:1.Result (dBuV/m) = Correct Factor (dB/m) + Reading(dBuV).

2.Correction factor (dB/m) = Antenna Factor (dB/m) + Cable loss (dB) – Pre-Amplifier gain (dB).

3. When the peak results are less than average limit, so not need to evaluate the average.



Standard:	FCC Part 15.407	Test Distance:	3m
Test item:	Band edge	Power:	AC 120V/60Hz
Frequency:	5745MHz	Temp.(°C)/Hum.(%RH):	26(°C)/60%RH
Mode:	Mode 1	Date:	04/06/2017
Ant.Polar.:	Vertical		

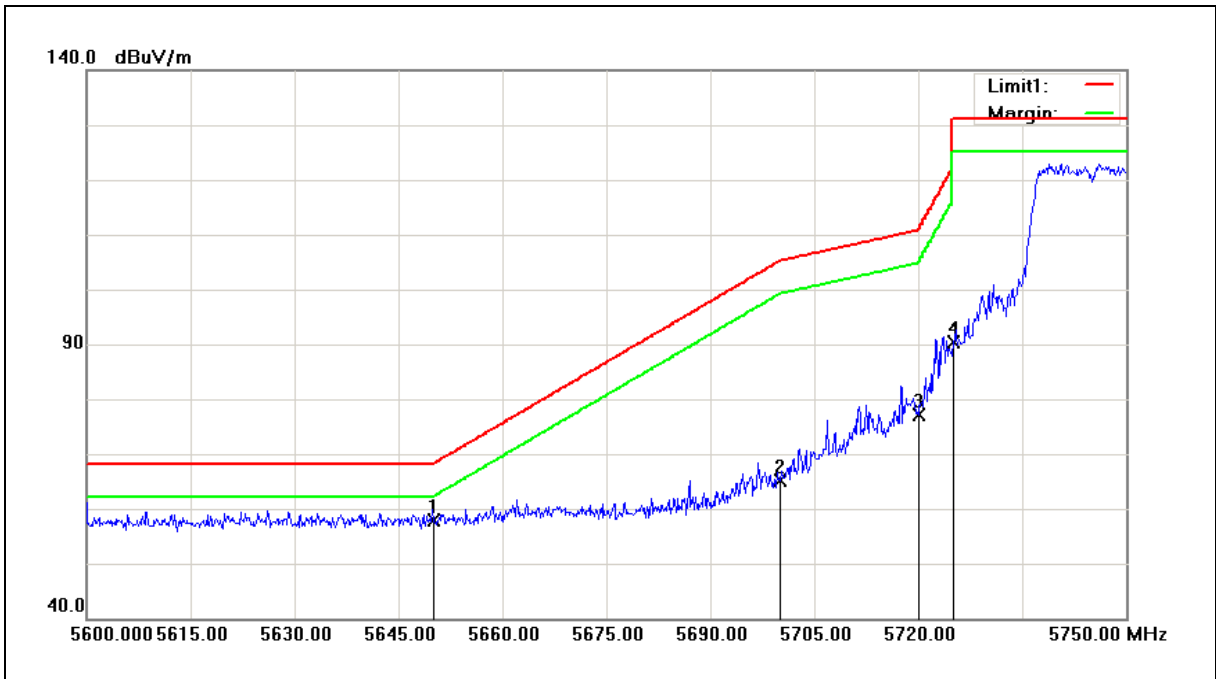

No.	Frequency (MHz)	Reading (dBuV)	Correct Factor (dB/m)	Result (dBuV/m)	Limit (dBuV/m)	Margin (dB)	Remark
1	5650.000	48.83	8.93	57.76	68.20	-10.44	peak
2	5700.000	56.15	9.05	65.20	105.20	-40.00	peak
3	5720.000	68.10	9.09	77.19	110.80	-33.61	peak
4	5725.000	81.23	9.11	90.34	122.20	-31.86	peak

Note:1.Result (dBuV/m) = Correct Factor (dB/m) + Reading(dBuV).

2.Correction factor (dB/m) = Antenna Factor (dB/m) + Cable loss (dB) – Pre-Amplifier gain (dB).

3. When the peak results are less than average limit, so not need to evaluate the average.



Standard:	FCC Part 15.407	Test Distance:	3m
Test item:	Band edge	Power:	AC 120V/60Hz
Frequency:	5785MHz	Temp.(°C)/Hum.(%RH):	26(°C)/60%RH
Mode:	Mode 1	Date:	04/06/2017
Ant.Polar.:	Horizontal		

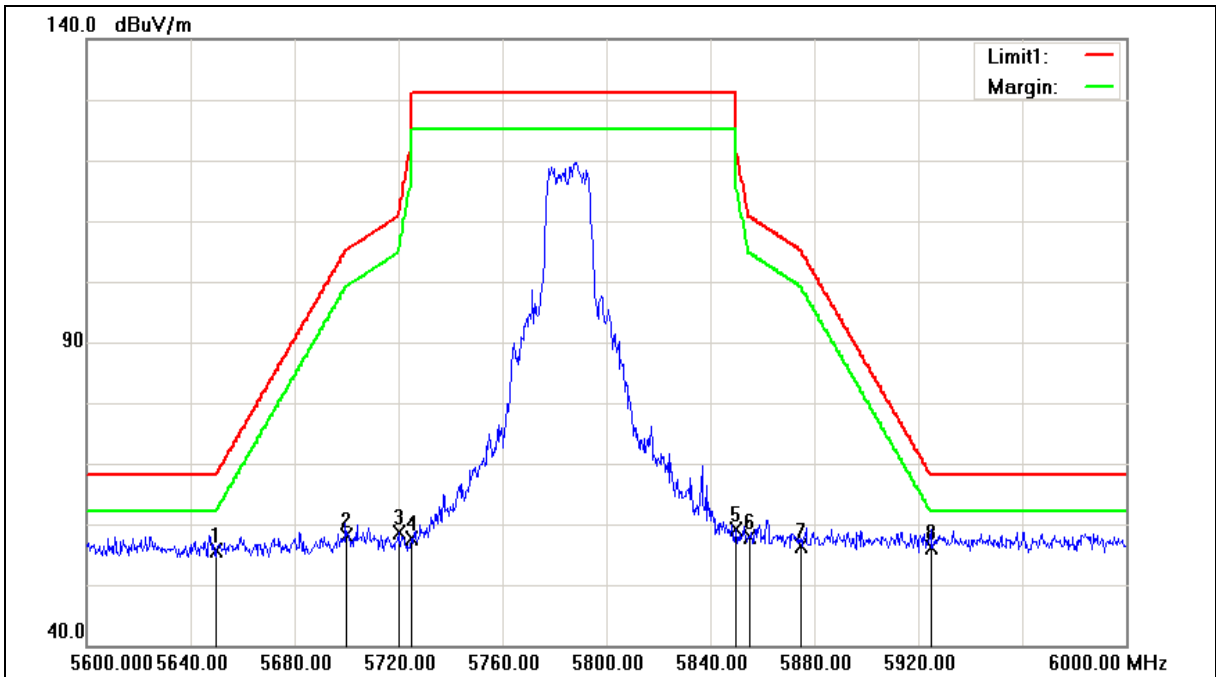



Standard:	FCC Part 15.407	Test Distance:	3m
Test item:	Band edge	Power:	AC 120V/60Hz
Frequency:	5785MHz	Temp.(°C)/Hum.(%RH):	26(°C)/60%RH
Mode:	Mode 1	Date:	04/06/2017
Ant.Polar.:	Horizontal		

No.	Frequency (MHz)	Reading (dBuV)	Correct Factor (dB/m)	Result (dBuV/m)	Limit (dBuV/m)	Margin (dB)	Remark
1	5650.000	46.77	8.93	55.70	68.20	-12.50	peak
2	5700.000	49.10	9.05	58.15	105.20	-47.05	peak
3	5720.000	49.49	9.09	58.58	110.80	-52.22	peak
4	5725.000	48.59	9.11	57.70	122.20	-64.50	peak
5	5850.000	49.71	9.41	59.12	122.20	-63.08	peak
6	5855.000	48.35	9.43	57.78	110.80	-53.02	peak
7	5875.000	47.00	9.48	56.48	105.20	-48.72	peak
8	5925.000	46.41	9.61	56.02	68.20	-12.18	peak

Note:1.Result (dBuV/m) = Correct Factor (dB/m) + Reading(dBuV).

2.Correction factor (dB/m) = Antenna Factor (dB/m) + Cable loss (dB) – Pre-Amplifier gain (dB).

3. When the peak results are less than average limit, so not need to evaluate the average.





Standard:	FCC Part 15.407	Test Distance:	3m
Test item:	Band edge	Power:	AC 120V/60Hz
Frequency:	5785MHz	Temp.(°C)/Hum.(%RH):	26(°C)/60%RH
Mode:	Mode 1	Date:	04/06/2017
Ant.Polar.:	Vertical		

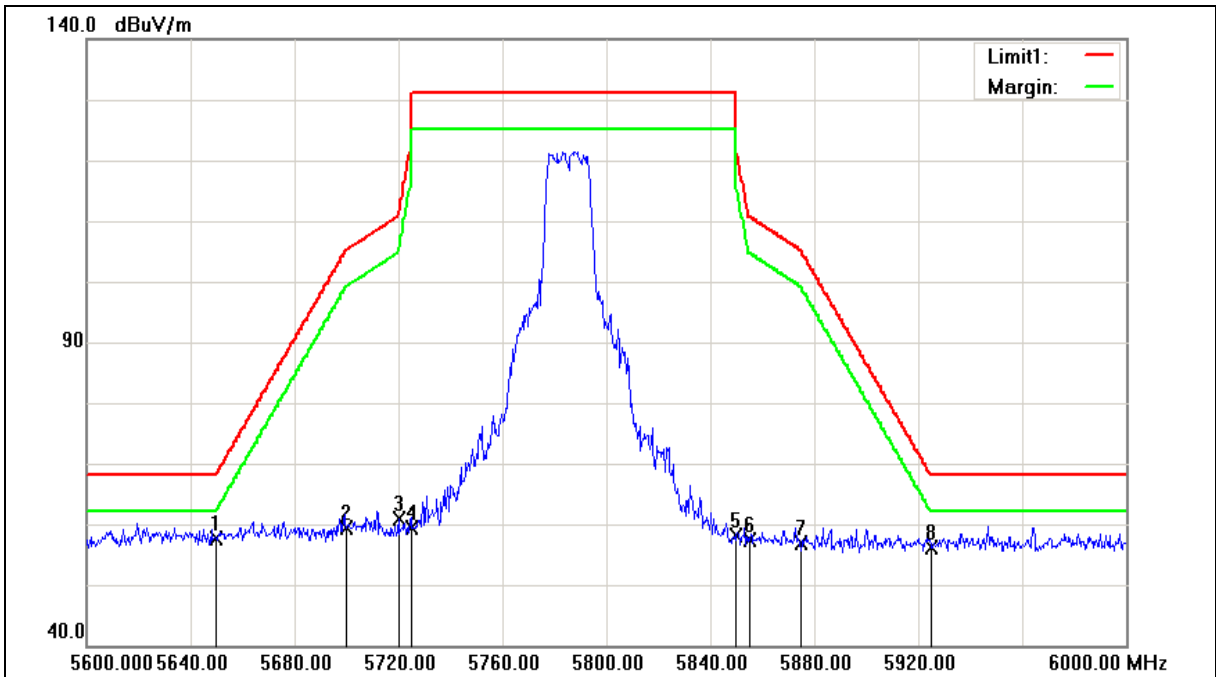



Standard:	FCC Part 15.407	Test Distance:	3m
Test item:	Band edge	Power:	AC 120V/60Hz
Frequency:	5785MHz	Temp.(°C)/Hum. (%RH):	26(°C)/60%RH
Mode:	Mode 1	Date:	04/06/2017
Ant.Polar.:	Vertical		

No.	Frequency (MHz)	Reading (dBuV)	Correct Factor (dB/m)	Result (dBuV/m)	Limit (dBuV/m)	Margin (dB)	Remark
1	5650.000	48.62	8.93	57.55	68.20	-10.65	peak
2	5700.000	50.37	9.05	59.42	105.20	-45.78	peak
3	5720.000	51.68	9.09	60.77	110.80	-50.03	peak
4	5725.000	50.38	9.11	59.49	122.20	-62.71	peak
5	5850.000	48.63	9.41	58.04	122.20	-64.16	peak
6	5855.000	47.89	9.43	57.32	110.80	-53.48	peak
7	5875.000	47.42	9.48	56.90	105.20	-48.30	peak
8	5925.000	46.56	9.61	56.17	68.20	-12.03	peak

Note:1.Result (dBuV/m) = Correct Factor (dB/m) + Reading(dBuV).

2.Correction factor (dB/m) = Antenna Factor (dB/m) + Cable loss (dB) – Pre-Amplifier gain (dB).

3. When the peak results are less than average limit, so not need to evaluate the average.



Standard:	FCC Part 15.407	Test Distance:	3m
Test item:	Band edge	Power:	AC 120V/60Hz
Frequency:	5825MHz	Temp.(°C)/Hum.(%RH):	26(°C)/60%RH
Mode:	Mode 1	Date:	04/06/2017
Ant.Polar.:	Horizontal		

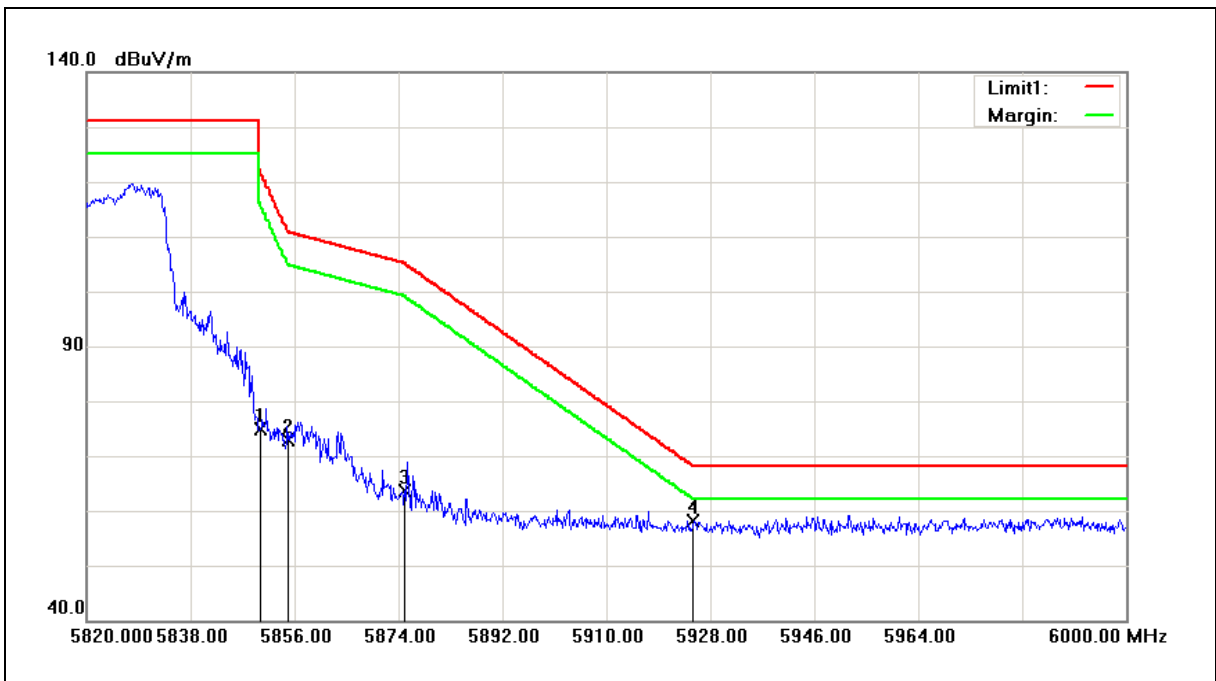

No.	Frequency (MHz)	Reading (dBuV)	Correct Factor (dB/m)	Result (dBuV/m)	Limit (dBuV/m)	Margin (dB)	Remark
1	5850.000	65.54	9.41	74.95	122.20	-47.25	peak
2	5855.000	63.47	9.43	72.90	110.80	-37.90	peak
3	5875.000	54.09	9.48	63.57	105.20	-41.63	peak
4	5925.000	48.51	9.61	58.12	68.20	-10.08	peak

Note:1.Result (dBuV/m) = Correct Factor (dB/m) + Reading(dBuV).

2.Correction factor (dB/m) = Antenna Factor (dB/m) + Cable loss (dB) – Pre-Amplifier gain (dB).

3. When the peak results are less than average limit, so not need to evaluate the average.



Standard:	FCC Part 15.407	Test Distance:	3m
Test item:	Band edge	Power:	AC 120V/60Hz
Frequency:	5825MHz	Temp.(°C)/Hum.(%RH):	26(°C)/60%RH
Mode:	Mode 1	Date:	04/06/2017
Ant.Polar.:	Vertical		

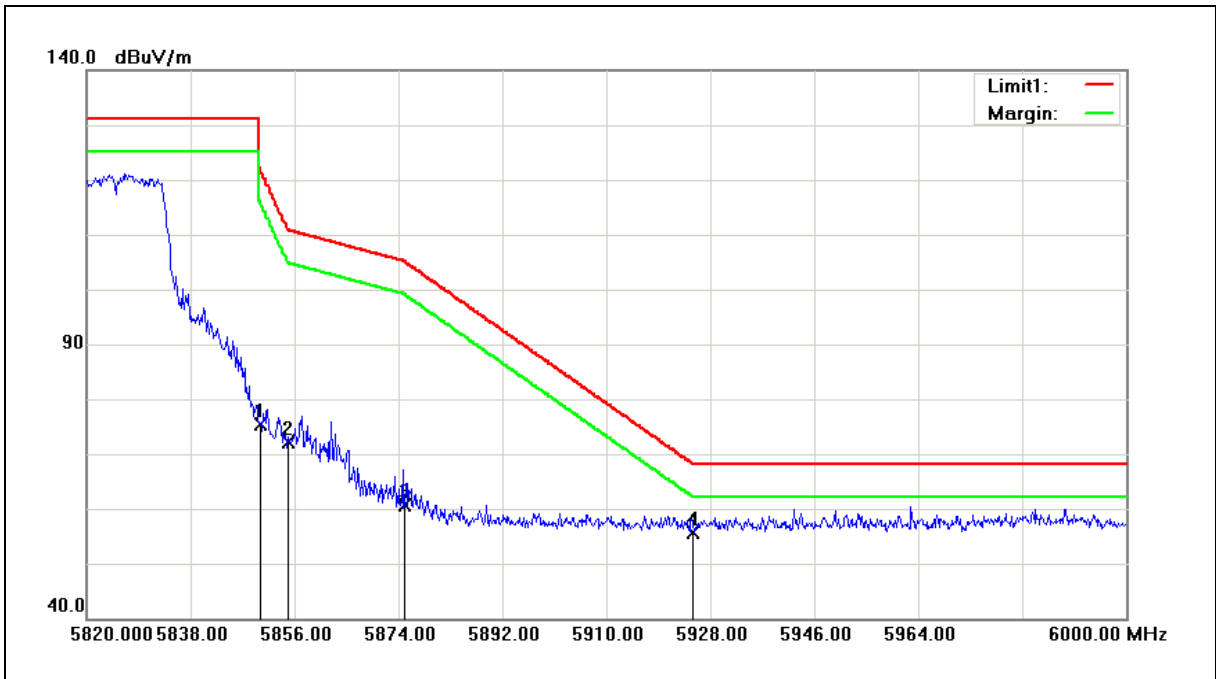

No.	Frequency (MHz)	Reading (dBuV)	Correct Factor (dB/m)	Result (dBuV/m)	Limit (dBuV/m)	Margin (dB)	Remark
1	5850.000	66.06	9.41	75.47	122.20	-46.73	peak
2	5855.000	62.64	9.43	72.07	110.80	-38.73	peak
3	5875.000	51.15	9.48	60.63	105.20	-44.57	peak
4	5925.000	46.00	9.61	55.61	68.20	-12.59	peak

Note:1.Result (dBuV/m) = Correct Factor (dB/m) + Reading(dBuV).

2.Correction factor (dB/m) = Antenna Factor (dB/m) + Cable loss (dB) – Pre-Amplifier gain (dB).

3. When the peak results are less than average limit, so not need to evaluate the average.



Standard:	FCC Part 15.407	Test Distance:	3m
Test item:	Band edge	Power:	AC 120V/60Hz
Frequency:	5180MHz	Temp.(°C)/Hum.(%RH):	26(°C)/60%RH
Mode:	Mode 2	Date:	04/06/2017
Ant.Polar.:	Horizontal		

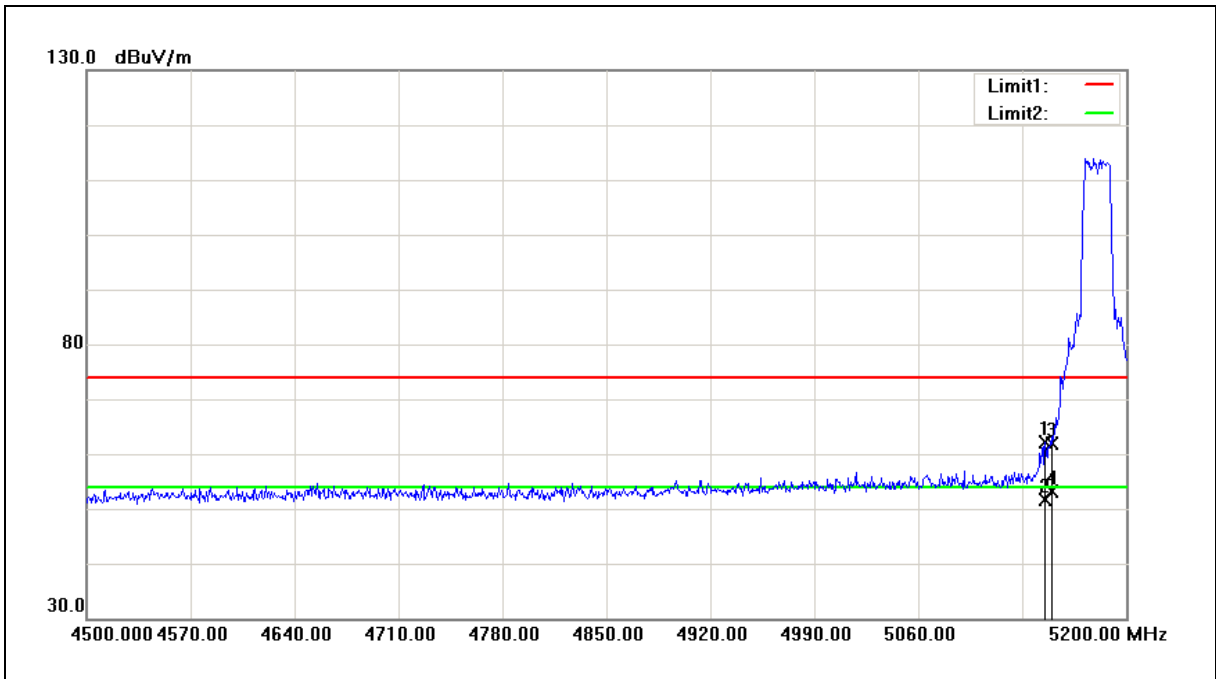

No.	Frequency (MHz)	Reading (dBuV)	Correct Factor (dB/m)	Result (dBuV/m)	Limit (dBuV/m)	Margin (dB)	Remark
1	5145.400	53.77	8.24	62.01	74.00	-11.99	peak
2	5145.400	43.51	8.24	51.75	54.00	-2.25	AVG
3	5150.000	53.52	8.25	61.77	74.00	-12.23	peak
4	5150.000	44.80	8.25	53.05	54.00	-0.95	AVG

Note:1.Result (dBuV/m) = Correct Factor (dB/m) + Reading(dBuV).

2.Correction factor (dB/m) = Antenna Factor (dB/m) + Cable loss (dB) – Pre-Amplifier gain (dB).

3. When the peak results are less than average limit, so not need to evaluate the average.



Standard:	FCC Part 15.407	Test Distance:	3m
Test item:	Band edge	Power:	AC 120V/60Hz
Frequency:	5180MHz	Temp.(°C)/Hum.(%RH):	26(°C)/60%RH
Mode:	Mode 2	Date:	04/06/2017
Ant.Polar.:	Vertical		

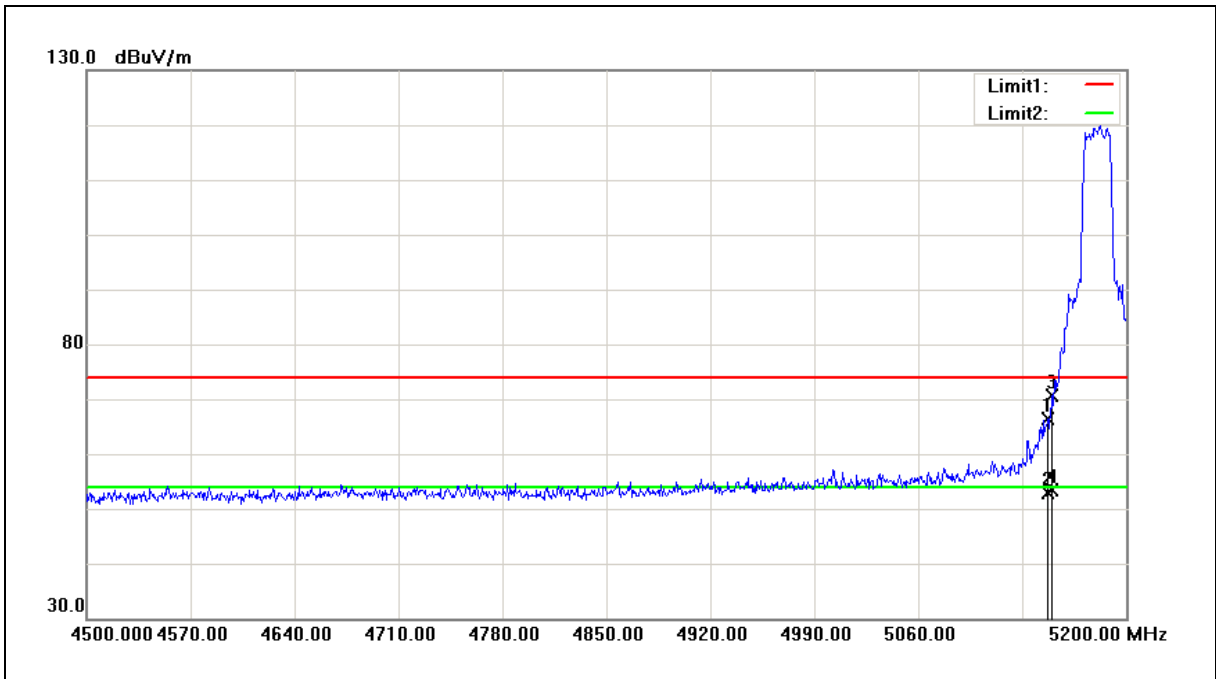

No.	Frequency (MHz)	Reading (dBuV)	Correct Factor (dB/m)	Result (dBuV/m)	Limit (dBuV/m)	Margin (dB)	Remark
1	5147.500	58.14	8.24	66.38	74.00	-7.62	peak
2	5147.500	44.70	8.24	52.94	54.00	-1.06	AVG
3	5150.000	62.38	8.25	70.63	74.00	-3.37	peak
4	5150.000	45.24	8.25	53.49	54.00	-0.51	AVG

Note:1.Result (dBuV/m) = Correct Factor (dB/m) + Reading(dBuV).

2.Correction factor (dB/m) = Antenna Factor (dB/m) + Cable loss (dB) – Pre-Amplifier gain (dB).

3. When the peak results are less than average limit, so not need to evaluate the average.



Standard:	FCC Part 15.407	Test Distance:	3m
Test item:	Band edge	Power:	AC 120V/60Hz
Frequency:	5200MHz	Temp.(°C)/Hum.(%RH):	26(°C)/60%RH
Mode:	Mode 2	Date:	04/06/2017
Ant.Polar.:	Horizontal		

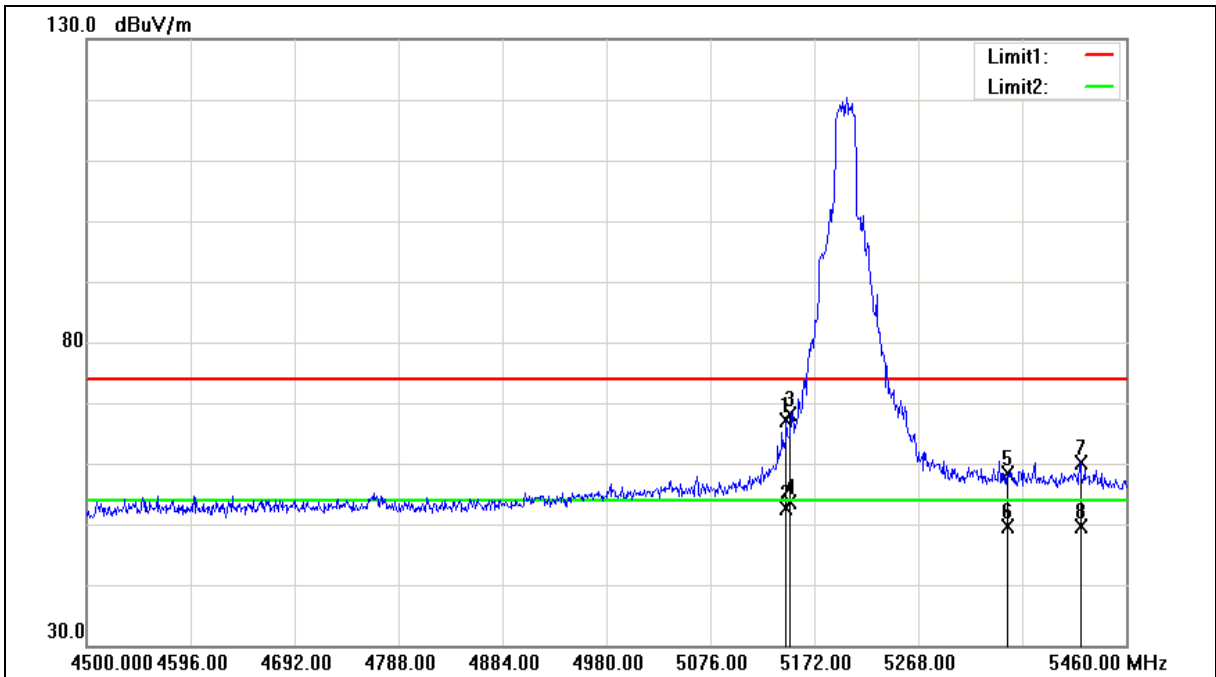



Standard:	FCC Part 15.407	Test Distance:	3m
Test item:	Band edge	Power:	AC 120V/60Hz
Frequency:	5200MHz	Temp.(°C)/Hum.(%RH):	26(°C)/60%RH
Mode:	Mode 2	Date:	04/06/2017
Ant.Polar.:	Horizontal		

No.	Frequency (MHz)	Reading (dBuV)	Correct Factor (dB/m)	Result (dBuV/m)	Limit (dBuV/m)	Margin (dB)	Remark
1	5146.080	58.87	8.24	67.11	74.00	-6.89	peak
2	5146.080	44.33	8.24	52.57	54.00	-1.43	AVG
3	5150.000	59.88	8.25	68.13	74.00	-5.87	peak
4	5150.000	45.46	8.25	53.71	54.00	-0.29	AVG
5	5350.000	50.05	8.41	58.46	74.00	-15.54	peak
6	5350.000	41.18	8.41	49.59	54.00	-4.41	AVG
7	5417.760	51.72	8.48	60.20	74.00	-13.80	peak
8	5417.760	41.26	8.48	49.74	54.00	-4.26	AVG

Note:1.Result (dBuV/m) = Correct Factor (dB/m) + Reading(dBuV).

2.Correction factor (dB/m) = Antenna Factor (dB/m) + Cable loss (dB) – Pre-Amplifier gain (dB).

3. When the peak results are less than average limit, so not need to evaluate the average.





Standard:	FCC Part 15.407	Test Distance:	3m
Test item:	Band edge	Power:	AC 120V/60Hz
Frequency:	5200MHz	Temp.(°C)/Hum.(%RH):	26(°C)/60%RH
Mode:	Mode 2	Date:	04/06/2017
Ant.Polar.:	Vertical		

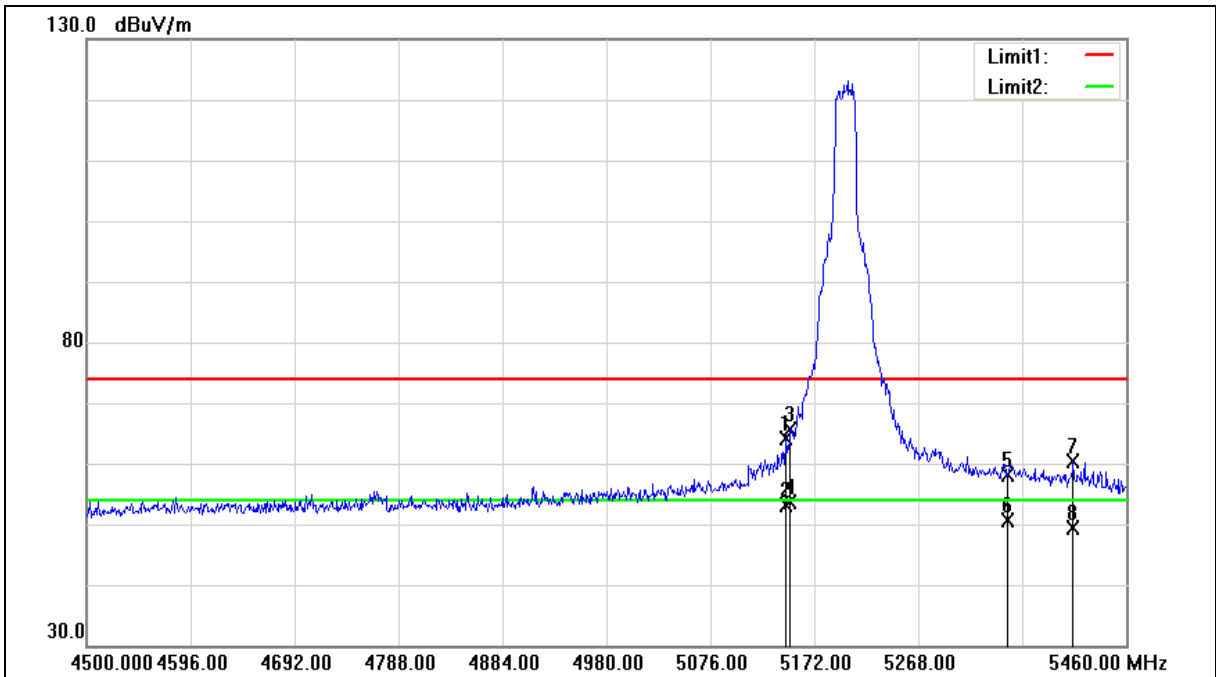



Standard:	FCC Part 15.407	Test Distance:	3m
Test item:	Band edge	Power:	AC 120V/60Hz
Frequency:	5200MHz	Temp.(°C)/Hum.(%RH):	26(°C)/60%RH
Mode:	Mode 2	Date:	04/06/2017
Ant.Polar.:	Vertical		

No.	Frequency (MHz)	Reading (dBuV)	Correct Factor (dB/m)	Result (dBuV/m)	Limit (dBuV/m)	Margin (dB)	Remark
1	5146.080	55.80	8.24	64.04	74.00	-9.96	peak
2	5146.080	44.91	8.24	53.15	54.00	-0.85	AVG
3	5150.000	57.28	8.25	65.53	74.00	-8.47	peak
4	5150.000	45.50	8.25	53.75	54.00	-0.25	AVG
5	5350.000	49.76	8.41	58.17	74.00	-15.83	peak
6	5350.000	42.14	8.41	50.55	54.00	-3.45	AVG
7	5411.040	51.86	8.47	60.33	74.00	-13.67	peak
8	5411.040	40.95	8.47	49.42	54.00	-4.58	AVG

Note:1.Result (dBuV/m) = Correct Factor (dB/m) + Reading(dBuV).

2.Correction factor (dB/m) = Antenna Factor (dB/m) + Cable loss (dB) – Pre-Amplifier gain (dB).

3. When the peak results are less than average limit, so not need to evaluate the average.



Standard:	FCC Part 15.407	Test Distance:	3m
Test item:	Band edge	Power:	AC 120V/60Hz
Frequency:	5240MHz	Temp.(°C)/Hum.(%RH):	26(°C)/60%RH
Mode:	Mode 2	Date:	04/06/2017
Ant.Polar.:	Horizontal		

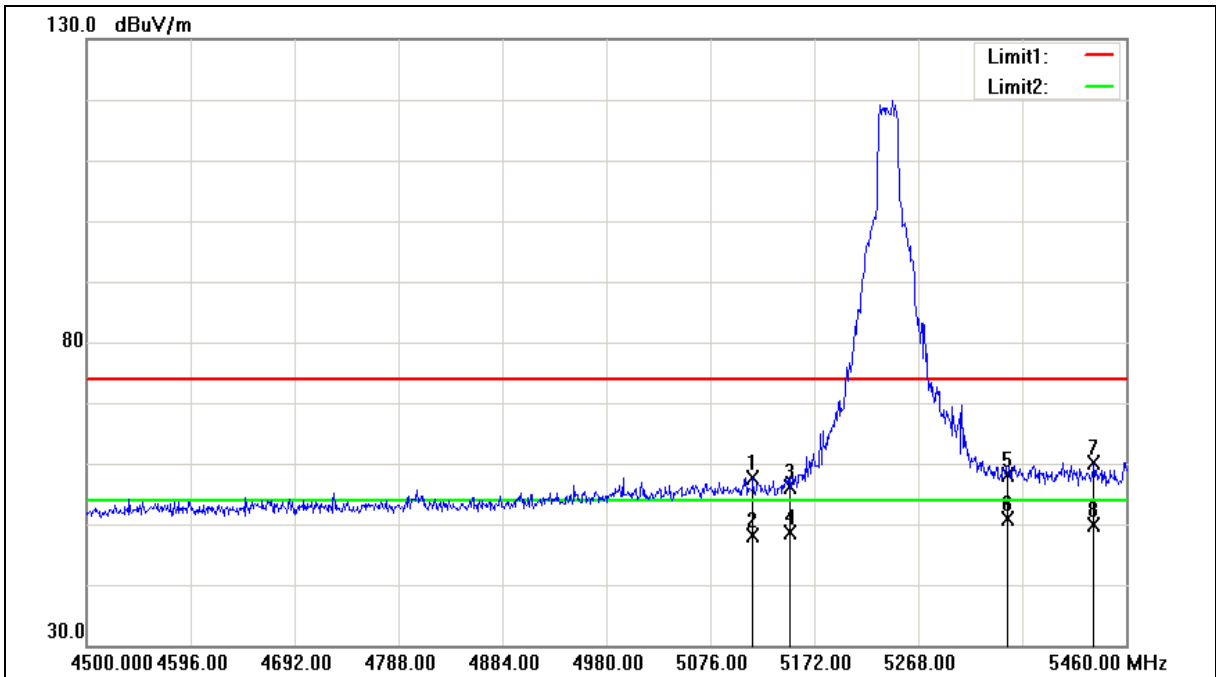



Standard:	FCC Part 15.407	Test Distance:	3m
Test item:	Band edge	Power:	AC 120V/60Hz
Frequency:	5240MHz	Temp.(°C)/Hum.(%RH):	26(°C)/60%RH
Mode:	Mode 2	Date:	04/06/2017
Ant.Polar.:	Horizontal		

No.	Frequency (MHz)	Reading (dBuV)	Correct Factor (dB/m)	Result (dBuV/m)	Limit (dBuV/m)	Margin (dB)	Remark
1	5115.360	49.47	8.21	57.68	74.00	-16.32	peak
2	5115.360	39.80	8.21	48.01	54.00	-5.99	AVG
3	5150.000	47.76	8.25	56.01	74.00	-17.99	peak
4	5150.000	40.49	8.25	48.74	54.00	-5.26	AVG
5	5350.000	49.65	8.41	58.06	74.00	-15.94	peak
6	5350.000	42.35	8.41	50.76	54.00	-3.24	AVG
7	5430.240	51.76	8.49	60.25	74.00	-13.75	peak
8	5430.240	41.45	8.49	49.94	54.00	-4.06	AVG

Note:1.Result (dBuV/m) = Correct Factor (dB/m) + Reading(dBuV).

2.Correction factor (dB/m) = Antenna Factor (dB/m) + Cable loss (dB) – Pre-Amplifier gain (dB).

3. When the peak results are less than average limit, so not need to evaluate the average.



Standard:	FCC Part 15.407	Test Distance:	3m
Test item:	Band edge	Power:	AC 120V/60Hz
Frequency:	5240MHz	Temp.(°C)/Hum.(%RH):	26(°C)/60%RH
Mode:	Mode 2	Date:	04/06/2017
Ant.Polar.:	Vertical		

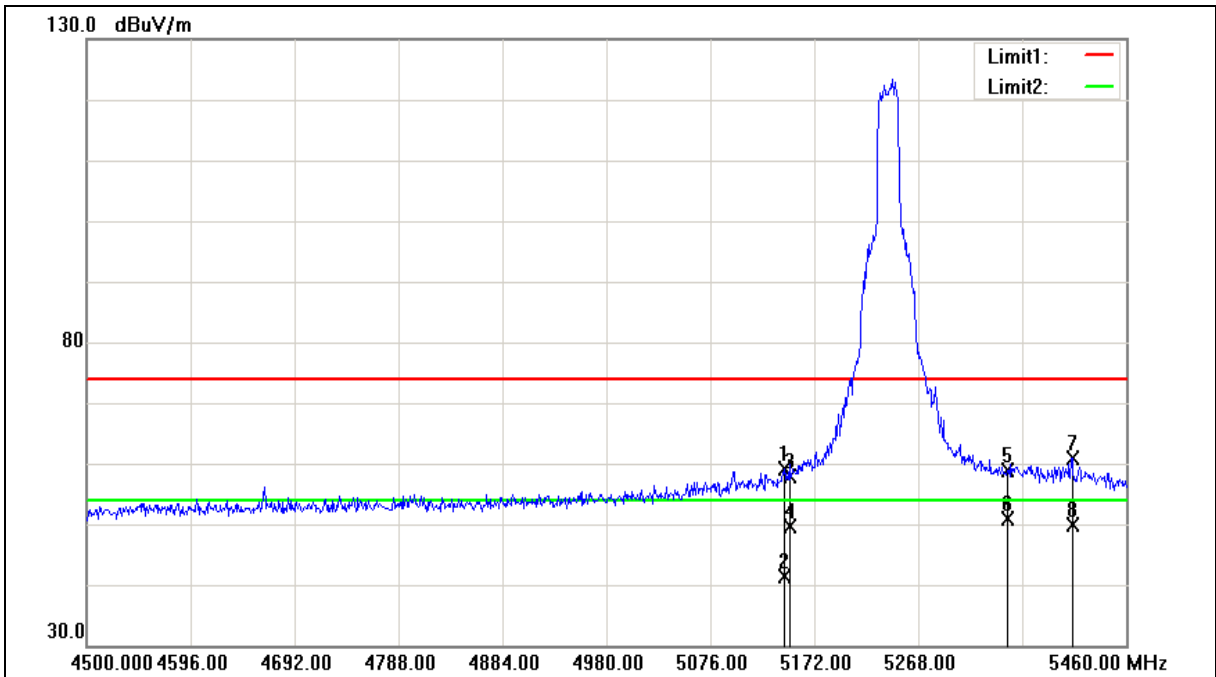



Standard:	FCC Part 15.407	Test Distance:	3m
Test item:	Band edge	Power:	AC 120V/60Hz
Frequency:	5240MHz	Temp.(°C)/Hum. (%RH):	26(°C)/60%RH
Mode:	Mode 2	Date:	04/06/2017
Ant.Polar.:	Vertical		

No.	Frequency (MHz)	Reading (dBuV)	Correct Factor (dB/m)	Result (dBuV/m)	Limit (dBuV/m)	Margin (dB)	Remark
1	5144.160	50.88	8.24	59.12	74.00	-14.88	peak
2	5144.160	33.16	8.24	41.40	54.00	-12.60	AVG
3	5150.000	49.51	8.25	57.76	74.00	-16.24	peak
4	5150.000	41.41	8.25	49.66	54.00	-4.34	AVG
5	5350.000	50.53	8.41	58.94	74.00	-15.06	peak
6	5350.000	42.37	8.41	50.78	54.00	-3.22	AVG
7	5410.080	52.39	8.47	60.86	74.00	-13.14	peak
8	5410.080	41.31	8.47	49.78	54.00	-4.22	AVG

Note:1.Result (dBuV/m) = Correct Factor (dB/m) + Reading(dBuV).

2.Correction factor (dB/m) = Antenna Factor (dB/m) + Cable loss (dB) – Pre-Amplifier gain (dB).

3. When the peak results are less than average limit, so not need to evaluate the average.



Standard:	FCC Part 15.407	Test Distance:	3m
Test item:	Band edge	Power:	AC 120V/60Hz
Frequency:	5745MHz	Temp.(°C)/Hum.(%RH):	26(°C)/60%RH
Mode:	Mode 2	Date:	04/06/2017
Ant.Polar.:	Horizontal		

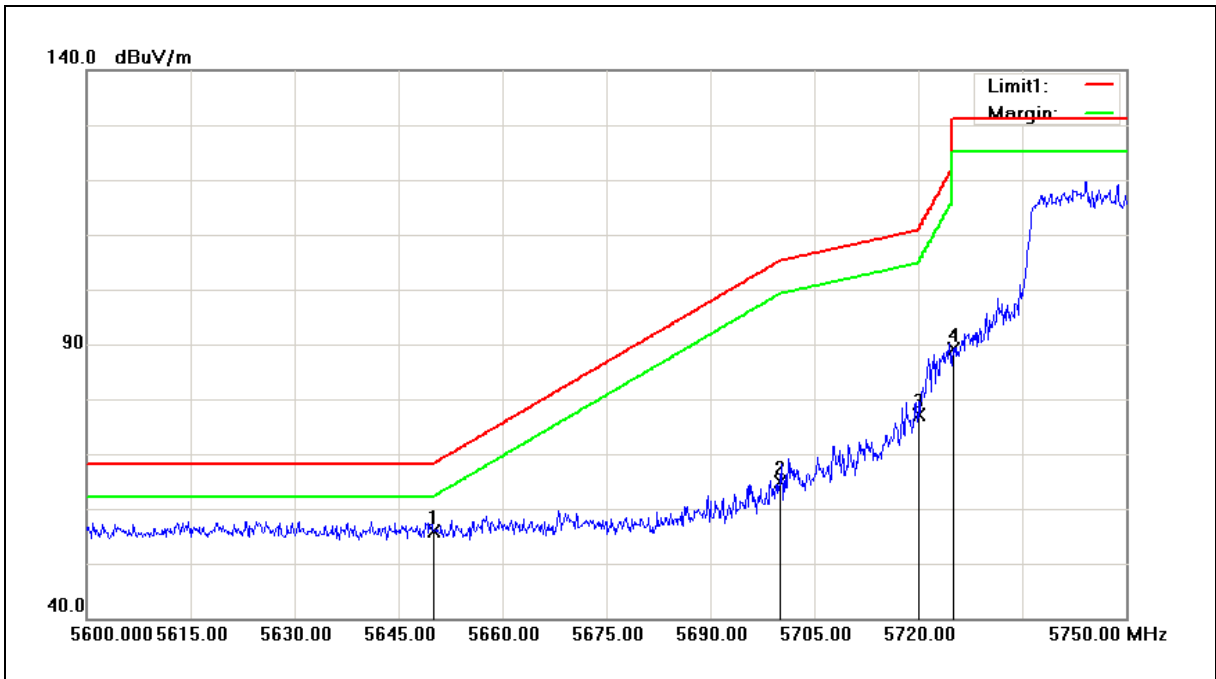

No.	Frequency (MHz)	Reading (dBuV)	Correct Factor (dB/m)	Result (dBuV/m)	Limit (dBuV/m)	Margin (dB)	Remark
1	5650.000	47.05	8.93	55.98	68.20	-12.22	peak
2	5700.000	55.90	9.05	64.95	105.20	-40.25	peak
3	5720.000	67.97	9.09	77.06	110.80	-33.74	peak
4	5725.000	80.06	9.11	89.17	122.20	-33.03	peak

Note:1.Result (dBuV/m) = Correct Factor (dB/m) + Reading(dBuV).

2.Correction factor (dB/m) = Antenna Factor (dB/m) + Cable loss (dB) – Pre-Amplifier gain (dB).

3. When the peak results are less than average limit, so not need to evaluate the average.



Standard:	FCC Part 15.407	Test Distance:	3m
Test item:	Band edge	Power:	AC 120V/60Hz
Frequency:	5745MHz	Temp.(°C)/Hum.(%RH):	26(°C)/60%RH
Mode:	Mode 2	Date:	04/06/2017
Ant.Polar.:	Vertical		

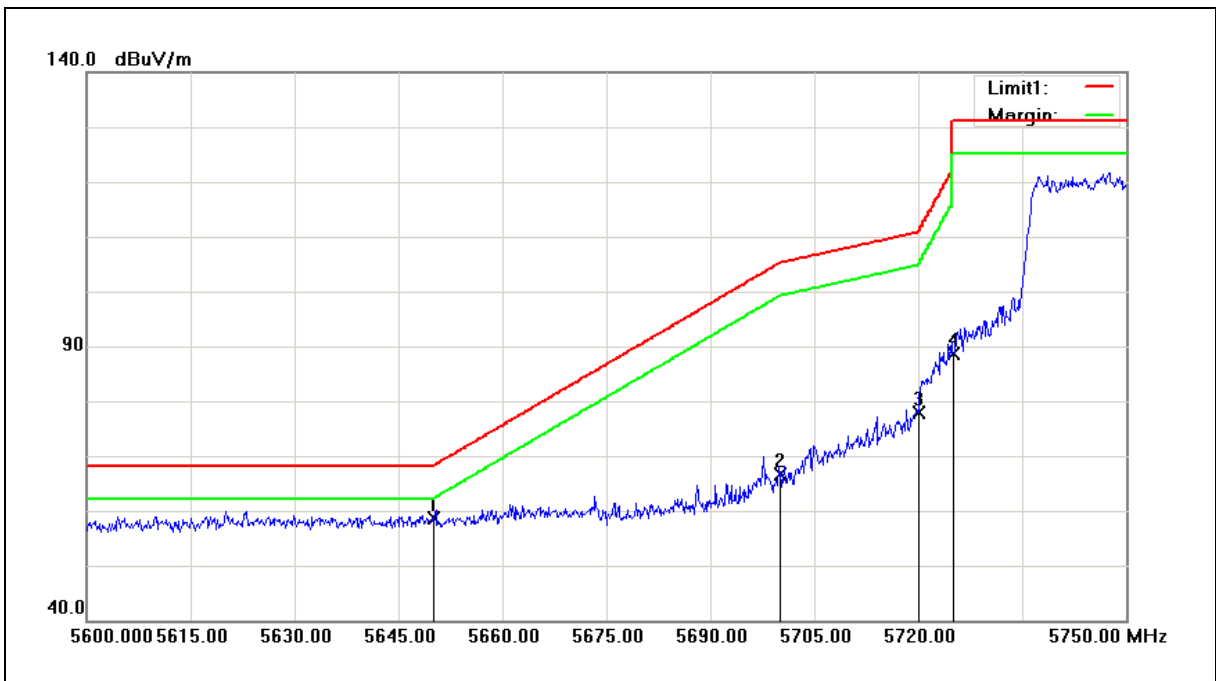

No.	Frequency (MHz)	Reading (dBuV)	Correct Factor (dB/m)	Result (dBuV/m)	Limit (dBuV/m)	Margin (dB)	Remark
1	5650.000	49.77	8.93	58.70	68.20	-9.50	peak
2	5700.000	57.58	9.05	66.63	105.20	-38.57	peak
3	5720.000	68.87	9.09	77.96	110.80	-32.84	peak
4	5725.000	79.56	9.11	88.67	122.20	-33.53	peak

Note:1.Result (dBuV/m) = Correct Factor (dB/m) + Reading(dBuV).

2.Correction factor (dB/m) = Antenna Factor (dB/m) + Cable loss (dB) – Pre-Amplifier gain (dB).

3. When the peak results are less than average limit, so not need to evaluate the average.





Standard:	FCC Part 15.407	Test Distance:	3m
Test item:	Band edge	Power:	AC 120V/60Hz
Frequency:	5785MHz	Temp.(°C)/Hum.(%RH):	26(°C)/60%RH
Mode:	Mode 2	Date:	04/06/2017
Ant.Polar.:	Horizontal		

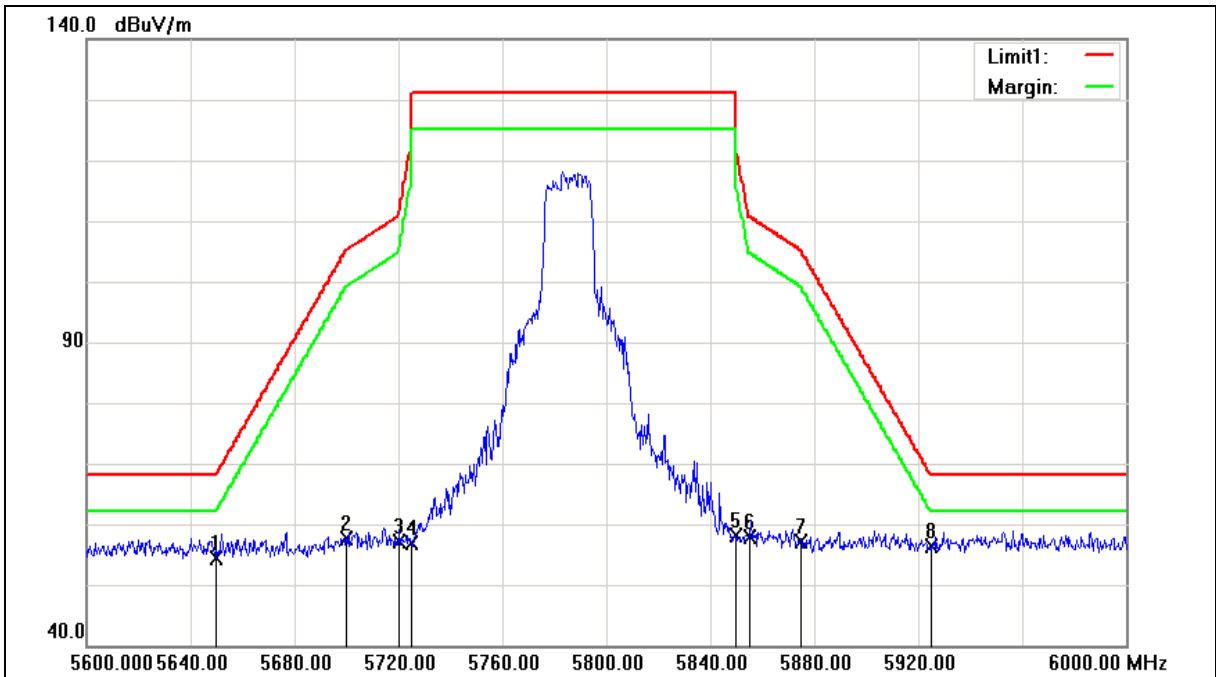



Standard:	FCC Part 15.407	Test Distance:	3m
Test item:	Band edge	Power:	AC 120V/60Hz
Frequency:	5785MHz	Temp.(°C)/Hum.(%RH):	26(°C)/60%RH
Mode:	Mode 2	Date:	04/06/2017
Ant.Polar.:	Horizontal		

No.	Frequency (MHz)	Reading (dBuV)	Correct Factor (dB/m)	Result (dBuV/m)	Limit (dBuV/m)	Margin (dB)	Remark
1	5650.000	45.45	8.93	54.38	68.20	-13.82	peak
2	5700.000	48.61	9.05	57.66	105.20	-47.54	peak
3	5720.000	48.12	9.09	57.21	110.80	-53.59	peak
4	5725.000	47.82	9.11	56.93	122.20	-65.27	peak
5	5850.000	48.67	9.41	58.08	122.20	-64.12	peak
6	5855.000	48.38	9.43	57.81	110.80	-52.99	peak
7	5875.000	47.64	9.48	57.12	105.20	-48.08	peak
8	5925.000	46.84	9.61	56.45	68.20	-11.75	peak

Note:1.Result (dBuV/m) = Correct Factor (dB/m) + Reading(dBuV).

2.Correction factor (dB/m) = Antenna Factor (dB/m) + Cable loss (dB) – Pre-Amplifier gain (dB).

3. When the peak results are less than average limit, so not need to evaluate the average.



Standard:	FCC Part 15.407	Test Distance:	3m
Test item:	Band edge	Power:	AC 120V/60Hz
Frequency:	5785MHz	Temp.(°C)/Hum.(%RH):	26(°C)/60%RH
Mode:	Mode 2	Date:	04/06/2017
Ant.Polar.:	Vertical		

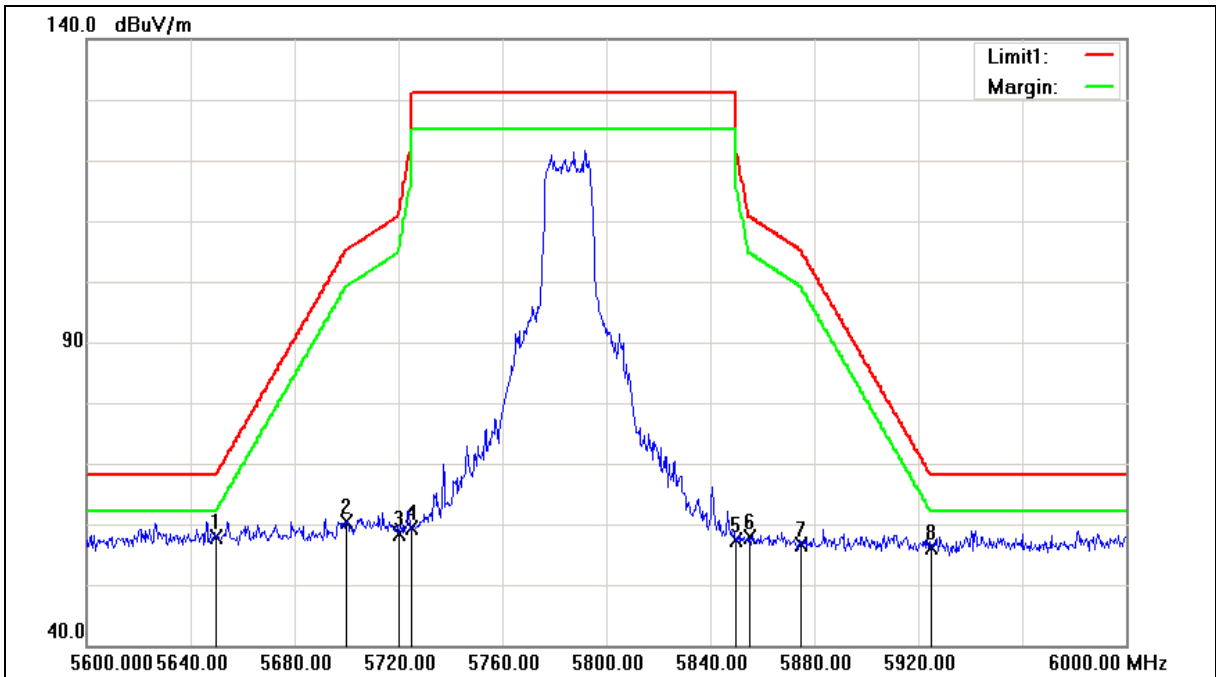



Standard:	FCC Part 15.407	Test Distance:	3m
Test item:	Band edge	Power:	AC 120V/60Hz
Frequency:	5785MHz	Temp.(°C)/Hum.(%RH):	26(°C)/60%RH
Mode:	Mode 2	Date:	04/06/2017
Ant.Polar.:	Vertical		

No.	Frequency (MHz)	Reading (dBuV)	Correct Factor (dB/m)	Result (dBuV/m)	Limit (dBuV/m)	Margin (dB)	Remark
1	5650.000	48.83	8.93	57.76	68.20	-10.44	peak
2	5700.000	51.25	9.05	60.30	105.20	-44.90	peak
3	5720.000	49.29	9.09	58.38	110.80	-52.42	peak
4	5725.000	50.39	9.11	59.50	122.20	-62.70	peak
5	5850.000	47.85	9.41	57.26	122.20	-64.94	peak
6	5855.000	48.42	9.43	57.85	110.80	-52.95	peak
7	5875.000	47.18	9.48	56.66	105.20	-48.54	peak
8	5925.000	46.46	9.61	56.07	68.20	-12.13	peak

Note:1.Result (dBuV/m) = Correct Factor (dB/m) + Reading(dBuV).

2.Correction factor (dB/m) = Antenna Factor (dB/m) + Cable loss (dB) – Pre-Amplifier gain (dB).

3. When the peak results are less than average limit, so not need to evaluate the average.



Standard:	FCC Part 15.407	Test Distance:	3m
Test item:	Band edge	Power:	AC 120V/60Hz
Frequency:	5825MHz	Temp.(°C)/Hum.(%RH):	26(°C)/60%RH
Mode:	Mode 2	Date:	04/06/2017
Ant.Polar.:	Horizontal		

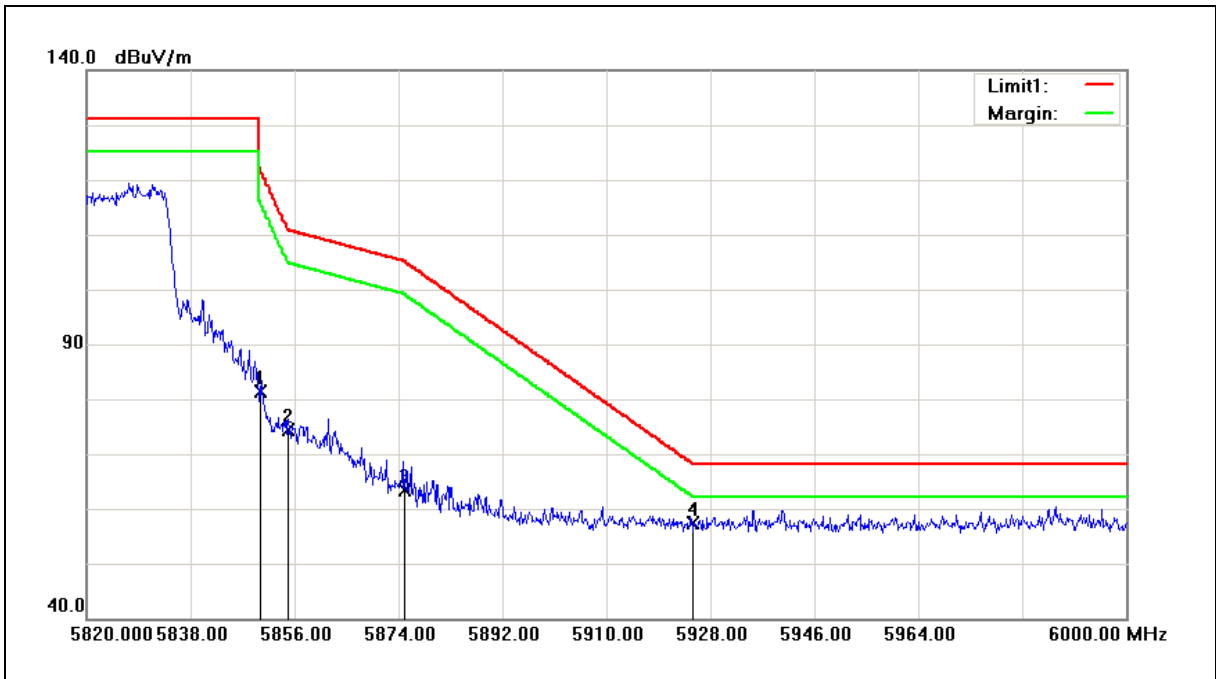

No.	Frequency (MHz)	Reading (dBuV)	Correct Factor (dB/m)	Result (dBuV/m)	Limit (dBuV/m)	Margin (dB)	Remark
1	5850.000	72.01	9.41	81.42	122.20	-40.78	peak
2	5855.000	65.06	9.43	74.49	110.80	-36.31	peak
3	5875.000	54.02	9.48	63.50	105.20	-41.70	peak
4	5925.000	47.86	9.61	57.47	68.20	-10.73	peak

Note:1.Result (dBuV/m) = Correct Factor (dB/m) + Reading(dBuV).

2.Correction factor (dB/m) = Antenna Factor (dB/m) + Cable loss (dB) – Pre-Amplifier gain (dB).

3. When the peak results are less than average limit, so not need to evaluate the average.



Standard:	FCC Part 15.407	Test Distance:	3m
Test item:	Band edge	Power:	AC 120V/60Hz
Frequency:	5825MHz	Temp.(°C)/Hum.(%RH):	26(°C)/60%RH
Mode:	Mode 2	Date:	04/06/2017
Ant.Polar.:	Vertical		

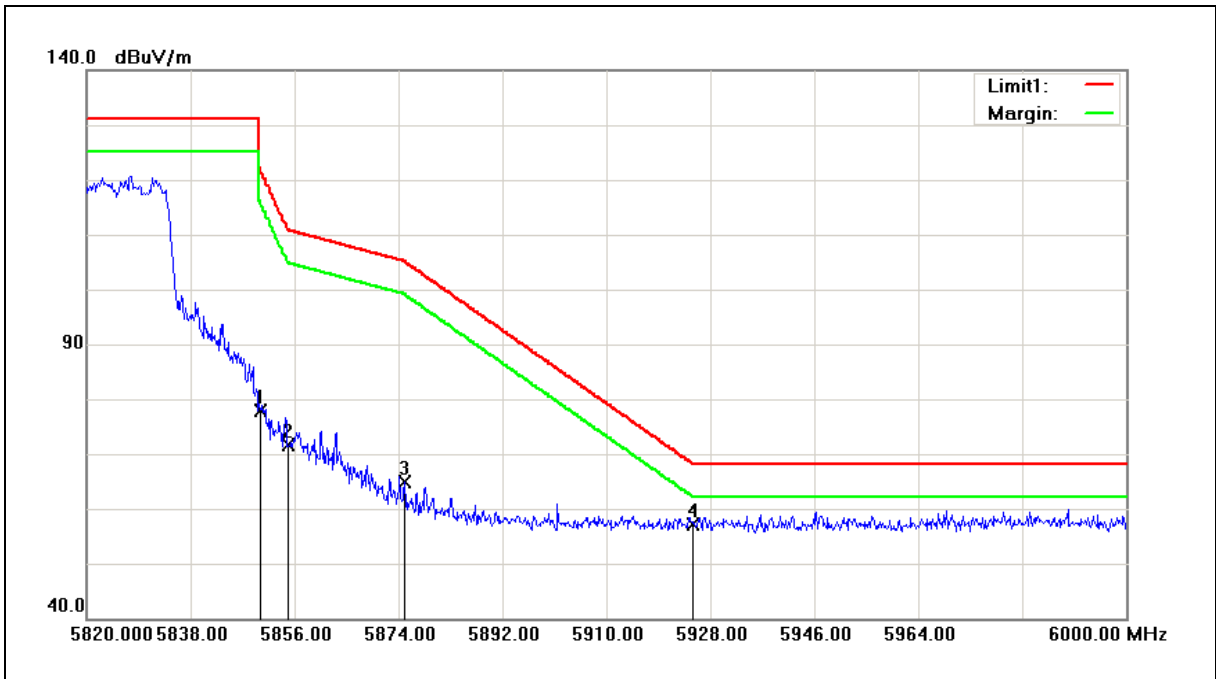

No.	Frequency (MHz)	Reading (dBuV)	Correct Factor (dB/m)	Result (dBuV/m)	Limit (dBuV/m)	Margin (dB)	Remark
1	5850.000	68.59	9.41	78.00	122.20	-44.20	peak
2	5855.000	62.09	9.43	71.52	110.80	-39.28	peak
3	5875.000	55.35	9.48	64.83	105.20	-40.37	peak
4	5925.000	47.60	9.61	57.21	68.20	-10.99	peak

Note:1.Result (dBuV/m) = Correct Factor (dB/m) + Reading(dBuV).

2.Correction factor (dB/m) = Antenna Factor (dB/m) + Cable loss (dB) – Pre-Amplifier gain (dB).

3. When the peak results are less than average limit, so not need to evaluate the average.



Standard:	FCC Part 15.407	Test Distance:	3m
Test item:	Band edge	Power:	AC 120V/60Hz
Frequency:	5190MHz	Temp.(°C)/Hum.(%RH):	26(°C)/60%RH
Mode:	Mode 3	Date:	04/06/2017
Ant.Polar.:	Horizontal		

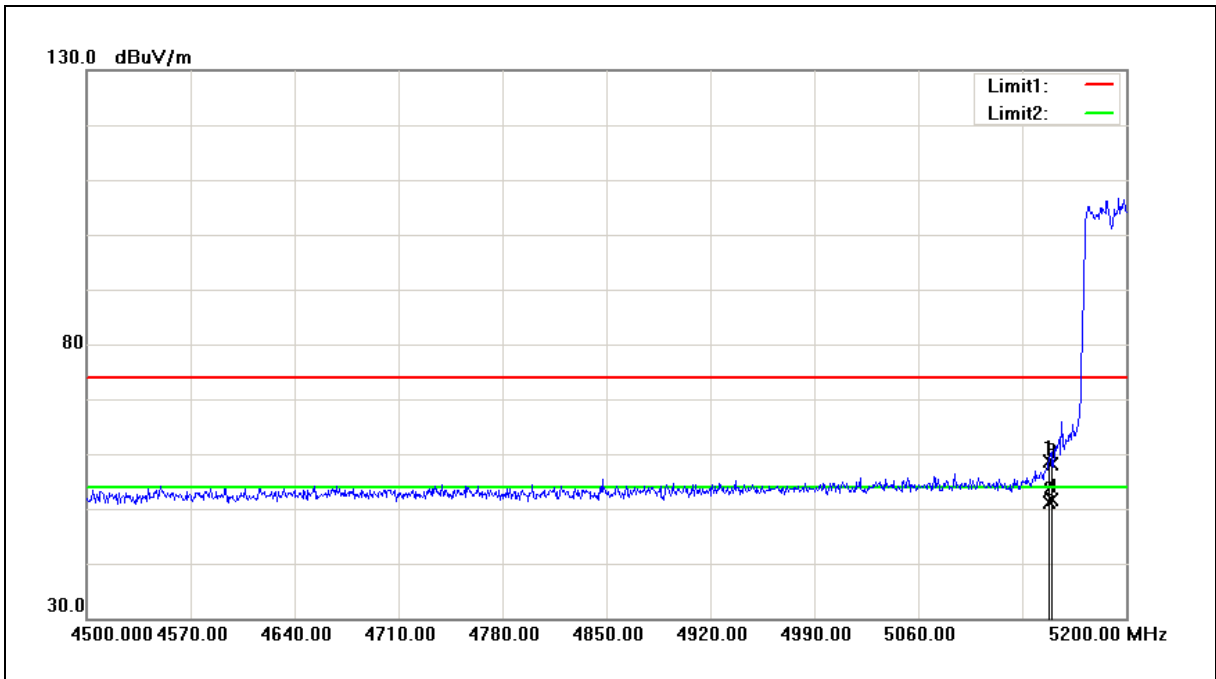

No.	Frequency (MHz)	Reading (dBuV)	Correct Factor (dB/m)	Result (dBuV/m)	Limit (dBuV/m)	Margin (dB)	Remark
1	5148.200	50.47	8.25	58.72	74.00	-15.28	peak
2	5148.200	42.91	8.25	51.16	54.00	-2.84	AVG
3	5150.000	49.99	8.25	58.24	74.00	-15.76	peak
4	5150.000	43.48	8.25	51.73	54.00	-2.27	AVG

Note:1.Result (dBuV/m) = Correct Factor (dB/m) + Reading(dBuV).

2.Correction factor (dB/m) = Antenna Factor (dB/m) + Cable loss (dB) – Pre-Amplifier gain (dB).

3. When the peak results are less than average limit, so not need to evaluate the average.



Standard:	FCC Part 15.407	Test Distance:	3m
Test item:	Band edge	Power:	AC 120V/60Hz
Frequency:	5190MHz	Temp.(°C)/Hum.(%RH):	26(°C)/60%RH
Mode:	Mode 3	Date:	04/06/2017
Ant.Polar.:	Vertical		

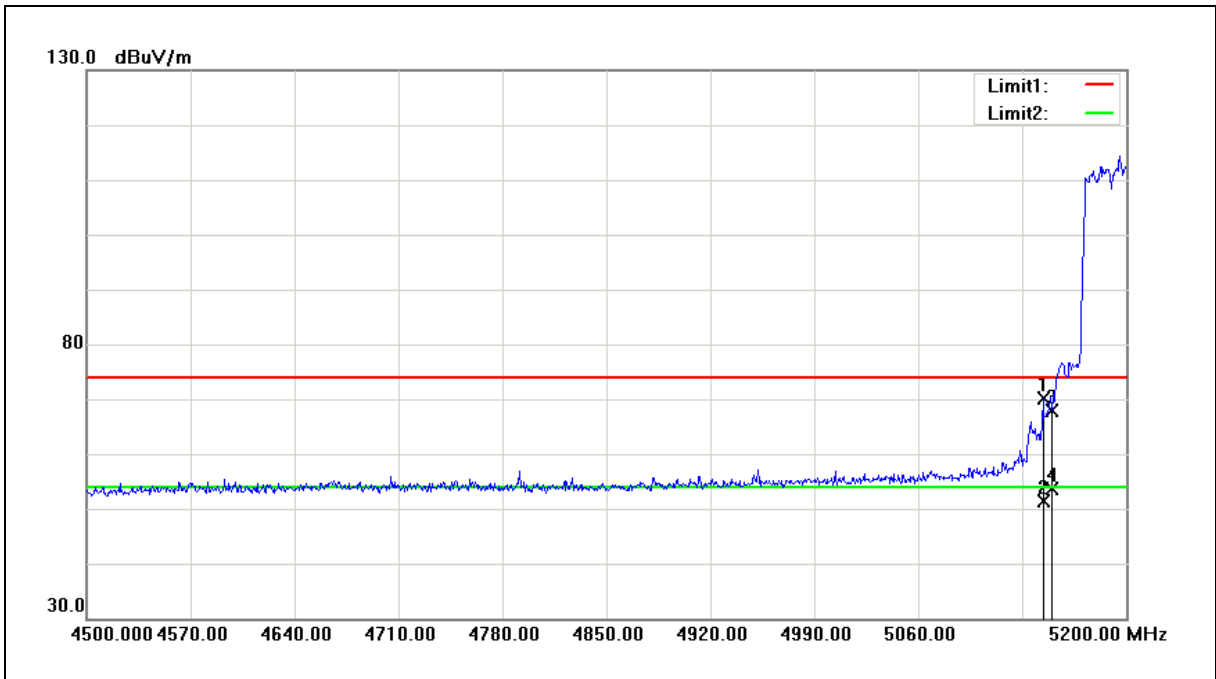

No.	Frequency (MHz)	Reading (dBuV)	Correct Factor (dB/m)	Result (dBuV/m)	Limit (dBuV/m)	Margin (dB)	Remark
1	5144.000	61.97	8.24	70.21	74.00	-3.79	peak
2	5144.000	43.24	8.24	51.48	54.00	-2.52	AVG
3	5150.000	59.68	8.25	67.93	74.00	-6.07	peak
4	5150.000	45.34	8.25	53.59	54.00	-0.41	AVG

Note:1.Result (dBuV/m) = Correct Factor (dB/m) + Reading(dBuV).

2.Correction factor (dB/m) = Antenna Factor (dB/m) + Cable loss (dB) – Pre-Amplifier gain (dB).

3. When the peak results are less than average limit, so not need to evaluate the average.





Standard:	FCC Part 15.407	Test Distance:	3m
Test item:	Band edge	Power:	AC 120V/60Hz
Frequency:	5230MHz	Temp.(°C)/Hum.(%RH):	26(°C)/60%RH
Mode:	Mode 3	Date:	04/06/2017
Ant.Polar.:	Horizontal		

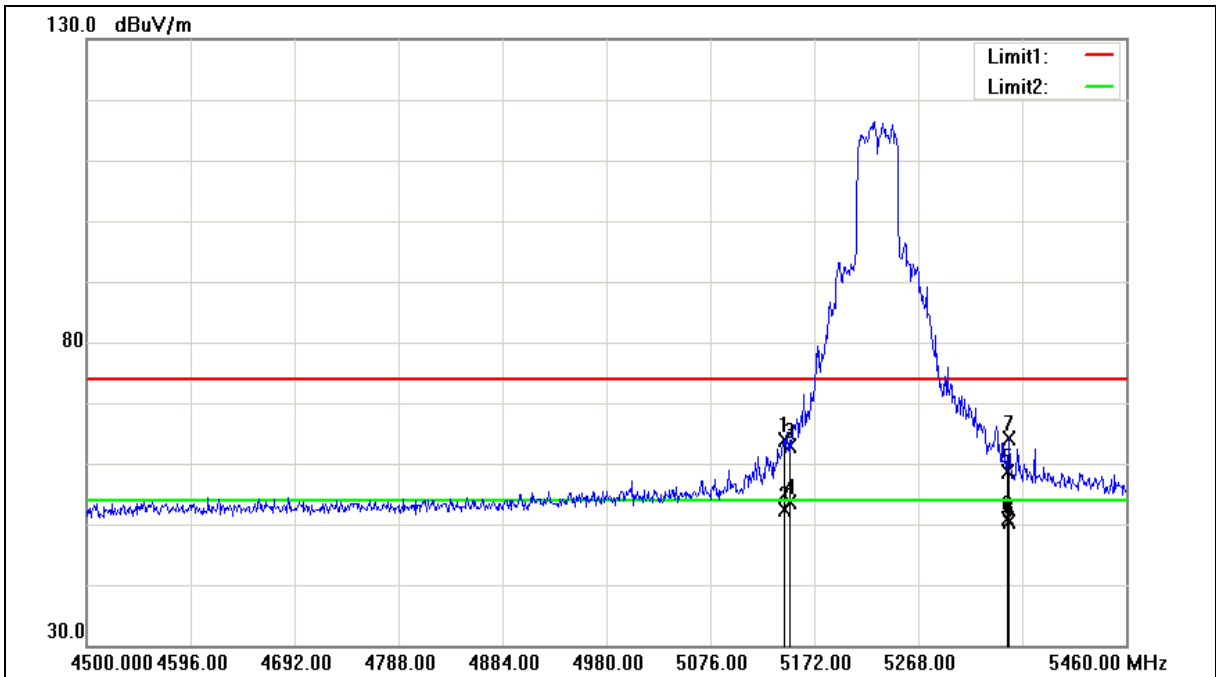



Standard:	FCC Part 15.407	Test Distance:	3m
Test item:	Band edge	Power:	AC 120V/60Hz
Frequency:	5230MHz	Temp.(°C)/Hum.(%RH):	26(°C)/60%RH
Mode:	Mode 3	Date:	04/06/2017
Ant.Polar.:	Horizontal		

No.	Frequency (MHz)	Reading (dBuV)	Correct Factor (dB/m)	Result (dBuV/m)	Limit (dBuV/m)	Margin (dB)	Remark
1	5144.160	55.62	8.24	63.86	74.00	-10.14	peak
2	5144.160	44.21	8.24	52.45	54.00	-1.55	AVG
3	5150.000	54.69	8.25	62.94	74.00	-11.06	peak
4	5150.000	45.46	8.25	53.71	54.00	-0.29	AVG
5	5350.000	50.32	8.41	58.73	74.00	-15.27	peak
6	5350.000	42.41	8.41	50.82	54.00	-3.18	AVG
7	5351.520	55.72	8.41	64.13	74.00	-9.87	peak
8	5351.520	42.06	8.41	50.47	54.00	-3.53	AVG

Note:1.Result (dBuV/m) = Correct Factor (dB/m) + Reading(dBuV).

2.Correction factor (dB/m) = Antenna Factor (dB/m) + Cable loss (dB) – Pre-Amplifier gain (dB).

3. When the peak results are less than average limit, so not need to evaluate the average.



Standard:	FCC Part 15.407	Test Distance:	3m
Test item:	Band edge	Power:	AC 120V/60Hz
Frequency:	5230MHz	Temp.(°C)/Hum.(%RH):	26(°C)/60%RH
Mode:	Mode 3	Date:	04/06/2017
Ant.Polar.:	Vertical		

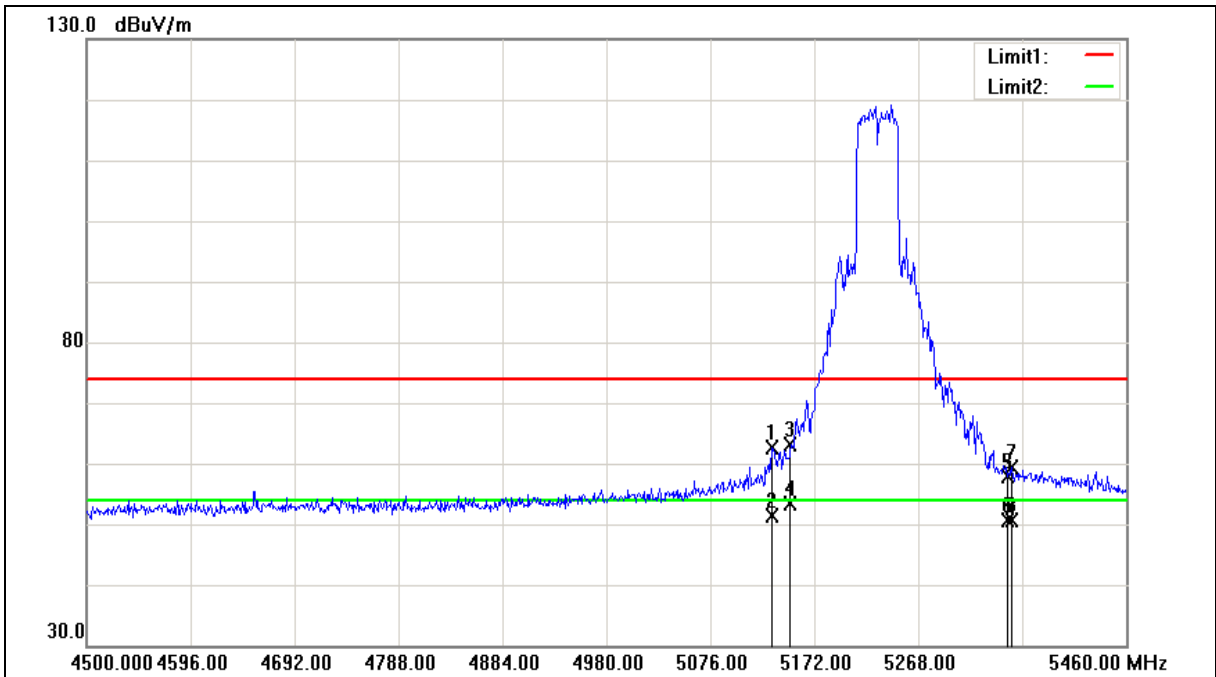



Standard:	FCC Part 15.407	Test Distance:	3m
Test item:	Band edge	Power:	AC 120V/60Hz
Frequency:	5230MHz	Temp.(°C)/Hum.(%RH):	26(°C)/60%RH
Mode:	Mode 3	Date:	04/06/2017
Ant.Polar.:	Vertical		

No.	Frequency (MHz)	Reading (dBuV)	Correct Factor (dB/m)	Result (dBuV/m)	Limit (dBuV/m)	Margin (dB)	Remark
1	5132.640	54.29	8.23	62.52	74.00	-11.48	peak
2	5132.640	43.12	8.23	51.35	54.00	-2.65	AVG
3	5150.000	54.88	8.25	63.13	74.00	-10.87	peak
4	5150.000	45.10	8.25	53.35	54.00	-0.65	AVG
5	5350.000	49.41	8.41	57.82	74.00	-16.18	peak
6	5350.000	42.22	8.41	50.63	54.00	-3.37	AVG
7	5354.400	50.95	8.42	59.37	74.00	-14.63	peak
8	5354.400	42.24	8.42	50.66	54.00	-3.34	AVG

Note:1.Result (dBuV/m) = Correct Factor (dB/m) + Reading(dBuV).

2.Correction factor (dB/m) = Antenna Factor (dB/m) + Cable loss (dB) – Pre-Amplifier gain (dB).

3. When the peak results are less than average limit, so not need to evaluate the average.



Standard:	FCC Part 15.407	Test Distance:	3m
Test item:	Band edge	Power:	AC 120V/60Hz
Frequency:	5755MHz	Temp.(°C)/Hum.(%RH):	26(°C)/60%RH
Mode:	Mode 3	Date:	04/06/2017
Ant.Polar.:	Horizontal		

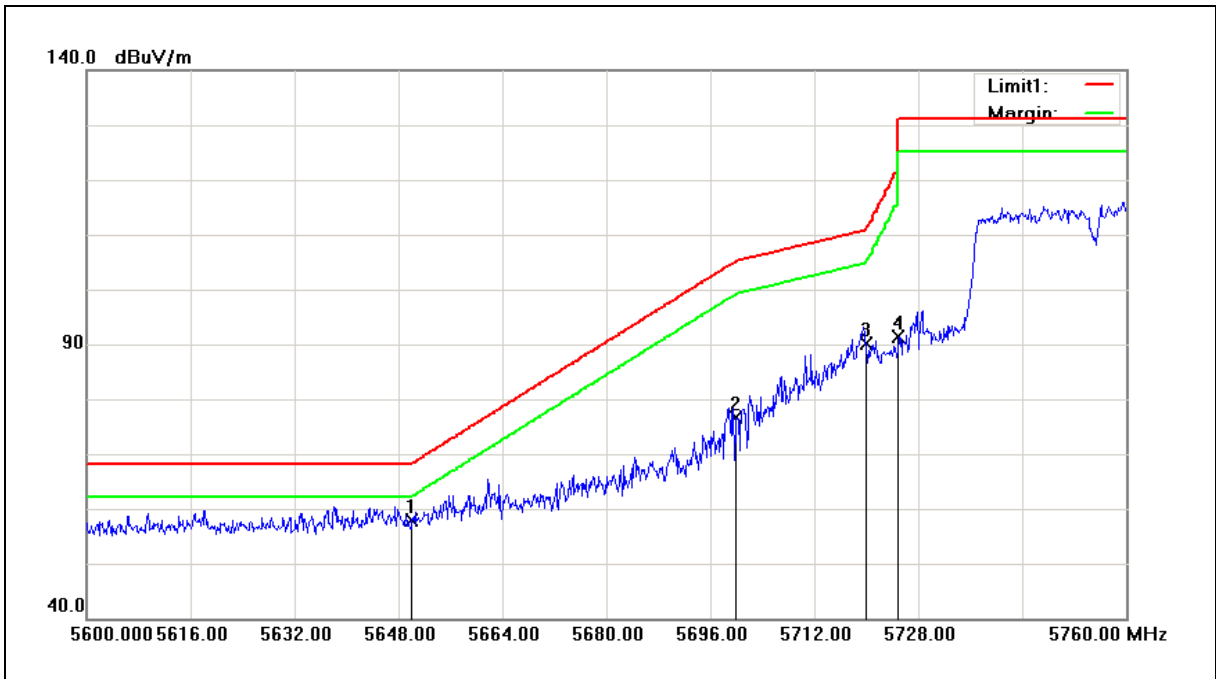

No.	Frequency (MHz)	Reading (dBuV)	Correct Factor (dB/m)	Result (dBuV/m)	Limit (dBuV/m)	Margin (dB)	Remark
1	5650.000	48.84	8.93	57.77	68.20	-10.43	peak
2	5700.000	67.50	9.05	76.55	105.20	-28.65	peak
3	5720.000	80.94	9.09	90.03	110.80	-20.77	peak
4	5725.000	82.32	9.11	91.43	122.20	-30.77	peak

Note:1.Result (dBuV/m) = Correct Factor (dB/m) + Reading(dBuV).

2.Correction factor (dB/m) = Antenna Factor (dB/m) + Cable loss (dB) – Pre-Amplifier gain (dB).

3. When the peak results are less than average limit, so not need to evaluate the average.



Standard:	FCC Part 15.407	Test Distance:	3m
Test item:	Band edge	Power:	AC 120V/60Hz
Frequency:	5755MHz	Temp.(°C)/Hum.(%RH):	26(°C)/60%RH
Mode:	Mode 3	Date:	04/06/2017
Ant.Polar.:	Vertical		

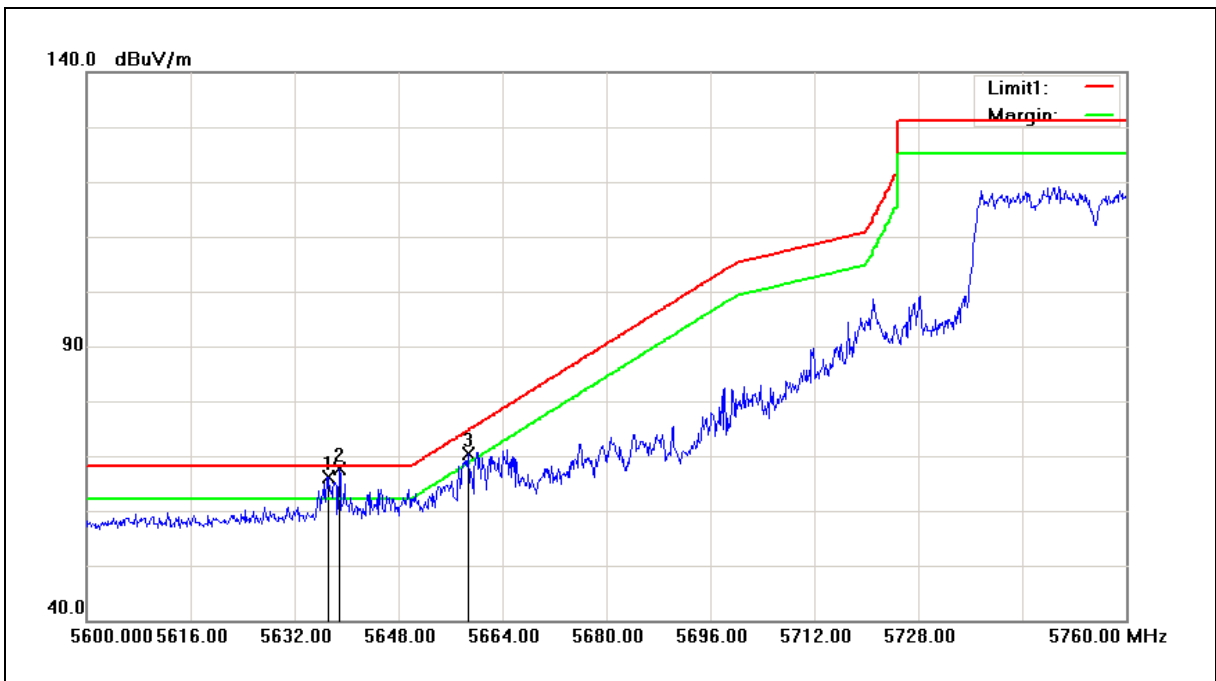

No.	Frequency (MHz)	Reading (dBuV)	Correct Factor (dB/m)	Result (dBuV/m)	Limit (dBuV/m)	Margin (dB)	Remark
1	5637.280	57.34	8.90	66.24	68.20	-1.96	peak
2	5638.880	58.69	8.90	67.59	68.20	-0.61	peak
3	5658.720	61.34	8.94	70.28	74.65	-4.37	peak

Note:1.Result (dBuV/m) = Correct Factor (dB/m) + Reading(dBuV).

2.Correction factor (dB/m) = Antenna Factor (dB/m) + Cable loss (dB) – Pre-Amplifier gain (dB).

3. When the peak results are less than average limit, so not need to evaluate the average.



Standard:	FCC Part 15.407	Test Distance:	3m
Test item:	Band edge	Power:	AC 120V/60Hz
Frequency:	5795MHz	Temp.(°C)/Hum.(%RH):	26(°C)/60%RH
Mode:	Mode 3	Date:	04/06/2017
Ant.Polar.:	Horizontal		

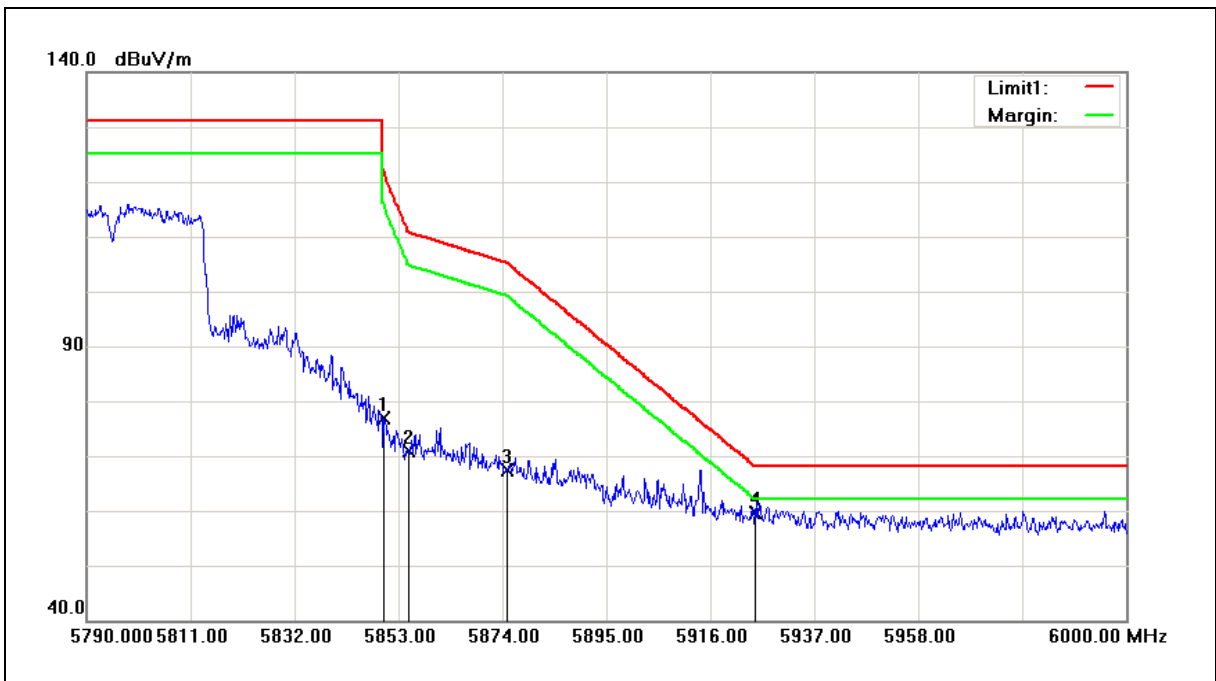

No.	Frequency (MHz)	Reading (dBuV)	Correct Factor (dB/m)	Result (dBuV/m)	Limit (dBuV/m)	Margin (dB)	Remark
1	5850.000	67.41	9.41	76.82	122.20	-45.38	peak
2	5855.000	61.33	9.43	70.76	110.80	-40.04	peak
3	5875.000	57.86	9.48	67.34	105.20	-37.86	peak
4	5925.000	49.95	9.61	59.56	68.20	-8.64	peak

Note:1.Result (dBuV/m) = Correct Factor (dB/m) + Reading(dBuV).

2.Correction factor (dB/m) = Antenna Factor (dB/m) + Cable loss (dB) – Pre-Amplifier gain (dB).

3. When the peak results are less than average limit, so not need to evaluate the average.



Standard:	FCC Part 15.407	Test Distance:	3m
Test item:	Band edge	Power:	AC 120V/60Hz
Frequency:	5795MHz	Temp.(°C)/Hum.(%RH):	26(°C)/60%RH
Mode:	Mode 3	Date:	04/06/2017
Ant.Polar.:	Vertical		

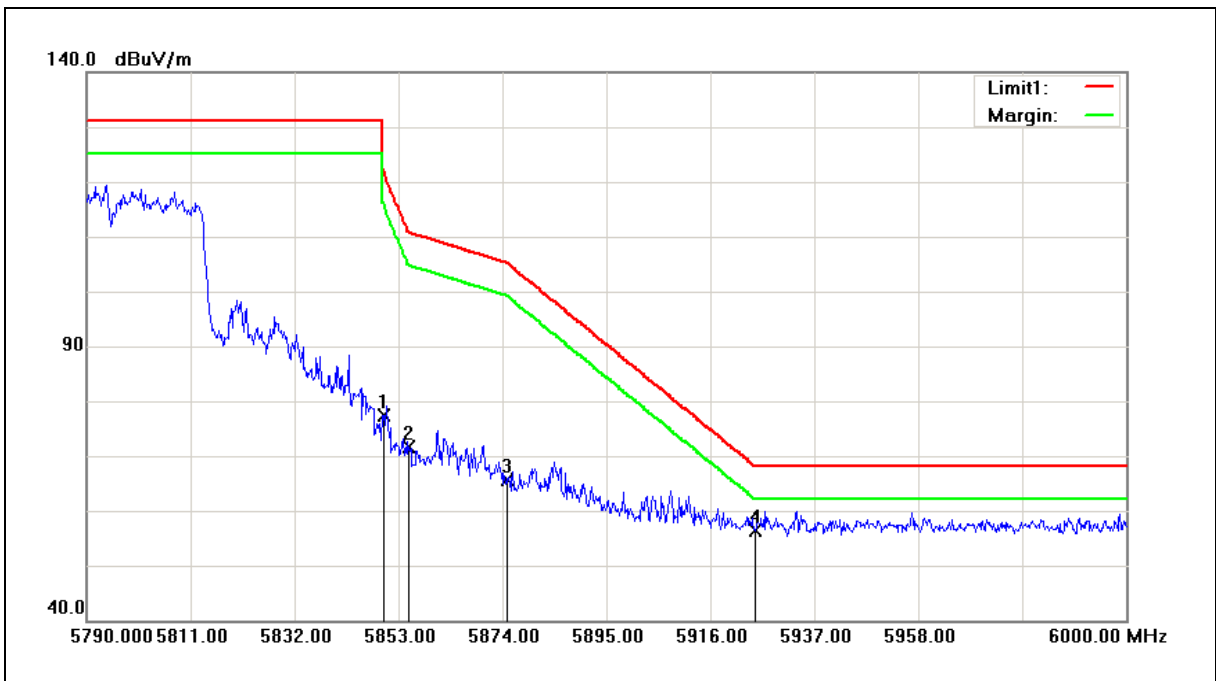

No.	Frequency (MHz)	Reading (dBuV)	Correct Factor (dB/m)	Result (dBuV/m)	Limit (dBuV/m)	Margin (dB)	Remark
1	5850.000	67.92	9.41	77.33	122.20	-44.87	peak
2	5855.000	62.11	9.43	71.54	110.80	-39.26	peak
3	5875.000	56.23	9.48	65.71	105.20	-39.49	peak
4	5925.000	46.76	9.61	56.37	68.20	-11.83	peak

Note:1.Result (dBuV/m) = Correct Factor (dB/m) + Reading(dBuV).

2.Correction factor (dB/m) = Antenna Factor (dB/m) + Cable loss (dB) – Pre-Amplifier gain (dB).

3. When the peak results are less than average limit, so not need to evaluate the average.





Standard:	FCC Part 15.407	Test Distance:	3m
Test item:	Band edge	Power:	AC 120V/60Hz
Frequency:	5210MHz	Temp.(°C)/Hum.(%RH):	26(°C)/60%RH
Mode:	Mode 4	Date:	04/06/2017
Ant.Polar.:	Horizontal		

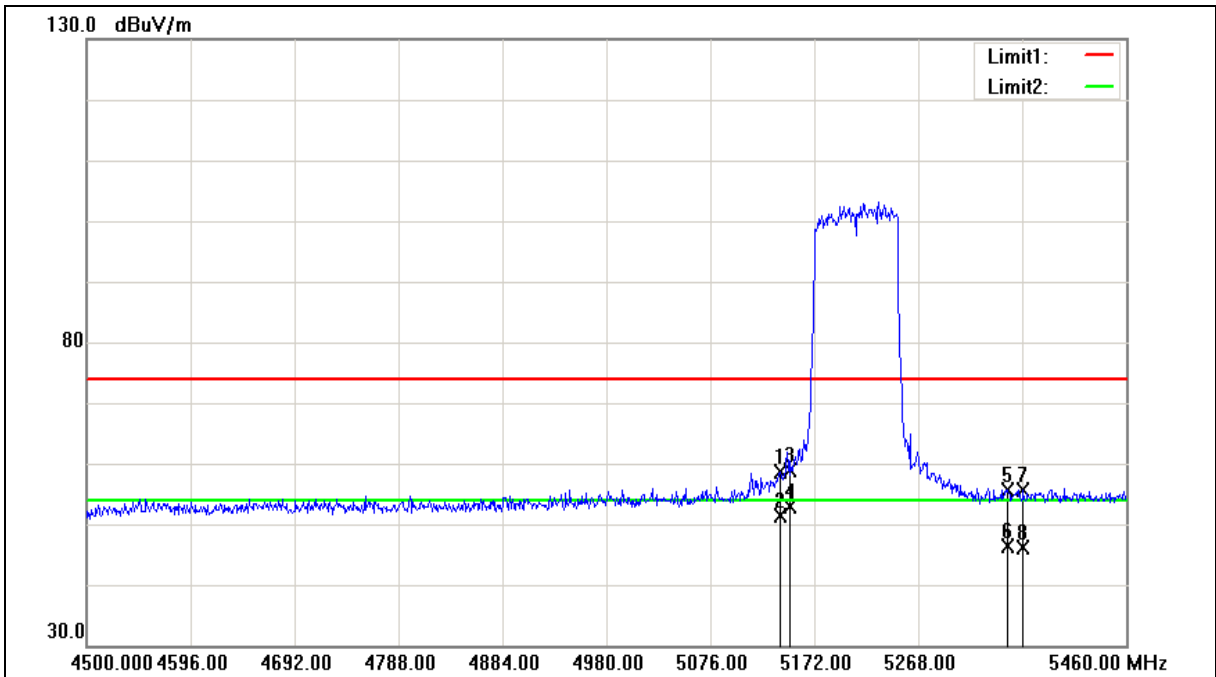



Standard:	FCC Part 15.407	Test Distance:	3m
Test item:	Band edge	Power:	AC 120V/60Hz
Frequency:	5210MHz	Temp.(°C)/Hum.(%RH):	26(°C)/60%RH
Mode:	Mode 4	Date:	04/06/2017
Ant.Polar.:	Horizontal		

No.	Frequency (MHz)	Reading (dBuV)	Correct Factor (dB/m)	Result (dBuV/m)	Limit (dBuV/m)	Margin (dB)	Remark
1	5140.320	50.42	8.24	58.66	74.00	-15.34	peak
2	5140.320	43.25	8.24	51.49	54.00	-2.51	AVG
3	5150.000	50.61	8.25	58.86	74.00	-15.14	peak
4	5150.000	44.73	8.25	52.98	54.00	-1.02	AVG
5	5350.000	47.13	8.41	55.54	74.00	-18.46	peak
6	5350.000	37.91	8.41	46.32	54.00	-7.68	AVG
7	5364.960	47.16	8.43	55.59	74.00	-18.41	peak
8	5364.960	37.70	8.43	46.13	54.00	-7.87	AVG

Note:1.Result (dBuV/m) = Correct Factor (dB/m) + Reading(dBuV).

2.Correction factor (dB/m) = Antenna Factor (dB/m) + Cable loss (dB) – Pre-Amplifier gain (dB).

3. When the peak results are less than average limit, so not need to evaluate the average.



Standard:	FCC Part 15.407	Test Distance:	3m
Test item:	Band edge	Power:	AC 120V/60Hz
Frequency:	5210MHz	Temp.(°C)/Hum.(%RH):	26(°C)/60%RH
Mode:	Mode 4	Date:	04/06/2017
Ant.Polar.:	Vertical		

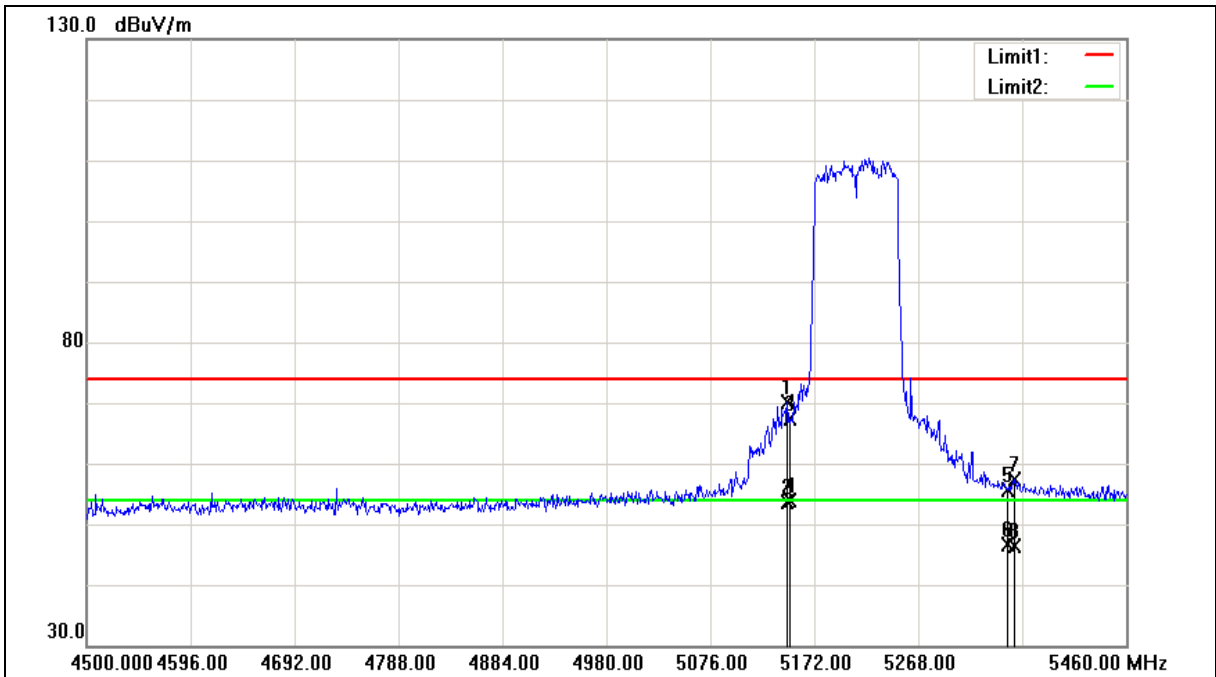



Standard:	FCC Part 15.407	Test Distance:	3m
Test item:	Band edge	Power:	AC 120V/60Hz
Frequency:	5210MHz	Temp.(°C)/Hum.(%RH):	26(°C)/60%RH
Mode:	Mode 4	Date:	04/06/2017
Ant.Polar.:	Vertical		

No.	Frequency (MHz)	Reading (dBuV)	Correct Factor (dB/m)	Result (dBuV/m)	Limit (dBuV/m)	Margin (dB)	Remark
1	5147.040	61.84	8.24	70.08	74.00	-3.92	peak
2	5147.040	45.34	8.24	53.58	54.00	-0.42	AVG
3	5150.000	59.04	8.25	67.29	74.00	-6.71	peak
4	5150.000	45.51	8.25	53.76	54.00	-0.24	AVG
5	5350.000	47.17	8.41	55.58	74.00	-18.42	peak
6	5350.000	38.27	8.41	46.68	54.00	-7.32	AVG
7	5356.320	48.98	8.42	57.40	74.00	-16.60	peak
8	5356.320	38.04	8.42	46.46	54.00	-7.54	AVG

Note:1.Result (dBuV/m) = Correct Factor (dB/m) + Reading(dBuV).

2.Correction factor (dB/m) = Antenna Factor (dB/m) + Cable loss (dB) – Pre-Amplifier gain (dB).

3. When the peak results are less than average limit, so not need to evaluate the average.



Standard:	FCC Part 15.407	Test Distance:	3m
Test item:	Band edge	Power:	AC 120V/60Hz
Frequency:	5775MHz	Temp.(°C)/Hum.(%RH):	26(°C)/60%RH
Mode:	Mode 4	Date:	04/06/2017
Ant.Polar.:	Horizontal		

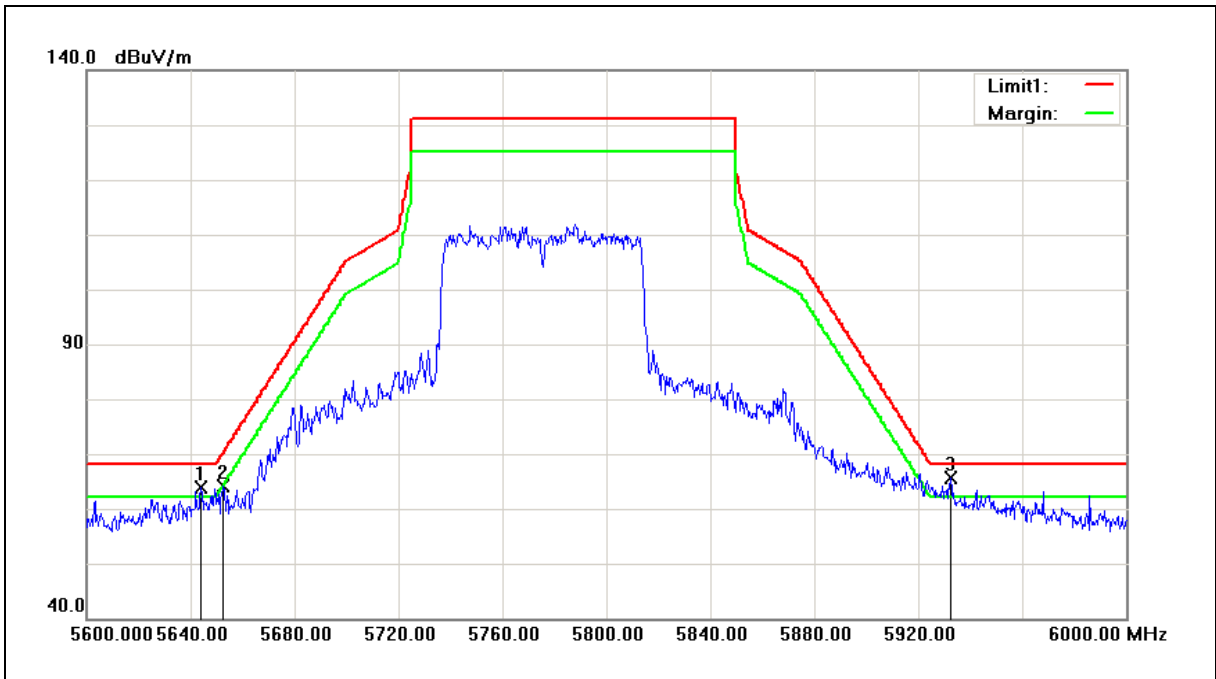

No.	Frequency (MHz)	Reading (dBuV)	Correct Factor (dB/m)	Result (dBuV/m)	Limit (dBuV/m)	Margin (dB)	Remark
1	5644.000	55.01	8.91	63.92	68.20	-4.28	peak
2	5652.400	55.14	8.93	64.07	69.98	-5.91	peak
3	5932.400	56.10	9.62	65.72	68.20	-2.48	peak

Note:1.Result (dBuV/m) = Correct Factor (dB/m) + Reading(dBuV).

2.Correction factor (dB/m) = Antenna Factor (dB/m) + Cable loss (dB) – Pre-Amplifier gain (dB).

3. When the peak results are less than average limit, so not need to evaluate the average.



Standard:	FCC Part 15.407	Test Distance:	3m
Test item:	Band edge	Power:	AC 120V/60Hz
Frequency:	5775MHz	Temp.(°C)/Hum.(%RH):	26(°C)/60%RH
Mode:	Mode 4	Date:	04/06/2017
Ant.Polar.:	Vertical		

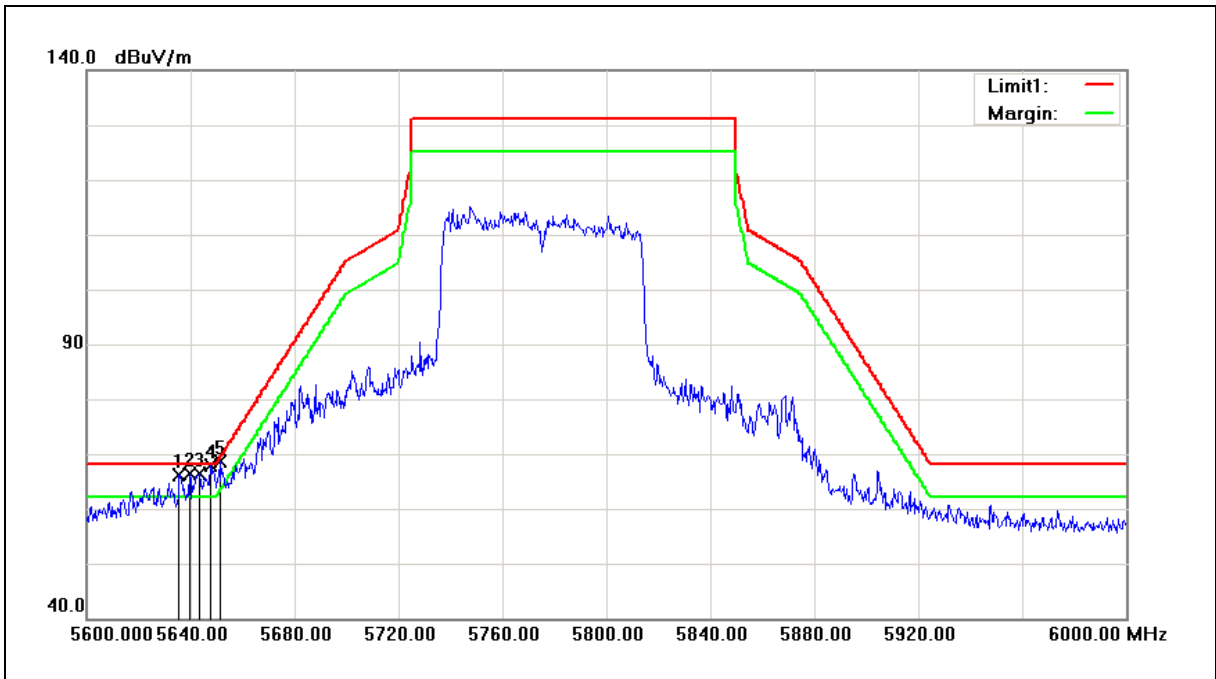

No.	Frequency (MHz)	Reading (dBuV)	Correct Factor (dB/m)	Result (dBuV/m)	Limit (dBuV/m)	Margin (dB)	Remark
1	5635.600	57.35	8.89	66.24	68.20	-1.96	peak
2	5639.600	57.53	8.90	66.43	68.20	-1.77	peak
3	5643.600	57.45	8.91	66.36	68.20	-1.84	peak
4	5647.600	58.93	8.92	67.85	68.20	-0.35	peak
5	5651.200	59.64	8.93	68.57	69.09	-0.52	peak

Note:1.Result (dBuV/m) = Correct Factor (dB/m) + Reading(dBuV).

2.Correction factor (dB/m) = Antenna Factor (dB/m) + Cable loss (dB) – Pre-Amplifier gain (dB).

3. When the peak results are less than average limit, so not need to evaluate the average.



Beamforming on

Below 1GHz

Standard:		FCC Part 15E		Test Distance:		3m	
Test item:		Radiated Emission		Power:		AC 120V/60Hz	
Test Mode:		Mode 1		Temp.(°C)/Hum.(%RH):		26(°C)/60%RH	
Description:				Date:		04/17/2017	
Frequency (MHz)	Reading (dBuV)	Correct Factor (dB/m)	Result (dBuV/m)	Limit (dBuV/m)	Margin (dB)	Remark	Ant.Polar. H / V
93.0500	52.04	-11.59	40.45	43.50	-3.05	QP	H
176.4700	34.44	-5.94	28.50	43.50	-15.00	QP	H
263.7700	33.35	-4.80	28.55	46.00	-17.45	QP	H
344.2800	29.80	-2.76	27.04	46.00	-18.96	QP	H
624.6100	29.63	3.40	33.03	46.00	-12.97	QP	H
730.3400	27.10	5.49	32.59	46.00	-13.41	QP	H
93.0500	53.89	-11.59	42.30	43.50	-1.20	QP	V
120.2100	39.02	-7.66	31.36	43.50	-12.14	QP	V
180.3500	33.79	-6.25	27.54	43.50	-15.96	QP	V
398.6000	26.65	-1.73	24.92	46.00	-21.08	QP	V
532.4600	31.63	1.21	32.84	46.00	-13.16	QP	V
658.5600	28.54	4.03	32.57	46.00	-13.43	QP	V

- Note: 1. No emission found between lowest internal used/generated frequency to 30MHz (9kHz~30MHz).  
 2. Result = Correction factor + Reading  
 3. Correction factor = Antenna Factor + Cable loss – Pre-Amplifier gain.



Above 1GHz

Standard:	FCC Part 15.407	Test Distance:	3m
Test item:	Harmonic	Power:	AC 120V/60Hz
Frequency:	5180MHz	Temp.(°C)/Hum.(%RH):	26(°C)/60%RH
Mode:	Mode 3	Date:	04/08/2017
Ant.Polar.:	Horizontal		

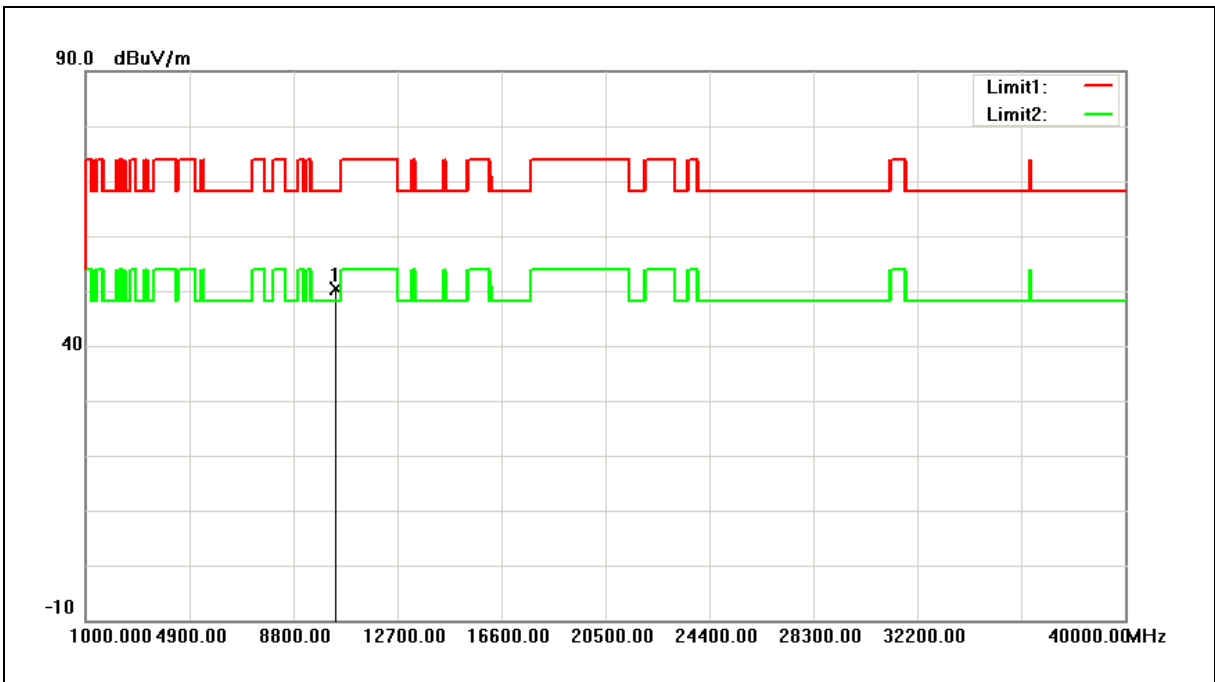

No.	Frequency (MHz)	Reading (dBuV)	Correct Factor (dB/m)	Result (dBuV/m)	Limit (dBuV/m)	Margin (dB)	Remark
1	10360.000	45.06	5.36	50.42	68.20	-17.78	peak

Note:1.Result (dBuV/m) = Correct Factor (dB/m) + Reading(dBuV).

2.Correction factor (dB/m) = Antenna Factor (dB/m) + Cable loss (dB) – Pre-Amplifier gain (dB).

3. When the peak results are less than average limit, so not need to evaluate the average.





Standard:	FCC Part 15.407	Test Distance:	3m
Test item:	Harmonic	Power:	AC 120V/60Hz
Frequency:	5180MHz	Temp.(°C)/Hum.(%RH):	26(°C)/60%RH
Mode:	Mode 3	Date:	04/08/2017
Ant.Polar.:	Vertical		

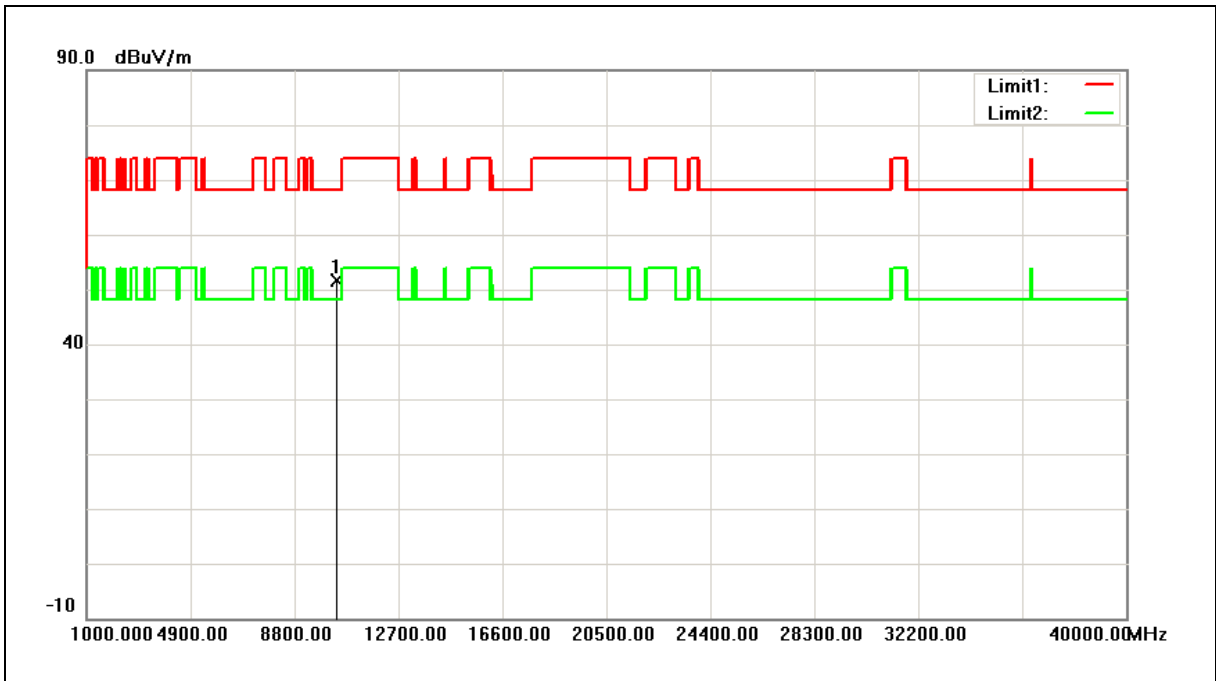

No.	Frequency (MHz)	Reading (dBuV)	Correct Factor (dB/m)	Result (dBuV/m)	Limit (dBuV/m)	Margin (dB)	Remark
1	10360.000	46.19	5.36	51.55	68.20	-16.65	peak

Note:1.Result (dBuV/m) = Correct Factor (dB/m) + Reading(dBuV).

2.Correction factor (dB/m) = Antenna Factor (dB/m) + Cable loss (dB) – Pre-Amplifier gain (dB).

3. When the peak results are less than average limit, so not need to evaluate the average.



Standard:	FCC Part 15.407	Test Distance:	3m
Test item:	Harmonic	Power:	AC 120V/60Hz
Frequency:	5200MHz	Temp.(°C)/Hum.(%RH):	26(°C)/60%RH
Mode:	Mode 3	Date:	04/08/2017
Ant.Polar.:	Horizontal		

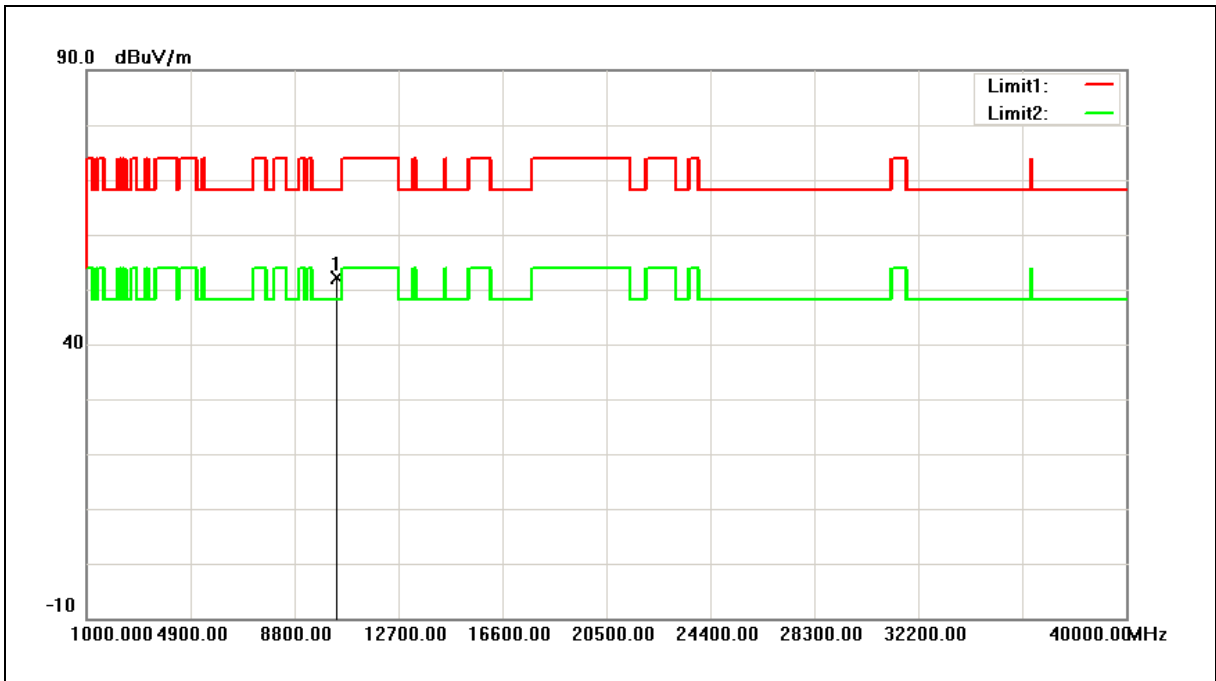

No.	Frequency (MHz)	Reading (dBuV)	Correct Factor (dB/m)	Result (dBuV/m)	Limit (dBuV/m)	Margin (dB)	Remark
1	10400.000	46.66	5.45	52.11	68.20	-16.09	peak

Note:1.Result (dBuV/m) = Correct Factor (dB/m) + Reading(dBuV).

2.Correction factor (dB/m) = Antenna Factor (dB/m) + Cable loss (dB) – Pre-Amplifier gain (dB).

3. When the peak results are less than average limit, so not need to evaluate the average.



Standard:	FCC Part 15.407	Test Distance:	3m
Test item:	Harmonic	Power:	AC 120V/60Hz
Frequency:	5200MHz	Temp.(°C)/Hum.(%RH):	26(°C)/60%RH
Mode:	Mode 3	Date:	04/08/2017
Ant.Polar.:	Vertical		

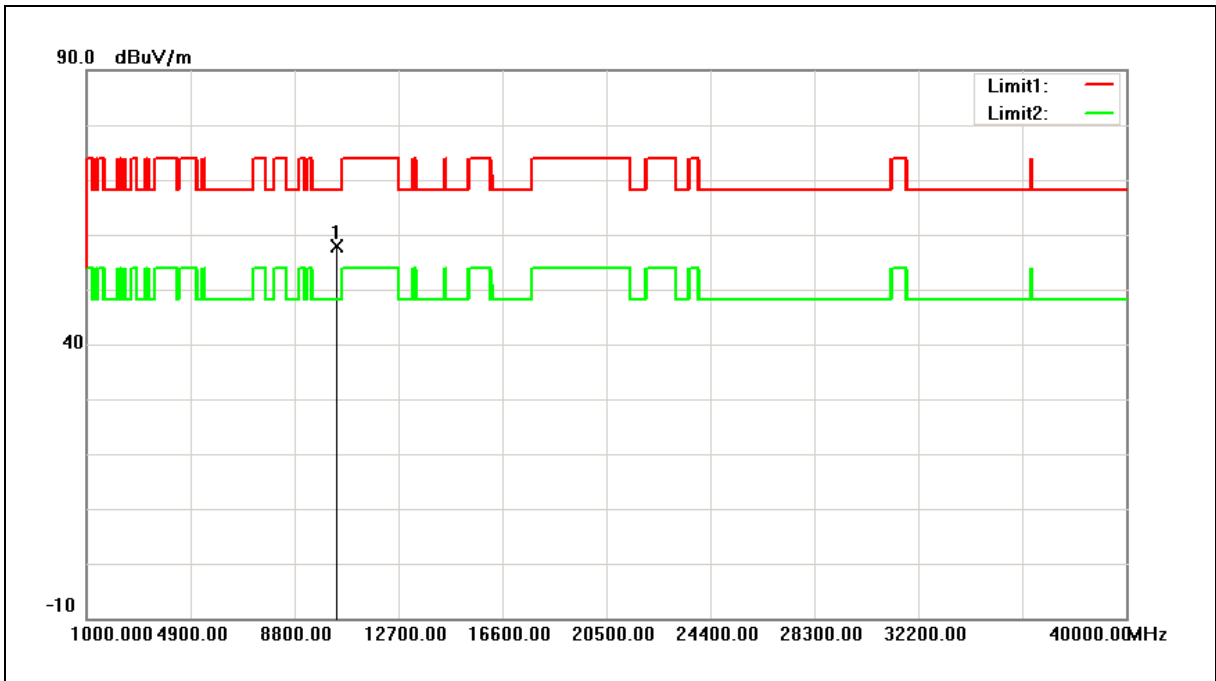

No.	Frequency (MHz)	Reading (dBuV)	Correct Factor (dB/m)	Result (dBuV/m)	Limit (dBuV/m)	Margin (dB)	Remark
1	10400.000	52.46	5.45	57.91	68.20	-10.29	peak

Note:1.Result (dBuV/m) = Correct Factor (dB/m) + Reading(dBuV).

2.Correction factor (dB/m) = Antenna Factor (dB/m) + Cable loss (dB) – Pre-Amplifier gain (dB).

3. When the peak results are less than average limit, so not need to evaluate the average.



Standard:	FCC Part 15.407	Test Distance:	3m
Test item:	Harmonic	Power:	AC 120V/60Hz
Frequency:	5240MHz	Temp.(°C)/Hum.(%RH):	26(°C)/60%RH
Mode:	Mode 3	Date:	04/08/2017
Ant.Polar.:	Horizontal		

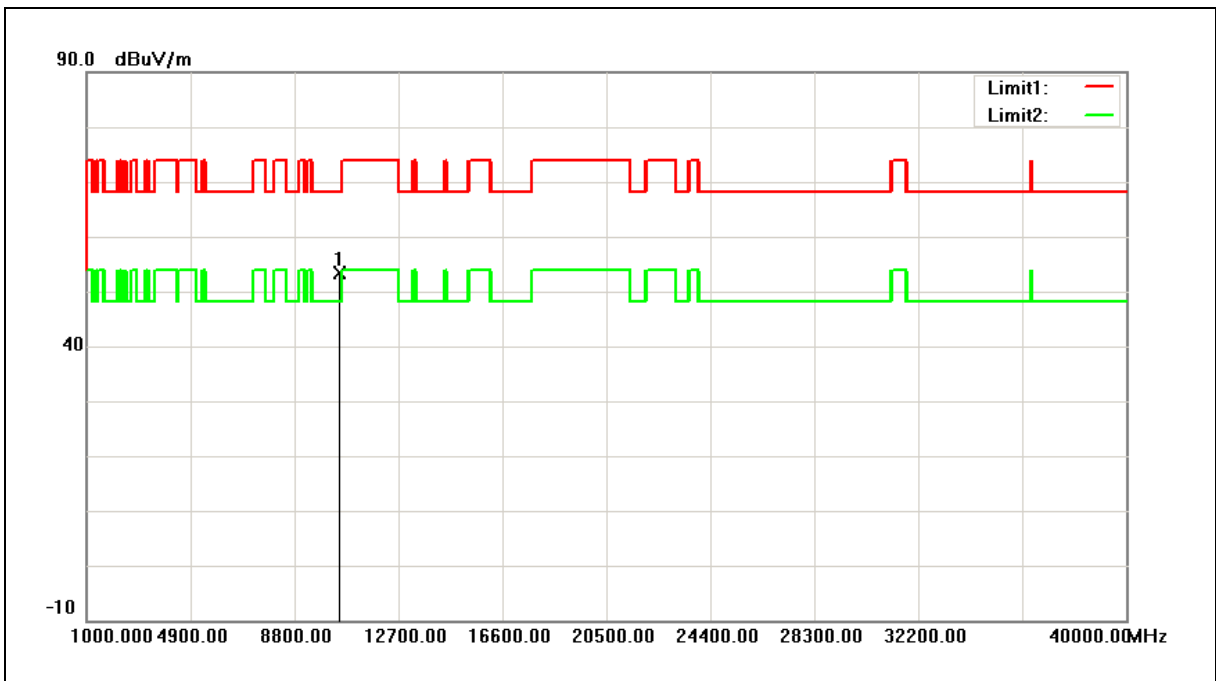

No.	Frequency (MHz)	Reading (dBuV)	Correct Factor (dB/m)	Result (dBuV/m)	Limit (dBuV/m)	Margin (dB)	Remark
1	10480.000	47.63	5.63	53.26	68.20	-14.94	peak

Note:1.Result (dBuV/m) = Correct Factor (dB/m) + Reading(dBuV).

2.Correction factor (dB/m) = Antenna Factor (dB/m) + Cable loss (dB) – Pre-Amplifier gain (dB).

3. When the peak results are less than average limit, so not need to evaluate the average.



Standard:	FCC Part 15.407	Test Distance:	3m
Test item:	Harmonic	Power:	AC 120V/60Hz
Frequency:	5240MHz	Temp.(°C)/Hum.(%RH):	26(°C)/60%RH
Mode:	Mode 3	Date:	04/08/2017
Ant.Polar.:	Vertical		

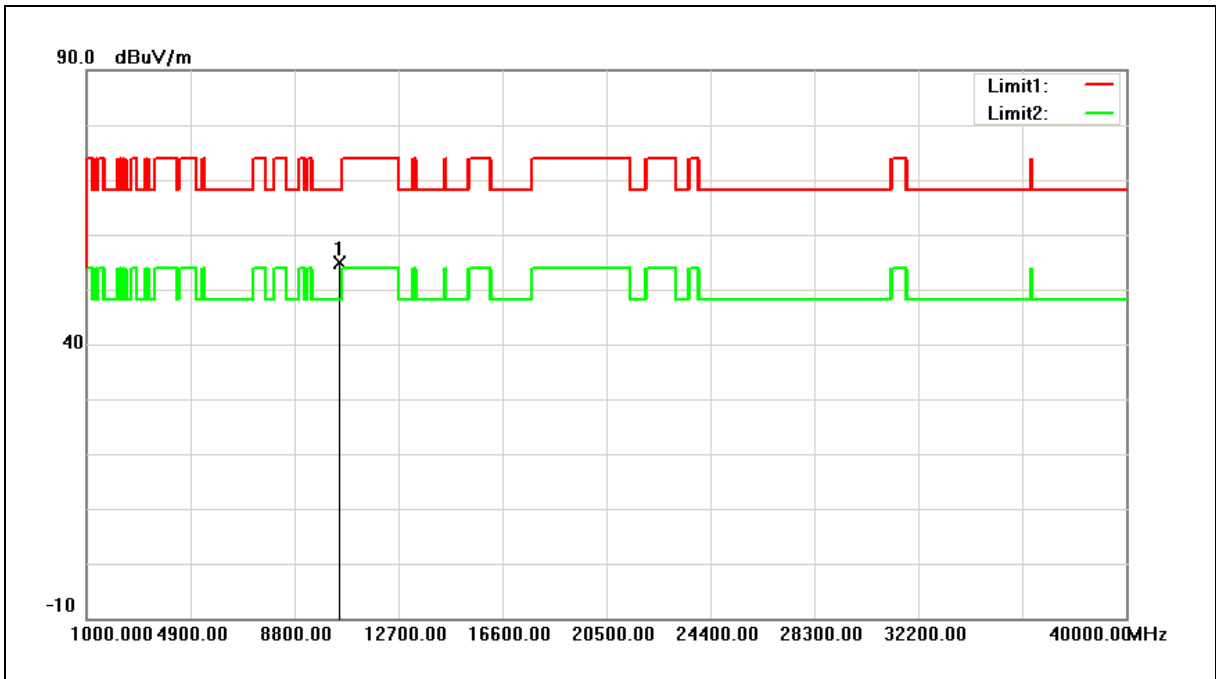

No.	Frequency (MHz)	Reading (dBuV)	Correct Factor (dB/m)	Result (dBuV/m)	Limit (dBuV/m)	Margin (dB)	Remark
1	10480.000	49.16	5.63	54.79	68.20	-13.41	peak

Note:1.Result (dBuV/m) = Correct Factor (dB/m) + Reading(dBuV).

2.Correction factor (dB/m) = Antenna Factor (dB/m) + Cable loss (dB) – Pre-Amplifier gain (dB).

3. When the peak results are less than average limit, so not need to evaluate the average.



Standard:	FCC Part 15.407	Test Distance:	3m
Test item:	Harmonic	Power:	AC 120V/60Hz
Frequency:	5745MHz	Temp.(°C)/Hum.(%RH):	26(°C)/60%RH
Mode:	Mode 3	Date:	04/08/2017
Ant.Polar.:	Horizontal		

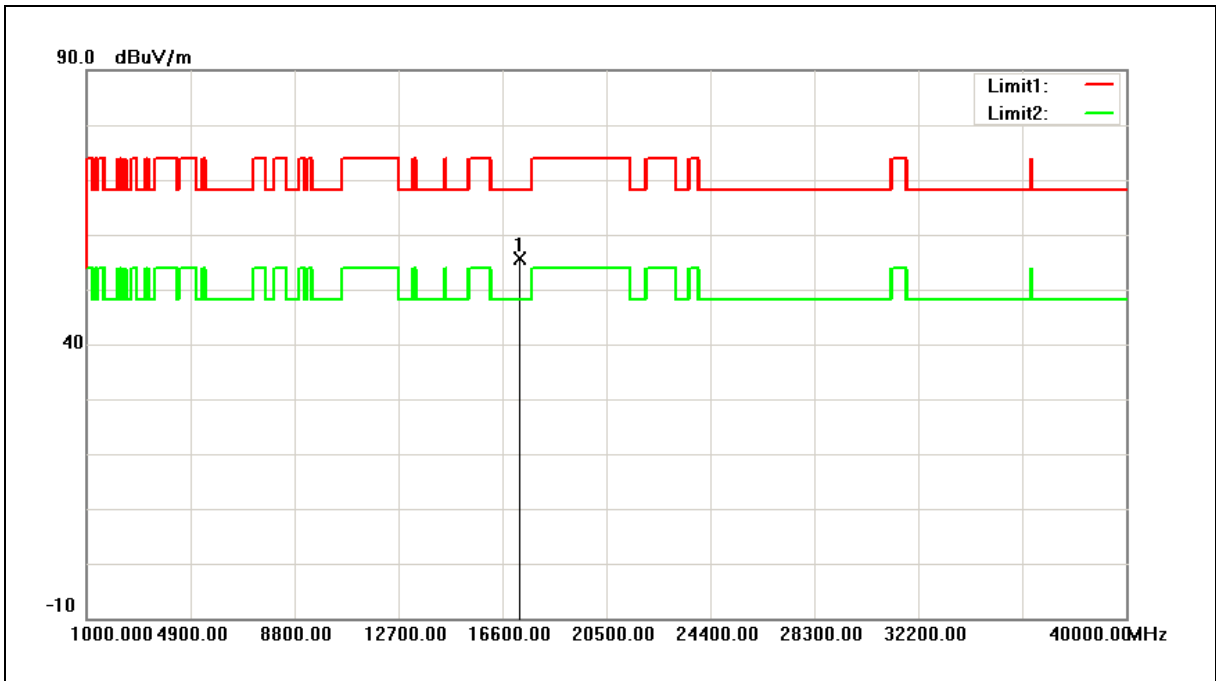

No.	Frequency (MHz)	Reading (dBuV)	Correct Factor (dB/m)	Result (dBuV/m)	Limit (dBuV/m)	Margin (dB)	Remark
1	17235.000	44.77	10.87	55.64	68.20	-12.56	peak

Note:1.Result (dBuV/m) = Correct Factor (dB/m) + Reading(dBuV).

2.Correction factor (dB/m) = Antenna Factor (dB/m) + Cable loss (dB) – Pre-Amplifier gain (dB).

3. When the peak results are less than average limit, so not need to evaluate the average.



Standard:	FCC Part 15.407	Test Distance:	3m
Test item:	Harmonic	Power:	AC 120V/60Hz
Frequency:	5745MHz	Temp.(°C)/Hum.(%RH):	26(°C)/60%RH
Mode:	Mode 3	Date:	04/08/2017
Ant.Polar.:	Vertical		

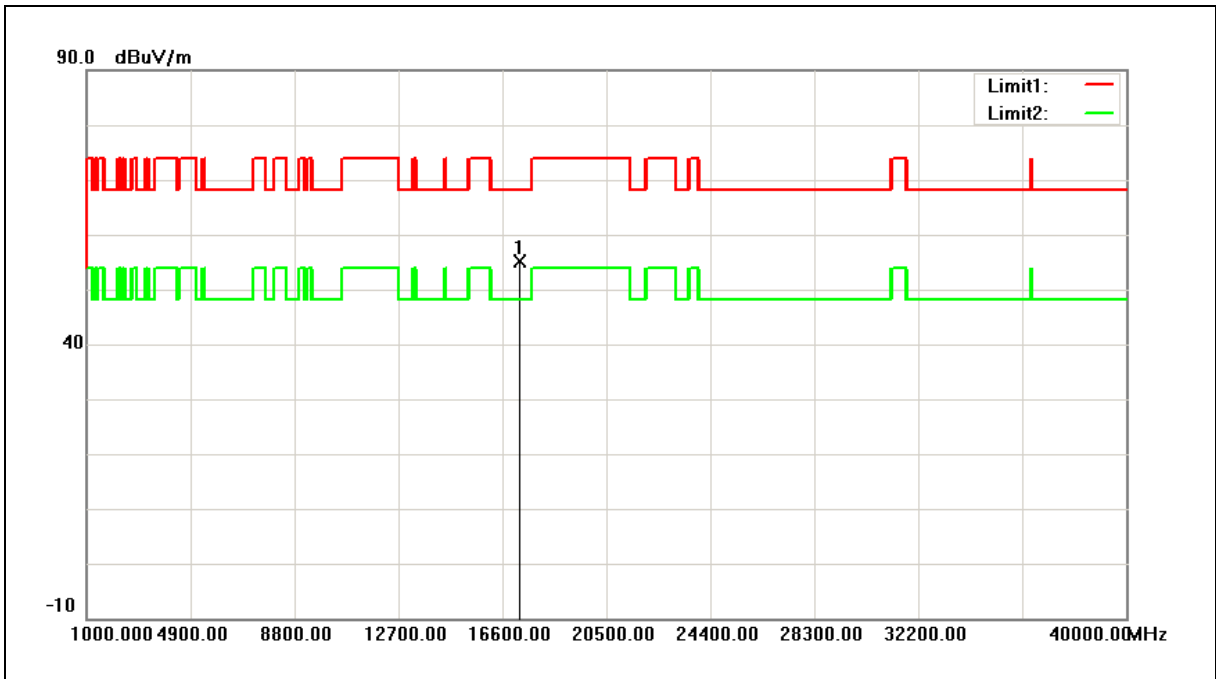

No.	Frequency (MHz)	Reading (dBuV)	Correct Factor (dB/m)	Result (dBuV/m)	Limit (dBuV/m)	Margin (dB)	Remark
1	17235.000	44.25	10.87	55.12	68.20	-13.08	peak

Note:1.Result (dBuV/m) = Correct Factor (dB/m) + Reading(dBuV).

2.Correction factor (dB/m) = Antenna Factor (dB/m) + Cable loss (dB) – Pre-Amplifier gain (dB).

3. When the peak results are less than average limit, so not need to evaluate the average.



Standard:	FCC Part 15.407	Test Distance:	3m
Test item:	Harmonic	Power:	AC 120V/60Hz
Frequency:	5785MHz	Temp.(°C)/Hum.(%RH):	26(°C)/60%RH
Mode:	Mode 3	Date:	04/08/2017
Ant.Polar.:	Horizontal		

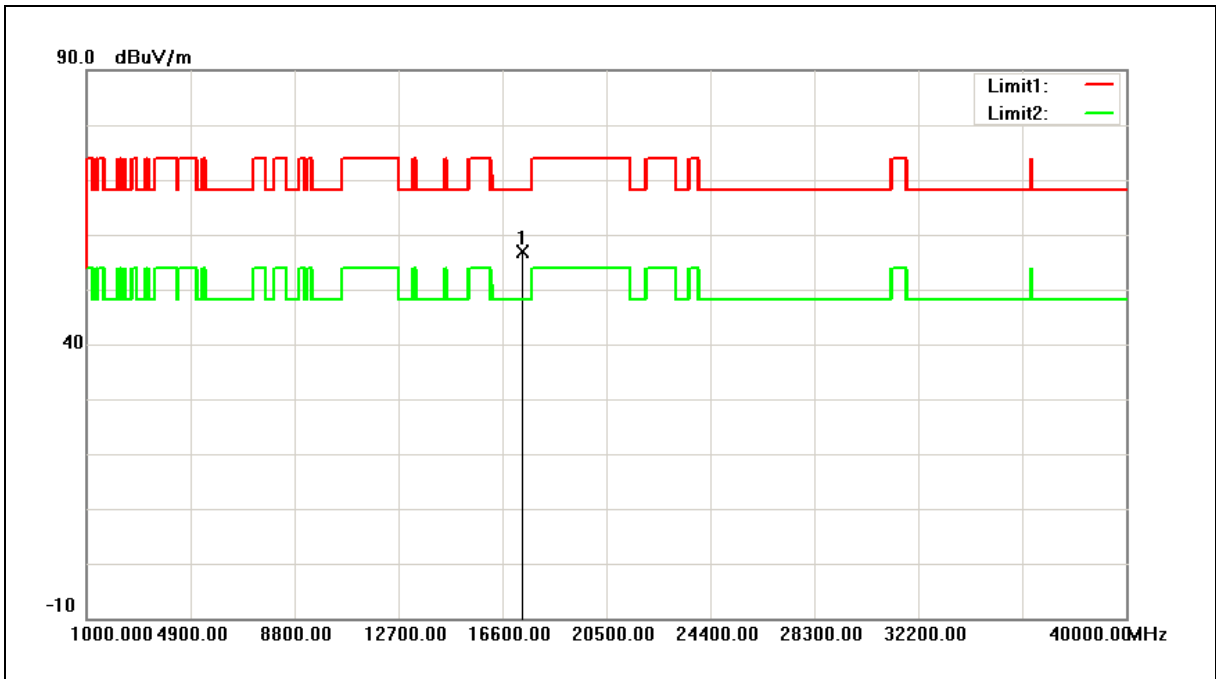

No.	Frequency (MHz)	Reading (dBuV)	Correct Factor (dB/m)	Result (dBuV/m)	Limit (dBuV/m)	Margin (dB)	Remark
1	17355.000	45.24	11.52	56.76	68.20	-11.44	peak

Note:1.Result (dBuV/m) = Correct Factor (dB/m) + Reading(dBuV).

2.Correction factor (dB/m) = Antenna Factor (dB/m) + Cable loss (dB) – Pre-Amplifier gain (dB).

3. When the peak results are less than average limit, so not need to evaluate the average.





Standard:	FCC Part 15.407	Test Distance:	3m
Test item:	Harmonic	Power:	AC 120V/60Hz
Frequency:	5785MHz	Temp.(°C)/Hum.(%RH):	26(°C)/60%RH
Mode:	Mode 3	Date:	04/08/2017
Ant.Polar.:	Vertical		

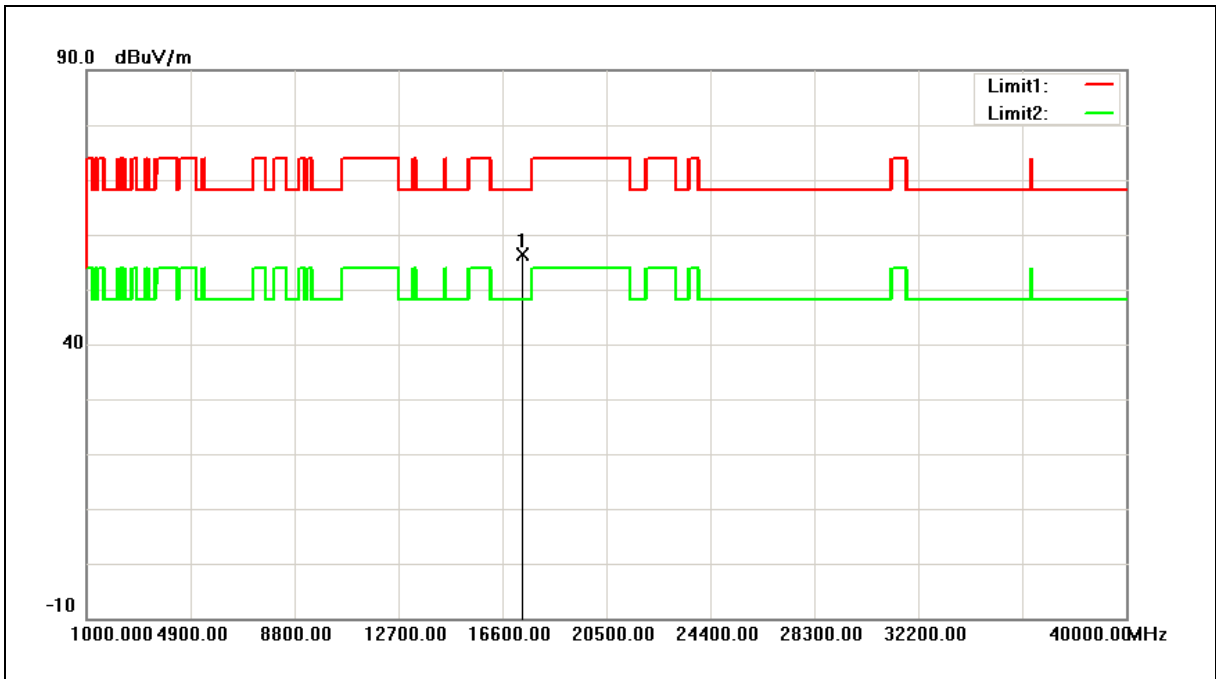

No.	Frequency (MHz)	Reading (dBuV)	Correct Factor (dB/m)	Result (dBuV/m)	Limit (dBuV/m)	Margin (dB)	Remark
1	17355.000	44.76	11.52	56.28	68.20	-11.92	peak

Note:1.Result (dBuV/m) = Correct Factor (dB/m) + Reading(dBuV).

2.Correction factor (dB/m) = Antenna Factor (dB/m) + Cable loss (dB) – Pre-Amplifier gain (dB).

3. When the peak results are less than average limit, so not need to evaluate the average.



Standard:	FCC Part 15.407	Test Distance:	3m
Test item:	Harmonic	Power:	AC 120V/60Hz
Frequency:	5825MHz	Temp.(°C)/Hum.(%RH):	26(°C)/60%RH
Mode:	Mode 3	Date:	04/08/2017
Ant.Polar.:	Horizontal		

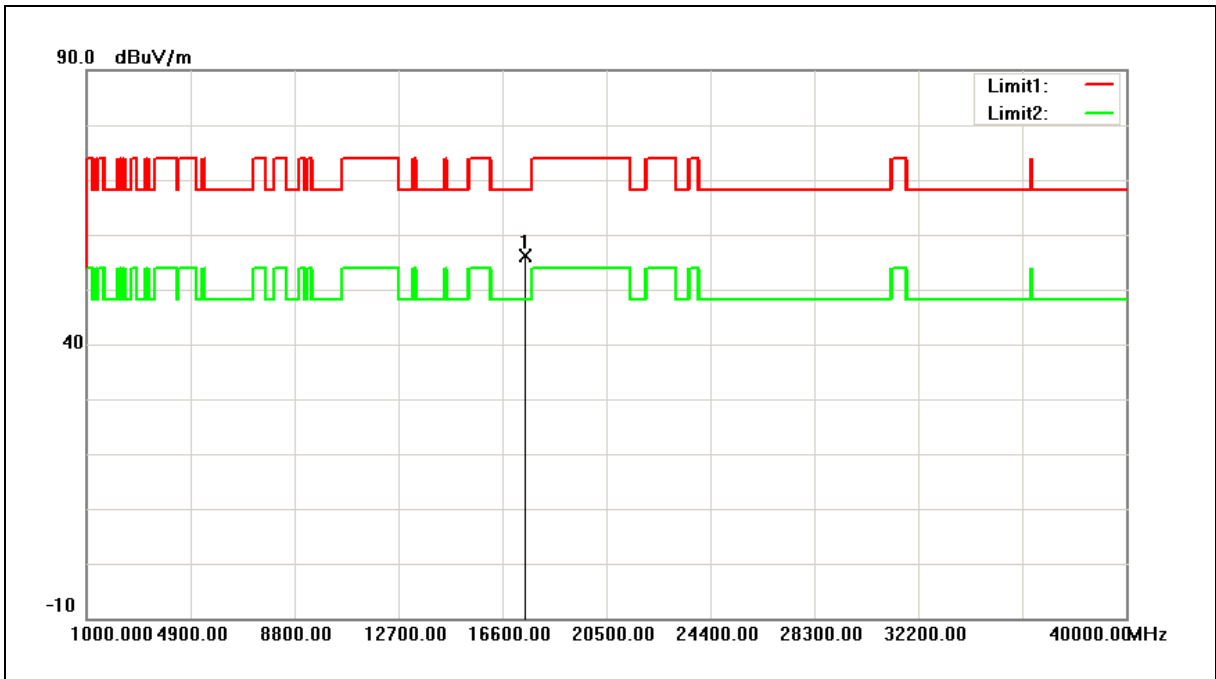

No.	Frequency (MHz)	Reading (dBuV)	Correct Factor (dB/m)	Result (dBuV/m)	Limit (dBuV/m)	Margin (dB)	Remark
1	17475.000	44.08	12.17	56.25	68.20	-11.95	peak

Note:1.Result (dBuV/m) = Correct Factor (dB/m) + Reading(dBuV).

2.Correction factor (dB/m) = Antenna Factor (dB/m) + Cable loss (dB) – Pre-Amplifier gain (dB).

3. When the peak results are less than average limit, so not need to evaluate the average.