

# FCC Radio Test Report

## FCC ID: TE7CPE605

This report concerns: **Original Grant**

**Project No.** : 1812C197  
**Equipment** : 5GHz 150Mbps 23dBi Outdoor CPE  
**Test Model** : CPE605  
**Series Model** : N/A  
**Applicant** : TP-Link Technologies Co., Ltd.  
**Address** : Building 24 (floors 1,3,4,5) and 28 (floors1-4), Central Science and Technology Park, Nanshan Shenzhen, 518057 China

**Date of Receipt** : Dec. 27, 2018  
**Date of Test** : Dec. 27, 2018 ~ Mar. 09, 2019  
**Issued Date** : Jun. 14, 2019  
**Tested by** : BTL Inc.

**Testing Engineer** :   
(Welly Zhou)

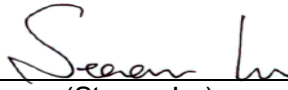
**Technical Manager** :   
(Steven Lu)

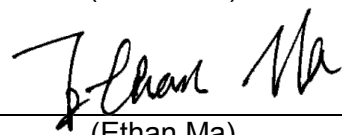
**Authorized Signatory** :   
(Ethan Ma)

# **B T L I N C .**

No.3, Jinshagang 1st Road, Shixia, Dalang Town, Dongguan,  
Guangdong, China.

TEL: +86-769-8318-3000 FAX: +86-769-8319-6000



Certificate #5123.02

### **Declaration**

**BTL** represents to the client that testing is done in accordance with standard procedures as applicable and that test instruments used has been calibrated with standards traceable to international standard(s) and/or national standard(s).

**BTL's** reports apply only to the specific samples tested under conditions. It is manufacture's responsibility to ensure that additional production units of this model are manufactured with the identical electrical and mechanical components. **BTL** shall have no liability for any declarations, inferences or generalizations drawn by the client or others from **BTL** issued reports.

The report must not be used by the client to claim product certification, approval, or endorsement by NVLAP, NIST, A2LA, or any agency of the U.S. Government.

This report is the confidential property of the client. As a mutual protection to the clients, the public and ourselves, the test report shall not be reproduced, except in full, without our written approval.

**BTL's** laboratory quality assurance procedures are in compliance with the **ISO/IEC 17025** requirements, and accredited by the conformity assessment authorities listed in this test report.

**BTL** is not responsible for the sampling stage, so the results only apply to the sample as received.

The information, data and test plan are provided by manufacturer which may affect the validity of results, so it is manufacturer's responsibility to ensure that the apparatus meets the essential requirements of applied standards and in all the possible configurations as representative of its intended use.

### **Limitation**

For the use of the authority's logo is limited unless the Test Standard(s)/Scope(s)/Item(s) mentioned in this test report is (are) included in the conformity assessment authorities acceptance respective.

<b>Table of Contents</b>	<b>Page</b>
<b>REPORT ISSUED HISTORY</b>	<b>6</b>
<b>1 . GENERAL SUMMARY</b>	<b>7</b>
<b>2 . SUMMARY OF TEST RESULTS</b>	<b>8</b>
2.1 TEST FACILITY	9
2.2 MEASUREMENT UNCERTAINTY	9
<b>3 . GENERAL INFORMATION</b>	<b>10</b>
3.1 GENERAL DESCRIPTION OF EUT	10
3.2 TEST MODES	12
3.3 PARAMETERS OF TEST SOFTWARE	14
3.4 DUTY CYCLE	15
3.5 BLOCK DIAGRAM SHOWING THE CONFIGURATION OF SYSTEM TESTED	17
3.6 SUPPORT UNITS	17
<b>4 . AC POWER LINE CONDUCTED EMISSIONS TEST</b>	<b>18</b>
4.1 LIMIT	18
4.2 TEST PROCEDURE	19
4.3 DEVIATION FROM TEST STANDARD	19
4.4 TEST SETUP	19
4.5 EUT OPERATION CONDITIONS	19
4.6 EUT TEST CONDITIONS	19
4.7 TEST RESULTS	19
<b>5 . RADIATED EMISSIONS TEST</b>	<b>20</b>
5.1 LIMIT	20
5.2 TEST PROCEDURE	21
5.3 DEVIATION FROM TEST STANDARD	21
5.4 TEST SETUP	21
5.5 EUT OPERATION CONDITIONS	23
5.6 EUT TEST CONDITIONS	23
5.7 TEST RESULTS - 9 KHZ to 30 MHZ	23
5.8 TEST RESULTS - 30 MHz TO 1000 MHz	23
5.9 TEST RESULTS - ABOVE 1000 MHz	23
<b>6 . BANDWIDTH TEST</b>	<b>24</b>
6.1 LIMIT	24

<b>Table of Contents</b>	<b>Page</b>
6.2 TEST PROCEDURE	24
6.3 TEST PROCEDURE	24
6.4 TEST SETUP	25
6.5 EUT OPERATION CONDITIONS	25
6.6 EUT TEST CONDITIONS	25
6.7 TEST RESULTS	25
<b>7 . MAXIMUM OUTPUT POWER TEST</b>	<b>26</b>
7.1 LIMIT	26
7.2 TEST PROCEDURE	26
7.3 DEVIATION FROM STANDARD	26
7.4 TEST SETUP	27
7.5 EUT OPERATION CONDITIONS	27
7.6 EUT TEST CONDITIONS	27
7.7 TEST RESULTS	27
<b>8 . POWER SPECTRAL DENSITY TEST</b>	<b>28</b>
8.1 LIMIT	28
8.2 TEST PROCEDURE	28
8.3 DEVIATION FROM STANDARD	28
8.4 TEST SETUP	28
8.5 EUT OPERATION CONDITIONS	28
8.6 UT TEST CONDITIONS	28
8.7 TEST RESULTS	28
<b>9 . FREQUENCY STABILITY MEASUREMENT</b>	<b>29</b>
9.1 LIMIT	29
9.2 TEST PROCEDURE	29
9.3 DEVIATION FROM STANDARD	29
9.4 TEST SETUP	29
9.5 EUT OPERATION CONDITIONS	29
9.6 EUT TEST CONDITIONS	29
9.7 TEST RESULTS	29
<b>10 . MEASUREMENT INSTRUMENTS LIST</b>	<b>30</b>
<b>11 . EUT TEST PHOTOS</b>	<b>32</b>
<b>APPENDIX A - AC POWER LINE CONDUCTED EMISSIONS</b>	<b>36</b>

## Table of Contents

Page

<b>APPENDIX B - RADIATED EMISSION - 9 KHZ TO 30 MHZ</b>	<b>39</b>
<b>APPENDIX C - RADIATED EMISSION - 30 MHZ TO 1 GHZ</b>	<b>44</b>
<b>APPENDIX D - RADIATED EMISSION - ABOVE 1000 MHZ</b>	<b>47</b>
<b>APPENDIX E - BANDWIDTH</b>	<b>160</b>
<b>APPENDIX F - CONDUCTED OUTPUT POWER</b>	<b>167</b>
<b>APPENDIX G - POWER SPECTRAL DENSITY</b>	<b>172</b>
<b>APPENDIX H - FREQUENCY STABILITY</b>	<b>179</b>

### REPORT ISSUED HISTORY

Report Version	Description	Issued Date
R00	Original Issue.	Mar. 22, 2019
R01	Revised report to address ACB's comments.	May 24, 2019
R02	Revised report to address ACB's comments.	Jun. 14, 2019

## 1. GENERAL SUMMARY

Equipment : 5GHz 150Mbps 23dBi Outdoor CPE  
Brand Name : tp-link  
Test Model : CPE605  
Series Model : N/A  
Applicant : TP-Link Technologies Co., Ltd.  
Manufacturer : TP-Link Technologies Co., Ltd.  
Address : Building 24 (floors 1,3,4,5) and 28 (floors1-4), Central Science and Technology Park, Nanshan Shenzhen, 518057 China  
Factory : TP-Link Technologies Co., Ltd.  
Address : Building 24 (floors 1,3,4,5) and 28 (floors1-4), Central Science and Technology Park, Nanshan Shenzhen, 518057 China  
Date of Test : Dec. 27, 2018 ~ Mar. 09, 2019  
Test Sample : Engineering Sample No.: D181110844  
Standard(s) : FCC Part15, Subpart E(15.407)  
ANSI C63.10-2013

The above equipment has been tested and found compliance with the requirement of the relative standards by BTL Inc..

The test data, data evaluation, and equipment configuration contained in our test report (Ref No. BTL-FCCP-1-1812C197) were obtained utilizing the test procedures, test instruments, test sites that has been accredited by the Authority of A2LA according to the ISO/IEC 17025 quality assessment standard and technical standard(s).

**Test results included in this report are only for the UNII-1 and UNII-3 part.**

## 2. SUMMARY OF TEST RESULTS

Test procedures according to the technical standard(s):

FCC Part15, Subpart E(15.407)				
Standard(s) Section	Test Item	Test Result	Judgement	Remark
15.207 15.407(b)	AC Power Line Conducted Emissions	APPENDIX A	PASS	-----
15.205 15.407(b)	Radiated Emissions	APPENDIX B APPENDIX C APPENDIX D	PASS	-----
15.407(a) 15.407(e)	Spectrum Bandwidth	APPENDIX E	PASS	-----
15.407(a)	Maximum Output Power	APPENDIX F	PASS	-----
15.407(a)	Power Spectral Density	APPENDIX G	PASS	-----
15.407(g)	Frequency Stability	APPENDIX H	PASS	-----
15.203	Antenna Requirements	-----	PASS	-----
15.407(c)	Automatically Discontinue Transmission	-----	PASS	NOTE (2)

Note:

- (1) "N/A" denotes test is not applicable in this test report.
- (2) During no any information transmission, the EUT can automatically discontinue transmission and become standby mode for power saving. the EUT can detect the controlling signal of ACK message transmitting from remote device and verify whether it shall resend or discontinue transmission.
- (3) For UNII-1 this device was functioned as a  
 Access point device     Client device



## 2.1 TEST FACILITY

The test facilities used to collect the test data in this report is at the location of No.3, Jinshagang 1st Road, Shixia, Dalang Town, Dongguan, Guangdong, China.

BTL's Test Firm Registration Number for FCC: 357015

BTL's Designation Number for FCC: CN1240

## 2.2 MEASUREMENT UNCERTAINTY

ISO/IEC 17025 requires that an estimate of the measurement uncertainties associated with the emissions test results be included in the report. The measurement uncertainties given below are based on a 95% confidence level (based on a coverage factor (k=2)

The BTL measurement uncertainty as below table:

### A. AC power line conducted emissions test:

Test Site	Method	Measurement Frequency Range	U, (dB)
DG-C02	CISPR	150 KHz ~ 30 MHz	2.32

### B. Radiated emissions test:

Test Site	Method	Measurement Frequency Range	Ant. H / V	U, (dB)
DG-CB03	CISPR	9 kHz~30 MHz	V	3.79
		9 kHz~30 MHz	H	3.57
		30 MHz~200 MHz	V	3.82
		30 MHz~200 MHz	H	3.60
		200 MHz~1,000 MHz	V	3.86
		200 MHz~1,000 MHz	H	3.94
		1 GHz~18 GHz	V	3.12
		1 GHz~18 GHz	H	3.68
		18 GHz~40 GHz	V	4.15
		18 GHz~40 GHz	H	4.14

Note: Unless specifically mentioned, the uncertainty of measurement has not been taken into account to declare the compliance or non-compliance to the specification.

### 3. GENERAL INFORMATION

#### 3.1 GENERAL DESCRIPTION OF EUT

Equipment	5GHz 150Mbps 23dBi Outdoor CPE
Brand Name	tp-link
Test Model	CPE605
Series Model	N/A
Model Difference(s)	N/A
Power Source	DC voltage supplied from PoE adapter.
Power Rating	I/P: 100-240V~ 50/60Hz O/P: 24V --- 0.25A
Operation Frequency	UNII-1: 5150 MHz~5250 MHz UNII-3: 5725 MHz~5850 MHz
Modulation Type	OFDM
Bit Rate of Transmitter	Up to 150 Mbps
Maximum Conducted Output Power for UNII-1	IEEE 802.11a (10M): 12.39dBm (0.0173W) IEEE 802.11n (HT10): 12.28dBm (0.0169W) IEEE 802.11a (20M): 12.54 dBm (0.0179 W) IEEE 802.11n (HT20): 12.48 dBm (0.0177 W) IEEE 802.11n (HT40): 12.86 dBm (0.0193 W)
Maximum Conducted Output Power for UNII-3	IEEE 802.11a (10M): 17.35dBm (0.0543W) IEEE 802.11n (HT10): 17.21dBm (0.0526W) IEEE 802.11a (20M): 17.39 dBm (0.0548 W) IEEE 802.11n (HT20): 17.33 dBm (0.0541 W) IEEE 802.11n (HT40): 17.36 dBm (0.0545 W)

**Note:**

1. For a more detailed features description, please refer to the manufacturer's specifications or the user's manual.

2. Channel List:

IEEE 802.11a (10M),IEEE 802.11a (20M) IEEE 802.11n (HT10),IEEE 802.11n (HT20)		IEEE 802.11n (HT40)	
UNII-1		UNII-1	
Channel	Frequency (MHz)	Channel	Frequency (MHz)
36	5180	38	5190
40	5200	46	5230
44	5220		
48	5240		

IEEE 802.11a (10M),IEEE 802.11a (20M) IEEE 802.11n (HT10),IEEE 802.11n (HT20)		IEEE 802.11n (HT40)	
UNII-3		UNII-3	
Channel	Frequency (MHz)	Channel	Frequency (MHz)
149	5745	151	5755
153	5765	159	5795
157	5785		
161	5805		
165	5825		

3. Antenna Specification:

Ant.	Brand	Model Name	Antenna Type	Connector	Gain (dBi)
1		N/A	PCB	N/A	18.32

Note:

The antenna were fixed point to point,so the power and PSD limit not need to be reduced.

### 3.2 TEST MODES

The test system was pre-tested based on the consideration of all possible combinations of EUT operation mode.

Pretest Mode	Description
Mode 1	TX A (10M) Mode / CH36, CH40, CH48 (UNII-1)
Mode 2	TX A (20M) Mode / CH36, CH40, CH48 (UNII-1)
Mode 3	TX N (HT10) Mode / CH36, CH40, CH48 (UNII-1)
Mode 4	TX N (HT20) Mode / CH36, CH40, CH48 (UNII-1)
Mode 5	TX N (HT40) Mode / CH38, CH46 (UNII-1)
Mode 6	TX A (10M) Mode / CH149,CH157,CH165 (UNII-3)
Mode 7	TX A (20M) Mode / CH149,CH157,CH165 (UNII-3)
Mode 8	TX N (HT10) Mode / CH149,CH157,CH165 (UNII-3)
Mode 9	TX N (HT20) Mode / CH149,CH157,CH165 (UNII-3)
Mode 10	TX N (HT40) Mode / CH151,CH159 (UNII-3)
Mode 11	TX A Mode / CH149 (UNII-3)

Following mode(s) was (were) found to be the worst case(s) and selected for the final test.

<b>AC power line conducted emissions test</b>	
Final Test Mode	Description
Mode 11	TX A Mode / CH149 (UNII-3)

<b>Radiated emissions test</b>	
Final Test Mode	Description
Mode 1	TX A (10M) Mode / CH36, CH40, CH48 (UNII-1)
Mode 2	TX A (20M) Mode / CH36, CH40, CH48 (UNII-1)
Mode 3	TX N (HT10) Mode / CH36, CH40, CH48 (UNII-1)
Mode 4	TX N (HT20) Mode / CH36, CH40, CH48 (UNII-1)
Mode 5	TX N (HT40) Mode / CH38, CH46 (UNII-1)
Mode 6	TX A (10M) Mode / CH149,CH157,CH165 (UNII-3)
Mode 7	TX A (20M) Mode / CH149,CH157,CH165 (UNII-3)
Mode 8	TX N (HT10) Mode / CH149,CH157,CH165 (UNII-3)
Mode 9	TX N (HT20) Mode / CH149,CH157,CH165 (UNII-3)
Mode 10	TX N (HT40) Mode / CH151,CH159 (UNII-3)

Conducted test	
Test Mode	Description
Mode 1	TX A (10M) Mode / CH36, CH40, CH48 (UNII-1)
Mode 2	TX A (20M) Mode / CH36, CH40, CH48 (UNII-1)
Mode 3	TX N (HT10) Mode / CH36, CH40, CH48 (UNII-1)
Mode 4	TX N (HT20) Mode / CH36, CH40, CH48 (UNII-1)
Mode 5	TX N (HT40) Mode / CH38, CH46 (UNII-1)
Mode 6	TX A (10M) Mode / CH149,CH157,CH165 (UNII-3)
Mode 7	TX A (20M) Mode / CH149,CH157,CH165 (UNII-3)
Mode 8	TX N (HT10) Mode / CH149,CH157,CH165 (UNII-3)
Mode 9	TX N (HT20) Mode / CH149,CH157,CH165 (UNII-3)
Mode 10	TX N (HT40) Mode / CH151,CH159 (UNII-3)

**Note :**

- (1) For radiated emission below 1 GHz test, the IEEE 802.11a channel149 is found to be the worst case and recorded.
- (2) For radiated emission above 1 GHz test, 1GHz~26.5GHz and 26.5GHz~40GHz have been pre-tested and in this report only recorded the worst case. The remaining spurious points are all below the limit value of 20dB.

### 3.3 PARAMETERS OF TEST SOFTWARE

UNII-1			
Test Software	cart		
Test Frequency (MHz)	5180	5200	5240
IEEE 802.11a (10M)	8	8	13
IEEE 802.11a (20M)	11	11	13
Test Frequency (MHz)	5180	5200	5240
IEEE 802.11n (HT10)	9	9	13
IEEE 802.11n (HT20)	11	11	13
Test Frequency (MHz)	5190	5230	
IEEE 802.11n (HT40)	8	13	

UNII-3			
Test Software	cart		
Test Frequency (MHz)	5745	5785	5825
IEEE 802.11a (10M)	17	17	17
IEEE 802.11a (20M)	17	17	17
Test Frequency (MHz)	5745	5785	5825
IEEE 802.11n (HT10)	17	17	17
IEEE 802.11n (HT20)	17	17	17
Test Frequency (MHz)	5755	5795	
IEEE 802.11n (HT40)	17	17	

### 3.4 DUTY CYCLE

If duty cycle is  $\geq 98\%$ , duty factor is not required.  
 If duty cycle is  $< 98\%$ , duty factor shall be considered.

#### IEEE 802.11a (10M)

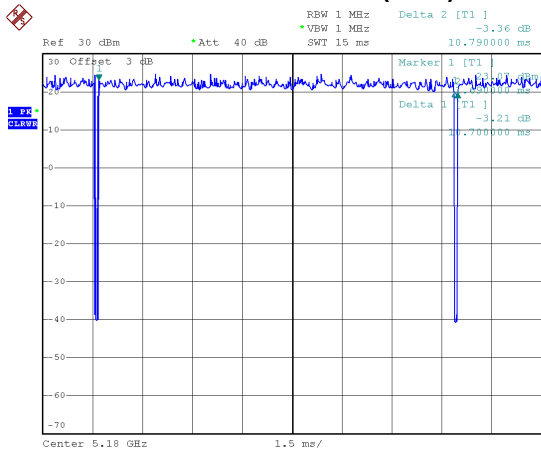

Date: 14.JAN.2019 17:28:53

Duty cycle =  $10.700 \text{ ms} / 10.790 \text{ ms} = 99.17\%$   
 Duty Factor =  $10 * \log(1 / 99.17\%) = 0.00 \text{ dB}$

#### IEEE 802.11a (20M)

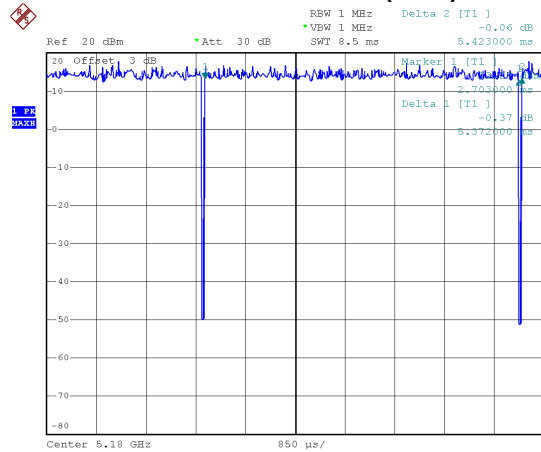

Date: 14.JAN.2019 11:07:56

Duty cycle =  $5.372 \text{ ms} / 5.423 \text{ ms} = 99.06\%$   
 Duty Factor =  $10 * \log(1 / 99.06\%) = 0.00 \text{ dB}$

#### IEEE 802.11n (HT10)

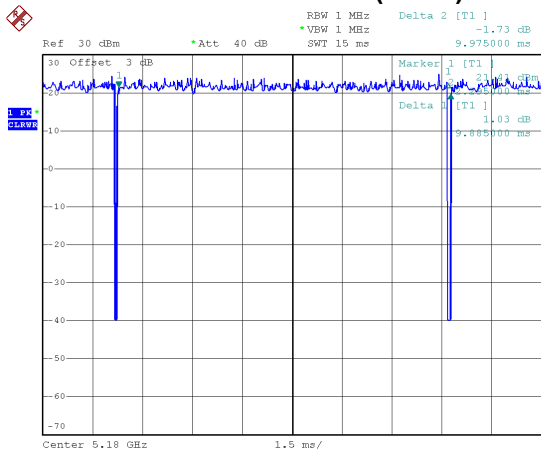

Date: 14.JAN.2019 17:25:06

Duty cycle =  $9.885 \text{ ms} / 9.975 \text{ ms} = 99.10\%$   
 Duty Factor =  $10 * \log(1 / 99.10\%) = 0.00 \text{ dB}$

#### IEEE 802.11n (HT20)

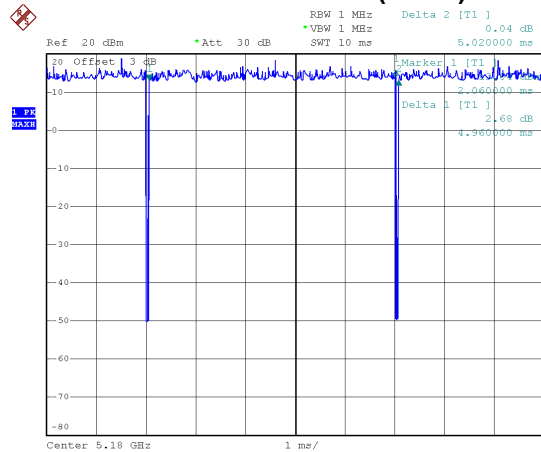

Date: 14.JAN.2019 11:24:52

Duty cycle =  $4.960 \text{ ms} / 5.020 \text{ ms} = 98.81\%$   
 Duty Factor =  $10 * \log(1 / 98.81\%) = 0.00 \text{ dB}$

### IEEE 802.11n (HT40)

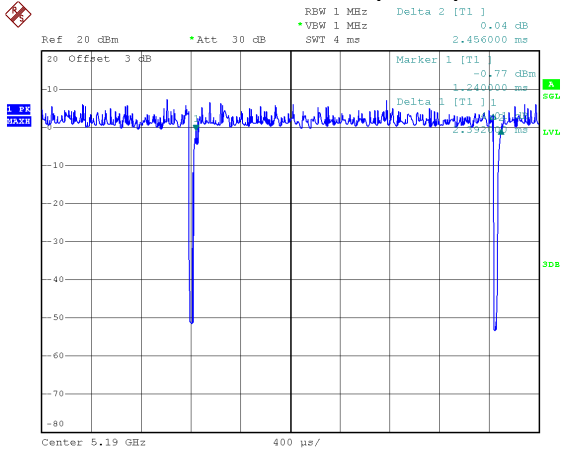

Date: 14.JAN.2019 11:40:07

Duty cycle = 2.392 ms / 2.456 ms = 97.39%  
 Duty Factor = 10 \* log(1 / 97.39%) = 0.11 dB

**NOTE:**

For IEEE 802.11n (HT40):

For radiated emissions frequency above 1 GHz, the resolution bandwidth of test receiver/spectrum analyzer is 1 MHz and the video bandwidth is 2 kHz (Duty cycle < 98%).



**3.5 BLOCK DIAGRAM SHOWING THE CONFIGURATION OF SYSTEM TESTED**

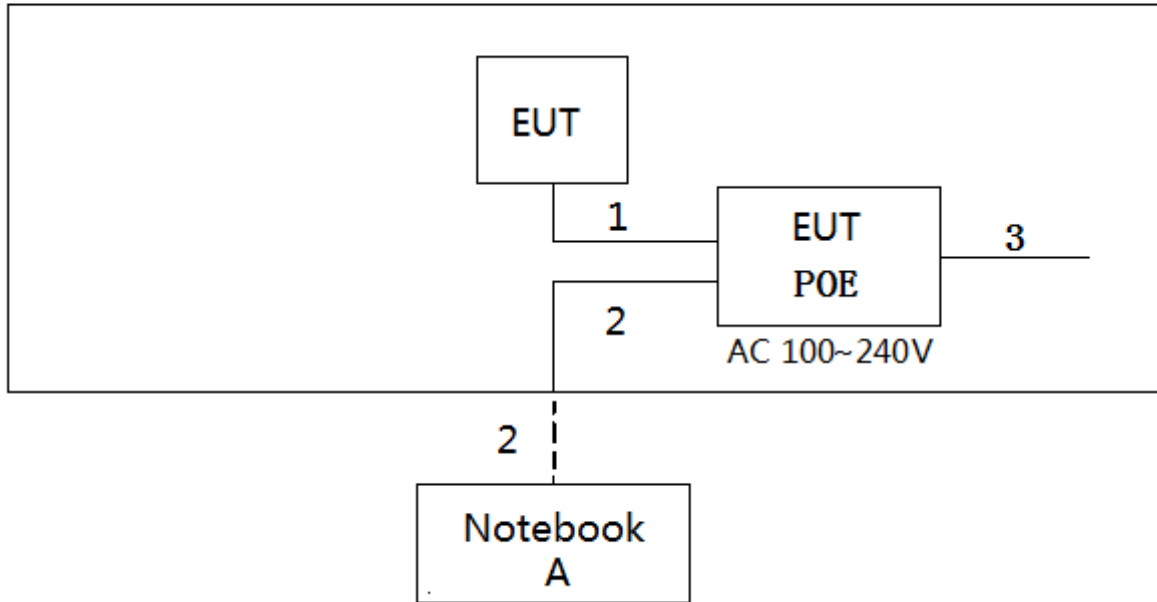

**3.6 SUPPORT UNITS**

Item	Equipment	Mfr/Brand	Model/Type No.	Series No.
A	Notebook	Lenovo	G410	N/A

Item	Shielded Type	Ferrite Core	Length	Note
1	NO	NO	1.5m	RJ45 Cable
2	NO	NO	10m	RJ45 Cable
3	NO	NO	0.8m	AC Cable

## 4. AC POWER LINE CONDUCTED EMISSIONS TEST

### 4.1 LIMIT

Frequency (MHz)	Limit (dB $\mu$ V)	
	Quasi-peak	Average
0.15 - 0.5	66 to 56*	56 - 46*
0.50 - 5.0	56	46
5.0 - 30.0	60	50

**NOTE:**

- (1) The tighter limit applies at the band edges.
- (2) The limit of " \* " marked band means the limitation decreases linearly with the logarithm of the frequency in the range.
- (3) The test result calculated as following:  
 Measurement Value = Reading Level + Correct Factor  
 Correct Factor = Insertion Loss + Cable Loss + Attenuator Factor (if use)  
 Margin Level = Measurement Value – Limit Value  
 Sample calculations: (Refer to page 37, test result No.1.)

Reading Level		Correct Factor		Measurement Value
37.44	+	9.80	=	47.24

Measurement Value		Limit Value		Margin Level
47.24	-	56.44	=	-9.20

The following table is the setting of the receiver

Receiver Parameter	Setting
Attenuation	10 dB
Start Frequency	0.15 MHz
Stop Frequency	30 MHz
IF Bandwidth	9 KHz

**4.2 TEST PROCEDURE**

- a. The EUT was placed 0.8 meters from the horizontal ground plane with EUT being connected to the power mains through a line impedance stabilization network (LISN). All other support equipment powered from additional LISN(s). The LISN provide 50 Ohm/ 50uH of coupling impedance for the measuring instrument.
- b. Interconnecting cables that hang closer than 40 cm to the ground plane shall be folded back and forth in the center forming a bundle 30 to 40 cm long.
- c. I/O cables that are not connected to a peripheral shall be bundled in the center. The end of the cable may be terminated, if required, using the correct terminating impedance. The overall length shall not exceed 1 m.
- d. LISN at least 80 cm from nearest part of EUT chassis.
- e. For the actual test configuration, please refer to the related Item -EUT Test Photos.

**4.3 DEVIATION FROM TEST STANDARD**

No deviation

**4.4 TEST SETUP**

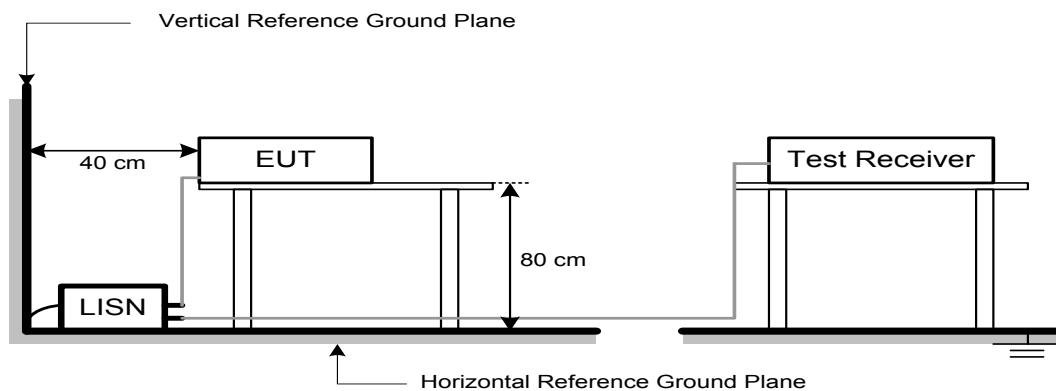

**4.5 EUT OPERATION CONDITIONS**

The EUT was configured for testing in a typical fashion (as a customer would normally use it). The EUT has been programmed to continuously transmit during test. This operating condition was tested and used to collect the included data.

The EUT was programmed to be in continuously transmitting/TX mode.

**4.6 EUT TEST CONDITIONS**

Temperature: 25°C    Relative Humidity: 53%    Test Voltage: AC 120V/60Hz

**4.7 TEST RESULTS**

Please refer to the APPENDIX A.

## 5. RADIATED EMISSIONS TEST

### 5.1 LIMIT

In case the emission fall within the restricted band specified on 15.205(a), then the 15.209(a) limit in the table below has to be followed.

#### LIMITS OF RADIATED EMISSIONS MEASUREMENT (9 kHz to 1000 MHz)

Frequency (MHz)	Field Strength (microvolts/meter)	Measurement Distance (meters)
0.009-0.490	2400/F(kHz)	300
0.490-1.705	24000/F(kHz)	30
1.705-30.0	30	30
30-88	100	3
88-216	150	3
216-960	200	3
Above 960	500	3

#### LIMITS OF UNWANTED EMISSION OUT OF THE RESTRICTED BANDS

Frequency (MHz)	EIRP Limit (dBm/MHz)	Equivalent Field Strength at 3m (dBμV/m)
5150-5250	-27	68.3
5725-5850	-27 NOTE (2)	68.3
	10 NOTE (2)	105.3
	15.6 NOTE (2)	110.9
	27 NOTE (2)	122.3

#### NOTE:

(1) The following formula is used to convert the equipment isotropic radiated power (eirp) to field

strength:  $E = \frac{1000000\sqrt{30P}}{3}$  μV/m, where P is the eirp (Watts)

(2) According to FCC 16-24, all emissions shall be limited to a level of -27 dBm/MHz at 75 MHz or more above or below the band edge increasing linearly to 10 dBm/MHz at 25 MHz above or below the band edge, and from 25 MHz above or below the band edge increasing linearly to a level of 15.6 dBm/MHz at 5 MHz above or below the band edge, and from 5 MHz above or below the band edge increasing linearly to a level of 27 dBm/MHz at the band edge.

(3) Sample calculations: (Refer to page 45, test result No.5.)

Reading Level		Correct Factor		Measurement Value
37.09	+	-3.96	=	33.13

Measurement Value		Limit Value		Margin Level
33.13	-	46.00	=	-12.87

## 5.2 TEST PROCEDURE

- a. The measuring distance of 3 m shall be used for measurements. The EUT was placed on the top of a rotating table 0.8 meter above the ground at a 3 meter semi-anechoic chamber. The table was rotated 360 degrees to determine the position of the highest radiation.(below 1GHz)
- b. The measuring distance of 3 m shall be used for measurements. The EUT was placed on the top of a rotating table 1.5 meter above the ground at a 3 meter semi-anechoic chamber. The table was rotated 360 degrees to determine the position of the highest radiation.(above 1GHz)
- c. The height of the equipment or of the substitution antenna shall be 0.8m or 1.5m; the height of the test antenna shall vary between 1 m to 4 m. Both horizontal and vertical polarizations of the antenna are set to make the measurement.
- d. For each suspected emission, the EUT was arranged to its worst case and then the antenna was tuned to heights find the maximum reading (used Bore sight function).
- e. The receiver system was set to peak and average detect function and specified bandwidth with maximum hold mode when the test frequency is above 1 GHz.
- f. The initial step in collecting radiated emission data is a receiver peak detector mode pre-scanning the measurement frequency range. Significant peaks are then marked and then Quasi Peak detector mode re-measured.
- g. All readings are Peak unless otherwise stated QP in column of Note. Peak denotes that the Peak reading compliance with the QP Limits and then QP Mode measurement didn't perform. (below 1 GHz)
- h. All readings are Peak Mode value unless otherwise stated AVG in column of Note. If the Peak Mode Measured value compliance with the Peak Limits and lower than AVG Limits, the EUT shall be deemed to meet both Peak & AVG Limits and then only Peak Mode was measured, but AVG Mode didn't perform. (above 1 GHz)
- i. For the actual test configuration, please refer to the related Item –EUT Test Photos.

## 5.3 DEVIATION FROM TEST STANDARD

No deviation

## 5.4 TEST SETUP

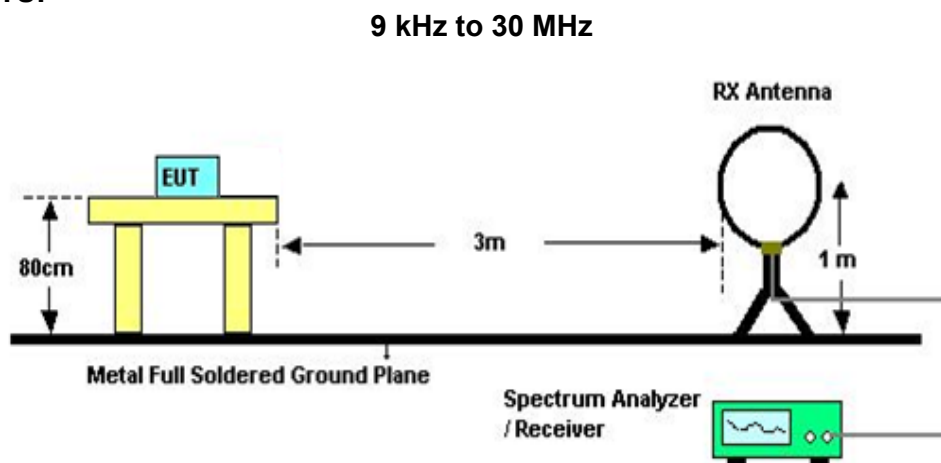

30 MHz to 1 GHz

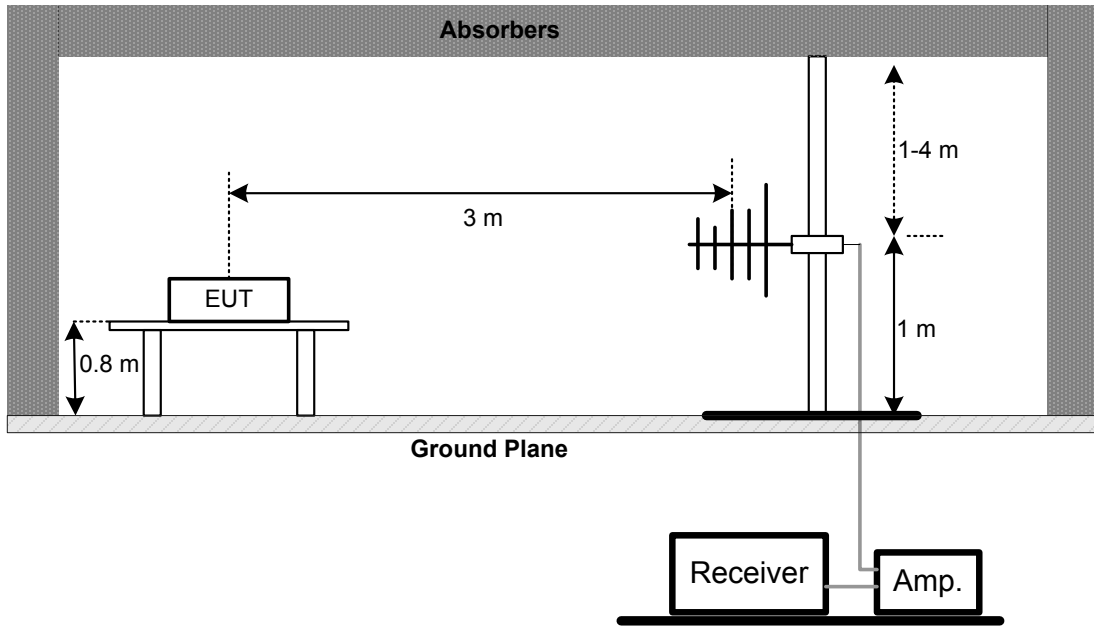

Above 1 GHz

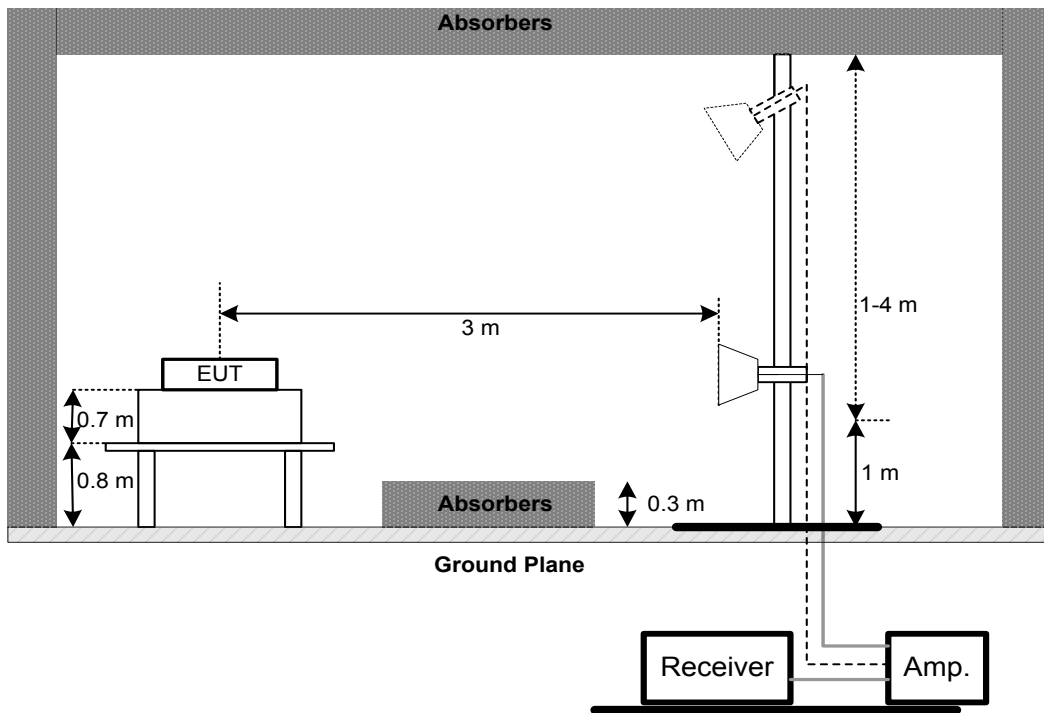

### 5.5 EUT OPERATION CONDITIONS

The EUT tested system was configured as the statements of 4.1.5 unless otherwise a special operating condition is specified in the follows during the testing.

### 5.6 EUT TEST CONDITIONS

Temperature: 25°C    Relative Humidity: 60%    Test Voltage: AC 120V/60Hz

### 5.7 TEST RESULTS - 9 KHZ to 30 MHZ

Please refer to the APPENDIX B

Remark:

- (1) Distance extrapolation factor =  $40 \log$  (specific distance / test distance) (dB).
- (2) Limit line = specific limits (dBuV) + distance extrapolation factor.

### 5.8 TEST RESULTS - 30 MHz TO 1000 MHz

Please refer to the APPENDIX C.

### 5.9 TEST RESULTS - ABOVE 1000 MHz

Please refer to the APPENDIX D.

Remark:

- (1) No limit: This is fundamental signal, the judgment is not applicable.  
For fundamental signal judgment was referred to Peak output test.

## 6. BANDWIDTH TEST

### 6.1 LIMIT

FCC Part15, Subpart E (15.407)			
Section	Test Item	Limit	Frequency Range (MHz)
15.407(a)	26 dB Bandwidth	-	5150-5250
15.407(e)	6 dB Bandwidth	Minimum 500 kHz	5725-5850

### 6.2 TEST PROCEDURE

- a. The EUT was directly connected to the spectrum analyzer and antenna output port as show in the block diagram below
- b. Spectrum Setting:

For UNII-1:

Spectrum Parameter	Setting
Attenuation	Auto
Span Frequency	> 26 dB Bandwidth
RBW	300 kHz (Bandwidth 20 MHz) 1 MHz (Bandwidth 40 MHz and 80 MHz)
VBW	1 MHz (Bandwidth 20 MHz) 3 MHz (Bandwidth 40 MHz and 80 MHz)
Detector	Peak
Trace	Max Hold
Sweep Time	Auto

For UNII-3:

Spectrum Parameter	Setting
Attenuation	Auto
Span Frequency	6 dB Bandwidth
RBW	100 kHz
VBW	300 kHz
Detector	Peak
Trace	Max Hold
Sweep Time	Auto

- c. Measured the spectrum width with power higher than 26 dB below carrier

### 6.3 TEST PROCEDURE

No deviation.



#### 6.4 TEST SETUP

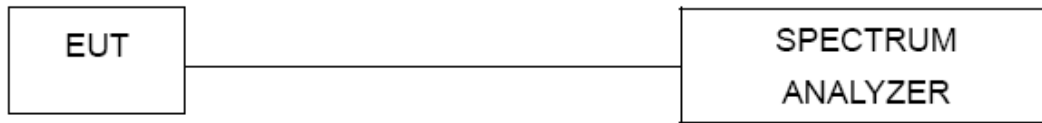

#### 6.5 EUT OPERATION CONDITIONS

The EUT was programmed to be in continuously transmitting mode.

#### 6.6 EUT TEST CONDITIONS

Temperature: 24°C    Relative Humidity: 58%    Test Voltage: AC 120V/60Hz

#### 6.7 TEST RESULTS

Please refer to the APPENDIX E.

## 7. MAXIMUM OUTPUT POWER TEST

### 7.1 LIMIT

FCC Part15, Subpart E (15.407)			
Section	Test Item	Limit	Frequency Range (MHz)
15.407(a)	Conducted Output Power	AP device: 1 Watt (30 dBm) Client device: 250 mW (24 dBm)	5150-5250
		1 Watt (30dBm)	5725-5850

Note:

- a. For an outdoor access point operating in the band 5.15-5.25 GHz, the maximum conducted output power over the frequency band of operation shall not exceed 1 W provided the maximum antenna gain does not exceed 6 dBi. In addition, the maximum power spectral density shall not exceed 17 dBm in any 1 megahertz band. If transmitting antennas of directional gain greater than 6 dBi are used, both the maximum conducted output power and the maximum power spectral density shall be reduced by the amount in dB that the directional gain of the antenna exceeds 6 dBi. The maximum e.i.r.p. at any elevation angle above 30 degrees as measured from the horizon must not exceed 125 mW (21 dBm).

### 7.2 TEST PROCEDURE

- a. The EUT was directly connected to the spectrum analyzer and antenna output port as show in the block diagram below.
- b. Used spectrum analyzer band power measurement function.
- c. Spectrum Setting

Spectrum Parameter	Setting
Attenuation	Auto
Span Frequency	Encompass the entire emissions bandwidth (EBW) of the signal
RBW	= 1 MHz.
VBW	≥ 3 MHz.
Sweep points	≥ 2 x span / RBW
Detector	RMS
Trace	Trace average at least 100 traces in power averaging(rms) mode.
Sweep Time	auto

- c. Test test was performed in accordance with method of FCC KDB 789033 D02 General UNII Test Procedures New Rules v02r01.

### 7.3 DEVIATION FROM STANDARD

No deviation.

#### 7.4 TEST SETUP



#### 7.5 EUT OPERATION CONDITIONS

The EUT was programmed to be in continuously transmitting mode.

#### 7.6 EUT TEST CONDITIONS

Temperature: 24°C    Relative Humidity: 58%    Test Voltage: AC 120V/60Hz

#### 7.7 TEST RESULTS

Please refer to the APPENDIX F.

## 8. POWER SPECTRAL DENSITY TEST

### 8.1 LIMIT

FCC Part15, Subpart E (15.407)			
Section	Test Item	Limit	Frequency Range (MHz)
15.407(a)	Power Spectral Density	AP device: 17 dBm/MHz Client device: 11 dBm/MHz	5150-5250
		30 dBm/500 kHz	5725-5850

### 8.2 TEST PROCEDURE

- a. The EUT was directly connected to the spectrum analyzer and antenna output port as show in the block diagram below.
- b. Spectrum Setting

Spectrum Parameter	Setting
Attenuation	Auto
Span Frequency	Encompass the entire emissions bandwidth (EBW) of the signal
RBW	= 1 MHz.
VBW	≥ 3 MHz.
Detector	RMS
Trace average	100 trace
Sweep Time	Auto

Note:

1. For UNII-3, according to KDB publication 789033 D02 General UNII Test Procedures New Rules v02r01, section II.F.5., it is acceptable to set RBW at 1 MHz and VBW at 3 MHz if the spectrum analyzer does not have 500 kHz RBW.
2. The value measured with RBW=1 MHz is to be added with  $10\log(500\text{ kHz}/1\text{ MHz})$  which is -3 dB. For example, if the measured value is +10dBm using RBW=1 MHz (that is +10 dBm/MHz), then the converted value will be +7dBm/500kHz.

### 8.3 DEVIATION FROM STANDARD

No deviation.

### 8.4 TEST SETUP



### 8.5 EUT OPERATION CONDITIONS

The EUT was programmed to be in continuously transmitting mode.

### 8.6 UT TEST CONDITIONS

Temperature: 24°C    Relative Humidity: 58%    Test Voltage: AC 120V/60Hz

### 8.7 TEST RESULTS

Please refer to the APPENDIX H.

## 9. FREQUENCY STABILITY MEASUREMENT

### 9.1 LIMIT

FCC Part15, Subpart E (15.407)			
Section	Test Item	Limit	Frequency Range (MHz)
15.407(g)	Frequency Stability	Specified in the user's manual	5150-5250
			5725-5850

### 9.2 TEST PROCEDURE

- The EUT was directly connected to the spectrum analyzer and antenna output port as show in the block diagram below.
- Spectrum Setting:

Spectrum Parameter	Setting
Attenuation	Auto
Span Frequency	Entire absence of modulation emissions bandwidth
RBW	10 kHz
VBW	10 kHz
Sweep Time	Auto

- The test extreme voltage is to change the primary supply voltage from 85 to 115 percent of the nominal value.
- User manual temperature is  $-40^{\circ}\text{C}\sim 70^{\circ}\text{C}$ .

### 9.3 DEVIATION FROM STANDARD

No deviation.

### 9.4 TEST SETUP

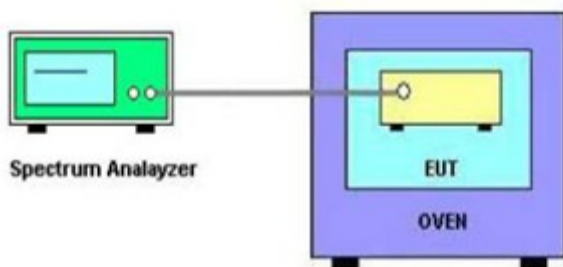

### 9.5 EUT OPERATION CONDITIONS

The EUT was programmed to be in continuously transmitting mode.

### 9.6 EUT TEST CONDITIONS

Temperature:  $24^{\circ}\text{C}$     Relative Humidity: 58%    Test Voltage: AC 120V/60Hz

### 9.7 TEST RESULTS

Please refer to the APPENDIX I.

## 10. MEASUREMENT INSTRUMENTS LIST

### AC Power Line Conducted Emissions

Item	Kind of Equipment	Manufacturer	Type No.	Serial No.	Calibrated until
1	EMI Test Receiver	R&S	ESCI	100382	Mar. 11, 2019
2	LISN	EMCO	3816/2	52765	Mar. 11, 2019
3	50Ω Terminator	SHX	TF2-3G-A	8122901	Mar. 11, 2019
4	TWO-LINE V-NETWORK	R&S	ENV216	101447	Mar. 11, 2019
5	Measurement Software	Farad	EZ-EMC Ver.NB-03A1-01	N/A	N/A
6	Cable	N/A	RG223	12m	Mar. 23, 2019

### Radiated Emissions - 9 kHz to 30 MHz

Item	Kind of Equipment	Manufacturer	Type No.	Serial No.	Calibrated until
1	Loop Antenna	EM	EM-6876-1	230	Jan. 15, 2020
2	Cable	N/A	RG 213/U	C-102	Jun. 01, 2019
3	EMI Test Receiver	R&S	ESCI	100382	Mar. 11, 2019
4	Measurement Software	Farad	EZ-EMC Ver.NB-03A1-01	N/A	N/A

### Radiated Emissions - 30 MHz to 1 GHz

Item	Kind of Equipment	Manufacturer	Type No.	Serial No.	Calibrated until
1	Antenna	Schwarbeck	VULB9160	9160-3232	Mar. 11, 2019
2	Amplifier	HP	8447D	2944A09673	Aug. 11, 2019
3	Receiver	Agilent	N9038A	MY52130039	Aug. 11, 2019
4	Cable	emci	LMR-400(30MHz-1GHz)(8m+5m)	N/A	May 25, 2019
5	Controller	CT	SC100	N/A	N/A
6	Controller	MF	MF-7802	MF780208416	N/A
7	Measurement Software	Farad	EZ-EMC Ver.NB-03A1-01	N/A	N/A

### Radiated Emissions - Above 1 GHz

Item	Kind of Equipment	Manufacturer	Type No.	Serial No.	Calibrated until
1	Double Ridged Guide Antenna	ETS	3115	75789	Mar. 11, 2019
2	Broad-Band Horn Antenna	Schwarzbeck	BBHA 9170	9170319	Jun. 30, 2019
3	Amplifier	Agilent	8449B	3008A02274	Mar. 11, 2019
4	Microwave Preamplifier With Adaptor	EMC INSTRUMENT	EMC2654045	980039 & HA01	Mar. 11, 2019
5	Receiver	Agilent	N9038A	MY52130039	Aug. 11, 2019
6	Controller	CT	SC100	N/A	N/A
7	Controller	MF	MF-7802	MF780208416	N/A
8	Cable	mitron	B10-01-01-12M	18072744	Jul. 30, 2019
9	Measurement Software	Farad	EZ-EMC Ver.NB-03A1-01	N/A	N/A

Bandwidth					
Item	Kind of Equipment	Manufacturer	Type No.	Serial No.	Calibrated until
1	Spectrum Analyzer	R&S	FSP40	100185	Aug. 11, 2019

Conducted Output Power					
Item	Kind of Equipment	Manufacturer	Type No.	Serial No.	Calibrated until
1	Spectrum Analyzer	R&S	FSP40	100185	Aug. 11, 2019

Power Spectral Density					
Item	Kind of Equipment	Manufacturer	Type No.	Serial No.	Calibrated until
1	Spectrum Analyzer	R&S	FSP40	100185	Aug. 11, 2019

Frequency Stability					
Item	Kind of Equipment	Manufacturer	Type No.	Serial No.	Calibrated until
1	Spectrum Analyzer	R&S	FSP40	100185	Aug. 11, 2019
2	Precision Oven Tester	Bell	BTH-50C	20170306001	Mar. 11, 2019

REMARK: "N/A" denotes no model name, no serial no. or no calibration specified.  
All calibration period of equipment list is one year.

## 11. EUT TEST PHOTOS

### AC Power Line Conducted Emissions Test Photos





### Radiated Emissions Test Photos

9 kHz to 30 MHz

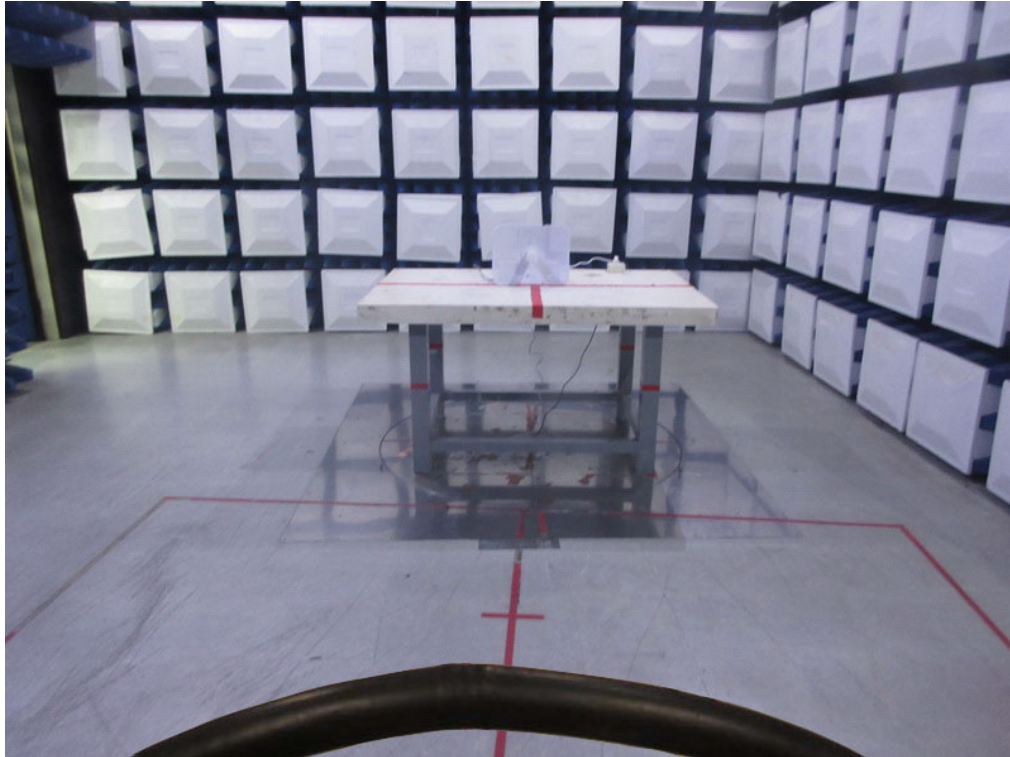

**Radiated Emissions Test Photos**

**30 MHz to 1 GHz**

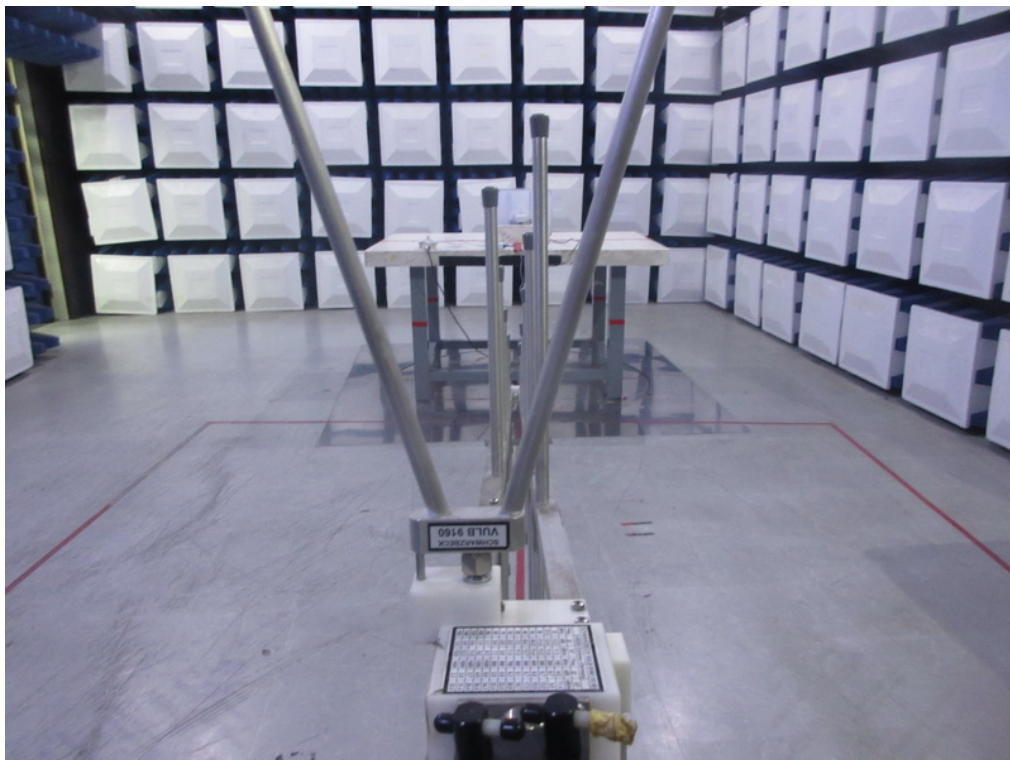

### Radiated Emissions Test Photos

#### Above 1 GHz

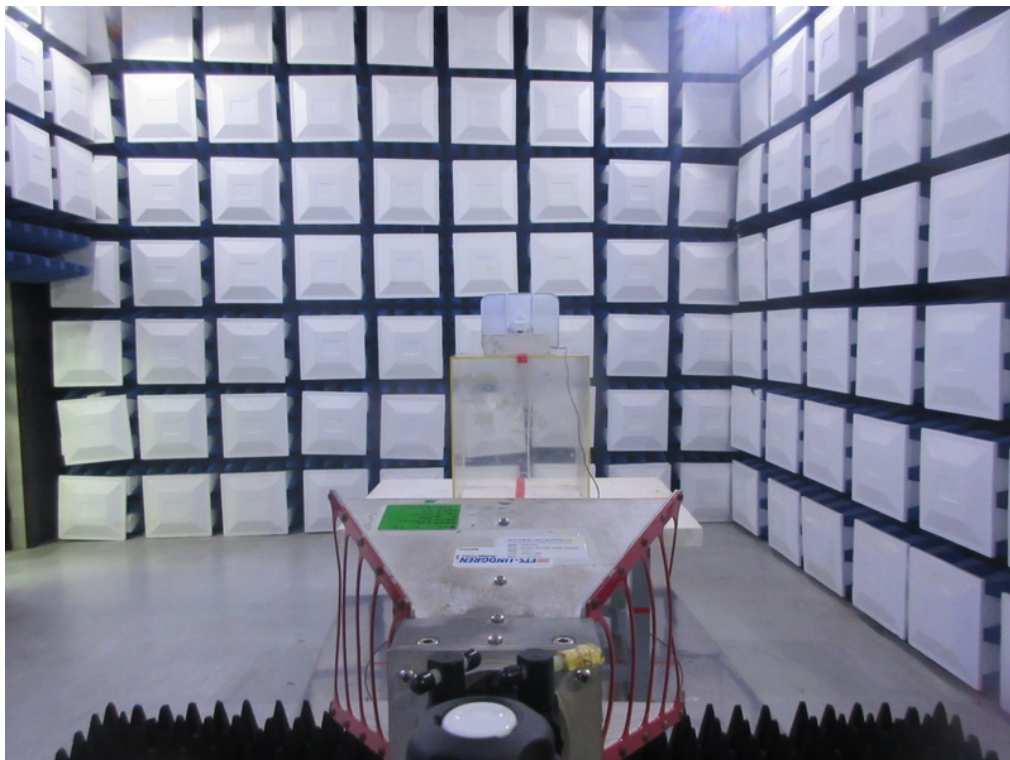
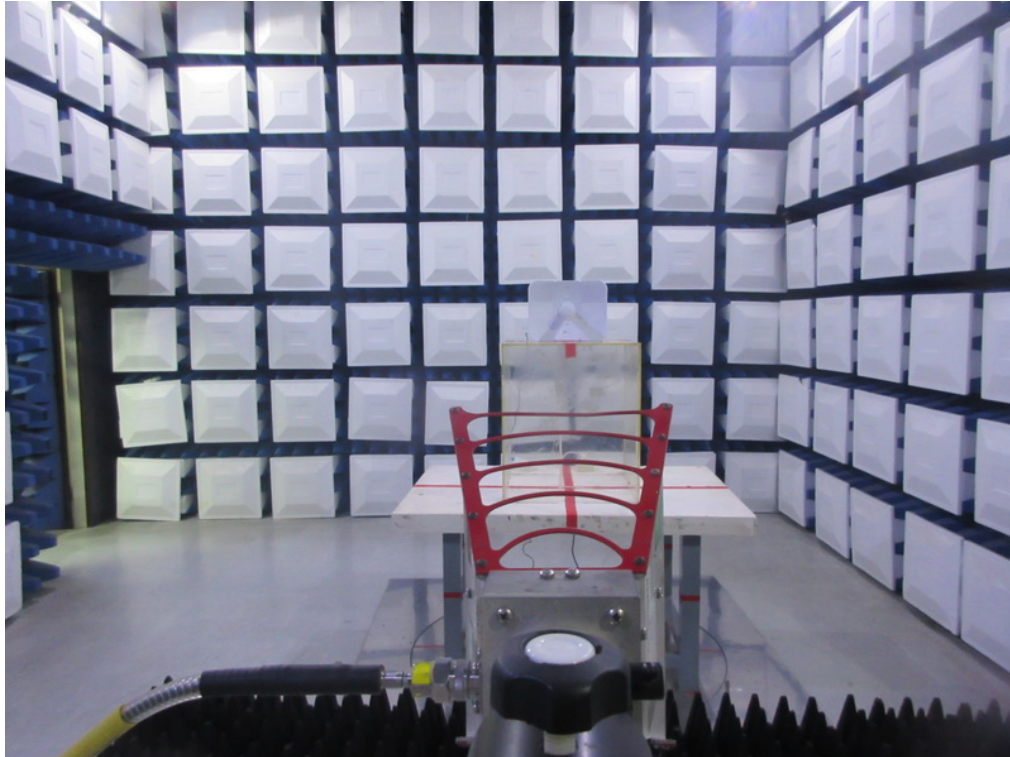

## APPENDIX A - AC POWER LINE CONDUCTED EMISSIONS

Test Mode: TX A MODE CHANNEL 149

**Line**

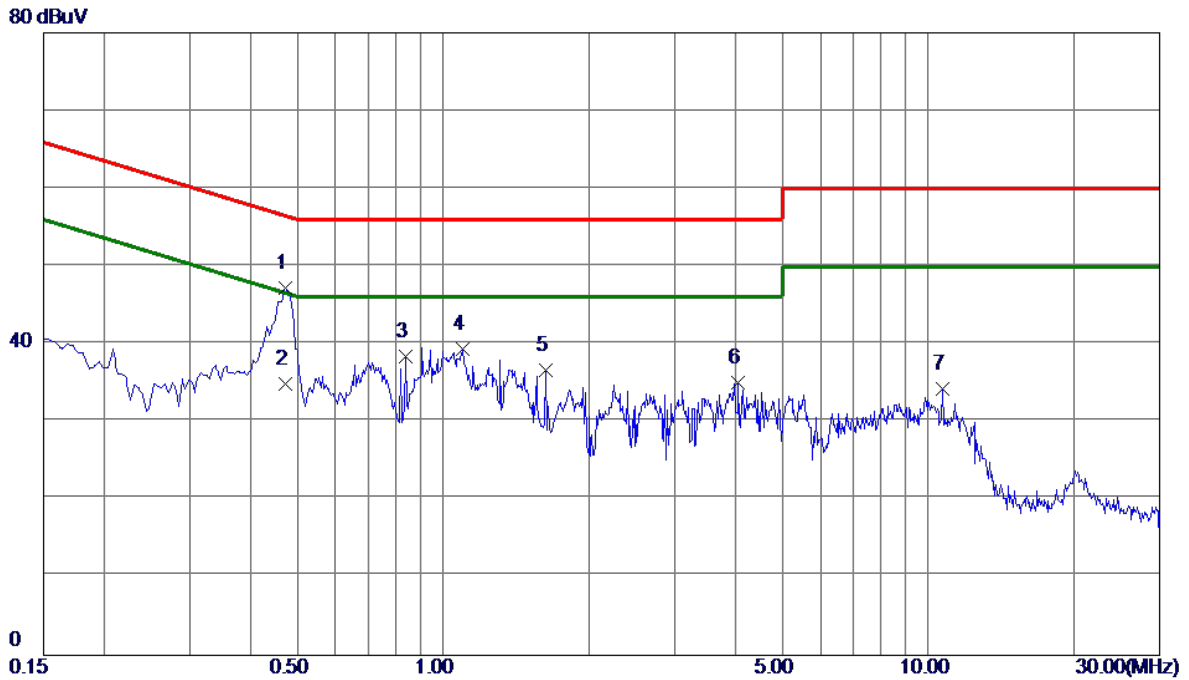

No.	Freq. MHz	Reading Level dBuV	Correct Factor dB	Measure ment dBuV	Limit dBuV	Margin dB	Detector	Comment
1 *	0.4740	37.44	9.80	47.24	56.44	-9.20	Peak	
2	0.4740	25.10	9.80	34.90	46.44	-11.54	AVG	
3	0.8385	28.56	9.91	38.47	56.00	-17.53	Peak	
4	1.0995	29.36	9.93	39.29	56.00	-16.71	Peak	
5	1.6260	26.70	9.97	36.67	56.00	-19.33	Peak	
6	4.0650	24.88	10.13	35.01	56.00	-20.99	Peak	
7	10.6800	23.75	10.53	34.28	60.00	-25.72	Peak	

**REMARKS:**

- (1) Measurement Value = Reading Level + Correct Factor.
- (2) Margin Level = Measurement Value - Limit Value.
- (3) The test result has included the cable loss.

Test Mode: TX A MODE CHANNEL 149

### Neutral

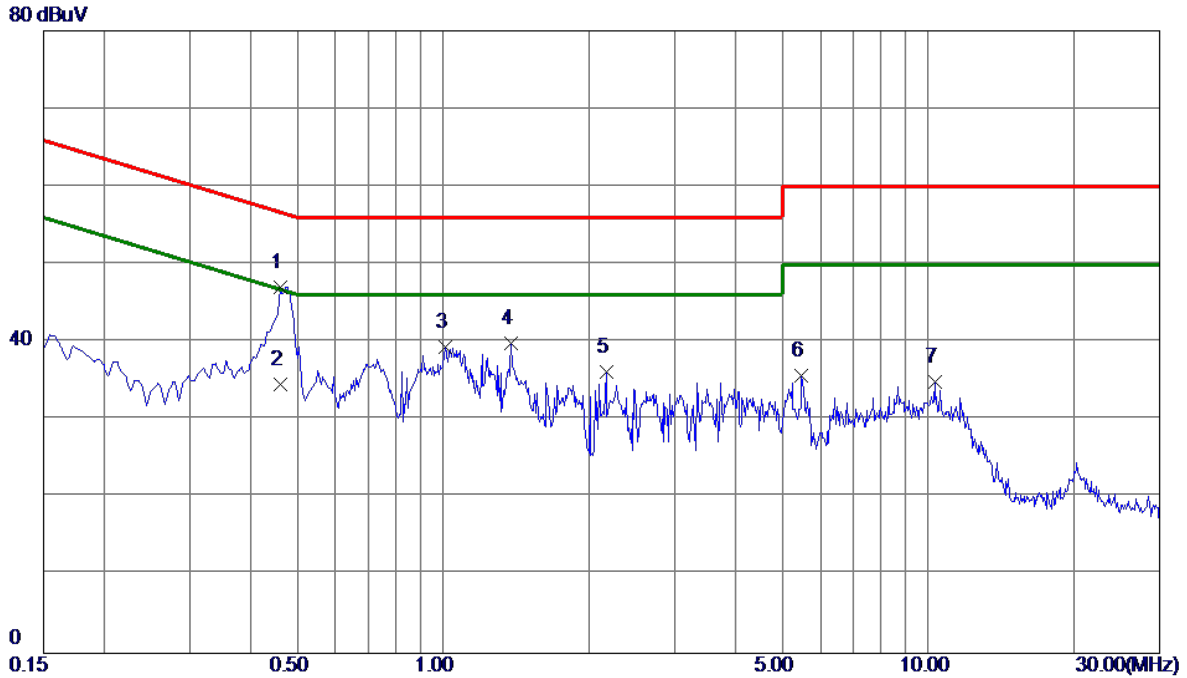

No.	Freq. MHz	Reading Level dBuV	Correct Factor dB	Measure ment dBuV	Limit dBuV	Margin dB	Detector	Comment
1 *	0.4605	37.09	9.94	47.03	56.68	-9.65	Peak	
2	0.4605	24.61	9.94	34.55	46.68	-12.13	AVG	
3	1.0095	29.21	10.12	39.33	56.00	-16.67	Peak	
4	1.3829	29.76	10.15	39.91	56.00	-16.09	Peak	
5	2.1660	26.02	10.20	36.22	56.00	-19.78	Peak	
6	5.4870	25.23	10.45	35.68	60.00	-24.32	Peak	
7	10.3200	24.08	10.76	34.84	60.00	-25.16	Peak	

**REMARKS:**

- (1) Measurement Value = Reading Level + Correct Factor.
- (2) Margin Level = Measurement Value - Limit Value.
- (3) The test result has included the cable loss.

## APPENDIX B - RADIATED EMISSION - 9 KHZ TO 30 MHZ

Test Mode: TX A MODE CHANNEL 149

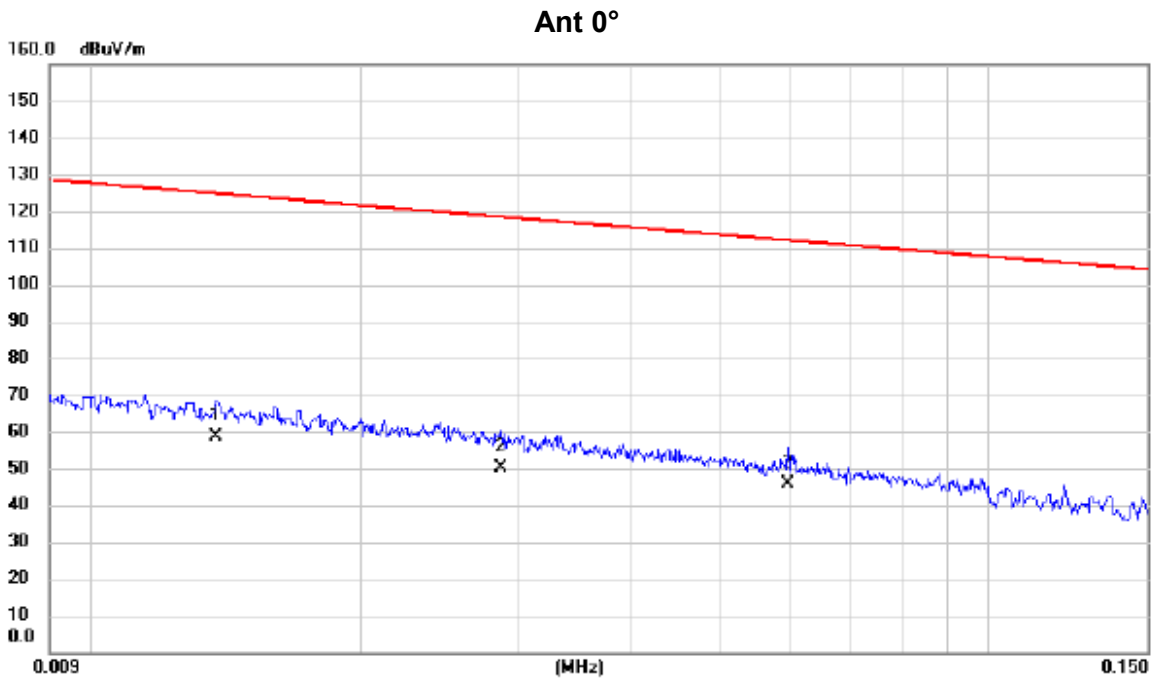

No.	Mk.	Freq.	Reading Level	Correct Factor	Measurement	Limit	Margin		
		MHz	dBuV	dB	dBuV/m	dBuV/m	dB	Detector	Comment
1	*	0.0138	37.90	20.89	58.79	124.81	-66.02	AVG	
2		0.0286	30.30	19.88	50.18	118.48	-68.30	AVG	
3		0.0598	26.60	19.33	45.93	112.07	-66.14	AVG	

**REMARKS:**

(1) Measurement Value = Reading Level + Correct Factor.

(2) Margin Level = Measurement Value - Limit Value.



Test Mode: TX A MODE CHANNEL 149

Ant 0°



No.	Mk.	Freq.	Reading Level	Correct Factor	Measurement	Limit	Margin	Detector	Comment
		MHz	dBuV	dB	dBuV/m	dBuV/m	dB		
1		0.4711	32.90	16.97	49.87	94.14	-44.27	AVG	
2	*	1.8780	34.40	17.05	51.45	69.54	-18.09	QP	
3		2.7942	26.50	16.65	43.15	69.54	-26.39	QP	

REMARKS:

- (1) Measurement Value = Reading Level + Correct Factor.
- (2) Margin Level = Measurement Value - Limit Value.

Test Mode: TX A MODE CHANNEL 149

Ant 90°

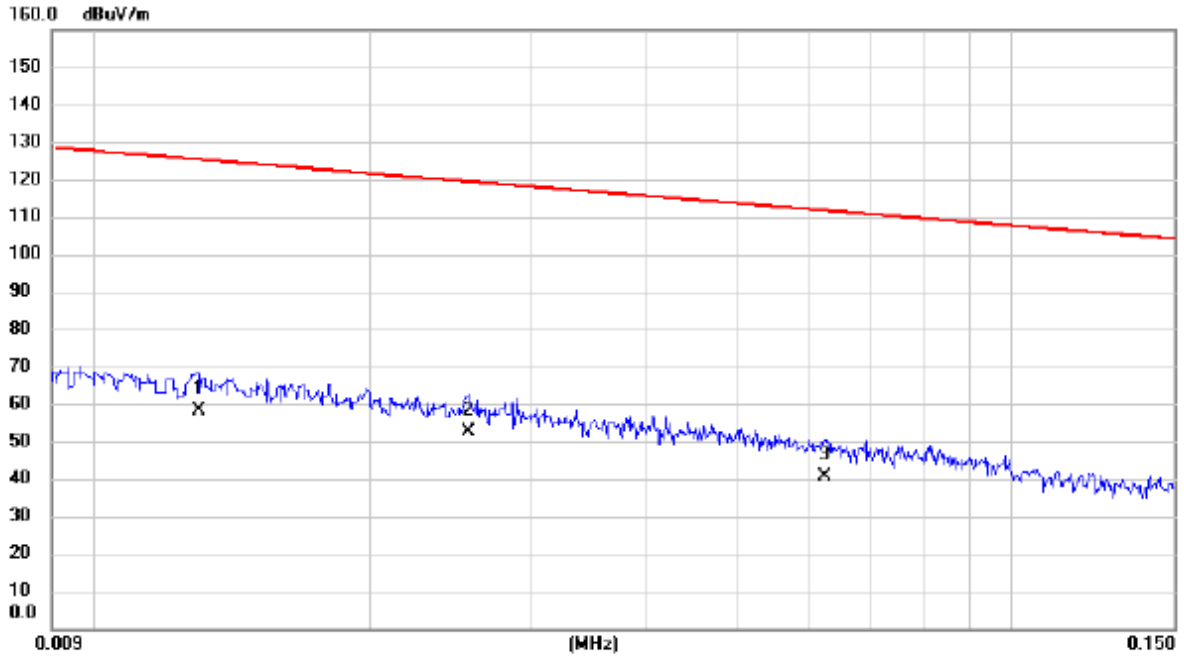

No.	Mk.	Freq.	Reading Level	Correct Factor	Measurement	Limit	Margin		
		MHz	dBuV	dB	dBuV/m	dBuV/m	dB	Detector	Comment
1		0.0130	37.21	21.00	58.21	125.33	-67.12	AVG	
2	*	0.0256	32.80	19.93	52.73	119.44	-66.71	AVG	
3		0.0625	21.50	19.28	40.78	111.69	-70.91	AVG	

REMARKS:

- (1) Measurement Value = Reading Level + Correct Factor.
- (2) Margin Level = Measurement Value - Limit Value.

Test Mode: TX A MODE CHANNEL 149

Ant 90°

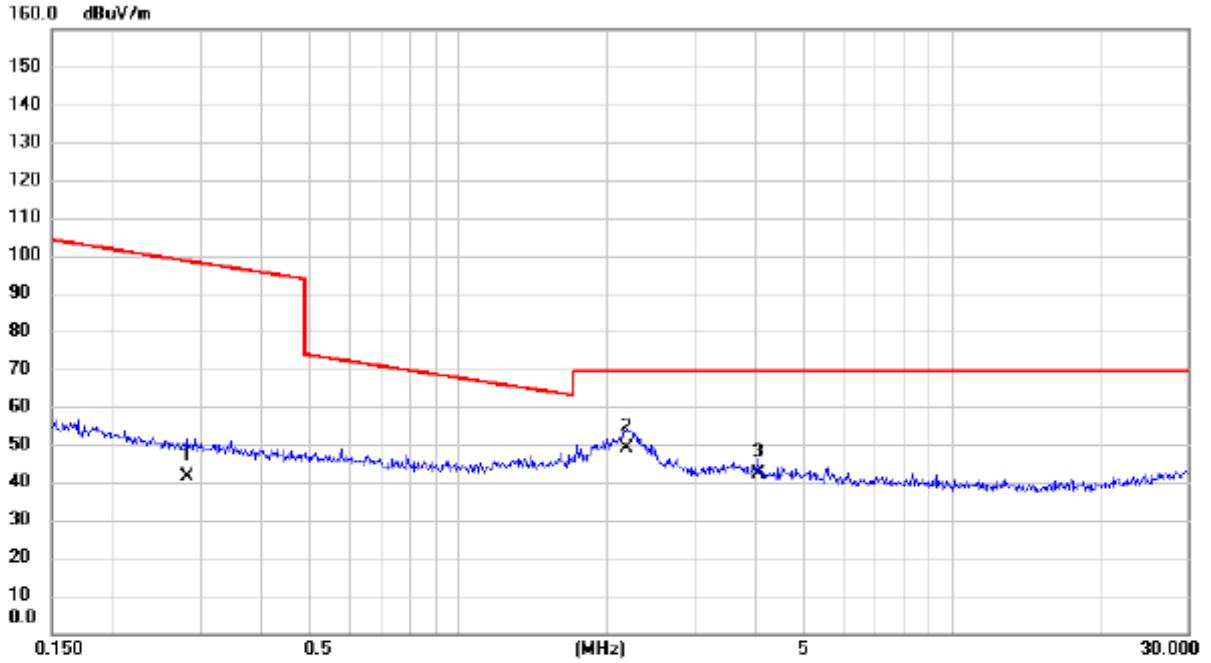

No.	Mk.	Freq. MHz	Reading Level dBuV	Correct Factor dB	Measure- ment dBuV/m	Limit dBuV/m	Margin dB	Detector	Comment
1		0.2818	24.50	17.05	41.55	98.61	-57.06	AVG	
2	*	2.1898	32.10	17.01	49.11	69.54	-20.43	QP	
3		4.0490	26.30	15.72	42.02	69.54	-27.52	QP	

REMARKS:

- (1) Measurement Value = Reading Level + Correct Factor.
- (2) Margin Level = Measurement Value - Limit Value.

## APPENDIX C - RADIATED EMISSION - 30 MHZ TO 1 GHZ

Test Mode: TX A MODE CHANNEL 149

Vertical

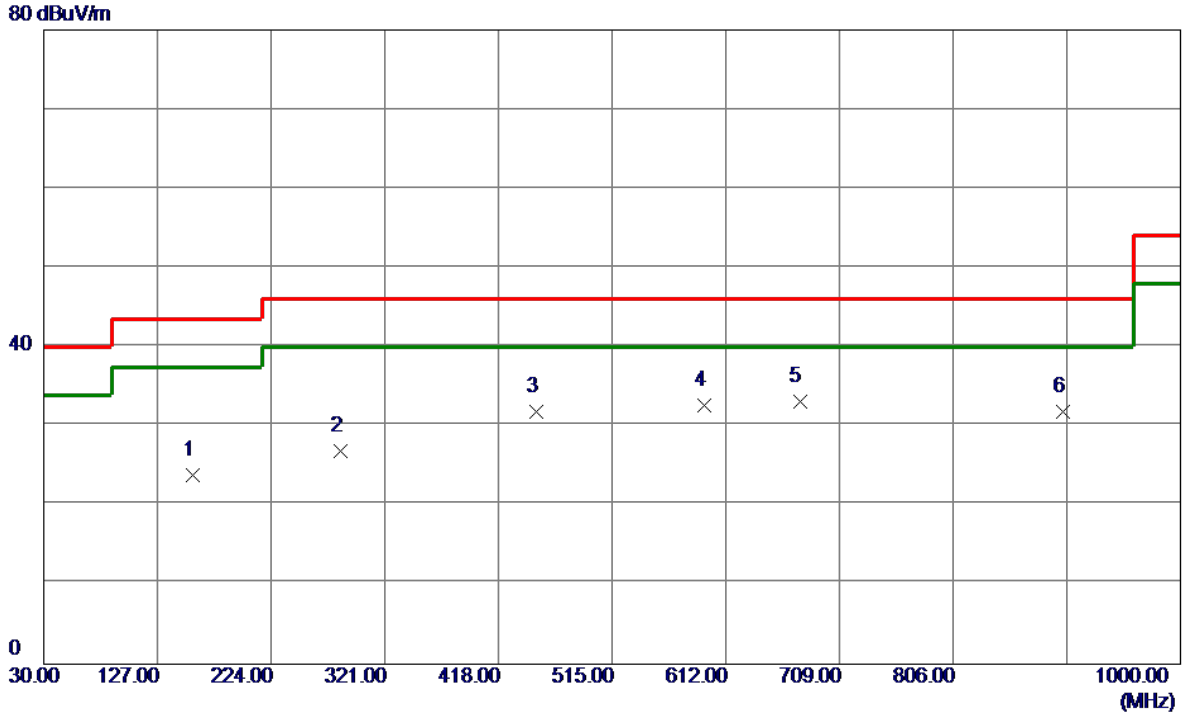

No.	Freq. MHz	Reading Level dBuV/m	Correct Factor dB	Measure ment dBuV/m	Limit dBuV/m	Margin dB	Detector	Comment
1	157.0700	34.66	-10.86	23.80	43.50	-19.70	Peak	
2	283.6550	38.09	-11.20	26.89	46.00	-19.11	Peak	
3	450.0100	39.32	-7.41	31.91	46.00	-14.09	Peak	
4	593.5700	38.80	-6.19	32.61	46.00	-13.39	Peak	
5 *	675.0500	37.09	-3.96	33.13	46.00	-12.87	Peak	
6	900.0900	32.41	-0.60	31.81	46.00	-14.19	Peak	

REMARKS:

- (1) Measurement Value = Reading Level + Correct Factor.
- (2) Margin Level = Measurement Value - Limit Value.

Test Mode: TX A MODE CHANNEL 149

Horizontal

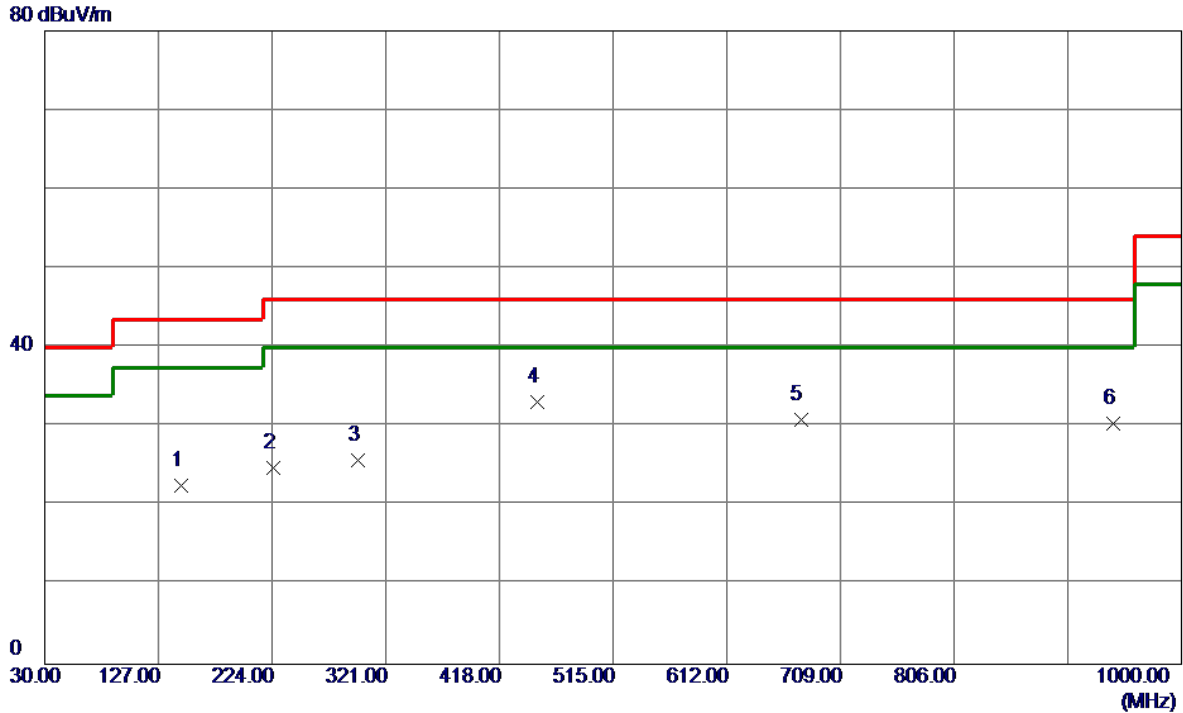

No.	Freq. MHz	Reading Level dBuV/m	Correct Factor dB	Measurement dBuV/m	Limit dBuV/m	Margin dB	Detector	Comment
1	145.9149	34.26	-11.74	22.52	43.50	-20.98	Peak	
2	224.9700	39.70	-14.90	24.80	46.00	-21.20	Peak	
3	297.7200	36.24	-10.50	25.74	46.00	-20.26	Peak	
4 *	450.0100	40.50	-7.41	33.09	46.00	-12.91	Peak	
5	675.0500	34.87	-3.96	30.91	46.00	-15.09	Peak	
6	941.8000	29.31	1.08	30.39	46.00	-15.61	Peak	

REMARKS:

- (1) Measurement Value = Reading Level + Correct Factor.
- (2) Margin Level = Measurement Value - Limit Value.

## APPENDIX D - RADIATED EMISSION - ABOVE 1000 MHZ

Orthogonal Axis	X
Test Mode	UNII-1_TX A (10M) Mode 5180 MHz

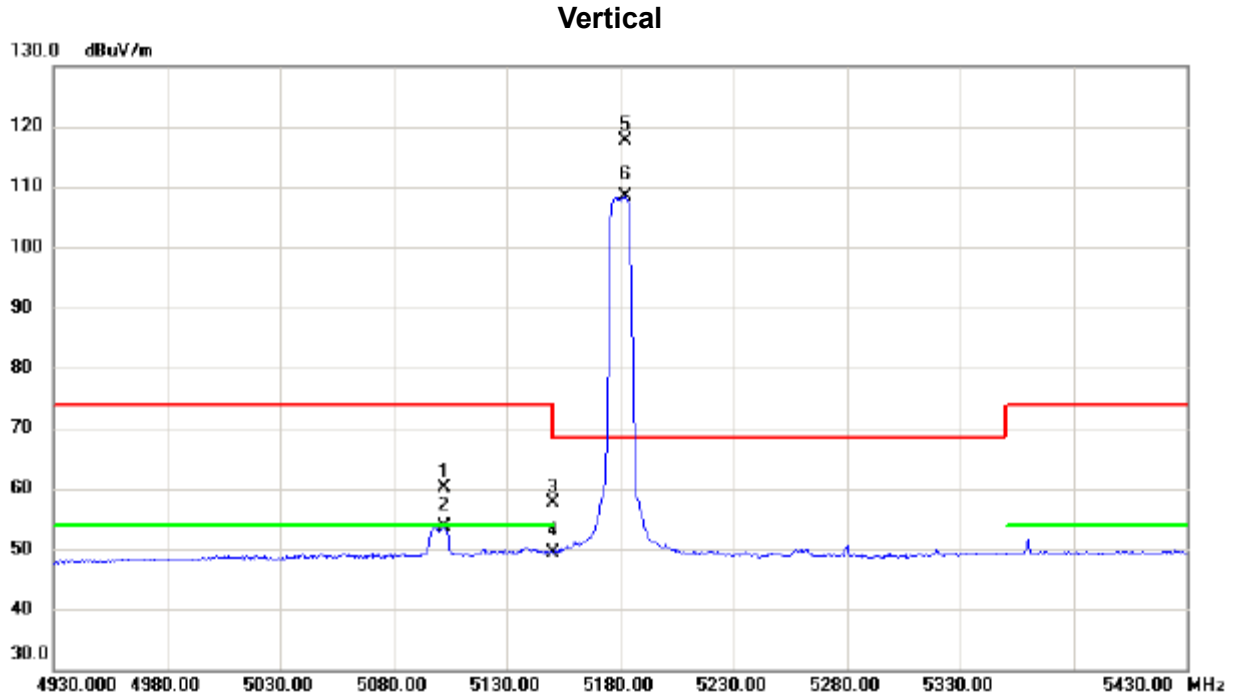

No.	Mk.	Freq. MHz	Reading Level dBuV	Correct Factor dB	Measure- ment dBuV/m	Limit dBuV/m	Margin dB	Detector	Comment
1		5102.500	44.52	15.64	60.16	74.00	-13.84	peak	
2		5102.500	37.96	15.64	53.60	54.00	-0.40	AVG	
3		5150.000	41.87	15.73	57.60	74.00	-16.40	peak	
4		5150.000	33.76	15.73	49.49	54.00	-4.51	AVG	
5	*	5182.000	101.71	15.80	117.51	68.30	49.21	peak	No Limit
6	X	5182.000	92.48	15.80	108.28	68.30	39.98	AVG	No Limit

**REMARKS:**

- (1) Measurement Value = Reading Level + Correct Factor.
- (2) Margin Level = Measurement Value - Limit Value.



Orthogonal Axis	X
Test Mode	UNII-1_TX A (10M) Mode 5180 MHz

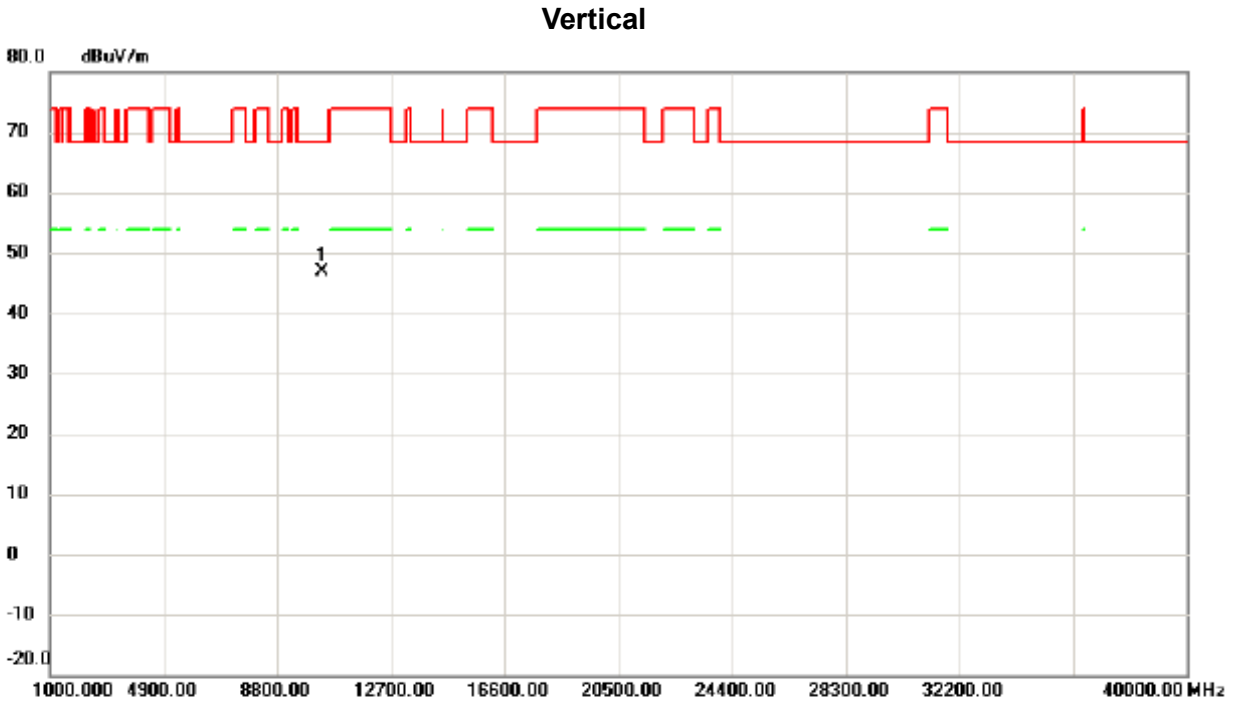

No.	Mk.	Freq.	Reading Level	Correct Factor	Measurement	Limit	Margin	Detector	Comment
		MHz	dBuV	dB	dBuV/m	dBuV/m	dB		
1	*	10351.100	34.55	12.45	47.00	68.30	-21.30	peak	

**REMARKS:**

- (1) Measurement Value = Reading Level + Correct Factor.
- (2) Margin Level = Measurement Value - Limit Value.

Orthogonal Axis	X
Test Mode	UNII-1_TX A (10M) Mode 5180 MHz

**Horizontal**

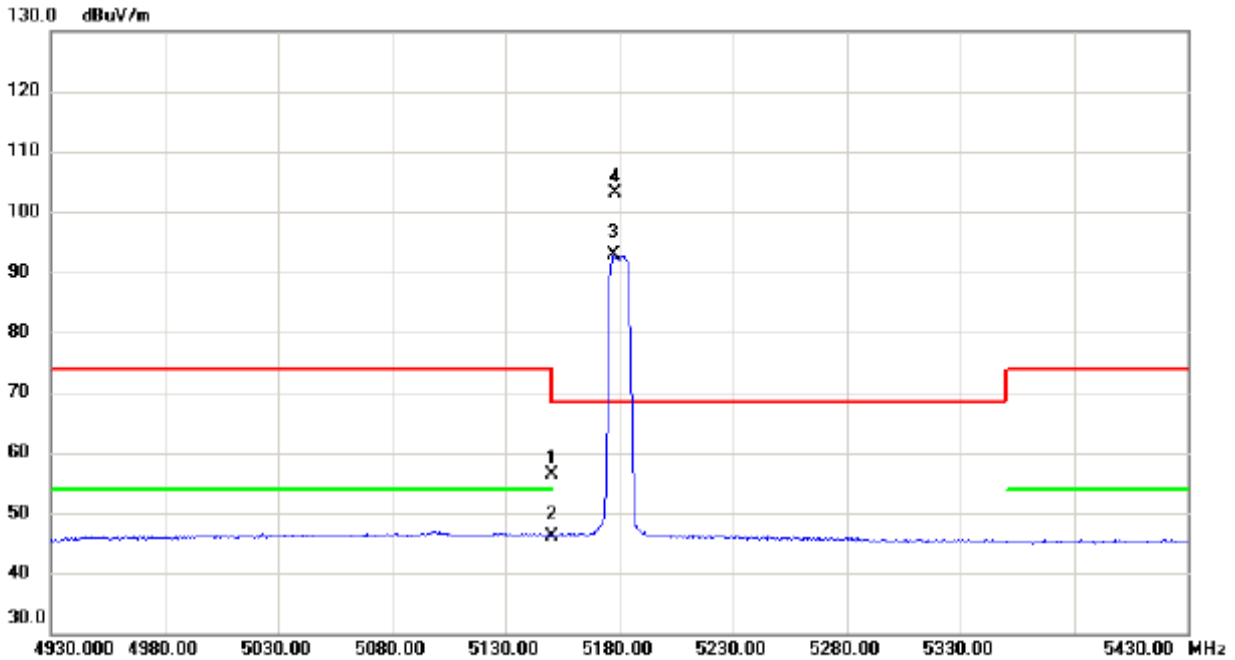

No.	Mk.	Freq.	Reading Level	Correct Factor	Measurement	Limit	Margin	Detector	Comment
		MHz	dBuV	dB	dBuV/m	dBuV/m	dB		
1		5150.000	40.72	15.73	56.45	74.00	-17.55	peak	
2		5150.000	30.38	15.73	46.11	54.00	-7.89	AVG	
3	X	5177.500	76.97	15.79	92.76	68.30	24.46	AVG	No Limit
4	*	5178.500	87.27	15.79	103.06	68.30	34.76	peak	No Limit

**REMARKS:**

- (1) Measurement Value = Reading Level + Correct Factor.
- (2) Margin Level = Measurement Value - Limit Value.

Orthogonal Axis	X
Test Mode	UNII-1_TX A (10M) Mode 5180 MHz

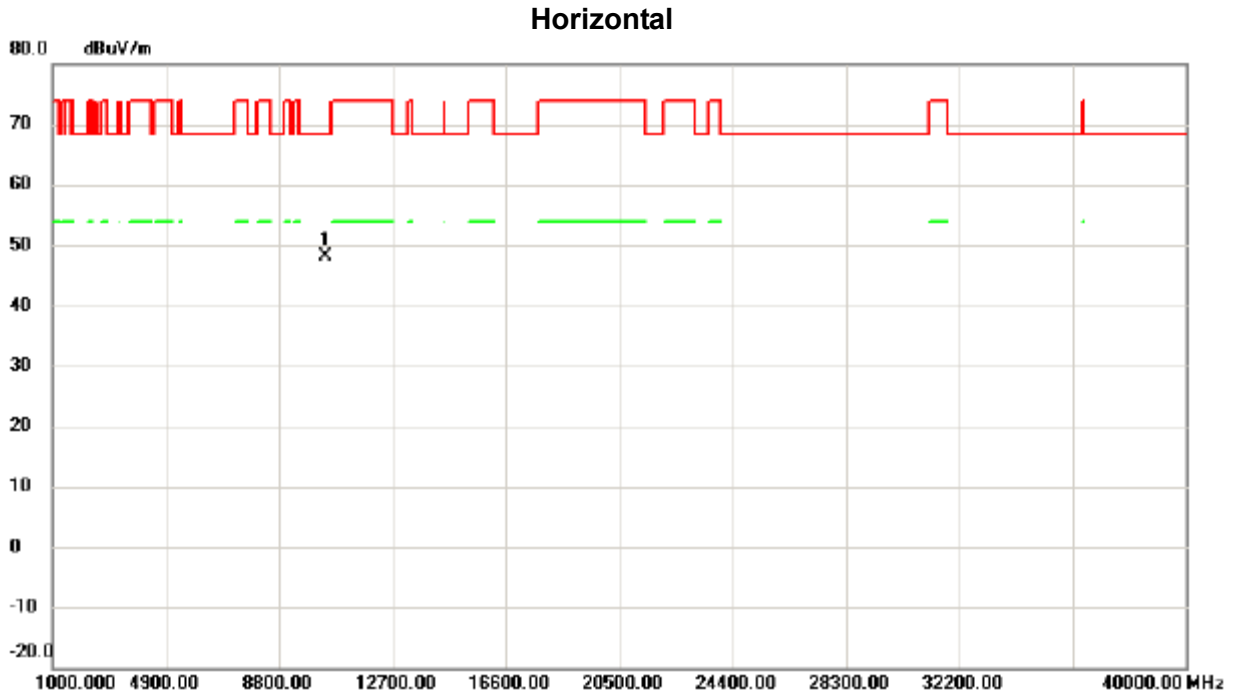

No.	Mk.	Freq.	Reading Level	Correct Factor	Measurement	Limit	Margin	Detector	Comment
		MHz	dBuV	dB	dBuV/m	dBuV/m	dB		
1	*	10363.525	35.62	12.47	48.09	68.30	-20.21	peak	

**REMARKS:**

- (1) Measurement Value = Reading Level + Correct Factor.
- (2) Margin Level = Measurement Value - Limit Value.

Orthogonal Axis	X
Test Mode	UNII-1_TX A (10M) Mode 5200 MHz

**Vertical**

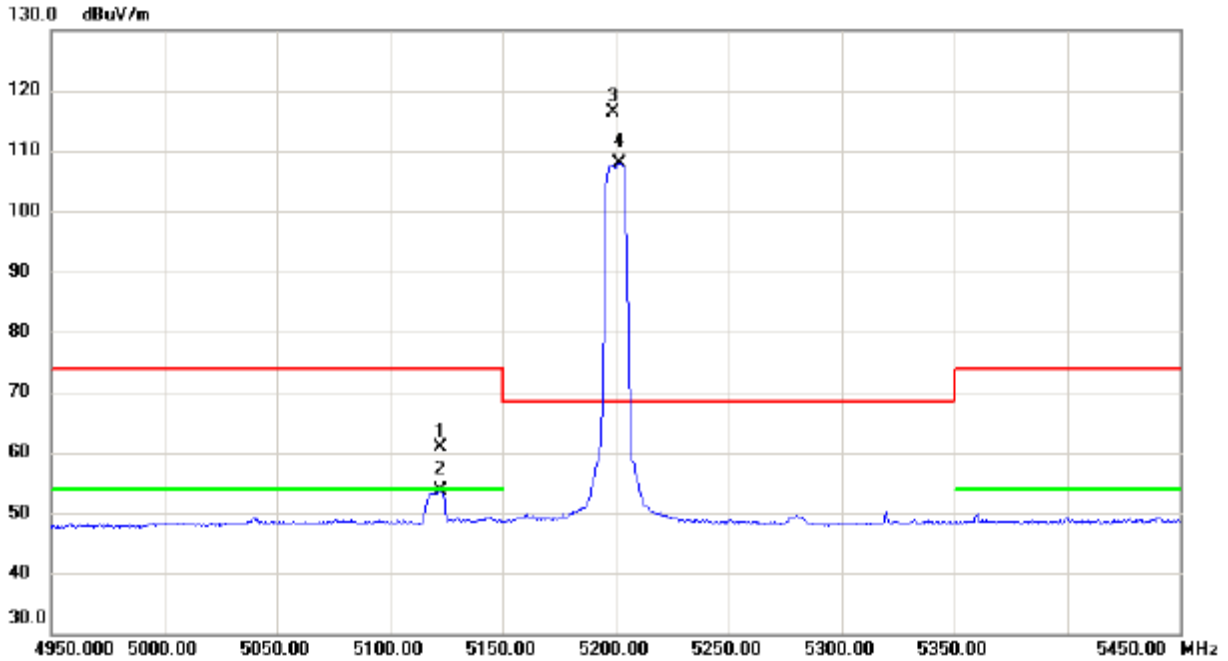

No.	Mk.	Freq.	Reading Level	Correct Factor	Measurement	Limit	Margin	Detector	Comment
		MHz	dBuV	dB	dBuV/m	dBuV/m	dB		
1		5122.250	45.26	15.69	60.95	74.00	-13.05	peak	
2		5122.250	37.83	15.69	53.52	54.00	-0.48	AVG	
3	*	5198.750	100.48	15.83	116.31	68.30	48.01	peak	No Limit
4	X	5201.750	92.08	15.84	107.92	68.30	39.62	AVG	No Limit

**REMARKS:**

- (1) Measurement Value = Reading Level + Correct Factor.
- (2) Margin Level = Measurement Value - Limit Value.

Orthogonal Axis	X
Test Mode	UNII-1_TX A (10M) Mode 5200 MHz

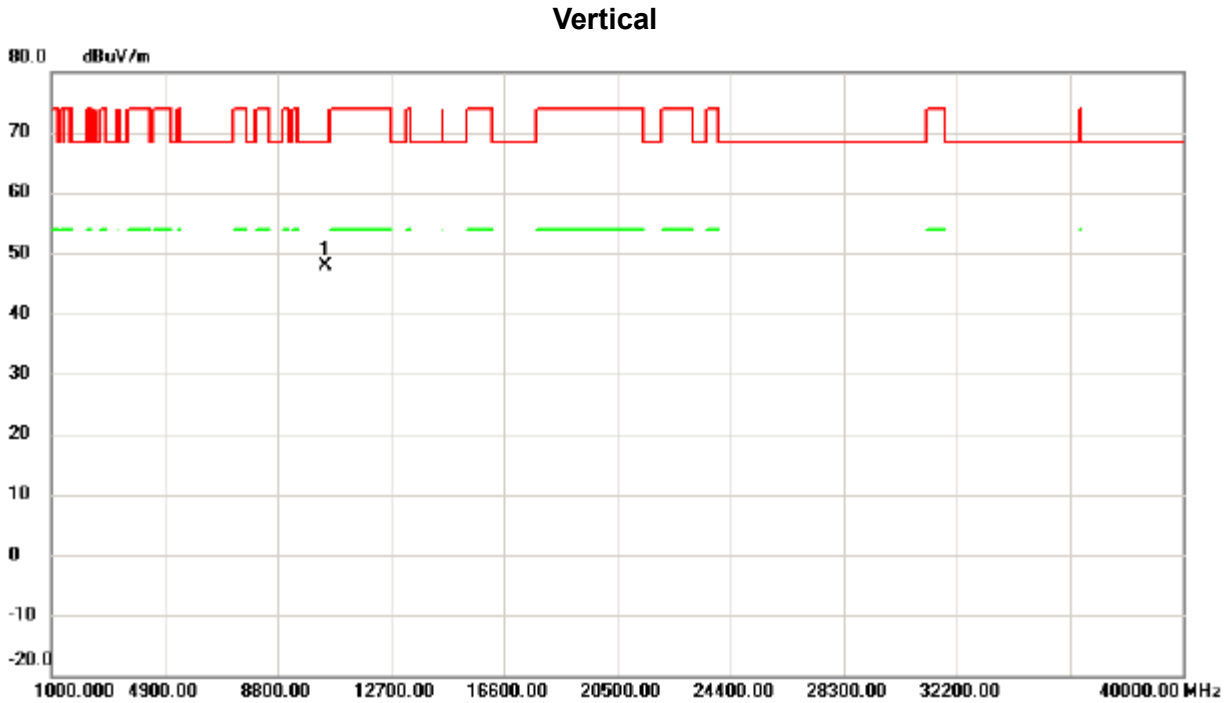

No.	Mk.	Freq.	Reading Level	Correct Factor	Measurement	Limit	Margin	Detector	Comment
		MHz	dBuV	dB	dBuV/m	dBuV/m	dB		
1	*	10423.325	35.24	12.59	47.83	68.30	-20.47	peak	

REMARKS:

- (1) Measurement Value = Reading Level + Correct Factor.
- (2) Margin Level = Measurement Value - Limit Value.

Orthogonal Axis	X
Test Mode	UNII-1_TX A (10M) Mode 5200 MHz

### Horizontal

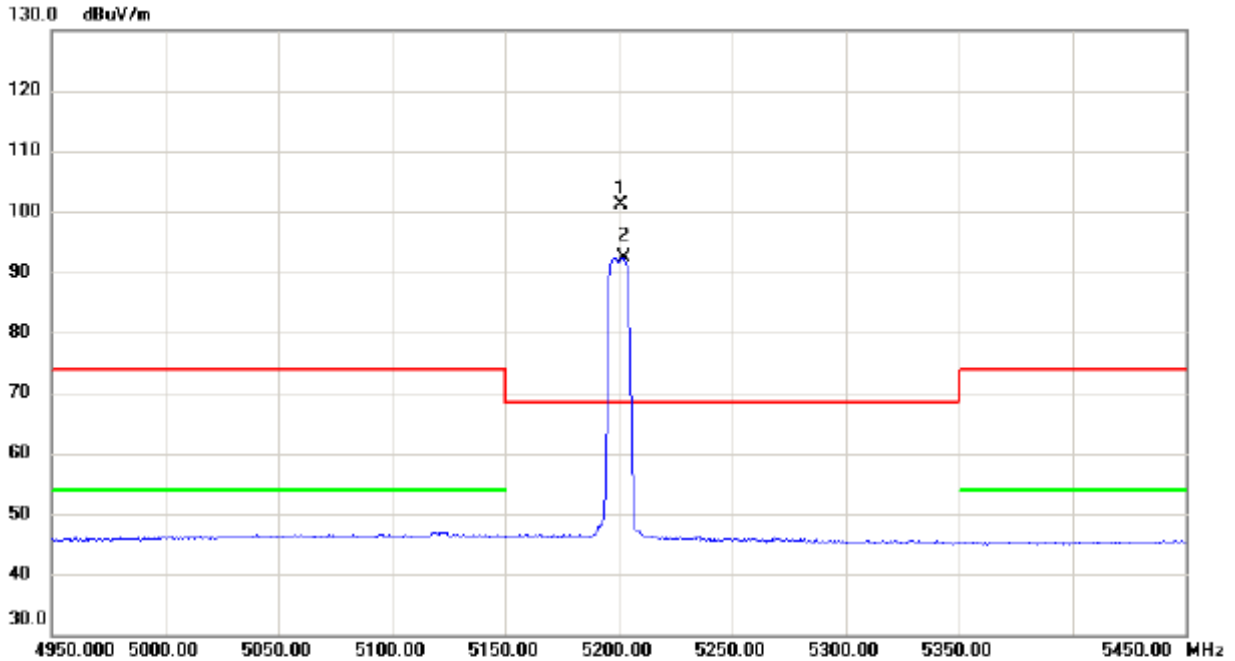

No.	Mk.	Freq.	Reading Level	Correct Factor	Measurement	Limit	Margin		
		MHz	dBuV	dB	dBuV/m	dBuV/m	dB	Detector	Comment
1	*	5201.250	85.25	15.84	101.09	68.30	32.79	peak	No Limit
2	X	5202.000	76.57	15.84	92.41	68.30	24.11	AVG	No Limit

**REMARKS:**

- (1) Measurement Value = Reading Level + Correct Factor.
- (2) Margin Level = Measurement Value - Limit Value.

Orthogonal Axis	X
Test Mode	UNII-1_TX A (10M) Mode 5200 MHz

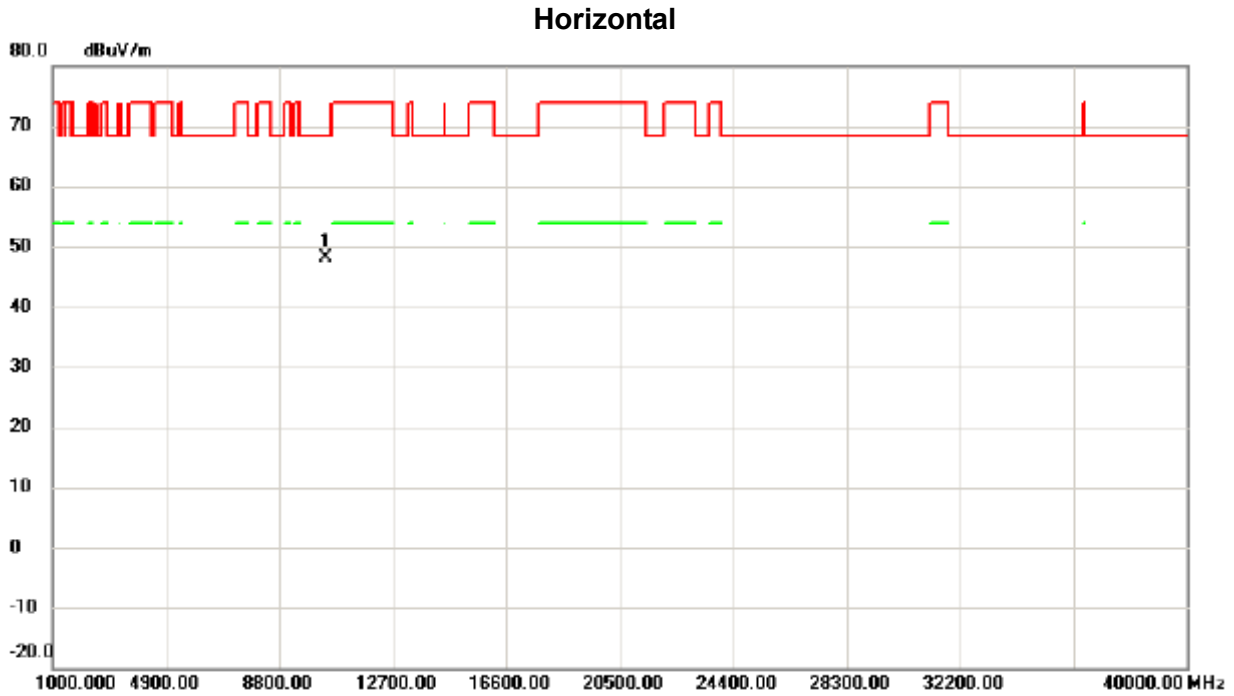

No.	Mk.	Freq.	Reading Level	Correct Factor	Measurement	Limit	Margin	Detector	Comment
		MHz	dBuV	dB	dBuV/m	dBuV/m	dB		
1	*	10396.550	35.46	12.55	48.01	68.30	-20.29	peak	

REMARKS:

- (1) Measurement Value = Reading Level + Correct Factor.
- (2) Margin Level = Measurement Value - Limit Value.

Orthogonal Axis	X
Test Mode	UNII-1_TX A (10M) Mode 5240 MHz

**Vertical**

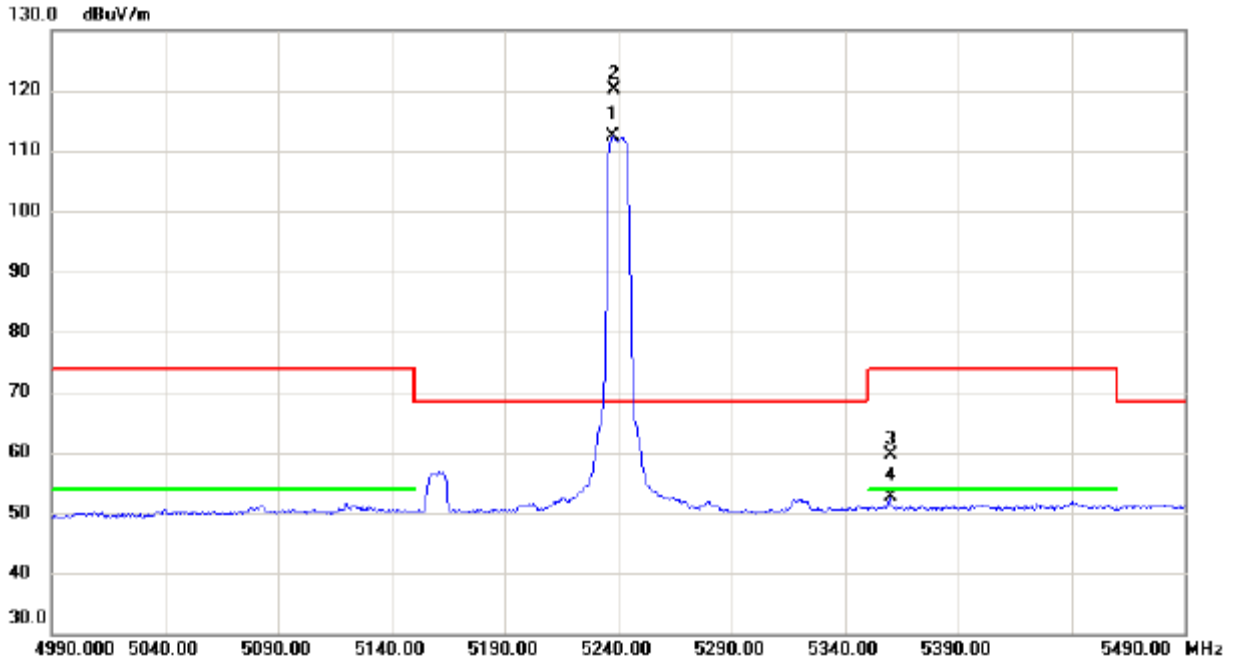

No.	Mk.	Freq. MHz	Reading Level dBuV	Correct Factor dB	Measure- ment dBuV/m	Limit dBuV/m	Margin dB	Detector	Comment
1	X	5237.750	96.50	15.91	112.41	68.30	44.11	AVG	No Limit
2	*	5238.250	104.33	15.91	120.24	68.30	51.94	peak	No Limit
3		5360.000	43.41	16.15	59.56	74.00	-14.44	peak	
4		5360.000	36.57	16.15	52.72	54.00	-1.28	AVG	

**REMARKS:**

- (1) Measurement Value = Reading Level + Correct Factor.
- (2) Margin Level = Measurement Value - Limit Value.



Orthogonal Axis	X
Test Mode	UNII-1_TX A (10M) Mode 5240 MHz

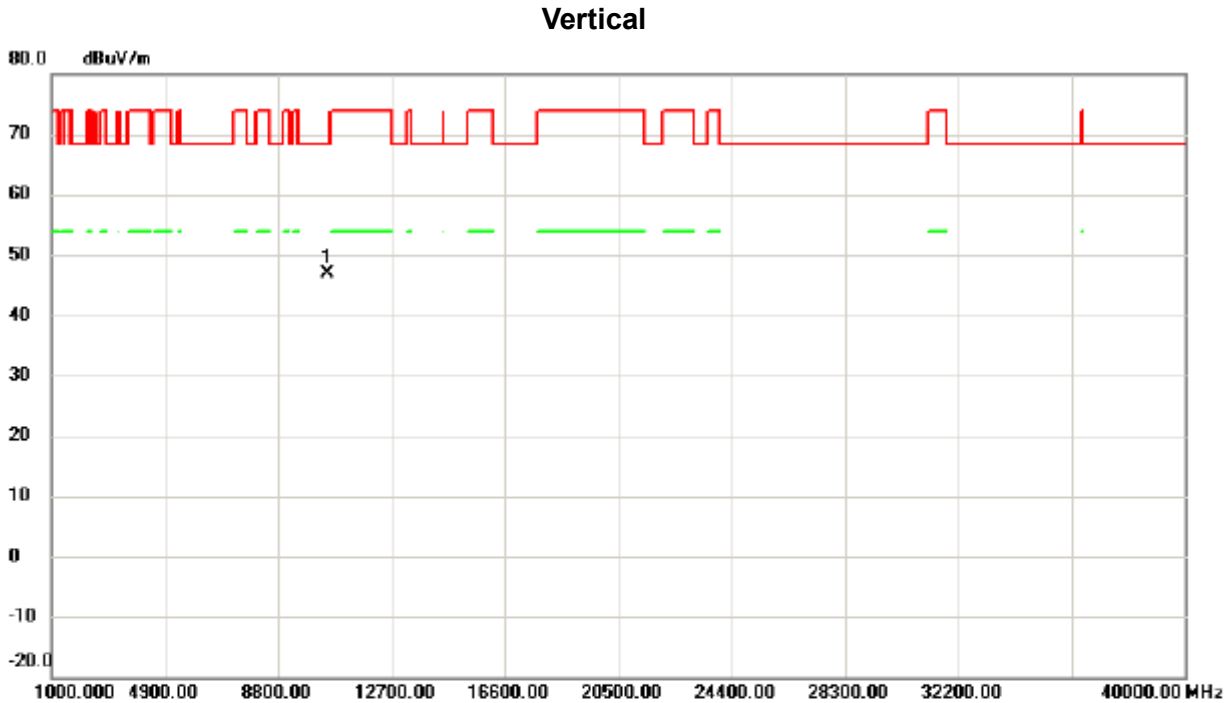

No.	Mk.	Freq.	Reading Level	Correct Factor	Measurement	Limit	Margin	Detector	Comment
		MHz	dBuV	dB	dBuV/m	dBuV/m	dB		
1	*	10501.025	34.20	12.76	46.96	68.30	-21.34	peak	

**REMARKS:**

- (1) Measurement Value = Reading Level + Correct Factor.
- (2) Margin Level = Measurement Value - Limit Value.

Orthogonal Axis	X
Test Mode	UNII-1_TX A (10M) Mode 5240 MHz

### Horizontal

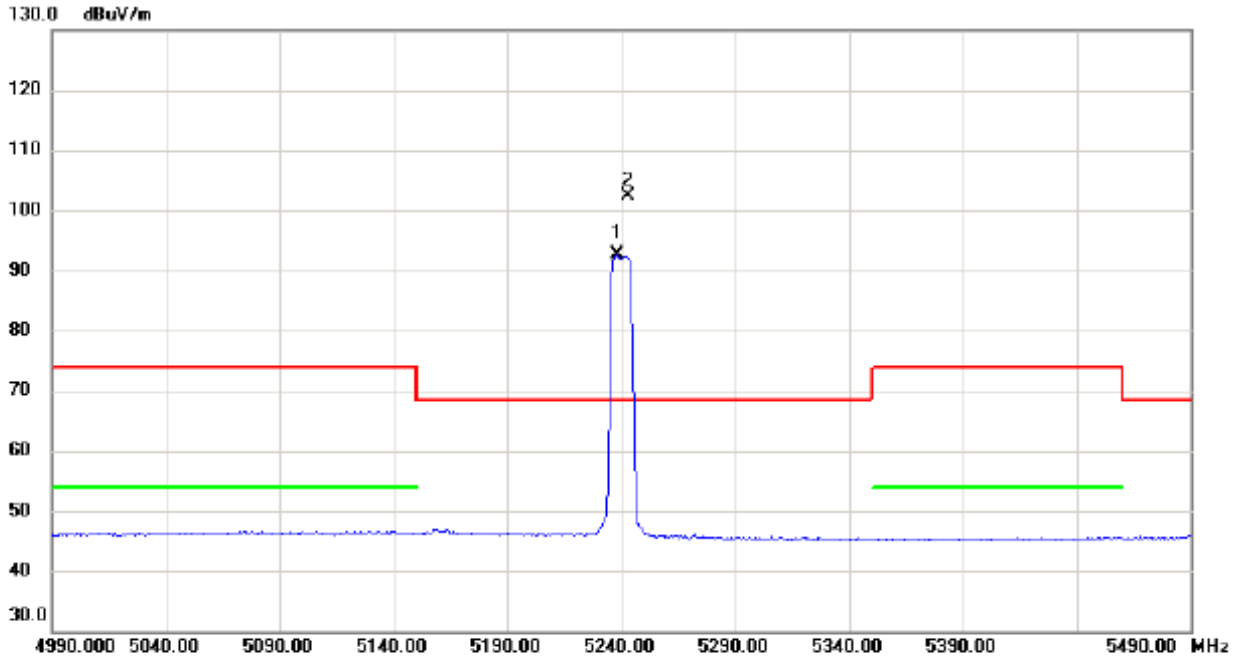

No.	Mk.	Freq.	Reading Level	Correct Factor	Measurement	Limit	Margin		
		MHz	dBuV	dB	dBuV/m	dBuV/m	dB	Detector	Comment
1	X	5238.000	76.73	15.91	92.64	68.30	24.34	AVG	No Limit
2	*	5243.250	86.56	15.92	102.48	68.30	34.18	peak	No Limit

**REMARKS:**

- (1) Measurement Value = Reading Level + Correct Factor.
- (2) Margin Level = Measurement Value - Limit Value.

Orthogonal Axis	X
Test Mode	UNII-1_TX A (10M) Mode 5240 MHz

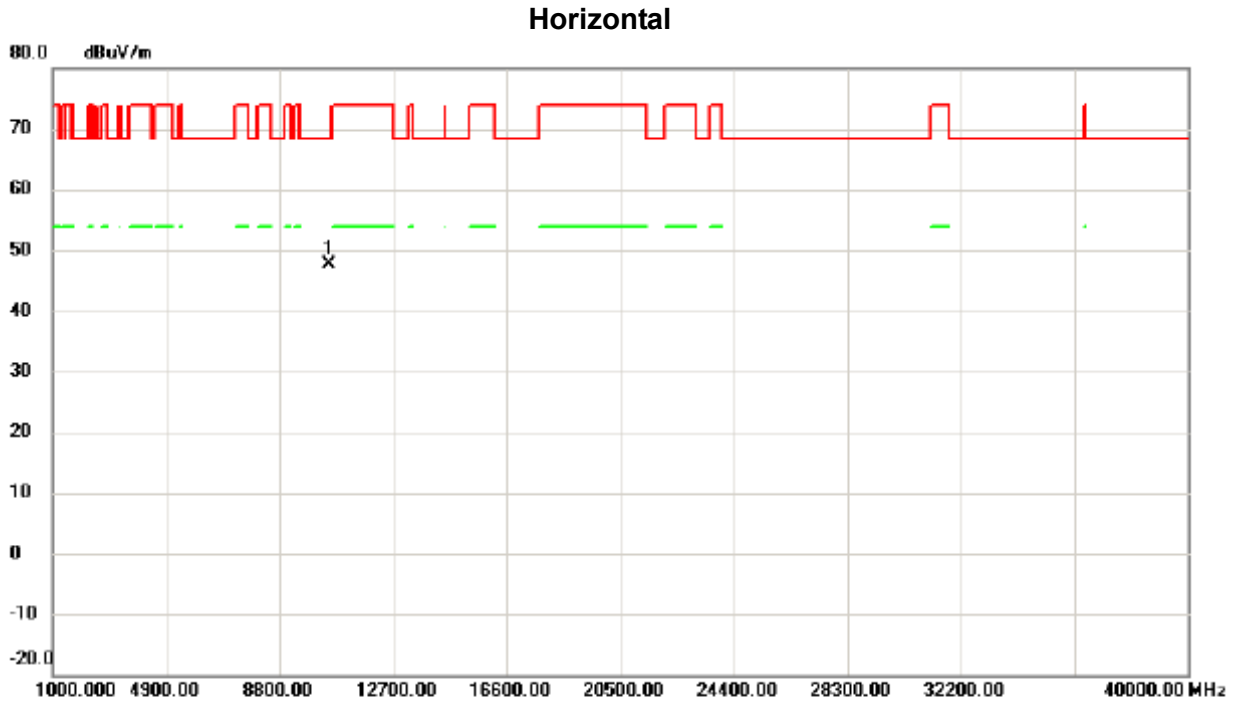

No.	Mk.	Freq.	Reading Level	Correct Factor	Measurement	Limit	Margin	Detector	Comment
		MHz	dBuV	dB	dBuV/m	dBuV/m	dB		
1	*	10488.575	34.97	12.74	47.71	68.30	-20.59	peak	

**REMARKS:**

- (1) Measurement Value = Reading Level + Correct Factor.
- (2) Margin Level = Measurement Value - Limit Value.

Orthogonal Axis	X
Test Mode	UNII-1_TX A (20M) Mode 5180 MHz

### Vertical

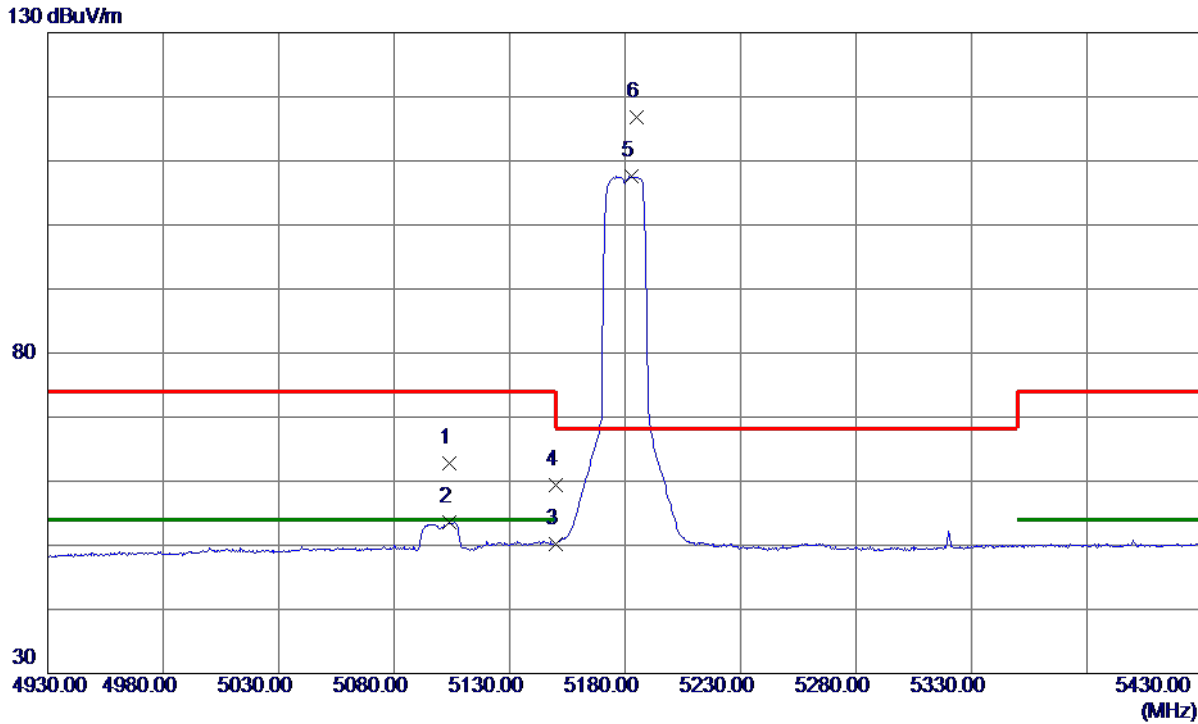

No.	Freq. MHz	Reading Level dBuV/m	Correct Factor dB	Measure ment dBuV/m	Limit dBuV/m	Margin dB	Detector	Comment
1	5103.7500	47.10	15.65	62.75	74.00	-11.25	Peak	
2 *	5103.7500	37.99	15.65	53.64	54.00	-0.36	AVG	
3	5150.0000	34.53	15.74	50.27	74.00	-23.73	Peak	
4	5150.0000	43.65	15.74	59.39	74.00	-14.61	Peak	
5	5182.7500	91.84	15.80	107.64	999.00	-891.36	AVG	No Limit
6	5184.7500	101.00	15.81	116.81	999.00	-882.19	AVG	No Limit

**REMARKS:**

- (1) Measurement Value = Reading Level + Correct Factor.
- (2) Margin Level = Measurement Value - Limit Value.

Orthogonal Axis	X
Test Mode	UNII-1_TX A (20M) Mode 5180 MHz

**Vertical**

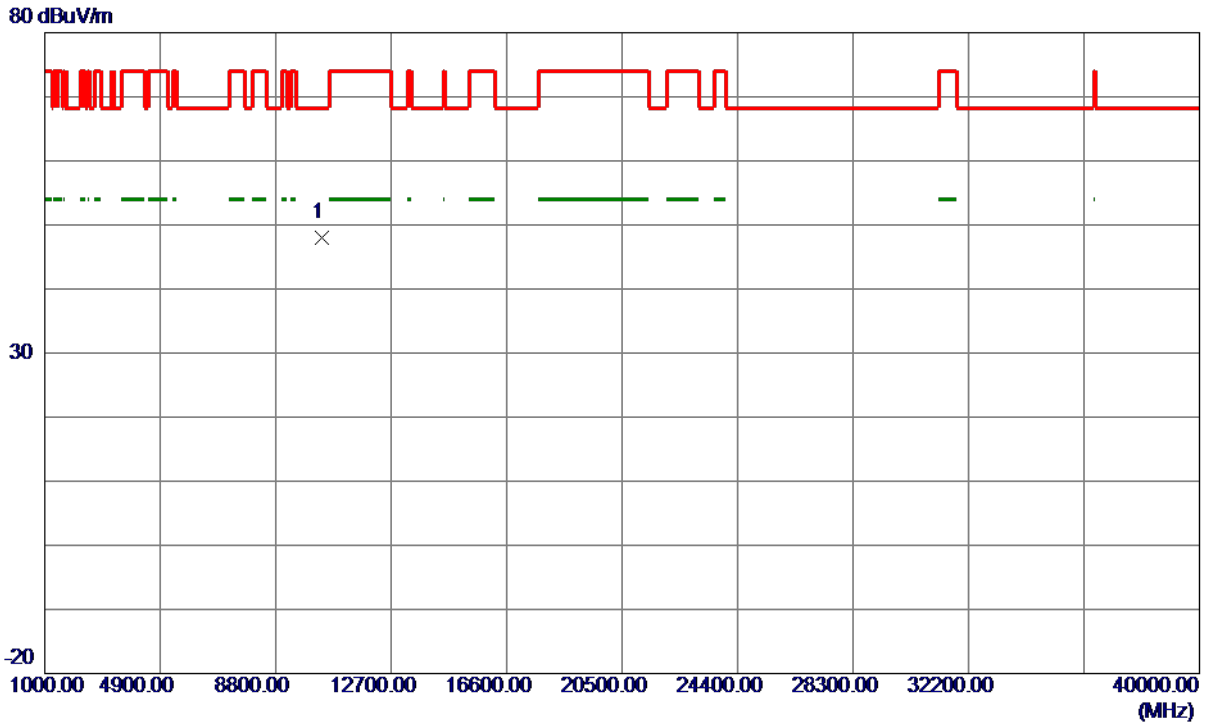

No.	Freq. MHz	Reading Level dBuV/m	Correct Factor dB	Measure ment dBuV/m	Limit dBuV/m	Margin dB	Detector	Comment
1 *	10347.9000	35.56	12.44	48.00	68.30	-20.30	Peak	

**REMARKS:**

- (1) Measurement Value = Reading Level + Correct Factor.
- (2) Margin Level = Measurement Value - Limit Value.

Orthogonal Axis	X
Test Mode	UNII-1_TX A (20M) Mode 5180 MHz

**Horizontal**

130 dBuV/m

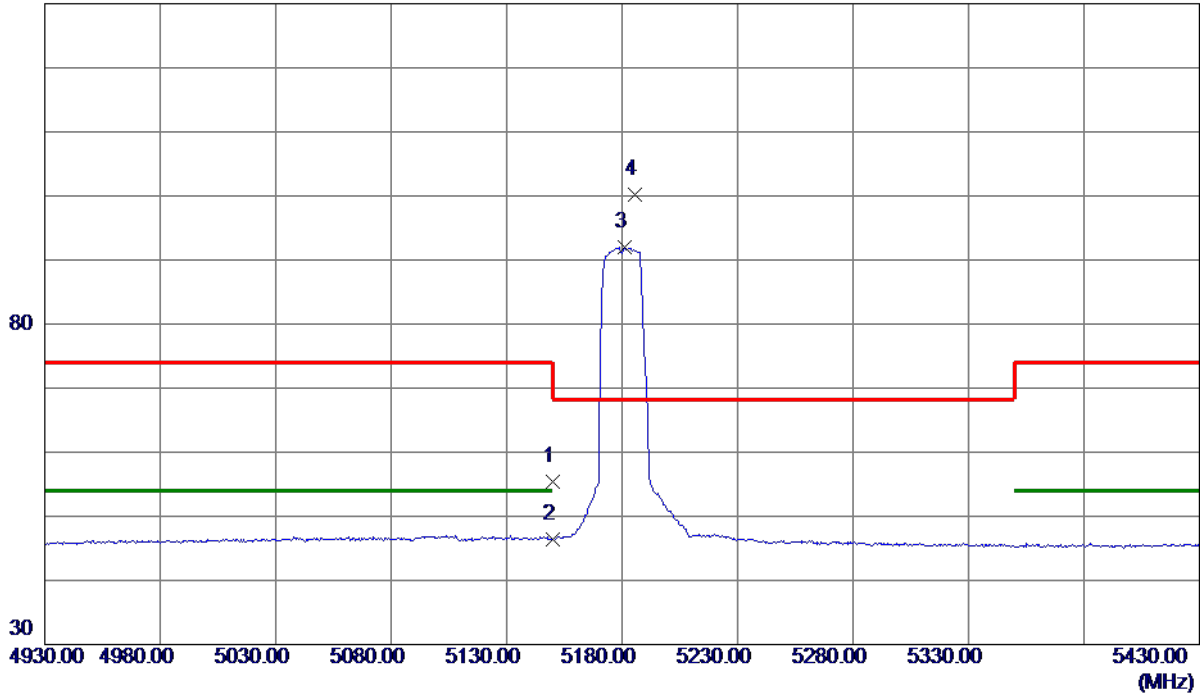

No.	Freq. MHz	Reading Level dBuV/m	Correct Factor dB	Measure ment dBuV/m	Limit dBuV/m	Margin dB	Detector	Comment
1	5150.0000	39.73	15.74	55.47	74.00	-18.53	Peak	
2	5150.0000	30.58	15.74	46.32	54.00	-7.68	AVG	
3	5181.2500	76.14	15.80	91.94	999.00	-907.06	AVG	No Limit
4 *	5185.7500	84.42	15.81	100.23	68.30	31.93	Peak	No Limit

**REMARKS:**

- (1) Measurement Value = Reading Level + Correct Factor.
- (2) Margin Level = Measurement Value - Limit Value.

Orthogonal Axis	X
Test Mode	UNII-1_TX A (20M) Mode 5180 MHz

### Horizontal

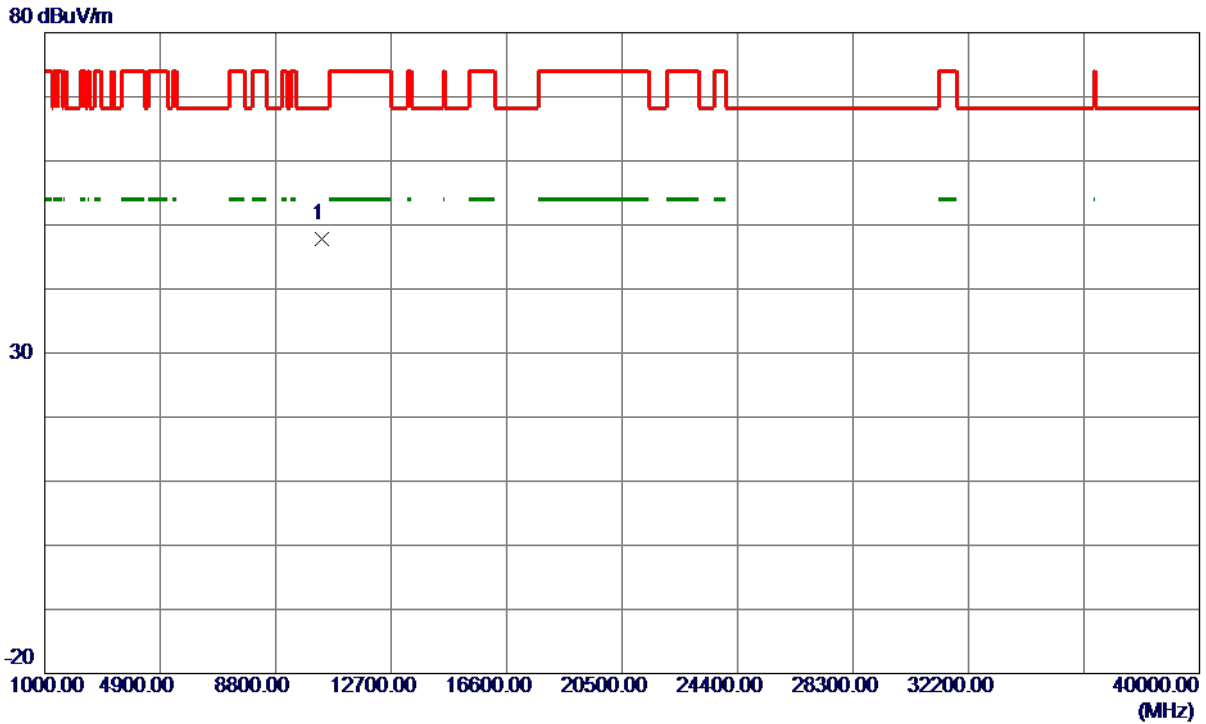

No.	Freq. MHz	Reading Level dBuV/m	Correct Factor dB	Measure ment dBuV/m	Limit dBuV/m	Margin dB	Detector	Comment
1 *	10371.7250	35.40	12.49	47.89	68.30	-20.41	Peak	

**REMARKS:**

- (1) Measurement Value = Reading Level + Correct Factor.
- (2) Margin Level = Measurement Value - Limit Value.

Orthogonal Axis	X
Test Mode	UNII-1_TX A (20M) Mode 5200 MHz

**Vertical**

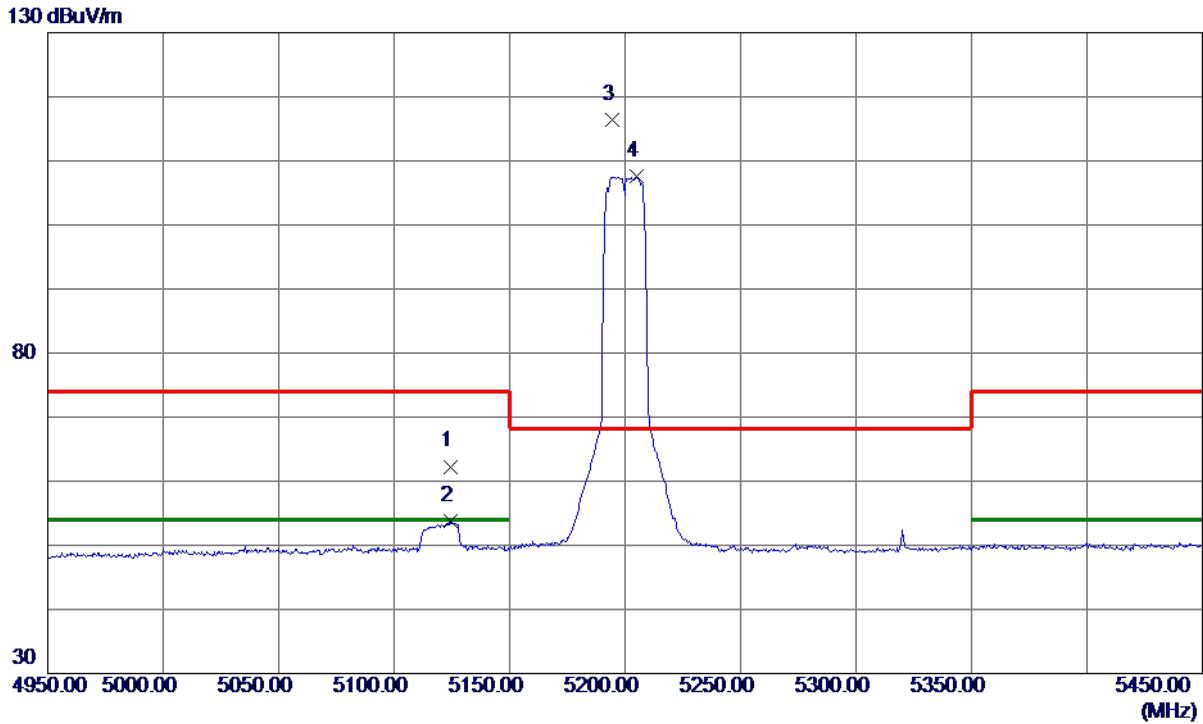

No.	Freq. MHz	Reading Level dBuV/m	Correct Factor dB	Measure ment dBuV/m	Limit dBuV/m	Margin dB	Detector	Comment
1	5124.2500	46.61	15.69	62.30	74.00	-11.70	Peak	
2	5124.2500	38.03	15.69	53.72	54.00	-0.28	AVG	
3 *	5194.2500	100.60	15.82	116.42	68.30	48.12	Peak	No Limit
4	5205.0000	91.75	15.85	107.60	999.00	-891.40	AVG	No Limit

**REMARKS:**

- (1) Measurement Value = Reading Level + Correct Factor.
- (2) Margin Level = Measurement Value - Limit Value.



Orthogonal Axis	X
Test Mode	UNII-1_TX A (20M) Mode 5200 MHz

**Vertical**

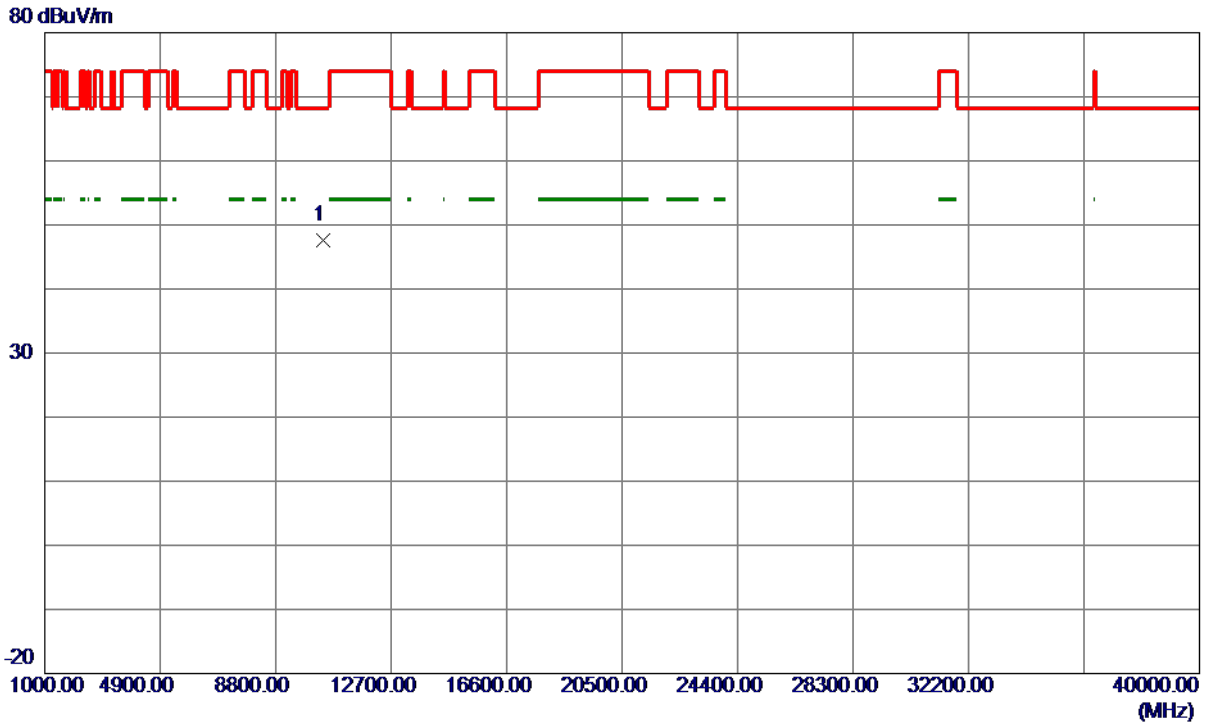

No.	Freq. MHz	Reading Level dBuV/m	Correct Factor dB	Measure ment dBuV/m	Limit dBuV/m	Margin dB	Detector	Comment
1 *	10390.0250	35.13	12.53	47.66	68.30	-20.64	Peak	

**REMARKS:**

- (1) Measurement Value = Reading Level + Correct Factor.
- (2) Margin Level = Measurement Value - Limit Value.

Orthogonal Axis	X
Test Mode	UNII-1_TX A (20M) Mode 5200 MHz

**Horizontal**

130 dBuV/m

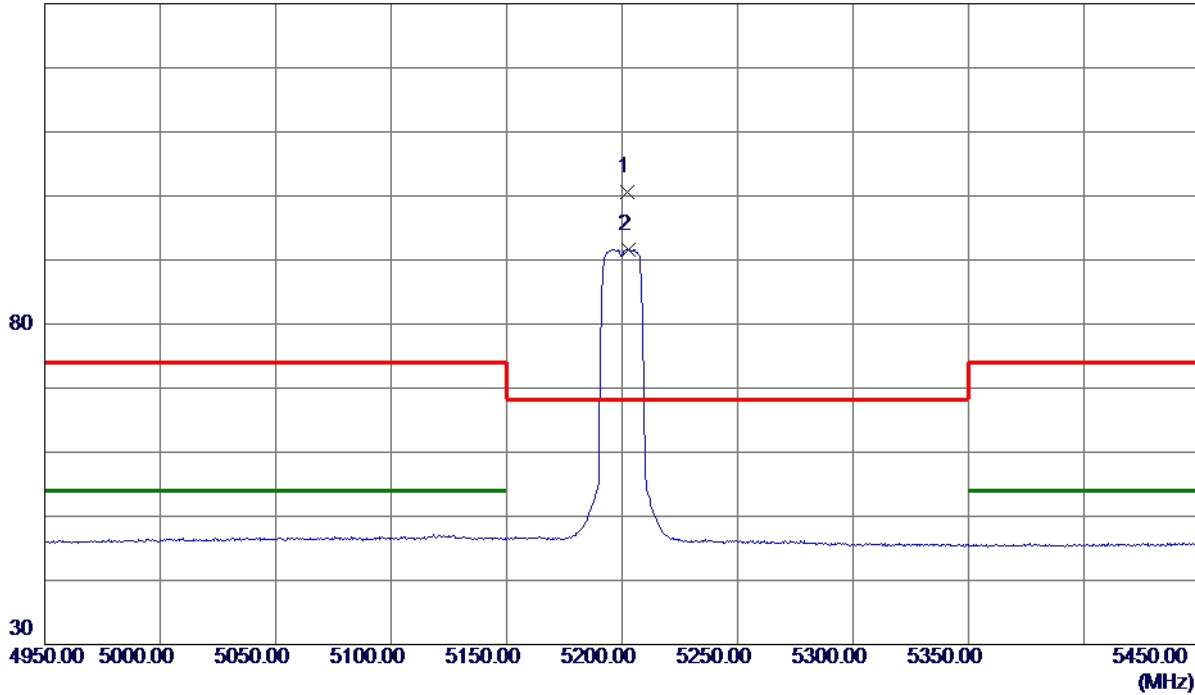

No.	Freq. MHz	Reading Level dBuV/m	Correct Factor dB	Measure ment dBuV/m	Limit dBuV/m	Margin dB	Detector	Comment
1 *	5202.2500	84.68	15.84	100.52	68.30	32.22	Peak	No Limit
2	5203.0000	75.76	15.84	91.60	999.00	-907.40	AVG	No Limit

**REMARKS:**

- (1) Measurement Value = Reading Level + Correct Factor.
- (2) Margin Level = Measurement Value - Limit Value.

Orthogonal Axis	X
Test Mode	UNII-1_TX A (20M) Mode 5200 MHz

**Horizontal**

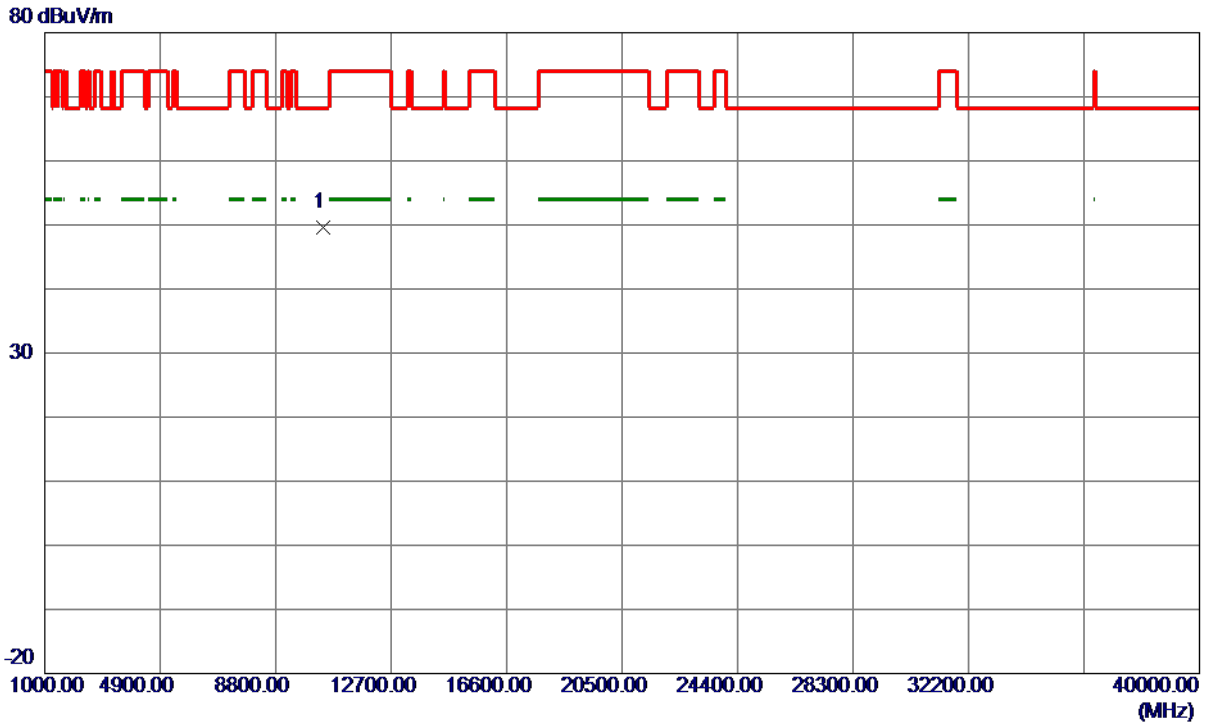

No.	Freq. MHz	Reading Level dBuV/m	Correct Factor dB	Measure ment dBuV/m	Limit dBuV/m	Margin dB	Detector	Comment
1 *	10407.8000	37.07	12.57	49.64	68.30	-18.66	Peak	

**REMARKS:**

- (1) Measurement Value = Reading Level + Correct Factor.
- (2) Margin Level = Measurement Value - Limit Value.

Orthogonal Axis	X
Test Mode	UNII-1_TX A (20M) Mode 5240 MHz

**Vertical**

130 dBuV/m

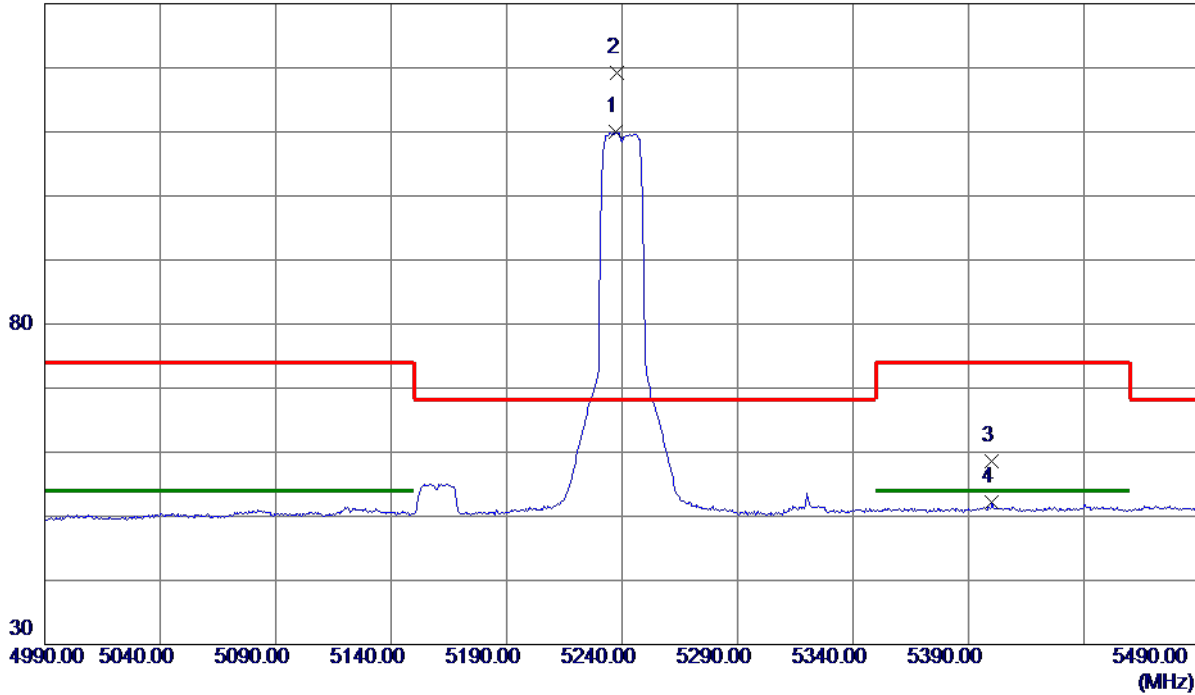

No.	Freq. MHz	Reading Level dBuV/m	Correct Factor dB	Measure ment dBuV/m	Limit dBuV/m	Margin dB	Detector	Comment
1	5237.2500	94.02	15.91	109.93	999.00	-889.07	AVG	No Limit
2 *	5238.0000	103.20	15.91	119.11	68.30	50.81	Peak	No Limit
3	5400.2500	42.41	16.23	58.64	74.00	-15.36	Peak	
4	5400.2500	36.03	16.23	52.26	54.00	-1.74	AVG	

**REMARKS:**

- (1) Measurement Value = Reading Level + Correct Factor.
- (2) Margin Level = Measurement Value - Limit Value.

Orthogonal Axis	X
Test Mode	UNII-1_TX A (20M) Mode 5240 MHz

**Vertical**

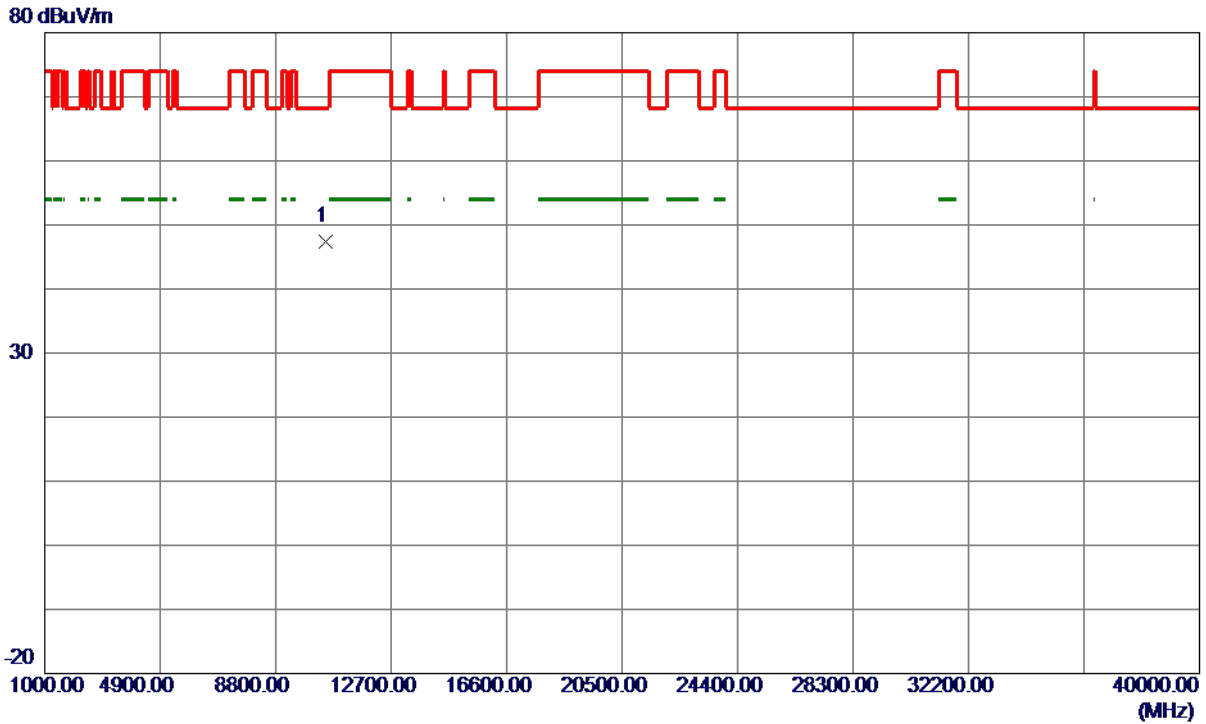

No.	Freq. MHz	Reading Level dBuV/m	Correct Factor dB	Measure ment dBuV/m	Limit dBuV/m	Margin dB	Detector	Comment
1 *	10484.2750	34.69	12.73	47.42	68.30	-20.88	Peak	

**REMARKS:**

- (1) Measurement Value = Reading Level + Correct Factor.
- (2) Margin Level = Measurement Value - Limit Value.

Orthogonal Axis	X
Test Mode	UNII-1_TX A (20M) Mode 5240 MHz

**Horizontal**

130 dBuV/m

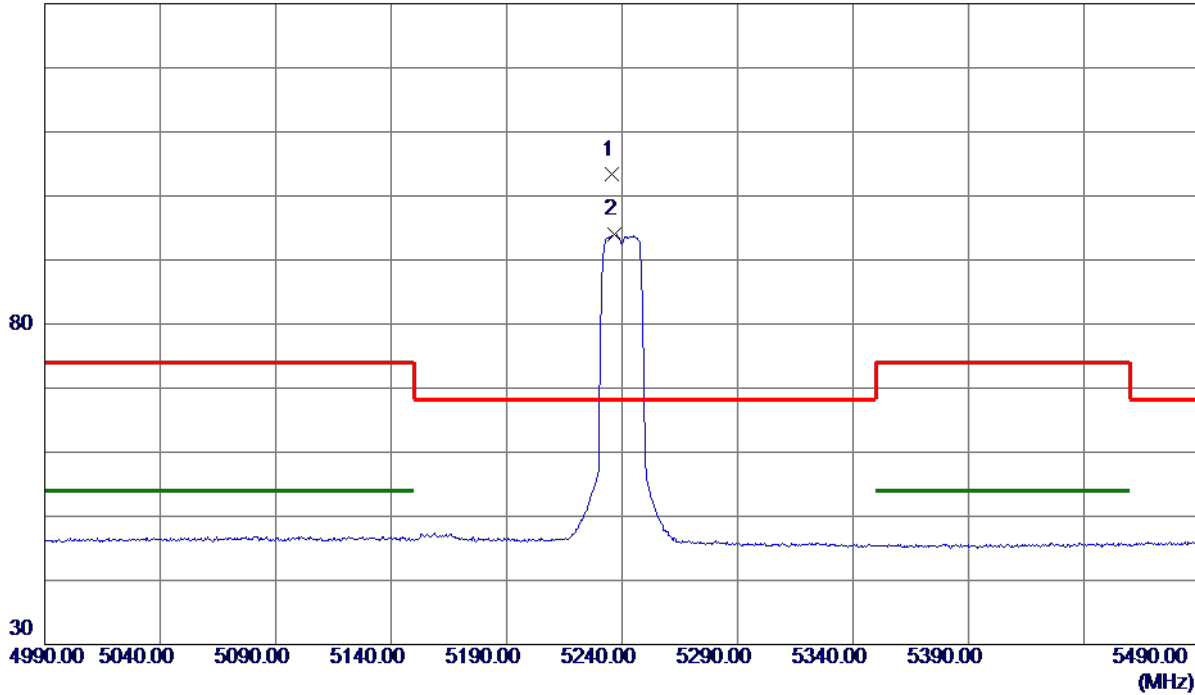

No.	Freq. MHz	Reading Level dBuV/m	Correct Factor dB	Measure ment dBuV/m	Limit dBuV/m	Margin dB	Detector	Comment
1 *	5235.7500	87.39	15.91	103.30	68.30	35.00	Peak	No Limit
2	5236.7500	78.10	15.91	94.01	999.00	-904.99	AVG	No Limit

**REMARKS:**

- (1) Measurement Value = Reading Level + Correct Factor.
- (2) Margin Level = Measurement Value - Limit Value.

Orthogonal Axis	X
Test Mode	UNII-1_TX A (20M) Mode 5240 MHz

**Horizontal**

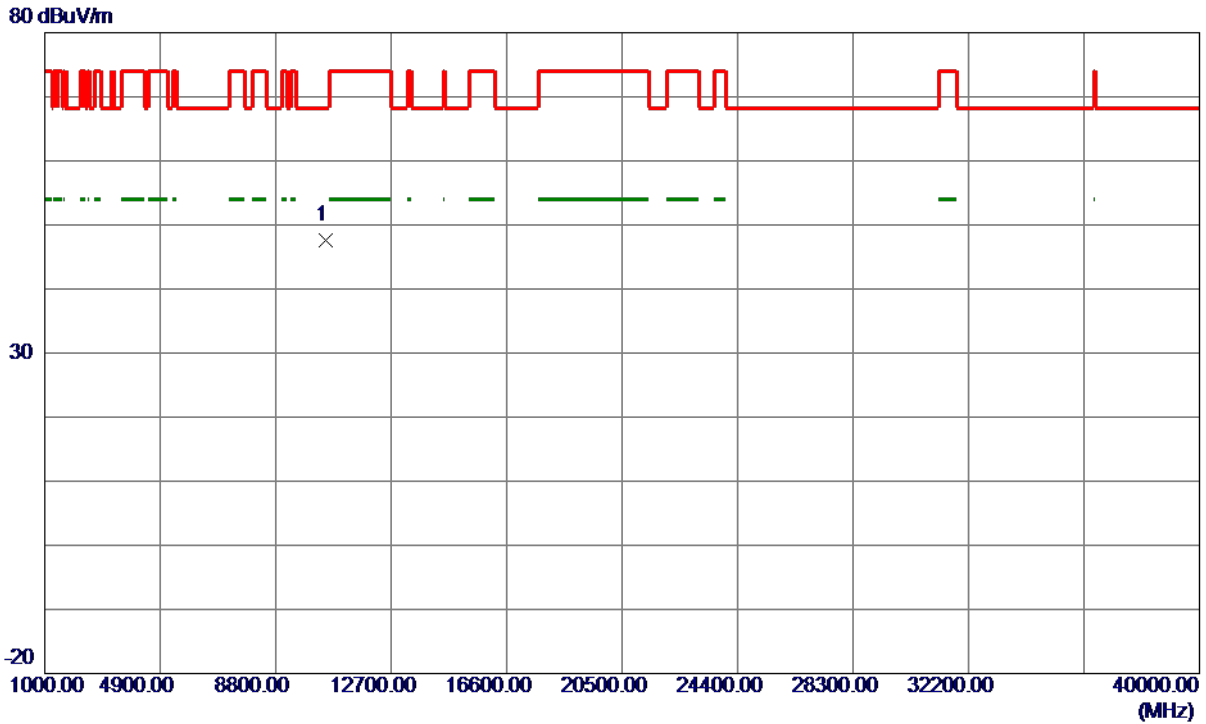

No.	Freq. MHz	Reading Level dBuV/m	Correct Factor dB	Measure ment dBuV/m	Limit dBuV/m	Margin dB	Detector	Comment
1 *	10485.9500	34.88	12.73	47.61	68.30	-20.69	Peak	

**REMARKS:**

- (1) Measurement Value = Reading Level + Correct Factor.
- (2) Margin Level = Measurement Value - Limit Value.

Orthogonal Axis	X
Test Mode	UNII-1_TX N (HT10) Mode 5180 MHz

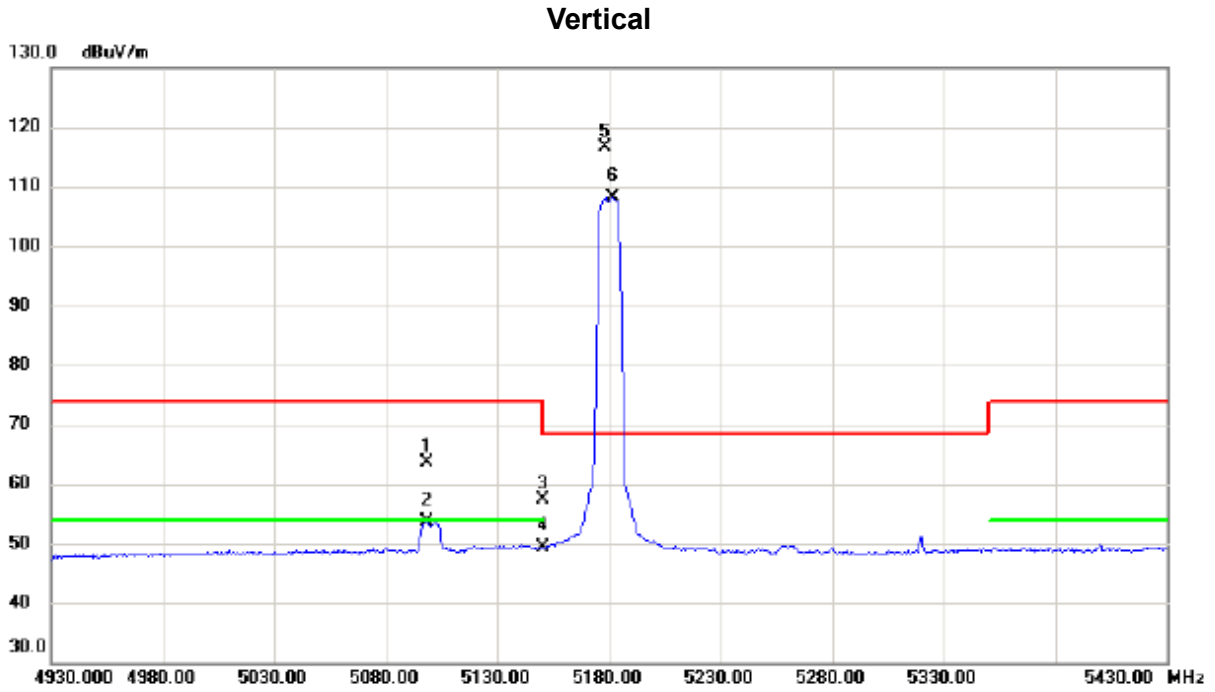

No.	Mk.	Freq. MHz	Reading Level dBuV	Correct Factor dB	Measure- ment dBuV/m	Limit dBuV/m	Margin dB	Detector	Comment
1		5098.250	48.11	15.64	63.75	74.00	-10.25	peak	
2		5098.250	37.96	15.64	53.60	54.00	-0.40	AVG	
3		5150.000	41.75	15.73	57.48	74.00	-16.52	peak	
4		5150.000	33.67	15.73	49.40	54.00	-4.60	AVG	
5	*	5178.250	100.83	15.79	116.62	68.30	48.32	peak	No Limit
6	X	5181.750	92.33	15.80	108.13	68.30	39.83	AVG	No Limit

**REMARKS:**

- (1) Measurement Value = Reading Level + Correct Factor.
- (2) Margin Level = Measurement Value - Limit Value.



Orthogonal Axis	X
Test Mode	UNII-1_TX N (HT10) Mode 5180 MHz

**Vertical**

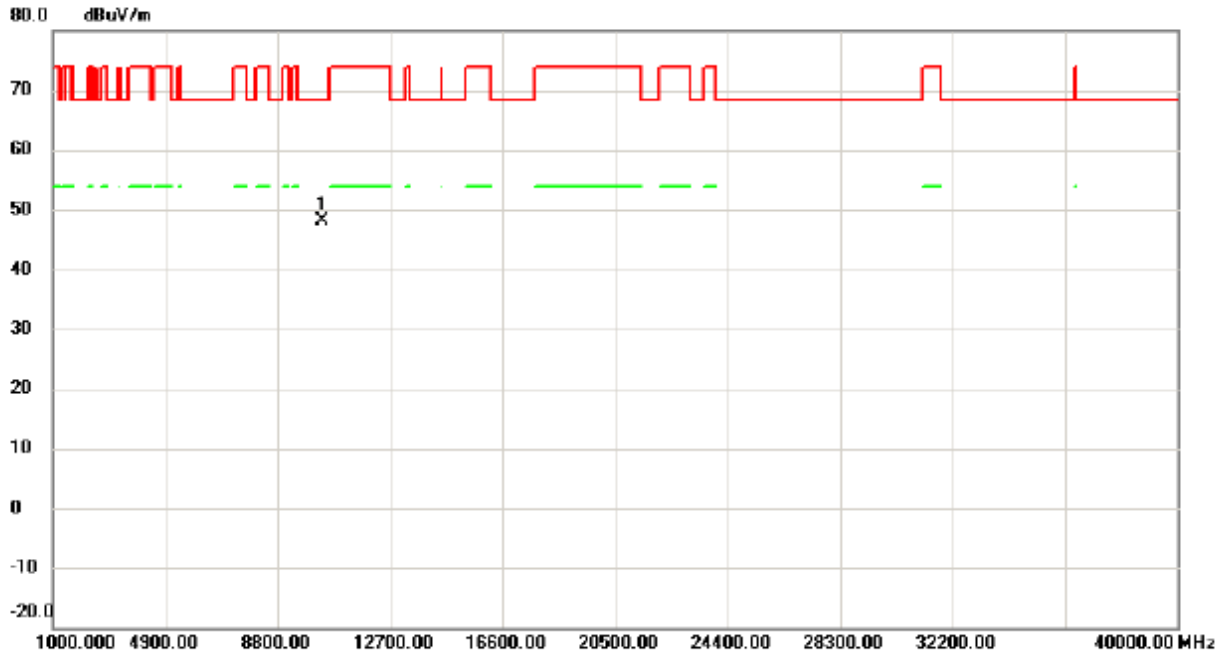

No.	Mk.	Freq.	Reading Level	Correct Factor	Measurement	Limit	Margin	Detector	Comment
		MHz	dBuV	dB	dBuV/m	dBuV/m	dB		
1	*	10356.650	35.59	12.46	48.05	68.30	-20.25	peak	

**REMARKS:**

- (1) Measurement Value = Reading Level + Correct Factor.
- (2) Margin Level = Measurement Value - Limit Value.

Orthogonal Axis	X
Test Mode	UNII-1_TX N (HT10) Mode 5180 MHz

### Horizontal

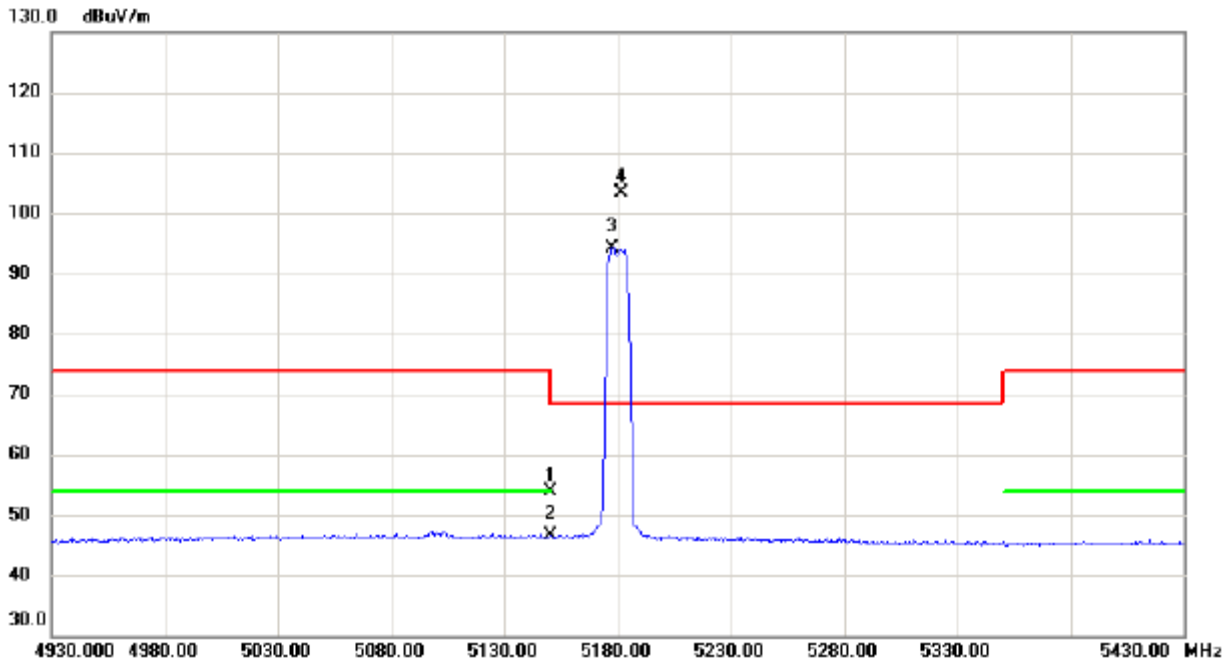

No.	Mk.	Freq.	Reading Level	Correct Factor	Measurement	Limit	Margin	Detector	Comment
		MHz	dBuV	dB	dBuV/m	dBuV/m	dB		
1		5150.000	38.25	15.73	53.98	74.00	-20.02	peak	
2		5150.000	30.79	15.73	46.52	54.00	-7.48	AVG	
3	X	5177.500	78.34	15.79	94.13	68.30	25.83	AVG	No Limit
4	*	5181.750	87.47	15.80	103.27	68.30	34.97	peak	No Limit

**REMARKS:**

- (1) Measurement Value = Reading Level + Correct Factor.
- (2) Margin Level = Measurement Value - Limit Value.

Orthogonal Axis	X
Test Mode	UNII-1_TX N (HT10) Mode 5180 MHz

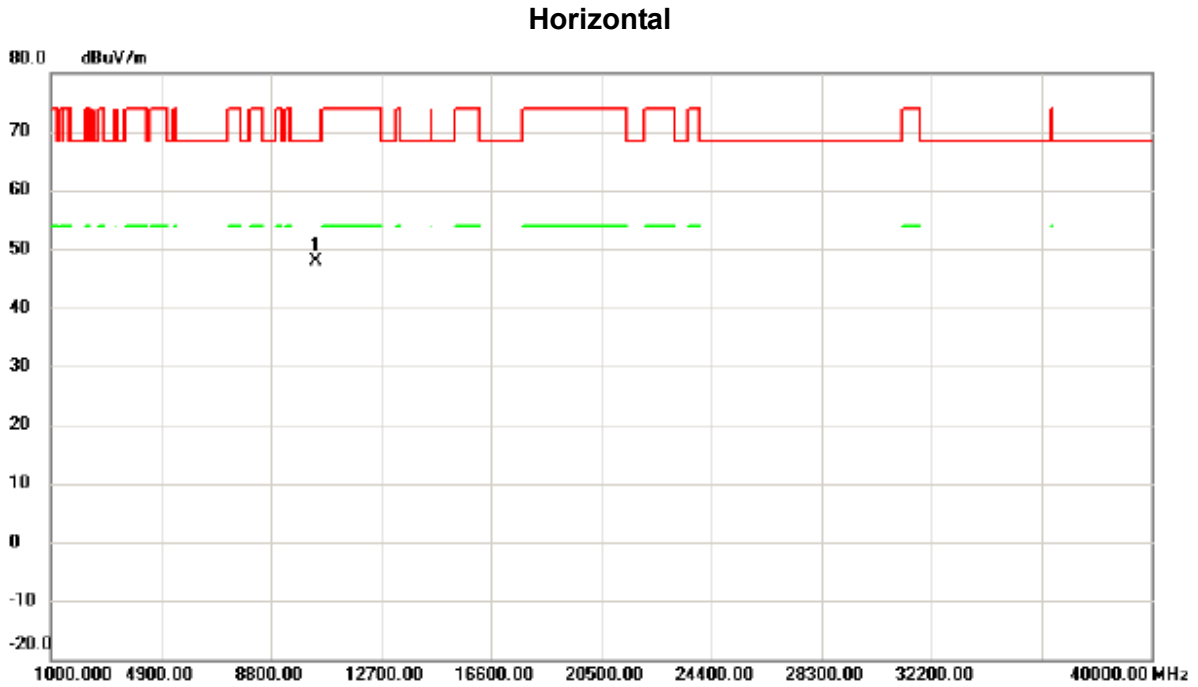

No.	Mk.	Freq.	Reading Level	Correct Factor	Measurement	Limit	Margin	Detector	Comment
		MHz	dBuV	dB	dBuV/m	dBuV/m	dB		
1	*	10375.200	35.28	12.51	47.79	68.30	-20.51	peak	

**REMARKS:**

- (1) Measurement Value = Reading Level + Correct Factor.
- (2) Margin Level = Measurement Value - Limit Value.

Orthogonal Axis	X
Test Mode	UNII-1_TX N (HT10) Mode 5200 MHz

**Vertical**

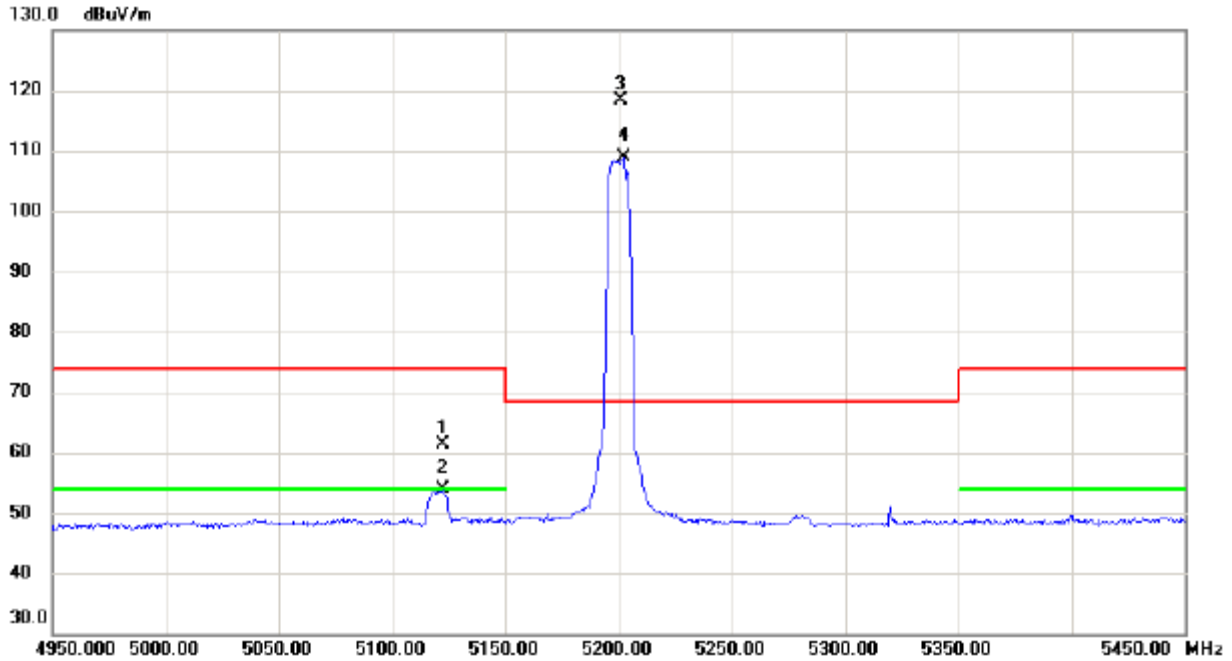

No.	Mk.	Freq. MHz	Reading Level dBuV	Correct Factor dB	Measure- ment dBuV/m	Limit dBuV/m	Margin dB	Detector	Comment
1		5122.250	45.67	15.69	61.36	74.00	-12.64	peak	
2		5122.250	38.17	15.69	53.86	54.00	-0.14	AVG	
3	*	5201.250	102.47	15.84	118.31	68.30	50.01	peak	No Limit
4	X	5202.000	93.05	15.84	108.89	68.30	40.59	AVG	No Limit

REMARKS:

- (1) Measurement Value = Reading Level + Correct Factor.
- (2) Margin Level = Measurement Value - Limit Value.

Orthogonal Axis	X
Test Mode	UNII-1_TX N (HT10) Mode 5200 MHz

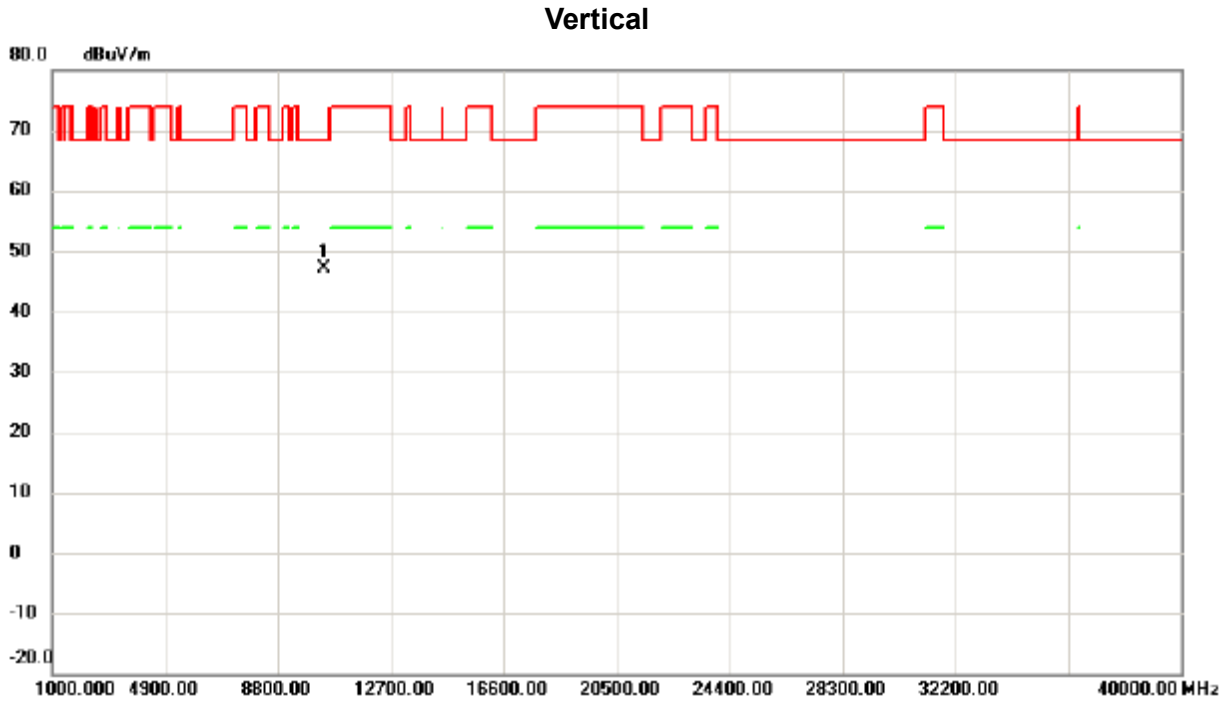

No.	Mk.	Freq.	Reading Level	Correct Factor	Measurement	Limit	Margin	Detector	Comment
		MHz	dBuV	dB	dBuV/m	dBuV/m	dB		
1	*	10376.750	34.53	12.51	47.04	68.30	-21.26	peak	

**REMARKS:**

- (1) Measurement Value = Reading Level + Correct Factor.
- (2) Margin Level = Measurement Value - Limit Value.

Orthogonal Axis	X
Test Mode	UNII-1_TX N (HT10) Mode 5200 MHz

### Horizontal

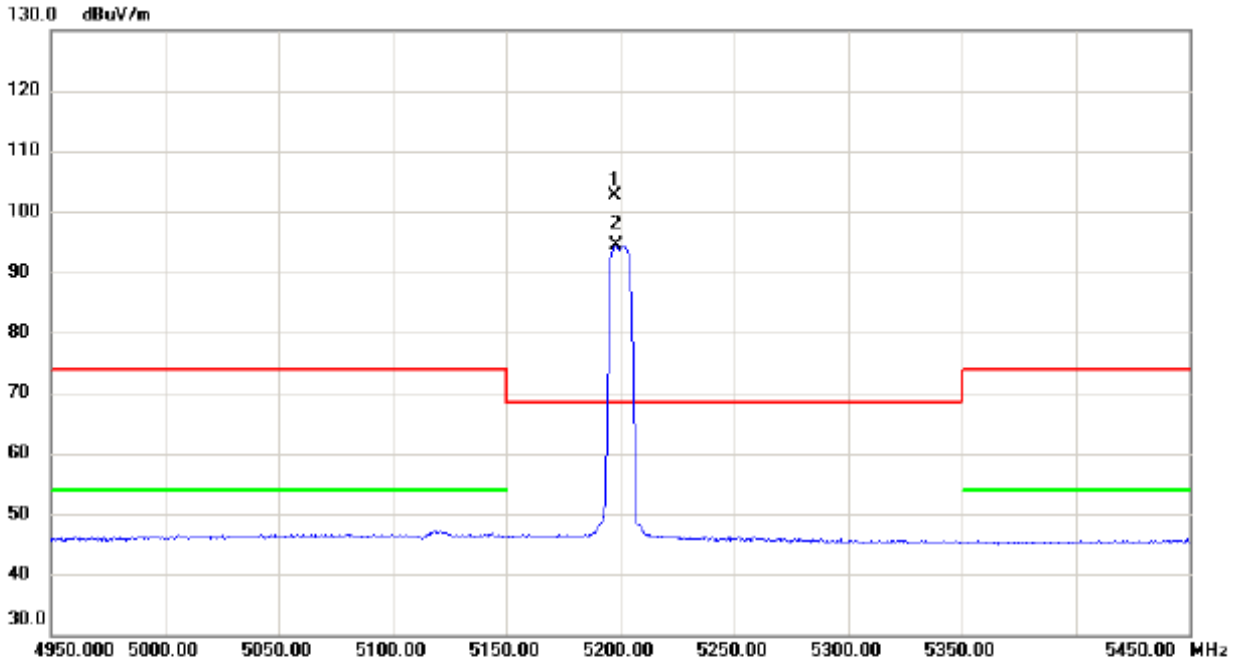

No.	Mk.	Freq. MHz	Reading Level dBuV	Correct Factor dB	Measure- ment dBuV/m	Limit dBuV/m	Margin dB	Detector	Comment
1	*	5197.750	86.84	15.83	102.67	68.30	34.37	peak	No Limit
2	X	5198.250	78.60	15.83	94.43	68.30	26.13	AVG	No Limit

**REMARKS:**

- (1) Measurement Value = Reading Level + Correct Factor.
- (2) Margin Level = Measurement Value - Limit Value.

Orthogonal Axis	X
Test Mode	UNII-1_TX N (HT10) Mode 5200 MHz

**Horizontal**

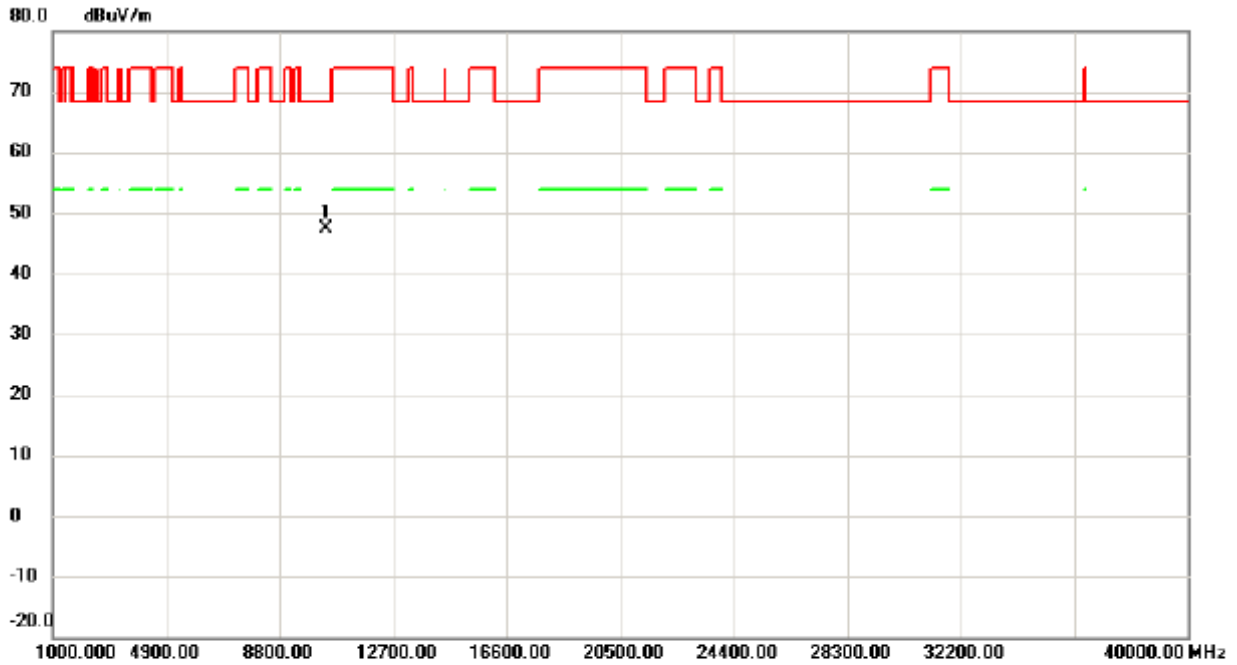

No.	Mk.	Freq.	Reading Level	Correct Factor	Measurement	Limit	Margin	Detector	Comment
		MHz	dBuV	dB	dBuV/m	dBuV/m	dB		
1	*	10392.950	34.73	12.54	47.27	68.30	-21.03	peak	

**REMARKS:**

- (1) Measurement Value = Reading Level + Correct Factor.
- (2) Margin Level = Measurement Value - Limit Value.

Orthogonal Axis	X
Test Mode	UNII-1_TX N (HT10) Mode 5240 MHz

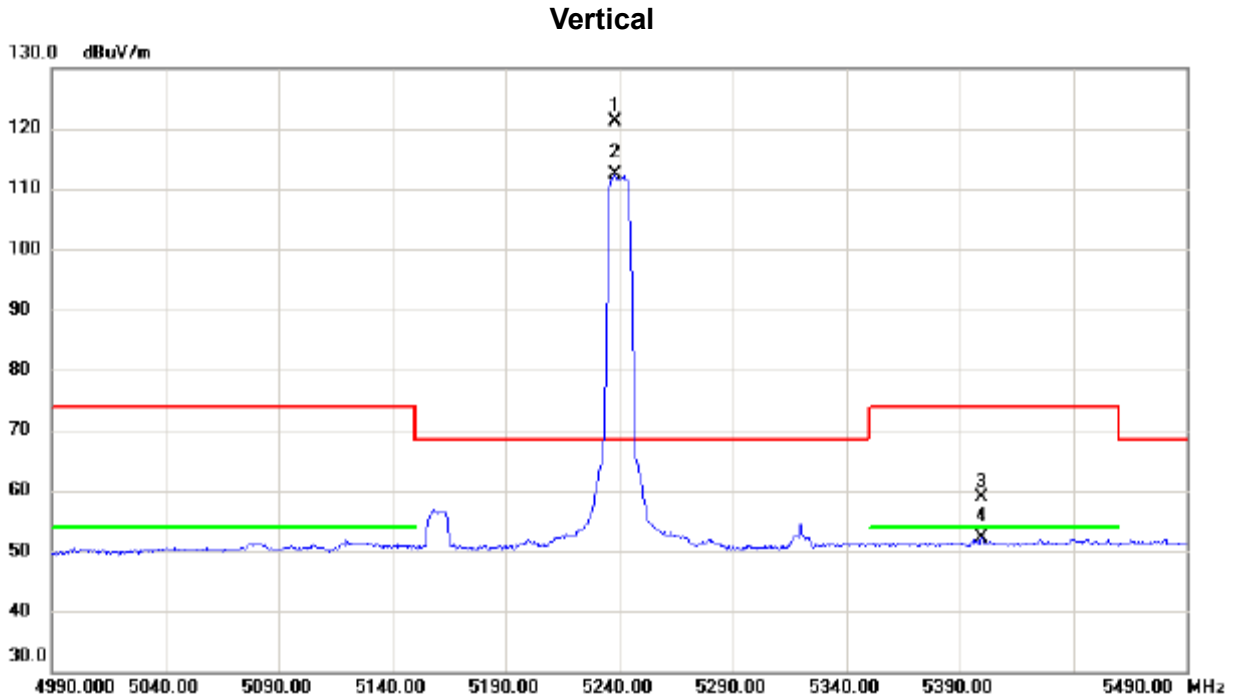

No.	Mk.	Freq.	Reading Level	Correct Factor	Measurement	Limit	Margin		
		MHz	dBuV	dB	dBuV/m	dBuV/m	dB	Detector	Comment
1	*	5238.500	105.18	15.92	121.10	68.30	52.80	peak	No Limit
2	X	5238.500	96.36	15.92	112.28	68.30	43.98	AVG	No Limit
3		5399.500	42.72	16.23	58.95	74.00	-15.05	peak	
4		5399.500	35.79	16.23	52.02	54.00	-1.98	AVG	

**REMARKS:**

- (1) Measurement Value = Reading Level + Correct Factor.
- (2) Margin Level = Measurement Value - Limit Value.



Orthogonal Axis	X
Test Mode	UNII-1_TX N (HT10) Mode 5240 MHz

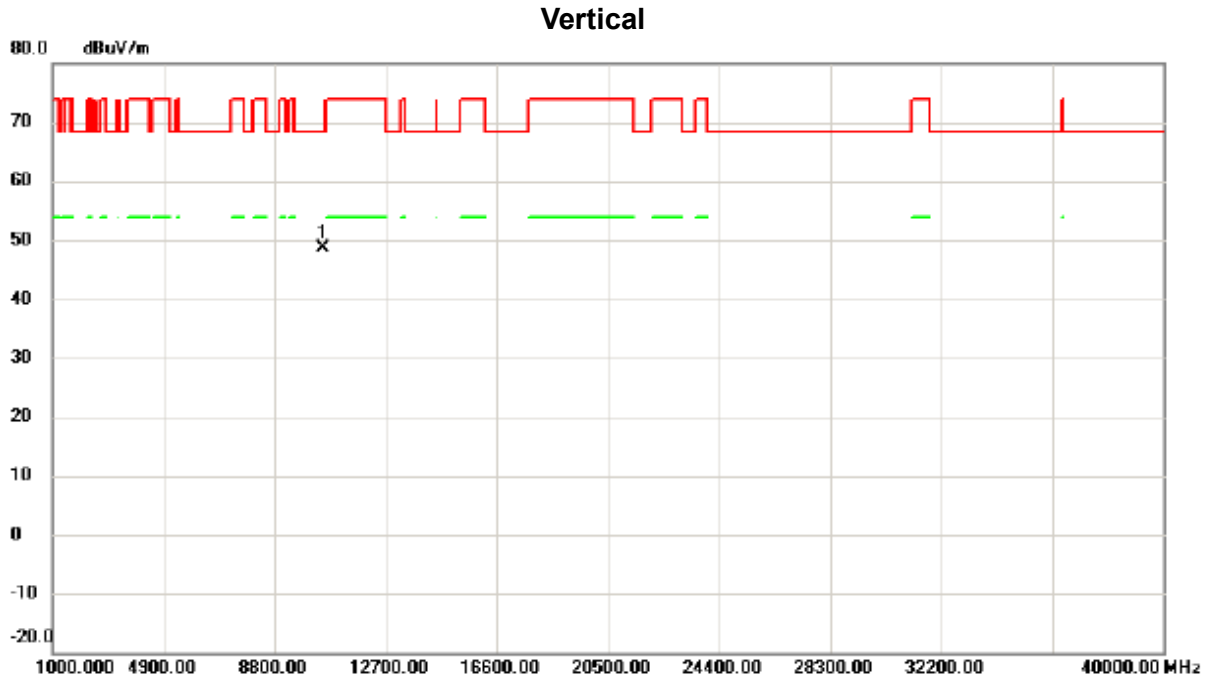

No.	Mk.	Freq.	Reading Level	Correct Factor	Measurement	Limit	Margin	Detector	Comment
		MHz	dBuV	dB	dBuV/m	dBuV/m	dB		
1	*	10501.475	35.82	12.76	48.58	68.30	-19.72	peak	

**REMARKS:**

- (1) Measurement Value = Reading Level + Correct Factor.
- (2) Margin Level = Measurement Value - Limit Value.

Orthogonal Axis	X
Test Mode	UNII-1_TX N (HT10) Mode 5240 MHz

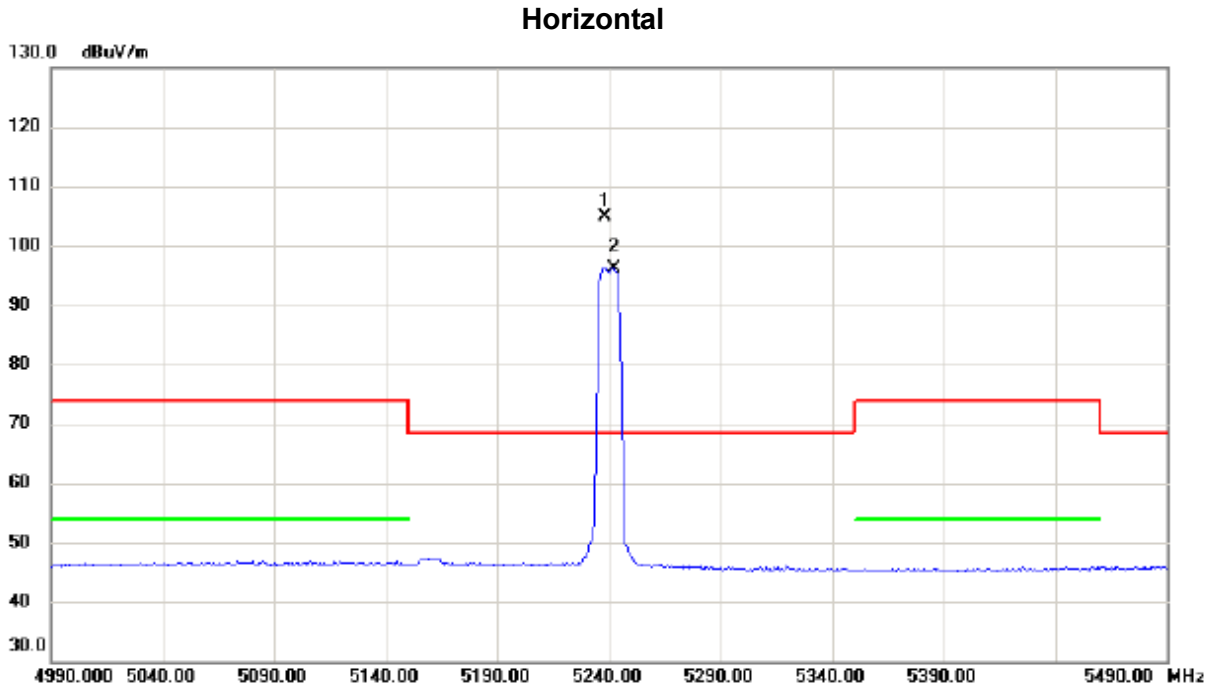

No.	Mk.	Freq.	Reading Level	Correct Factor	Measurement	Limit	Margin		
		MHz	dBuV	dB	dBuV/m	dBuV/m	dB	Detector	Comment
1	*	5238.250	88.96	15.91	104.87	68.30	36.57	peak	No Limit
2	X	5242.250	80.23	15.92	96.15	68.30	27.85	AVG	No Limit

**REMARKS:**

- (1) Measurement Value = Reading Level + Correct Factor.
- (2) Margin Level = Measurement Value - Limit Value.

Orthogonal Axis	X
Test Mode	UNII-1_TX N (HT10) Mode 5240 MHz

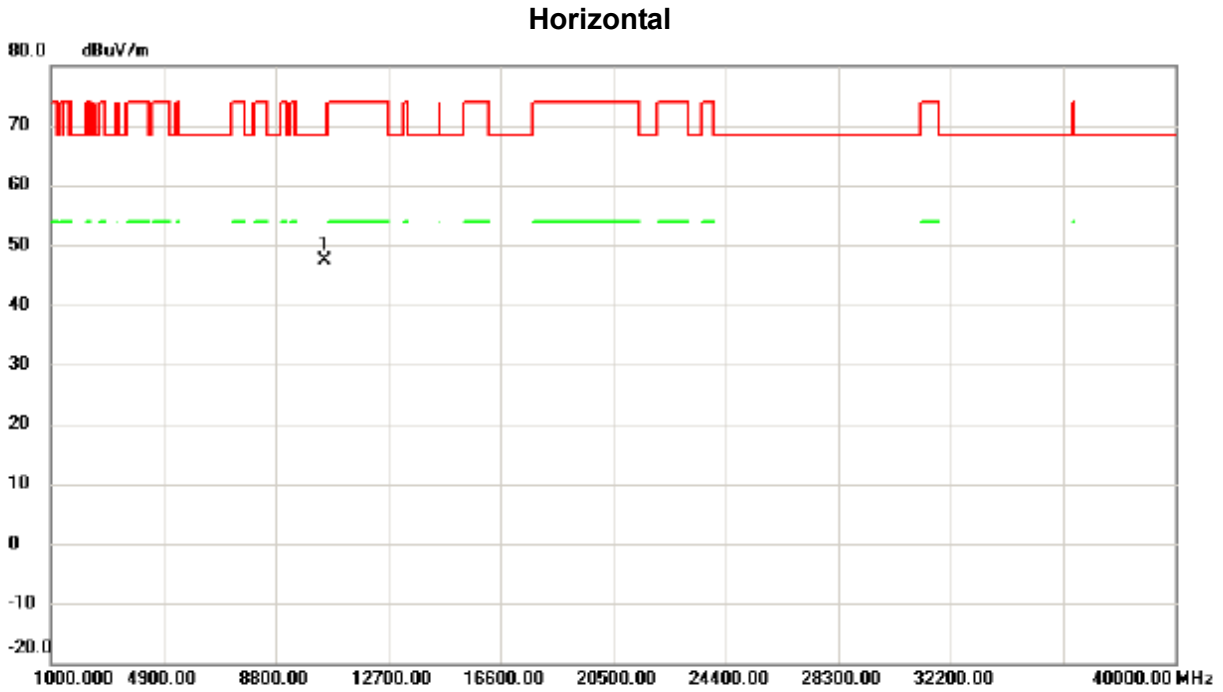

No.	Mk.	Freq.	Reading Level	Correct Factor	Measurement	Limit	Margin	Detector	Comment
		MHz	dBuV	dB	dBuV/m	dBuV/m	dB		
1	*	10465.075	34.71	12.69	47.40	68.30	-20.90	peak	

**REMARKS:**

- (1) Measurement Value = Reading Level + Correct Factor.
- (2) Margin Level = Measurement Value - Limit Value.

Orthogonal Axis	X
Test Mode	UNII-1_TX N (HT20) Mode 5180 MHz

**Vertical**

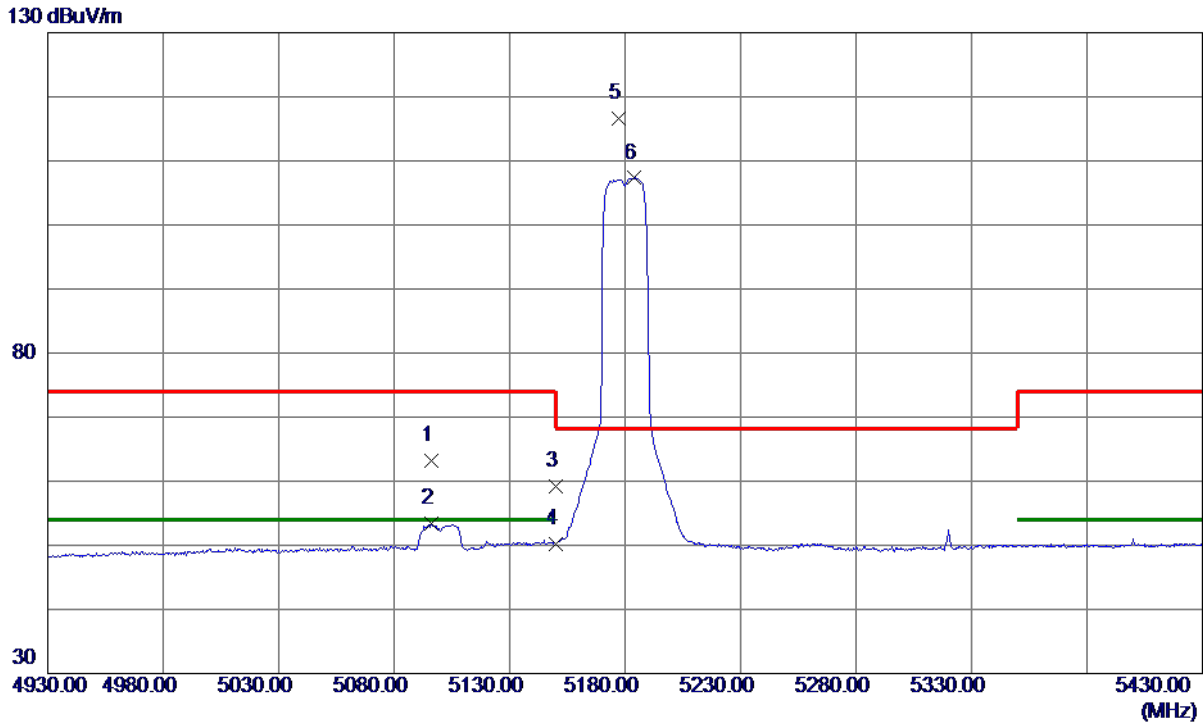

No.	Freq. MHz	Reading Level dBuV/m	Correct Factor dB	Measure ment dBuV/m	Limit dBuV/m	Margin dB	Detector	Comment
1	5096.2500	47.62	15.63	63.25	74.00	-10.75	Peak	
2	5096.2500	37.68	15.63	53.31	54.00	-0.69	AVG	
3	5150.0000	43.53	15.74	59.27	74.00	-14.73	Peak	
4	5150.0000	34.51	15.74	50.25	54.00	-3.75	AVG	
5 *	5177.2500	100.89	15.79	116.68	68.30	48.38	Peak	No Limit
6	5184.0000	91.50	15.80	107.30	999.00	-891.70	AVG	No Limit

**REMARKS:**

- (1) Measurement Value = Reading Level + Correct Factor.
- (2) Margin Level = Measurement Value - Limit Value.

Orthogonal Axis	X
Test Mode	UNII-1_TX N (HT20) Mode 5180 MHz

**Vertical**

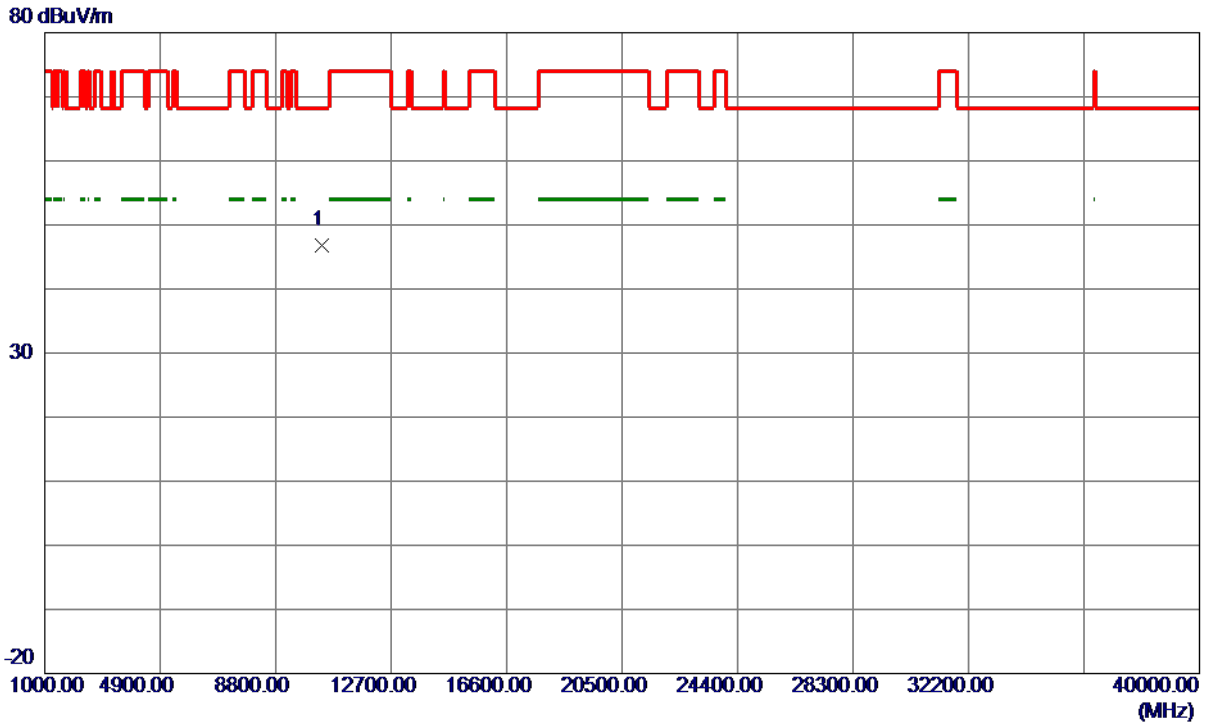

No.	Freq. MHz	Reading Level dBuV/m	Correct Factor dB	Measure ment dBuV/m	Limit dBuV/m	Margin dB	Detector	Comment
1 *	10340.2750	34.40	12.43	46.83	68.30	-21.47	Peak	

**REMARKS:**

- (1) Measurement Value = Reading Level + Correct Factor.
- (2) Margin Level = Measurement Value - Limit Value.

Orthogonal Axis	X
Test Mode	UNII-1_TX N (HT20) Mode 5180 MHz

### Horizontal

130 dBuV/m

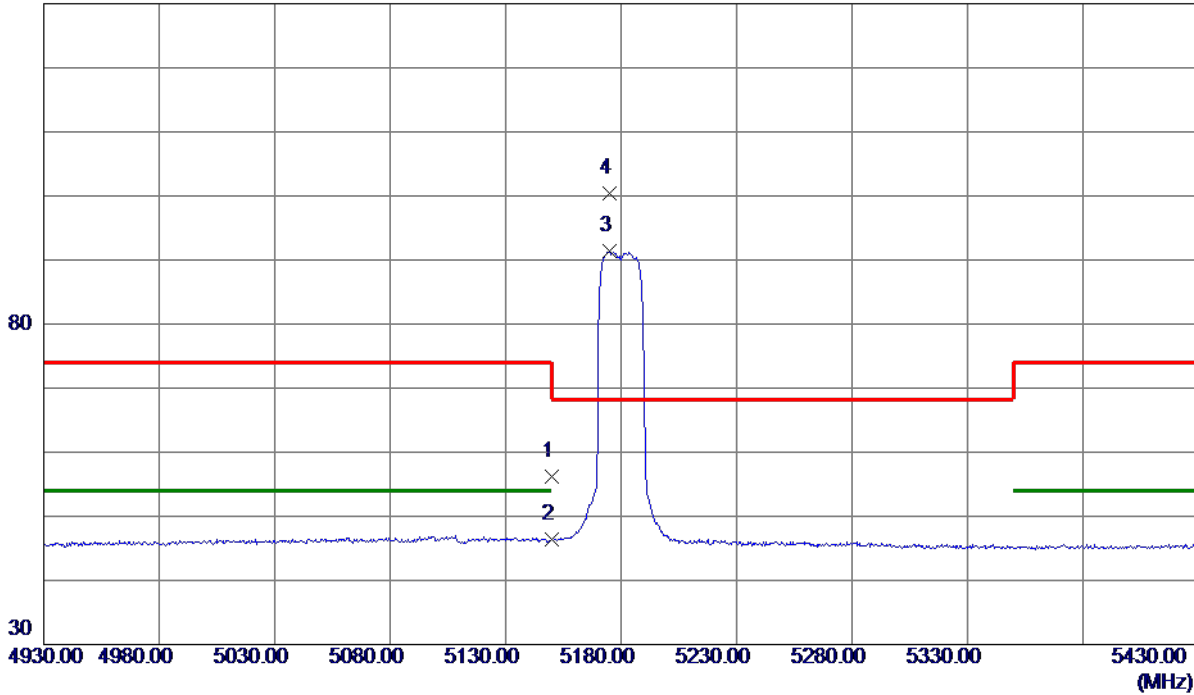

No.	Freq. MHz	Reading Level dBuV/m	Correct Factor dB	Measure ment dBuV/m	Limit dBuV/m	Margin dB	Detector	Comment
1	5150.0000	40.44	15.74	56.18	74.00	-17.82	Peak	
2	5150.0000	30.58	15.74	46.32	54.00	-7.68	AVG	
3	5175.0000	75.53	15.79	91.32	999.00	-907.68	AVG	No Limit
4 *	5175.2500	84.58	15.79	100.37	68.30	32.07	Peak	No Limit

**REMARKS:**

- (1) Measurement Value = Reading Level + Correct Factor.
- (2) Margin Level = Measurement Value - Limit Value.

Orthogonal Axis	X
Test Mode	UNII-1_TX N (HT20) Mode 5180 MHz

**Horizontal**

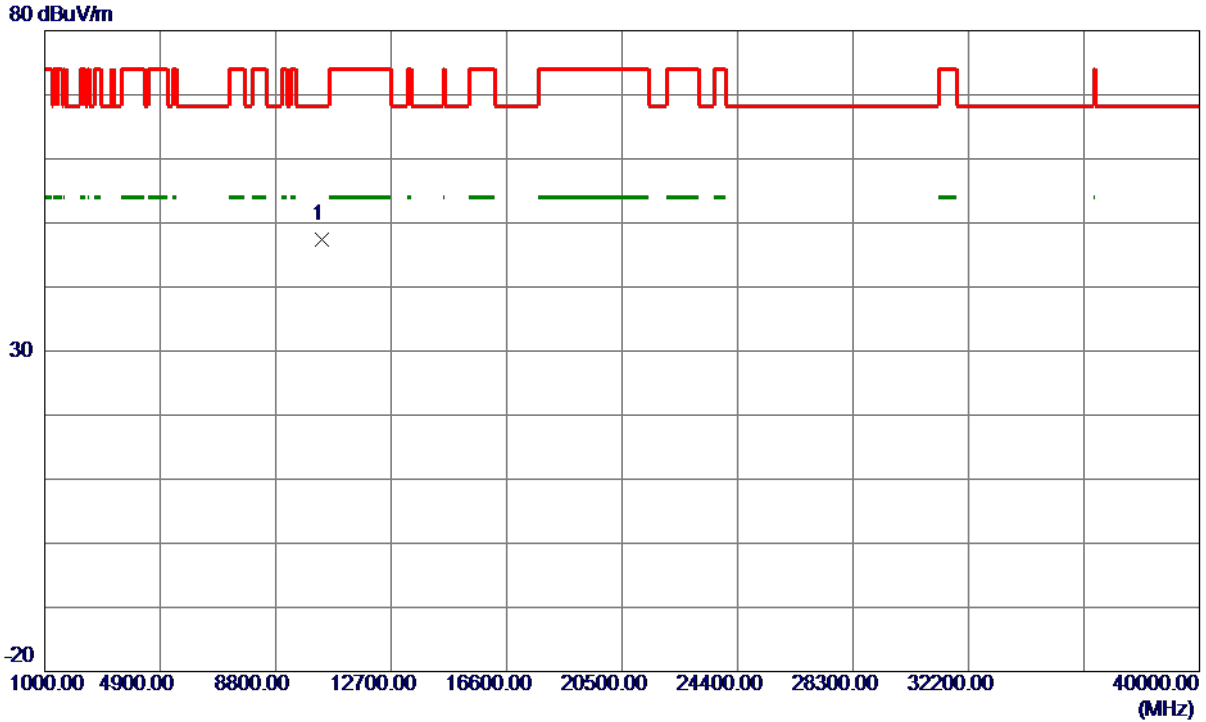

No.	Freq. MHz	Reading Level dBuV/m	Correct Factor dB	Measure ment dBuV/m	Limit dBuV/m	Margin dB	Detector	Comment
1 *	10373.8750	34.97	12.50	47.47	68.30	-20.83	Peak	

**REMARKS:**

- (1) Measurement Value = Reading Level + Correct Factor.
- (2) Margin Level = Measurement Value - Limit Value.

Orthogonal Axis	X
Test Mode	UNII-1_TX N (HT20) Mode 5200 MHz

Vertical

130 dBuV/m

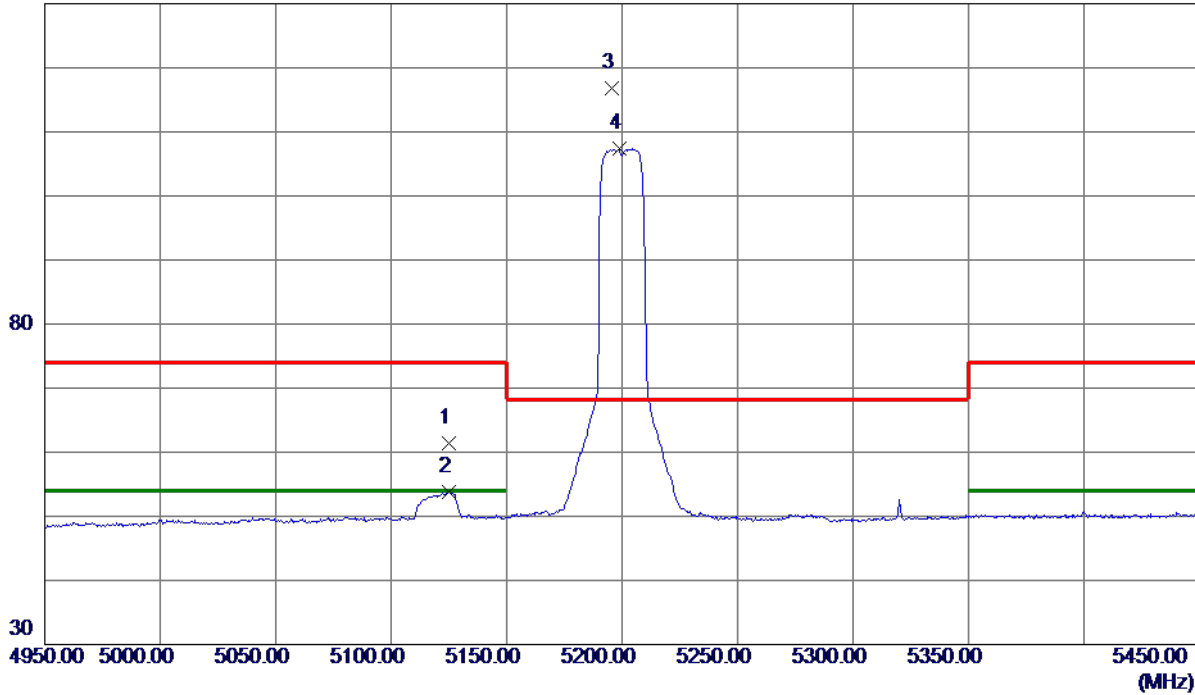

No.	Freq. MHz	Reading Level dBuV/m	Correct Factor dB	Measure ment dBuV/m	Limit dBuV/m	Margin dB	Detector	Comment
1	5125.0000	45.80	15.69	61.49	74.00	-12.51	Peak	
2	5125.0000	38.10	15.69	53.79	54.00	-0.21	AVG	
3 *	5195.7500	101.03	15.83	116.86	68.30	48.56	Peak	No Limit
4	5198.7500	91.63	15.83	107.46	999.00	-891.54	AVG	No Limit

REMARKS:

- (1) Measurement Value = Reading Level + Correct Factor.
- (2) Margin Level = Measurement Value - Limit Value.



Orthogonal Axis	X
Test Mode	UNII-1_TX N (HT20) Mode 5200 MHz

**Vertical**

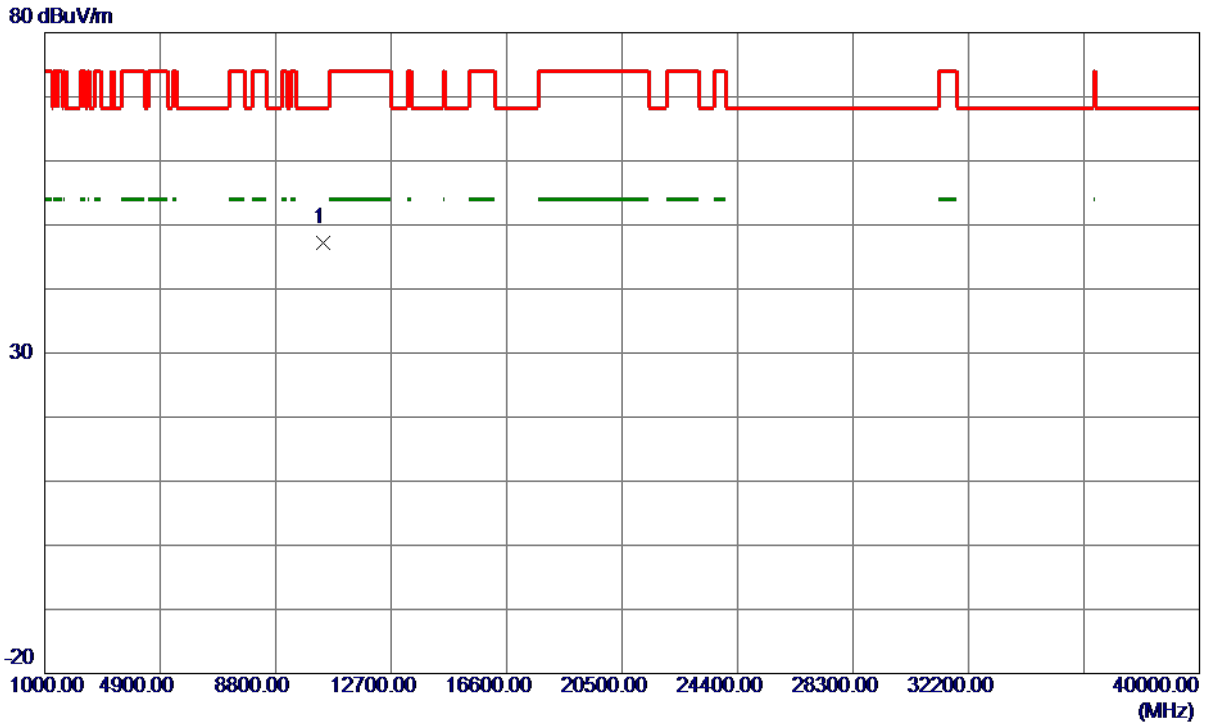

No.	Freq. MHz	Reading Level dBuV/m	Correct Factor dB	Measure ment dBuV/m	Limit dBuV/m	Margin dB	Detector	Comment
1 *	10406.7000	34.66	12.57	47.23	68.30	-21.07	Peak	

**REMARKS:**

- (1) Measurement Value = Reading Level + Correct Factor.
- (2) Margin Level = Measurement Value - Limit Value.

Orthogonal Axis	X
Test Mode	UNII-1_TX N (HT20) Mode 5200 MHz

### Horizontal

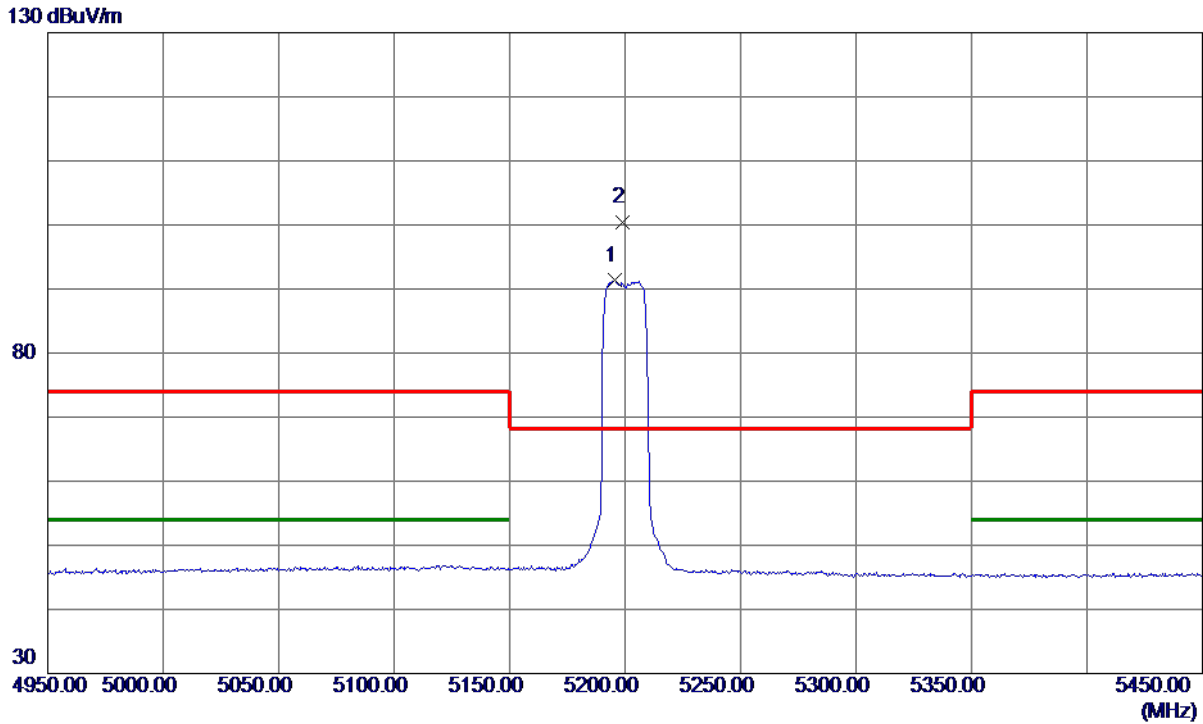

No.	Freq. MHz	Reading Level dBuV/m	Correct Factor dB	Measure ment dBuV/m	Limit dBuV/m	Margin dB	Detector	Comment
1	5195.7500	75.47	15.83	91.30	999.00	-907.70	AVG	No Limit
2 *	5199.0000	84.57	15.83	100.40	68.30	32.10	Peak	No Limit

**REMARKS:**

- (1) Measurement Value = Reading Level + Correct Factor.
- (2) Margin Level = Measurement Value - Limit Value.

Orthogonal Axis	X
Test Mode	UNII-1_TX N (HT20) Mode 5200 MHz

**Horizontal**

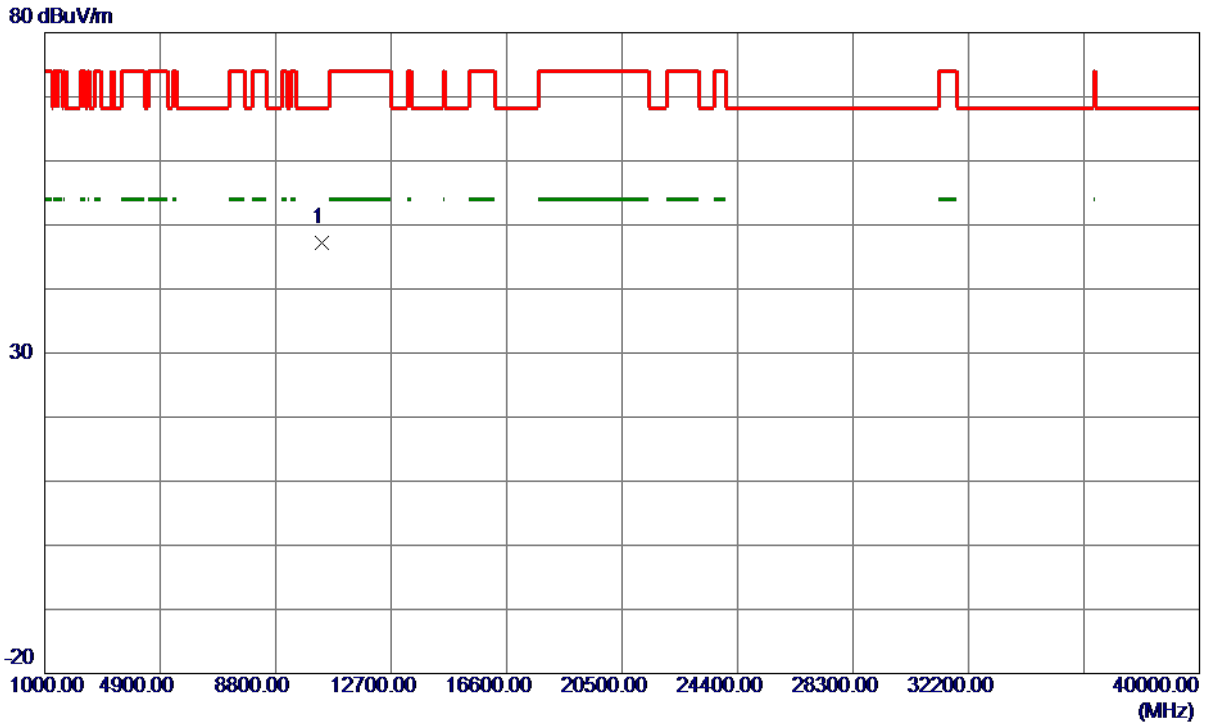

No.	Freq. MHz	Reading Level dBuV/m	Correct Factor dB	Measure ment dBuV/m	Limit dBuV/m	Margin dB	Detector	Comment
1 *	10377.3000	34.78	12.50	47.28	68.30	-21.02	Peak	

**REMARKS:**

- (1) Measurement Value = Reading Level + Correct Factor.
- (2) Margin Level = Measurement Value - Limit Value.

Orthogonal Axis	X
Test Mode	UNII-1_TX N (HT20) Mode 5240 MHz

**Vertical**

130 dBuV/m

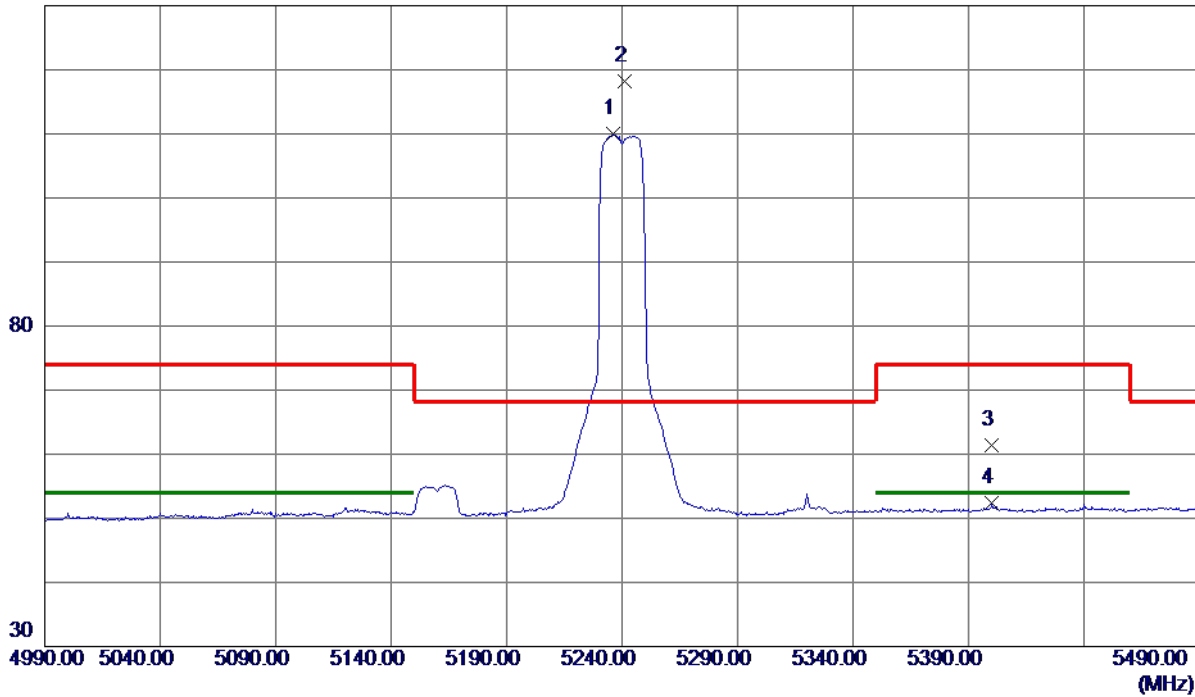

No.	Freq. MHz	Reading Level dBuV/m	Correct Factor dB	Measure ment dBuV/m	Limit dBuV/m	Margin dB	Detector	Comment
1	5236.0000	94.04	15.91	109.95	999.00	-889.05	AVG	No Limit
2 *	5241.0000	102.19	15.92	118.11	68.30	49.81	Peak	No Limit
3	5400.0000	45.12	16.23	61.35	74.00	-12.65	Peak	
4	5400.0000	36.21	16.23	52.44	54.00	-1.56	AVG	

**REMARKS:**

- (1) Measurement Value = Reading Level + Correct Factor.
- (2) Margin Level = Measurement Value - Limit Value.

Orthogonal Axis	X
Test Mode	UNII-1_TX N (HT20) Mode 5240 MHz

**Vertical**



No.	Freq. MHz	Reading Level dBuV/m	Correct Factor dB	Measure ment dBuV/m	Limit dBuV/m	Margin dB	Detector	Comment
1 *	10469.3500	35.50	12.70	48.20	68.30	-20.10	Peak	

**REMARKS:**

- (1) Measurement Value = Reading Level + Correct Factor.
- (2) Margin Level = Measurement Value - Limit Value.

Orthogonal Axis	X
Test Mode	UNII-1_TX N (HT20) Mode 5240 MHz

**Horizontal**

130 dBuV/m

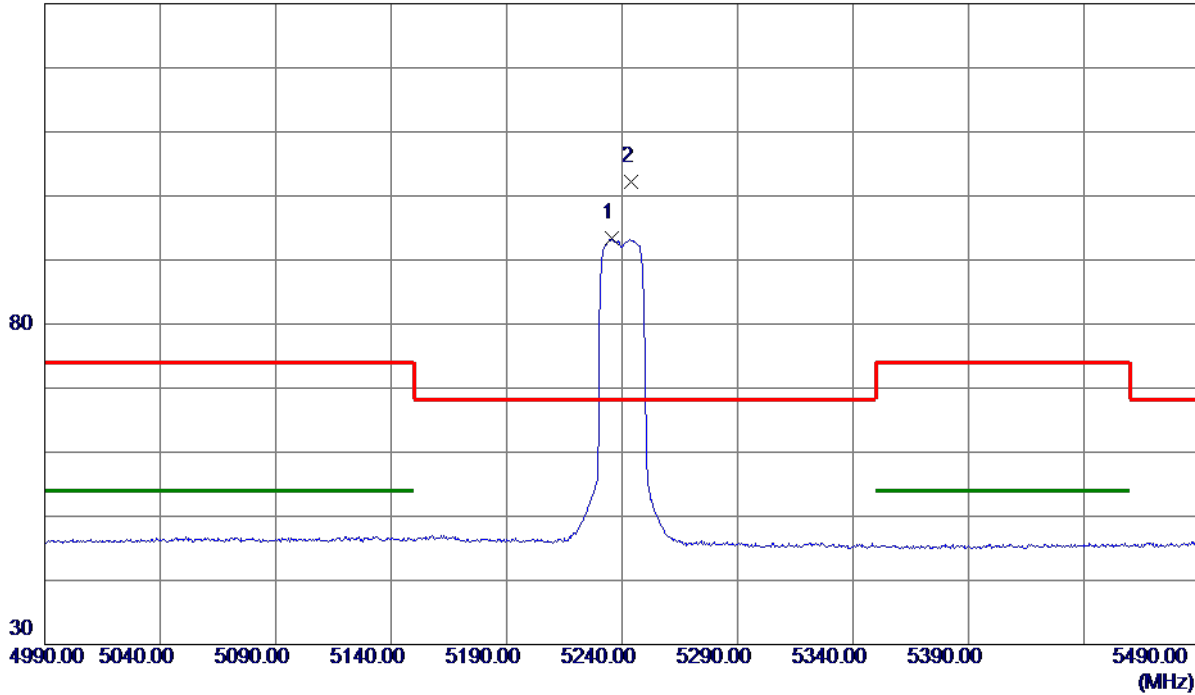

No.	Freq. MHz	Reading Level dBuV/m	Correct Factor dB	Measure ment dBuV/m	Limit dBuV/m	Margin dB	Detector	Comment
1	5235.7500	77.41	15.91	93.32	999.00	-905.68	AVG	No Limit
2 *	5244.0000	86.36	15.92	102.28	68.30	33.98	Peak	No Limit

**REMARKS:**

- (1) Measurement Value = Reading Level + Correct Factor.
- (2) Margin Level = Measurement Value - Limit Value.

Orthogonal Axis	X
Test Mode	UNII-1_TX N (HT20) Mode 5240 MHz

**Horizontal**

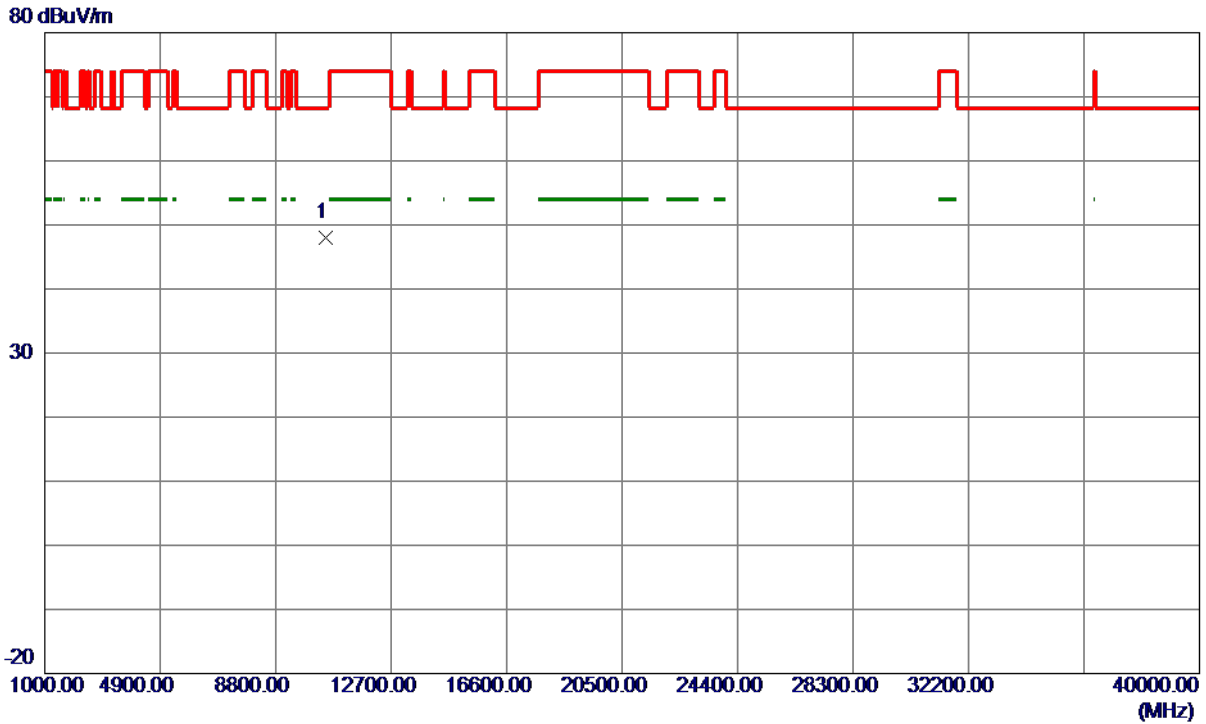

No.	Freq. MHz	Reading Level dBuV/m	Correct Factor dB	Measure ment dBuV/m	Limit dBuV/m	Margin dB	Detector	Comment
1 *	10487.3750	35.20	12.73	47.93	68.30	-20.37	Peak	

**REMARKS:**

- (1) Measurement Value = Reading Level + Correct Factor.
- (2) Margin Level = Measurement Value - Limit Value.

Orthogonal Axis	X
Test Mode	UNII-1_TX N (HT40) Mode 5190 MHz

Vertical

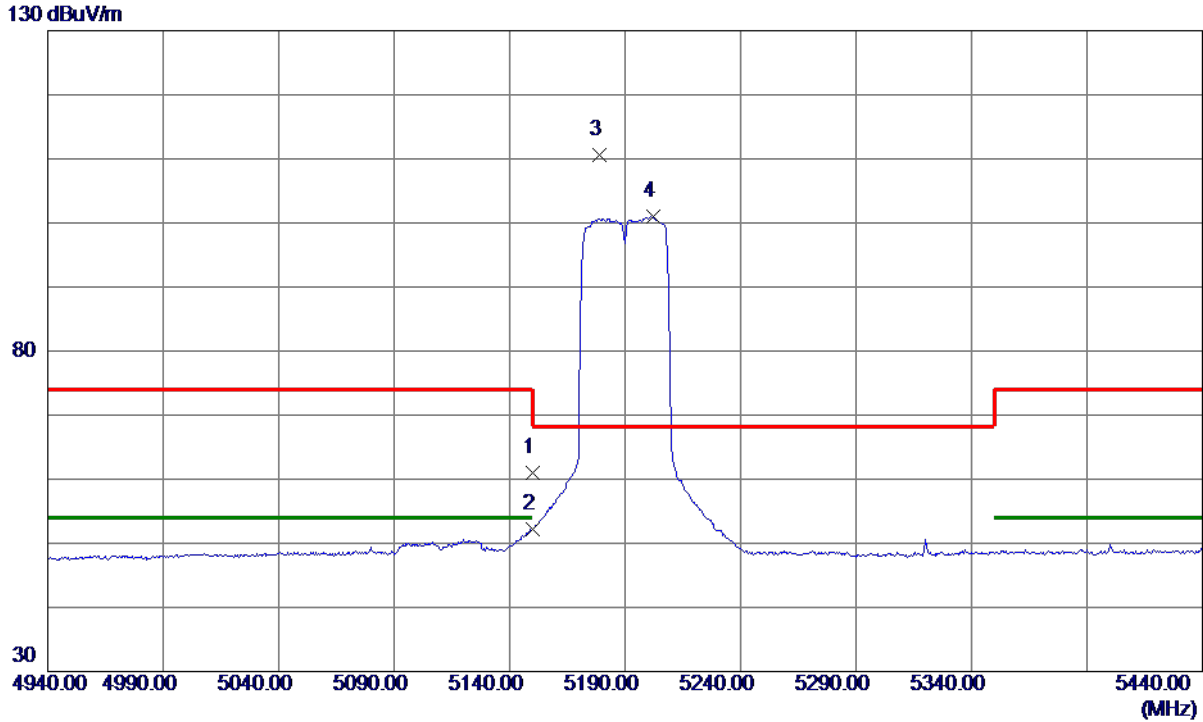

No.	Freq. MHz	Reading Level dBuV/m	Correct Factor dB	Measure ment dBuV/m	Limit dBuV/m	Margin dB	Detector	Comment
1	5150.0000	45.29	15.74	61.03	74.00	-12.97	Peak	
2	5150.0000	36.44	15.74	52.18	54.00	-1.82	AVG	
3 *	5178.7500	94.80	15.79	110.59	68.30	42.29	Peak	No Limit
4	5202.2500	85.09	15.84	100.93	999.00	-898.07	AVG	No Limit

REMARKS:

- (1) Measurement Value = Reading Level + Correct Factor.
- (2) Margin Level = Measurement Value - Limit Value.



Orthogonal Axis	X
Test Mode	UNII-1_TX N (HT40) Mode 5190 MHz

**Vertical**

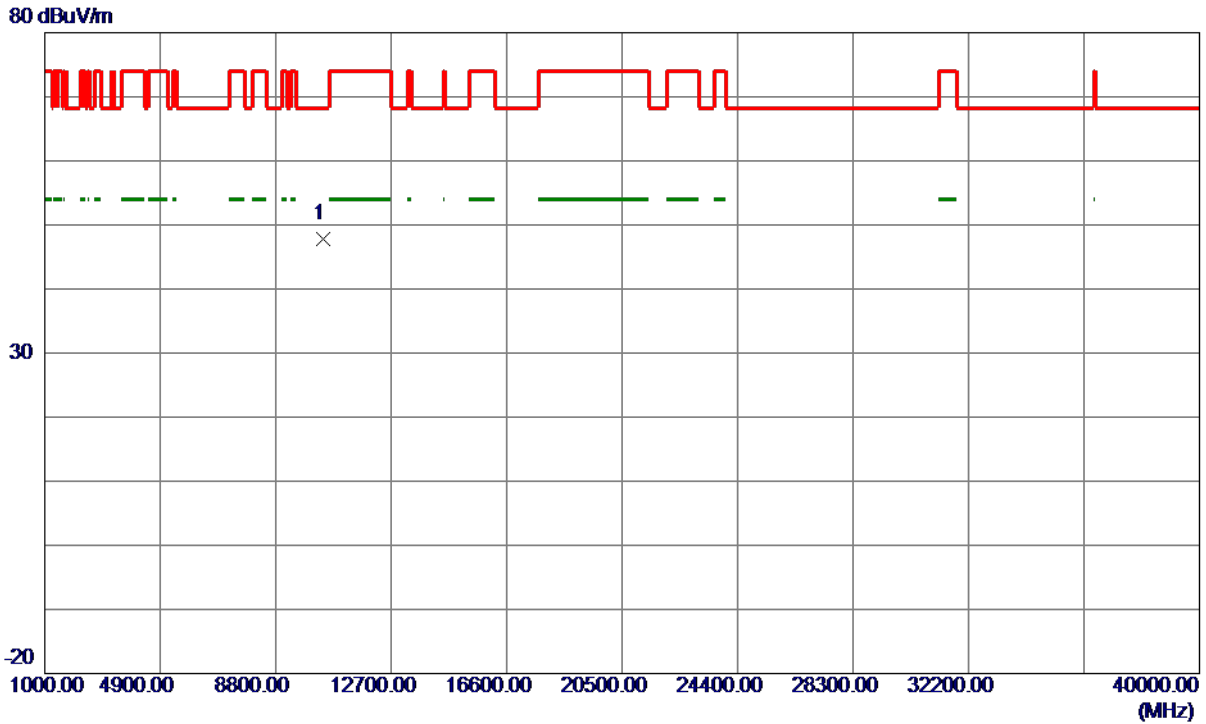

No.	Freq. MHz	Reading Level dBuV/m	Correct Factor dB	Measure ment dBuV/m	Limit dBuV/m	Margin dB	Detector	Comment
1 *	10394.0500	35.28	12.54	47.82	68.30	-20.48	Peak	

**REMARKS:**

- (1) Measurement Value = Reading Level + Correct Factor.
- (2) Margin Level = Measurement Value - Limit Value.

Orthogonal Axis	X
Test Mode	UNII-1_TX N (HT40) Mode 5190 MHz

**Horizontal**

130 dBuV/m

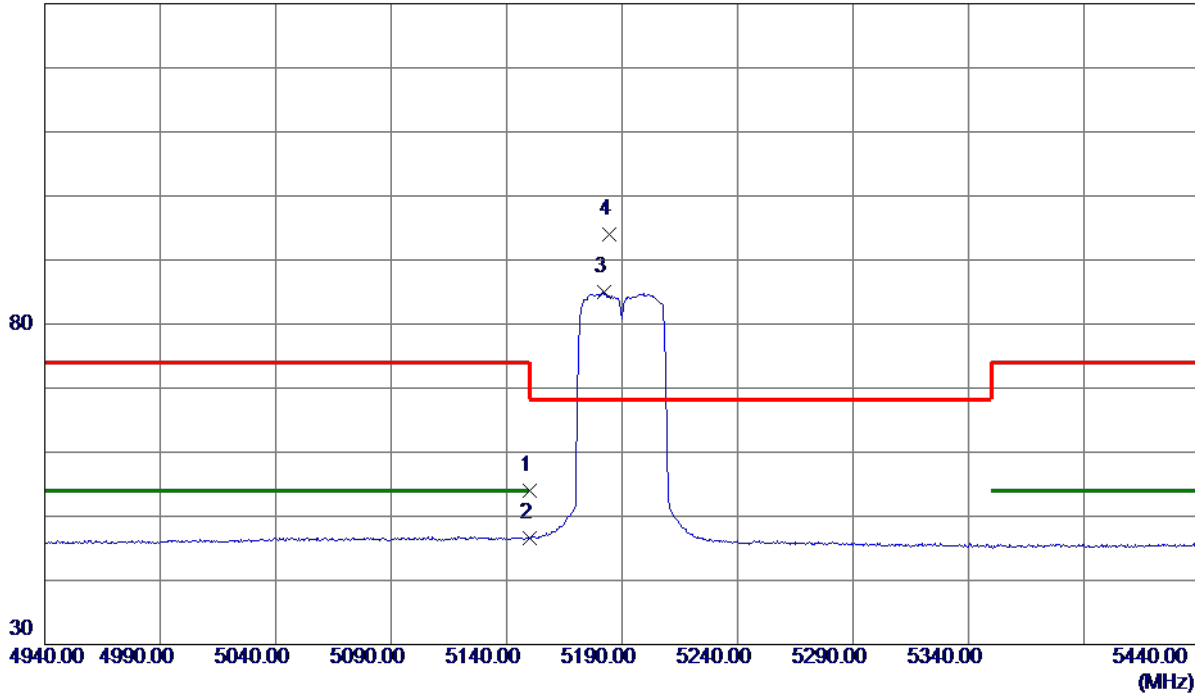

No.	Freq. MHz	Reading Level dBuV/m	Correct Factor dB	Measure ment dBuV/m	Limit dBuV/m	Margin dB	Detector	Comment
1	5150.0000	38.35	15.74	54.09	74.00	-19.91	Peak	
2	5150.0000	30.90	15.74	46.64	54.00	-7.36	AVG	
3	5182.0000	69.21	15.80	85.01	999.00	-913.99	AVG	No Limit
4 *	5184.5000	78.18	15.81	93.99	68.30	25.69	Peak	No Limit

**REMARKS:**

- (1) Measurement Value = Reading Level + Correct Factor.
- (2) Margin Level = Measurement Value - Limit Value.

Orthogonal Axis	X
Test Mode	UNII-1_TX N (HT40) Mode 5190 MHz

**Horizontal**



No.	Freq. MHz	Reading Level dBuV/m	Correct Factor dB	Measure ment dBuV/m	Limit dBuV/m	Margin dB	Detector	Comment
1 *	10401.3500	35.68	12.55	48.23	68.30	-20.07	Peak	

**REMARKS:**

- (1) Measurement Value = Reading Level + Correct Factor.
- (2) Margin Level = Measurement Value - Limit Value.

Orthogonal Axis	X
Test Mode	UNII-1_TX N (HT40) Mode 5230 MHz

**Vertical**

130 dBuV/m

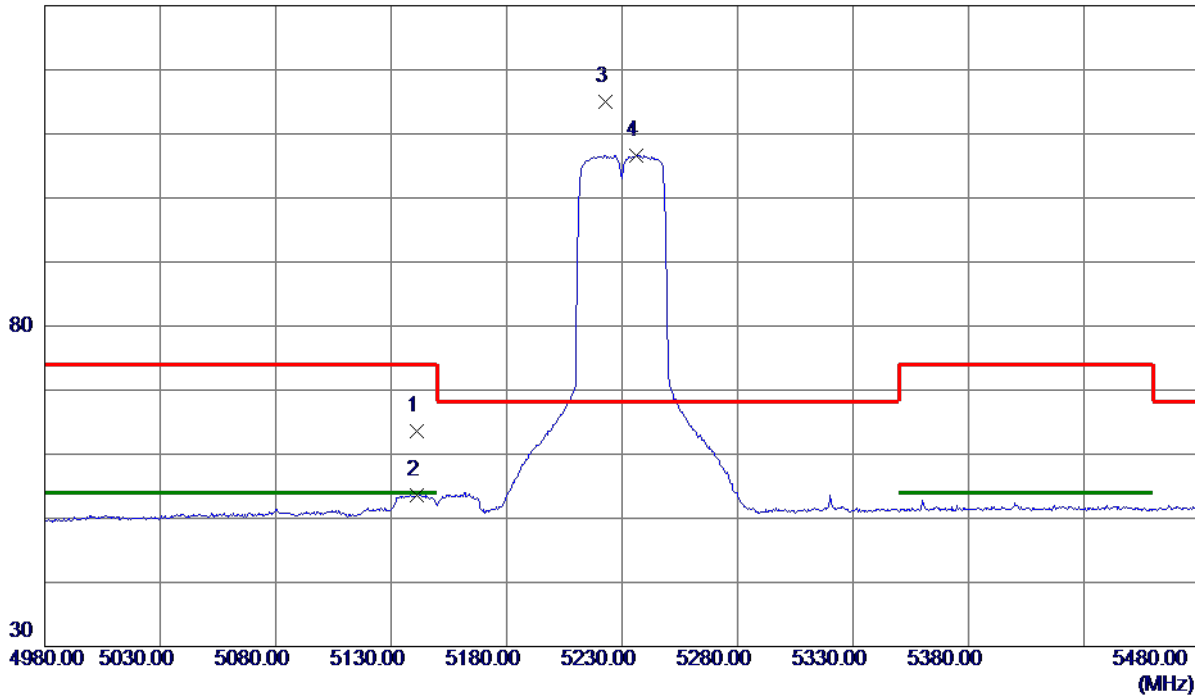

No.	Freq. MHz	Reading Level dBuV/m	Correct Factor dB	Measure ment dBuV/m	Limit dBuV/m	Margin dB	Detector	Comment
1	5141.0000	47.92	15.72	63.64	74.00	-10.36	Peak	
2	5141.0000	37.91	15.72	53.63	54.00	-0.37	AVG	
3 *	5223.0000	99.14	15.88	115.02	68.30	46.72	Peak	No Limit
4	5236.0000	90.73	15.91	106.64	999.00	-892.36	AVG	No Limit

**REMARKS:**

- (1) Measurement Value = Reading Level + Correct Factor.
- (2) Margin Level = Measurement Value - Limit Value.

Orthogonal Axis	X
Test Mode	UNII-1_TX N (HT40) Mode 5230 MHz

**Vertical**

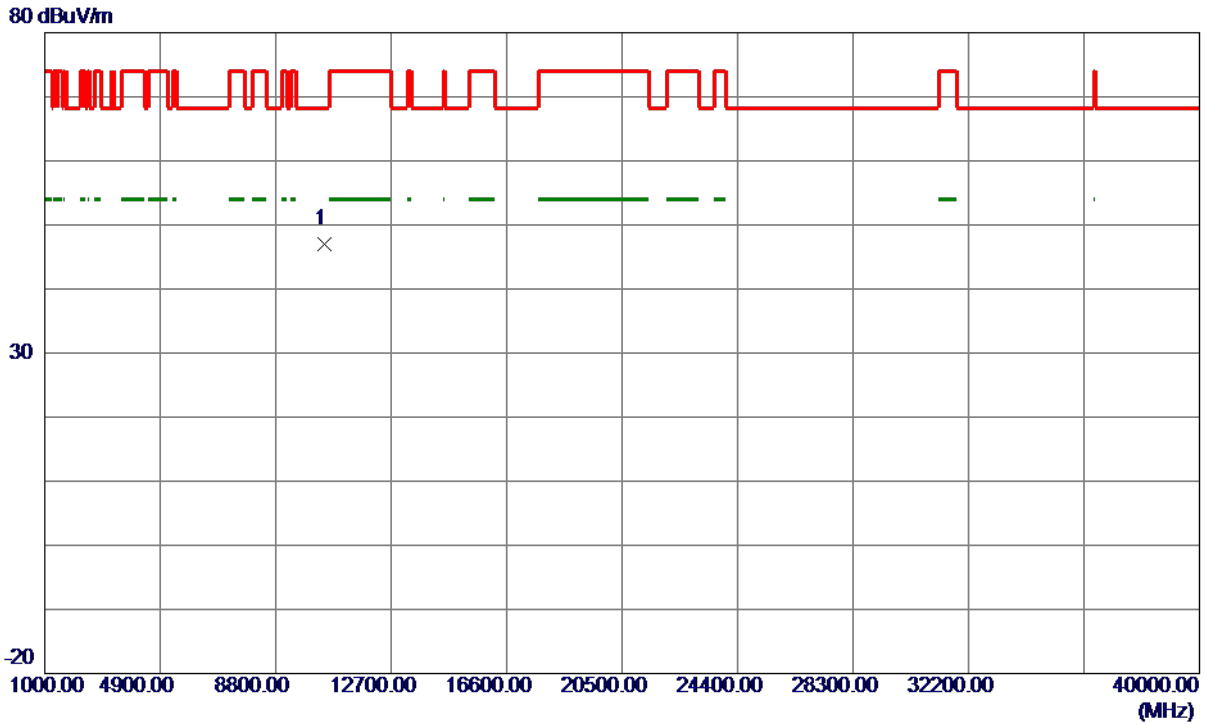

No.	Freq. MHz	Reading Level dBuV/m	Correct Factor dB	Measure ment dBuV/m	Limit dBuV/m	Margin dB	Detector	Comment
1 *	10467.0599	34.31	12.69	47.00	68.30	-21.30	Peak	

**REMARKS:**

- (1) Measurement Value = Reading Level + Correct Factor.
- (2) Margin Level = Measurement Value - Limit Value.

Orthogonal Axis	X
Test Mode	UNII-1_TX N (HT40) Mode 5230 MHz

### Horizontal

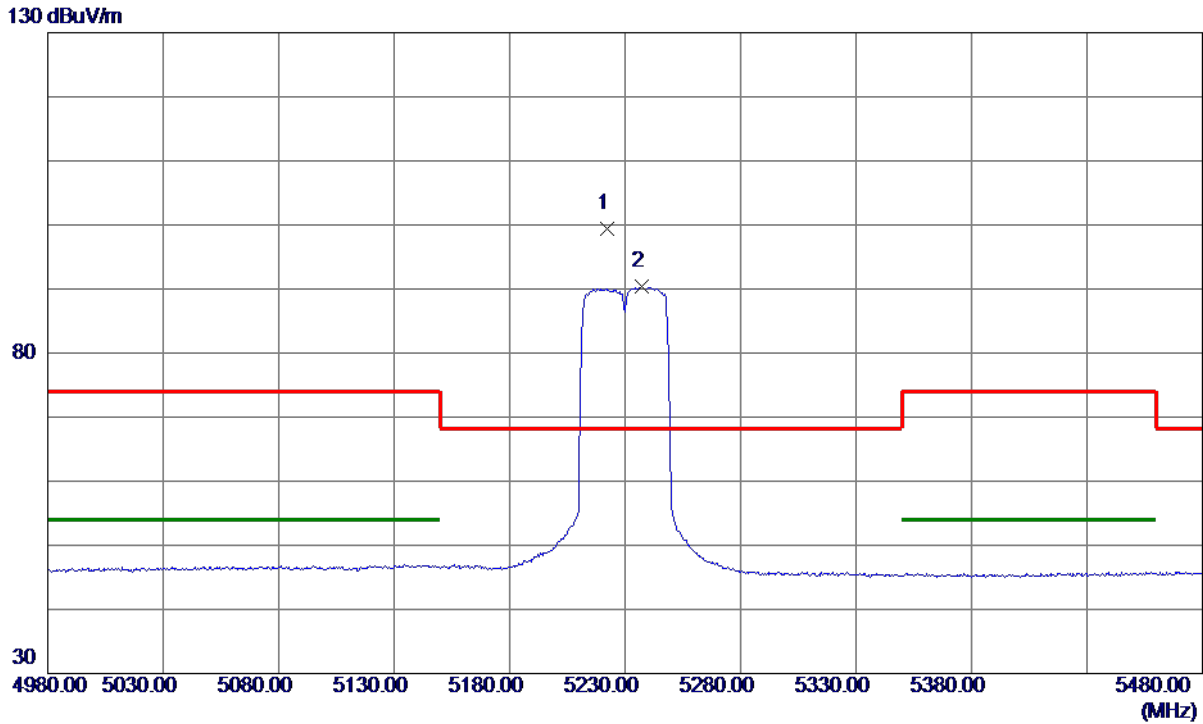

No.	Freq. MHz	Reading Level dBuV/m	Correct Factor dB	Measure ment dBuV/m	Limit dBuV/m	Margin dB	Detector	Comment
1 *	5222.2500	83.45	15.88	99.33	68.30	31.03	Peak	No Limit
2	5237.0000	74.40	15.91	90.31	999.00	-908.69	AVG	No Limit

**REMARKS:**

- (1) Measurement Value = Reading Level + Correct Factor.
- (2) Margin Level = Measurement Value - Limit Value.

Orthogonal Axis	X
Test Mode	UNII-1_TX N (HT40) Mode 5230 MHz

**Horizontal**

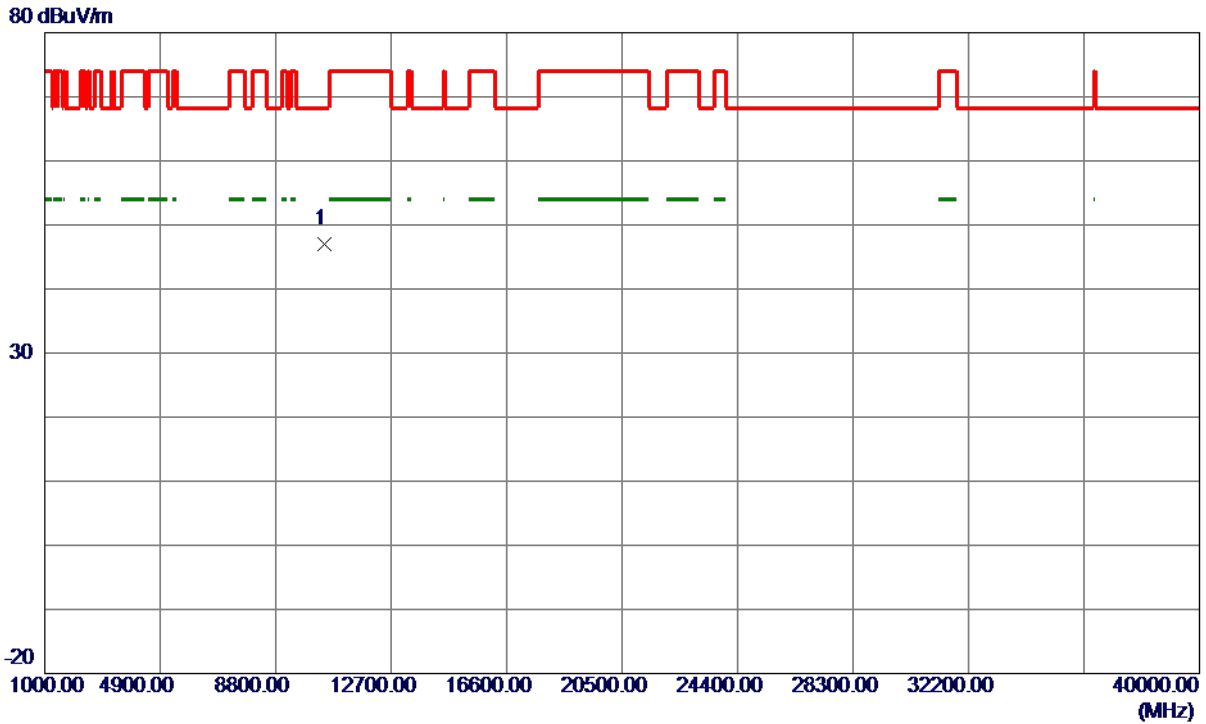

No.	Freq. MHz	Reading Level dBuV/m	Correct Factor dB	Measure ment dBuV/m	Limit dBuV/m	Margin dB	Detector	Comment
1 *	10465.2300	34.23	12.69	46.92	68.30	-21.38	Peak	

**REMARKS:**

- (1) Measurement Value = Reading Level + Correct Factor.
- (2) Margin Level = Measurement Value - Limit Value.

Orthogonal Axis	X
Test Mode	UNII-3_TX A (10M) Mode 5745 MHz

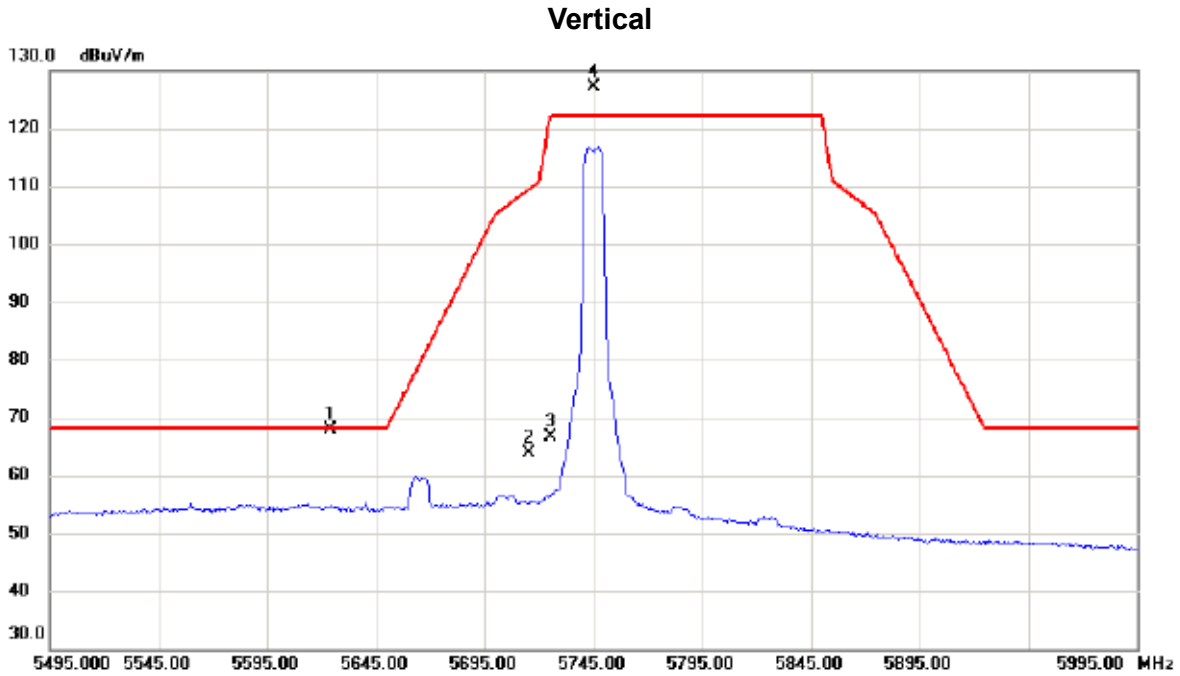

No.	Mk.	Freq. MHz	Reading Level dBuV	Correct Factor dB	Measure- ment dBuV/m	Limit dBuV/m	Margin dB	Detector	Comment
1		5623.750	51.24	16.55	67.79	68.20	-0.41	peak	
2		5715.000	47.18	16.64	63.82	109.40	-45.58	peak	
3		5725.000	49.99	16.64	66.63	122.20	-55.57	peak	
4	*	5745.250	110.38	16.66	127.04	122.20	4.84	peak	No Limit

REMARKS:

- (1) Measurement Value = Reading Level + Correct Factor.
- (2) Margin Level = Measurement Value - Limit Value.



Orthogonal Axis	X
Test Mode	UNII-3_TX A (10M) Mode 5745 MHz

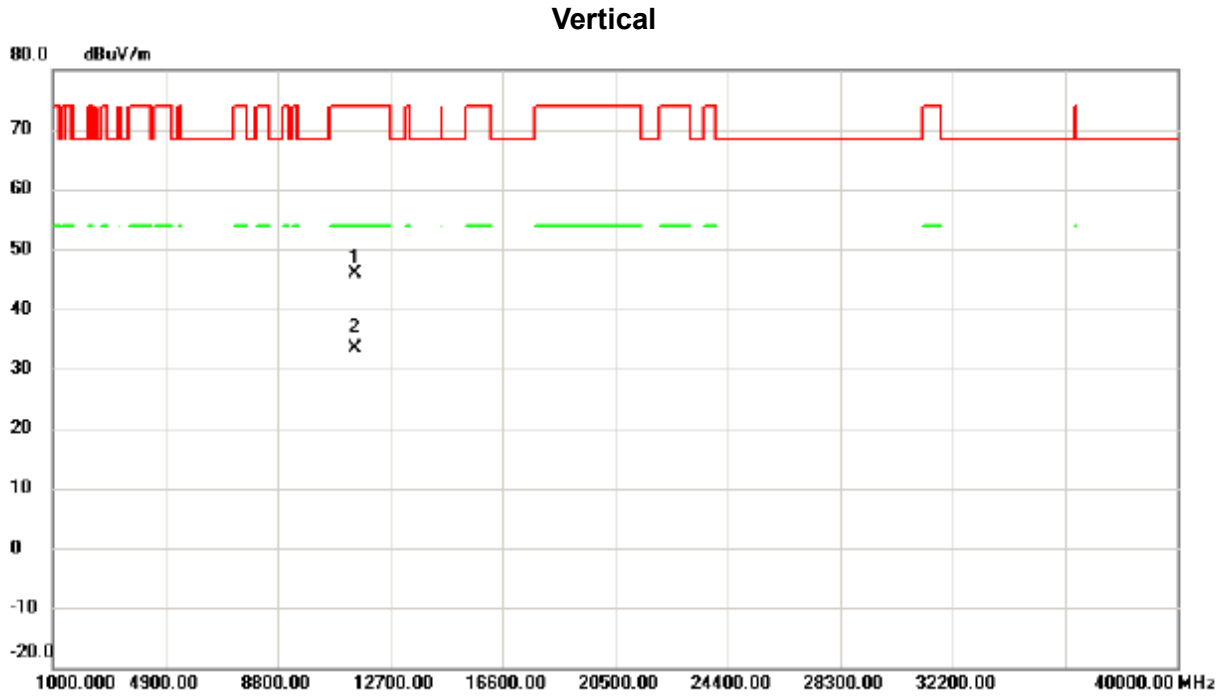

No.	Mk.	Freq. MHz	Reading Level dBuV	Correct Factor dB	Measure- ment dBuV/m	Limit dBuV/m	Margin dB	Detector	Comment
1		11480.070	32.07	13.82	45.89	74.00	-28.11	peak	
2	*	11480.940	19.63	13.82	33.45	54.00	-20.55	AVG	

**REMARKS:**

- (1) Measurement Value = Reading Level + Correct Factor.
- (2) Margin Level = Measurement Value - Limit Value.

Orthogonal Axis	X
Test Mode	UNII-3_TX A (10M) Mode 5745 MHz

### Horizontal

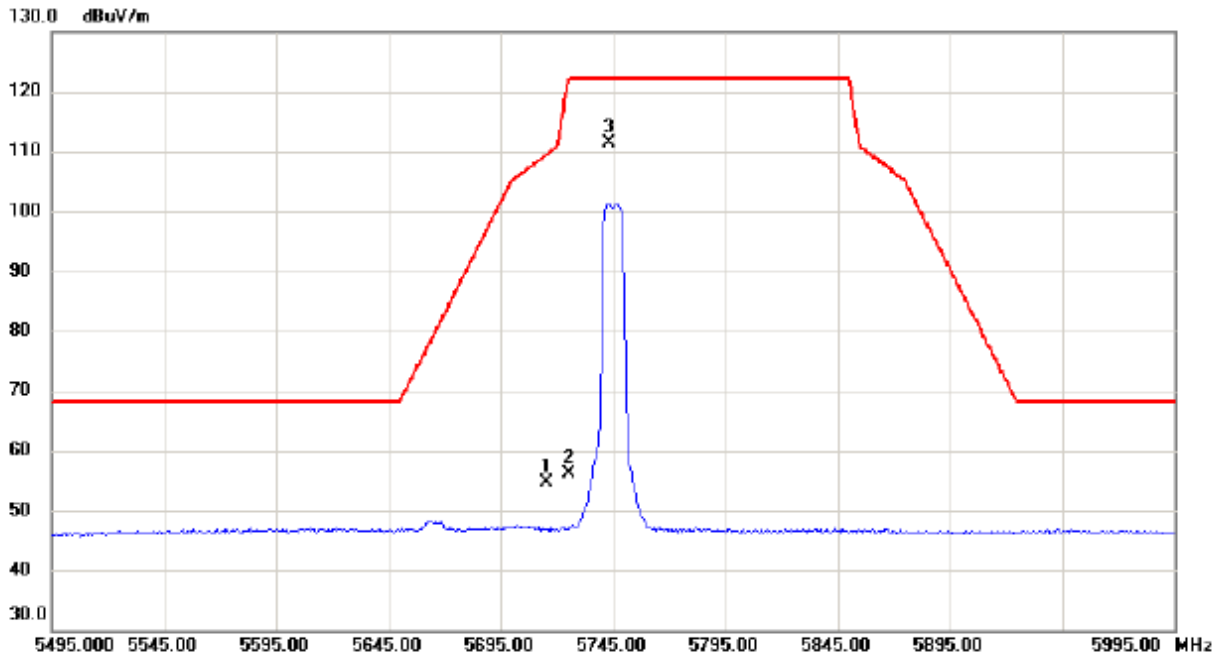

No.	Mk.	Freq. MHz	Reading Level dBuV	Correct Factor dB	Measure- ment dBuV/m	Limit dBuV/m	Margin dB	Detector	Comment
1		5715.000	38.01	16.64	54.65	109.40	-54.75	peak	
2		5725.000	39.52	16.64	56.16	122.20	-66.04	peak	
3 *		5743.000	94.72	16.66	111.38	122.20	-10.82	peak	No Limit

**REMARKS:**

- (1) Measurement Value = Reading Level + Correct Factor.
- (2) Margin Level = Measurement Value - Limit Value.

Orthogonal Axis	X
Test Mode	UNII-3_TX A (10M) Mode 5745 MHz

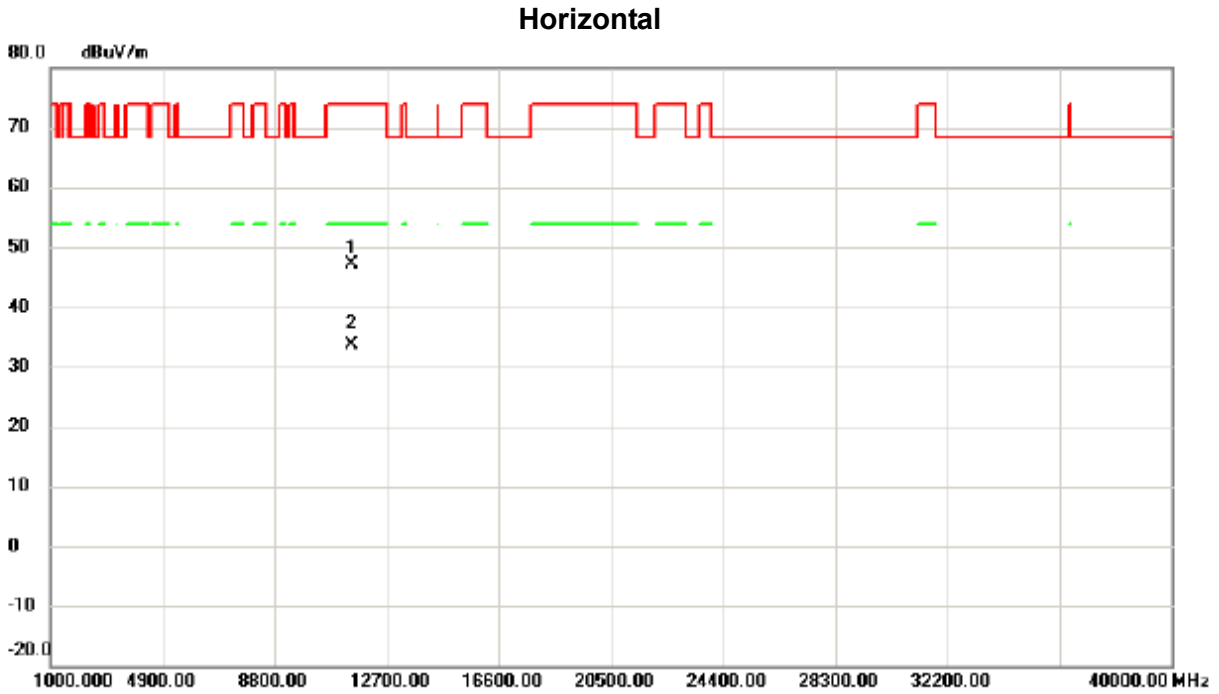

No.	Mk.	Freq. MHz	Reading Level dBuV	Correct Factor dB	Measure- ment dBuV/m	Limit dBuV/m	Margin dB	Detector	Comment
1		11490.090	33.27	13.84	47.11	74.00	-26.89	peak	
2	*	11492.920	19.81	13.84	33.65	54.00	-20.35	AVG	

REMARKS:

- (1) Measurement Value = Reading Level + Correct Factor.
- (2) Margin Level = Measurement Value - Limit Value.

Orthogonal Axis	X
Test Mode	UNII-3_TX A (10M) Mode 5785 MHz

Vertical

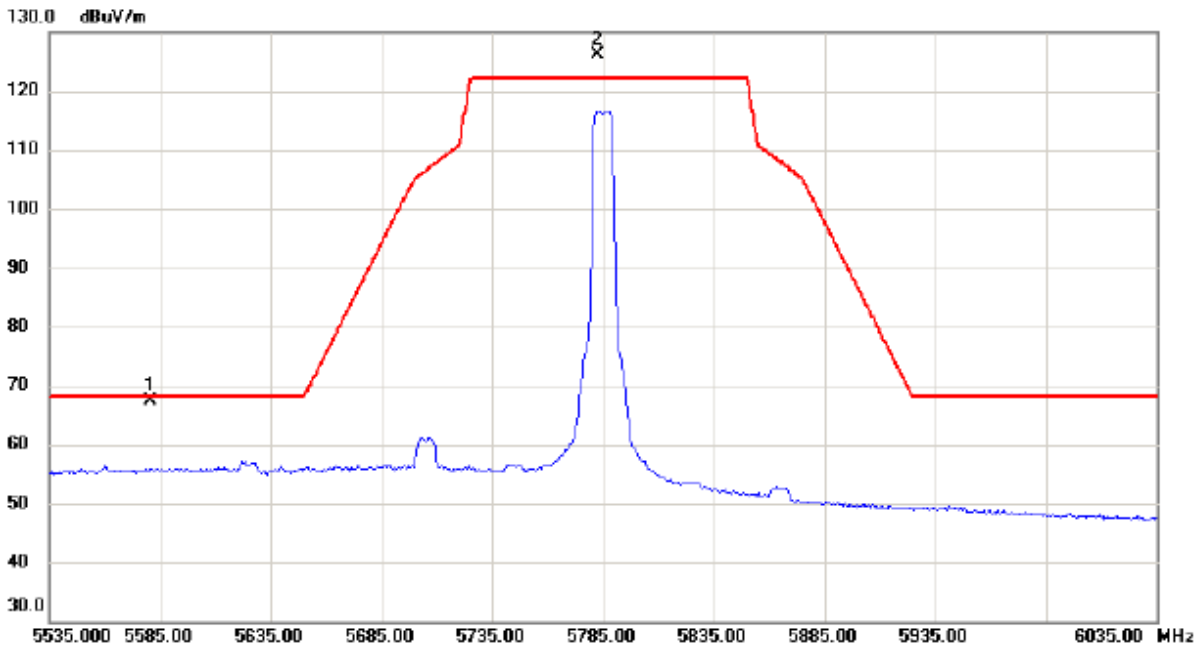

No.	Mk.	Freq.	Reading Level	Correct Factor	Measurement	Limit	Margin	Detector	Comment
		MHz	dBuV	dB	dBuV/m	dBuV/m	dB		
1		5580.500	50.89	16.51	67.40	68.20	-0.80	peak	
2 *		5782.500	109.51	16.69	126.20	122.20	4.00	peak	No Limit

REMARKS:

- (1) Measurement Value = Reading Level + Correct Factor.
- (2) Margin Level = Measurement Value - Limit Value.

Orthogonal Axis	X
Test Mode	UNII-3_TX A (10M) Mode 5785 MHz

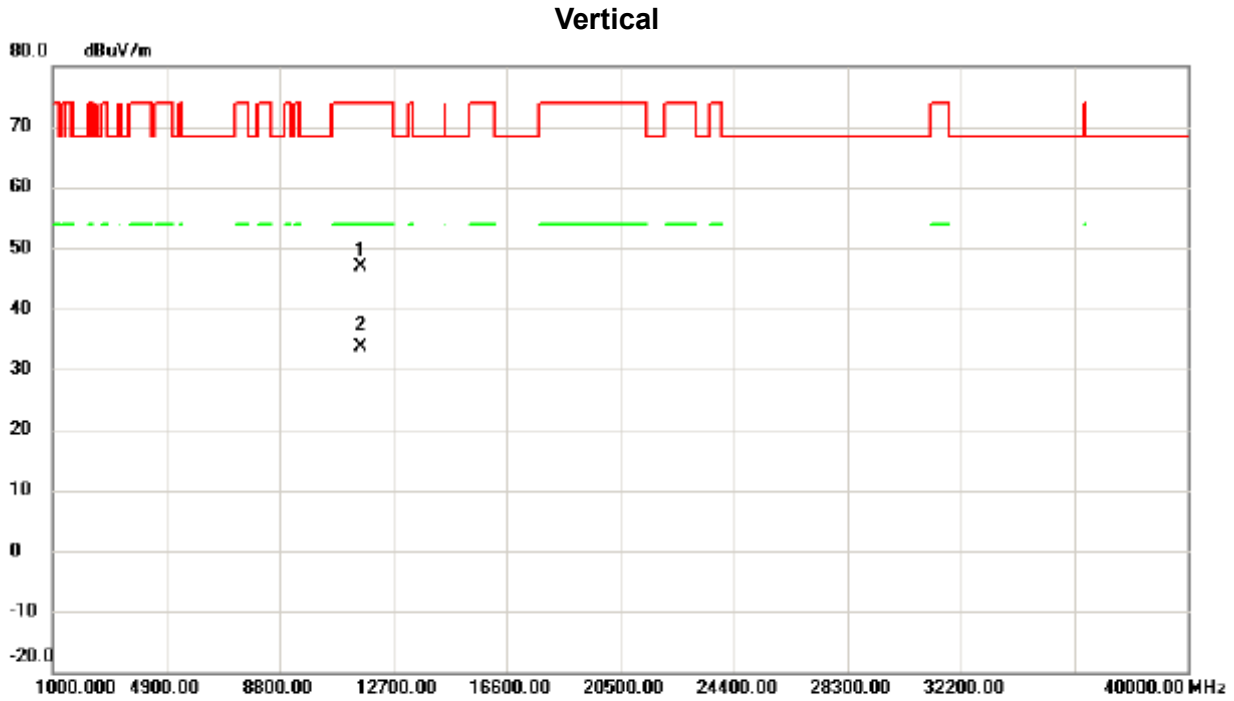

No.	Mk.	Freq.	Reading Level	Correct Factor	Measurement	Limit	Margin	Detector	Comment
		MHz	dBuV	dB	dBuV/m	dBuV/m	dB		
1		11563.670	33.12	13.85	46.97	74.00	-27.03	peak	
2	*	11565.740	19.88	13.85	33.73	54.00	-20.27	AVG	

REMARKS:

- (1) Measurement Value = Reading Level + Correct Factor.
- (2) Margin Level = Measurement Value - Limit Value.

Orthogonal Axis	X
Test Mode	UNII-3_TX A (10M) Mode 5785 MHz

Horizontal

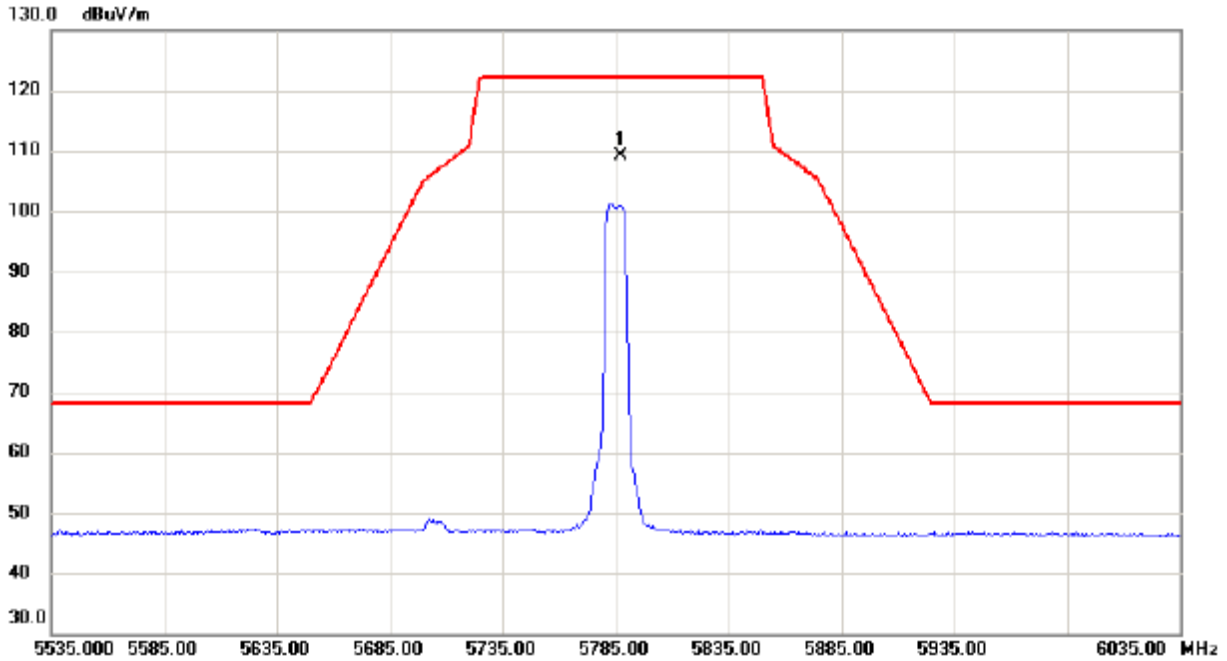

No.	Mk.	Freq.	Reading Level	Correct Factor	Measurement	Limit	Margin	Detector	Comment
		MHz	dBuV	dB	dBuV/m	dBuV/m	dB		
1	*	5787.250	92.47	16.69	109.16	122.20	-13.04	peak	No Limit

REMARKS:

- (1) Measurement Value = Reading Level + Correct Factor.
- (2) Margin Level = Measurement Value - Limit Value.

Orthogonal Axis	X
Test Mode	UNII-3_TX A (10M) Mode 5785 MHz

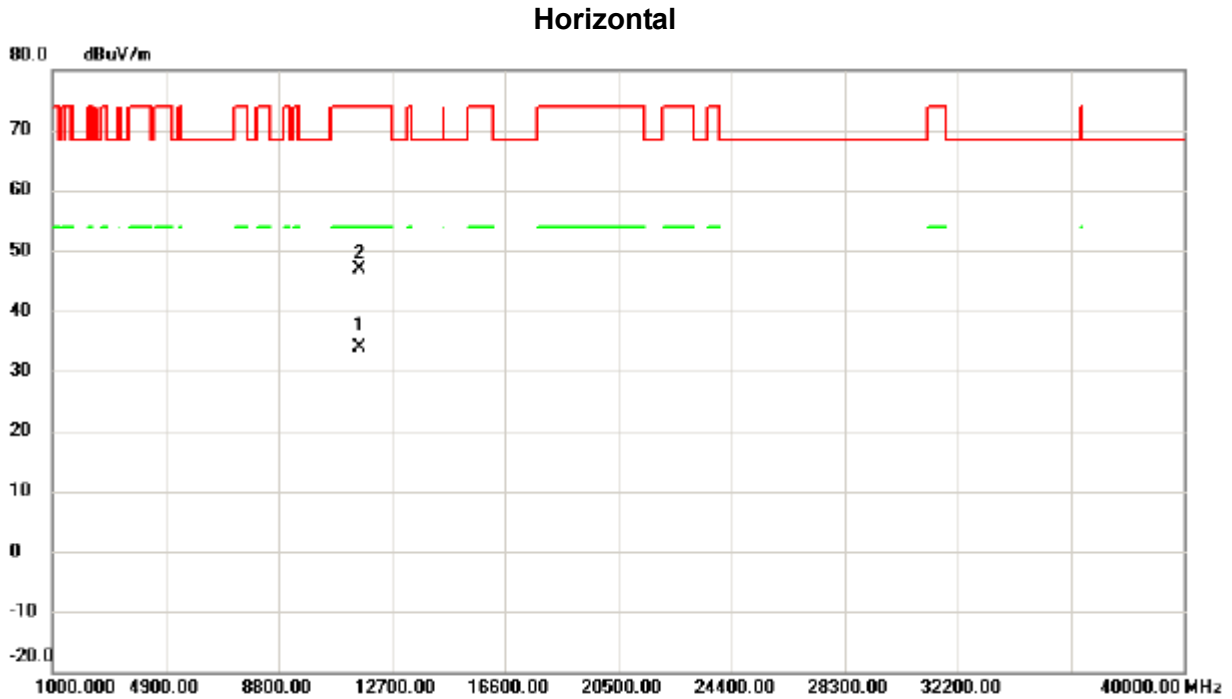

No.	Mk.	Freq. MHz	Reading Level dBuV	Correct Factor dB	Measure- ment dBuV/m	Limit dBuV/m	Margin dB	Detector	Comment
1	*	11565.690	20.05	13.85	33.90	54.00	-20.10	AVG	
2		11571.150	33.01	13.85	46.86	74.00	-27.14	peak	

**REMARKS:**

- (1) Measurement Value = Reading Level + Correct Factor.
- (2) Margin Level = Measurement Value - Limit Value.

Orthogonal Axis	X
Test Mode	UNII-3_TX A (10M) Mode 5825 MHz

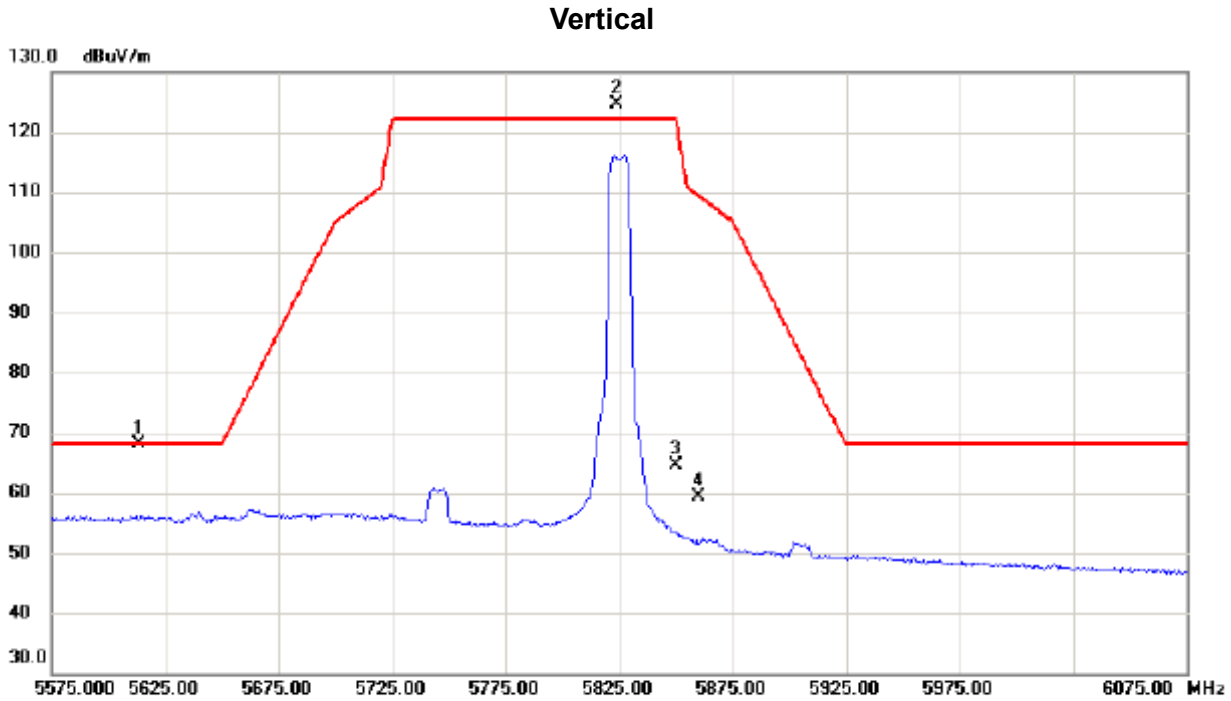

No.	Mk.	Freq. MHz	Reading Level dBuV	Correct Factor dB	Measure- ment dBuV/m	Limit dBuV/m	Margin dB	Detector	Comment
1		5613.500	51.52	16.54	68.06	68.20	-0.14	peak	
2	*	5824.000	107.87	16.74	124.61	122.20	2.41	peak	No Limit
3		5850.000	47.79	16.75	64.54	122.20	-57.66	peak	
4		5860.000	42.56	16.76	59.32	109.40	-50.08	peak	

REMARKS:  
 (1) Measurement Value = Reading Level + Correct Factor.  
 (2) Margin Level = Measurement Value - Limit Value.



Orthogonal Axis	X
Test Mode	UNII-3_TX A (10M) Mode 5825 MHz

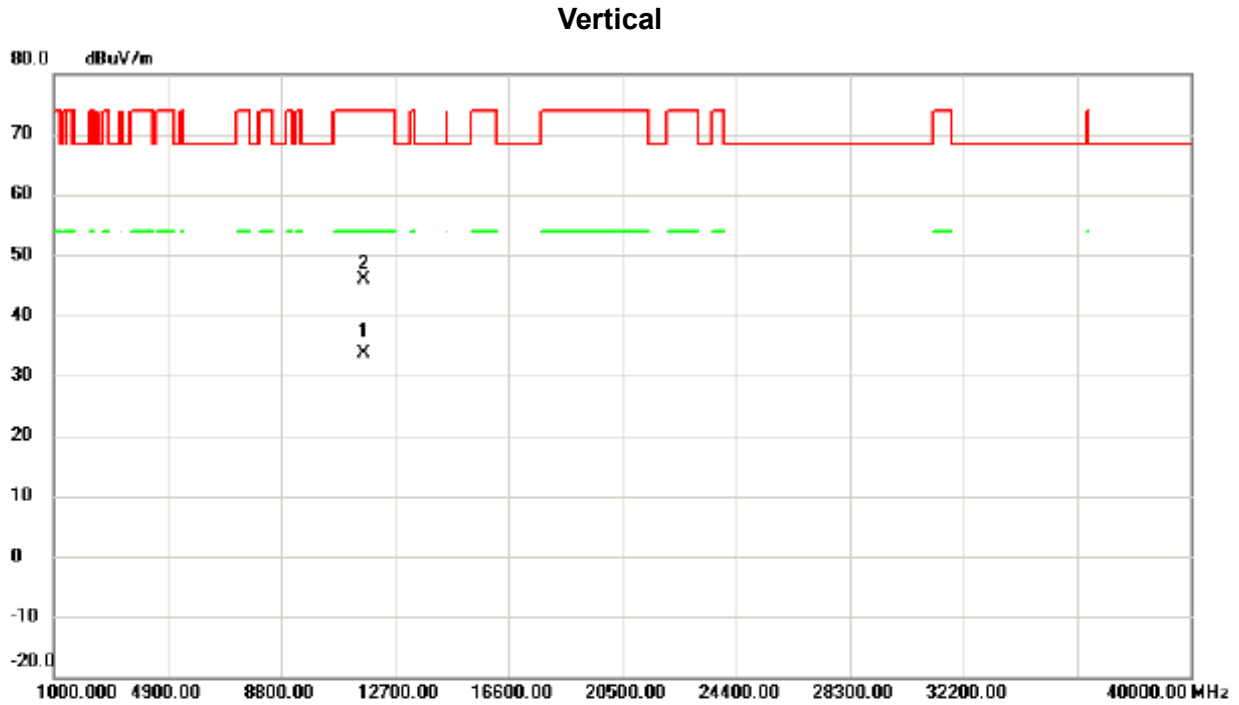

No.	Mk.	Freq. MHz	Reading Level dBuV	Correct Factor dB	Measure- ment dBuV/m	Limit dBuV/m	Margin dB	Detector	Comment
1	*	11640.690	19.77	13.86	33.63	54.00	-20.37	AVG	
2		11652.620	32.07	13.86	45.93	74.00	-28.07	peak	

**REMARKS:**

- (1) Measurement Value = Reading Level + Correct Factor.
- (2) Margin Level = Measurement Value - Limit Value.

Orthogonal Axis	X
Test Mode	UNII-3_TX A (10M) Mode 5825 MHz

**Horizontal**

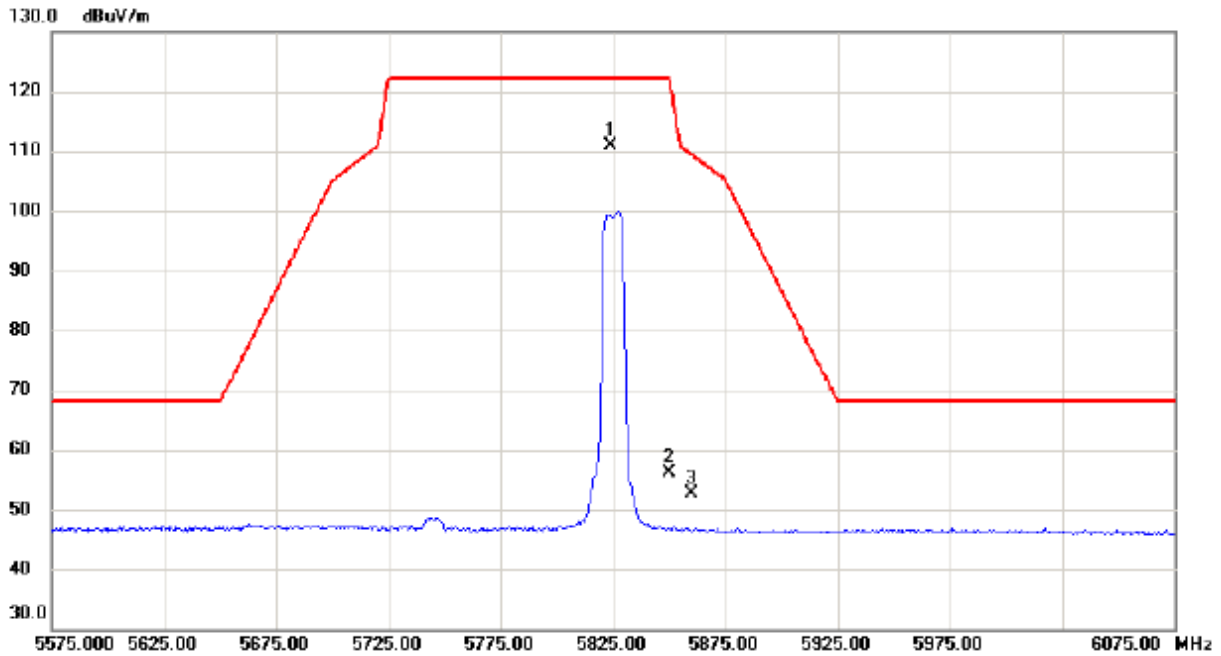

No.	Mk.	Freq.	Reading Level	Correct Factor	Measurement	Limit	Margin		
		MHz	dBuV	dB	dBuV/m	dBuV/m	dB	Detector	Comment
1	*	5823.750	94.25	16.74	110.99	122.20	-11.21	peak	No Limit
2		5850.000	39.37	16.75	56.12	122.20	-66.08	peak	
3		5860.000	35.79	16.76	52.55	109.40	-56.85	peak	

**REMARKS:**

- (1) Measurement Value = Reading Level + Correct Factor.
- (2) Margin Level = Measurement Value - Limit Value.

Orthogonal Axis	X
Test Mode	UNII-3_TX A (10M) Mode 5825 MHz

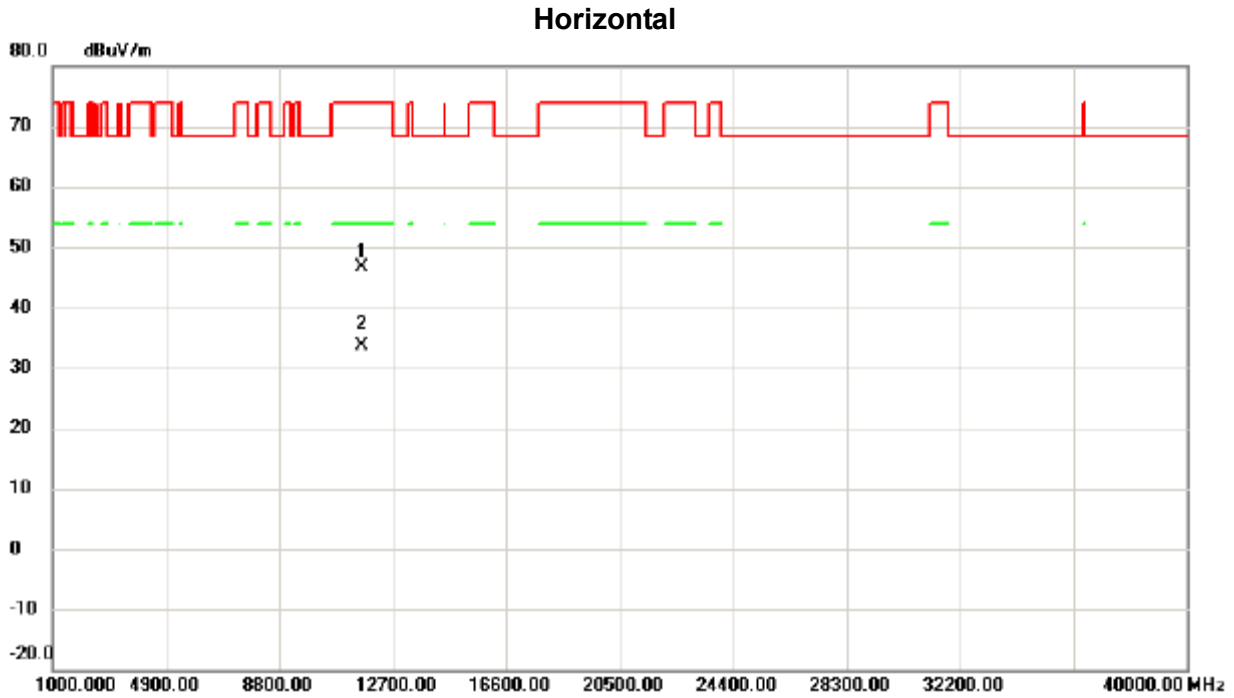

No.	Mk.	Freq.	Reading Level	Correct Factor	Measurement	Limit	Margin	Detector	Comment
		MHz	dBuV	dB	dBuV/m	dBuV/m	dB		
1		11641.510	32.71	13.86	46.57	74.00	-27.43	peak	
2	*	11643.410	19.79	13.86	33.65	54.00	-20.35	AVG	

REMARKS:

- (1) Measurement Value = Reading Level + Correct Factor.
- (2) Margin Level = Measurement Value - Limit Value.

Orthogonal Axis	X
Test Mode	UNII-3_TX A (20M) Mode 5745 MHz

**Vertical**

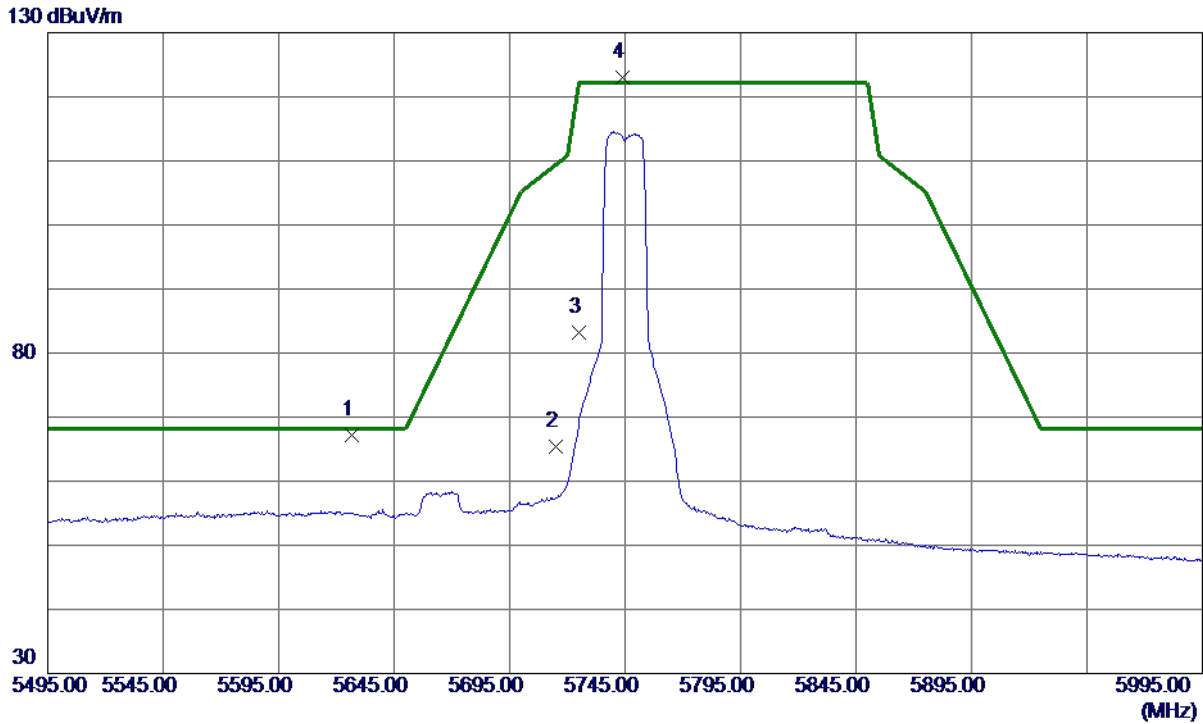

No.	Freq. MHz	Reading Level dBuV/m	Correct Factor dB	Measure ment dBuV/m	Limit dBuV/m	Margin dB	Detector	Comment
1	5626.5000	50.71	16.55	67.26	68.20	-0.94	Peak	
2	5715.0000	48.72	16.63	65.35	109.40	-44.05	Peak	
3	5725.0000	66.61	16.64	83.25	122.20	-38.95	Peak	
4 *	5744.0000	106.42	16.66	123.08	122.20	0.88	Peak	No Limit

**REMARKS:**

- (1) Measurement Value = Reading Level + Correct Factor.
- (2) Margin Level = Measurement Value - Limit Value.

Orthogonal Axis	X
Test Mode	UNII-3_TX A (20M) Mode 5745 MHz

**Vertical**

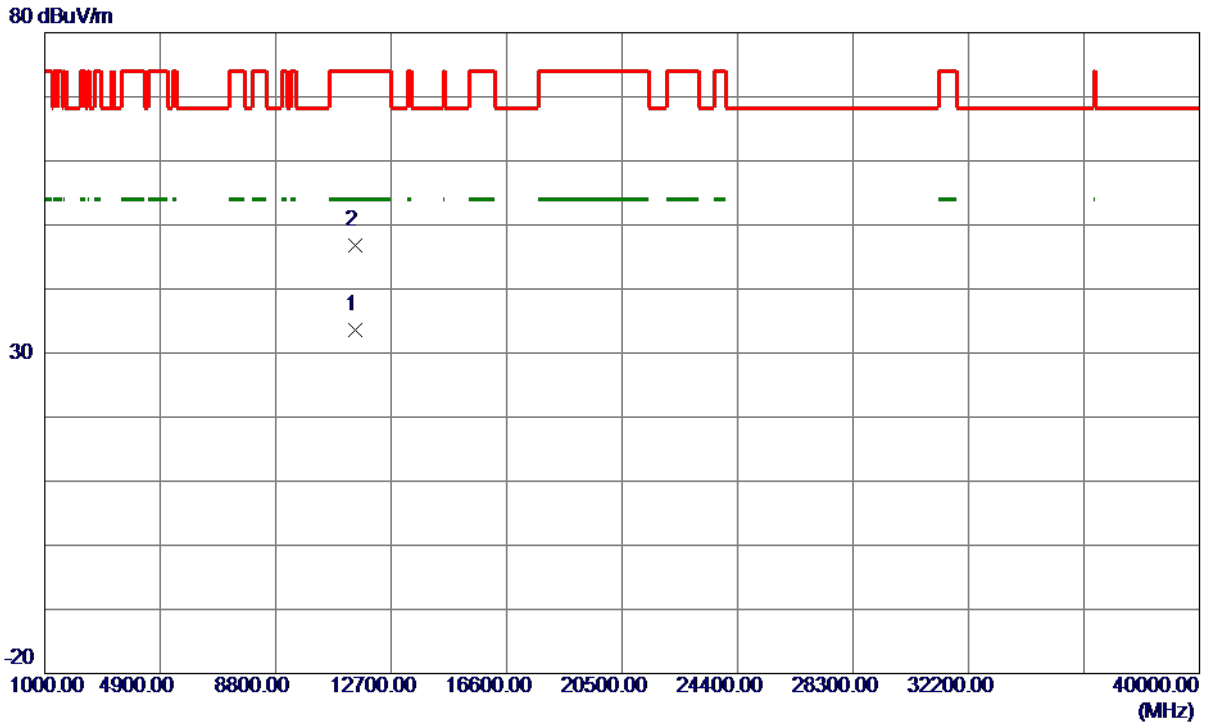

No.	Freq. MHz	Reading Level dBuV/m	Correct Factor dB	Measure ment dBuV/m	Limit dBuV/m	Margin dB	Detector	Comment
1 *	11480.6600	19.69	13.82	33.51	54.00	-20.49	AVG	
2	11480.8300	33.03	13.82	46.85	74.00	-27.15	Peak	

**REMARKS:**

- (1) Measurement Value = Reading Level + Correct Factor.
- (2) Margin Level = Measurement Value - Limit Value.

Orthogonal Axis	X
Test Mode	UNII-3_TX A (20M) Mode 5745 MHz

**Horizontal**

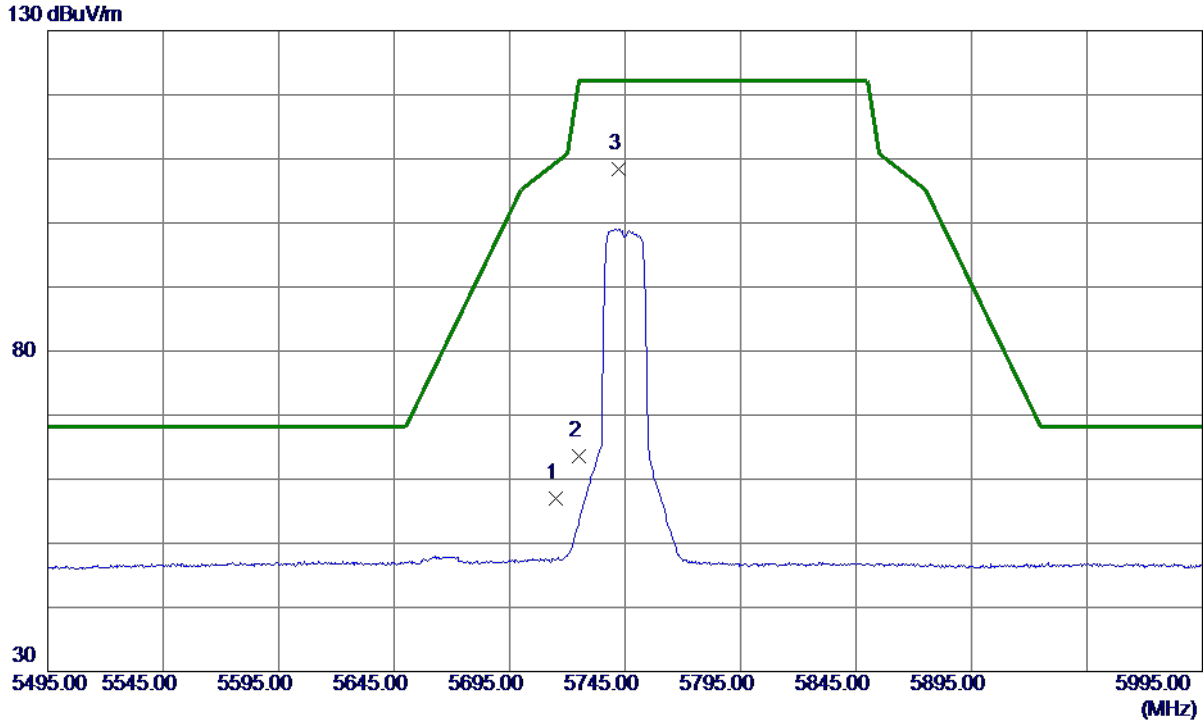

No.	Freq. MHz	Reading Level dBuV/m	Correct Factor dB	Measure ment dBuV/m	Limit dBuV/m	Margin dB	Detector	Comment
1	5715.0000	40.44	16.63	57.07	109.40	-52.33	Peak	
2	5725.0000	46.88	16.64	63.52	122.20	-58.68	Peak	
3 *	5742.0000	91.74	16.66	108.40	122.20	-13.80	Peak	No Limit

**REMARKS:**

- (1) Measurement Value = Reading Level + Correct Factor.
- (2) Margin Level = Measurement Value - Limit Value.

Orthogonal Axis	X
Test Mode	UNII-3_TX A (20M) Mode 5745 MHz

**Horizontal**

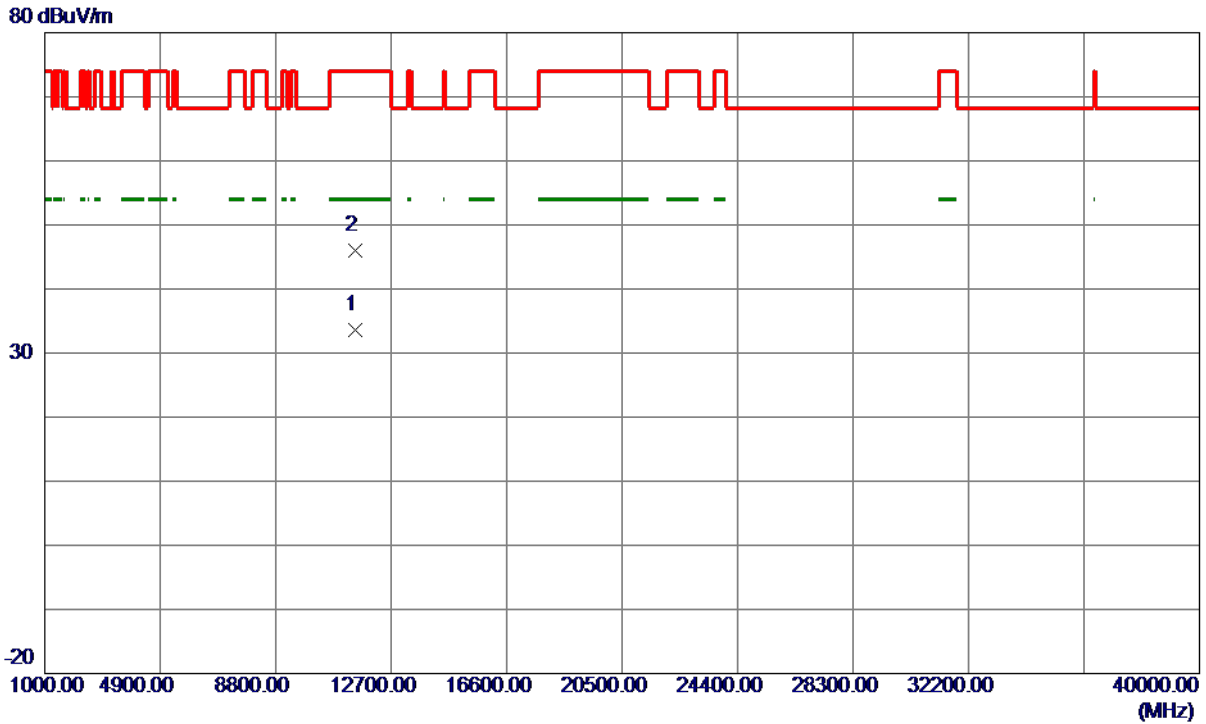

No.	Freq. MHz	Reading Level dBuV/m	Correct Factor dB	Measure ment dBuV/m	Limit dBuV/m	Margin dB	Detector	Comment
1 *	11493.0199	19.85	13.84	33.69	54.00	-20.31	AVG	
2	11496.2200	32.11	13.84	45.95	74.00	-28.05	Peak	

**REMARKS:**

- (1) Measurement Value = Reading Level + Correct Factor.
- (2) Margin Level = Measurement Value - Limit Value.

Orthogonal Axis	X
Test Mode	UNII-3_TX A (20M) Mode 5785 MHz

**Vertical**

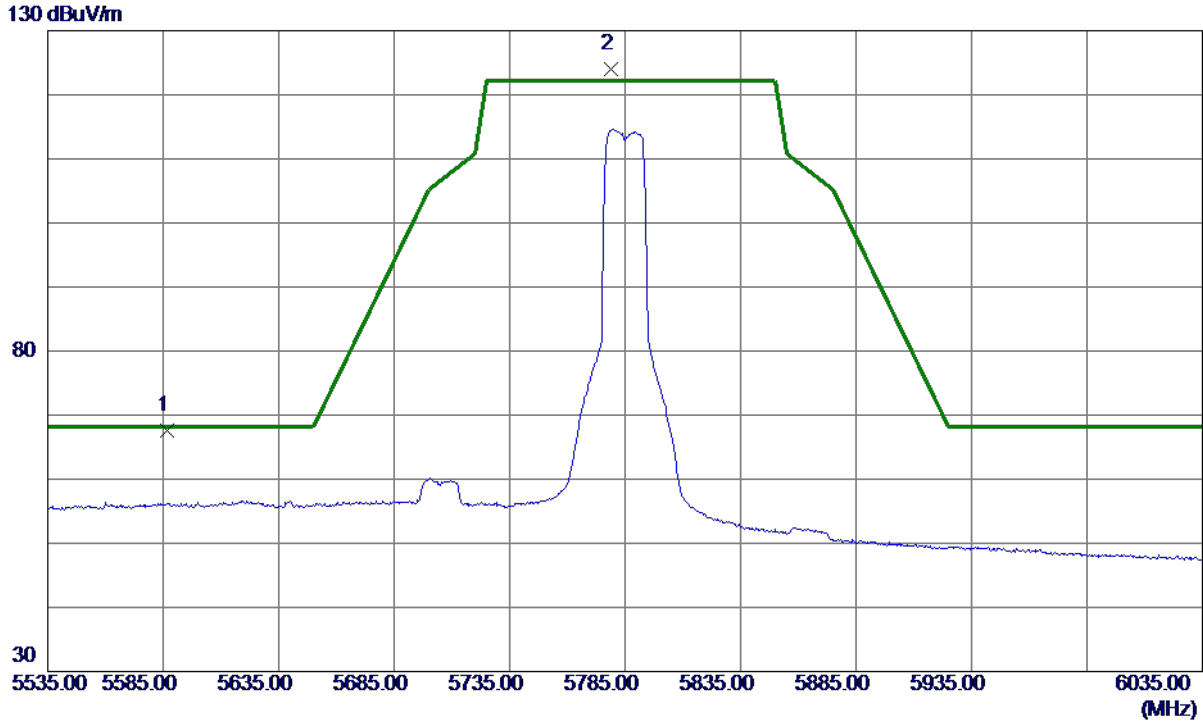

No.	Freq. MHz	Reading Level dBuV/m	Correct Factor dB	Measure ment dBuV/m	Limit dBuV/m	Margin dB	Detector	Comment
1	5586.7500	51.06	16.51	67.57	68.20	-0.63	Peak	
2 *	5779.0000	107.37	16.69	124.06	122.20	1.86	Peak	No Limit

**REMARKS:**

- (1) Measurement Value = Reading Level + Correct Factor.
- (2) Margin Level = Measurement Value - Limit Value.



Orthogonal Axis	X
Test Mode	UNII-3_TX A (20M) Mode 5785 MHz

**Vertical**

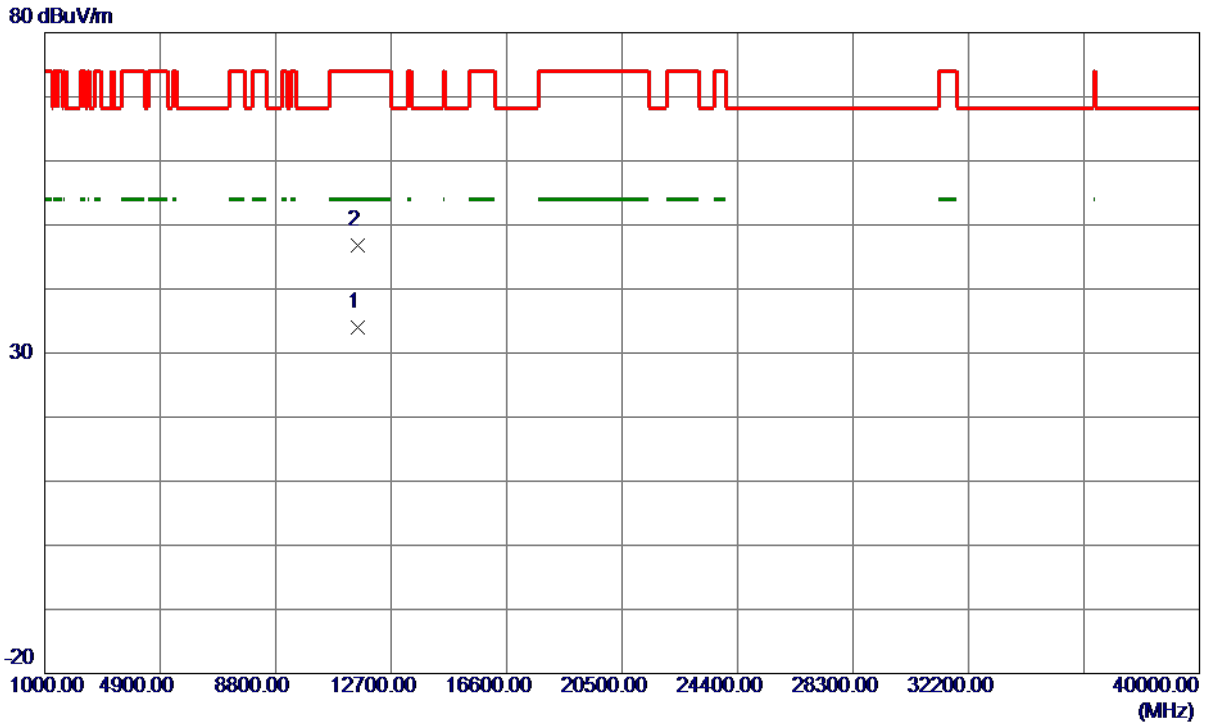

No.	Freq. MHz	Reading Level dBuV/m	Correct Factor dB	Measure ment dBuV/m	Limit dBuV/m	Margin dB	Detector	Comment
1 *	11564.3600	20.06	13.85	33.91	54.00	-20.09	AVG	
2	11567.3200	33.03	13.85	46.88	74.00	-27.12	Peak	

**REMARKS:**

- (1) Measurement Value = Reading Level + Correct Factor.
- (2) Margin Level = Measurement Value - Limit Value.

Orthogonal Axis	X
Test Mode	UNII-3_TX A (20M) Mode 5785 MHz

**Horizontal**

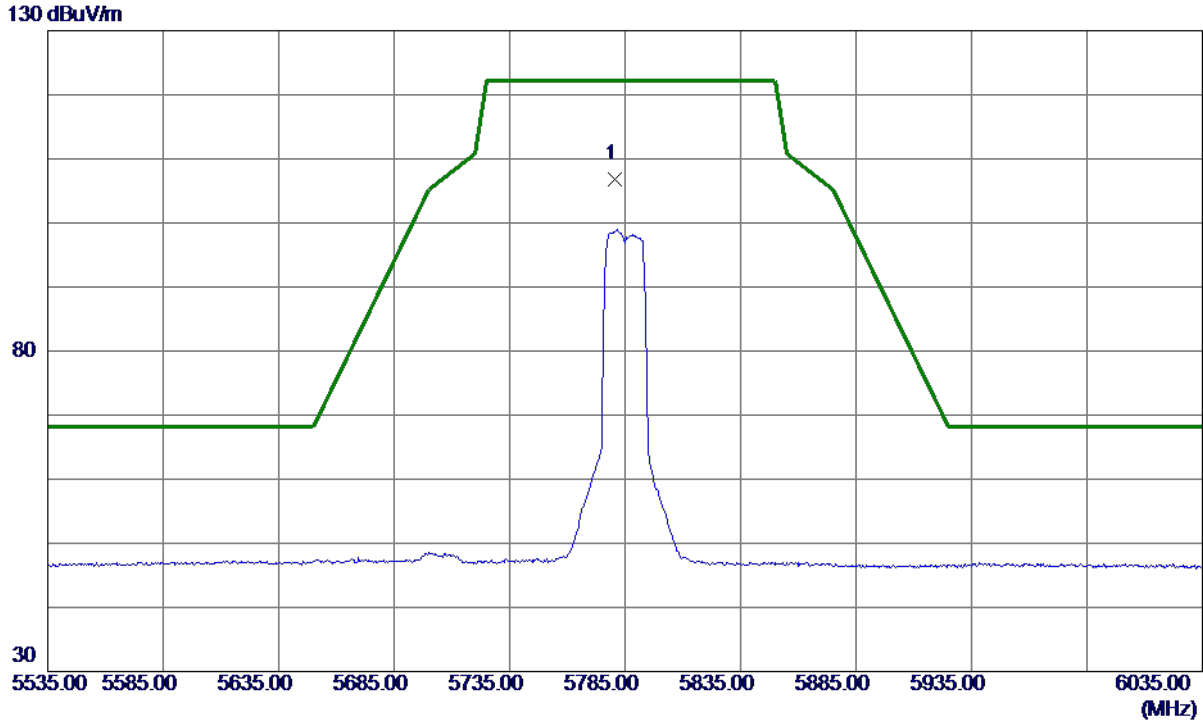

No.	Freq. MHz	Reading Level dBuV/m	Correct Factor dB	Measure ment dBuV/m	Limit dBuV/m	Margin dB	Detector	Comment
1 *	5780.5000	90.11	16.69	106.80	122.20	-15.40	Peak	No Limit

**REMARKS:**

- (1) Measurement Value = Reading Level + Correct Factor.
- (2) Margin Level = Measurement Value - Limit Value.

Orthogonal Axis	X
Test Mode	UNII-3_TX A (20M) Mode 5785 MHz

**Horizontal**

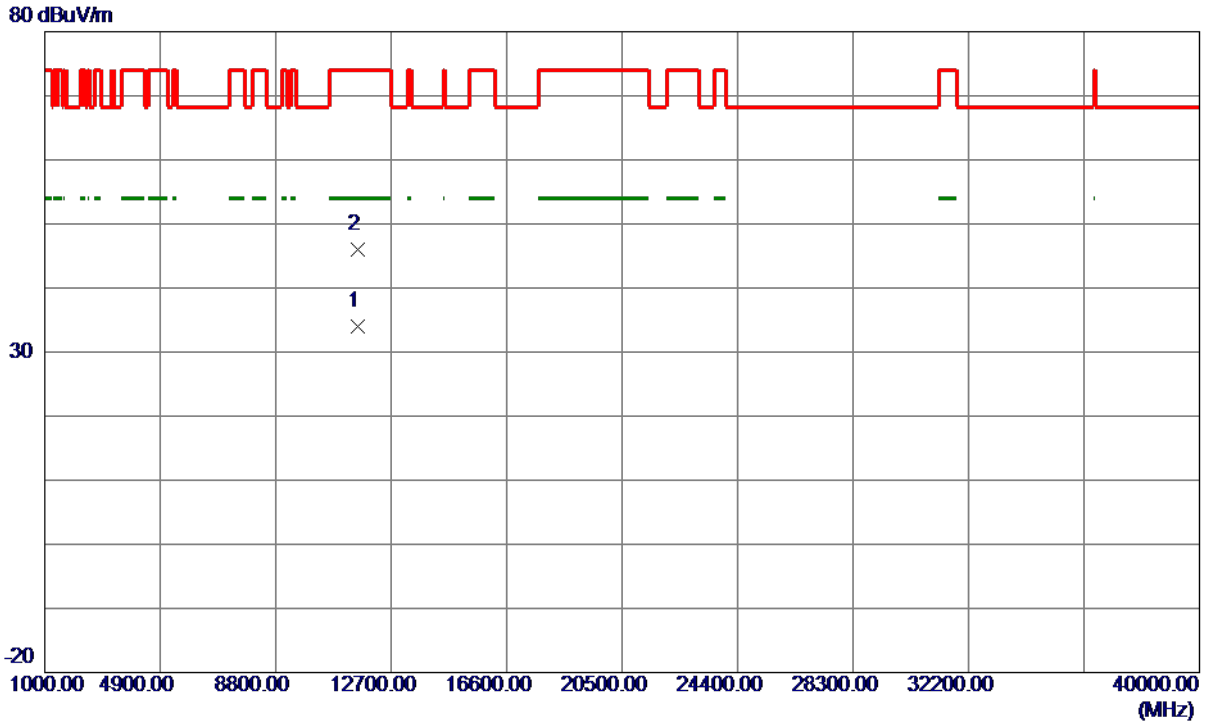

No.	Freq. MHz	Reading Level dBuV/m	Correct Factor dB	Measure ment dBuV/m	Limit dBuV/m	Margin dB	Detector	Comment
1 *	11565.8500	20.18	13.85	34.03	54.00	-19.97	AVG	
2	11567.1100	32.08	13.85	45.93	74.00	-28.07	Peak	

**REMARKS:**

- (1) Measurement Value = Reading Level + Correct Factor.
- (2) Margin Level = Measurement Value - Limit Value.

Orthogonal Axis	X
Test Mode	UNII-3_TX A (20M) Mode 5825 MHz

**Vertical**

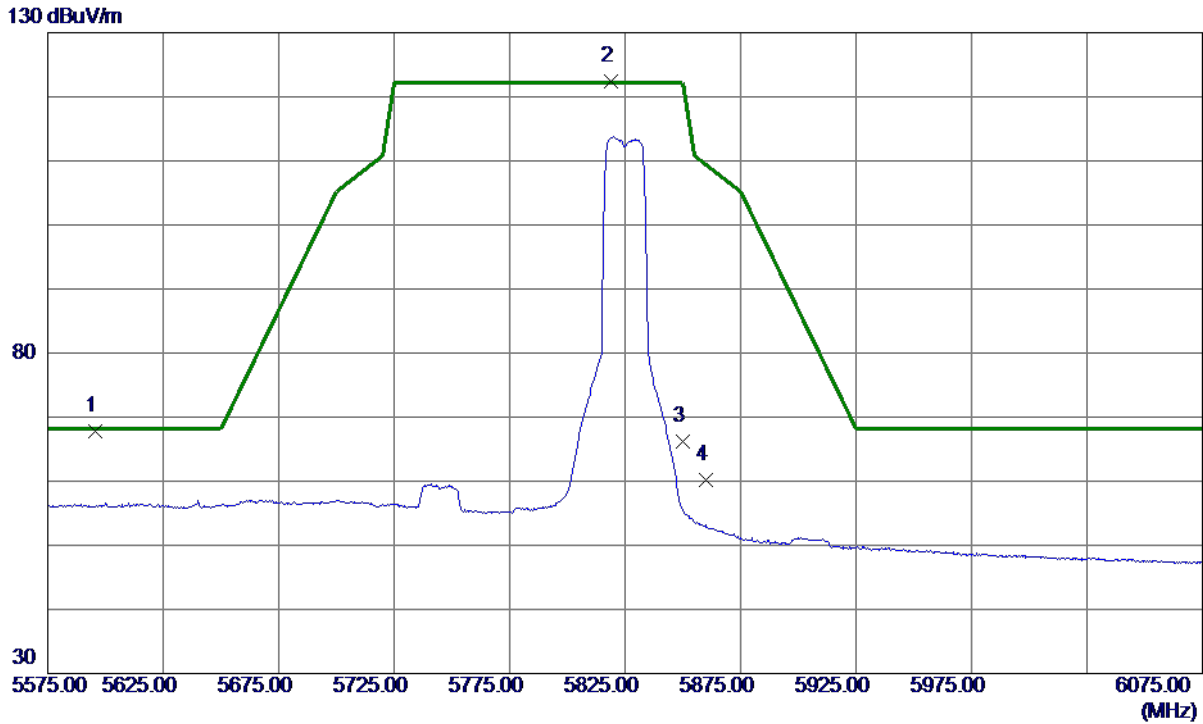

No.	Freq. MHz	Reading Level dBuV/m	Correct Factor dB	Measure ment dBuV/m	Limit dBuV/m	Margin dB	Detector	Comment
1	5595.5000	51.36	16.52	67.88	68.20	-0.32	Peak	
2 *	5818.7500	105.74	16.73	122.47	122.20	0.27	Peak	No Limit
3	5850.0000	49.41	16.76	66.17	122.20	-56.03	Peak	
4	5860.0000	43.35	16.77	60.12	109.40	-49.28	Peak	

**REMARKS:**

- (1) Measurement Value = Reading Level + Correct Factor.
- (2) Margin Level = Measurement Value - Limit Value.

Orthogonal Axis	X
Test Mode	UNII-3_TX A (20M) Mode 5825 MHz

**Vertical**

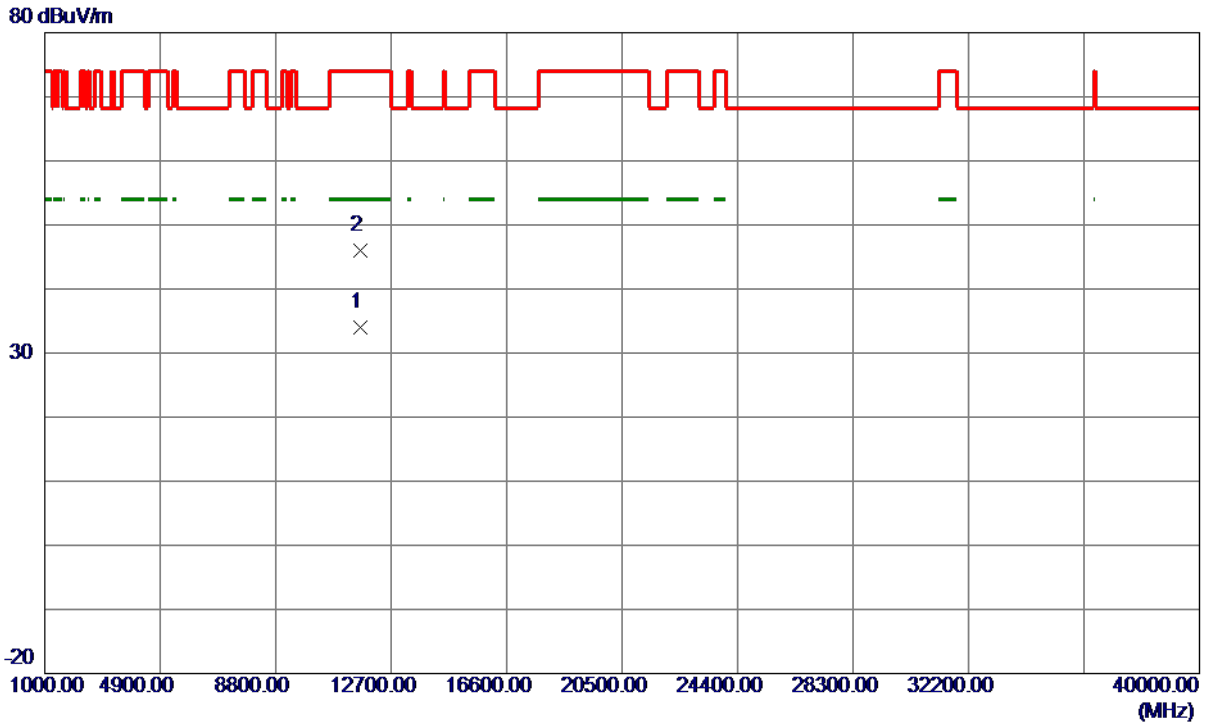

No.	Freq. MHz	Reading Level dBuV/m	Correct Factor dB	Measure ment dBuV/m	Limit dBuV/m	Margin dB	Detector	Comment
1 *	11640.2800	20.17	13.86	34.03	54.00	-19.97	AVG	
2	11657.5700	32.09	13.86	45.95	74.00	-28.05	Peak	

**REMARKS:**

- (1) Measurement Value = Reading Level + Correct Factor.
- (2) Margin Level = Measurement Value - Limit Value.

Orthogonal Axis	X
Test Mode	UNII-3_TX A (20M) Mode 5825 MHz

**Horizontal**

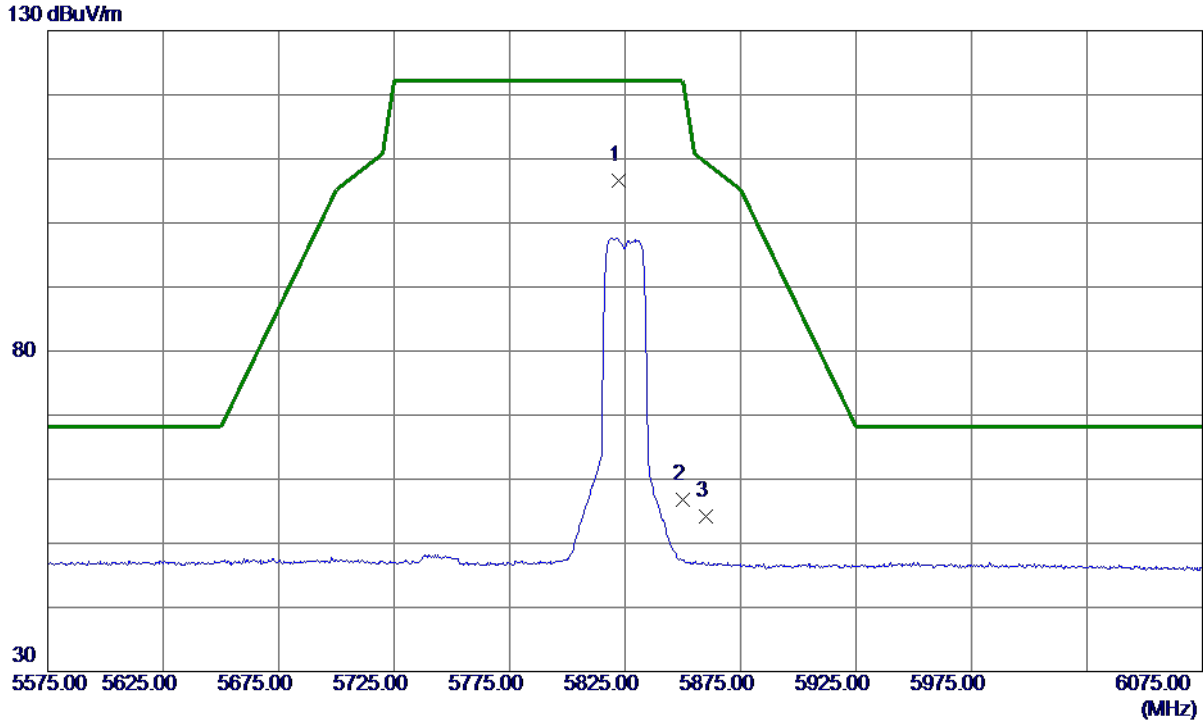

No.	Freq. MHz	Reading Level dBuV/m	Correct Factor dB	Measure ment dBuV/m	Limit dBuV/m	Margin dB	Detector	Comment
1 *	5822.2500	89.83	16.73	106.56	122.20	-15.64	Peak	No Limit
2	5850.0000	39.96	16.76	56.72	122.20	-65.48	Peak	
3	5860.0000	37.50	16.77	54.27	109.40	-55.13	Peak	

**REMARKS:**

- (1) Measurement Value = Reading Level + Correct Factor.
- (2) Margin Level = Measurement Value - Limit Value.

Orthogonal Axis	X
Test Mode	UNII-3_TX A (20M) Mode 5825 MHz

**Horizontal**

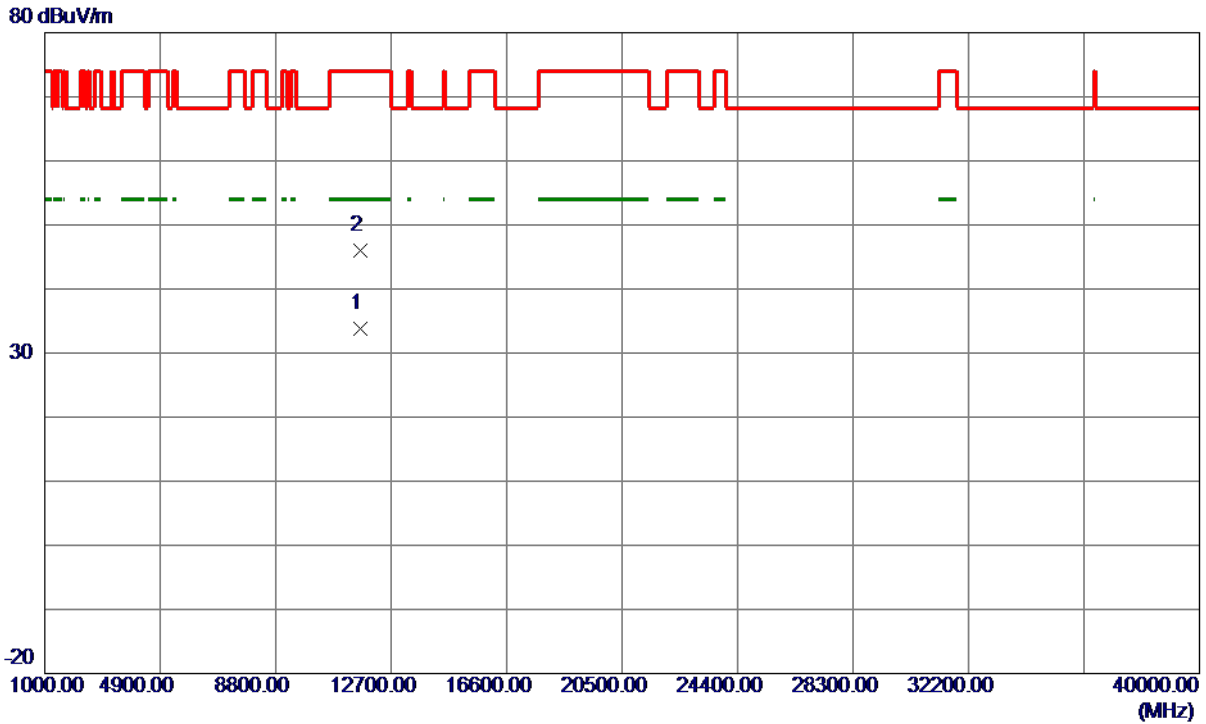

No.	Freq. MHz	Reading Level dBuV/m	Correct Factor dB	Measure ment dBuV/m	Limit dBuV/m	Margin dB	Detector	Comment
1 *	11640.7300	19.86	13.86	33.72	54.00	-20.28	AVG	
2	11641.9500	32.23	13.86	46.09	74.00	-27.91	Peak	

**REMARKS:**

- (1) Measurement Value = Reading Level + Correct Factor.
- (2) Margin Level = Measurement Value - Limit Value.

Orthogonal Axis	X
Test Mode	UNII-3_TX N (HT10) Mode 5745 MHz

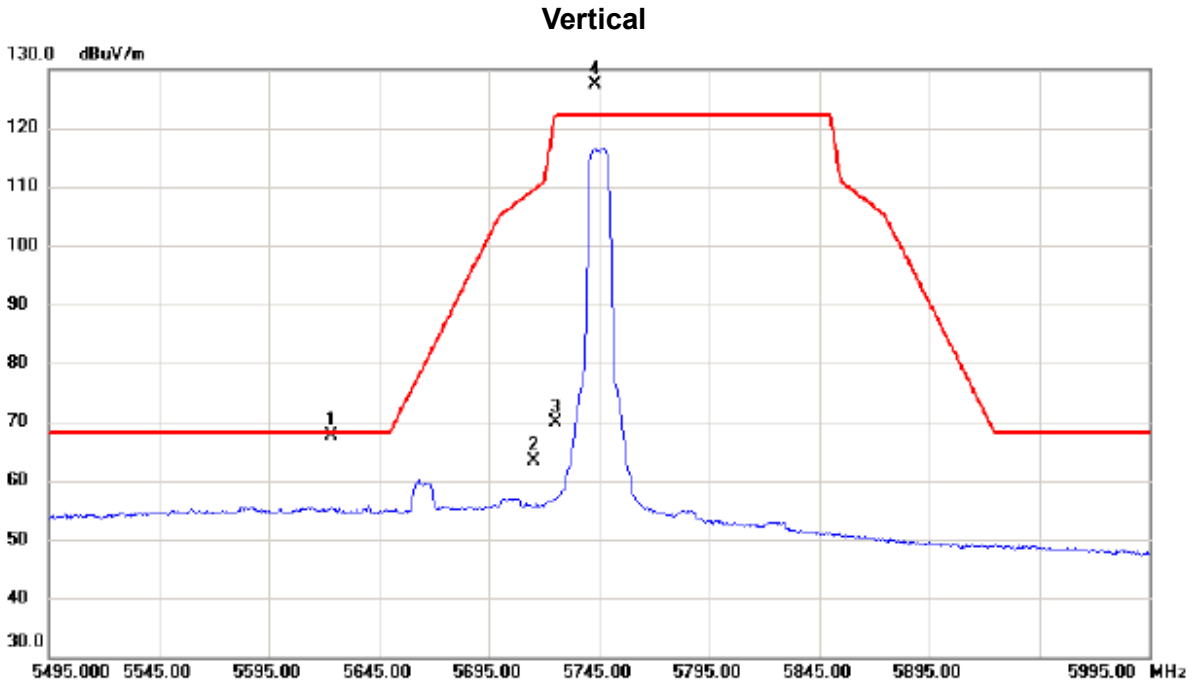

No.	Mk.	Freq.	Reading Level	Correct Factor	Measurement	Limit	Margin		
		MHz	dBuV	dB	dBuV/m	dBuV/m	dB	Detector	Comment
1		5623.250	51.03	16.55	67.58	68.20	-0.62	peak	
2		5715.000	46.80	16.64	63.44	109.40	-45.96	peak	
3		5725.000	53.21	16.64	69.85	122.20	-52.35	peak	
4	*	5743.500	110.70	16.66	127.36	122.20	5.16	peak	No Limit

**REMARKS:**

- (1) Measurement Value = Reading Level + Correct Factor.
- (2) Margin Level = Measurement Value - Limit Value.



Orthogonal Axis	X
Test Mode	UNII-3_TX N (HT10) Mode 5745 MHz

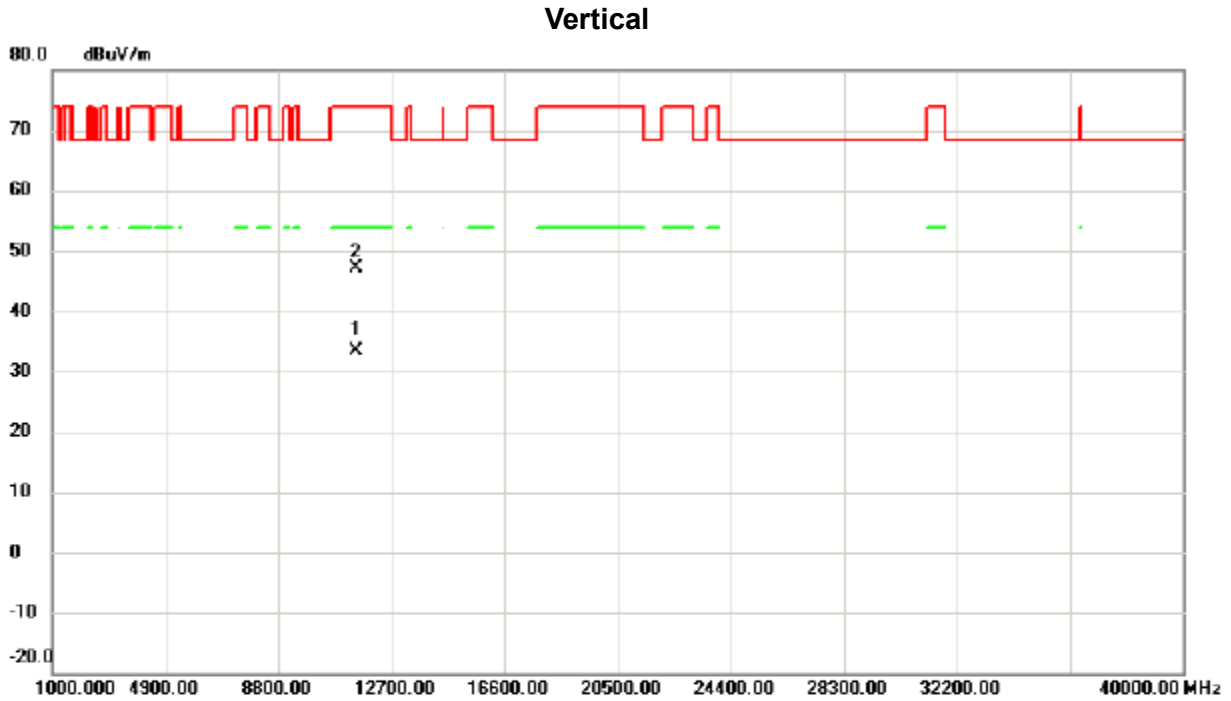

No.	Mk.	Freq.	Reading Level	Correct Factor	Measurement	Limit	Margin	Detector	Comment
		MHz	dBuV	dB	dBuV/m	dBuV/m	dB		
1	*	11480.750	19.62	13.82	33.44	54.00	-20.56	AVG	
2		11492.200	33.35	13.84	47.19	74.00	-26.81	peak	

REMARKS:

- (1) Measurement Value = Reading Level + Correct Factor.
- (2) Margin Level = Measurement Value - Limit Value.

Orthogonal Axis	X
Test Mode	UNII-3_TX N (HT10) Mode 5745 MHz

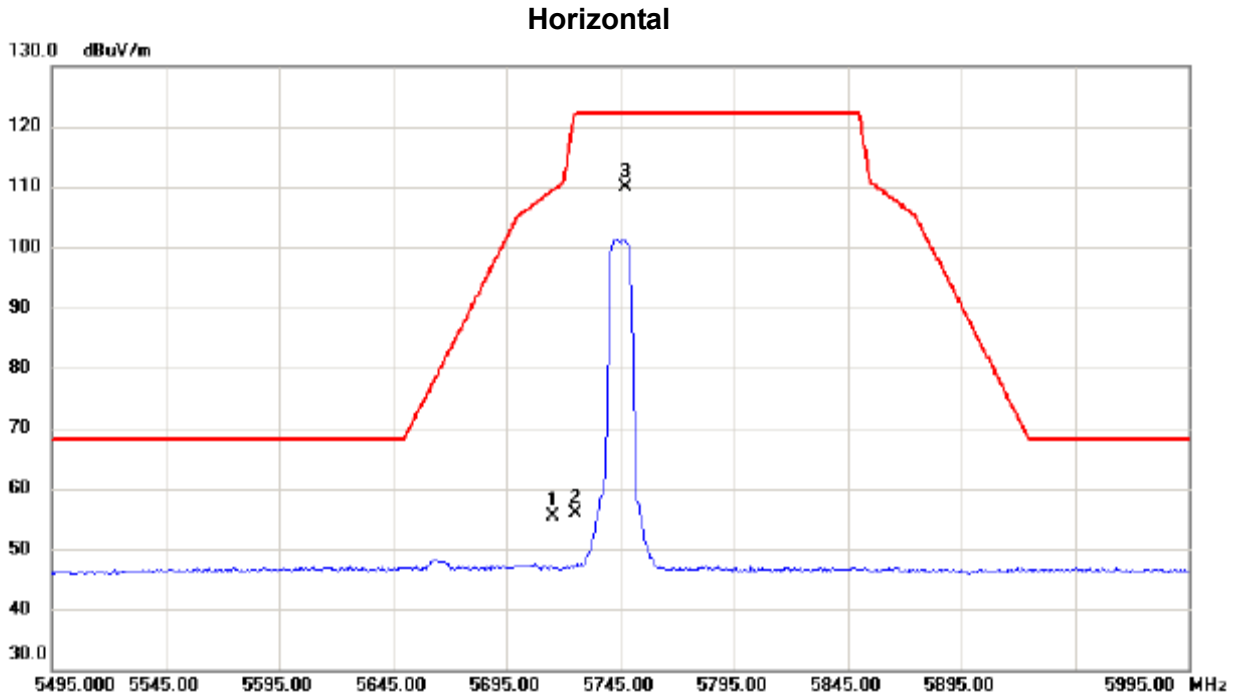

No.	Mk.	Freq.	Reading Level	Correct Factor	Measurement	Limit	Margin	Detector	Comment
		MHz	dBuV	dB	dBuV/m	dBuV/m	dB		
1		5715.000	38.67	16.64	55.31	109.40	-54.09	peak	
2		5725.000	39.13	16.64	55.77	122.20	-66.43	peak	
3	*	5747.250	93.32	16.67	109.99	122.20	-12.21	peak	No Limit

REMARKS:

- (1) Measurement Value = Reading Level + Correct Factor.
- (2) Margin Level = Measurement Value - Limit Value.

Orthogonal Axis	X
Test Mode	UNII-3_TX N (HT10) Mode 5745 MHz

Horizontal

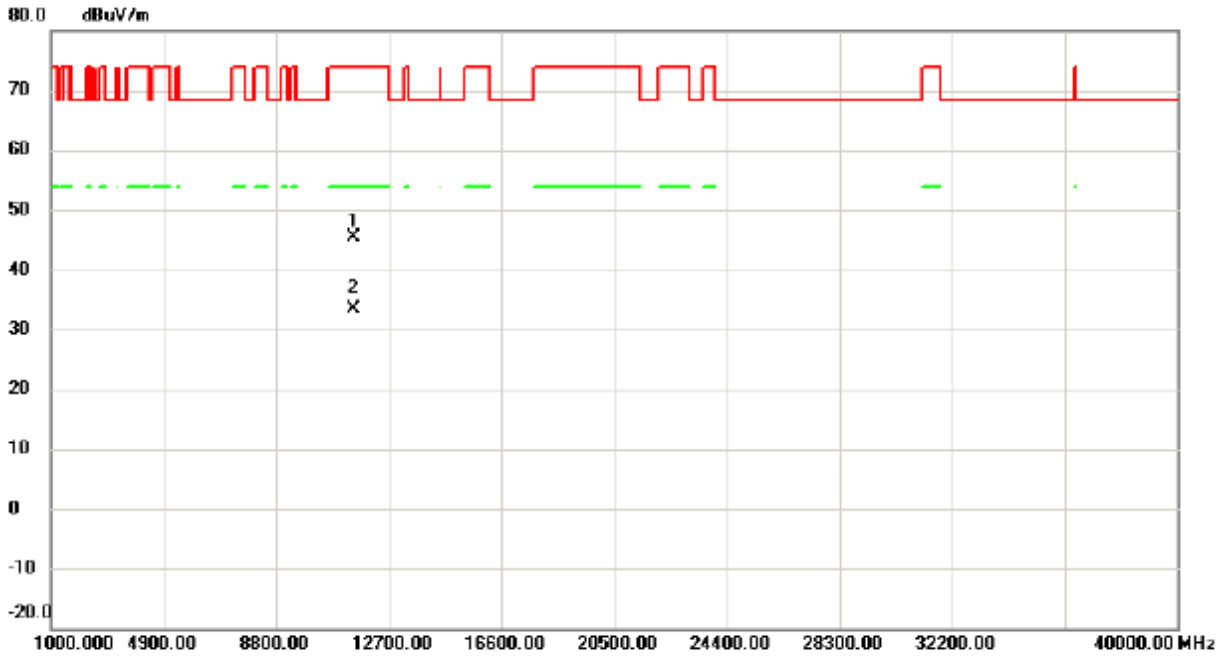

No.	Mk.	Freq. MHz	Reading Level dBuV	Correct Factor dB	Measure- ment dBuV/m	Limit dBuV/m	Margin dB	Detector	Comment
1		11488.550	31.65	13.84	45.49	74.00	-28.51	peak	
2	*	11492.760	19.64	13.84	33.48	54.00	-20.52	AVG	

REMARKS:

- (1) Measurement Value = Reading Level + Correct Factor.
- (2) Margin Level = Measurement Value - Limit Value.

Orthogonal Axis	X
Test Mode	UNII-3_TX N (HT10) Mode 5785 MHz

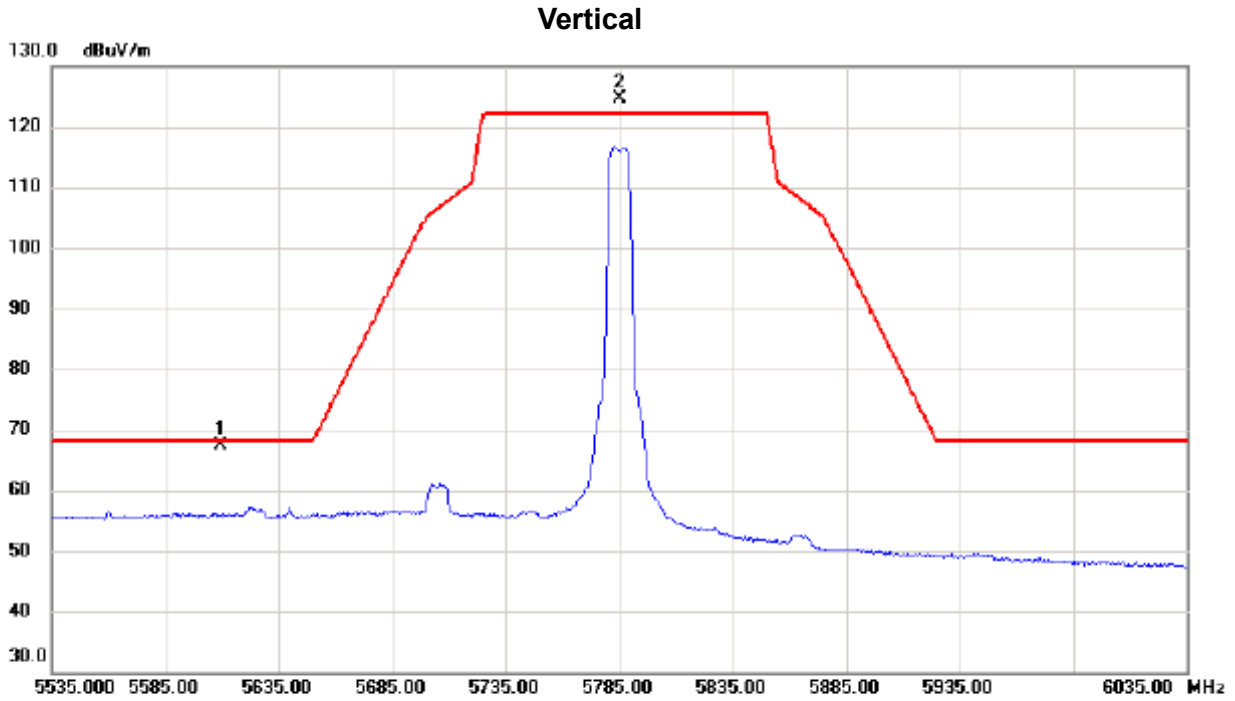

No.	Mk.	Freq. MHz	Reading Level dBuV	Correct Factor dB	Measure- ment dBuV/m	Limit dBuV/m	Margin dB	Detector	Comment
1		5609.000	50.75	16.53	67.28	68.20	-0.92	peak	
2	*	5785.250	108.02	16.69	124.71	122.20	2.51	peak	No Limit

**REMARKS:**

- (1) Measurement Value = Reading Level + Correct Factor.
- (2) Margin Level = Measurement Value - Limit Value.

Orthogonal Axis	X
Test Mode	UNII-3_TX N (HT10) Mode 5785 MHz

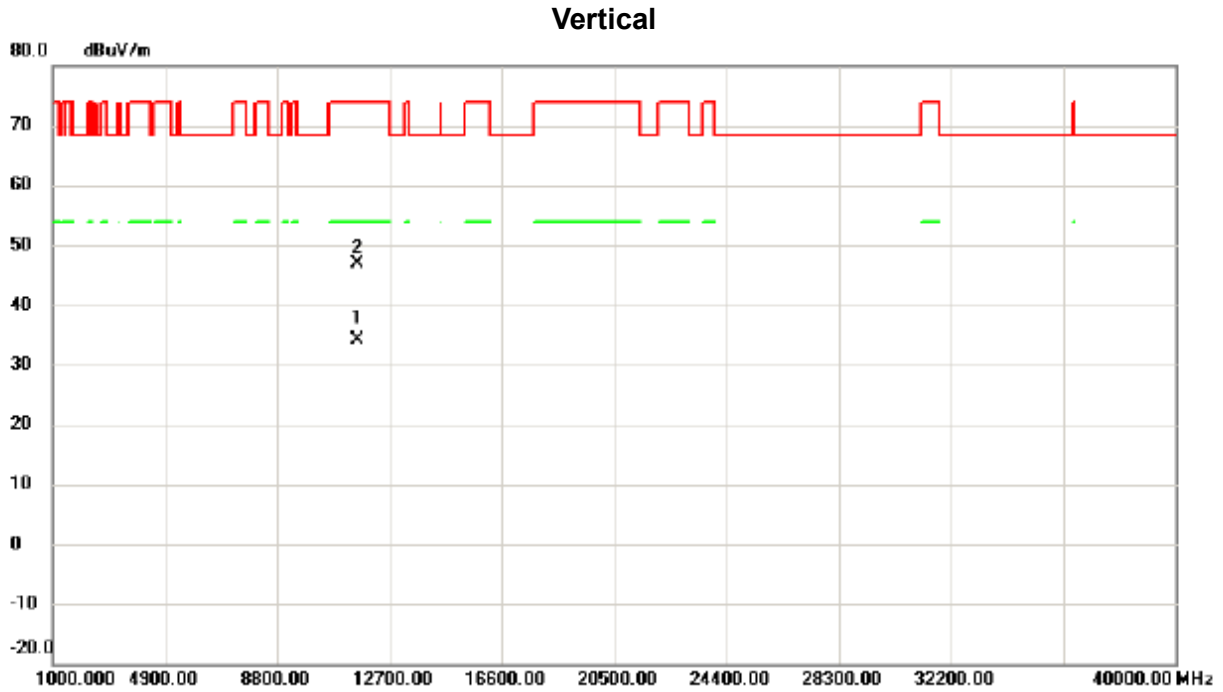

No.	Mk.	Freq.	Reading Level	Correct Factor	Measurement	Limit	Margin	Detector	Comment
		MHz	dBuV	dB	dBuV/m	dBuV/m	dB		
1	*	11564.400	20.18	13.85	34.03	54.00	-19.97	AVG	
2		11573.640	32.95	13.85	46.80	74.00	-27.20	peak	

REMARKS:

- (1) Measurement Value = Reading Level + Correct Factor.
- (2) Margin Level = Measurement Value - Limit Value.

Orthogonal Axis	X
Test Mode	UNII-3_TX N (HT10) Mode 5785 MHz

**Horizontal**

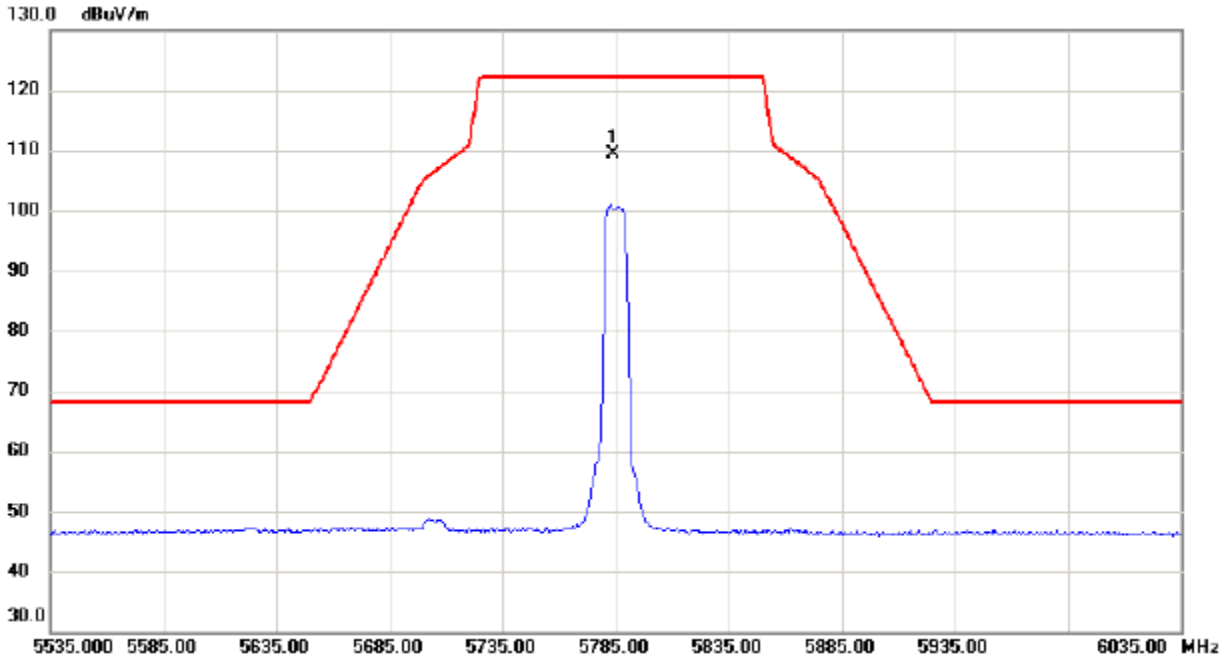

No.	Mk.	Freq.	Reading Level	Correct Factor	Measurement	Limit	Margin		
		MHz	dBuV	dB	dBuV/m	dBuV/m	dB	Detector	Comment
1	*	5784.250	92.58	16.69	109.27	122.20	-12.93	peak	No Limit

**REMARKS:**

- (1) Measurement Value = Reading Level + Correct Factor.
- (2) Margin Level = Measurement Value - Limit Value.

Orthogonal Axis	X
Test Mode	UNII-3_TX N (HT10) Mode 5785 MHz

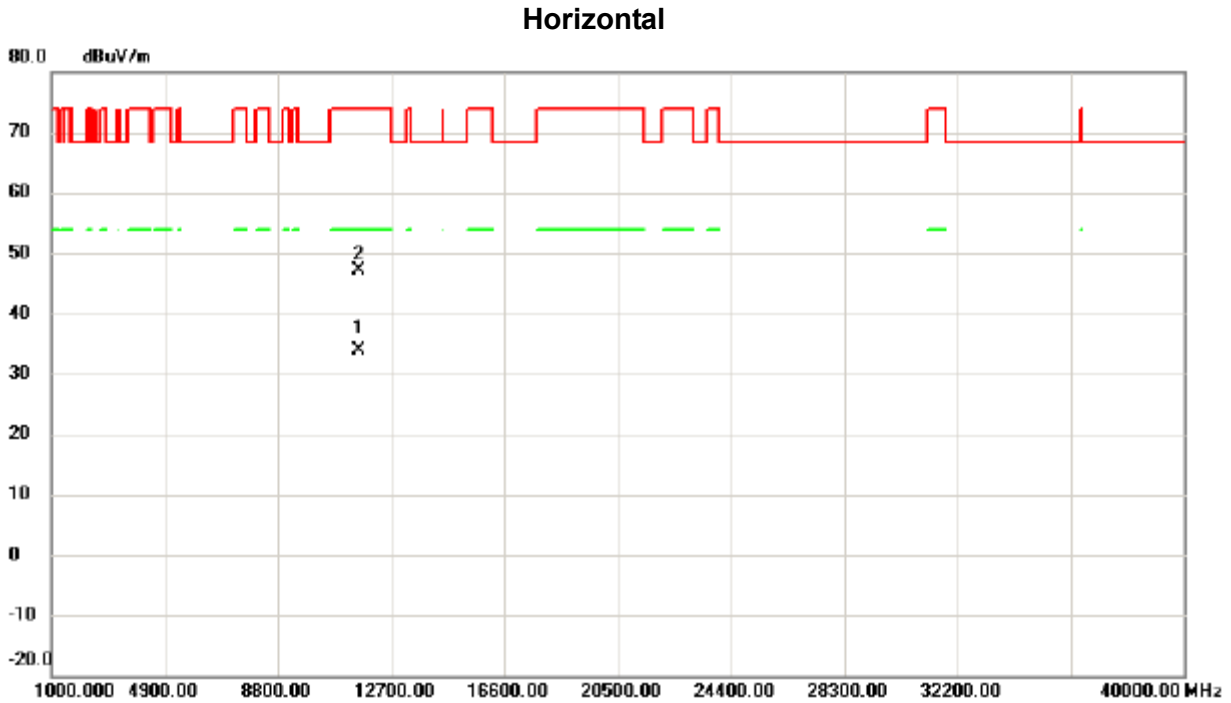

No.	Mk.	Freq.	Reading Level	Correct Factor	Measurement	Limit	Margin	Detector	Comment
		MHz	dBuV	dB	dBuV/m	dBuV/m	dB		
1	*	11565.210	19.97	13.85	33.82	54.00	-20.18	AVG	
2		11576.630	33.33	13.86	47.19	74.00	-26.81	peak	

**REMARKS:**

- (1) Measurement Value = Reading Level + Correct Factor.
- (2) Margin Level = Measurement Value - Limit Value.

Orthogonal Axis	X
Test Mode	UNII-3_TX N (HT10) Mode 5825 MHz

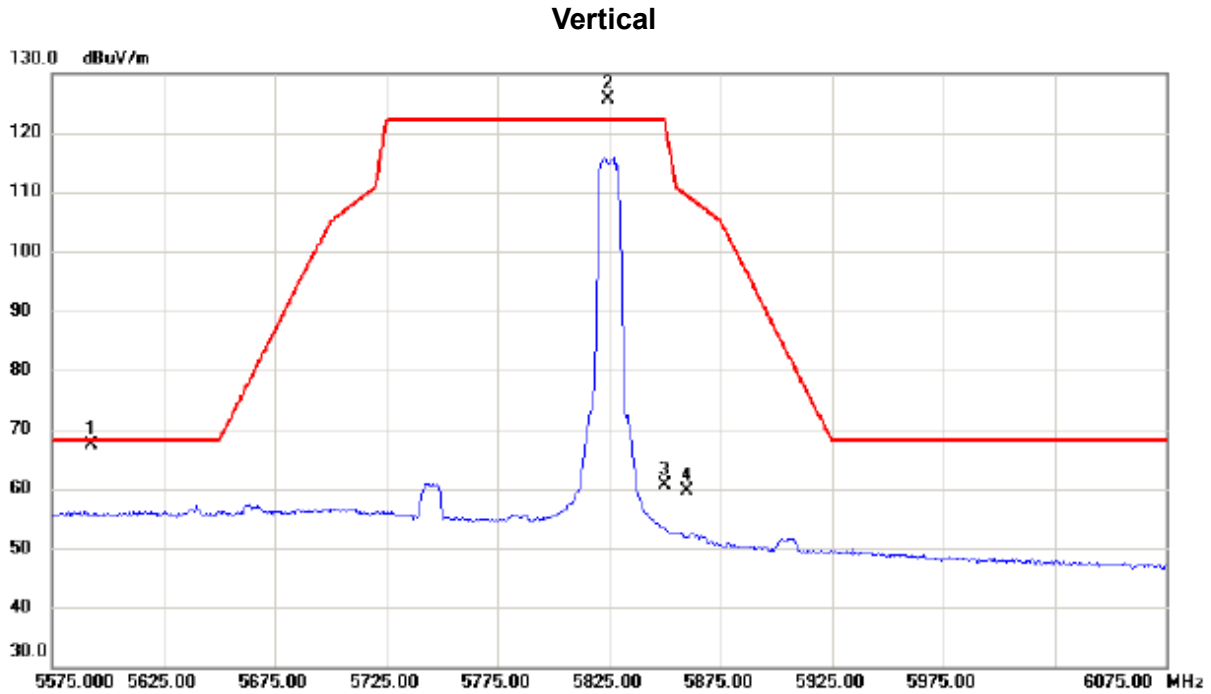

No.	Mk.	Freq.	Reading Level	Correct Factor	Measurement	Limit	Margin		
		MHz	dBuV	dB	dBuV/m	dBuV/m	dB	Detector	Comment
1		5592.750	50.89	16.52	67.41	68.20	-0.79	peak	
2	*	5824.500	108.84	16.74	125.58	122.20	3.38	peak	No Limit
3		5850.000	43.81	16.75	60.56	122.20	-61.64	peak	
4		5860.000	42.83	16.76	59.59	109.40	-49.81	peak	

REMARKS:

- (1) Measurement Value = Reading Level + Correct Factor.
- (2) Margin Level = Measurement Value - Limit Value.



Orthogonal Axis	X
Test Mode	UNII-3_TX N (HT10) Mode 5825 MHz

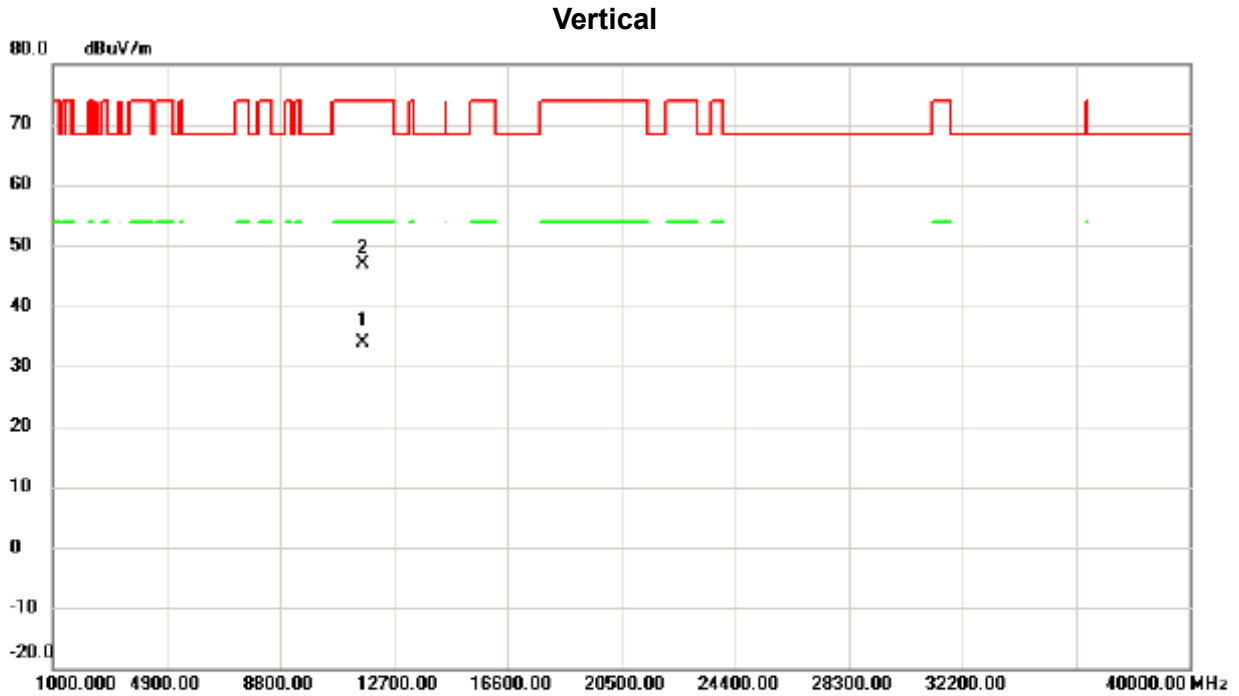

No.	Mk.	Freq. MHz	Reading Level dBuV	Correct Factor dB	Measure- ment dBuV/m	Limit dBuV/m	Margin dB	Detector	Comment
1	*	11641.950	19.96	13.86	33.82	54.00	-20.18	AVG	
2		11643.230	33.13	13.86	46.99	74.00	-27.01	peak	

REMARKS:

(1) Measurement Value = Reading Level + Correct Factor.

(2) Margin Level = Measurement Value - Limit Value.

Orthogonal Axis	X
Test Mode	UNII-3_TX N (HT10) Mode 5825 MHz

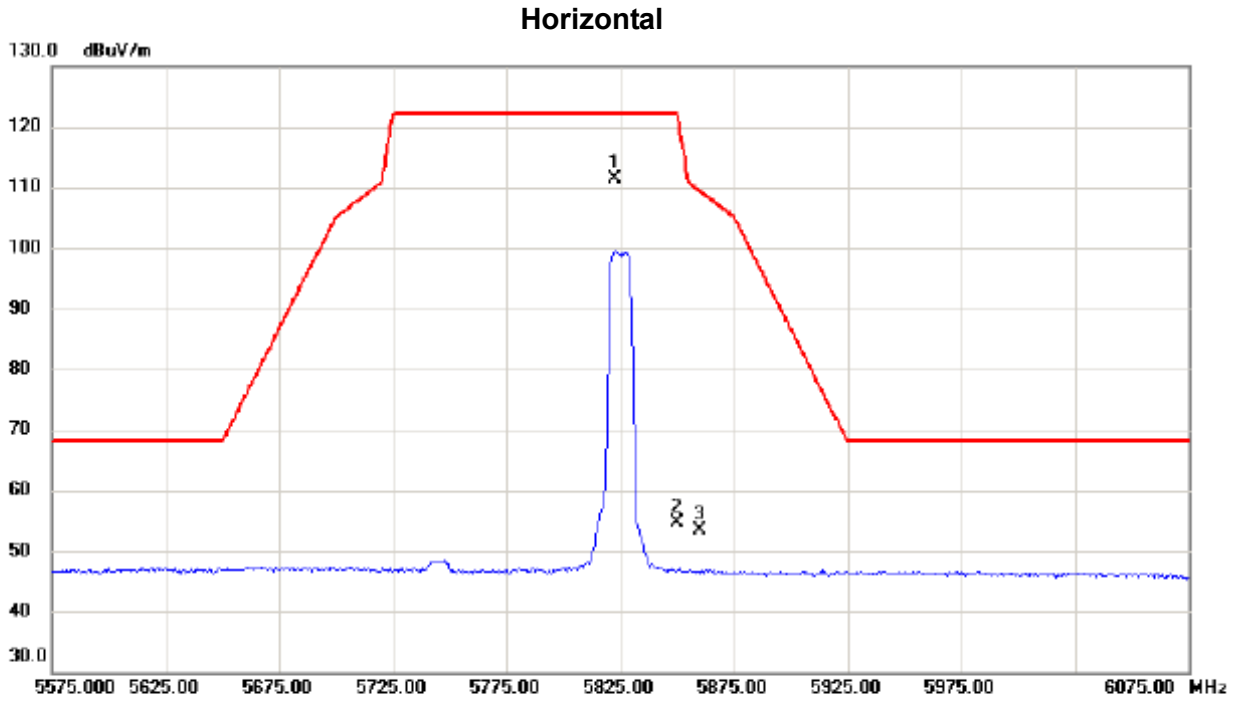

No.	Mk.	Freq. MHz	Reading Level dBuV	Correct Factor dB	Measure- ment dBuV/m	Limit dBuV/m	Margin dB	Detector	Comment
1	*	5822.750	94.65	16.74	111.39	122.20	-10.81	peak	No Limit
2		5850.000	37.85	16.75	54.60	122.20	-67.60	peak	
3		5860.000	36.60	16.76	53.36	109.40	-56.04	peak	

**REMARKS:**

- (1) Measurement Value = Reading Level + Correct Factor.
- (2) Margin Level = Measurement Value - Limit Value.

Orthogonal Axis	X
Test Mode	UNII-3_TX N (HT10) Mode 5825 MHz

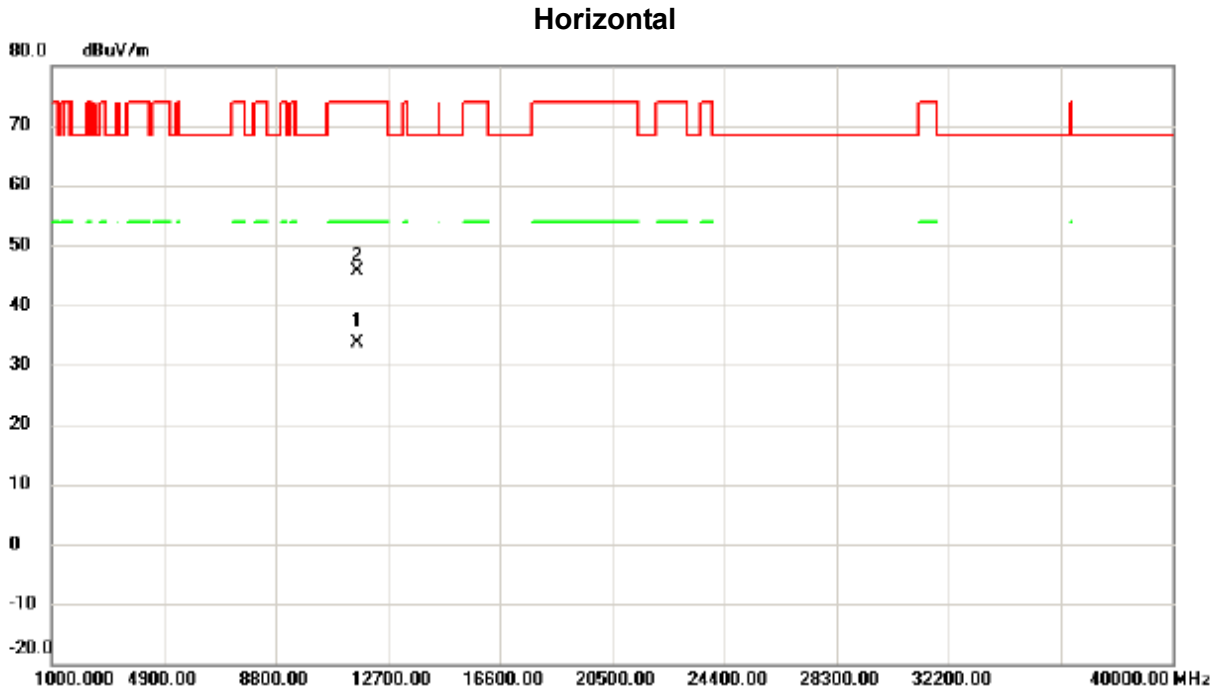

No.	Mk.	Freq.	Reading Level	Correct Factor	Measurement	Limit	Margin	Detector	Comment
		MHz	dBuV	dB	dBuV/m	dBuV/m	dB		
1	*	11641.500	19.79	13.86	33.65	54.00	-20.35	AVG	
2		11651.980	31.78	13.86	45.64	74.00	-28.36	peak	

REMARKS:

- (1) Measurement Value = Reading Level + Correct Factor.
- (2) Margin Level = Measurement Value - Limit Value.

Orthogonal Axis	X
Test Mode	UNII-3_TX N (HT20) Mode 5745 MHz

**Vertical**

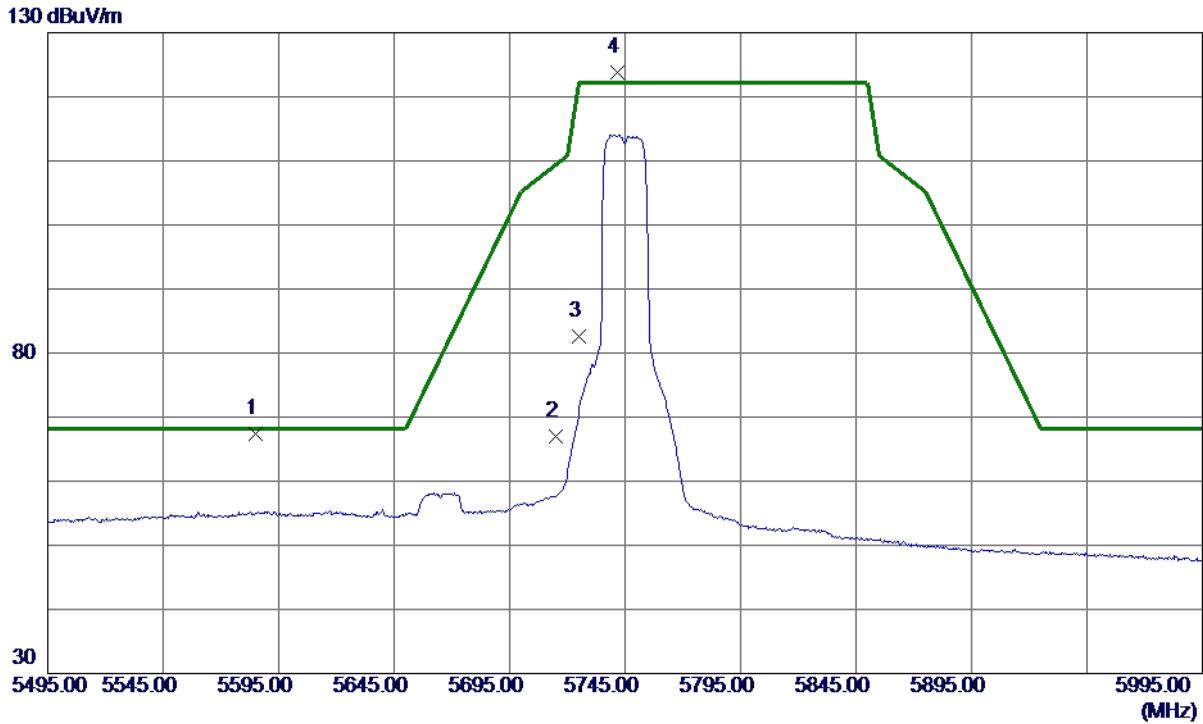

No.	Freq. MHz	Reading Level dBuV/m	Correct Factor dB	Measure ment dBuV/m	Limit dBuV/m	Margin dB	Detector	Comment
1	5585.0000	50.96	16.51	67.47	68.20	-0.73	Peak	
2	5715.0000	50.39	16.63	67.02	109.40	-42.38	Peak	
3	5725.0000	66.03	16.64	82.67	122.20	-39.53	Peak	
4 *	5741.5000	107.13	16.66	123.79	122.20	1.59	Peak	No Limit

**REMARKS:**

- (1) Measurement Value = Reading Level + Correct Factor.
- (2) Margin Level = Measurement Value - Limit Value.

Orthogonal Axis	X
Test Mode	UNII-3_TX N (HT20) Mode 5745 MHz

**Vertical**

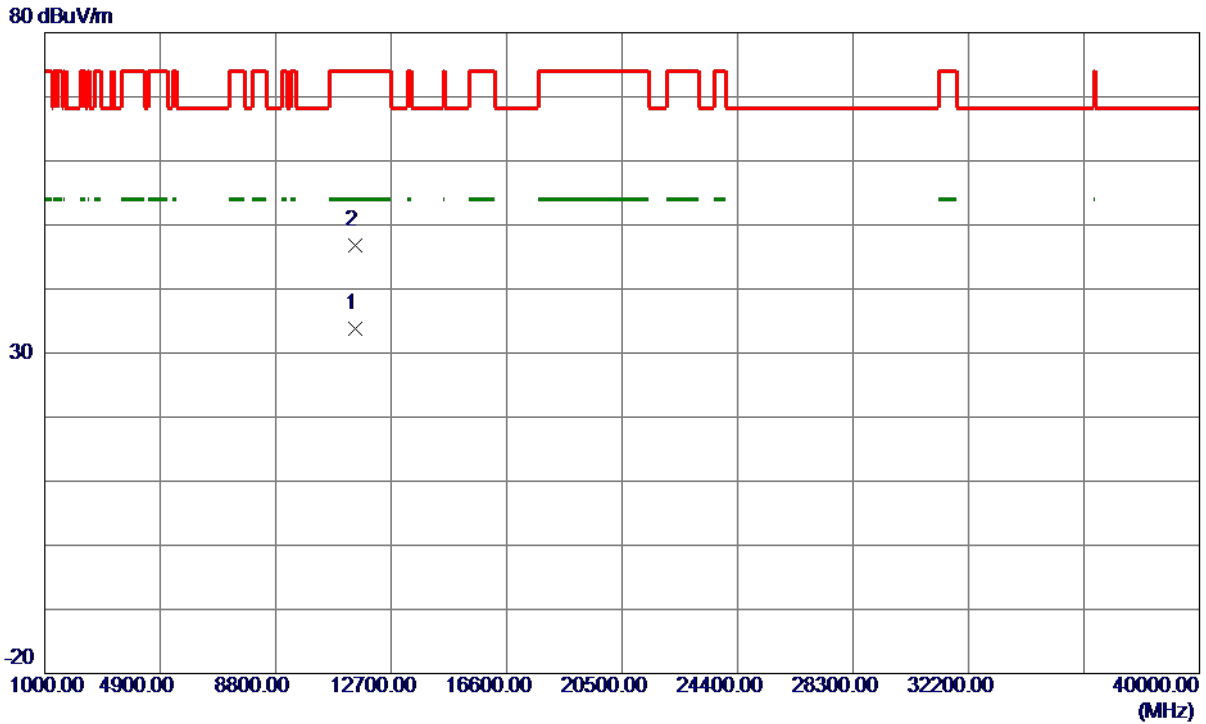

No.	Freq. MHz	Reading Level dBuV/m	Correct Factor dB	Measure ment dBuV/m	Limit dBuV/m	Margin dB	Detector	Comment
1 *	11481.4900	19.90	13.82	33.72	54.00	-20.28	AVG	
2	11488.2200	32.97	13.83	46.80	74.00	-27.20	Peak	

**REMARKS:**

- (1) Measurement Value = Reading Level + Correct Factor.
- (2) Margin Level = Measurement Value - Limit Value.

Orthogonal Axis	X
Test Mode	UNII-3_TX N (HT20) Mode 5745 MHz

**Horizontal**

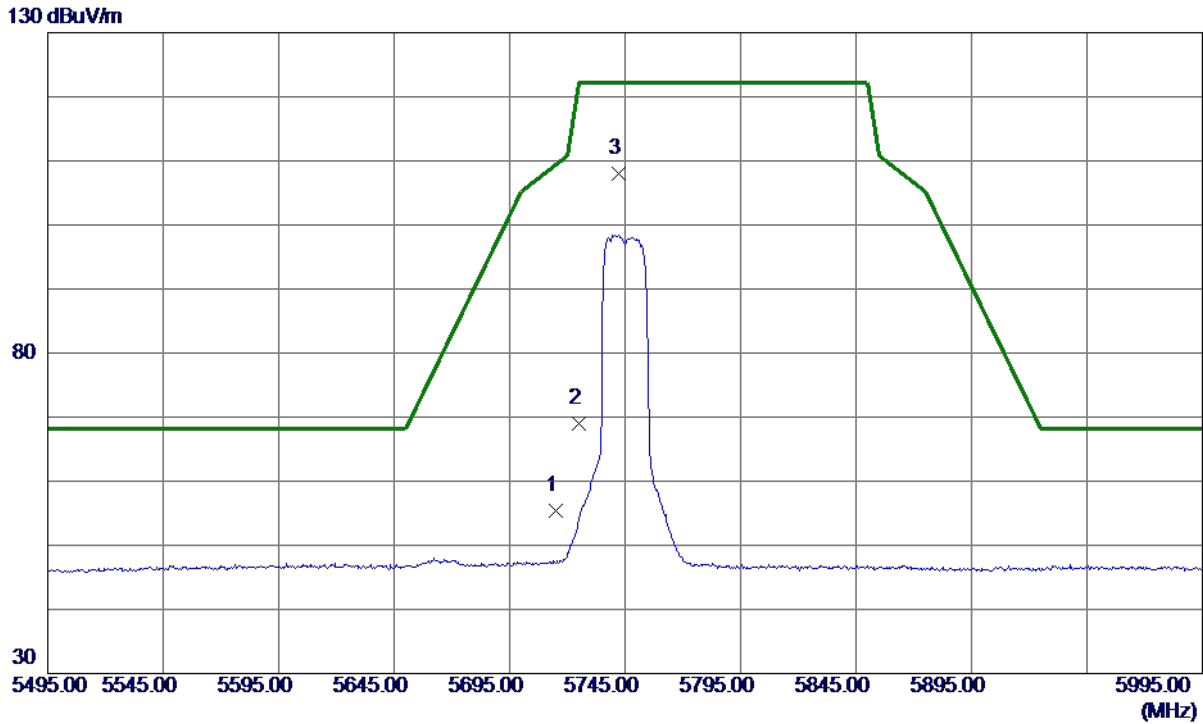

No.	Freq. MHz	Reading Level dBuV/m	Correct Factor dB	Measure ment dBuV/m	Limit dBuV/m	Margin dB	Detector	Comment
1	5715.0000	38.78	16.63	55.41	109.40	-53.99	Peak	
2	5725.0000	52.32	16.64	68.96	122.20	-53.24	Peak	
3 *	5742.0000	91.29	16.66	107.95	122.20	-14.25	Peak	No Limit

**REMARKS:**

- (1) Measurement Value = Reading Level + Correct Factor.
- (2) Margin Level = Measurement Value - Limit Value.

Orthogonal Axis	X
Test Mode	UNII-3_TX N (HT20) Mode 5745 MHz

**Horizontal**

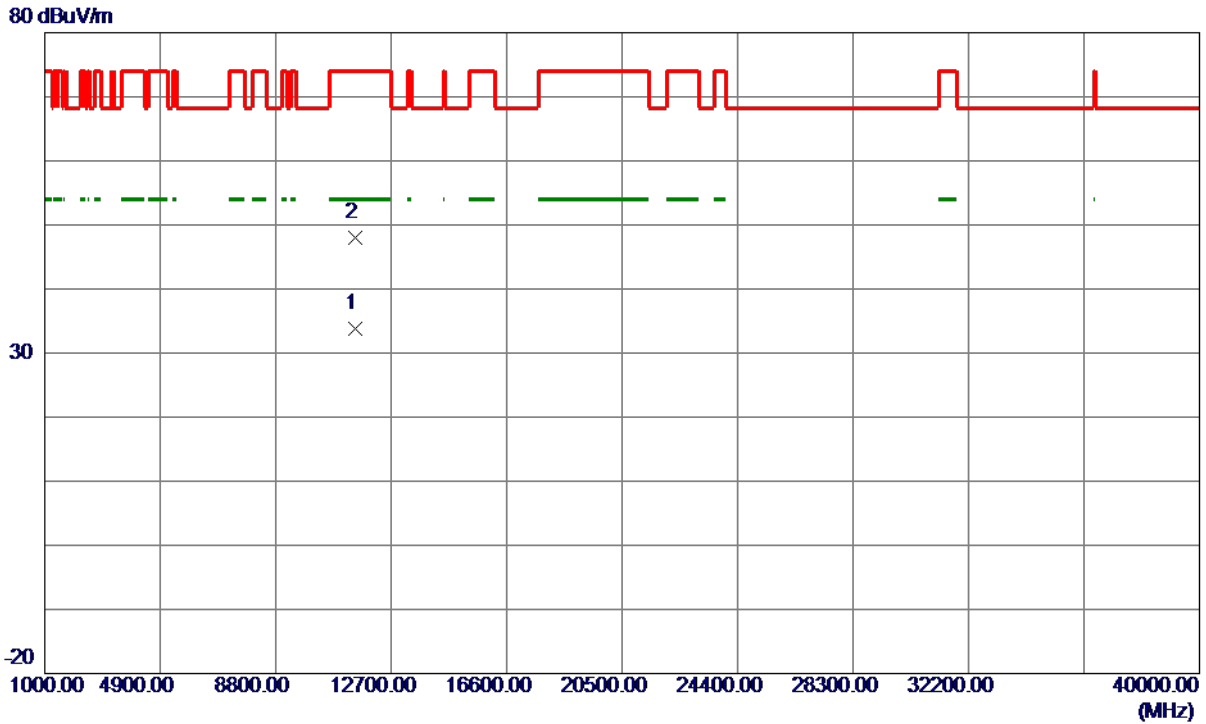

No.	Freq. MHz	Reading Level dBuV/m	Correct Factor dB	Measure ment dBuV/m	Limit dBuV/m	Margin dB	Detector	Comment
1 *	11492.1000	19.88	13.84	33.72	54.00	-20.28	AVG	
2	11499.4000	34.12	13.85	47.97	74.00	-26.03	Peak	

**REMARKS:**

- (1) Measurement Value = Reading Level + Correct Factor.
- (2) Margin Level = Measurement Value - Limit Value.

Orthogonal Axis	X
Test Mode	UNII-3_TX N (HT20) Mode 5785 MHz

**Vertical**

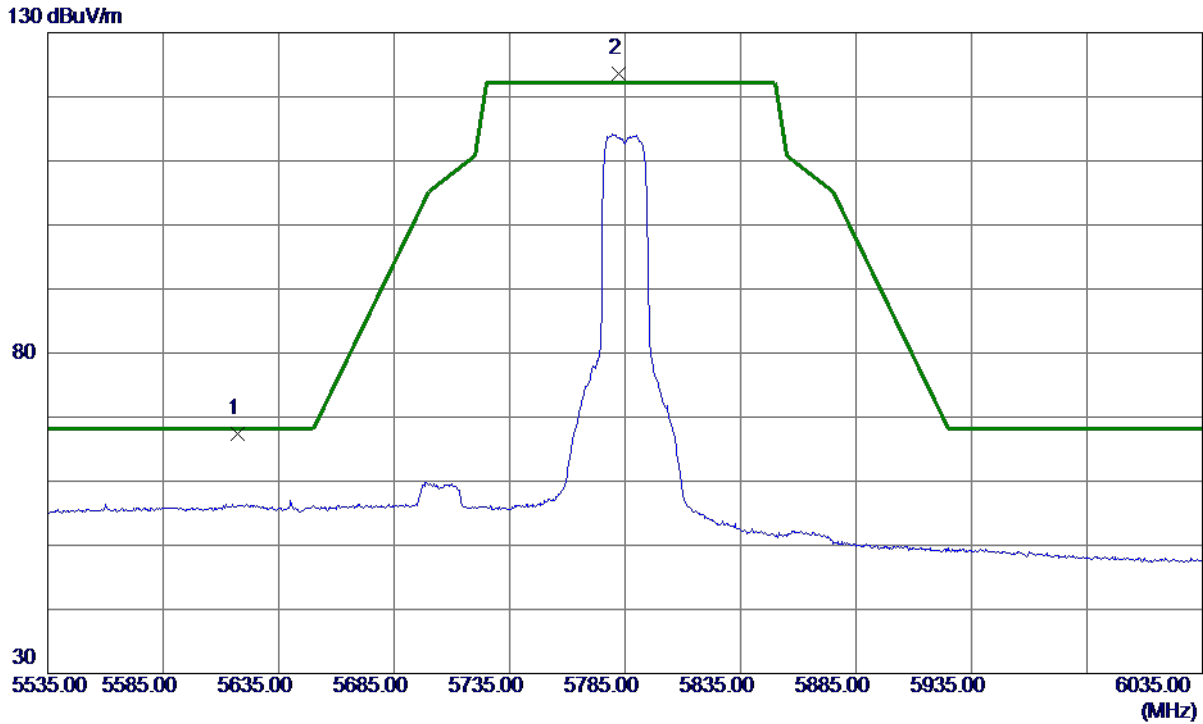

No.	Freq. MHz	Reading Level dBuV/m	Correct Factor dB	Measure ment dBuV/m	Limit dBuV/m	Margin dB	Detector	Comment
1	5617.0000	50.93	16.54	67.47	68.20	-0.73	Peak	
2 *	5782.0000	106.82	16.70	123.52	122.20	1.32	Peak	No Limit

**REMARKS:**

- (1) Measurement Value = Reading Level + Correct Factor.
- (2) Margin Level = Measurement Value - Limit Value.



Orthogonal Axis	X
Test Mode	UNII-3_TX N (HT20) Mode 5785 MHz

**Vertical**

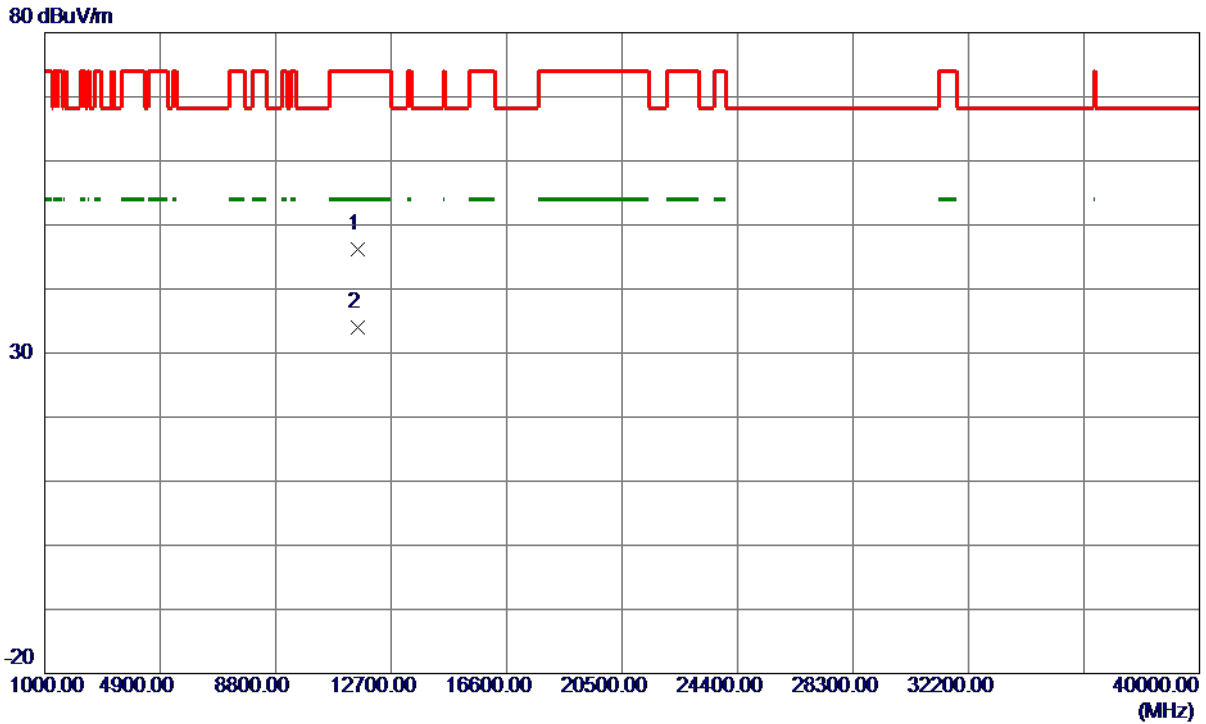

No.	Freq. MHz	Reading Level dBuV/m	Correct Factor dB	Measure ment dBuV/m	Limit dBuV/m	Margin dB	Detector	Comment
1	11561.4700	32.44	13.85	46.29	74.00	-27.71	Peak	
2 *	11565.1000	20.23	13.85	34.08	54.00	-19.92	AVG	

**REMARKS:**

- (1) Measurement Value = Reading Level + Correct Factor.
- (2) Margin Level = Measurement Value - Limit Value.

Orthogonal Axis	X
Test Mode	UNII-3_TX N (HT20) Mode 5785 MHz

**Horizontal**

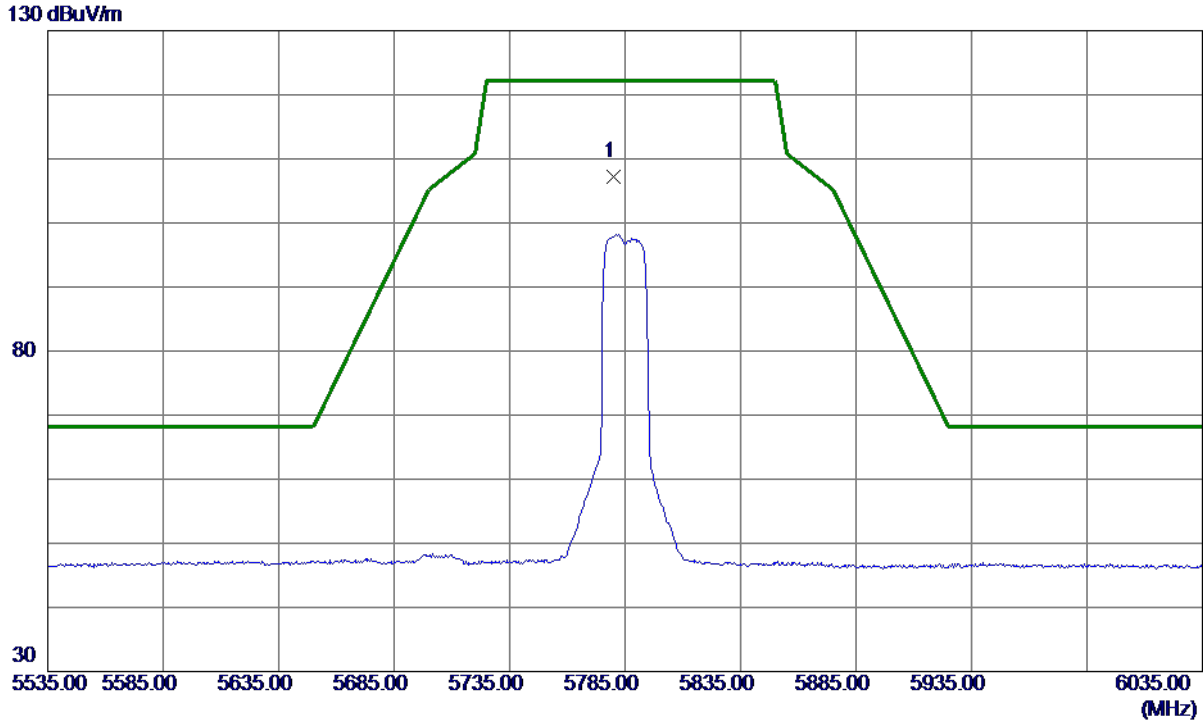

No.	Freq. MHz	Reading Level dBuV/m	Correct Factor dB	Measure ment dBuV/m	Limit dBuV/m	Margin dB	Detector	Comment
1 *	5779.7500	90.48	16.69	107.17	122.20	-15.03	Peak	No Limit

**REMARKS:**

- (1) Measurement Value = Reading Level + Correct Factor.
- (2) Margin Level = Measurement Value - Limit Value.

Orthogonal Axis	X
Test Mode	UNII-3_TX N (HT20) Mode 5785 MHz

**Horizontal**

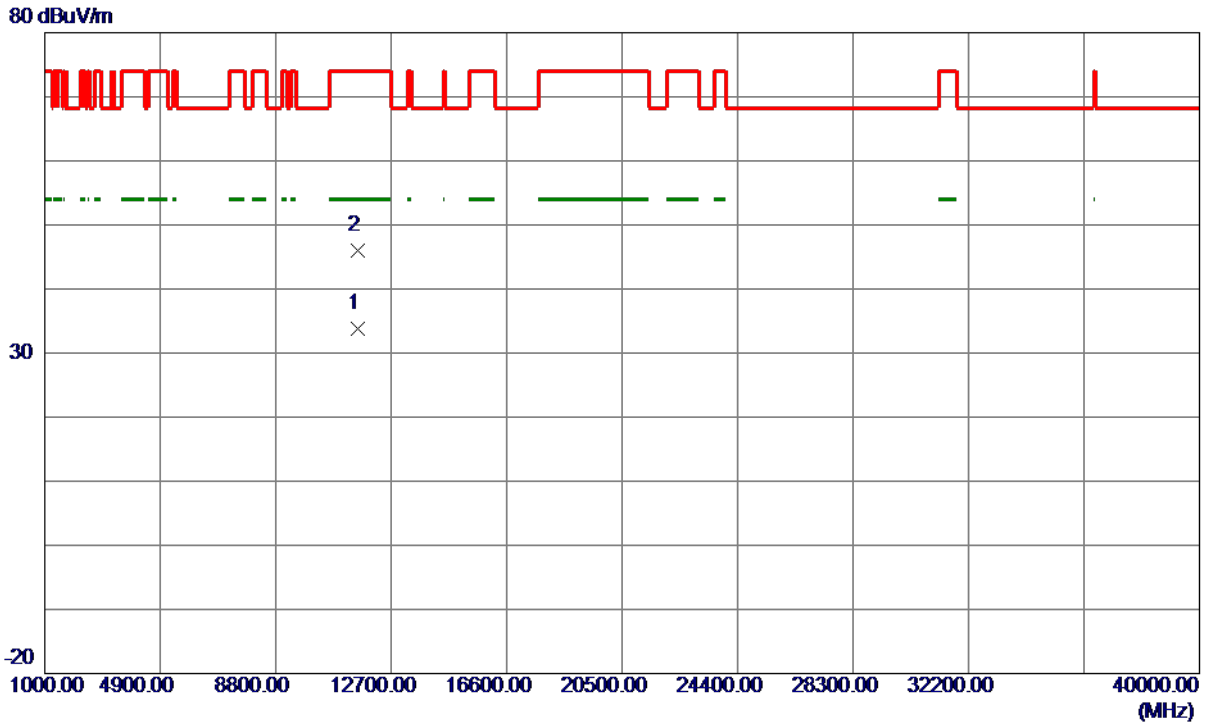

No.	Freq. MHz	Reading Level dBuV/m	Correct Factor dB	Measure ment dBuV/m	Limit dBuV/m	Margin dB	Detector	Comment
1 *	11567.4600	20.01	13.85	33.86	54.00	-20.14	AVG	
2	11570.5300	32.20	13.85	46.05	74.00	-27.95	Peak	

**REMARKS:**

- (1) Measurement Value = Reading Level + Correct Factor.
- (2) Margin Level = Measurement Value - Limit Value.

Orthogonal Axis	X
Test Mode	UNII-3_TX N (HT20) Mode 5825 MHz

**Vertical**

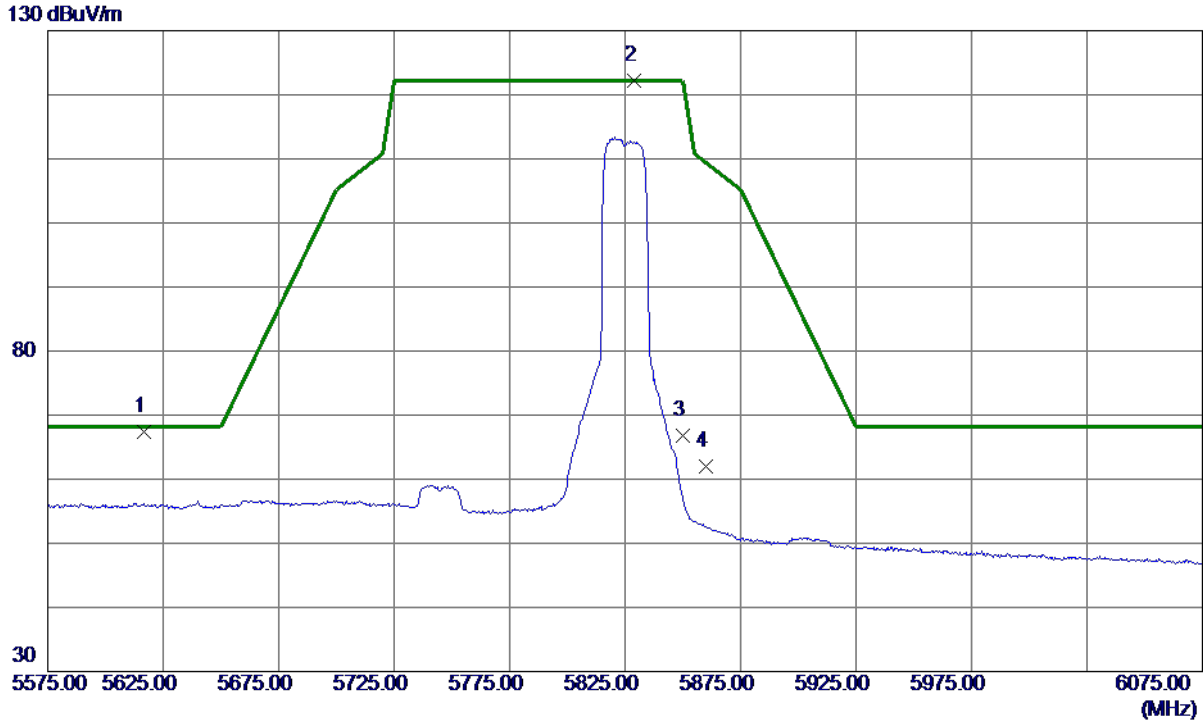

No.	Freq. MHz	Reading Level dBuV/m	Correct Factor dB	Measure ment dBuV/m	Limit dBuV/m	Margin dB	Detector	Comment
1	5616.7500	50.83	16.54	67.37	68.20	-0.83	Peak	
2 *	5829.0000	105.49	16.74	122.23	122.20	0.03	Peak	No Limit
3	5850.0000	50.02	16.76	66.78	122.20	-55.42	Peak	
4	5860.0000	45.31	16.77	62.08	109.40	-47.32	Peak	

**REMARKS:**

- (1) Measurement Value = Reading Level + Correct Factor.
- (2) Margin Level = Measurement Value - Limit Value.

Orthogonal Axis	X
Test Mode	UNII-3_TX N (HT20) Mode 5825 MHz

**Vertical**

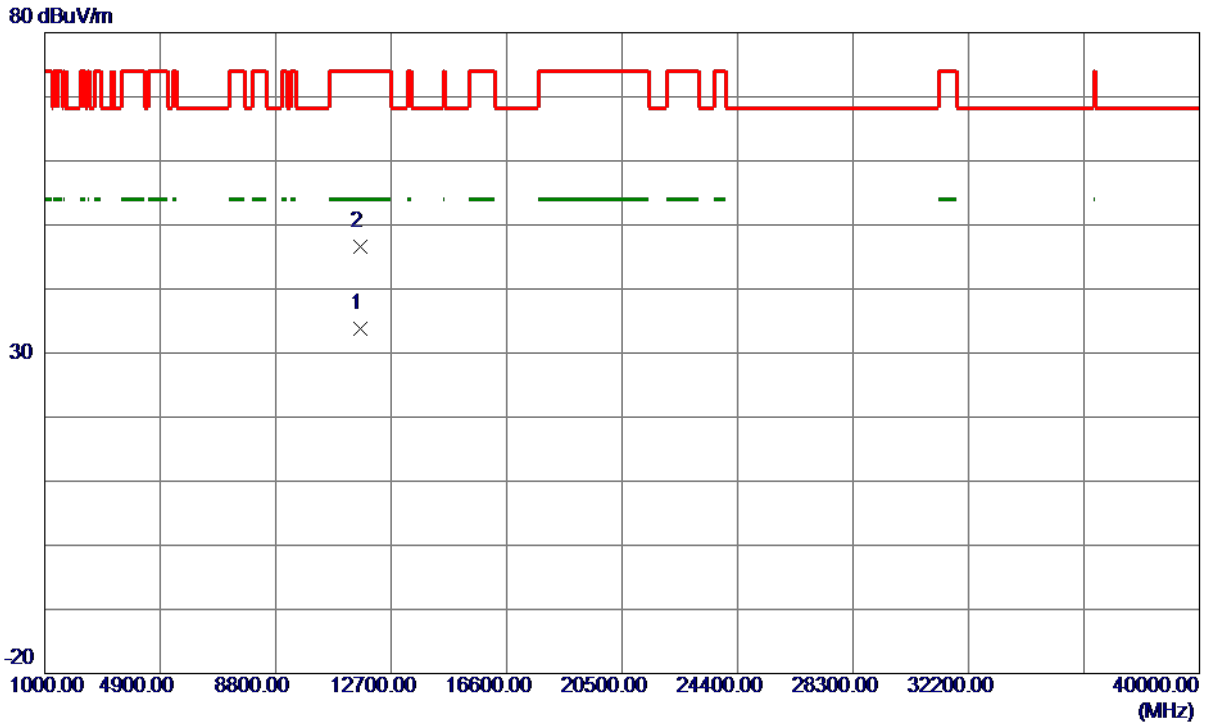

No.	Freq. MHz	Reading Level dBuV/m	Correct Factor dB	Measure ment dBuV/m	Limit dBuV/m	Margin dB	Detector	Comment
1 *	11641.3300	19.89	13.86	33.75	54.00	-20.25	AVG	
2	11659.5000	32.69	13.86	46.55	74.00	-27.45	Peak	

**REMARKS:**

- (1) Measurement Value = Reading Level + Correct Factor.
- (2) Margin Level = Measurement Value - Limit Value.

Orthogonal Axis	X
Test Mode	UNII-3_TX N (HT20) Mode 5825 MHz

**Horizontal**

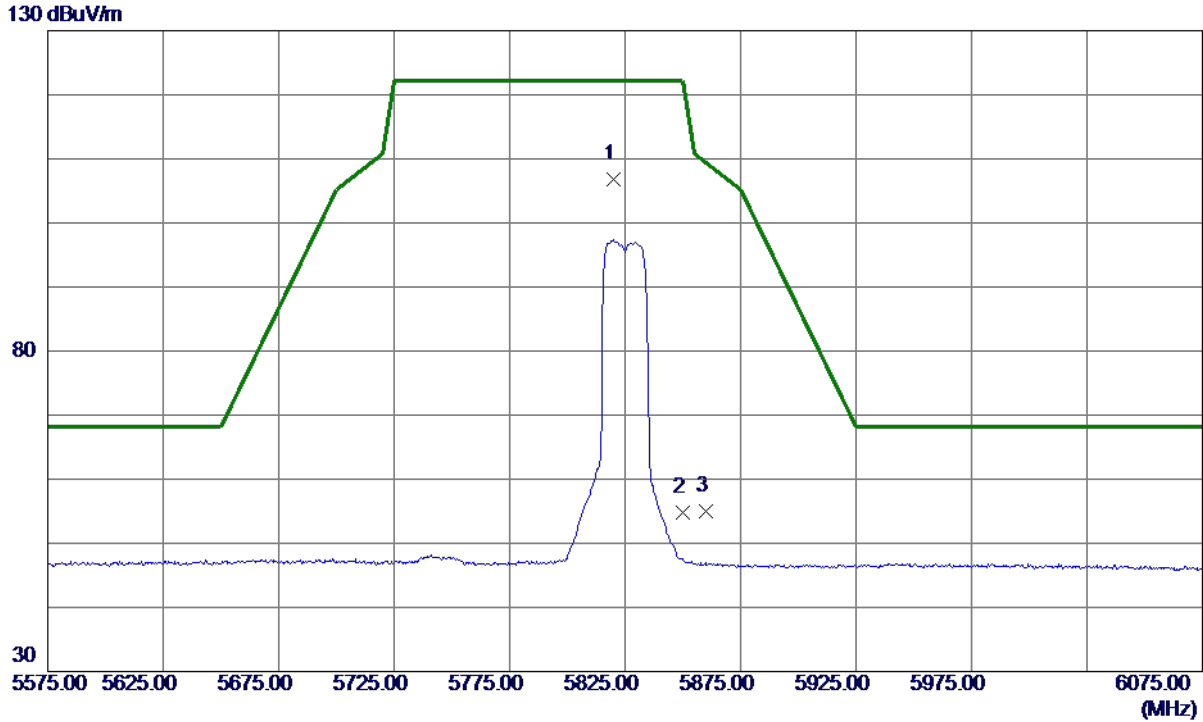

No.	Freq. MHz	Reading Level dBuV/m	Correct Factor dB	Measure ment dBuV/m	Limit dBuV/m	Margin dB	Detector	Comment
1 *	5820.2500	90.12	16.73	106.85	122.20	-15.35	Peak	No Limit
2	5850.0000	38.05	16.76	54.81	122.20	-67.39	Peak	
3	5860.0000	38.25	16.77	55.02	109.40	-54.38	Peak	

**REMARKS:**

- (1) Measurement Value = Reading Level + Correct Factor.
- (2) Margin Level = Measurement Value - Limit Value.

Orthogonal Axis	X
Test Mode	UNII-3_TX N (HT20) Mode 5825 MHz

**Horizontal**

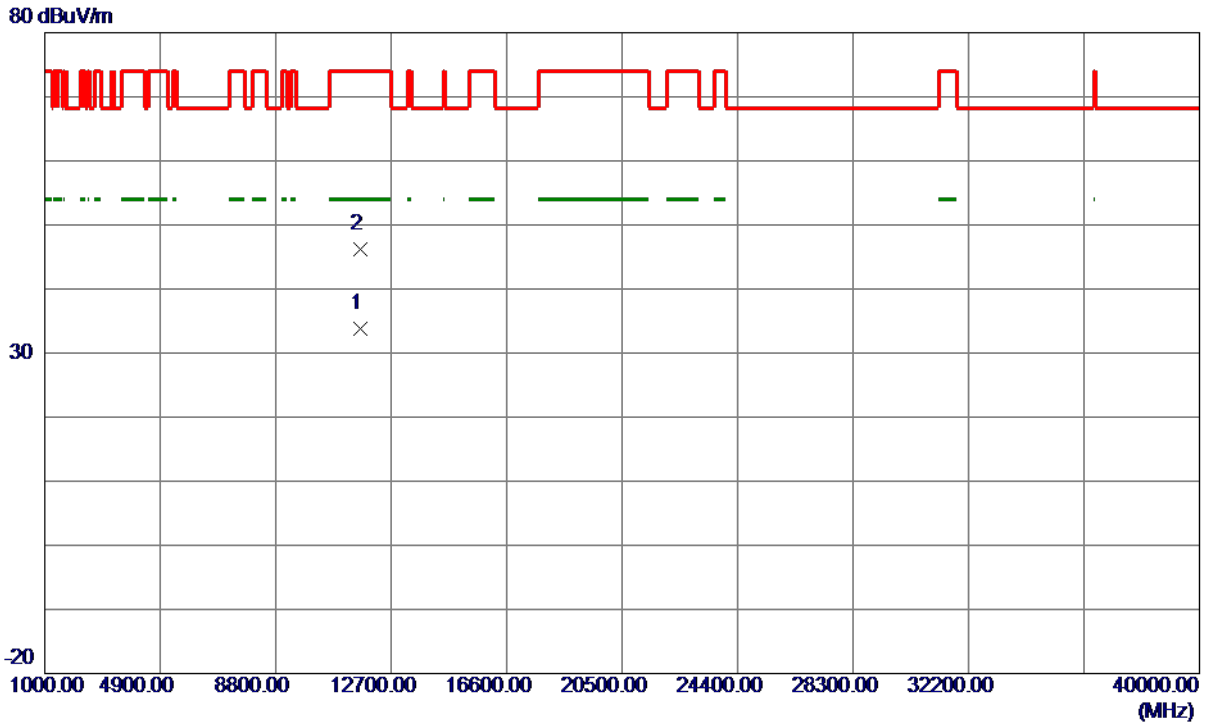

No.	Freq. MHz	Reading Level dBuV/m	Correct Factor dB	Measure ment dBuV/m	Limit dBuV/m	Margin dB	Detector	Comment
1 *	11640.8200	19.92	13.86	33.78	54.00	-20.22	AVG	
2	11642.0599	32.28	13.86	46.14	74.00	-27.86	Peak	

**REMARKS:**

- (1) Measurement Value = Reading Level + Correct Factor.
- (2) Margin Level = Measurement Value - Limit Value.

Orthogonal Axis	X
Test Mode	UNII-3_TX N (HT40) Mode 5755 MHz

**Vertical**

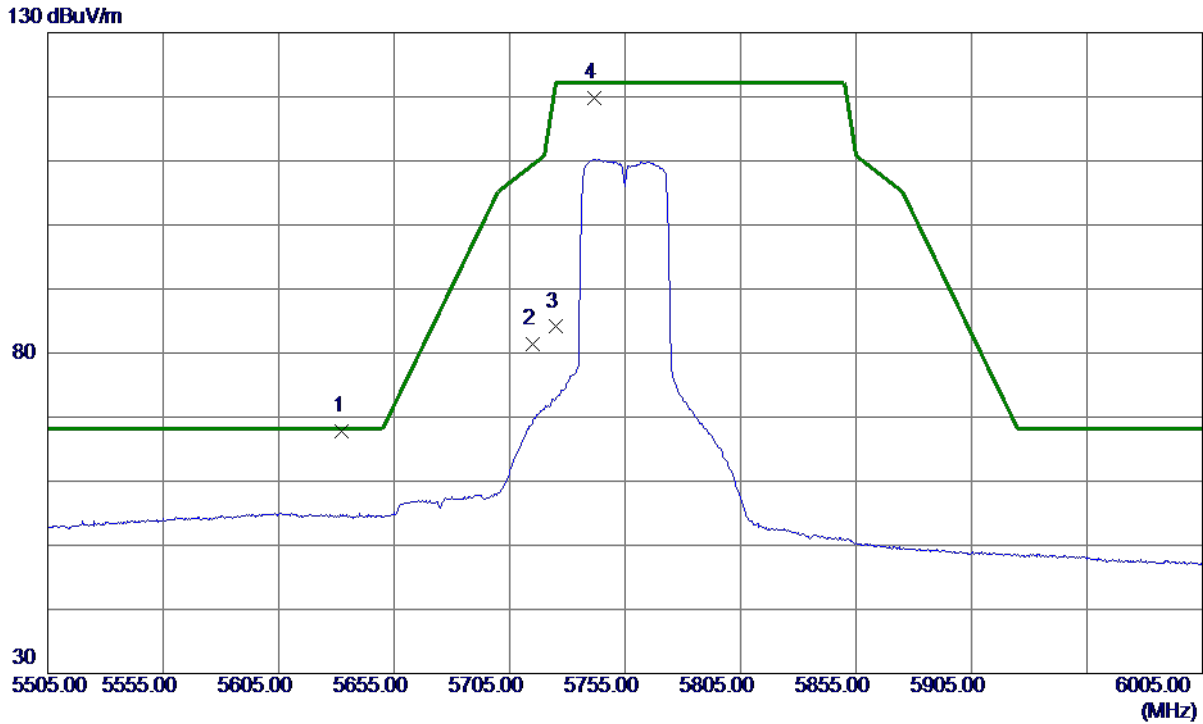

No.	Freq. MHz	Reading Level dBuV/m	Correct Factor dB	Measure ment dBuV/m	Limit dBuV/m	Margin dB	Detector	Comment
1 *	5632.5000	52.36	15.35	67.71	68.20	-0.49	Peak	
2	5715.0000	65.91	15.47	81.38	109.40	-28.02	Peak	
3	5725.0000	68.62	15.48	84.10	122.20	-38.10	Peak	
4	5741.5000	104.25	15.50	119.75	122.20	-2.45	Peak	No Limit

**REMARKS:**

- (1) Measurement Value = Reading Level + Correct Factor.
- (2) Margin Level = Measurement Value - Limit Value.



Orthogonal Axis	X
Test Mode	UNII-3_TX N (HT40) Mode 5755 MHz

**Vertical**

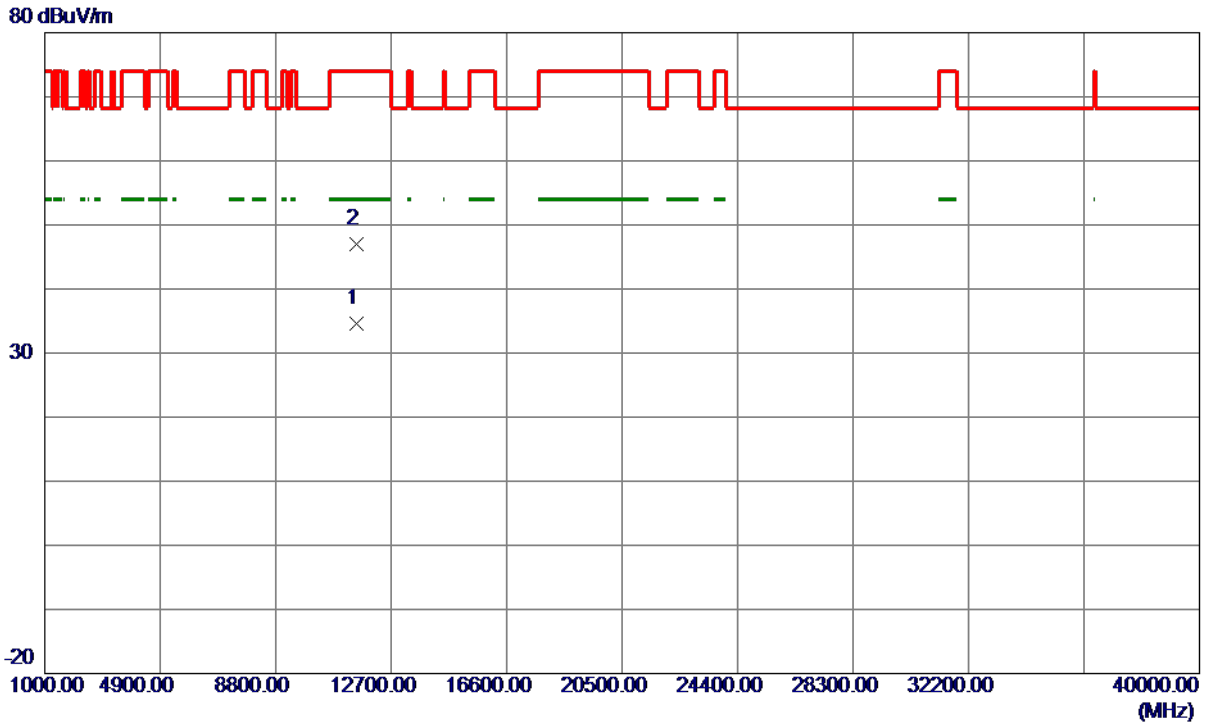

No.	Freq. MHz	Reading Level dBuV/m	Correct Factor dB	Measure ment dBuV/m	Limit dBuV/m	Margin dB	Detector	Comment
1 *	11510.0000	20.76	13.85	34.61	54.00	-19.39	AVG	
2	11511.0000	33.19	13.85	47.04	74.00	-26.96	Peak	

**REMARKS:**

- (1) Measurement Value = Reading Level + Correct Factor.
- (2) Margin Level = Measurement Value - Limit Value.

Orthogonal Axis	X
Test Mode	UNII-3_TX N (HT40) Mode 5755 MHz

**Horizontal**

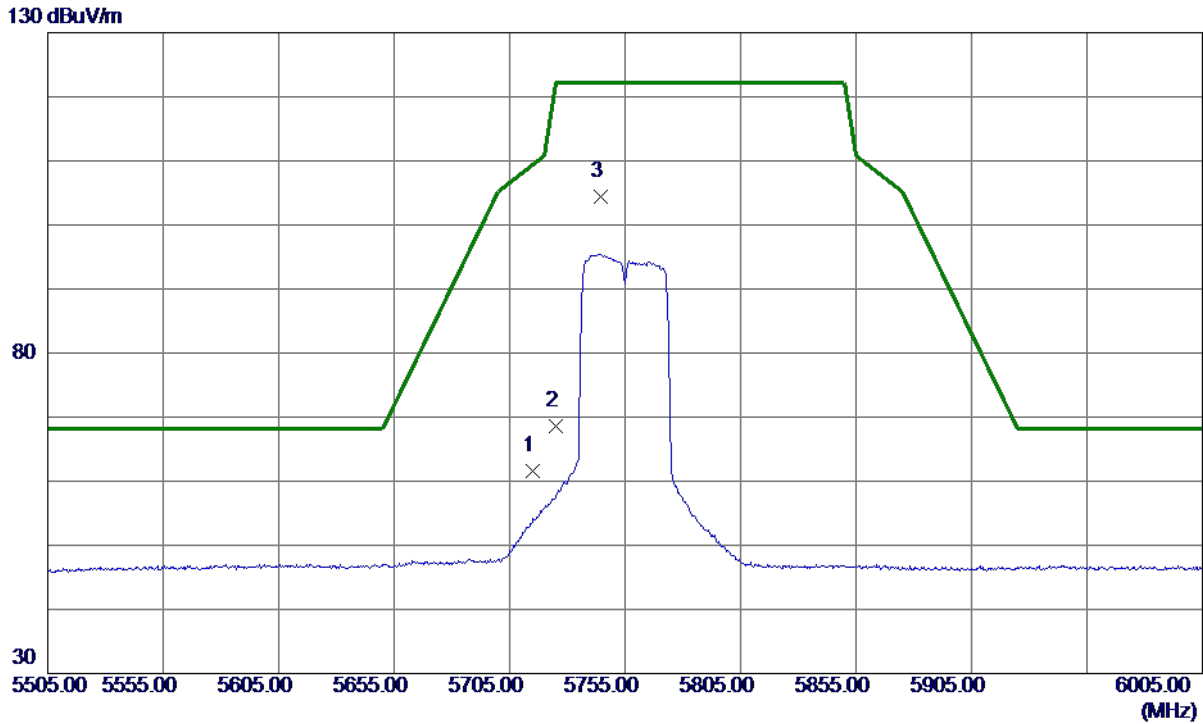

No.	Freq. MHz	Reading Level dBuV/m	Correct Factor dB	Measure ment dBuV/m	Limit dBuV/m	Margin dB	Detector	Comment
1	5715.0000	45.03	16.63	61.66	109.40	-47.74	Peak	
2	5725.0000	52.03	16.64	68.67	122.20	-53.53	Peak	
3 *	5744.5000	87.76	16.66	104.42	122.20	-17.78	Peak	No Limit

**REMARKS:**

- (1) Measurement Value = Reading Level + Correct Factor.
- (2) Margin Level = Measurement Value - Limit Value.

Orthogonal Axis	X
Test Mode	UNII-3_TX N (HT40) Mode 5755 MHz

**Horizontal**

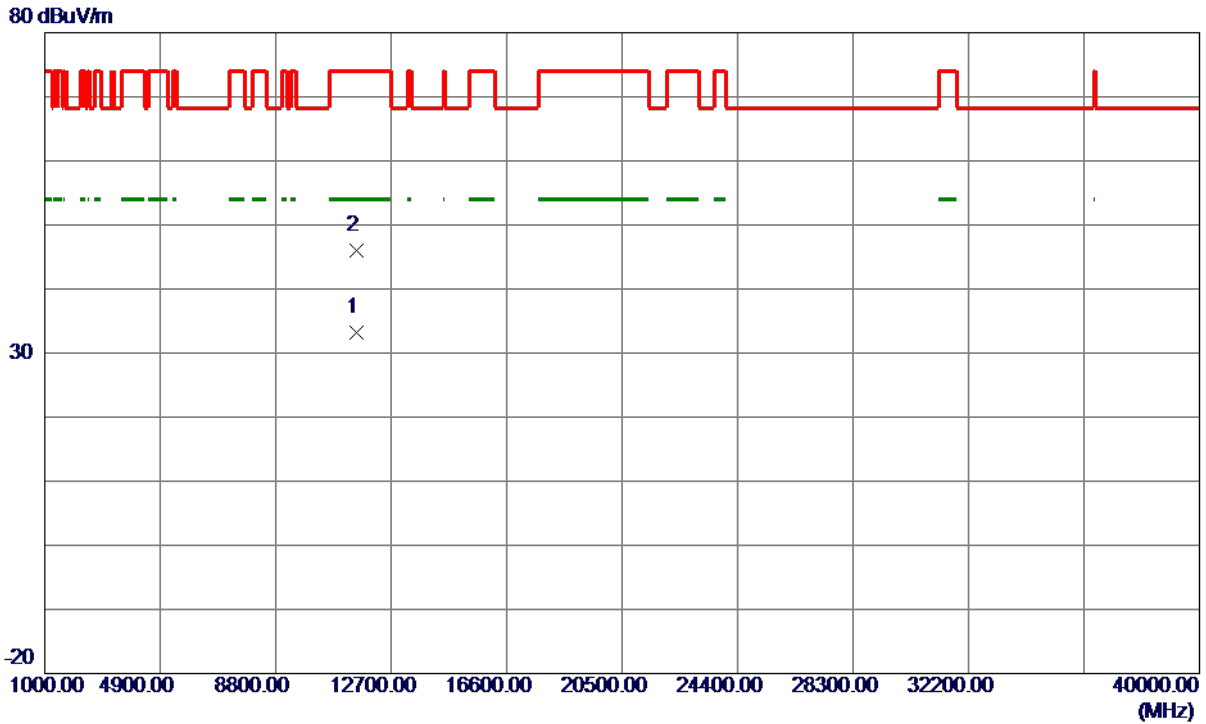

No.	Freq. MHz	Reading Level dBuV/m	Correct Factor dB	Measure ment dBuV/m	Limit dBuV/m	Margin dB	Detector	Comment
1 *	11510.0800	19.32	13.85	33.17	54.00	-20.83	AVG	
2	11510.1200	32.09	13.85	45.94	74.00	-28.06	Peak	

**REMARKS:**

- (1) Measurement Value = Reading Level + Correct Factor.
- (2) Margin Level = Measurement Value - Limit Value.

Orthogonal Axis	X
Test Mode	UNII-3_TX N (HT40) Mode 5795 MHz

Vertical

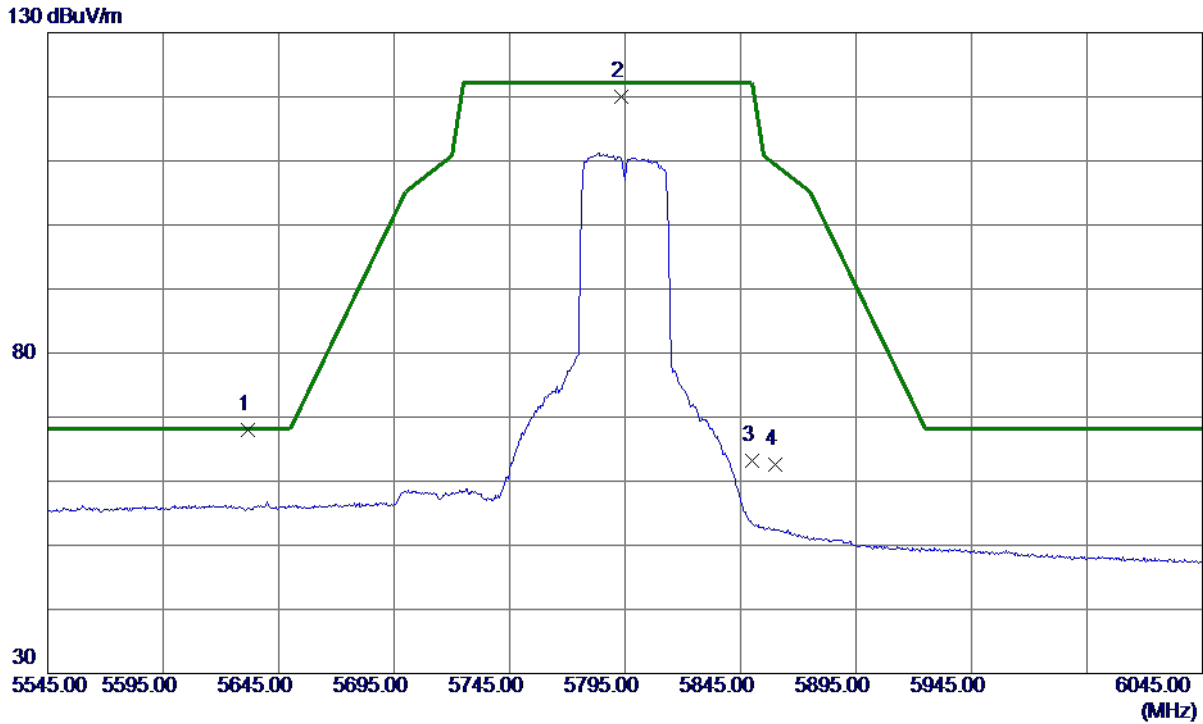

No.	Freq. MHz	Reading Level dBuV/m	Correct Factor dB	Measure ment dBuV/m	Limit dBuV/m	Margin dB	Detector	Comment
1 *	5631.5000	51.53	16.55	68.08	68.20	-0.12	Peak	
2	5793.5000	103.38	16.71	120.09	122.20	-2.11	Peak	No Limit
3	5850.0000	46.40	16.76	63.16	122.20	-59.04	Peak	
4	5860.0000	45.90	16.77	62.67	109.40	-46.73	Peak	

REMARKS:

- (1) Measurement Value = Reading Level + Correct Factor.
- (2) Margin Level = Measurement Value - Limit Value.

Orthogonal Axis	X
Test Mode	UNII-3_TX N (HT40) Mode 5795 MHz

**Vertical**

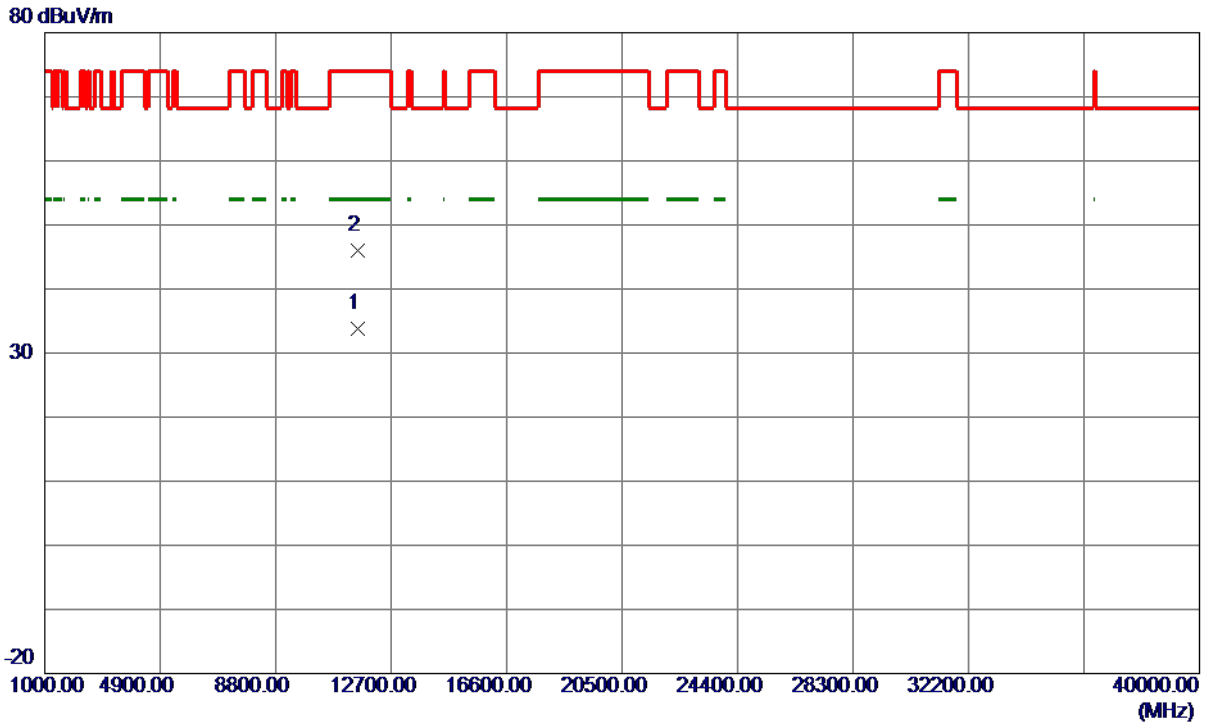

No.	Freq. MHz	Reading Level dBuV/m	Correct Factor dB	Measure ment dBuV/m	Limit dBuV/m	Margin dB	Detector	Comment
1 *	11590.0000	19.85	13.86	33.71	54.00	-20.29	AVG	
2	11593.0000	32.23	13.86	46.09	74.00	-27.91	Peak	

**REMARKS:**

- (1) Measurement Value = Reading Level + Correct Factor.
- (2) Margin Level = Measurement Value - Limit Value.

Orthogonal Axis	X
Test Mode	UNII-3_TX N (HT40) Mode 5795 MHz

**Horizontal**

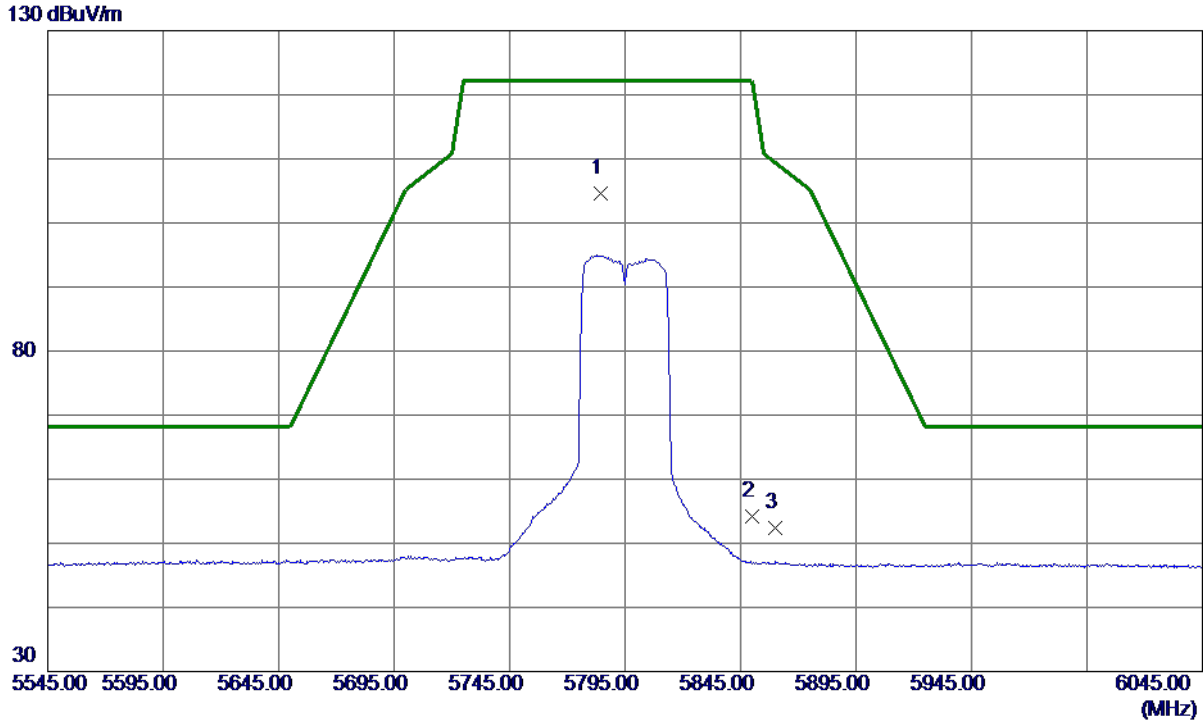

No.	Freq. MHz	Reading Level dBuV/m	Correct Factor dB	Measure ment dBuV/m	Limit dBuV/m	Margin dB	Detector	Comment
1 *	5784.5000	87.88	16.70	104.58	122.20	-17.62	Peak	No Limit
2	5850.0000	37.52	16.76	54.28	122.20	-67.92	Peak	
3	5860.0000	35.62	16.77	52.39	109.40	-57.01	Peak	

**REMARKS:**

- (1) Measurement Value = Reading Level + Correct Factor.
- (2) Margin Level = Measurement Value - Limit Value.

Orthogonal Axis	X
Test Mode	UNII-3_TX N (HT40) Mode 5795 MHz

**Horizontal**

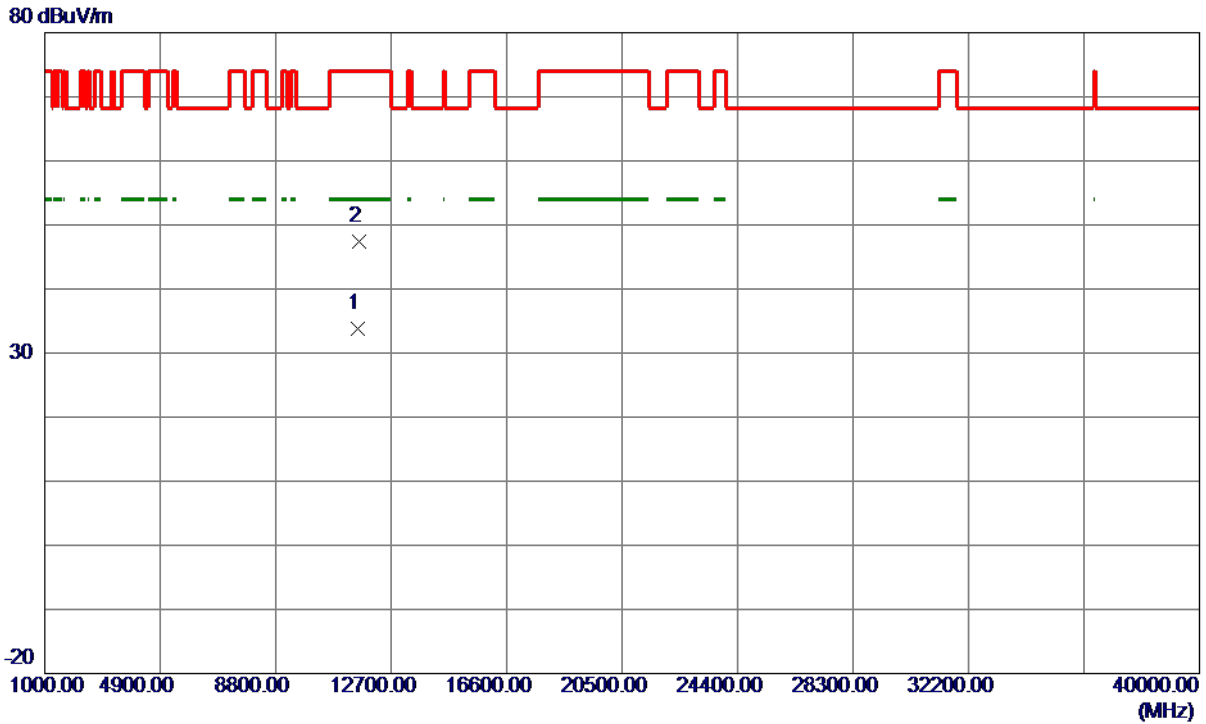

No.	Freq. MHz	Reading Level dBuV/m	Correct Factor dB	Measure ment dBuV/m	Limit dBuV/m	Margin dB	Detector	Comment
1 *	11585.6500	19.94	13.86	33.80	54.00	-20.20	AVG	
2	11595.4200	33.54	13.86	47.40	74.00	-26.60	Peak	

**REMARKS:**

- (1) Measurement Value = Reading Level + Correct Factor.
- (2) Margin Level = Measurement Value - Limit Value.

## APPENDIX E - BANDWIDTH