

Test Report

FCC Part15 Subpart C (Class II Permissive Change)

Product Name : AC1750 Wireless Dual Band Gigabit
Router

Model No. : Archer C7

FCC ID : TE7C7V2

Applicant : TP-LINK TECHNOLOGIES CO., LTD.

Address : Building 24 (floors 1,3,4,5) and 28 (floors1-4) Central
Science and Technology Park,Shennan Rd, Nanshan,
Shenzhen,China

Date of Receipt : Mar. 16, 2016

Test Date : Mar. 17, 2016~May. 16, 2016

Issued Date : May. 27, 2016

Report No. : 1612064R-RF-US-P06V01

Report Version : V1.0

Note: This report is based on ADT No. RF130829C04, it is only update the regulation, so we re-evaluate items are output power, radiated emission and bandedge.

The test results relate only to the samples tested.

The test results shown in the test report are traceable to the national/international standard through the calibration of the equipment and evaluated measurement uncertainty herein.

This report must not be used to claim product endorsement by CNAS,TAF or any agency of the government.

The test report shall not be reproduced without the written approval of Quietek Corporation.

Test Report Certification

Issued Date : May. 27, 2016

Report No. : 1612064R-RF-US-P06V01

Quietek

a  DEKRA company

Product Name : AC1750 Wireless Dual Band Gigabit Router
 Applicant : TP-LINK TECHNOLOGIES CO., LTD.
 Address : Building 24 (floors 1,3,4,5) and 28 (floors1-4) Central Science and Technology Park,Shennan Rd, Nanshan, Shenzhen,China
 Manufacturer : TP-LINK TECHNOLOGIES CO., LTD
 Address : Building 24 (floors 1,3,4,5) and 28 (floors1-4) Central Science and Technology Park,Shennan Rd, Nanshan, Shenzhen,China
 Model No. : Archer C7
 FCC ID : TE7C7V2
 EUT Voltage : AC 100-240V, 50/60Hz
 Brand Name : TP-LINK
 Applicable Standard : FCC CFR Title 47 Part 15 Subpart C: 2015
 ANSI C63.4:2014;
 ANSI C63.10:2013;
 KDB 558074 D01v03r05
 KDB 662911 D01 Multiple Transmitter Output v02r01
 Test Result : Complied
 Performed Location : Quietek Corporation - Suzhou EMC Laboratory
 No.99 Hongye Rd., Suzhou Industrial Park, Suzhou, 215006, Jiangsu, China
 TEL: +86-512-6251-5088 / FAX: +86-512-6251-5098
 FCC Registration Number: 800392

Documented By : 
 (Senior Adm. Specialist: Alice Ni)

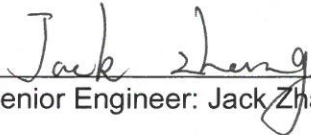
Reviewed By : 
 (Senior Engineer: Jack Zhang)

Approved By : 
 (Engineering Manager : Harry Zhao)

Laboratory Information

We, **Quietek Corporation**, are an independent EMC and safety consultancy that was established the whole facility in our laboratories. The test facility has been accredited/accepted(audited or listed) by the following related bodies in compliance with ISO 17025, EN 45001 and specified testing scope:

Taiwan R.O.C.	:	BSMI, NCC, TAF
USA	:	FCC
Japan	:	VCCI
China	:	CNAS

The related certificate for our laboratories about the test site and management system can be downloaded from Quietek Corporation's Web Site : <http://www.quietek.com/english/about/certificates.aspx?bval=5>
The address and introduction of Quietek Corporation's laboratories can be founded in our Web site : http://www.quietek.com/index_en.aspx

If you have any comments, Please don't hesitate to contact us. Our contact information is as below:

HsinChu Testing Laboratory :

No.75-2, 3rd Lin, Wangye Keng, Yonghxing Tsuen, Qionglin Shiang, Hsinchu County 307, Taiwan, R.O.C.
TEL:+886-3-592-8858 / FAX:+886-3-592-8859 E-Mail : service@quietek.com

LinKou Testing Laboratory :

No.5-22, Ruishukeng, Linkou Dist., New Taipei City 24451, Taiwan, R.O.C.
TEL : 886-2-8601-3788 / FAX : 886-2-8601-3789 E-Mail : service@quietek.com

Suzhou Testing Laboratory :

No.99 Hongye Rd., Suzhou Industrial Park, Suzhou, 215006, Jiangsu, China
TEL : +86-512-6251-5088 / FAX : 86-512-6251-5098 E-Mail : service@quietek.com

TABLE OF CONTENTS

Description	Page
1. General Information	6
1.1. EUT Description	6
1.2. Working Frequency of Each Channel:	7
1.3. Antenna information	7
1.4. Mode of Operation	8
1.5. Tested System Details	8
1.6. Configuration of Tested System	9
2. Technical Test	11
2.1. Summary of Test Result	11
2.2. Test Frequency configuration:	11
2.3. Power setting parameter	12
2.4. Power vs Data Rate	13
2.5. Test Environment	14
2.6. Measurement Uncertainty	14
3. Emissions in restricted frequency bands	15
3.1. Test Equipment	15
3.2. Test Setup	16
3.3. Limit	17
3.4. Test Procedure	19
3.5. EUT test Axis definition	20
3.6. Test Result	21
4. Radiated Emission Band Edge	27
4.1. Test Equipment	27
4.2. Test Setup	28
4.3. Limit	28
4.4. Test Procedure	29
4.5. EUT test definition	30
4.6. Duty Cycle	31
4.7. Test Result	32
5. Fundamental emission output power	64
5.1. Test Equipment	64
5.2. Test Setup	64
5.3. Limit	65
5.4. Test Procedure	66
5.5. EUT test definition	68
5.6. Test Result	69

History of This Test Report

REPORT NO.	VERSION	DESCRIPTION	ISSUED DATE
1612064R-RF-US-P06V01	V1.0	Initial Issued Report	May. 27, 2016

1. General Information

1.1. EUT Description

Product Name	AC1750 Wireless Dual Band Gigabit Router
Brand Name	TP-LINK
Model No.	Archer C7
EUT Voltage	AC 100-240V, 50/60Hz
Frequency Range	For 2.4GHz Band 802.11b/g/n(20MHz): 2412~2462MHz 802.11n(40MHz): 2422~2452MHz
Channel Number	For 2.4GHz Band 802.11b/g/n(20MHz): 11 802.11n(40MHz): 7
Type of Modulation	802.11b: DSSS 802.11g/n: OFDM
Data Rate	802.11b: 1/2/5.5/11 Mbps 802.11g: 6/9/12/18/24/36/48/54 Mbps 802.11n: up to 450 Mbps
Channel Control	Auto

1.2. Working Frequency of Each Channel:

802.11b/g/n(20MHz) Working Frequency of Each Channel:							
Channel	Frequency	Channel	Frequency	Channel	Frequency	Channel	Frequency
01	2412 MHz	02	2417 MHz	03	2422 MHz	04	2427 MHz
05	2432 MHz	06	2437 MHz	07	2442 MHz	08	2447 MHz
09	2452 MHz	10	2457 MHz	11	2462 MHz	N/A	N/A

802.11n(40MHz) Working Frequency of Each Channel:							
Channel	Frequency	Channel	Frequency	Channel	Frequency	Channel	Frequency
03	2422 MHz	04	2427 MHz	05	2432 MHz	06	2437 MHz
07	2442 MHz	08	2447 MHz	09	2452 MHz	N/A	N/A

1.3. Antenna information

Model No.	N/A						
Antenna manufacturer	TP-LINK						
Antenna Delivery	<input type="checkbox"/>	1*TX+1*RX	<input type="checkbox"/>	2*TX+2*RX	<input checked="" type="checkbox"/>	3*TX+3*RX	
Antenna technology	<input type="checkbox"/>	SISO					
	<input checked="" type="checkbox"/>	MIMO	<input type="checkbox"/>	Basic			
			<input checked="" type="checkbox"/>	CDD			
			<input type="checkbox"/>	Beam-forming			
Antenna Type	<input type="checkbox"/>	External	<input type="checkbox"/>	Dipole			
	<input checked="" type="checkbox"/>	Internal	<input checked="" type="checkbox"/>	PIFA			
			<input type="checkbox"/>	PCB			
			<input type="checkbox"/>	Ceramic Chip Antenna			
			<input type="checkbox"/>	Metal plate type F antenna			
Antenna Technology	Ant Gain (dBi)				Directional Gain (dBi)		
					For Power	For PSD	
<input checked="" type="checkbox"/>	CDD	Ant 0: 3.81 Ant 1: 2.44 Ant 2: 3.67			3.3	8.1	
<input type="checkbox"/>	Beam-forming	N/A			N/A	N/A	

1.4. Mode of Operation

Test Modes List
Mode 1: Transmit by 802.11b with CDD
Mode 2: Transmit by 802.11g with CDD
Mode 3: Transmit by 802.11n(20MHz) with CDD
Mode 4: Transmit by 802.11n(40MHz) with CDD

1.5. Tested System Details

The types for all equipments, plus descriptions of all cables used in the tested system (including inserted cards) are:

No.	Product	Manufacturer	Model No.	Serial No.	Power Cord
1	Notebook	Lenovo	Think pad x220	SUA0600195	Non-shielded
A	LAN cable	N/A	N/A	N/A	Non-shielded, 1.5m
B	LAN cable	N/A	N/A	N/A	Non-shielded, 10m

1.6. Configuration of Tested System

Test setup Diagram- AC Line Conducted Emission Test

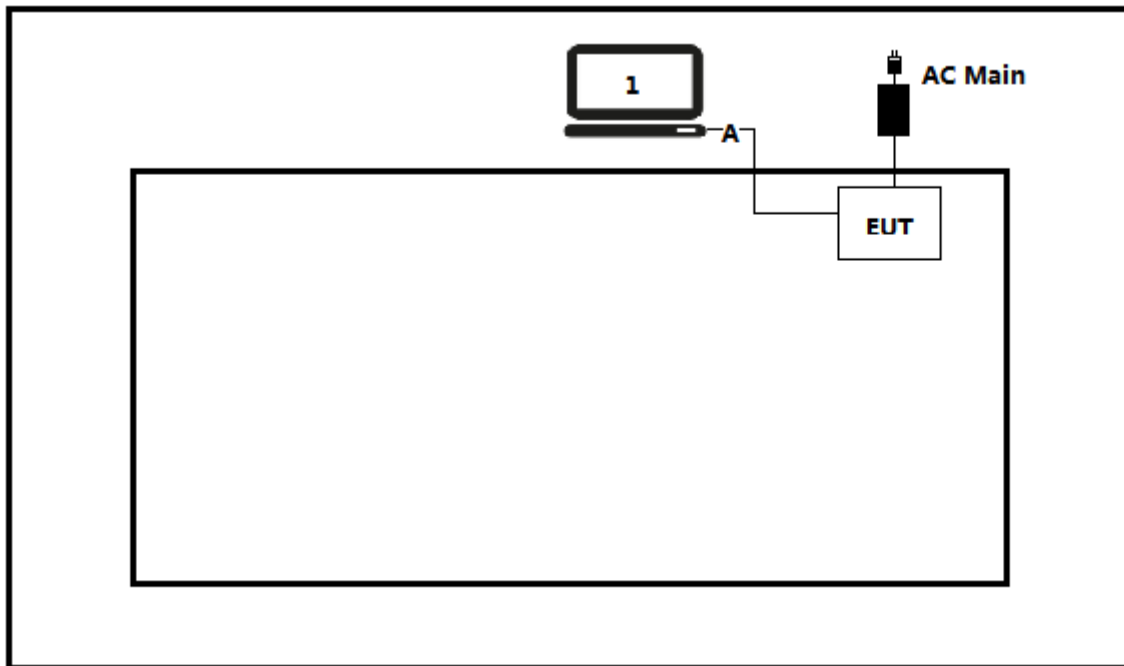

Test setup Diagram- Radiated Emission

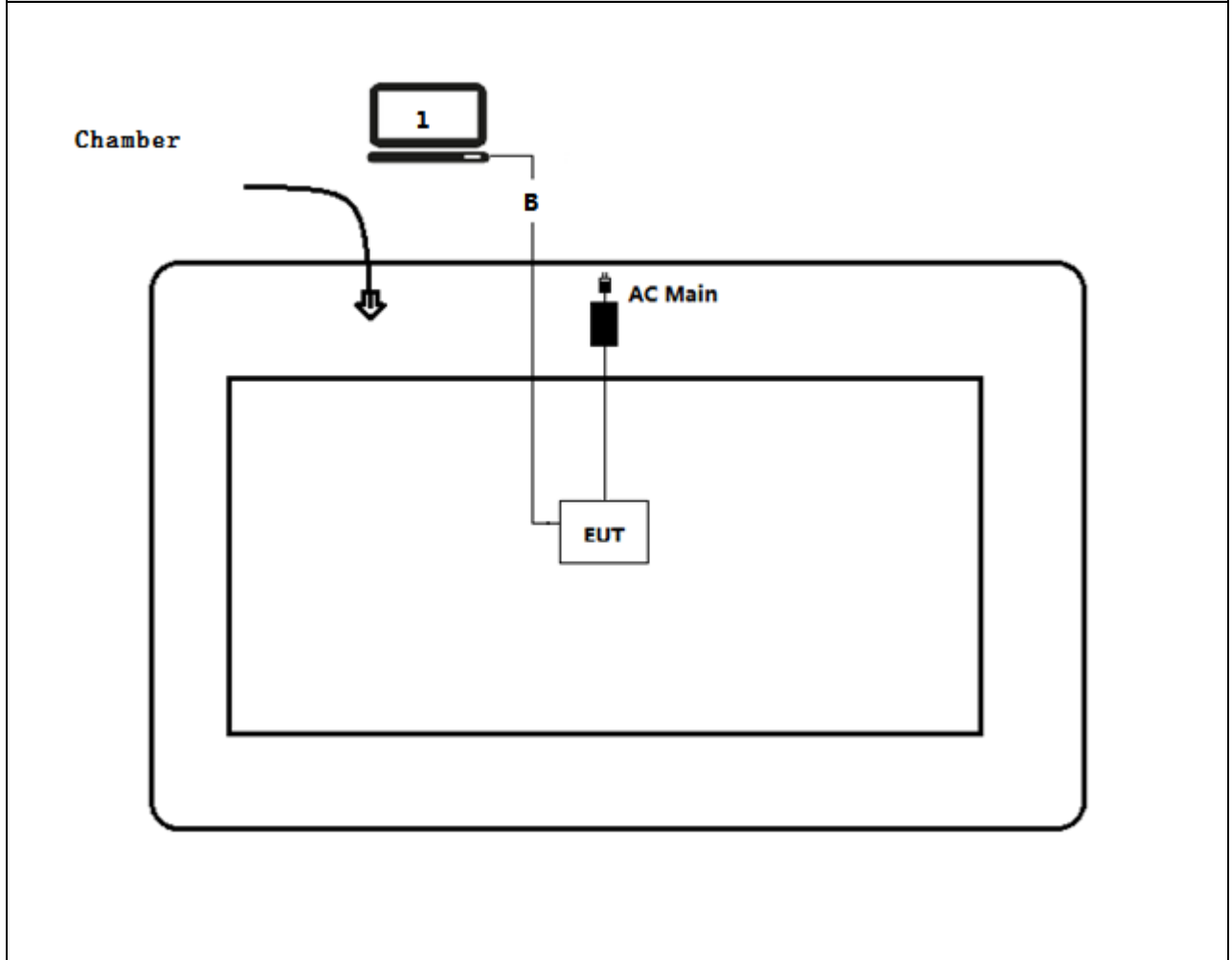

2. Technical Test

2.1. Summary of Test Result

Performed Test Item	Normative References	Worst case mode	Limit	Result
AC Power Line Conducted Emission	FCC CFR Title 47 Part 15 Subpart C: 2015 Section 15.207	802.11b	FCC 15.207	PASS
Emissions in restricted frequency bands	FCC CFR Title 47 Part 15 Subpart C: 2015 Section 15.209	802.11g	FCC 15.209	PASS
Radiated Emission Band Edge	FCC CFR Title 47 Part 15 Subpart C: 2015 15.247(d)	802.11g	FCC 15.209	PASS
Fundamental emission output power	FCC CFR Title 47 Part 15 Subpart C: 2015 Section 15.247(b)(3)	802.11b		

2.3. Power setting parameter

Test Software	Cart			
Modulation Mode	Test Frequency	Ant 0	Ant 1	Ant 2
802.11b	2412	20	20	20
	2437	22	22	22
	2462	16	16	16
802.11g	2412	12	12	12
	2437	18	18	18
	2462	12	12	12
802.11n(20MHz)	2412	12	12	12
	2437	19	19	19
	2462	12	12	12
802.11n(40MHz)	2422	8	8	8
	2437	12	12	12
	2452	10	10	10

Note: The device can only support MIMO mode.

2.4. Power vs Data Rate

MCS Index for 802.11n	Spatial Streams	Data Rate (Mbps)						
		802.11b	802.11g	802.11a	20MHz Bandwidth		40MHz Bandwidth	
					800ns GI	400ns GI	800ns GI	400ns GI
0	1	1	6	6	6.5	7.2	13.5	15.0
1	1	2	9	9	13.0	14.4	27.0	30.0
2	1	5.5	12	12	19.5	21.7	40.5	45.0
3	1	11	18	18	26.0	28.9	54.0	60.0
4	1	---	24	24	39.0	43.3	81.0	90.0
5	1	---	36	36	52.0	57.8	108.0	120.0
6	1	---	48	48	58.5	65.0	121.5	135.0
7	1	---	54	54	65.0	72.2	135.0	150.0
8	2	---	---	---	13.0	14.4	27.0	30.0
9	2	---	---	---	26.0	28.9	54.0	60.0
10	2	---	---	---	39.0	43.3	81.0	90.0
11	2	---	---	---	52.0	57.8	108.0	120.0
12	2	---	---	---	78.0	86.7	162.0	180.0
13	2	---	---	---	104.0	115.6	216.0	240.0
14	2	---	---	---	117.0	130.0	243.0	270.0
15	2	---	---	---	130.0	144.0	270.0	300.0

Note 1 : The blue form is the maximum power data rate

2.5. Test Environment

Items	Required (IEC 68-1)	Actual
Temperature (°C)	15-35	21
Humidity (%RH)	25-75	50
Barometric pressure (mbar)	860-1060	950-1000

2.6. Measurement Uncertainty

Test Items	Uncertainty
------------	-------------

AC Power Line Conducted Emission

3. Emissions in restricted frequency bands

3.1. Test Equipment

Emissions in restricted frequency bands/ AC-2					
Instrument	Manufacturer	Type No.	Serial No.	Cal. Date	Cal. Due Date
EMI Test Receiver	R&S	ESCI	100573	2016.03.29	2017.03.28
Loop Antenna	R&S	HFH2-Z2	833799/003	2015.11.16	2016.11.17
Bilog Antenna	Teseq GmbH	CBL6112D	27611	2015.10.16	2016.10.15
Coaxial Cable	Huber+Suhner	SUCOFLEX 106	AC2-C	2016.03.02	2017.03.01
Temperature/Humidity Meter	Zhichen	ZC1-2	AC2-TH	2016.01.04	2017.01.03
Note: All equipments are calibrated with traceable calibrations. Each calibration is traceable to the national or international standards.					

Emissions in restricted frequency bands / AC-5					
Instrument	Manufacturer	Type No.	Serial No.	Cal. Date	Cal. Due Date
Spectrum Analyzer	Agilent	E4446A	MY45300103	2016.01.04	2017.01.03
Preamplifier	Miteq	NSP1800-25	1364185	2016.05.06	2017.05.05
Preamplifier	Quietek	AP-040G	CHM-0906001	2016.05.06	2017.05.05
DRG Horn	ETS-Lindgren	3117	00123988	2016.01.22	2017.01.21
Broad-Band Horn Antenna	Schwarzbeck	BBHA9170	294	2015.11.25	2016.11.24
Coaxial Cable	Huber+Suhner	SUCOFLEX 106	AC5-C1	2016.03.02	2017.03.01
Coaxial Cable	Huber+Suhner	SUCOFLEX 106	AC5-C2	2016.03.02	2017.03.01
Coaxial Cable	Huber+Suhner	SUCOFLEX 102	AC5-C3	2016.03.02	2017.03.01
EMI Receiver	Agilent	N9038A	MY51210196	2015.06.10	2016.06.09
Temperature/Humidity Meter	Zhichen	ZC1-2	AC5-TH	2016.01.04	2017.01.03
Note: All equipments are calibrated with traceable calibrations. Each calibration is traceable to the national or international standards.					

3.2. Test Setup

Below 30MHz Test Setup:

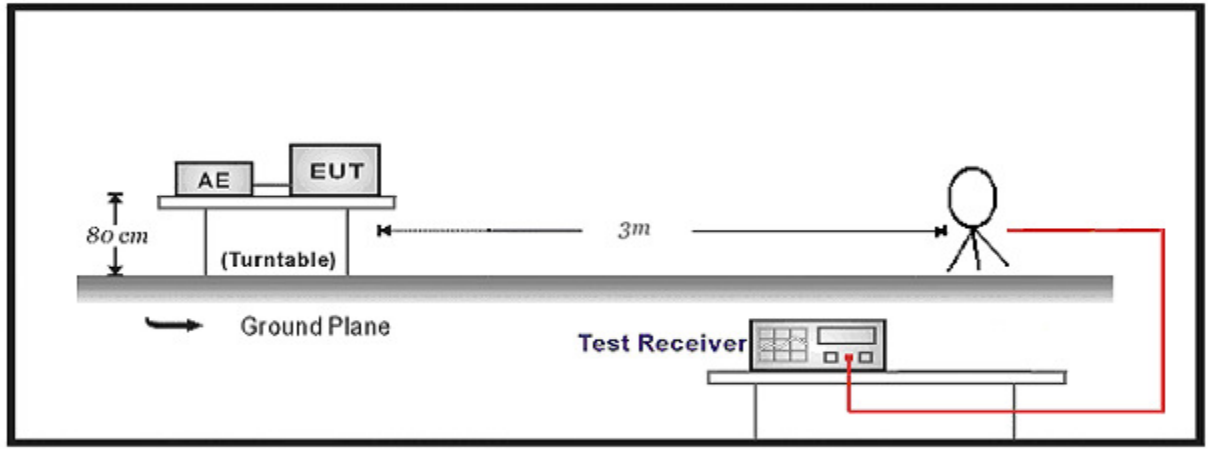

30MHz-1GHz Test Setup:

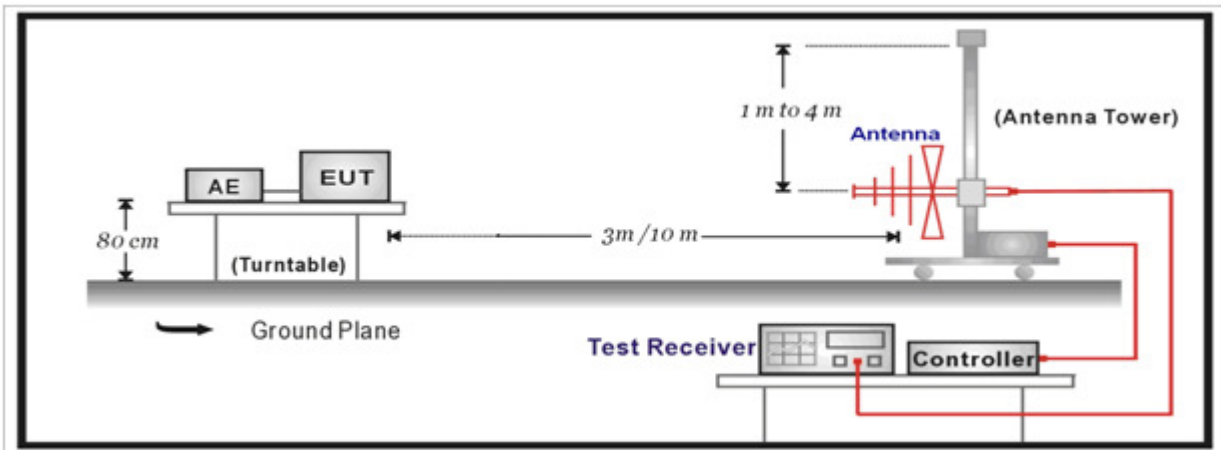

Above 1GHz Test Setup:

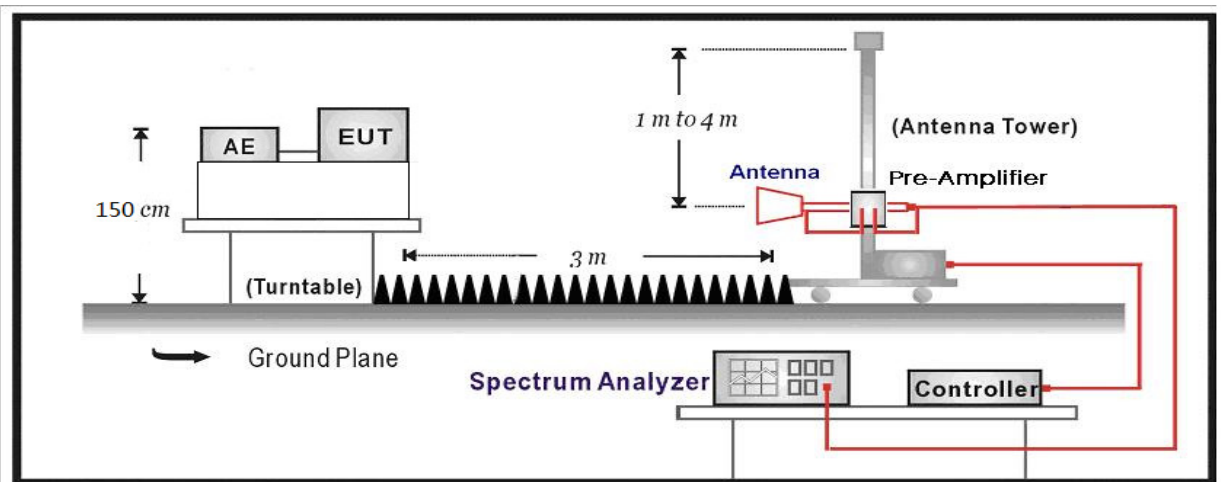

3.3. Limit

Restricted Bands			
Frequency (MHz)	Frequency (MHz)	Frequency (MHz)	Frequency (GHz)
0.090 – 0.110	16.42 – 16.423	399.9 – 410	4.5 – 5.15
0.495 – 0.505	16.69475 – 16.69525	608 – 614	5.35 – 5.46
2.1735 – 2.1905	16.80425 – 16.80475	960 – 1240	7.25 – 7.75
4.125 – 4.128	25.5 – 25.67	1300 – 1427	8.025 – 8.5
4.17725 – 4.17775	37.5 – 38.25	1435 – 1626.5	9.0 – 9.2
4.20725 – 4.20775	73 – 74.6	1645.5 – 1646.5	9.3 – 9.5
6.215 – 6.218	74.8 – 75.2	1660 – 1710	10.6 – 12.7
6.26775 – 6.26825	108 – 121.94	1718.8 – 1722.2	13.25 – 13.4
6.31175 – 6.31225	123 – 138	2200 – 2300	14.47 – 14.5
8.291 – 8.294	149.9 – 150.05	2310 – 2390	15.35 – 16.2
8.362 – 8.366	156.52475 – 156.52525	2483.5 – 2500	17.7 – 21.4
8.37625 – 8.38675	156.7 – 156.9	2690 – 2900	22.01 – 23.12
8.81425 – 8.81475	162.0125 – 167.17	3260 – 3267	23.6 – 24.0
12.29 – 12.293	167.72 – 173.2	3332 – 3339	31.2 – 31.8
12.51975 – 12.52025	240 – 285	3345.8 – 3358	36.43 – 36.5
12.57675 – 12.57725	322 – 335.4	3600 – 4400	
13.36 – 13.41			



Restricted Band Emissions Limit

Frequency (MHz)	Field strength (
--------------------	---------------------

3.4. Test Procedure

Test Method			
	References Rule	Chapter	Description
<input type="checkbox"/>	ANSI C63.10	11.11	Emissions in non-restricted frequency bands
	<input type="checkbox"/> ANSI C63.10	11.11.2	Reference level measurement
	<input type="checkbox"/> ANSI C63.10	11.11.3	Emission level measurement
<input checked="" type="checkbox"/>	ANSI C63.10	11.12	Emissions in restricted frequency bands
	<input checked="" type="checkbox"/> ANSI C63.10	11.12.1	Radiated emission measurements
	<input checked="" type="checkbox"/> ANSI C63.10	11.12.2.7	Radiated spurious emission test
	<input checked="" type="checkbox"/> ANSI C63.10	6.4	Radiated emissions from unlicensed wireless devices below 30 MHz
	<input checked="" type="checkbox"/> ANSI C63.10	6.5	Radiated emissions from unlicensed wireless devices in the frequency range of 30 MHz to 1000 MHz
	<input checked="" type="checkbox"/> ANSI C63.10	6.6	Radiated emissions from unlicensed wireless devices above 1 GHz
<input type="checkbox"/>	ANSI C63.10	11.12.2	Antenna-port conducted measurements
	<input type="checkbox"/> ANSI C63.10	11.12.2.3	Quasi-peak measurement procedure
	<input type="checkbox"/> ANSI C63.10	11.12.2.4	Peak power measurement procedure
	<input checked="" type="checkbox"/> ANSI C63.10	11.12.2.5	Average power measurement procedures
	<input type="checkbox"/> ANSI C63.10	11.12.2.5.1	Trace averaging with continuous EUT transmission at full power
	<input type="checkbox"/> ANSI C63.10	11.12.2.5.2	Trace averaging across ON and OFF times of the EUT transmissions followed by duty cycle correction
	<input checked="" type="checkbox"/> ANSI C63.10	11.12.2.5.3	Reduced VBW averaging across ON and OFF times of the EUT transmissions with max hold

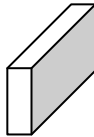
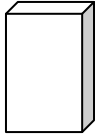
3.5. EUT test Axis definition

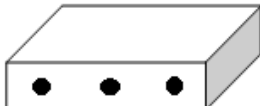
Item	Radiated Emission			
Device Category	<input checked="" type="checkbox"/>	Indoor use		
	<input type="checkbox"/>	Outdoor use		
	<input type="checkbox"/>	Fix position use		
	<input type="checkbox"/>	Mobile position use		
Test mode	Mode 1-4			
Test method	<input checked="" type="checkbox"/>	Radiated		
		X Axis	Y Axis	Z Axis
				
		Worst Axis <input type="checkbox"/>	Worst Axis <input checked="" type="checkbox"/>	Worst Axis <input type="checkbox"/>
	<input type="checkbox"/>	Conducted		
	<input type="checkbox"/>	Chain 0		
				
	<input type="checkbox"/>	Chain 0	Chain 1	
				
	<input type="checkbox"/>	Chain 0	Chain 1	Chain 2
				

3.6. Test Result

Product Name	:	AC1750 Wireless Dual Band Gigabit Router	Power	:	AC 120V/60Hz
Test Mode	:	Mode 1	Test Site	:	AC-5

Chain	CH	Antenna Polarity	Frequency (MHz)	Measure Level (dB)
-------	----	---------------------	--------------------	--------------------------

Product Name	:	AC1750 Wireless Dual Band Gigabit Router	Power	:	AC 120V/60Hz
Test Site	:	Mode 2	Test Site	:	AC-5

Chain	CH	Antenna Polarity	Frequency (MHz)	Measure Level (dB
-------	----	---------------------	--------------------	-------------------------

Product Name	:	AC1750 Wireless Dual Band Gigabit Router	Power	:	AC 120V/60Hz
Test Site	:	Mode 3	Test Site	:	AC-5

Chain	CH	Antenna Polarity	Frequency (MHz)	Measure Level (dB)
-------	----	------------------	-----------------	--------------------

Product Name	:	AC1750 Wireless Dual Band Gigabit Router	Power	:	AC 120V/60Hz
Test Site	:	Mode 4	Test Site	:	AC-5

Chain	CH	Antenna Polarity	Frequency (MHz)	Measure Level (dB)
-------	----	---------------------	--------------------	--------------------------

The worst case of Radiated Emission below 1GHz:

Site: AC2	Time: 2016/01/28
Limit: FCC_Part15.109_RE(3m)_ClassB	Margin: 0
Probe: CB7_CBL6112_0726	Polarity: Horizontal
EUT: AC1750 Wireless Dual Band Gigabit Router	Power: AC 120V/60Hz
Note: Mode 1	

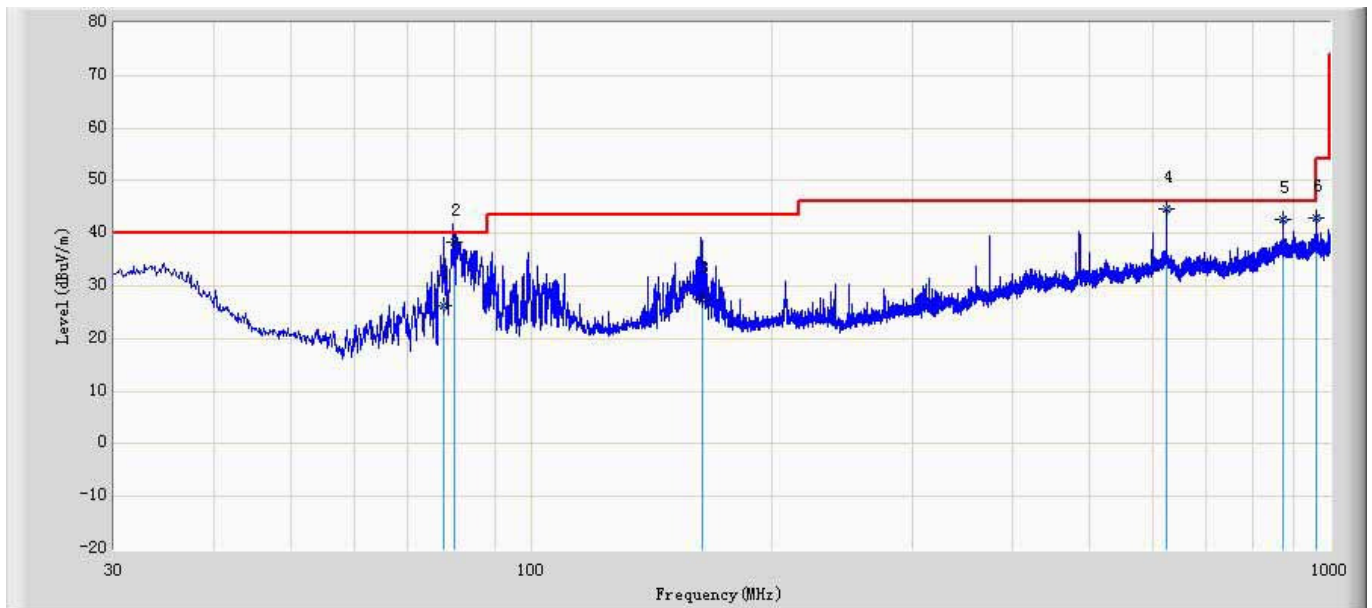

No	Mark	Frequency (MHz)	Measure Level (dBuV/m)	Reading Level (dBuV)	Over Limit (dB)	Limit (dBuV/m)	Probe (dB/m)	Cable (dB)	Amp (dB)	Ant Pos (cm)	Table Pos (deg)	Type
1		77.796	26.144	41.448	-13.856	40.000	6.846	0.950	23.100	200	336	QP
2		79.920	38.452	53.569	-1.548	40.000	7.023	0.960	23.100	199	360	QP
3		163.326	27.493	39.353	-16.007	43.500	9.800	1.384	23.044	100	360	QP
4	*	624.990	44.598	45.394	-1.402	46.000	19.000	2.740	22.536	138	360	QP
5		875.053	42.629	41.579	-3.371	46.000	20.450	3.260	22.660	100	312	QP
6		960.055	42.966	40.855	-11.034	54.000	20.981	3.420	22.290	100	29	QP

Site: AC2	Time: 2016/01/28
Limit: FCC_Part15.109_RE(3m)_ClassB	Margin: 0
Probe: CB7_CBL6112_0726	Polarity: Vertical
EUT: AC1750 Wireless Dual Band Gigabit Router	Power: AC 120V/60Hz
Note: Mode 1	

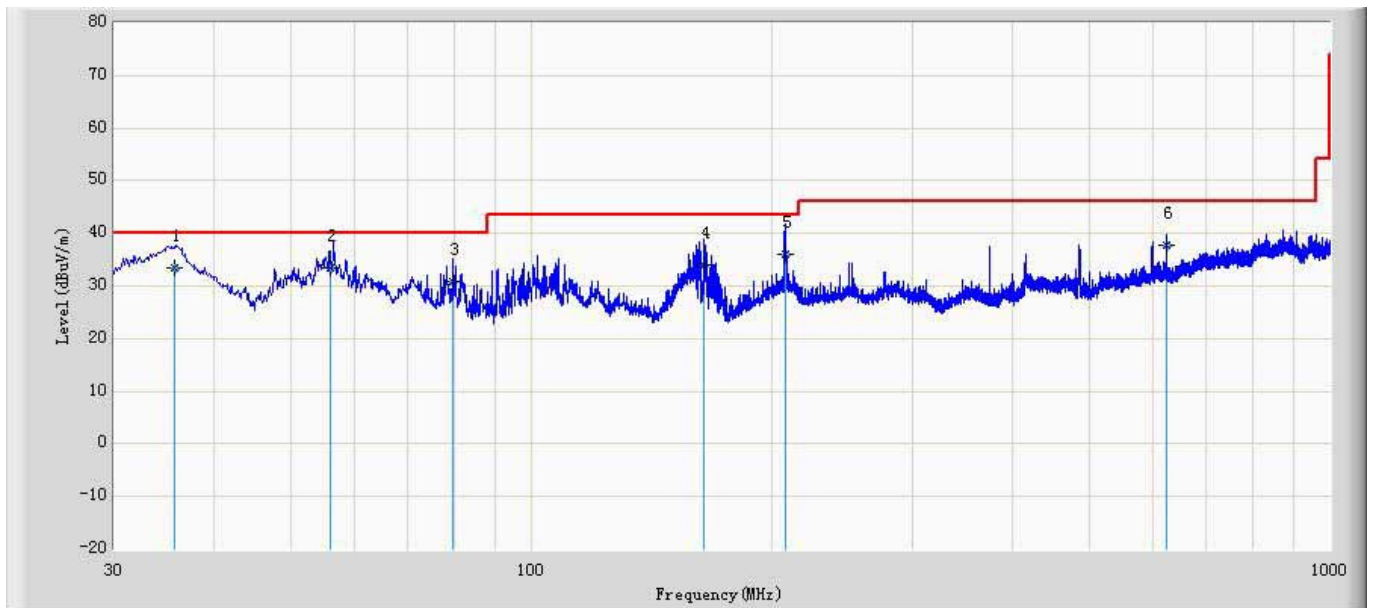

No	Mark	Frequency (MHz)	Measure Level (dBuV/m)	Reading Level (dBuV)	Over Limit (dB)	Limit (dBuV/m)	Probe (dB/m)	Cable (dB)	Amp (dB)	Ant Pos (cm)	Table Pos (deg)	Type
1	*	35.792	33.519	40.609	-6.481	40.000	15.440	0.650	23.180	100	165	QP
2		56.014	33.484	48.524	-6.516	40.000	7.178	0.810	23.028	100	114	QP
3		79.569	30.976	46.140	-9.024	40.000	6.976	0.960	23.100	200	118	QP
4		164.381	33.899	45.791	-9.601	43.500	9.768	1.390	23.050	200	312	QP
5		208.312	36.062	48.443	-7.438	43.500	9.251	1.568	23.200	100	263	QP
6		625.223	37.763	38.557	-8.237	46.000	19.000	2.740	22.534	100	32	QP

4. Radiated Emission Band Edge

4.1. Test Equipment

Radiated Emission Band Edge/ AC-5					
Instrument	Manufacturer	Type No.	Serial No.	Cal. Date	Cal. Due Date
Spectrum Analyzer	Agilent	E4446A	MY45300103	2016.01.04	2017.01.03
Preamplifier	Miteq	NSP1800-25	1364185	2016.05.06	2017.05.05
Preamplifier	Quietek	AP-040G	CHM-0906001	2016.05.06	2017.05.05
DRG Horn	ETS-Lindgren	3117	00123988	2016.01.22	2017.01.21
Broad-Band Horn Antenna	Schwarzbeck	BBHA9170	294	2015.11.25	2016.11.24
Coaxial Cable	Huber+Suhner	SUCOFLEX 106	AC5-C1	2016.03.02	2017.03.01
Coaxial Cable	Huber+Suhner	SUCOFLEX 106	AC5-C2	2016.03.02	2017.03.01
Coaxial Cable	Huber+Suhner	SUCOFLEX 102	AC5-C3	2016.03.02	2017.03.01
EMI Receiver	Agilent	N9038A	MY51210196	2015.06.10	2016.06.09
Temperature/Humidity Meter	Zhichen	ZC1-2	AC5-TH	2016.01.04	2017.01.03
Note: All equipments are calibrated with traceable calibrations. Each calibration is traceable to the national or international standards.					

4.2. Test Setup

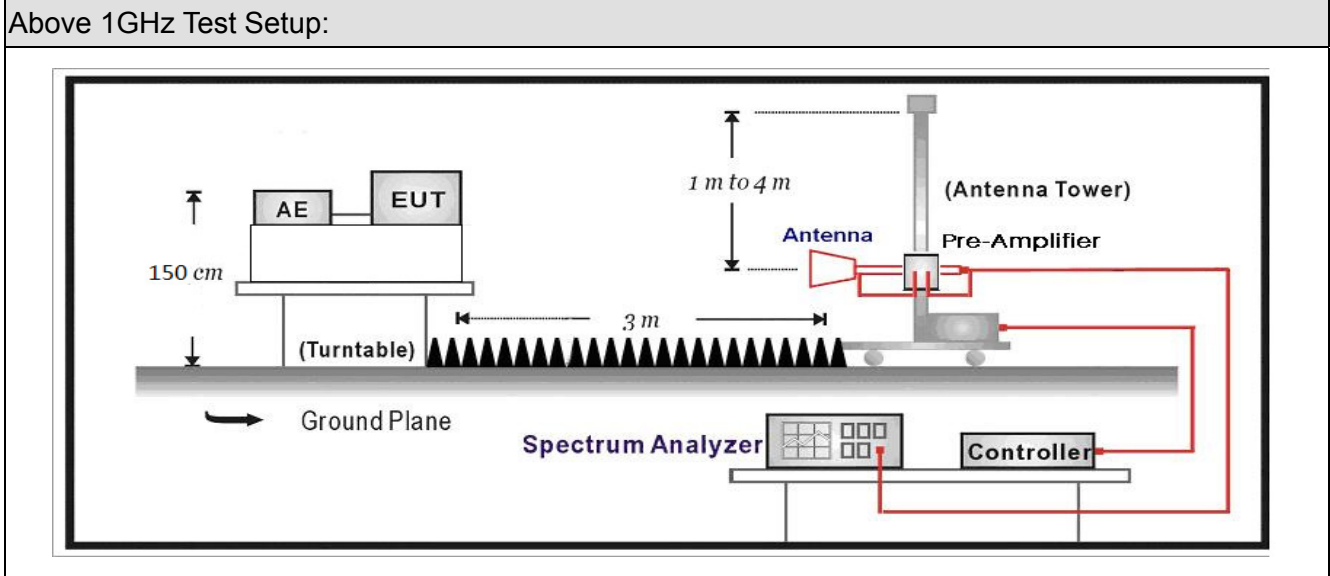

4.3. Limit

Band edge Limit		
Frequency bands (MHz)	Detector	Limit (dB)

4.4. Test Procedure

Test Method			
	References Rule	Chapter	Description
<input checked="" type="checkbox"/>	ANSI C63.10	6.10	Band-edge testing
	<input checked="" type="checkbox"/> ANSI C63.10	6.10.5	Restricted-band band-edge measurements
	<input type="checkbox"/> ANSI C63.10	6.10.6	Marker-delta method
<input checked="" type="checkbox"/>	ANSI C63.10	11.12	Emissions in restricted frequency bands
	<input checked="" type="checkbox"/> ANSI C63.10	11.12.1	Radiated emission measurements
	<input checked="" type="checkbox"/> ANSI C63.10	11.12.2.7	Radiated spurious emission test
<input type="checkbox"/>	ANSI C63.10	6.4	Radiated emissions from unlicensed wireless devices below 30 MHz
<input type="checkbox"/>	ANSI C63.10	6.5	Radiated emissions from unlicensed wireless devices in the frequency range of 30 MHz to 1000 MHz
<input checked="" type="checkbox"/>	ANSI C63.10	6.6	Radiated emissions from unlicensed wireless devices above 1 GHz
	<input type="checkbox"/> ANSI C63.10	11.12.2	Antenna-port conducted measurements
	<input type="checkbox"/> ANSI C63.10	11.12.2.3	Quasi-peak measurement procedure
	<input checked="" type="checkbox"/> ANSI C63.10	11.12.2.4	Peak power measurement procedure
	<input checked="" type="checkbox"/> ANSI C63.10	11.12.2.5	Average power measurement procedures
	<input type="checkbox"/> ANSI C63.10	11.12.2.5.1	Trace averaging with continuous EUT transmission at full power
	<input type="checkbox"/> ANSI C63.10	11.12.2.5.2	Trace averaging across ON and OFF times of the EUT transmissions followed by duty cycle correction
	<input checked="" type="checkbox"/> ANSI C63.10	11.12.2.5.3	Reduced VBW averaging across ON and OFF times of the EUT transmissions with max hold

4.5. EUT test definition

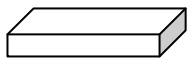
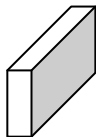
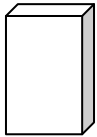
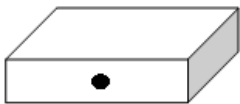
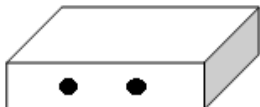
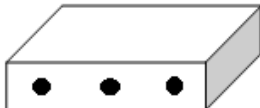
Item	Radiated Emission Band Edge			
Device Category	<input checked="" type="checkbox"/>	Indoor use		
	<input type="checkbox"/>	Outdoor use		
	<input type="checkbox"/>	Fix position use		
	<input type="checkbox"/>	Mobile position use		
Test mode	Mode 1-4			
Test method	<input checked="" type="checkbox"/>	Radiated		
		X Axis	Y Axis	Z Axis
				
		Worst Axis <input type="checkbox"/>	Worst Axis <input checked="" type="checkbox"/>	Worst Axis <input type="checkbox"/>
	<input type="checkbox"/>	Conducted		
	<input type="checkbox"/>	Chain 0		
				
	<input type="checkbox"/>	Chain 0	Chain 1	
				
	<input type="checkbox"/>	Chain 0	Chain 1	Chain 2
				

4.6. Duty Cycle

CDD mode:

Test Mode	Tx On (ms)	Tx Off (ms)	VBW	Tx On + Tx Off (ms)	Duty Cycle
802.11b	12.17	0.07	82.17Hz	12.24	99.43%
802.11g	2.02	0.06	495Hz	2.07	97.58%
802.11n(20MHz)	1.88	0.06	532Hz	1.94	96.91 %
802.11n(40MHz)	0.93	0.04	1.08KHz	0.97	95.88%

Note 1: T means the minimum transmission duration over which the transmitter is on and is transmitting at its maximum power control level for the tested mode of operation.

Note 2: According to KDB 558074

4.7. Test Result

Site: AC5	Time: 2016/04/06 - 09:46
Limit: FCC_Part15.209_RE(3m)	Margin: 0
Probe: Horn_3117_00167055(1-18GHz)	Polarity: Vertical
EUT: AC1750 Wireless Dual Band Gigabit Router	Power: AC 120V/60Hz
Note: Mode 1:Transmit at CH2412Mhz by 802.11b	

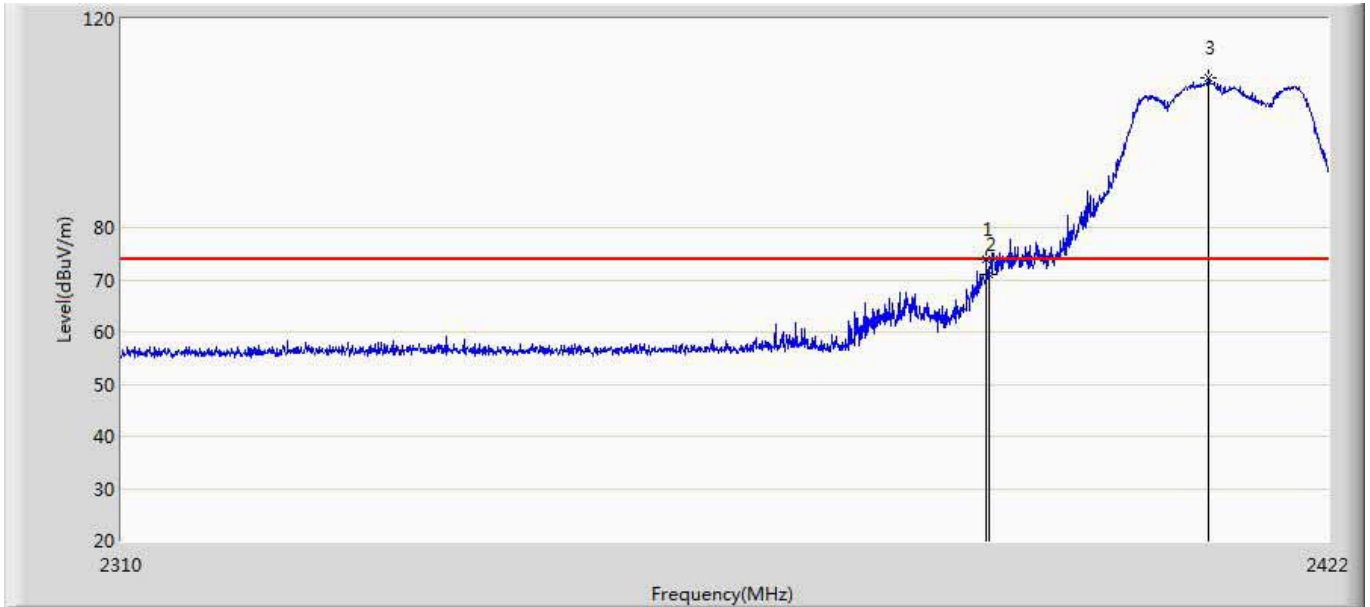

No	Mark	Frequency (MHz)	Measure Level (dBuV/m)	Reading Level (dBuV)	Over Limit (dB)	Limit (dBuV/m)	Factor (dB)	Type
1		2389.800	73.979	36.623	-0.021	74.000	37.356	PK
2		2390.000	71.046	33.691	-2.954	74.000	37.355	PK
3	*	2410.744	108.664	71.336	34.664	74.000	37.328	PK

Site: AC5	Time: 2016/04/06 - 10:03
Limit: FCC_Part15.209_RE(3m)	Margin: 0
Probe: Horn_3117_00167055(1-18GHz)	Polarity: Vertical
EUT: AC1750 Wireless Dual Band Gigabit Router	Power: AC 120V/60Hz
Note: Mode 1:Transmit at CH2412Mhz by 802.11b	

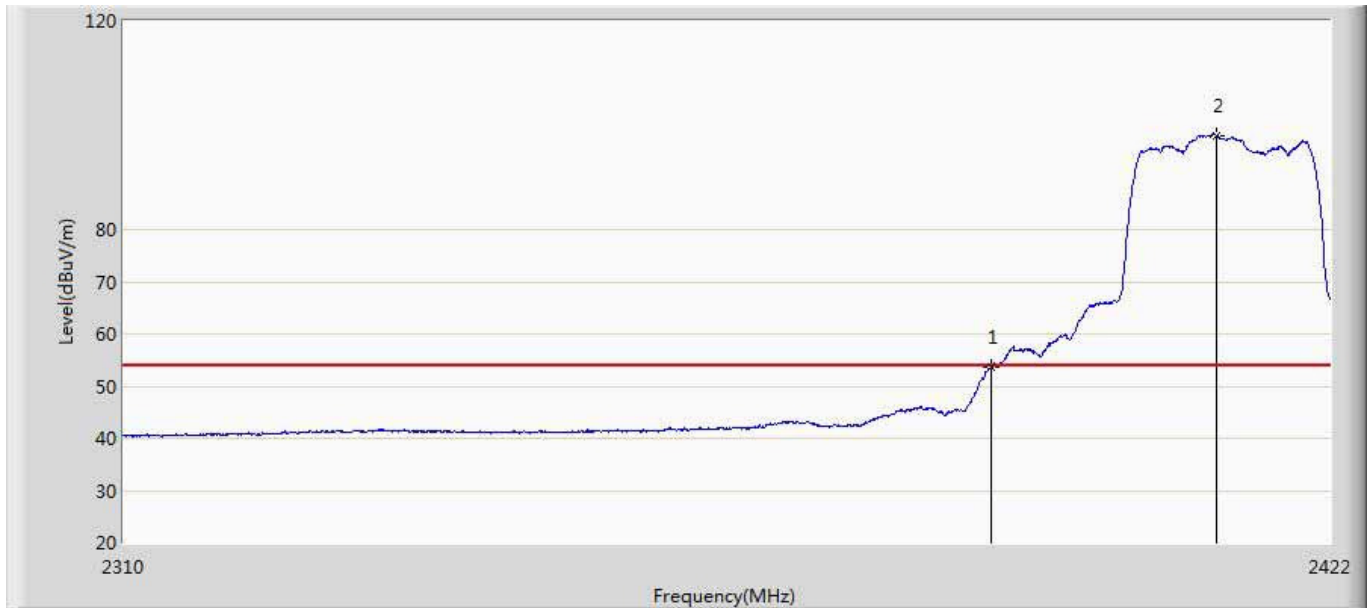

No	Mark	Frequency (MHz)	Measure Level (dBuV/m)	Reading Level (dBuV)	Over Limit (dB)	Limit (dBuV/m)	Factor (dB)	Type
1		2390.000	53.496	16.141	-0.504	54.000	37.355	AV
2	*	2411.192	98.106	60.777	44.106	54.000	37.329	AV

Site: AC5	Time: 2016/04/06 - 10:05
Limit: FCC_Part15.209_RE(3m)	Margin: 0
Probe: Horn_3117_00167055(1-18GHz)	Polarity: Horizontal
EUT: AC1750 Wireless Dual Band Gigabit Router	Power: AC 120V/60Hz
Note: Mode 1:Transmit at CH2412Mhz by 802.11b	

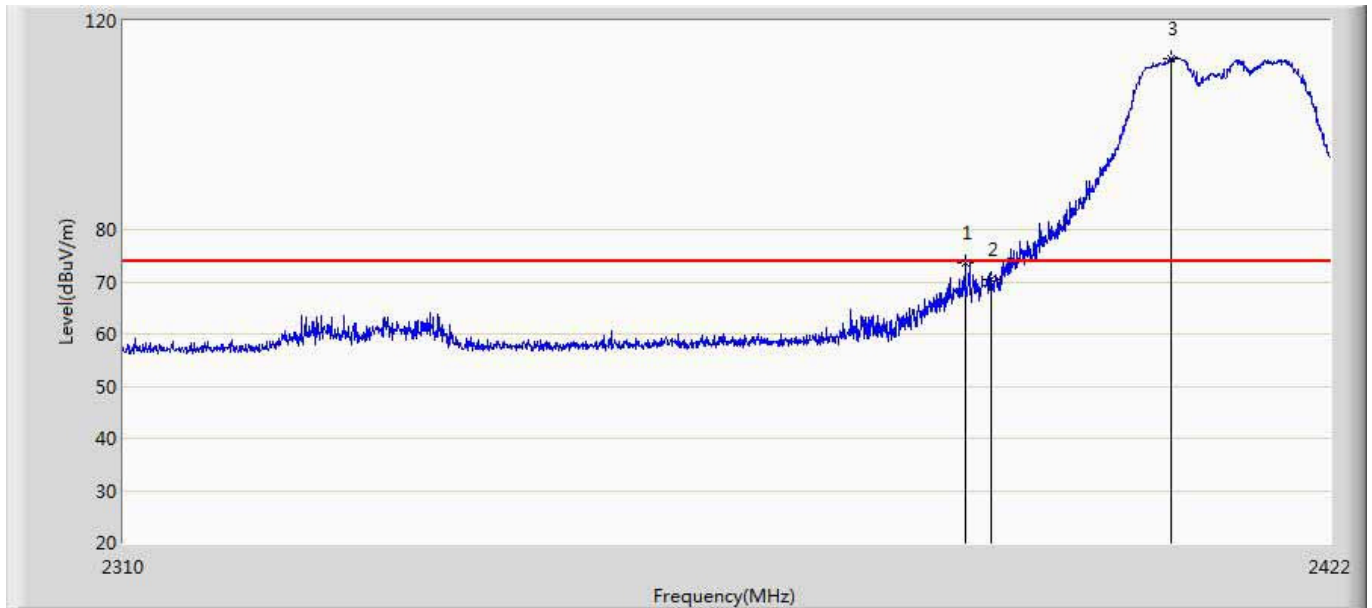

No	Mark	Frequency (MHz)	Measure Level (dBuV/m)	Reading Level (dBuV)	Over Limit (dB)	Limit (dBuV/m)	Factor (dB)	Type
1		2387.560	73.701	36.345	-0.299	74.000	37.356	PK
2		2390.000	70.576	33.221	-3.424	74.000	37.355	PK
3	*	2406.992	112.789	75.455	38.789	74.000	37.334	PK

Site: AC5	Time: 2016/04/06 - 10:11
Limit: FCC_Part15.209_RE(3m)	Margin: 0
Probe: Horn_3117_00167055(1-18GHz)	Polarity: Horizontal
EUT: AC1750 Wireless Dual Band Gigabit Router	Power: AC 120V/60Hz
Note: Mode 1:Transmit at CH2412Mhz by 802.11b	

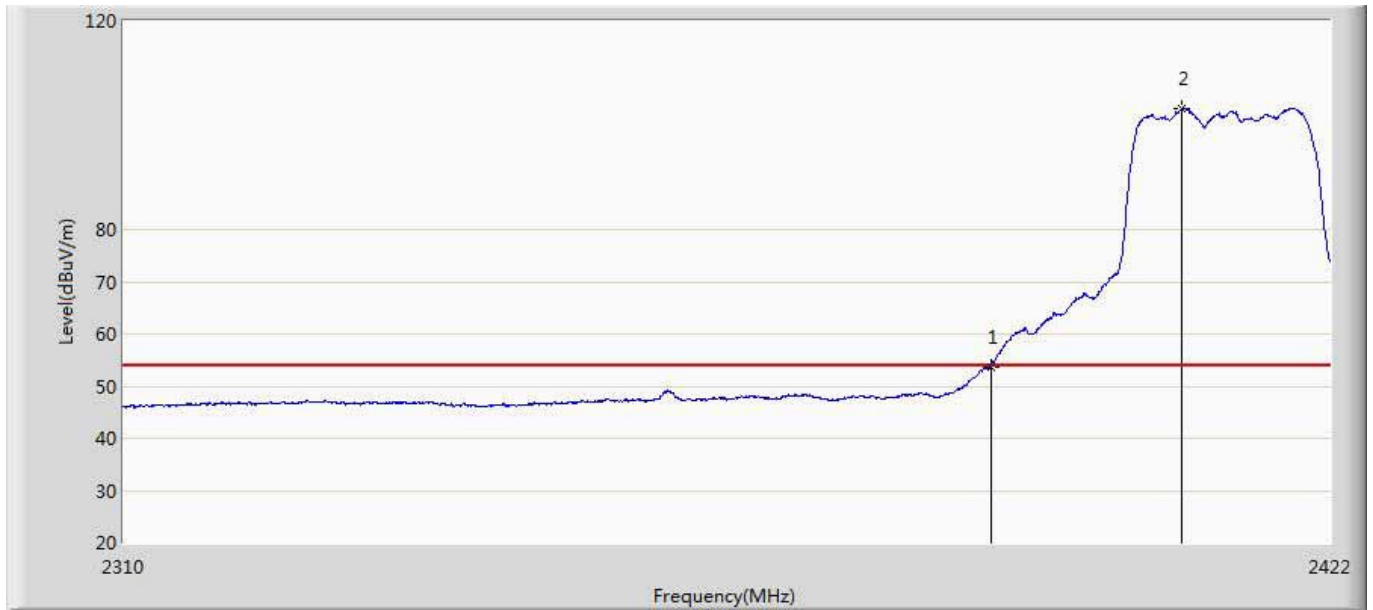

No	Mark	Frequency (MHz)	Measure Level (dBuV/m)	Reading Level (dBuV)	Over Limit (dB)	Limit (dBuV/m)	Factor (dB)	Type
1		2390.000	53.715	16.360	-0.285	54.000	37.355	AV
2	*	2407.944	103.163	65.831	49.163	54.000	37.332	AV

Site: AC5	Time: 2016/04/06 - 10:32
Limit: FCC_Part15.209_RE(3m)	Margin: 0
Probe: Horn_3117_00167055(1-18GHz)	Polarity: Horizontal
EUT: AC1750 Wireless Dual Band Gigabit Router	Power: AC 120V/60Hz
Note: Mode 1:Transmit at CH2462Mhz by 802.11b	

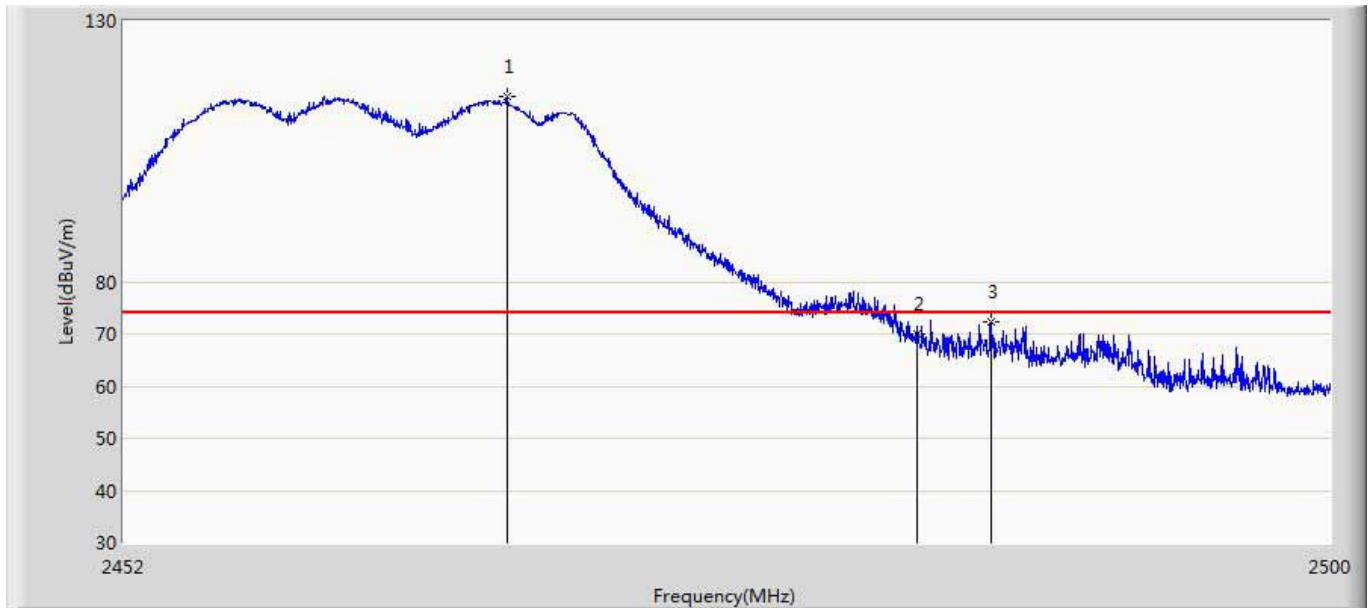

No	Mark	Frequency (MHz)	Measure Level (dBuV/m)	Reading Level (dBuV)	Over Limit (dB)	Limit (dBuV/m)	Factor (dB)	Type
1	*	2467.168	115.637	78.199	41.637	74.000	37.438	PK
2		2483.500	70.001	32.490	-3.999	74.000	37.511	PK
3		2486.440	72.355	34.823	-1.645	74.000	37.533	PK

Site: AC5	Time: 2016/04/06 - 10:46
Limit: FCC_Part15.209_RE(3m)	Margin: 0
Probe: Horn_3117_00167055(1-18GHz)	Polarity: Horizontal
EUT: AC1750 Wireless Dual Band Gigabit Router	Power: AC 120V/60Hz
Note: Mode 1: Transmit at CH2462Mhz by 802.11b	

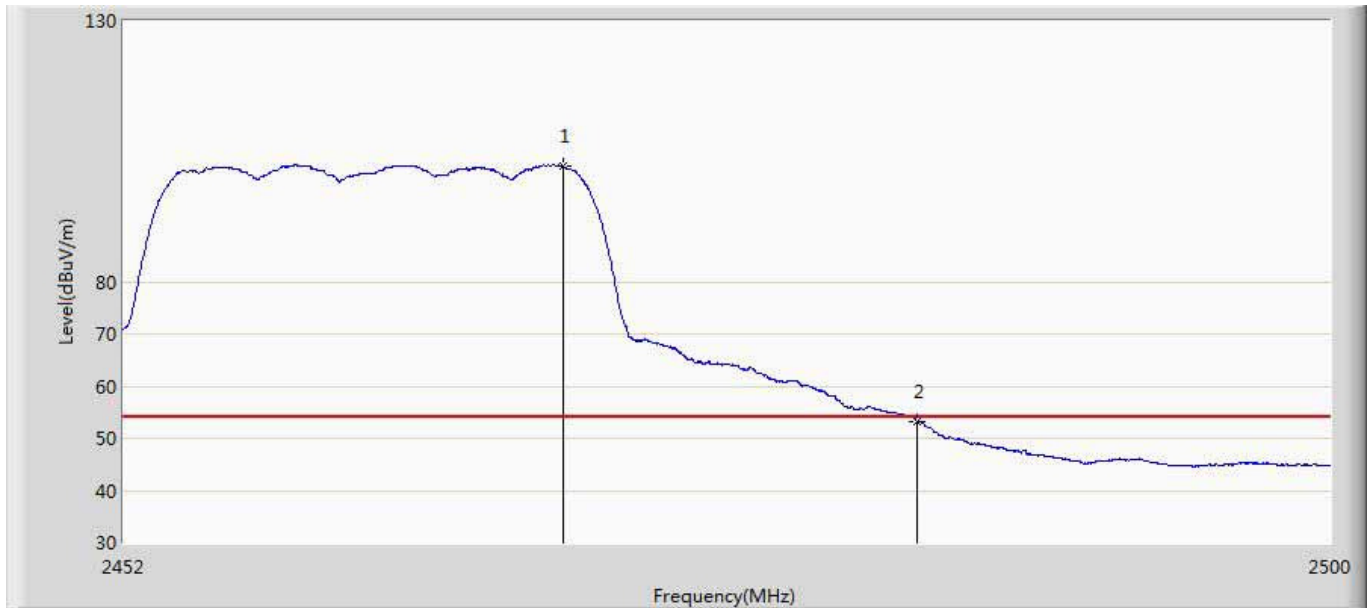

No	Mark	Frequency (MHz)	Measure Level (dBuV/m)	Reading Level (dBuV)	Over Limit (dB)	Limit (dBuV/m)	Factor (dB)	Type
1	*	2469.376	102.239	64.793	48.239	54.000	37.446	AV
2		2483.500	53.219	15.708	-0.781	54.000	37.511	AV

Site: AC5	Time: 2016/04/18 - 10:25
Limit: FCC_Part15.209_RE(3m)	Margin: 0
Probe: Horn_3117_00167055(1-18GHz)	Polarity: Vertical
EUT: AC1750 Wireless Dual Band Gigabit Router	Power: AC 120V/60Hz
Note: Mode 1:Transmit at CH2462Mhz by 802.11b	

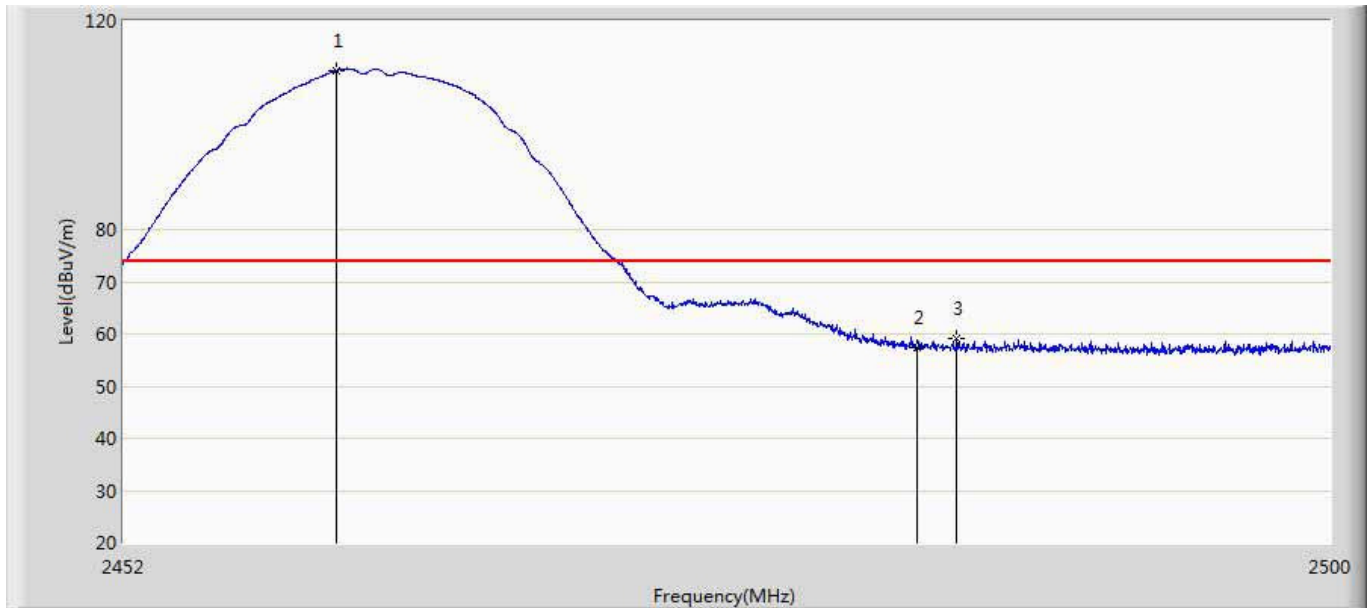

No	Mark	Frequency (MHz)	Measure Level (dBuV/m)	Reading Level (dBuV)	Over Limit (dB)	Limit (dBuV/m)	Factor (dB)	Type
1	*	2460.424	110.530	73.108	36.530	74.000	37.421	PK
2		2483.500	57.333	19.822	-16.667	74.000	37.511	PK
3		2485.072	59.046	21.523	-14.954	74.000	37.522	PK

Site: AC5	Time: 2016/04/18 - 10:25
Limit: FCC_Part15.209_RE(3m)	Margin: 0
Probe: Horn_3117_00167055(1-18GHz)	Polarity: Vertical
EUT: AC1750 Wireless Dual Band Gigabit Router	Power: AC 120V/60Hz
Note: Mode 1:Transmit at CH2462Mhz by 802.11b	

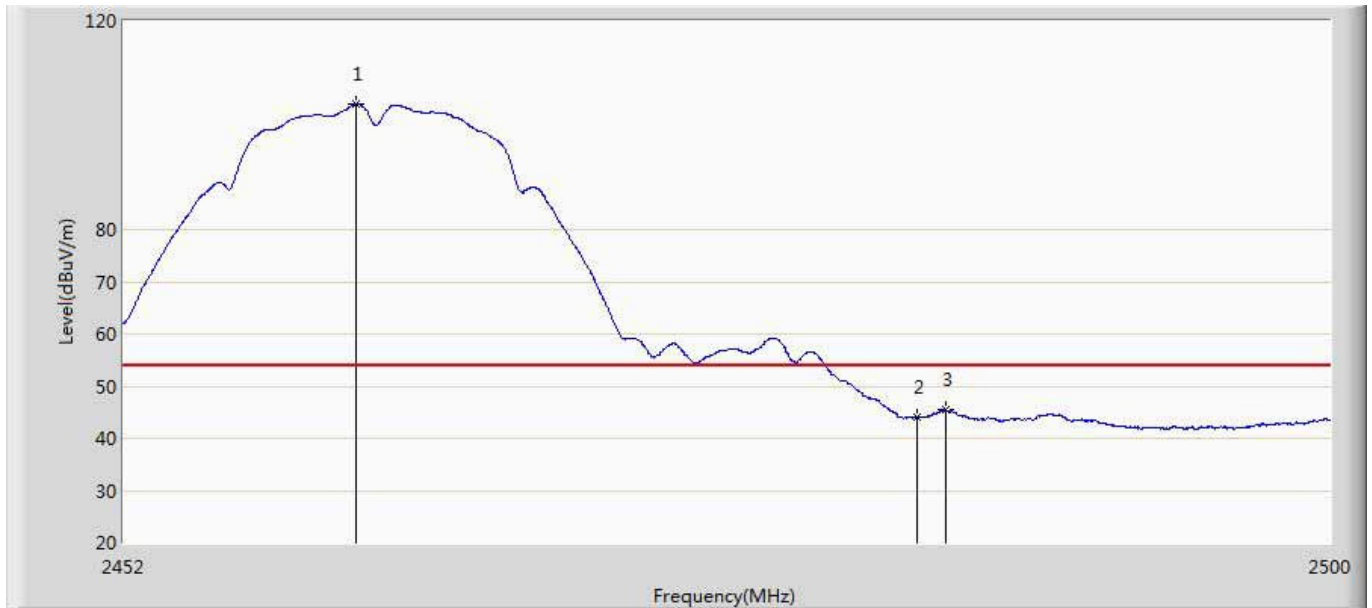

No	Mark	Frequency (MHz)	Measure Level (dBuV/m)	Reading Level (dBuV)	Over Limit (dB)	Limit (dBuV/m)	Factor (dB)	Type
1	*	2461.168	104.013	66.592	50.013	54.000	37.421	AV
2		2483.500	44.007	6.496	-9.993	54.000	37.511	AV
3		2484.616	45.375	7.856	-8.625	54.000	37.520	AV

Site: AC5	Time: 2016/04/06 - 10:52
Limit: FCC_Part15.209_RE(3m)	Margin: 0
Probe: Horn_3117_00167055(1-18GHz)	Polarity: Horizontal
EUT: AC1750 Wireless Dual Band Gigabit Router	Power: AC 120V/60Hz
Note: Mode 2:Transmit at CH2412Mhz by 802.11g	

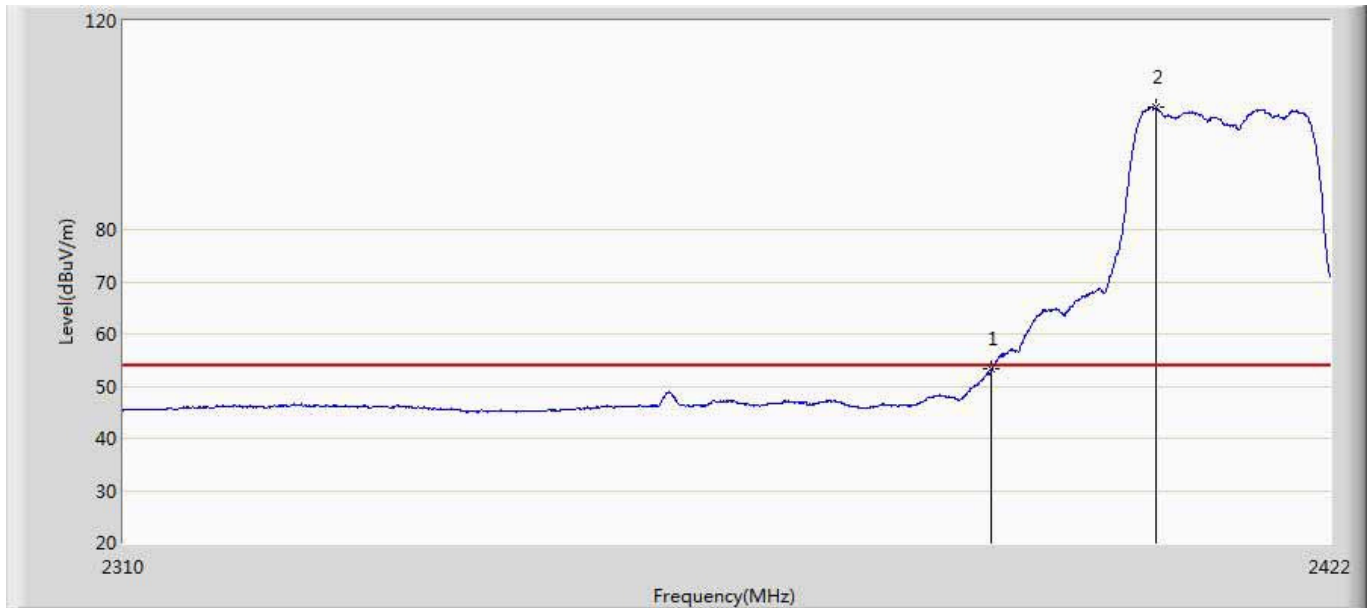

No	Mark	Frequency (MHz)	Measure Level (dBuV/m)	Reading Level (dBuV)	Over Limit (dB)	Limit (dBuV/m)	Factor (dB)	Type
1		2390.000	53.374	16.019	-0.626	54.000	37.355	AV
2	*	2405.480	103.394	66.058	49.394	54.000	37.337	AV

Site: AC5	Time: 2016/04/06 - 10:56
Limit: FCC_Part15.209_RE(3m)	Margin: 0
Probe: Horn_3117_00167055(1-18GHz)	Polarity: Horizontal
EUT: AC1750 Wireless Dual Band Gigabit Router	Power: AC 120V/60Hz
Note: Mode 2:Transmit at CH2412Mhz by 802.11g	

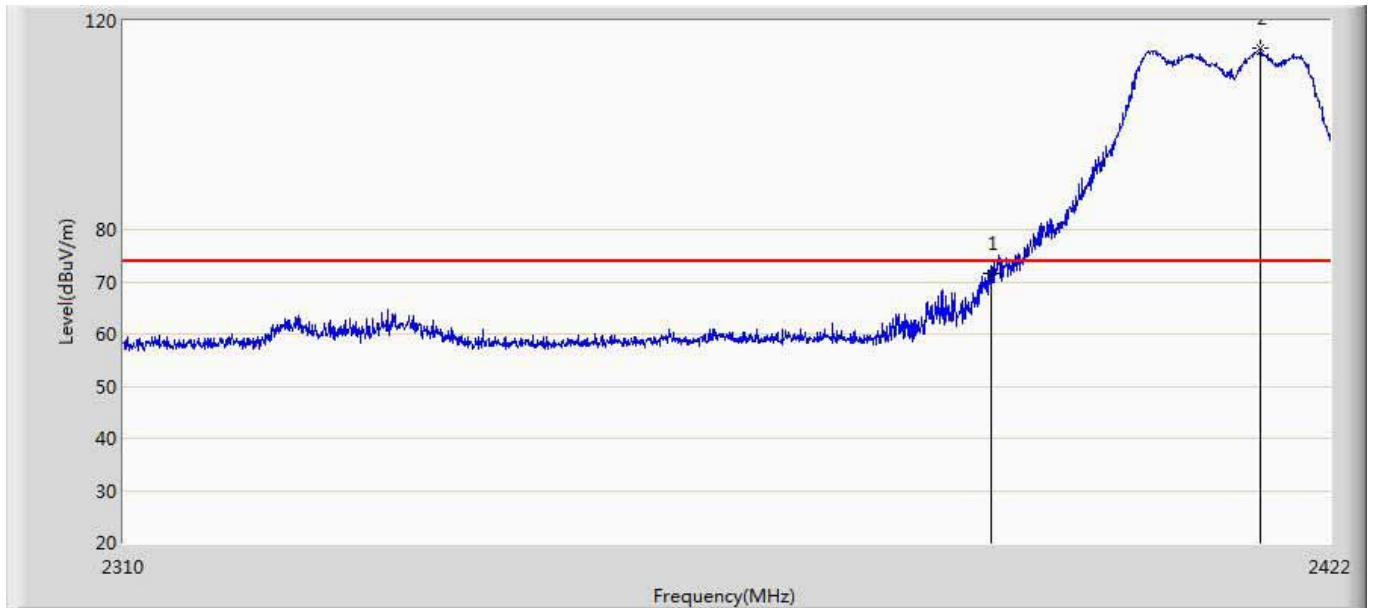

No	Mark	Frequency (MHz)	Measure Level (dBuV/m)	Reading Level (dBuV)	Over Limit (dB)	Limit (dBuV/m)	Factor (dB)	Type
1		2390.000	71.703	34.348	-2.297	74.000	37.355	PK
2	*	2415.448	114.715	77.358	40.715	74.000	37.357	PK

Site: AC5	Time: 2016/04/10 - 14:04
Limit: FCC_Part15.209_RE(3m)	Margin: 0
Probe: Horn_3117_00167055(1-18GHz)	Polarity: Vertical
EUT: AC1750 Wireless Dual Band Gigabit Router	Power: AC 120V/60Hz
Note: Mode 2:Transmit at CH2412Mhz by 802.11g	

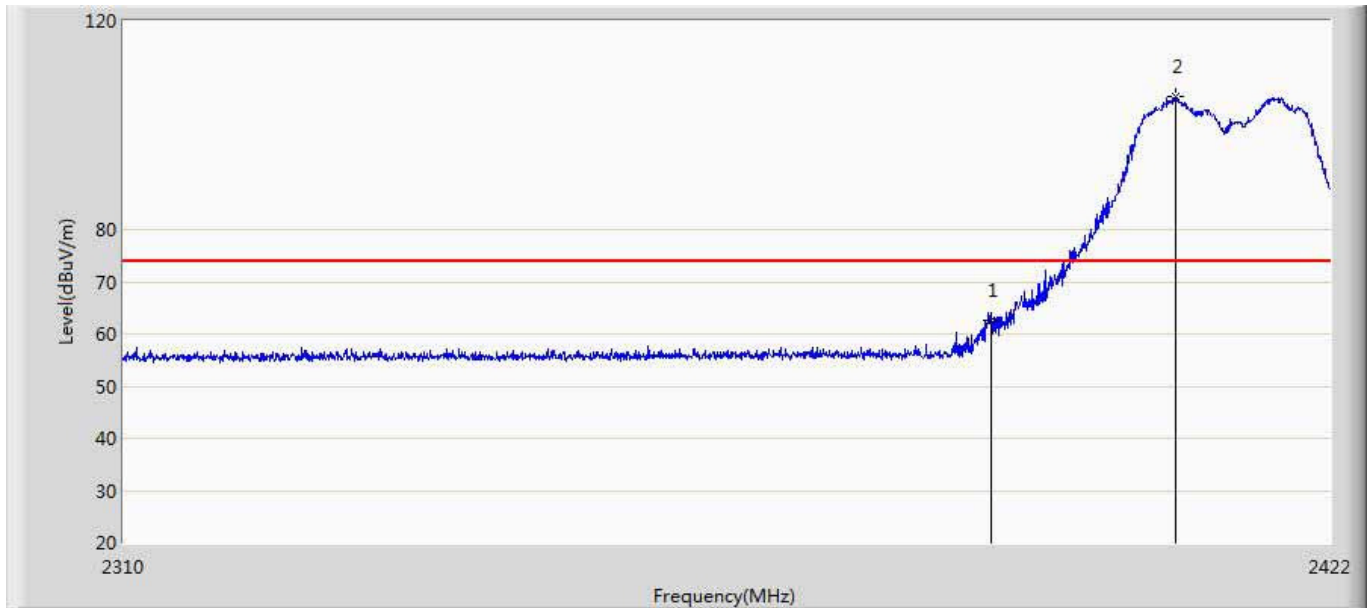

No	Mark	Frequency (MHz)	Measure Level (dBuV/m)	Reading Level (dBuV)	Over Limit (dB)	Limit (dBuV/m)	Factor (dB)	Type
1		2390.000	62.524	24.661	-11.476	74.000	37.863	PK
2	*	2407.384	105.545	67.710	31.545	74.000	37.835	PK

Site: AC5	Time: 2016/04/10 - 14:08
Limit: FCC_Part15.209_RE(3m)	Margin: 0
Probe: Horn_3117_00167055(1-18GHz)	Polarity: Vertical
EUT: AC1750 Wireless Dual Band Gigabit Router	Power: AC 120V/60Hz
Note: Mode 2:Transmit at CH2412Mhz by 802.11g	

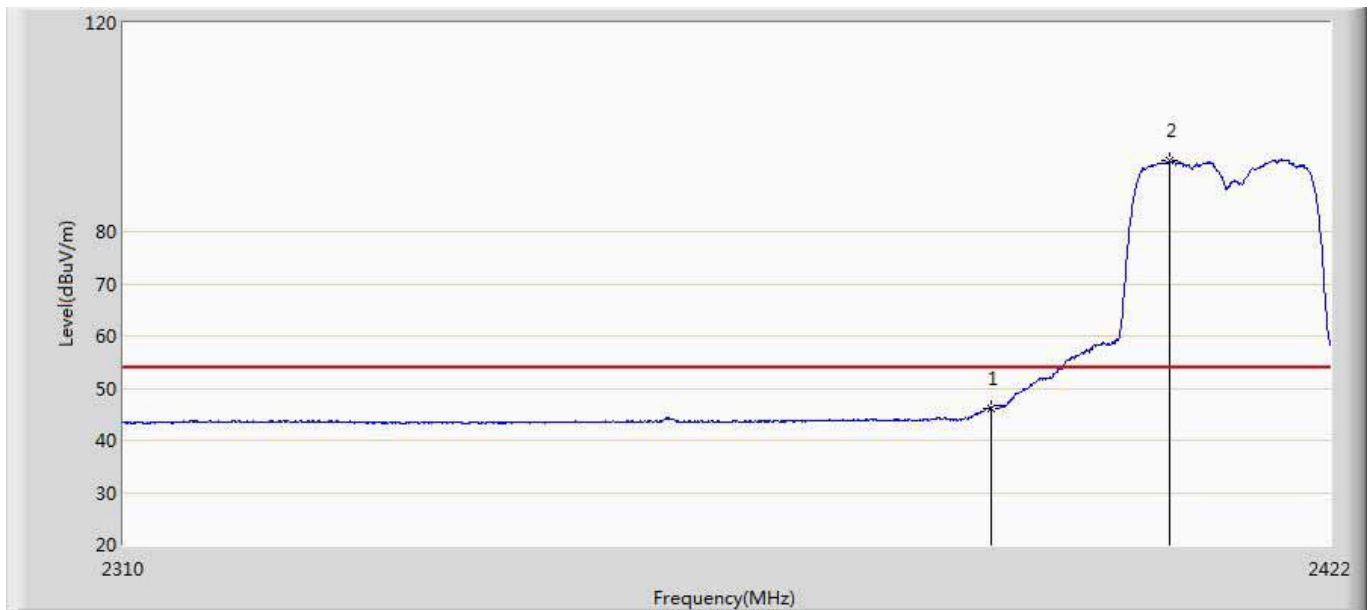

No	Mark	Frequency (MHz)	Measure Level (dBuV/m)	Reading Level (dBuV)	Over Limit (dB)	Limit (dBuV/m)	Factor (dB)	Type
1		2390.000	46.218	8.355	-7.782	54.000	37.863	AV
2	*	2406.880	93.479	55.644	39.479	54.000	37.835	AV

Site: AC5	Time: 2016/04/06 - 11:11
Limit: FCC_Part15.209_RE(3m)	Margin: 0
Probe: Horn_3117_00167055(1-18GHz)	Polarity: Horizontal
EUT: AC1750 Wireless Dual Band Gigabit Router	Power: AC 120V/60Hz
Note: Mode 2:Transmit at CH2462Mhz by 802.11g	

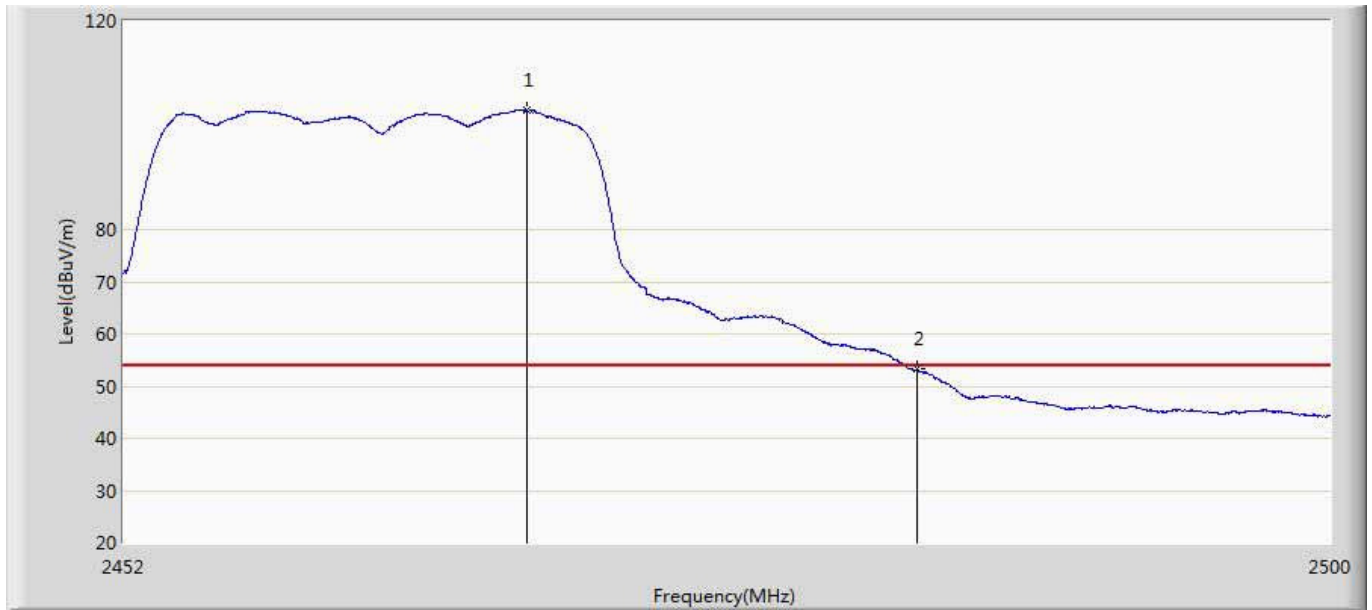

No	Mark	Frequency (MHz)	Measure Level (dBuV/m)	Reading Level (dBuV)	Over Limit (dB)	Limit (dBuV/m)	Factor (dB)	Type
1	*	2467.936	102.808	65.367	48.808	54.000	37.440	AV
2		2483.500	53.216	15.705	-0.784	54.000	37.511	AV

Site: AC5	Time: 2016/04/06 - 11:21
Limit: FCC_Part15.209_RE(3m)	Margin: 0
Probe: Horn_3117_00167055(1-18GHz)	Polarity: Horizontal
EUT: AC1750 Wireless Dual Band Gigabit Router	Power: AC 120V/60Hz
Note: Mode 2:Transmit at CH2462Mhz by 802.11g	

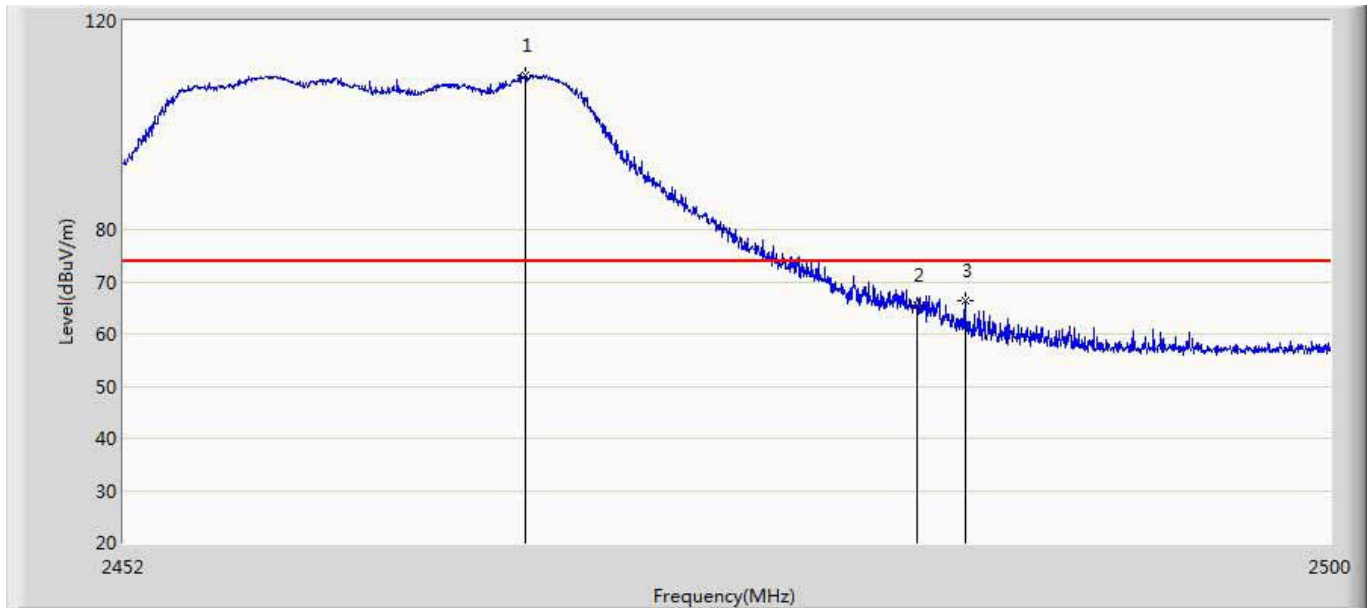

No	Mark	Frequency (MHz)	Measure Level (dBuV/m)	Reading Level (dBuV)	Over Limit (dB)	Limit (dBuV/m)	Factor (dB)	Type
1	*	2467.888	109.629	72.188	35.629	74.000	37.440	PK
2		2483.500	65.520	28.009	-8.480	74.000	37.511	PK
3		2485.408	66.264	28.739	-7.736	74.000	37.526	PK

Site: AC5	Time: 2016/04/10 - 14:13
Limit: FCC_Part15.209_RE(3m)	Margin: 0
Probe: Horn_3117_00167055(1-18GHz)	Polarity: Vertical
EUT: AC1750 Wireless Dual Band Gigabit Router	Power: AC 120V/60Hz
Note: Mode 2:Transmit at CH2462Mhz by 802.11g	

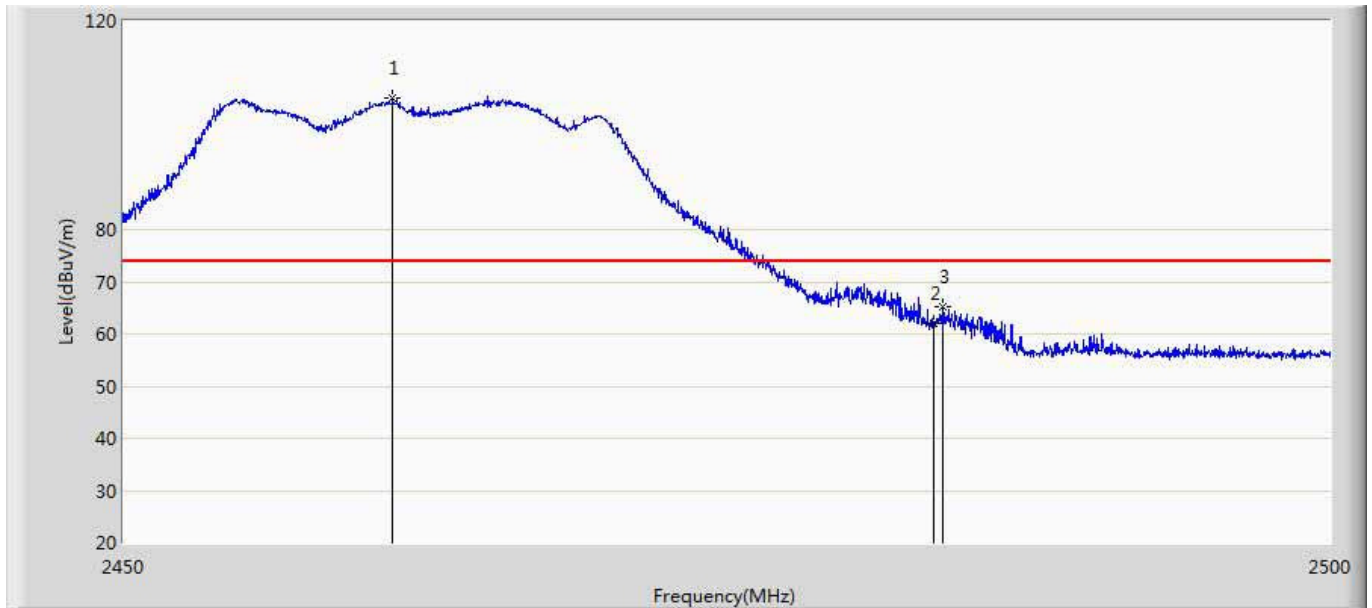

No	Mark	Frequency (MHz)	Measure Level (dBuV/m)	Reading Level (dBuV)	Over Limit (dB)	Limit (dBuV/m)	Factor (dB)	Type
1	*	2461.075	105.296	67.292	31.296	74.000	38.004	PK
2		2483.500	62.096	24.058	-11.904	74.000	38.038	PK
3		2483.850	65.290	27.250	-8.710	74.000	38.041	PK

Site: AC5	Time: 2016/04/10 - 14:17
Limit: FCC_Part15.209_RE(3m)	Margin: 0
Probe: Horn_3117_00167055(1-18GHz)	Polarity: Vertical
EUT: AC1750 Wireless Dual Band Gigabit Router	Power: AC 120V/60Hz
Note: Mode 2:Transmit at CH2462Mhz by 802.11g	

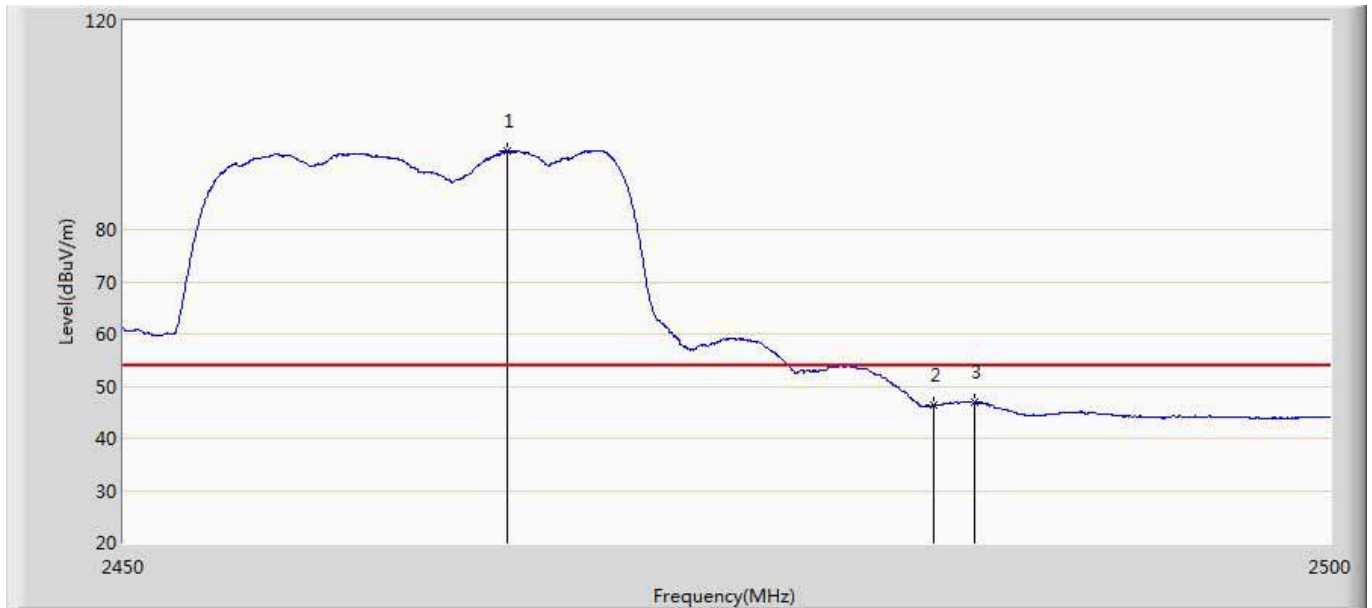

No	Mark	Frequency (MHz)	Measure Level (dBuV/m)	Reading Level (dBuV)	Over Limit (dB)	Limit (dBuV/m)	Factor (dB)	Type
1	*	2465.825	95.065	57.058	41.065	54.000	38.008	AV
2		2483.500	46.332	8.294	-7.668	54.000	38.038	AV
3		2485.175	46.885	8.835	-7.115	54.000	38.049	AV

Site: AC5	Time: 2016/04/06 - 11:23
Limit: FCC_Part15.209_RE(3m)	Margin: 0
Probe: Horn_3117_00167055(1-18GHz)	Polarity: Horizontal
EUT: AC1750 Wireless Dual Band Gigabit Router	Power: AC 120V/60Hz
Note: Mode 3:Transmit at CH2412Mhz by 802.11n20	

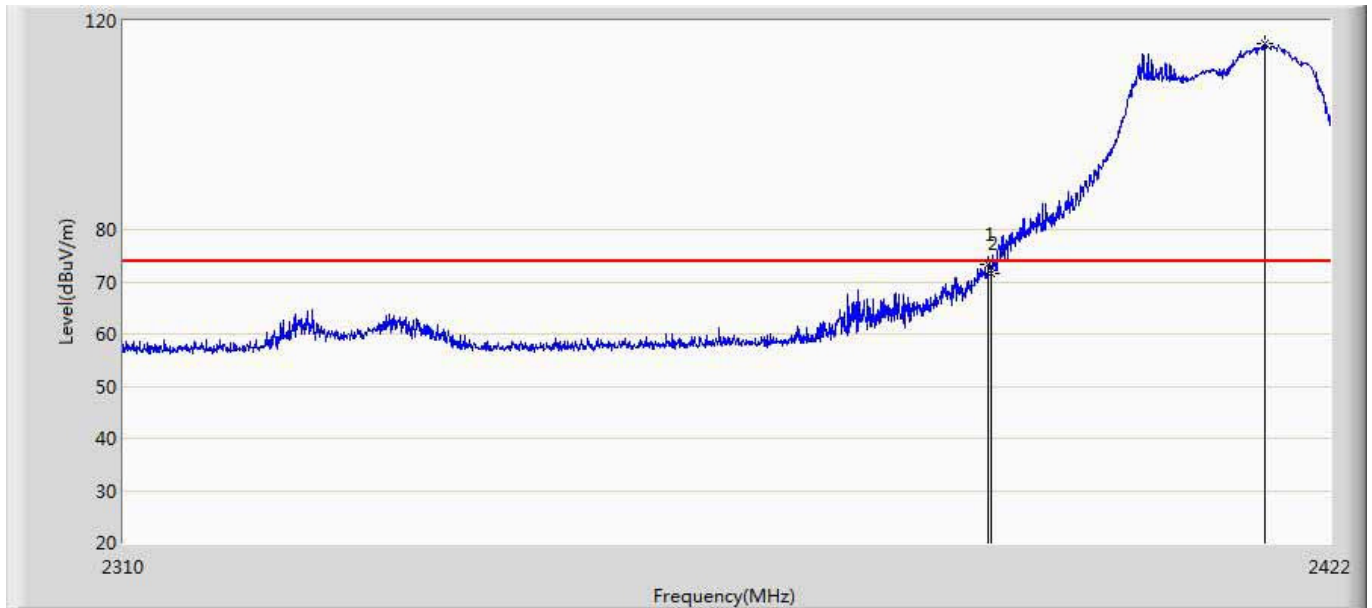

No	Mark	Frequency (MHz)	Measure Level (dBuV/m)	Reading Level (dBuV)	Over Limit (dB)	Limit (dBuV/m)	Factor (dB)	Type
1		2389.744	73.400	36.044	-0.600	74.000	37.356	PK
2		2390.000	71.687	34.332	-2.313	74.000	37.355	PK
3	*	2415.896	115.529	78.168	41.529	74.000	37.360	PK

Site: AC5	Time: 2016/04/06 - 11:26
Limit: FCC_Part15.209_RE(3m)	Margin: 0
Probe: Horn_3117_00167055(1-18GHz)	Polarity: Horizontal
EUT: AC1750 Wireless Dual Band Gigabit Router	Power: AC 120V/60Hz
Note: Mode 3:Transmit at CH2412Mhz by 802.11n20	

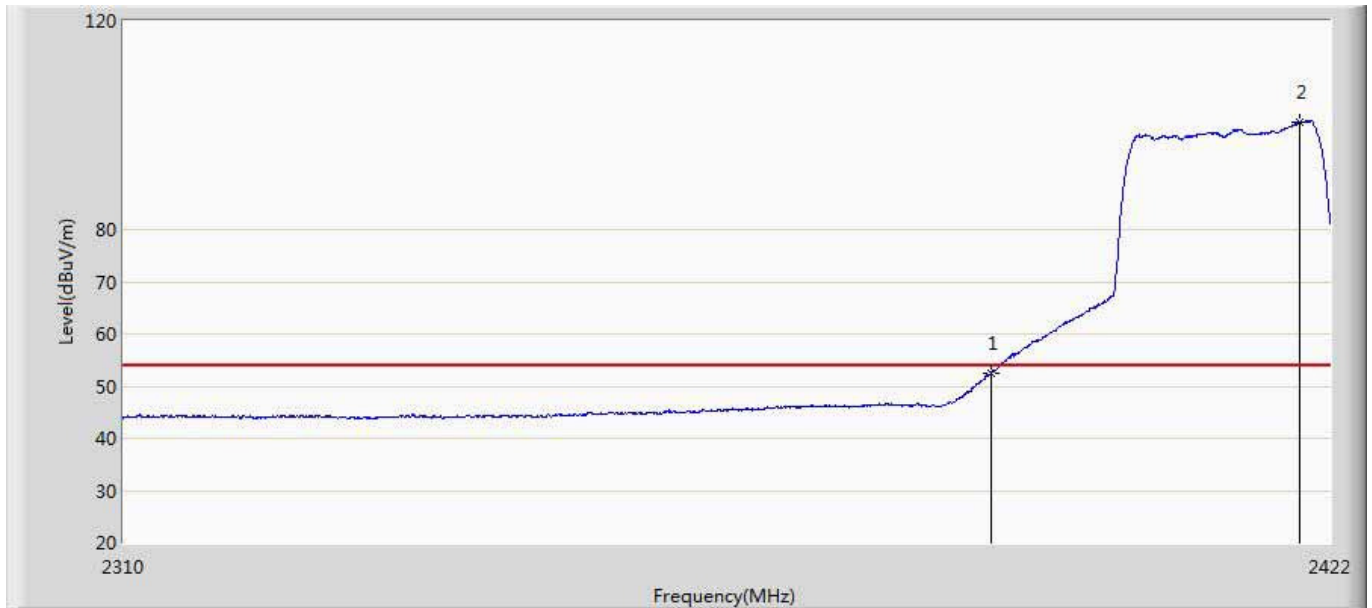

No	Mark	Frequency (MHz)	Measure Level (dBuV/m)	Reading Level (dBuV)	Over Limit (dB)	Limit (dBuV/m)	Factor (dB)	Type
1		2390.000	52.414	15.059	-1.586	54.000	37.355	AV
2	*	2419.088	100.697	63.315	46.697	54.000	37.382	AV

Site: AC5	Time: 2016/04/10 - 14:19
Limit: FCC_Part15.209_RE(3m)	Margin: 0
Probe: Horn_3117_00167055(1-18GHz)	Polarity: Vertical
EUT: AC1750 Wireless Dual Band Gigabit Router	Power: AC 120V/60Hz
Note: Mode 3:Transmit at CH2412Mhz by 802.11n20	

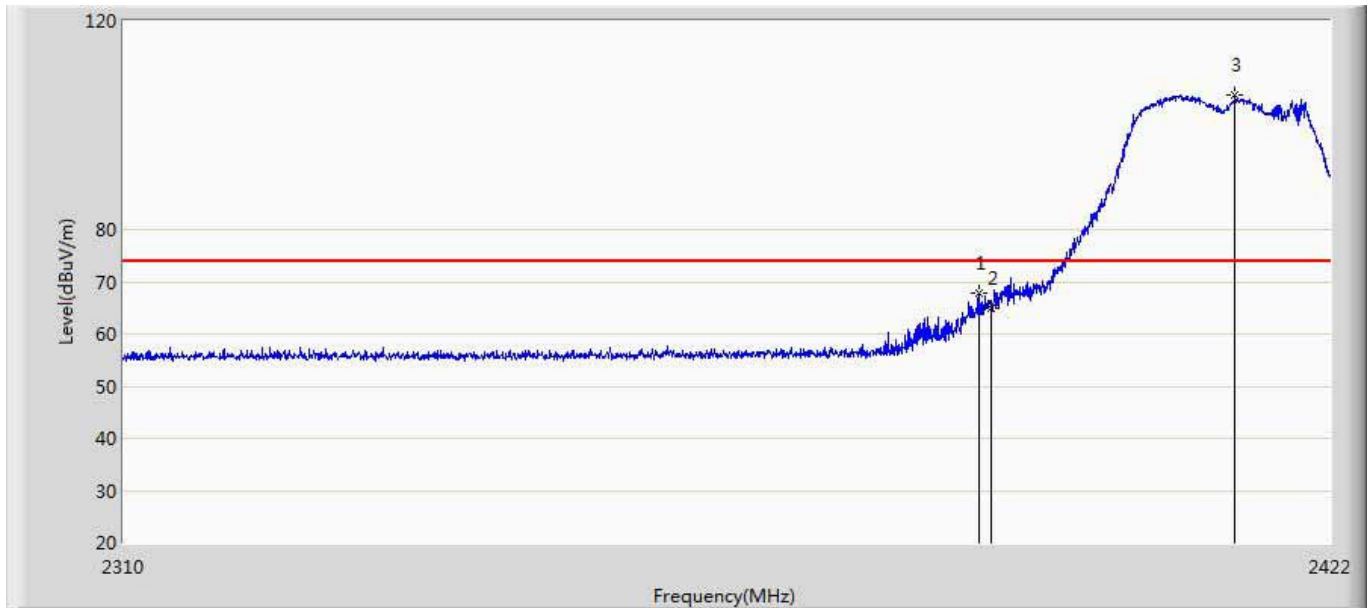

No	Mark	Frequency (MHz)	Measure Level (dBuV/m)	Reading Level (dBuV)	Over Limit (dB)	Limit (dBuV/m)	Factor (dB)	Type
1		2388.904	67.928	30.061	-6.072	74.000	37.867	PK
2		2390.000	64.902	27.039	-9.098	74.000	37.863	PK
3	*	2412.984	105.739	67.896	31.739	74.000	37.842	PK

Site: AC5	Time: 2016/04/10 - 14:21
Limit: FCC_Part15.209_RE(3m)	Margin: 0
Probe: Horn_3117_00167055(1-18GHz)	Polarity: Vertical
EUT: AC1750 Wireless Dual Band Gigabit Router	Power: AC 120V/60Hz
Note: Mode 3:Transmit at CH2412Mhz by 802.11n20	

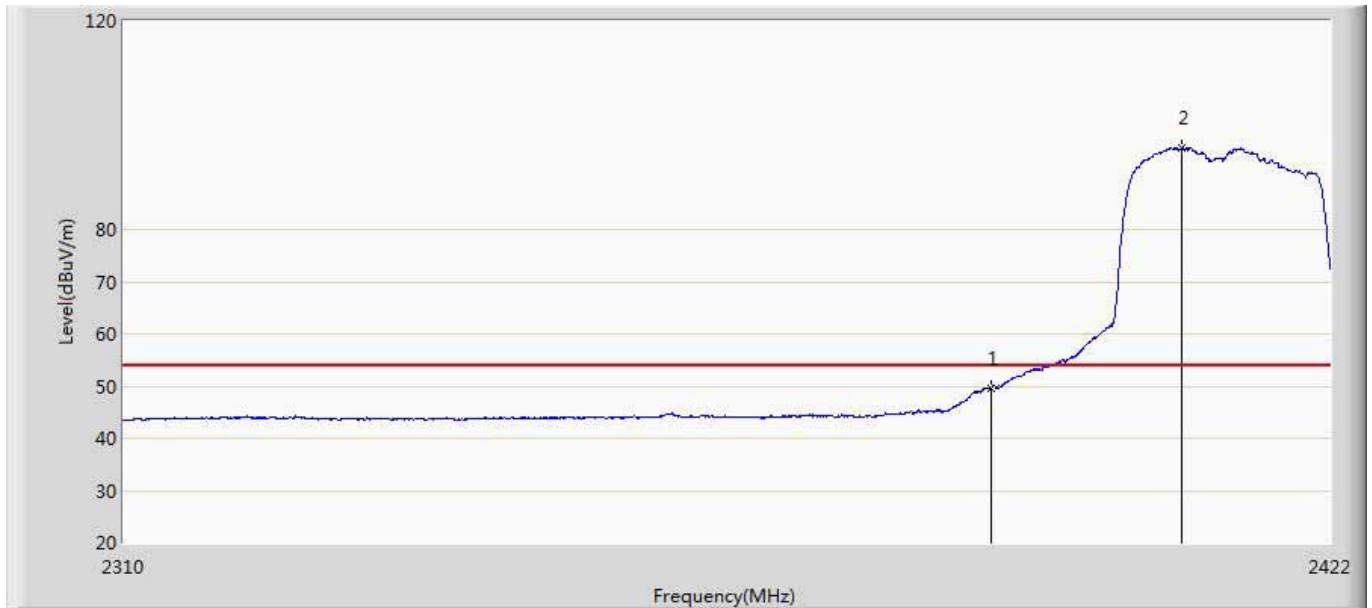

No	Mark	Frequency (MHz)	Measure Level (dBuV/m)	Reading Level (dBuV)	Over Limit (dB)	Limit (dBuV/m)	Factor (dB)	Type
1		2390.000	49.576	11.713	-4.424	54.000	37.863	AV
2	*	2408.000	95.655	57.821	41.655	54.000	37.834	AV

Site: AC5	Time: 2016/04/06 - 11:38
Limit: FCC_Part15.209_RE(3m)	Margin: 0
Probe: Horn_3117_00167055(1-18GHz)	Polarity: Horizontal
EUT: AC1750 Wireless Dual Band Gigabit Router	Power: AC 120V/60Hz
Note: Mode 3:Transmit at CH2462Mhz by 802.11n20	

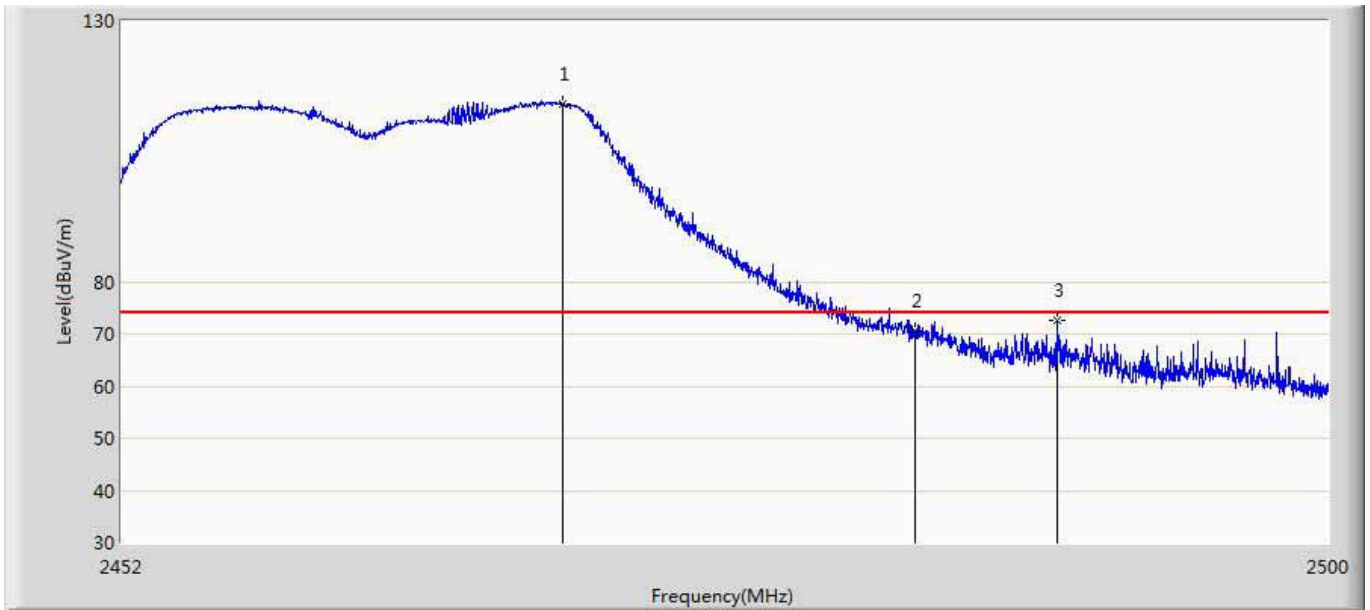

No	Mark	Frequency (MHz)	Measure Level (dBuV/m)	Reading Level (dBuV)	Over Limit (dB)	Limit (dBuV/m)	Factor (dB)	Type
1	*	2469.472	114.139	76.693	40.139	74.000	37.446	PK
2		2483.500	70.471	32.960	-3.529	74.000	37.511	PK
3		2489.176	72.582	35.030	-1.418	74.000	37.552	PK

Site: AC5	Time: 2016/04/06 - 11:41
Limit: FCC_Part15.209_RE(3m)	Margin: 0
Probe: Horn_3117_00167055(1-18GHz)	Polarity: Horizontal
EUT: AC1750 Wireless Dual Band Gigabit Router	Power: AC 120V/60Hz
Note: Mode 3:Transmit at CH2462Mhz by 802.11n20	

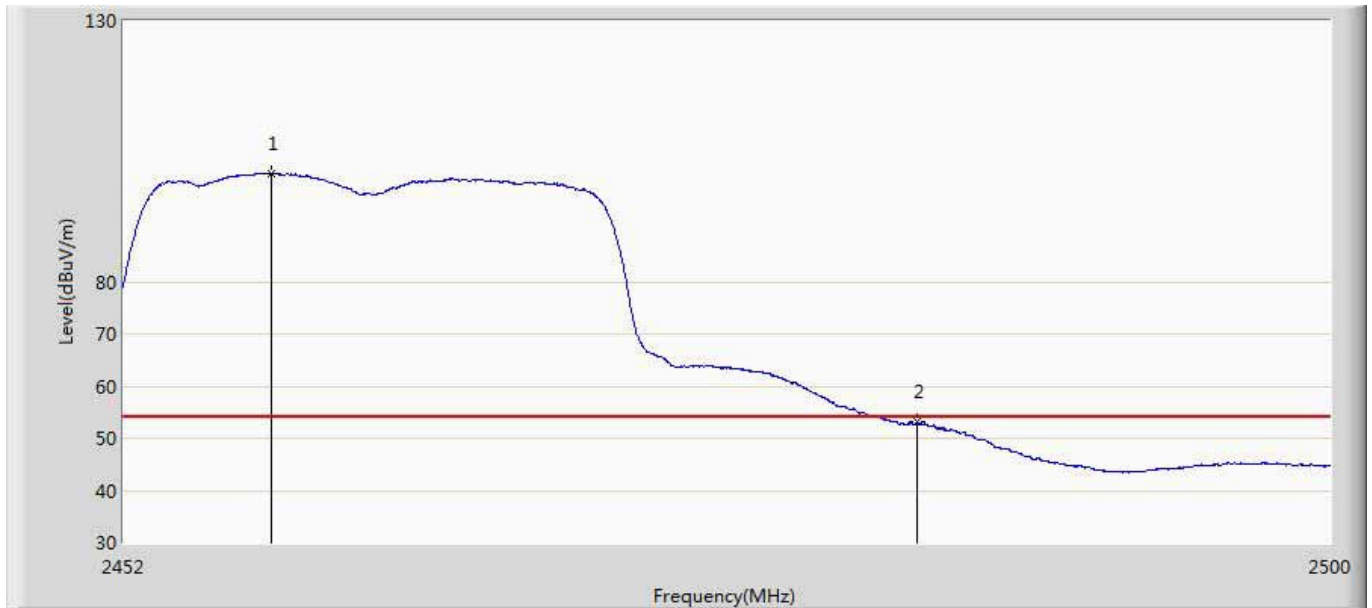

No	Mark	Frequency (MHz)	Measure Level (dBuV/m)	Reading Level (dBuV)	Over Limit (dB)	Limit (dBuV/m)	Factor (dB)	Type
1	*	2457.856	100.836	63.412	46.836	54.000	37.423	AV
2		2483.500	53.162	15.651	-0.838	54.000	37.511	AV

Site: AC5	Time: 2016/04/10 - 14:22
Limit: FCC_Part15.209_RE(3m)	Margin: 0
Probe: Horn_3117_00167055(1-18GHz)	Polarity: Vertical
EUT: AC1750 Wireless Dual Band Gigabit Router	Power: AC 120V/60Hz
Note: Mode 3:Transmit at CH2462Mhz by 802.11n20	

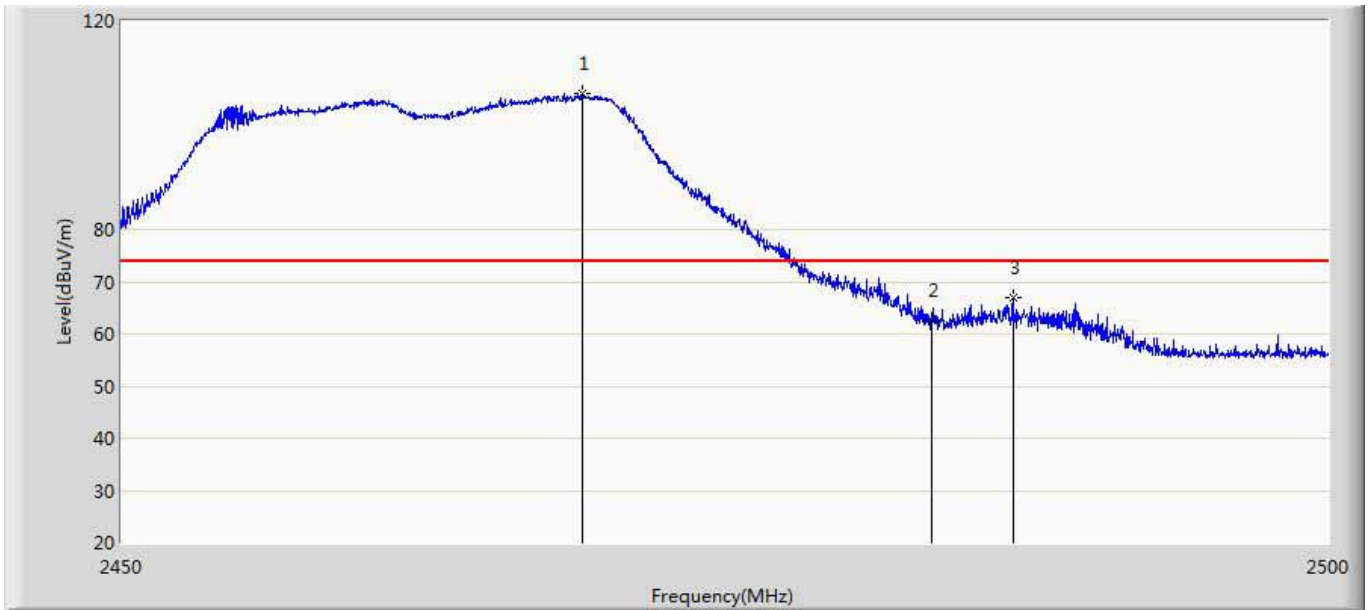

No	Mark	Frequency (MHz)	Measure Level (dBuV/m)	Reading Level (dBuV)	Over Limit (dB)	Limit (dBuV/m)	Factor (dB)	Type
1	*	2469.000	105.975	67.968	31.975	74.000	38.007	PK
2		2483.500	62.746	24.708	-11.254	74.000	38.038	PK
3		2486.850	66.959	28.898	-7.041	74.000	38.061	PK

Site: AC5	Time: 2016/04/10 - 14:25
Limit: FCC_Part15.209_RE(3m)	Margin: 0
Probe: Horn_3117_00167055(1-18GHz)	Polarity: Vertical
EUT: AC1750 Wireless Dual Band Gigabit Router	Power: AC 120V/60Hz
Note: Mode 3:Transmit at CH2462Mhz by 802.11n20	

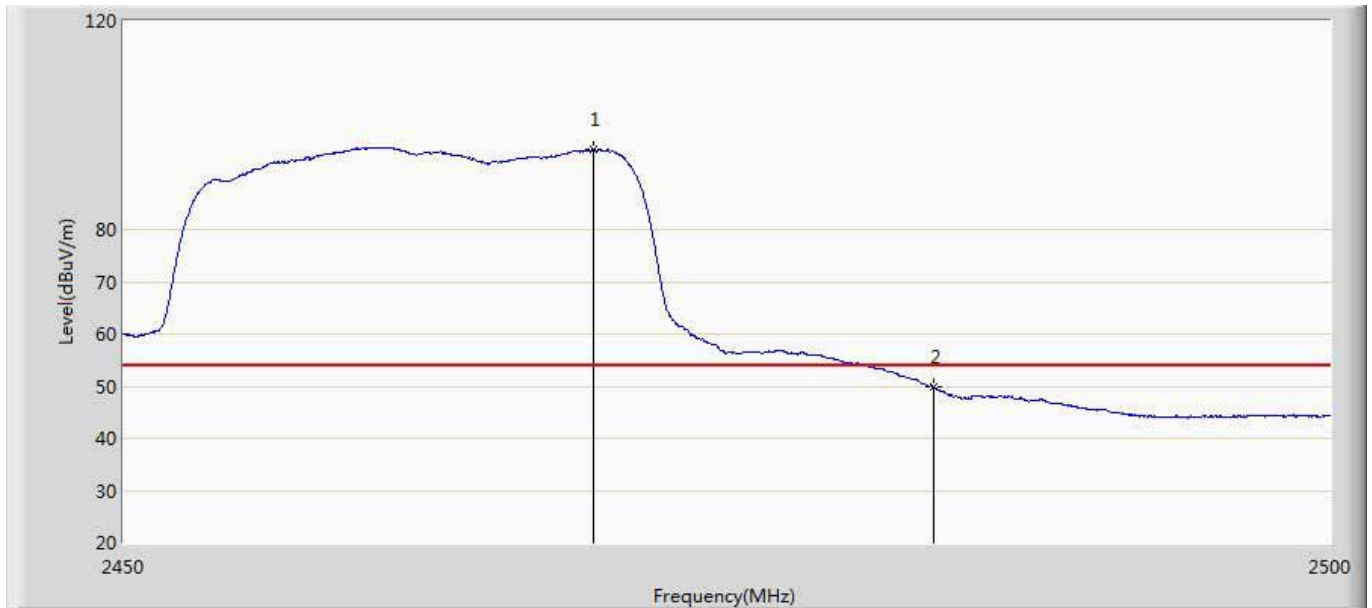

No	Mark	Frequency (MHz)	Measure Level (dBuV/m)	Reading Level (dBuV)	Over Limit (dB)	Limit (dBuV/m)	Factor (dB)	Type
1	*	2469.350	95.313	57.306	41.313	54.000	38.007	AV
2		2483.500	49.810	11.772	-4.190	54.000	38.038	AV

Site: AC5	Time: 2016/04/06 - 11:53
Limit: FCC_Part15.209_RE(3m)	Margin: 0
Probe: Horn_3117_00167055(1-18GHz)	Polarity: Horizontal
EUT: AC1750 Wireless Dual Band Gigabit Router	Power: AC 120V/60Hz
Note: Mode 4:Transmit at CH2422Mhz by 802.11n40	

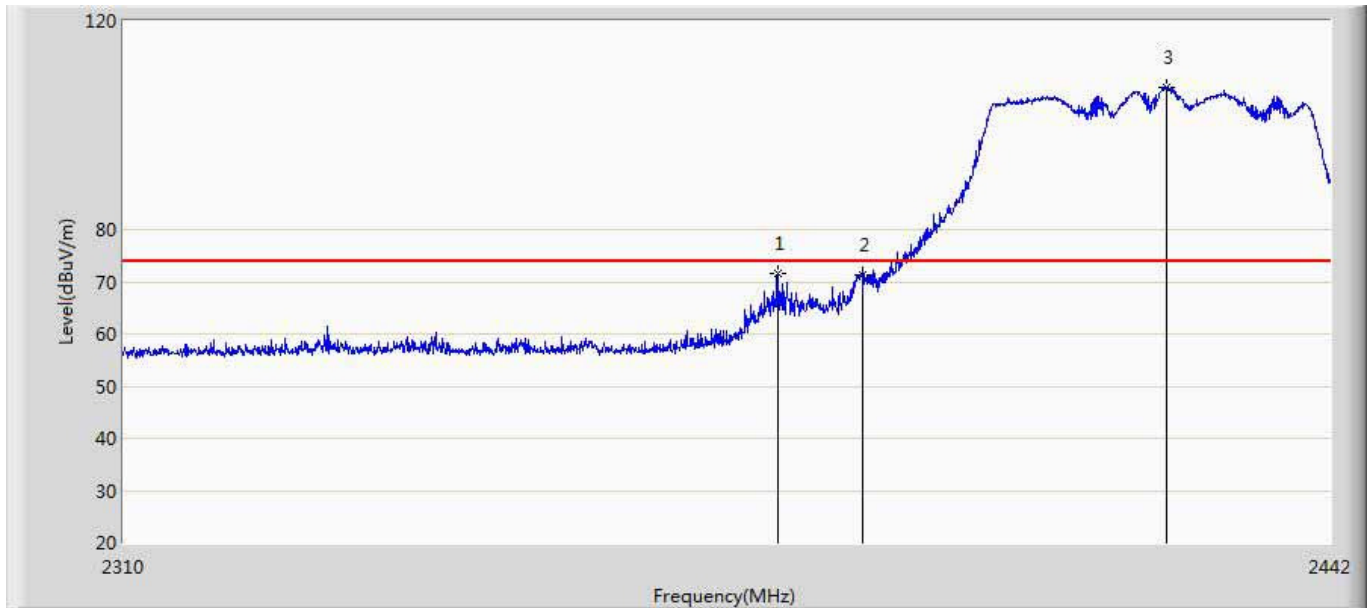

No	Mark	Frequency (MHz)	Measure Level (dBuV/m)	Reading Level (dBuV)	Over Limit (dB)	Limit (dBuV/m)	Factor (dB)	Type
1		2380.752	71.585	34.227	-2.415	74.000	37.358	PK
2		2390.000	71.313	33.958	-2.687	74.000	37.355	PK
3	*	2423.718	107.342	69.929	33.342	74.000	37.414	PK

Site: AC5	Time: 2016/04/06 - 11:56
Limit: FCC_Part15.209_RE(3m)	Margin: 0
Probe: Horn_3117_00167055(1-18GHz)	Polarity: Horizontal
EUT: AC1750 Wireless Dual Band Gigabit Router	Power: AC 120V/60Hz
Note: Mode 4:Transmit at CH2422Mhz by 802.11n40	

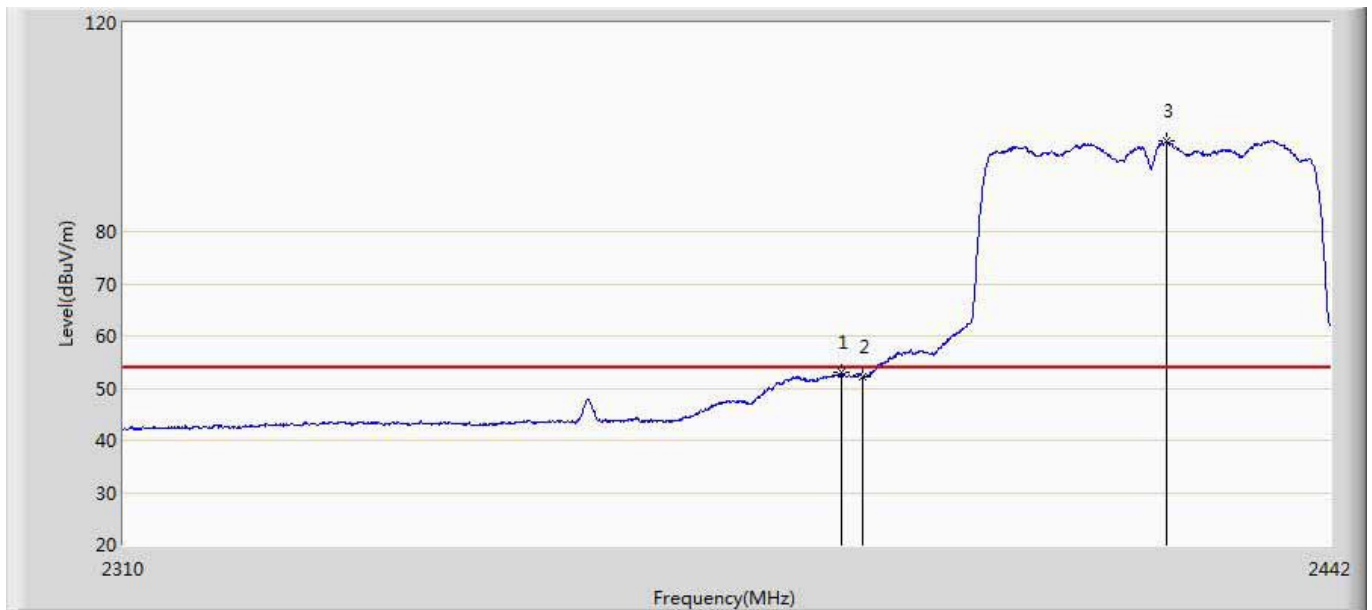

No	Mark	Frequency (MHz)	Measure Level (dBuV/m)	Reading Level (dBuV)	Over Limit (dB)	Limit (dBuV/m)	Factor (dB)	Type
1		2387.748	53.120	15.764	-0.880	54.000	37.356	AV
2		2390.000	52.167	14.812	-1.833	54.000	37.355	AV
3	*	2423.718	97.415	60.002	43.415	54.000	37.414	AV

Site: AC5	Time: 2016/04/10 - 14:26
Limit: FCC_Part15.209_RE(3m)	Margin: 0
Probe: Horn_3117_00167055(1-18GHz)	Polarity: Vertical
EUT: AC1750 Wireless Dual Band Gigabit Router	Power: AC 120V/60Hz
Note: Mode 4:Transmit at CH2422Mhz by 802.11n40	

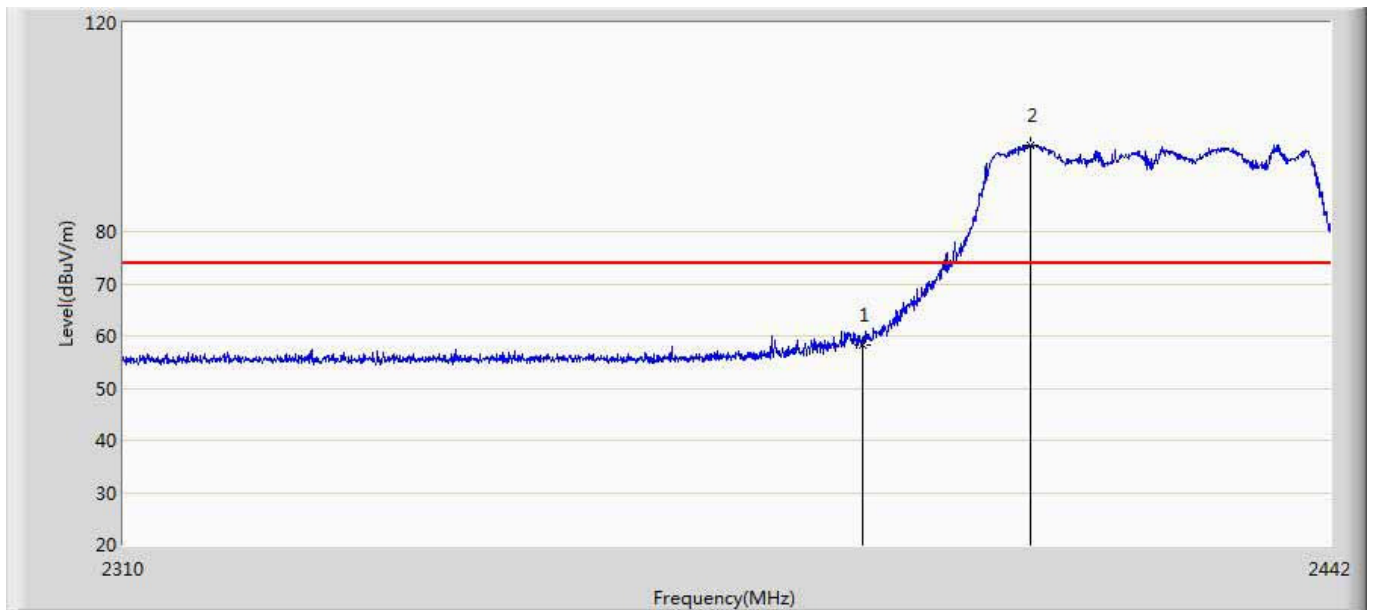

No	Mark	Frequency (MHz)	Measure Level (dBuV/m)	Reading Level (dBuV)	Over Limit (dB)	Limit (dBuV/m)	Factor (dB)	Type
1		2390.000	58.202	20.339	-15.798	74.000	37.863	PK
2	*	2408.604	96.594	58.760	22.594	74.000	37.834	PK

Site: AC5	Time: 2016/04/10 - 14:30
Limit: FCC_Part15.209_RE(3m)	Margin: 0
Probe: Horn_3117_00167055(1-18GHz)	Polarity: Vertical
EUT: AC1750 Wireless Dual Band Gigabit Router	Power: AC 120V/60Hz
Note: Mode 4:Transmit at CH2422Mhz by 802.11n40	

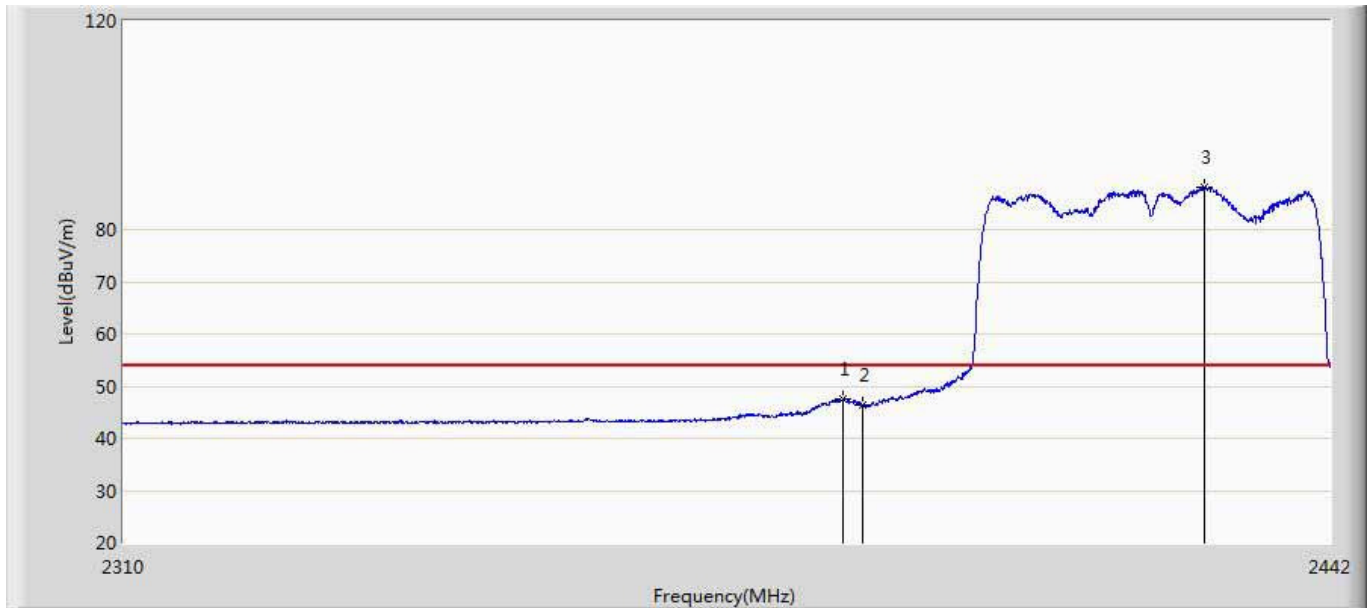

No	Mark	Frequency (MHz)	Measure Level (dBuV/m)	Reading Level (dBuV)	Over Limit (dB)	Limit (dBuV/m)	Factor (dB)	Type
1		2387.880	47.530	9.659	-6.470	54.000	37.871	AV
2		2390.000	46.333	8.470	-7.667	54.000	37.863	AV
3	*	2428.008	88.196	50.267	34.196	54.000	37.929	AV

Site: AC5	Time: 2016/04/06 - 12:37
Limit: FCC_Part15.209_RE(3m)	Margin: 0
Probe: Horn_3117_00167055(1-18GHz)	Polarity: Horizontal
EUT: AC1750 Wireless Dual Band Gigabit Router	Power: AC 120V/60Hz
Note: Mode 4:Transmit at CH2452Mhz by 802.11n40	

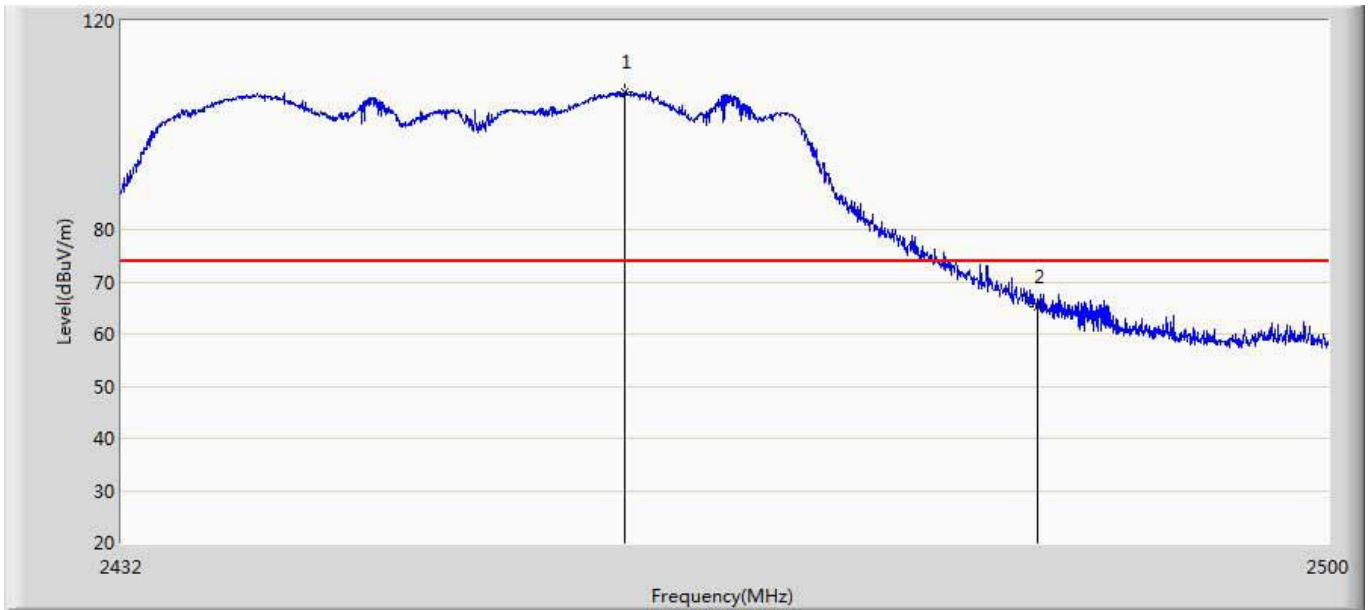

No	Mark	Frequency (MHz)	Measure Level (dBuV/m)	Reading Level (dBuV)	Over Limit (dB)	Limit (dBuV/m)	Factor (dB)	Type
1	*	2483.500	65.175	27.664	-8.825	74.000	37.511	PK

Site: AC5	Time: 2016/04/06 - 12:40
Limit: FCC_Part15.209_RE(3m)	Margin: 0
Probe: Horn_3117_00167055(1-18GHz)	Polarity: Horizontal
EUT: AC1750 Wireless Dual Band Gigabit Router	Power: AC 120V/60Hz
Note: Mode 4:Transmit at CH2452Mhz by 802.11n40	

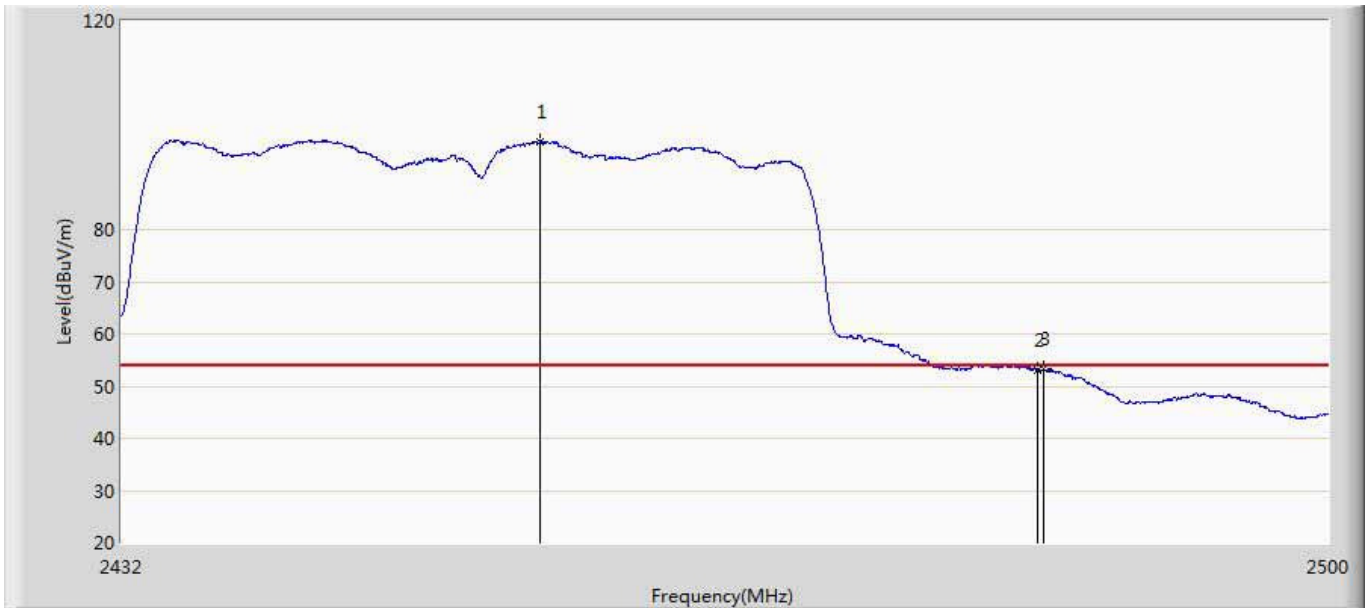

No	Mark	Frequency (MHz)	Measure Level (dBuV/m)	Reading Level (dBuV)	Over Limit (dB)	Limit (dBuV/m)	Factor (dB)	Type
1	*	2455.392	96.891	59.466	42.891	54.000	37.425	AV
2		2483.500	53.155	15.644	-0.845	54.000	37.511	AV
3		2483.816	53.222	15.708	-0.778	54.000	37.514	AV

Site: AC5	Time: 2016/04/10 - 14:31
Limit: FCC_Part15.209_RE(3m)	Margin: 0
Probe: Horn_3117_00167055(1-18GHz)	Polarity: Vertical
EUT: AC1750 Wireless Dual Band Gigabit Router	Power: AC 120V/60Hz
Note: Mode 4:Transmit at CH2452Mhz by 802.11n40	

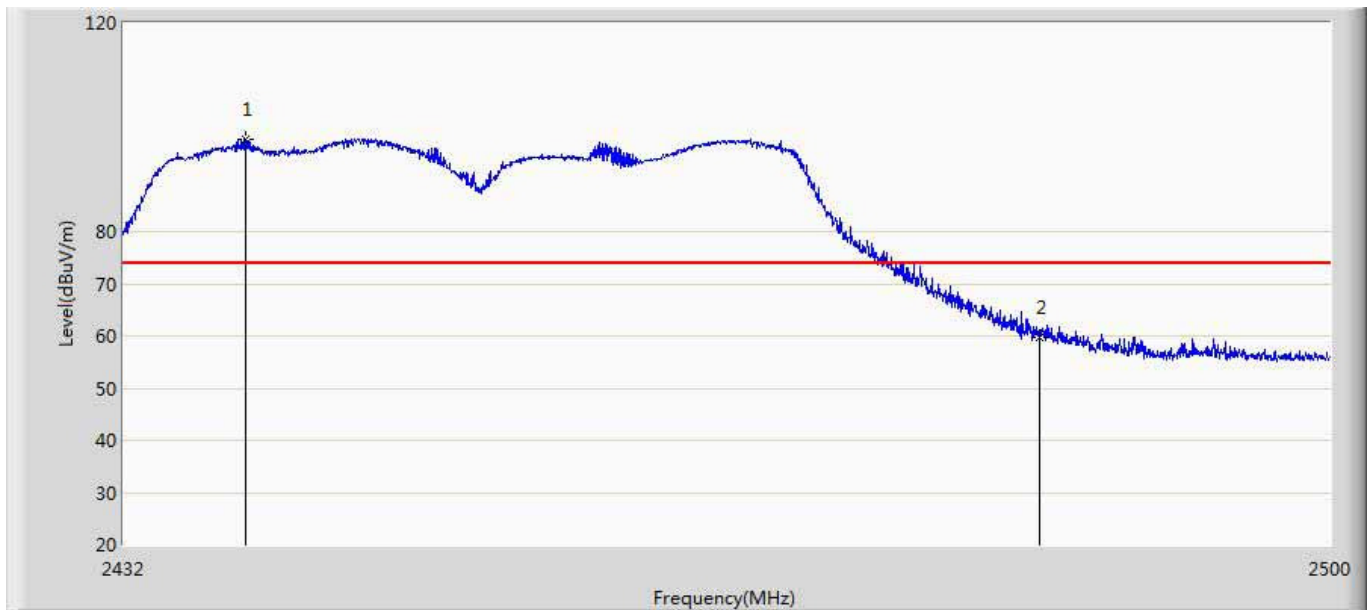

No	Mark	Frequency (MHz)	Measure Level (dBuV/m)	Reading Level (dBuV)	Over Limit (dB)	Limit (dBuV/m)	Factor (dB)	Type
1	*	2438.834	97.653	59.717	23.653	74.000	37.936	PK
2		2483.500	59.844	21.806	-14.156	74.000	38.038	PK

Site: AC5	Time: 2016/04/10 - 14:34
Limit: FCC_Part15.209_RE(3m)	Margin: 0
Probe: Horn_3117_00167055(1-18GHz)	Polarity: Vertical
EUT: AC1750 Wireless Dual Band Gigabit Router	Power: AC 120V/60Hz
Note: Mode 4:Transmit at CH2452Mhz by 802.11n40	

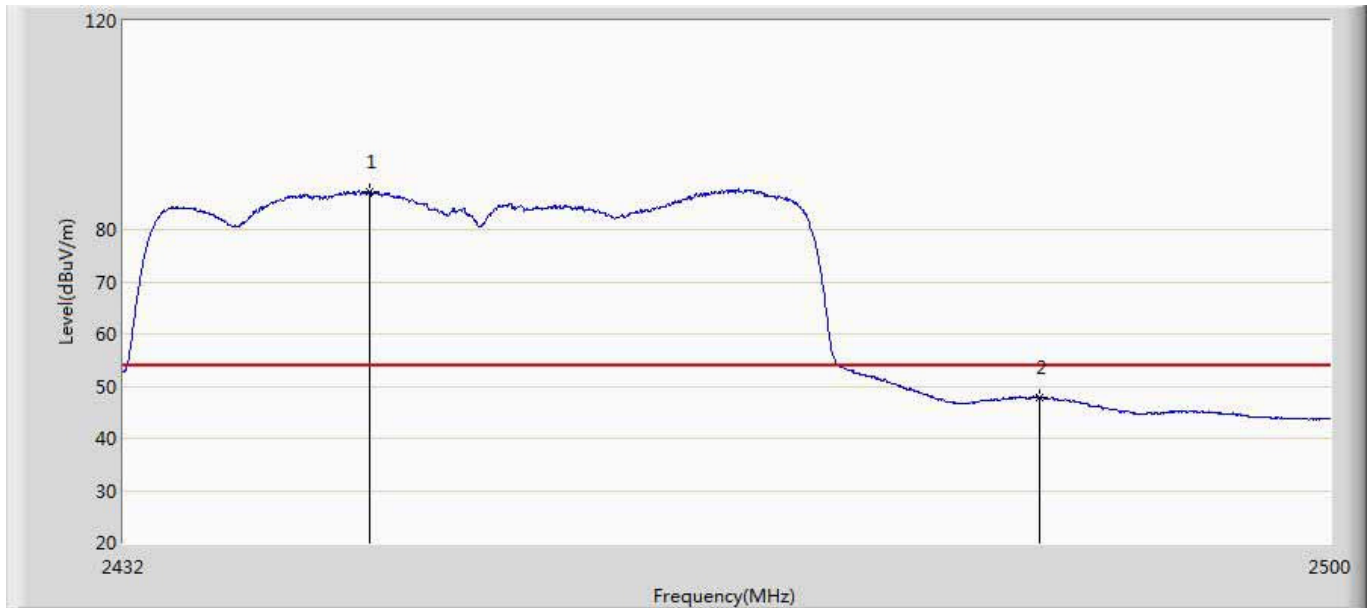

No	Mark	Frequency (MHz)	Measure Level (dBuV/m)	Reading Level (dBuV)	Over Limit (dB)	Limit (dBuV/m)	Factor (dB)	Type
1	*	2445.736	87.379	49.436	33.379	54.000	37.943	AV
2		2483.500	47.737	9.699	-6.263	54.000	38.038	AV

5. Fundamental emission output power

5.1. Test Equipment

Fundamental emission output power/ TR-8					
Instrument	Manufacturer	Type No.	Serial No.	Cal. Date	Cal. Due Date
Spectrum Analyzer	Agilent	E4446A	MY45300103	2016.01.04	2017.01.03
Spectrum Analyzer	Agilent	N9010A	MY48030494	2016.03.11	2017.03.10
Wideband Peak Power Meter	Anritsu	ML2495A	0905006	2015.11.11	2016.11.10
Power Sensor	Anritsu	MA2411B	0846014	2015.11.11	2016.11.10
Temperature/Humidity Meter	zhicheng	ZC1-2	TR8-TH	2016.04.10	2017.04.09

Note: All equipments are calibrated with traceable calibrations. Each calibration is traceable to the national or international standards.

5.2. Test Setup

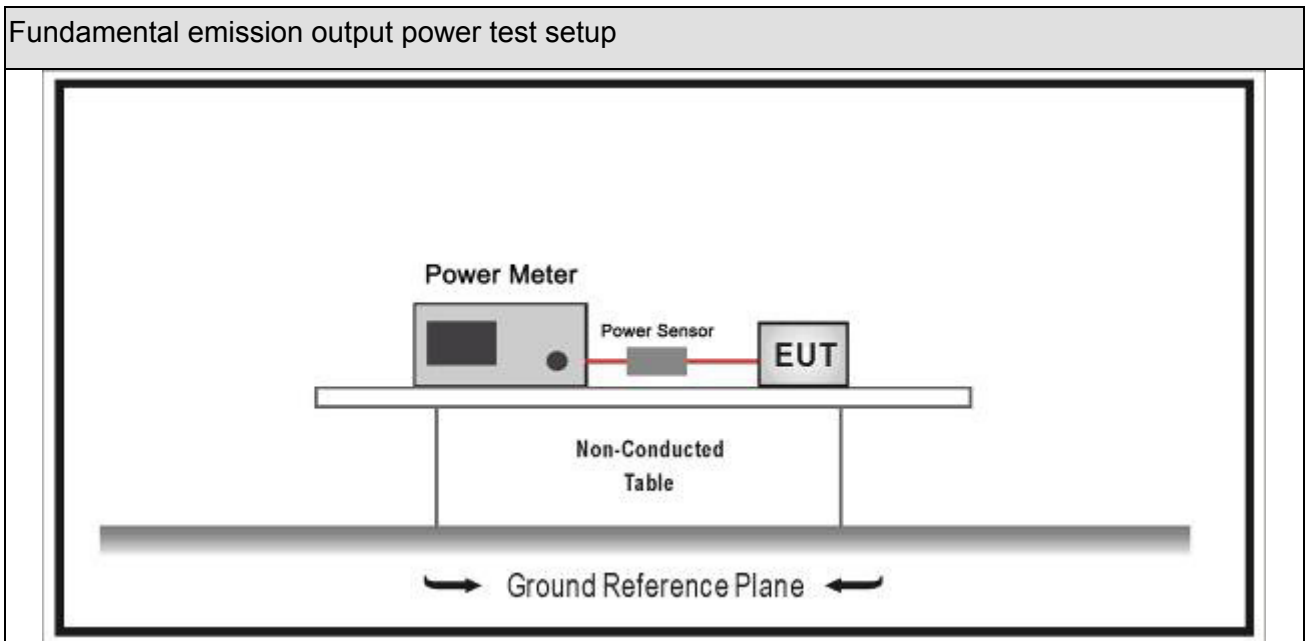

5.3. Limit

Fundamental emission output power Limit



GTX

5.4. Test Procedure

Fundamental emission output power Test Method				
	References Rule		Chapter	Description
<input checked="" type="checkbox"/>	ANSI C63.10		11.9	Fundamental emission output power
	<input type="checkbox"/>	ANSI C63.10	11.9.1	Maximum peak conducted output power
		<input type="checkbox"/> ANSI C63.10	11.9.1.1	RBW \geq DTS bandwidth
		<input type="checkbox"/> ANSI C63.10	11.9.1.2	Integrated band power method
		<input type="checkbox"/> ANSI C63.10	11.9.1.3	PKPM1 Peak power meter method
	<input checked="" type="checkbox"/>	ANSI C63.10	11.9.2	Maximum conducted (average) output power
		<input checked="" type="checkbox"/> ANSI C63.10	11.9.2.2	Measurement using a spectrum analyzer (SA)
		<input type="checkbox"/> ANSI C63.10	11.9.2.2.2	Method AVGSA-1(Duty cycle

Directional Gain Calculations for In-Band test method			
	References Rule	Chapter	Description
<input type="checkbox"/>	KDB 662911	F2)a)	Basic methodology with NANT transmit antennas
	<input type="checkbox"/> KDB 662911	F2)a) (i)	transmit signals are correlated
	<input type="checkbox"/> KDB 662911	F2)a) (ii)	transmit signals are uncorrelated
<input type="checkbox"/>	KDB 662911	F2)b)	Sectorized antenna systems.
<input type="checkbox"/>	KDB 662911	F2)c)	Cross-polarized antennas
	<input type="checkbox"/> ANSI C63.10	F2)c) (i)	Cross-polarized antennas with NANT = 2.
	<input type="checkbox"/> ANSI C63.10	F2)c) (ii)	Multiple antennas
<input type="checkbox"/>	KDB 662911	F2)d)	Sectorized antenna systems.
	<input type="checkbox"/> KDB 662911	F2)d) (i)	transmit signals are correlated
	<input type="checkbox"/> KDB 662911	F2)d) (ii)	transmit signals are uncorrelated
<input type="checkbox"/>	KDB 662911	F2)e)	Spatial stream
	<input type="checkbox"/> KDB 662911	F2)e) (i)	Antennas have the same gain
	<input type="checkbox"/> KDB 662911	F2)e) (ii)	Antenna have the different gain with one spatial stream
	<input type="checkbox"/> KDB 662911	F2)e) (iii)	Antenna have the different gain with more than one spatial stream
<input checked="" type="checkbox"/>	KDB 662911	F2)f)	Cyclic Delay Diversity (CDD)
	<input type="checkbox"/> KDB 662911	F2)f) (i)	Antennas have the same gain
	<input type="checkbox"/> KDB 662911	F2)f) (ii)	Antenna have the different gain with one spatial stream
	<input checked="" type="checkbox"/> KDB 662911	F2)f) (ii)	Antenna have the different gain with more than one spatial stream

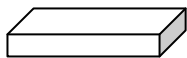
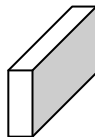
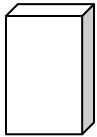
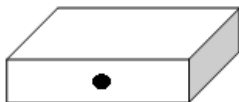
5.5. EUT test definition

Item	Fundamental emission output power			
Device Category	<input checked="" type="checkbox"/>	Indoor use		
	<input type="checkbox"/>	Outdoor use		
	<input type="checkbox"/>	Fix position use		
	<input type="checkbox"/>	Mobile position use		
Test mode	Mode 1-4			
Test method	<input type="checkbox"/>	Radiated		
		X Axis	Y Axis	Z Axis
				
		Worst Axis <input type="checkbox"/>	Worst Axis <input type="checkbox"/>	Worst Axis <input type="checkbox"/>
	<input checked="" type="checkbox"/>	Conducted		
	<input type="checkbox"/>	Chain 0		
				
	<input type="checkbox"/>	Chain 0	Chain 1	
				
	<input checked="" type="checkbox"/>	Chain 0	Chain 1	Chain 2
				

5.6. Test Result

Product Name	:	AC1750 Wireless Dual Band Gigabit Router	Test Power	:	AC 120V/60Hz
Test Site	:	TR8			

Mode	Channel	Test Frequency (MHz)	Measurement Power Output (dBm)			Total Power (dBm)	Directional Gain (dBi)	Limit (dBm)	Result
			Ant 0	Ant 1	Ant 2				
1	01	2412	19.42	18.24	18.36	23.48	3.3	30	Pass
1	06	2437	21.46	20.75	19.87	25.51	3.3	30	Pass
1	11	2462	16.47	15.27	15.19	20.46	3.3	30	Pass
2	01	2412	12.43	12.63	12.79	17.39	3.3	30	Pass
2	06	2437	18.27	17.44	16.91	22.35	3.3	30	Pass
2	11	2462	12.65	12.01	11.56	16.87	3.3	30	Pass
3	01	2412	12.86	12.25	11.38	16.98	3.3	30	Pass
3	06	2437	19.01	18.73	18.51	23.53	3.3	30	Pass
3	11	2462	12.81	12.33	11.62	17.05	3.3	30	Pass
4	03	2422	8.44	8.69	8.78	13.41	3.3	30	Pass
4	06	2437	12.64	12.35	12.18	17.17	3.3	30	Pass
4	09	2452	10.69	10.01	9.25	14.79	3.3	30	Pass

Note: Array gain is 0dBi for NANT ≤ 4

————— The End —————