

FCC Radio Test Report

FCC ID: TE7C60V3

This report concerns: **Original Grant**

Project No. : 1906C116
Equipment : AC1350 Wireless Dual Band Router
Test Model : Archer C60
Series Model : N/A
Applicant : TP-Link Technologies Co., Ltd.
Address : Building 24(floors1,3,4,5) and 28(floors1-4) Central
Science and Technology Park, Shennan Rd,
Nanshan, Shenzhen, China

Date of Receipt : Jun. 20, 2019
Date of Test : Jun. 21, 2019 ~ Aug. 12, 2019
Issued Date : Aug. 22, 2019
Tested by : BTL Inc.

Testing Engineer : Chay Cai
(Chay Cai)

Technical Manager : Steven Lu
(Steven Lu)

Authorized Signatory : Ethan Ma
(Ethan Ma)

B T L I N C .

No.3, Jinshagang 1st Road, Shixia, Dalang Town, Dongguan,
Guangdong, China.

TEL: +86-769-8318-3000 FAX: +86-769-8319-6000



Certificate #5123.02

Declaration

BTL represents to the client that testing is done in accordance with standard procedures as applicable and that test instruments used has been calibrated with standards traceable to international standard(s) and/or national standard(s).

BTL's reports apply only to the specific samples tested under conditions. It is manufacture's responsibility to ensure that additional production units of this model are manufactured with the identical electrical and mechanical components. **BTL** shall have no liability for any declarations, inferences or generalizations drawn by the client or others from **BTL** issued reports.

The report must not be used by the client to claim product certification, approval, or endorsement by NVLAP, NIST, A2LA, or any agency of the U.S. Government.

This report is the confidential property of the client. As a mutual protection to the clients, the public and ourselves, the test report shall not be reproduced, except in full, without our written approval.

BTL's laboratory quality assurance procedures are in compliance with the **ISO/IEC 17025** requirements, and accredited by the conformity assessment authorities listed in this test report.

BTL is not responsible for the sampling stage, so the results only apply to the sample as received.

The information, data and test plan are provided by manufacturer which may affect the validity of results, so it is manufacturer's responsibility to ensure that the apparatus meets the essential requirements of applied standards and in all the possible configurations as representative of its intended use.

Limitation

For the use of the authority's logo is limited unless the Test Standard(s)/Scope(s)/Item(s) mentioned in this test report is (are) included in the conformity assessment authorities acceptance respective.

Please note that the measurement uncertainty is provided for informational purpose only and are not use in determining the Pass/Fail results.

Table of Contents

Page

APPENDIX G - POWER SPECTRAL DENSITY

207

APPENDIX H - FREQUENCY STABILITY

228

REPORT ISSUED HISTORY

Report Version	Description	Issued Date
R00	Original Issue.	Aug. 22, 2019

1. GENERAL SUMMARY

Equipment : AC1350 Wireless Dual Band Router
Brand Name : tp-link
Test Model : Archer C60
Series Model : N/A
Applicant : TP-Link Technologies Co., Ltd.
Manufacturer : TP-Link Technologies Co., Ltd.
Address : Building 24(floors1,3,4,5) and 28(floors1-4) Central Science and Technology Park, Shennan Rd, Nanshan, Shenzhen, China
Date of Test : Jun. 21, 2019 ~ Aug. 12, 2019
Test Sample : Engineering Sample No.: DG19062092 for conducted, DG19080597 for radiated Non Beamforming, DG19080598 for radiated With Beamforming.
Standard(s) : FCC Part15, Subpart E(15.407)
ANSI C63.10-2013
FCC KDB 789033 D02 General UNII Test Procedures New Rules v02r01
FCC KDB 662911 D01 Multiple Transmitter Output v02r01

The above equipment has been tested and found compliance with the requirement of the relative standards by BTL Inc.

The test data, data evaluation, and equipment configuration contained in our test report (Ref No. BTL-FCCP-2-1906C116) were obtained utilizing the test procedures, test instruments, test sites that has been accredited by the Authority of A2LA according to the ISO/IEC 17025 quality assessment standard and technical standard(s).

Test results included in this report are only for the RLAN 5 GHz UNII-1 and UNII-3 part.

2. SUMMARY OF TEST RESULTS

Test procedures according to the technical standard(s):

FCC Part15, Subpart E(15.407)				
Standard(s) Section	Test Item	Test Result	Judgement	Remark
15.207 15.407(b)	AC Power Line Conducted Emissions	APPENDIX A	PASS	-----
15.407(b) 15.205(a) 15.209(a)	Radiated Emissions	APPENDIX B APPENDIX C APPENDIX D	PASS	-----
15.407(a) 15.407(e)	Spectrum Bandwidth	APPENDIX E	PASS	-----
15.407(a)	Maximum Output Power	APPENDIX F	PASS	-----
15.407(a)	Power Spectral Density	APPENDIX G	PASS	-----
15.407(g)	Frequency Stability	APPENDIX H	PASS	-----
15.203	Antenna Requirements	-----	PASS	Note(4)
15.407(c)	Automatically Discontinue Transmission	-----	PASS	Note(2)

Note:

- (1) "N/A" denotes test is not applicable in this test report.
- (2) During no any information transmission, the EUT can automatically discontinue transmission and become standby mode for power saving. the EUT can detect the controlling signal of ACK message transmitting from remote device and verify whether it shall resend or discontinue transmission.
- (3) For UNII-1 this device was functioned as a
 Access point device Client device
- (4) The device what use a permanently attached antenna were considered sufficient to comply with the provisions of 15.203.

2.1 TEST FACILITY

The test facilities used to collect the test data in this report is at the location of No.3, Jinshagang 1st Road, Shixia, Dalang Town, Dongguan, Guangdong, China.

BTL's Test Firm Registration Number for FCC: 357015

BTL's Designation Number for FCC: CN1240

2.2 MEASUREMENT UNCERTAINTY

ISO/IEC 17025 requires that an estimate of the measurement uncertainties associated with the emissions test results be included in the report. The measurement uncertainties given below are based on a 95% confidence level (based on a coverage factor (k=2))

The BTL measurement uncertainty as below table:

A. AC power line conducted emissions test:

Test Site	Method	Measurement Frequency Range	U, (dB)
DG-C02	CISPR	150 kHz ~ 30 MHz	2.32

B. Radiated emissions test:

Test Site	Method	Measurement Frequency Range	Ant. H / V	U, (dB)
DG-CB03	CISPR	9kHz ~ 30MHz	V	3.79
		9kHz ~ 30MHz	H	3.57
		30MHz ~ 200MHz	V	4.88
		30MHz ~ 200MHz	H	4.14
		200MHz ~ 1,000MHz	V	4.62
		200MHz ~ 1,000MHz	H	4.80
		1GHz ~ 6GHz	-	4.58
		6GHz ~ 18GHz	-	5.18
		18GHz ~ 26.5GHz	-	3.80
26.5GHz ~ 40GHz	-	4.30		

Note: Unless specifically mentioned, the uncertainty of measurement has not been taken into account to declare the compliance or non-compliance to the specification.

2.3 TEST ENVIRONMENT CONDITIONS

Test Item	Temperature	Humidity	Test Voltage	Tested By
AC Power Line Conducted Emissions	25°C	53%	AC 120V/60Hz	Damon Deng
Radiated Emissions-9K-30MHz	24°C	52%	AC 120V/60Hz	Robin Zhuang
Radiated Emissions-30 MHz to 1GHz	24°C	68%	AC 120V/60Hz	Laughing Zhang
Radiated Emissions-Above 1000 MHz	24°C	52%	AC 120V/60Hz	Laughing Zhang
Spectrum Bandwidth	26°C	53%	AC 120V/60Hz	Jonas Chen
Maximum Output Power	26°C	53%	AC 120V/60Hz	Jonas Chen
Power Spectral Density	26°C	53%	AC 120V/60Hz	Jonas Chen
Frequency Stability	26°C	53%	AC 120V/60Hz	Jonas Chen

3. GENERAL INFORMATION

3.1 GENERAL DESCRIPTION OF EUT

Equipment	AC1350 Wireless Dual Band Router
Brand Name	tp-link
Test Model	Archer C60
Series Model	N/A
Model Difference(s)	N/A
Power Source	DC Voltage supplied from AC/DC adapter. Model: AMS159A-1201000FU
Power Rating	I/P:100-240V~ 50/60Hz 0.5A O/P: 12V --- 1.0A
Operation Frequency	UNII-1: 5150 MHz ~ 5250 MHz UNII-3: 5725 MHz ~ 5850 MHz
Modulation Type	OFDM
Bit Rate of Transmitter	Up to 866.7 Mbps
Maximum Output Power for UNII-1 Non-Beamforming	IEEE 802.11a: 24.18 dBm (0.2618 W) IEEE 802.11n (HT20): 24.24 dBm (0.2655 W) IEEE 802.11n (HT40): 24.21 dBm (0.2636 W) IEEE 802.11ac (VHT20): 24.19 dBm (0.2624 W) IEEE 802.11ac (VHT40): 24.06 dBm (0.2547 W) IEEE 802.11ac (VHT80): 18.25 dBm (0.0668 W)
Maximum Output Power for UNII-3 Non-Beamforming	IEEE 802.11a: 24.26 dBm (0.2667 W) IEEE 802.11n (HT20): 24.11 dBm (0.2576 W) IEEE 802.11n (HT40): 24.74 dBm (0.2979 W) IEEE 802.11ac (VHT20): 23.99 dBm (0.2506 W) IEEE 802.11ac (VHT40): 24.54 dBm (0.2844 W) IEEE 802.11ac (VHT80): 22.00 dBm (0.1585 W)
Maximum Output Power for UNII-1 With Beamforming	IEEE 802.11n (HT20): 24.28 dBm (0.2679 W) IEEE 802.11n (HT40): 24.41 dBm (0.2761 W) IEEE 802.11ac (VHT20): 24.18 dBm (0.2618 W) IEEE 802.11ac (VHT40): 24.39 dBm (0.2748 W) IEEE 802.11ac (VHT80): 24.19 dBm (0.2624 W)
Maximum Output Power for UNII-3 With Beamforming	IEEE 802.11n (HT20): 24.12 dBm (0.2582 W) IEEE 802.11n (HT40): 24.67 dBm (0.2931 W) IEEE 802.11ac (VHT20): 23.95 dBm (0.2483 W) IEEE 802.11ac (VHT40): 24.58 dBm (0.2871 W) IEEE 802.11ac (VHT80): 24.52 dBm (0.2831 W)

Note:

- For a more detailed features description, please refer to the manufacturer's specifications or the user's manual.

2. Channel List:

IEEE 802.11a IEEE 802.11n (HT20) IEEE 802.11ac (VHT20)		IEEE 802.11n (HT40) IEEE 802.11ac (VHT40)		IEEE 802.11ac (VHT80)	
UNII-1		UNII-1		UNII-1	
Channel	Frequency (MHz)	Channel	Frequency (MHz)	Channel	Frequency (MHz)
36	5180	38	5190	42	5210
40	5200	46	5230		
44	5220				
48	5240				

IEEE 802.11a IEEE 802.11n (HT20) IEEE 802.11ac (VHT20)		IEEE 802.11n (HT40) IEEE 802.11ac (VHT40)		IEEE 802.11ac (VHT80)	
UNII-3		UNII-3		UNII-3	
Channel	Frequency (MHz)	Channel	Frequency (MHz)	Channel	Frequency (MHz)
149	5745	151	5755	155	5775
153	5765	159	5795		
157	5785				
161	5805				
165	5825				

3. Antenna Specification:

Ant.	Brand	P/N	Antenna Type	Connector	Gain (dBi)	Note
1		3101502331	Dipole	Weld	1.98	UNII-1
2		3101502330	Dipole	Weld	1.98	UNII-1
1		3101502331	Dipole	Weld	0.78	UNII-3
2		3101502330	Dipole	Weld	0.78	UNII-3

Note:

This EUT supports CDD, and all antennas have the same gain for UNII-1 and UNII-3, so

(1) For Non Beamforming Function:

For UNII-1:

a) power spectral density measurements, $N_{ANT} = 2, N_{SS} = 1$.

So Directional gain = $G_{ANT} + \text{Array Gain} = 10 \log (N_{ANT}/ N_{SS}) \text{ dB} = 1.98 + 10 \log(2/1) \text{ dBi} = 4.99$.

b) Power measurements, Array Gain = 0 dB ($N_{ANT} \leq 4$), so the Directional gain=1.98.

For UNII-3:

c) power spectral density measurements, $N_{ANT} = 2, N_{SS} = 1$.

So Directional gain = $G_{ANT} + \text{Array Gain} = 10 \log (N_{ANT}/ N_{SS}) \text{ dB} = 0.78 + 10 \log(2/1) \text{ dBi} = 3.79$.

d) Power measurements, Array Gain = 0 dB ($N_{ANT} \leq 4$), so the Directional gain=0.78.

(2) For With Beamforming Function:

Beamforming Gain: 3 dB. So UNII-1 Directional gain = $1.98 + 3 = 4.98$, UNII-3 Directional gain = $0.78 + 3 = 3.78$.

4. Table for Antenna Configuration:
For Non Beamforming:

Operating Mode	TX Mode	2TX
IEEE 802.11a		V (Ant. 1 + Ant. 2)
IEEE 802.11n (HT20)		V (Ant. 1 + Ant. 2)
IEEE 802.11n (HT40)		V (Ant. 1 + Ant. 2)
IEEE 802.11ac (VHT20)		V (Ant. 1 + Ant. 2)
IEEE 802.11ac (VHT40)		V (Ant. 1 + Ant. 2)
IEEE 802.11ac (VHT80)		V (Ant. 1 + Ant. 2)

For With Beamforming:

Operating Mode	TX Mode	2TX
IEEE 802.11n (HT20)		V (Ant. 1 + Ant. 2)
IEEE 802.11n (HT40)		V (Ant. 1 + Ant. 2)
IEEE 802.11ac (VHT20)		V (Ant. 1 + Ant. 2)
IEEE 802.11ac (VHT40)		V (Ant. 1 + Ant. 2)
IEEE 802.11ac (VHT80)		V (Ant. 1 + Ant. 2)

3.2 TEST MODES

The test system was pre-tested based on the consideration of all possible combinations of EUT operation mode.

Pretest Mode	Description
Mode 1	TX A Mode / CH36, CH40, CH48 (UNII-1)
Mode 2	TX N (HT20) Mode / CH36, CH40, CH48 (UNII-1)
Mode 3	TX N (HT40) Mode / CH38, CH46 (UNII-1)
Mode 4	TX AC (VHT20) Mode / CH36, CH40, CH48 (UNII-1)
Mode 5	TX AC (VHT40) Mode / CH38, CH46 (UNII-1)
Mode 6	TX AC (VHT80) Mode / CH42 (UNII-1)
Mode 7	TX A Mode / CH149,CH157,CH165 (UNII-3)
Mode 8	TX N (HT20) Mode / CH149,CH157,CH165 (UNII-3)
Mode 9	TX N (HT40) Mode / CH151,CH159 (UNII-3)
Mode 10	TX AC (VHT20) Mode / CH149,CH157,CH165 (UNII-3)
Mode 11	TX AC (VHT40) Mode / CH151,CH159 (UNII-3)
Mode 12	TX AC (VHT80) Mode / CH155 (UNII-3)
Mode 13	TX N(HT40) Mode / CH151 (UNII-3)

Following mode(s) as (were) found to be the worst case(s) and selected for the final test.

AC power line conducted emissions test	
Final Test Mode	Description
Mode 13	TX N(HT40) Mode / CH151 (UNII-3)

Radiated emissions test - Below 1G	
Final Test Mode	Description
Mode 13	TX N(HT40) Mode / CH151 (UNII-3)

Radiated emissions test - Above 1G for Non Beamforming	
Final Test Mode	Description
Mode 1	TX A Mode / CH36, CH40, CH48 (UNII-1)
Mode 2	TX N (HT20) Mode / CH36, CH40, CH48 (UNII-1)
Mode 3	TX N (HT40) Mode / CH38, CH46 (UNII-1)
Mode 6	TX AC (VHT80) Mode / CH42 (UNII-1)
Mode 7	TX A Mode / CH149,CH157,CH165 (UNII-3)
Mode 8	TX N (HT20) Mode / CH149,CH157,CH165 (UNII-3)
Mode 9	TX N (HT40) Mode / CH151,CH159 (UNII-3)
Mode 12	TX AC (VHT80) Mode / CH155 (UNII-3)

Radiated emissions test - Above 1G for With Beamforming	
Final Test Mode	Description
Mode 2	TX N (HT20) Mode / CH36, CH40, CH48 (UNII-1)
Mode 3	TX N (HT40) Mode / CH38, CH46 (UNII-1)
Mode 6	TX AC (VHT80) Mode / CH42 (UNII-1)
Mode 8	TX N (HT20) Mode / CH149,CH157,CH165 (UNII-3)
Mode 9	TX N (HT40) Mode / CH151,CH159 (UNII-3)
Mode 12	TX AC (VHT80) Mode / CH155 (UNII-3)

Output Power test for Non Beamforming	
Final Test Mode	Description
Mode 1	TX A Mode / CH36, CH40, CH48 (UNII-1)
Mode 2	TX N (HT20) Mode / CH36, CH40, CH48 (UNII-1)
Mode 3	TX N (HT40) Mode / CH38, CH46 (UNII-1)
Mode 4	TX AC (VHT20) Mode / CH36, CH40, CH48 (UNII-1)
Mode 5	TX AC (VHT40) Mode / CH38, CH46 (UNII-1)
Mode 6	TX AC (VHT80) Mode / CH42 (UNII-1)
Mode 7	TX A Mode / CH149,CH157,CH165 (UNII-3)
Mode 8	TX N (HT20) Mode / CH149,CH157,CH165 (UNII-3)
Mode 9	TX N (HT40) Mode / CH151,CH159 (UNII-3)
Mode 10	TX AC (VHT20) Mode / CH149,CH157,CH165 (UNII-3)
Mode 11	TX AC (VHT40) Mode / CH151,CH159 (UNII-3)
Mode 12	TX AC (VHT80) Mode / CH155 (UNII-3)

Output Power test for With Beamforming	
Final Test Mode	Description
Mode 2	TX N (HT20) Mode / CH36, CH40, CH48 (UNII-1)
Mode 3	TX N (HT40) Mode / CH38, CH46 (UNII-1)
Mode 4	TX AC (VHT20) Mode / CH36, CH40, CH48 (UNII-1)
Mode 5	TX AC (VHT40) Mode / CH38, CH46 (UNII-1)
Mode 6	TX AC (VHT80) Mode / CH42 (UNII-1)
Mode 8	TX N (HT20) Mode / CH149,CH157,CH165 (UNII-3)
Mode 9	TX N (HT40) Mode / CH151,CH159 (UNII-3)
Mode 10	TX AC (VHT20) Mode / CH149,CH157,CH165 (UNII-3)
Mode 11	TX AC (VHT40) Mode / CH151,CH159 (UNII-3)
Mode 12	TX AC (VHT80) Mode / CH155 (UNII-3)

Others Conducted test for Non Beamforming	
Final Test Mode	Description
Mode 1	TX A Mode / CH36, CH40, CH48 (UNII-1)
Mode 2	TX N (HT20) Mode / CH36, CH40, CH48 (UNII-1)
Mode 3	TX N (HT40) Mode / CH38, CH46 (UNII-1)
Mode 6	TX AC (VHT80) Mode / CH42 (UNII-1)
Mode 7	TX A Mode / CH149,CH157,CH165 (UNII-3)
Mode 8	TX N (HT20) Mode / CH149,CH157,CH165 (UNII-3)
Mode 9	TX N (HT40) Mode / CH151,CH159 (UNII-3)
Mode 12	TX AC (VHT80) Mode / CH155 (UNII-3)

Others Conducted test for With Beamforming	
Final Test Mode	Description
Mode 2	TX N (HT20) Mode / CH36, CH40, CH48 (UNII-1)
Mode 3	TX N (HT40) Mode / CH38, CH46 (UNII-1)
Mode 6	TX AC (VHT80) Mode / CH42 (UNII-1)
Mode 8	TX N (HT20) Mode / CH149,CH157,CH165 (UNII-3)
Mode 9	TX N (HT40) Mode / CH151,CH159 (UNII-3)
Mode 12	TX AC (VHT80) Mode / CH155 (UNII-3)

Note :

- (1) For radiated emission below 1 GHz test, the IEEE 802.11n40 channel 151 is found to be the worst case and recorded.
- (2) For radiated emission above 1 GHz test, 1GHz~26.5GHz and 26.5GHz~40GHz have been pre-tested and in this report only recorded the worst case. The remaining spurious points are all below the limit value of 20dB.
- (3) All the bit rate of transmitter have been tested and found the lowest rate is found to be the worst case and recorded.
- (4) The measurements for Power were tested, the worst case were IEEE 802.11a mode, IEEE 802.11n (HT20) mode, IEEE 802.11n (HT40) mode and IEEE 802.11ac(VHT80) mode, only worst case were documented for other test items.

3.3 PARAMETERS OF TEST SOFTWARE

Non Beamforming

UNII-1			
Test Software	QRCT V3.0.187.0		
Test Frequency (MHz)	5180	5200	5240
IEEE 802.11a	18	18	18
IEEE 802.11n (HT20)	18	18	19
IEEE 802.11ac (VHT20)	18	18	19
Test Frequency (MHz)	5190	5230	
IEEE 802.11n (HT40)	14	18	
IEEE 802.11ac (VHT40)	14	18	
Test Frequency (MHz)	5210		
IEEE 802.11ac (VHT80)	11.5		

UNII-3			
Test Software	QRCT V3.0.187.0		
Test Frequency (MHz)	5745	5785	5825
IEEE 802.11a	21	21	21
IEEE 802.11n (HT20)	21	21	21
IEEE 802.11ac (VHT20)	21	21	21
Test Frequency (MHz)	5755	5795	
IEEE 802.11n (HT40)	21	20	
IEEE 802.11ac (VHT40)	21	21	
Test Frequency (MHz)	5775		
IEEE 802.11ac (VHT80)	17		

With Beamforming

UNII-1

UNII-1			
Test Software	QRCT V3.0.187.0		
Test Frequency (MHz)	5180	5200	5240
IEEE 802.11n (HT20)	19	18	19
IEEE 802.11ac (VHT20)	19	18	19
Test Frequency (MHz)	5190	5230	
IEEE 802.11n (HT40)	18	18	
IEEE 802.11ac (VHT40)	18	18	
Test Frequency (MHz)	5210		
IEEE 802.11ac (VHT80)	19		

UNII-3

UNII-3			
Test Software	QRCT V3.0.187.0		
Test Frequency (MHz)	5745	5785	5825
IEEE 802.11n (HT20)	21	21	21
IEEE 802.11ac (VHT20)	21	21	21
Test Frequency (MHz)	5755	5795	
IEEE 802.11n (HT40)	21	20	
IEEE 802.11ac (VHT40)	21	21	
Test Frequency (MHz)	5775		
IEEE 802.11ac (VHT80)	21		

3.4 DUTY CYCLE

If duty cycle is $\geq 98\%$, duty factor is not required.
 If duty cycle is $< 98\%$, duty factor shall be considered.
 The output power = measured power + duty factor.

IEEE 802.11a

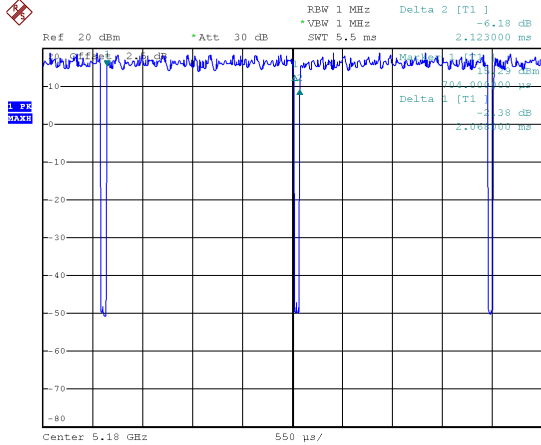

IEEE 802.11n (HT20)

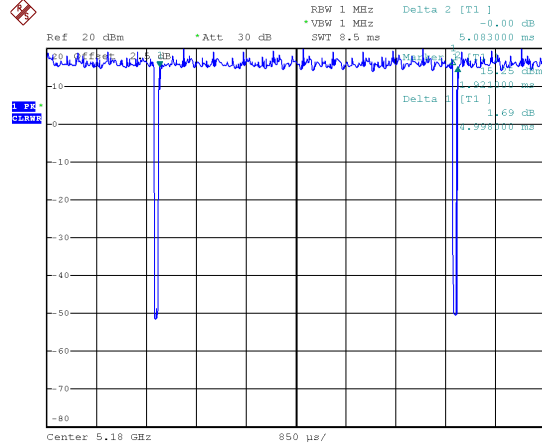

Date: 27.JUN.2019 19:57:10

Duty cycle = 2.068 ms / 2.123 ms = 97.41%
 Duty Factor = 10 log(1 / Duty cycle) = 0.11

Date: 27.JUN.2019 19:57:34

Duty cycle = 4.998 ms / 5.083 ms = 98.33%
 Duty Factor = 10 log(1 / Duty cycle) = 0.00

IEEE 802.11n (HT40)

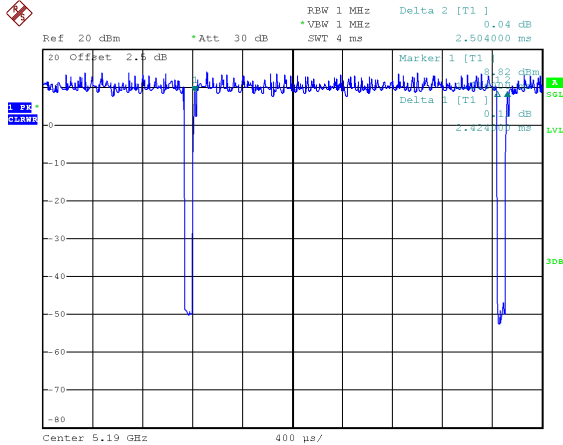

Date: 27.JUN.2019 19:58:46

Duty cycle = 2.424 ms / 2.504 ms = 96.81%
 Duty Factor = 10 log(1 / Duty cycle) = 0.14

IEEE 802.11ac (VHT20)

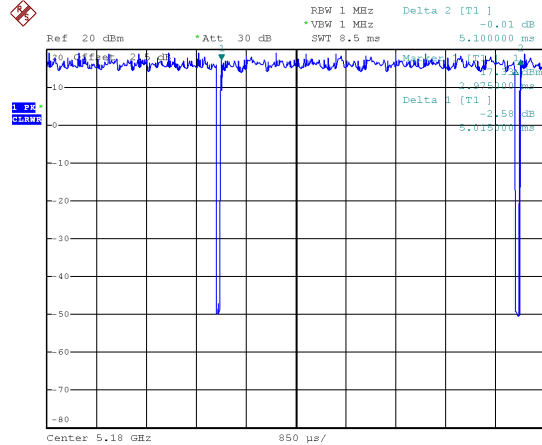

Date: 27.JUN.2019 20:00:07

Duty cycle = 5.015 ms / 5.100 ms = 98.33%
 Duty Factor = 10 log(1 / Duty cycle) = 0.00

IEEE 802.11ac (VHT40)

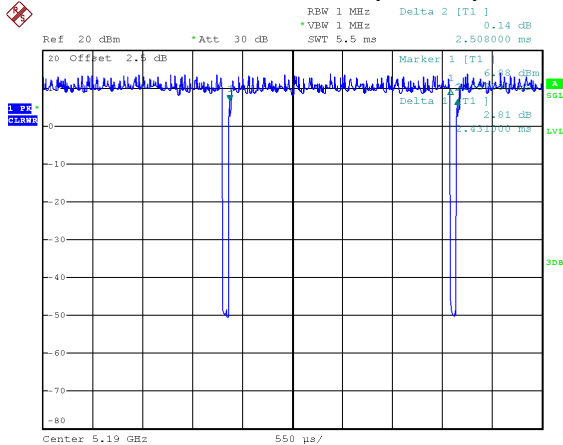

Date: 27.JUN.2019 19:59:08

Duty cycle = 2.431 ms / 2.508 ms = 96.93%
 Duty Factor = $10 \log(1 / \text{Duty cycle}) = 0.14$

IEEE 802.11ac (VHT80)

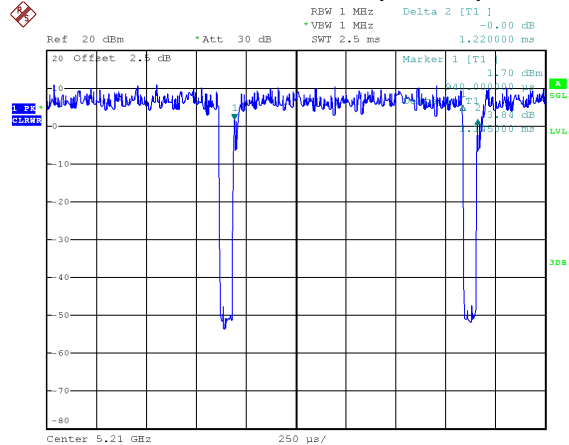

Date: 27.JUN.2019 19:59:27

Duty cycle = 1.145 ms / 1.220 ms = 93.85%
 Duty Factor = $10 \log(1 / \text{Duty cycle}) = 0.28$

NOTE:

For IEEE 802.11a, IEEE 802.11n (HT20) and IEEE 802.11ac (VHT20):

For radiated emissions frequency above 1 GHz, the resolution bandwidth of test receiver/spectrum analyzer is 1 MHz and the video bandwidth is 1 kHz (Duty cycle < 98%).

For IEEE 802.11n (HT40) and IEEE 802.11ac (VHT40):

For radiated emissions frequency above 1 GHz, the resolution bandwidth of test receiver/spectrum analyzer is 1 MHz and the video bandwidth is 2 kHz (Duty cycle < 98%).

For IEEE 802.11ac (VHT80):

For radiated emissions frequency above 1 GHz, the resolution bandwidth of test receiver/spectrum analyzer is 1 MHz and the video bandwidth is 3 kHz (Duty cycle < 98%).

3.5 BLOCK DIAGRAM SHOWING THE CONFIGURATION OF SYSTEM TESTED

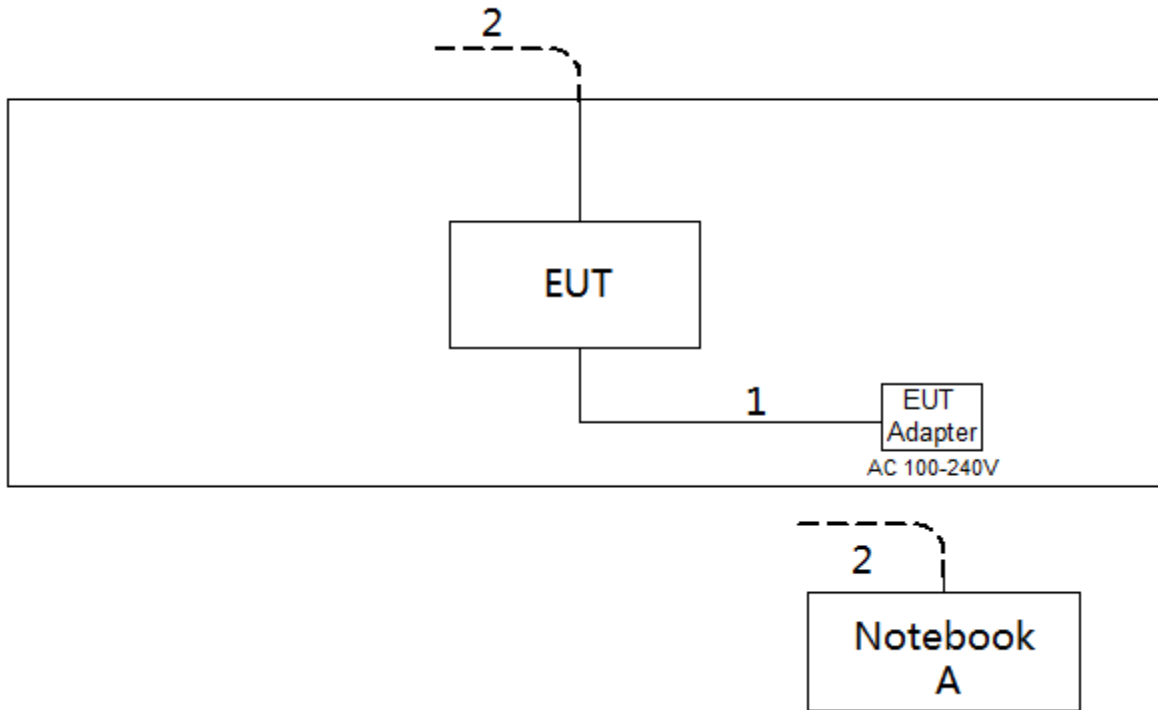

3.6 SUPPORT UNITS

Item	Equipment	Brand	Model No.	Series No.
A	Notebook	Lenovo	G410	N/A

Item	Cable Type	Shielded Type	Ferrite Core	Length
1	DC Cable	NO	NO	1.5m
2	RJ45 Cable	NO	NO	10m

4. AC POWER LINE CONDUCTED EMISSIONS TEST

4.1 LIMIT

Frequency (MHz)	Limit (dB μ V)	
	Quasi-peak	Average
0.15 - 0.50	66 to 56*	56 to 46*
0.50 - 5.0	56	46
5.0 - 30.0	60	50

NOTE:

- (1) The tighter limit applies at the band edges.
- (2) The limit of " * " marked band means the limitation decreases linearly with the logarithm of the frequency in the range.

The following table is the setting of the receiver

Receiver Parameter	Setting
Attenuation	10 dB
Start Frequency	0.15 MHz
Stop Frequency	30 MHz
IF Bandwidth	9 KHz

4.2 TEST PROCEDURE

- a. The EUT was placed 0.8 meters from the horizontal ground plane with EUT being connected to the power mains through a line impedance stabilization network (LISN). All other support equipment powered from additional LISN(s). The LISN provide 50 Ohm/ 50uH of coupling impedance for the measuring instrument.
- b. Interconnecting cables that hang closer than 40 cm to the ground plane shall be folded back and forth in the center forming a bundle 30 to 40 cm long.
- c. I/O cables that are not connected to a peripheral shall be bundled in the center. The end of the cable may be terminated, if required, using the correct terminating impedance. The overall length shall not exceed 1 m.
- d. LISN at least 80 cm from nearest part of EUT chassis.
- e. For the actual test configuration, please refer to the related Item -EUT Test Photos.

4.3 DEVIATION FROM TEST STANDARD

No deviation

4.4 TEST SETUP

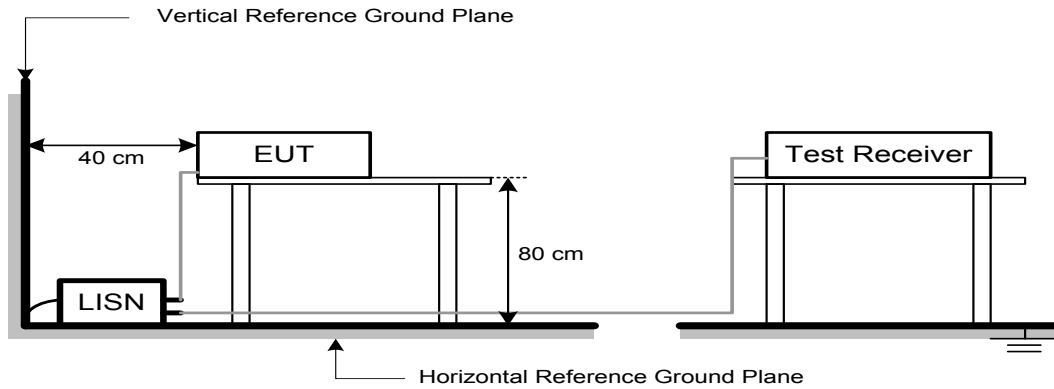

4.5 EUT OPERATION CONDITIONS

The EUT was configured for testing in a typical fashion (as a customer would normally use it). The EUT has been programmed to continuously transmit during test. This operating condition was tested and used to collect the included data.
 The EUT was programmed to be in continuously transmitting/TX mode.

4.6 TEST RESULTS

Please refer to the APPENDIX A.

5. RADIATED EMISSIONS TEST

5.1 LIMIT

In case the emission fall within the restricted band specified on 15.205(a), then the 15.209(a) limit in the table below has to be followed.

LIMITS OF RADIATED EMISSIONS MEASUREMENT (9 kHz to 1000 MHz)

Frequency (MHz)	Field Strength (microvolts/meter)	Measurement Distance (meters)
0.009-0.490	2400/F(kHz)	300
0.490-1.705	24000/F(kHz)	30
1.705-30.0	30	30
30-88	100	3
88-216	150	3
216-960	200	3
Above 960	500	3

LIMITS OF UNWANTED EMISSION OUT OF THE RESTRICTED BANDS

Frequency (MHz)	EIRP Limit (dBm/MHz)	Equivalent Field Strength at 3m (dBμV/m)
5150-5250	-27	68.3
5725-5850	-27 NOTE (2)	68.3
	10 NOTE (2)	105.3
	15.6 NOTE (2)	110.9
	27 NOTE (2)	122.3

NOTE:

- The following formula is used to convert the equipment isotropic radiated power (eirp) to field strength: $E = \frac{1000000\sqrt{30P}}{3}$ μV/m, where P is the eirp (Watts)
- According to 15.407(b)(4)(i), all emissions shall be limited to a level of -27 dBm/MHz at 75 MHz or more above or below the band edge increasing linearly to 10 dBm/MHz at 25 MHz above or below the band edge, and from 25 MHz above or below the band edge increasing linearly to a level of 15.6 dBm/MHz at 5 MHz above or below the band edge, and from 5 MHz above or below the band edge increasing linearly to a level of 27 dBm/MHz at the band edge.

5.2 TEST PROCEDURE

- a. The measuring distance of 3 m shall be used for measurements. The EUT was placed on the top of a rotating table 0.8 meter above the ground at a 3 meter semi-anechoic chamber. The table was rotated 360 degrees to determine the position of the highest radiation.(below 1GHz)
- b. The measuring distance of 3 m shall be used for measurements. The EUT was placed on the top of a rotating table 1.5 meter above the ground at a 3 meter semi-anechoic chamber. The table was rotated 360 degrees to determine the position of the highest radiation.(above 1GHz)
- c. The height of the equipment or of the substitution antenna shall be 0.8m or 1.5m; the height of the test antenna shall vary between 1 m to 4 m. Both horizontal and vertical polarizations of the antenna are set to make the measurement.
- d. For each suspected emission, the EUT was arranged to its worst case and then the antenna was tuned to heights find the maximum reading (used Bore sight function).
- e. The receiver system was set to peak and average detect function and specified bandwidth with maximum hold mode when the test frequency is above 1 GHz.
- f. The initial step in collecting radiated emission data is a receiver peak detector mode pre-scanning the measurement frequency range. Significant peaks are then marked and then Quasi Peak detector mode re-measured.
- g. All readings are Peak unless otherwise stated QP in column of Note. Peak denotes that the Peak reading compliance with the QP Limits and then QP Mode measurement didn't perform. (below 1 GHz)
- h. All readings are Peak Mode value unless otherwise stated AVG in column of Note. If the Peak Mode Measured value compliance with the Peak Limits and lower than AVG Limits, the EUT shall be deemed to meet both Peak & AVG Limits and then only Peak Mode was measured, but AVG Mode didn't perform. (above 1 GHz)
- i. For the actual test configuration, please refer to the related Item –EUT Test Photos.

5.3 DEVIATION FROM TEST STANDARD

No deviation

5.4 TEST SETUP

9 kHz to 30 MHz

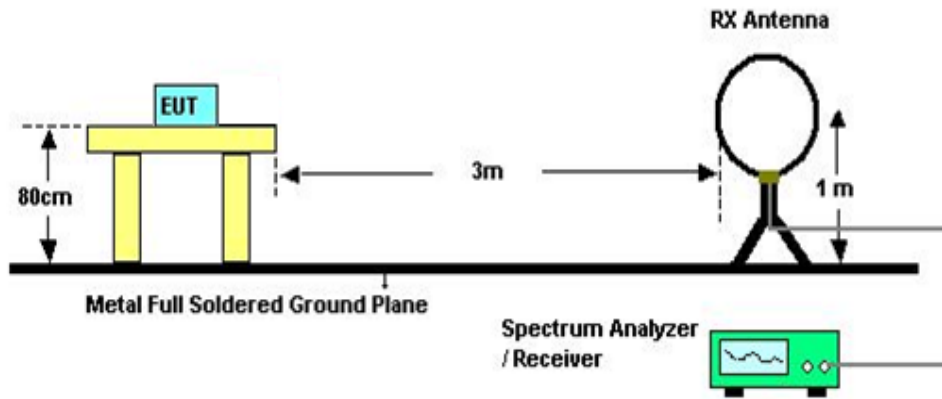

30 MHz to 1 GHz

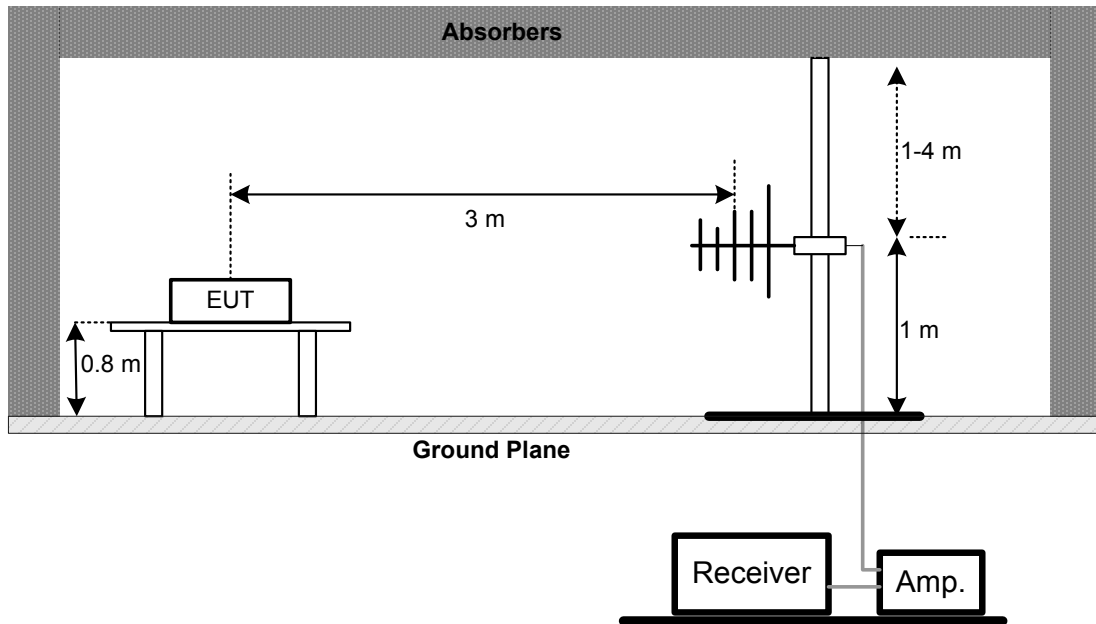

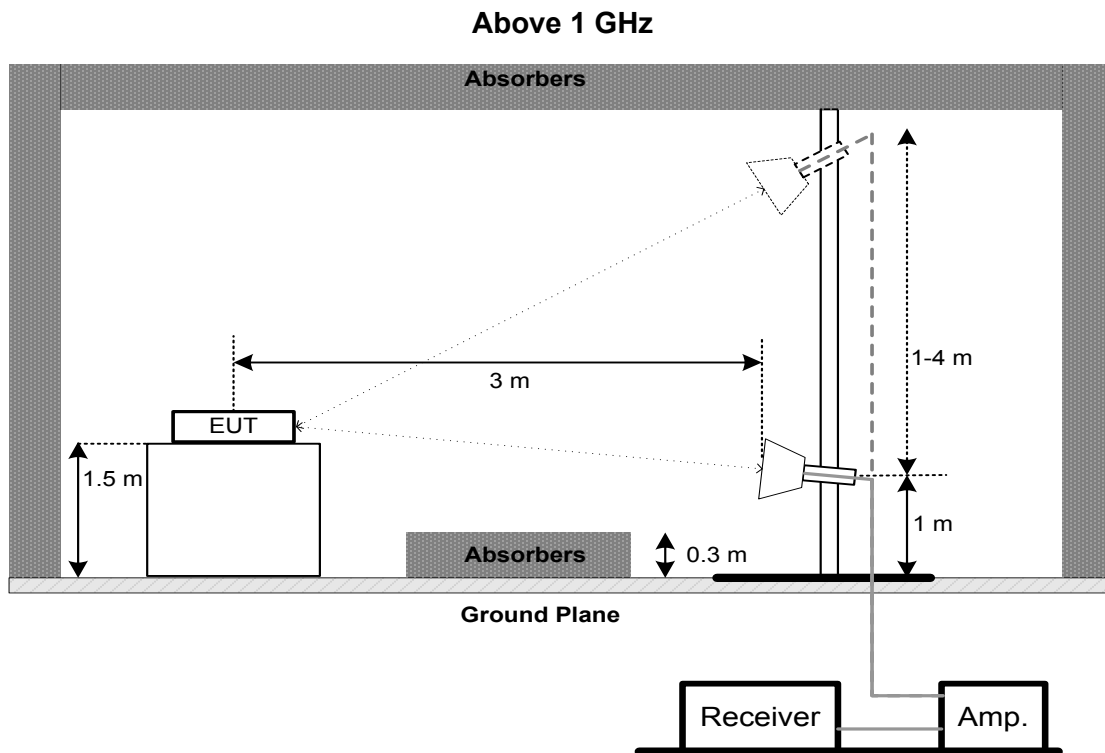

5.5 EUT OPERATION CONDITIONS

The EUT tested system was configured as the statements of 4.5 unless otherwise a special operating condition is specified in the follows during the testing.

5.6 TEST RESULTS - 9 KHZ to 30 MHZ

Please refer to the APPENDIX B

Remark:

- (1) Distance extrapolation factor = $40 \log(\text{specific distance} / \text{test distance})$ (dB).
- (2) Limit line = specific limits (dBuV) + distance extrapolation factor.

5.7 TEST RESULTS - 30 MHZ TO 1000 MHZ

Please refer to the APPENDIX C.

5.8 TEST RESULTS - ABOVE 1000 MHZ

Please refer to the APPENDIX D.

Remark:

- (1) No limit: This is fundamental signal, the judgment is not applicable.
For fundamental signal judgment was referred to Peak output test.

6. BANDWIDTH TEST

6.1 LIMIT

FCC Part15, Subpart E (15.407)			
Section	Test Item	Limit	Frequency Range (MHz)
15.407(a)	26 dB Bandwidth	-	5150-5250
15.407(e)	6 dB Bandwidth	Minimum 500 kHz	5725-5850

6.2 TEST PROCEDURE

- a. The EUT was directly connected to the spectrum analyzer and antenna output port as show in the block diagram below
- b. Spectrum Setting:

For UNII-1:

Spectrum Parameter	Setting
Attenuation	Auto
Span Frequency	> 26 dB Bandwidth
RBW	300 kHz (Bandwidth 20 MHz) 1 MHz (Bandwidth 40 MHz and 80 MHz)
VBW	1 MHz (Bandwidth 20 MHz) 3 MHz (Bandwidth 40 MHz and 80 MHz)
Detector	Peak
Trace	Max Hold
Sweep Time	Auto

For UNII-3:

Spectrum Parameter	Setting
Attenuation	Auto
Span Frequency	6 dB Bandwidth
RBW	100 kHz
VBW	300 kHz
Detector	Peak
Trace	Max Hold
Sweep Time	Auto

- c. Measured the spectrum width with power higher than 26 dB below carrier

6.3 DEVIATION FROM STANDARD

No deviation.

6.4 TEST SETUP



6.5 EUT OPERATION CONDITIONS

The EUT was programmed to be in continuously transmitting mode.

6.6 TEST RESULTS

Please refer to the APPENDIX E.

7. MAXIMUM OUTPUT POWER TEST

7.1 LIMIT

FCC Part15, Subpart E (15.407)			
Section	Test Item	Limit	Frequency Range (MHz)
15.407(a)	Maximum Output Power	AP device: 1 Watt (30 dBm) Client device: 250 mW (24 dBm)	5150-5250
		1 Watt (30dBm)	5725-5850

Note:

- a. For an indoor access point operating in the band 5.15-5.25 GHz, the maximum conducted output power over the frequency band of operation shall not exceed 1 W provided the maximum antenna gain does not exceed 6 dBi. In addition, the maximum power spectral density shall not exceed 17 dBm in any 1 megahertz band. If transmitting antennas of directional gain greater than 6 dBi are used, both the maximum conducted output power and the maximum power spectral density shall be reduced by the amount in dB that the directional gain of the antenna exceeds 6 dBi.

7.2 TEST PROCEDURE

- a. The EUT was directly connected to the power meter and antenna output port as show in the block diagram below.
- b. Test test was performed in accordance with method of FCC KDB 789033 D02 General UNII Test Procedures New Rules v02r01.

7.3 DEVIATION FROM STANDARD

No deviation.

7.4 TEST SETUP



7.5 EUT OPERATION CONDITIONS

The EUT was programmed to be in continuously transmitting mode.

7.6 TEST RESULTS

Please refer to the APPENDIX F.

8. POWER SPECTRAL DENSITY TEST

8.1 LIMIT

FCC Part15, Subpart E (15.407)			
Section	Test Item	Limit	Frequency Range (MHz)
15.407(a)	Power Spectral Density	AP device: 17 dBm/MHz Client device: 11 dBm/MHz	5150-5250
		30 dBm/500 kHz	5725-5850

8.2 TEST PROCEDURE

- a. The EUT was directly connected to the spectrum analyzer and antenna output port as show in the block diagram below.
- b. Spectrum Setting:

Spectrum Parameter	Setting
Attenuation	Auto
Span Frequency	Encompass the entire emissions bandwidth (EBW) of the signal
RBW	= 1 MHz.
VBW	≥ 3 MHz.
Detector	RMS
Trace average	100 trace
Sweep Time	Auto

Note:

1. For UNII-3, according to KDB publication 789033 D02 General UNII Test Procedures New Rules v02r01, section II.F.5., it is acceptable to set RBW at 1 MHz and VBW at 3 MHz if the spectrum analyzer does not have 500 kHz RBW.
2. The value measured with RBW=1 MHz is to be added with $10\log(500\text{ kHz}/1\text{ MHz})$ which is -3 dB. For example, if the measured value is +10dBm using RBW=1 MHz (that is +10 dBm/MHz), then the converted value will be +7dBm/500kHz.

8.3 DEVIATION FROM STANDARD

No deviation.

8.4 TEST SETUP

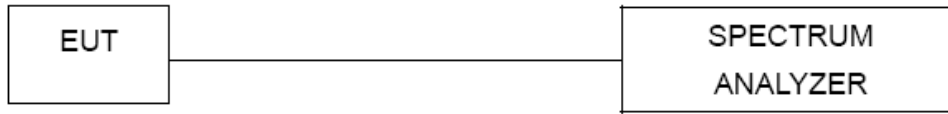

8.5 EUT OPERATION CONDITIONS

The EUT was programmed to be in continuously transmitting mode.

8.6 TEST RESULTS

Please refer to the APPENDIX G.

9. FREQUENCY STABILITY MEASUREMENT

9.1 LIMIT

FCC Part15, Subpart E (15.407)			
Section	Test Item	Limit	Frequency Range (MHz)
15.407(g)	Frequency Stability	Specified in the user's manual	5150-5250
			5725-5850

9.2 TEST PROCEDURE

- a. The EUT was directly connected to the spectrum analyzer and antenna output port as show in the block diagram below.
- b. Spectrum Setting:

Spectrum Parameter	Setting
Attenuation	Auto
Span Frequency	Entire absence of modulation emissions bandwidth
RBW	10 kHz
VBW	10 kHz
Sweep Time	Auto

- c. The test extreme voltage is to change the primary supply voltage from 85 to 115 percent of the nominal value.
- d. User manual temperature is 0°C~40°C.

9.3 DEVIATION FROM STANDARD

No deviation.

9.4 TEST SETUP

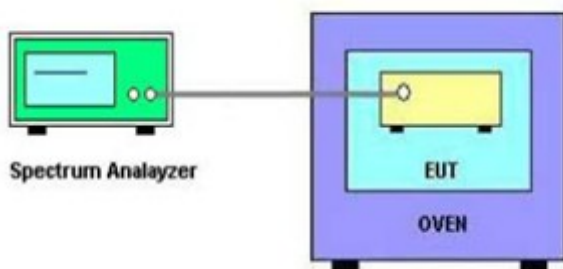

9.5 EUT OPERATION CONDITIONS

The EUT was programmed to be in continuously transmitting mode.

9.6 TEST RESULTS

Please refer to the APPENDIX H.

10. MEASUREMENT INSTRUMENTS LIST

AC Power Line Conducted Emissions

Item	Kind of Equipment	Manufacturer	Type No.	Serial No.	Calibrated until
1	EMI Test Receiver	R&S	ESCI	100382	Mar. 10, 2020
2	LISN	EMCO	3816/2	52765	Mar. 10, 2020
3	50ohm Terminator	SHX	TF5-3	15041305	Mar. 10, 2020
4	Artificial-Mains Network	Schwarzbeck	NSLK 8127	8127685	Mar. 10, 2020
5	TRANSIENT LIMITER	EM	EM-7600	772	Mar. 10, 2020
6	Measurement Software	Farad	EZ-EMC Ver.NB-03A1-01	N/A	N/A
7	Cable	N/A	RG223	12m	Mar. 12, 2020

Radiated Emissions - 9 kHz to 30 MHz

Item	Kind of Equipment	Manufacturer	Type No.	Serial No.	Calibrated until
1	Loop Antenna	EM	EM-6876-1	230	Jan. 15, 2020
2	Cable	N/A	RG 213/U	C-102	May 31, 2020
3	EMI Test Receiver	R&S	ESCI	100895	Mar. 10, 2020
4	Measurement Software	Farad	EZ-EMC Ver.NB-03A1-01	N/A	N/A

Radiated Emissions - 30 MHz to 1 GHz

Item	Kind of Equipment	Manufacturer	Type No.	Serial No.	Calibrated until
1	Antenna	Schwarzbeck	VULB9160	9160-3232	Mar. 09, 2020
2*	Amplifier	HP	8447D	2944A09673	Aug. 11, 2021
3	Receiver	Agilent	N9038A	MY52130039	Aug. 03, 2020
4	Cable	emci	LMR-400(30MHz-1GHz)(8m+5m)	N/A	May 24, 2020
5	Controller	CT	SC100	N/A	N/A
6	Controller	MF	MF-7802	MF780208416	N/A
7	Measurement Software	Farad	EZ-EMC Ver.NB-03A1-01	N/A	N/A

Radiated Emissions - Above 1 GHz

Item	Kind of Equipment	Manufacturer	Type No.	Serial No.	Calibrated until
1	Double Ridged Guide Antenna	ETS	3115	75789	Mar. 09, 2020
2	Broad-Band Horn Antenna	Schwarzbeck	BBHA 9170	9170319	Jun. 23, 2020
3	Amplifier	Agilent	8449B	3008A02333	Mar. 10, 2020
4	Microwave Preamp With Adaptor	EMC INSTRUMENT	EMC2654045	980039 & HA01	Mar. 10, 2020
5	Receiver	Agilent	N9038A	MY52130039	Aug. 03, 2020
6	Controller	CT	SC100	N/A	N/A
7	Controller	MF	MF-7802	MF780208416	N/A
8	Cable	mitron	B10-01-01-12M	18072744	Jun. 29, 2020
9	Measurement Software	Farad	EZ-EMC Ver.NB-03A1-01	N/A	N/A

Bandwidth & Power Spectral Density					
Item	Kind of Equipment	Manufacturer	Type No.	Serial No.	Calibrated until
1	Spectrum Analyzer	R&S	FSP40	100185	Aug. 03, 2020

Maximum Output Power					
Item	Kind of Equipment	Manufacturer	Type No.	Serial No.	Calibrated until
1	Peak Power Analyzer	Keysight	8990B	MY51000506	Aug. 03, 2020
2	Wideband power sensor	Keysight	N1923A	MY58310004	Aug. 03, 2020

Frequency Stability					
Item	Kind of Equipment	Manufacturer	Type No.	Serial No.	Calibrated until
1	Spectrum Analyzer	R&S	FSP40	100185	Aug. 03, 2020
2	Precision Oven Tester	Bell	BTH-50C	20170306001	Mar. 10, 2020

Remark: "N/A" denotes no model name, serial no. or calibration specified.
 "*" calibration period of equipment list is three year.
 Except * item, all calibration period of equipment list is one year.

11. EUT TEST PHOTOS

AC Power Line Conducted Emissions Test Photos



Radiated Emissions Test Photos

9 kHz to 30 MHz



Radiated Emissions Test Photos

30 MHz to 1 GHz

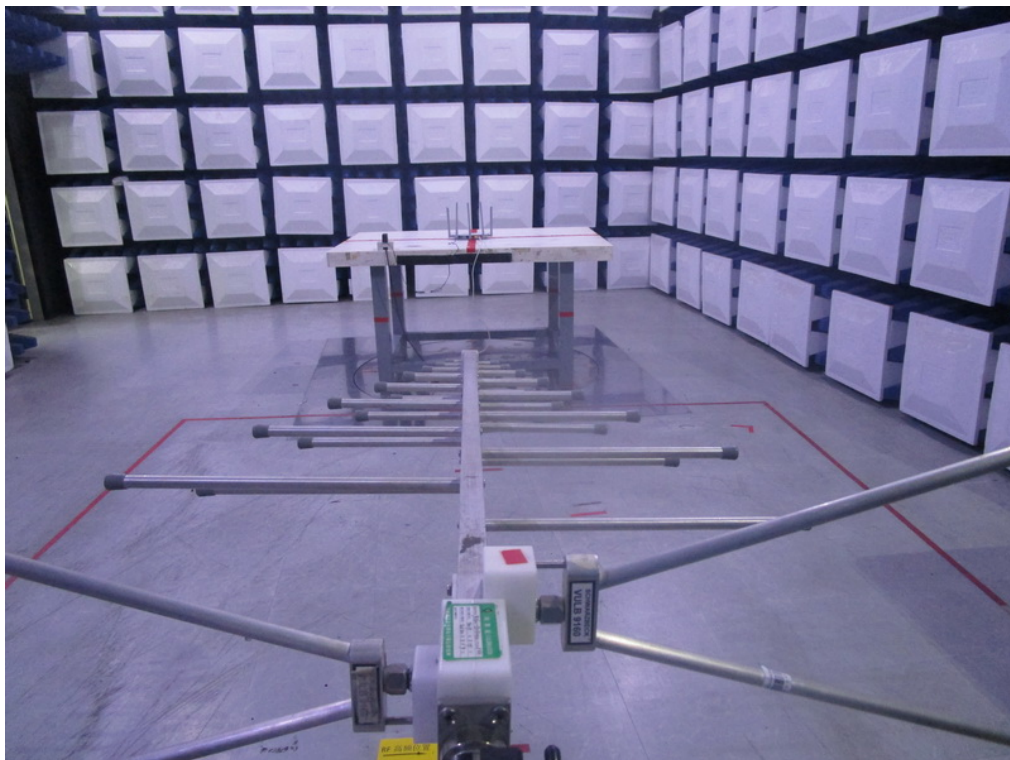

Radiated Emissions Test Photos
Above 1 GHz

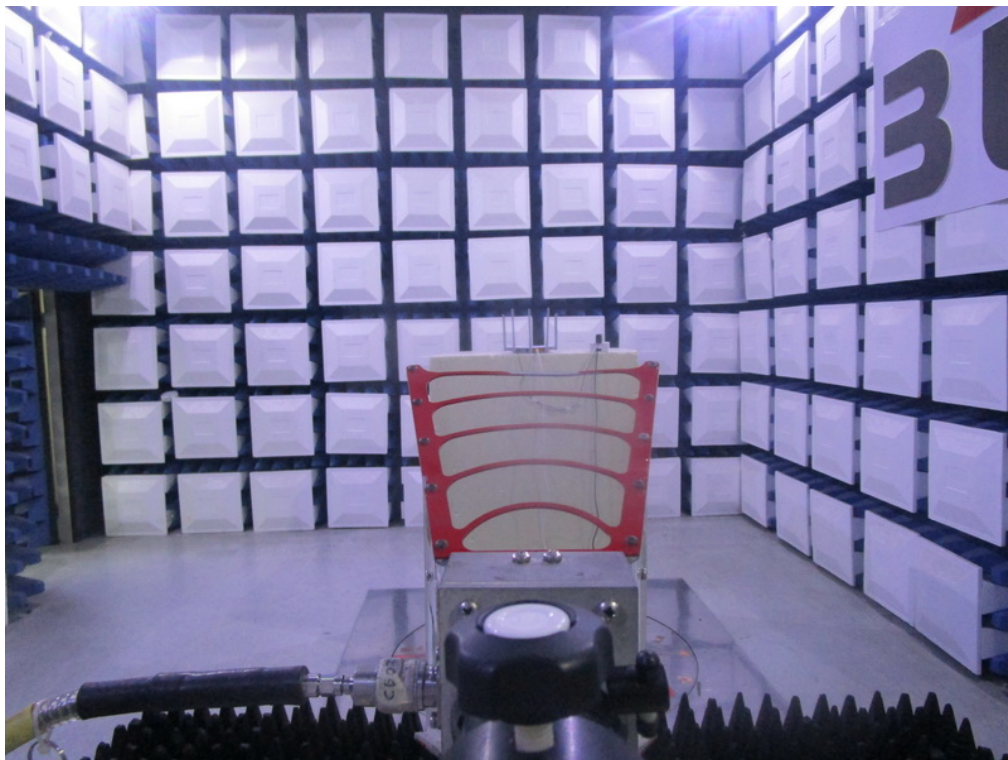
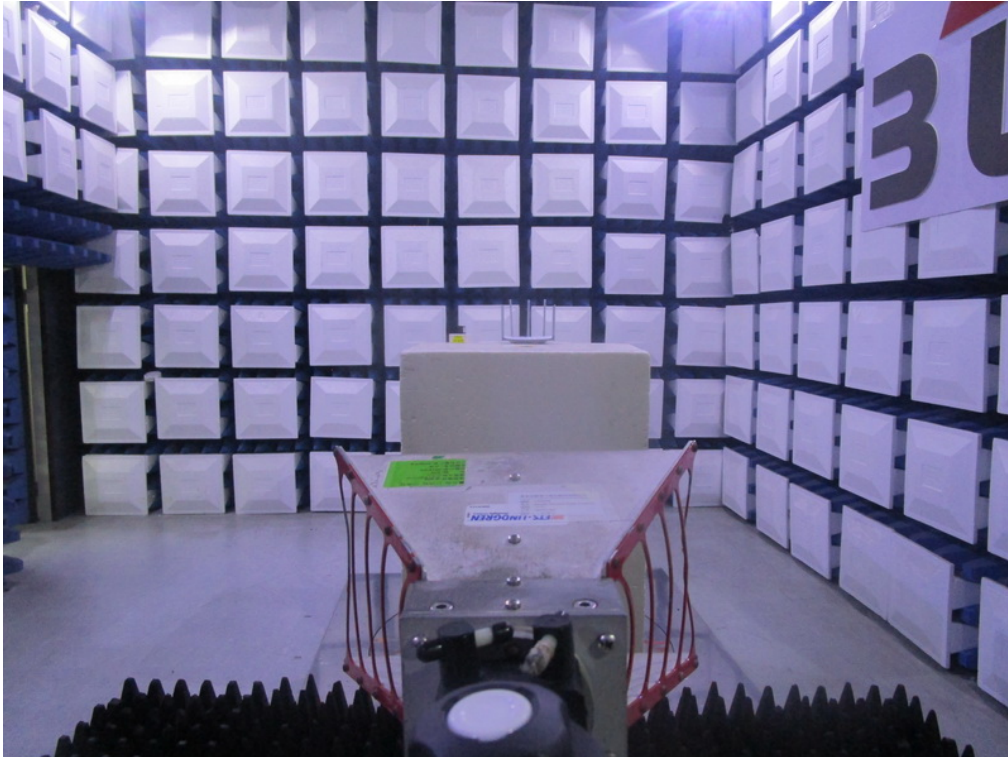

APPENDIX A - AC POWER LINE CONDUCTED EMISSIONS

Test Mode: TX N(HT40) Mode Channel 151

Line

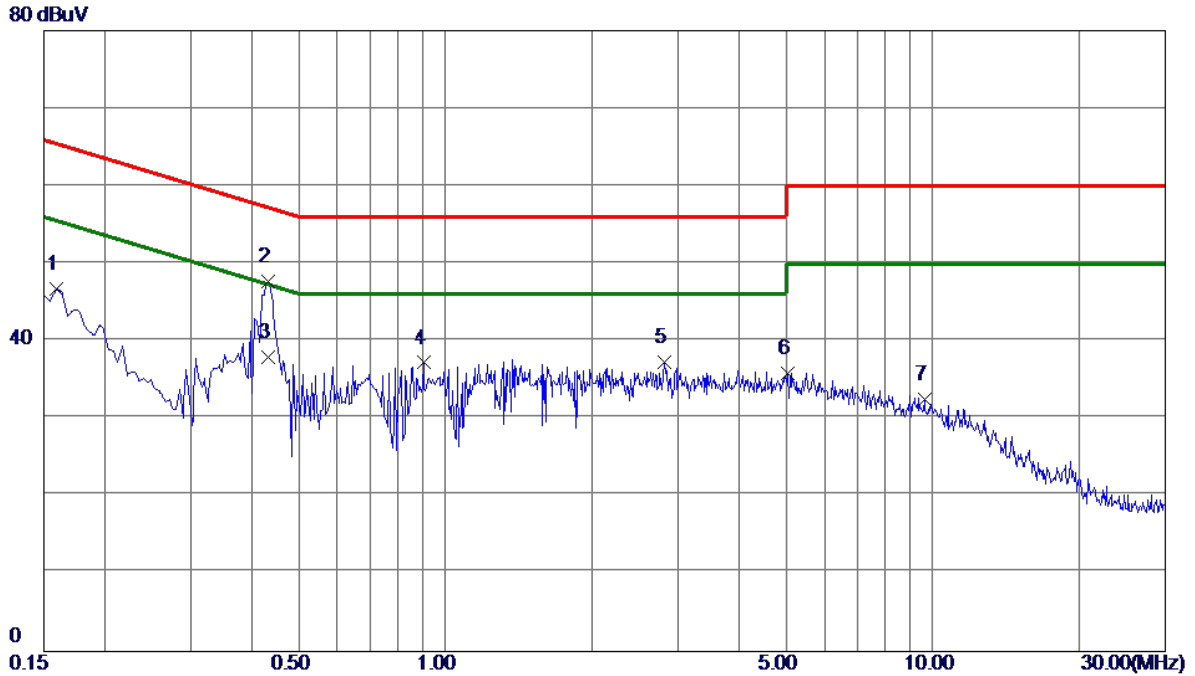

No.	Freq. MHz	Reading Level dBuV	Correct Factor dB	Measurement dBuV	Limit dBuV	Margin dB	Detector	Comment
1	0.1590	36.97	9.82	46.79	65.52	-18.73	Peak	
2	0.4334	37.82	9.87	47.69	57.19	-9.50	Peak	
3 *	0.4335	28.12	9.87	37.99	47.19	-9.20	AVG	
4	0.9015	27.29	9.91	37.20	56.00	-18.80	Peak	
5	2.8184	27.19	10.05	37.24	56.00	-18.76	Peak	
6	5.0415	25.64	10.19	35.83	60.00	-24.17	Peak	
7	9.6360	21.94	10.47	32.41	60.00	-27.59	Peak	

REMARKS:

- (1) Measurement Value = Reading Level + Correct Factor.
- (2) Margin Level = Measurement Value - Limit Value.
- (3) The test result has included the cable loss.

Test Mode: TX N(HT40) Mode Channel 151

Neutral

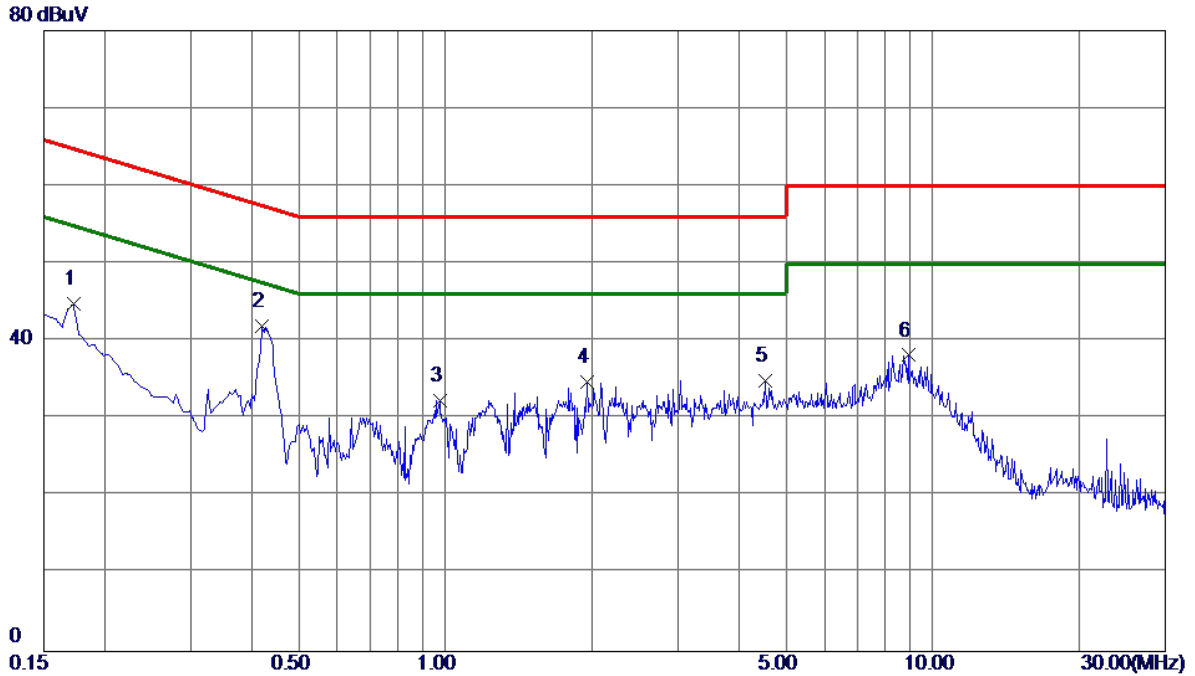

No.	Freq. MHz	Reading Level dBuV	Correct Factor dB	Measure ment dBuV	Limit dBuV	Margin dB	Detector	Comment
1	0.1725	34.88	9.91	44.79	64.84	-20.05	Peak	
2 *	0.4200	31.94	10.01	41.95	57.45	-15.50	Peak	
3	0.9735	22.23	10.11	32.34	56.00	-23.66	Peak	
4	1.9500	24.50	10.19	34.69	56.00	-21.31	Peak	
5	4.5375	24.46	10.36	34.82	56.00	-21.18	Peak	
6	8.9070	27.47	10.69	38.16	60.00	-21.84	Peak	

Note: The test result has included the cable loss.

REMARKS:

- (1) Measurement Value = Reading Level + Correct Factor.
- (2) Margin Level = Measurement Value - Limit Value.
- (3) The test result has included the cable loss.

APPENDIX B - RADIATED EMISSION - 9 KHZ TO 30 MHZ

Test Mode: TX N(HT40) Mode Channel 151

Ant 0°

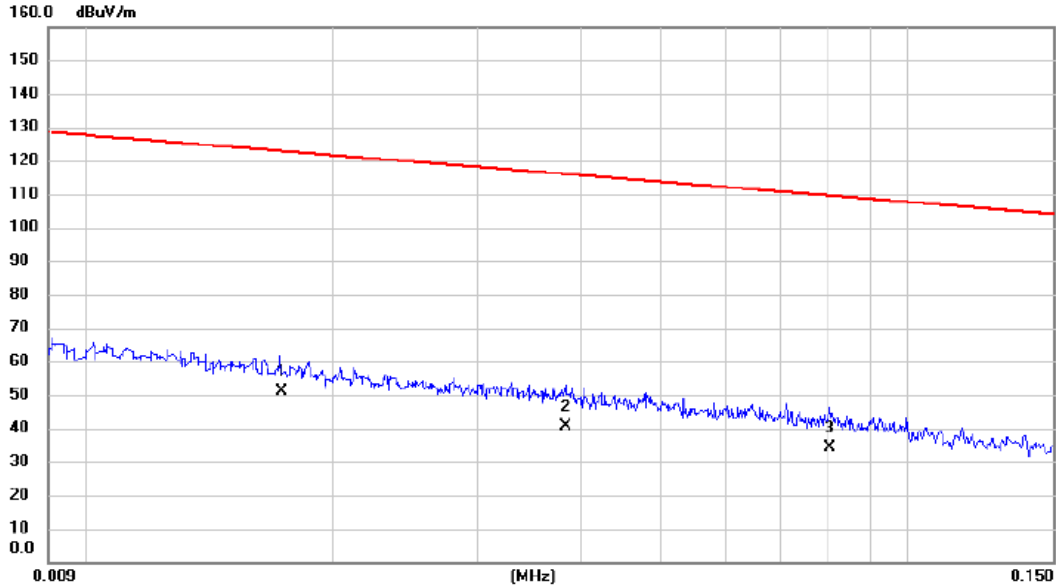

No.	Mk.	Freq. MHz	Reading Level dBuV	Correct Factor dB	Measure- ment dBuV/m	Limit dBuV/m	Margin dB	Detector	Comment
1	*	0.017	36.20	14.63	50.83	122.84	-72.01	AVG	
2		0.038	26.80	13.89	40.69	115.94	-75.25	AVG	
3		0.080	20.70	13.54	34.24	109.51	-75.27	AVG	

REMARKS:

- (1) Measurement Value = Reading Level + Correct Factor.
- (2) Margin Level = Measurement Value - Limit Value.

Test Mode: TX N(HT40) Mode Channel 151

Ant 0°

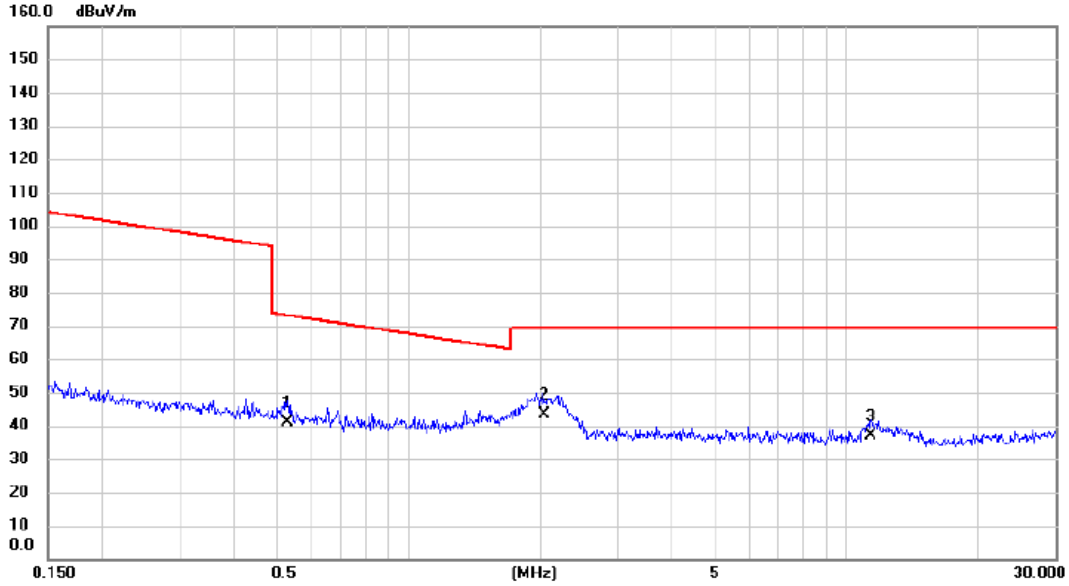

No.	Mk.	Freq. MHz	Reading Level dBuV	Correct Factor dB	Measure- ment dBuV/m	Limit dBuV/m	Margin dB	Detector	Comment
1		0.529	27.90	13.00	40.90	73.13	-32.23	QP	
2	*	2.033	31.60	11.80	43.40	69.54	-26.14	QP	
3		11.377	25.50	11.61	37.11	69.54	-32.43	QP	

REMARKS:

- (1) Measurement Value = Reading Level + Correct Factor.
- (2) Margin Level = Measurement Value - Limit Value.

Test Mode: TX N(HT40) Mode Channel 151

Ant 90°

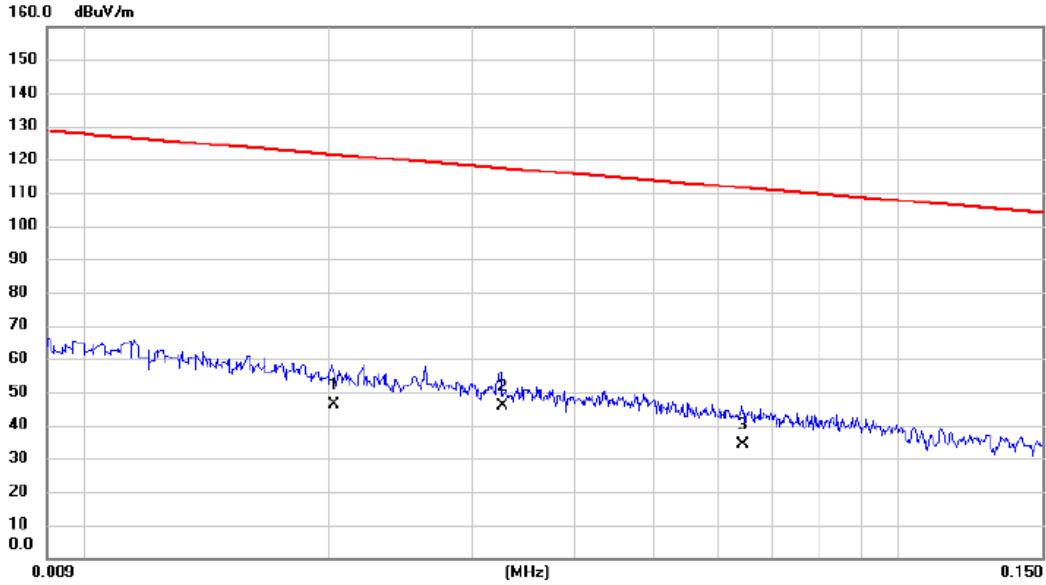

No.	Mk.	Freq. MHz	Reading Level dBuV	Correct Factor dB	Measure- ment dBuV/m	Limit dBuV/m	Margin dB	Detector	Comment
1		0.020	32.30	13.82	46.12	121.45	-75.33	AVG	
2	*	0.033	32.10	13.87	45.97	117.34	-71.37	AVG	
3		0.064	20.60	13.70	34.30	111.44	-77.14	AVG	

REMARKS:

- (1) Measurement Value = Reading Level + Correct Factor.
- (2) Margin Level = Measurement Value - Limit Value.

Test Mode: TX N(HT40) Mode Channel 151

Ant 90°

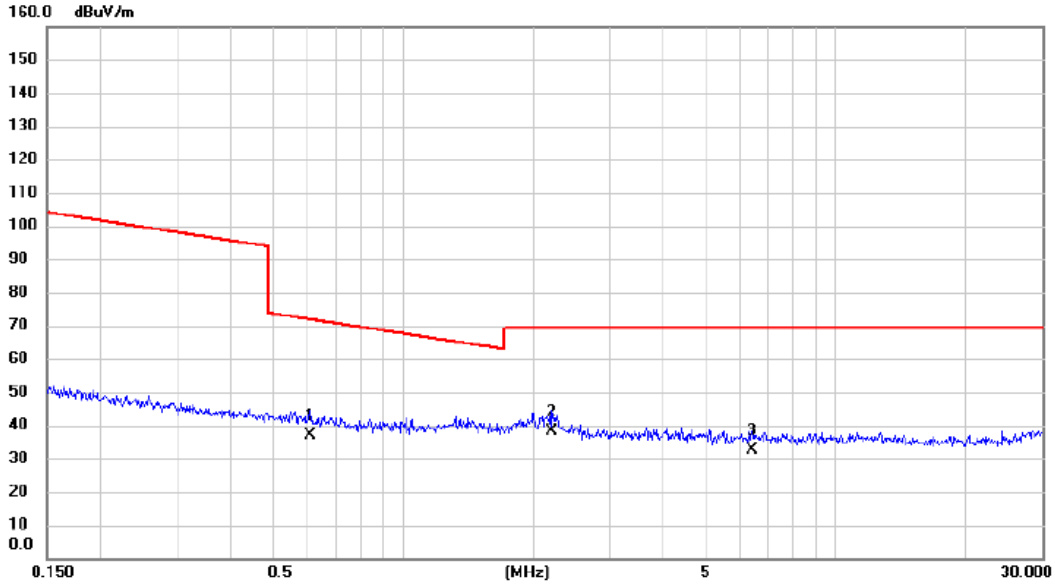

No. Mk.	Freq. MHz	Reading Level dBuV	Correct Factor dB	Measure- ment dBuV/m	Limit dBuV/m	Margin dB	Detector	Comment
1	0.611	24.30	12.85	37.15	71.89	-34.74	QP	
2 *	2.201	26.70	11.70	38.40	69.54	-31.14	QP	
3	6.420	21.60	11.08	32.68	69.54	-36.86	QP	

REMARKS:

- (1) Measurement Value = Reading Level + Correct Factor.
- (2) Margin Level = Measurement Value - Limit Value.

APPENDIX C - RADIATED EMISSION - 30 MHZ TO 1 GHZ

Test Mode: TX N(HT40) Mode Channel 151

Vertical

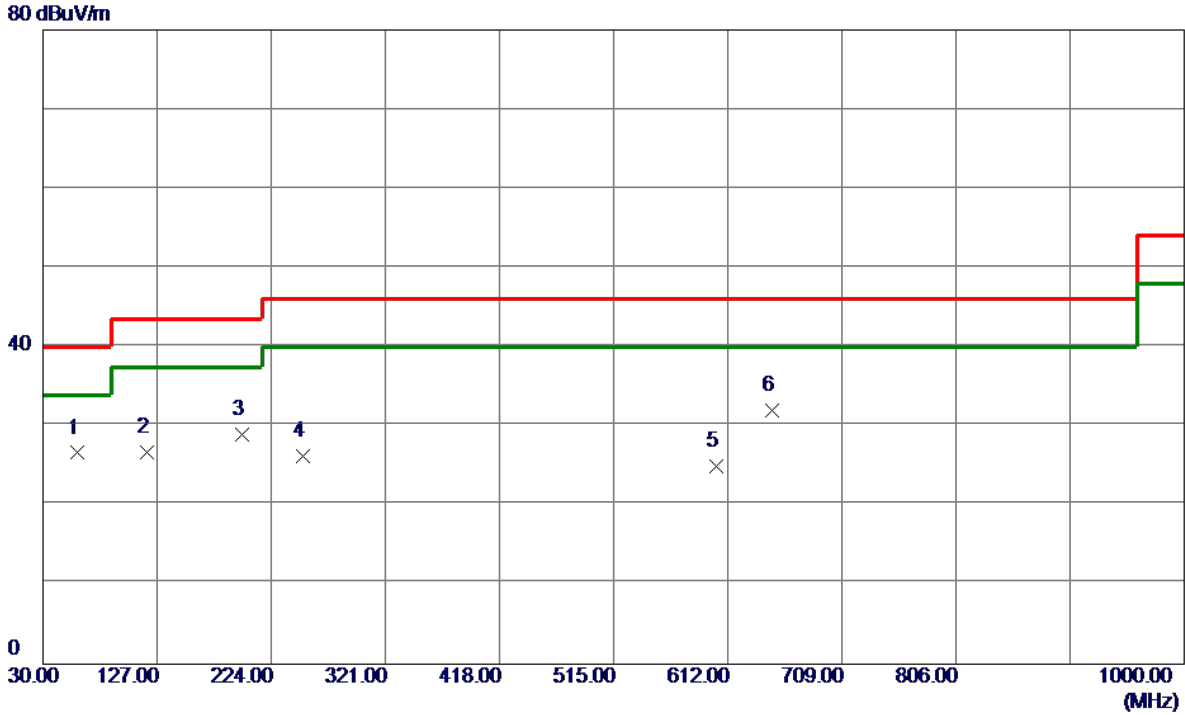

No.	Freq. MHz	Reading Level dBuV/m	Correct Factor dB	Measure ment dBuV/m	Limit dBuV/m	Margin dB	Detector	Comment
1 *	59.5850	41.44	-14.80	26.64	40.00	-13.36	Peak	
2	118.7550	39.91	-13.22	26.69	43.50	-16.81	Peak	
3	199.2650	44.09	-15.13	28.96	43.50	-14.54	Peak	
4	250.6750	39.88	-13.65	26.23	46.00	-19.77	Peak	
5	602.3000	30.71	-5.69	25.02	46.00	-20.98	Peak	
6	649.8300	36.66	-4.68	31.98	46.00	-14.02	Peak	

REMARKS:

- (1) Measurement Value = Reading Level + Correct Factor.
- (2) Margin Level = Measurement Value - Limit Value.

Test Mode: TX N(HT40) Mode Channel 151

Horizontal

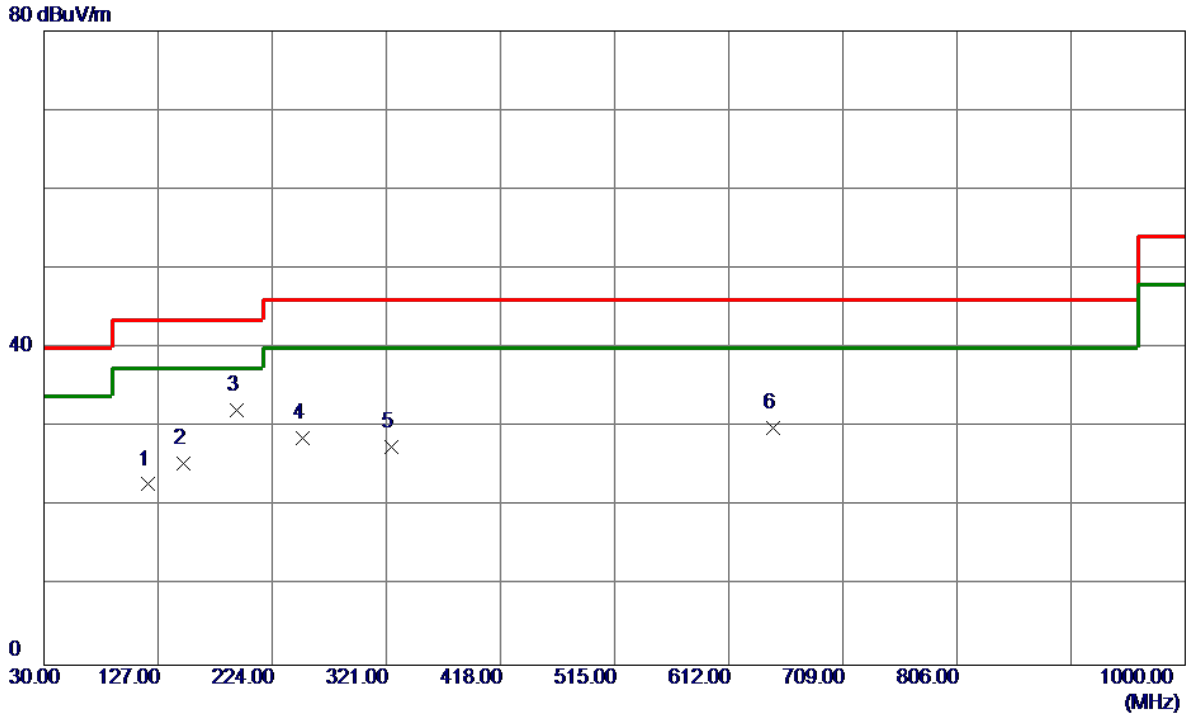

No.	Freq. MHz	Reading Level dBuV/m	Correct Factor dB	Measure ment dBuV/m	Limit dBuV/m	Margin dB	Detector	Comment
1	118.2700	36.09	-13.29	22.80	43.50	-20.70	Peak	
2	148.3400	37.88	-12.38	25.50	43.50	-18.00	Peak	
3 *	193.4450	46.81	-14.71	32.10	43.50	-11.40	Peak	
4	249.7050	42.42	-13.73	28.69	46.00	-17.31	Peak	
5	324.8800	38.56	-11.08	27.48	46.00	-18.52	Peak	
6	649.8300	34.55	-4.68	29.87	46.00	-16.13	Peak	

REMARKS:

- (1) Measurement Value = Reading Level + Correct Factor.
- (2) Margin Level = Measurement Value - Limit Value.

APPENDIX D - RADIATED EMISSION - ABOVE 1000 MHZ

Non Beamforming

Orthogonal Axis	X
Test Mode	UNII-1_TX A Mode 5180 MHz

Vertical

130 dBuV/m

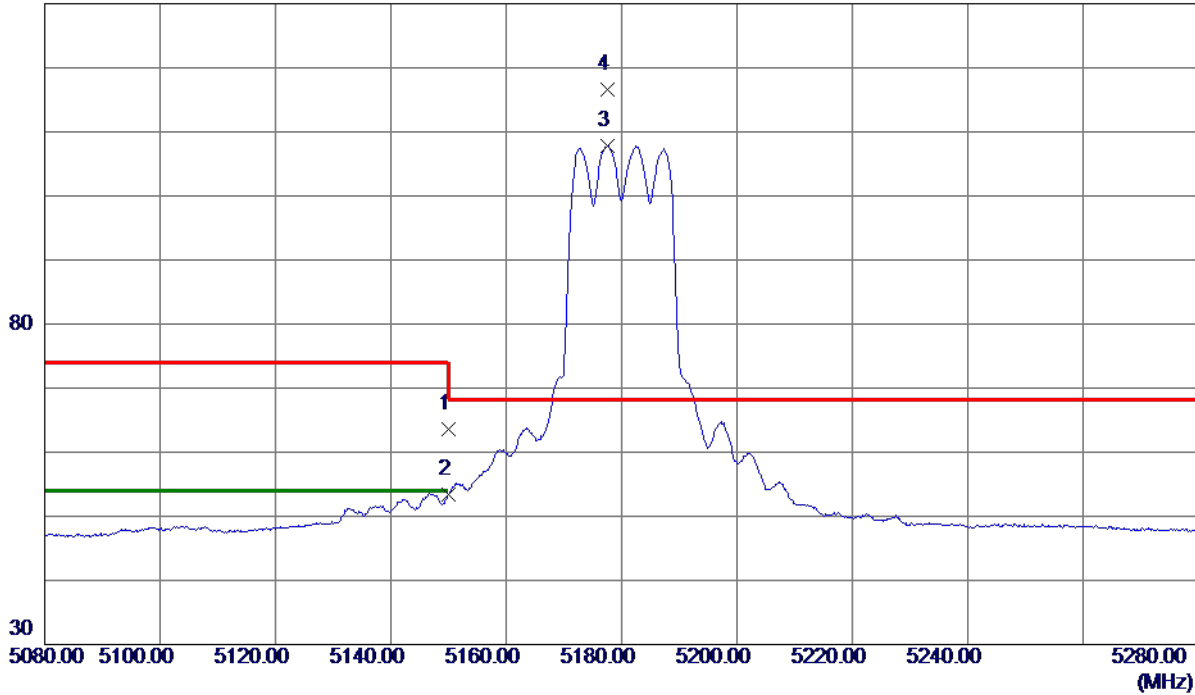

No.	Freq. MHz	Reading Level dBuV/m	Correct Factor dB	Measure ment dBuV/m	Limit dBuV/m	Margin dB	Detector	Comment
1	5150.0000	48.62	15.02	63.64	74.00	-10.36	Peak	
2	5150.0000	38.47	15.02	53.49	54.00	-0.51	AVG	
3	5177.5000	92.81	15.03	107.84	999.00	-891.16	AVG	No Limit
4 *	5177.6000	101.52	15.03	116.55	68.30	48.25	Peak	No Limit

REMARKS:

- (1) Measurement Value = Reading Level + Correct Factor.
- (2) Margin Level = Measurement Value - Limit Value.

Orthogonal Axis	X
Test Mode	UNII-1_TX A Mode 5180 MHz

Vertical

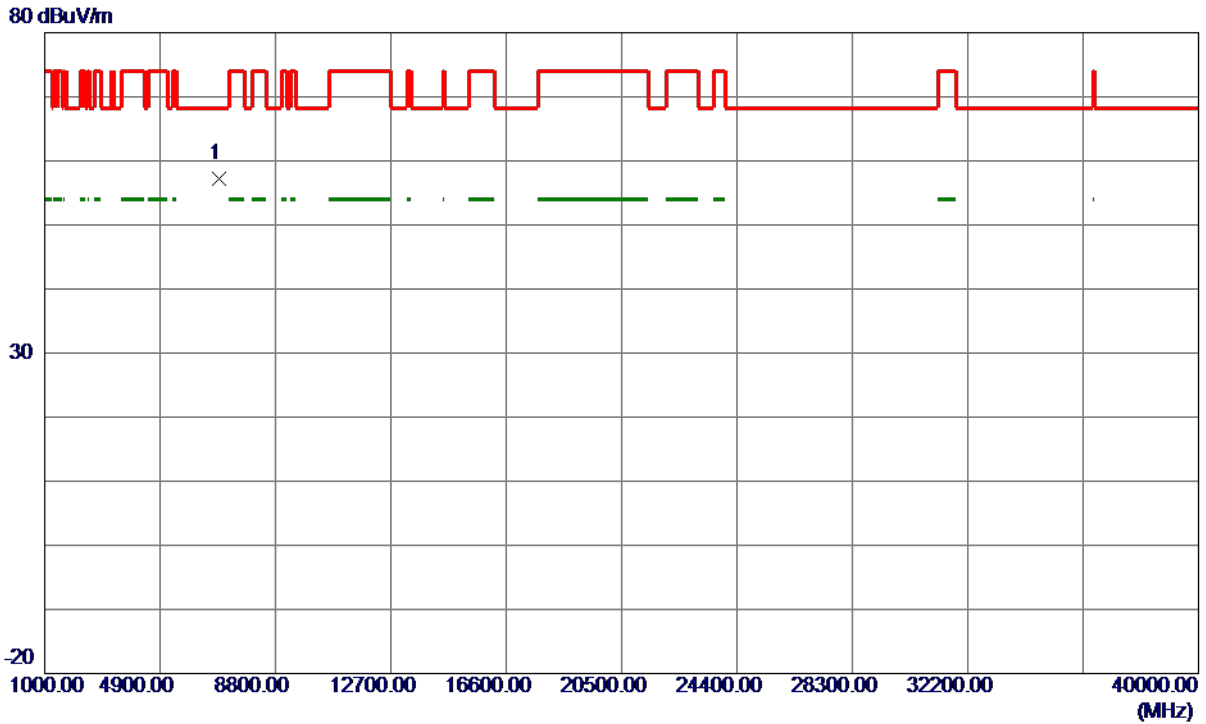

No.	Freq. MHz	Reading Level dBuV/m	Correct Factor dB	Measure ment dBuV/m	Limit dBuV/m	Margin dB	Detector	Comment
1 *	6906.8290	49.73	7.44	57.17	68.30	-11.13	Peak	

REMARKS:

- (1) Measurement Value = Reading Level + Correct Factor.
- (2) Margin Level = Measurement Value - Limit Value.

Orthogonal Axis	X
Test Mode	UNII-1_TX A Mode 5180 MHz

Horizontal

130 dBuV/m

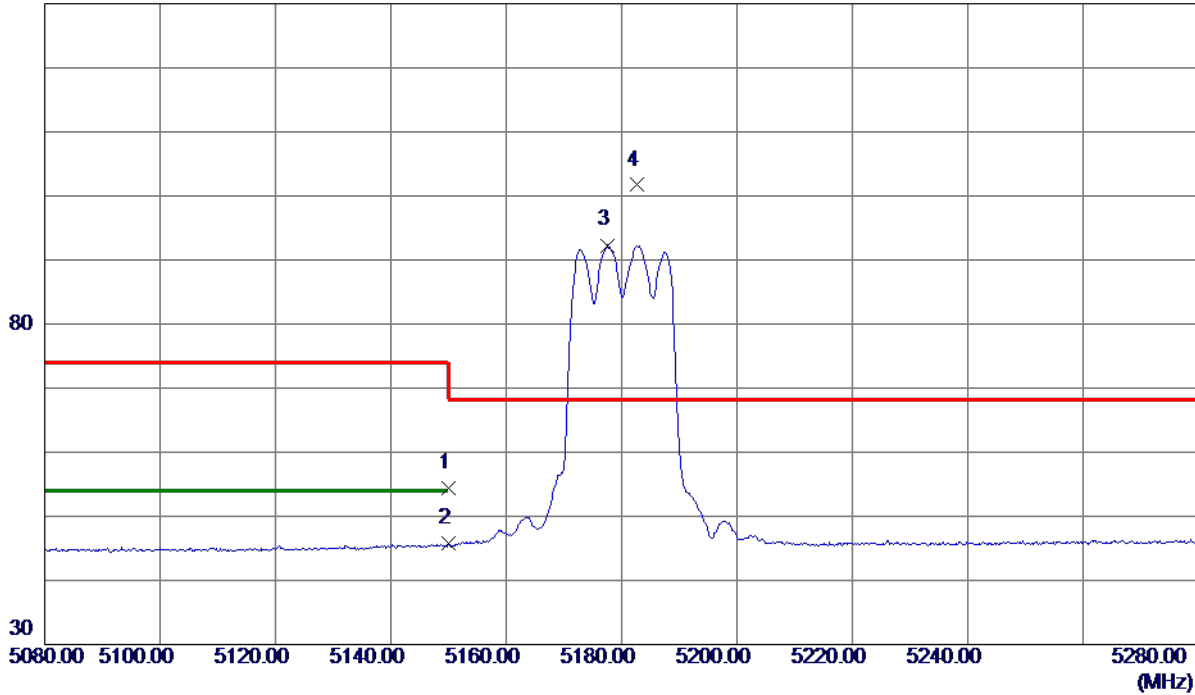

No.	Freq. MHz	Reading Level dBuV/m	Correct Factor dB	Measure ment dBuV/m	Limit dBuV/m	Margin dB	Detector	Comment
1	5150.0000	39.29	15.02	54.31	74.00	-19.69	Peak	
2	5150.0000	30.83	15.02	45.85	54.00	-8.15	AVG	
3	5177.6000	77.27	15.03	92.30	999.00	-906.70	AVG	No Limit
4 *	5182.7000	86.66	15.04	101.70	68.30	33.40	Peak	No Limit

REMARKS:

- (1) Measurement Value = Reading Level + Correct Factor.
- (2) Margin Level = Measurement Value - Limit Value.

Orthogonal Axis	X
Test Mode	UNII-1_TX A Mode 5180 MHz

Horizontal

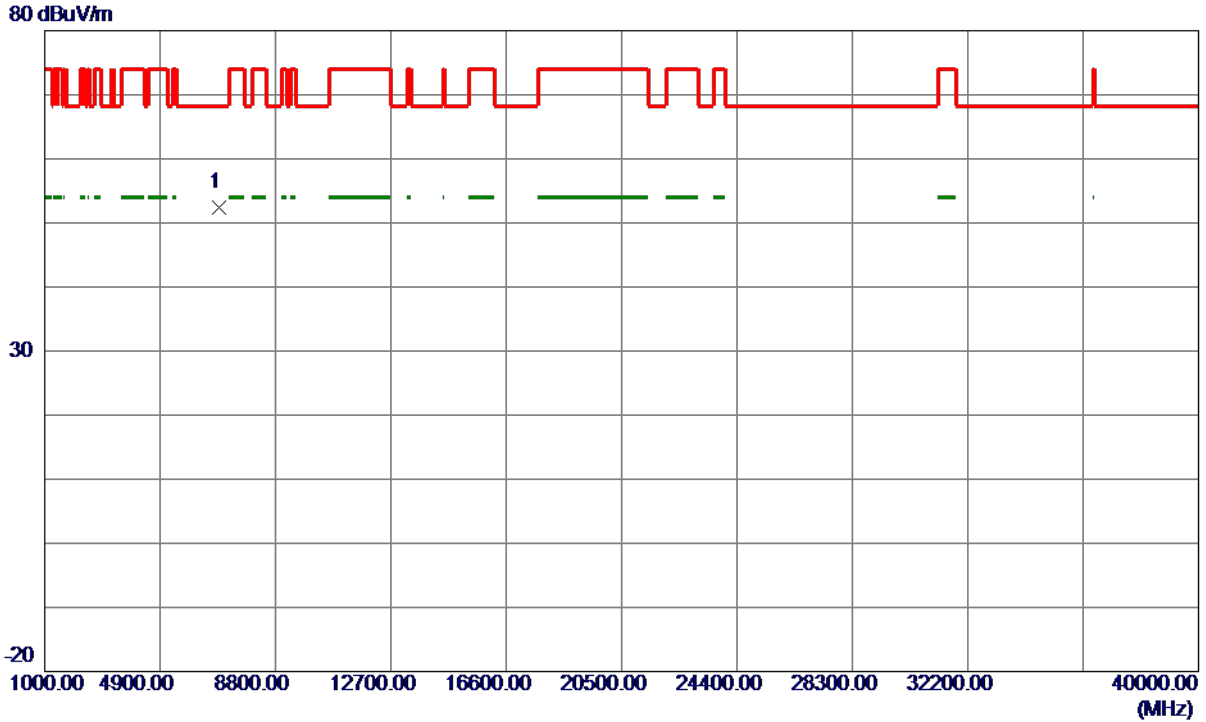

No.	Freq. MHz	Reading Level dBuV/m	Correct Factor dB	Measure ment dBuV/m	Limit dBuV/m	Margin dB	Detector	Comment
1 *	6906.7310	45.00	7.44	52.44	68.30	-15.86	Peak	

REMARKS:

- (1) Measurement Value = Reading Level + Correct Factor.
- (2) Margin Level = Measurement Value - Limit Value.

Orthogonal Axis	X
Test Mode	UNII-1_TX A Mode 5200 MHz

Vertical

130 dBuV/m

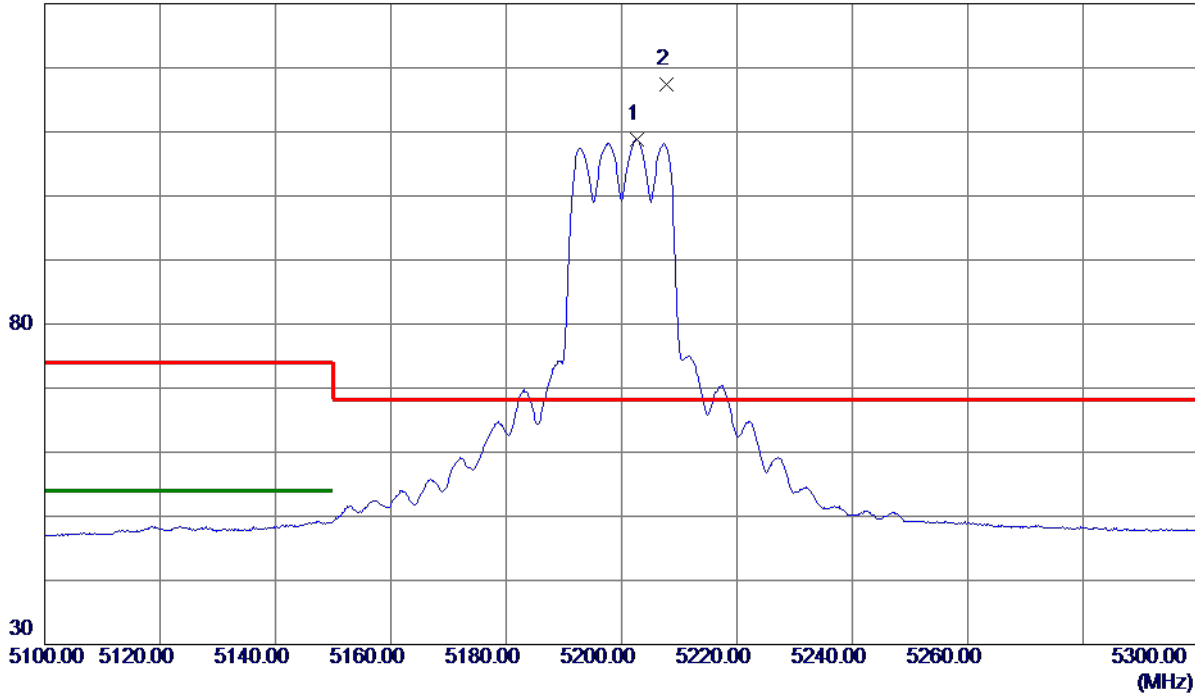

No.	Freq. MHz	Reading Level dBuV/m	Correct Factor dB	Measure ment dBuV/m	Limit dBuV/m	Margin dB	Detector	Comment
1	5202.7000	93.78	15.05	108.83	999.00	-890.17	AVG	No Limit
2 *	5207.7000	102.33	15.06	117.39	68.30	49.09	Peak	No Limit

REMARKS:

- (1) Measurement Value = Reading Level + Correct Factor.
- (2) Margin Level = Measurement Value - Limit Value.

Orthogonal Axis	X
Test Mode	UNII-1_TX A Mode 5200 MHz

Vertical

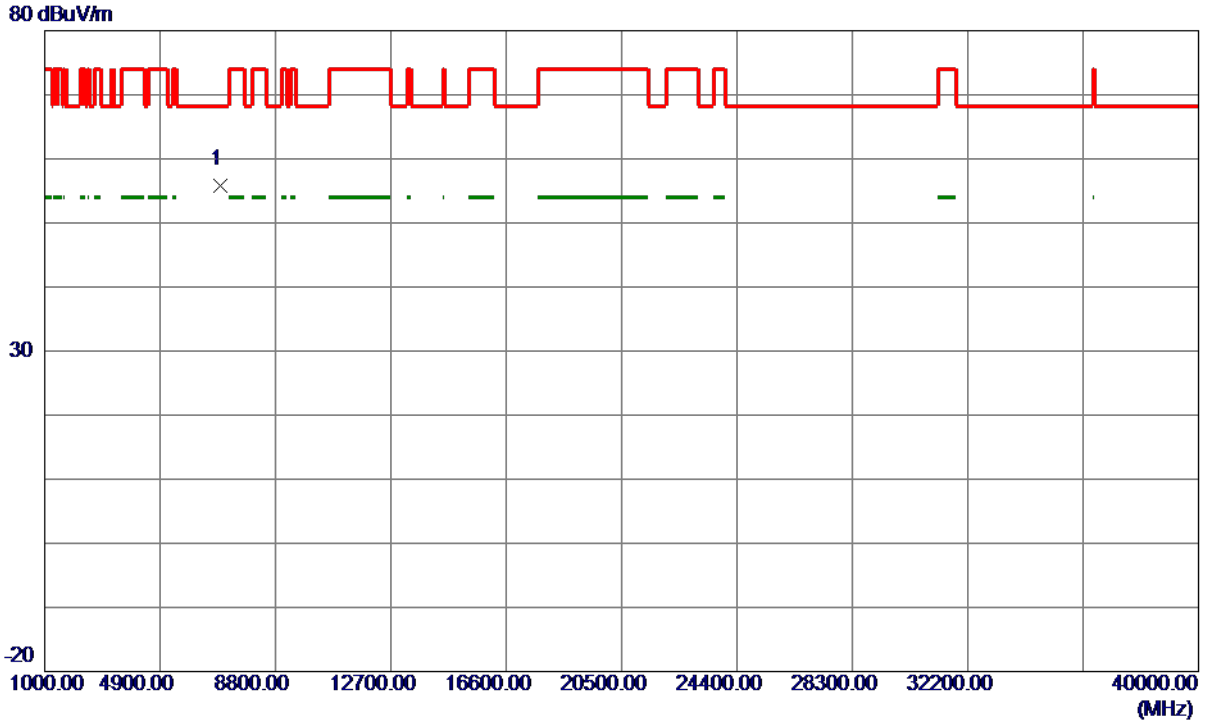

No.	Freq. MHz	Reading Level dBuV/m	Correct Factor dB	Measure ment dBuV/m	Limit dBuV/m	Margin dB	Detector	Comment
1 *	6933.3480	48.44	7.46	55.90	68.30	-12.40	Peak	

REMARKS:

- (1) Measurement Value = Reading Level + Correct Factor.
- (2) Margin Level = Measurement Value - Limit Value.

Orthogonal Axis	X
Test Mode	UNII-1_TX A Mode 5200 MHz

Horizontal

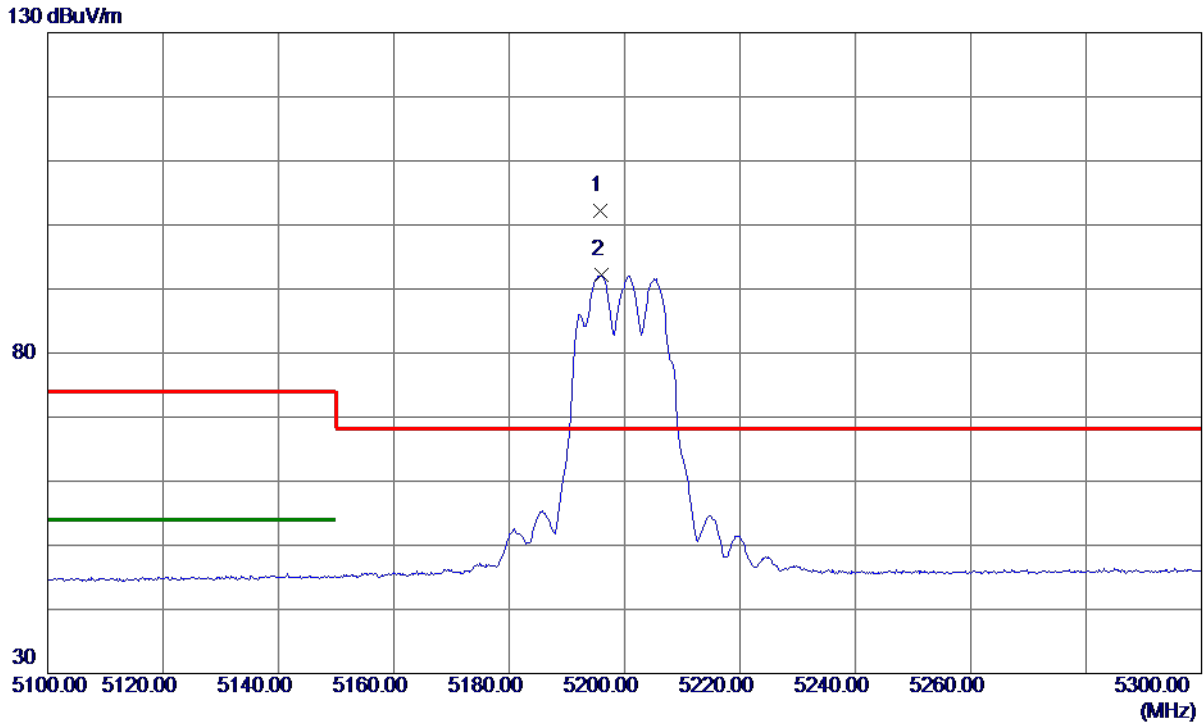

No.	Freq. MHz	Reading Level dBuV/m	Correct Factor dB	Measure ment dBuV/m	Limit dBuV/m	Margin dB	Detector	Comment
1 *	5195.7000	87.11	15.05	102.16	68.30	33.86	Peak	No Limit
2	5196.0000	77.13	15.05	92.18	999.00	-906.82	AVG	No Limit

REMARKS:

- (1) Measurement Value = Reading Level + Correct Factor.
- (2) Margin Level = Measurement Value - Limit Value.

Orthogonal Axis	X
Test Mode	UNII-1_TX A Mode 5200 MHz

Horizontal

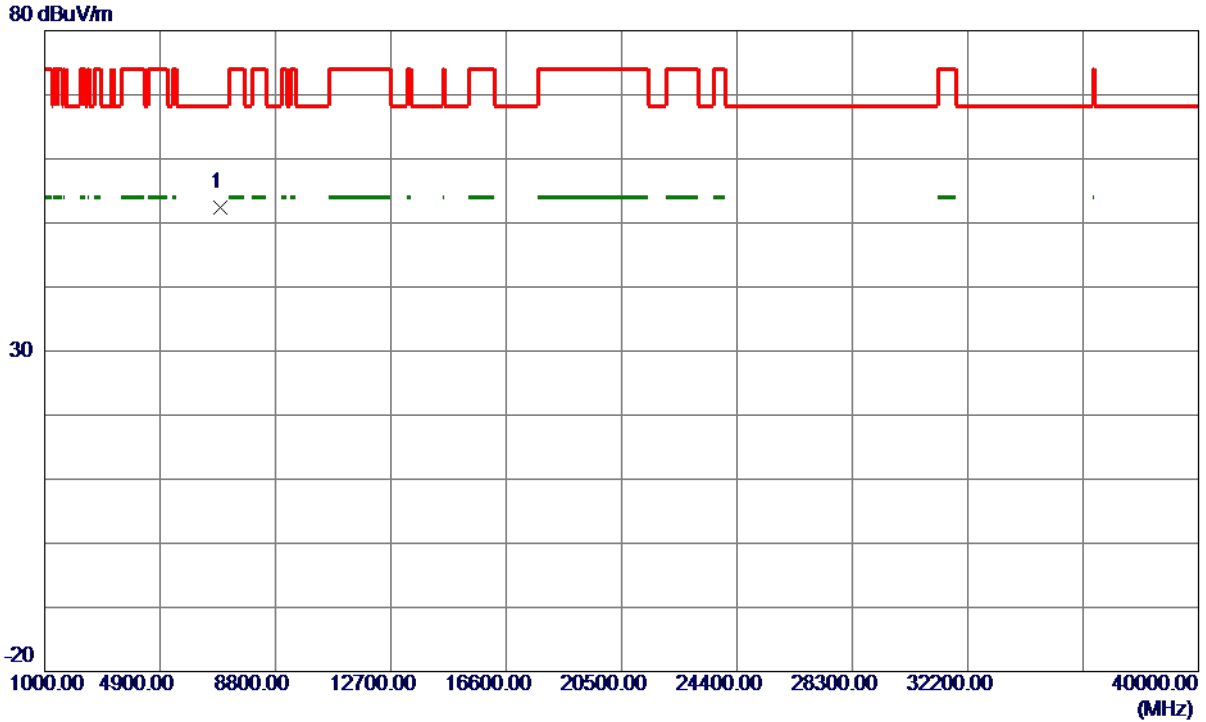

No.	Freq. MHz	Reading Level dBuV/m	Correct Factor dB	Measure ment dBuV/m	Limit dBuV/m	Margin dB	Detector	Comment
1 *	6933.4070	44.99	7.46	52.45	68.30	-15.85	Peak	

REMARKS:

- (1) Measurement Value = Reading Level + Correct Factor.
- (2) Margin Level = Measurement Value - Limit Value.

Orthogonal Axis	X
Test Mode	UNII-1_TX A Mode 5240 MHz

Vertical

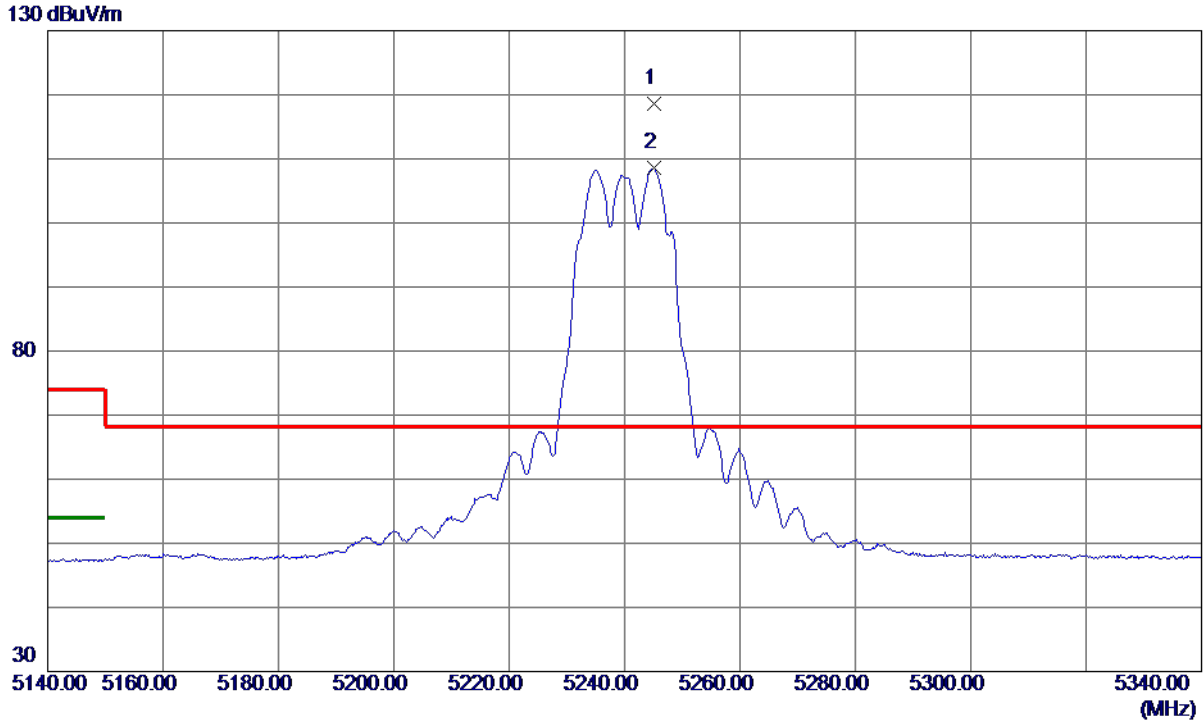

No.	Freq. MHz	Reading Level dBuV/m	Correct Factor dB	Measure ment dBuV/m	Limit dBuV/m	Margin dB	Detector	Comment
1 *	5245.1000	103.43	15.08	118.51	68.30	50.21	Peak	No Limit
2	5245.1000	93.47	15.08	108.55	999.00	-890.45	AVG	No Limit

REMARKS:

- (1) Measurement Value = Reading Level + Correct Factor.
- (2) Margin Level = Measurement Value - Limit Value.

Orthogonal Axis	X
Test Mode	UNII-1_TX A Mode 5240 MHz

Vertical

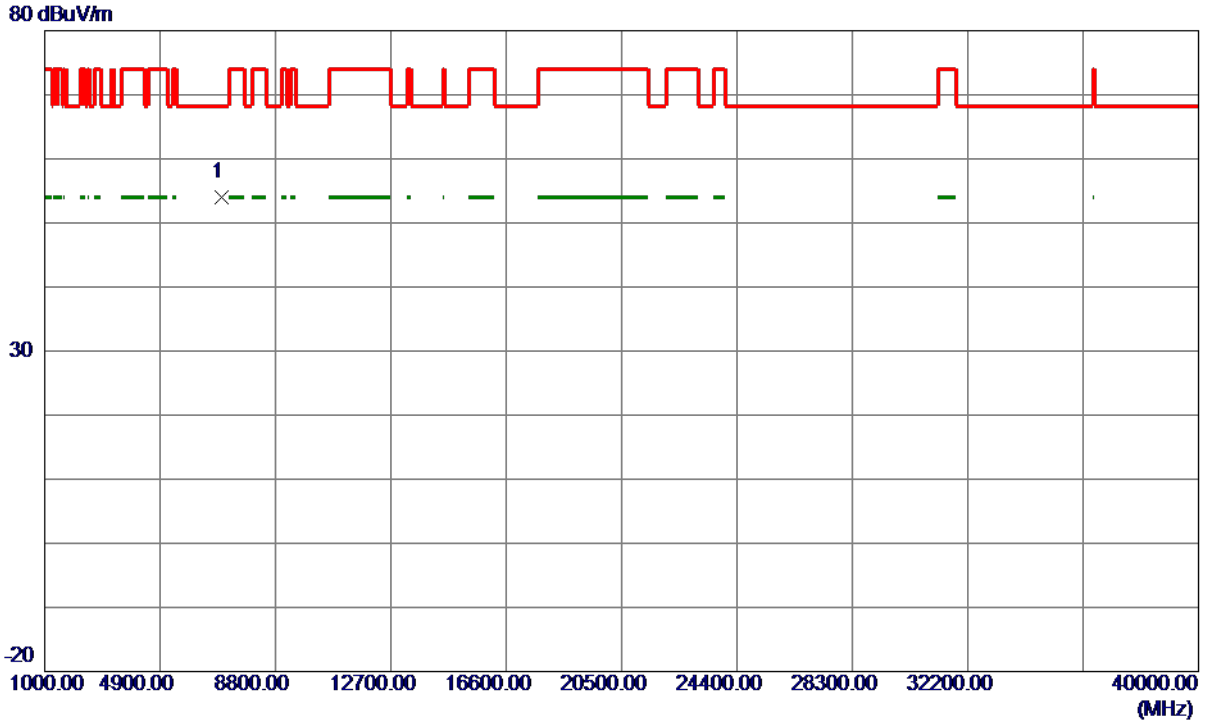

No.	Freq. MHz	Reading Level dBuV/m	Correct Factor dB	Measure ment dBuV/m	Limit dBuV/m	Margin dB	Detector	Comment
1 *	6986.7000	46.42	7.50	53.92	68.30	-14.38	Peak	

REMARKS:

- (1) Measurement Value = Reading Level + Correct Factor.
- (2) Margin Level = Measurement Value - Limit Value.

Orthogonal Axis	X
Test Mode	UNII-1_TX A Mode 5240 MHz

Horizontal

130 dBuV/m

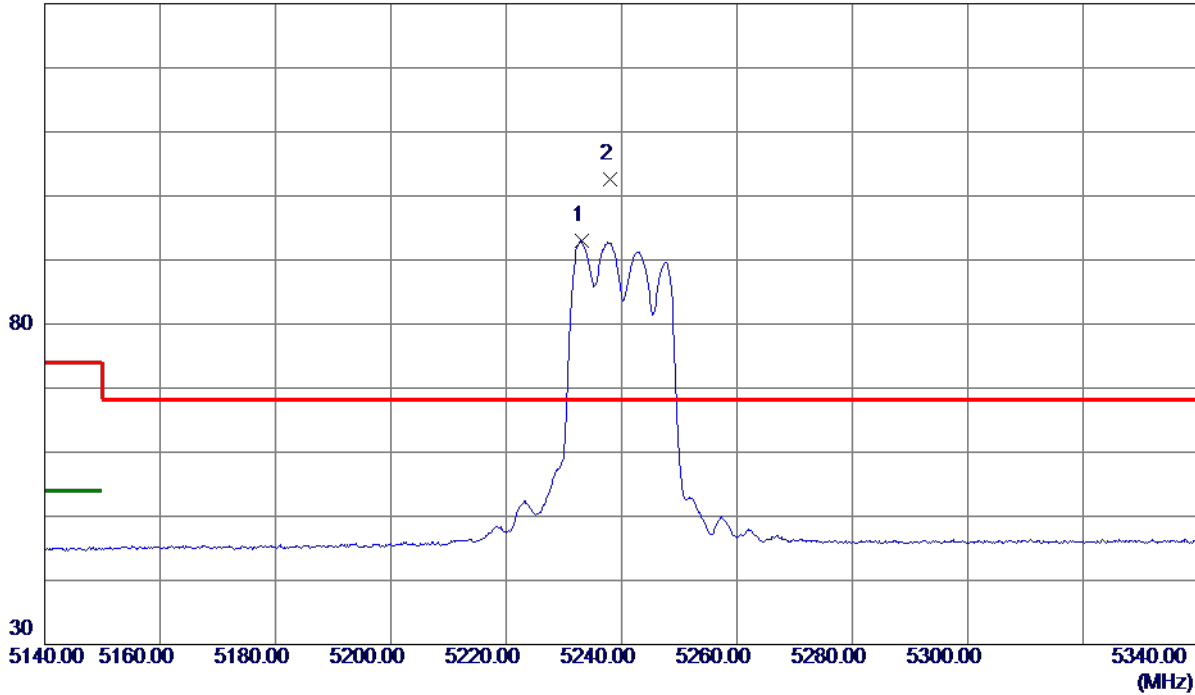

No.	Freq. MHz	Reading Level dBuV/m	Correct Factor dB	Measure ment dBuV/m	Limit dBuV/m	Margin dB	Detector	Comment
1	5233.1000	77.95	15.07	93.02	999.00	-905.98	AVG	No Limit
2 *	5237.9000	87.46	15.08	102.54	68.30	34.24	Peak	No Limit

REMARKS:

- (1) Measurement Value = Reading Level + Correct Factor.
- (2) Margin Level = Measurement Value - Limit Value.

Orthogonal Axis	X
Test Mode	UNII-1_TX A Mode 5240 MHz

Horizontal

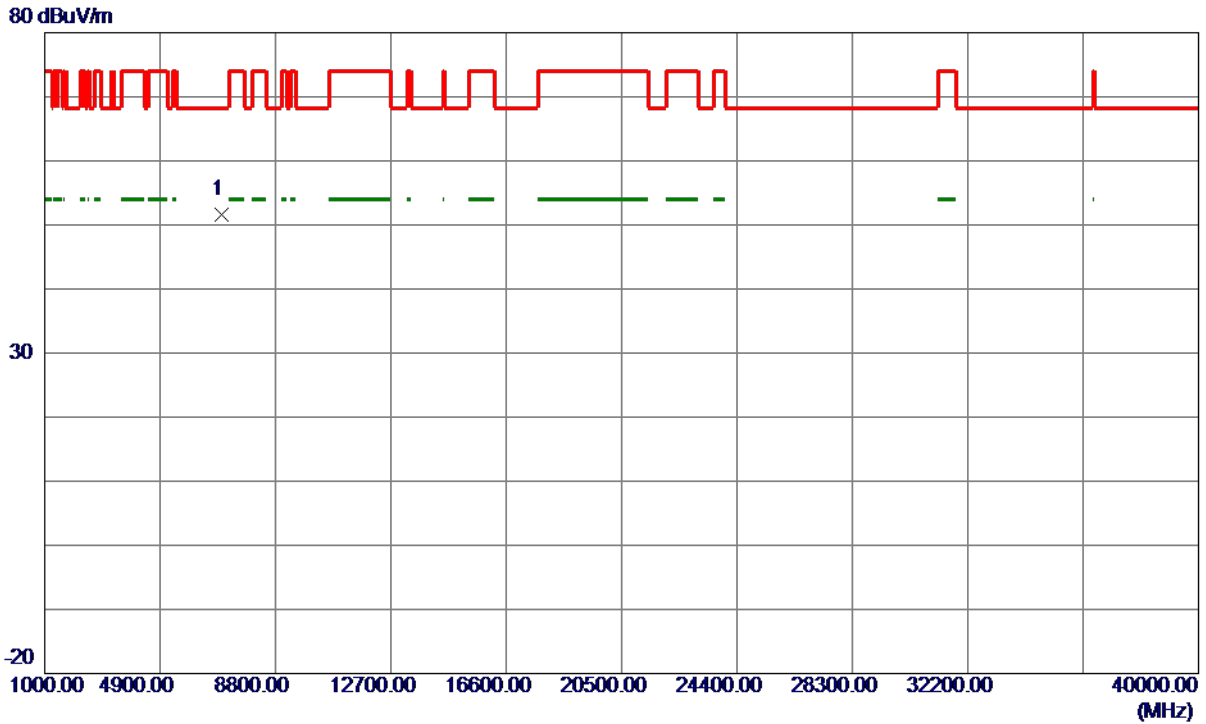

No.	Freq. MHz	Reading Level dBuV/m	Correct Factor dB	Measure ment dBuV/m	Limit dBuV/m	Margin dB	Detector	Comment
1 *	6986.7860	44.19	7.50	51.69	68.30	-16.61	Peak	

REMARKS:

- (1) Measurement Value = Reading Level + Correct Factor.
- (2) Margin Level = Measurement Value - Limit Value.

Orthogonal Axis	X
Test Mode	UNII-1_TX N (HT20) Mode 5180 MHz

Vertical

130 dBuV/m

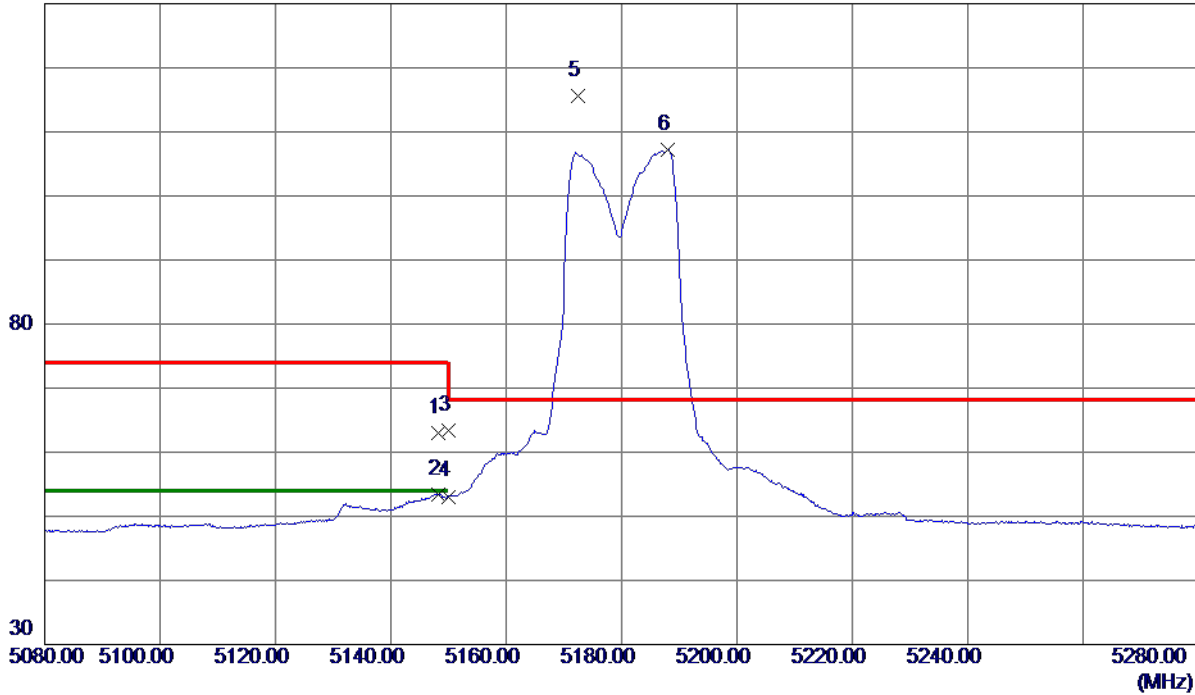

No.	Freq. MHz	Reading Level dBuV/m	Correct Factor dB	Measure ment dBuV/m	Limit dBuV/m	Margin dB	Detector	Comment
1	5148.2000	47.98	15.01	62.99	74.00	-11.01	Peak	
2	5148.2000	38.46	15.01	53.47	54.00	-0.53	AVG	
3	5150.0000	48.30	15.02	63.32	74.00	-10.68	Peak	
4	5150.0000	38.08	15.02	53.10	54.00	-0.90	AVG	
5 *	5172.4000	100.63	15.03	115.66	68.30	47.36	Peak	No Limit
6	5188.1000	92.20	15.04	107.24	999.00	-891.76	AVG	No Limit

REMARKS:

- (1) Measurement Value = Reading Level + Correct Factor.
- (2) Margin Level = Measurement Value - Limit Value.

Orthogonal Axis	X
Test Mode	UNII-1_TX N (HT20) Mode 5180 MHz

Vertical

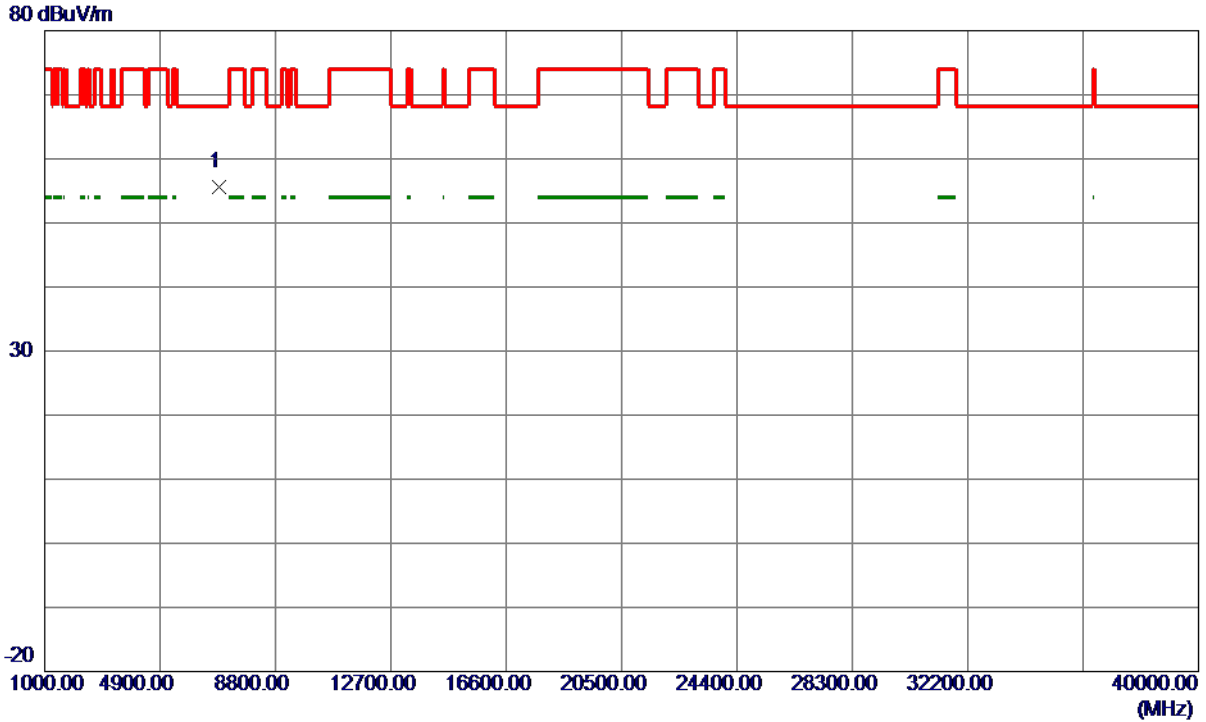

No.	Freq. MHz	Reading Level dBuV/m	Correct Factor dB	Measure ment dBuV/m	Limit dBuV/m	Margin dB	Detector	Comment
1 *	6906.7640	48.13	7.44	55.57	68.30	-12.73	Peak	

REMARKS:

- (1) Measurement Value = Reading Level + Correct Factor.
- (2) Margin Level = Measurement Value - Limit Value.

Orthogonal Axis	X
Test Mode	UNII-1_TX N (HT20) Mode 5180 MHz

Horizontal

130 dBuV/m

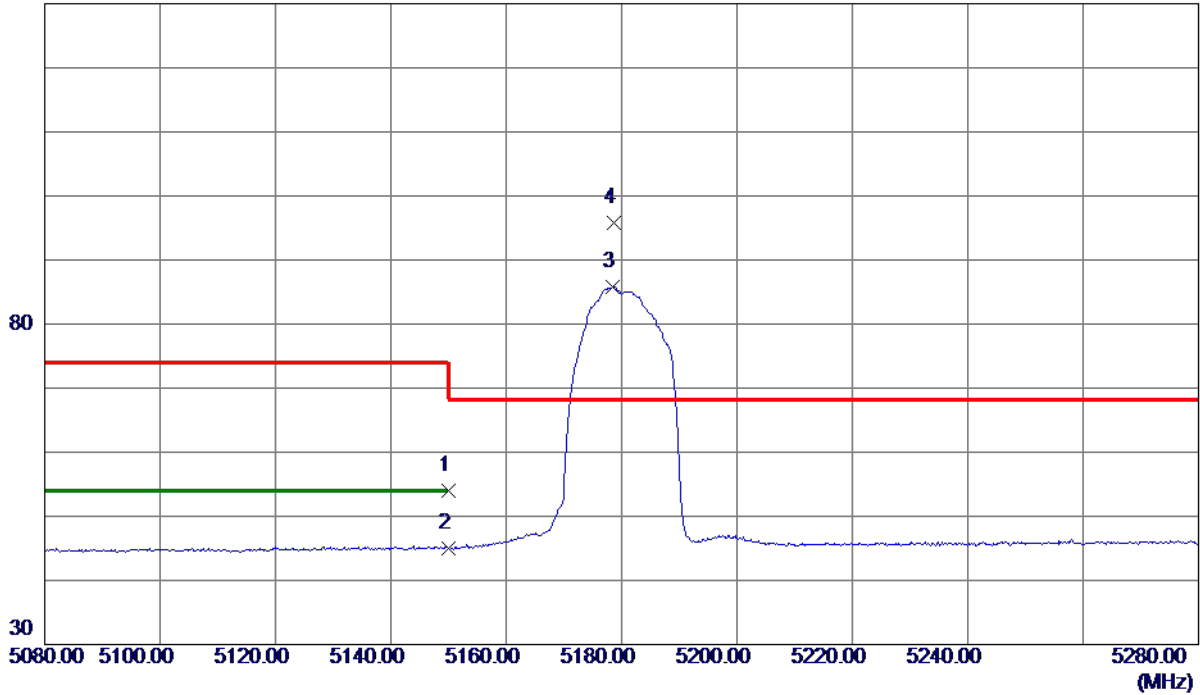

No.	Freq. MHz	Reading Level dBuV/m	Correct Factor dB	Measure ment dBuV/m	Limit dBuV/m	Margin dB	Detector	Comment
1	5150.0000	38.90	15.02	53.92	74.00	-20.08	Peak	
2	5150.0000	29.96	15.02	44.98	54.00	-9.02	AVG	
3	5178.4000	70.82	15.03	85.85	999.00	-913.15	AVG	No Limit
4 *	5178.6000	80.80	15.04	95.84	68.30	27.54	Peak	No Limit

REMARKS:

- (1) Measurement Value = Reading Level + Correct Factor.
- (2) Margin Level = Measurement Value - Limit Value.

Orthogonal Axis	X
Test Mode	UNII-1_TX N (HT20) Mode 5180 MHz

Horizontal



No.	Freq. MHz	Reading Level dBuV/m	Correct Factor dB	Measure ment dBuV/m	Limit dBuV/m	Margin dB	Detector	Comment
1 *	6906.7490	46.03	7.44	53.47	68.30	-14.83	Peak	

REMARKS:

- (1) Measurement Value = Reading Level + Correct Factor.
- (2) Margin Level = Measurement Value - Limit Value.

Orthogonal Axis	X
Test Mode	UNII-1_TX N (HT20) Mode 5200 MHz

Vertical

130 dBuV/m

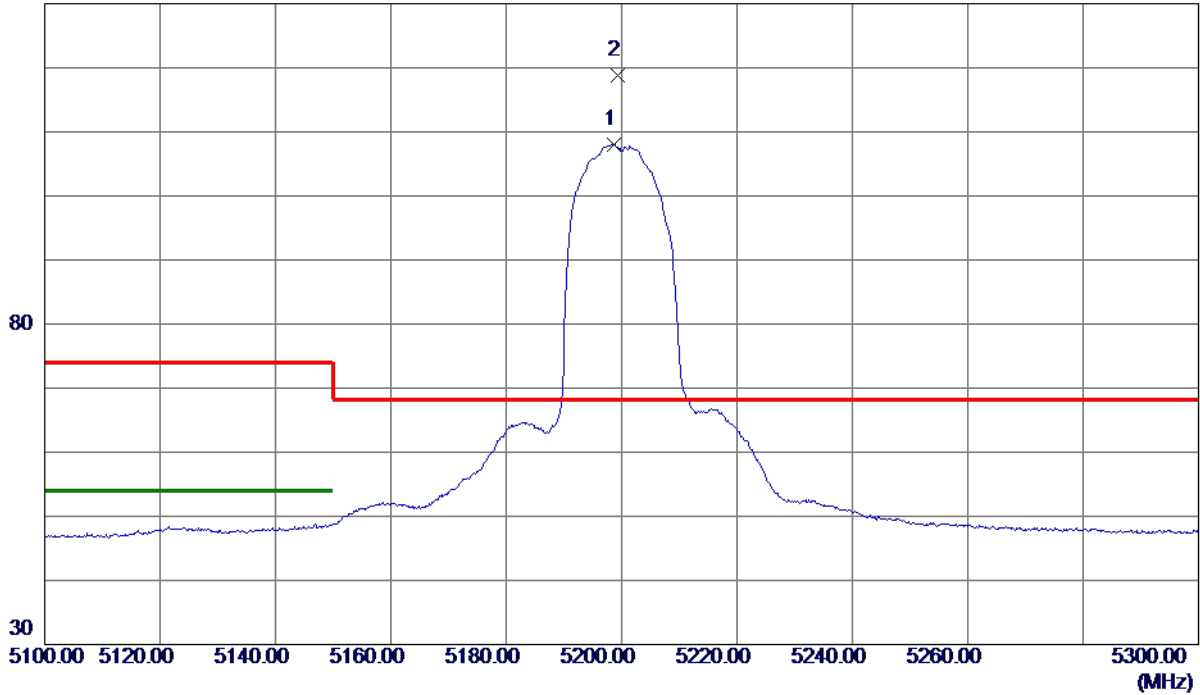

No.	Freq. MHz	Reading Level dBuV/m	Correct Factor dB	Measure ment dBuV/m	Limit dBuV/m	Margin dB	Detector	Comment
1	5198.6000	93.04	15.05	108.09	999.00	-890.91	AVG	No Limit
2 *	5199.4000	103.81	15.05	118.86	68.30	50.56	Peak	No Limit

REMARKS:

- (1) Measurement Value = Reading Level + Correct Factor.
- (2) Margin Level = Measurement Value - Limit Value.

Orthogonal Axis	X
Test Mode	UNII-1_TX N (HT20) Mode 5200 MHz

Vertical

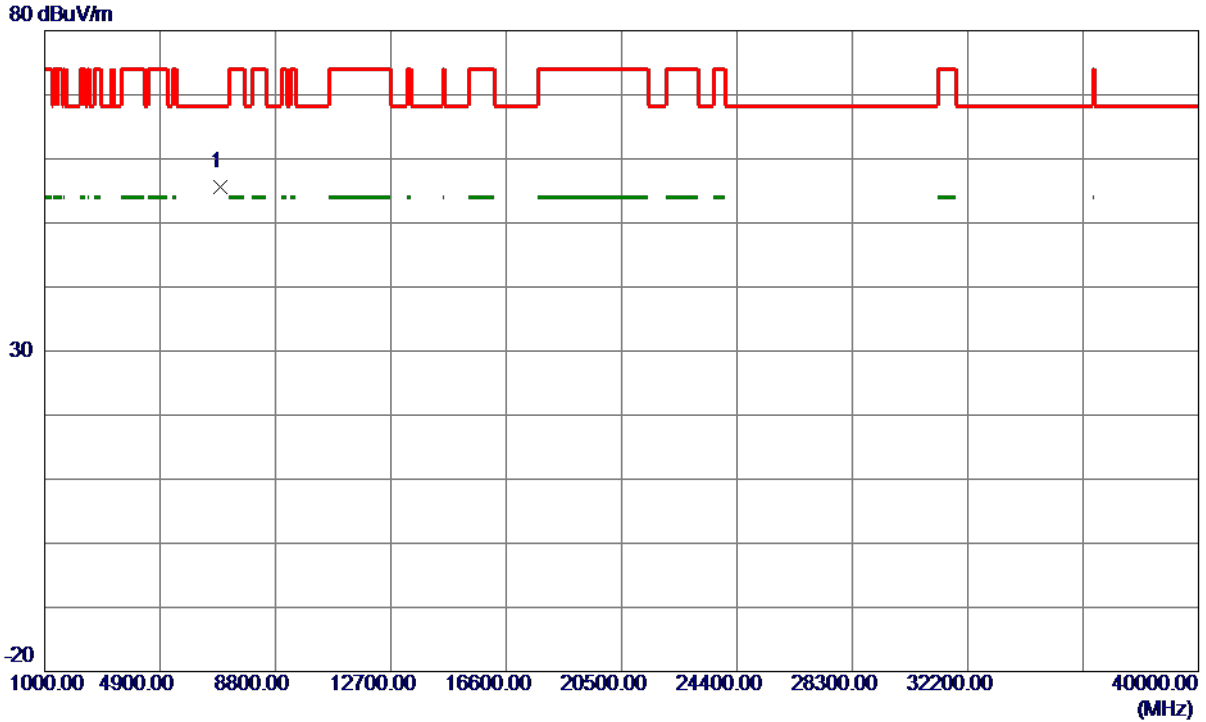

No.	Freq. MHz	Reading Level dBuV/m	Correct Factor dB	Measure ment dBuV/m	Limit dBuV/m	Margin dB	Detector	Comment
1 *	6933.3000	48.19	7.46	55.65	68.30	-12.65	Peak	

REMARKS:

- (1) Measurement Value = Reading Level + Correct Factor.
- (2) Margin Level = Measurement Value - Limit Value.

Orthogonal Axis	X
Test Mode	UNII-1_TX N (HT20) Mode 5200 MHz

Horizontal

130 dBuV/m

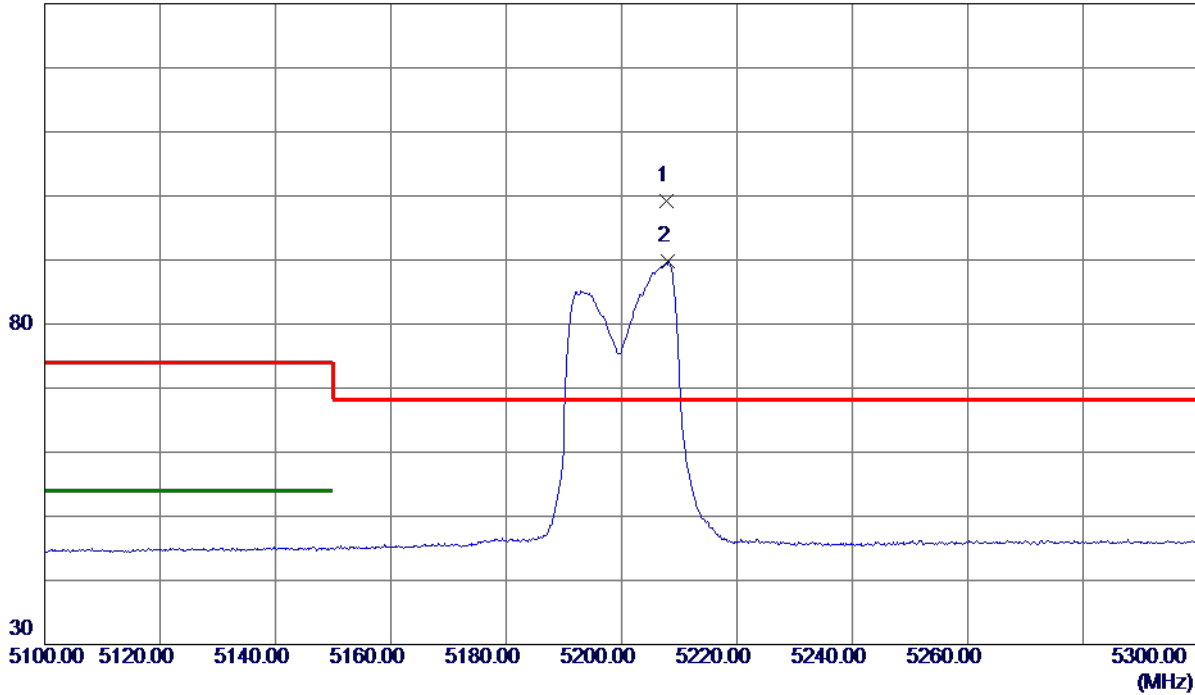

No.	Freq. MHz	Reading Level dBuV/m	Correct Factor dB	Measure ment dBuV/m	Limit dBuV/m	Margin dB	Detector	Comment
1 *	5207.8000	84.20	15.06	99.26	68.30	30.96	Peak	No Limit
2	5208.1000	74.71	15.06	89.77	999.00	-909.23	AVG	No Limit

REMARKS:

- (1) Measurement Value = Reading Level + Correct Factor.
- (2) Margin Level = Measurement Value - Limit Value.

Orthogonal Axis	X
Test Mode	UNII-1_TX N (HT20) Mode 5200 MHz

Horizontal

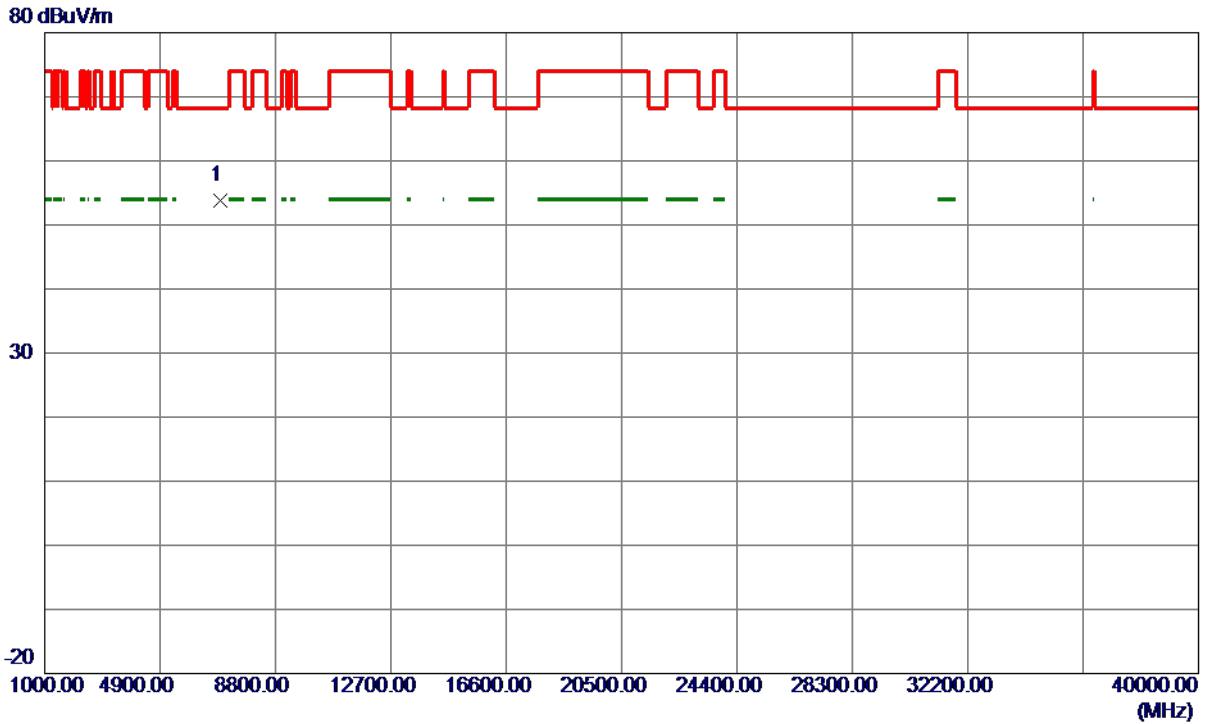

No.	Freq. MHz	Reading Level dBuV/m	Correct Factor dB	Measure ment dBuV/m	Limit dBuV/m	Margin dB	Detector	Comment
1 *	6933.4550	46.27	7.46	53.73	68.30	-14.57	Peak	

REMARKS:

- (1) Measurement Value = Reading Level + Correct Factor.
- (2) Margin Level = Measurement Value - Limit Value.

Orthogonal Axis	X
Test Mode	UNII-1_TX N (HT20) Mode 5240 MHz

Vertical

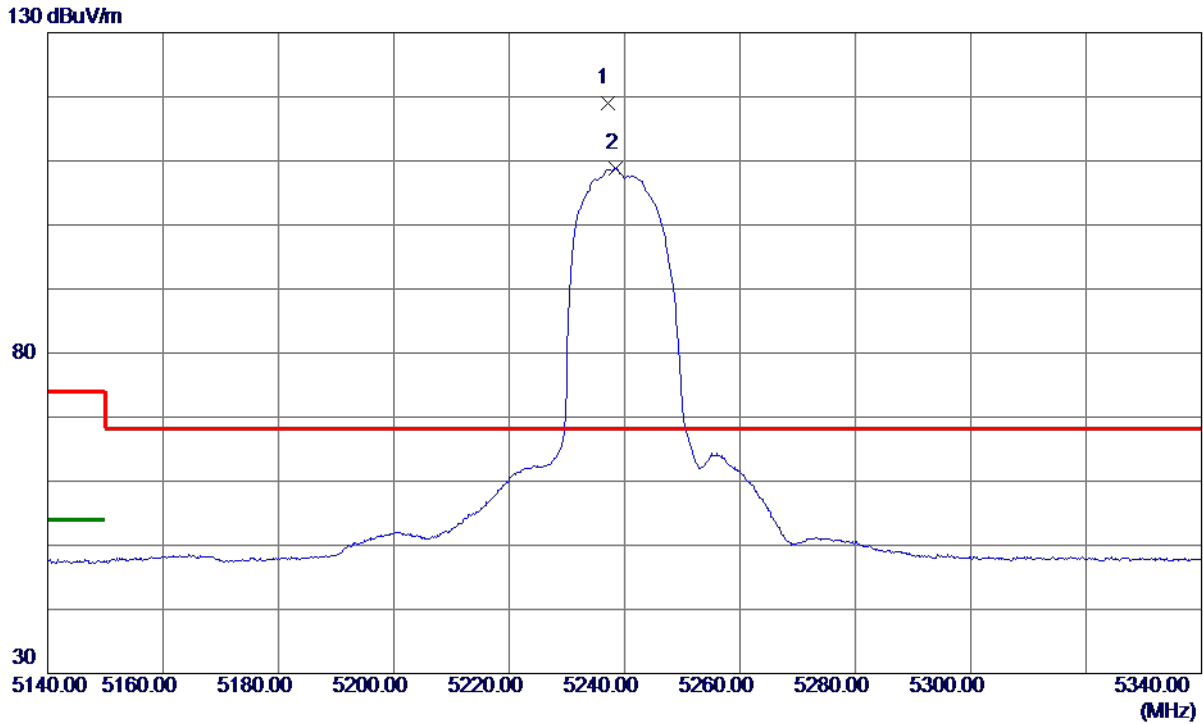

No.	Freq. MHz	Reading Level dBuV/m	Correct Factor dB	Measure ment dBuV/m	Limit dBuV/m	Margin dB	Detector	Comment
1 *	5237.0000	103.85	15.08	118.93	68.30	50.63	Peak	No Limit
2	5238.4000	93.66	15.08	108.74	999.00	-890.26	AVG	No Limit

REMARKS:

- (1) Measurement Value = Reading Level + Correct Factor.
- (2) Margin Level = Measurement Value - Limit Value.

Orthogonal Axis	X
Test Mode	UNII-1_TX N (HT20) Mode 5240 MHz

Vertical

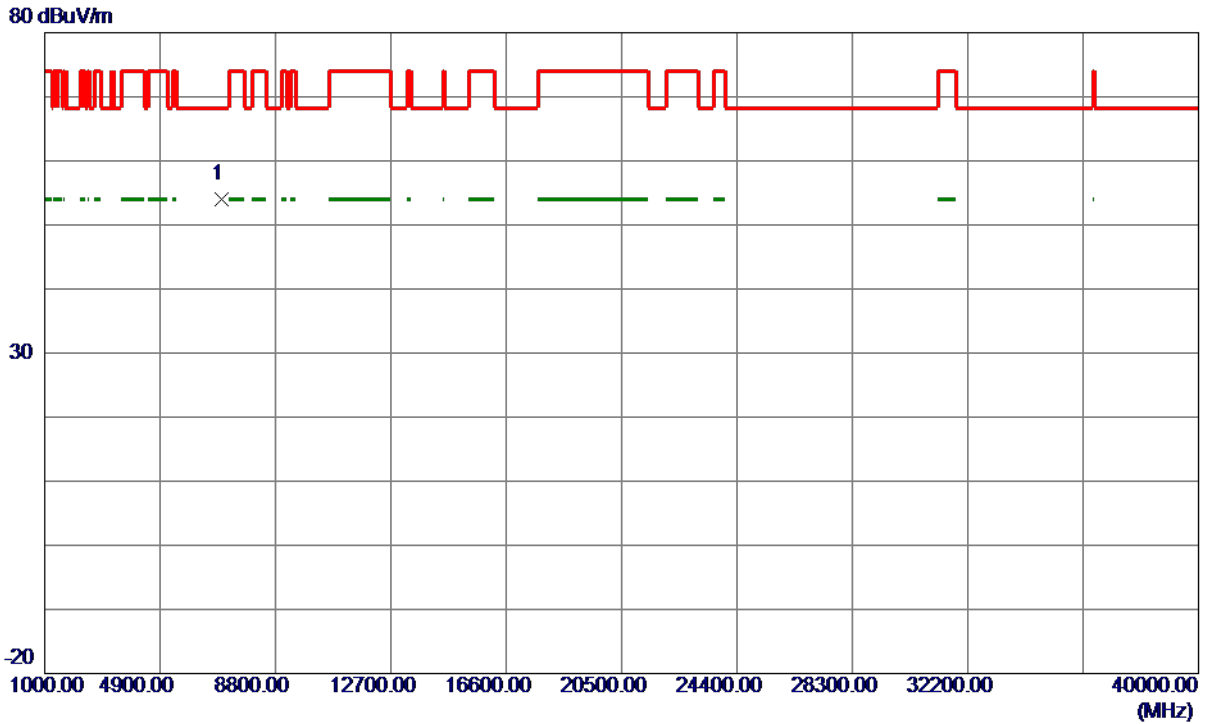

No.	Freq. MHz	Reading Level dBuV/m	Correct Factor dB	Measure ment dBuV/m	Limit dBuV/m	Margin dB	Detector	Comment
1 *	6986.7270	46.47	7.50	53.97	68.30	-14.33	Peak	

REMARKS:

- (1) Measurement Value = Reading Level + Correct Factor.
- (2) Margin Level = Measurement Value - Limit Value.

Orthogonal Axis	X
Test Mode	UNII-1_TX N (HT20) Mode 5240 MHz

Horizontal

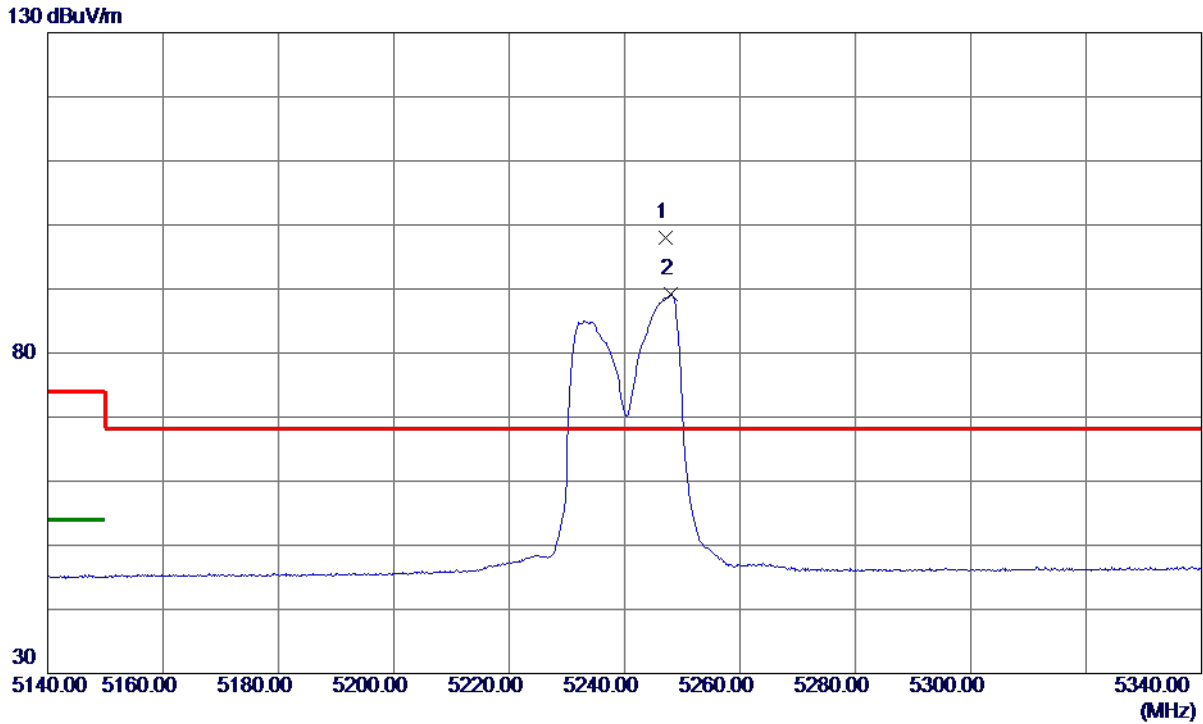

No.	Freq. MHz	Reading Level dBuV/m	Correct Factor dB	Measure ment dBuV/m	Limit dBuV/m	Margin dB	Detector	Comment
1 *	5247.1000	82.91	15.08	97.99	68.30	29.69	Peak	No Limit
2	5248.0000	74.07	15.08	89.15	999.00	-909.85	AVG	No Limit

REMARKS:

- (1) Measurement Value = Reading Level + Correct Factor.
- (2) Margin Level = Measurement Value - Limit Value.

Orthogonal Axis	X
Test Mode	UNII-1_TX N (HT20) Mode 5240 MHz

Horizontal

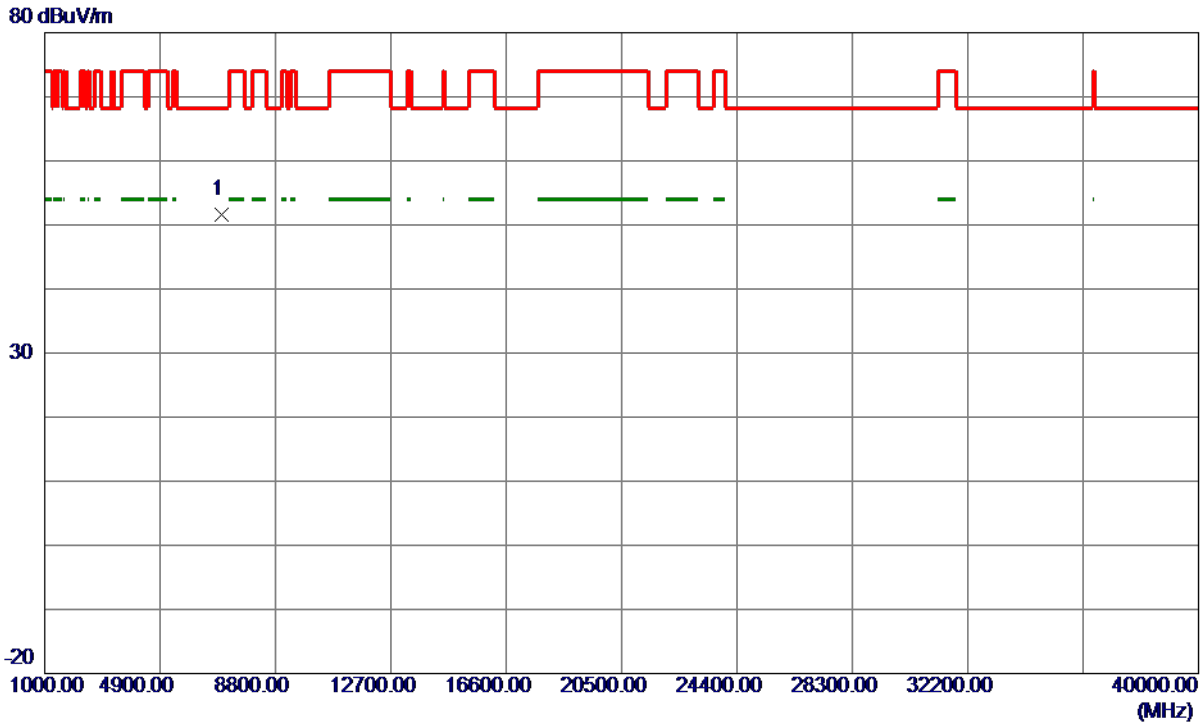

No.	Freq. MHz	Reading Level dBuV/m	Correct Factor dB	Measure ment dBuV/m	Limit dBuV/m	Margin dB	Detector	Comment
1 *	6986.7330	44.17	7.50	51.67	68.30	-16.63	Peak	

REMARKS:

- (1) Measurement Value = Reading Level + Correct Factor.
- (2) Margin Level = Measurement Value - Limit Value.

Orthogonal Axis	X
Test Mode	UNII-1_TX N (HT40) Mode 5190 MHz

Vertical

130 dBuV/m

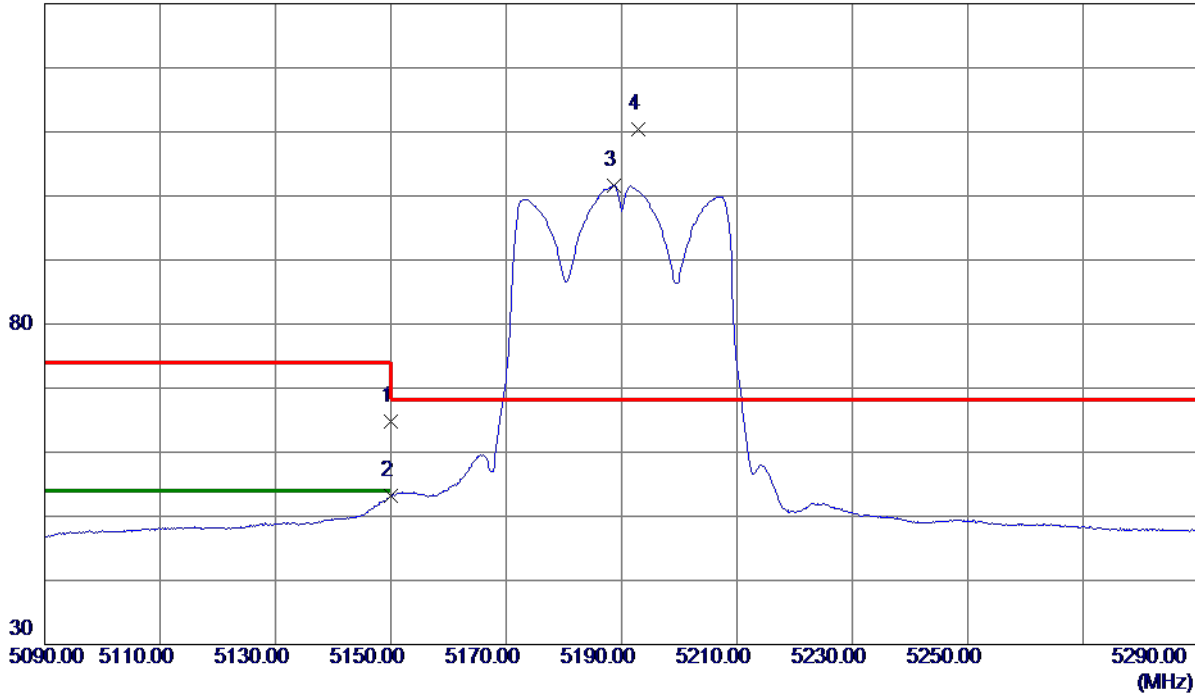

No.	Freq. MHz	Reading Level dBuV/m	Correct Factor dB	Measure ment dBuV/m	Limit dBuV/m	Margin dB	Detector	Comment
1	5150.0000	49.79	15.02	64.81	74.00	-9.19	Peak	
2	5150.0000	38.23	15.02	53.25	54.00	-0.75	AVG	
3	5188.7000	86.62	15.04	101.66	999.00	-897.34	AVG	No Limit
4 *	5192.9000	95.33	15.05	110.38	68.30	42.08	Peak	No Limit

REMARKS:

- (1) Measurement Value = Reading Level + Correct Factor.
- (2) Margin Level = Measurement Value - Limit Value.

Orthogonal Axis	X
Test Mode	UNII-1_TX N (HT40) Mode 5190 MHz

Vertical

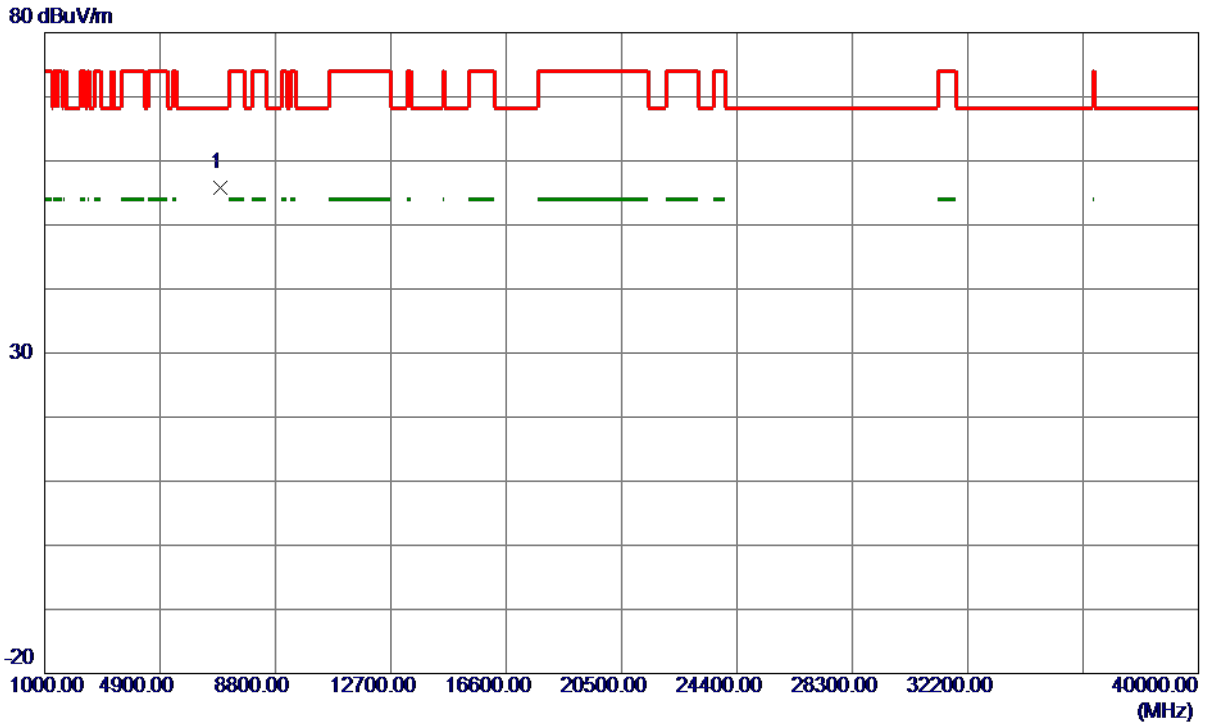

No.	Freq. MHz	Reading Level dBuV/m	Correct Factor dB	Measure ment dBuV/m	Limit dBuV/m	Margin dB	Detector	Comment
1 *	6919.9950	48.41	7.45	55.86	68.30	-12.44	Peak	

REMARKS:

- (1) Measurement Value = Reading Level + Correct Factor.
- (2) Margin Level = Measurement Value - Limit Value.

Orthogonal Axis	X
Test Mode	UNII-1_TX N (HT40) Mode 5190 MHz

Horizontal

130 dBuV/m

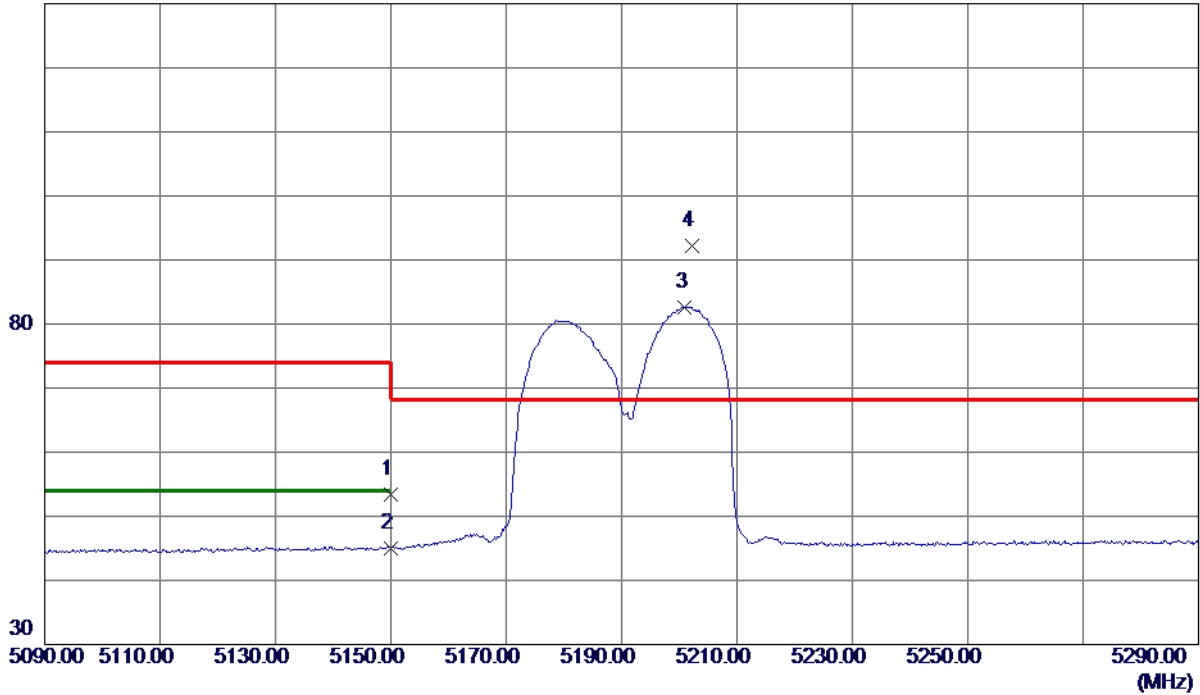

No.	Freq. MHz	Reading Level dBuV/m	Correct Factor dB	Measure ment dBuV/m	Limit dBuV/m	Margin dB	Detector	Comment
1	5150.0000	38.35	15.02	53.37	74.00	-20.63	Peak	
2	5150.0000	30.00	15.02	45.02	54.00	-8.98	AVG	
3	5201.0000	67.64	15.05	82.69	999.00	-916.31	AVG	No Limit
4 *	5202.2000	77.14	15.05	92.19	68.30	23.89	Peak	No Limit

REMARKS:

- (1) Measurement Value = Reading Level + Correct Factor.
- (2) Margin Level = Measurement Value - Limit Value.

Orthogonal Axis	X
Test Mode	UNII-1_TX N (HT40) Mode 5190 MHz

Horizontal

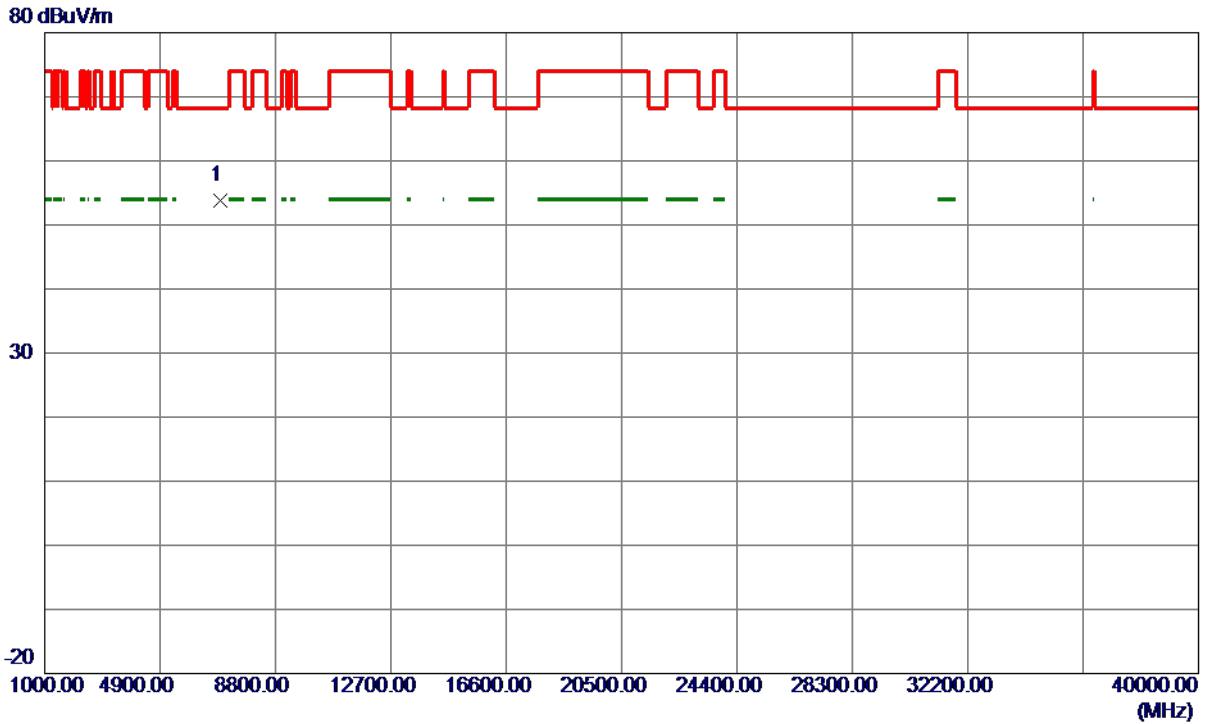

No.	Freq. MHz	Reading Level dBuV/m	Correct Factor dB	Measure ment dBuV/m	Limit dBuV/m	Margin dB	Detector	Comment
1 *	6920.0520	46.28	7.45	53.73	68.30	-14.57	Peak	

REMARKS:

- (1) Measurement Value = Reading Level + Correct Factor.
- (2) Margin Level = Measurement Value - Limit Value.

Orthogonal Axis	X
Test Mode	UNII-1_TX N (HT40) Mode 5230 MHz

Vertical

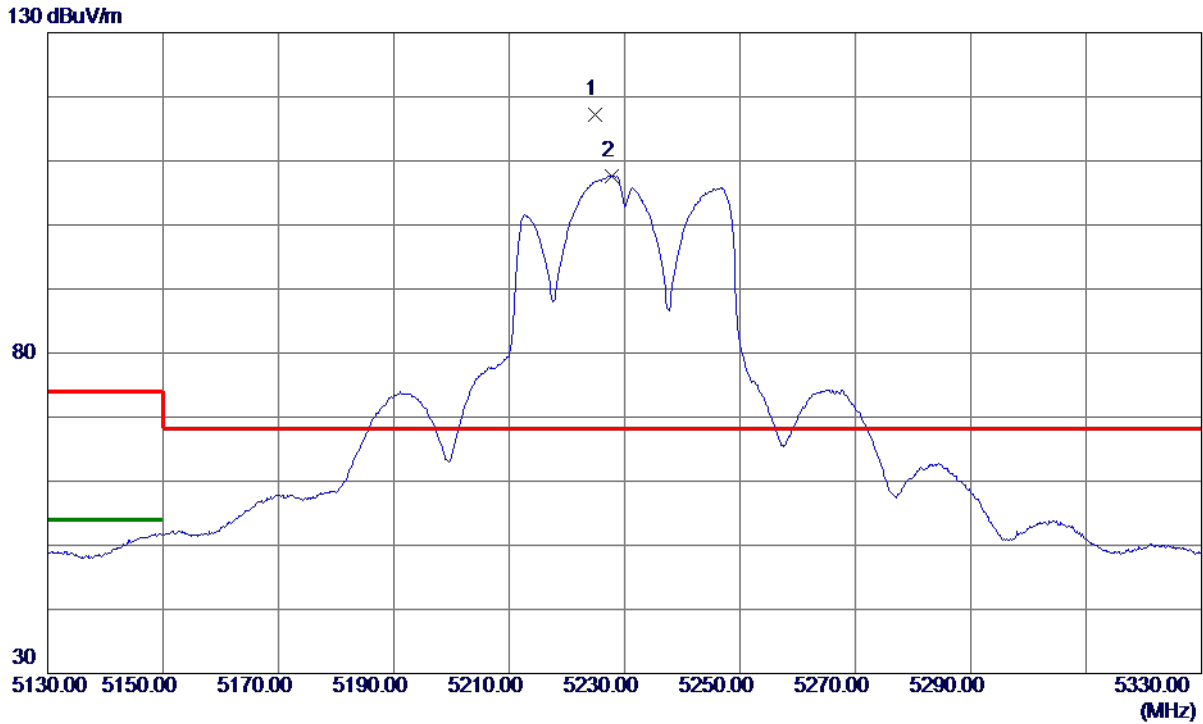

No.	Freq. MHz	Reading Level dBuV/m	Correct Factor dB	Measure ment dBuV/m	Limit dBuV/m	Margin dB	Detector	Comment
1 *	5224.9000	102.04	15.07	117.11	68.30	48.81	Peak	No Limit
2	5227.7000	92.57	15.07	107.64	999.00	-891.36	AVG	No Limit

REMARKS:

- (1) Measurement Value = Reading Level + Correct Factor.
- (2) Margin Level = Measurement Value - Limit Value.

Orthogonal Axis	X
Test Mode	UNII-1_TX N (HT40) Mode 5230 MHz

Vertical

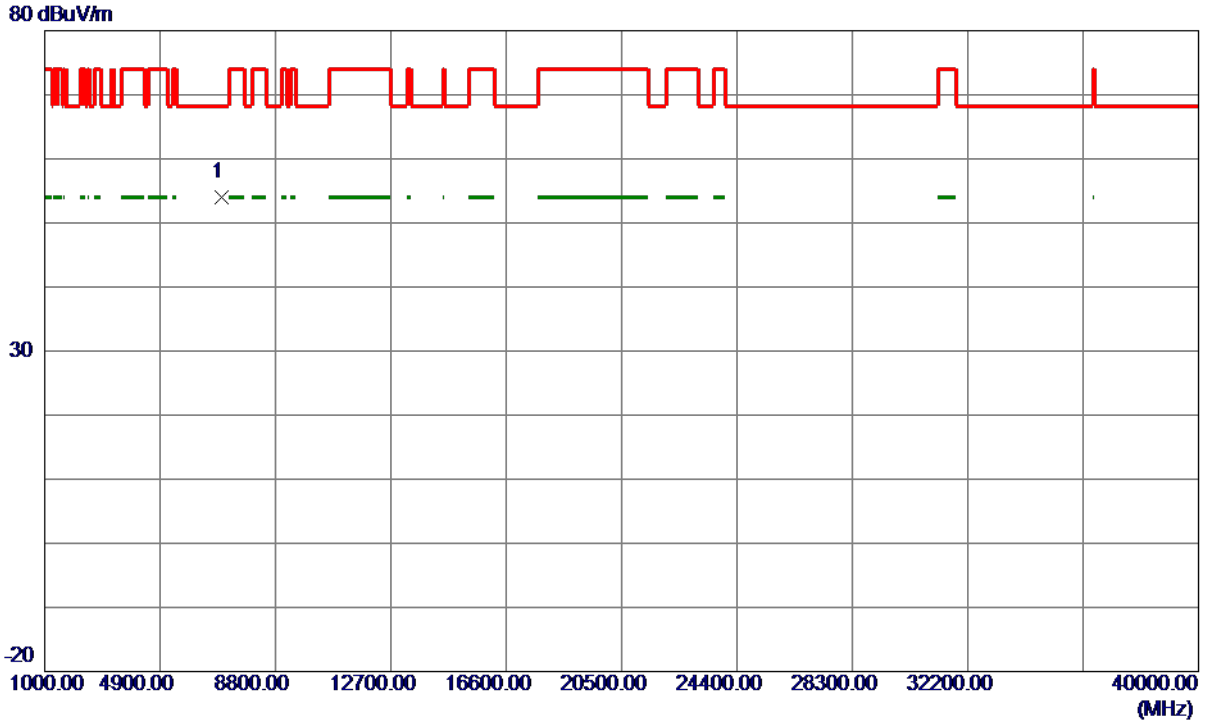

No.	Freq. MHz	Reading Level dBuV/m	Correct Factor dB	Measure ment dBuV/m	Limit dBuV/m	Margin dB	Detector	Comment
1 *	6973.2290	46.50	7.49	53.99	68.30	-14.31	Peak	

REMARKS:

- (1) Measurement Value = Reading Level + Correct Factor.
- (2) Margin Level = Measurement Value - Limit Value.

Orthogonal Axis	X
Test Mode	UNII-1_TX N (HT40) Mode 5230 MHz

Horizontal

130 dBuV/m

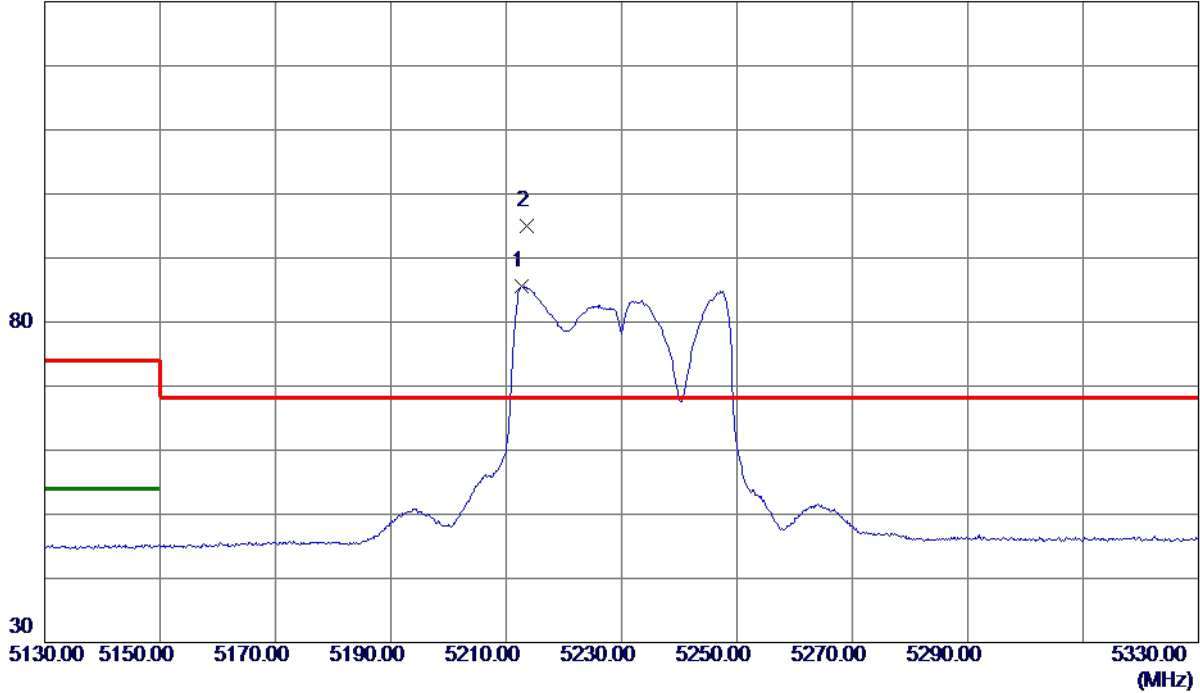

No.	Freq. MHz	Reading Level dBuV/m	Correct Factor dB	Measure ment dBuV/m	Limit dBuV/m	Margin dB	Detector	Comment
1	5212.6000	70.52	15.06	85.58	999.00	-913.42	AVG	No Limit
2 *	5213.5000	79.91	15.06	94.97	68.30	26.67	Peak	No Limit

REMARKS:

- (1) Measurement Value = Reading Level + Correct Factor.
- (2) Margin Level = Measurement Value - Limit Value.

Orthogonal Axis	X
Test Mode	UNII-1_TX N (HT40) Mode 5230 MHz

Horizontal

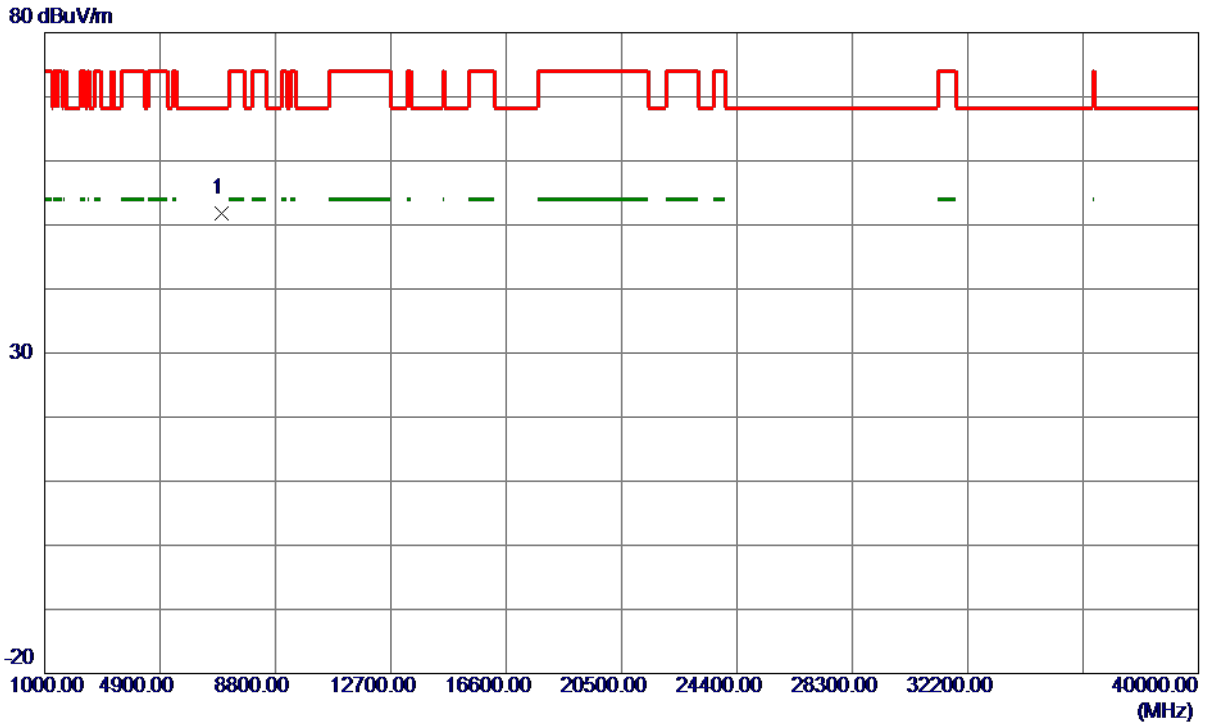

No.	Freq. MHz	Reading Level dBuV/m	Correct Factor dB	Measure ment dBuV/m	Limit dBuV/m	Margin dB	Detector	Comment
1 *	6973.4360	44.23	7.49	51.72	68.30	-16.58	Peak	

REMARKS:

- (1) Measurement Value = Reading Level + Correct Factor.
- (2) Margin Level = Measurement Value - Limit Value.

Orthogonal Axis	X
Test Mode	UNII-3_TX A Mode 5745 MHz

Vertical

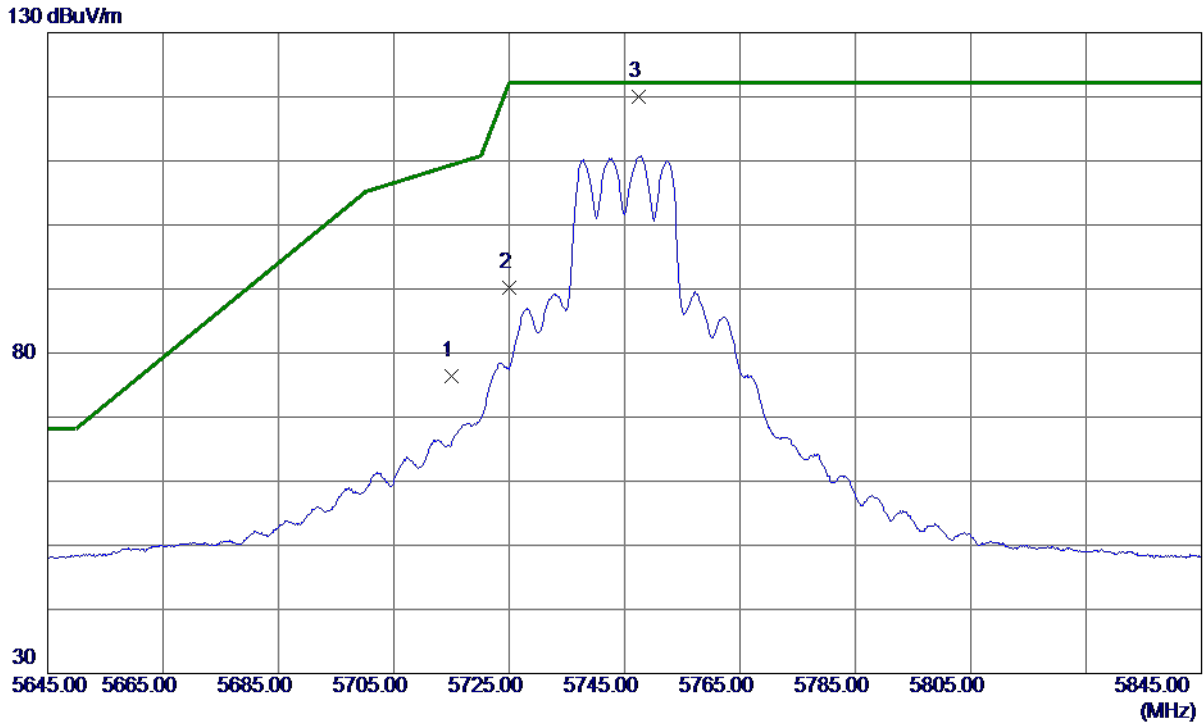

No.	Freq. MHz	Reading Level dBuV/m	Correct Factor dB	Measure ment dBuV/m	Limit dBuV/m	Margin dB	Detector	Comment
1	5715.0000	60.81	15.65	76.46	109.40	-32.94	Peak	
2	5725.0000	74.44	15.67	90.11	122.20	-32.09	Peak	
3 *	5747.4000	104.26	15.71	119.97	122.20	-2.23	Peak	No Limit

REMARKS:

- (1) Measurement Value = Reading Level + Correct Factor.
- (2) Margin Level = Measurement Value - Limit Value.

Orthogonal Axis	X
Test Mode	UNII-3_TX A Mode 5745 MHz

Vertical

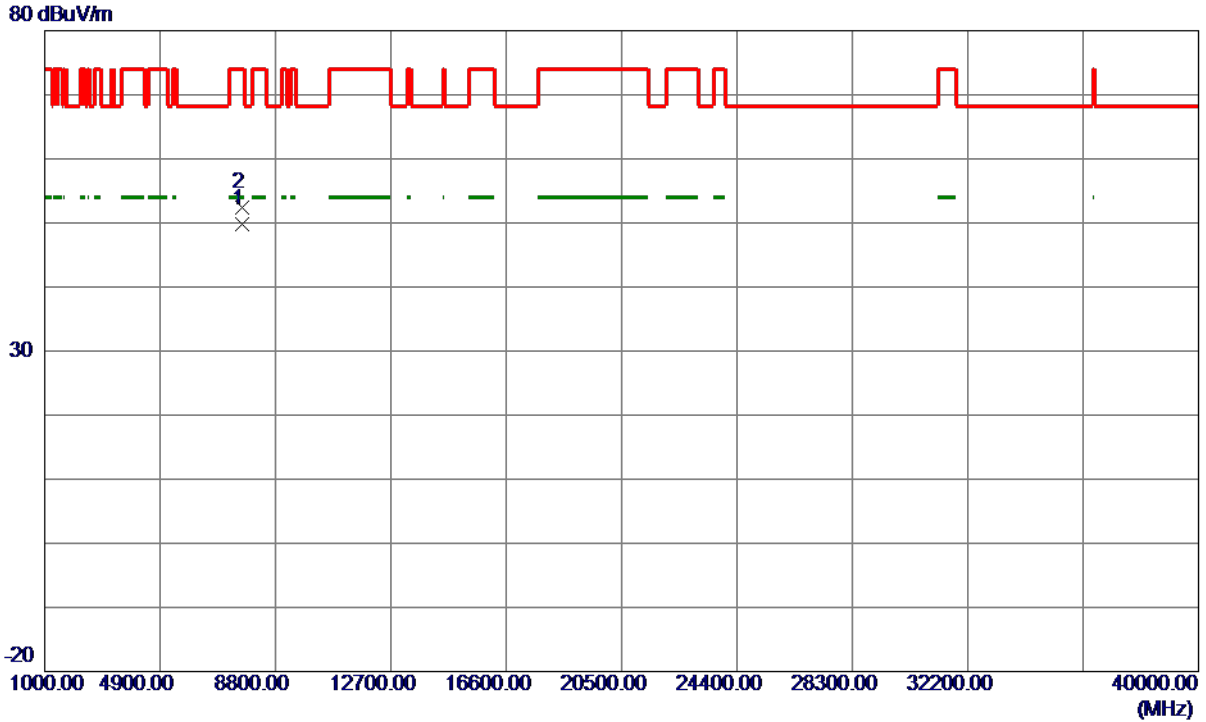

No.	Freq. MHz	Reading Level dBuV/m	Correct Factor dB	Measure ment dBuV/m	Limit dBuV/m	Margin dB	Detector	Comment
1 *	7660.0070	41.68	8.15	49.83	54.00	-4.17	AVG	
2	7660.0250	44.27	8.15	52.42	74.00	-21.58	Peak	

REMARKS:

- (1) Measurement Value = Reading Level + Correct Factor.
- (2) Margin Level = Measurement Value - Limit Value.

Orthogonal Axis	X
Test Mode	UNII-3_TX A Mode 5745 MHz

Horizontal

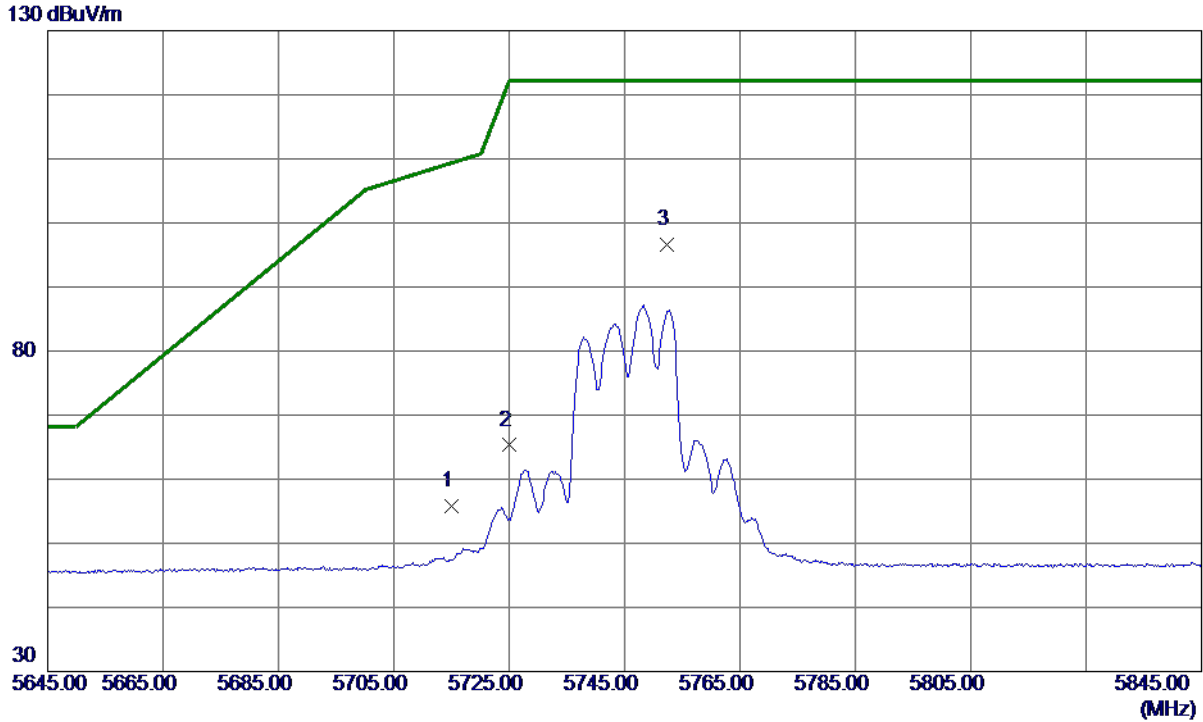

No.	Freq. MHz	Reading Level dBuV/m	Correct Factor dB	Measure ment dBuV/m	Limit dBuV/m	Margin dB	Detector	Comment
1	5715.0000	40.22	15.65	55.87	109.40	-53.53	Peak	
2	5725.0000	49.63	15.67	65.30	122.20	-56.90	Peak	
3 *	5752.4000	80.91	15.72	96.63	122.20	-25.57	Peak	No Limit

REMARKS:

- (1) Measurement Value = Reading Level + Correct Factor.
- (2) Margin Level = Measurement Value - Limit Value.

Orthogonal Axis	X
Test Mode	UNII-3_TX A Mode 5745 MHz

Horizontal



No.	Freq. MHz	Reading Level dBuV/m	Correct Factor dB	Measure ment dBuV/m	Limit dBuV/m	Margin dB	Detector	Comment
1 *	7659.9620	29.37	8.15	37.52	54.00	-16.48	AVG	
2	7660.0000	37.85	8.15	46.00	74.00	-28.00	Peak	

REMARKS:

- (1) Measurement Value = Reading Level + Correct Factor.
- (2) Margin Level = Measurement Value - Limit Value.

Orthogonal Axis	X
Test Mode	UNII-3_TX A Mode 5785 MHz

Vertical

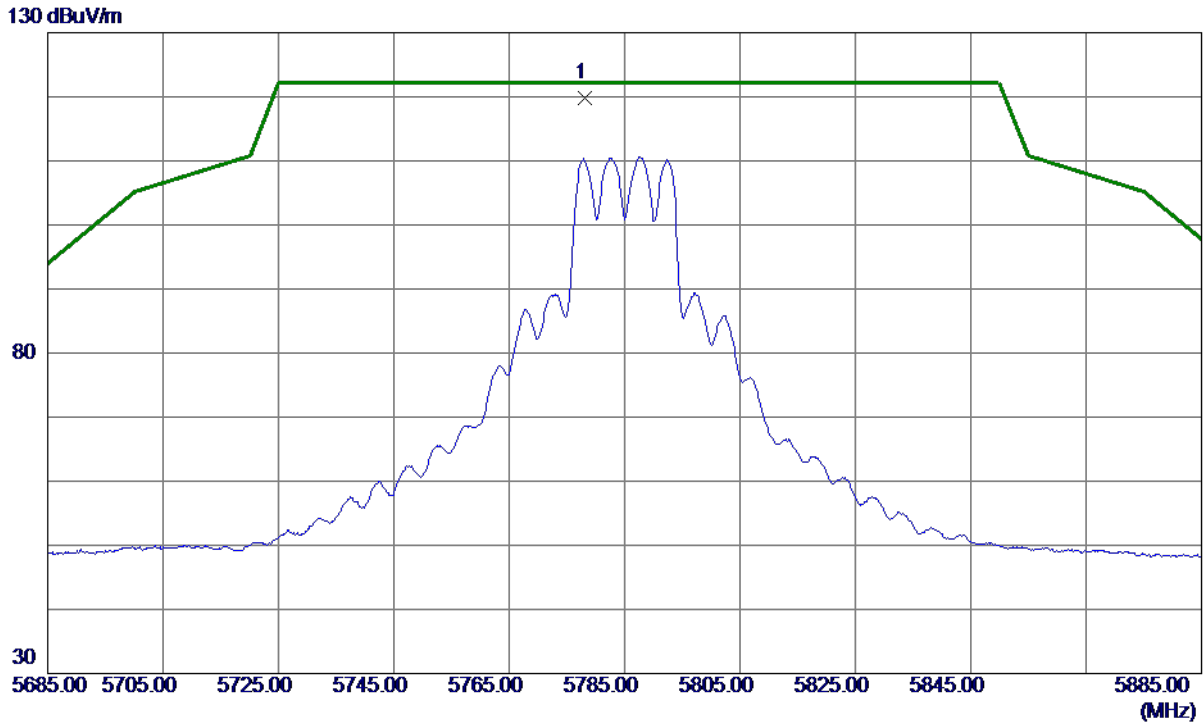

No.	Freq. MHz	Reading Level dBuV/m	Correct Factor dB	Measure ment dBuV/m	Limit dBuV/m	Margin dB	Detector	Comment
1 *	5778.1000	104.07	15.77	119.84	122.20	-2.36	Peak	No Limit

REMARKS:

- (1) Measurement Value = Reading Level + Correct Factor.
- (2) Margin Level = Measurement Value - Limit Value.

Orthogonal Axis	X
Test Mode	UNII-3_TX A Mode 5785 MHz

Vertical

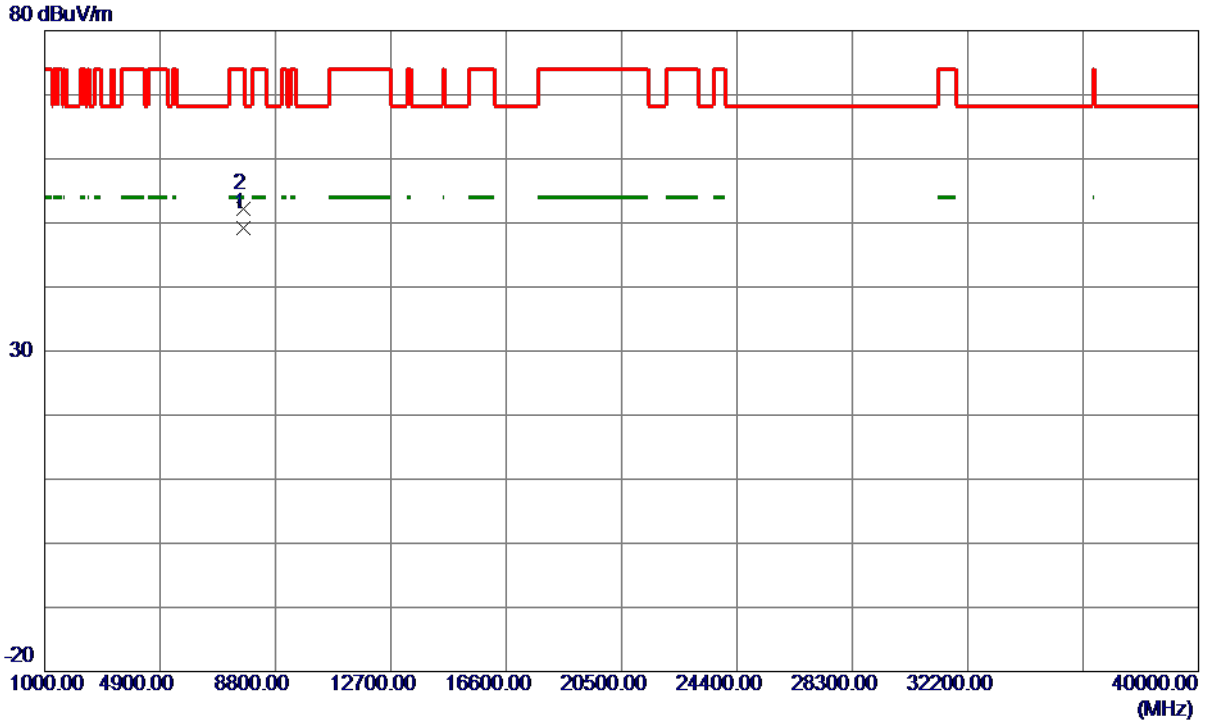

No.	Freq. MHz	Reading Level dBuV/m	Correct Factor dB	Measure ment dBuV/m	Limit dBuV/m	Margin dB	Detector	Comment
1 *	7713.3500	40.96	8.15	49.11	54.00	-4.89	AVG	
2	7713.4900	44.07	8.15	52.22	74.00	-21.78	Peak	

REMARKS:

- (1) Measurement Value = Reading Level + Correct Factor.
- (2) Margin Level = Measurement Value - Limit Value.

Orthogonal Axis	X
Test Mode	UNII-3_TX A Mode 5785 MHz

Horizontal

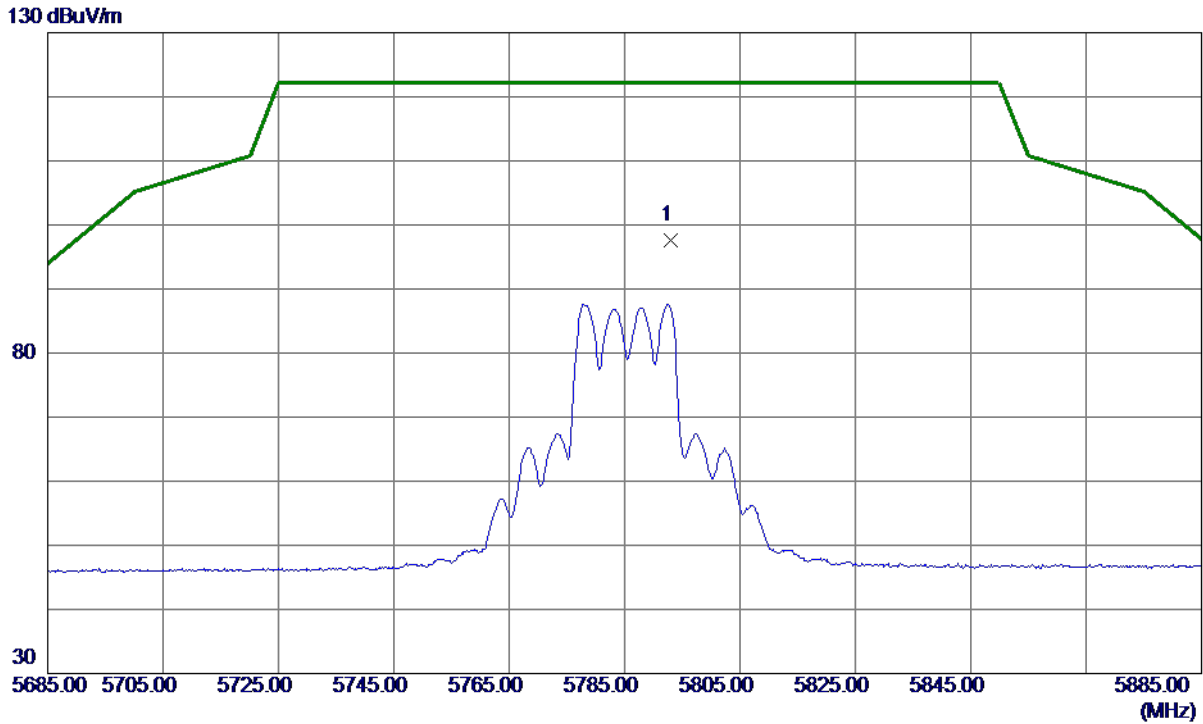

No.	Freq. MHz	Reading Level dBuV/m	Correct Factor dB	Measure ment dBuV/m	Limit dBuV/m	Margin dB	Detector	Comment
1 *	5792.9000	81.90	15.79	97.69	122.20	-24.51	Peak	No Limit

REMARKS:

- (1) Measurement Value = Reading Level + Correct Factor.
- (2) Margin Level = Measurement Value - Limit Value.

Orthogonal Axis	X
Test Mode	UNII-3_TX A Mode 5785 MHz

Horizontal

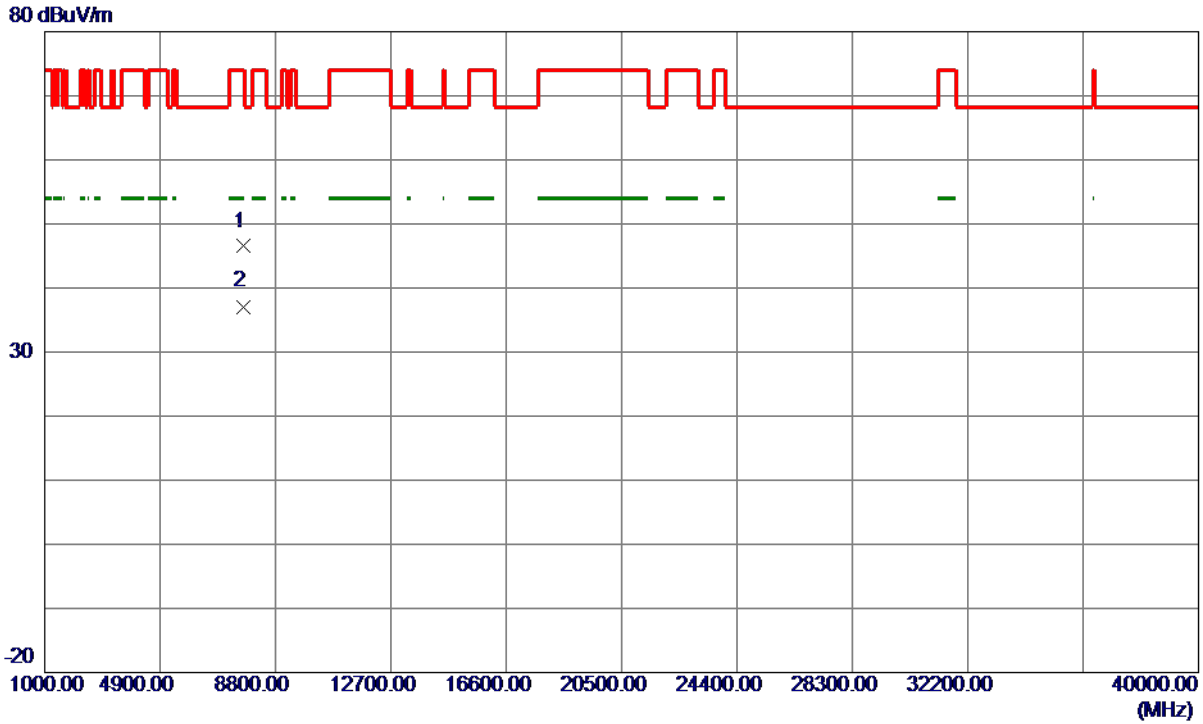

No.	Freq. MHz	Reading Level dBuV/m	Correct Factor dB	Measure ment dBuV/m	Limit dBuV/m	Margin dB	Detector	Comment
1	7713.1980	38.35	8.15	46.50	74.00	-27.50	Peak	
2 *	7713.4250	28.95	8.15	37.10	54.00	-16.90	AVG	

REMARKS:

- (1) Measurement Value = Reading Level + Correct Factor.
- (2) Margin Level = Measurement Value - Limit Value.

Orthogonal Axis	X
Test Mode	UNII-3_TX A Mode 5825 MHz

Vertical

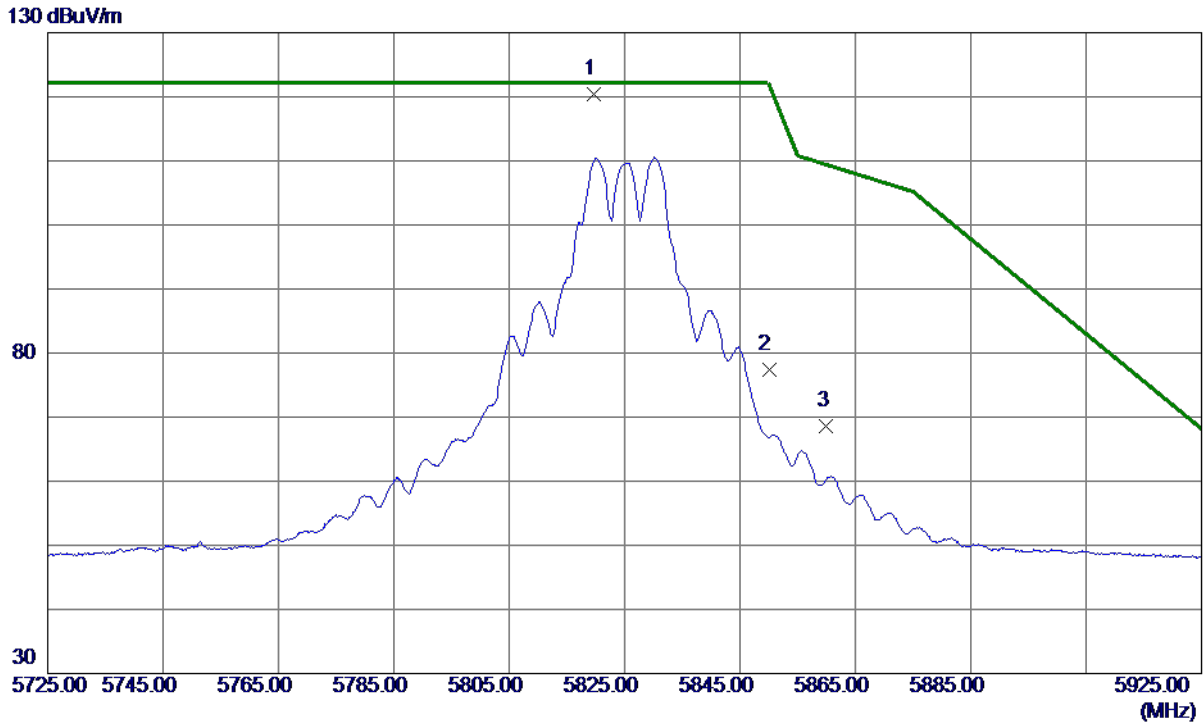

No.	Freq. MHz	Reading Level dBuV/m	Correct Factor dB	Measure ment dBuV/m	Limit dBuV/m	Margin dB	Detector	Comment
1 *	5819.7000	104.54	15.84	120.38	122.20	-1.82	Peak	No Limit
2	5850.0000	61.46	15.90	77.36	122.20	-44.84	Peak	
3	5860.0000	52.70	15.92	68.62	109.40	-40.78	Peak	

REMARKS:

- (1) Measurement Value = Reading Level + Correct Factor.
- (2) Margin Level = Measurement Value - Limit Value.

Orthogonal Axis	X
Test Mode	UNII-3_TX A Mode 5825 MHz

Vertical

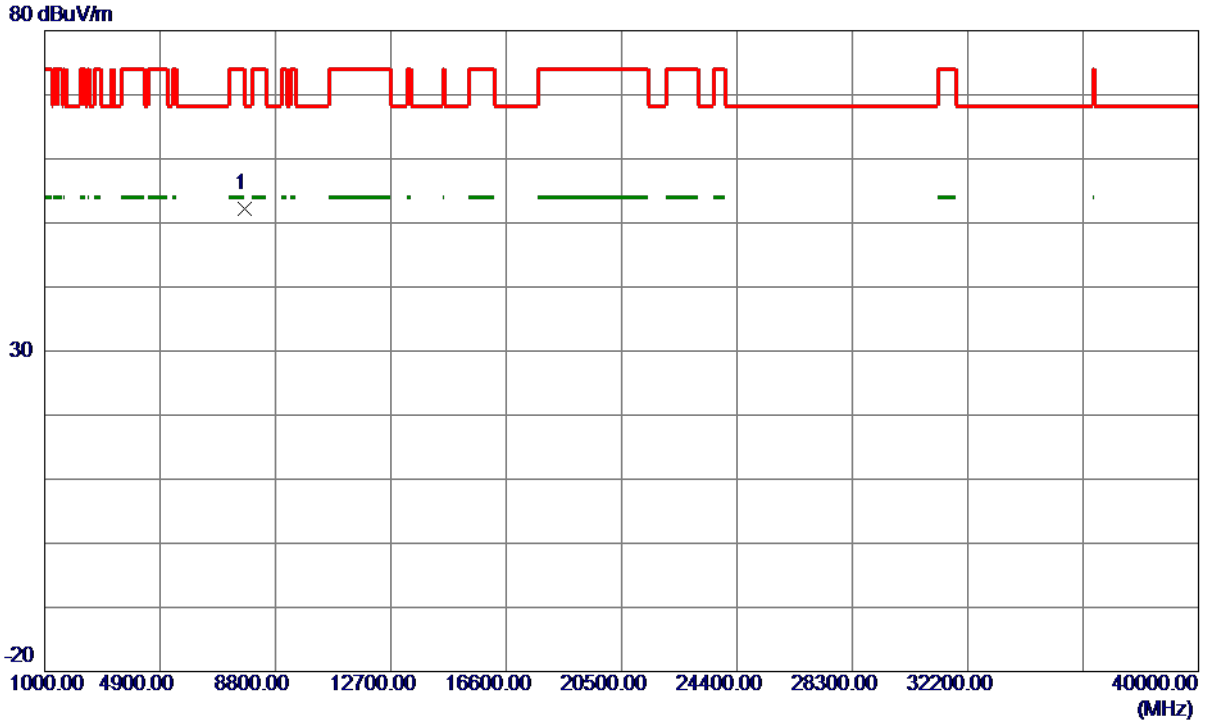

No.	Freq. MHz	Reading Level dBuV/m	Correct Factor dB	Measure ment dBuV/m	Limit dBuV/m	Margin dB	Detector	Comment
1 *	7766.8250	43.99	8.16	52.15	68.30	-16.15	Peak	

REMARKS:

- (1) Measurement Value = Reading Level + Correct Factor.
- (2) Margin Level = Measurement Value - Limit Value.

Orthogonal Axis	X
Test Mode	UNII-3_TX A Mode 5825 MHz

Horizontal

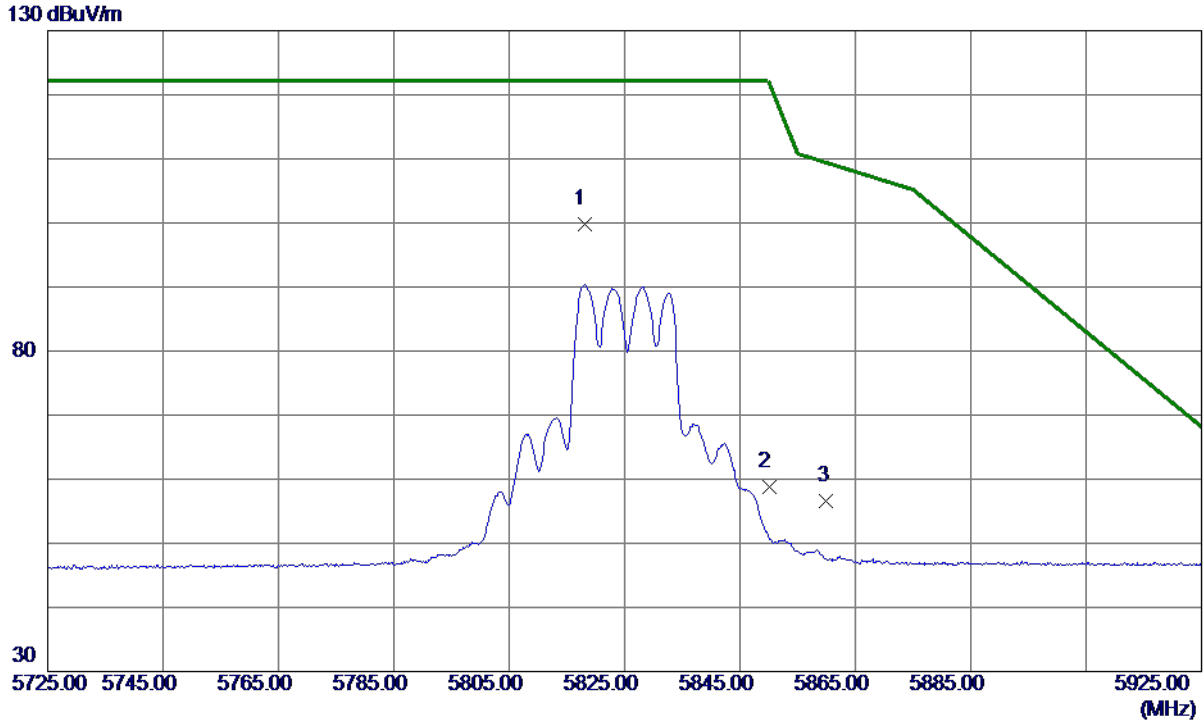

No.	Freq. MHz	Reading Level dBuV/m	Correct Factor dB	Measure ment dBuV/m	Limit dBuV/m	Margin dB	Detector	Comment
1 *	5818.0000	83.98	15.84	99.82	122.20	-22.38	Peak	No Limit
2	5850.0000	42.99	15.90	58.89	122.20	-63.31	Peak	
3	5860.0000	40.59	15.92	56.51	109.40	-52.89	Peak	

REMARKS:

- (1) Measurement Value = Reading Level + Correct Factor.
- (2) Margin Level = Measurement Value - Limit Value.

Orthogonal Axis	X
Test Mode	UNII-3_TX A Mode 5825 MHz

Horizontal



No.	Freq. MHz	Reading Level dBuV/m	Correct Factor dB	Measure ment dBuV/m	Limit dBuV/m	Margin dB	Detector	Comment
1 *	7766.6200	36.73	8.16	44.89	68.30	-23.41	Peak	

REMARKS:

- (1) Measurement Value = Reading Level + Correct Factor.
- (2) Margin Level = Measurement Value - Limit Value.

Orthogonal Axis	X
Test Mode	UNII-3_TX N (HT20) Mode 5745 MHz

Vertical

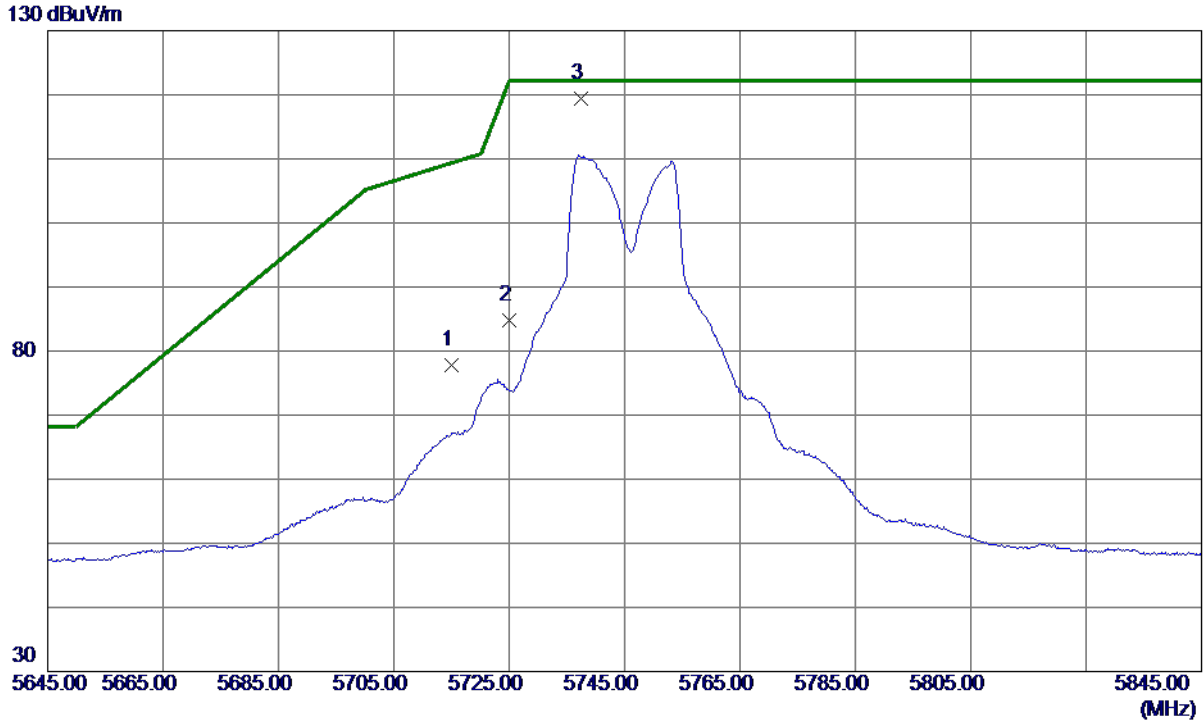

No.	Freq. MHz	Reading Level dBuV/m	Correct Factor dB	Measure ment dBuV/m	Limit dBuV/m	Margin dB	Detector	Comment
1	5715.0000	62.18	15.65	77.83	109.40	-31.57	Peak	
2	5725.0000	69.04	15.67	84.71	122.20	-37.49	Peak	
3 *	5737.4000	103.78	15.69	119.47	122.20	-2.73	Peak	No Limit

REMARKS:

- (1) Measurement Value = Reading Level + Correct Factor.
- (2) Margin Level = Measurement Value - Limit Value.

Orthogonal Axis	X
Test Mode	UNII-3_TX N (HT20) Mode 5745 MHz

Vertical

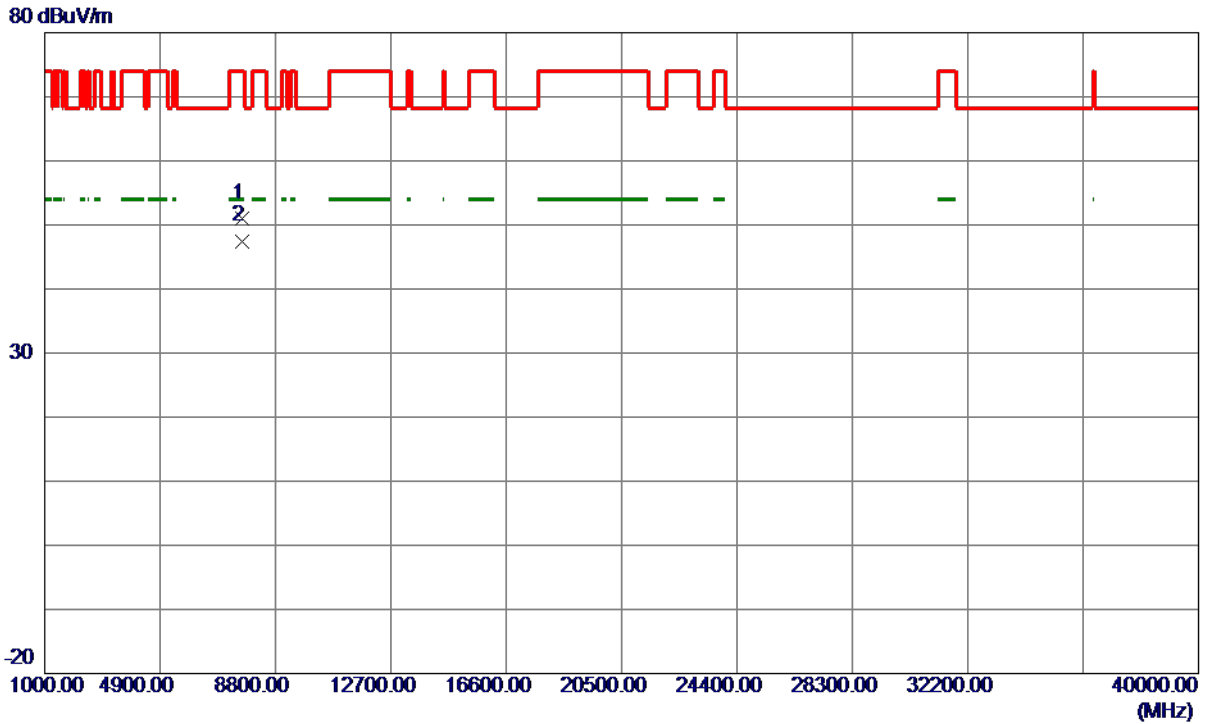

No.	Freq. MHz	Reading Level dBuV/m	Correct Factor dB	Measurement dBuV/m	Limit dBuV/m	Margin dB	Detector	Comment
1	7660.0020	42.91	8.15	51.06	74.00	-22.94	Peak	
2 *	7660.0550	39.35	8.15	47.50	54.00	-6.50	AVG	

REMARKS:

- (1) Measurement Value = Reading Level + Correct Factor.
- (2) Margin Level = Measurement Value - Limit Value.

Orthogonal Axis	X
Test Mode	UNII-3_TX N (HT20) Mode 5745 MHz

Horizontal

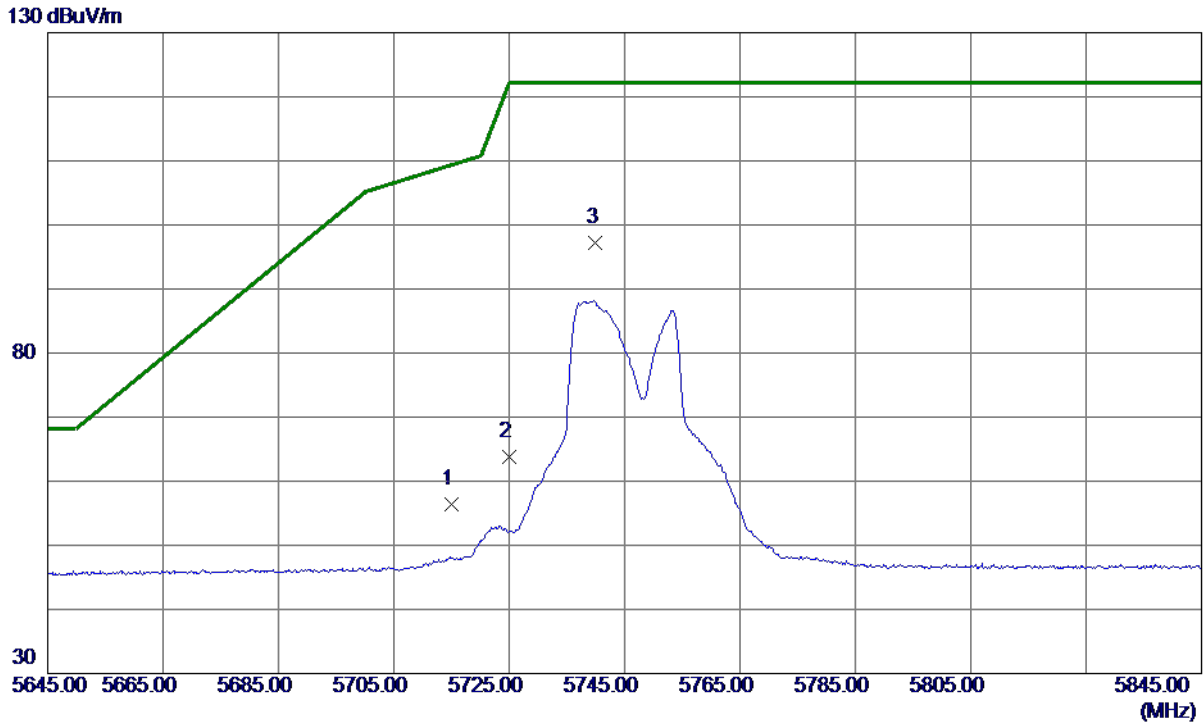

No.	Freq. MHz	Reading Level dBuV/m	Correct Factor dB	Measure ment dBuV/m	Limit dBuV/m	Margin dB	Detector	Comment
1	5715.0000	40.78	15.65	56.43	109.40	-52.97	Peak	
2	5725.0000	48.09	15.67	63.76	122.20	-58.44	Peak	
3 *	5740.0000	81.45	15.70	97.15	122.20	-25.05	Peak	No Limit

REMARKS:

- (1) Measurement Value = Reading Level + Correct Factor.
- (2) Margin Level = Measurement Value - Limit Value.

Orthogonal Axis	X
Test Mode	UNII-3_TX N (HT20) Mode 5745 MHz

Horizontal

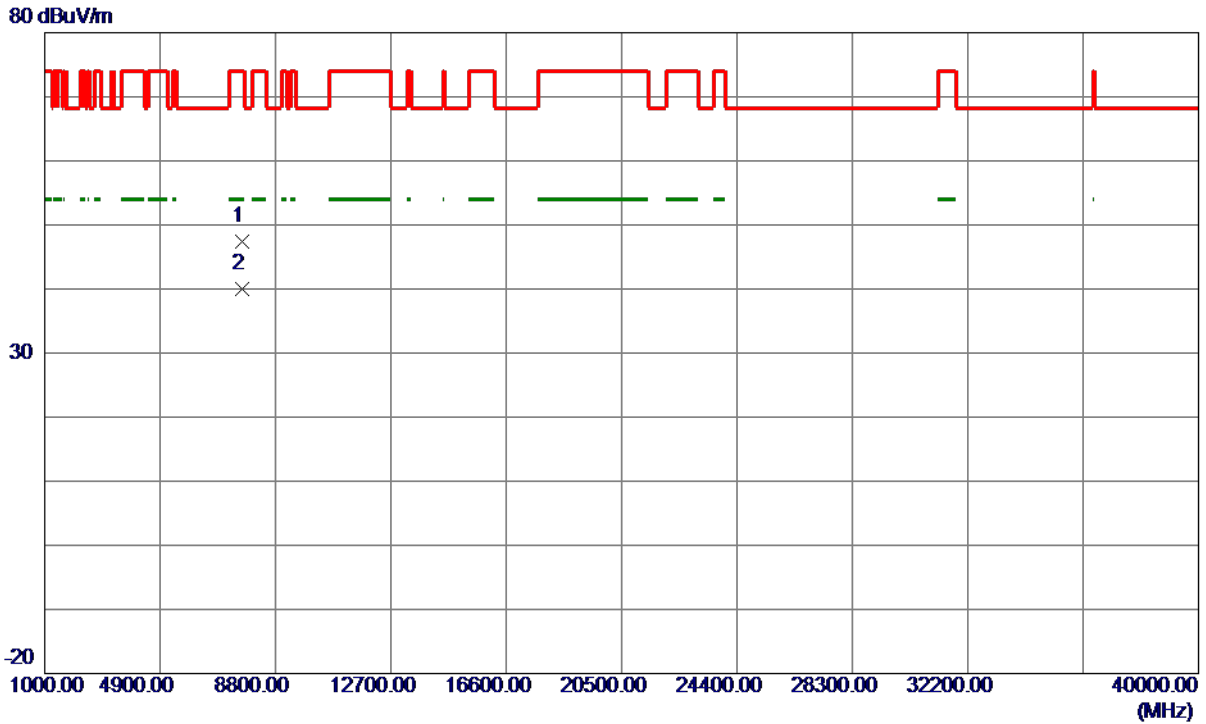

No.	Freq. MHz	Reading Level dBuV/m	Correct Factor dB	Measure ment dBuV/m	Limit dBuV/m	Margin dB	Detector	Comment
1	7659.8350	39.23	8.15	47.38	74.00	-26.62	Peak	
2 *	7659.9980	31.85	8.15	40.00	54.00	-14.00	AVG	

REMARKS:

- (1) Measurement Value = Reading Level + Correct Factor.
- (2) Margin Level = Measurement Value - Limit Value.

Orthogonal Axis	X
Test Mode	UNII-3_TX N (HT20) Mode 5785 MHz

Vertical

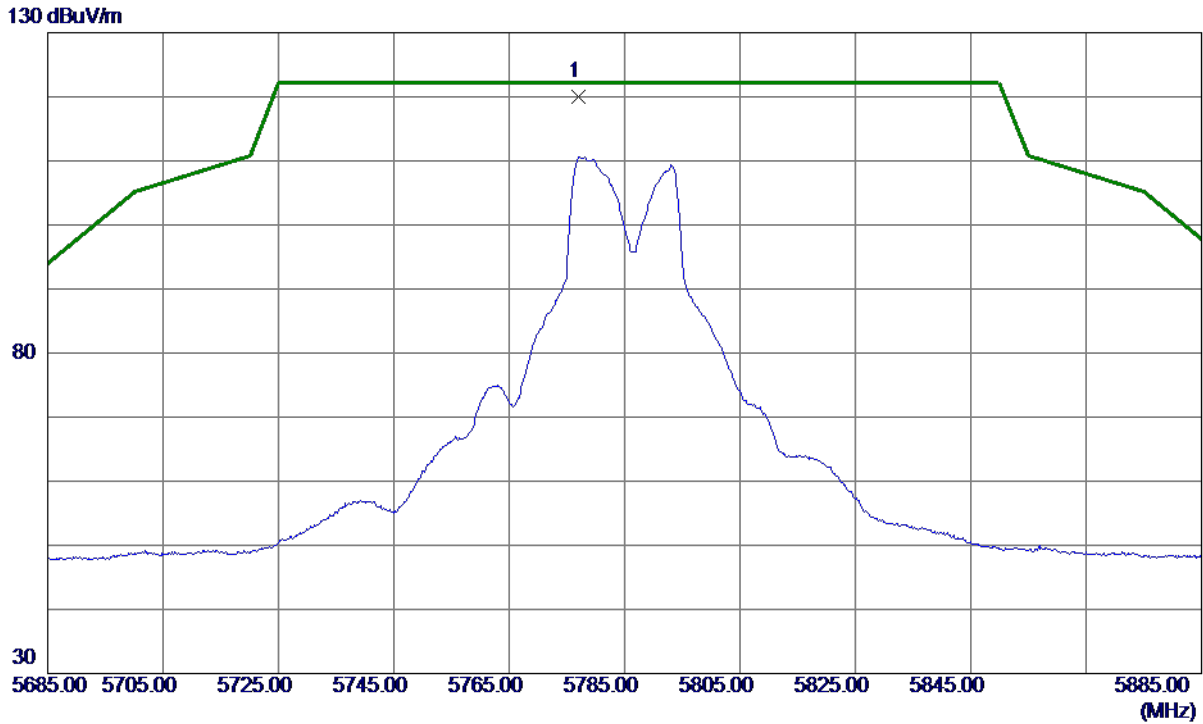

No.	Freq. MHz	Reading Level dBuV/m	Correct Factor dB	Measure ment dBuV/m	Limit dBuV/m	Margin dB	Detector	Comment
1 *	5777.0000	104.33	15.76	120.09	122.20	-2.11	Peak	No Limit

REMARKS:

- (1) Measurement Value = Reading Level + Correct Factor.
- (2) Margin Level = Measurement Value - Limit Value.

Orthogonal Axis	X
Test Mode	UNII-3_TX N (HT20) Mode 5785 MHz

Vertical

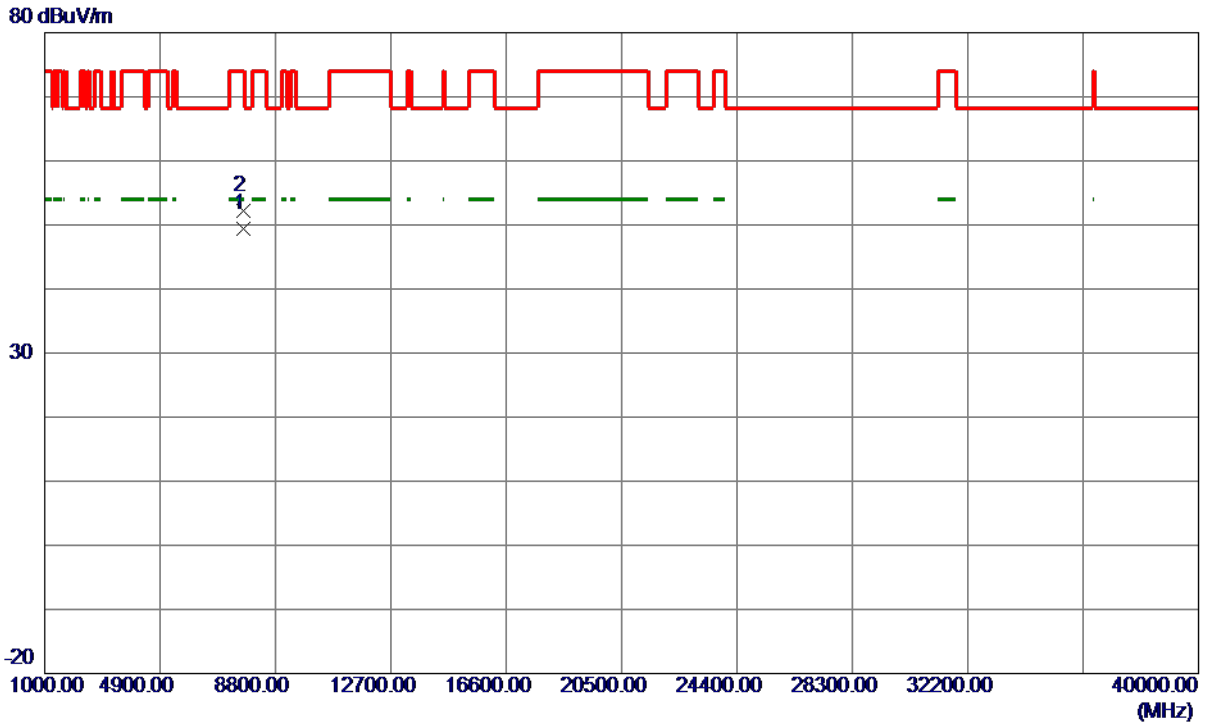

No.	Freq. MHz	Reading Level dBuV/m	Correct Factor dB	Measure ment dBuV/m	Limit dBuV/m	Margin dB	Detector	Comment
1 *	7713.3330	41.34	8.15	49.49	54.00	-4.51	AVG	
2	7713.4400	44.09	8.15	52.24	74.00	-21.76	Peak	

REMARKS:

- (1) Measurement Value = Reading Level + Correct Factor.
- (2) Margin Level = Measurement Value - Limit Value.

Orthogonal Axis	X
Test Mode	UNII-3_TX N (HT20) Mode 5785 MHz

Horizontal

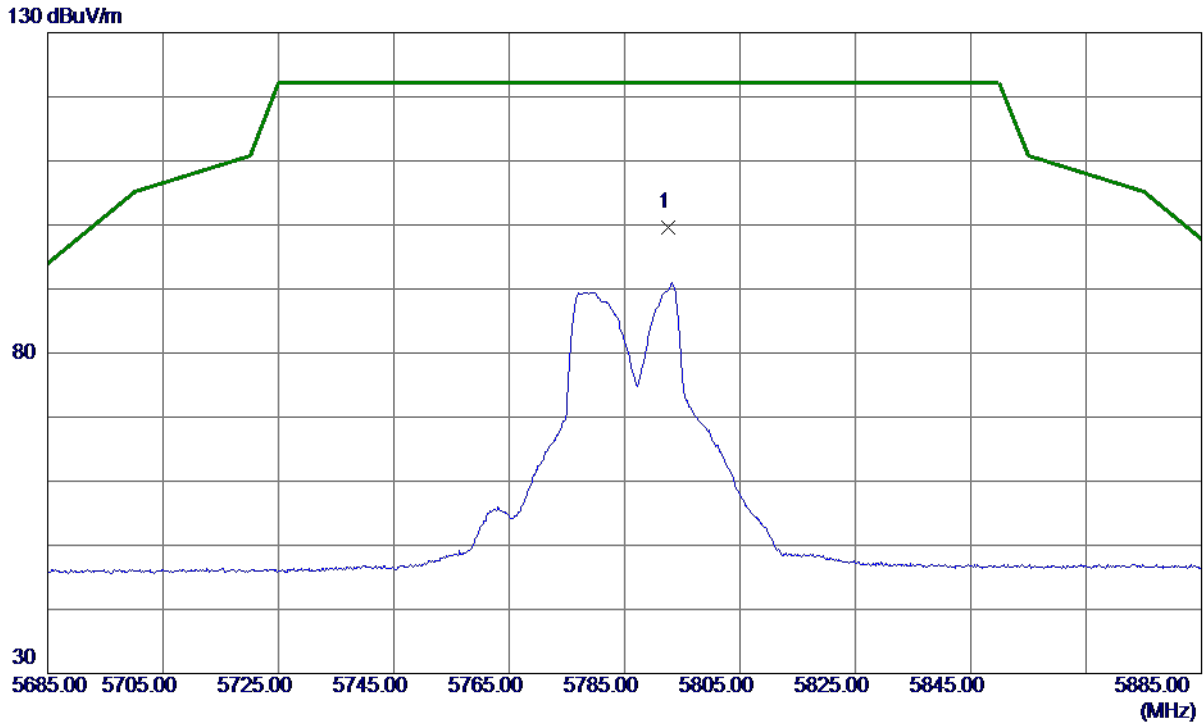

No.	Freq. MHz	Reading Level dBuV/m	Correct Factor dB	Measure ment dBuV/m	Limit dBuV/m	Margin dB	Detector	Comment
1 *	5792.6000	83.74	15.79	99.53	122.20	-22.67	Peak	No Limit

REMARKS:

- (1) Measurement Value = Reading Level + Correct Factor.
- (2) Margin Level = Measurement Value - Limit Value.

Orthogonal Axis	X
Test Mode	UNII-3_TX N (HT20) Mode 5785 MHz

Horizontal

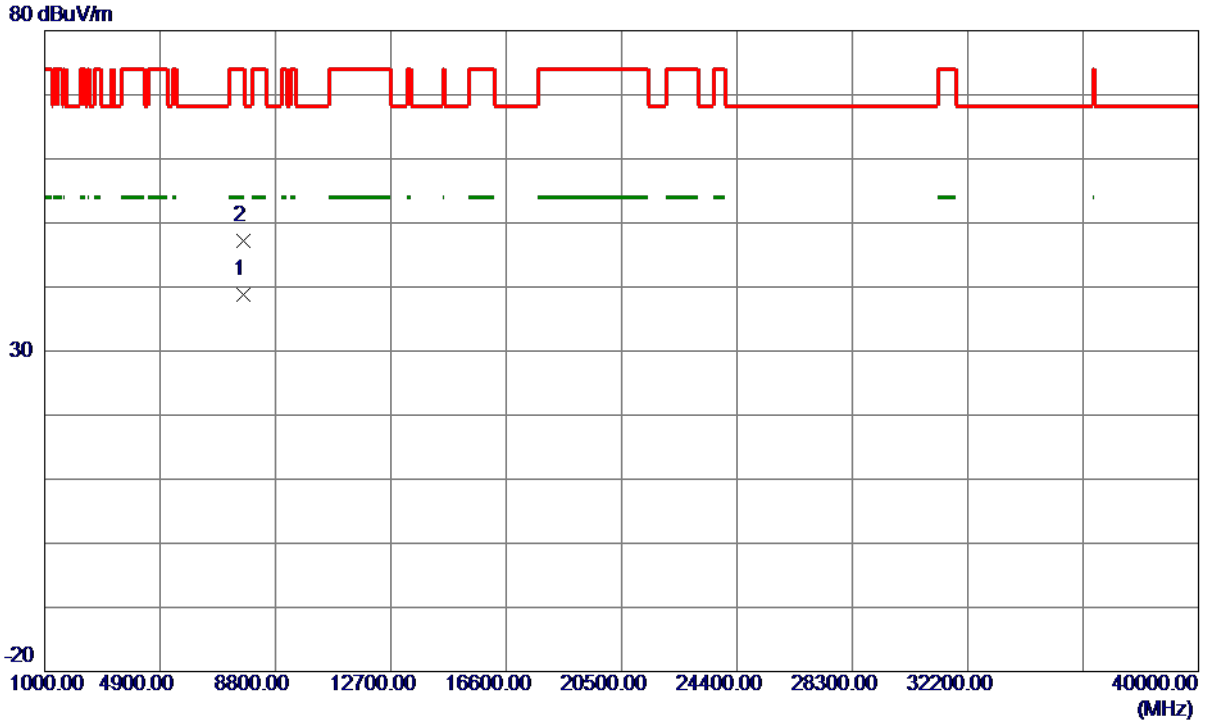

No.	Freq. MHz	Reading Level dBuV/m	Correct Factor dB	Measure ment dBuV/m	Limit dBuV/m	Margin dB	Detector	Comment
1 *	7713.3250	30.59	8.15	38.74	54.00	-15.26	AVG	
2	7713.5150	39.00	8.15	47.15	74.00	-26.85	Peak	

REMARKS:

- (1) Measurement Value = Reading Level + Correct Factor.
- (2) Margin Level = Measurement Value - Limit Value.

Orthogonal Axis	X
Test Mode	UNII-3_TX N (HT20) Mode 5825 MHz

Vertical

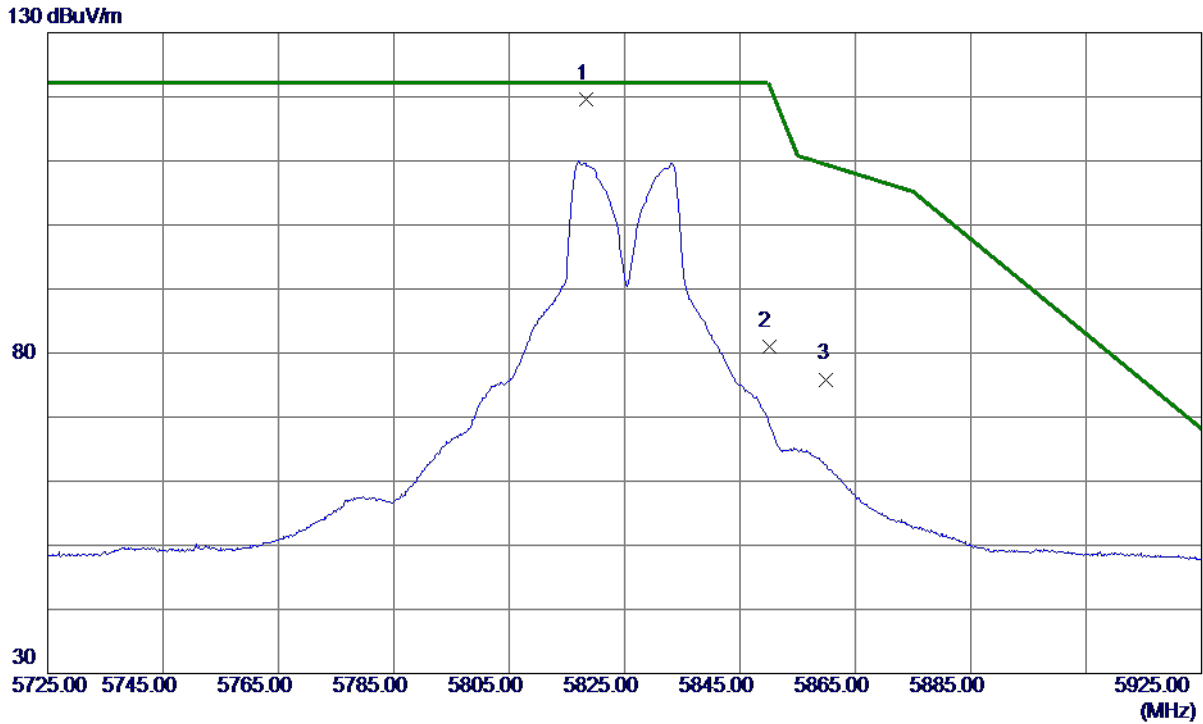

No.	Freq. MHz	Reading Level dBuV/m	Correct Factor dB	Measure ment dBuV/m	Limit dBuV/m	Margin dB	Detector	Comment
1 *	5818.4000	103.79	15.84	119.63	122.20	-2.57	Peak	No Limit
2	5850.0000	65.19	15.90	81.09	122.20	-41.11	Peak	
3	5860.0000	59.98	15.92	75.90	109.40	-33.50	Peak	

REMARKS:

- (1) Measurement Value = Reading Level + Correct Factor.
- (2) Margin Level = Measurement Value - Limit Value.

Orthogonal Axis	X
Test Mode	UNII-3_TX N (HT20) Mode 5825 MHz

Vertical

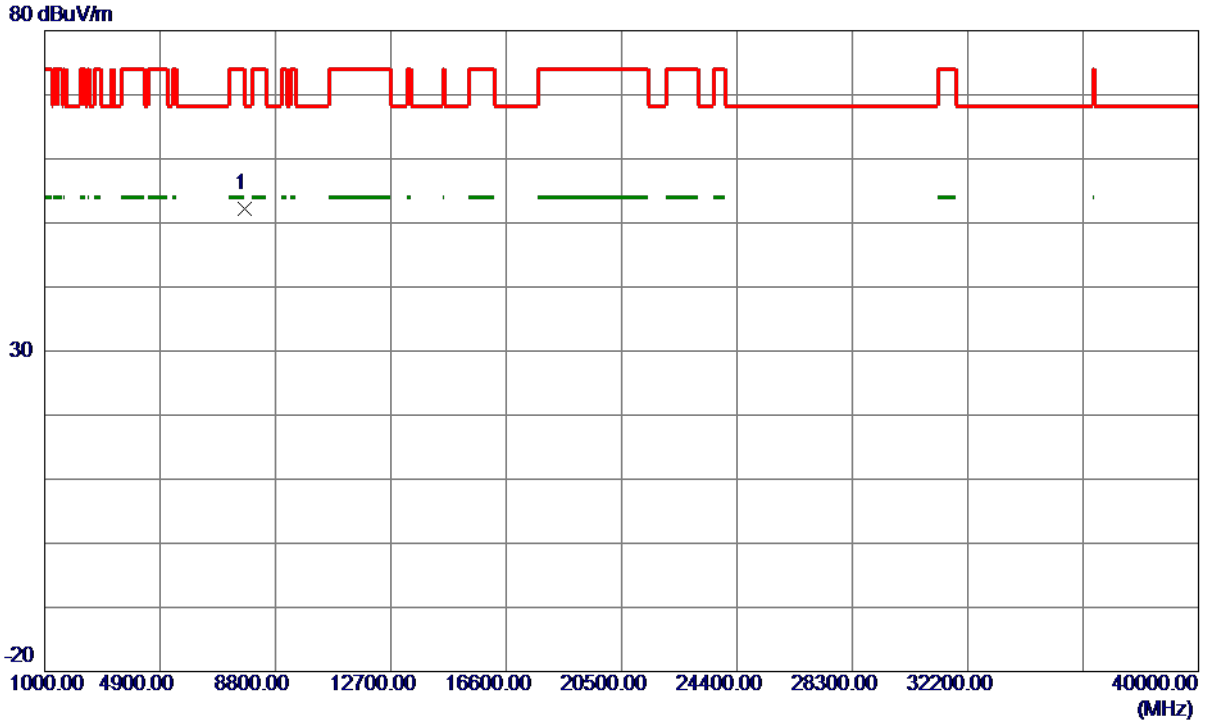

No.	Freq. MHz	Reading Level dBuV/m	Correct Factor dB	Measure ment dBuV/m	Limit dBuV/m	Margin dB	Detector	Comment
1 *	7766.6250	44.11	8.16	52.27	68.30	-16.03	Peak	

REMARKS:

- (1) Measurement Value = Reading Level + Correct Factor.
- (2) Margin Level = Measurement Value - Limit Value.

Orthogonal Axis	X
Test Mode	UNII-3_TX N (HT20) Mode 5825 MHz

Horizontal

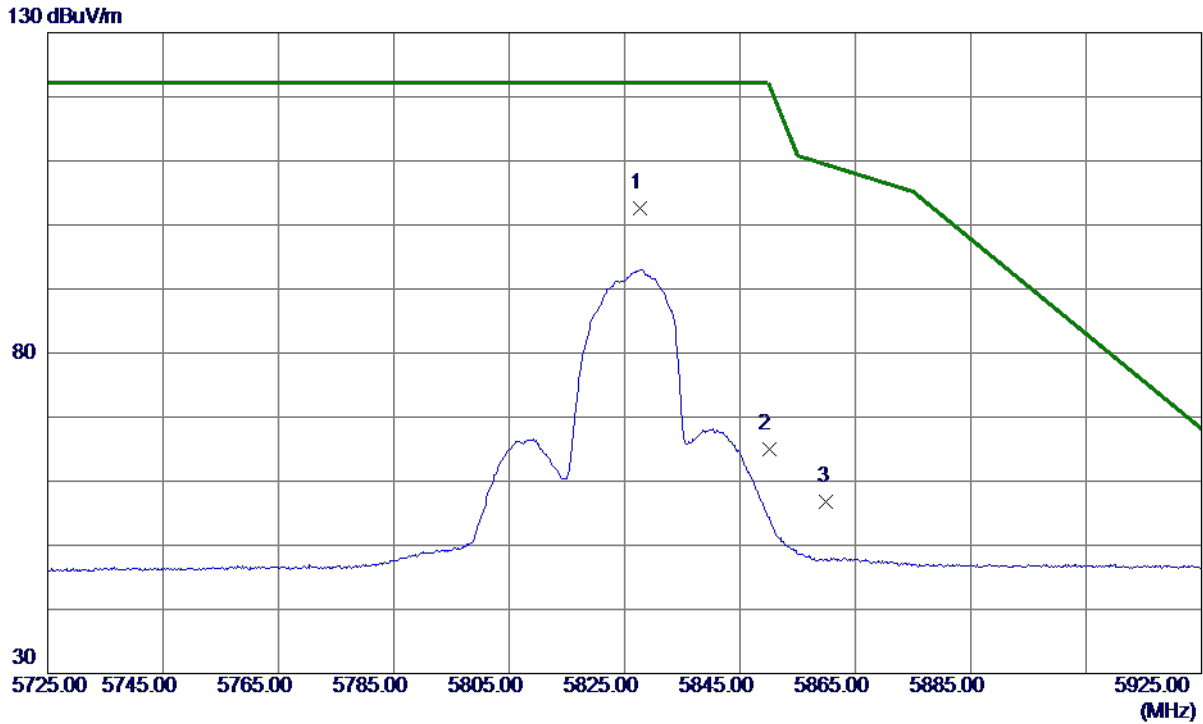

No.	Freq. MHz	Reading Level dBuV/m	Correct Factor dB	Measure ment dBuV/m	Limit dBuV/m	Margin dB	Detector	Comment
1 *	5827.7000	86.83	15.86	102.69	122.20	-19.51	Peak	No Limit
2	5850.0000	49.18	15.90	65.08	122.20	-57.12	Peak	
3	5860.0000	40.90	15.92	56.82	109.40	-52.58	Peak	

REMARKS:

- (1) Measurement Value = Reading Level + Correct Factor.
- (2) Margin Level = Measurement Value - Limit Value.

Orthogonal Axis	X
Test Mode	UNII-3_TX N (HT20) Mode 5825 MHz

Horizontal

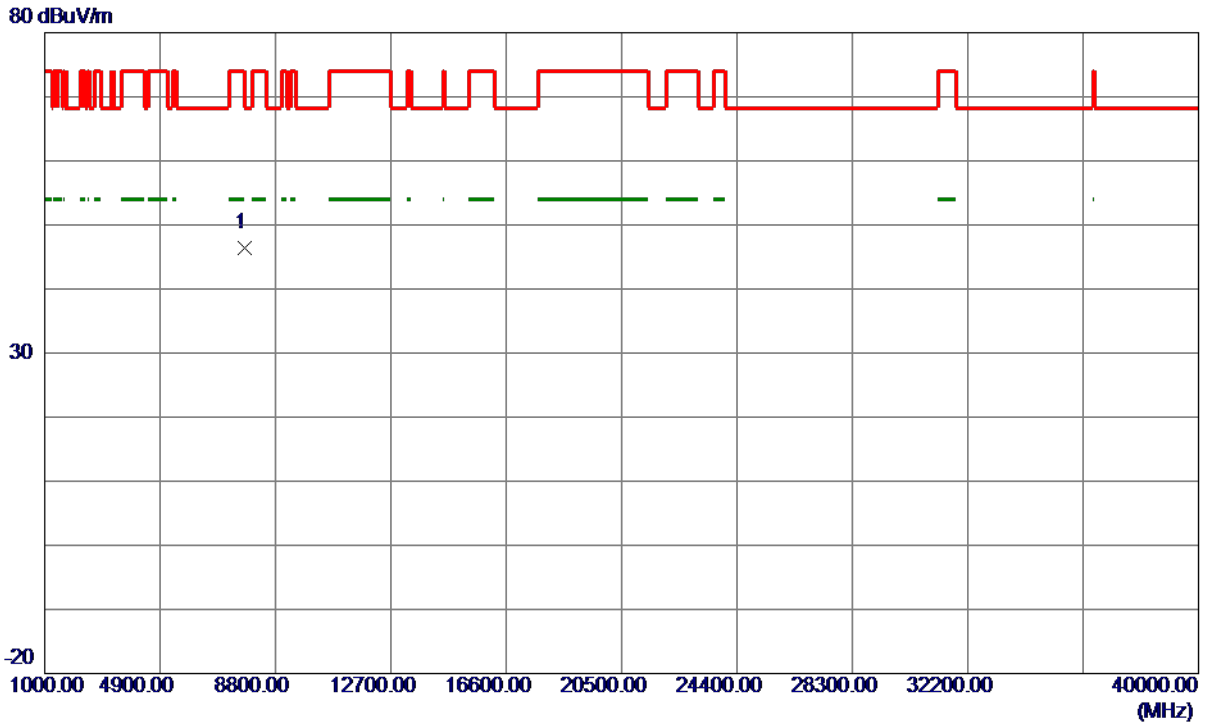

No.	Freq. MHz	Reading Level dBuV/m	Correct Factor dB	Measure ment dBuV/m	Limit dBuV/m	Margin dB	Detector	Comment
1 *	7766.6450	38.20	8.16	46.36	68.30	-21.94	Peak	

REMARKS:

- (1) Measurement Value = Reading Level + Correct Factor.
- (2) Margin Level = Measurement Value - Limit Value.

Orthogonal Axis	X
Test Mode	UNII-3_TX N (HT40) Mode 5755 MHz

Vertical

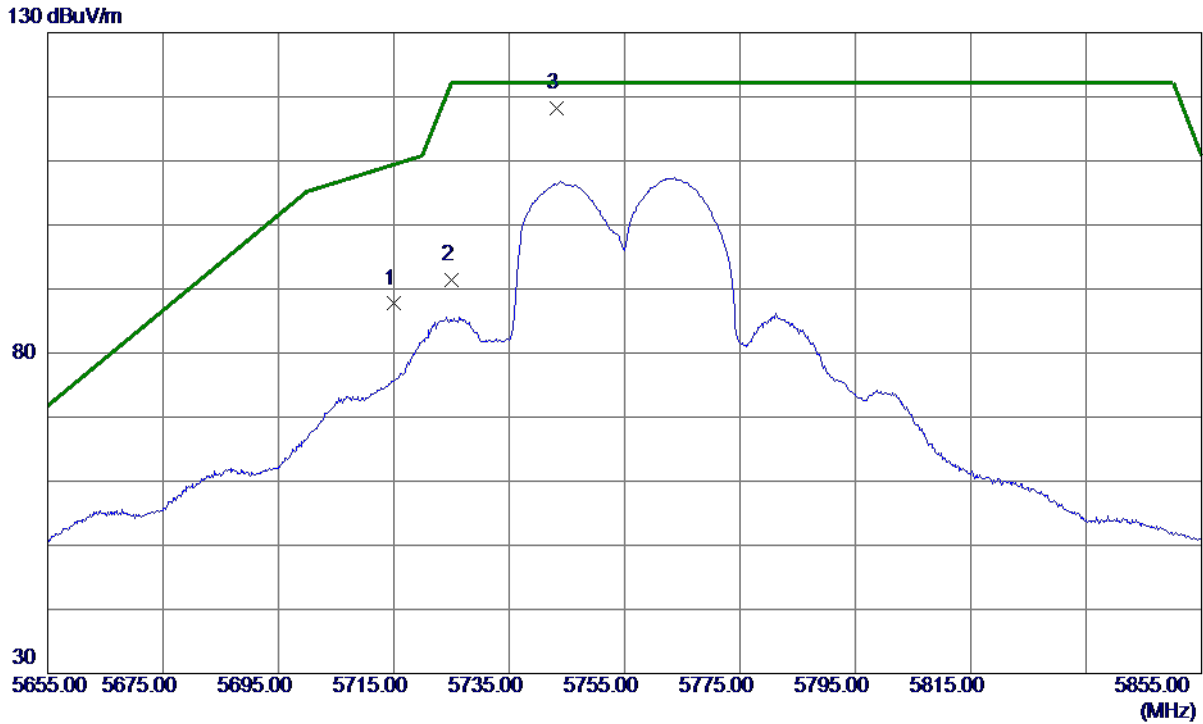

No.	Freq. MHz	Reading Level dBuV/m	Correct Factor dB	Measure ment dBuV/m	Limit dBuV/m	Margin dB	Detector	Comment
1	5715.0000	72.05	15.65	87.70	109.40	-21.70	Peak	
2	5725.0000	75.68	15.67	91.35	122.20	-30.85	Peak	
3 *	5743.3000	102.54	15.70	118.24	122.20	-3.96	Peak	No Limit

REMARKS:

- (1) Measurement Value = Reading Level + Correct Factor.
- (2) Margin Level = Measurement Value - Limit Value.

Orthogonal Axis	X
Test Mode	UNII-3_TX N (HT40) Mode 5755 MHz

Vertical



No.	Freq. MHz	Reading Level dBuV/m	Correct Factor dB	Measure ment dBuV/m	Limit dBuV/m	Margin dB	Detector	Comment
1	7673.2410	42.78	8.15	50.93	74.00	-23.07	Peak	
2 *	7673.3170	38.93	8.15	47.08	54.00	-6.92	AVG	

REMARKS:

- (1) Measurement Value = Reading Level + Correct Factor.
- (2) Margin Level = Measurement Value - Limit Value.

Orthogonal Axis	X
Test Mode	UNII-3_TX N (HT40) Mode 5755 MHz

Horizontal

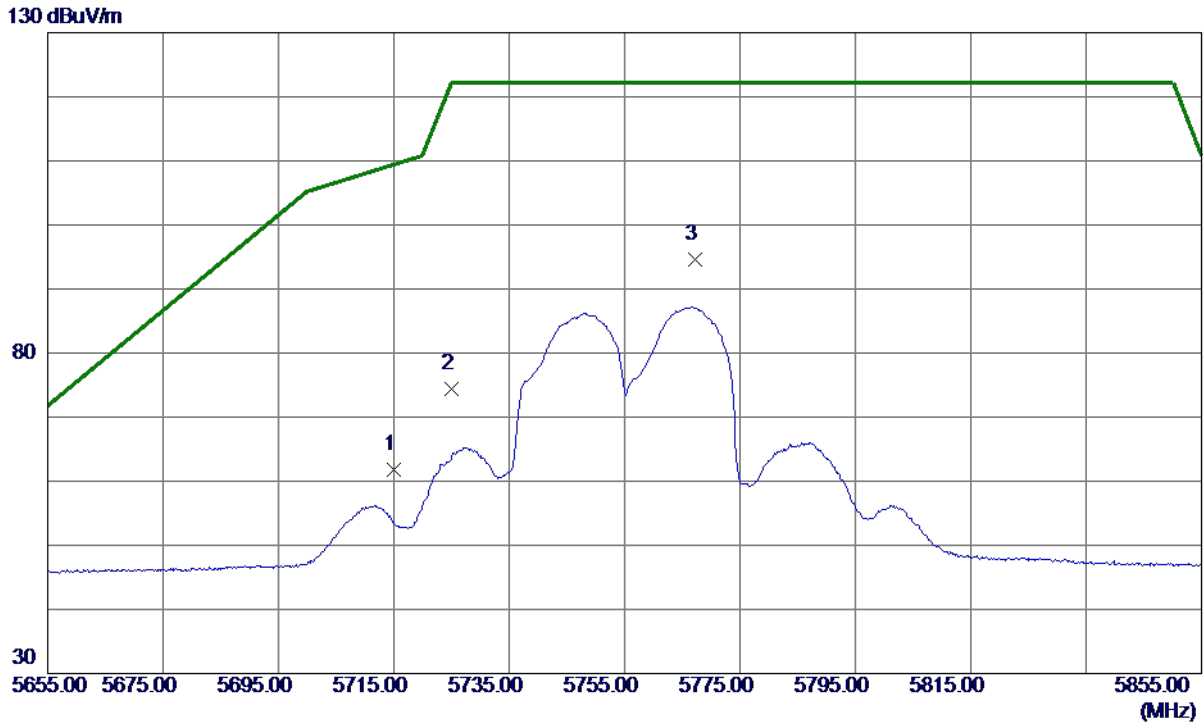

No.	Freq. MHz	Reading Level dBuV/m	Correct Factor dB	Measure ment dBuV/m	Limit dBuV/m	Margin dB	Detector	Comment
1	5715.0000	46.21	15.65	61.86	109.40	-47.54	Peak	
2	5725.0000	58.81	15.67	74.48	122.20	-47.72	Peak	
3 *	5767.3000	78.81	15.75	94.56	122.20	-27.64	Peak	No Limit

REMARKS:

- (1) Measurement Value = Reading Level + Correct Factor.
- (2) Margin Level = Measurement Value - Limit Value.

Orthogonal Axis	X
Test Mode	UNII-3_TX N (HT40) Mode 5755 MHz

Horizontal

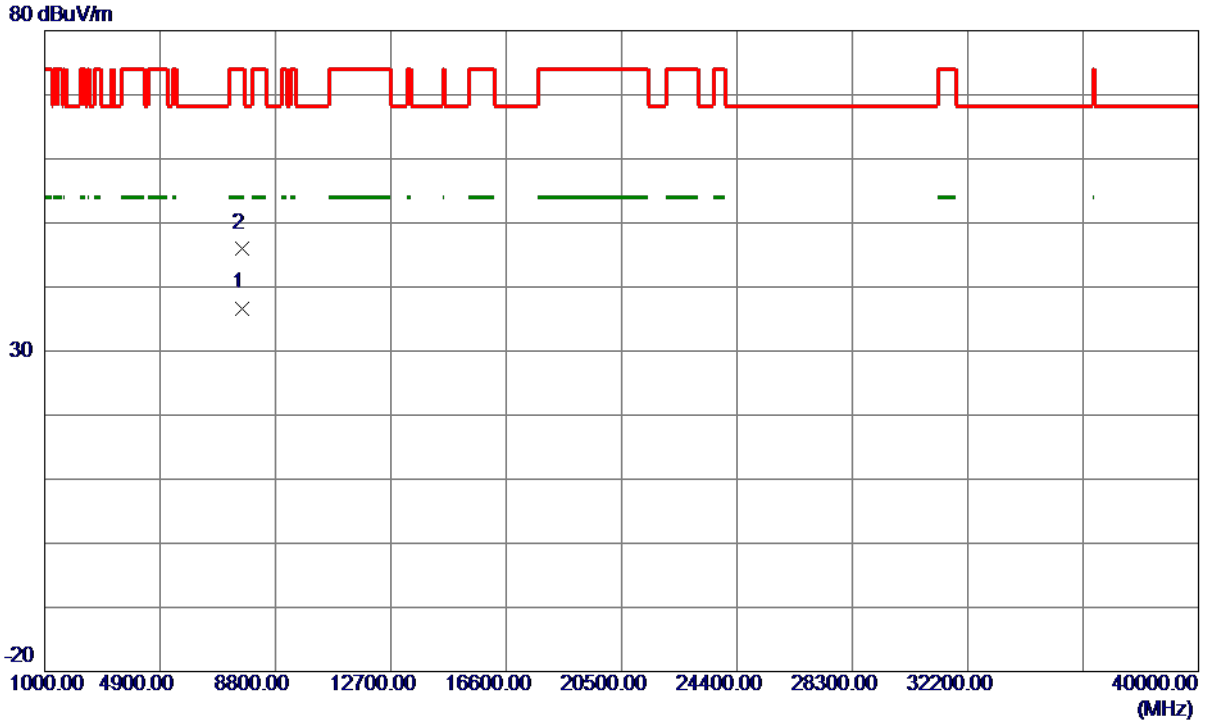

No.	Freq. MHz	Reading Level dBuV/m	Correct Factor dB	Measure ment dBuV/m	Limit dBuV/m	Margin dB	Detector	Comment
1 *	7673.1940	28.55	8.15	36.70	54.00	-17.30	AVG	
2	7673.3190	37.80	8.15	45.95	74.00	-28.05	Peak	

REMARKS:

- (1) Measurement Value = Reading Level + Correct Factor.
- (2) Margin Level = Measurement Value - Limit Value.

Orthogonal Axis	X
Test Mode	UNII-3_TX N (HT40) Mode 5795 MHz

Vertical

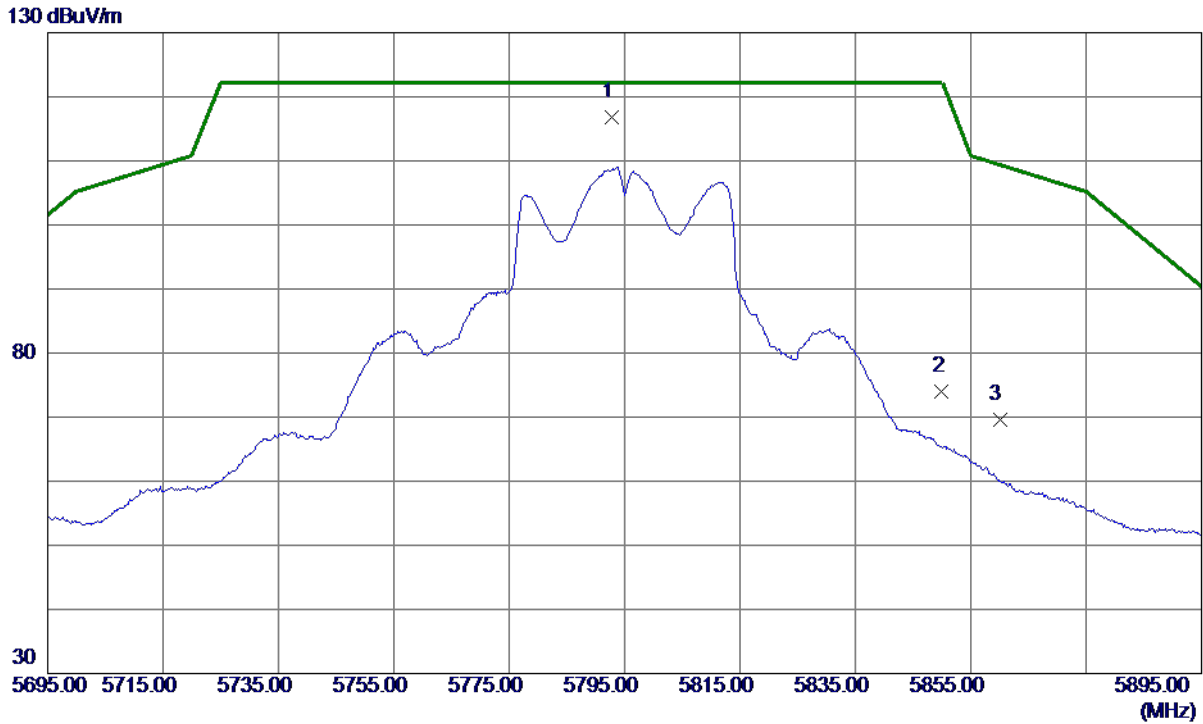

No.	Freq. MHz	Reading Level dBuV/m	Correct Factor dB	Measure ment dBuV/m	Limit dBuV/m	Margin dB	Detector	Comment
1 *	5792.7000	101.03	15.79	116.82	122.20	-5.38	Peak	No Limit
2	5850.0000	58.12	15.90	74.02	122.20	-48.18	Peak	
3	5860.0000	53.63	15.92	69.55	109.40	-39.85	Peak	

REMARKS:

- (1) Measurement Value = Reading Level + Correct Factor.
- (2) Margin Level = Measurement Value - Limit Value.

Orthogonal Axis	X
Test Mode	UNII-3_TX N (HT40) Mode 5795 MHz

Vertical

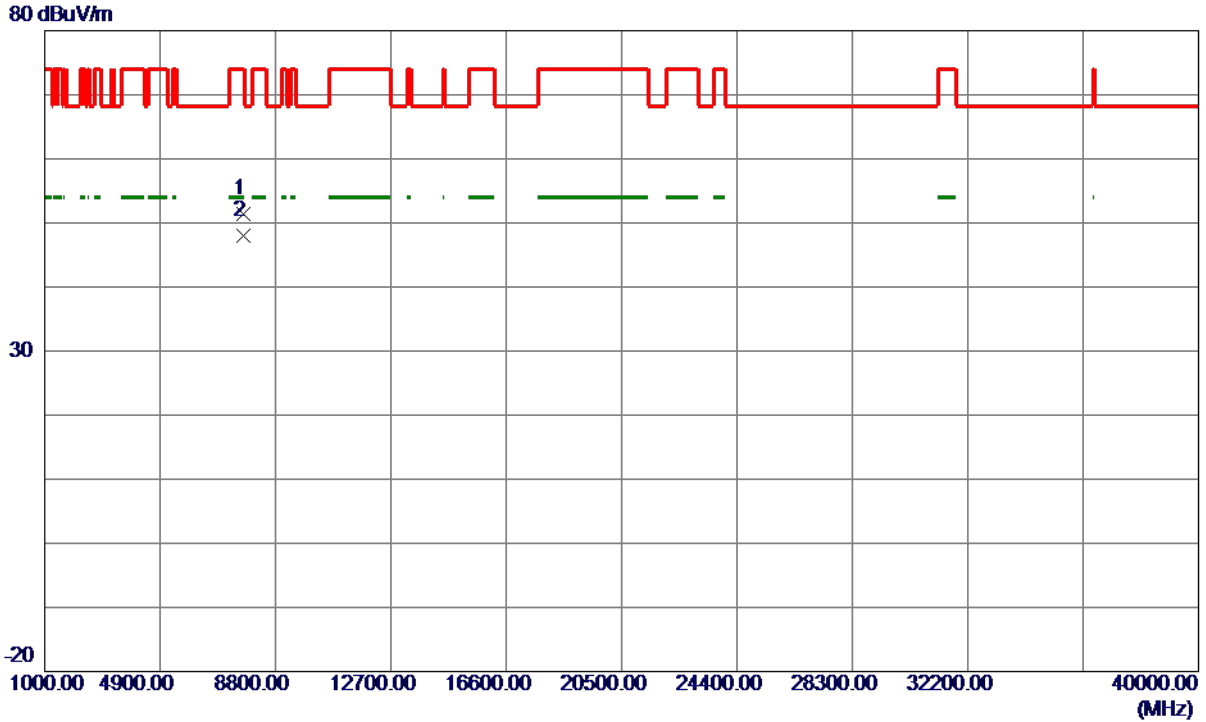

No.	Freq. MHz	Reading Level dBuV/m	Correct Factor dB	Measure ment dBuV/m	Limit dBuV/m	Margin dB	Detector	Comment
1	7726.6610	43.29	8.15	51.44	74.00	-22.56	Peak	
2 *	7726.6750	39.78	8.15	47.93	54.00	-6.07	AVG	

REMARKS:

- (1) Measurement Value = Reading Level + Correct Factor.
- (2) Margin Level = Measurement Value - Limit Value.

Orthogonal Axis	X
Test Mode	UNII-3_TX N (HT40) Mode 5795 MHz

Horizontal

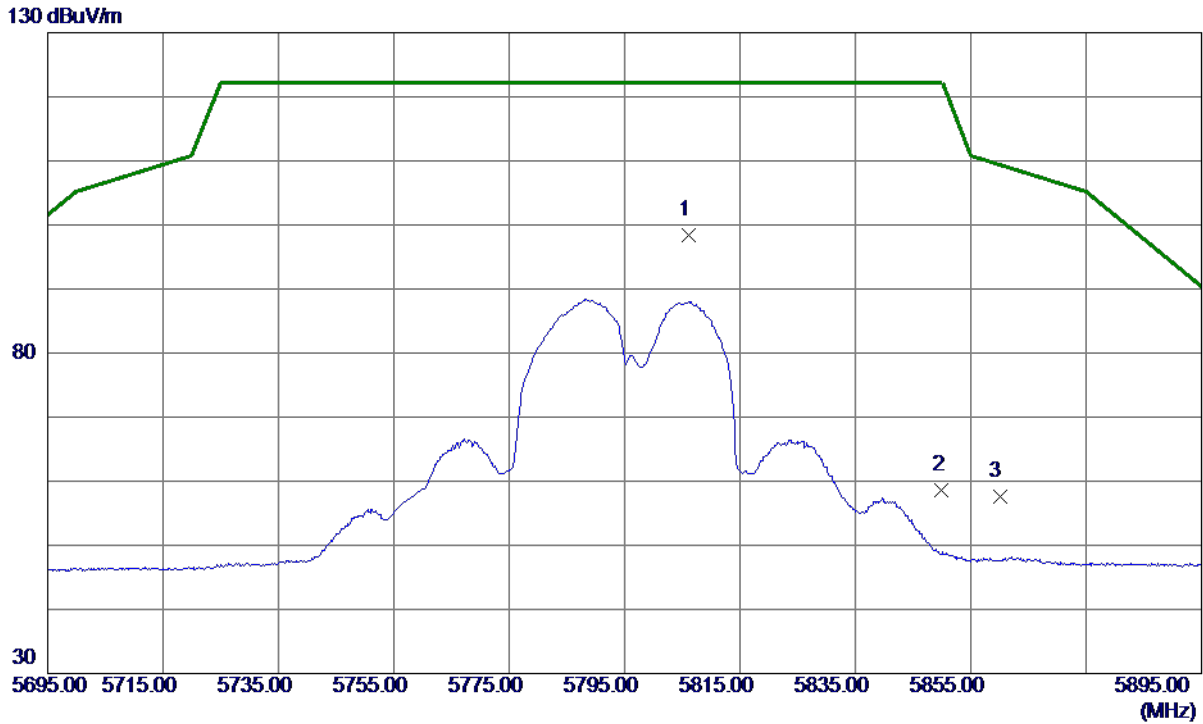

No.	Freq. MHz	Reading Level dBuV/m	Correct Factor dB	Measure ment dBuV/m	Limit dBuV/m	Margin dB	Detector	Comment
1 *	5806.2000	82.64	15.82	98.46	122.20	-23.74	Peak	No Limit
2	5850.0000	42.63	15.90	58.53	122.20	-63.67	Peak	
3	5860.0000	41.76	15.92	57.68	109.40	-51.72	Peak	

REMARKS:

- (1) Measurement Value = Reading Level + Correct Factor.
- (2) Margin Level = Measurement Value - Limit Value.

Orthogonal Axis	X
Test Mode	UNII-3_TX N (HT40) Mode 5795 MHz

Horizontal

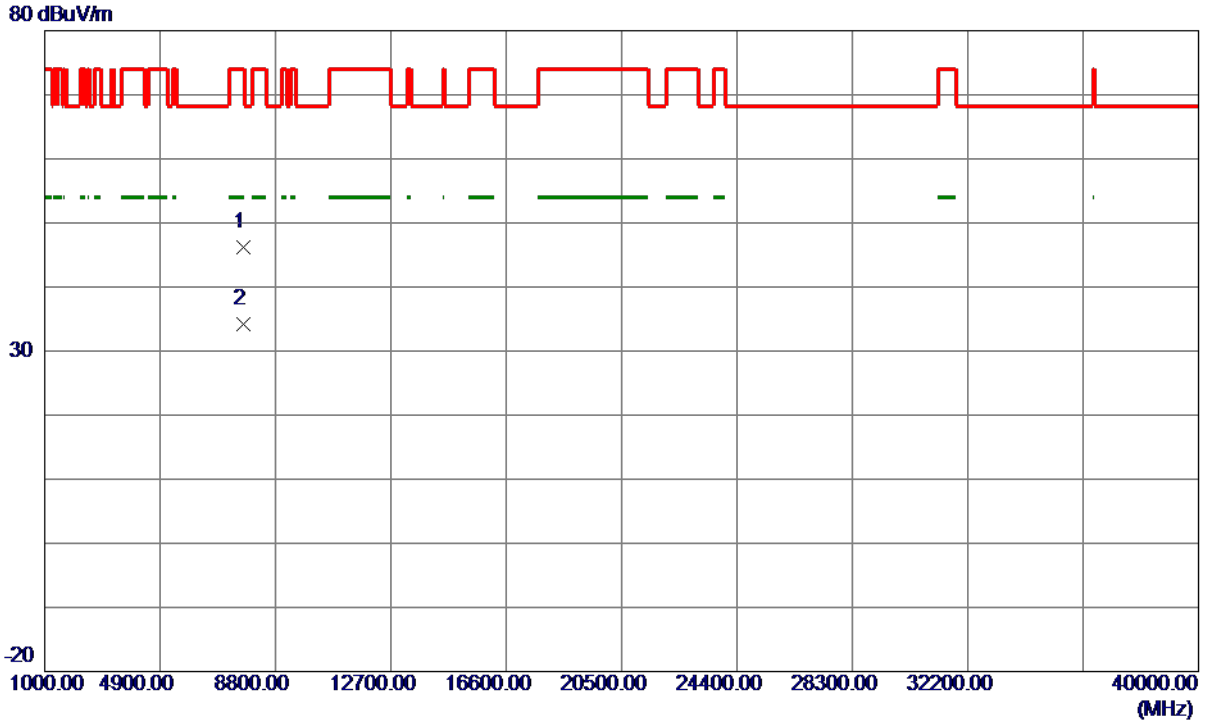

No.	Freq. MHz	Reading Level dBuV/m	Correct Factor dB	Measure ment dBuV/m	Limit dBuV/m	Margin dB	Detector	Comment
1	7726.6750	38.10	8.15	46.25	74.00	-27.75	Peak	
2 *	7726.8360	26.02	8.15	34.17	54.00	-19.83	AVG	

REMARKS:

- (1) Measurement Value = Reading Level + Correct Factor.
- (2) Margin Level = Measurement Value - Limit Value.

Orthogonal Axis	X
Test Mode	UNII-1_TX AC (VHT80) Mode 5210 MHz

Vertical

130 dBuV/m

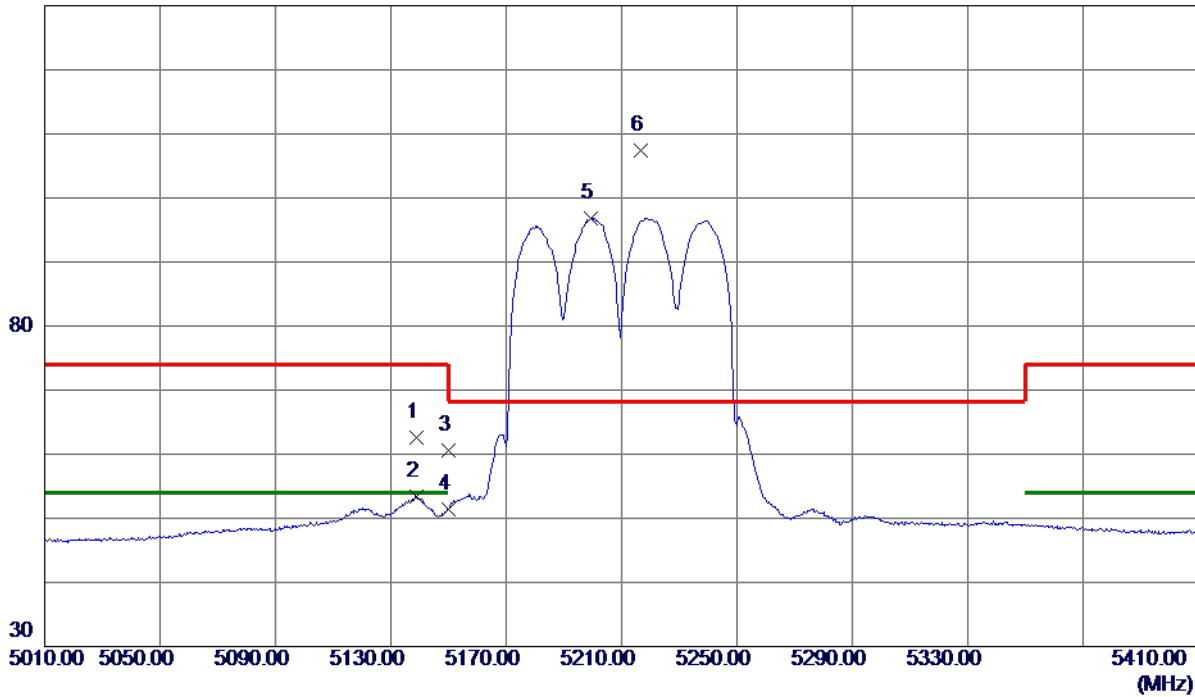

No.	Freq. MHz	Reading Level dBuV/m	Correct Factor dB	Measure ment dBuV/m	Limit dBuV/m	Margin dB	Detector	Comment
1	5138.8000	47.65	15.01	62.66	74.00	-11.34	Peak	
2	5138.8000	38.40	15.01	53.41	54.00	-0.59	AVG	
3	5150.0000	45.63	15.02	60.65	74.00	-13.35	Peak	
4	5150.0000	36.45	15.02	51.47	54.00	-2.53	AVG	
5	5199.4000	81.82	15.05	96.87	999.00	-902.13	AVG	No Limit
6 *	5216.8000	92.28	15.06	107.34	68.30	39.04	Peak	No Limit

REMARKS:

- (1) Measurement Value = Reading Level + Correct Factor.
- (2) Margin Level = Measurement Value - Limit Value.

Orthogonal Axis	X
Test Mode	UNII-1_TX AC (VHT80) Mode 5210 MHz

Vertical

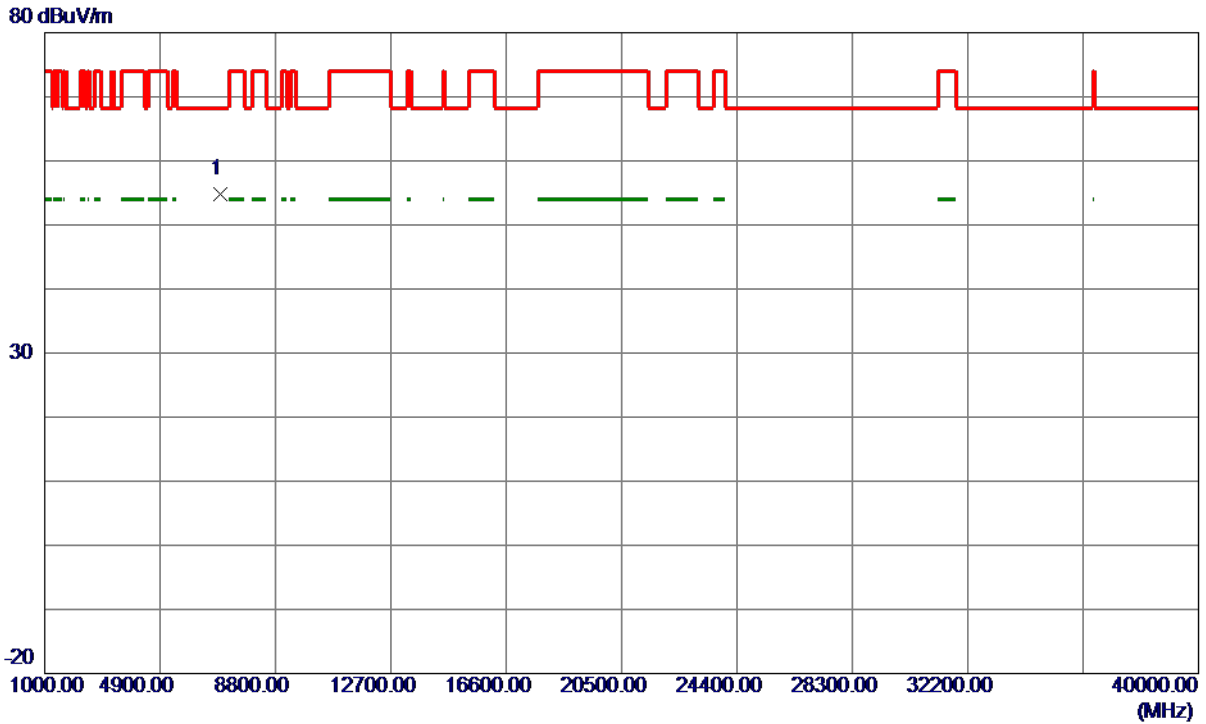

No.	Freq. MHz	Reading Level dBuV/m	Correct Factor dB	Measure ment dBuV/m	Limit dBuV/m	Margin dB	Detector	Comment
1 *	6946.6630	47.37	7.47	54.84	68.30	-13.46	Peak	

REMARKS:

- (1) Measurement Value = Reading Level + Correct Factor.
- (2) Margin Level = Measurement Value - Limit Value.

Orthogonal Axis	X
Test Mode	UNII-1_TX AC (VHT80) Mode 5210 MHz

Horizontal

130 dBuV/m

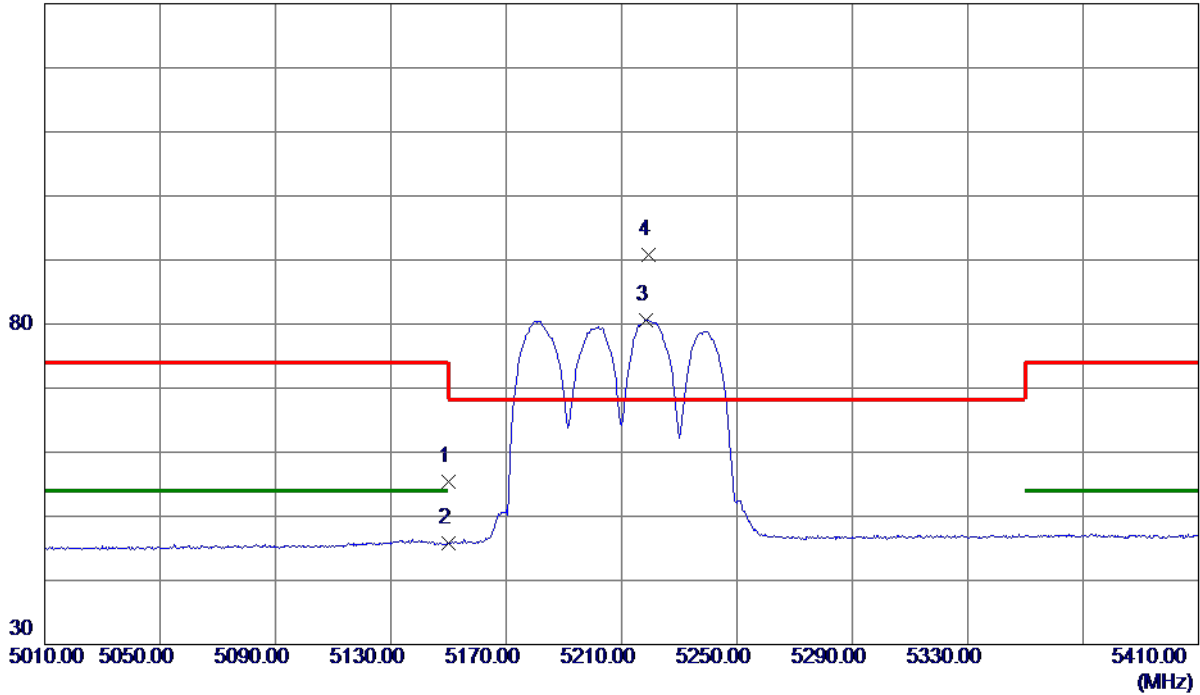

No.	Freq. MHz	Reading Level dBuV/m	Correct Factor dB	Measure ment dBuV/m	Limit dBuV/m	Margin dB	Detector	Comment
1	5150.0000	40.44	15.02	55.46	74.00	-18.54	Peak	
2	5150.0000	30.86	15.02	45.88	54.00	-8.12	AVG	
3	5218.4000	65.63	15.06	80.69	999.00	-918.31	AVG	No Limit
4 *	5219.2000	75.80	15.06	90.86	68.30	22.56	Peak	No Limit

REMARKS:

- (1) Measurement Value = Reading Level + Correct Factor.
- (2) Margin Level = Measurement Value - Limit Value.

Orthogonal Axis	X
Test Mode	UNII-1_TX AC (VHT80) Mode 5210 MHz

Horizontal

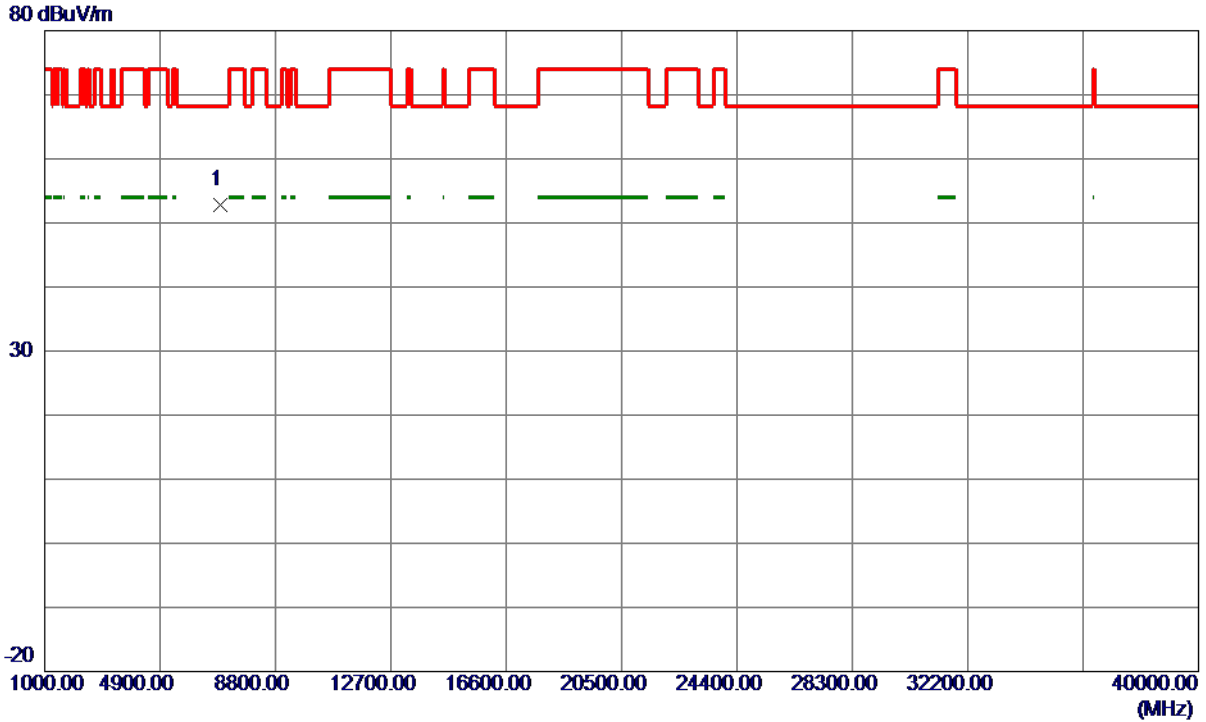

No.	Freq. MHz	Reading Level dBuV/m	Correct Factor dB	Measure ment dBuV/m	Limit dBuV/m	Margin dB	Detector	Comment
1 *	6946.7580	45.32	7.47	52.79	68.30	-15.51	Peak	

REMARKS:

- (1) Measurement Value = Reading Level + Correct Factor.
- (2) Margin Level = Measurement Value - Limit Value.

Orthogonal Axis	X
Test Mode	UNII-3_TX AC (VHT80) Mode 5775 MHz

Vertical

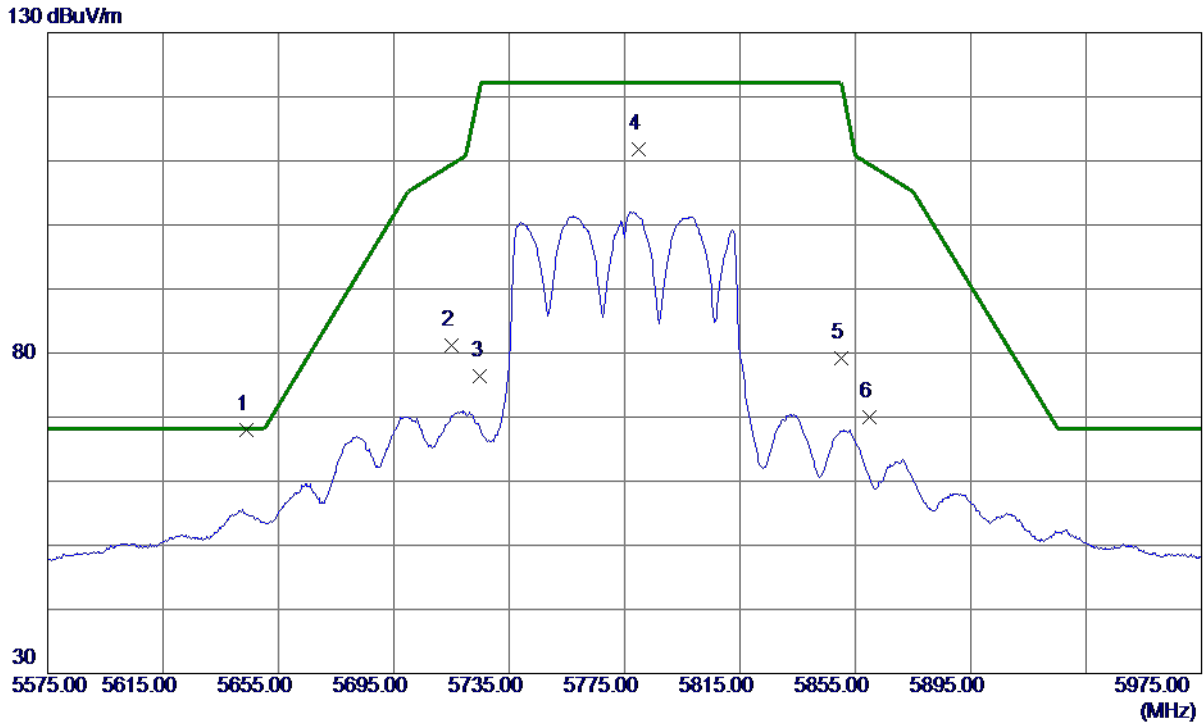

No.	Freq. MHz	Reading Level dBuV/m	Correct Factor dB	Measure ment dBuV/m	Limit dBuV/m	Margin dB	Detector	Comment
1 *	5643.8000	52.46	15.52	67.98	68.20	-0.22	Peak	
2	5715.0000	65.54	15.65	81.19	109.40	-28.21	Peak	
3	5725.0000	60.72	15.67	76.39	122.20	-45.81	Peak	
4	5780.0000	96.03	15.77	111.80	122.20	-10.40	Peak	No Limit
5	5850.0000	63.34	15.90	79.24	122.20	-42.96	Peak	
6	5860.0000	54.01	15.92	69.93	109.40	-39.47	Peak	

REMARKS:

- (1) Measurement Value = Reading Level + Correct Factor.
- (2) Margin Level = Measurement Value - Limit Value.

Orthogonal Axis	X
Test Mode	UNII-3_TX AC (VHT80) Mode 5775 MHz

Vertical

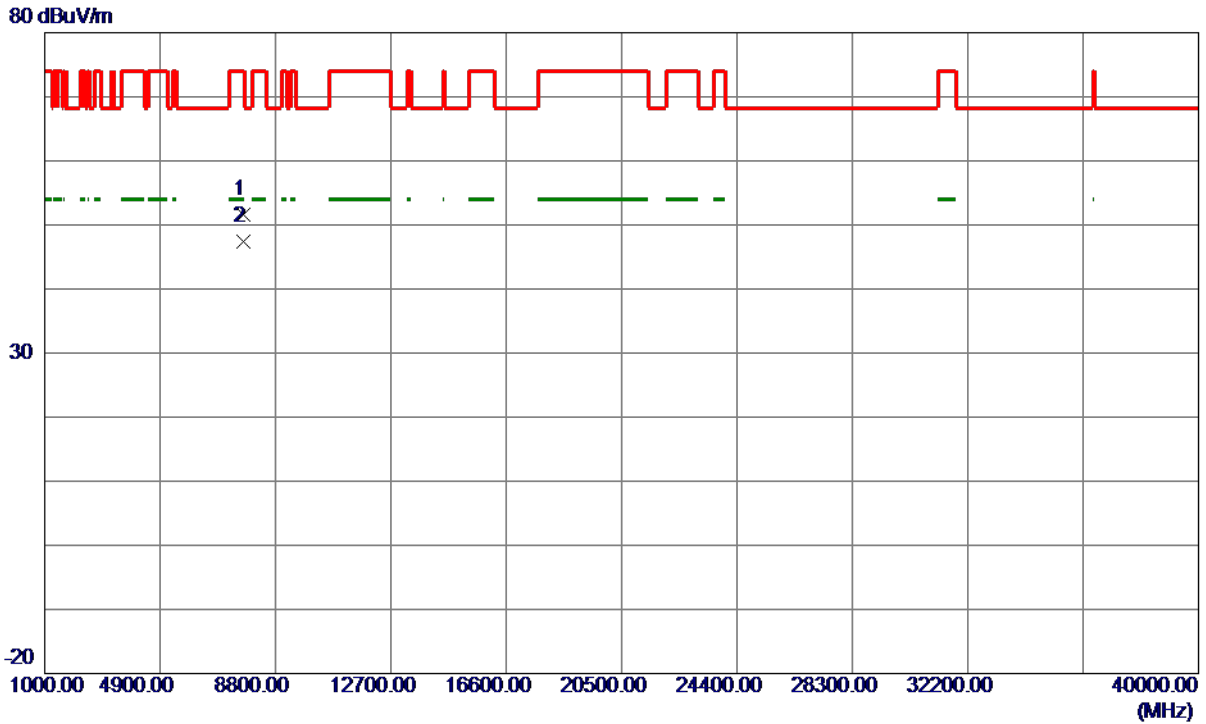

No.	Freq. MHz	Reading Level dBuV/m	Correct Factor dB	Measure ment dBuV/m	Limit dBuV/m	Margin dB	Detector	Comment
1	7699.8970	43.37	8.15	51.52	74.00	-22.48	Peak	
2 *	7700.0160	39.33	8.15	47.48	54.00	-6.52	AVG	

REMARKS:

- (1) Measurement Value = Reading Level + Correct Factor.
- (2) Margin Level = Measurement Value - Limit Value.

Orthogonal Axis	X
Test Mode	UNII-3_TX AC (VHT80) Mode 5775 MHz

Horizontal

130 dBuV/m

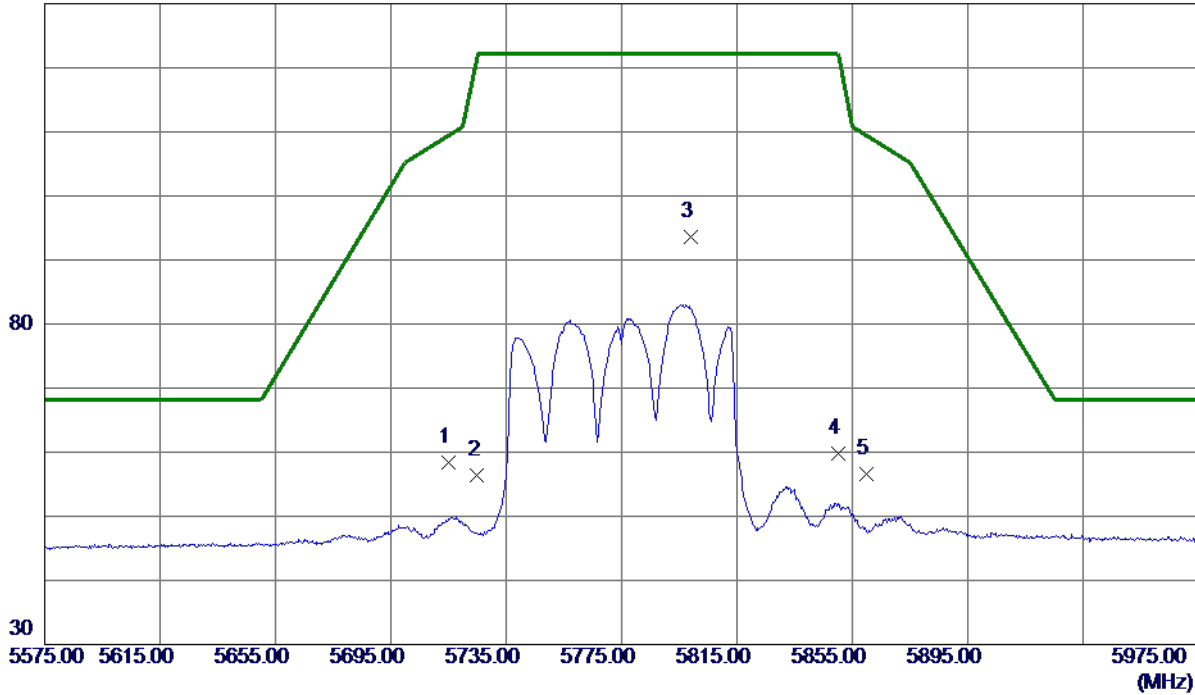

No.	Freq. MHz	Reading Level dBuV/m	Correct Factor dB	Measure ment dBuV/m	Limit dBuV/m	Margin dB	Detector	Comment
1	5715.0000	42.72	15.65	58.37	109.40	-51.03	Peak	
2	5725.0000	40.69	15.67	56.36	122.20	-65.84	Peak	
3 *	5798.8000	77.84	15.80	93.64	122.20	-28.56	Peak	No Limit
4	5850.0000	43.94	15.90	59.84	122.20	-62.36	Peak	
5	5860.0000	40.64	15.92	56.56	109.40	-52.84	Peak	

REMARKS:

- (1) Measurement Value = Reading Level + Correct Factor.
- (2) Margin Level = Measurement Value - Limit Value.

Orthogonal Axis	X
Test Mode	UNII-3_TX AC (VHT80) Mode 5775 MHz

Horizontal

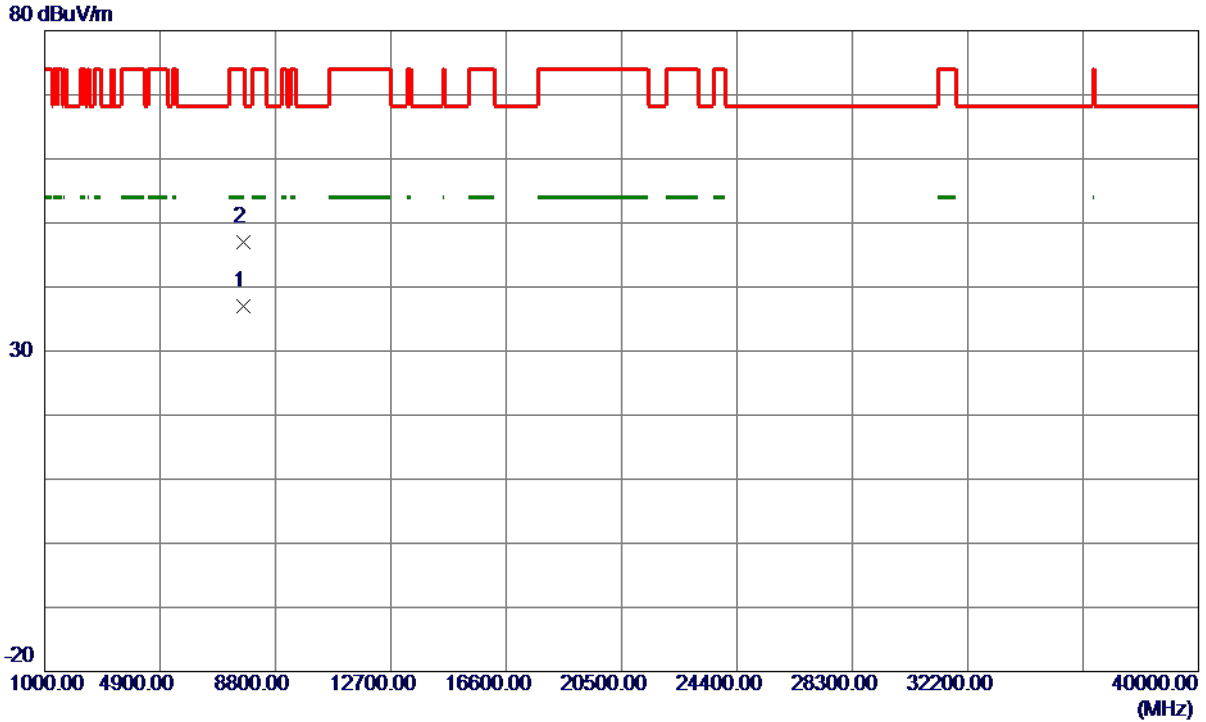

No.	Freq. MHz	Reading Level dBuV/m	Correct Factor dB	Measure ment dBuV/m	Limit dBuV/m	Margin dB	Detector	Comment
1 *	7699.8760	28.78	8.15	36.93	54.00	-17.07	AVG	
2	7700.1640	38.94	8.15	47.09	74.00	-26.91	Peak	

REMARKS:

- (1) Measurement Value = Reading Level + Correct Factor.
- (2) Margin Level = Measurement Value - Limit Value.

With Beamforming

Orthogonal Axis	X
Test Mode	UNII-1_TX N (HT20) Mode 5180 MHz

Vertical

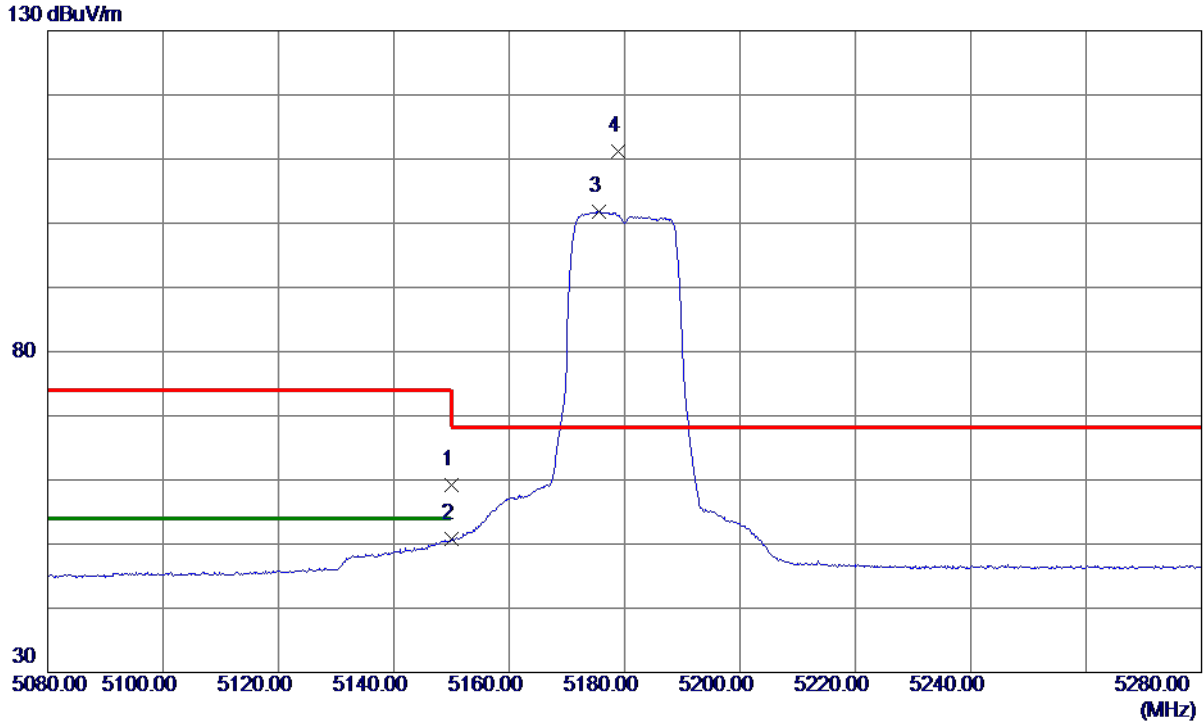

No.	Freq. MHz	Reading Level dBuV/m	Correct Factor dB	Measure ment dBuV/m	Limit dBuV/m	Margin dB	Detector	Comment
1	5150.0000	44.20	15.02	59.22	74.00	-14.78	Peak	
2	5150.0000	35.75	15.02	50.77	54.00	-3.23	AVG	
3	5175.6000	86.81	15.03	101.84	999.00	-897.16	AVG	No Limit
4 *	5178.9000	96.14	15.04	111.18	68.30	42.88	Peak	No Limit

REMARKS:

- (1) Measurement Value = Reading Level + Correct Factor.
- (2) Margin Level = Measurement Value - Limit Value.

Orthogonal Axis	X
Test Mode	UNII-1_TX N (HT20) Mode 5180 MHz

Vertical

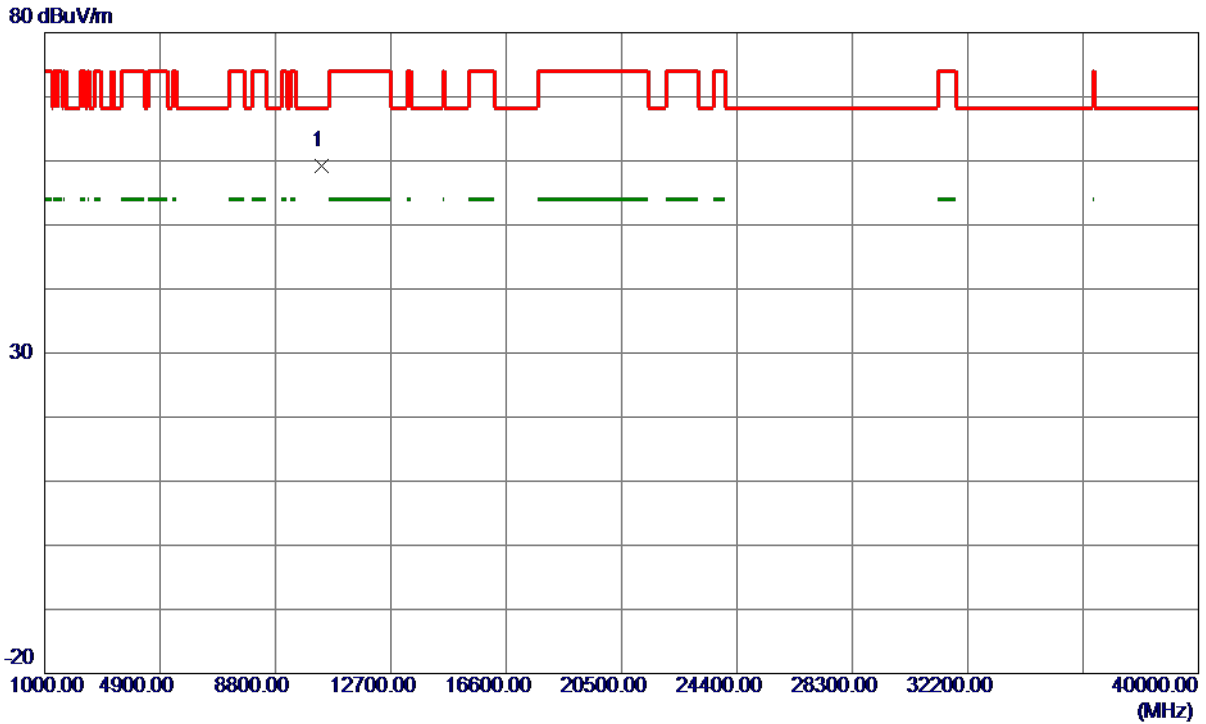

No.	Freq. MHz	Reading Level dBuV/m	Correct Factor dB	Measure ment dBuV/m	Limit dBuV/m	Margin dB	Detector	Comment
1 *	10358.9250	50.34	8.89	59.23	68.30	-9.07	Peak	

REMARKS:

- (1) Measurement Value = Reading Level + Correct Factor.
- (2) Margin Level = Measurement Value - Limit Value.

Orthogonal Axis	X
Test Mode	UNII-1_TX N (HT20) Mode 5180 MHz

Horizontal

130 dBuV/m

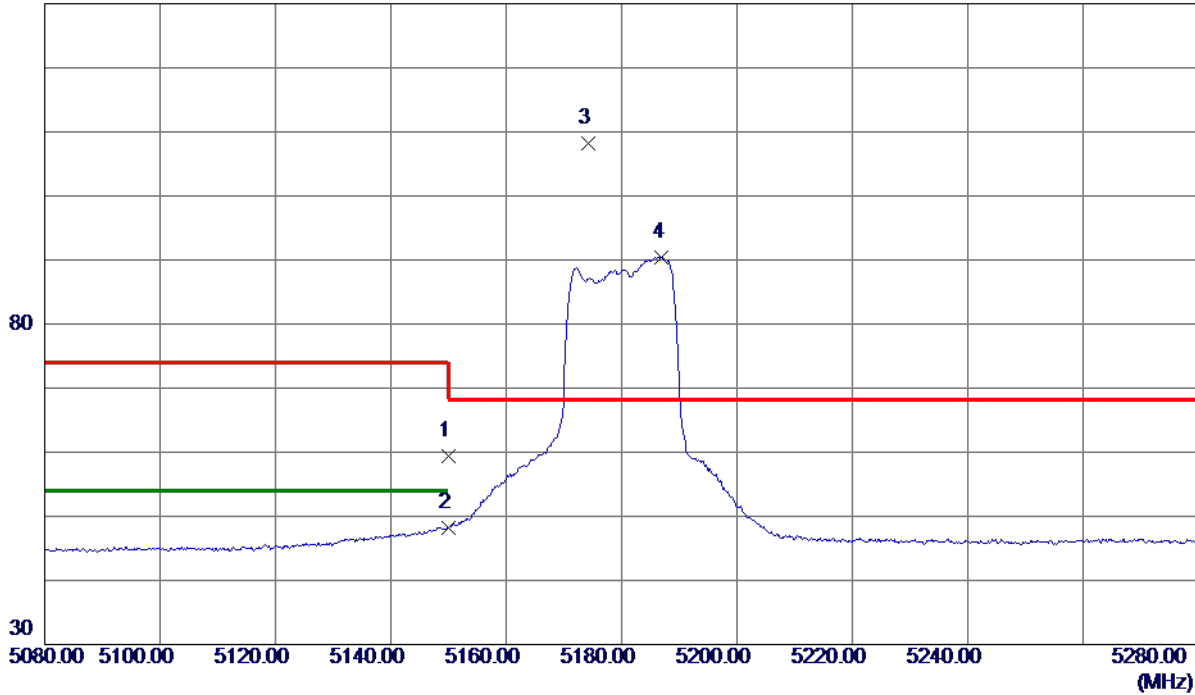

No.	Freq. MHz	Reading Level dBuV/m	Correct Factor dB	Measure ment dBuV/m	Limit dBuV/m	Margin dB	Detector	Comment
1	5150.0000	44.34	15.02	59.36	74.00	-14.64	Peak	
2	5150.0000	33.27	15.02	48.29	54.00	-5.71	AVG	
3 *	5174.3000	93.08	15.03	108.11	68.30	39.81	Peak	No Limit
4	5187.0000	75.44	15.04	90.48	999.00	-908.52	AVG	No Limit

REMARKS:

- (1) Measurement Value = Reading Level + Correct Factor.
- (2) Margin Level = Measurement Value - Limit Value.

Orthogonal Axis	X
Test Mode	UNII-1_TX N (HT20) Mode 5180 MHz

Horizontal

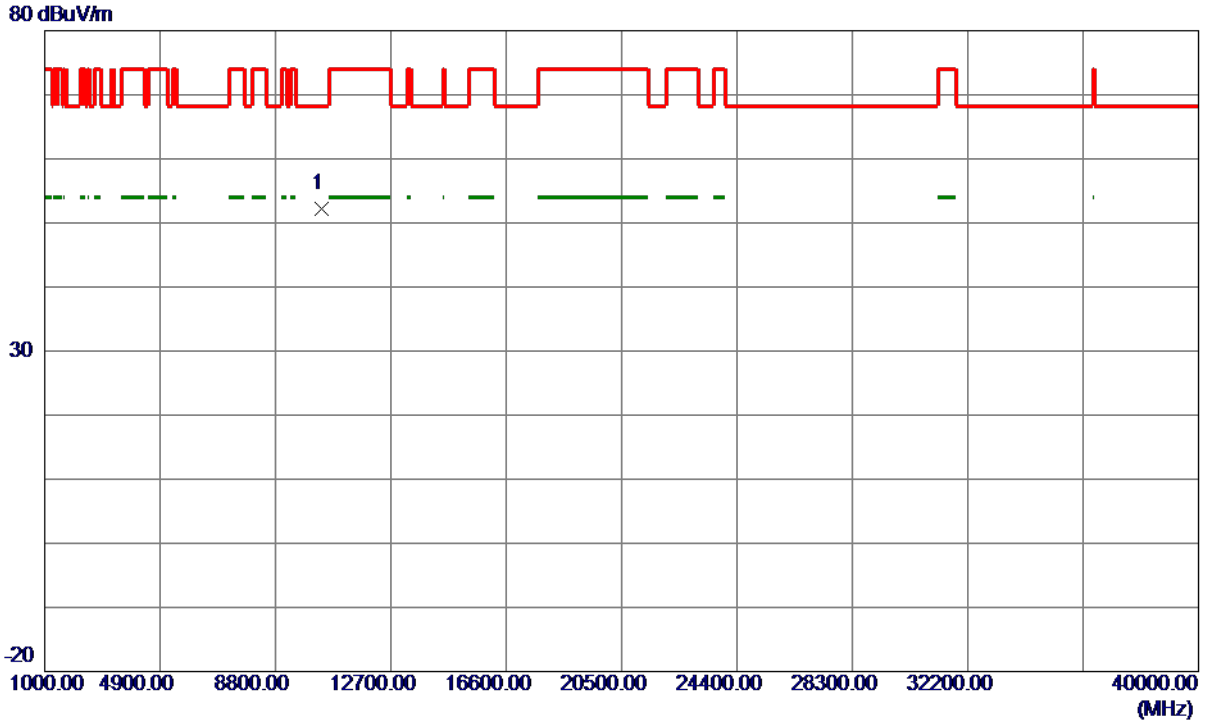

No.	Freq. MHz	Reading Level dBuV/m	Correct Factor dB	Measure ment dBuV/m	Limit dBuV/m	Margin dB	Detector	Comment
1 *	10366.8750	43.23	8.91	52.14	68.30	-16.16	Peak	

REMARKS:

- (1) Measurement Value = Reading Level + Correct Factor.
- (2) Margin Level = Measurement Value - Limit Value.

Orthogonal Axis	X
Test Mode	UNII-1_TX N (HT20) Mode 5200 MHz

Vertical

130 dBuV/m

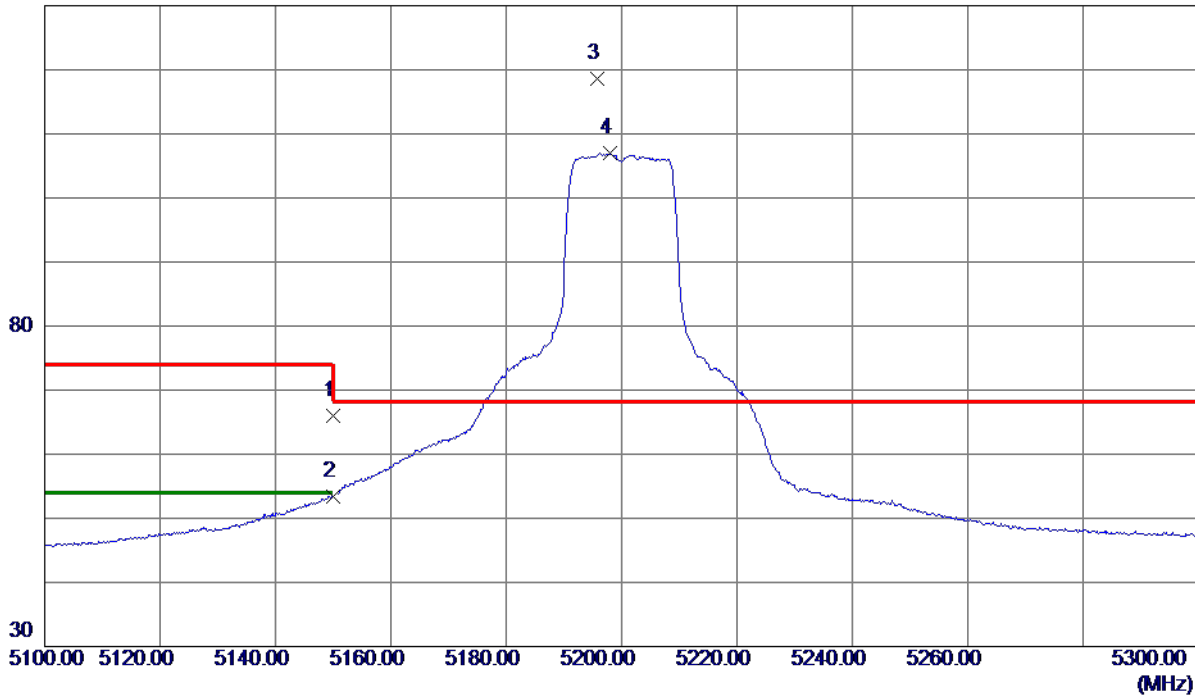

No.	Freq. MHz	Reading Level dBuV/m	Correct Factor dB	Measure ment dBuV/m	Limit dBuV/m	Margin dB	Detector	Comment
1	5150.0000	50.94	15.02	65.96	74.00	-8.04	Peak	
2	5150.0000	38.40	15.02	53.42	54.00	-0.58	AVG	
3 *	5195.8000	103.53	15.05	118.58	68.30	50.28	Peak	No Limit
4	5197.9000	91.87	15.05	106.92	999.00	-892.08	AVG	No Limit

REMARKS:

- (1) Measurement Value = Reading Level + Correct Factor.
- (2) Margin Level = Measurement Value - Limit Value.

Orthogonal Axis	X
Test Mode	UNII-1_TX N (HT20) Mode 5200 MHz

Vertical

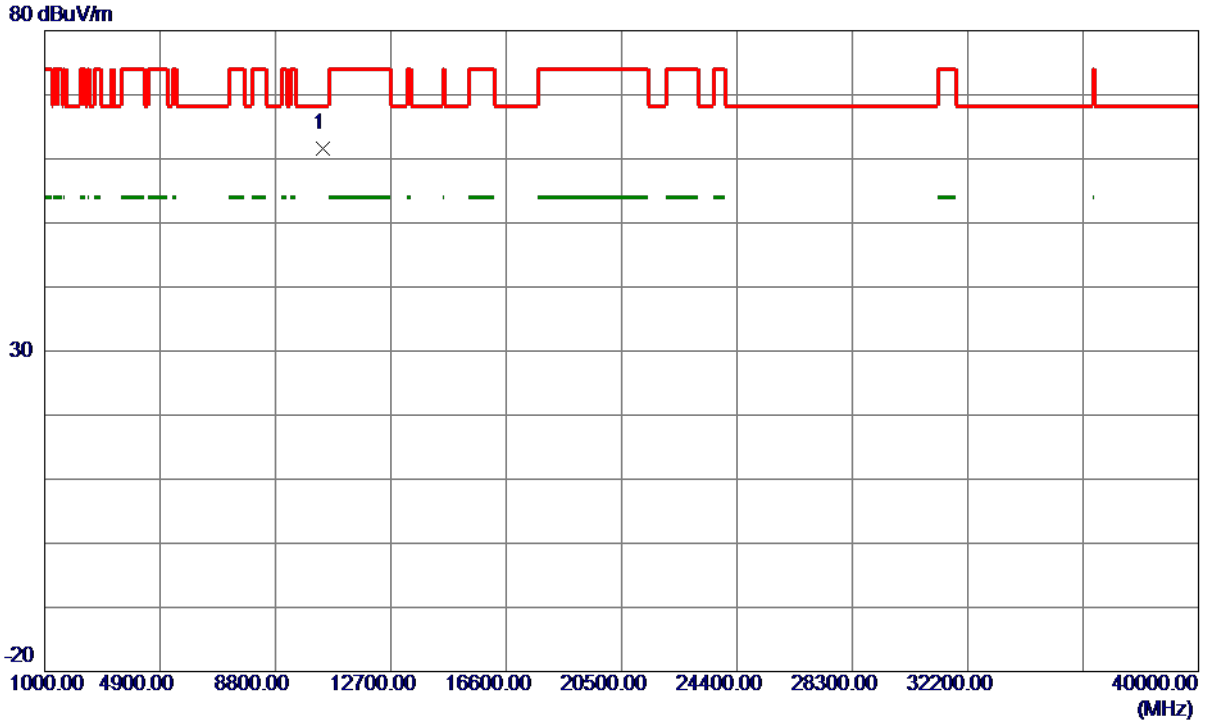

No.	Freq. MHz	Reading Level dBuV/m	Correct Factor dB	Measure ment dBuV/m	Limit dBuV/m	Margin dB	Detector	Comment
1 *	10402.7500	52.56	8.98	61.54	68.30	-6.76	Peak	

REMARKS:

- (1) Measurement Value = Reading Level + Correct Factor.
- (2) Margin Level = Measurement Value - Limit Value.

Orthogonal Axis	X
Test Mode	UNII-1_TX N (HT20) Mode 5200 MHz

Horizontal

130 dBuV/m

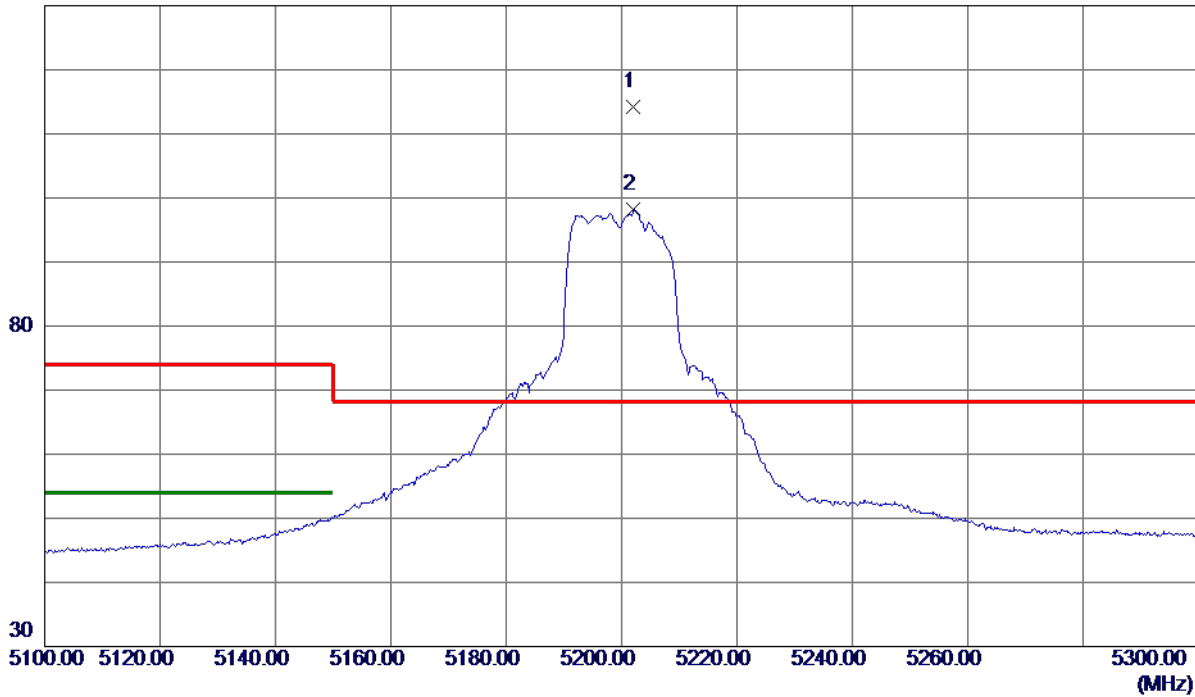

No.	Freq. MHz	Reading Level dBuV/m	Correct Factor dB	Measure ment dBuV/m	Limit dBuV/m	Margin dB	Detector	Comment
1 *	5202.0000	99.20	15.05	114.25	68.30	45.95	Peak	No Limit
2	5202.0000	83.15	15.05	98.20	999.00	-900.80	AVG	No Limit

REMARKS:

- (1) Measurement Value = Reading Level + Correct Factor.
- (2) Margin Level = Measurement Value - Limit Value.

Orthogonal Axis	X
Test Mode	UNII-1_TX N (HT20) Mode 5200 MHz

Horizontal

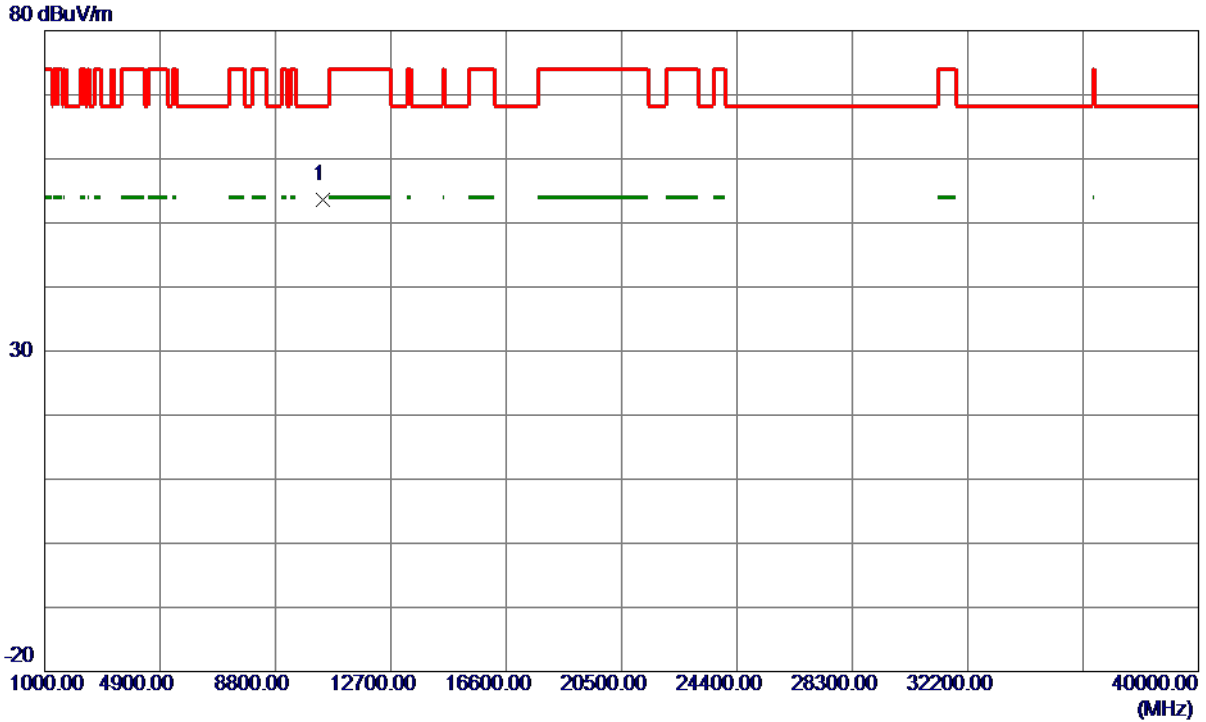

No.	Freq. MHz	Reading Level dBuV/m	Correct Factor dB	Measure ment dBuV/m	Limit dBuV/m	Margin dB	Detector	Comment
1 *	10405.0500	44.64	8.98	53.62	68.30	-14.68	Peak	

REMARKS:

- (1) Measurement Value = Reading Level + Correct Factor.
- (2) Margin Level = Measurement Value - Limit Value.

Orthogonal Axis	X
Test Mode	UNII-1_TX N (HT20) Mode 5240 MHz

Vertical

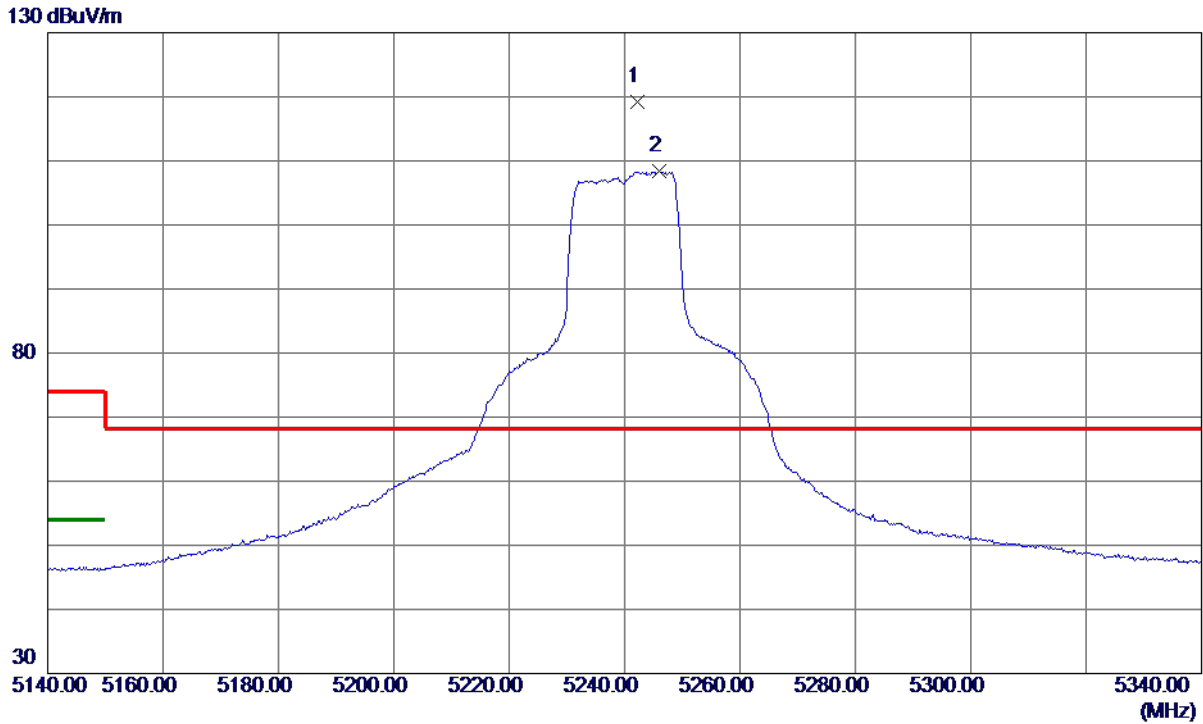

No.	Freq. MHz	Reading Level dBuV/m	Correct Factor dB	Measure ment dBuV/m	Limit dBuV/m	Margin dB	Detector	Comment
1 *	5242.3000	104.09	15.08	119.17	68.30	50.87	Peak	No Limit
2	5246.0000	93.29	15.08	108.37	999.00	-890.63	AVG	No Limit

REMARKS:

- (1) Measurement Value = Reading Level + Correct Factor.
- (2) Margin Level = Measurement Value - Limit Value.

Orthogonal Axis	X
Test Mode	UNII-1_TX N (HT20) Mode 5240 MHz

Vertical

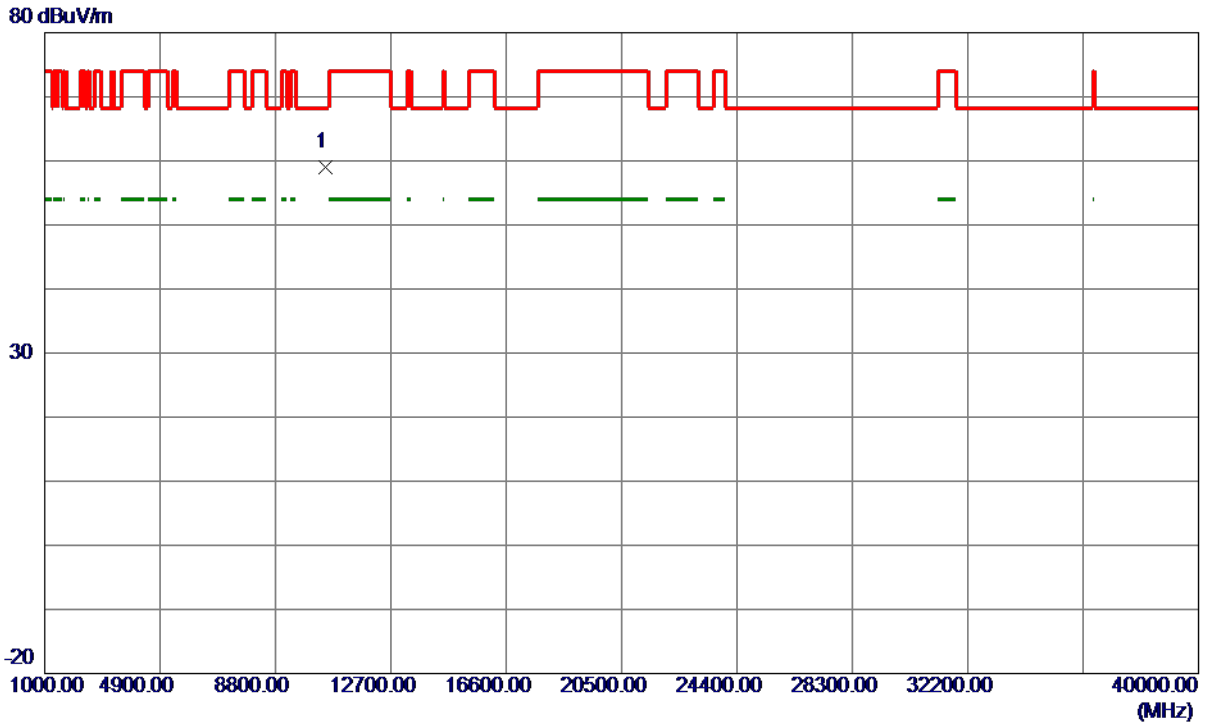

No.	Freq. MHz	Reading Level dBuV/m	Correct Factor dB	Measure ment dBuV/m	Limit dBuV/m	Margin dB	Detector	Comment
1 *	10476.4500	49.93	9.12	59.05	68.30	-9.25	Peak	

REMARKS:

- (1) Measurement Value = Reading Level + Correct Factor.
- (2) Margin Level = Measurement Value - Limit Value.

Orthogonal Axis	X
Test Mode	UNII-1_TX N (HT20) Mode 5240 MHz

Horizontal

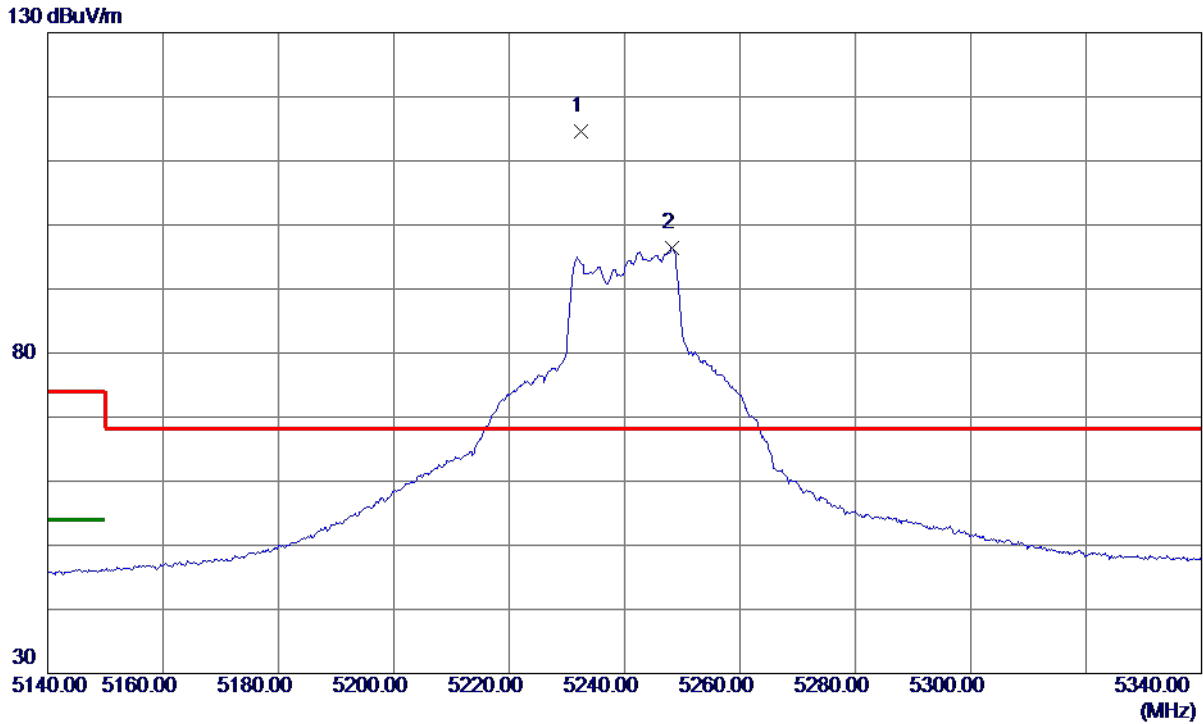

No.	Freq. MHz	Reading Level dBuV/m	Correct Factor dB	Measure ment dBuV/m	Limit dBuV/m	Margin dB	Detector	Comment
1 *	5232.5000	99.48	15.07	114.55	68.30	46.25	Peak	No Limit
2	5248.2000	81.41	15.08	96.49	999.00	-902.51	AVG	No Limit

REMARKS:

- (1) Measurement Value = Reading Level + Correct Factor.
- (2) Margin Level = Measurement Value - Limit Value.

Orthogonal Axis	X
Test Mode	UNII-1_TX N (HT20) Mode 5240 MHz

Horizontal



No.	Freq. MHz	Reading Level dBuV/m	Correct Factor dB	Measure ment dBuV/m	Limit dBuV/m	Margin dB	Detector	Comment
1 *	10481.6000	44.54	9.13	53.67	68.30	-14.63	Peak	

REMARKS:

- (1) Measurement Value = Reading Level + Correct Factor.
- (2) Margin Level = Measurement Value - Limit Value.

Orthogonal Axis	X
Test Mode	UNII-1_TX N (HT40) Mode 5190 MHz

Vertical

130 dBuV/m

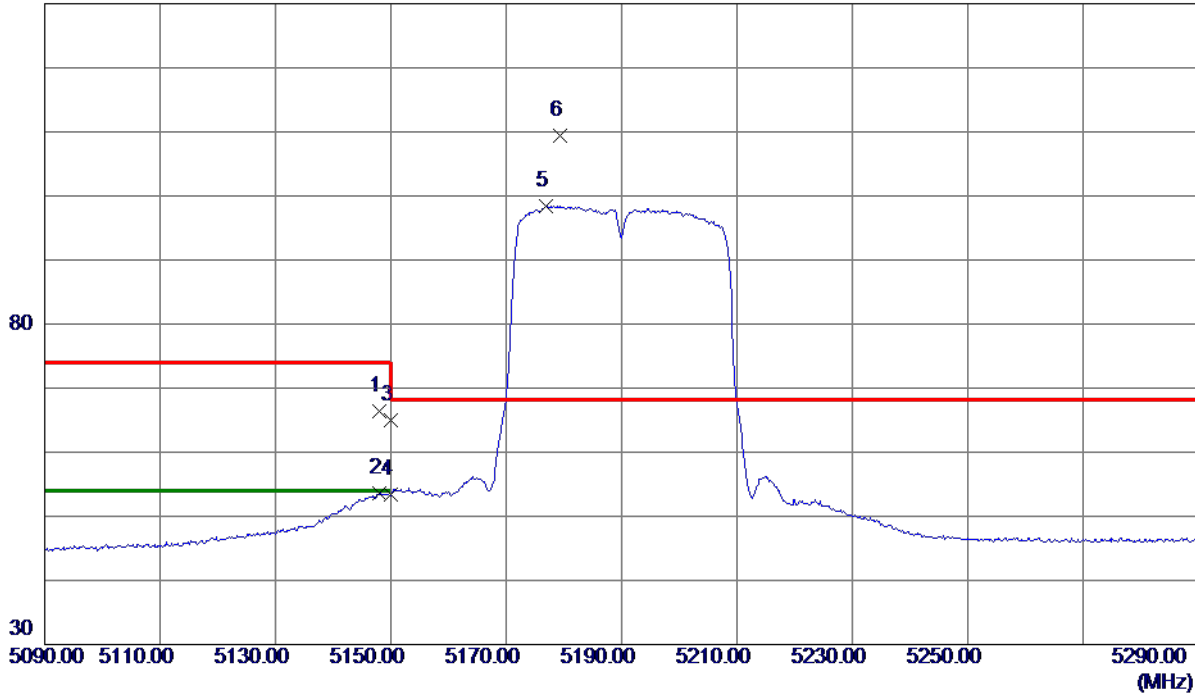

No.	Freq. MHz	Reading Level dBuV/m	Correct Factor dB	Measure ment dBuV/m	Limit dBuV/m	Margin dB	Detector	Comment
1	5148.0000	51.35	15.01	66.36	74.00	-7.64	Peak	
2	5148.0000	38.57	15.01	53.58	54.00	-0.42	AVG	
3	5150.0000	50.03	15.02	65.05	74.00	-8.95	Peak	
4	5150.0000	38.44	15.02	53.46	54.00	-0.54	AVG	
5	5176.9000	83.34	15.03	98.37	999.00	-900.63	AVG	No Limit
6 *	5179.3000	94.34	15.04	109.38	68.30	41.08	Peak	No Limit

REMARKS:

- (1) Measurement Value = Reading Level + Correct Factor.
- (2) Margin Level = Measurement Value - Limit Value.

Orthogonal Axis	X
Test Mode	UNII-1_TX N (HT40) Mode 5190 MHz

Vertical

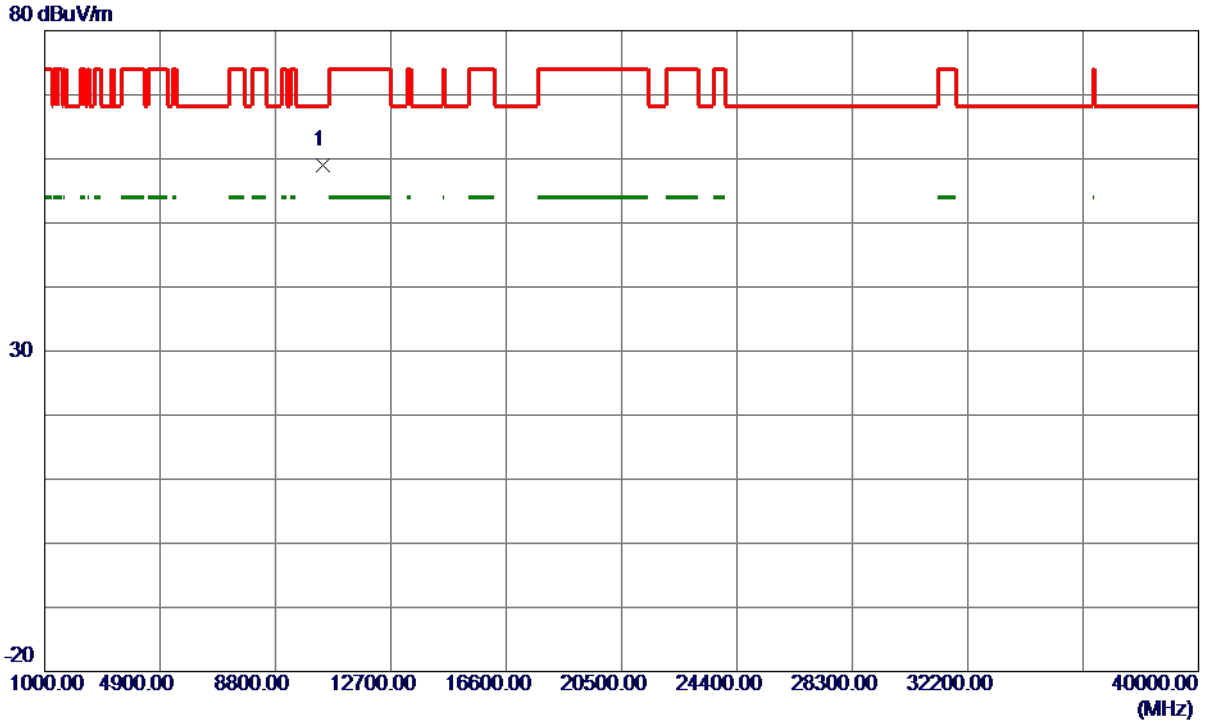

No.	Freq. MHz	Reading Level dBuV/m	Correct Factor dB	Measure ment dBuV/m	Limit dBuV/m	Margin dB	Detector	Comment
1 *	10383.4500	49.99	8.94	58.93	68.30	-9.37	Peak	

REMARKS:

- (1) Measurement Value = Reading Level + Correct Factor.
- (2) Margin Level = Measurement Value - Limit Value.

Orthogonal Axis	X
Test Mode	UNII-1_TX N (HT40) Mode 5190 MHz

Horizontal

130 dBuV/m

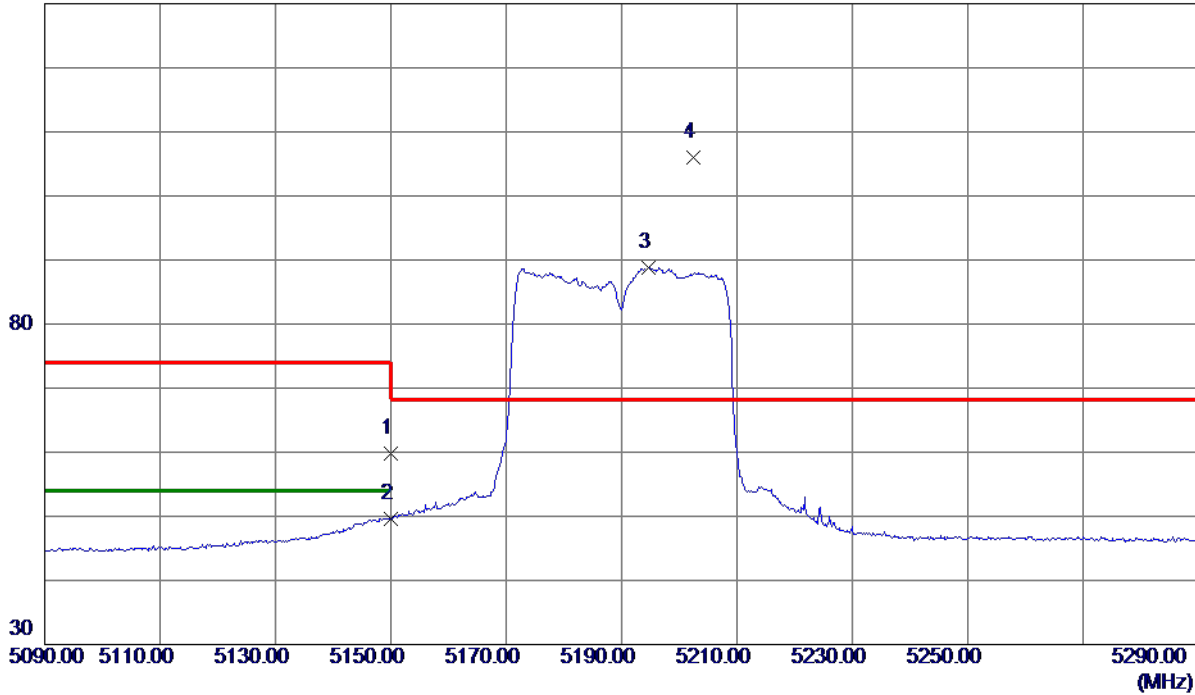

No.	Freq. MHz	Reading Level dBuV/m	Correct Factor dB	Measure ment dBuV/m	Limit dBuV/m	Margin dB	Detector	Comment
1	5150.0000	44.76	15.02	59.78	74.00	-14.22	Peak	
2	5150.0000	34.54	15.02	49.56	54.00	-4.44	AVG	
3	5194.6000	73.79	15.05	88.84	999.00	-910.16	AVG	No Limit
4 *	5202.4000	90.93	15.05	105.98	68.30	37.68	Peak	No Limit

REMARKS:

- (1) Measurement Value = Reading Level + Correct Factor.
- (2) Margin Level = Measurement Value - Limit Value.

Orthogonal Axis	X
Test Mode	UNII-1_TX N (HT40) Mode 5190 MHz

Horizontal

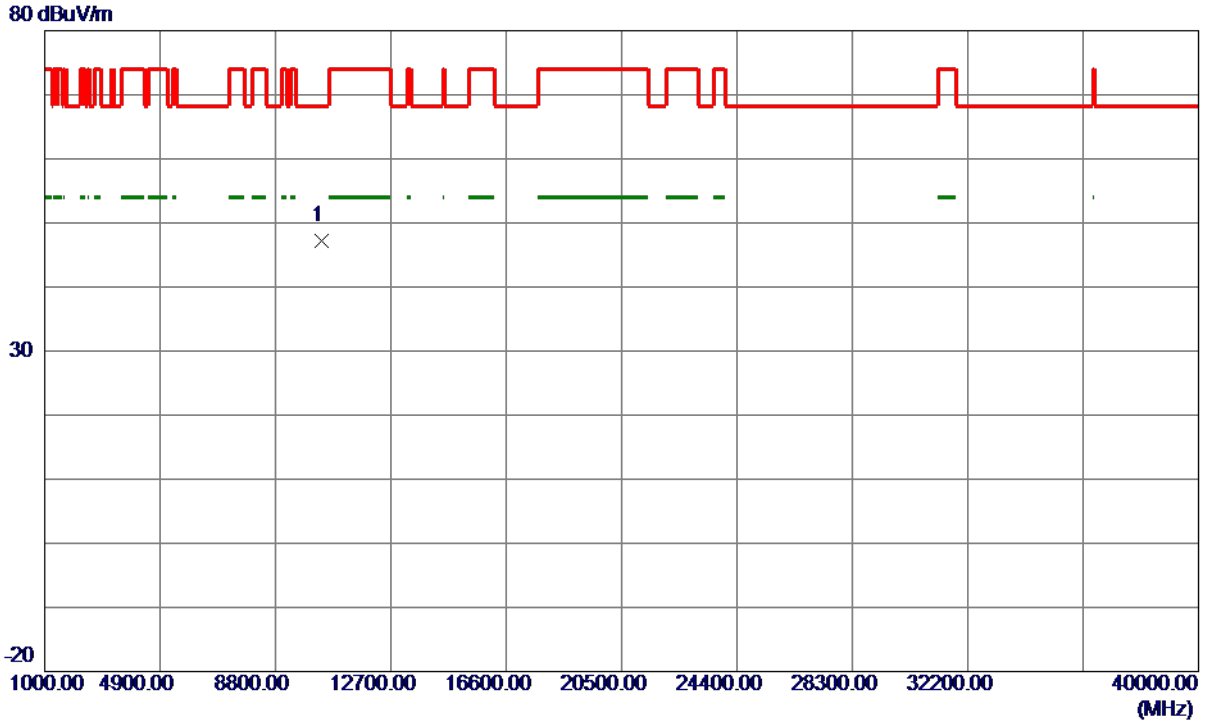

No.	Freq. MHz	Reading Level dBuV/m	Correct Factor dB	Measure ment dBuV/m	Limit dBuV/m	Margin dB	Detector	Comment
1 *	10362.6500	38.30	8.90	47.20	68.30	-21.10	Peak	

REMARKS:

- (1) Measurement Value = Reading Level + Correct Factor.
- (2) Margin Level = Measurement Value - Limit Value.

Orthogonal Axis	X
Test Mode	UNII-1_TX N (HT40) Mode 5230 MHz

Vertical

130 dBuV/m

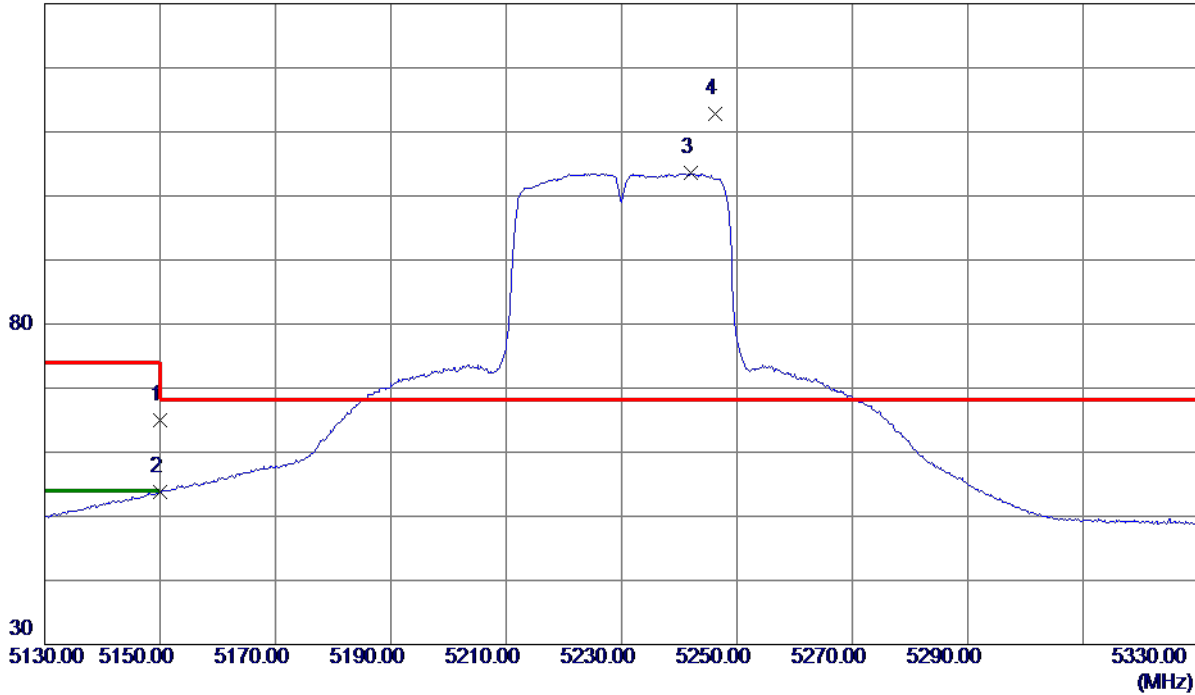

No.	Freq. MHz	Reading Level dBuV/m	Correct Factor dB	Measure ment dBuV/m	Limit dBuV/m	Margin dB	Detector	Comment
1	5150.0000	50.06	15.02	65.08	74.00	-8.92	Peak	
2	5150.0000	38.75	15.02	53.77	54.00	-0.23	AVG	
3	5242.0000	88.44	15.08	103.52	999.00	-895.48	AVG	No Limit
4 *	5246.3000	97.74	15.08	112.82	68.30	44.52	Peak	No Limit

REMARKS:

- (1) Measurement Value = Reading Level + Correct Factor.
- (2) Margin Level = Measurement Value - Limit Value.

Orthogonal Axis	X
Test Mode	UNII-1_TX N (HT40) Mode 5230 MHz

Vertical

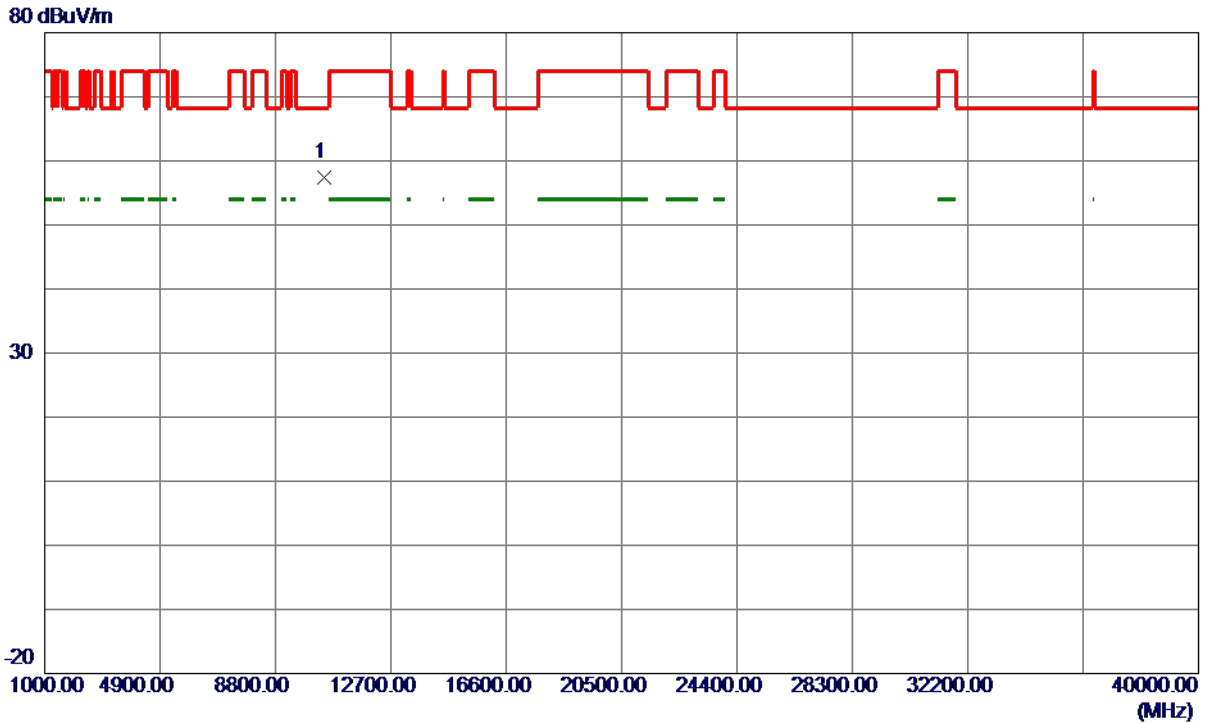

No.	Freq. MHz	Reading Level dBuV/m	Correct Factor dB	Measure ment dBuV/m	Limit dBuV/m	Margin dB	Detector	Comment
1 *	10458.3500	48.35	9.08	57.43	68.30	-10.87	Peak	

REMARKS:

- (1) Measurement Value = Reading Level + Correct Factor.
- (2) Margin Level = Measurement Value - Limit Value.

Orthogonal Axis	X
Test Mode	UNII-1_TX N (HT40) Mode 5230 MHz

Horizontal

130 dBuV/m

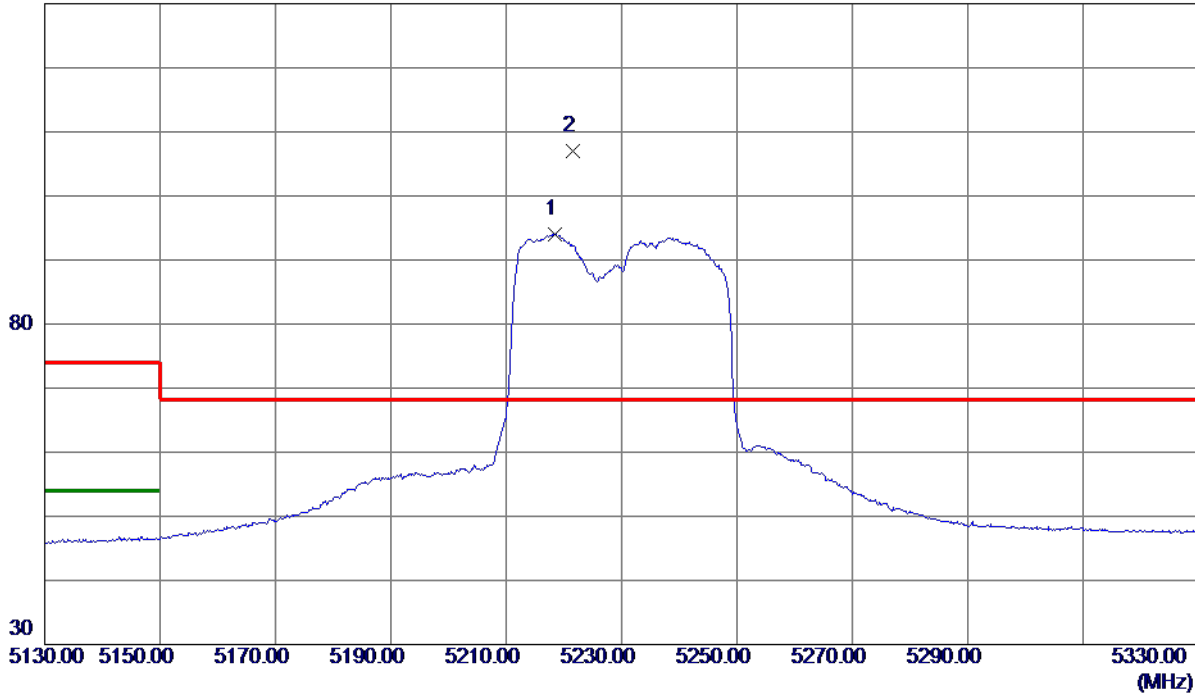

No.	Freq. MHz	Reading Level dBuV/m	Correct Factor dB	Measure ment dBuV/m	Limit dBuV/m	Margin dB	Detector	Comment
1	5218.4000	79.04	15.06	94.10	999.00	-904.90	AVG	No Limit
2 *	5221.6000	91.94	15.07	107.01	68.30	38.71	Peak	No Limit

REMARKS:

- (1) Measurement Value = Reading Level + Correct Factor.
- (2) Margin Level = Measurement Value - Limit Value.

Orthogonal Axis	X
Test Mode	UNII-1_TX N (HT40) Mode 5230 MHz

Horizontal

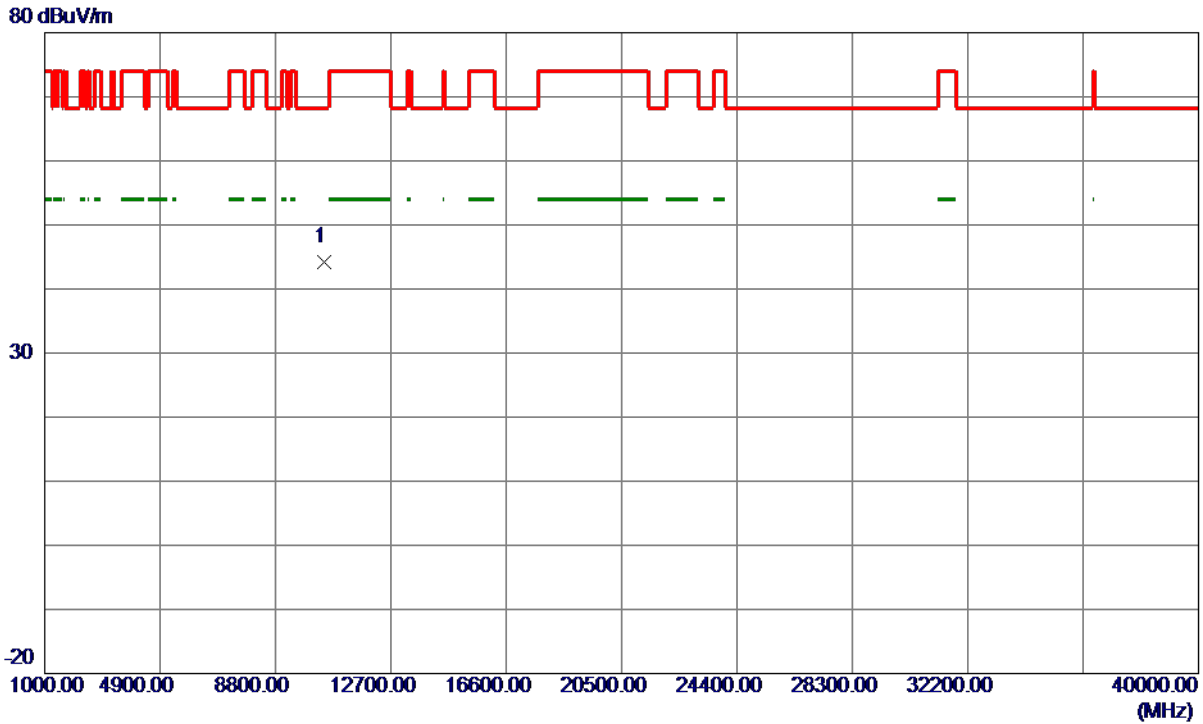

No.	Freq. MHz	Reading Level dBuV/m	Correct Factor dB	Measure ment dBuV/m	Limit dBuV/m	Margin dB	Detector	Comment
1 *	10441.6000	35.21	9.05	44.26	68.30	-24.04	Peak	

REMARKS:

- (1) Measurement Value = Reading Level + Correct Factor.
- (2) Margin Level = Measurement Value - Limit Value.

Orthogonal Axis	X
Test Mode	UNII-3_TX N (HT20) Mode 5745 MHz

Vertical

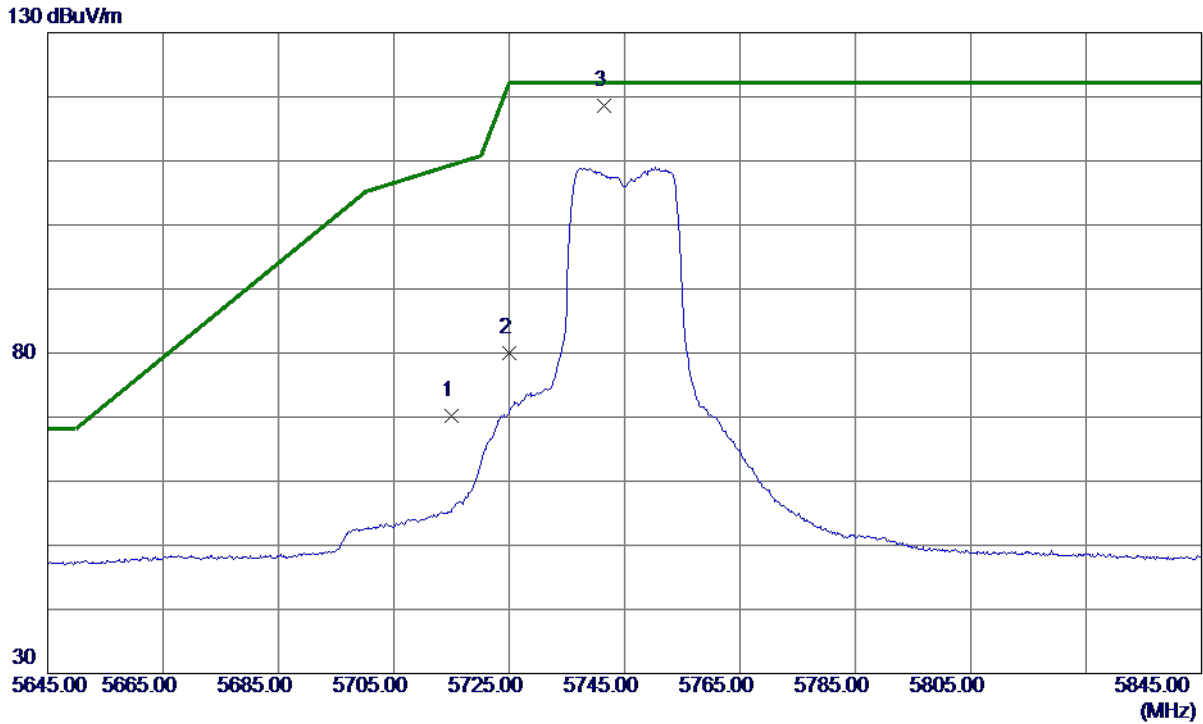

No.	Freq. MHz	Reading Level dBuV/m	Correct Factor dB	Measure ment dBuV/m	Limit dBuV/m	Margin dB	Detector	Comment
1	5715.0000	54.49	15.65	70.14	109.40	-39.26	Peak	
2	5725.0000	64.42	15.67	80.09	122.20	-42.11	Peak	
3 *	5741.4000	102.90	15.70	118.60	122.20	-3.60	Peak	No Limit

REMARKS:

- (1) Measurement Value = Reading Level + Correct Factor.
- (2) Margin Level = Measurement Value - Limit Value.

Orthogonal Axis	X
Test Mode	UNII-3_TX N (HT20) Mode 5745 MHz

Vertical

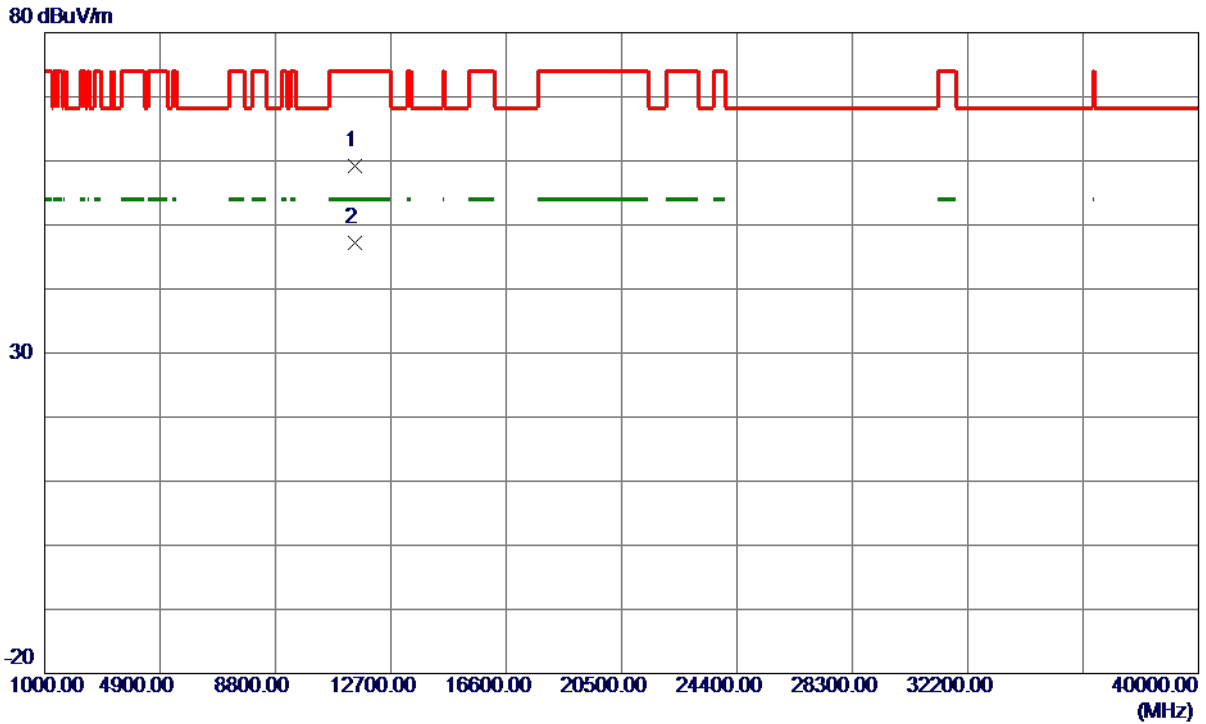

No.	Freq. MHz	Reading Level dBuV/m	Correct Factor dB	Measure ment dBuV/m	Limit dBuV/m	Margin dB	Detector	Comment
1	11483.5500	48.05	11.08	59.13	74.00	-14.87	Peak	
2 *	11490.1000	36.11	11.10	47.21	54.00	-6.79	AVG	

REMARKS:

- (1) Measurement Value = Reading Level + Correct Factor.
- (2) Margin Level = Measurement Value - Limit Value.

Orthogonal Axis	X
Test Mode	UNII-3_TX N (HT20) Mode 5745 MHz

Horizontal

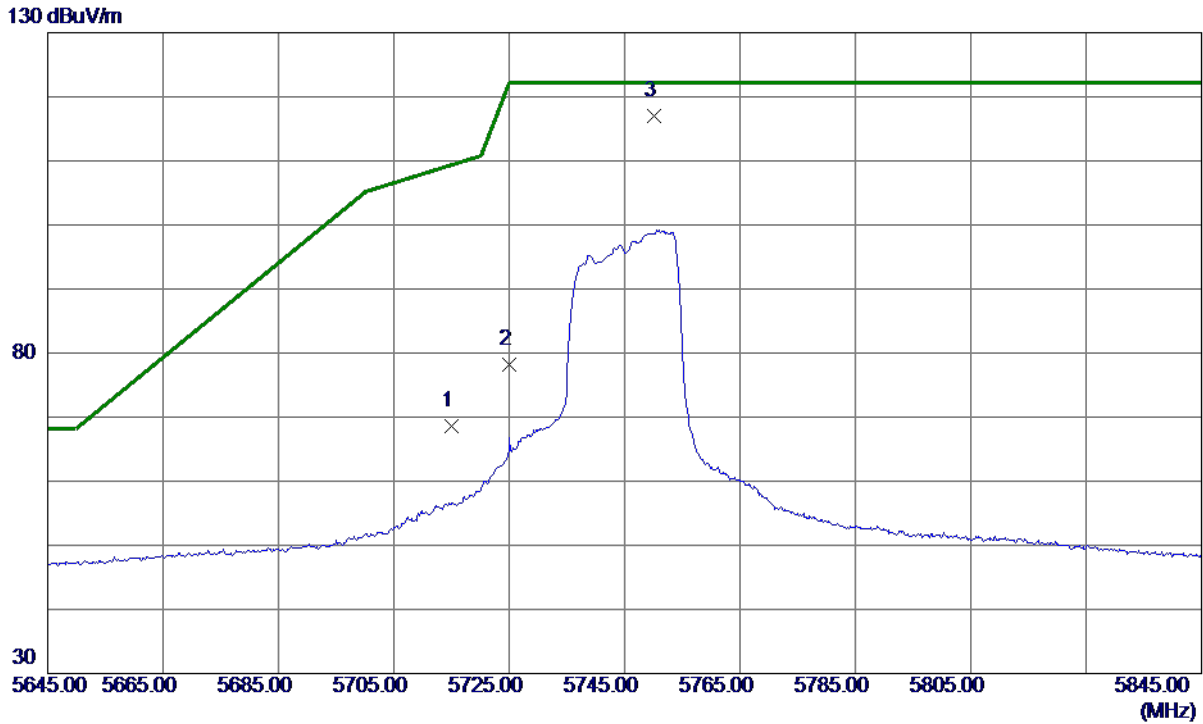

No.	Freq. MHz	Reading Level dBuV/m	Correct Factor dB	Measure ment dBuV/m	Limit dBuV/m	Margin dB	Detector	Comment
1	5715.0000	52.90	15.65	68.55	109.40	-40.85	Peak	
2	5725.0000	62.47	15.67	78.14	122.20	-44.06	Peak	
3 *	5750.1000	101.19	15.72	116.91	122.20	-5.29	Peak	No Limit

REMARKS:

- (1) Measurement Value = Reading Level + Correct Factor.
- (2) Margin Level = Measurement Value - Limit Value.

Orthogonal Axis	X
Test Mode	UNII-3_TX N (HT20) Mode 5745 MHz

Horizontal

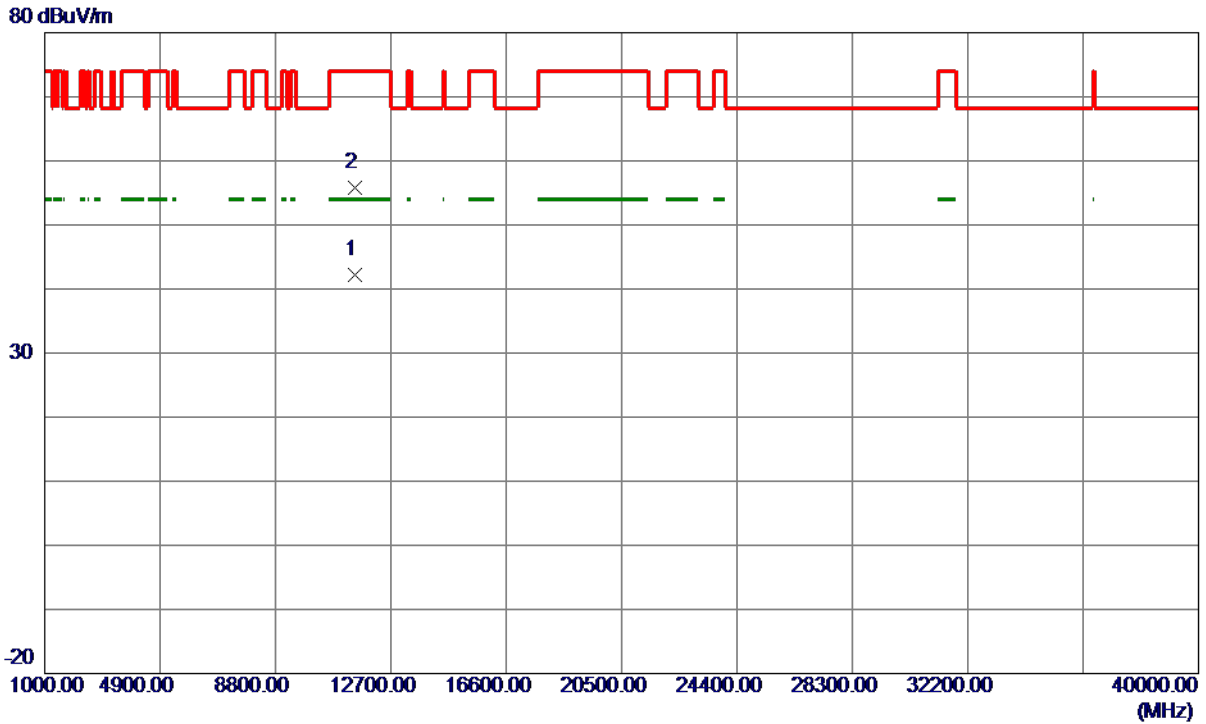

No.	Freq. MHz	Reading Level dBuV/m	Correct Factor dB	Measure ment dBuV/m	Limit dBuV/m	Margin dB	Detector	Comment
1 *	11490.5250	31.11	11.10	42.21	54.00	-11.79	AVG	
2	11491.3500	44.64	11.10	55.74	74.00	-18.26	Peak	

REMARKS:

- (1) Measurement Value = Reading Level + Correct Factor.
- (2) Margin Level = Measurement Value - Limit Value.

Orthogonal Axis	X
Test Mode	UNII-3_TX N (HT20) Mode 5785 MHz

Vertical

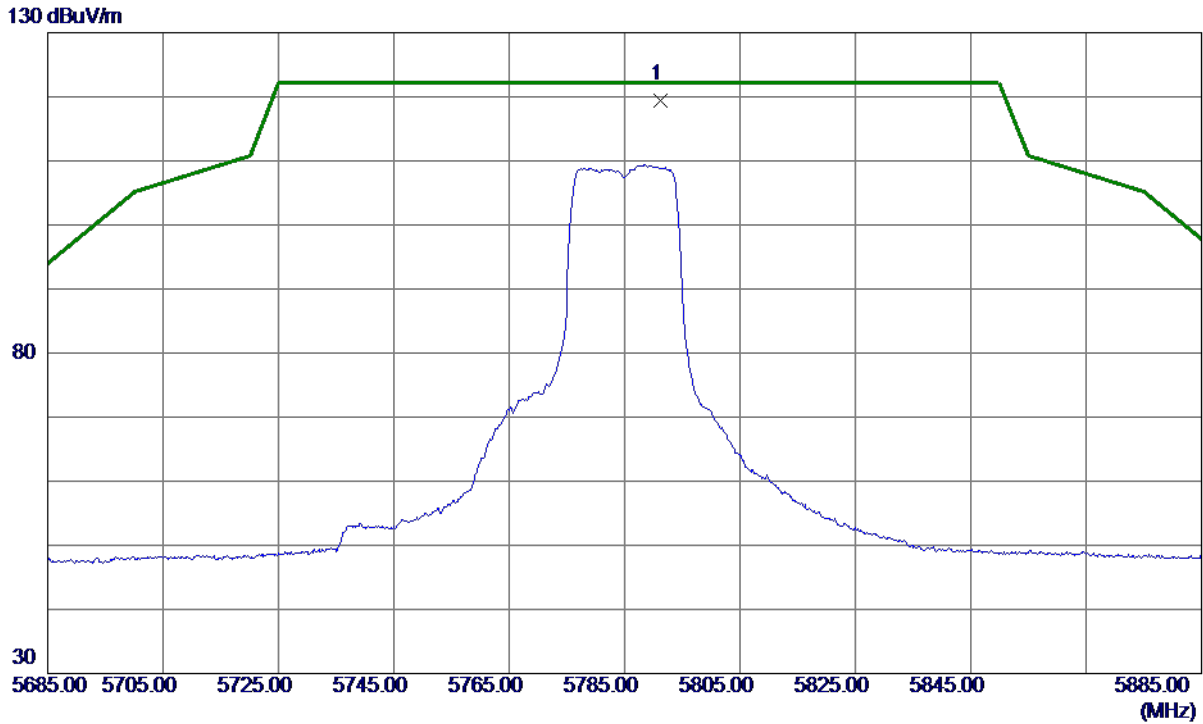

No.	Freq. MHz	Reading Level dBuV/m	Correct Factor dB	Measure ment dBuV/m	Limit dBuV/m	Margin dB	Detector	Comment
1 *	5791.3000	103.71	15.79	119.50	122.20	-2.70	Peak	No Limit

REMARKS:

- (1) Measurement Value = Reading Level + Correct Factor.
- (2) Margin Level = Measurement Value - Limit Value.

Orthogonal Axis	X
Test Mode	UNII-3_TX N (HT20) Mode 5785 MHz

Vertical

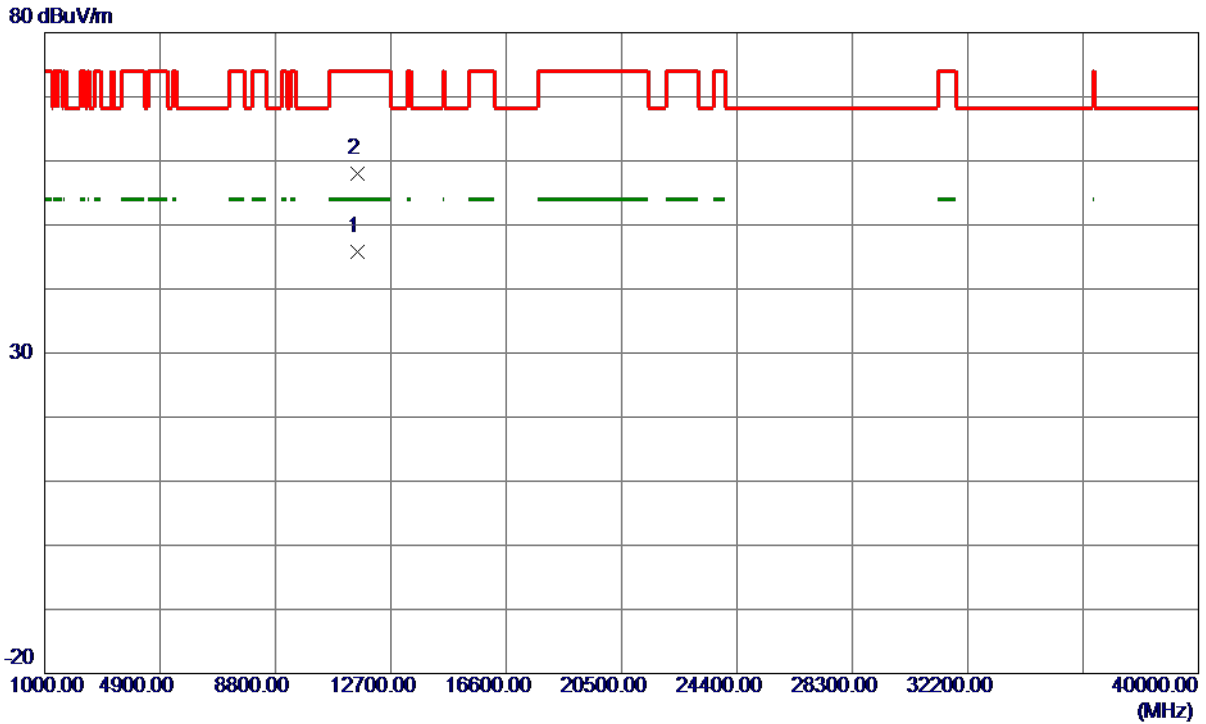

No.	Freq. MHz	Reading Level dBuV/m	Correct Factor dB	Measure ment dBuV/m	Limit dBuV/m	Margin dB	Detector	Comment
1 *	11570.0500	34.60	11.22	45.82	54.00	-8.18	AVG	
2	11572.4000	46.70	11.22	57.92	74.00	-16.08	Peak	

REMARKS:

- (1) Measurement Value = Reading Level + Correct Factor.
- (2) Margin Level = Measurement Value - Limit Value.

Orthogonal Axis	X
Test Mode	UNII-3_TX N (HT20) Mode 5785 MHz

Horizontal

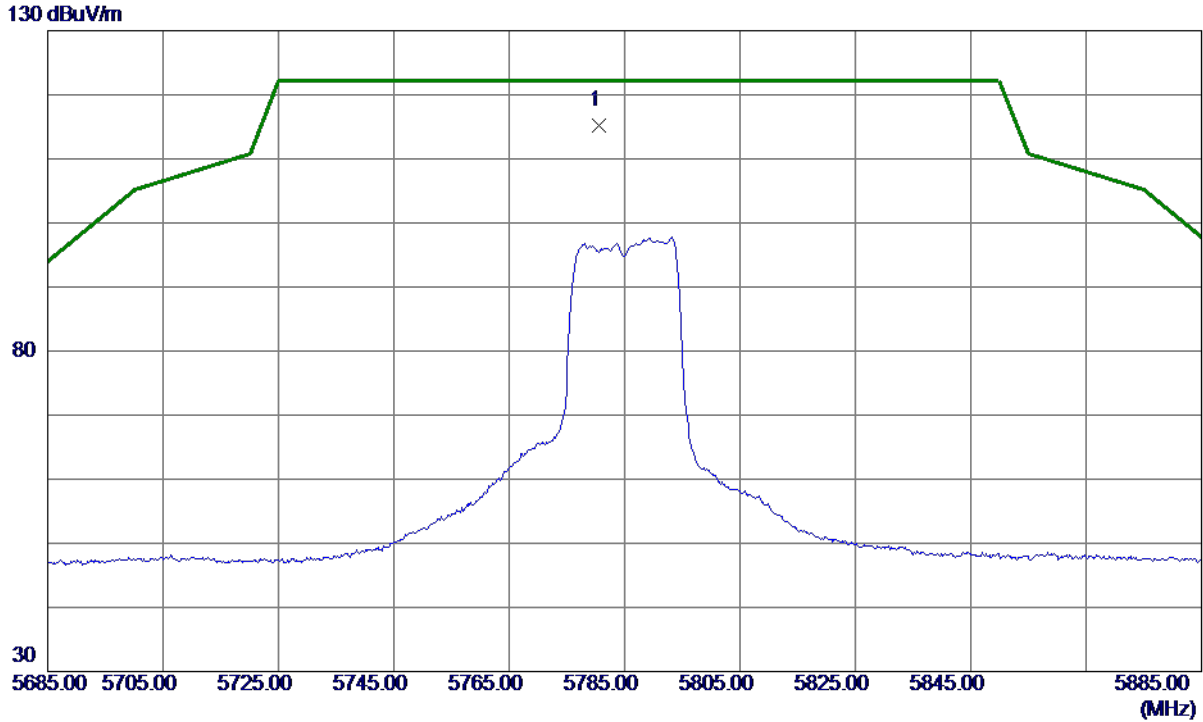

No.	Freq. MHz	Reading Level dBuV/m	Correct Factor dB	Measure ment dBuV/m	Limit dBuV/m	Margin dB	Detector	Comment
1 *	5780.6000	99.41	15.77	115.18	122.20	-7.02	Peak	No Limit

REMARKS:

- (1) Measurement Value = Reading Level + Correct Factor.
- (2) Margin Level = Measurement Value - Limit Value.

Orthogonal Axis	X
Test Mode	UNII-3_TX N (HT20) Mode 5785 MHz

Horizontal

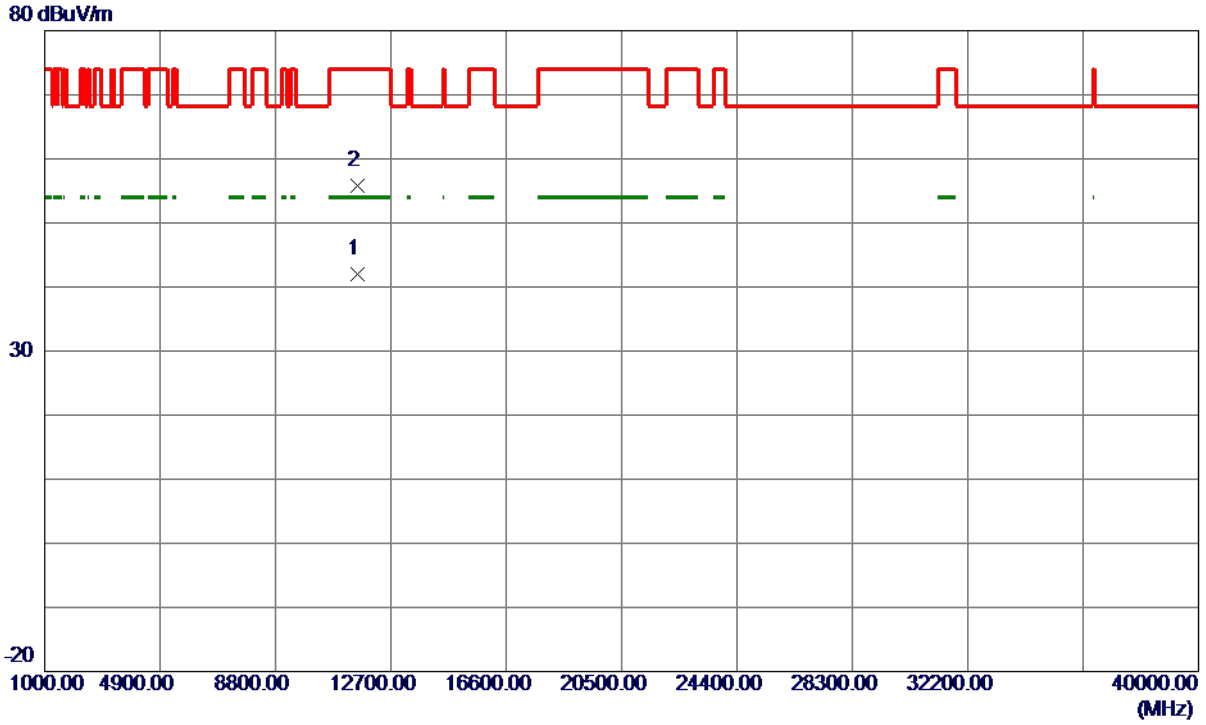

No.	Freq. MHz	Reading Level dBuV/m	Correct Factor dB	Measure ment dBuV/m	Limit dBuV/m	Margin dB	Detector	Comment
1 *	11570.5000	30.71	11.22	41.93	54.00	-12.07	AVG	
2	11570.5250	44.50	11.22	55.72	74.00	-18.28	Peak	

REMARKS:

- (1) Measurement Value = Reading Level + Correct Factor.
- (2) Margin Level = Measurement Value - Limit Value.

Orthogonal Axis	X
Test Mode	UNII-3_TX N (HT20) Mode 5825 MHz

Vertical

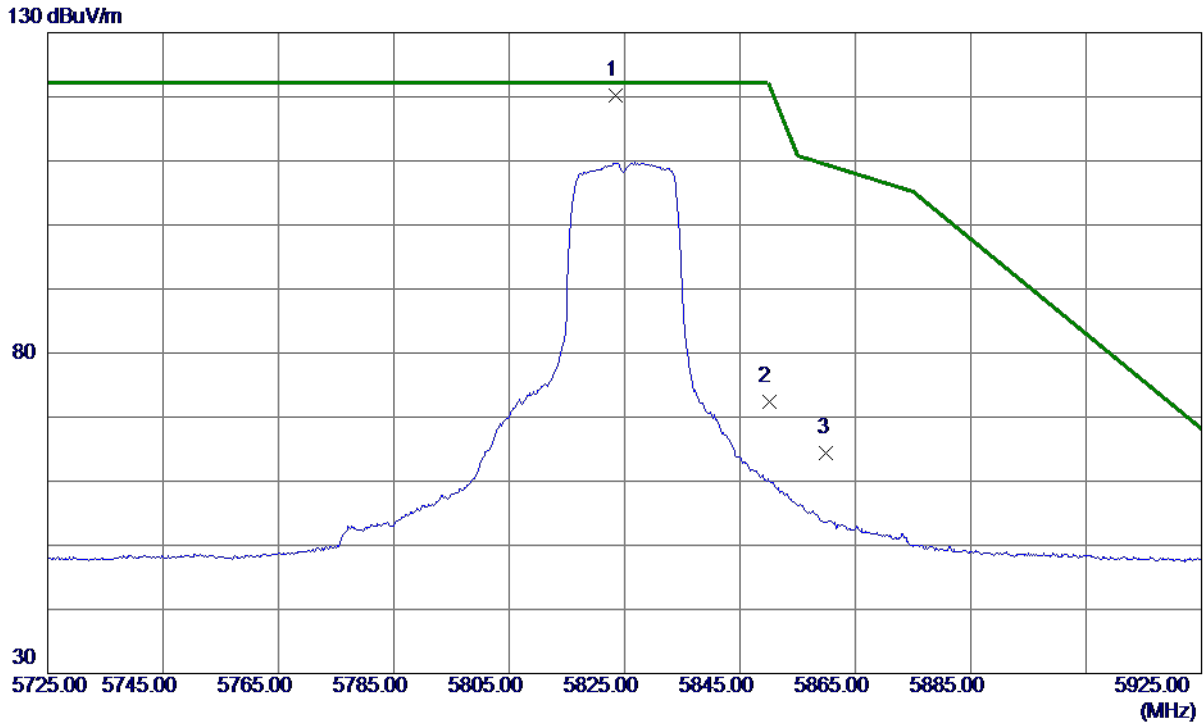

No.	Freq. MHz	Reading Level dBuV/m	Correct Factor dB	Measure ment dBuV/m	Limit dBuV/m	Margin dB	Detector	Comment
1 *	5823.5000	104.37	15.85	120.22	122.20	-1.98	Peak	No Limit
2	5850.0000	56.47	15.90	72.37	122.20	-49.83	Peak	
3	5860.0000	48.47	15.92	64.39	109.40	-45.01	Peak	

REMARKS:

- (1) Measurement Value = Reading Level + Correct Factor.
- (2) Margin Level = Measurement Value - Limit Value.

Orthogonal Axis	X
Test Mode	UNII-3_TX N (HT20) Mode 5825 MHz

Vertical

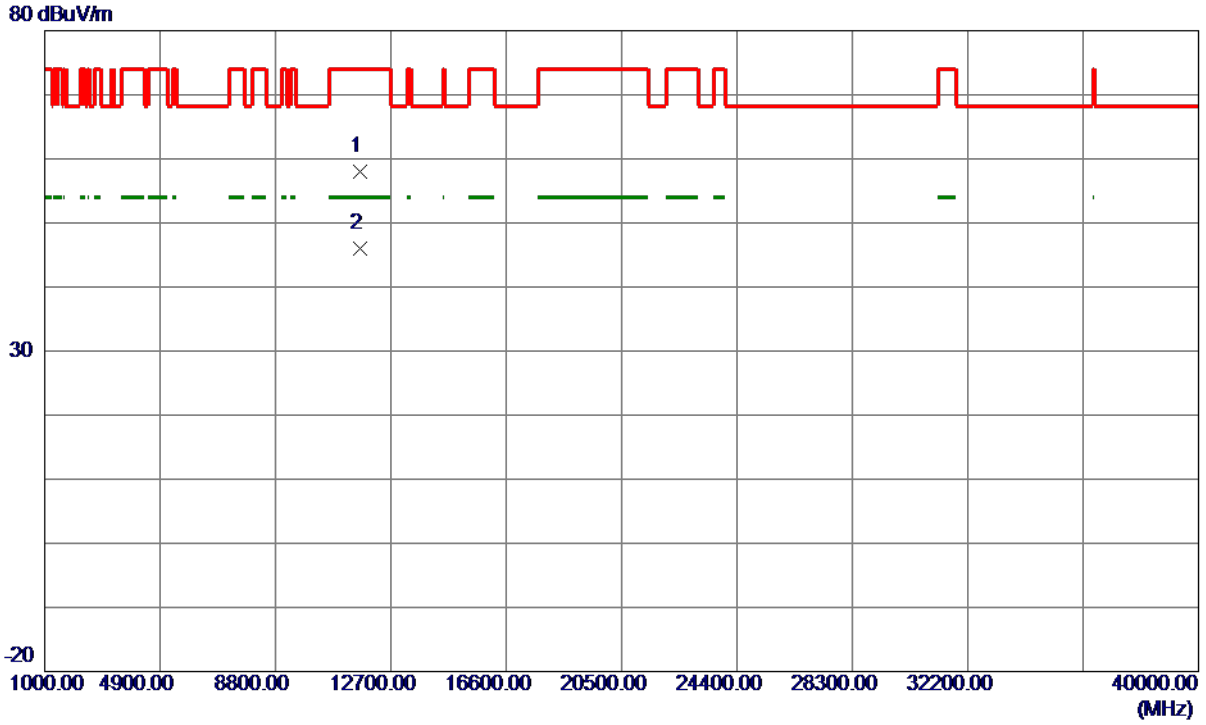

No.	Freq. MHz	Reading Level dBuV/m	Correct Factor dB	Measure ment dBuV/m	Limit dBuV/m	Margin dB	Detector	Comment
1	11646.4000	46.60	11.32	57.92	74.00	-16.08	Peak	
2 *	11649.8250	34.73	11.32	46.05	54.00	-7.95	AVG	

REMARKS:

- (1) Measurement Value = Reading Level + Correct Factor.
- (2) Margin Level = Measurement Value - Limit Value.

Orthogonal Axis	X
Test Mode	UNII-3_TX N (HT20) Mode 5825 MHz

Horizontal

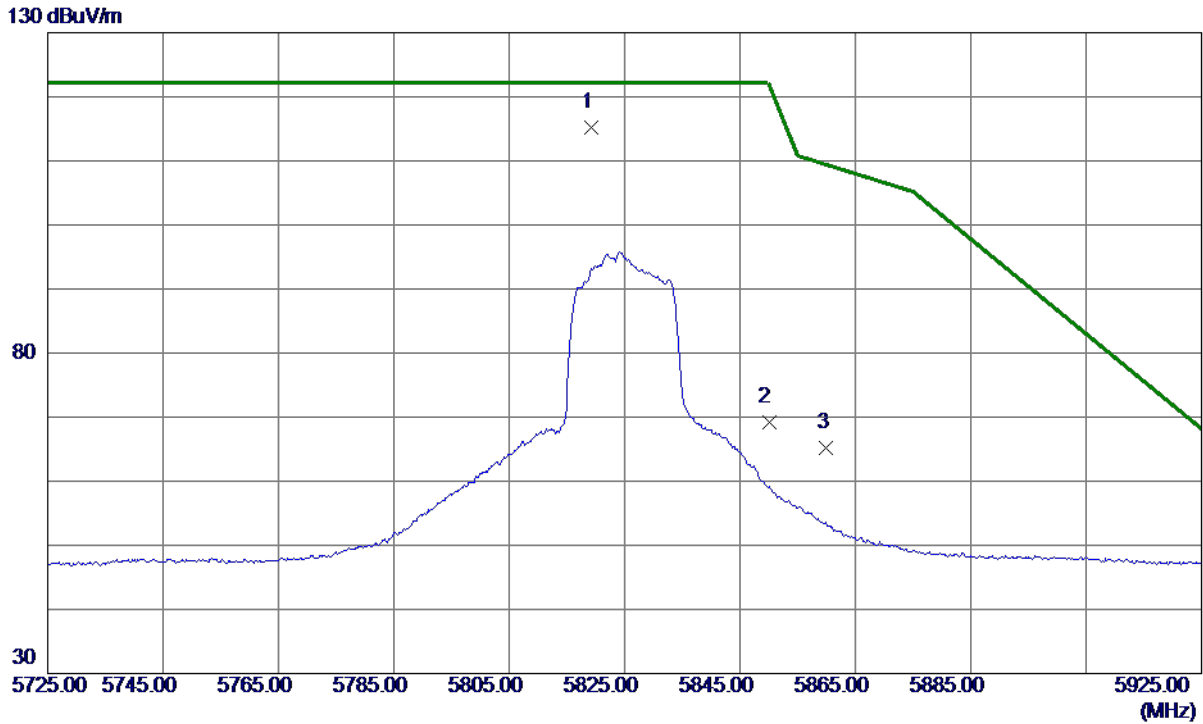

No.	Freq. MHz	Reading Level dBuV/m	Correct Factor dB	Measure ment dBuV/m	Limit dBuV/m	Margin dB	Detector	Comment
1 *	5819.3000	99.35	15.84	115.19	122.20	-7.01	Peak	No Limit
2	5850.0000	53.34	15.90	69.24	122.20	-52.96	Peak	
3	5860.0000	49.34	15.92	65.26	109.40	-44.14	Peak	

REMARKS:

- (1) Measurement Value = Reading Level + Correct Factor.
- (2) Margin Level = Measurement Value - Limit Value.

Orthogonal Axis	X
Test Mode	UNII-3_TX N (HT20) Mode 5825 MHz

Horizontal

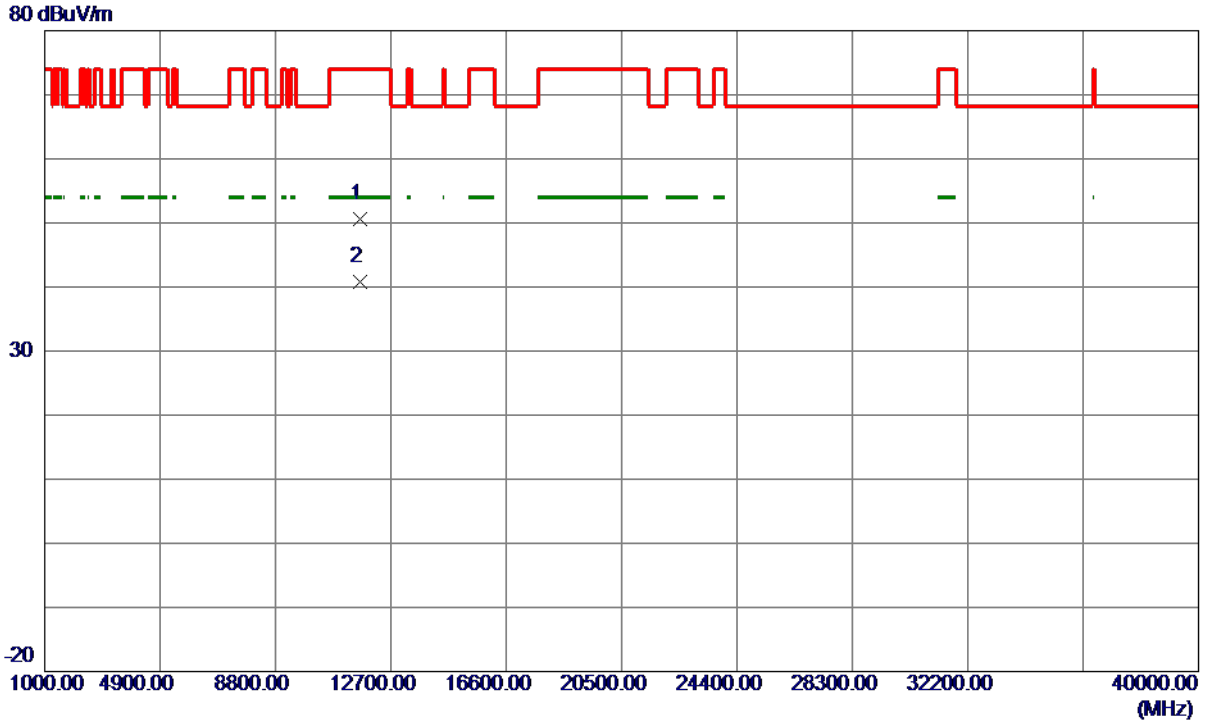

No.	Freq. MHz	Reading Level dBuV/m	Correct Factor dB	Measure ment dBuV/m	Limit dBuV/m	Margin dB	Detector	Comment
1	11646.2500	39.28	11.32	50.60	74.00	-23.40	Peak	
2 *	11650.0000	29.40	11.33	40.73	54.00	-13.27	AVG	

REMARKS:

- (1) Measurement Value = Reading Level + Correct Factor.
- (2) Margin Level = Measurement Value - Limit Value.

Orthogonal Axis	X
Test Mode	UNII-3_TX N (HT40) Mode 5755 MHz

Vertical

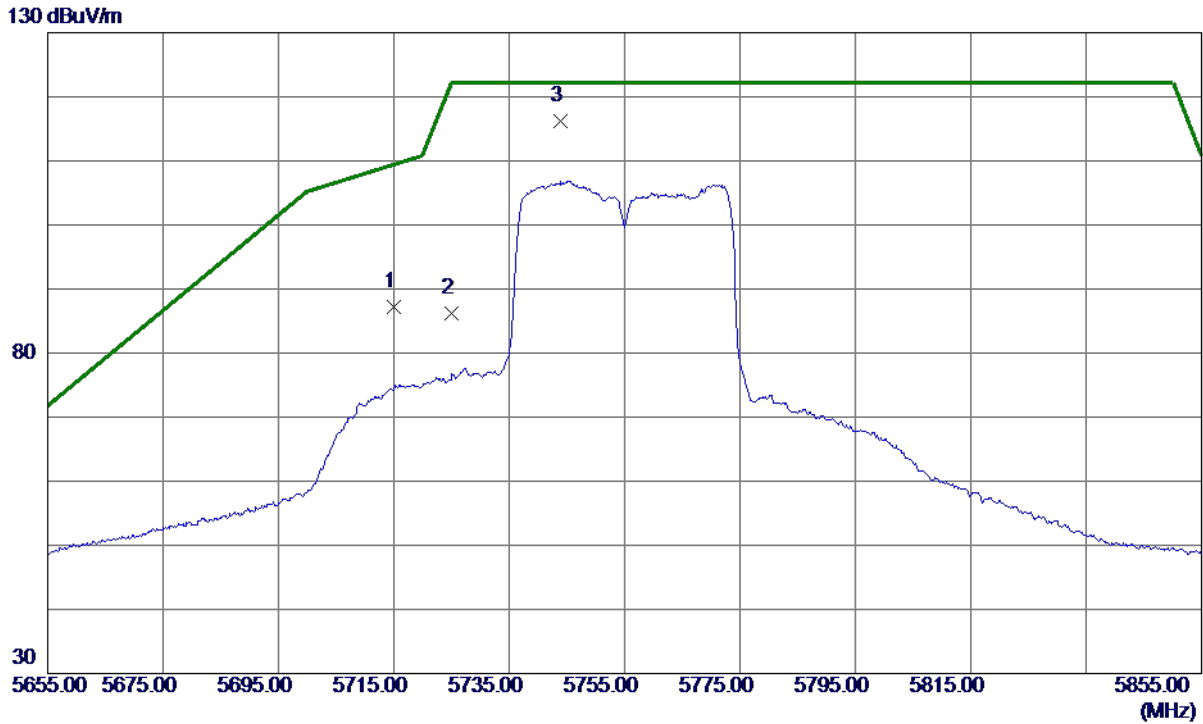

No.	Freq. MHz	Reading Level dBuV/m	Correct Factor dB	Measure ment dBuV/m	Limit dBuV/m	Margin dB	Detector	Comment
1	5715.0000	71.47	15.65	87.12	109.40	-22.28	Peak	
2	5725.0000	70.51	15.67	86.18	122.20	-36.02	Peak	
3 *	5743.8000	100.43	15.70	116.13	122.20	-6.07	Peak	No Limit

REMARKS:

- (1) Measurement Value = Reading Level + Correct Factor.
- (2) Margin Level = Measurement Value - Limit Value.

Orthogonal Axis	X
Test Mode	UNII-3_TX N (HT40) Mode 5755 MHz

Vertical

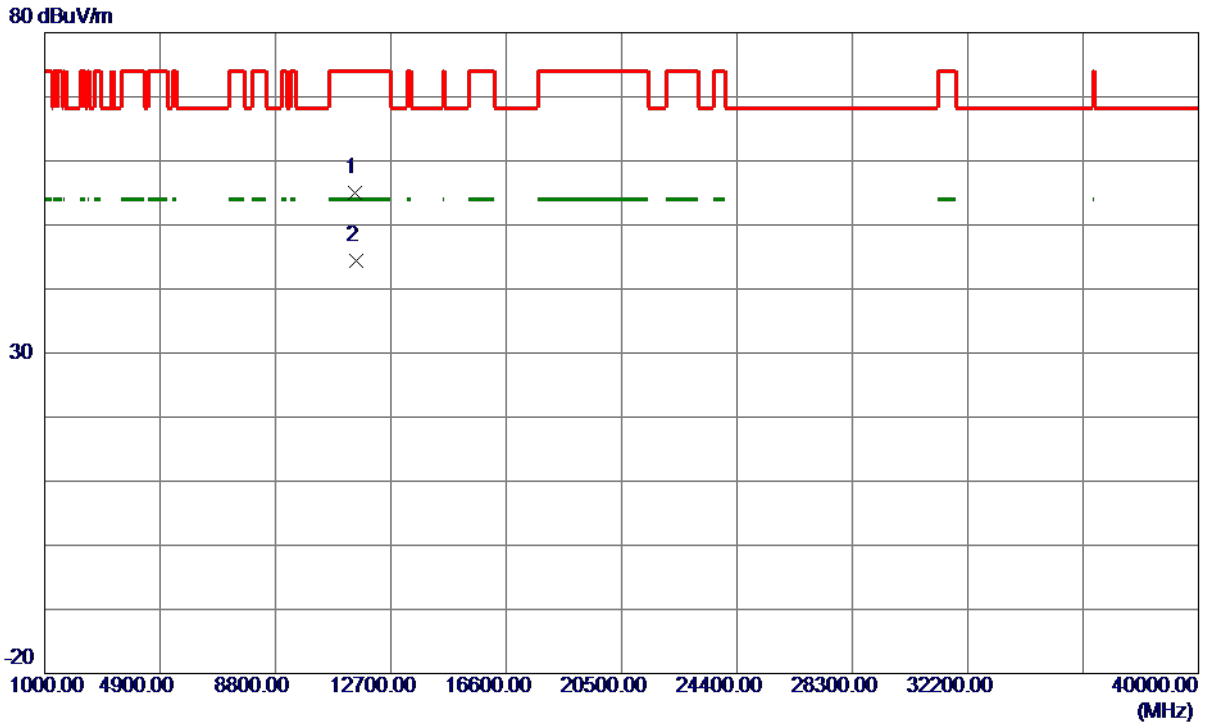

No.	Freq. MHz	Reading Level dBuV/m	Correct Factor dB	Measure ment dBuV/m	Limit dBuV/m	Margin dB	Detector	Comment
1	11506.5500	43.77	11.14	54.91	74.00	-19.09	Peak	
2 *	11510.0000	33.18	11.14	44.32	54.00	-9.68	AVG	

REMARKS:

- (1) Measurement Value = Reading Level + Correct Factor.
- (2) Margin Level = Measurement Value - Limit Value.

Orthogonal Axis	X
Test Mode	UNII-3_TX N (HT40) Mode 5755 MHz

Horizontal

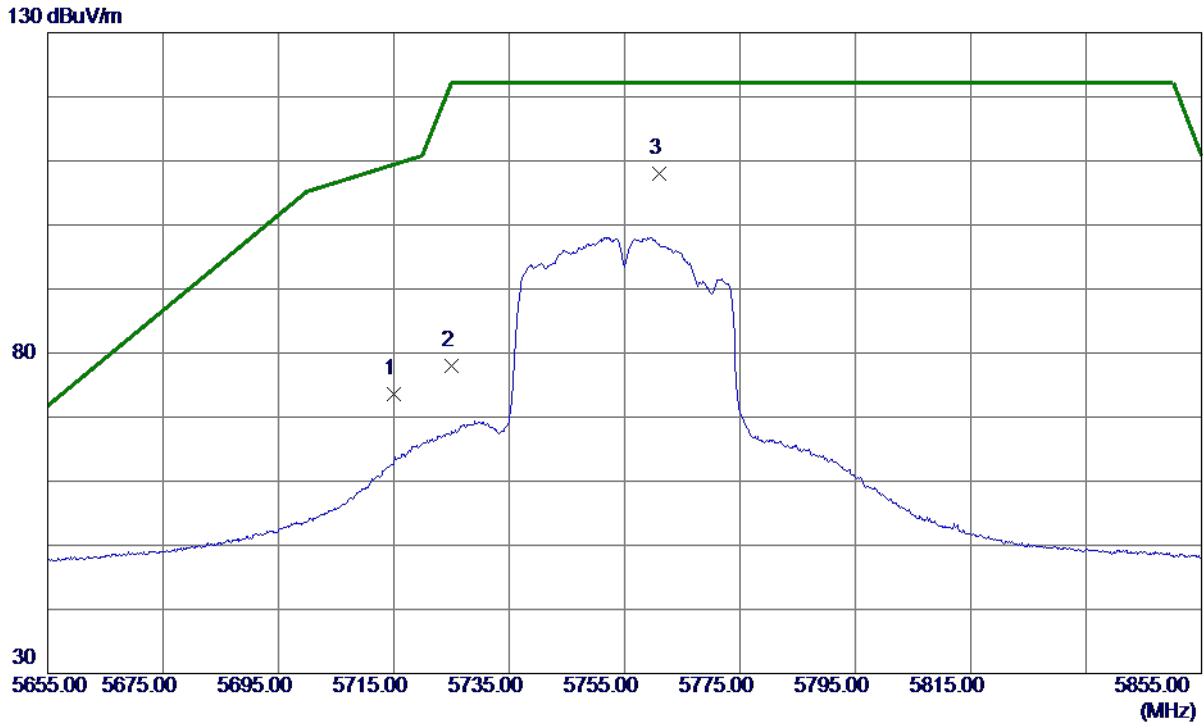

No.	Freq. MHz	Reading Level dBuV/m	Correct Factor dB	Measure ment dBuV/m	Limit dBuV/m	Margin dB	Detector	Comment
1	5715.0000	57.90	15.65	73.55	109.40	-35.85	Peak	
2	5725.0000	62.26	15.67	77.93	122.20	-44.27	Peak	
3 *	5761.0000	92.37	15.73	108.10	122.20	-14.10	Peak	No Limit

REMARKS:

- (1) Measurement Value = Reading Level + Correct Factor.
- (2) Margin Level = Measurement Value - Limit Value.

Orthogonal Axis	X
Test Mode	UNII-3_TX N (HT40) Mode 5755 MHz

Horizontal



No.	Freq. MHz	Reading Level dBuV/m	Correct Factor dB	Measure ment dBuV/m	Limit dBuV/m	Margin dB	Detector	Comment
1 *	11509.9750	28.65	11.14	39.79	54.00	-14.21	AVG	
2	11510.2000	38.95	11.14	50.09	74.00	-23.91	Peak	

REMARKS:

- (1) Measurement Value = Reading Level + Correct Factor.
- (2) Margin Level = Measurement Value - Limit Value.

Orthogonal Axis	X
Test Mode	UNII-3_TX N (HT40) Mode 5795 MHz

Vertical

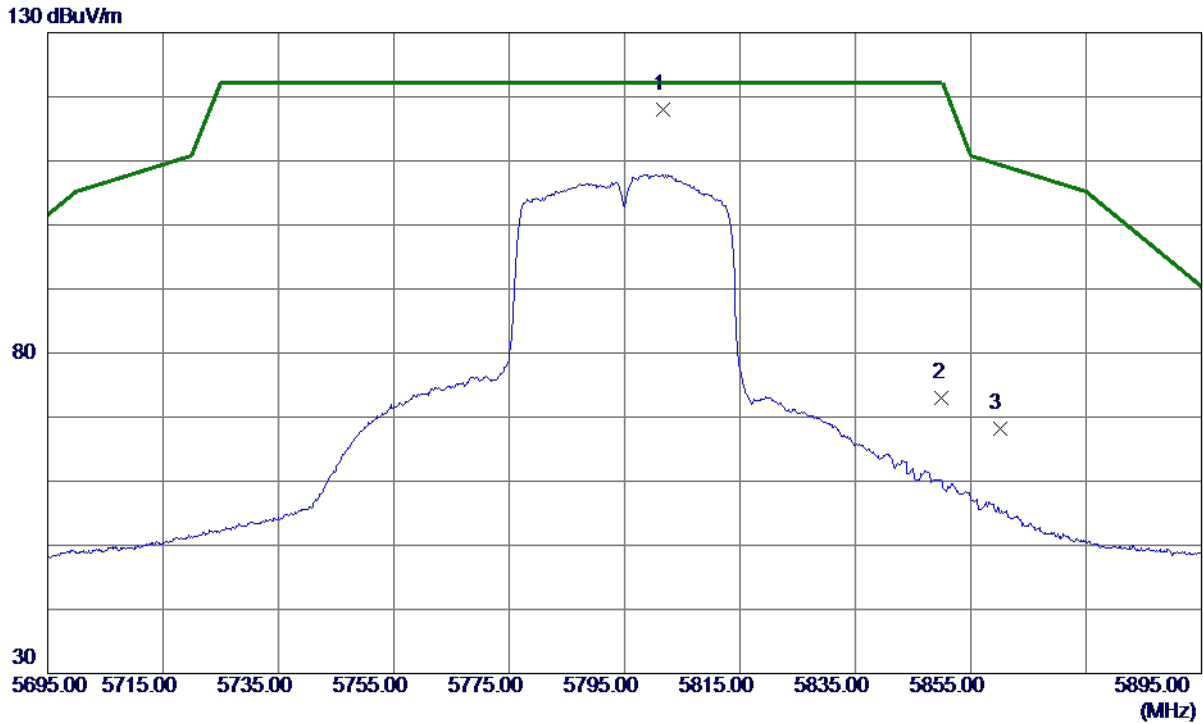

No.	Freq. MHz	Reading Level dBuV/m	Correct Factor dB	Measure ment dBuV/m	Limit dBuV/m	Margin dB	Detector	Comment
1 *	5801.7000	102.12	15.81	117.93	122.20	-4.27	Peak	No Limit
2	5850.0000	57.13	15.90	73.03	122.20	-49.17	Peak	
3	5860.0000	52.33	15.92	68.25	109.40	-41.15	Peak	

REMARKS:

- (1) Measurement Value = Reading Level + Correct Factor.
- (2) Margin Level = Measurement Value - Limit Value.

Orthogonal Axis	X
Test Mode	UNII-3_TX N (HT40) Mode 5795 MHz

Vertical

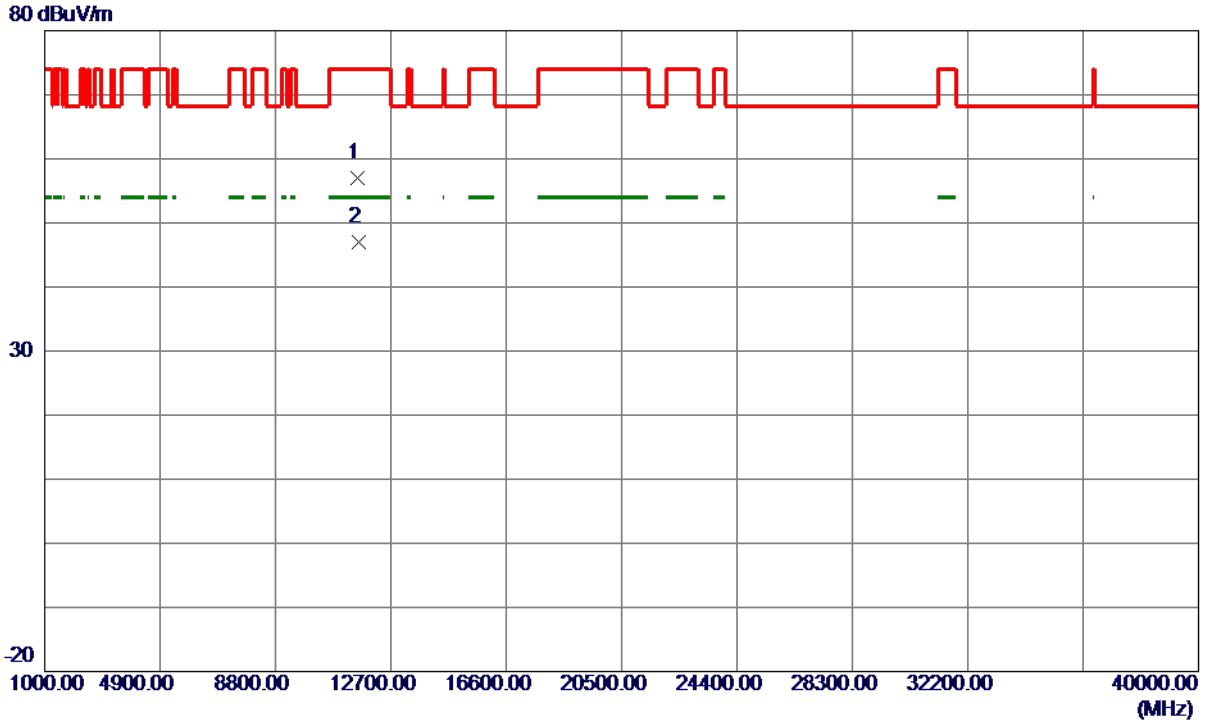

No.	Freq. MHz	Reading Level dBuV/m	Correct Factor dB	Measure ment dBuV/m	Limit dBuV/m	Margin dB	Detector	Comment
1	11590.0000	45.70	11.25	56.95	74.00	-17.05	Peak	
2 *	11611.6500	35.64	11.28	46.92	54.00	-7.08	AVG	

REMARKS:

- (1) Measurement Value = Reading Level + Correct Factor.
- (2) Margin Level = Measurement Value - Limit Value.

Orthogonal Axis	X
Test Mode	UNII-3_TX N (HT40) Mode 5795 MHz

Horizontal

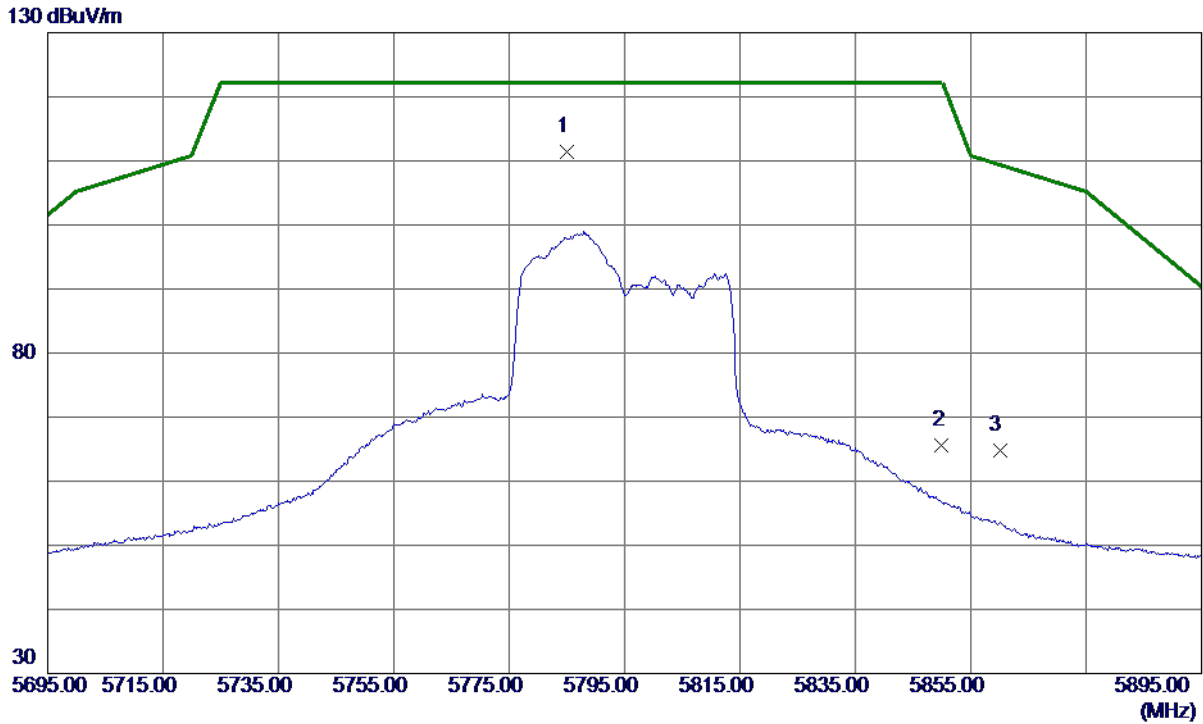

No.	Freq. MHz	Reading Level dBuV/m	Correct Factor dB	Measure ment dBuV/m	Limit dBuV/m	Margin dB	Detector	Comment
1 *	5784.9000	95.67	15.78	111.45	122.20	-10.75	Peak	No Limit
2	5850.0000	49.65	15.90	65.55	122.20	-56.65	Peak	
3	5860.0000	48.86	15.92	64.78	109.40	-44.62	Peak	

REMARKS:

- (1) Measurement Value = Reading Level + Correct Factor.
- (2) Margin Level = Measurement Value - Limit Value.

Orthogonal Axis	X
Test Mode	UNII-3_TX N (HT40) Mode 5795 MHz

Horizontal

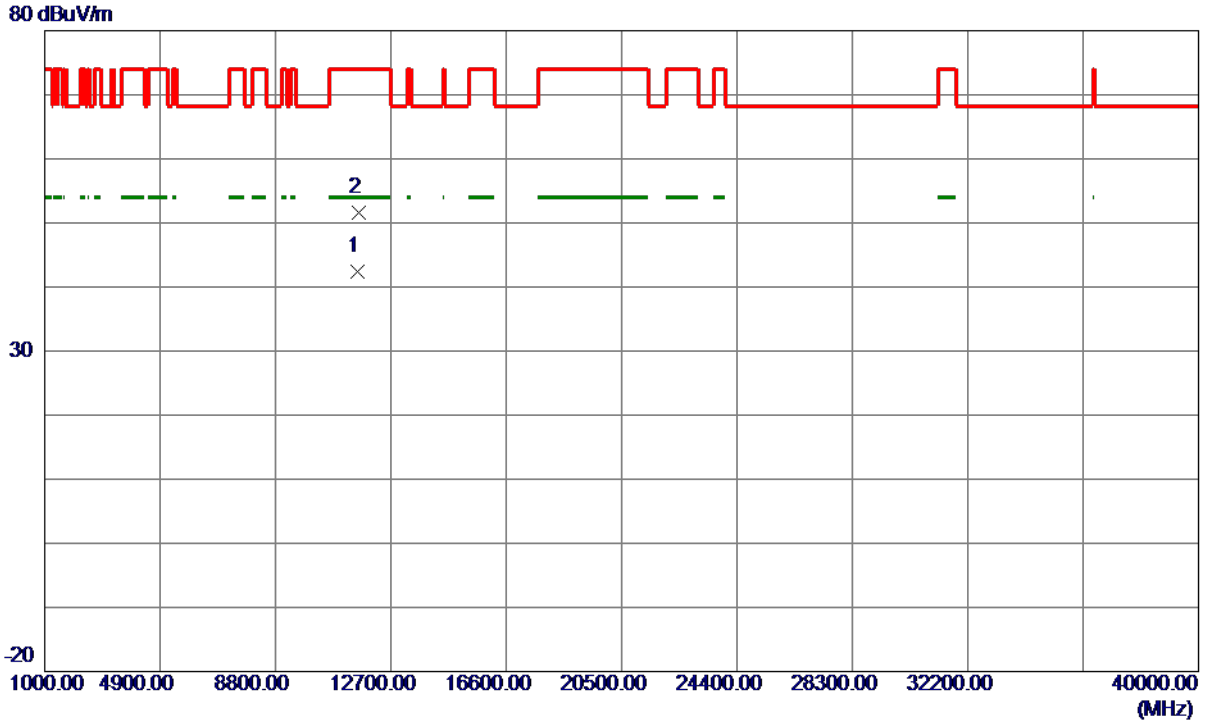

No.	Freq. MHz	Reading Level dBuV/m	Correct Factor dB	Measure ment dBuV/m	Limit dBuV/m	Margin dB	Detector	Comment
1 *	11589.8500	31.06	11.25	42.31	54.00	-11.69	AVG	
2	11595.9000	40.40	11.25	51.65	74.00	-22.35	Peak	

REMARKS:

- (1) Measurement Value = Reading Level + Correct Factor.
- (2) Margin Level = Measurement Value - Limit Value.

Orthogonal Axis	X
Test Mode	UNII-1_TX AC (VHT80) Mode 5210 MHz

Vertical

130 dBuV/m

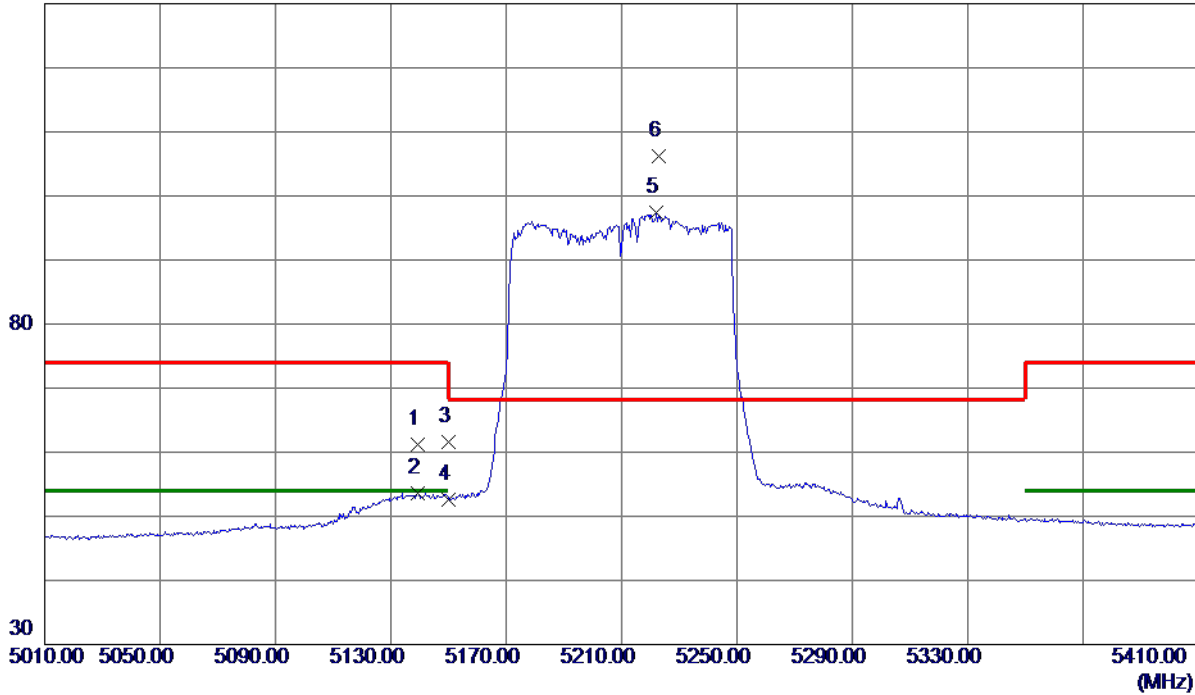

No.	Freq. MHz	Reading Level dBuV/m	Correct Factor dB	Measure ment dBuV/m	Limit dBuV/m	Margin dB	Detector	Comment
1	5139.2000	46.26	15.01	61.27	74.00	-12.73	Peak	
2	5139.2000	38.56	15.01	53.57	54.00	-0.43	AVG	
3	5150.0000	46.52	15.02	61.54	74.00	-12.46	Peak	
4	5150.0000	37.52	15.02	52.54	54.00	-1.46	AVG	
5	5222.2000	82.27	15.07	97.34	999.00	-901.66	AVG	No Limit
6 *	5223.0000	91.10	15.07	106.17	68.30	37.87	Peak	No Limit

REMARKS:

- (1) Measurement Value = Reading Level + Correct Factor.
- (2) Margin Level = Measurement Value - Limit Value.

Orthogonal Axis	X
Test Mode	UNII-1_TX AC (VHT80) Mode 5210 MHz

Vertical



No.	Freq. MHz	Reading Level dBuV/m	Correct Factor dB	Measure ment dBuV/m	Limit dBuV/m	Margin dB	Detector	Comment
1 *	10427.2000	43.38	9.02	52.40	68.30	-15.90	Peak	

REMARKS:

- (1) Measurement Value = Reading Level + Correct Factor.
- (2) Margin Level = Measurement Value - Limit Value.

Orthogonal Axis	X
Test Mode	UNII-1_TX AC (VHT80) Mode 5210 MHz

Horizontal

130 dBuV/m

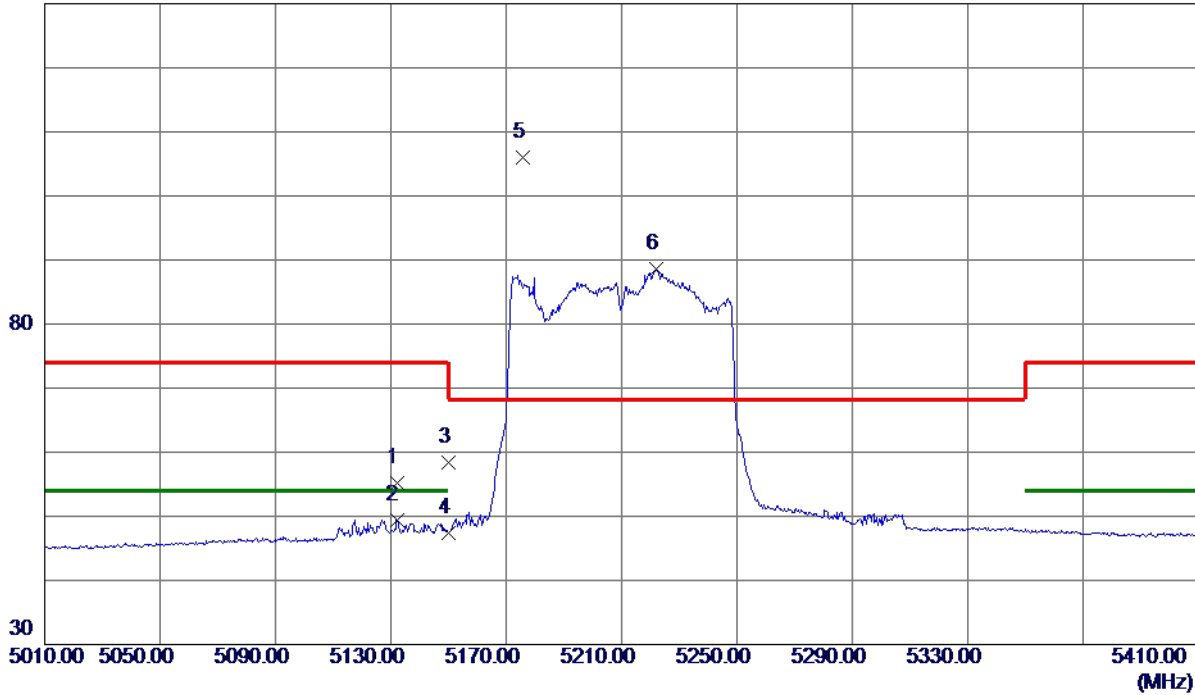

No.	Freq. MHz	Reading Level dBuV/m	Correct Factor dB	Measure ment dBuV/m	Limit dBuV/m	Margin dB	Detector	Comment
1	5132.0000	40.29	15.00	55.29	74.00	-18.71	Peak	
2	5132.0000	34.44	15.00	49.44	54.00	-4.56	AVG	
3	5150.0000	43.30	15.02	58.32	74.00	-15.68	Peak	
4	5150.0000	32.36	15.02	47.38	54.00	-6.62	AVG	
5 *	5175.6000	91.04	15.03	106.07	68.30	37.77	Peak	No Limit
6	5221.8000	73.60	15.07	88.67	999.00	-910.33	AVG	No Limit

REMARKS:

- (1) Measurement Value = Reading Level + Correct Factor.
- (2) Margin Level = Measurement Value - Limit Value.

Orthogonal Axis	X
Test Mode	UNII-1_TX AC (VHT80) Mode 5210 MHz

Horizontal

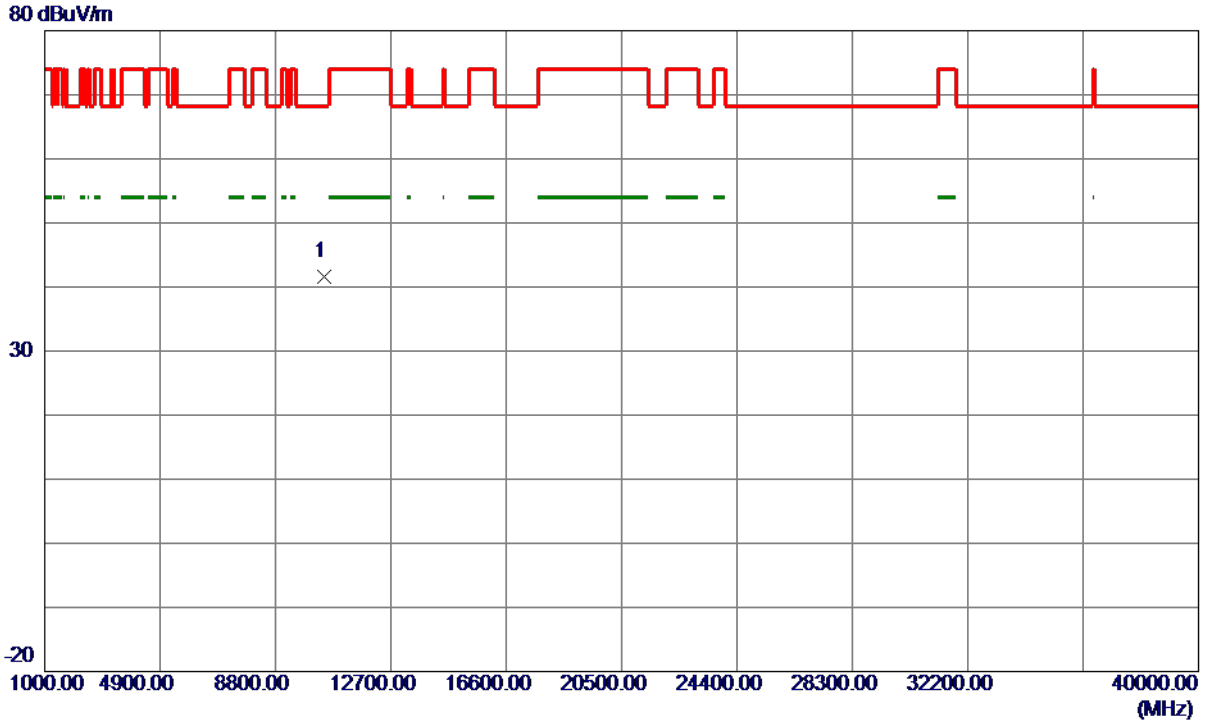

No.	Freq. MHz	Reading Level dBuV/m	Correct Factor dB	Measure ment dBuV/m	Limit dBuV/m	Margin dB	Detector	Comment
1 *	10427.5000	32.50	9.02	41.52	68.30	-26.78	Peak	

REMARKS:

- (1) Measurement Value = Reading Level + Correct Factor.
- (2) Margin Level = Measurement Value - Limit Value.

Orthogonal Axis	X
Test Mode	UNII-3_TX AC (VHT80) Mode 5775 MHz

Vertical

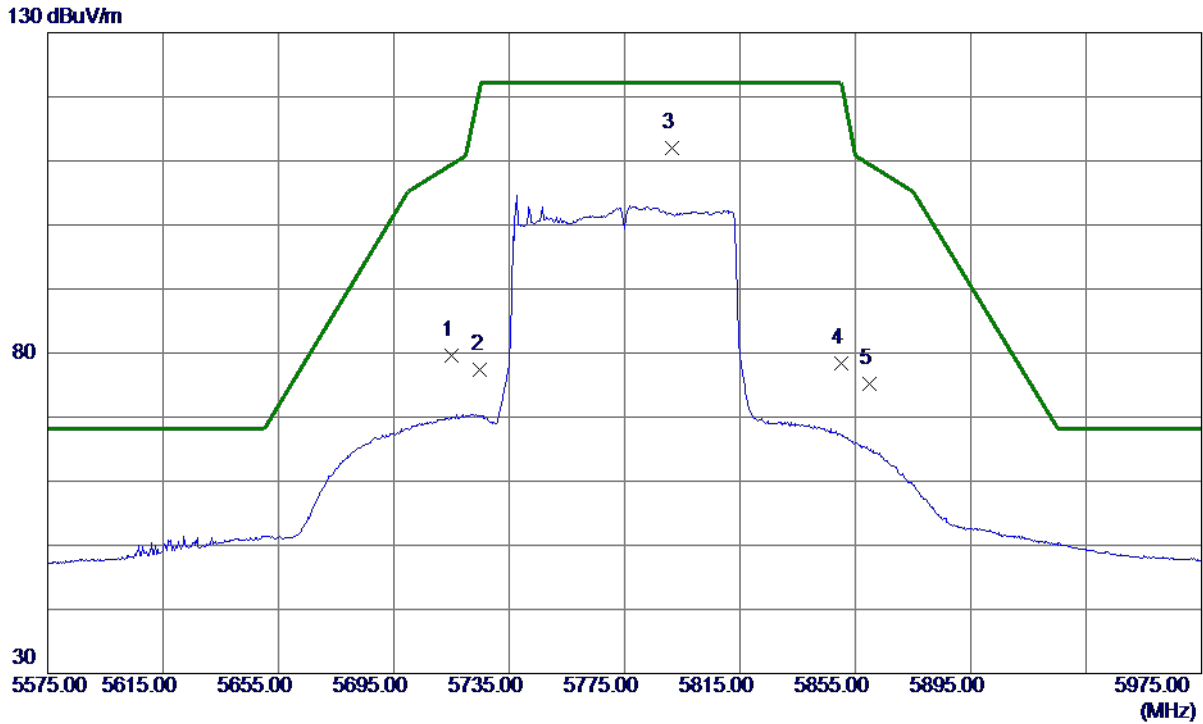

No.	Freq. MHz	Reading Level dBuV/m	Correct Factor dB	Measure ment dBuV/m	Limit dBuV/m	Margin dB	Detector	Comment
1	5715.0000	63.91	15.65	79.56	109.40	-29.84	Peak	
2	5725.0000	61.77	15.67	77.44	122.20	-44.76	Peak	
3 *	5791.4000	96.26	15.79	112.05	122.20	-10.15	Peak	No Limit
4	5850.0000	62.56	15.90	78.46	122.20	-43.74	Peak	
5	5860.0000	59.25	15.92	75.17	109.40	-34.23	Peak	

REMARKS:

- (1) Measurement Value = Reading Level + Correct Factor.
- (2) Margin Level = Measurement Value - Limit Value.

Orthogonal Axis	X
Test Mode	UNII-3_TX AC (VHT80) Mode 5775 MHz

Vertical

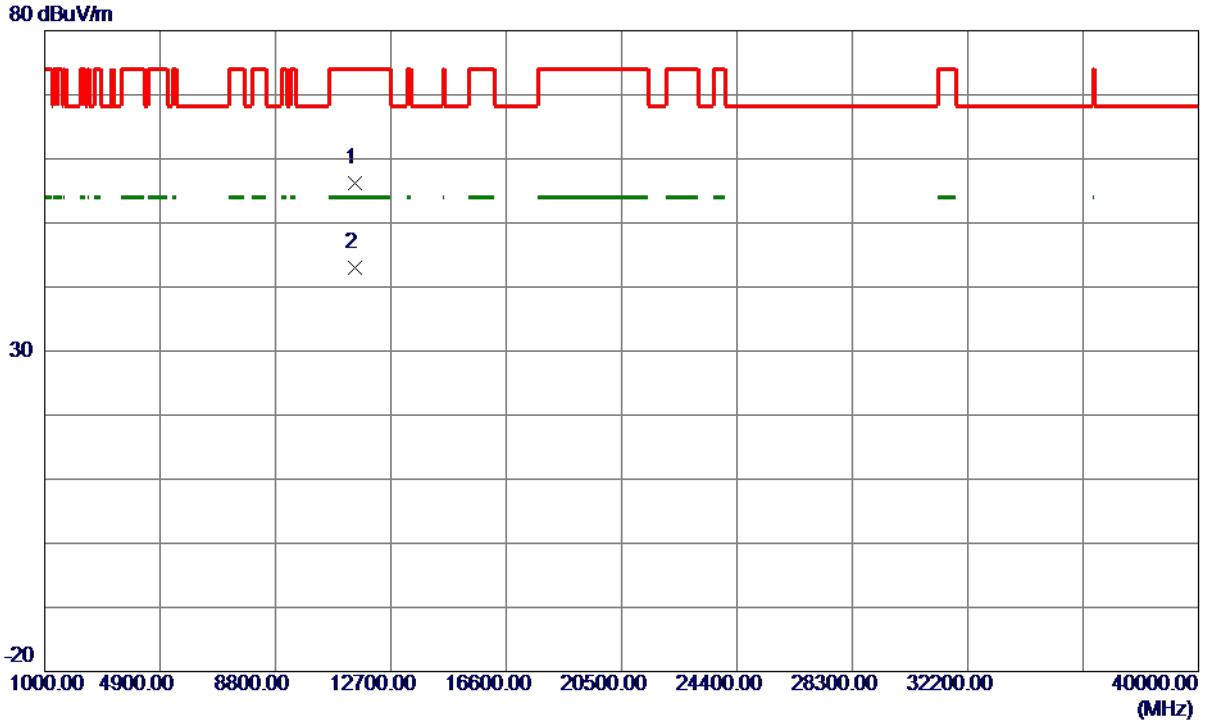

No.	Freq. MHz	Reading Level dBuV/m	Correct Factor dB	Measure ment dBuV/m	Limit dBuV/m	Margin dB	Detector	Comment
1	11495.4000	45.12	11.12	56.24	74.00	-17.76	Peak	
2 *	11504.5000	31.89	11.14	43.03	54.00	-10.97	AVG	

REMARKS:

- (1) Measurement Value = Reading Level + Correct Factor.
- (2) Margin Level = Measurement Value - Limit Value.

Orthogonal Axis	X
Test Mode	UNII-3_TX AC (VHT80) Mode 5775 MHz

Horizontal

130 dBuV/m

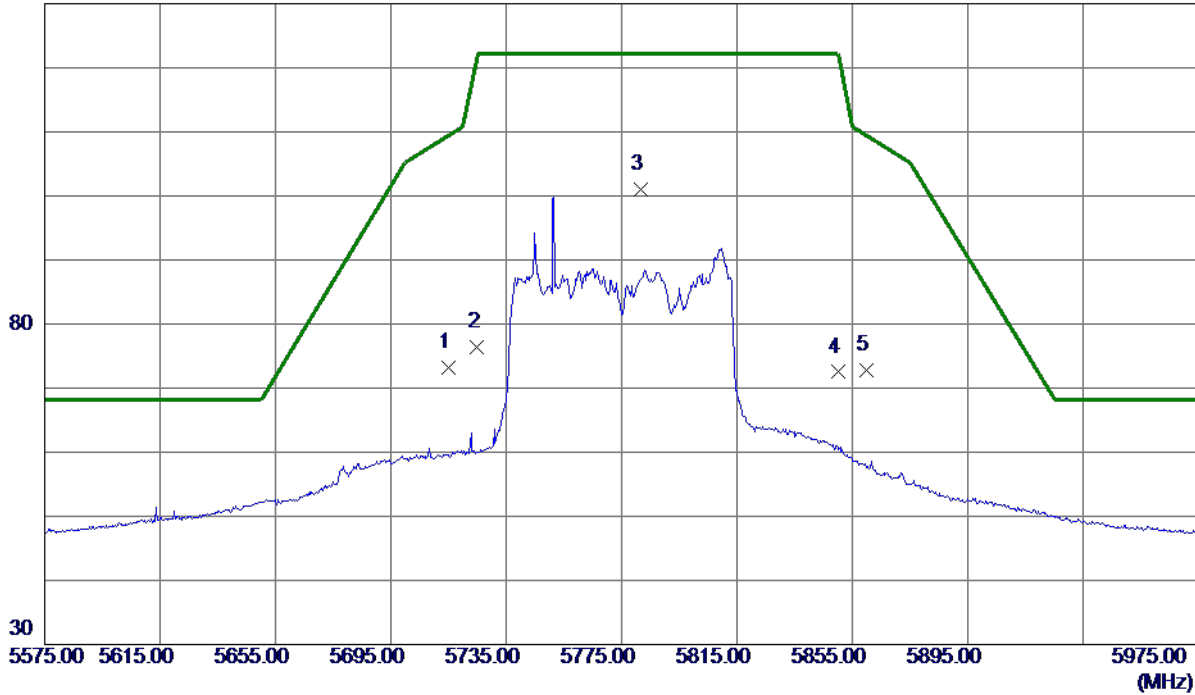

No.	Freq. MHz	Reading Level dBuV/m	Correct Factor dB	Measure ment dBuV/m	Limit dBuV/m	Margin dB	Detector	Comment
1	5715.0000	57.55	15.65	73.20	109.40	-36.20	Peak	
2	5725.0000	60.78	15.67	76.45	122.20	-45.75	Peak	
3 *	5781.8000	85.24	15.77	101.01	122.20	-21.19	Peak	No Limit
4	5850.0000	56.60	15.90	72.50	122.20	-49.70	Peak	
5	5860.0000	56.80	15.92	72.72	109.40	-36.68	Peak	

REMARKS:

- (1) Measurement Value = Reading Level + Correct Factor.
- (2) Margin Level = Measurement Value - Limit Value.

Orthogonal Axis	X
Test Mode	UNII-3_TX AC (VHT80) Mode 5775 MHz

Horizontal

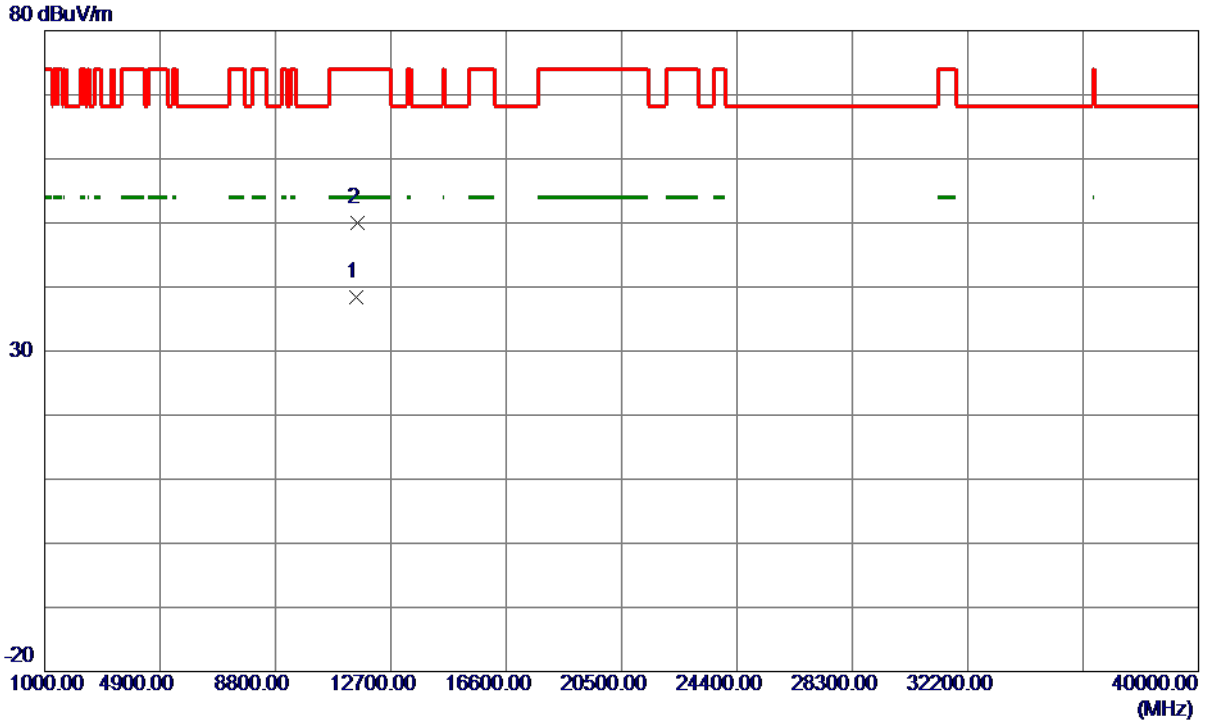

No.	Freq. MHz	Reading Level dBuV/m	Correct Factor dB	Measure ment dBuV/m	Limit dBuV/m	Margin dB	Detector	Comment
1 *	11551.2500	27.23	11.20	38.43	54.00	-15.57	AVG	
2	11553.6000	38.80	11.20	50.00	74.00	-24.00	Peak	

REMARKS:

- (1) Measurement Value = Reading Level + Correct Factor.
- (2) Margin Level = Measurement Value - Limit Value.

APPENDIX E - BANDWIDTH