



RADIO TEST REPORT

Report No:STS1803009W01

Issued for

TP-Link Technologies Co., Ltd.

Building 24-1F/3F/4F/5F, 28-1F/2F/3F/4F Science and Technology Park, Shennan Road, Nanshan District, Shenzhen City, Guangdong Province, P.R. China

Product Name:	C5s FDD-LTE Smartphone
Brand Name:	neffos
Model Name:	TP704C
Series Model:	TP704CXYZZ
FCC ID:	TE7C5SV1
Test Standard:	FCC Part 22H and 24E, 27

Any reproduction of this document must be done in full. No single part of this document may be reproduced without permission from STS, All Test Data Presented in this report is only applicable to presented Test sample.

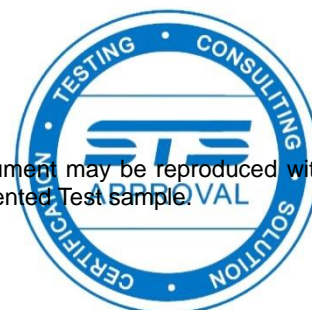



TEST RESULT CERTIFICATION

Applicant's name : TP-Link Technologies Co., Ltd.
Address: Building 24-1F/3F/4F/5F, 28-1F/2F/3F/4F Science and Technology Park, Shennan Road, Nanshan District, Shenzhen City, Guangdong Province, P.R. China

Manufacture's Name : TP-Link Technologies Co., Ltd.
Address: Building 24-1F/3F/4F/5F, 28-1F/2F/3F/4F Science and Technology Park, Shennan Road, Nanshan District, Shenzhen City, Guangdong Province, P.R. China

Product description

Product Name : C5s FDD-LTE Smartphone
Brand Name : neffos
Model Name : TP704C
Series Model : TP704CXYZZ

Test Standards : FCC Part 22H and 24E, 27

Test procedure : KDB 971168 D01 v03r01,ANSI C63.26(2015)

This device described above has been tested by STS and the test results show that the equipment under test (EUT) is in compliance with the FCC requirements. And it is applicable only to the tested sample identified in the report.

This report shall not be reproduced except in full, without the written approval of STS, this document only be altered or revised by STS, personal only, and shall be noted in the revision of the document.

Date of Test

Date of performance of tests : 02 March. 2018~25 April. 2018

Date of Issue : 25 April. 2018

Test Result : Pass

Testing Engineer : Chris chen
(Chris chen)

Technical Manager : Sean She
(Sean she)

Authorized Signatory : Vita Li
(Vita Li)





TABLE OF CONTENTS	Page
1 INTRODUCTION	6
1.1 TEST FACTORY	6
1.2 MEASUREMENT UNCERTAINTY	6
2 PRODUCT INFORMATION	7
3 TEST CONFIGURATION OF EQUIPMENT UNDER TEST	9
4 MEASUREMENT INSTRUMENTS	10
5 TEST ITEMS	11
5.1 CONDUCTED OUTPUT POWER	11
5.2 PEAK TO AVERAGE RATIO	12
5.3 TRANSMITTER RADIATED POWER (EIRP/ERP)	13
5.4 OCCUPIED BANDWIDTH	14
5.5 FREQUENCY STABILITY	15
5.6 SPURIOUS EMISSIONS AT ANTENNA TERMINALS	16
5.7 BAND EDGE	17
5.8 FIELD STRENGTH OF SPURIOUS RADIATION MEASUREMENT	18
APPENDIX A.TESTRESULT	20
A1.CONDUCTED OUTPUT POWER	20
A2. PEAK-TO-AVERAGE RADIO	25
A3. TRANSMITTER RADIATED POWER (EIRP/ERP)	27
A4. OCCUPIED BANDWIDTH (99% OCCUPIED BANDWIDTH/26DB BANDWIDTH)	30
A5.FREQUENCY STABILITY	42
A6. SPURIOUS EMISSIONS AT ANTENNA TERMINALS	48
A7. BAND EDGE	57
A8. FIELD STRENGTH OF SPURIOUS RADIATION MEASUREMENT	66
APPENDIX BPHOTOS OF TEST SETUP	75



Revision History

Rev.	Issue Date	Report NO.	Effect Page	Contents
00	09 Mar. 2018	STS1803009W01	ALL	Initial Issue





SUMMARY OF TEST RESULTS

Test procedures according to the technical standards:

The radiated emission testing was performed according to the procedures of KDB 971168 D01 v03r01 and ANSI C63.26(2015)

FCC Rules	Test Description	Test Limit	Test Result	Reference
2.1049	Conducted OutputPower	Reporting Only	PASS	
2.0146 24.232	Peak-to-AverageRatio	< 13 dB	PASS	
2.1046 22.913 24.232	Effective Radiated Power/Equivalent Isotropic Radiated Power	< 7 Watts max. ERP(Part 22) < 2 Watts max. EIRP(Part 24) <1 Watts max. EIRP(Part 27)	PASS	
2.1049 22.917 24.238	Occupied Bandwidth	Reporting Only	PASS	
2.1055 22.355 24.235	Frequency Stability	< 2.5 ppm (Part 22) Emission must remain in band (Part 24) Emission must remain in band (Part 27)	PASS	
2.1051 22.917 24.238	Spurious Emission at Antenna Terminals	< 43+10log10(P[Watts])	PASS	
2.1053 22.917 24.238	Field Strength of Spurious Radiation	< 43+10log10(P[Watts])	PASS	
2.1051 22.917 24.238	Band Edge	< 43+10log10(P[Watts])	PASS	



1 INTRODUCTION

1.1 TEST FACTORY

Shenzhen STS Test Services Co., Ltd.

Add. : 1/F., Building B, Zhuoke Science Park, No.190, Chongqing Road,
Fuyong Street, Bao'an District, Shenzhen, Guangdong, China

CNAS Registration No.: L7649; FCC Registration No.: 625569

IC Registration No.: 12108A; A2LA Certificate No.: 4338.01;

1.2 MEASUREMENT UNCERTAINTY

The measurement uncertainties shown below were calculated in accordance with the requirements of ANSI C63.4-2014. All measurement uncertainty values are shown with a coverage factor of $k = 2$ to indicate a 95% level of confidence. The measurement data shown herein meets or exceeds the CISPR measurement uncertainty values specified in CISPR 16-4-2 and, thus, can be compared directly to specified limits to determine compliance.

No.	Item	Uncertainty
1	RF power, conducted	± 0.70 dB
2	Spurious emissions, conducted	± 1.19 dB
5	All emissions, radiated (<1G) 30MHz-200MHz	± 2.83 dB
6	All emissions, radiated (<1G) 200MHz-1000MHz	± 2.94 dB
7	All emissions, radiated (>1G)	± 3.03 dB
8	Temperature	$\pm 0.5^{\circ}$ C
9	Humidity	$\pm 2\%$



2 PRODUCT INFORMATION

Product Name	C5s FDD-LTE Smartphone
Hardware version number:	B50046_MAIN_PCB_V1.2
Software version number:	B50040_TP-LINK_E3_V0.2.3.1_S1115
FCC ID:	TE7C5SV1
Tx Frequency:	GSM/GPRS/EDGE: 850: 824 MHz ~ 849MHz 1900: 1850 MHz ~ 1910MHz WCDMA: Band V: 824 MHz ~ 849 MHz Band II: 1850 MHz ~ 1910 MHz Band IV: 1710 MHz ~ 1755 MHz
Rx Frequency:	GSM/GPRS/EDGE: 850: 869 MHz ~ 894 MHz 1900: 1930 MHz ~ 1990MHz WCDMA: Band V: 869 MHz ~ 894 MHz Band II: 1930 MHz ~ 1990 MHz Band IV: 2110 MHz ~ 2155 MHz
Max RF Output Power:	GSM850:32.41dBm, PCS1900:26.41dBm GPRS850(1-Slot):32.36dBm, GPRS1900(1-Slot):26.28dBm GPRS850(2-Slot):31.95dBm, GPRS1900(2-Slot):25.78dBm GPRS850(3-Slot):31.52dBm, GPRS1900(3-Slot):25.35dBm GPRS850(4-Slot):31.04dBm, GPRS1900(4-Slot):24.92dBm EDGE 850(1-Slot):32.29dBm, EDGE 1900(1-Slot):26.13dBm EDGE 850(2-Slot):31.72dBm, EDGE 1900(2-Slot):25.39dBm EDGE 850(3-Slot):31.32dBm, EDGE 1900(3-Slot):24.68dBm EDGE 850(4-Slot):30.75dBm, EDGE 1900(4-Slot):23.89dBm WCDMABand V:22.99dBm, WCDMA Band II:19.58dBm WCDMA Band IV:22.91dBm
Type of Emission:	GSM(850): 322KGXW; GSM(1900): 316KGXW GPRS(850): 318KGXW; GPRS(1900): 321KGXW EDGE(850): 328KG7W; EDGE(1900): 315KG7W WCDMA850: 4M86F9W WCDMA1900: 4M86F9W WCDMA1700: 4M87F9W
SIM Card:	SIM 1 and SIM 2 is a chipset unit and tested as single chipset,SIM 1 is used to tested
Antenna:	PIFA Antenna
Antenna gain:	GSM 850: -1.93dBi ,PCS 1900:-1.85dBi WCDMA 850: -1.93dBi, WCDMA1900: -1.85dBi, WCDMA1700: -1.9dBi



Power Supply:	DC 3.8V by battery
Battery parameter:	Capacity: 2300mAh, Rated Voltage: 3.8V
Adapter:	Input: AC 100-240V, 50/60Hz, 0.2A Max Output: DC 5.0V, 1000mA
GPRS/EDGE Class:	Multi-Class12
Extreme Vol. Limits:	DC 3.4 V to 4.35 V (Nominal DC3.8V)
Extreme Temp. Tolerance:	-30°C to +50°C
<i>** Note: The High Voltage 4.35 V and Low Voltage 3.4 V was declared by manufacturer, The EUT couldn't be operate normally with higher or lower voltage.</i>	





3 TEST CONFIGURATION OF EQUIPMENT UNDER TEST

Antenna port conducted and radiated test items were performed according to KDB 971168 D01 and ANSI C63.26 2015 Power Meas. License Digital Systems with maximum output power.

Radiated measurements were performed with rotating EUT in different three orthogonal test planes to find the maximum emission.

Radiated emissions were investigated as following frequency range:

1. 30 MHz to 10th harmonic for GSM850 and WCDMA Band V.
2. 30 MHz to 10th harmonic for WCDMA Band IV.
3. 30 MHz to 10th harmonic for GSM1900 and WCDMA Band II.

All modes and data rates and positions were investigated.

Test modes are chosen to be reported as the worst case configuration below:

BAND	TEST MODES	
	RADIATED TCS	CONDUCTED TCS
GSM 850	GSM LINK GPRS/EDGE CLASS 12 LINK	GSM LINK GPRS/EDGE CLASS 12 LINK
GSM 1900	GSM LINK GPRS/EDGE CLASS 12 LINK	GSM LINK GPRS/EDGE CLASS 12 LINK
WCDMA BAND V	RMC 12.2KBPS LINK	RMC 12.2KBPS LINK
WCDMA BAND II	RMC 12.2KBPS LINK	RMC 12.2KBPS LINK
WCDMA BAND IV	RMC 12.2KBPS LINK	RMC 12.2KBPS LINK



4 MEASUREMENT INSTRUMENTS

Kind of Equipment	Manufacturer	Type No.	Serial No.	Last Calibration	Calibrated Until
EMI Test Receiver	R&S	ESW	101535	2017.06.01	2018.05.31
Signal Analyzer	Agilent	N9020A	MY49100060	2018.03.11	2019.03.10
Test Receiver	R&S	ESCI	101427	2017.10.15	2018.10.14
Universal Radio Communication Tester	R&S	CMW500	117239	2017.06.15	2018.06.14
Bilog Antenna	TESEQ	CBL6111D	34678	2017.03.24	2018.03.23
Horn Antenna	SCHWARZBECK	BBHA 9120D	1343	2017.10.27	2018.10.26
Horn Antenna	SCHWARZBECK	BBHA 9120D	1201	2017.10.27	2018.10.26
Horn Antenna	A-INFO	LB-180400-KF	J211020657	2017.10.27	2018.10.26
SHF-EHF Horn Antenna (15G-40GHz)	BBHA 9170	SCHWARZBECK	BBHA9170367	2017.05.02	2018.05.01
Low frequency cable	EM	R01	N/A	2017.03.12	2018.03.11
Low frequency cable	EM	R06	N/A	2017.03.12	2018.03.11
High frequency cable	SCHWARZBECK	R04	N/A	2017.03.12	2018.03.11
High frequency cable	SCHWARZBECK	R02	N/A	2017.03.12	2018.03.11
Pre-mpifier (0.1M-3GHz)	EM	EM330	60538	2017.03.12	2018.03.11
PreAmplifier (1G-26.5GHz)	Agilent	8449B	60538	2017.10.15	2018.10.14
Pre-mpifier (18G-40G)	MINI-CIRCUITS	AP-040G	1382501	2017.05.15	2018.05.14
Band Reject filter(1920-1980MHz)	COM-MW	ZBSF-1920-1980	0092	2017.10.15	2018.10.14
Band Reject filter(880-915MHz)	COM-MW	ZBSF-C897.5-35	707	2017.10.15	2018.10.14
Band Reject filter(1710-1785MHz)	COM-MW	ZBSF-C1747.5-75	708	2017.10.15	2018.10.14
Band Reject filter(1850-1910MHz)	COM-MW	ZBSF-C1880-60	709	2017.10.15	2018.10.14
Band Reject filter(2500-2570MHz)	COM-MW	ZBSF-C2535-70	710	2017.10.15	2018.10.14
Highpass Filter	WHKX7.0/18G-8SS	Wainwright	18	2017.10.15	2018.10.14
trun table	EM	SC100_1	60531	N/A	N/A
Antnna mast	EM	SC100	N/A	N/A	N/A

Equipment with a calibration date of "NCR" shown in this list was not used to make direct calibrated measurements.

5 TEST ITEMS

5.1 CONDUCTED OUTPUT POWER

Test overview

A system simulator was used to establish communication with the EUT. Its parameters were set to enforce EUT transmitting at the maximum power. The measured power in the radio frequency on the transmitter output terminals shall be reported.

Test procedures

1. The transmitter output port was connected to the system simulator.
2. Set eut at maximum power through the system simulator.
3. Select lowest, middle, and highest channels for each band and different modulation.
4. Measure and record the power level from the system simulator.

Test setup

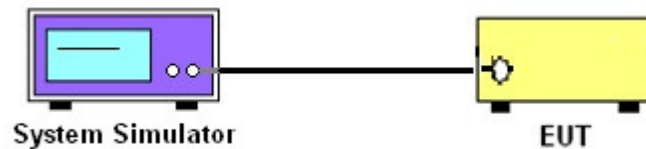

5.2 PEAK TO AVERAGE RATIO

TEST OVERVIEW

According to §24.232(d), power measurements for transmissions by stations authorized under this section may be made either in accordance with a commission-approved average power technique or in compliance with paragraph (e) of this section. In both instances, equipment employed must be authorized in accordance with the provisions of §24.51. In measuring transmissions in this band using an average power technique, the peak-to-average ratio (PAR) of the transmission may not exceed 13 db.

TEST PROCEDURES

1. The testing follows fcckdb 971168 v03r01 section
2. The eut was connected to the and peak and av system simulator& spectrum analysis reads
3. Select lowest, middle, and highest channels for each band and different modulation.
4. Set the test probe and measure average power of the spectrum analysis

TEST SETUP

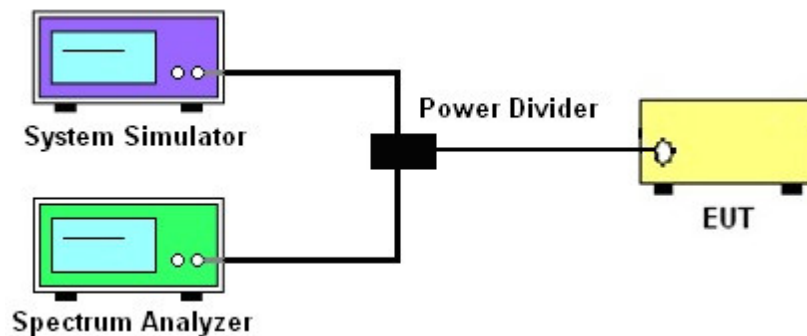



5.3 TRANSMITTER RADIATED POWER (EIRP/ERP)

TEST OVERVIEW

Effective Radiated Power (ERP) and Equivalent Isotropic Radiated Power (EIRP) measurements are performed using the substitution method described in ANSI C63.26 2015 with the EUT transmitting into an integral antenna. Measurements on signals operating below 1GHz are performed using vertically polarized tuned dipole antennas. Measurements on signals operating above 1GHz are performed using vertically polarized broadband horn antennas. All measurements are performed as RMS average measurements while the EUT is operating at maximum power, and at the appropriate frequencies.

TEST PROCEDURE

1. The testing follows FCC KDB 971168 D01 Section 5.2.1. (for CDMA/WCDMA), Section 5.2.2 (for GSM/GPRS/EDGE) and ANSI C63.26-2015 Section 5.2.
2. The transmitter was placed on a wooden turntable, and it was transmitting into a non-radiating load which was also placed on the turntable.
3. The measurement antenna was placed at a distance of 3 meters from the EUT. During the tests, the antenna height and polarization as well as EUT azimuth were varied in order to identify the maximum level of emissions from the EUT. The test was performed by placing the EUT on 3-orthogonal axis.
4. The frequency range up to tenth harmonic of the fundamental frequency was investigated.
5. Remove the EUT and replace it with substitution antenna. A signal generator was connected to the substitution antenna by a nonradiating cable. The absolute levels of the spurious emissions were measured by the substitution.
6. Effective Isotropic Radiated Power (EIRP) was measured by substitution method according to TIA/EIA-603-D. The EUT was replaced by the substitution antenna at same location, and then a known power from S.G. was applied into the dipole antenna through a Tx cable, and then recorded the maximum Analyzer reading through raised and lowered the test antenna. The correction factor (in dB) = S.G. - Tx Cable loss + Substitution antenna gain - Analyzer reading. Then the EUT's EIRP/ERP was calculated with the correction factor,
$$ERP/EIRP = P.SG + GT - LC$$

ERP/EIRP = effective or equivalent radiated power, respectively (expressed in the same units as P_{Meas} as, typically dBW or dBm);
P_{Meas}(PK) = measured transmitter output power or PSD, in dBm or dBW;
GT = gain of the transmitting antenna, in dBd (ERP) or dBi (EIRP);
LC = signal attenuation in the connecting cable between the transmitter and antenna, in dB.

5.4 OCCUPIED BANDWIDTH

TEST OVERVIEW

The occupied bandwidth, that is the frequency bandwidth such that, below its lower and above its upper frequency limits, the mean powers radiated are each equal to 0.5 percent of the total mean power radiated by a given emission shall be measured.

The 26 dB emission bandwidth is defined as the frequency range between two points, one above and one below the carrier frequency, at which the spectral density of the emission is attenuated 26 dB below the maximum in-band spectral density of the modulated signal. Spectral density (power per unit bandwidth) is to be measured with a detector of resolution bandwidth equal to approximately 1.0% of the emission bandwidth.

All modes of operation were investigated and the worst case configuration results are reported in this section.

TEST PROCEDURE

1. The signal analyzer's automatic bandwidth measurement capability was used to perform the 99% occupied bandwidth and the 26dB bandwidth. The bandwidth measurement was not influenced by any intermediate power nulls in the fundamental emission.
2. $RBW = 1 - 5\%$ of the expected OBW
3. $VBW \geq 3 \times RBW$
4. Detector = Peak
5. Trace mode = max hold
6. Sweep = auto couple
7. The trace was allowed to stabilize
8. If necessary, steps 2 – 7 were repeated after changing the RBW such that it would be within 1 – 5% of the 99% occupied bandwidth observed in Step 7

TEST SETUP

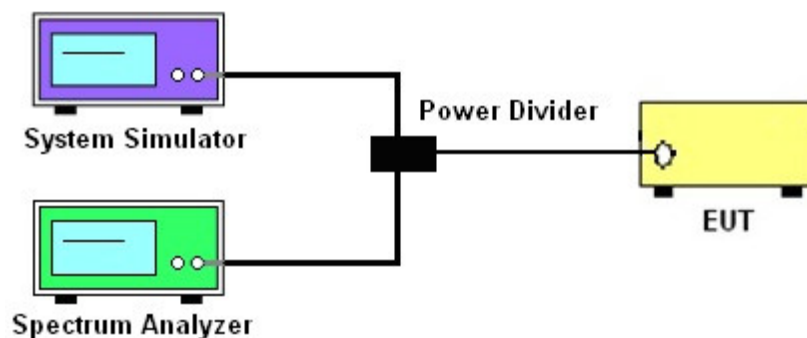

5.5 FREQUENCY STABILITY

Test Overview

Frequency stability testing is performed in accordance with the guidelines of ANSI C63.26 2015. The frequency stability of the transmitter is measured by:

- a.) Temperature: The temperature is varied from -30°C to $+50^{\circ}\text{C}$ in 10°C increments using an environmental chamber.
- b.) Primary Supply Voltage: The primary supply voltage is varied from 85% to 115% of the nominal value for non hand-carried battery and AC powered equipment. For hand-carried, battery-powered equipment, primary supply voltage is reduced to the battery operating end point which shall be specified by the manufacturer.

For Part 22, the frequency stability of the transmitter shall be maintained within $\pm 0.00025\%$ (± 2.5 ppm) of the center frequency. For Part 24 the frequency stability shall be sufficient to ensure that the fundamental emission stays within the authorized frequency block.

Test Procedure

Temperature Variation

1. The testing follows fccdb 971168 D01 section 9.0
2. The EUT was set up in the thermal chamber and connected with the system simulator.
3. With power OFF, the temperature was decreased to -30°C and the EUT was stabilized before testing. Power was applied and the maximum change in frequency was recorded within one minute.
4. With power OFF, the temperature was raised in 10°C steps up to 50°C . The EUT was stabilized at each step for at least half an hour. Power was applied and the maximum frequency change was recorded within one minute.

Voltage Variation

1. The testing follows FCC KDB 971168 D01 Section 9.0.
2. The EUT was placed in a temperature chamber at $25\pm 5^{\circ}\text{C}$ and connected with the system simulator.
3. The power supply voltage to the EUT was varied from 85% to 115% of the nominal value measured at the input to the EUT.
4. The variation in frequency was measured for the worst case.

TEST SETUP

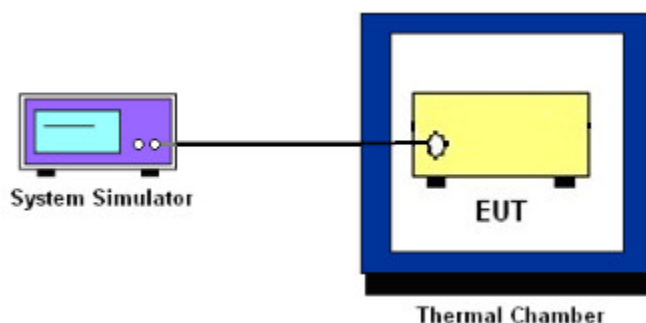

5.6 SPURIOUS EMISSIONS AT ANTENNA TERMINALS

Test Overview

The power of any emission outside of the authorized operating frequency ranges must be lower than the transmitter power (P) by a factor of at least $43 + 10 \log (P)$ dB.

It is measured by means of a calibrated spectrum analyzer and scanned from 30 MHz up to a frequency including its 10th harmonic.

Test procedure

1. The testing FCC KDB 971168 D01 v02r02 Section 6.0. and ANSI C63.26-2015-Section 5.5
2. The EUT was connected to the spectrum analyzer and system simulator via a power divider.
3. The RF output of EUT was connected to the spectrum analyzer by an RF cable and attenuator. The path loss was compensated to the results for each measurement.
4. The middle channel for the highest RF power within the transmitting frequency was measured.
5. The conducted spurious emission for the whole frequency range was taken.
6. The RF fundamental frequency should be excluded against the limit line in the operating frequency band.

7. The limit line is derived from $43 + 10\log(P)$ dB below the transmitter power P(Watts)

$$= P(W) - [43 + 10\log(P)] \text{ (dB)}$$

$$= [30 + 10\log(P)] \text{ (dBm)} - [43 + 10\log(P)] \text{ (dB)}$$

$$= -13\text{dBm.}$$

Test Setup

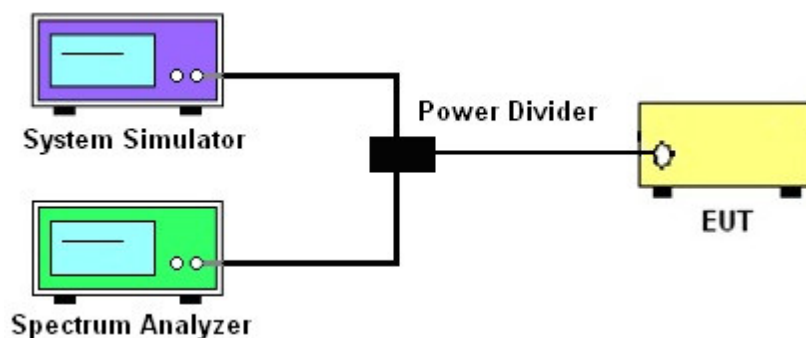

5.7 BAND EDGE

OVERVIEW

All out of band emissions are measured with a spectrum analyzer connected to the antenna terminal of the EUT while the EUT is operating at maximum power, and at the appropriate frequencies. All data rates were investigated to determine the worst case configuration. All modes of operation were investigated and the worst case configuration results are reported in this section.

The minimum permissible attenuation level of any spurious emission is $43 + \log_{10}(P[\text{Watts}])$, where P is the transmitter power in Watts.

TEST PROCEDURE

1. The testing FCC KDB 971168 D01 v02r02 Section 6.0. and ANSI C63.26-2015-Section 5.7
2. Start and stop frequency were set such that the band edge would be placed in the center of the Plot.
3. The EUT was connected to the spectrum analyzer and system simulator via a power divider.
4. The RF output of EUT was connected to the spectrum analyzer by an RF cable and attenuator.

The path loss was compensated to the results for each measurement.

5. The band edges of low and high channels for the highest RF powers were measured.

6. The RF fundamental frequency should be excluded against the limit line in the operating frequency band.

7. The limit line is derived from $43 + 10\log(P)$ dB below the transmitter power P(Watts)

$$= P(\text{W}) - [43 + 10\log(P)] (\text{dB})$$

$$= [30 + 10\log(P)] (\text{dBm}) - [43 + 10\log(P)] (\text{dB})$$

$$= -13\text{dBm}.$$

TEST SETUP

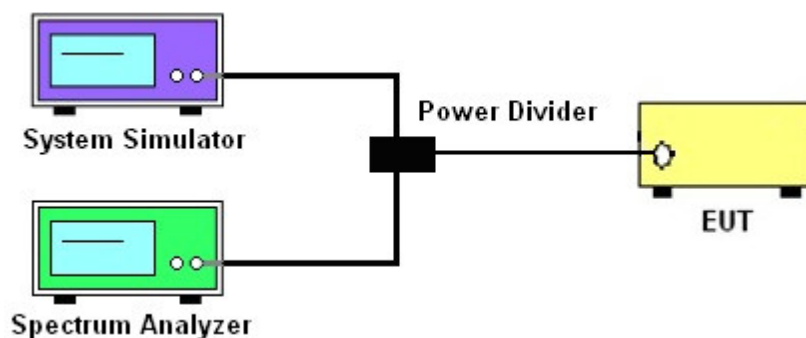



5.8 FIELD STRENGTH OF SPURIOUS RADIATION MEASUREMENT

Test overview

Radiated spurious emissions measurements are performed using the substitution method described in ANSI C63.26-2015 with the EUT transmitting into an integral antenna. Measurements on signals operating below 1GHz are performed using horizontally and vertically polarized tuned dipole antennas. Measurements on signals operating above 1GHz are performed using vertically and horizontally polarized horn antennas. All measurements are performed as peak measurements while the EUT is operating at maximum power and at the appropriate frequencies.

It is measured by means of a calibrated spectrum analyzer and scanned from 30 MHz up to a frequency including its 10th harmonic.

Test procedure

1. The testing FCC KDB 971168 D01 Section 5.8 and ANSI C63.26-2015-Section 5.5.
2. RBW = 100kHz for emissions below 1GHz and 1MHz for emissions above 1GHz
3. VBW $\geq 3 \times$ RBW
4. Span = 1.5 times the OBW
5. No. of sweep points $> 2 \times$ span/RBW
6. Detector = Peak
7. Trace mode = max hold
8. The trace was allowed to stabilize
9. Effective Isotropic Spurious Radiation was measured by substitution method according to ANSI C63.26-2015. The EUT was replaced by the substitution antenna at same location, and then a known power from S.G. was applied into the dipole antenna through a Tx cable, and then recorded the maximum Analyzer reading through raised and lowered the test antenna. The correction factor (in dB) = S.G. - Tx Cable loss + Substitution antenna gain - Analyzer reading. Then the EUT's EIRP/ERP was calculated with the correction factor,
$$\text{ERP/EIRP} = \text{P.SG} + \text{GT} - \text{LC}$$

ERP/EIRP = effective or equivalent radiated power, respectively (expressed in the same units as P_{Meas}, typically dBW or dBm);
P.SG = measured transmitter output power or PSD, in dBm or dBW;
GT = gain of the transmitting antenna, in dBd (ERP) or dBi (EIRP);
LC = signal attenuation in the connecting cable between the transmitter and antenna, in dB.

TEST SETUP

For radiated test from 30MHz to 1GHz

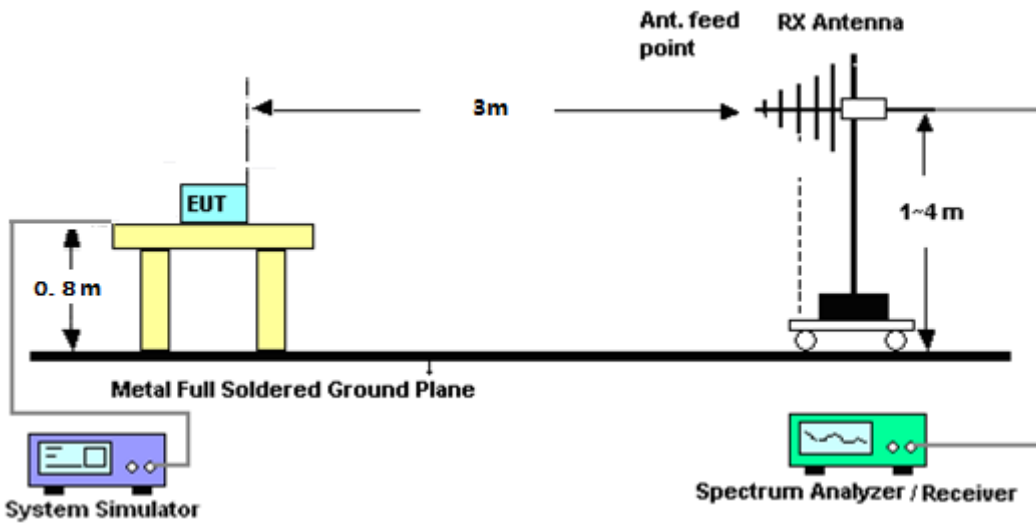

For radiated test from above 1GHz

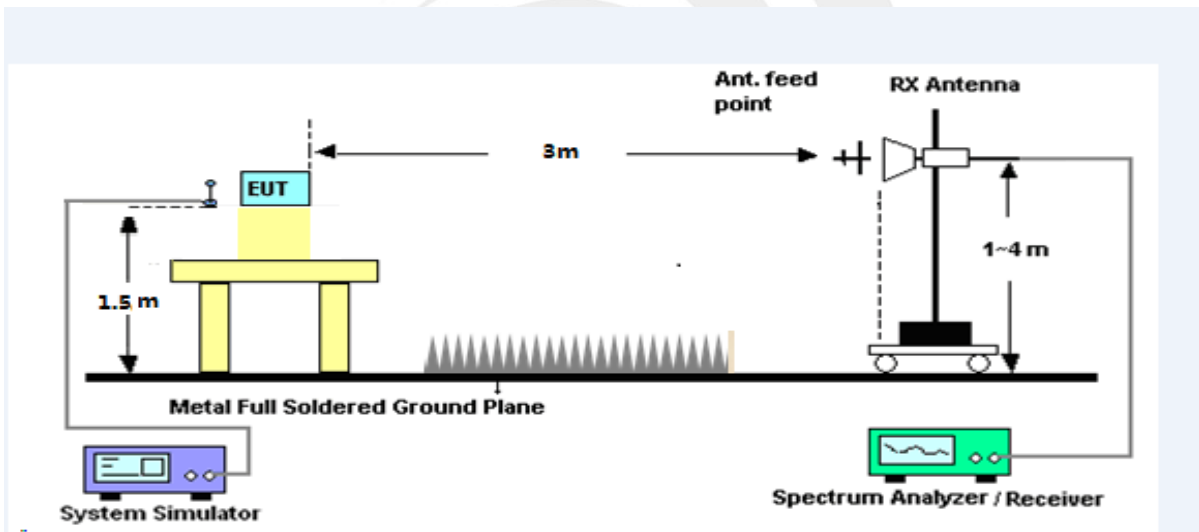

APPENDIX A.TESTRESULT
A1.CONDUCTED OUTPUT POWER

GSM 850:

Mode	Frequency (MHz)	AVG Power(dBm)
GSM	824.2	32.26
	836.6	32.40
	848.8	32.41
GPRS(GMSK,1-Slot)	824.2	32.22
	836.6	32.35
	848.8	32.36
GPRS(GMSK,2-Slot)	824.2	31.78
	836.6	31.95
	848.8	31.86
GPRS(GMSK,3-Slot)	824.2	31.32
	836.6	31.52
	848.8	31.43
GPRS(GMSK,4-Slot)	824.2	30.88
	836.6	31.04
	848.8	30.93
EGPRS(GMSK,1-Slot)	824.2	32.18
	836.6	32.28
	848.8	32.29
EGPRS(GMSK,2-Slot)	824.2	31.53
	836.6	31.72
	848.8	31.65
EGPRS(GMSK,3-Slot)	824.2	31.10
	836.6	31.32
	848.8	31.13
EGPRS(GMSK,4-Slot)	824.2	30.60
	836.6	30.75
	848.8	30.72



PCS 1900:

Mode	Frequency (MHz)	AVG Power(dBm)
GSM	1850.2	26.38
	1880.0	26.41
	1909.8	26.40
GPRS(GMSK,1-Slot)	1850.2	26.19
	1880.0	26.28
	1909.8	26.27
GPRS(GMSK,2-Slot)	1850.2	25.76
	1880.0	25.78
	1909.8	25.78
GPRS(GMSK,3-Slot)	1850.2	25.35
	1880.0	25.34
	1909.8	25.35
GPRS(GMSK,4-Slot)	1850.2	24.92
	1880.0	24.92
	1909.8	24.86
EGPRS(GMSK,1-Slot)	1850.2	26.08
	1880.0	26.13
	1909.8	26.12
EGPRS(GMSK,2-Slot)	1850.2	25.29
	1880.0	25.39
	1909.8	25.35
EGPRS(GMSK,3-Slot)	1850.2	24.52
	1880.0	24.68
	1909.8	24.60
EGPRS(GMSK,4-Slot)	1850.2	23.79
	1880.0	23.89
	1909.8	23.83



UMTS BAND V

Mode	Frequency(MHz)	AVG Power
WCDMA 850 RMC	826.4	22.98
	836.6	22.99
	846.6	22.85
HSDPA Subtest 1	826.4	22.87
	836.6	22.88
	846.6	22.76
HSDPA Subtest 2	826.4	22.40
	836.6	22.40
	846.6	22.33
HSDPA Subtest 3	826.4	21.93
	836.6	21.91
	846.6	21.98
HSDPA Subtest 4	826.4	21.59
	836.6	21.59
	846.6	21.58
HSUPA Subtest 1	826.4	22.78
	836.6	22.87
	846.6	22.28
HSUPA Subtest 2	826.4	21.86
	836.6	21.95
	846.6	21.34
HSUPA Subtest 3	826.4	21.71
	836.6	21.55
	846.6	21.01
HSUPA Subtest 4	826.4	21.29
	836.6	21.17
	846.6	20.68
HSUPA Subtest 5	826.4	19.88
	836.6	19.72
	846.6	19.20



UMTS BAND II

Mode	Frequency(MHz)	AVG Power
WCDMA 1900 RMC	1852.4	19.58
	1880	19.55
	1907.6	19.57
HSDPA Subtest 1	1852.4	19.42
	1880	19.43
	1907.6	19.45
HSDPA Subtest 2	1852.4	18.99
	1880	18.93
	1907.6	18.96
HSDPA Subtest 3	1852.4	18.53
	1880	18.49
	1907.6	18.64
HSDPA Subtest 4	1852.4	18.10
	1880	18.06
	1907.6	18.26
HSUPA Subtest 1	1852.4	19.32
	1880	19.42
	1907.6	18.98
HSUPA Subtest 2	1852.4	18.41
	1880	18.42
	1907.6	18.04
HSUPA Subtest 3	1852.4	18.30
	1880	17.99
	1907.6	17.61
HSUPA Subtest 4	1852.4	17.97
	1880	17.60
	1907.6	17.24
HSUPA Subtest 5	1852.4	16.53
	1880	16.13
	1907.6	15.82



UMTS BAND IV

Mode	Frequency(MHz)	AVG Power
WCDMA 1900 RMC	1712.6	22.89
	1740	22.91
	1752.4	22.88
HSDPA Subtest 1	1712.6	22.76
	1740	22.81
	1752.4	22.75
HSDPA Subtest 2	1712.6	22.27
	1740	22.31
	1752.4	22.28
HSDPA Subtest 3	1712.6	21.95
	1740	21.87
	1752.4	21.95
HSDPA Subtest 4	1712.6	21.61
	1740	21.48
	1752.4	21.59
HSUPA Subtest 1	1712.6	22.73
	1740	22.72
	1752.4	22.29
HSUPA Subtest 2	1712.6	21.92
	1740	21.81
	1752.4	21.36
HSUPA Subtest 3	1712.6	21.91
	1740	21.39
	1752.4	21.04
HSUPA Subtest 4	1712.6	21.60
	1740	20.93
	1752.4	20.55
HSUPA Subtest 5	1712.6	20.18
	1740	19.45
	1752.4	19.05



A2. PEAK-TO-AVERAGE RADIO

Mode	Frequency (MHz)	PEAK Power (dBm)	AVG Power (dBm)	PAR (dB)
GSM850	824.2	32.42	32.21	0.21
	836.6	32.35	32.13	0.22
	848.8	32.25	32.03	0.22
GPRS850	824.2	31.88	31.66	0.22
	836.6	31.97	31.75	0.22
	848.8	31.78	31.56	0.22
EDGE850 (8-PSK)	824.2	28.17	25.34	2.83
	836.6	28.47	25.50	2.97
	848.8	28.44	25.39	3.05
PCS1900	1850.2	26.45	26.29	0.16
	1880	26.42	26.27	0.15
	1909.8	26.06	25.91	0.15
GPRS1900	1850.2	25.94	25.74	0.20
	1880	26.35	26.19	0.16
	1909.8	26.10	25.95	0.15
EDGE1900 (8-PSK)	1850.2	24.52	22.05	2.47
	1880	24.36	21.80	2.56
	1909.8	24.13	21.63	2.50



Mode	Frequency (MHz)	PEAK Power (dBm)	AVG Power (dBm)	PAR (dB)
WCDMA 850 RMC	826.4	25.55	22.63	2.92
	836.6	25.95	22.80	3.15
	846.6	25.51	22.48	3.03
HSDPA 850	826.4	26.32	22.15	4.17
	836.6	26.16	22.13	4.03
	846.6	26.03	22.21	3.82
HSUPA 850	826.4	25.19	21.65	3.54
	836.6	25.65	21.86	3.79
	846.6	25.79	22.03	3.76
WCDMA 1900 RMC	1852.4	22.63	19.47	3.16
	1880	22.38	19.30	3.08
	1907.6	22.15	19.34	2.81
HSDPA 1900	1852.4	23.36	19.25	4.11
	1880	23.01	19.21	3.80
	1907.6	23.03	18.94	4.09
HSUPA 1900	1852.4	23.30	19.14	4.16
	1880	23.00	19.08	3.92
	1907.6	22.59	18.88	3.71
WCDMA 1700 RMC	1712.6	25.35	22.24	3.11
	1740	25.25	22.29	2.96
	1752.4	25.46	22.37	3.09
HSDPA 1700	1712.6	26.30	22.12	4.18
	1740	25.97	22.07	3.90
	1752.4	26.63	22.19	4.44
HSUPA 1700	1712.6	25.24	21.57	3.67
	1740	25.90	21.84	4.06
	1752.4	25.60	21.72	3.88

NOTE:Test chart See Appendix D



A3. TRANSMITTER RADIATED POWER (EIRP/ERP)

Radiated Power (ERP) for GSM 850 MHZ							
Mode	Frequency	Result					Conclusion
		S G.Level (dBm)	Cable loss	Gain (dBi)	PMeas E.R.P(dBm)	Polarization Of Max. ERP	
GSM850	824.2	23.87	0.44	6.5	29.93	Horizontal	Pass
	824.2	25.66	0.44	6.5	31.72	Vertical	Pass
	836.6	23.82	0.45	6.5	29.87	Horizontal	Pass
	836.6	25.80	0.45	6.5	31.85	Vertical	Pass
	848.8	24.00	0.46	6.5	30.04	Horizontal	Pass
	848.8	25.82	0.46	6.5	31.86	Vertical	Pass
GPRS850	824.2	23.70	0.44	6.5	29.76	Horizontal	Pass
	824.2	25.64	0.44	6.5	31.70	Vertical	Pass
	836.6	23.85	0.45	6.5	29.90	Horizontal	Pass
	836.6	25.61	0.45	6.5	31.66	Vertical	Pass
	848.8	23.87	0.46	6.5	29.91	Horizontal	Pass
	848.8	25.68	0.46	6.5	31.72	Vertical	Pass
EDGE850	824.2	23.87	0.44	6.5	29.93	Horizontal	Pass
	824.2	25.37	0.44	6.5	31.43	Vertical	Pass
	836.6	24.00	0.45	6.5	30.05	Horizontal	Pass
	836.6	25.53	0.45	6.5	31.58	Vertical	Pass
	848.8	23.87	0.46	6.5	29.91	Horizontal	Pass
	848.8	25.77	0.46	6.5	31.81	Vertical	Pass



Radiated Power (EIRP) for PCS 1900 MHZ							
Mode	Frequency	Result					Conclusion
		S G. Level (dBm)	Cable loss	Gain (dBi)	PMeas E.I.R.P.(dBm)	Polarization Of Max. EIRP.	
PCS1900	1850.2	16.15	2.41	10.35	24.09	Horizontal	Pass
	1850.2	17.91	2.41	10.35	25.85	Vertical	Pass
	1880	16.06	2.42	10.35	23.99	Horizontal	Pass
	1880	17.96	2.42	10.35	25.89	Vertical	Pass
	1909.8	16.08	2.43	10.35	24.00	Horizontal	Pass
	1909.8	17.96	2.43	10.35	25.88	Vertical	Pass
GPRS1900	1850.2	15.91	2.41	10.35	23.85	Horizontal	Pass
	1850.2	17.88	2.41	10.35	25.82	Vertical	Pass
	1880	16.06	2.42	10.35	23.99	Horizontal	Pass
	1880	17.89	2.42	10.35	25.82	Vertical	Pass
	1909.8	16.15	2.43	10.35	24.07	Horizontal	Pass
	1909.8	17.85	2.43	10.35	25.77	Vertical	Pass
EDGE1900	1850.2	16.02	2.41	10.35	23.96	Horizontal	Pass
	1850.2	17.65	2.41	10.35	25.59	Vertical	Pass
	1880	16.19	2.42	10.35	24.12	Horizontal	Pass
	1880	17.86	2.42	10.35	25.79	Vertical	Pass
	1909.8	16.26	2.43	10.35	24.18	Horizontal	Pass
	1909.8	17.71	2.43	10.35	25.63	Vertical	Pass



Radiated Power (ERP) for WCDMA Band V							
Mode	Frequency	Result					Conclusion
		S G. Level (dBm)	Cable loss	Gain (dBi)	PMeas E.R.P (dBm)	Polarization Of Max.ERP	
Band V	826.4	14.66	0.44	6.5	20.72	Horizontal	Pass
	826.4	16.41	0.44	6.5	22.47	Vertical	Pass
	835	14.50	0.45	6.5	20.55	Horizontal	Pass
	835	16.43	0.45	6.5	22.48	Vertical	Pass
	846.4	14.45	0.46	6.5	20.49	Horizontal	Pass
	846.4	16.30	0.46	6.5	22.34	Vertical	Pass

Radiated Power (EIRP) for WCDMA Band II							
Mode	Frequency	Result					Conclusion
		S G. Level (dBm)	Cable loss	Gain (dBi)	PMeas E.I.R.P.(dBm)	Polarization Of Max.EIRP	
Band II	1852.4	12.58	2.41	10.35	20.52	Horizontal	Pass
	1852.4	14.41	2.41	10.35	22.35	Vertical	Pass
	1880	12.55	2.42	10.35	20.48	Horizontal	Pass
	1880	14.54	2.42	10.35	22.47	Vertical	Pass
	1907.4	12.6	2.43	10.35	20.52	Horizontal	Pass
	1907.4	14.56	2.43	10.35	22.48	Vertical	Pass

Radiated Power (EIRP) for WCDMA Band IV							
Mode	Frequency	Result					Conclusion
		S G. Level (dBm)	Cable loss	Gain (dBi)	PMeas E.I.R.P.(dBm)	Polarization Of Max.EIRP	
Band II	1712.6	12.59	2.07	10.13	20.65	Horizontal	Pass
	1712.6	14.3	2.07	10.13	22.36	Vertical	Pass
	1740	12.45	2.08	10.13	20.50	Horizontal	Pass
	1740	14.33	2.08	10.13	22.38	Vertical	Pass
	1752.4	12.34	2.09	10.13	20.38	Horizontal	Pass
	1752.4	14.31	2.09	10.13	22.35	Vertical	Pass



A4. OCCUPIED BANDWIDTH (99% OCCUPIED BANDWIDTH/26dB BANDWIDTH)

Occupied Bandwidth for GSM 850 band			
Mode	Frequency(MHz)	Occupied Bandwidth (99%)(kHz)	Emission Bandwidth (-26dBc)(kHz)
Low Channel	824.2	244.05	316.4
Middle Channel	836.6	242.61	320.0
High Channel	848.8	244.55	322.4
Occupied Bandwidth for GPRS 850 band			
Mode	Frequency(MHz)	Occupied Bandwidth (99%)(kHz)	Emission Bandwidth (-26dBc)(kHz)
Low Channel	824.2	247.03	315.9
Middle Channel	836.6	246.76	318.3
High Channel	848.8	241.19	318.1
Occupied Bandwidth for EGPRS 850 band			
Mode	Frequency(MHz)	Occupied Bandwidth (99%)(kHz)	Emission Bandwidth (-26dBc)(kHz)
Low Channel	824.2	248.85	317.7
Middle Channel	836.6	248.01	320.9
High Channel	848.8	244.02	327.7



Occupied Bandwidth for GSM1900 band			
Mode	Frequency(MHz)	Occupied Bandwidth (99%)(kHz)	Emission Bandwidth (-26dBc)(kHz)
Low Channel	1850.2	246.15	314.8
Middle Channel	1880.0	246.01	316.0
High Channel	1909.8	247.50	312.6
Occupied Bandwidth for GPRS 1900 band			
Mode	Frequency(MHz)	Occupied Bandwidth (99%)(kHz)	Emission Bandwidth (-26dBc)(kHz)
Low Channel	1850.2	242.99	310.6
Middle Channel	1880.0	240.89	315.2
High Channel	1909.8	245.69	320.5
Occupied Bandwidth for EDGE 1900 band			
Mode	Frequency(MHz)	Occupied Bandwidth (99%)(kHz)	Emission Bandwidth (-26dBc)(kHz)
Low Channel	1850.2	243.73	314.5
Middle Channel	1880.0	245.58	315.2
High Channel	1909.8	241.22	314.5



Occupied Bandwidth for UMTS band V			
Mode	Frequency(MHz)	Occupied Bandwidth (99%)(MHz)	Emission Bandwidth (-26dBc)(MHz)
Low Channel	826.4	4.1944	4.861
Middle Channel	836.6	4.2003	4.864
High Channel	846.6	4.1895	4.842

Occupied Bandwidth for UMTS band II			
Mode	Frequency(MHz)	Occupied Bandwidth (99%)(MHz)	Emission Bandwidth (-26dBc)(MHz)
Low Channel	1852.4	4.1964	4.836
Middle Channel	1880	4.2029	4.860
High Channel	1907.6	4.1941	4.864

Occupied Bandwidth for UMTS band IV			
Mode	Frequency(MHz)	Occupied Bandwidth (99%)(MHz)	Emission Bandwidth (-26dBc)(MHz)
Low Channel	1712.6	4.1936	4.848
Middle Channel	1740	4.2064	4.870
High Channel	1752.4	4.2020	4.860



GSM 850 CH 128

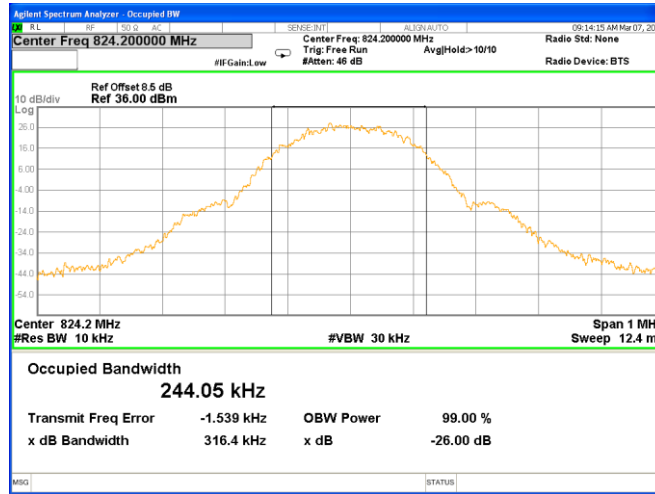

GSM 850 CH 190

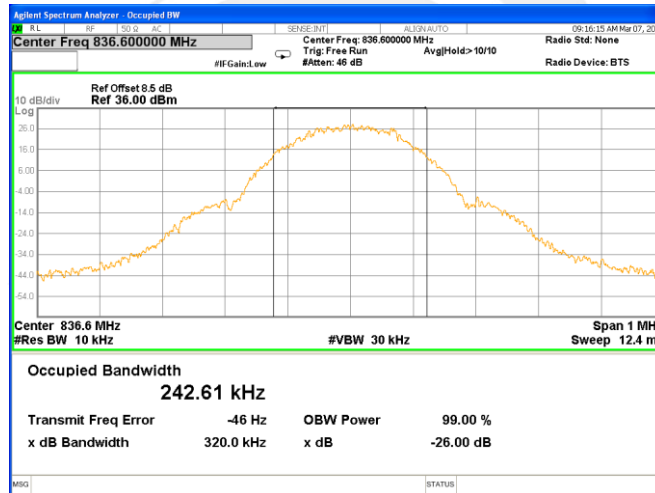

GSM 850 CH 251

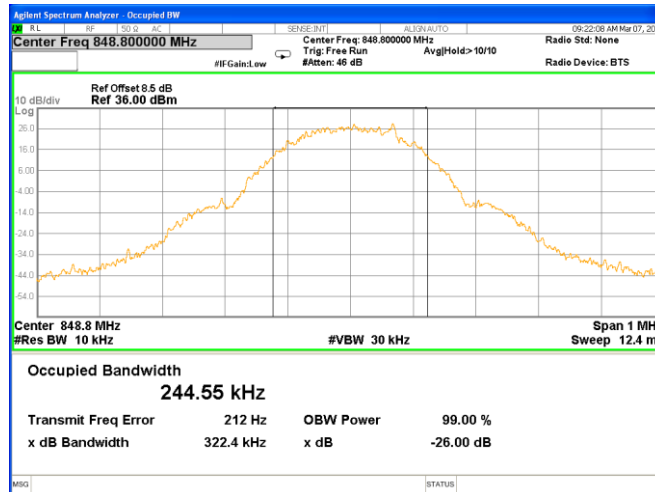



GPRS 850 CH 128

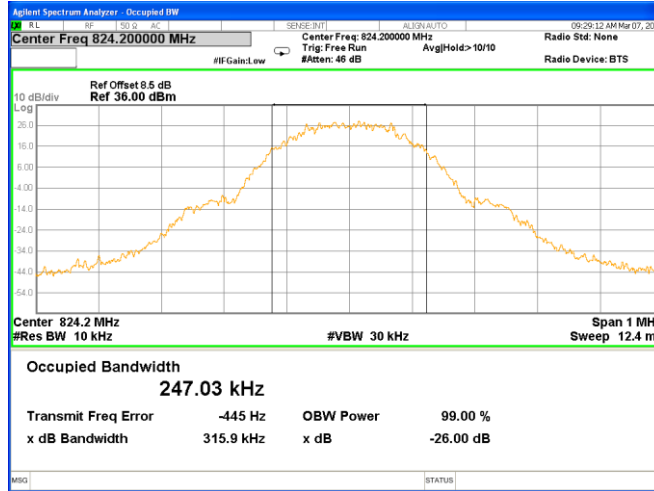

GPRS 850 CH 190

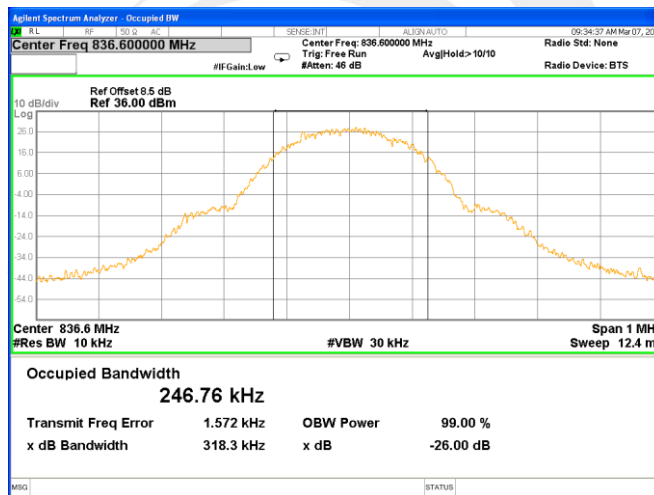

GPRS 850 CH 251

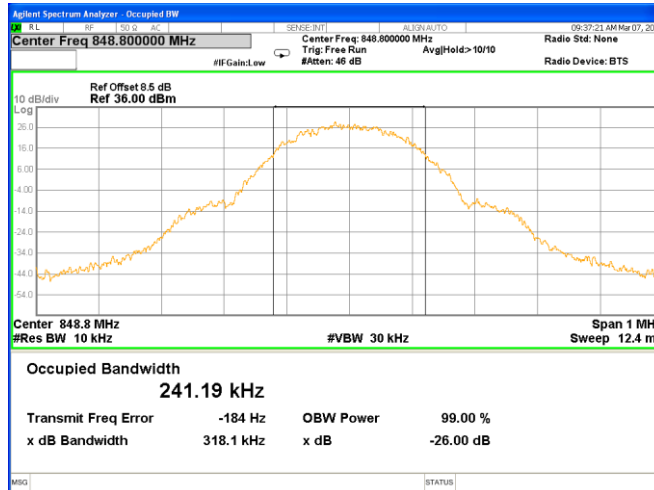



EDGE 850 CH 128

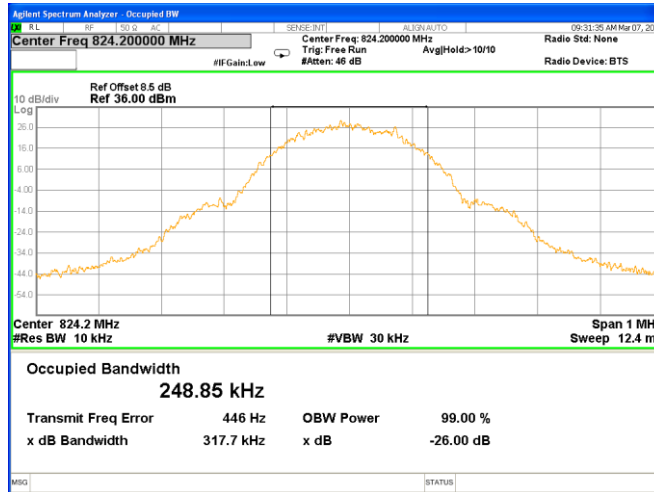

EDGE 850 CH 190

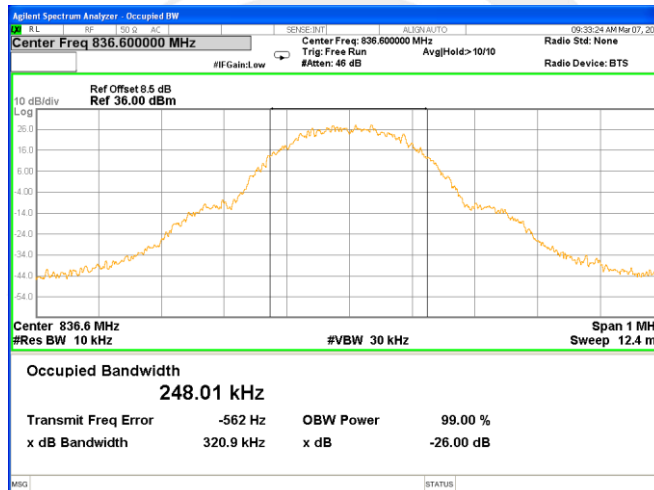

EDGE 850 CH 251

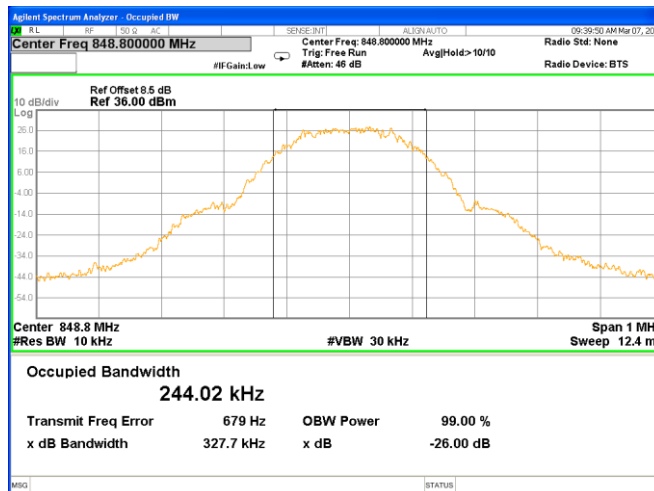



PCS 1900 CH 512

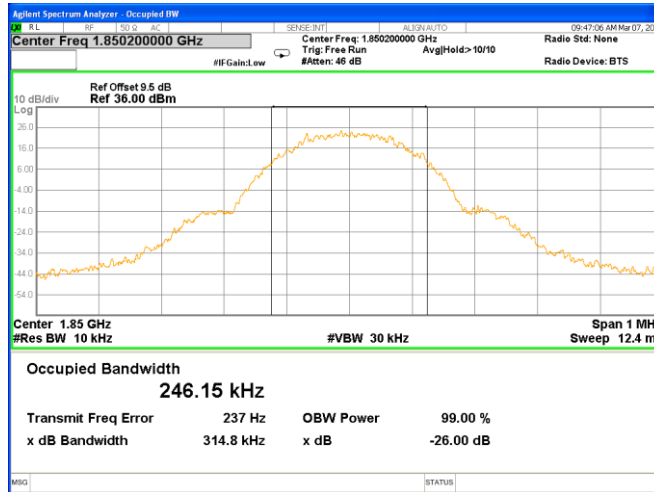

PCS 1900 CH 661

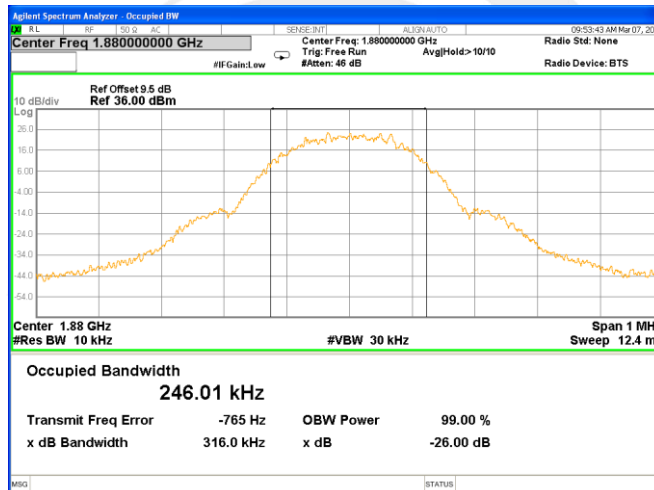

PCS 1900 CH 810

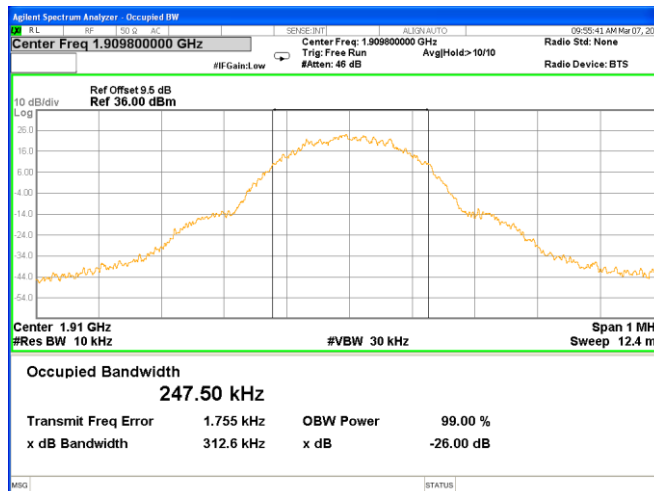



GPRS 1900 CH 512

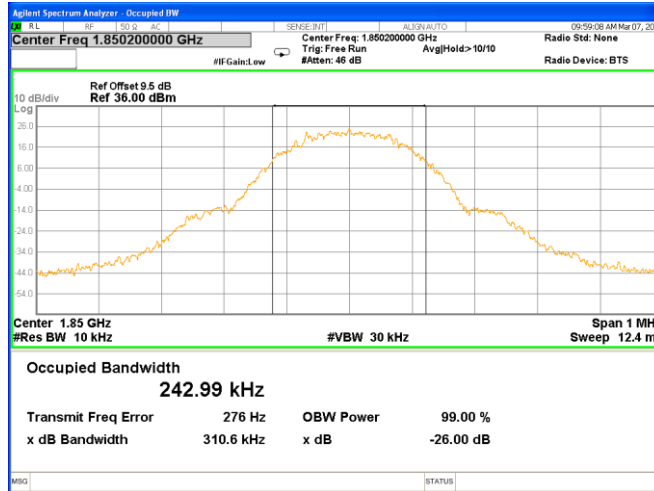

GPRS 1900 CH 661

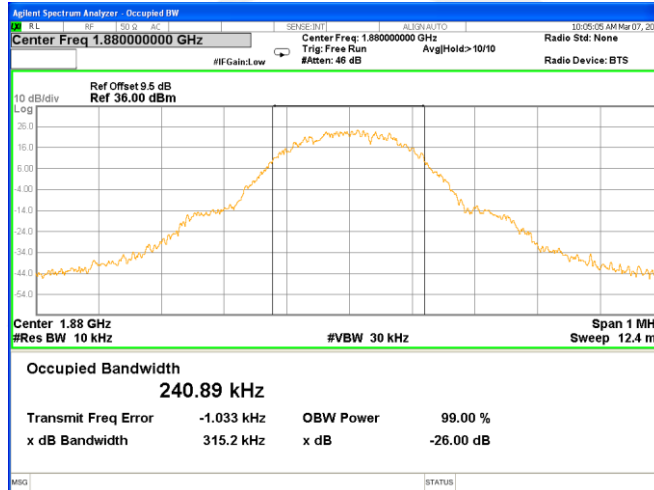

GPRS 1900 CH 810

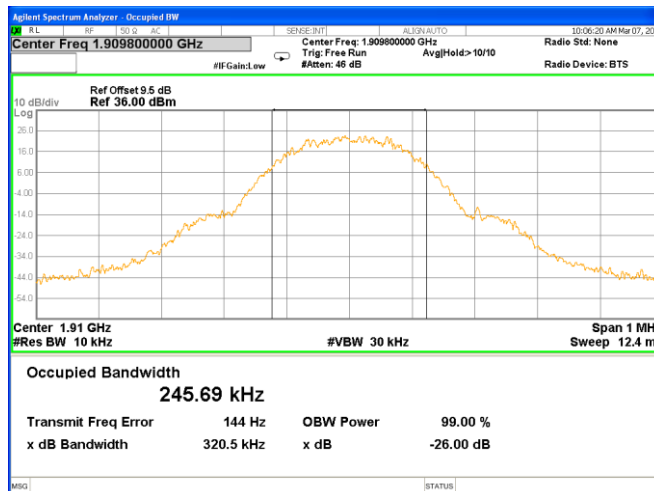



EDGE 1900 CH 512

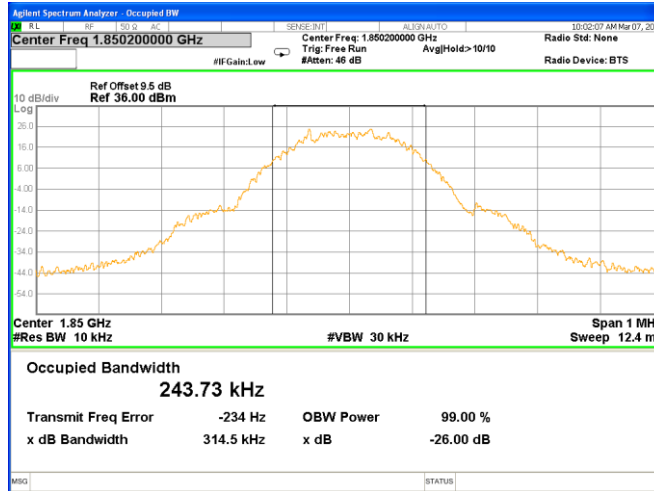

EDGE 1900 CH 661

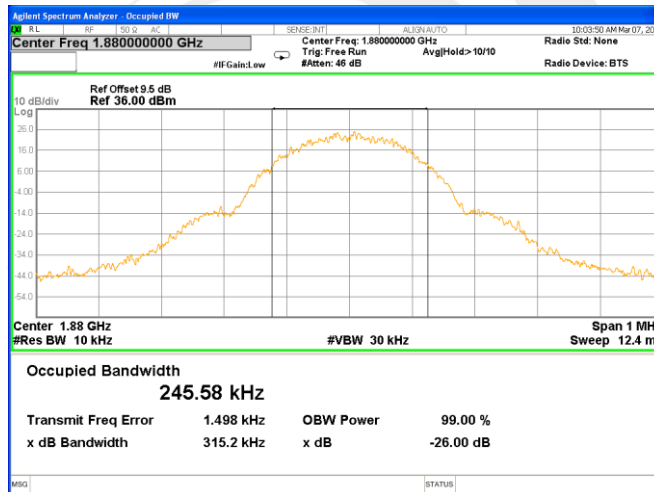

EDGE 1900 CH 810

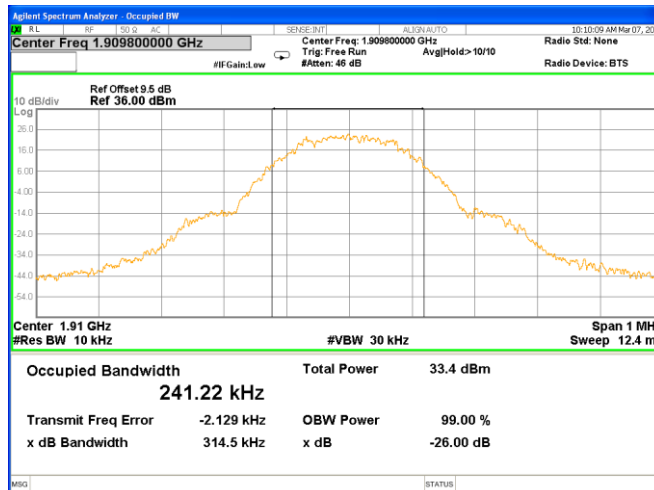



UMTS BAND V CH 4132

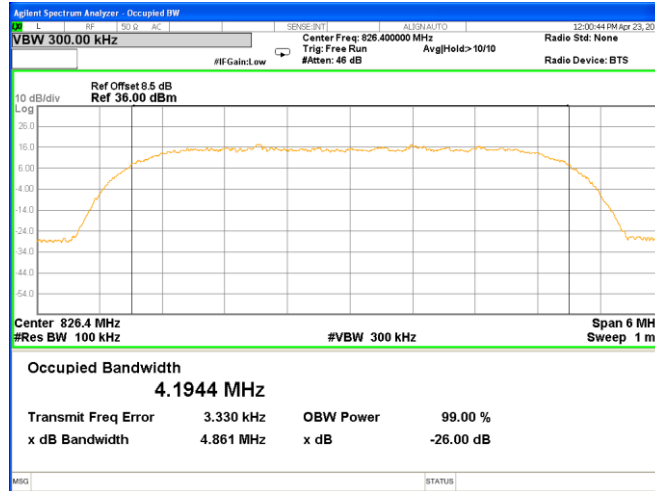

UMTS BAND V CH 4183

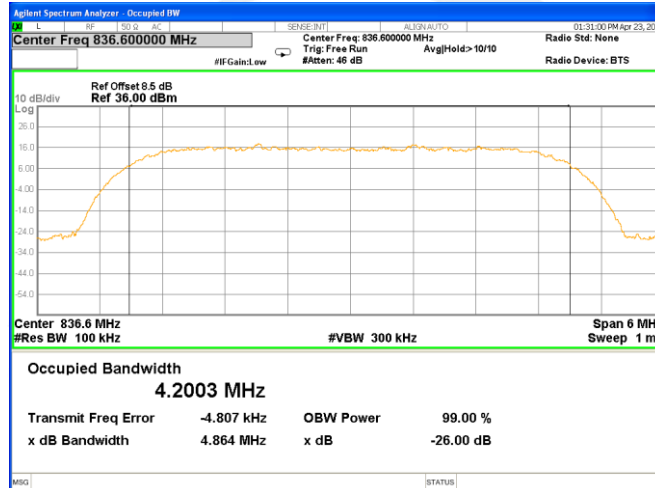

UMTS BAND V CH 4233

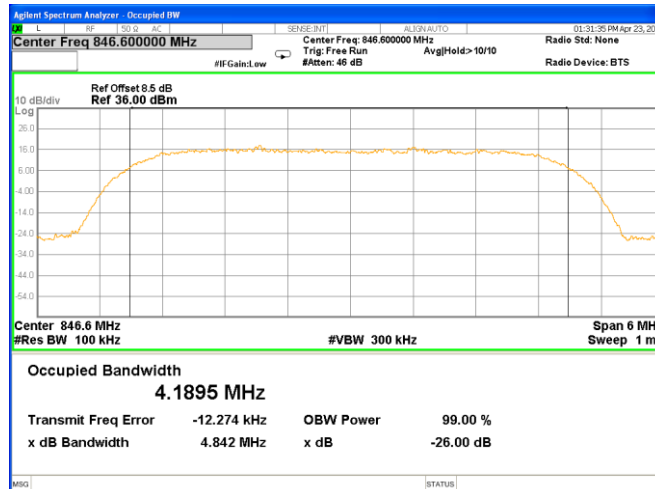



UMTS BAND II CH 9262

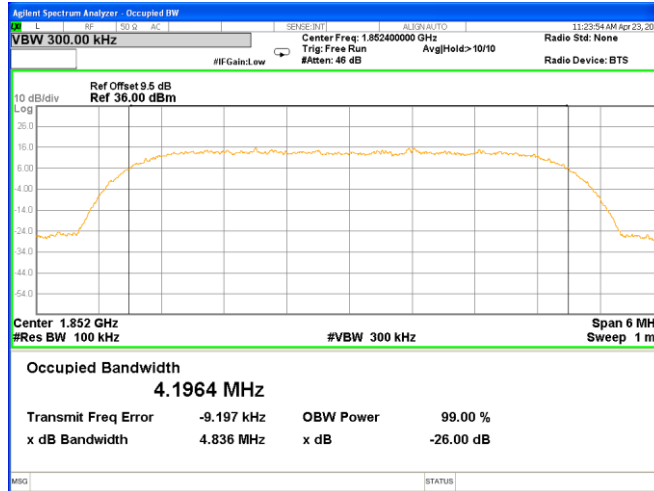

UMTS BAND II CH 9400

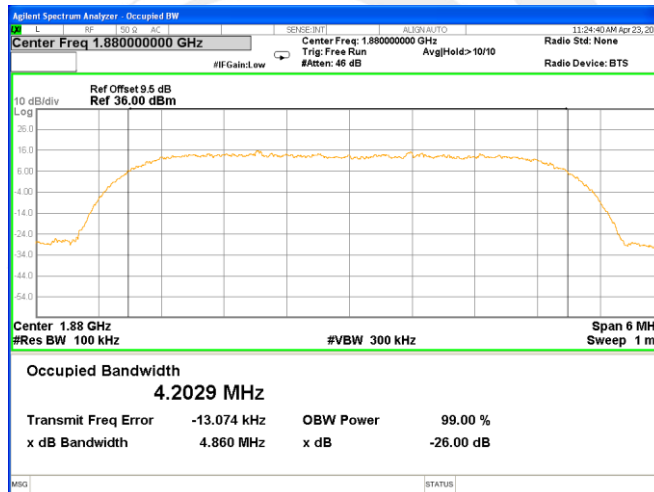

UMTS BAND II CH 9538

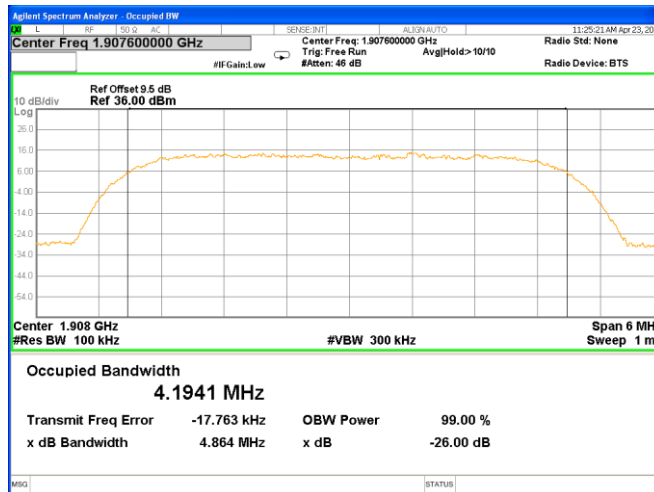



UMTS BAND IV CH 9262

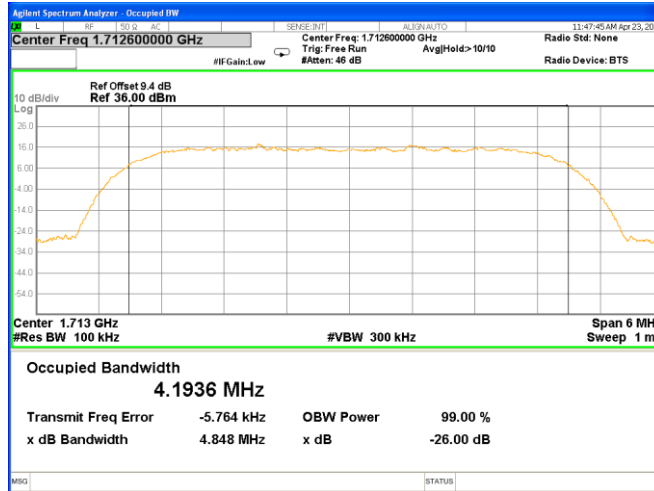

UMTS BAND IV CH 9400

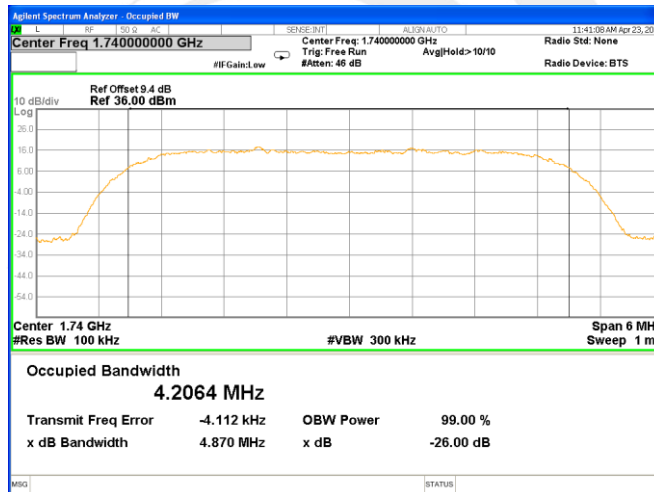

UMTS BAND IV CH 9538

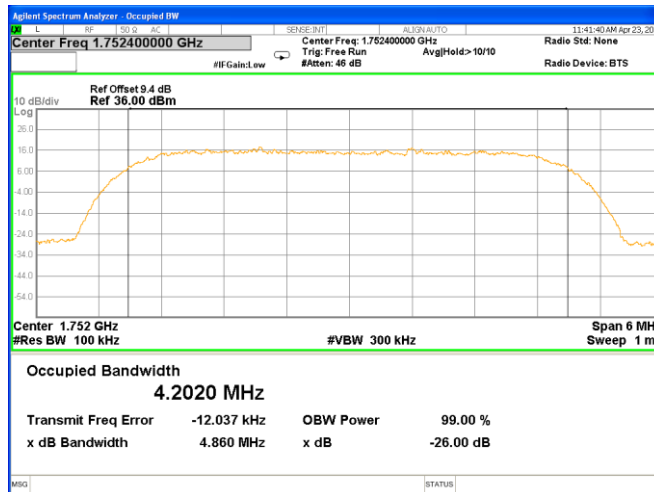



A5.FREQUENCY STABILITY

Normal Voltage = 3.8V. ; Battery End Point (BEP) = 3.4 V.; Maximum Voltage =4.35 V

GSM 850 Middle Channel/836.6MHz					
Temperature (°C)	Voltage (Volt)	Freq. Dev. (Hz)	Freq. Dev. (ppm)	Limit	Result
50	Normal Voltage	12.70	0.015	2.5ppm	PASS
40		18.35	0.022		
30		36.40	0.044		
20		13.23	0.016		
10		13.48	0.016		
0		26.38	0.032		
-10		18.13	0.022		
-20		24.51	0.029		
-30		30.63	0.037		
25		Maximum Voltage	30.20		
25	BEP	29.53	0.035		

GPRS 850 Middle Channel/836.6MHz					
Temperature (°C)	Voltage (Volt)	Freq. Dev. (Hz)	Freq. Dev. (ppm)	Limit	Result
50	Normal Voltage	17.97	0.021	2.5ppm	PASS
40		32.82	0.039		
30		29.05	0.035		
20		34.28	0.041		
10		16.19	0.019		
0		25.01	0.030		
-10		18.25	0.022		
-20		24.54	0.029		
-30		18.11	0.022		
25		Maximum Voltage	16.60		
25	BEP	15.84	0.019		



EDGE 850 Middle Channel/836.6MHz					
Temperature (°C)	Voltage (Volt)	Freq. Dev. (Hz)	Freq. Dev. (ppm)	Limit	Result
50	Normal Voltage	32.78	0.039	2.5ppm	PASS
40		26.93	0.032		
30		28.84	0.034		
20		33.26	0.040		
10		32.20	0.038		
0		11.60	0.014		
-10		24.29	0.029		
-20		23.58	0.028		
-30		15.13	0.018		
25		Maximum Voltage	36.41		
25	BEP	23.85	0.029		



GSM 1900 Middle Channel/1880MHz					
Temperature (°C)	Voltage (Volt)	Freq. Dev. (Hz)	Freq. Dev. (ppm)	Limit	Result
50	Normal Voltage	19.71	0.010	Within Authorized Band	PASS
40		14.14	0.008		
30		29.11	0.015		
20		35.48	0.019		
10		15.42	0.008		
0		22.10	0.012		
-10		32.79	0.017		
-20		35.22	0.019		
-30		24.18	0.013		
25		Maximum Voltage	30.97		
25	BEP	18.43	0.010		

GPRS 1900 Middle Channel/1880MHz					
Temperature (°C)	Voltage (Volt)	Freq. Dev. (Hz)	Freq. Dev. (ppm)	Limit	Result
50	Normal Voltage	23.19	0.012	Within Authorized Band	PASS
40		31.46	0.017		
30		15.68	0.008		
20		29.08	0.015		
10		26.22	0.014		
0		25.45	0.014		
-10		27.13	0.014		
-20		16.58	0.009		
-30		31.10	0.017		
25		Maximum Voltage	28.49		
25	BEP	21.54	0.011		



EDGE 1900 Middle Channel/1880MHz					
Temperature (°C)	Voltage (Volt)	Freq. Dev. (Hz)	Freq. Dev. (ppm)	Limit	Result
50	Normal Voltage	26.15	0.014	Within Authorized Band	PASS
40		13.85	0.007		
30		17.56	0.009		
20		29.78	0.016		
10		23.87	0.013		
0		31.04	0.017		
-10		24.66	0.013		
-20		28.50	0.015		
-30		23.16	0.012		
25		Maximum Voltage	32.86		
25	BEP	12.93	0.007		



WCDMA V Middle Channel/836.6MHz					
Temperature (°C)	Voltage (Volt)	Freq. Dev. (Hz)	Freq. Dev. (ppm)	Limit	Result
50	Normal Voltage	12.66	0.015	2.5ppm	PASS
40		15.28	0.018		
30		14.33	0.017		
20		17.80	0.021		
10		27.78	0.033		
0		25.11	0.030		
-10		19.12	0.023		
-20		23.48	0.028		
-30		20.65	0.025		
25		Maximum Voltage	30.64		
25	BEP	23.68	0.028		

1. The frequency fundamental emissions stay within the authorized frequency block based on the frequency deviation measured is small.

WCDMA II Middle Channel/1880MHz					
Temperature (°C)	Voltage (Volt)	Freq. Dev. (Hz)	Freq. Dev. (ppm)	Limit	Result
50	Normal Voltage	27.27	0.015	Within Authorized Band	PASS
40		19.29	0.010		
30		24.21	0.013		
20		23.14	0.012		
10		29.75	0.016		
0		31.77	0.017		
-10		33.26	0.018		
-20		31.46	0.017		
-30		30.61	0.016		
25		Maximum Voltage	12.88		
25	BEP	17.07	0.009		

1. The frequency fundamental emissions stay within the authorized frequency block based on the frequency deviation measured is small.



WCDMA IV Middle Channel/1880MHz					
Temperature (°C)	Voltage (Volt)	Freq. Dev. (Hz)	Freq. Dev. (ppm)	Limit	Result
50	Normal Voltage	35.91	0.021	Within Authorized Band	PASS
40		23.33	0.013		
30		15.94	0.009		
20		22.35	0.013		
10		34.18	0.020		
0		30.71	0.018		
-10		30.55	0.018		
-20		19.60	0.011		
-30		24.61	0.014		
25		Maximum Voltage	21.81		
25	BEP	20.20	0.012		

1. The frequency fundamental emissions stay within the authorized frequency block based on the frequency deviation measured is small.



A6. SPURIOUS EMISSIONS AT ANTENNA TERMINALS GSM 850 BAND Lowest Channel

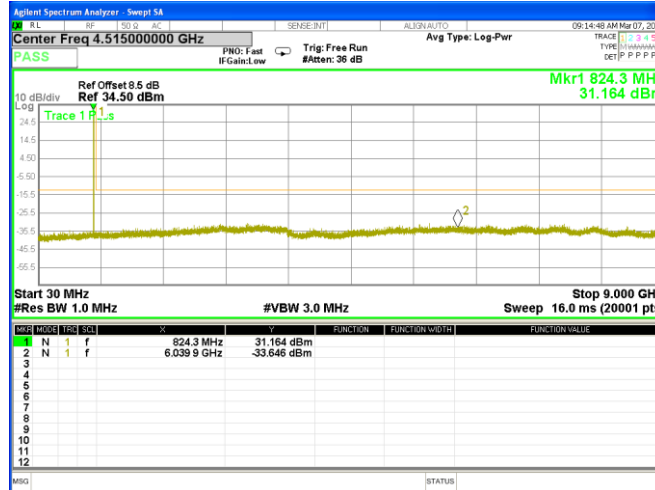

Middle Channel

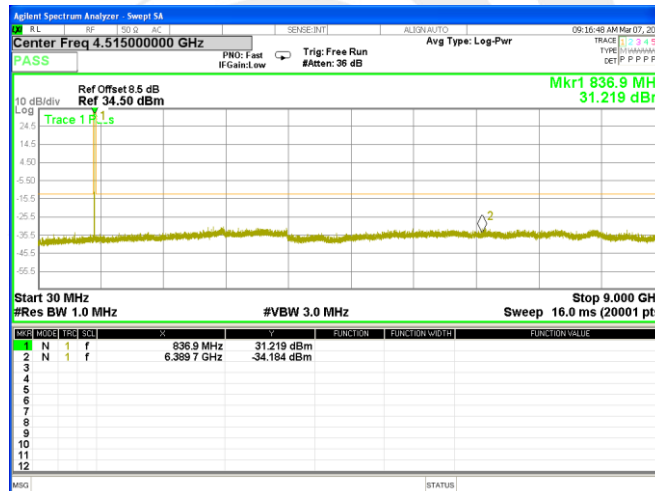

Highest Channel

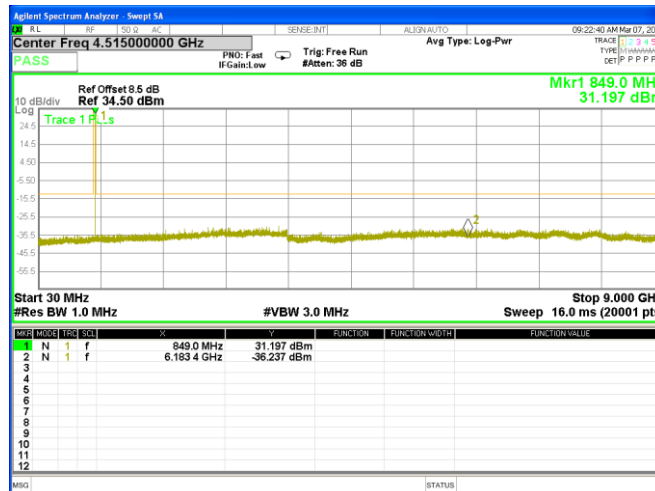



GPRS 850 BAND

Lowest Channel



Middle Channel

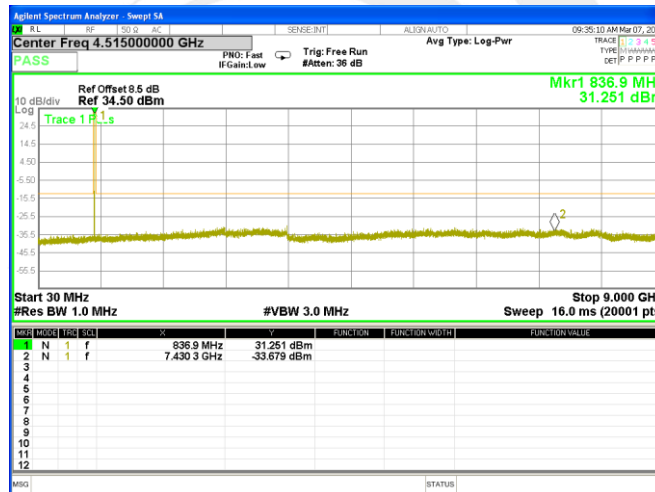

Highest Channel

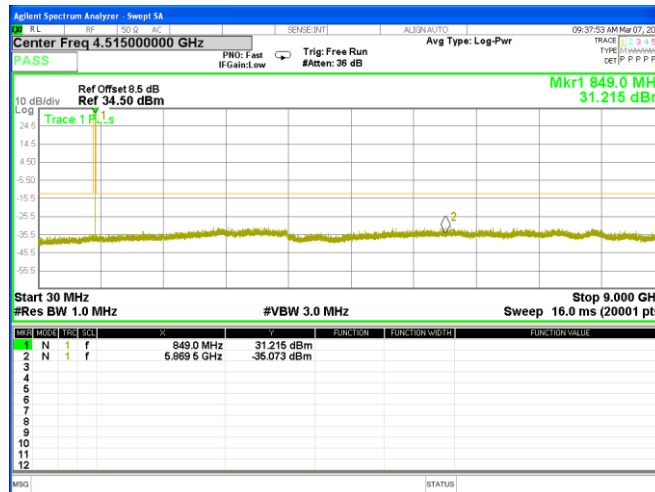



EDGE 850 BAND

Lowest Channel



Middle Channel

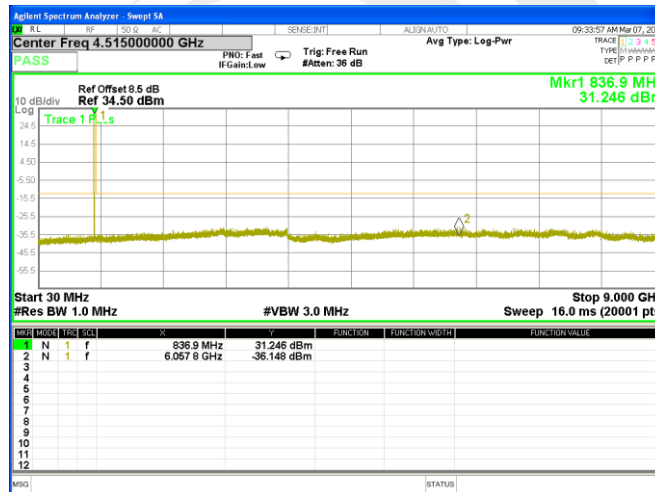

Highest Channel

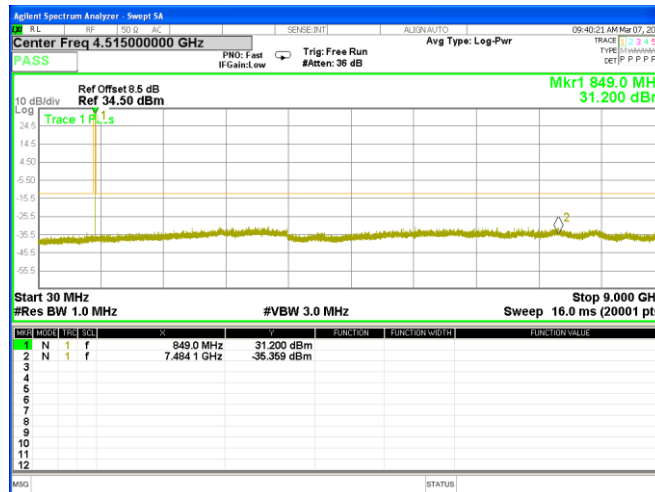



GSM1900 BAND(30M-20G)

Lowest Channel



Middle Channel



Highest Channel

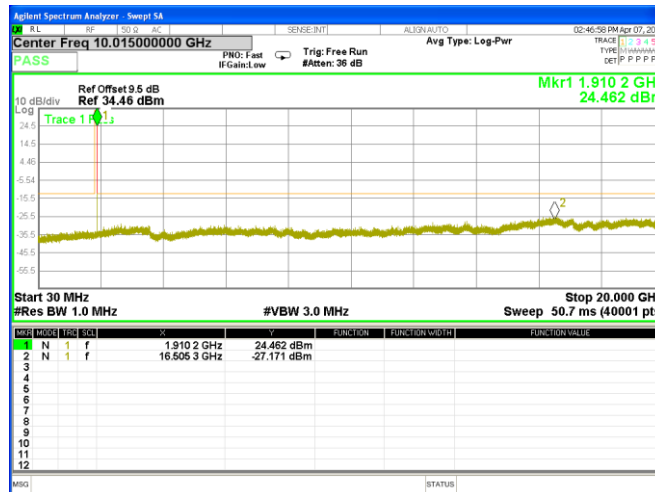



GPRS1900 BAND(30M-20G)

Lowest Channel

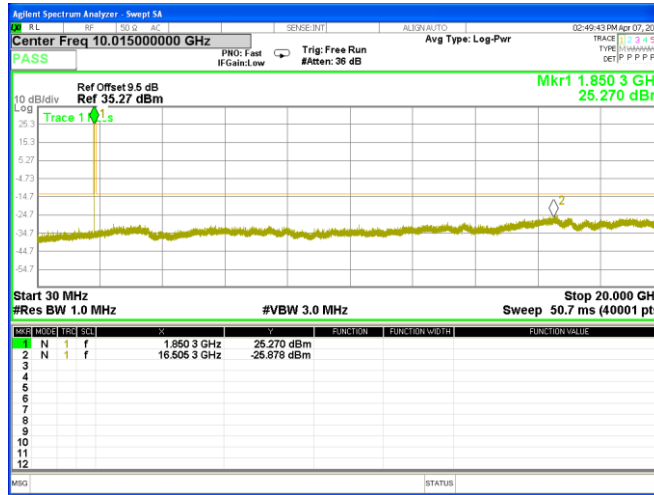

Middle Channel



Highest Channel

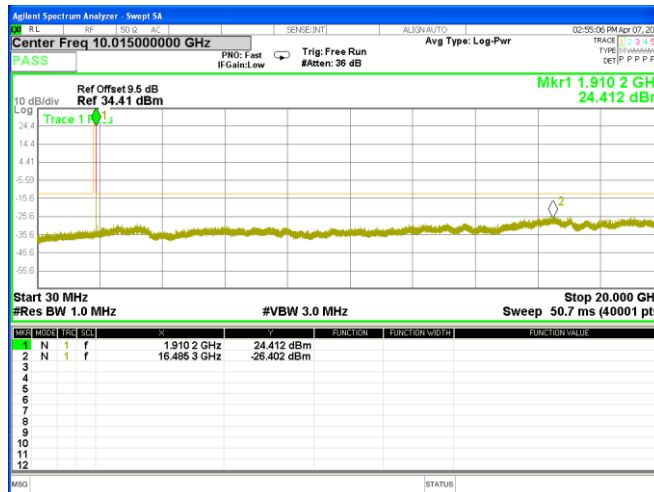



EDGE 1900 BAND(30M-20G)

Lowest Channel

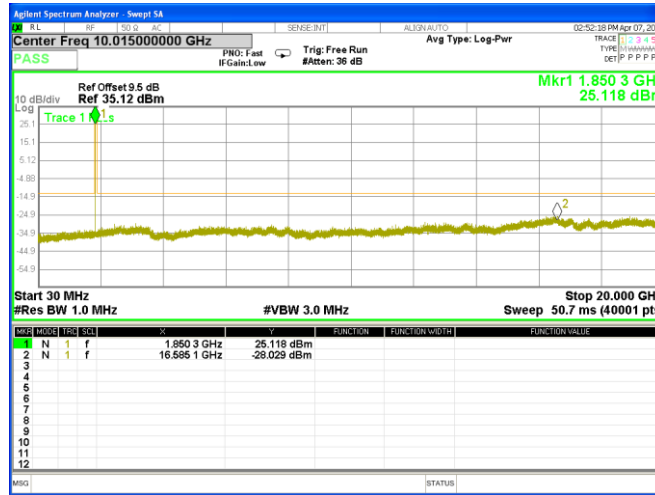

Middle Channel

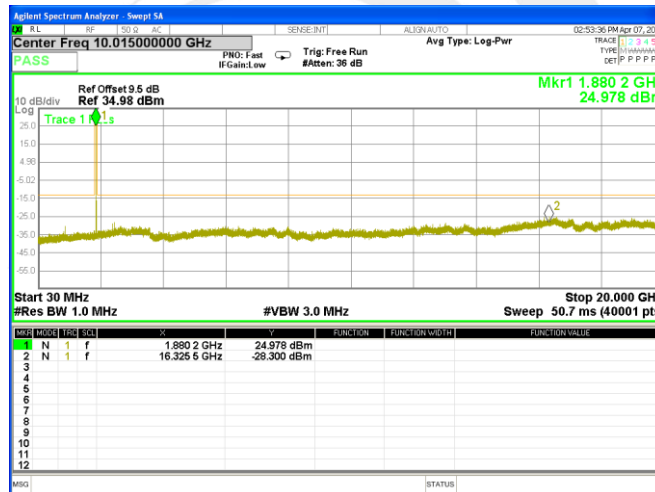

Highest Channel

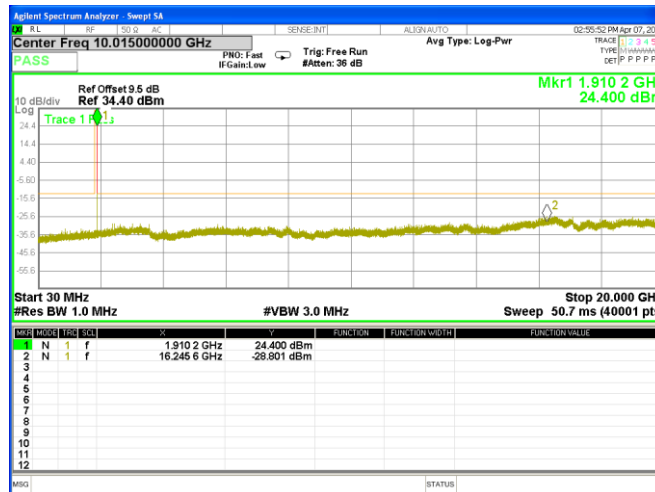



WCDMA Band V (RMC 12.2Kbps)

Lowest Channel



Middle Channel

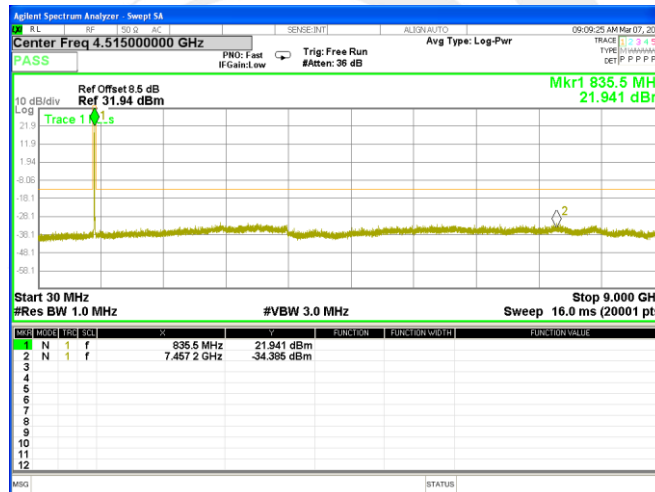

Highest Channel

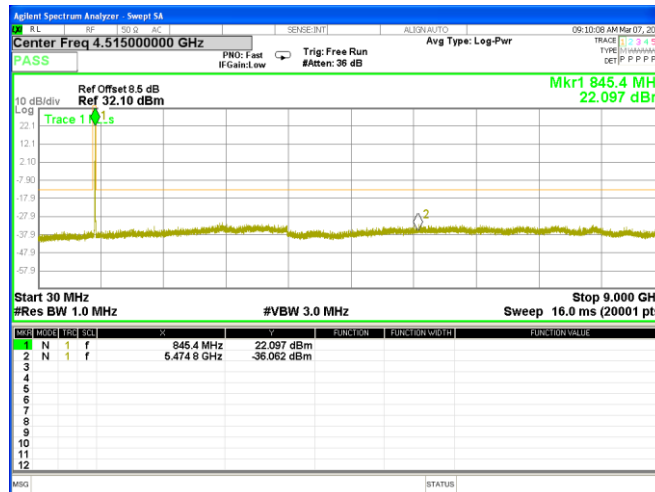



WCDMA Band II (RMC 12.2Kbps)(30M-20G)

Lowest Channel

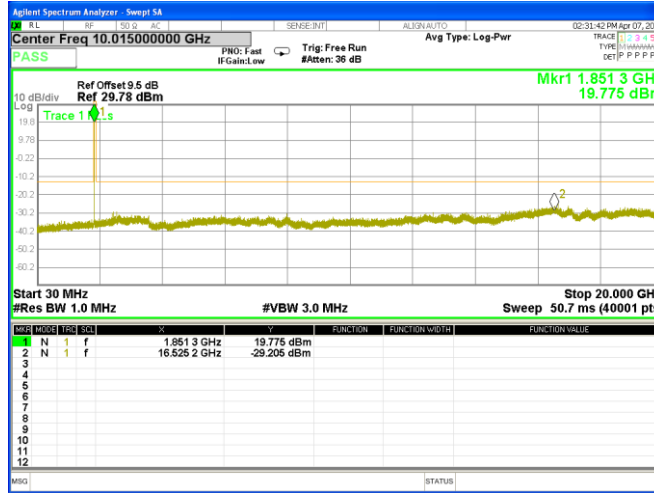

Middle Channel

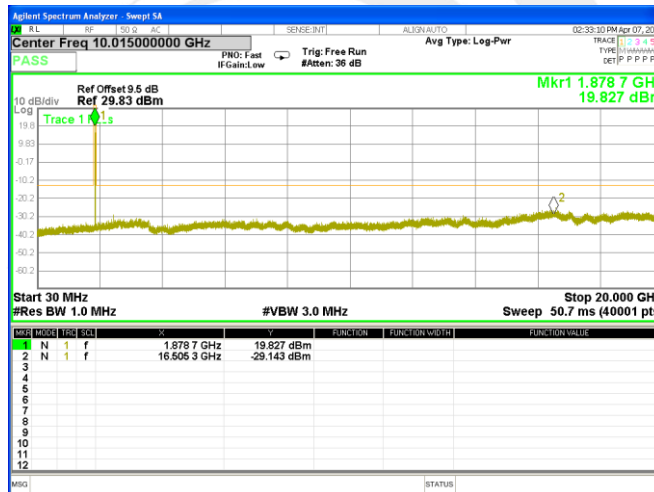

Highest Channel

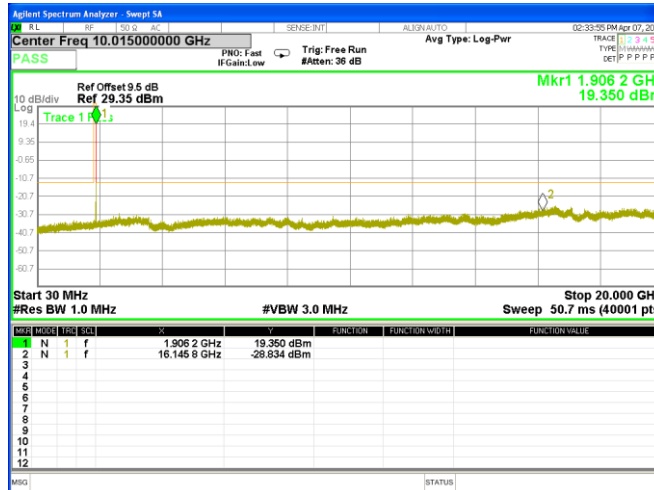



WCDMA Band IV (RMC 12.2Kbps)(30M-20G)

Lowest Channel



Middle Channel



Highest Channel

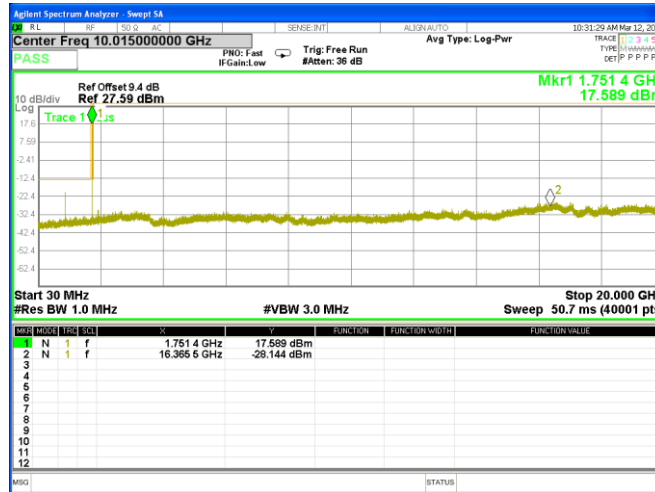



A7. BAND EDGE

GSM 850

Lowest Band Edge

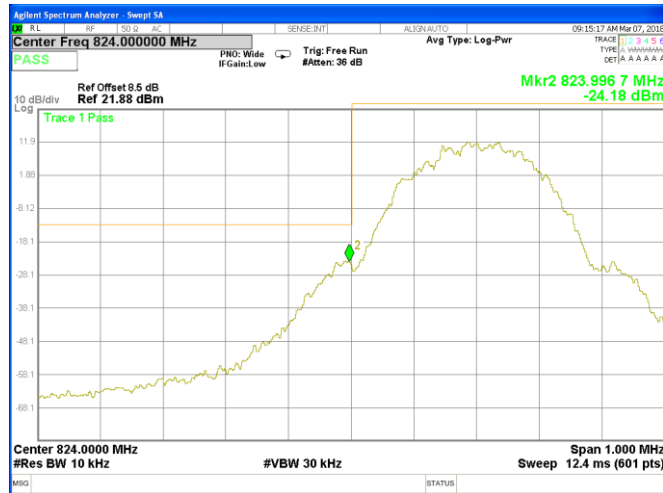

Highest Band Edge

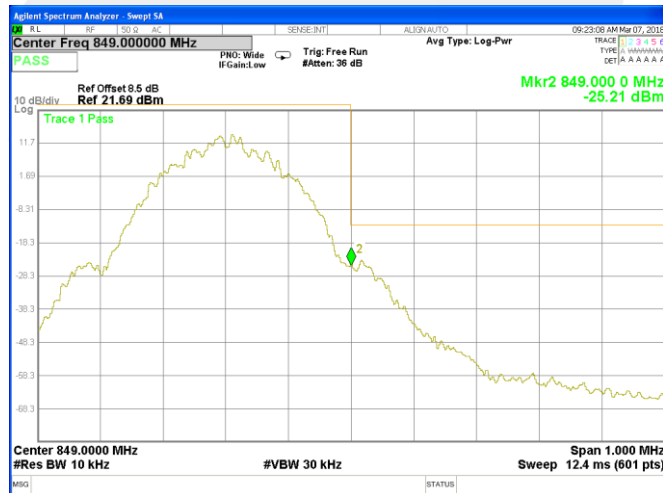



GPRS 850

Lowest Band Edge

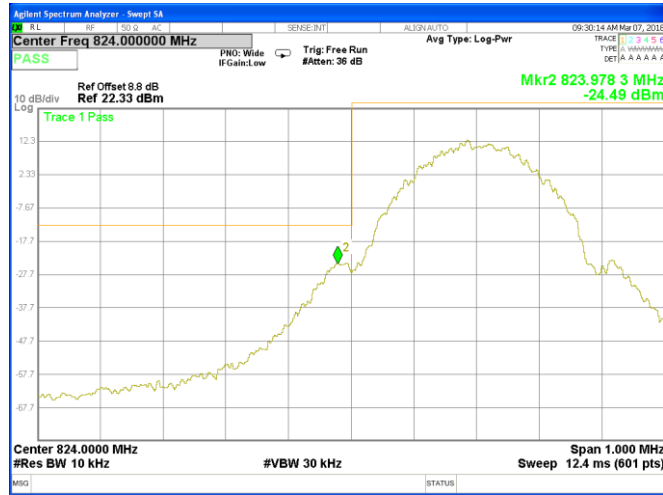

Highest Band Edge

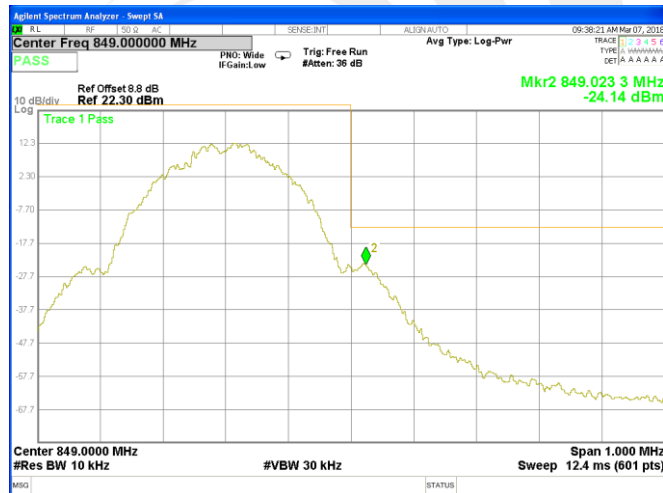



EDGE 850

Lowest Band Edge

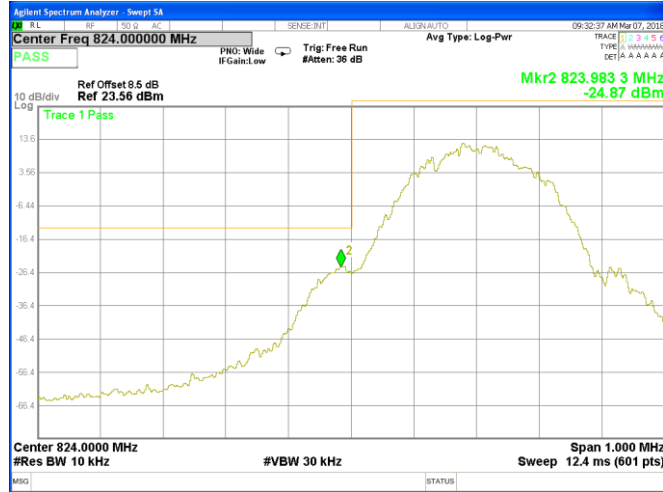

Highest Band Edge

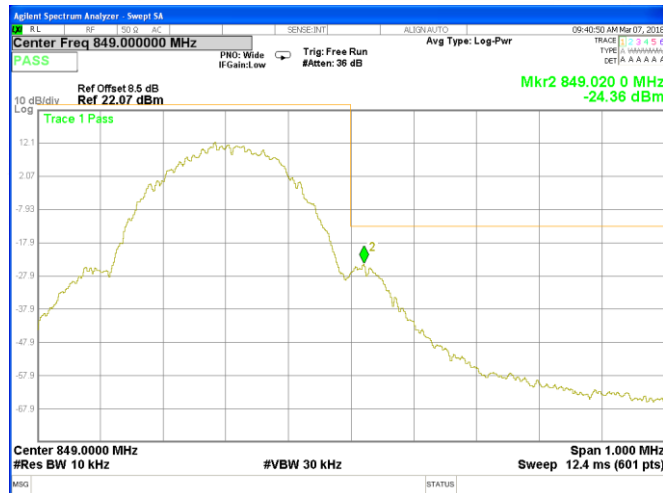



GSM 1900

Lowest Band Edge

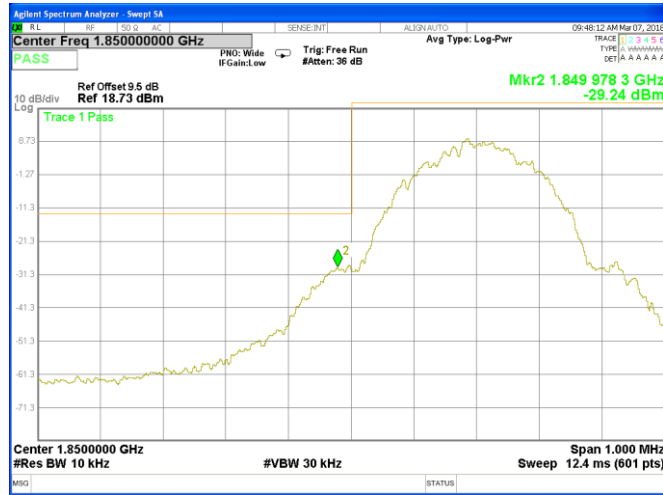

Highest Band Edge





GPRS 1900

Lowest Band Edge

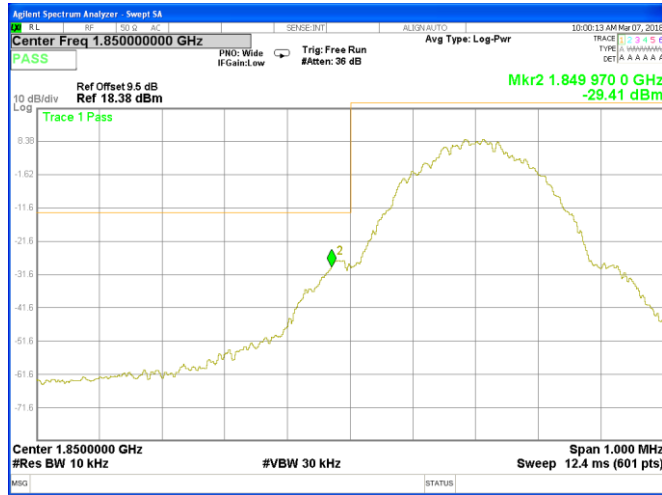

Highest Band Edge





EDGE 1900

Lowest Band Edge

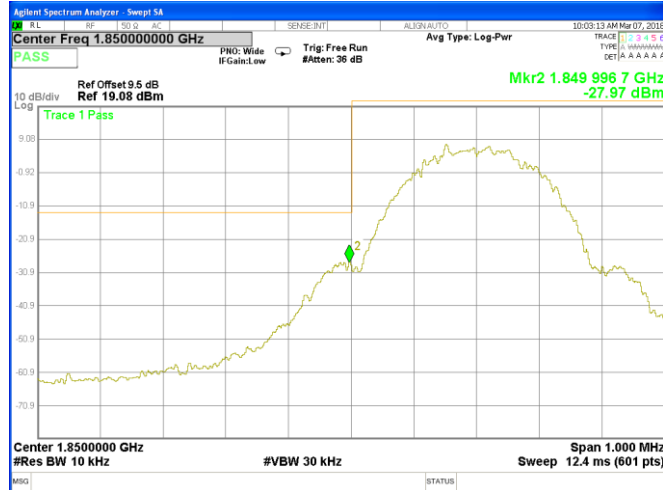

Highest Band Edge





WCDMA Band V RMC 12.2Kbps

Lowest Band Edge

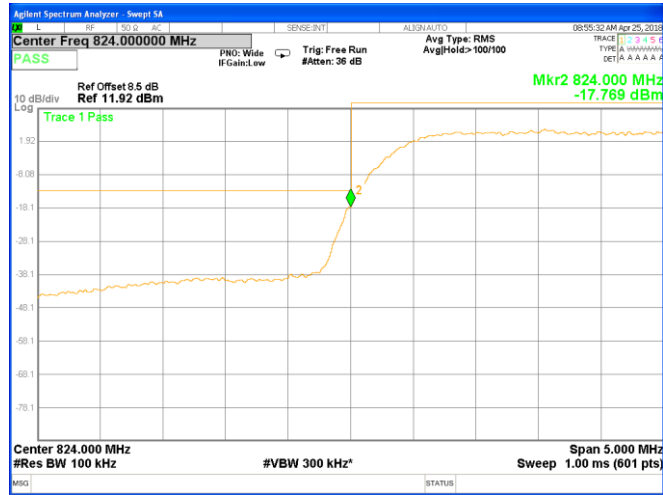

Highest Band Edge

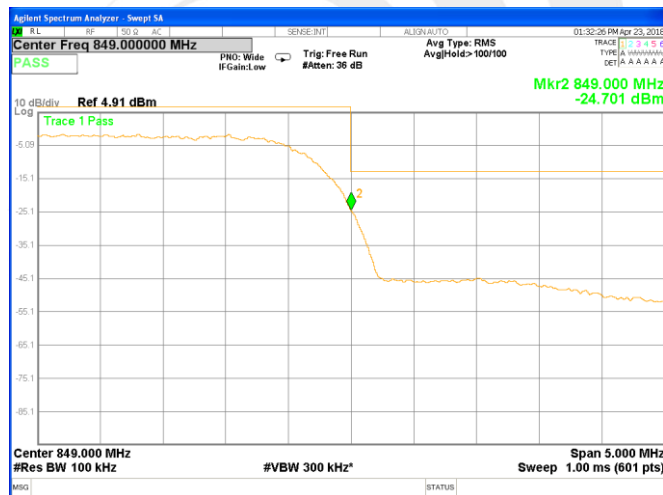



WCDMA Band II RMC 12.2Kbps

Lowest Band Edge

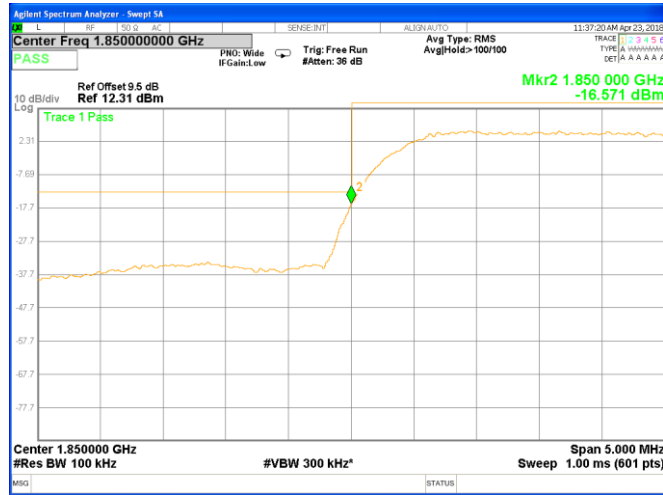

Highest Band Edge

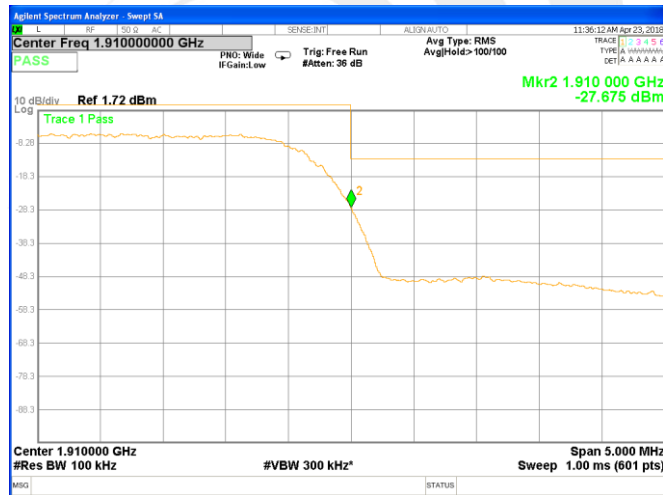



WCDMA Band IV RMC 12.2Kbps

Lowest Band Edge

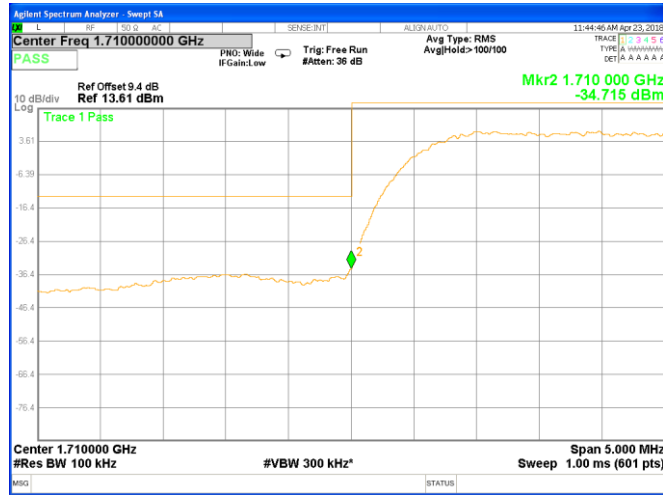

Highest Band Edge





A8. FIELD STRENGTH OF SPURIOUS RADIATION MEASUREMENT

GSM 850: (30-9000)MHz

GSM 850: (30-9000)MHz							
The Worst Test Results Channel 128/824.2 MHz							
Frequency(MHz)	S G.Lev (dBm)	Ant(dBi)	Loss	PMea	Limit	Margin	Polarity
				(dBm)	(dBm)	(dB)	
1648.40	-41.59	9.40	4.75	-36.94	-13.00	-23.94	H
2472.52	-40.38	10.60	8.39	-38.17	-13.00	-25.17	H
3296.50	-31.34	12.00	11.79	-31.13	-13.00	-18.13	H
1648.15	-44.21	9.40	4.75	-39.56	-13.00	-26.56	V
2472.64	-45.06	10.60	8.39	-42.85	-13.00	-29.85	V
3296.58	-43.45	12.00	11.79	-43.24	-13.00	-30.24	V
The Worst Test Results Channel 190/836.6 MHz							
Frequency(MHz)	S G.Lev (dBm)	Ant(dBi)	Loss	PMea	Limit	Margin	Polarity
				(dBm)	(dBm)	(dB)	
1672.82	-40.94	9.50	4.76	-36.20	-13.00	-23.20	H
2509.68	-39.53	10.70	8.40	-37.23	-13.00	-24.23	H
3346.09	-32.33	12.20	11.80	-31.93	-13.00	-18.93	H
1673.22	-43.91	9.40	4.75	-39.26	-13.00	-26.26	V
2509.58	-44.15	10.60	8.39	-41.94	-13.00	-28.94	V
3346.20	-42.75	12.20	11.82	-42.37	-13.00	-29.37	V
The Worst Test Results Channel 251/848.8 MHz							
Frequency(MHz)	S G.Lev (dBm)	Ant(dBi)	Loss	PMea	Limit	Margin	Polarity
				(dBm)	(dBm)	(dB)	
1697.42	-41.62	9.60	4.77	-36.79	-13.00	-23.79	H
2546.22	-40.30	10.80	8.50	-38.00	-13.00	-25.00	H
3395.11	-31.99	12.50	11.90	-31.39	-13.00	-18.39	H
1697.19	-43.64	9.60	4.77	-38.81	-13.00	-25.81	V
2546.53	-44.58	10.80	8.50	-42.28	-13.00	-29.28	V
3395.06	-42.61	12.50	11.90	-42.01	-13.00	-29.01	V

Note: (1) Below 30MHz no Spurious found is the worst condition.

(2) Above 3.5GHz amplitude of spurious emissions which are attenuated by more than 20dB below the permissible value



GPRS 850: (30-9000)MHz

GPRS 850: (30-9000)MHz							
The Worst Test Results Channel 128/824.2 MHz							
Frequency(MHz)	S G.Lev (dBm)	Ant(dBi)	Loss	PMea	Limit	Margin	Polarity
				(dBm)	(dBm)	(dB)	
1648.44	-41.63	9.40	4.75	-36.98	-13.00	-23.98	H
2472.28	-39.90	10.60	8.39	-37.69	-13.00	-24.69	H
3296.64	-31.23	12.00	11.79	-31.02	-13.00	-18.02	H
1648.48	-44.58	9.40	4.75	-39.93	-13.00	-26.93	V
2472.63	-44.91	10.60	8.39	-42.70	-13.00	-29.70	V
3296.67	-43.71	12.00	11.79	-43.50	-13.00	-30.50	V
The Worst Test Results Channel 190/836.6 MHz							
Frequency(MHz)	S G.Lev (dBm)	Ant(dBi)	Loss	PMea	Limit	Margin	Polarity
				(dBm)	(dBm)	(dB)	
1672.99	-40.30	9.50	4.76	-35.56	-13.00	-22.56	H
2509.89	-40.40	10.70	8.40	-38.10	-13.00	-25.10	H
3346.14	-32.29	12.20	11.80	-31.89	-13.00	-18.89	H
1673.22	-44.21	9.40	4.75	-39.56	-13.00	-26.56	V
2509.83	-44.64	10.60	8.39	-42.43	-13.00	-29.43	V
3345.95	-43.47	12.20	11.82	-43.09	-13.00	-30.09	V
The Worst Test Results Channel 251/848.8 MHz							
Frequency(MHz)	S G.Lev (dBm)	Ant(dBi)	Loss	PMea	Limit	Margin	Polarity
				(dBm)	(dBm)	(dB)	
1697.55	-41.24	9.60	4.77	-36.41	-13.00	-23.41	H
2546.09	-40.41	10.80	8.50	-38.11	-13.00	-25.11	H
3394.96	-31.32	12.50	11.90	-30.72	-13.00	-17.72	H
1697.59	-43.74	9.60	4.77	-38.91	-13.00	-25.91	V
2546.37	-44.97	10.80	8.50	-42.67	-13.00	-29.67	V
3395.27	-43.68	12.50	11.90	-43.08	-13.00	-30.08	V

Note: (1) Below 30MHz no Spurious found is the worst condition.

(2) Above 3.5GHz amplitude of spurious emissions which are attenuated by more than 20dB below the permissible value



EDGE 850: (30-9000)MHz

EGPRS 850: (30-9000)MHz							
The Worst Test Results Channel 128/824.2 MHz							
Frequency(MHz)	S G.Lev (dBm)	Ant(dBi)	Loss	PMea	Limit	Margin	Polarity
				(dBm)	(dBm)	(dB)	
1648.44	-41.50	9.40	4.75	-36.85	-13.00	-23.85	H
2472.66	-40.65	10.60	8.39	-38.44	-13.00	-25.44	H
3296.78	-31.75	12.00	11.79	-31.54	-13.00	-18.54	H
1648.24	-44.46	9.40	4.75	-39.81	-13.00	-26.81	V
2472.43	-44.93	10.60	8.39	-42.72	-13.00	-29.72	V
3296.53	-43.78	12.00	11.79	-43.57	-13.00	-30.57	V
The Worst Test Results Channel 190/836.6 MHz							
Frequency(MHz)	S G.Lev (dBm)	Ant(dBi)	Loss	PMea	Limit	Margin	Polarity
				(dBm)	(dBm)	(dB)	
1673.00	-41.38	9.50	4.76	-36.64	-13.00	-23.64	H
2509.56	-40.29	10.70	8.40	-37.99	-13.00	-24.99	H
3346.32	-31.28	12.20	11.80	-30.88	-13.00	-17.88	H
1672.92	-43.70	9.40	4.75	-39.05	-13.00	-26.05	V
2509.91	-44.23	10.60	8.39	-42.02	-13.00	-29.02	V
3345.96	-43.04	12.20	11.82	-42.66	-13.00	-29.66	V
The Worst Test Results Channel 251/848.8 MHz							
Frequency(MHz)	S G.Lev (dBm)	Ant(dBi)	Loss	PMea	Limit	Margin	Polarity
				(dBm)	(dBm)	(dB)	
1697.27	-41.42	9.60	4.77	-36.59	-13.00	-23.59	H
2546.48	-39.25	10.80	8.50	-36.95	-13.00	-23.95	H
3394.94	-31.48	12.50	11.90	-30.88	-13.00	-17.88	H
1697.33	-43.59	9.60	4.77	-38.76	-13.00	-25.76	V
2546.30	-45.09	10.80	8.50	-42.79	-13.00	-29.79	V
3394.90	-42.68	12.50	11.90	-42.08	-13.00	-29.08	V

Note: (1) Below 30MHz no Spurious found is the worst condition.

(2) Above 3.5GHz amplitude of spurious emissions which are attenuated by more than 20dB below the permissible value



PCS 1900: (30-20000)MHz

DCS 1900: (30-20000)MHz							
The Worst Test Results for Channel 512/1850.2MHz							
Frequency(MHz)	S G.Lev (dBm)	Ant(dBi)	Loss	PMea	Limit	Margin	Polarity
				(dBm)	(dBm)	(dB)	
3700.44	-33.90	12.60	12.93	-34.23	-13.00	-21.23	H
5550.59	-35.27	13.10	17.11	-39.28	-13.00	-26.28	H
7400.77	-32.61	11.50	22.20	-43.31	-13.00	-30.31	H
3700.51	-35.79	12.60	12.93	-36.12	-13.00	-23.12	V
5550.27	-33.83	13.10	17.11	-37.84	-13.00	-24.84	V
7400.75	-32.45	11.50	22.20	-43.15	-13.00	-30.15	V
The Worst Test Results for Channel 661/1880.0MHz							
Frequency(MHz)	S G.Lev (dBm)	Ant(dBi)	Loss	PMea	Limit	Margin	Polarity
				(dBm)	(dBm)	(dB)	
3760.18	-33.85	12.60	12.93	-34.18	-13.00	-21.18	H
5640.24	-35.44	13.10	17.11	-39.45	-13.00	-26.45	H
7519.83	-32.73	11.50	22.20	-43.43	-13.00	-30.43	H
3760.06	-35.88	12.60	12.93	-36.21	-13.00	-23.21	V
5640.12	-35.07	13.10	17.11	-39.08	-13.00	-26.08	V
7520.20	-33.06	11.50	22.20	-43.76	-13.00	-30.76	V
The Worst Test Results for Channel 810/1909.8MHz							
Frequency(MHz)	S G.Lev (dBm)	Ant(dBi)	Loss	PMea	Limit	Margin	Polarity
				(dBm)	(dBm)	(dB)	
3819.29	-34.76	12.60	12.93	-35.09	-13.00	-22.09	H
5729.41	-34.08	13.10	17.11	-38.09	-13.00	-25.09	H
7639.15	-32.28	11.50	22.20	-42.98	-13.00	-29.98	H
3819.72	-35.17	12.60	12.93	-35.50	-13.00	-22.50	V
5729.35	-34.10	13.10	17.11	-38.11	-13.00	-25.11	V
7639.16	-32.56	11.50	22.20	-43.26	-13.00	-30.26	V

- Note:** (1) Below 30MHz no Spurious found is the worst condition.
 (2) Above 8GHz amplitude of spurious emissions which are attenuated by more than 20dB below the permissible value



GPRS 1900: (30-20000)MHz

GPRS1900: (30-20000)MHz							
The Worst Test Results for Channel 512/1850.2MHz							
Frequency(MHz)	S G.Lev (dBm)	Ant(dBi)	Loss	PMea	Limit	Margin	Polarity
				(dBm)	(dBm)	(dB)	
3700.34	-34.13	12.60	12.93	-34.46	-13.00	-21.46	H
5550.30	-34.71	13.10	17.11	-38.72	-13.00	-25.72	H
7400.91	-33.37	11.50	22.20	-44.07	-13.00	-31.07	H
3700.51	-34.93	12.60	12.93	-35.26	-13.00	-22.26	V
5550.62	-34.17	13.10	17.11	-38.18	-13.00	-25.18	V
7400.89	-32.53	11.50	22.20	-43.23	-13.00	-30.23	V
The Worst Test Results for Channel 661/1880.0MHz							
Frequency(MHz)	S G.Lev (dBm)	Ant(dBi)	Loss	PMea	Limit	Margin	Polarity
				(dBm)	(dBm)	(dB)	
3760.13	-34.74	12.60	12.93	-35.07	-13.00	-22.07	H
5639.94	-34.74	13.10	17.11	-38.75	-13.00	-25.75	H
7520.23	-32.55	11.50	22.20	-43.25	-13.00	-30.25	H
3760.01	-35.11	12.60	12.93	-35.44	-13.00	-22.44	V
5640.30	-34.61	13.10	17.11	-38.62	-13.00	-25.62	V
7520.00	-32.38	11.50	22.20	-43.08	-13.00	-30.08	V
The Worst Test Results for Channel 810/1909.8MHz							
Frequency(MHz)	S G.Lev (dBm)	Ant(dBi)	Loss	PMea	Limit	Margin	Polarity
				(dBm)	(dBm)	(dB)	
3819.41	-34.85	12.60	12.93	-35.18	-13.00	-22.18	H
5729.37	-34.32	13.10	17.11	-38.33	-13.00	-25.33	H
7639.11	-32.42	11.50	22.20	-43.12	-13.00	-30.12	H
3819.57	-35.22	12.60	12.93	-35.55	-13.00	-22.55	V
5729.50	-35.23	13.10	17.11	-39.24	-13.00	-26.24	V
7639.25	-32.86	11.50	22.20	-43.56	-13.00	-30.56	V

Note: (1) Below 30MHz no Spurious found is the worst condition.

(2) Above 8GHz amplitude of spurious emissions which are attenuated by more than 20dB below the permissible value



EDGE 1900: (30-20000)MHz

EGPRS 1900: (30-20000)MHz							
The Worst Test Results for Channel 512/1850.2MHz							
Frequency(MHz)	S G.Lev (dBm)	Ant(dBi)	Loss	PMea	Limit	Margin	Polarity
				(dBm)	(dBm)	(dB)	
3700.36	-34.37	12.60	12.93	-34.70	-13.00	-21.70	H
5550.53	-34.24	13.10	17.11	-38.25	-13.00	-25.25	H
7400.80	-32.77	11.50	22.20	-43.47	-13.00	-30.47	H
3700.51	-35.19	12.60	12.93	-35.52	-13.00	-22.52	V
5550.43	-34.38	13.10	17.11	-38.39	-13.00	-25.39	V
7400.60	-32.46	11.50	22.20	-43.16	-13.00	-30.16	V
The Worst Test Results for Channel 661/1880.0MHz							
Frequency(MHz)	S G.Lev (dBm)	Ant(dBi)	Loss	PMea	Limit	Margin	Polarity
				(dBm)	(dBm)	(dB)	
3759.94	-33.76	12.60	12.93	-34.09	-13.00	-21.09	H
5640.11	-34.55	13.10	17.11	-38.56	-13.00	-25.56	H
7520.00	-33.43	11.50	22.20	-44.13	-13.00	-31.13	H
3760.31	-35.69	12.60	12.93	-36.02	-13.00	-23.02	V
5640.16	-34.69	13.10	17.11	-38.70	-13.00	-25.70	V
7519.94	-32.24	11.50	22.20	-42.94	-13.00	-29.94	V
The Worst Test Results for Channel 810/1909.8MHz							
Frequency(MHz)	S G.Lev (dBm)	Ant(dBi)	Loss	PMea	Limit	Margin	Polarity
				(dBm)	(dBm)	(dB)	
3819.46	-34.84	12.60	12.93	-35.17	-13.00	-22.17	H
5729.40	-35.05	13.10	17.11	-39.06	-13.00	-26.06	H
7638.92	-33.20	11.50	22.20	-43.90	-13.00	-30.90	H
3819.57	-34.65	12.60	12.93	-34.98	-13.00	-21.98	V
5729.08	-35.08	13.10	17.11	-39.09	-13.00	-26.09	V
7638.94	-32.43	11.50	22.20	-43.13	-13.00	-30.13	V

Note: (1) Below 30MHz no Spurious found is the worst condition.
 (2) Above 8GHz amplitude of spurious emissions which are attenuated by more than 20dB below the permissible value has.



UMTS band V(30-9000)MHz

WCDMA Band V: (30-9000)MHz							
The most testresults channel 4132/826.4MHz							
Frequency(MHz)	S G.Lev (dBm)	Ant(dBi)	Loss	PMea	Limit	Margin	Polarity
				(dBm)	(dBm)	(dB)	
1652.48	-40.98	9.40	4.75	-36.33	-13.00	-23.33	H
2479.63	-40.47	10.60	8.39	-38.26	-13.00	-25.26	H
3305.90	-32.09	12.00	11.79	-31.88	-13.00	-18.88	H
1652.36	-43.49	9.40	4.75	-38.84	-13.00	-25.84	V
2479.69	-44.78	10.60	8.39	-42.57	-13.00	-29.57	V
3305.50	-43.26	12.00	11.79	-43.05	-13.00	-30.05	V
The Worst Test Results Channel 4183/836.6MHz							
Frequency(MHz)	S G.Lev (dBm)	Ant(dBi)	Loss	PMea	Limit	Margin	Polarity
				(dBm)	(dBm)	(dB)	
1672.90	-40.81	9.50	4.76	-36.07	-13.00	-23.07	H
2509.67	-39.65	10.70	8.40	-37.35	-13.00	-24.35	H
3346.07	-31.36	12.20	11.80	-30.96	-13.00	-17.96	H
1672.81	-44.32	9.40	4.75	-39.67	-13.00	-26.67	V
2509.45	-44.22	10.60	8.39	-42.01	-13.00	-29.01	V
3346.26	-42.55	12.20	11.82	-42.17	-13.00	-29.17	V
The Worst Test Results Channel 4233/846.6MHz							
Frequency(MHz)	S G.Lev (dBm)	Ant(dBi)	Loss	PMea	Limit	Margin	Polarity
				(dBm)	(dBm)	(dB)	
1693.48	-40.44	9.60	4.77	-35.61	-13.00	-22.61	H
2539.47	-39.69	10.80	8.50	-37.39	-13.00	-24.39	H
3386.34	-31.30	12.50	11.90	-30.70	-13.00	-17.70	H
1693.54	-44.42	9.60	4.77	-39.59	-13.00	-26.59	V
2539.49	-44.62	10.80	8.50	-42.32	-13.00	-29.32	V
3385.90	-43.69	12.50	11.90	-43.09	-13.00	-30.09	V

Note: (1) Below 30MHz no Spurious found is the worst condition.
 (2) Above 3GHz amplitude of spurious emissions which are attenuated by more than 20Db below the permissible value



UMTS band II(30-20000)MHz

WCDMA Band II: (30-20000)MHz							
The Worst Test Results for Channel 9262/1852.4MHz							
Frequency(MHz)	S G.Lev (dBm)	Ant(dBi)	Loss	PMea	Limit	Margin	Polarity
				(dBm)	(dBm)	(dB)	
3704.47	-34.86	12.60	12.93	-35.19	-13.00	-22.19	H
5557.22	-34.19	13.10	17.11	-38.20	-13.00	-25.20	H
7409.54	-33.48	11.50	22.20	-44.18	-13.00	-31.18	H
3704.39	-35.49	12.60	12.93	-35.82	-13.00	-22.82	V
5557.30	-33.93	13.10	17.11	-37.94	-13.00	-24.94	V
7409.56	-32.95	11.50	22.20	-43.65	-13.00	-30.65	V
The Worst Test Results for Channel 9400/1880MHz							
Frequency(MHz)	S G.Lev (dBm)	Ant(dBi)	Loss	PMea	Limit	Margin	Polarity
				(dBm)	(dBm)	(dB)	
3760.01	-34.51	12.60	12.93	-34.84	-13.00	-21.84	H
5640.04	-34.50	13.10	17.11	-38.51	-13.00	-25.51	H
7520.03	-33.16	11.50	22.20	-43.86	-13.00	-30.86	H
3759.96	-35.33	12.60	12.93	-35.66	-13.00	-22.66	V
5639.92	-35.04	13.10	17.11	-39.05	-13.00	-26.05	V
7520.02	-31.93	11.50	22.20	-42.63	-13.00	-29.63	V
The Worst Test Results for Channel 9538/1907.6MHz							
Frequency(MHz)	S G.Lev (dBm)	Ant(dBi)	Loss	PMea	Limit	Margin	Polarity
				(dBm)	(dBm)	(dB)	
3815.46	-34.14	12.60	12.93	-34.47	-13.00	-21.47	H
5722.34	-35.23	13.10	17.11	-39.24	-13.00	-26.24	H
7630.03	-33.47	11.50	22.20	-44.17	-13.00	-31.17	H
3815.50	-34.97	12.60	12.93	-35.30	-13.00	-22.30	V
5722.49	-35.21	13.10	17.11	-39.22	-13.00	-26.22	V
7630.26	-33.16	11.50	22.20	-43.86	-13.00	-30.86	V

Note: (1) Below 30MHz no Spurious found is the worst condition.
 (2) Above 6GHz amplitude of spurious emissions which are attenuated by more than 20dB below the permissible value



UMTS band IV(30-20000)MHz

WCDMA Band IV: (30-20000)MHz							
The Worst Test Results for Channel 9262/1712.6MHz							
Frequency(MHz)	S G.Lev (dBm)	Ant(dBi)	Loss	PMea	Limit	Margin	Polarity
				(dBm)	(dBm)	(dB)	
3425.19	-33.66	12.90	12.05	-32.81	-13.00	-19.81	H
5137.40	-35.31	12.80	16.27	-38.78	-13.00	-25.78	H
6850.25	-32.69	12.30	20.13	-40.52	-13.00	-27.52	H
3425.08	-35.26	12.90	12.05	-34.41	-13.00	-21.41	V
5137.37	-35.01	12.80	16.27	-38.48	-13.00	-25.48	V
6850.32	-32.73	12.30	20.13	-40.56	-13.00	-27.56	V
The Worst Test Results for Channel 9400/1740MHz							
Frequency(MHz)	S G.Lev (dBm)	Ant(dBi)	Loss	PMea	Limit	Margin	Polarity
				(dBm)	(dBm)	(dB)	
3479.64	-34.31	12.90	12.05	-33.46	-13.00	-20.46	H
5219.95	-35.06	12.80	16.27	-38.53	-13.00	-25.53	H
6959.88	-32.61	12.30	20.13	-40.44	-13.00	-27.44	H
3479.57	-35.04	12.90	12.05	-34.19	-13.00	-21.19	V
5219.50	-34.13	12.80	16.27	-37.60	-13.00	-24.60	V
6959.97	-31.74	12.30	20.13	-39.57	-13.00	-26.57	V
The Worst Test Results for Channel 9538/1752.4MHz							
Frequency(MHz)	S G.Lev (dBm)	Ant(dBi)	Loss	PMea	Limit	Margin	Polarity
				(dBm)	(dBm)	(dB)	
3504.44	-34.86	12.90	12.05	-34.01	-13.00	-21.01	H
5256.76	-35.38	12.80	16.27	-38.85	-13.00	-25.85	H
7009.17	-33.44	12.30	20.13	-41.27	-13.00	-28.27	H
3504.39	-35.42	12.90	12.05	-34.57	-13.00	-21.57	V
5257.04	-34.26	12.80	16.27	-37.73	-13.00	-24.73	V
7009.40	-33.04	12.30	20.13	-40.87	-13.00	-27.87	V

Note: (1) Below 30MHz no Spurious found is the worst condition.
 (2) Above 6GHz amplitude of spurious emissions which are attenuated by more than 20dB below the permissible value



APPENDIX B PHOTOS OF TEST SETUP

RADIATED SPURIOUS EMISSION

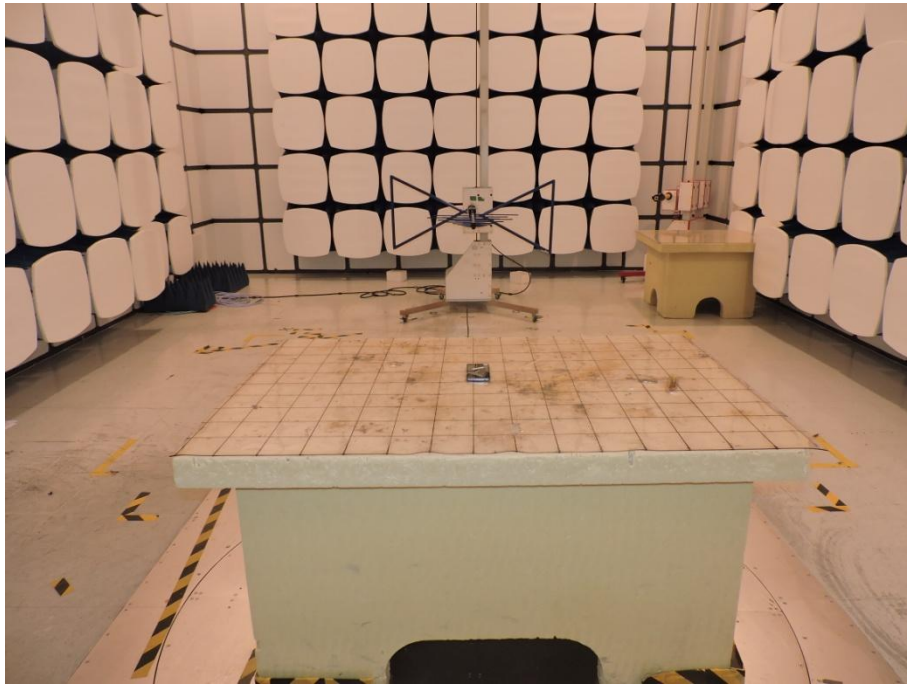

※※※※※END OF THE REPORT※※※※※