



FCC Test Report

Equipment : AC5400 MU-MIMO Tri-Band Wi-Fi Router
Brand Name : TP-Link
Model No. : Archer C5400X
FCC ID : TE7C5400X
Standard : 47 CFR FCC Part 15.247
Operating Band : 2400 MHz – 2483.5 MHz
Function : Point-to-multipoint; Point-to-point
Applicant : TP-Link Technologies Co., Ltd.
Building 24 (floors 1,3,4,5) and 28 (floors1-4)
Central Science and Technology Park,Shennan Rd,
Nanshan, Shenzhen,China
Manufacturer : TP-Link Technologies Co., Ltd.
Building 24 (floors 1,3,4,5) and 28 (floors1-4)
Central Science and Technology Park,Shennan Rd,
Nanshan, Shenzhen,China

The product sample received on Mar. 14, 2017 and completely tested on Apr. 26, 2017. We, SPORTON, would like to declare that the tested sample has been evaluated in accordance with the procedures given in ANSI C63.10-2013 and shown compliance with the applicable technical standards.

The test results in this report apply exclusively to the tested model / sample. Without written approval of SPORTON INTERNATIONAL INC., the test report shall not be reproduced except in full.

Cliff Chang
SPORTON INTERNATIONAL INC.





Table of Contents

- 1 GENERAL DESCRIPTION5**
- 1.1 Information.....5
- 1.2 Testing Applied Standards8
- 1.3 Testing Location Information8
- 1.4 Measurement Uncertainty8
- 2 TEST CONFIGURATION OF EUT9**
- 2.1 Test Channel Mode9
- 2.2 The Worst Case Measurement Configuration10
- 2.3 EUT Operation during Test11
- 2.4 Accessories11
- 2.5 Support Equipment.....12
- 2.6 Test Setup Diagram13
- 3 TRANSMITTER TEST RESULT16**
- 3.1 AC Power-line Conducted Emissions16
- 3.2 DTS Bandwidth18
- 3.3 Maximum Conducted Output Power19
- 3.4 Power Spectral Density21
- 3.5 Emissions in Non-restricted Frequency Bands23
- 3.6 Emissions in Restricted Frequency Bands.....24
- 4 TEST EQUIPMENT AND CALIBRATION DATA28**

APPENDIX A. TEST RESULTS OF AC POWER-LINE CONDUCTED EMISSIONS

APPENDIX B. TEST RESULTS OF DTS BANDWIDTH

APPENDIX C. TEST RESULTS OF MAXIMUM CONDUCTED OUTPUT POWER

APPENDIX D. TEST RESULTS OF POWER SPECTRAL DENSITY

APPENDIX E. TEST RESULTS OF EMISSIONS IN NON-RESTRICTED FREQUENCY BANDS

APPENDIX F. TEST RESULTS OF EMISSIONS IN RESTRICTED FREQUENCY BANDS

APPENDIX G. TEST RESULTS OF RADIATED EMISSION CO-LOCATION

APPENDIX H. TEST PHOTOS

PHOTOGRAPHS OF EUT V01



Summary of Test Result

Conformance Test Specifications				
Report Clause	Ref. Std. Clause	Description	Limit	Result
1.1.2	15.203	Antenna Requirement	FCC 15.203	Complied
3.1	15.207	AC Power-line Conducted Emissions	FCC 15.207	Complied
3.2	15.247(a)	DTS Bandwidth	≥500kHz	Complied
3.3	15.247(b)	Maximum Conducted Output Power	Power [dBm]:30	Complied
3.4	15.247(e)	Power Spectral Density	PSD [dBm/3kHz]:8	Complied
3.5	15.247(d)	Emissions in Non-restricted Frequency Bands	Non-Restricted Bands: > 30 dBc	Complied
3.6	15.247(d)	Emissions in Restricted Frequency Bands	Restricted Bands: FCC 15.209	Complied

1 General Description

1.1 Information

1.1.1 RF General Information

Frequency Range (MHz)	IEEE Std. 802.11	Ch. Frequency (MHz)	Channel Number
2400-2483.5	b, g, n (HT20), ac (VHT20)	2412-2462	1-11 [11]
2400-2483.5	n (HT40), ac (VHT40)	2422-2452	3-9 [7]

Band	Mode	BWch (MHz)	Nant
2.4-2.4835GHz	802.11b	20	4TX
2.4-2.4835GHz	802.11g	20	4TX
2.4-2.4835GHz	802.11n HT20	20	4TX
2.4-2.4835GHz	802.11ac VHT20	20	4TX
2.4-2.4835GHz	802.11n HT40	40	4TX
2.4-2.4835GHz	802.11ac VHT40	40	4TX

Note:

- ◆ 11b mode uses a combination of DSSS-DBPSK, DQPSK, CCK modulation.
- ◆ 11g, HT20 and HT40 use a combination of OFDM-BPSK, QPSK, 16QAM, 64QAM modulation.
- ◆ VHT20, VHT40 use a combination of OFDM-BPSK, QPSK, 16QAM, 64QAM, 256QAM and 1024QAM modulation.
- ◆ BWch is the nominal channel bandwidth.
- ◆ Nss-Min is the minimum number of spatial streams.
- ◆ Nant is the number of outputs. e.g., 2(2,3) means have 2 outputs for port 2 and port 3. 2 means have 2 outputs for port 1 and port 2.



1.1.2 Antenna Information

Ant.	Brand	Model Name	Antenna Type	Connector	Gain (dBi)
1	TP-LINK	Archer C5400X(US)1.0	Dipole	I-PEX	1.8
2	TP-LINK	Archer C5400X(US)1.0	Dipole	I-PEX	1.8
3	TP-LINK	Archer C5400X(US)1.0	Dipole	I-PEX	1.8
4	TP-LINK	Archer C5400X(US)1.0	Dipole	I-PEX	1.8
5	TP-LINK	Archer C5400X(US)1.0	Dipole	I-PEX	1.8
6	TP-LINK	Archer C5400X(US)1.0	Dipole	I-PEX	1.8
7	TP-LINK	Archer C5400X(US)1.0	Dipole	I-PEX	1.8
8	TP-LINK	Archer C5400X(US)1.0	Dipole	I-PEX	1.8

Note:

There are four radios, Radio 1, Radio 2, Radio 3 and Radio 4 are respectively.

Radio 1 supports WLAN 2.4GHz function.

Radio 2 supports WLAN 5GHz Band1 / Band2 function.

Radio 3 supports WLAN 5GHz Band3 / Band4 function.

Radio 4 supports Bluetooth function.

The EUT has eight antennas.

For 2.4GHz function:

Ant1 connect to port 1, Ant 2 connect to port 2, Ant 3 connect to port 3, Ant 4 connect to port 4.

For IEEE 802.11b/g/n/ac mode (4TX/4RX):

Ant 1 (Port 1), Ant 2 (Port 2), Ant 3 (Port 3) and Ant 4 (Port 4) can be used as transmitting/receiving antenna.

Ant 1 (Port 1), Ant 2 (Port 2), Ant 3 (Port 3) and Ant 4 (Port 4) could transmit/receive simultaneously.

For 5GHz (Band 1) function:

Ant 1 connect to port 1, Ant 2 connect to port 2, Ant 3 connect to port 3, Ant 4 connect to port 4.

For IEEE 802.11a/n/ac mode (4TX/4RX):

Ant 1 (Port 1), Ant 2 (Port 2), Ant 3 (Port 3) and Ant 4 (Port 4) can be used as transmitting/receiving antenna.

Ant 1 (Port 1), Ant 2 (Port 2), Ant 3 (Port 3) and Ant 4 (Port 4) could transmit/receive simultaneously.

For 5GHz (Band 4) function:

Ant 5 connect to port 1, Ant 6 connect to port 2, Ant 7 connect to port 3, Ant 8 connect to port 4.

For IEEE 802.11 a/n/ac mode (4TX/4RX):

Ant 5 (Port 1), Ant 6 (Port 2), Ant 7 (Port 3) and Ant 8 (Port 4) can be used as transmitting/receiving antenna.

Ant 5 (Port 1), Ant 6 (Port 2), Ant 7 (Port 3) and Ant 8 (Port 4) could transmit/receive simultaneously.

For Bluetooth function(1TX/1RX):

Ant 5 connect to port 1.

Only Ant 5 (Port 1) can be used as transmitting/receiving antenna.



1.1.3 Mode Test Duty Cycle

Mode	DC	DCF(dB)
802.11b	0.998	0.009
802.11g	0.988	0.052
802.11ac VHT20	0.986	0.061
802.11ac VHT40	0.965	0.155

1.1.4 EUT Operational Condition

EUT Power Type	From Power Adapter		
Beamforming Function	<input checked="" type="checkbox"/>	With beamforming for IEEE802.11n/ac in 5GHz	<input type="checkbox"/> Without beamforming

1.2 Testing Applied Standards

According to the specifications of the manufacturer, the EUT must comply with the requirements of the following standards:

- ◆ 47 CFR FCC Part 15
- ◆ ANSI C63.10-2013
- ◆ FCC KDB 558074 D01 v04
- ◆ FCC KDB 662911 D01 v02r01
- ◆ FCC KDB 644545 D01 v01r02.
- ◆ FCC KDB 412172 D01 v01r01

1.3 Testing Location Information

Testing Location		
<input type="checkbox"/>	HWA YA	ADD : No. 52, Hwa Ya 1st Rd., Kwei-Shan Hsiang, Tao Yuan Hsien, Taiwan, R.O.C. TEL : 886-3-327-3456 FAX : 886-3-318-0055
<input checked="" type="checkbox"/>	JHUBEI	ADD : No.8, Lane 724, Bo-ai St., Jhubei City, HsinChu County 302, Taiwan, R.O.C. TEL : 886-3-656-9065 FAX : 886-3-656-9085

Test Condition	Test Site No.	Test Engineer	Test Environment	Test Date
RF Conducted	TH01-CB	Brian Sun	26°C / 57%	Mar. 27, 2017~Apr. 26, 2017
Radiated	03CH01-CB	Welson Chen / Justin Lin	22°C / 54%	Mar. 25, 2017~Apr. 26, 2017
AC Conduction	CO01-CB	Rick Yeh / Ryo Fan	25°C / 60%	Apr. 22, 2017

Test site Designation No. TW0006 with FCC.

Test site registered number IC 4086D with Industry Canada.

1.4 Measurement Uncertainty

ISO/IEC 17025 requires that an estimate of the measurement uncertainties associated with the emissions test results be included in the report. The measurement uncertainties given below are based on a 95% confidence level (based on a coverage factor (k=2))

Test Items	Uncertainty	Remark
Conducted Emission (150kHz ~ 30MHz)	3.2 dB	Confidence levels of 95%
Radiated Emission (30MHz ~ 1,000MHz)	3.6 dB	Confidence levels of 95%
Radiated Emission (1GHz ~ 18GHz)	3.7 dB	Confidence levels of 95%
Radiated Emission (18GHz ~ 40GHz)	3.5 dB	Confidence levels of 95%
Conducted Emission	1.7 dB	Confidence levels of 95%
Output Power Measurement	1.33 dB	Confidence levels of 95%
Power Density Measurement	1.27 dB	Confidence levels of 95%
Bandwidth Measurement	9.74 x10 ⁻⁸	Confidence levels of 95%



2 Test Configuration of EUT

2.1 Test Channel Mode

Mode	Power Setting
802.11b_(1Mbps)_4TX	-
2412MHz	93
2437MHz	94
2462MHz	93
802.11g_(6Mbps)_4TX	-
2412MHz	86
2437MHz	96
2462MHz	83
802.11ac VHT20_Nss1,(MCS0)_4TX	-
2412MHz	83
2437MHz	96
2462MHz	86
802.11ac VHT40_Nss1,(MCS0)_4TX	-
2422MHz	63
2437MHz	72
2452MHz	69

Note:

- ♦ VHT20/VHT40 covers HT20/HT40, due to same modulation. The power setting for 802.11n HT20 and HT40 are the same or lower than 802.11ac VHT20 and VHT40.

2.2 The Worst Case Measurement Configuration

The Worst Case Mode for Following Conformance Tests	
Tests Item	AC power-line conducted emissions
Condition	AC power-line conducted measurement for line and neutral
Operating Mode	Normal Link

The Worst Case Mode for Following Conformance Tests	
Tests Item	DTS Bandwidth Maximum Conducted Output Power Power Spectral Density Emissions in Non-restricted Frequency Bands
Test Condition	Conducted measurement at transmit chains

The Worst Case Mode for Following Conformance Tests	
Tests Item	Emissions in Restricted Frequency Bands
Test Condition	Radiated measurement If EUT consist of multiple antenna assembly (multiple antenna are used in EUT regardless of spatial multiplexing MIMO configuration), the radiated test should be performed with highest antenna gain of each antenna type.
Operating Mode < 1GHz	Normal Link
Operating Mode > 1GHz	CTX

The Worst Case Mode for Following Conformance Tests	
Tests Item	Simultaneous Transmission Analysis - Radiated Emission Co-location
Test Condition	Radiated measurement
Operating Mode	Normal Link
1	Radio 1-WLAN 2.4G + Radio 2-WLAN 5G Band 1
2	Radio 3-WLAN 5G Band 4 + Radio 4-Bluetooth
Refer to Appendix G for Radiated Emission Co-location.	

The Worst Case Mode for Following Conformance Tests	
Tests Item	Simultaneous Transmission Analysis - Co-location RF Exposure Evaluation
Operating Mode	
1	Radio 1-WLAN 2.4G + Radio 2-WLAN 5G Band 1 + Radio 3-WLAN 5G Band 4 + Radio 4-Bluetooth
Refer to Sporton Test Report No.: FA731332 for Co-location RF Exposure Evaluation.	

Note: 1. The EUT can only be used in Z-axis position.

2. All the specification of test configurations and test modes were based on customer's request.



2.3 EUT Operation during Test

For CTX Mode:

The EUT was programmed to be in continuously transmitting mode.

For Normal Link:

During the test, the EUT operation to normal function.

2.4 Accessories

Accessories					
No.	Equipment Name	Brand Name	Model Name	Rating	DC Power Line
1	Adapter	HuntKey	HKA06012050-7G	Input: 100-240V-1.5A 50/60Hz Output: 12.0V, 5A	Non-Shielded, 1.2m
Other					
Power Cable*1, Non Shielded, 1.5m					



2.5 Support Equipment

For Test Site No: CO01-CB

Support Equipment				
No.	Equipment	Brand Name	Model Name	FCC ID
1	NB*5	DELL	E6430	DoC
2	iPad	Apple	A1430	DoC
3	Flash disk3.0	ADATA	C103	DoC
4	Flash disk3.0	Transcend	JetFlash-700	DoC

For Test Site No: 03CH01-CB (below 1GHz)

Support Equipment				
No.	Equipment	Brand Name	Model Name	FCC ID
1	NB*2	DELL	E4300	DoC
2	NB*3	Apple	Mac Book	DoC
3	iPad	Apple	A1430	DoC
4	Flash disk3.0*2	Silicon Power	B06	DoC

For Test Site No: 03CH01-CB (above 1GHz)

Support Equipment				
No.	Equipment	Brand Name	Model Name	FCC ID
1	NB	DELL	E4300	DoC

For Test Site No: TH01-CB

Support Equipment				
No.	Equipment	Brand Name	Model Name	FCC ID
1	NB	DELL	E4300	DoC

2.6 Test Setup Diagram

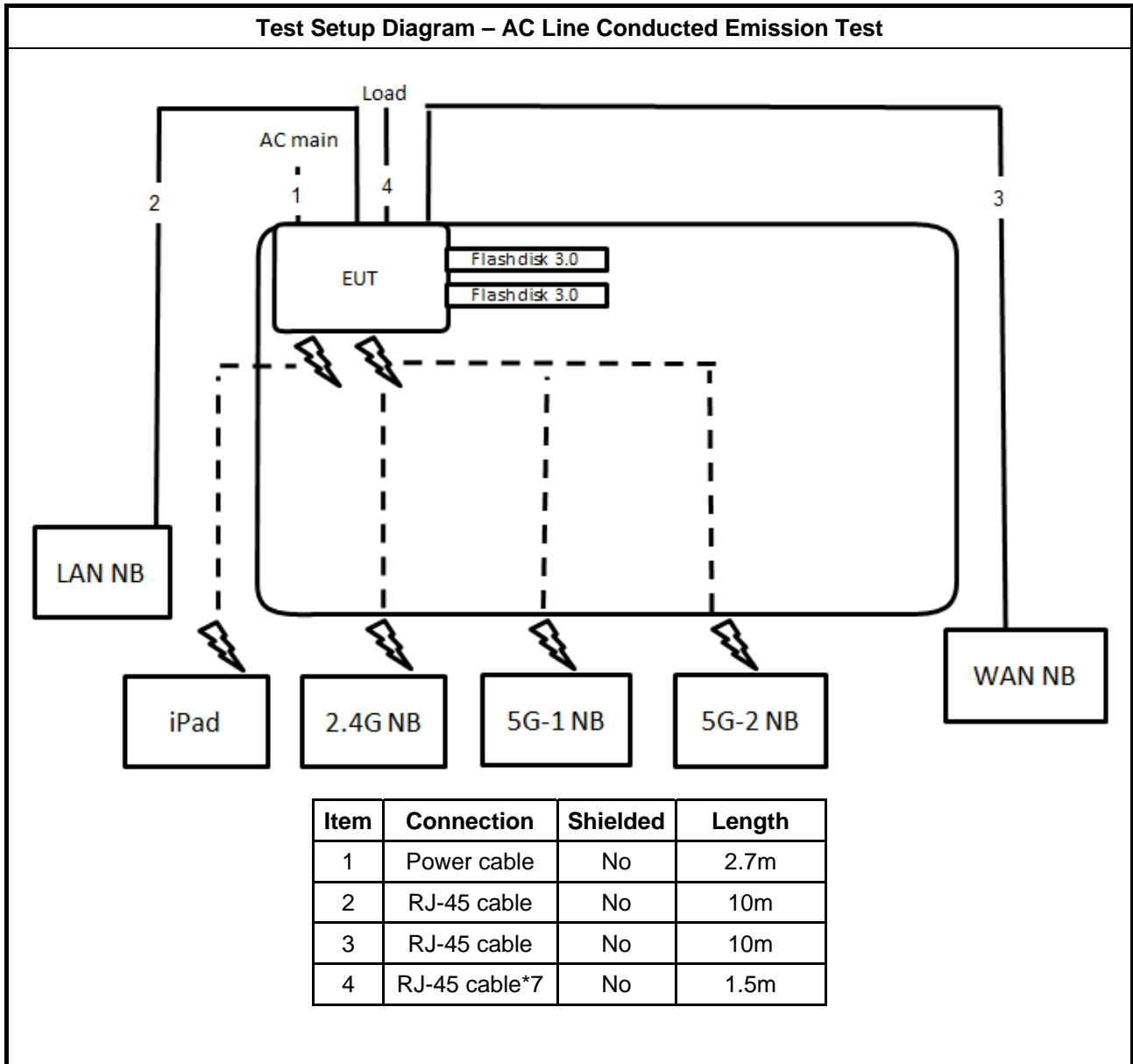

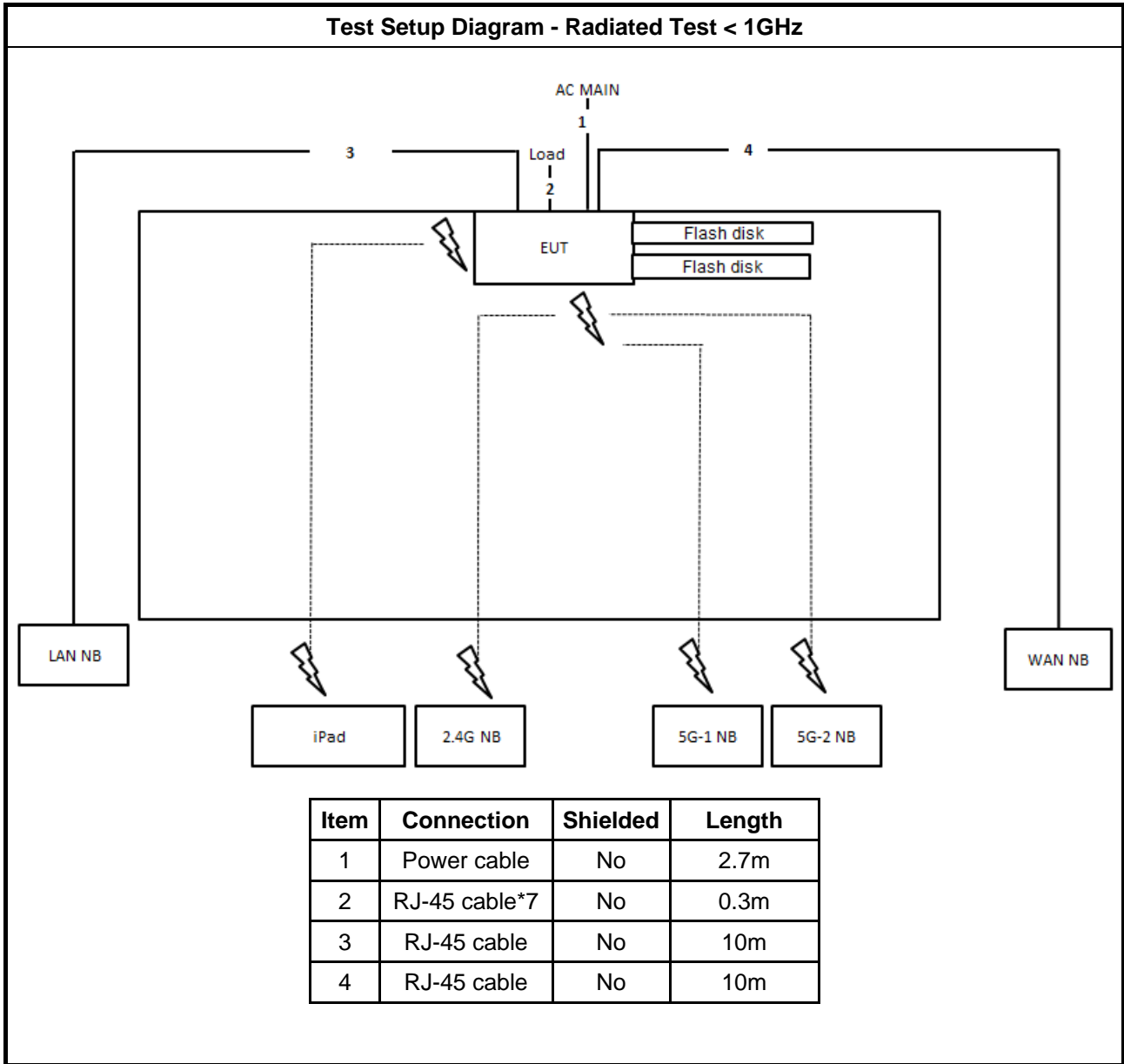

Test Setup Diagram - Radiated Test > 1GHz

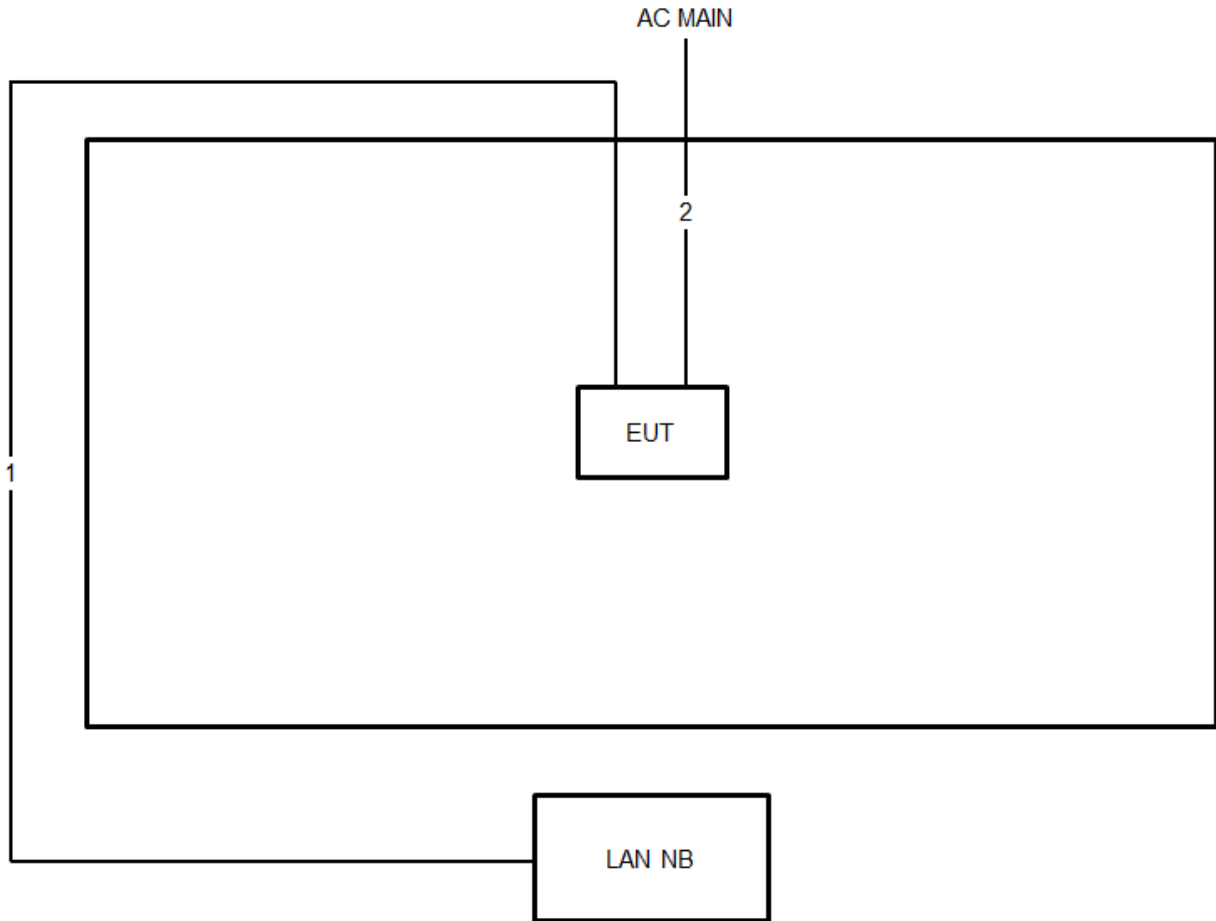

Item	Connection	Shielded	Length
1	RJ-45 cable	No	10m
2	Power cable	No	2.7m

3 Transmitter Test Result

3.1 AC Power-line Conducted Emissions

3.1.1 AC Power-line Conducted Emissions Limit

AC Power-line Conducted Emissions Limit		
Frequency Emission (MHz)	Quasi-Peak	Average
0.15-0.5	66 - 56 *	56 - 46 *
0.5-5	56	46
5-30	60	50

Note 1: * Decreases with the logarithm of the frequency.

3.1.2 Measuring Instruments

Refer a test equipment and calibration data table in this test report.

3.1.3 Test Procedures

Test Method
<input checked="" type="checkbox"/> Refer as ANSI C63.10-2013, clause 6.2 for AC power-line conducted emissions.

3.1.4 Test Setup

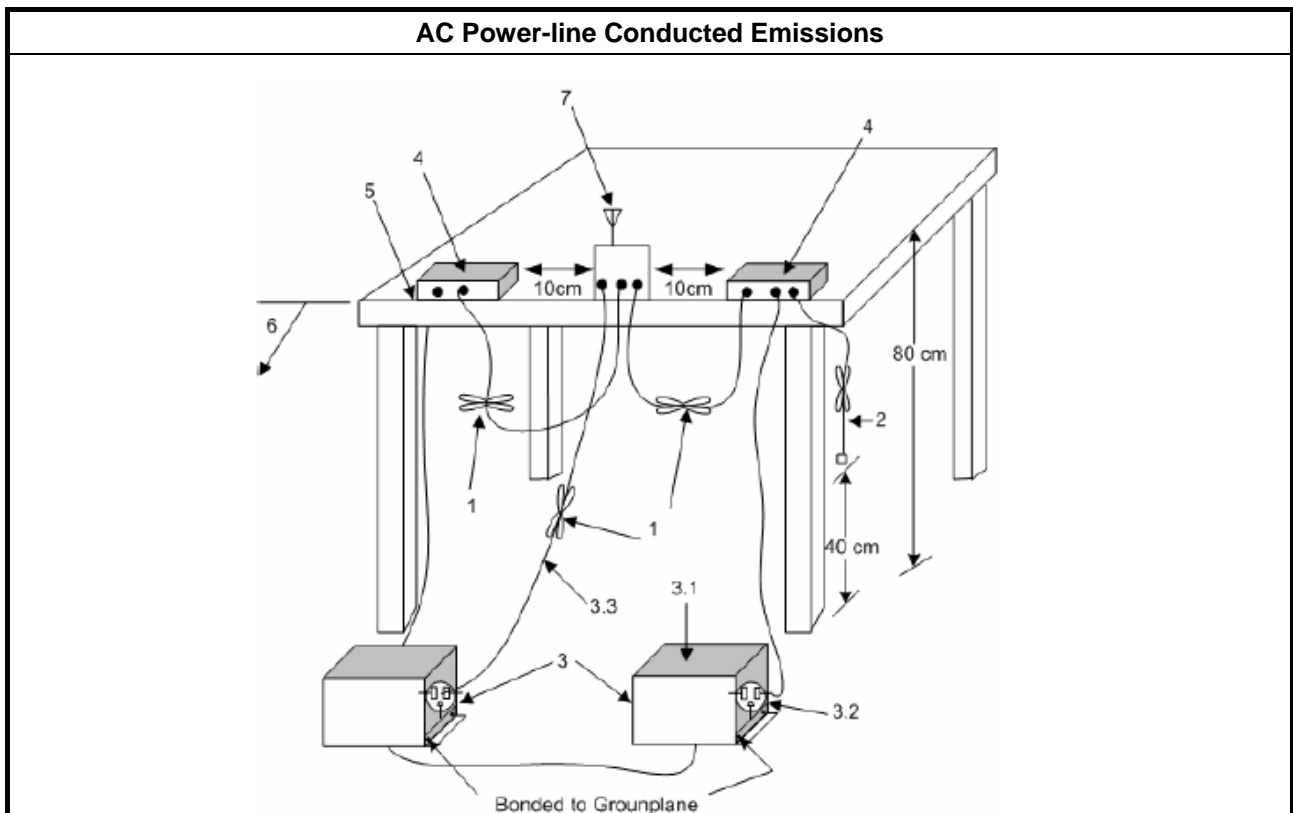



3.1.5 Test Result of AC Power-line Conducted Emissions

Refer as Appendix A

3.2 DTS Bandwidth

3.2.1 6dB Bandwidth Limit

6dB Bandwidth Limit
Systems using digital modulation techniques:
<ul style="list-style-type: none"> ▪ 6 dB bandwidth \geq 500 kHz.

3.2.2 Measuring Instruments

Refer a test equipment and calibration data table in this test report.

3.2.3 Test Procedures

Test Method
<ul style="list-style-type: none"> ▪ For the emission bandwidth shall be measured using one of the options below:
<input checked="" type="checkbox"/> Refer as FCC KDB 558074, clause 8.1 Option 1 for 6 dB bandwidth measurement.
<input type="checkbox"/> Refer as FCC KDB 558074, clause 8.2 Option 2 for 6 dB bandwidth measurement.
<input type="checkbox"/> Refer as ANSI C63.10, clause 6.9.1 for occupied bandwidth testing.

3.2.4 Test Setup

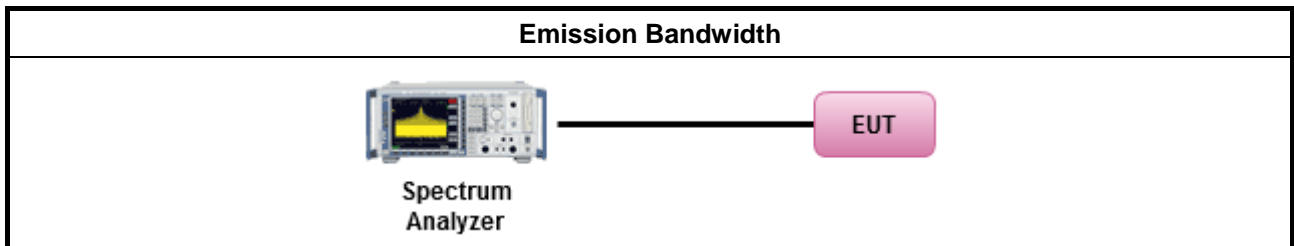

3.2.5 Test Result of Emission Bandwidth

Refer as Appendix B



3.3 Maximum Conducted Output Power

3.3.1 Maximum Conducted Output Power Limit

Maximum Conducted Output Power Limit	
	▪ If $G_{TX} \leq 6$ dBi, then $P_{Out} \leq 30$ dBm (1 W)
	▪ Point-to-multipoint systems (P2M): If $G_{TX} > 6$ dBi, then $P_{Out} = 30 - (G_{TX} - 6)$ dBm
	▪ Point-to-point systems (P2P): If $G_{TX} > 6$ dBi, then $P_{Out} = 30 - (G_{TX} - 6)/3$ dBm
	▪ Smart antenna system (SAS):
	- Single beam: If $G_{TX} > 6$ dBi, then $P_{Out} = 30 - (G_{TX} - 6)/3$ dBm
	- Overlap beam: If $G_{TX} > 6$ dBi, then $P_{Out} = 30 - (G_{TX} - 6)/3$ dBm
	- Aggregate power on all beams: If $G_{TX} > 6$ dBi, then $P_{Out} = 30 - (G_{TX} - 6)/3 + 8$ dB dBm
P_{Out} = maximum peak conducted output power or maximum conducted output power in dBm, G_{TX} = the maximum transmitting antenna directional gain in dBi.	

3.3.2 Measuring Instruments

Refer a test equipment and calibration data table in this test report.

3.3.3 Test Procedures

Test Method	
<ul style="list-style-type: none"> ▪ Maximum Peak Conducted Output Power 	
<input type="checkbox"/>	Refer as FCC KDB 558074, clause 9.1.1 Option 1 (RBW ≥ EBW method).
<input type="checkbox"/>	Refer as FCC KDB 558074, clause 9.1.2 Option 2 (peak power meter for VBW ≥ DTS BW)
<ul style="list-style-type: none"> ▪ Maximum Conducted Output Power 	
[duty cycle ≥ 98% or external video / power trigger]	
<input type="checkbox"/>	Refer as FCC KDB 558074, clause 9.2.2.2 Method AVGSA-1 (spectral trace averaging).
<input type="checkbox"/>	Refer as FCC KDB 558074, clause 9.2.2.3 Method AVGSA-1 Alt. (slow sweep speed)
duty cycle < 98% and average over on/off periods with duty factor	
<input type="checkbox"/>	Refer as FCC KDB 558074, clause 9.2.2.4 Method AVGSA-2 (spectral trace averaging).
<input type="checkbox"/>	Refer as FCC KDB 558074, clause 9.2.2.5 Method AVGSA-2 Alt. (slow sweep speed)
RF power meter and average over on/off periods with duty factor or gated trigger	
<input checked="" type="checkbox"/>	Refer as FCC KDB 558074, clause 9.2.3 Method AVGPM-G (using an RF average power meter).
<input type="checkbox"/>	Refer as FCC KDB 558074, clause 9.1.2 PKPM1 Peak power meter method.
<ul style="list-style-type: none"> ▪ For conducted measurement. 	
<ul style="list-style-type: none"> ▪ If the EUT supports multiple transmit chains using options given below: Refer as FCC KDB 662911, In-band power measurements. Using the measure-and-sum approach, measured all transmit ports individually. Sum the power (in linear power units e.g., mW) of all ports for each individual sample and save them. 	
<ul style="list-style-type: none"> ▪ If multiple transmit chains, EIRP calculation could be following as methods: $P_{total} = P_1 + P_2 + \dots + P_n$ (calculated in linear unit [mW] and transfer to log unit [dBm]) $EIRP_{total} = P_{total} + DG$ 	

3.3.4 Test Setup

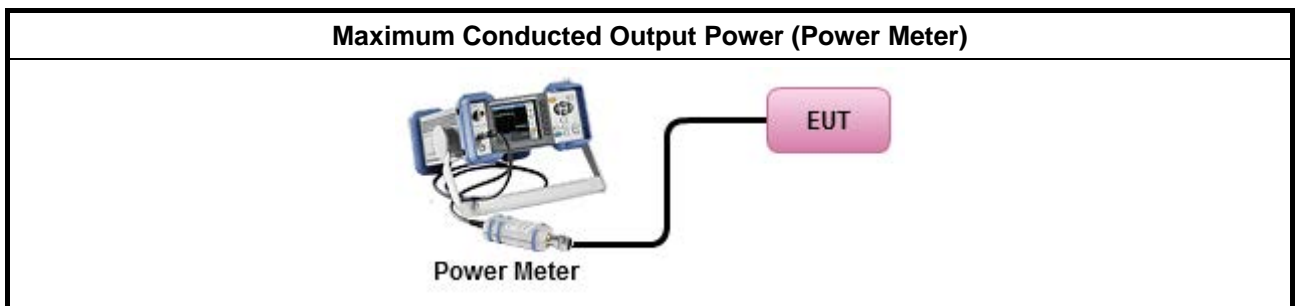

3.3.5 Test Result of Maximum Conducted Output Power

Refer as Appendix C

3.4 Power Spectral Density

3.4.1 Power Spectral Density Limit

Power Spectral Density Limit
<ul style="list-style-type: none"> ▪ Power Spectral Density (PSD) \leq 8 dBm/3kHz

3.4.2 Measuring Instruments

Refer a test equipment and calibration data table in this test report.

3.4.3 Test Procedures

Test Method
<ul style="list-style-type: none"> ▪ Peak power spectral density procedures that the same method as used to determine the conducted output power. If maximum peak conducted output power was measured to demonstrate compliance to the output power limit, then the peak PSD procedure below (Method PKPSD) shall be used. If maximum conducted output power was measured to demonstrate compliance to the output power limit, then one of the average PSD procedures shall be used, as applicable based on the following criteria (the peak PSD procedure is also an acceptable option).
<input checked="" type="checkbox"/> Refer as FCC KDB 558074, clause 10.2 Method PKPSD (RBW=3-100kHz; Detector=peak). [duty cycle \geq 98% or external video / power trigger]
<input type="checkbox"/> Refer as FCC KDB 558074, clause 10.3 Method AVGPSD-1 (spectral trace averaging).
<input type="checkbox"/> Refer as FCC KDB 558074, clause 10.4 Method AVGPSD-2 (slow sweep speed) duty cycle < 98% and average over on/off periods with duty factor
<input type="checkbox"/> Refer as FCC KDB 558074, clause 10.5 Method AVGPSD-1 Alt (spectral trace averaging).
<input type="checkbox"/> Refer as FCC KDB 558074, clause 10.6 Method AVGPSD-2 Alt. (slow sweep speed)
<ul style="list-style-type: none"> ▪ For conducted measurement.
<ul style="list-style-type: none"> ▪ If The EUT supports multiple transmit chains using options given below: <ul style="list-style-type: none"> <input checked="" type="checkbox"/> Option 1: Measure and sum the spectra across the outputs. Refer as FCC KDB 662911, In-band power spectral density (PSD). Sample all transmit ports simultaneously using a spectrum analyzer for each transmit port. Where the trace bin-by-bin of each transmit port summing can be performed. (i.e., in the first spectral bin of output 1 is summed with that in the first spectral bin of output 2 and that from the first spectral bin of output 3, and so on up to the NTX output to obtain the value for the first frequency bin of the summed spectrum.). Add up the amplitude (power) values for the different transmit chains and use this as the new data trace. <input type="checkbox"/> Option 2: Measure and sum spectral maxima across the outputs. With this technique, spectra are measured at each output of the device at the required resolution bandwidth. The maximum value (peak) of each spectrum is determined. These maximum values are then summed mathematically in linear power units across the outputs. These operations shall be performed separately over frequency spans that have different out-of-band or spurious emission limits, <input type="checkbox"/> Option 3: Measure and add 10 log(N) dB, where N is the number of transmit chains. Refer as FCC KDB 662911, In-band power spectral density (PSD). Performed at each transmit chains and each transmit chains shall be compared with the limit have been reduced with 10 log(N). Or each transmit chains shall be add 10 log(N) to compared with the limit.

3.4.4 Test Setup

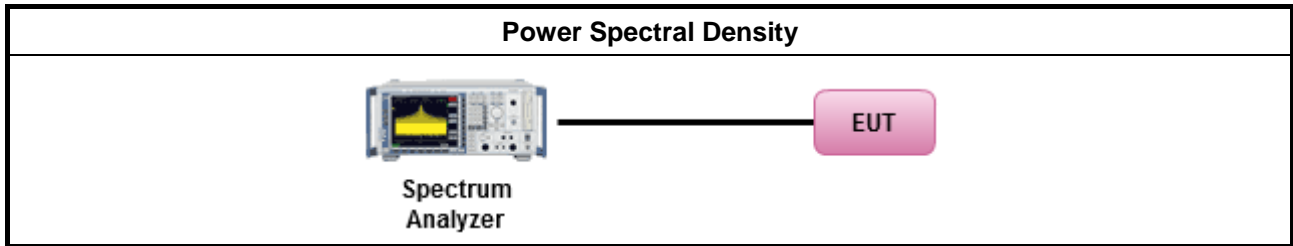

3.4.5 Test Result of Power Spectral Density

Refer as Appendix D

3.5 Emissions in Non-restricted Frequency Bands

3.5.1 Emissions in Non-restricted Frequency Bands Limit

Un-restricted Band Emissions Limit	
RF output power procedure	Limit (dB)
Peak output power procedure	20
Average output power procedure	30

Note 1: If the peak output power procedure is used to measure the fundamental emission power to demonstrate compliance to requirements, then the peak conducted output power measured within any 100 kHz outside the authorized frequency band shall be attenuated by at least 20 dB relative to the maximum measured in-band peak PSD level.

Note 2: If the average output power procedure is used to measure the fundamental emission power to demonstrate compliance to requirements, then the power in any 100 kHz outside of the authorized frequency band shall be attenuated by at least 30 dB relative to the maximum measured in-band average PSD level.

3.5.2 Measuring Instruments

Refer a test equipment and calibration data table in this test report.

3.5.3 Test Procedures

Test Method
<ul style="list-style-type: none"> Refer as FCC KDB 558074, clause 11 for unwanted emissions into non-restricted bands.

3.5.4 Test Setup

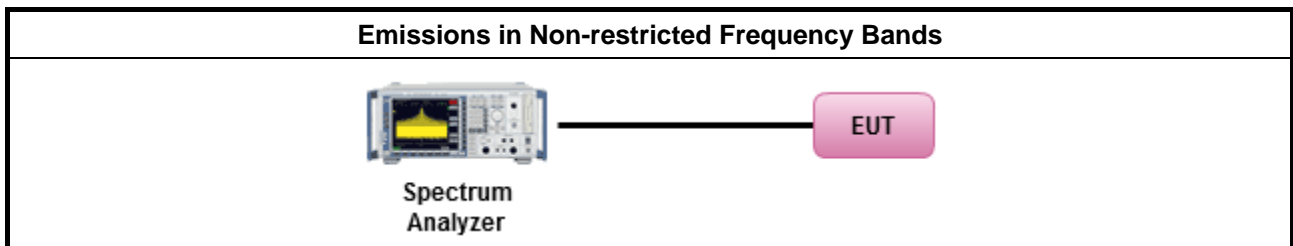

3.5.5 Test Result of Emissions in Non-restricted Frequency Bands

Refer as Appendix E

3.6 Emissions in Restricted Frequency Bands

3.6.1 Emissions in Restricted Frequency Bands Limit

Restricted Band Emissions Limit			
Frequency Range (MHz)	Field Strength (uV/m)	Field Strength (dBuV/m)	Measure Distance (m)
0.009~0.490	2400/F(kHz)	48.5 - 13.8	300
0.490~1.705	24000/F(kHz)	33.8 - 23	30
1.705~30.0	30	29	30
30~88	100	40	3
88~216	150	43.5	3
216~960	200	46	3
Above 960	500	54	3

Note 1: Test distance for frequencies at or above 30 MHz, measurements may be performed at a distance other than the limit distance provided they are not performed in the near field and the emissions to be measured can be detected by the measurement equipment. When performing measurements at a distance other than that specified, the results shall be extrapolated to the specified distance using an extrapolation factor of 20 dB/decade (inverse of linear distance for field-strength measurements, inverse of linear distance-squared for power-density measurements).

Note 2: Test distance for frequencies at below 30 MHz, measurements may be performed at a distance closer than the EUT limit distance; however, an attempt should be made to avoid making measurements in the near field. When performing measurements below 30 MHz at a closer distance than the limit distance, the results shall be extrapolated to the specified distance by either making measurements at a minimum of two or more distances on at least one radial to determine the proper extrapolation factor or by using the square of an inverse linear distance extrapolation factor (40 dB/decade). The test report shall specify the extrapolation method used to determine compliance of the EUT.

3.6.2 Measuring Instruments

Refer a test equipment and calibration data table in this test report.

3.6.3 Test Procedures

Test Method	
<ul style="list-style-type: none"> ▪ The average emission levels shall be measured in [duty cycle \geq 98 or duty factor]. 	
<ul style="list-style-type: none"> ▪ Refer as ANSI C63.10, clause 6.9.2.2 band-edge testing shall be performed at the lowest frequency channel and highest frequency channel within the allowed operating band. 	
<ul style="list-style-type: none"> ▪ For the transmitter unwanted emissions shall be measured using following options below: 	
	<ul style="list-style-type: none"> ▪ Refer as FCC KDB 558074, clause 12 for unwanted emissions into restricted bands.
	<input type="checkbox"/> Refer as FCC KDB 558074, clause 12.2.5.1 Option 1 (trace averaging for duty cycle \geq 98%)
	<input type="checkbox"/> Refer as FCC KDB 558074, clause 12.2.5.2 Option 2 (trace averaging + duty factor).
	<input checked="" type="checkbox"/> Refer as FCC KDB 558074, clause 12.2.5.3 Option 3 (Reduced VBW \geq 1/T).
	<input type="checkbox"/> Refer as ANSI C63.10, clause 4.2.3.2.3 (Reduced VBW). VBW \geq 1/T, where T is pulse time.
	<input type="checkbox"/> Refer as ANSI C63.10, clause 4.2.3.2.4 average value of pulsed emissions.
	<input checked="" type="checkbox"/> Refer as FCC KDB 558074, clause 12.2.4 measurement procedure peak limit.
<ul style="list-style-type: none"> ▪ For the transmitter band-edge emissions shall be measured using following options below: 	
	<ul style="list-style-type: none"> ▪ Refer as FCC KDB 558074 clause 13.1, When the performing peak or average radiated measurements, emissions within 2 MHz of the authorized band edge may be measured using the marker-delta method described below.
	<ul style="list-style-type: none"> ▪ Refer as FCC KDB 558074, clause 13.2 (ANSI C63.10, clause 6.9.3) for marker-delta method for band-edge measurements.
	<ul style="list-style-type: none"> ▪ Refer as FCC KDB 558074, clause 13.3 for narrower resolution bandwidth (100kHz) using the band power and summing the spectral levels (i.e., 1 MHz).
<ul style="list-style-type: none"> ▪ For conducted and cabinet radiation measurement, refer as FCC KDB 558074, clause 12.2.2. 	
	<ul style="list-style-type: none"> ▪ For conducted unwanted emissions into restricted bands (absolute emission limits). Devices with multiple transmit chains using options given below: (1) Measure and sum the spectra across the outputs or (2) Measure and add 10 log(N) dB
	<ul style="list-style-type: none"> ▪ For FCC KDB 662911 The methodology described here may overestimate array gain, thereby resulting in apparent failures to satisfy the out-of-band limits even if the device is actually compliant. In such cases, compliance may be demonstrated by performing radiated tests around the frequencies at which the apparent failures occurred.

3.6.4 Test Setup

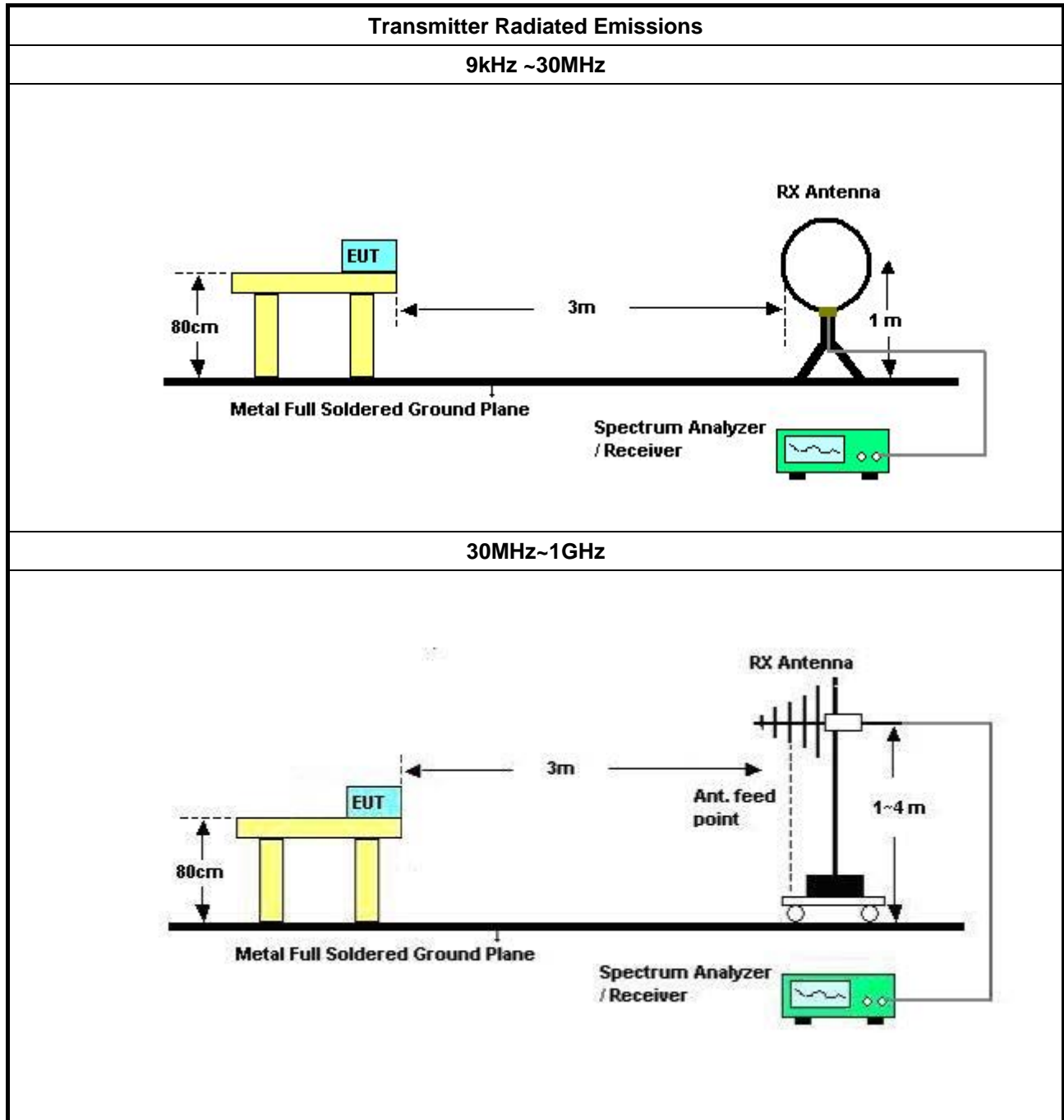

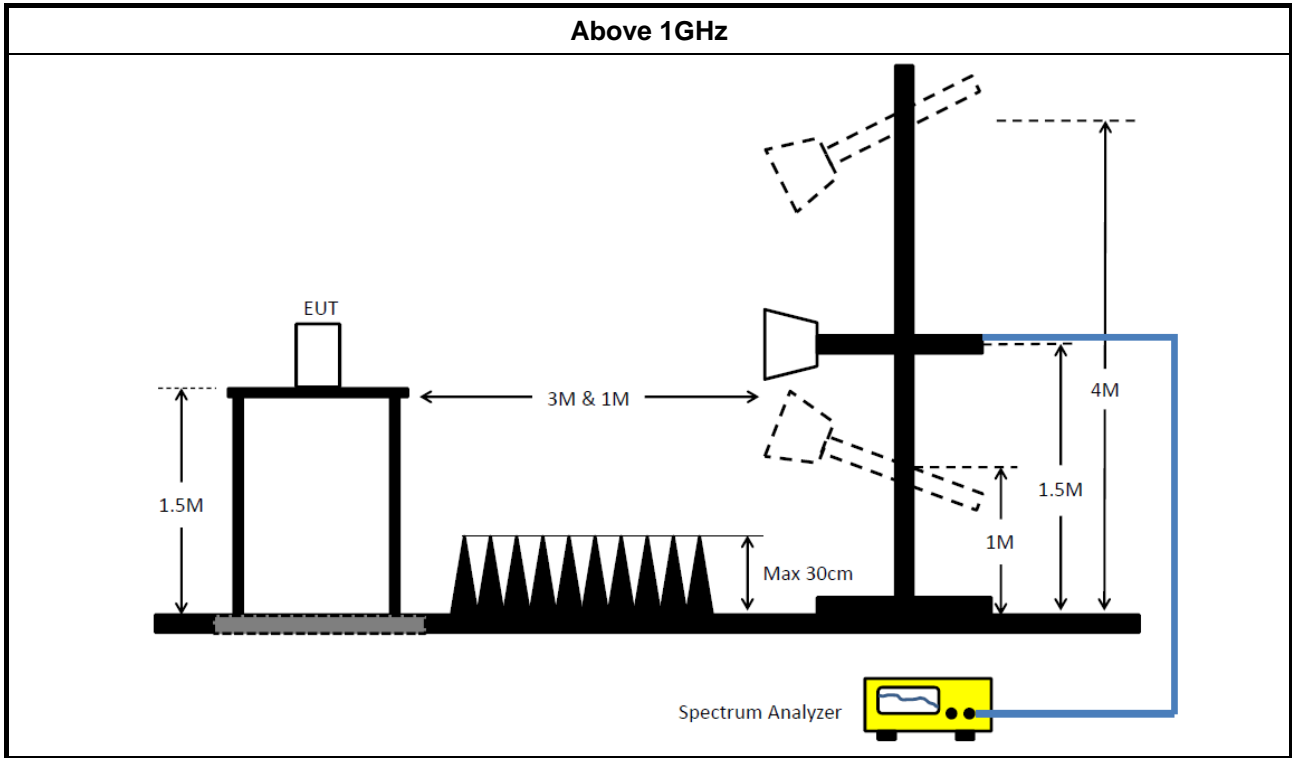

3.6.5 Transmitter Radiated Unwanted Emissions (Below 30MHz)

All amplitude of spurious emissions that are attenuated by more than 20 dB below the permissible value has no need to be reported.

3.6.6 Test Result of Transmitter Radiated Unwanted Emissions

Refer as Appendix F



4 Test Equipment and Calibration Data

Instrument	Manufacturer	Model No.	Serial No.	Characteristics	Calibration Date	Remark
EMI Receiver	Agilent	N9038A	My52260123	9kHz ~ 8.45GHz	Jan. 23, 2017	Conduction (CO01-CB)
LISN	F.C.C.	FCC-LISN-50-16-2	04083	150kHz ~ 100MHz	Dec. 14, 2016	Conduction (CO01-CB)
LISN	Schwarzbeck	NSLK 8127	8127647	9kHz ~ 30MHz	Dec. 21, 2016	Conduction (CO01-CB)
COND Cable	Woken	Cable	01	150kHz ~ 30MHz	May 24, 2016	Conduction (CO01-CB)
Software	Audix	E3	6.120210n	-	N.C.R.	Conduction (CO01-CB)
BILOG ANTENNA with 6dB Attenuator	TESEQ & EMCI	CBL6112D & N-6-06	37880 & AT-N0609	20MHz ~ 2GHz	Aug. 30, 2016	Radiation (03CH01-CB)
Loop Antenna	Teseq	HLA 6120	24155	9kHz - 30 MHz	Mar. 16, 2016*	Radiation (03CH01-CB)
Horn Antenna	EMCO	3115	00075790	750MHz ~ 18GHz	Nov. 10, 2016	Radiation (03CH01-CB)
Horn Antenna	Schwarzbeck	BBHA 9170	BBHA9170252	15GHz ~ 40GHz	Jul. 25, 2016	Radiation (03CH01-CB)
Pre-Amplifier	Agilent	8447D	2944A10991	0.1MHz ~ 1.3GHz	Mar. 13, 2017	Radiation (03CH01-CB)
Pre-Amplifier	Agilent	8449B	3008A02310	1GHz ~ 26.5GHz	Jan. 16, 2017	Radiation (03CH01-CB)
Pre-Amplifier	MITEQ	TTA1840-35-HG	1864479	18GHz ~ 40GHz	Jun. 28, 2016	Radiation (03CH01-CB)
Spectrum Analyzer	R&S	FSP40	100056	9kHz ~ 40GHz	Nov. 22, 2016	Radiation (03CH01-CB)
EMI Test	R&S	ESCS	100355	9kHz ~ 2.75GHz	May 16, 2016	Radiation (03CH01-CB)
RF Cable-low	Woken	Low Cable-16+17	N/A	30 MHz ~ 1 GHz	Oct. 24, 2016	Radiation (03CH01-CB)
RF Cable-high	Woken	High Cable-16	N/A	1 GHz ~ 18 GHz	Oct. 24, 2016	Radiation (03CH01-CB)
RF Cable-high	Woken	High Cable-16+17	N/A	1 GHz ~ 18 GHz	Oct. 24, 2016	Radiation (03CH01-CB)
RF Cable-high	Woken	High Cable-40G#1	N/A	18GHz ~ 40 GHz	Oct. 24, 2016	Radiation (03CH01-CB)
RF Cable-high	Woken	High Cable-40G#2	N/A	18GHz ~ 40 GHz	Oct. 24, 2016	Radiation (03CH01-CB)
Test Software	Audix	E3	6.2009-I0-7	N/A	N/A	Radiation (03CH01-CB)
Spectrum analyzer	R&S	FSV40	100979	9kHz~40GHz	Dec. 26, 2016	Conducted (TH01-CB)
RF Cable-high	Woken	RG402	High Cable-6	1 GHz – 26.5 GHz	Oct. 24, 2016	Conducted (TH01-CB)
RF Cable-high	Woken	RG402	High Cable-7	1 GHz –26.5 GHz	Oct. 24, 2016	Conducted (TH01-CB)
RF Cable-high	Woken	RG402	High Cable-8	1 GHz –26.5 GHz	Oct. 24, 2016	Conducted (TH01-CB)



Instrument	Manufacturer	Model No.	Serial No.	Characteristics	Calibration Date	Remark
RF Cable-high	Woken	RG402	High Cable-9	1 GHz –26.5 GHz	Oct. 24, 2016	Conducted (TH01-CB)
RF Cable-high	Woken	RG402	High Cable-10	1 GHz –26.5 GHz	Oct. 24, 2016	Conducted (TH01-CB)
Power Sensor	Agilent	U2021XA	MY53410001	50MHz~18GHz	Nov. 22, 2016	Conducted (TH01-CB)

Note: Calibration Interval of instruments listed above is one year.

“*” Calibration Interval of instruments listed above is two years.

N.C.R. means Non-Calibration required.



AC Power-line Conducted Emissions Result

Appendix A

AC Power-line Conducted Emissions Result									
Operating Mode	1		Power Phase	Neutral					
Operating Function	Normal Link								
<p>The graph displays the AC power-line conducted emissions. The y-axis represents Level in dBuV (0 to 80), and the x-axis represents Frequency in MHz (0.150.2 to 30). Two red lines indicate the CISPR limits: CISPR_B_QP (Quasi-Peak) and CISPR_B_AV (Average). The blue line shows the measured emission levels, with several peaks labeled 1 through 14. The test results table below provides the numerical data for these peaks.</p>									
	Freq	Level	Over Limit	Limit Line	Read Level	LISN Factor	Cable Loss	Remark	Pol/Phase
	MHz	dBuV	dB	dBuV	dBuV	dB	dB		
1	0.1749	33.95	-20.77	54.72	23.76	10.01	0.18	Average	NEUTRAL
2	0.1749	44.62	-20.10	64.72	34.43	10.01	0.18	QP	NEUTRAL
3	0.2547	36.29	-15.31	51.60	26.08	10.08	0.13	Average	NEUTRAL
4	0.2547	45.23	-16.37	61.60	35.02	10.08	0.13	QP	NEUTRAL
5	0.5128	29.84	-16.16	46.00	19.42	10.22	0.20	Average	NEUTRAL
6	0.5128	37.28	-18.72	56.00	26.86	10.22	0.20	QP	NEUTRAL
7	0.8449	28.16	-17.84	46.00	17.46	10.10	0.60	Average	NEUTRAL
8	0.8449	37.62	-18.38	56.00	26.92	10.10	0.60	QP	NEUTRAL
9	0.9331	30.80	-15.20	46.00	20.05	10.07	0.68	Average	NEUTRAL
10	0.9331	39.84	-16.16	56.00	29.09	10.07	0.68	QP	NEUTRAL
11	1.0211	28.94	-17.06	46.00	18.17	10.05	0.72	Average	NEUTRAL
12	1.0211	37.86	-18.14	56.00	27.09	10.05	0.72	QP	NEUTRAL
13	14.4623	33.96	-16.04	50.00	23.49	10.26	0.21	Average	NEUTRAL
14	14.4623	40.71	-19.29	60.00	30.24	10.26	0.21	QP	NEUTRAL

Note 1: ">20dB" means emission levels that exceed the level of 20 dB below the applicable limit.
 Note 2: "N/F" means Nothing Found emissions (No emissions were detected.)



AC Power-line Conducted Emissions Result

Appendix A

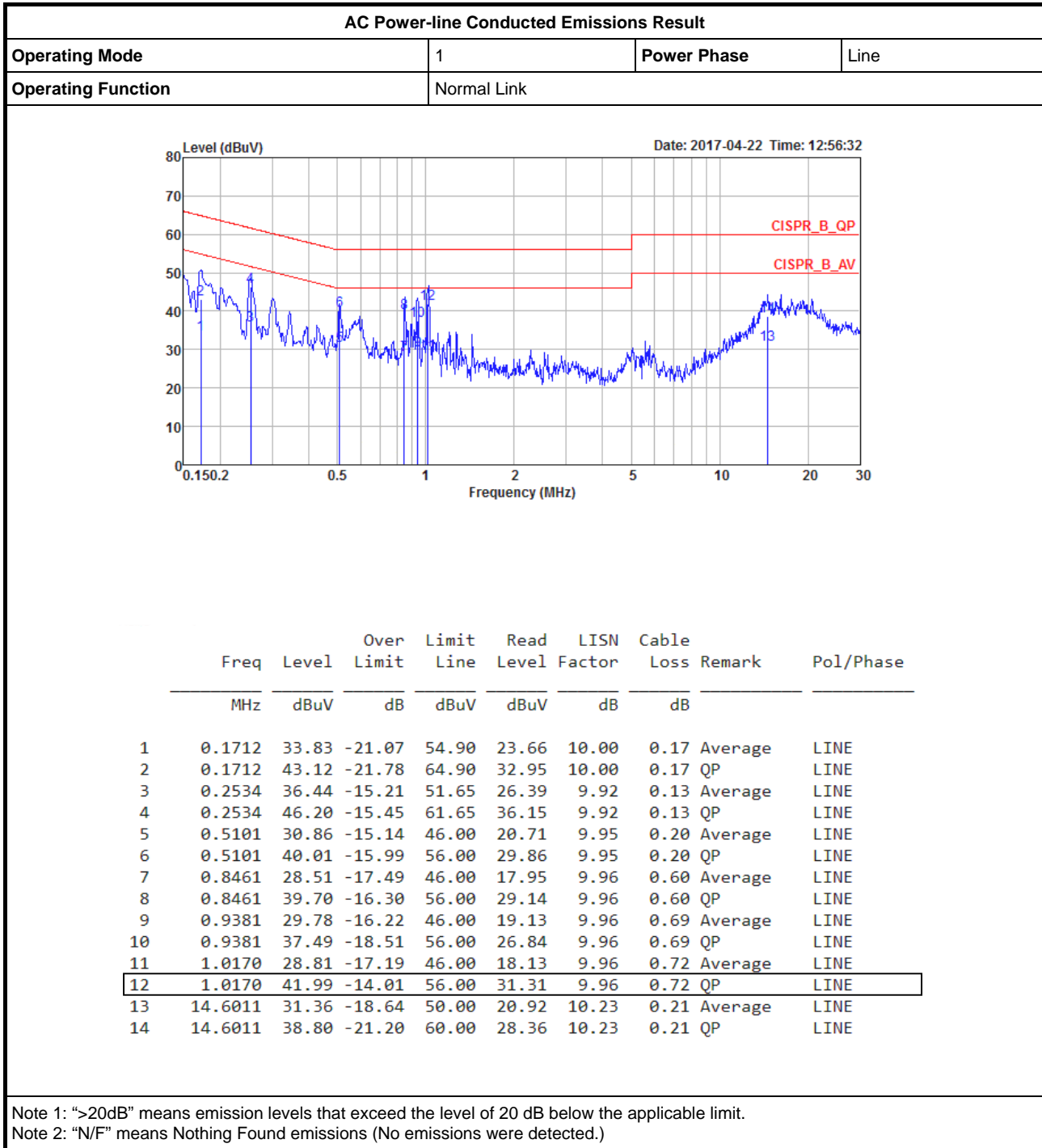



Summary

Mode	Max-N dB (Hz)	Max-OBW (Hz)	ITU-Code	Min-N dB (Hz)	Min-OBW (Hz)
802.11b_(1Mbps)_4TX	-	-	-	-	-
2.4-2.4835GHz	8.05M	10.22M	10M2G1D	7.1M	10.145M
802.11g_(6Mbps)_4TX	-	-	-	-	-
2.4-2.4835GHz	15.1M	16.392M	16M4D1D	13.7M	16.292M
802.11ac VHT20_Nss1,(MCS0)_4TX	-	-	-	-	-
2.4-2.4835GHz	15.625M	17.541M	17M5D1D	13.725M	17.491M
802.11ac VHT40_Nss1,(MCS0)_4TX	-	-	-	-	-
2.4-2.4835GHz	36.35M	36.332M	36M3D1D	35.7M	36.082M

Max-N dB = Maximum 6dB down bandwidth; **Max-OBW** = Maximum 99% occupied bandwidth;
Min-N dB = Minimum 6dB down bandwidth; **Min-OBW** = Minimum 99% occupied bandwidth;

Result

Mode	Result	Limit (Hz)	Port 1-N dB (Hz)	Port 1-OBW (Hz)	Port 2-N dB (Hz)	Port 2-OBW (Hz)	Port 3-N dB (Hz)	Port 3-OBW (Hz)	Port 4-N dB (Hz)	Port 4-OBW (Hz)
802.11b_(1Mbps)_4TX	-	-	-	-	-	-	-	-	-	-
2412MHz	Pass	500k	7.525M	10.145M	7.55M	10.195M	7.525M	10.22M	8M	10.17M
2437MHz	Pass	500k	8.05M	10.17M	7.55M	10.22M	7.1M	10.22M	7.975M	10.17M
2462MHz	Pass	500k	7.55M	10.17M	8.025M	10.195M	8M	10.22M	7.525M	10.17M
802.11g_(6Mbps)_4TX	-	-	-	-	-	-	-	-	-	-
2412MHz	Pass	500k	13.975M	16.292M	13.825M	16.317M	15.05M	16.342M	13.95M	16.367M
2437MHz	Pass	500k	15.1M	16.342M	15.075M	16.317M	13.775M	16.342M	15M	16.392M
2462MHz	Pass	500k	15.025M	16.292M	15.05M	16.317M	15.025M	16.292M	13.7M	16.342M
802.11ac VHT20_Nss1,(MCS0)_4TX	-	-	-	-	-	-	-	-	-	-
2412MHz	Pass	500k	15.05M	17.541M	13.75M	17.541M	14.4M	17.516M	13.725M	17.516M
2437MHz	Pass	500k	15.625M	17.516M	13.75M	17.516M	15M	17.541M	14.425M	17.541M
2462MHz	Pass	500k	15.075M	17.491M	13.8M	17.516M	14.925M	17.516M	15M	17.516M
802.11ac VHT40_Nss1,(MCS0)_4TX	-	-	-	-	-	-	-	-	-	-
2422MHz	Pass	500k	35.9M	36.232M	36.3M	36.232M	35.7M	36.232M	35.75M	36.232M
2437MHz	Pass	500k	36.35M	36.332M	35.75M	36.182M	36.3M	36.082M	36.35M	36.282M
2452MHz	Pass	500k	36.35M	36.332M	35.7M	36.182M	35.7M	36.232M	36.3M	36.182M

Port X-N dB = Port X 6dB down bandwidth; **Port X-OBW** = Port X 99% occupied bandwidth;

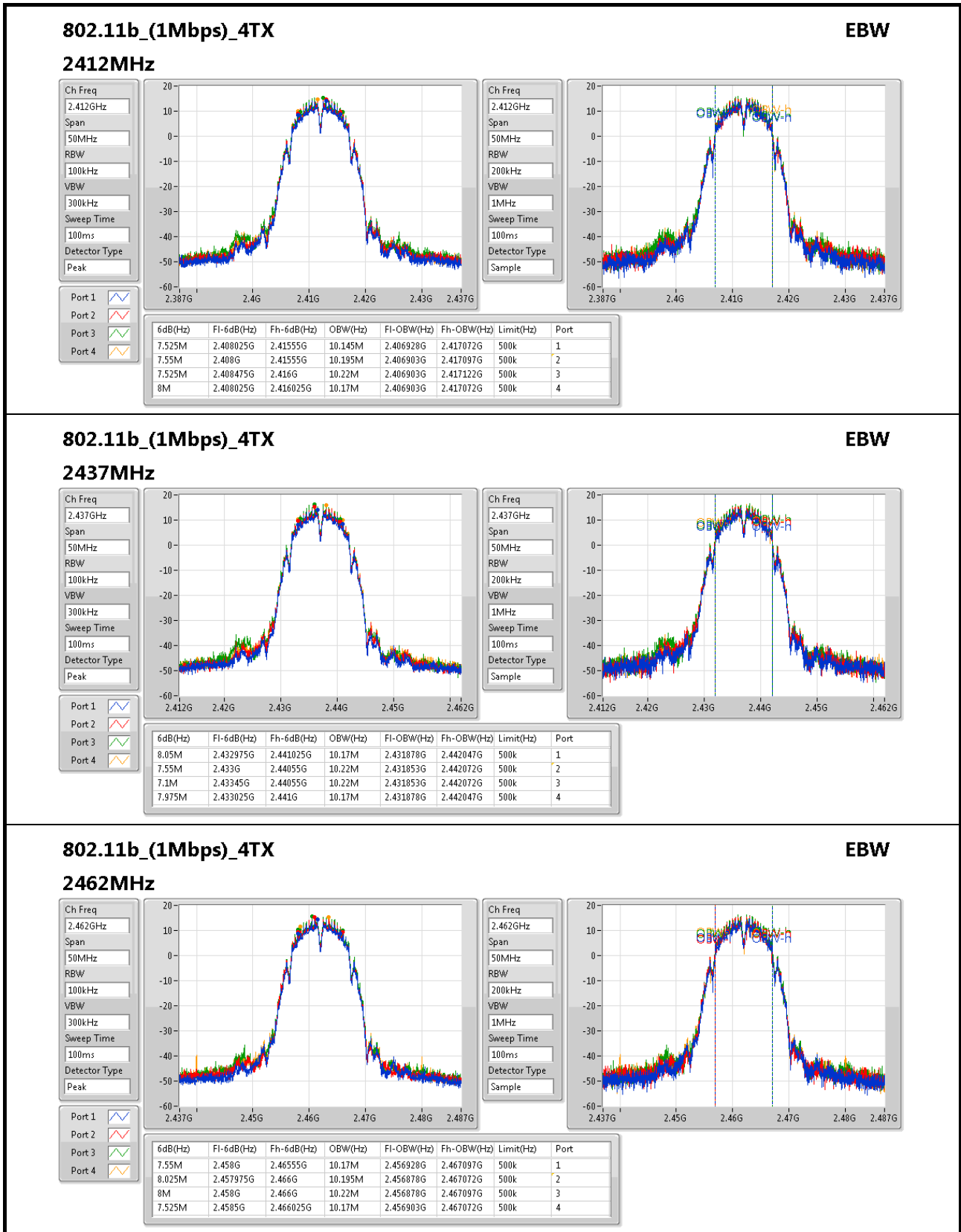

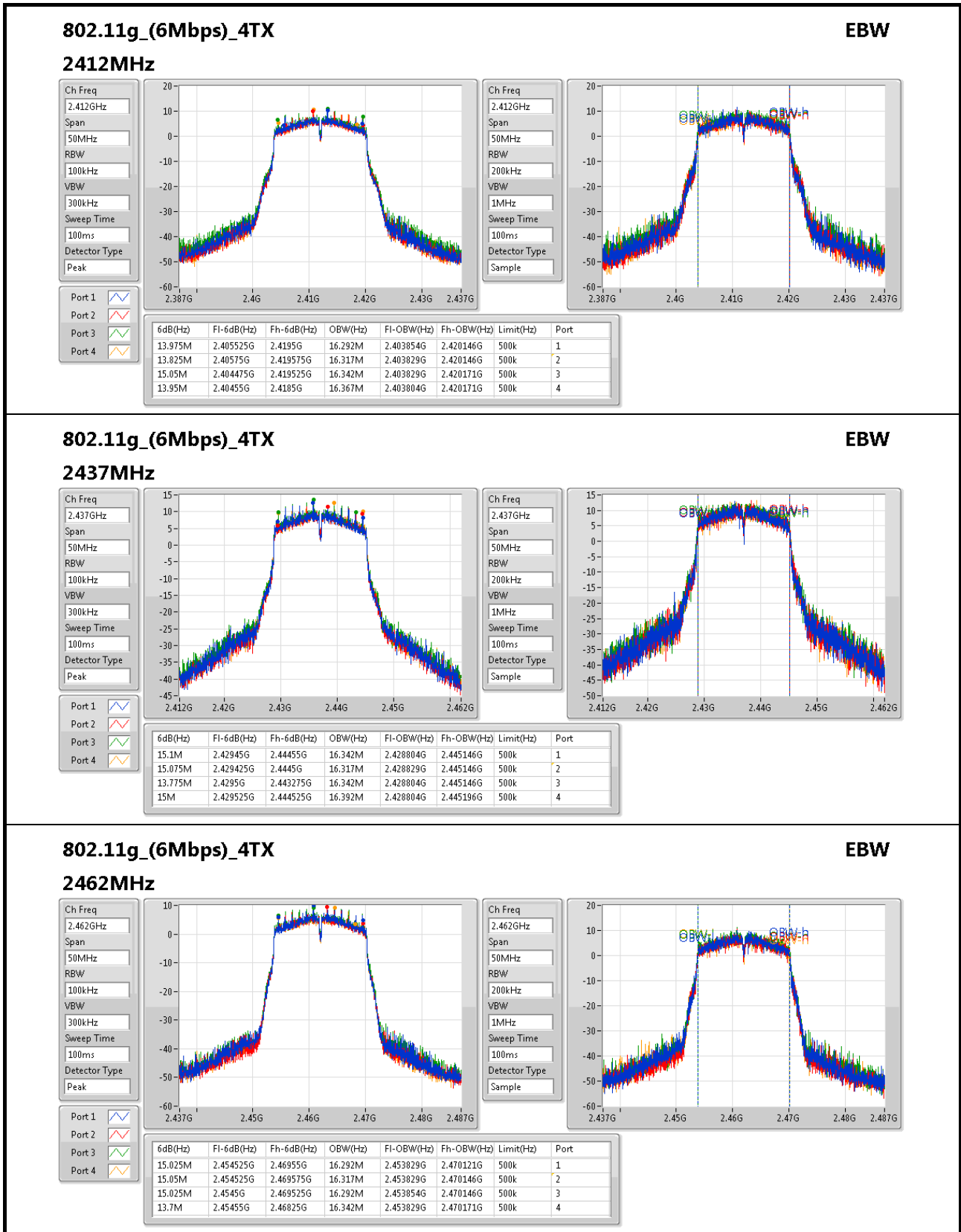

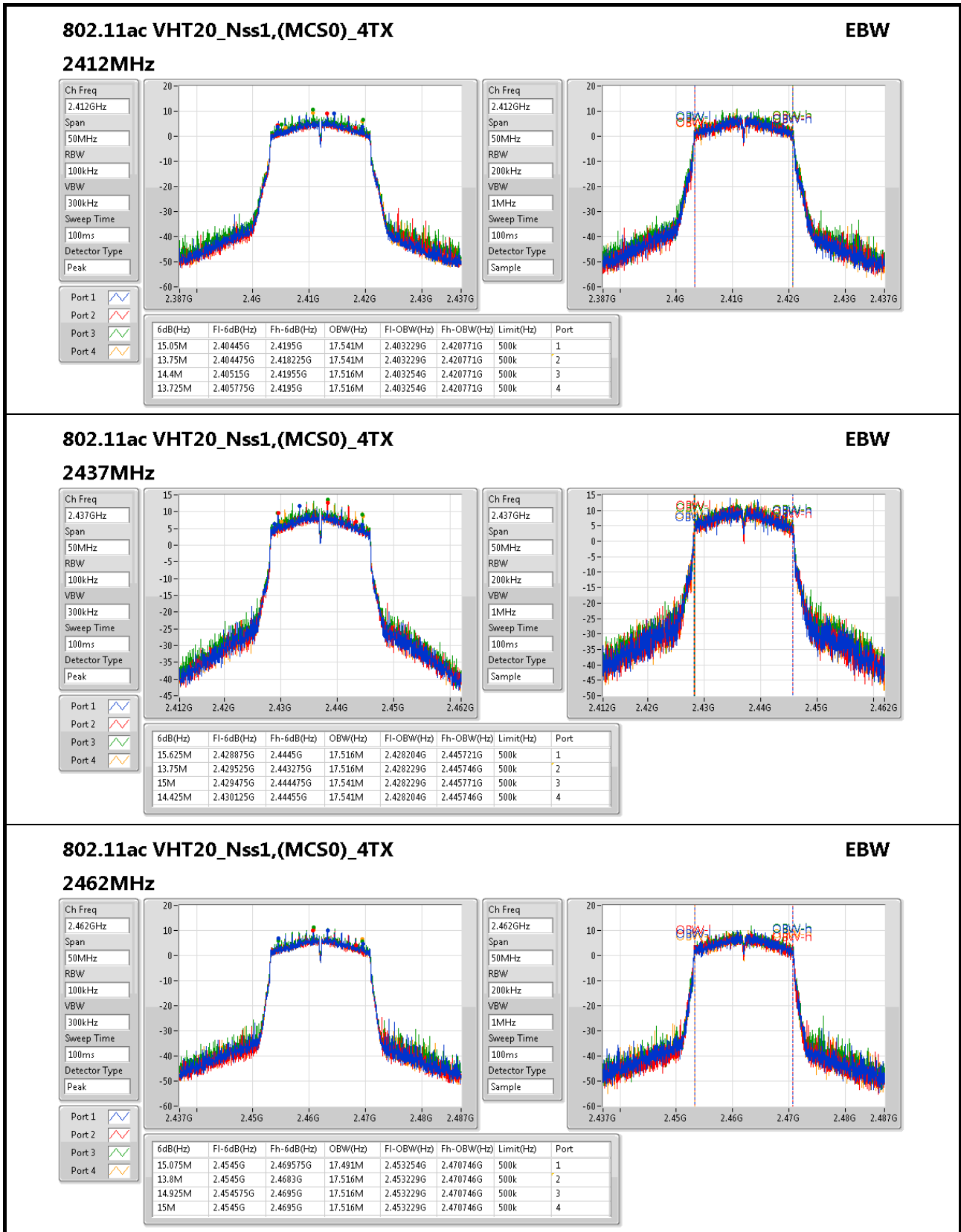

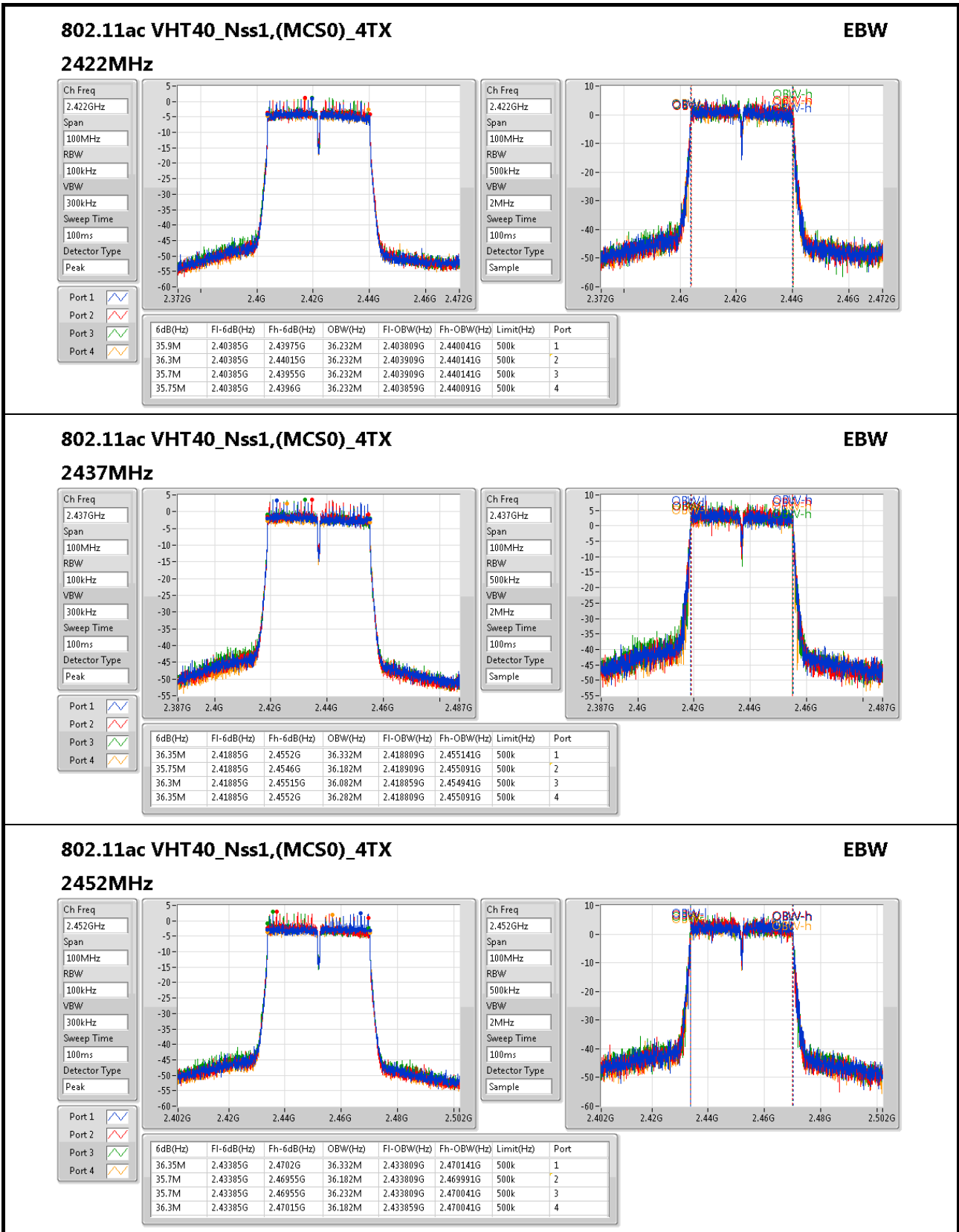



Summary

Mode	Total Power (dBm)	Total Power (W)
802.11b_(1Mbps)_4TX	-	-
2.4-2.4835GHz	29.99	0.99770
802.11g_(6Mbps)_4TX	-	-
2.4-2.4835GHz	29.99	0.99770
802.11ac VHT20_Nss1,(MCS0)_4TX	-	-
2.4-2.4835GHz	29.95	0.98855
802.11ac VHT40_Nss1,(MCS0)_4TX	-	-
2.4-2.4835GHz	23.55	0.22646

Result

Mode	Result	DG (dBi)	Port 1 (dBm)	Port 2 (dBm)	Port 3 (dBm)	Port 4 (dBm)	Total Power (dBm)	Power Limit (dBm)
802.11b_(1Mbps)_4TX	-	-	-	-	-	-	-	-
2412MHz	Pass	1.80	24.19	24.52	23.96	23.00	29.97	30.00
2437MHz	Pass	1.80	24.17	24.67	23.93	22.95	29.99	30.00
2462MHz	Pass	1.80	24.21	24.49	24.06	22.80	29.96	30.00
802.11g_(6Mbps)_4TX	-	-	-	-	-	-	-	-
2412MHz	Pass	1.80	21.09	21.85	20.90	21.34	27.33	30.00
2437MHz	Pass	1.80	23.81	24.65	23.68	23.64	29.99	30.00
2462MHz	Pass	1.80	20.34	21.30	20.52	20.71	26.75	30.00
802.11ac VHT20_Nss1,(MCS0)_4TX	-	-	-	-	-	-	-	-
2412MHz	Pass	1.80	20.16	21.09	20.03	20.20	26.41	30.00
2437MHz	Pass	1.80	23.84	24.50	23.61	23.73	29.95	30.00
2462MHz	Pass	1.80	21.22	21.80	20.88	21.15	27.30	30.00
802.11ac VHT40_Nss1,(MCS0)_4TX	-	-	-	-	-	-	-	-
2422MHz	Pass	1.80	15.27	15.37	15.61	15.10	21.36	30.00
2437MHz	Pass	1.80	17.41	17.62	17.75	17.32	23.55	30.00
2452MHz	Pass	1.80	17.08	16.90	17.11	16.80	22.99	30.00

DG = Directional Gain; Port X = Port X output power



Summary

Mode	PD (dBm/RBW)
802.11b_(1Mbps)_4TX 2.4-2.4835GHz	- 5.41
802.11g_(6Mbps)_4TX 2.4-2.4835GHz	- 4.39
802.11ac VHT20_Nss1,(MCS0)_4TX 2.4-2.4835GHz	- 2.42
802.11ac VHT40_Nss1,(MCS0)_4TX 2.4-2.4835GHz	- -5.97

RBW=3kHz.

Result

Mode	Result	DG (dBi)	Port 1 (dBm/RBW)	Port 2 (dBm/RBW)	Port 3 (dBm/RBW)	Port 4 (dBm/RBW)	PD (dBm/RBW)	PD Limit (dBm/RBW)
802.11b_(1Mbps)_4TX	-	-	-	-	-	-	-	-
2412MHz	Pass	7.82	0.52	0.71	2.94	0.63	4.61	6.18
2437MHz	Pass	7.82	-0.35	0.98	2.24	0.81	5.41	6.18
2462MHz	Pass	7.82	0.31	1.34	1.61	1.65	5.16	6.18
802.11g_(6Mbps)_4TX	-	-	-	-	-	-	-	-
2412MHz	Pass	7.82	-3.26	-4.20	-2.78	-2.95	2.74	6.18
2437MHz	Pass	7.82	-1.12	-1.89	-0.41	-1.23	4.39	6.18
2462MHz	Pass	7.82	-4.31	-5.01	-3.92	-4.31	1.11	6.18
802.11ac VHT20_Nss1,(MCS0)_4TX	-	-	-	-	-	-	-	-
2412MHz	Pass	7.82	-4.86	-4.86	-4.89	-3.71	-1.35	6.18
2437MHz	Pass	7.82	-1.48	-1.67	-0.66	-1.55	2.42	6.18
2462MHz	Pass	7.82	-3.89	-2.90	-3.46	-3.71	-0.32	6.18
802.11ac VHT40_Nss1,(MCS0)_4TX	-	-	-	-	-	-	-	-
2422MHz	Pass	7.82	-13.02	-12.59	-12.53	-13.90	-8.22	6.18
2437MHz	Pass	7.82	-10.47	-10.07	-10.20	-7.77	-5.97	6.18
2452MHz	Pass	7.82	-11.56	-10.87	-10.97	-11.33	-6.74	6.18

DG = Directional Gain; RBW=3kHz;

PD = trace bin-by-bin of each transmits port summing can be performed maximum power density; Port X = Port X power density;

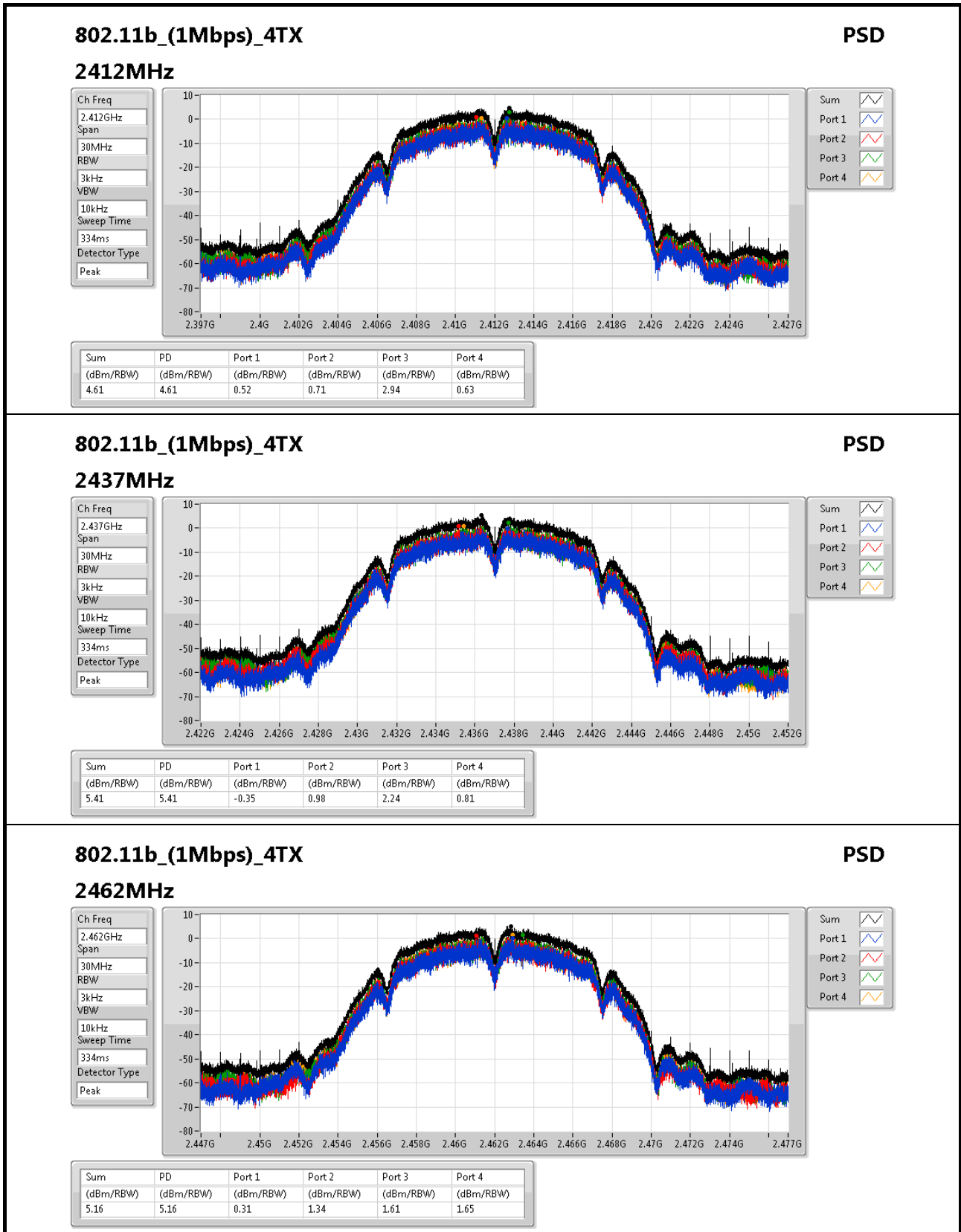

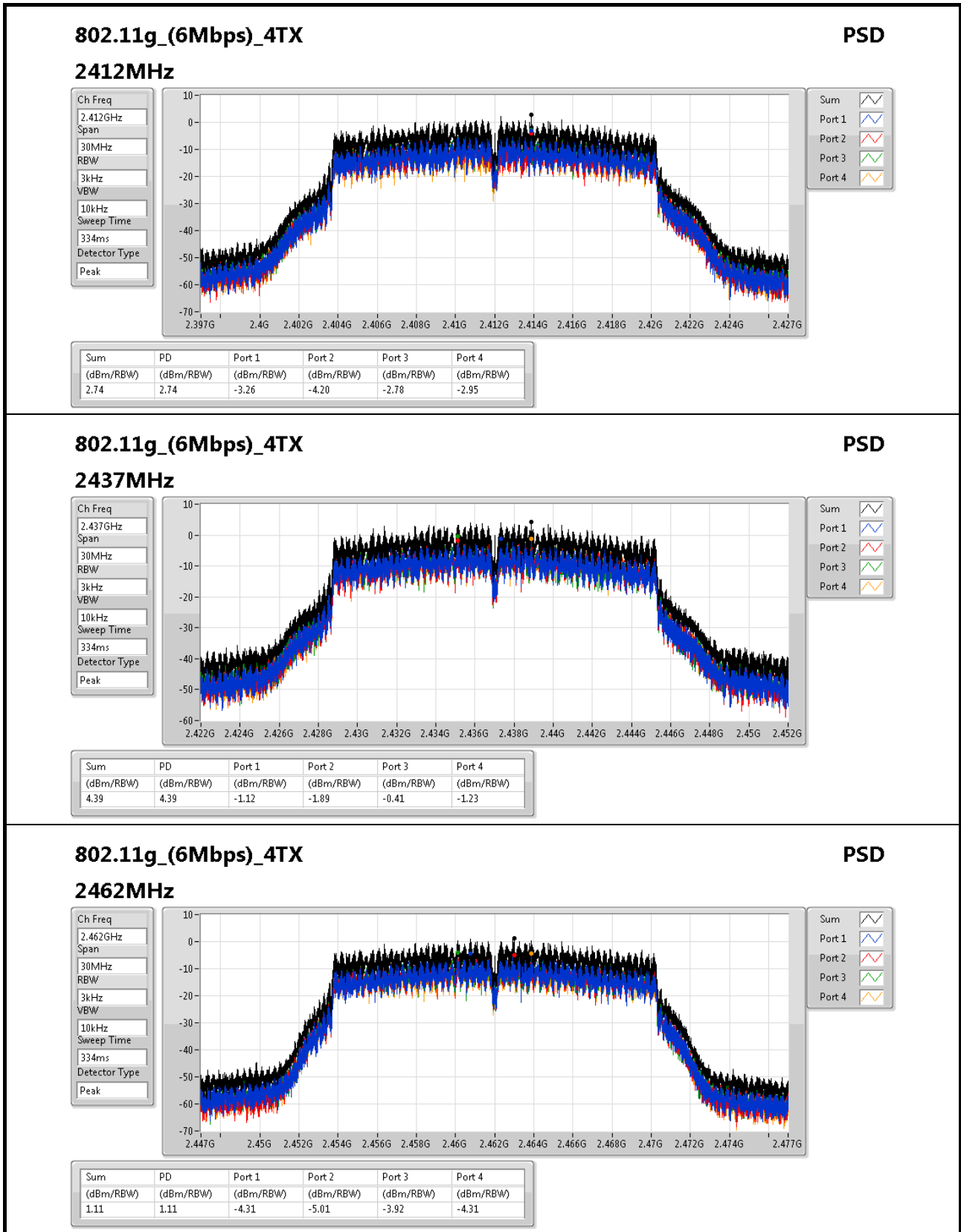

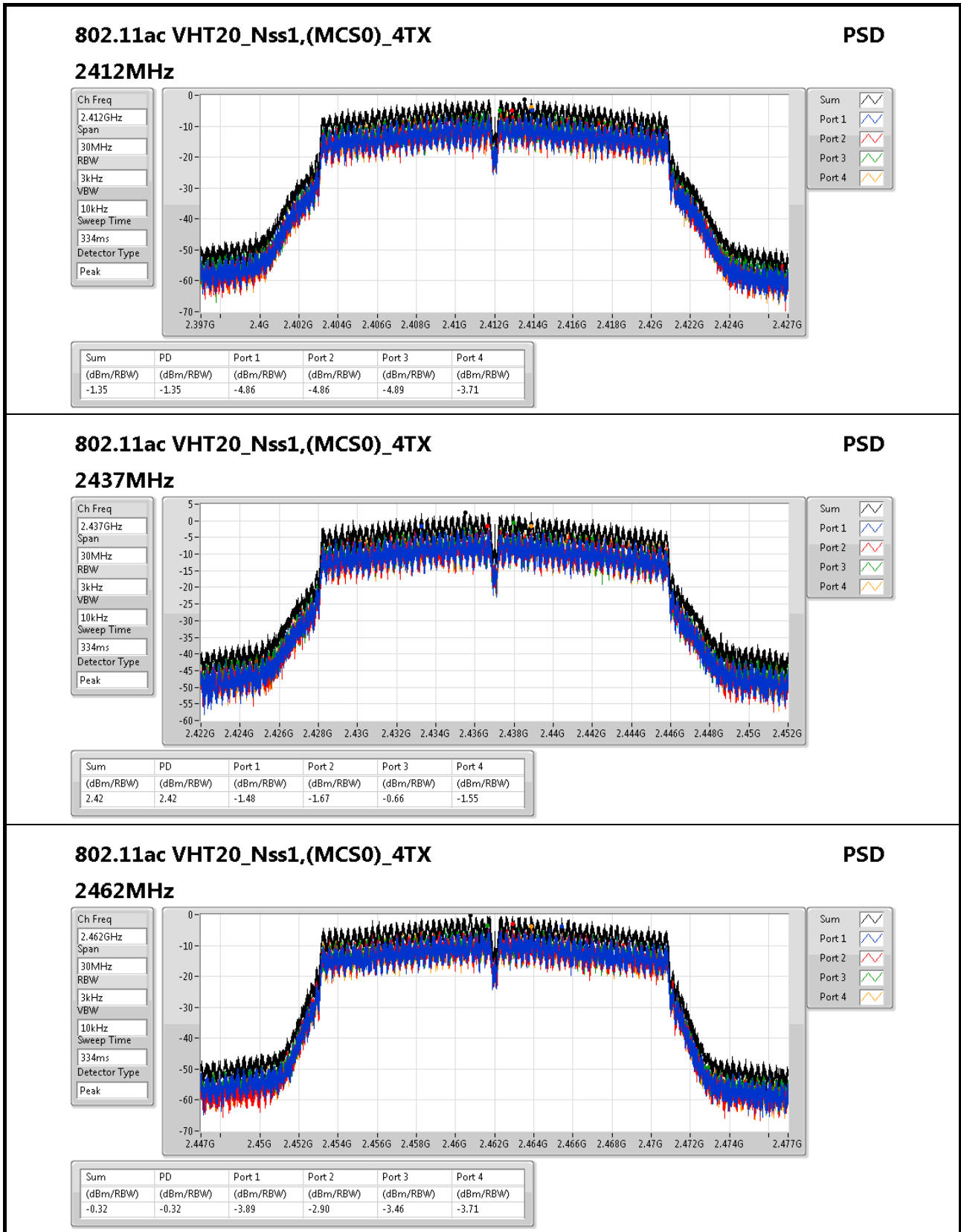

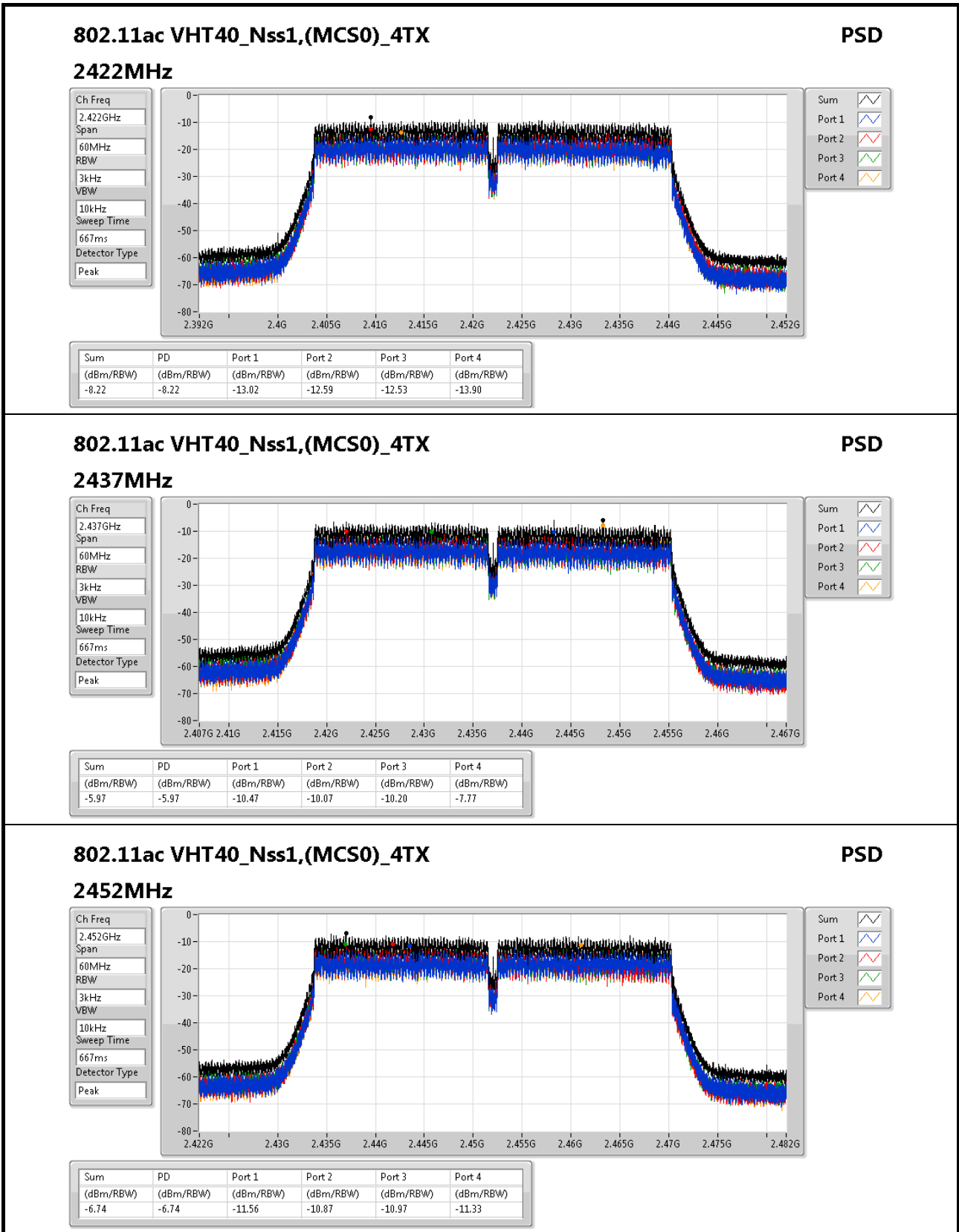



Summary

Mode	Result	Ref (Hz)	Ref (dBm)	Limit (dBm)	Freq (Hz)	Level (dBm)	Freq (Hz)	Level (dBm)	Freq (Hz)	Level (dBm)	Freq (Hz)	Level (dBm)	Port
802.11ac VHT20_Nss1,(MCS0)_4TX	-	-	-	-	-	-	-	-	-	-	-	-	-
2.4-2.4835GHz	Pass	2.434569G	13.18	-16.82	55.63M	-62.93	2.39864G	-30.98	2.48734G	-48.71	16.728648G	-53.00	2

Result

Mode	Result	Ref (Hz)	Ref (dBm)	Limit (dBm)	Freq (Hz)	Level (dBm)	Freq (Hz)	Level (dBm)	Freq (Hz)	Level (dBm)	Freq (Hz)	Level (dBm)	Port
802.11b_(1Mbps)_4TX	-	-	-	-	-	-	-	-	-	-	-	-	-
2412MHz	Pass	2.436573G	16.36	-13.64	2.17826G	-62.04	2.39856G	-41.66	2.48734G	-44.39	7.235136G	-48.31	1
2412MHz	Pass	2.436573G	16.36	-13.64	2.165445G	-62.32	2.39808G	-39.82	2.48734G	-48.53	7.235136G	-48.41	2
2412MHz	Pass	2.436573G	16.36	-13.64	618.325M	-61.19	2.39808G	-38.19	2.48734G	-53.70	7.235136G	-47.86	3
2412MHz	Pass	2.436573G	16.36	-13.64	2.30874G	-61.94	2.39856G	-38.96	2.48734G	-47.68	7.235136G	-47.53	4
2437MHz	Pass	2.436573G	16.36	-13.64	942.195M	-62.12	2.39136G	-52.10	2.51318G	-53.02	21.457142G	-53.75	1
2437MHz	Pass	2.436573G	16.36	-13.64	952.68M	-62.35	2.39136G	-51.50	2.51318G	-48.93	21.746527G	-52.52	2
2437MHz	Pass	2.436573G	16.36	-13.64	668.42M	-61.23	2.39136G	-48.84	2.51318G	-48.26	16.706172G	-53.75	3
2437MHz	Pass	2.436573G	16.36	-13.64	2.19457G	-60.84	2.39136G	-50.54	2.51318G	-48.88	21.577953G	-53.70	4
2462MHz	Pass	2.436573G	16.36	-13.64	49.805M	-61.61	2.39768G	-53.88	2.48534G	-48.94	24.851093G	-53.80	1
2462MHz	Pass	2.436573G	16.36	-13.64	2.302915G	-62.21	2.3948G	-53.48	2.4851G	-47.65	24.831426G	-53.97	2
2462MHz	Pass	2.436573G	16.36	-13.64	2.149135G	-61.23	2.39976G	-53.48	2.48518G	-47.90	24.794902G	-53.48	3
2462MHz	Pass	2.436573G	16.36	-13.64	2.04545G	-62.27	2.39992G	-53.58	2.48478G	-47.63	16.680885G	-53.55	4
802.11g_(6Mbps)_4TX	-	-	-	-	-	-	-	-	-	-	-	-	-
2412MHz	Pass	2.435738G	13.70	-16.30	797.735M	-62.54	2.39992G	-31.18	2.48734G	-45.92	7.232327G	-49.58	1
2412MHz	Pass	2.435738G	13.70	-16.30	49.805M	-62.55	2.39952G	-33.26	2.48734G	-56.07	24.842665G	-52.65	2
2412MHz	Pass	2.435738G	13.70	-16.30	2.309905G	-61.09	2.39936G	-31.57	2.48734G	-50.42	7.229517G	-53.56	3
2412MHz	Pass	2.435738G	13.70	-16.30	2.307575G	-61.94	2.39992G	-33.33	2.48734G	-48.61	7.243565G	-53.14	4
2437MHz	Pass	2.435738G	13.70	-16.30	2.01749G	-61.45	2.39704G	-47.97	2.51318G	-48.88	21.577953G	-53.94	1
2437MHz	Pass	2.435738G	13.70	-16.30	2.158455G	-61.61	2.39944G	-48.57	2.48478G	-54.07	16.737077G	-53.35	2
2437MHz	Pass	2.435738G	13.70	-16.30	2.305245G	-61.85	2.3992G	-47.66	2.48934G	-52.98	16.723029G	-53.74	3
2437MHz	Pass	2.435738G	13.70	-16.30	758.125M	-61.80	2.39704G	-48.20	2.51318G	-50.57	16.65279G	-53.81	4
2462MHz	Pass	2.435738G	13.70	-16.30	49.805M	-62.33	2.39816G	-54.12	2.48446G	-45.31	16.605027G	-53.52	1
2462MHz	Pass	2.435738G	13.70	-16.30	897.925M	-63.00	2.39736G	-55.62	2.4839G	-47.39	21.493666G	-53.13	2
2462MHz	Pass	2.435738G	13.70	-16.30	49.805M	-62.00	2.39016G	-54.87	2.4839G	-44.18	21.547048G	-53.83	3
2462MHz	Pass	2.435738G	13.70	-16.30	712.69M	-62.37	2.39104G	-55.36	2.48606G	-47.45	16.807316G	-52.84	4
802.11ac VHT20_Nss1,(MCS0)_4TX	-	-	-	-	-	-	-	-	-	-	-	-	-
2412MHz	Pass	2.434569G	13.18	-16.82	931.71M	-61.87	2.39928G	-35.53	2.48734G	-46.09	16.295975G	-53.56	1
2412MHz	Pass	2.434569G	13.18	-16.82	55.63M	-62.93	2.39864G	-30.98	2.48734G	-48.71	16.728648G	-53.00	2
2412MHz	Pass	2.434569G	13.18	-16.82	2.18525G	-61.96	2.39824G	-33.56	2.48734G	-47.24	7.226708G	-52.36	3
2412MHz	Pass	2.434569G	13.18	-16.82	49.805M	-62.08	2.39936G	-33.72	2.48734G	-47.06	21.46838G	-53.67	4
2437MHz	Pass	2.434569G	13.18	-16.82	2.17127G	-62.22	2.39968G	-44.70	2.51318G	-51.00	21.799908G	-53.51	1
2437MHz	Pass	2.434569G	13.18	-16.82	49.805M	-61.42	2.39976G	-48.47	2.51318G	-48.69	16.812935G	-53.07	2
2437MHz	Pass	2.434569G	13.18	-16.82	882.78M	-60.89	2.3992G	-45.83	2.51318G	-48.72	16.770791G	-53.85	3
2437MHz	Pass	2.434569G	13.18	-16.82	2.15263G	-63.14	2.39888G	-46.77	2.51318G	-50.19	16.686505G	-53.47	4
2462MHz	Pass	2.434569G	13.18	-16.82	2.30641G	-62.99	2.3968G	-54.52	2.48358G	-38.88	16.739886G	-53.93	1
2462MHz	Pass	2.434569G	13.18	-16.82	54.465M	-61.61	2.398G	-55.03	2.48422G	-43.90	21.746527G	-52.72	2
2462MHz	Pass	2.434569G	13.18	-16.82	2.14564G	-62.22	2.39944G	-54.10	2.48462G	-41.11	16.737077G	-52.93	3
2462MHz	Pass	2.434569G	13.18	-16.82	49.805M	-61.35	2.39992G	-54.35	2.48478G	-40.32	24.089702G	-53.47	4
802.11ac VHT40_Nss1,(MCS0)_4TX	-	-	-	-	-	-	-	-	-	-	-	-	-
2422MHz	Pass	2.442084G	3.35	-26.65	49.465M	-62.59	2.39952G	-44.14	2.48382G	-54.29	24.856967G	-52.93	1
2422MHz	Pass	2.442084G	3.35	-26.65	49.465M	-61.16	2.39792G	-44.45	2.4843G	-55.15	24.896231G	-53.58	2



CSE Non-restricted Band Result

Appendix E

Mode	Result	Ref (Hz)	Ref (dBm)	Limit (dBm)	Freq (Hz)	Level (dBm)	Freq (Hz)	Level (dBm)	Freq (Hz)	Level (dBm)	Freq (Hz)	Level (dBm)	Port
2422MHz	Pass	2.442084G	3.35	-26.65	919.665M	-62.00	2.39936G	-42.11	2.48478G	-53.65	16.765805G	-52.09	3
2422MHz	Pass	2.442084G	3.35	-26.65	886.46M	-62.91	2.39968G	-45.78	2.48366G	-54.87	21.805603G	-53.85	4
2437MHz	Pass	2.442084G	3.35	-26.65	900.2M	-61.94	2.39984G	-44.91	2.48798G	-50.73	16.249765G	-53.66	1
2437MHz	Pass	2.442084G	3.35	-26.65	49.465M	-61.58	2.39952G	-45.44	2.4883G	-51.07	21.499906G	-53.33	2
2437MHz	Pass	2.442084G	3.35	-26.65	2.30397G	-62.48	2.39968G	-43.11	2.48414G	-49.95	24.834531G	-53.36	3
2437MHz	Pass	2.442084G	3.35	-26.65	2.08642G	-62.56	2.39984G	-46.57	2.48366G	-50.95	16.389993G	-53.69	4
2452MHz	Pass	2.442084G	3.35	-26.65	2.30397G	-62.49	2.39968G	-47.71	2.4851G	-49.08	24.837335G	-53.87	1
2452MHz	Pass	2.442084G	3.35	-26.65	2.05665G	-62.27	2.39888G	-50.21	2.48382G	-49.14	16.746173G	-53.78	2
2452MHz	Pass	2.442084G	3.35	-26.65	924.245M	-62.08	2.39872G	-49.67	2.48494G	-46.76	16.389993G	-54.03	3
2452MHz	Pass	2.442084G	3.35	-26.65	892.185M	-62.53	2.39936G	-50.48	2.49006G	-49.11	21.415769G	-54.12	4

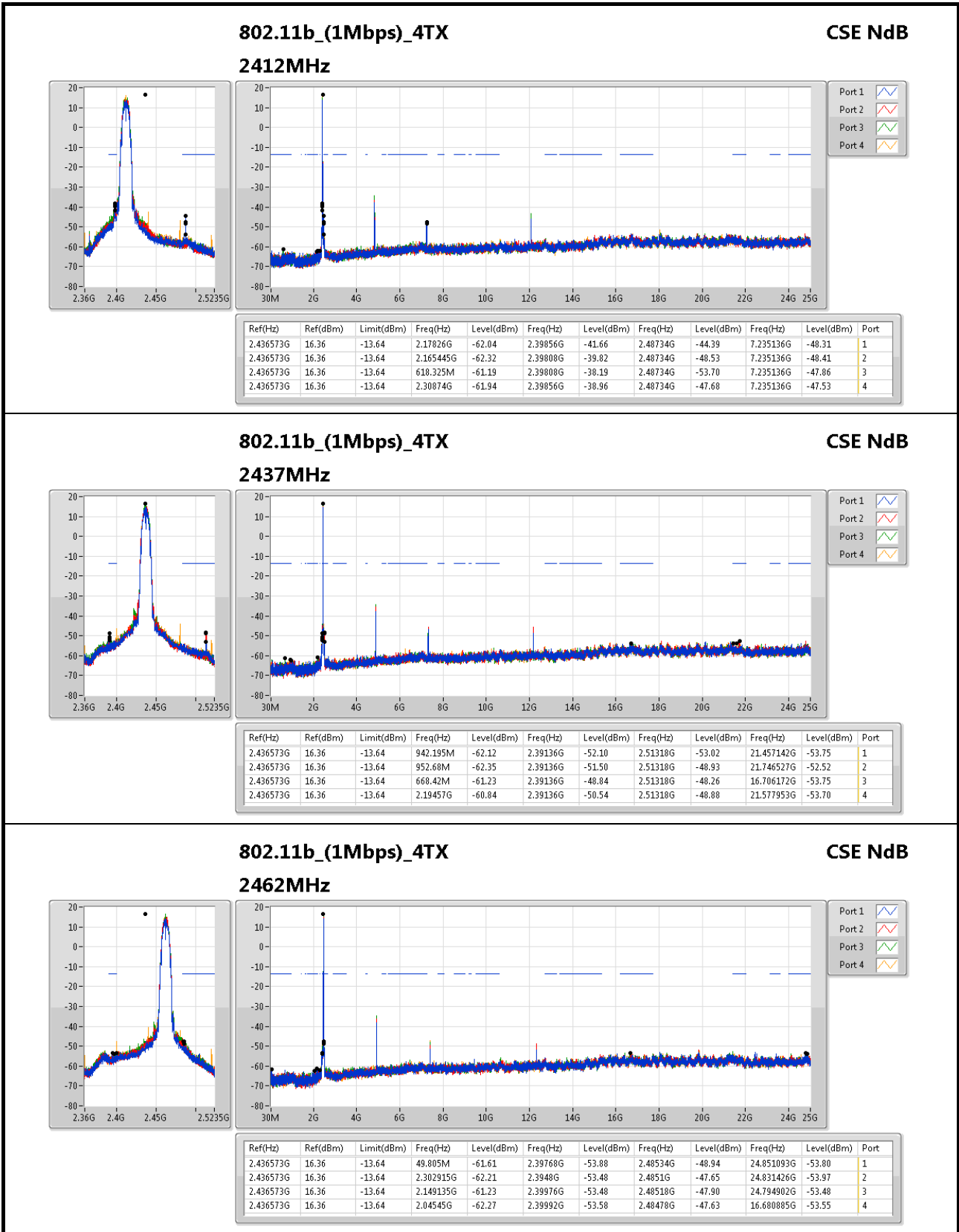

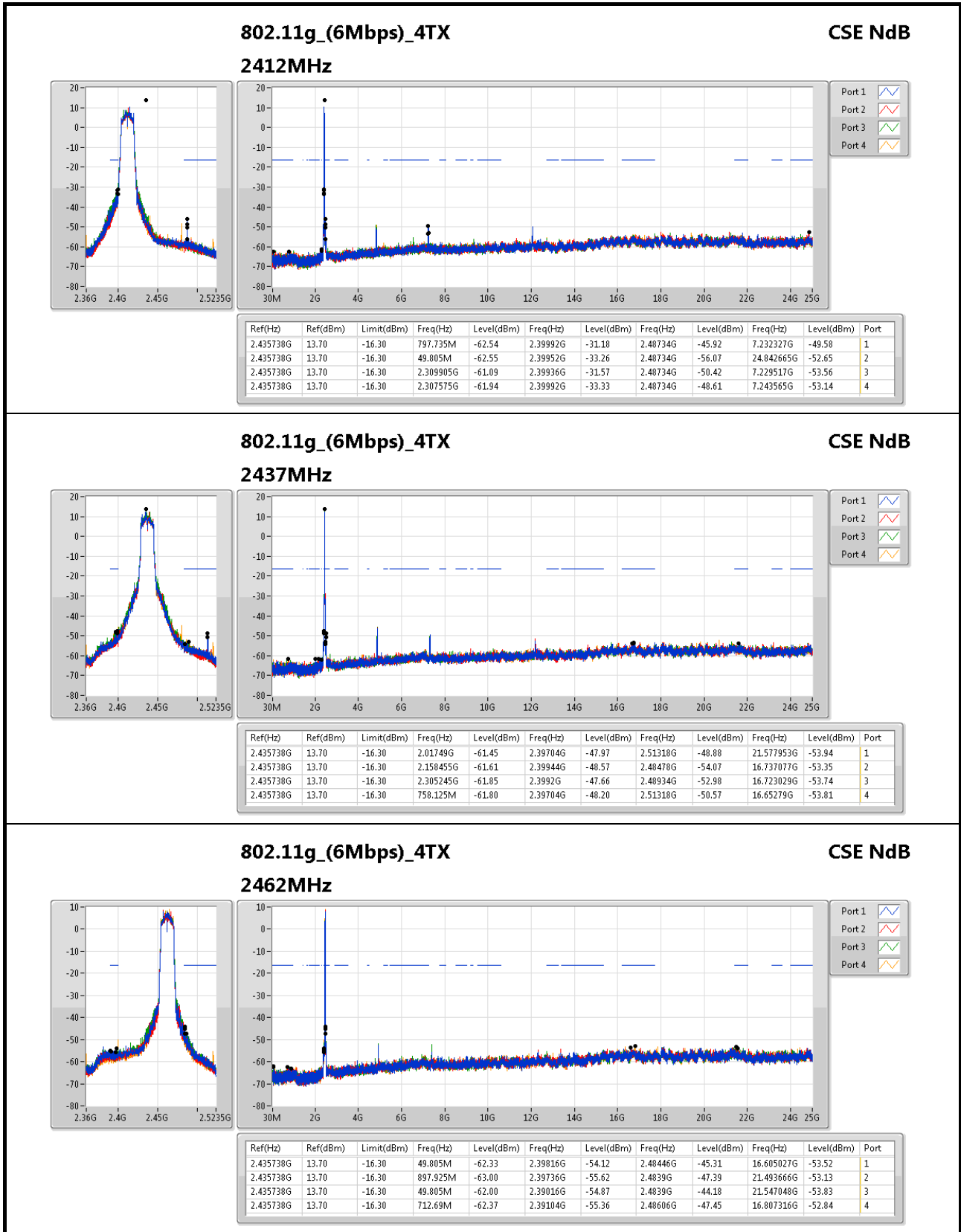

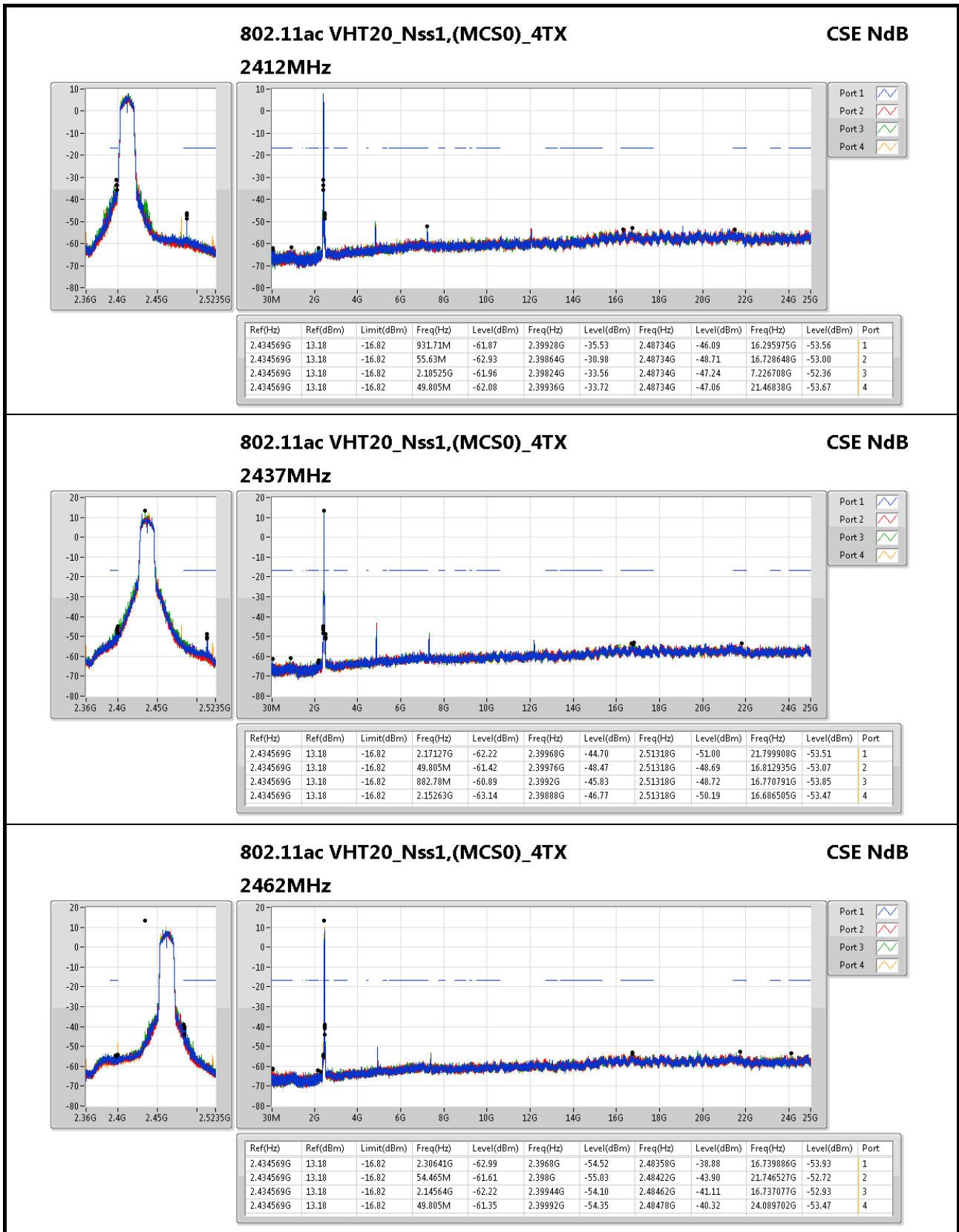

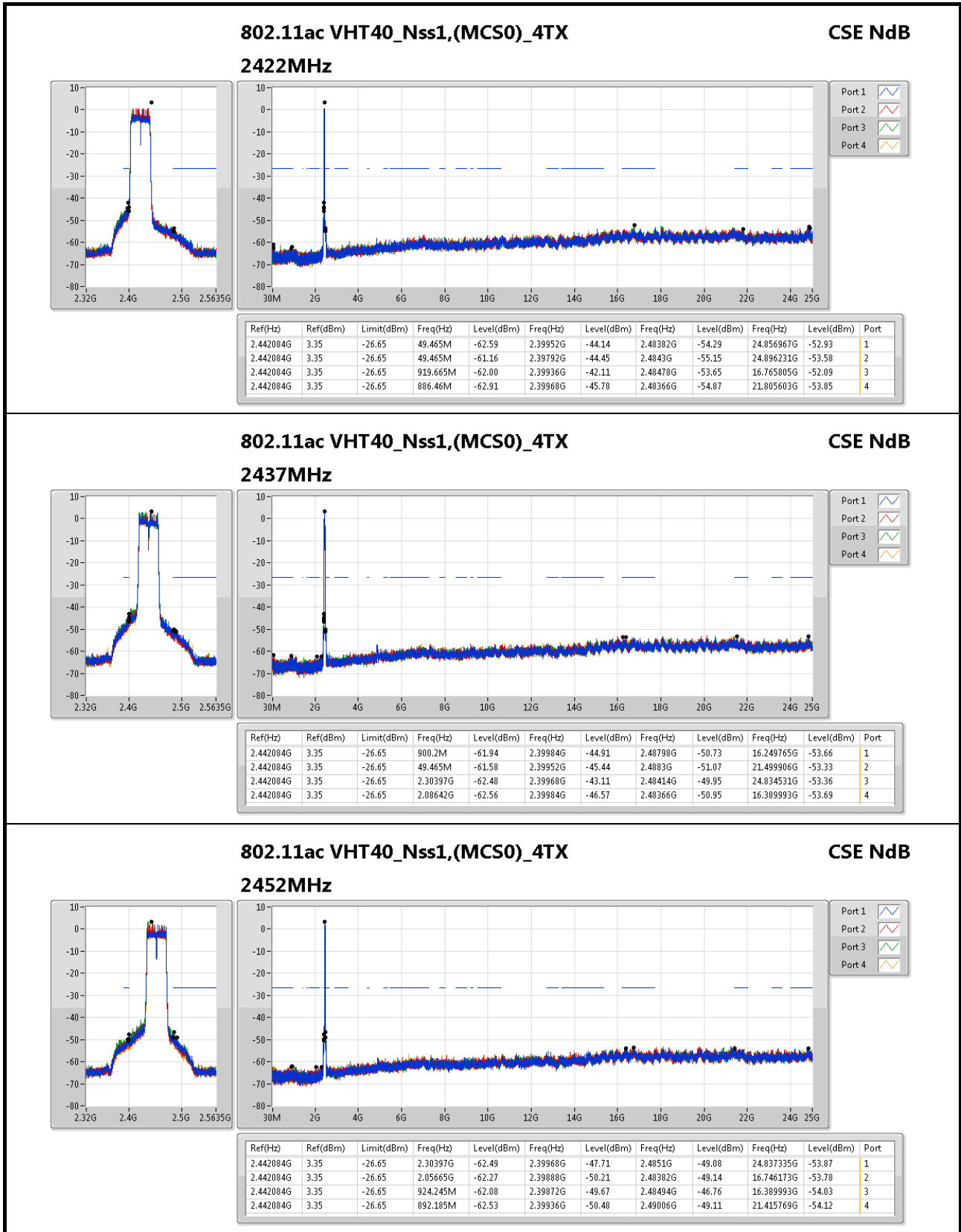

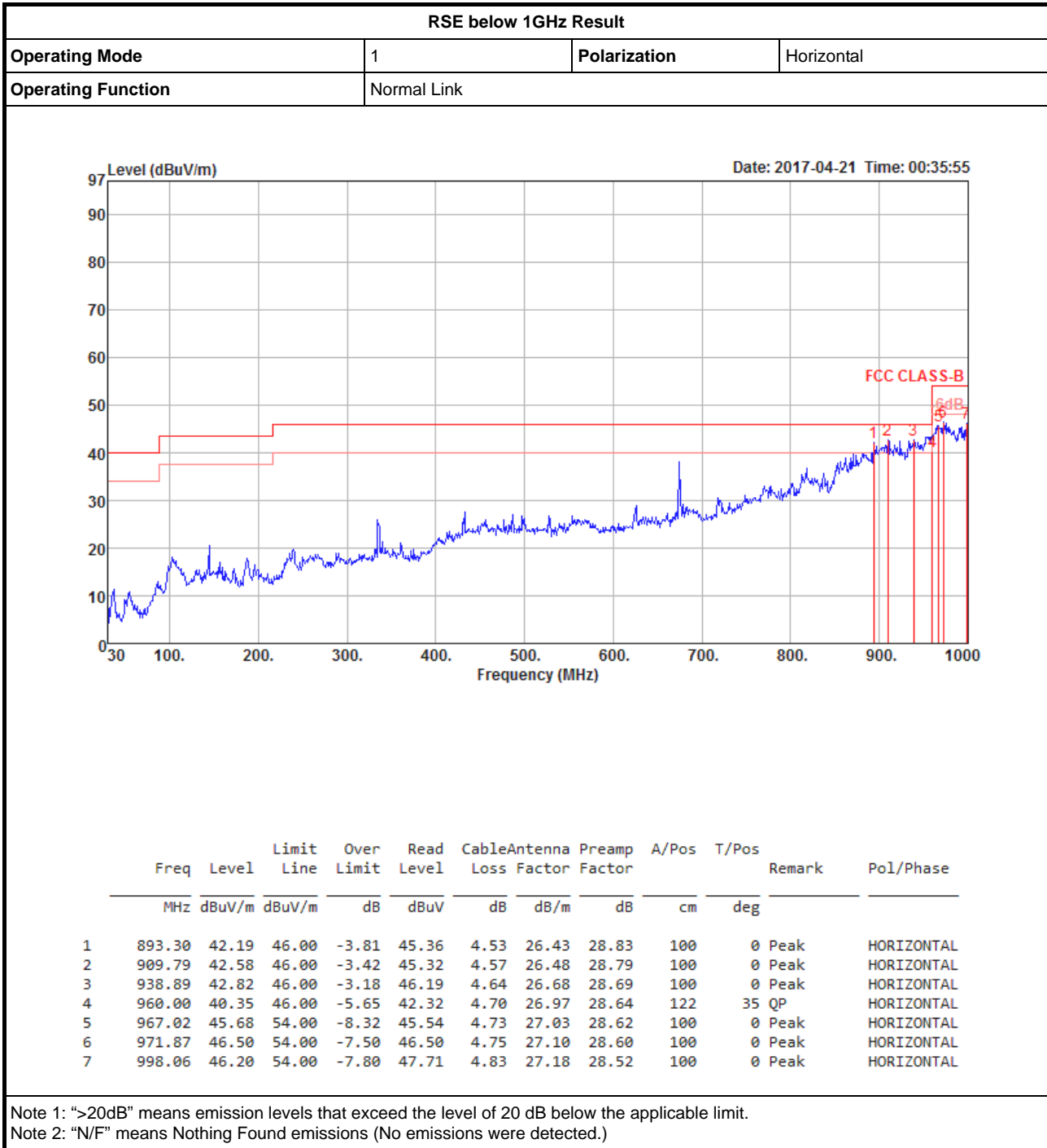



RSE below 1GHz Result

Appendix F.1

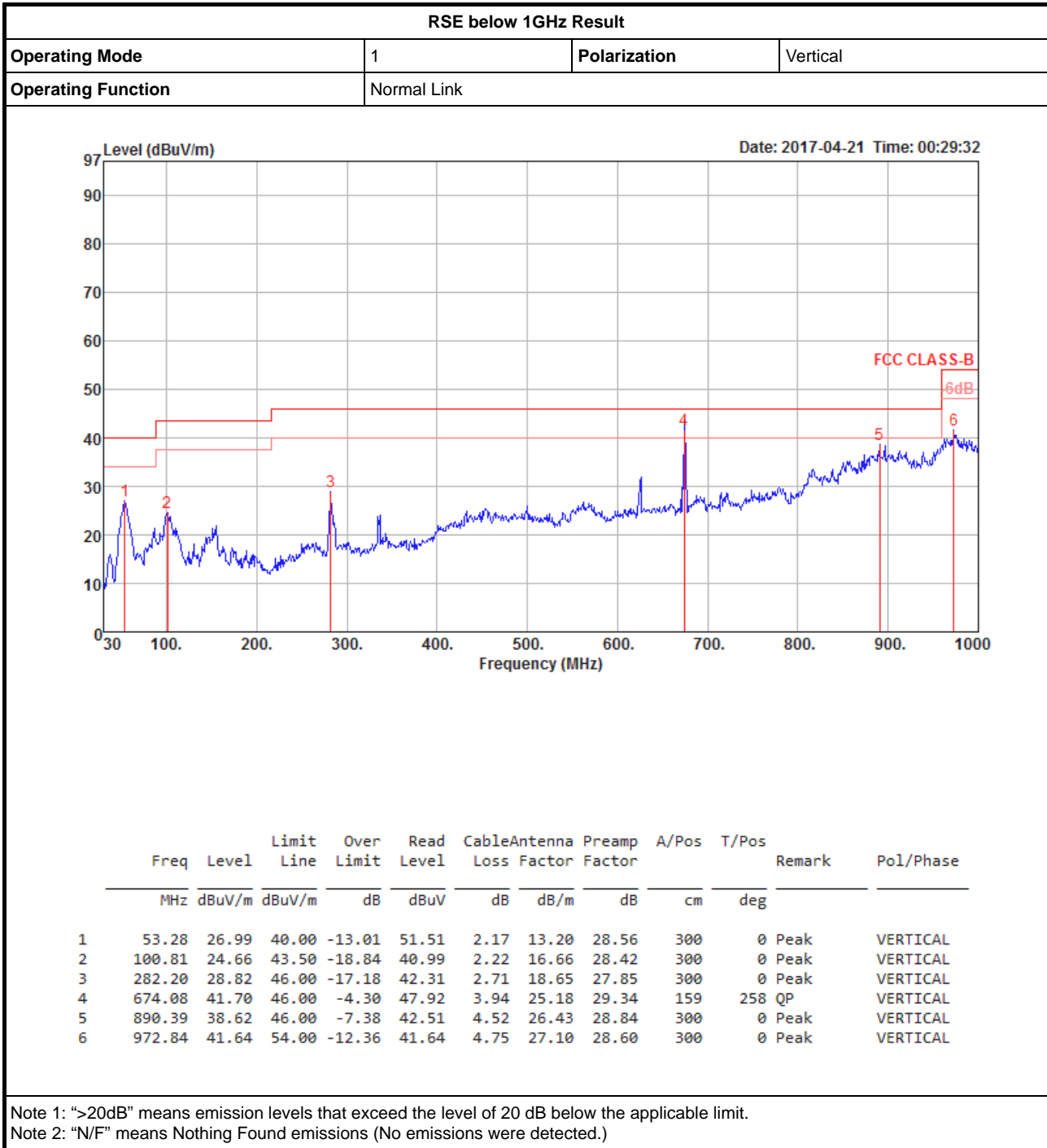



Summary

Mode	Result	Type	Freq (Hz)	Level (dBuV/m)	Limit (dBuV/m)	Margin (dB)	Factor (dB)	Dist (m)	Pol. (H/V)	Azimuth (°)	Height (m)	Comments
802.11b_(1Mbps)_4TX	-	-	-	-	-	-	-	-	-	-	-	-
2.4-2.4835GHz	Pass	AV	2.39G	53.95	54.00	-0.05	31.91	3	V	276	1.98	-

802.11b_(1Mbps)_4TX

2412MHz_TX

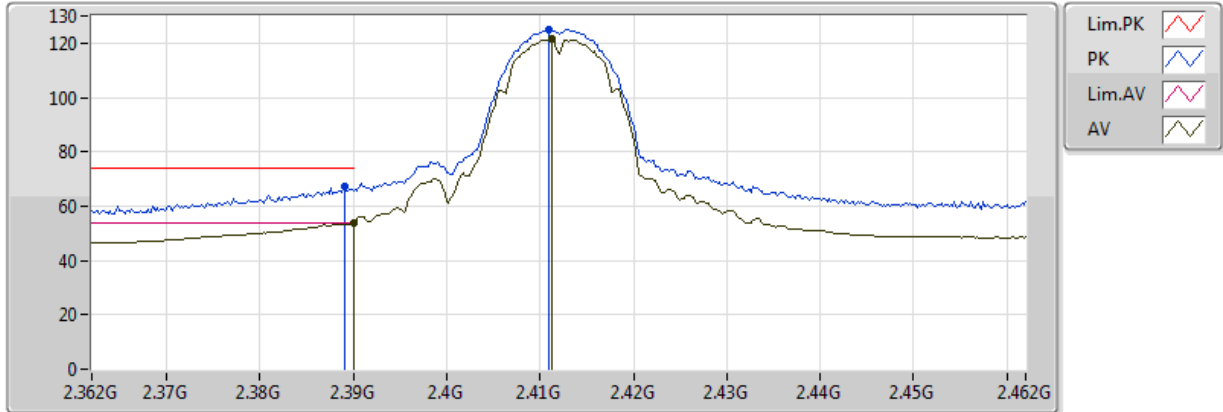

20170323
 EUT_Z_4TX
 Setting 98
 03-J-5
 FSU

Type	Freq(Hz)	Level(dBuV/m)	Limit(dBuV/m)	Margin(dB)	Factor(dB)	Dist(m)	Pol.(H/V)	Azimuth(°)	Height(m)	Comments
AV	2.39G	53.95	54.00	-0.05	31.91	3	V	276	1.98	-
AV	2.4112G	121.43	Inf	-Inf	31.97	3	V	276	1.98	-
PK	2.389G	66.97	74.00	-7.03	31.91	3	V	276	1.98	-
PK	2.411G	125.13	Inf	-Inf	31.97	3	V	276	1.98	-



802.11b_(1Mbps)_4TX

2412MHz_TX

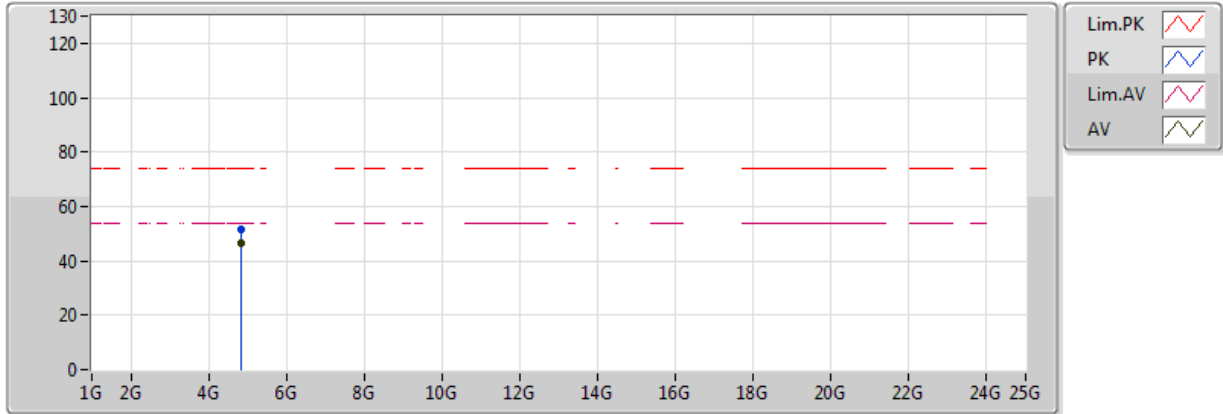

20170323
EUT_Z_4TX
Setting 98
03-J-5
FSU

Type	Freq(Hz)	Level(dBuV/m)	Limit(dBuV/m)	Margin(dB)	Factor(dB)	Dist(m)	Pol.(H/V)	Azimuth(°)	Height(m)	Comments
AV	4.82402G	46.45	54.00	-7.55	4.72	3	V	271	1.11	-
PK	4.82412G	51.65	74.00	-22.35	4.72	3	V	271	1.11	-

802.11b_(1Mbps)_4TX

2412MHz_TX

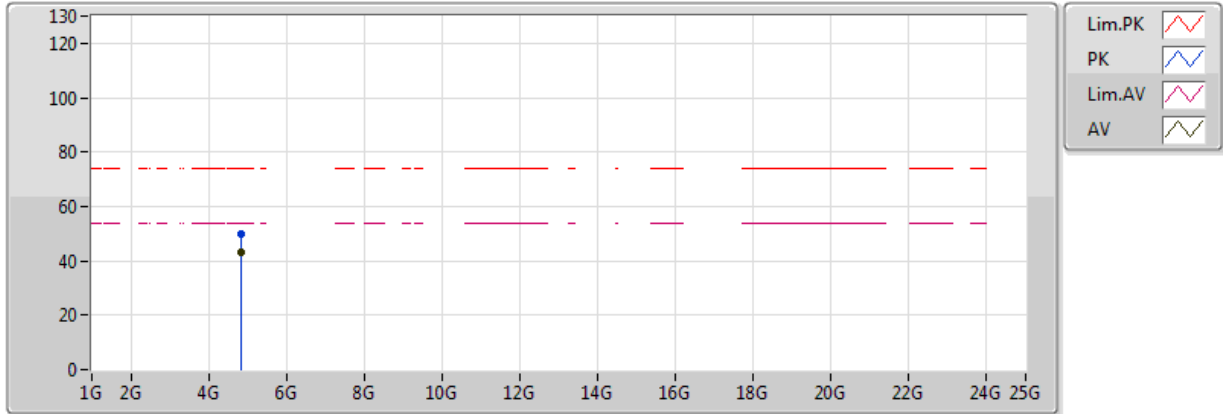

20170323
EUT_Z_4TX
Setting 98
03-J-5
FSU

Type	Freq(Hz)	Level(dBuV/m)	Limit(dBuV/m)	Margin(dB)	Factor(dB)	Dist(m)	Pol.(H/V)	Azimuth(°)	Height(m)	Comments
AV	4.82406G	43.20	54.00	-10.80	4.72	3	H	75	1.44	-
PK	4.82404G	49.60	74.00	-24.40	4.72	3	H	75	1.44	-

802.11b_(1Mbps)_4TX

2437MHz_TX

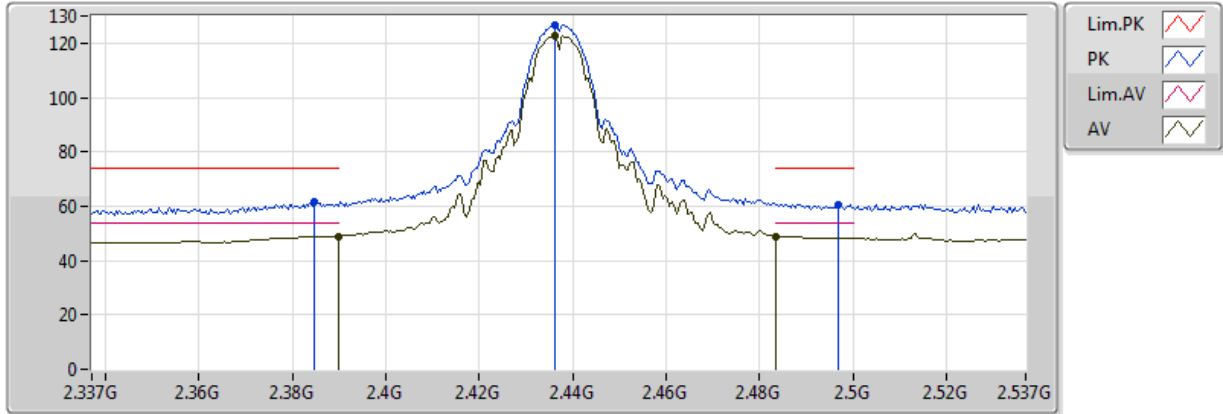

20170323
EUT_Z_4TX
Setting 106
03-J-5
FSU

Type	Freq(Hz)	Level(dBuV/m)	Limit(dBuV/m)	Margin(dB)	Factor(dB)	Dist(m)	Pol.(H/V)	Azimuth(°)	Height(m)	Comments
AV	2.389998G	48.93	54.00	-5.07	31.91	3	V	277	2.33	-
AV	2.4362G	122.78	Inf	-Inf	32.03	3	V	277	2.33	-
AV	2.483502G	48.90	54.00	-5.10	32.14	3	V	277	2.33	-
PK	2.3846G	61.50	74.00	-12.50	31.90	3	V	277	2.33	-
PK	2.4362G	126.58	Inf	-Inf	32.03	3	V	277	2.33	-
PK	2.497G	60.73	74.00	-13.27	32.17	3	V	277	2.33	-

802.11b_(1Mbps)_4TX

2437MHz_TX

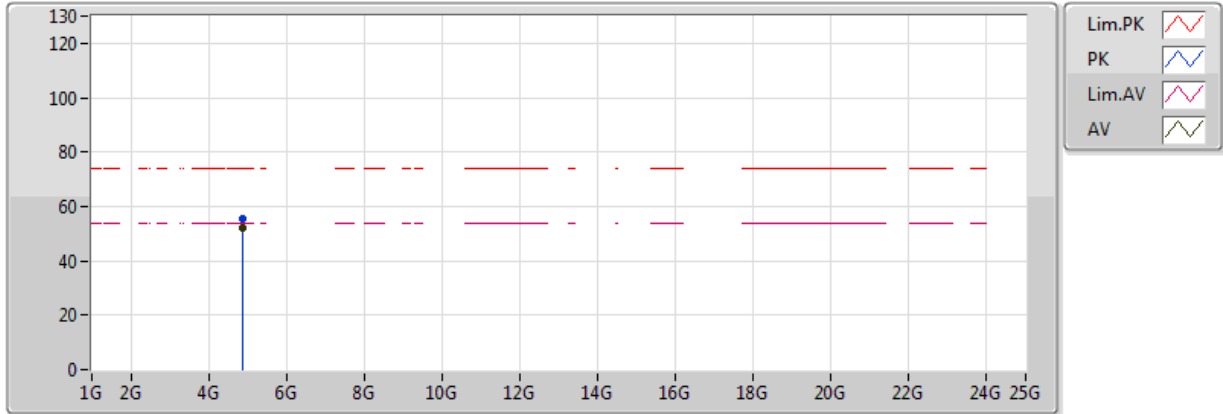

20170323
EUT_Z_4TX
Setting 106
03-J-5
FSU

Type	Freq(Hz)	Level(dBuV/m)	Limit(dBuV/m)	Margin(dB)	Factor(dB)	Dist(m)	Pol.(H/V)	Azimuth(°)	Height(m)	Comments
AV	4.874G	52.29	54.00	-1.71	4.82	3	V	275	1.17	-
PK	4.87406G	55.46	74.00	-18.54	4.82	3	V	275	1.17	-

802.11b_(1Mbps)_4TX

2437MHz_TX

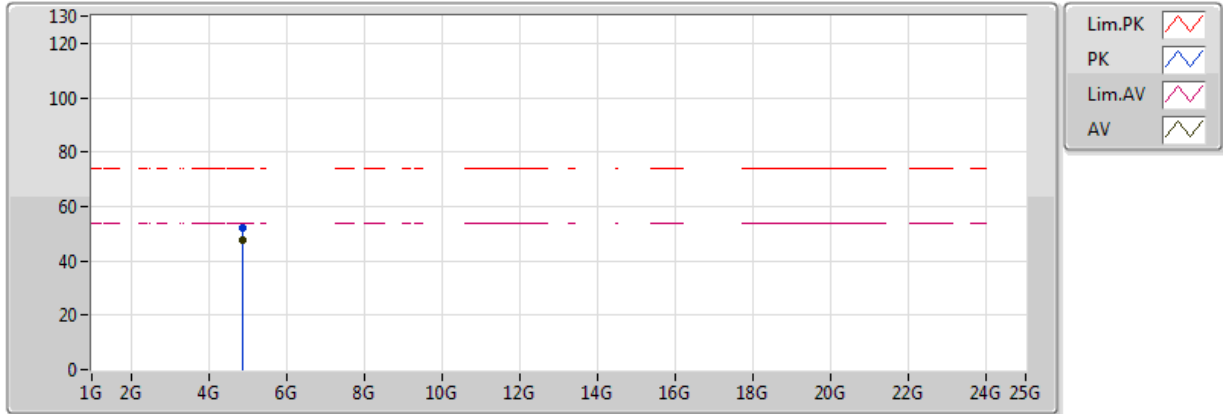

20170323
EUT_Z_4TX
Setting 106
03-J-5
FSU

Type	Freq(Hz)	Level(dBuV/m)	Limit(dBuV/m)	Margin(dB)	Factor(dB)	Dist(m)	Pol.(H/V)	Azimuth(°)	Height(m)	Comments
AV	4.87402G	47.68	54.00	-6.32	4.82	3	H	83	1.00	-
PK	4.87398G	52.06	74.00	-21.94	4.82	3	H	83	1.00	-

802.11b_(1Mbps)_4TX

2462MHz_TX

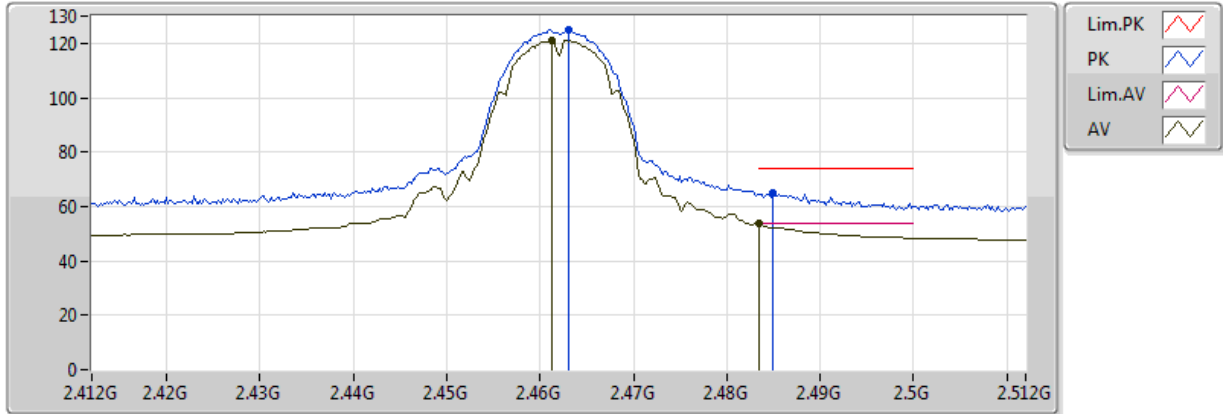

20170323
EUT_Z_4TX
Setting 96
03-J-5
FSU

Type	Freq(Hz)	Level(dBuV/m)	Limit(dBuV/m)	Margin(dB)	Factor(dB)	Dist(m)	Pol.(H/V)	Azimuth(°)	Height(m)	Comments
AV	2.4612G	121.05	Inf	-Inf	32.09	3	V	277	1.82	-
AV	2.483502G	53.80	54.00	-0.20	32.14	3	V	277	1.82	-
PK	2.463G	124.79	Inf	-Inf	32.09	3	V	277	1.82	-
PK	2.485G	65.27	74.00	-8.73	32.14	3	V	277	1.82	-

802.11b_(1Mbps)_4TX

2462MHz_TX

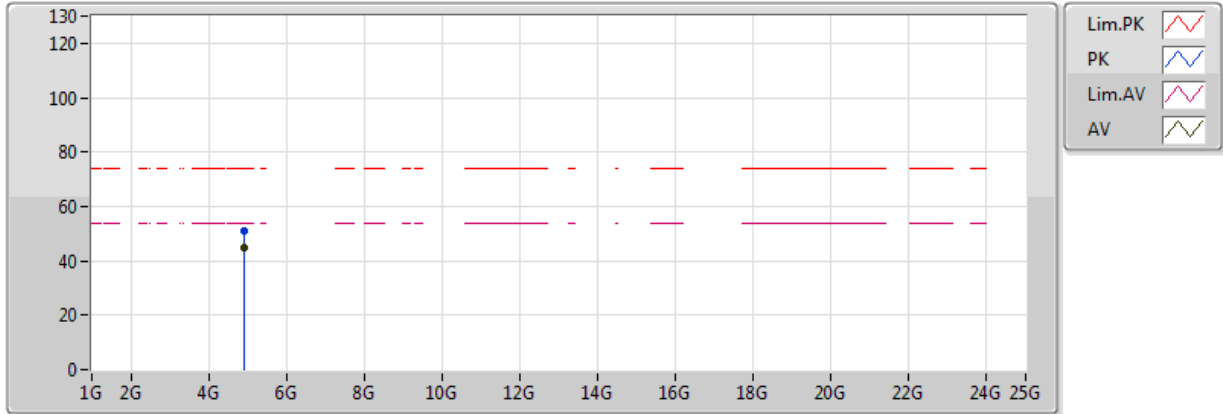

20170323
EUT_Z_4TX
Setting 96
03-J-5
FSU

Type	Freq(Hz)	Level(dBuV/m)	Limit(dBuV/m)	Margin(dB)	Factor(dB)	Dist(m)	Pol.(H/V)	Azimuth(°)	Height(m)	Comments
AV	4.92402G	44.75	54.00	-9.25	4.92	3	V	290	1.00	-
PK	4.92408G	50.73	74.00	-23.27	4.92	3	V	290	1.00	-

802.11b_(1Mbps)_4TX

2462MHz_TX

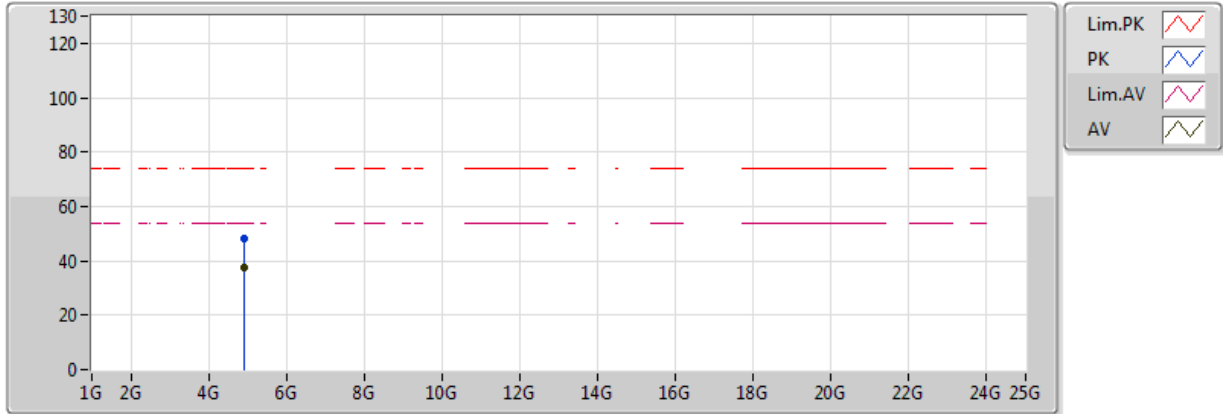

20170323
EUT_Z_4TX
Setting 96
03-J-5
FSU

Type	Freq(Hz)	Level(dBuV/m)	Limit(dBuV/m)	Margin(dB)	Factor(dB)	Dist(m)	Pol.(H/V)	Azimuth(°)	Height(m)	Comments
AV	4.92404G	37.32	54.00	-16.68	4.92	3	H	81	1.40	-
PK	4.92396G	48.20	74.00	-25.80	4.92	3	H	81	1.40	-

802.11g_(6Mbps)_4TX

2412MHz_TX

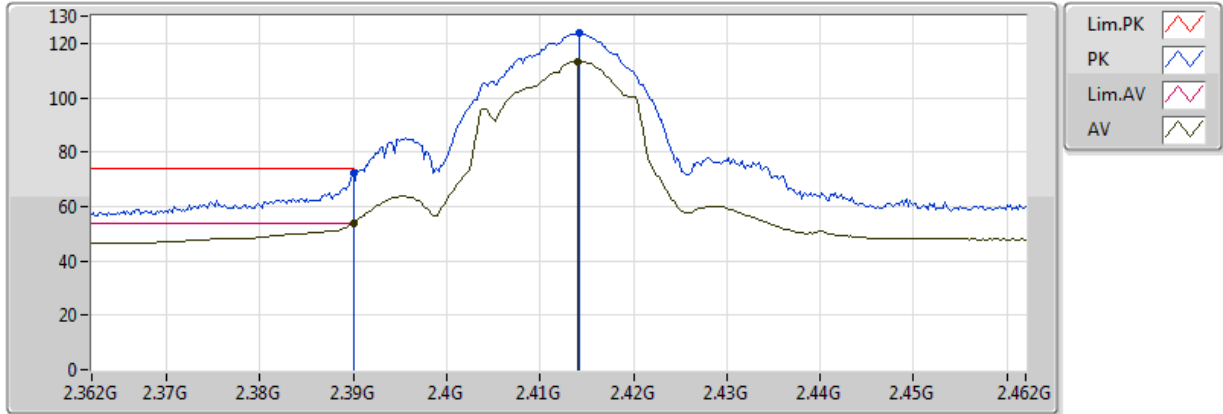

20170323
EUT_Z_4TX
Setting 86
03-J-5
FSU

Type	Freq(Hz)	Level(dBuV/m)	Limit(dBuV/m)	Margin(dB)	Factor(dB)	Dist(m)	Pol.(H/V)	Azimuth(°)	Height(m)	Comments
AV	2.39G	53.80	54.00	-0.20	31.91	3	V	284	2.27	-
AV	2.414G	113.26	Inf	-Inf	31.97	3	V	284	2.27	-
PK	2.39G	72.34	74.00	-1.66	31.91	3	V	284	2.27	-
PK	2.4142G	123.67	Inf	-Inf	31.97	3	V	284	2.27	-



802.11g_(6Mbps)_4TX

2412MHz_TX

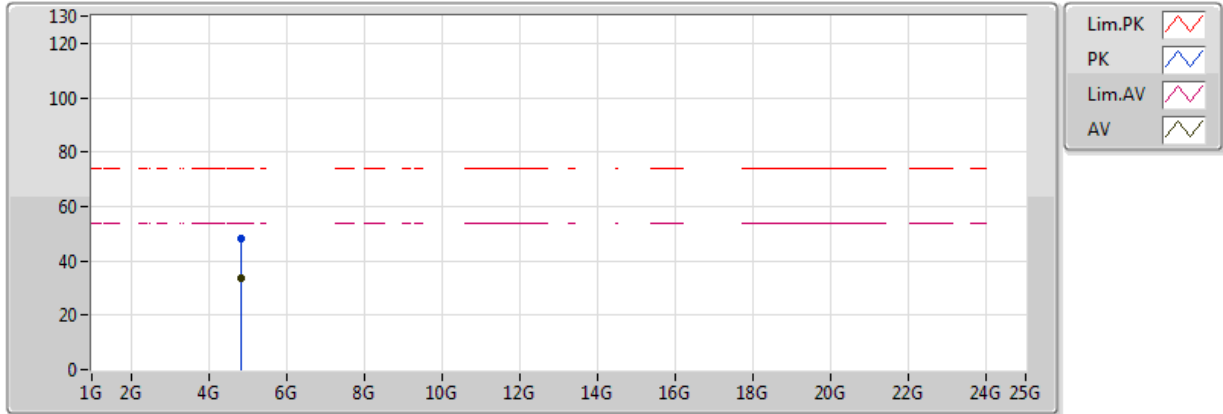

20170323
EUT_Z_4TX
Setting 86
03-J-5
FSU

Type	Freq(Hz)	Level(dBuV/m)	Limit(dBuV/m)	Margin(dB)	Factor(dB)	Dist(m)	Pol.(H/V)	Azimuth(°)	Height(m)	Comments
AV	4.82802G	33.90	54.00	-20.10	4.73	3	V	242	1.25	-
PK	4.82098G	48.37	74.00	-25.63	4.71	3	V	242	1.25	-



802.11g_(6Mbps)_4TX

2412MHz_TX

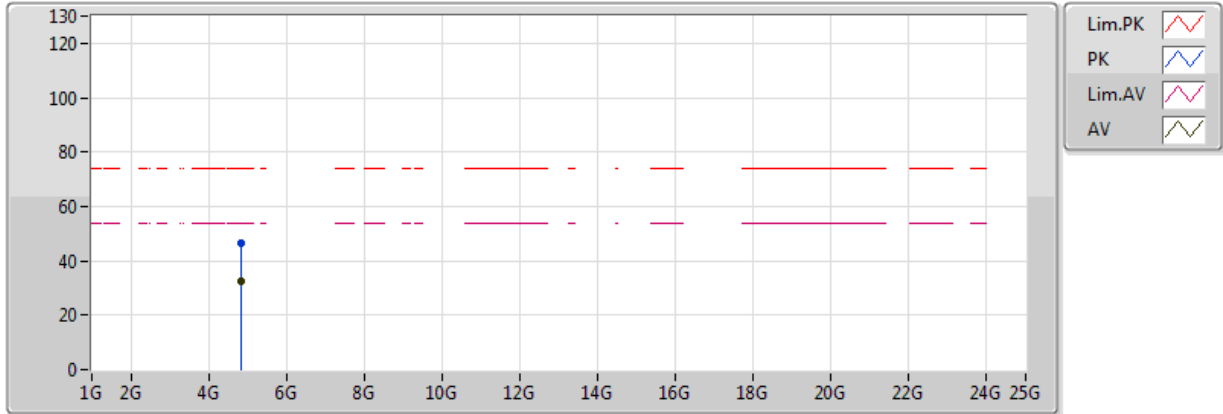

20170323
 EUT_Z_4TX
 Setting 86
 03-J-5
 FSU

Type	Freq(Hz)	Level(dBuV/m)	Limit(dBuV/m)	Margin(dB)	Factor(dB)	Dist(m)	Pol.(H/V)	Azimuth(°)	Height(m)	Comments
AV	4.83316G	32.48	54.00	-21.52	4.74	3	H	255	1.15	-
PK	4.82416G	46.27	74.00	-27.73	4.72	3	H	255	1.15	-

802.11g_(6Mbps)_4TX

2437MHz_TX

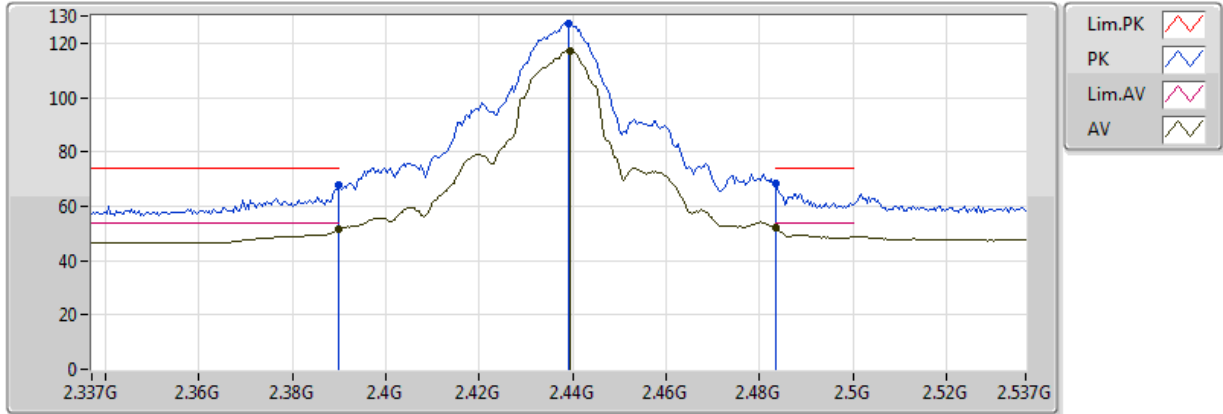

20170323
EUT_Z_4TX
Setting 106
03-J-5
FSU

Type	Freq(Hz)	Level(dBuV/m)	Limit(dBuV/m)	Margin(dB)	Factor(dB)	Dist(m)	Pol.(H/V)	Azimuth(°)	Height(m)	Comments
AV	2.389998G	51.29	54.00	-2.71	31.91	3	V	283	2.44	-
AV	2.4394G	117.00	Inf	-Inf	32.03	3	V	283	2.44	-
AV	2.483502G	51.91	54.00	-2.09	32.14	3	V	283	2.44	-
PK	2.389998G	67.63	74.00	-6.37	31.91	3	V	283	2.44	-
PK	2.439G	127.40	Inf	-Inf	32.03	3	V	283	2.44	-
PK	2.483502G	68.15	74.00	-5.85	32.14	3	V	283	2.44	-

802.11g_(6Mbps)_4TX

2437MHz_TX

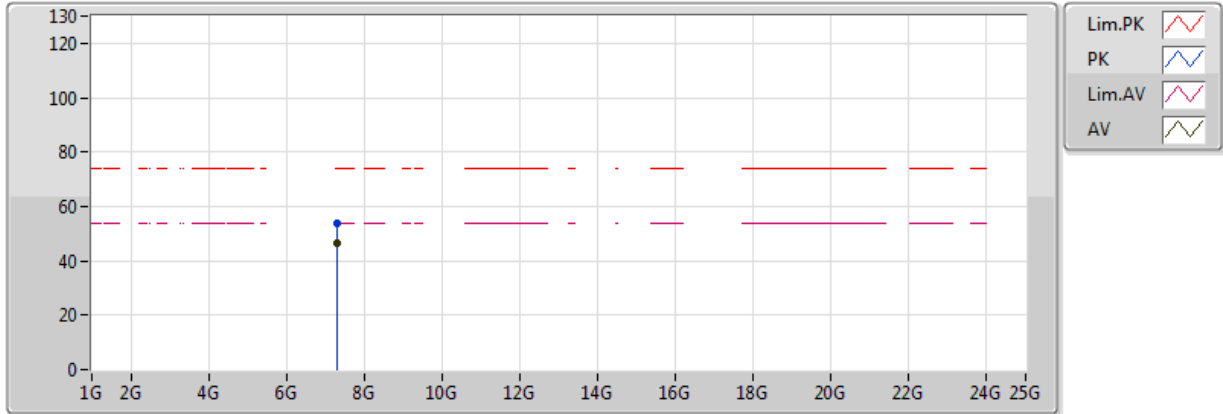

20170323
EUT_Z_4TX
Setting 106
03-J-5
FSU

Type	Freq(Hz)	Level(dBuV/m)	Limit(dBuV/m)	Margin(dB)	Factor(dB)	Dist(m)	Pol.(H/V)	Azimuth(°)	Height(m)	Comments
AV	7.31104G	46.35	54.00	-7.65	8.80	3	V	88	1.14	-
PK	7.31102G	53.86	74.00	-20.14	8.80	3	V	88	1.14	-

802.11g_(6Mbps)_4TX

2437MHz_TX

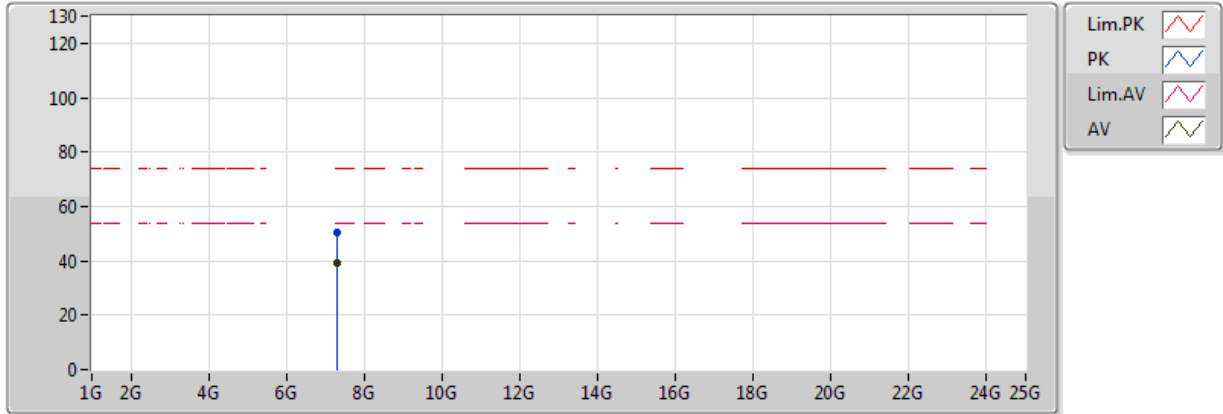

20170323
EUT_Z_4TX
Setting 106
03-J-5
FSU

Type	Freq(Hz)	Level(dBuV/m)	Limit(dBuV/m)	Margin(dB)	Factor(dB)	Dist(m)	Pol.(H/V)	Azimuth(°)	Height(m)	Comments
AV	7.31102G	39.24	54.00	-14.76	8.80	3	H	246	2.48	-
PK	7.31084G	50.55	74.00	-23.45	8.80	3	H	246	2.48	-

802.11g_(6Mbps)_4TX

2462MHz_TX

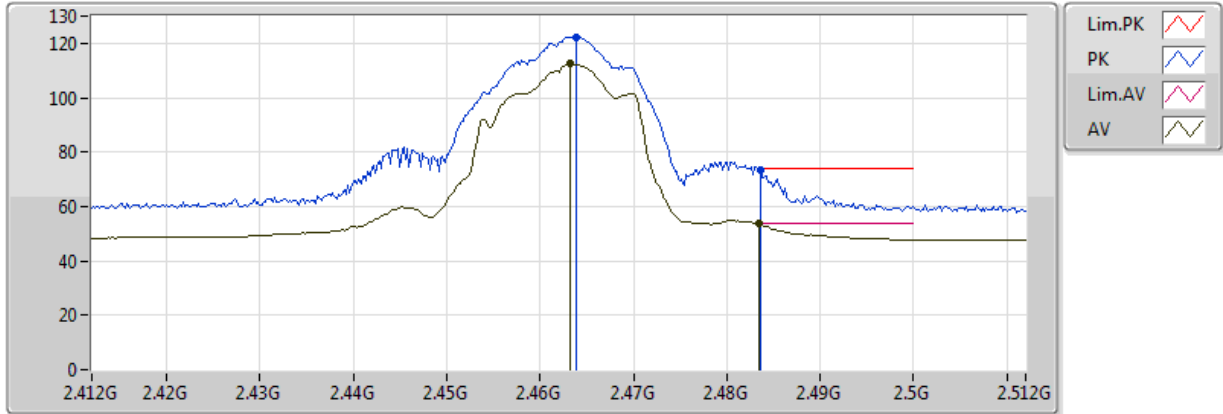

20170323
EUT_Z_4TX
Setting 83
03-J-5
FSU

Type	Freq(Hz)	Level(dBuV/m)	Limit(dBuV/m)	Margin(dB)	Factor(dB)	Dist(m)	Pol.(H/V)	Azimuth(°)	Height(m)	Comments
AV	2.4632G	112.51	Inf	-Inf	32.09	3	V	281	1.80	-
AV	2.483502G	53.59	54.00	-0.41	32.14	3	V	281	1.80	-
PK	2.4638G	122.33	Inf	-Inf	32.09	3	V	281	1.80	-
PK	2.4836G	73.24	74.00	-0.76	32.14	3	V	281	1.80	-



802.11g_(6Mbps)_4TX

2462MHz_TX

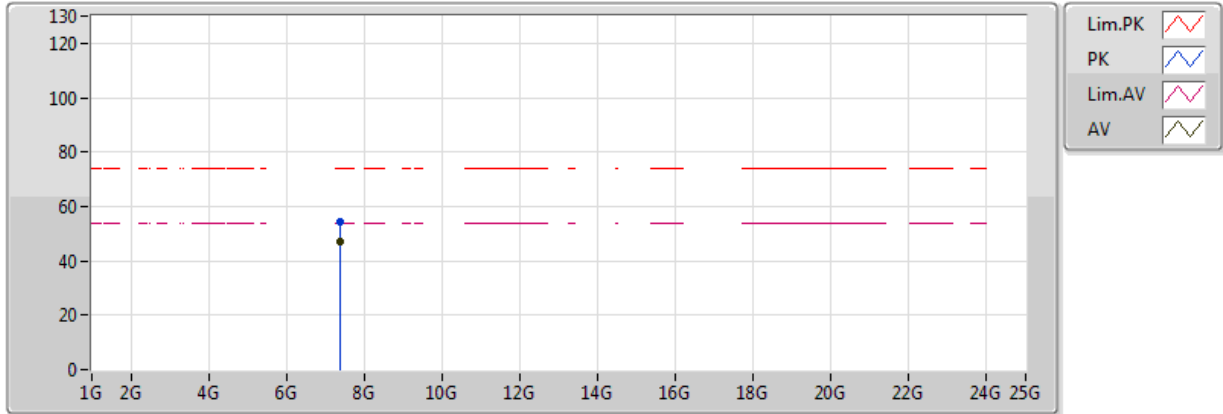

20170323
EUT_Z_4TX
Setting 83
03-J-5
FSU

Type	Freq(Hz)	Level(dBuV/m)	Limit(dBuV/m)	Margin(dB)	Factor(dB)	Dist(m)	Pol.(H/V)	Azimuth(°)	Height(m)	Comments
AV	7.38604G	47.31	54.00	-6.69	8.83	3	V	94	1.25	-
PK	7.38606G	54.13	74.00	-19.87	8.83	3	V	94	1.25	-



802.11g_(6Mbps)_4TX

2462MHz_TX

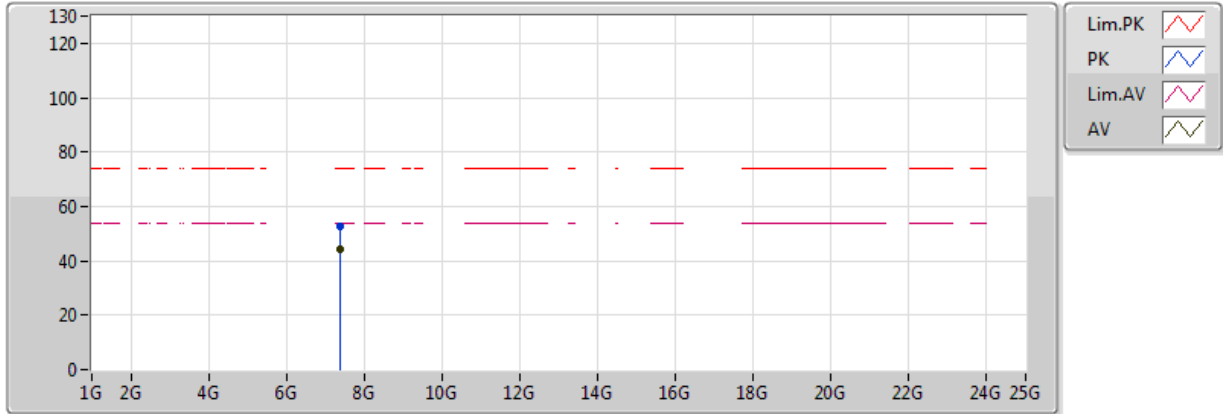

20170323
EUT_Z_4TX
Setting 83
03-J-5
FSU

Type	Freq(Hz)	Level(dBuV/m)	Limit(dBuV/m)	Margin(dB)	Factor(dB)	Dist(m)	Pol.(H/V)	Azimuth(°)	Height(m)	Comments
AV	7.38604G	44.20	54.00	-9.80	8.83	3	H	69	1.06	-
PK	7.38584G	52.59	74.00	-21.41	8.83	3	H	69	1.06	-

802.11ac VHT20_Nss1,(MCS0)_4TX

2412MHz_TX

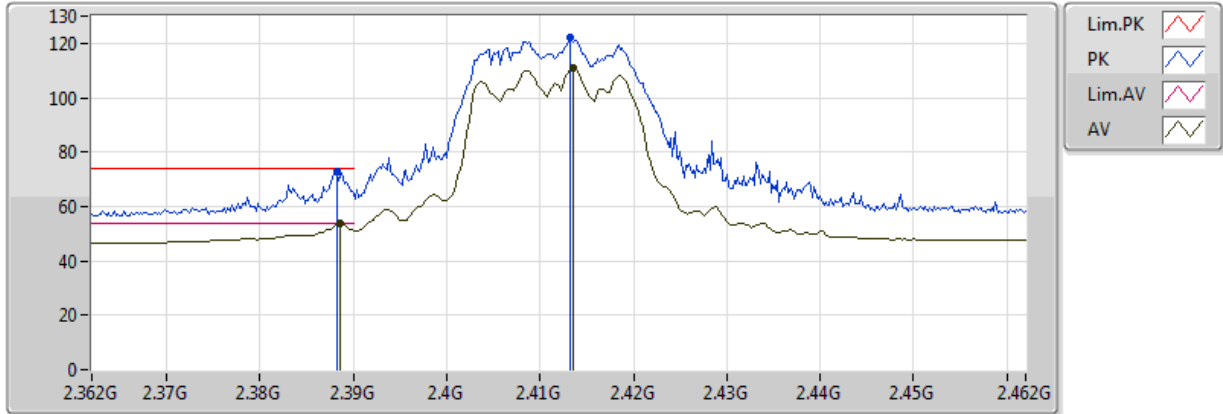

20170323
EUT_Z_4TX
Setting 83
03-J-5
FSU

Type	Freq(Hz)	Level(dBuV/m)	Limit(dBuV/m)	Margin(dB)	Factor(dB)	Dist(m)	Pol.(H/V)	Azimuth(°)	Height(m)	Comments
AV	2.3886G	53.69	54.00	-0.31	31.91	3	V	326	2.03	-
AV	2.4136G	110.83	Inf	-Inf	31.97	3	V	326	2.03	-
PK	2.3882G	72.65	74.00	-1.35	31.91	3	V	326	2.03	-
PK	2.4132G	121.99	Inf	-Inf	31.97	3	V	326	2.03	-

802.11ac VHT20_Nss1,(MCS0)_4TX

2412MHz_TX

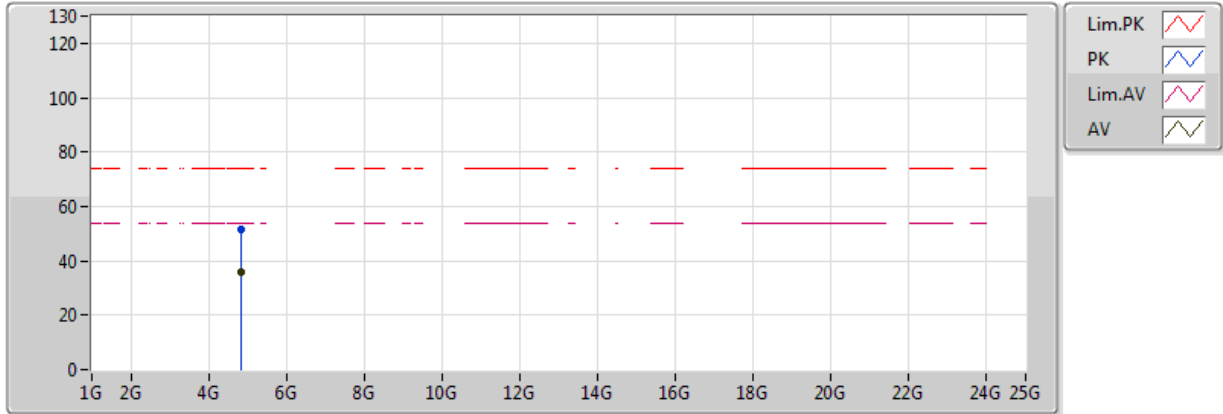

20170323
EUT_Z_4TX
Setting 83
03-J-5
FSU

Type	Freq(Hz)	Level(dBuV/m)	Limit(dBuV/m)	Margin(dB)	Factor(dB)	Dist(m)	Pol.(H/V)	Azimuth(°)	Height(m)	Comments
AV	4.82286G	36.07	54.00	-17.93	4.72	3	V	92	1.01	-
PK	4.82526G	51.29	74.00	-22.71	4.72	3	V	92	1.01	-

802.11ac VHT20_Nss1,(MCS0)_4TX

2412MHz_TX

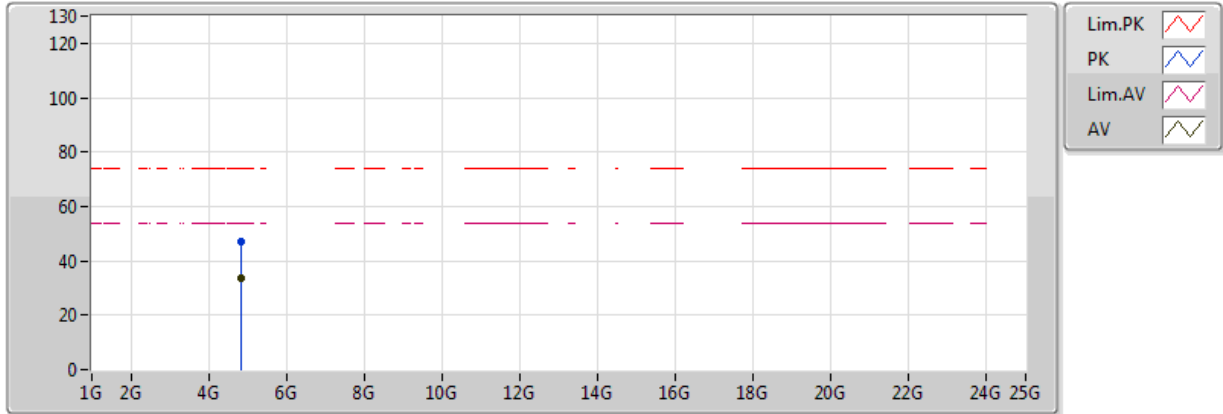

20170323
EUT_Z_4TX
Setting 83
03-J-5
FSU

Type	Freq(Hz)	Level(dBuV/m)	Limit(dBuV/m)	Margin(dB)	Factor(dB)	Dist(m)	Pol.(H/V)	Azimuth(°)	Height(m)	Comments
AV	4.82532G	33.43	54.00	-20.57	4.72	3	H	77	1.22	-
PK	4.82246G	47.33	74.00	-26.67	4.71	3	H	77	1.22	-

802.11ac VHT20_Nss1,(MCS0)_4TX

2437MHz_TX

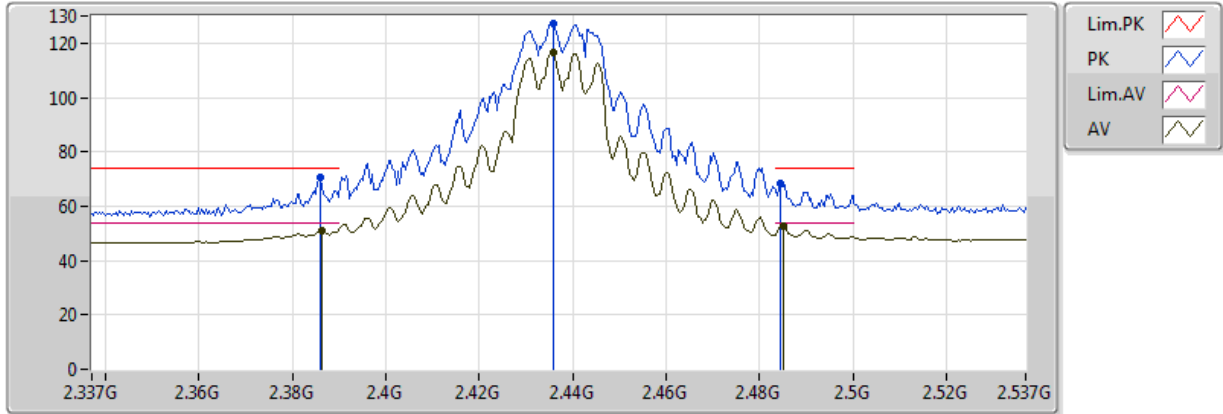

20170323
EUT_Z_4TX
Setting 106
03-J-5
FSU

Type	Freq(Hz)	Level(dBuV/m)	Limit(dBuV/m)	Margin(dB)	Factor(dB)	Dist(m)	Pol.(H/V)	Azimuth(°)	Height(m)	Comments
AV	2.3862G	51.07	54.00	-2.93	31.90	3	V	302	2.12	-
AV	2.4358G	116.68	Inf	-Inf	32.03	3	V	302	2.12	-
AV	2.485G	52.62	54.00	-1.38	32.14	3	V	302	2.12	-
PK	2.3858G	70.85	74.00	-3.15	31.90	3	V	302	2.12	-
PK	2.4358G	127.39	Inf	-Inf	32.03	3	V	302	2.12	-
PK	2.4846G	68.19	74.00	-5.81	32.14	3	V	302	2.12	-

802.11ac VHT20_Nss1,(MCS0)_4TX

2437MHz_TX

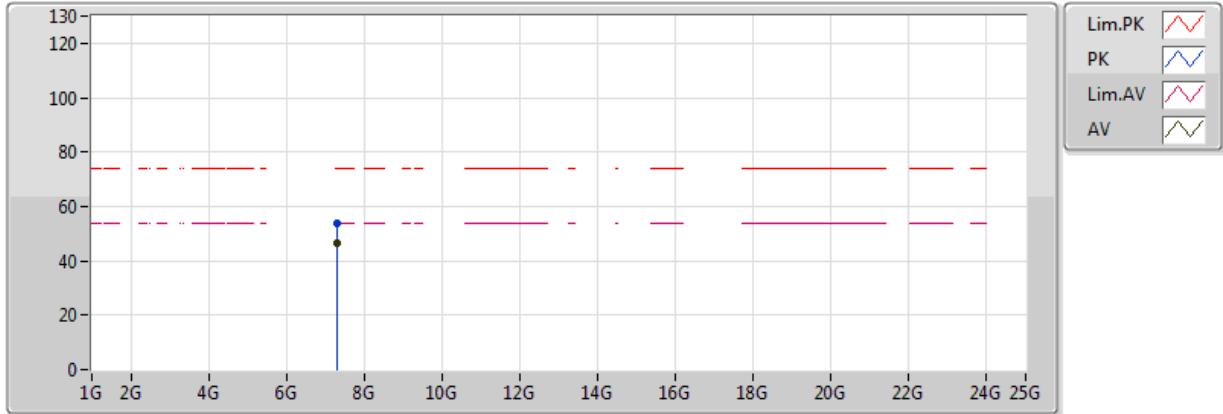

20170323
EUT_Z_4TX
Setting 106
03-J-5
FSU

Type	Freq(Hz)	Level(dBuV/m)	Limit(dBuV/m)	Margin(dB)	Factor(dB)	Dist(m)	Pol.(H/V)	Azimuth(°)	Height(m)	Comments
AV	7.31104G	46.64	54.00	-7.36	8.80	3	V	90	1.02	-
PK	7.31098G	53.56	74.00	-20.44	8.80	3	V	90	1.02	-

802.11ac VHT20_Nss1,(MCS0)_4TX

2437MHz_TX

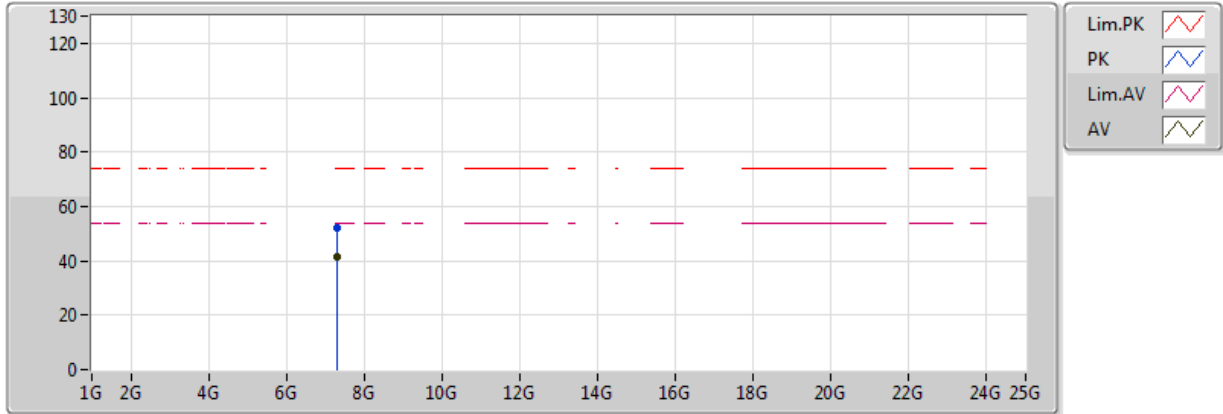

20170323
EUT_Z_4TX
Setting 106
03-J-5
FSU

Type	Freq(Hz)	Level(dBuV/m)	Limit(dBuV/m)	Margin(dB)	Factor(dB)	Dist(m)	Pol.(H/V)	Azimuth(°)	Height(m)	Comments
AV	7.31104G	41.53	54.00	-12.47	8.80	3	H	70	1.01	-
PK	7.31082G	52.13	74.00	-21.87	8.80	3	H	70	1.01	-

802.11ac VHT20_Nss1,(MCS0)_4TX

2462MHz_TX

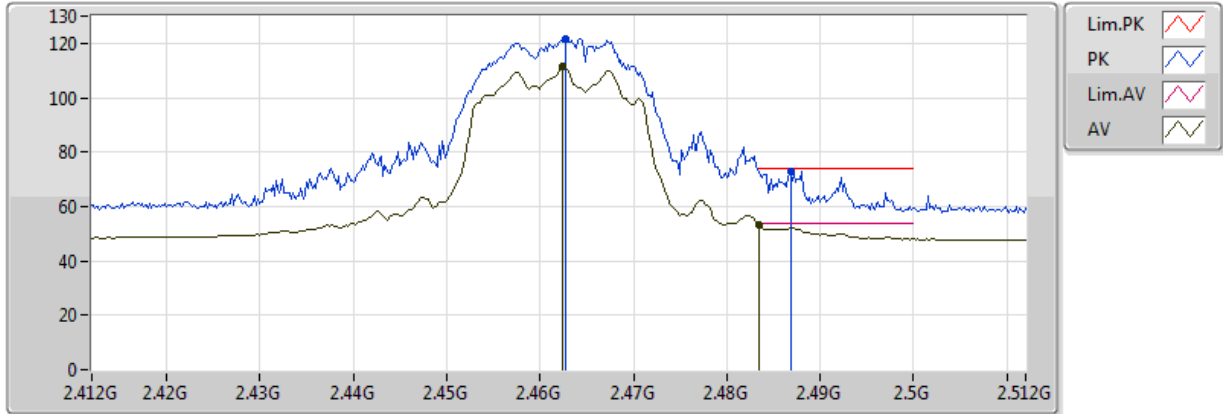

20170323
EUT_Z_4TX
Setting 86
03-J-5
FSU

Type	Freq(Hz)	Level(dBuV/m)	Limit(dBuV/m)	Margin(dB)	Factor(dB)	Dist(m)	Pol.(H/V)	Azimuth(°)	Height(m)	Comments
AV	2.4624G	111.71	Inf	-Inf	32.09	3	V	281	1.83	-
AV	2.483502G	53.48	54.00	-0.52	32.14	3	V	281	1.83	-
PK	2.4628G	121.67	Inf	-Inf	32.09	3	V	281	1.83	-
PK	2.4868G	73.09	74.00	-0.91	32.15	3	V	281	1.83	-

802.11ac VHT20_Nss1,(MCS0)_4TX

2462MHz_TX

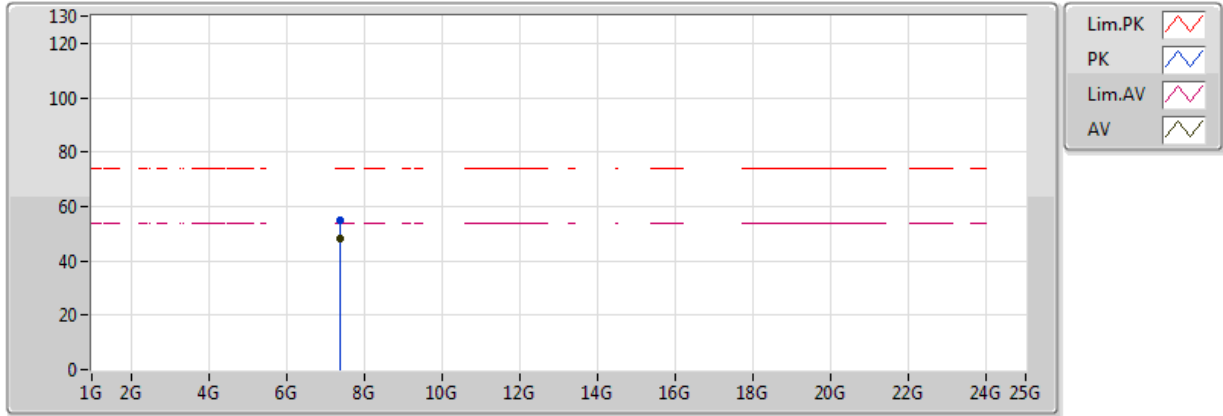

20170323
EUT_Z_4TX
Setting 86
03-J-5
FSU

Type	Freq(Hz)	Level(dBuV/m)	Limit(dBuV/m)	Margin(dB)	Factor(dB)	Dist(m)	Pol.(H/V)	Azimuth(°)	Height(m)	Comments
AV	7.38604G	48.05	54.00	-5.95	8.83	3	V	92	1.23	-
PK	7.38604G	54.91	74.00	-19.09	8.83	3	V	92	1.23	-

802.11ac VHT20_Nss1,(MCS0)_4TX

2462MHz_TX

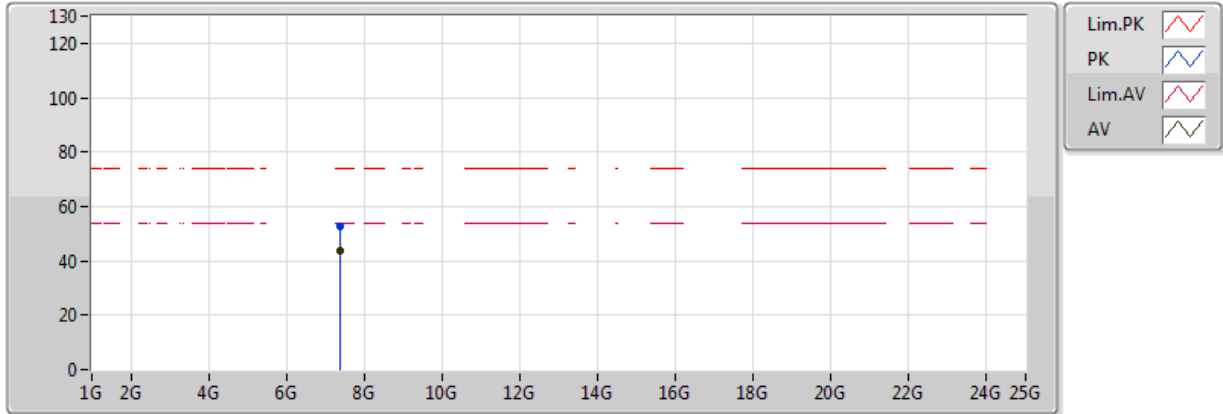

20170323
EUT_Z_4TX
Setting 86
03-J-5
FSU

Type	Freq(Hz)	Level(dBuV/m)	Limit(dBuV/m)	Margin(dB)	Factor(dB)	Dist(m)	Pol.(H/V)	Azimuth(°)	Height(m)	Comments
AV	7.38602G	43.95	54.00	-10.05	8.83	3	H	68	1.05	-
PK	7.38598G	52.92	74.00	-21.08	8.83	3	H	68	1.05	-

802.11ac VHT40_Nss1,(MCS0)_4TX

2422MHz_TX

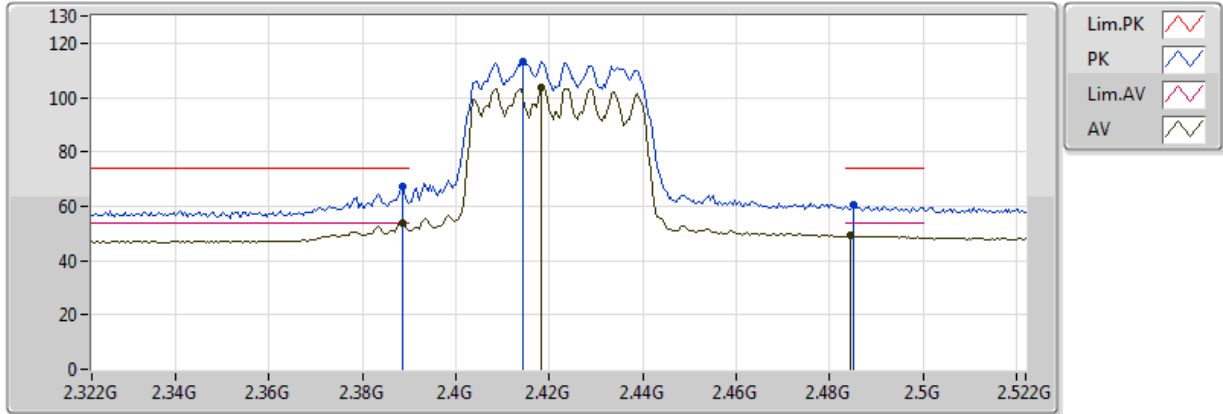

20170323
EUT_Z_4TX
Setting 63
03-J-5
FSU

Type	Freq(Hz)	Level(dBuV/m)	Limit(dBuV/m)	Margin(dB)	Factor(dB)	Dist(m)	Pol.(H/V)	Azimuth(°)	Height(m)	Comments
AV	2.3884G	53.95	54.00	-0.05	31.91	3	V	324	2.06	-
AV	2.4184G	103.55	Inf	-Inf	31.98	3	V	324	2.06	-
AV	2.4844G	49.24	54.00	-4.76	32.14	3	V	324	2.06	-
PK	2.3884G	67.19	74.00	-6.81	31.91	3	V	324	2.06	-
PK	2.4144G	113.06	Inf	-Inf	31.97	3	V	324	2.06	-
PK	2.4852G	60.55	74.00	-13.45	32.14	3	V	324	2.06	-



802.11ac VHT40_Nss1,(MCS0)_4TX

2422MHz_TX

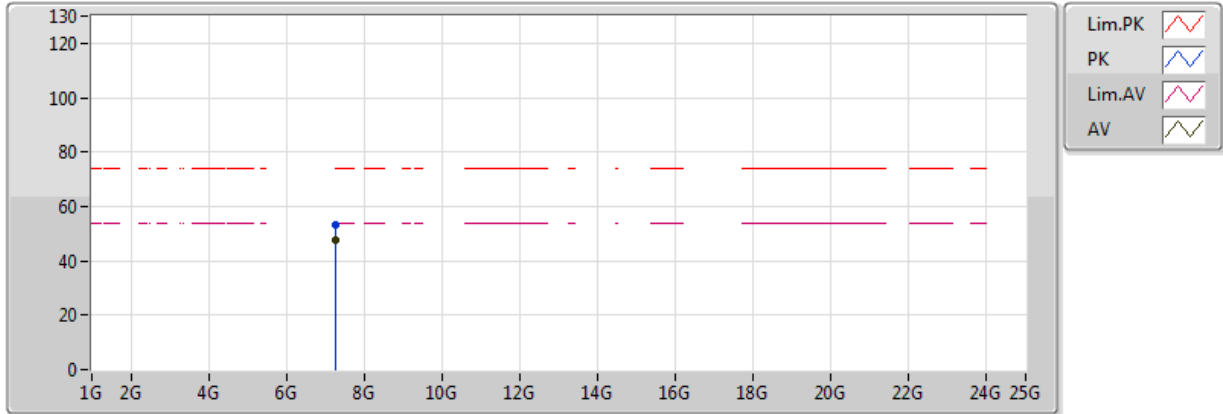

20170323
EUT_Z_4TX
Setting 63
03-J-5
FSU

Type	Freq(Hz)	Level(dBuV/m)	Limit(dBuV/m)	Margin(dB)	Factor(dB)	Dist(m)	Pol.(H/V)	Azimuth(°)	Height(m)	Comments
AV	7.26602G	47.60	54.00	-6.40	8.79	3	V	87	1.14	-
PK	7.266G	53.21	74.00	-20.79	8.79	3	V	87	1.14	-

802.11ac VHT40_Nss1,(MCS0)_4TX

2422MHz_TX

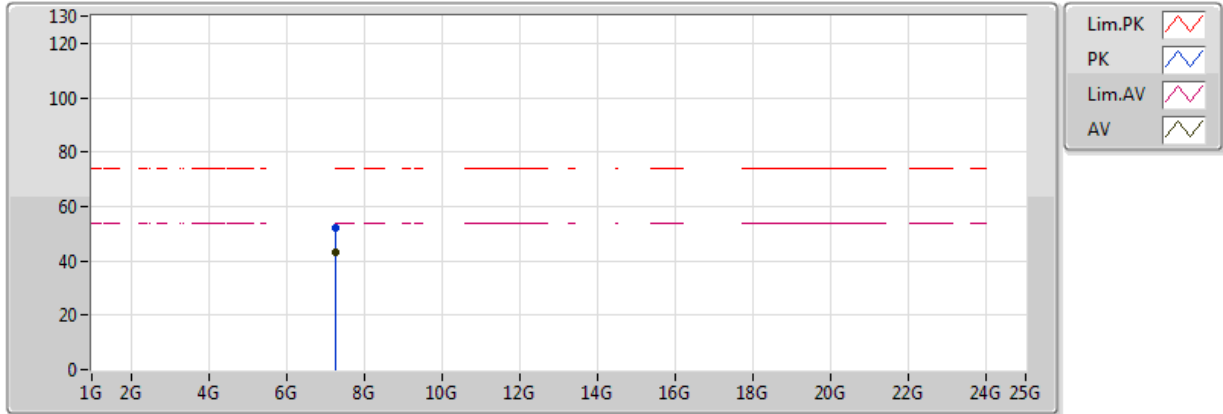

20170323
EUT_Z_4TX
Setting 63
03-J-5
FSU

Type	Freq(Hz)	Level(dBuV/m)	Limit(dBuV/m)	Margin(dB)	Factor(dB)	Dist(m)	Pol.(H/V)	Azimuth(°)	Height(m)	Comments
AV	7.26598G	43.34	54.00	-10.66	8.79	3	H	72	1.03	-
PK	7.26608G	52.11	74.00	-21.89	8.79	3	H	72	1.03	-

802.11ac VHT40_Nss1,(MCS0)_4TX

2437MHz_TX

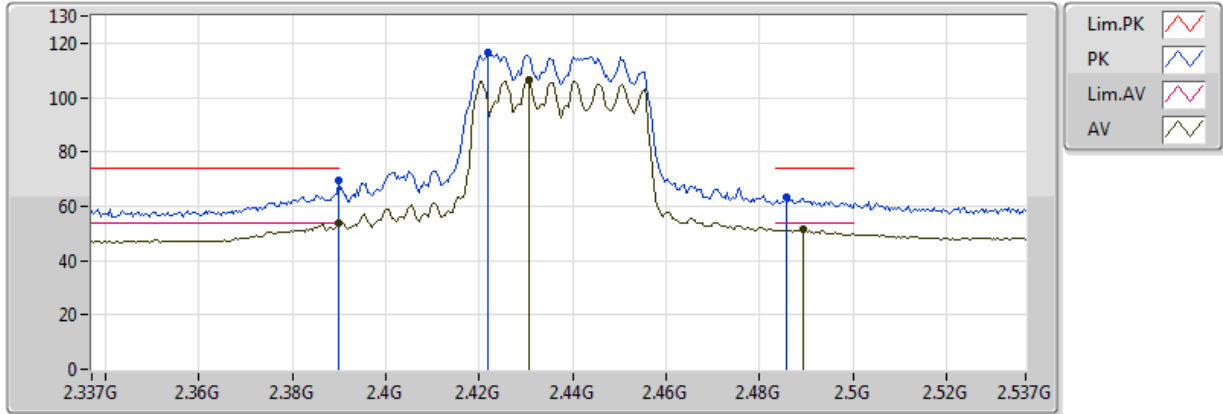

20170323
EUT_Z_4TX
Setting 72
03-J-5
FSU

Type	Freq(Hz)	Level(dBuV/m)	Limit(dBuV/m)	Margin(dB)	Factor(dB)	Dist(m)	Pol.(H/V)	Azimuth(°)	Height(m)	Comments
AV	2.389998G	53.87	54.00	-0.13	31.91	3	V	299	2.31	-
AV	2.4306G	106.22	Inf	-Inf	32.01	3	V	299	2.31	-
AV	2.4894G	51.36	54.00	-2.64	32.15	3	V	299	2.31	-
PK	2.389998G	69.39	74.00	-4.61	31.91	3	V	299	2.31	-
PK	2.4218G	116.35	Inf	-Inf	31.99	3	V	299	2.31	-
PK	2.4858G	63.36	74.00	-10.64	32.15	3	V	299	2.31	-

802.11ac VHT40_Nss1,(MCS0)_4TX

2437MHz_TX

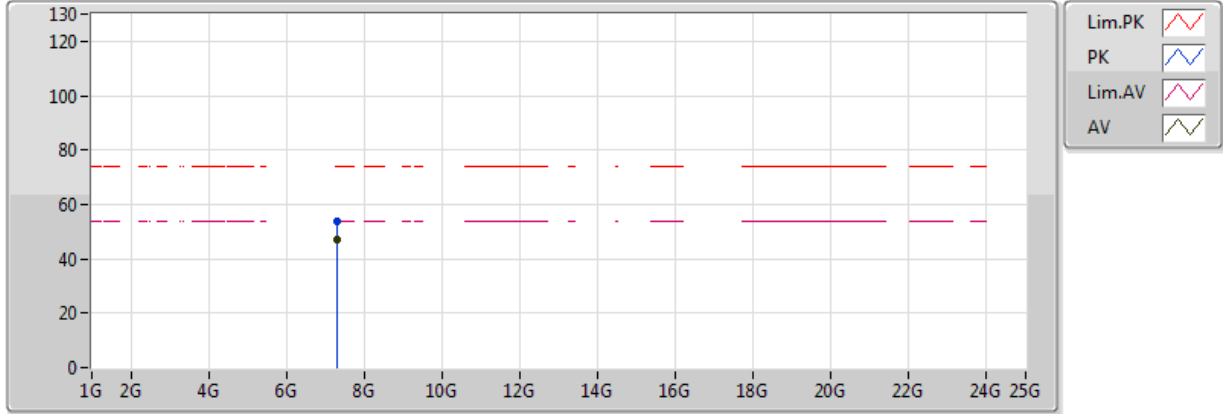

20170323
EUT_Z_4TX
Setting 72
03-J-5
FSU

Type	Freq(Hz)	Level(dBuV/m)	Limit(dBuV/m)	Margin(dB)	Factor(dB)	Dist(m)	Pol.(H/V)	Azimuth(°)	Height(m)	Comments
AV	7.31106G	47.12	54.00	-6.88	8.80	3	V	88	1.13	-
PK	7.31102G	53.54	74.00	-20.46	8.80	3	V	88	1.13	-

802.11ac VHT40_Nss1,(MCS0)_4TX

2437MHz_TX

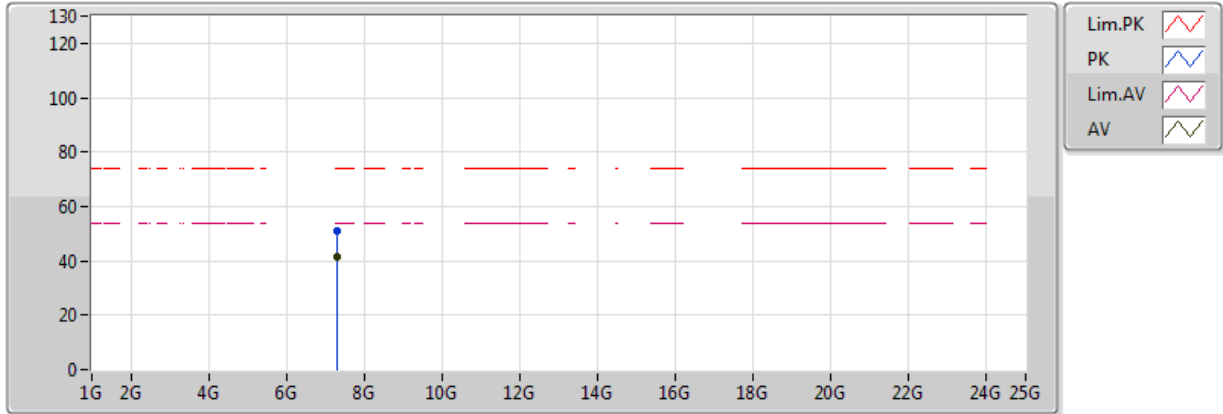

20170323
EUT_Z_4TX
Setting 72
03-J-5
FSU

Type	Freq(Hz)	Level(dBuV/m)	Limit(dBuV/m)	Margin(dB)	Factor(dB)	Dist(m)	Pol.(H/V)	Azimuth(°)	Height(m)	Comments
AV	7.31106G	41.29	54.00	-12.71	8.80	3	H	253	1.11	-
PK	7.31104G	51.24	74.00	-22.76	8.80	3	H	253	1.11	-

802.11ac VHT40_Nss1,(MCS0)_4TX

2452MHz_TX

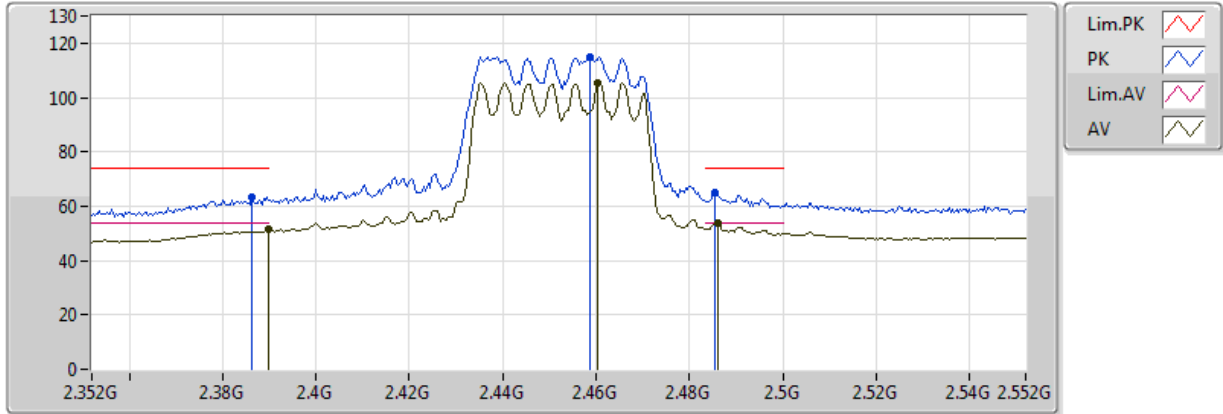

20170323
EUT_Z_4TX
Setting 69
03-J-5
FSU

Type	Freq(Hz)	Level(dBuV/m)	Limit(dBuV/m)	Margin(dB)	Factor(dB)	Dist(m)	Pol.(H/V)	Azimuth(°)	Height(m)	Comments
AV	2.39G	51.34	54.00	-2.66	31.91	3	V	301	2.51	-
AV	2.4604G	105.46	Inf	-Inf	32.08	3	V	301	2.51	-
AV	2.486G	53.92	54.00	-0.08	32.15	3	V	301	2.51	-
PK	2.3864G	63.18	74.00	-10.82	31.90	3	V	301	2.51	-
PK	2.4588G	115.01	Inf	-Inf	32.08	3	V	301	2.51	-
PK	2.4856G	64.86	74.00	-9.14	32.15	3	V	301	2.51	-

802.11ac VHT40_Nss1,(MCS0)_4TX

2452MHz_TX

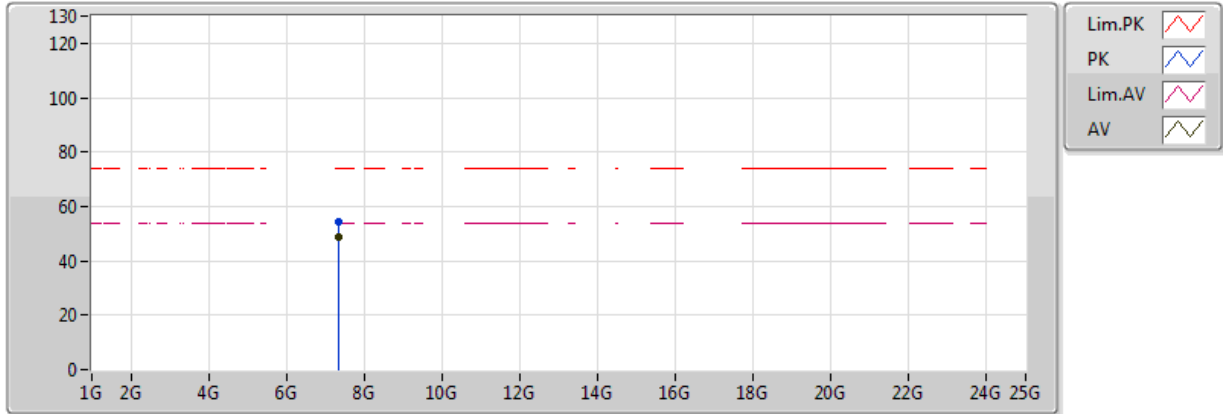

20170323
EUT_Z_4TX
Setting 69
03-J-5
FSU

Type	Freq(Hz)	Level(dBuV/m)	Limit(dBuV/m)	Margin(dB)	Factor(dB)	Dist(m)	Pol.(H/V)	Azimuth(°)	Height(m)	Comments
AV	7.356G	48.64	54.00	-5.36	8.82	3	V	87	1.11	-
PK	7.35604G	54.28	74.00	-19.72	8.82	3	V	87	1.11	-

802.11ac VHT40_Nss1,(MCS0)_4TX

2452MHz_TX

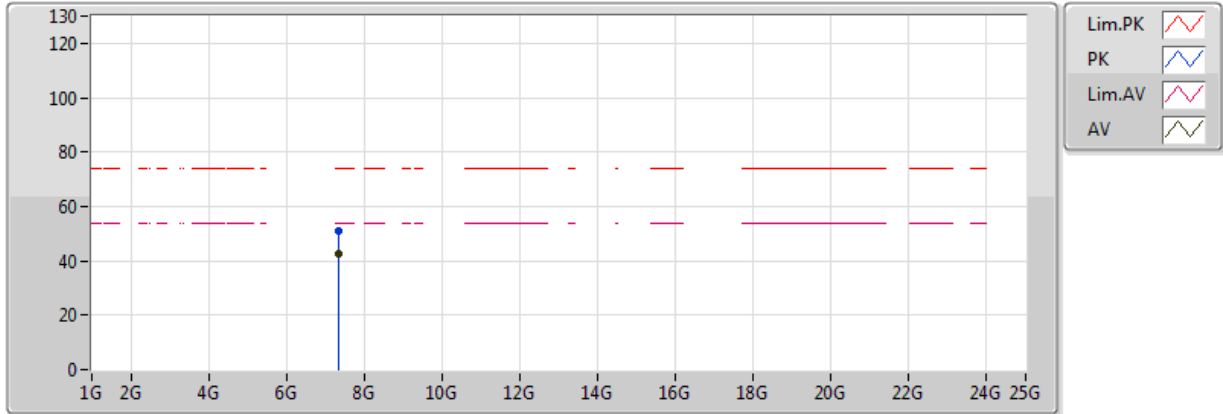

20170323
EUT_Z_4TX
Setting 69
03-J-5
FSU

Type	Freq(Hz)	Level(dBuV/m)	Limit(dBuV/m)	Margin(dB)	Factor(dB)	Dist(m)	Pol.(H/V)	Azimuth(°)	Height(m)	Comments
AV	7.35598G	42.31	54.00	-11.69	8.82	3	H	247	2.42	-
PK	7.35618G	51.27	74.00	-22.73	8.82	3	H	247	2.42	-

