

# FCC Radio Test Report

## FCC ID: TE7C54

This report concerns: **Original Grant**

**Project No.** : 2008C039  
**Equipment** : AC1200 Dual Band Wi-Fi Router  
**Brand Name** : tp-link  
**Test Model** : Archer C54  
**Series Model** : N/A  
**Applicant** : TP-Link Technologies Co., Ltd.  
**Address** : Building 24(floors1,3,4,5) and 28(floors1-4) Central Science and Technology Park, Shennan Rd, Nanshan, Shenzhen, China  
**Manufacturer** : TP-Link Technologies Co., Ltd.  
**Address** : Building 24(floors1,3,4,5) and 28(floors1-4) Central Science and Technology Park, Shennan Rd, Nanshan, Shenzhen, China  
**Date of Receipt** : Aug. 10, 2020  
**Date of Test** : Aug. 11, 2020 ~ Oct. 12, 2020  
**Issued Date** : Oct. 26, 2020  
**Report Version** : R01  
**Test Sample** : Engineering Sample No.:DG2020081118 for conducted, DG2020091758 for radiated.  
**Standard(s)** : FCC Part15, Subpart E(15.407)  
ANSI C63.10-2013  
FCC KDB 789033 D02 General UNII Test Procedures New Rules v02r01  
FCC KDB 662911 D01 Multiple Transmitter Output v02r01

The above equipment has been tested and found compliance with the requirement of the relative standards by BTL Inc.



Prepared by : Chella Zheng



Approved by : Ethan Ma



Certificate #5123.02

Add: No.3, Jinshagang 1st Road, Shixia, Dalang Town, Dongguan, Guangdong, China.

Tel: +86-769-8318-3000

Web: www.newbtl.com

**Declaration**

**BTL** represents to the client that testing is done in accordance with standard procedures as applicable and that test instruments used has been calibrated with standards traceable to international standard(s) and/or national standard(s).

**BTL's** reports apply only to the specific samples tested under conditions. It is manufacture's responsibility to ensure that additional production units of this model are manufactured with the identical electrical and mechanical components. **BTL** shall have no liability for any declarations, inferences or generalizations drawn by the client or others from **BTL** issued reports.

The report must not be used by the client to claim product certification, approval, or endorsement by NVLAP, NIST, A2LA, or any agency of the U.S. Government.

This report is the confidential property of the client. As a mutual protection to the clients, the public and ourselves, the test report shall not be reproduced, except in full, without our written approval.

**BTL's** laboratory quality assurance procedures are in compliance with the **ISO/IEC 17025** requirements, and accredited by the conformity assessment authorities listed in this test report.

**BTL** is not responsible for the sampling stage, so the results only apply to the sample as received.

The information, data and test plan are provided by manufacturer which may affect the validity of results, so it is manufacturer's responsibility to ensure that the apparatus meets the essential requirements of applied standards and in all the possible configurations as representative of its intended use.

**Limitation**

For the use of the authority's logo is limited unless the Test Standard(s)/Scope(s)/Item(s) mentioned in this test report is (are) included in the conformity assessment authorities acceptance respective.

Please note that the measurement uncertainty is provided for informational purpose only and are not use in determining the Pass/Fail results.

<b>Table of Contents</b>	<b>Page</b>
<b>REPORT ISSUED HISTORY</b>	<b>5</b>
<b>1 . SUMMARY OF TEST RESULTS</b>	<b>6</b>
1.1 TEST FACILITY	7
1.2 MEASUREMENT UNCERTAINTY	7
1.3 TEST ENVIRONMENT CONDITIONS	8
<b>2 . GENERAL INFORMATION</b>	<b>9</b>
2.1 GENERAL DESCRIPTION OF EUT	9
2.2 TEST MODES	12
2.3 PARAMETERS OF TEST SOFTWARE	14
2.4 DUTY CYCLE	16
2.5 BLOCK DIAGRAM SHOWING THE CONFIGURATION OF SYSTEM TESTED	17
2.6 SUPPORT UNITS	17
<b>3 . AC POWER LINE CONDUCTED EMISSIONS TEST</b>	<b>18</b>
3.1 LIMIT	18
3.2 TEST PROCEDURE	18
3.3 DEVIATION FROM TEST STANDARD	18
3.4 TEST SETUP	19
3.5 EUT OPERATION CONDITIONS	19
3.6 TEST RESULTS	19
<b>4 . RADIATED EMISSIONS TEST</b>	<b>20</b>
4.1 LIMIT	20
4.2 TEST PROCEDURE	21
4.3 DEVIATION FROM TEST STANDARD	21
4.4 TEST SETUP	22
4.5 EUT OPERATION CONDITIONS	23
4.6 TEST RESULTS - 9 KHZ to 30 MHZ	23
4.7 TEST RESULTS - 30 MHz TO 1000 MHz	23
4.8 TEST RESULTS - ABOVE 1000 MHz	23
<b>5 . BANDWIDTH TEST</b>	<b>24</b>
5.1 LIMIT	24
5.2 TEST PROCEDURE	24
5.3 DEVIATION FROM STANDARD	24
5.4 TEST SETUP	24
5.5 EUT OPERATION CONDITIONS	24

<b>Table of Contents</b>	<b>Page</b>
5.6 TEST RESULTS	24
<b>6 . MAXIMUM OUTPUT POWER TEST</b>	<b>25</b>
6.1 LIMIT	25
6.2 TEST PROCEDURE	25
6.3 DEVIATION FROM STANDARD	25
6.4 TEST SETUP	25
6.5 EUT OPERATION CONDITIONS	25
6.6 TEST RESULTS	25
<b>7 . POWER SPECTRAL DENSITY TEST</b>	<b>26</b>
7.1 LIMIT	26
7.2 TEST PROCEDURE	26
7.3 DEVIATION FROM STANDARD	26
7.4 TEST SETUP	26
7.5 EUT OPERATION CONDITIONS	26
7.6 TEST RESULTS	26
<b>8 . FREQUENCY STABILITY MEASUREMENT</b>	<b>27</b>
8.1 LIMIT	27
8.2 TEST PROCEDURE	27
8.3 DEVIATION FROM STANDARD	27
8.4 TEST SETUP	27
8.5 EUT OPERATION CONDITIONS	27
8.6 TEST RESULTS	27
<b>9 . MEASUREMENT INSTRUMENTS LIST</b>	<b>28</b>
<b>10 . EUT TEST PHOTOS</b>	<b>30</b>
<b>APPENDIX A - AC POWER LINE CONDUCTED EMISSIONS</b>	<b>35</b>
<b>APPENDIX B - RADIATED EMISSION - 9 KHZ TO 30 MHZ</b>	<b>38</b>
<b>APPENDIX C - RADIATED EMISSION - 30 MHZ TO 1 GHZ</b>	<b>43</b>
<b>APPENDIX D - RADIATED EMISSION - ABOVE 1000 MHZ</b>	<b>46</b>
<b>APPENDIX E - BANDWIDTH</b>	<b>107</b>
<b>APPENDIX F - MAXIMUM OUTPUT POWER</b>	<b>116</b>
<b>APPENDIX G - POWER SPECTRAL DENSITY</b>	<b>131</b>
<b>APPENDIX H - FREQUENCY STABILITY</b>	<b>152</b>

**REPORT ISSUED HISTORY**

Report Version	Description	Issued Date
R00	Original Issue.	Oct. 21, 2020
R01	Added the conducted test photos.	Oct. 26, 2020

## 1. SUMMARY OF TEST RESULTS

Test procedures according to the technical standard(s):

FCC Part15, Subpart E(15.407)				
Standard(s) Section	Test Item	Test Result	Judgment	Remark
15.207 15.407(b)	AC Power Line Conducted Emissions	APPENDIX A	PASS	-----
15.407(b) 15.205(a) 15.209(a)	Radiated Emissions	APPENDIX B APPENDIX C APPENDIX D	PASS	-----
15.407(a) 15.407(e)	Spectrum Bandwidth	APPENDIX E	PASS	-----
15.407(a)	Maximum Output Power	APPENDIX F	PASS	-----
15.407(a)	Power Spectral Density	APPENDIX G	PASS	-----
15.407(g)	Frequency Stability	APPENDIX H	PASS	-----
15.203	Antenna Requirements	-----	PASS	NOTE (2)
15.407(c)	Automatically Discontinue Transmission	-----	PASS	NOTE (3)

Note:

- (1) "N/A" denotes test is not applicable in this test report.
- (2) The device what use a permanently attached antenna were considered sufficient to comply with the provisions of 15.203.
- (3) During no any information transmission, the EUT can automatically discontinue transmission and become standby mode for power saving. the EUT can detect the controlling signal of ACK message transmitting from remote device and verify whether it shall resend or discontinue transmission.
- (4) For UNII-1 this device was functioned as a  
 Access point device     Client device

## 1.1 TEST FACILITY

The test facilities used to collect the test data in this report is at the location of No.3,Jinshagang 1st Road, Shixia, Dalang Town, Dongguan, Guangdong, China.

BTL's Test Firm Registration Number for FCC: 357015

BTL's Designation Number for FCC: CN1240

## 1.2 MEASUREMENT UNCERTAINTY

ISO/IEC 17025 requires that an estimate of the measurement uncertainties associated with the emissions test results be included in the report. The measurement uncertainties given below are based on a 95% confidence level (based on a coverage factor (k=2))

The BTL measurement uncertainty as below table:

### A. AC power line conducted emissions test:

Test Site	Method	Measurement Frequency Range	U, (dB)
DG-C02	CISPR	150kHz ~ 30MHz	2.68

### B. Radiated emissions test:

Test Site	Method	Measurement Frequency Range	Ant. H / V	U, (dB)
DG-CB03	CISPR	9kHz ~ 30MHz	V	3.79
		9kHz ~ 30MHz	H	3.57
		30MHz ~ 200MHz	V	4.26
		30MHz ~ 200MHz	H	3.38
		200MHz ~ 1,000MHz	V	3.98
		200MHz ~ 1,000MHz	H	3.94
		1GHz ~ 6GHz	-	4.58
		6GHz ~ 18GHz	-	5.18
		18GHz ~ 26.5GHz	-	3.62
		26.5GHz ~ 40GHz	-	4.00

### C. Other Measurement:

Parameter	Uncertainty
Spectrum Bandwidth	±3.8 %
Maximum Output Power	±0.95 dB
Power Spectral Density	±0.86 dB
Frequency Stability	±0.16 dB
Temperature	±0.08 °C
Time	±0.58 %
Supply voltages	±0.3 %

Note: Unless specifically mentioned, the uncertainty of measurement has not been taken into account to declare the compliance or non-compliance to the specification.

**1.3 TEST ENVIRONMENT CONDITIONS**

Test Item	Temperature	Humidity	Test Voltage	Tested By
AC Power Line Conducted Emissions	25°C	60%	AC 120V/60Hz	Kwok Guo
Radiated Emissions-9K-30MHz	26°C	52%	AC 120V/60Hz	Kwok Guo
Radiated Emissions-30 MHz to 1GHz	26°C	52%	AC 120V/60Hz	Kwok Guo
Radiated Emissions-Above 1000 MHz	24°C	60%	AC 120V/60Hz	Kwok Guo
Spectrum Bandwidth	25°C	53%	AC 120V/60Hz	Hayden Chen
Maximum Output Power	25°C	53%	AC 120V/60Hz	Hand Huang
Power Spectral Density	25°C	53%	AC 120V/60Hz	Hayden Chen
Frequency Stability	Normal & Extreme	53%	Normal & Extreme	Hayden Chen



## 2. GENERAL INFORMATION

### 2.1 GENERAL DESCRIPTION OF EUT

Equipment	AC1200 Dual Band Wi-Fi Router
Brand Name	tp-link
Test Model	Archer C54
Series Model	N/A
Model Difference(s)	N/A
Power Source	DC voltage supplied from AC adapter. Model: T090085-2B1
Power Rating	I/P: 100-240V~ 50/60Hz 0.3A O/P: 9V $\overline{=}$ 0.85A
Operation Frequency Bands	UNII-1: 5150 MHz~5250 MHz UNII-3: 5725 MHz~5850 MHz
Modulation Type	OFDM
Bit Rate of Transmitter	IEEE 802.11a: 54/48/36/24/18/12/9/6 Mbps IEEE 802.11n: Up to 300 Mbps IEEE 802.11ac: Up to 866.7 Mbps
Maximum Output Power _UNII-1 Non Beamforming	IEEE 802.11a: 24.75 dBm (0.2985 W) IEEE 802.11ac (VHT20): 24.92 dBm (0.3105 W) IEEE 802.11ac (VHT40): 24.17 dBm (0.2612 W) IEEE 802.11ac (VHT80): 17.02 dBm (0.0504 W)
Maximum Output Power _UNII-3 Non Beamforming	IEEE 802.11a: 25.37 dBm (0.3443 W) IEEE 802.11ac (VHT20): 24.79 dBm (0.3013 W) IEEE 802.11ac (VHT40): 25.00 dBm (0.3162 W) IEEE 802.11ac (VHT80): 24.76 dBm (0.2992 W)
Maximum Output Power _UNII-1 Beamforming	IEEE 802.11ac (VHT20): 24.74 dBm (0.2979 W) IEEE 802.11ac (VHT40): 24.05 dBm (0.2541 W) IEEE 802.11ac (VHT80): 16.84 dBm (0.0483 W)
Maximum Output Power _UNII-3 Beamforming	IEEE 802.11ac (VHT20): 24.87 dBm (0.3069 W) IEEE 802.11ac (VHT40): 25.38 dBm (0.3451 W) IEEE 802.11ac (VHT80): 24.74 dBm (0.2979 W)

**Note:**

1. For a more detailed features description, please refer to the manufacturer's specifications or the user's manual.

**2. Channel List:**

IEEE 802.11a IEEE 802.11n (HT20) IEEE 802.11ac (VHT20)		IEEE 802.11n (HT40) IEEE 802.11ac (VHT40)		IEEE 802.11ac (VHT80)	
UNII-1		UNII-1		UNII-1	
Channel	Frequency (MHz)	Channel	Frequency (MHz)	Channel	Frequency (MHz)
36	5180	38	5190	42	5210
40	5200	46	5230		
44	5220				
48	5240				

IEEE 802.11a IEEE 802.11n (HT20) IEEE 802.11ac (VHT20)		IEEE 802.11n (HT40) IEEE 802.11ac (VHT40)		IEEE 802.11ac (VHT80)	
UNII-3		UNII-3		UNII-3	
Channel	Frequency (MHz)	Channel	Frequency (MHz)	Channel	Frequency (MHz)
149	5745	151	5755	155	5775
153	5765	159	5795		
157	5785				
161	5805				
165	5825				

**3. Antenna Specification:**

Ant.	Brand	Model Name	Antenna Type	Connector	Gain (dBi)
1	tp-link	N/A	Dipole	Weld	1.1
2	tp-link	N/A	Dipole	Weld	1.1

**Note:**

- This EUT supports CDD, and all antennas have the same gain, Directional gain =  $G_{ANT} + \text{Array Gain}$ . For power measurements, Array Gain=0dB ( $N_{ANT} \leq 4$ ), so the Directional gain=1.1. For power spectral density measurements,  $N_{ANT}=2$ ,  $N_{SS} = 1$ . So the Directional gain= $G_{ANT} + \text{Array Gain} = G_{ANT} + 10 \log(N_{ANT}/N_{SS}) \text{dBi} = 1.1 + 10 \log(2/1) \text{dBi} = 3.11$ .
- Beamforming Gain:3 dB. So Directional gain= $3 + 1.1 = 4.1$ .

4. Table for Antenna Configuration:  
For Non Beamforming:

Operating Mode	TX Mode	2TX
IEEE 802.11a		V (Ant. 1 + Ant. 2)
IEEE 802.11n (HT20)		V (Ant. 1 + Ant. 2)
IEEE 802.11n (HT40)		V (Ant. 1 + Ant. 2)
IEEE 802.11ac (VHT20)		V (Ant. 1 + Ant. 2)
IEEE 802.11ac (VHT40)		V (Ant. 1 + Ant. 2)
IEEE 802.11ac (VHT80)		V (Ant. 1 + Ant. 2)

For Beamforming:

Operating Mode	TX Mode	2TX
IEEE 802.11ac (VHT20)		V (Ant. 1 + Ant. 2)
IEEE 802.11ac (VHT40)		V (Ant. 1 + Ant. 2)
IEEE 802.11ac (VHT80)		V (Ant. 1 + Ant. 2)

## 2.2 TEST MODES

The test system was pre-tested based on the consideration of all possible combinations of EUT operation mode.

Pretest Mode	Description
Mode 1	TX A Mode / CH36, CH40, CH48 (UNII-1)
Mode 2	TX AC (VHT20) Mode / CH36, CH40, CH48 (UNII-1)
Mode 3	TX AC (VHT40) Mode / CH38, CH46 (UNII-1)
Mode 4	TX AC (VHT80) Mode / CH42 (UNII-1)
Mode 5	TX A Mode / CH149,CH157,CH165 (UNII-3)
Mode 6	TX AC (VHT20) Mode / CH149,CH157,CH165 (UNII-3)
Mode 7	TX AC (VHT40) Mode / CH151,CH159 (UNII-3)
Mode 8	TX AC (VHT80) Mode / CH155 (UNII-3)
Mode 9	TX AC(VHT40) Mode / CH159 (UNII-3)

Following mode(s) was (were) found to be the worst case(s) and selected for the final test.

<b>AC power line conducted emissions test</b>	
Final Test Mode	Description
Mode 9	TX AC(VHT40) Mode / CH159 (UNII-3)

<b>Radiated emissions test - Below 1GHz</b>	
Final Test Mode	Description
Mode 9	TX AC(VHT40) Mode / CH159 (UNII-3)

<b>Radiated emissions test - Above 1GHz_Non Beamforming</b>	
Final Test Mode	Description
Mode 1	TX A Mode / CH36, CH40, CH48 (UNII-1)
Mode 2	TX AC (VHT20) Mode / CH36, CH40, CH48 (UNII-1)
Mode 3	TX AC (VHT40) Mode / CH38, CH46 (UNII-1)
Mode 4	TX AC (VHT80) Mode / CH42 (UNII-1)
Mode 5	TX A Mode / CH149,CH157,CH165 (UNII-3)
Mode 6	TX AC (VHT20) Mode / CH149,CH157,CH165 (UNII-3)
Mode 7	TX AC (VHT40) Mode / CH151,CH159 (UNII-3)
Mode 8	TX AC (VHT80) Mode / CH155 (UNII-3)

<b>Radiated emissions test - Above 1GHz_Beamforming</b>	
Final Test Mode	Description
Mode 2	TX AC (VHT20) Mode / CH36, CH40, CH48 (UNII-1)
Mode 3	TX AC (VHT40) Mode / CH38, CH46 (UNII-1)
Mode 4	TX AC (VHT80) Mode / CH42 (UNII-1)
Mode 6	TX AC (VHT20) Mode / CH149,CH157,CH165 (UNII-3)
Mode 7	TX AC (VHT40) Mode / CH151,CH159 (UNII-3)
Mode 8	TX AC (VHT80) Mode / CH155 (UNII-3)

<b>Maximum Output Power &amp; Power Spectral Density_Non Beamforming</b>	
Final Test Mode	Description
Mode 1	TX A Mode / CH36, CH40, CH48 (UNII-1)
Mode 2	TX AC (VHT20) Mode / CH36, CH40, CH48 (UNII-1)
Mode 3	TX AC (VHT40) Mode / CH38, CH46 (UNII-1)
Mode 4	TX AC (VHT80) Mode / CH42 (UNII-1)
Mode 5	TX A Mode / CH149,CH157,CH165 (UNII-3)
Mode 6	TX AC (VHT20) Mode / CH149,CH157,CH165 (UNII-3)
Mode 7	TX AC (VHT40) Mode / CH151,CH159 (UNII-3)
Mode 8	TX AC (VHT80) Mode / CH155 (UNII-3)

<b>Maximum Output Power &amp; Power Spectral Density_Beamforming</b>	
Final Test Mode	Description
Mode 2	TX AC (VHT20) Mode / CH36, CH40, CH48 (UNII-1)
Mode 3	TX AC (VHT40) Mode / CH38, CH46 (UNII-1)
Mode 4	TX AC (VHT80) Mode / CH42 (UNII-1)
Mode 6	TX AC (VHT20) Mode / CH149,CH157,CH165 (UNII-3)
Mode 7	TX AC (VHT40) Mode / CH151,CH159 (UNII-3)
Mode 8	TX AC (VHT80) Mode / CH155 (UNII-3)

<b>Other Conducted test_Non Beamforming</b>	
Final Test Mode	Description
Mode 1	TX A Mode / CH36, CH40, CH48 (UNII-1)
Mode 2	TX AC (VHT20) Mode / CH36, CH40, CH48 (UNII-1)
Mode 3	TX AC (VHT40) Mode / CH38, CH46 (UNII-1)
Mode 4	TX AC (VHT80) Mode / CH42 (UNII-1)
Mode 5	TX A Mode / CH149,CH157,CH165 (UNII-3)
Mode 6	TX AC (VHT20) Mode / CH149,CH157,CH165 (UNII-3)
Mode 7	TX AC (VHT40) Mode / CH151,CH159 (UNII-3)
Mode 8	TX AC (VHT80) Mode / CH155 (UNII-3)

**Note:**

- (1) For radiated emission below 1 GHz test, the IEEE 802.11ac40 channel 159 is found to be the worst case and recorded.
- (2) For radiated emission above 1 GHz test, 1GHz~26.5GHz and 26.5GHz~40GHz have been pre-tested and in this report only recorded the worst case. The remaining spurious points are all below the limit value of 20dB.
- (3) The measurements for RF Output Power were tested, the Non Beamforming and Beamforming are recorded in the report. The worst case was Non Beamforming and only worst case were documented for other test items except power spectral density and radiated rmissions above 1GHz.
- (4) VHT20/VHT40 covers HT20/HT40, due to same modulation. The power setting for 802.11n HT20 and HT40 are the same or lower than 802.11ac VHT20 and VHT40.
- (5) For Radiated emissions above 1GHz test, the vertical and horizontal polarities have tested, the worst case is vertical and recorded.

**2.3 PARAMETERS OF TEST SOFTWARE**
**Non Beamforming**

UNII-1			
Test Software	N/A		
Test Frequency (MHz)	5180	5200	5240
IEEE 802.11a	34	41	36
IEEE 802.11ac (VHT20)	34	42	36
Test Frequency (MHz)	5190	5230	
IEEE 802.11ac (VHT40)	27	39	
Test Frequency (MHz)	5210		
IEEE 802.11ac (VHT80)	21		

UNII-3			
Test Software	N/A		
Test Frequency (MHz)	5745	5785	5825
IEEE 802.11a	44	44	44
IEEE 802.11ac (VHT20)	42	42	42
Test Frequency (MHz)	5755	5795	
IEEE 802.11ac (VHT40)	43	43	
Test Frequency (MHz)	5775		
IEEE 802.11ac (VHT80)	44		

**Beamforming**

UNII-1			
Test Software	N/A		
Test Frequency (MHz)	5180	5200	5240
IEEE 802.11ac (VHT20)	33	42	36
Test Frequency (MHz)	5190	5230	
IEEE 802.11ac (VHT40)	27	39	
Test Frequency (MHz)	5210		
IEEE 802.11ac (VHT80)	21		

UNII-3			
Test Software	N/A		
Test Frequency (MHz)	5745	5785	5825
IEEE 802.11ac (VHT20)	42	42	42
Test Frequency (MHz)	5755	5795	
IEEE 802.11ac (VHT40)	43	43	
Test Frequency (MHz)	5775		
IEEE 802.11ac (VHT80)	45		

## 2.4 DUTY CYCLE

If duty cycle is  $\geq 98\%$ , duty factor is not required.  
 If duty cycle is  $< 98\%$ , duty factor shall be considered.  
 The output power = measured power + duty factor.  
 The power spectral density = measured power spectral density + duty factor.

**IEEE 802.11a**

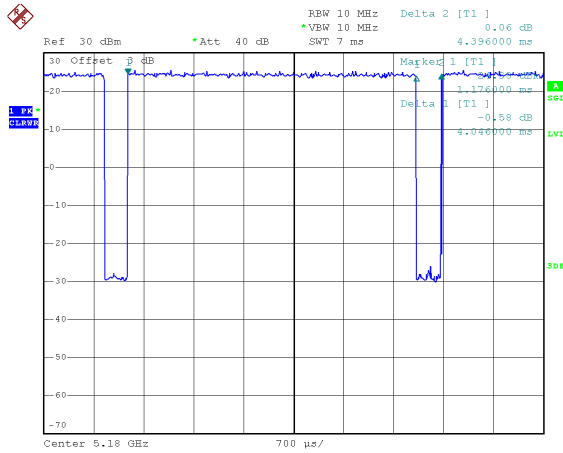

Date: 24.AUG.2020 19:32:35

Duty cycle =  $4.046 \text{ ms} / 4.396 \text{ ms} = 92.04\%$   
 Duty Factor =  $10\log(1 / \text{Duty cycle}) = 0.36$

**IEEE 802.11ac (VHT20)**

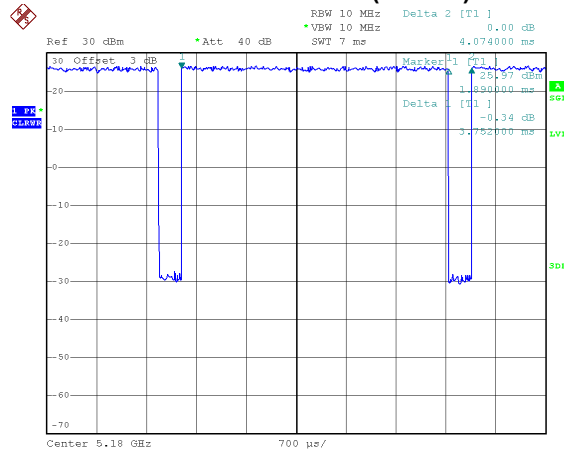

Date: 24.AUG.2020 19:40:34

Duty cycle =  $3.752 \text{ ms} / 4.074 \text{ ms} = 92.10\%$   
 Duty Factor =  $10\log(1 / \text{Duty cycle}) = 0.36$

**IEEE 802.11ac (VHT40)**

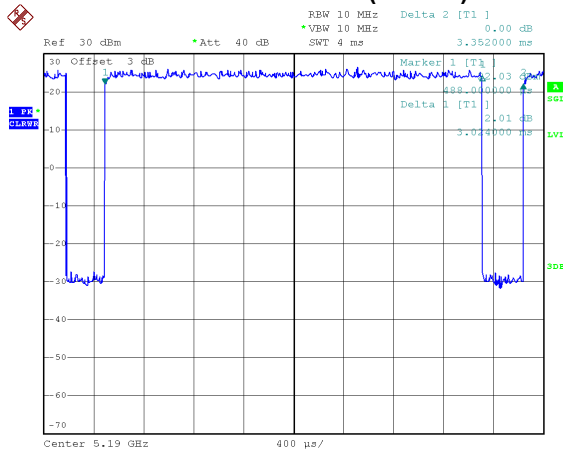

Date: 24.AUG.2020 19:44:08

Duty cycle =  $3.024 \text{ ms} / 3.352 \text{ ms} = 90.21\%$   
 Duty Factor =  $10\log(1 / \text{Duty cycle}) = 0.45$

**IEEE 802.11ac (VHT80)**

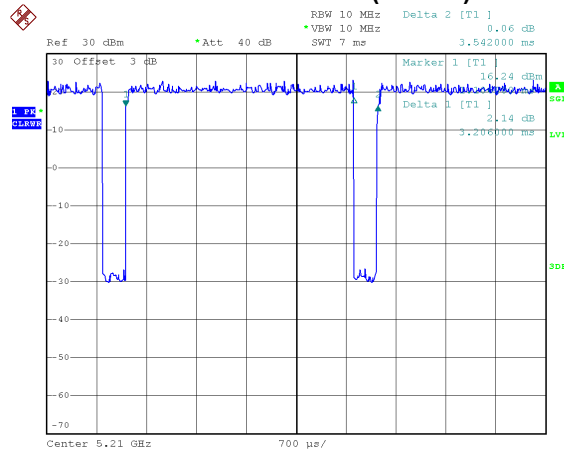

Date: 24.AUG.2020 19:49:59

Duty cycle =  $3.206 \text{ ms} / 3.542 \text{ ms} = 90.51\%$   
 Duty Factor =  $10\log(1 / \text{Duty cycle}) = 0.43$

**NOTE:**

- For IEEE 802.11a and IEEE 802.11ac (VHT20):  
 For radiated emissions frequency above 1 GHz, the resolution bandwidth of test receiver/spectrum analyzer is 1 MHz and the video bandwidth is 1 kHz (Duty cycle  $< 98\%$ ).
- For IEEE 802.11ac (VHT40):  
 For radiated emissions frequency above 1 GHz, the resolution bandwidth of test receiver/spectrum analyzer is 1 MHz and the video bandwidth is 2 kHz (Duty cycle  $< 98\%$ ).
- For IEEE 802.11ac (VHT80):  
 For radiated emissions frequency above 1 GHz, the resolution bandwidth of test receiver/spectrum analyzer is 1 MHz and the video bandwidth is 3 kHz (Duty cycle  $< 98\%$ ).



## 2.5 BLOCK DIAGRAM SHOWING THE CONFIGURATION OF SYSTEM TESTED

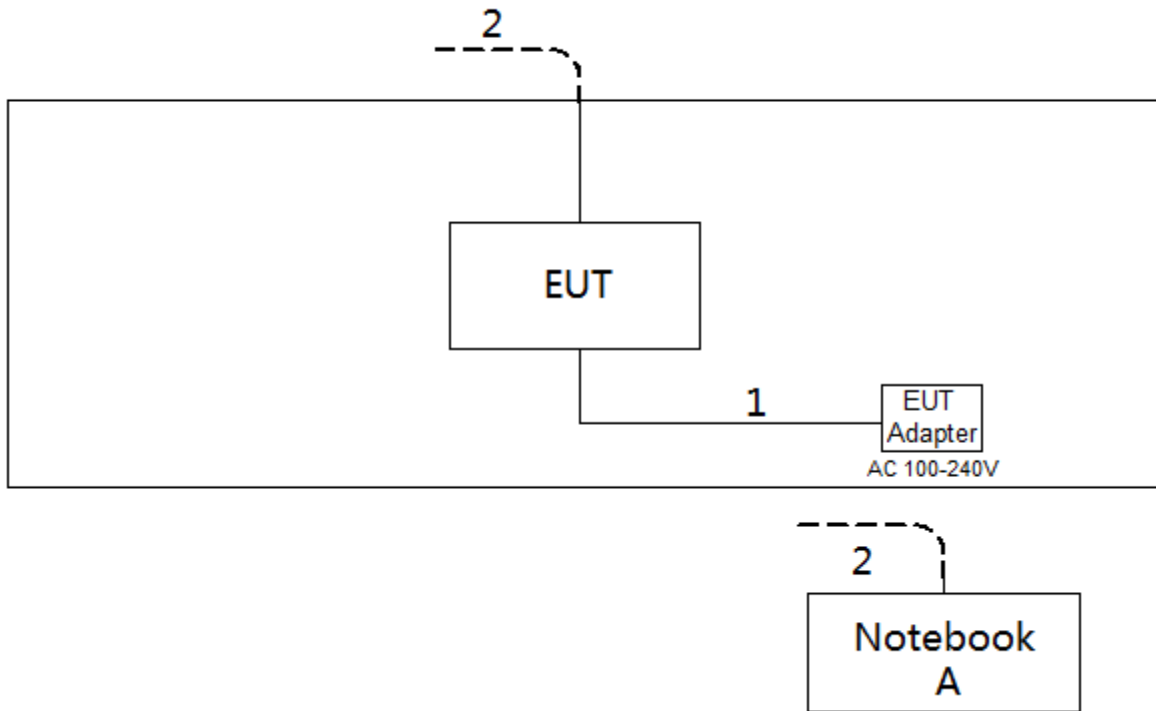

## 2.6 SUPPORT UNITS

Item	Equipment	Brand	Model No.	Series No.
A	Notebook	Dell	Inspiron 15-7559	N/A

Item	Cable Type	Shielded Type	Ferrite Core	Length
1	DC Cable	NO	NO	1.5m
2	RJ45 Cable	NO	NO	10m

### 3. AC POWER LINE CONDUCTED EMISSIONS TEST

#### 3.1 LIMIT

Frequency (MHz)	Limit (dB $\mu$ V)	
	Quasi-peak	Average
0.15 - 0.5	66 to 56*	56 to 46*
0.5 - 5.0	56	46
5.0 - 30.0	60	50

**NOTE:**

- (1) The tighter limit applies at the band edges.
- (2) The limit of " \* " marked band means the limitation decreases linearly with the logarithm of the frequency in the range.

The following table is the setting of the receiver

Receiver Parameter	Setting
Attenuation	10 dB
Start Frequency	0.15 MHz
Stop Frequency	30 MHz
IF Bandwidth	9 KHz

#### 3.2 TEST PROCEDURE

- a. The EUT was placed 0.8 meters from the horizontal ground plane with EUT being connected to the power mains through a line impedance stabilization network (LISN). All other support equipment powered from additional LISN(s). The LISN provide 50 Ohm/ 50uH of coupling impedance for the measuring instrument.
- b. Interconnecting cables that hang closer than 40 cm to the ground plane shall be folded back and forth in the center forming a bundle 30 to 40 cm long.
- c. I/O cables that are not connected to a peripheral shall be bundled in the center. The end of the cable may be terminated, if required, using the correct terminating impedance. The overall length shall not exceed 1 m.
- d. LISN at least 80 cm from nearest part of EUT chassis.
- e. For the actual test configuration, please refer to the related Item -EUT Test Photos.

#### 3.3 DEVIATION FROM TEST STANDARD

No deviation

### 3.4 TEST SETUP

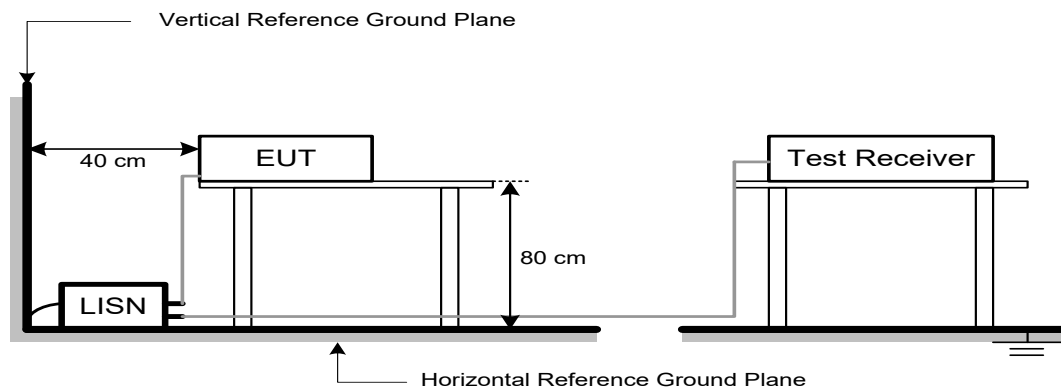

### 3.5 EUT OPERATION CONDITIONS

The EUT was configured for testing in a typical fashion (as a customer would normally use it). The EUT has been programmed to continuously transmit during test. This operating condition was tested and used to collect the included data.

The EUT was programmed to be in continuously transmitting/TX mode.

### 3.6 TEST RESULTS

Please refer to the APPENDIX A.

#### 4. RADIATED EMISSIONS TEST

##### 4.1 LIMIT

In case the emission fall within the restricted band specified on 15.205(a), then the 15.209(a) limit in the table below has to be followed.

##### LIMITS OF RADIATED EMISSIONS MEASUREMENT (9 kHz to 1000 MHz)

Frequency (MHz)	Field Strength (microvolts/meter)	Measurement Distance (meters)
0.009-0.490	2400/F(kHz)	300
0.490-1.705	24000/F(kHz)	30
1.705-30.0	30	30
30-88	100	3
88-216	150	3
216-960	200	3
Above 960	500	3

##### LIMITS OF UNWANTED EMISSION OUT OF THE RESTRICTED BANDS

Frequency (MHz)	EIRP Limit (dBm/MHz)	Equivalent Field Strength at 3m (dBμV/m)
5150-5250	-27	68.3
5725-5850	-27 NOTE (2)	68.3
	10 NOTE (2)	105.3
	15.6 NOTE (2)	110.9
	27 NOTE (2)	122.3

##### NOTE:

- (1) The following formula is used to convert the equipment isotropic radiated power (eirp) to field strength:

$$E = \frac{1000000\sqrt{30P}}{3} \mu\text{V/m, where P is the eirp (Watts)}$$

- (2) According to 15.407(b)(4)(i), all emissions shall be limited to a level of -27 dBm/MHz at 75 MHz or more above or below the band edge increasing linearly to 10 dBm/MHz at 25 MHz above or below the band edge, and from 25 MHz above or below the band edge increasing linearly to a level of 15.6 dBm/MHz at 5 MHz above or below the band edge, and from 5 MHz above or below the band edge increasing linearly to a level of 27 dBm/MHz at the band edge.

#### 4.2 TEST PROCEDURE

- a. The measuring distance of 3 m shall be used for measurements. The EUT was placed on the top of a rotating table 0.8 meter above the ground at a 3 meter semi-anechoic chamber. The table was rotated 360 degrees to determine the position of the highest radiation.(below 1GHz)
- b. The measuring distance of 3 m shall be used for measurements. The EUT was placed on the top of a rotating table 1.5 meter above the ground at a 3 meter semi-anechoic chamber. The table was rotated 360 degrees to determine the position of the highest radiation.(above 1GHz)
- c. The height of the equipment or of the substitution antenna shall be 0.8m or 1.5m; the height of the test antenna shall vary between 1 m to 4 m. Both horizontal and vertical polarizations of the antenna are set to make the measurement.
- d. For each suspected emission, the EUT was arranged to its worst case and then the antenna was tuned to heights find the maximum reading (used Bore sight function).
- e. The receiver system was set to peak and average detect function and specified bandwidth with maximum hold mode when the test frequency is above 1 GHz.
- f. The initial step in collecting radiated emission data is a receiver peak detector mode pre-scanning the measurement frequency range. Significant peaks are then marked and then Quasi Peak detector mode re-measured.
- g. All readings are Peak unless otherwise stated QP in column of Note. Peak denotes that the Peak reading compliance with the QP Limits and then QP Mode measurement didn't perform.  
(below 1 GHz)
- h. All readings are Peak Mode value unless otherwise stated AVG in column of Note. If the Peak Mode Measured value compliance with the Peak Limits and lower than AVG Limits, the EUT shall be deemed to meet both Peak & AVG Limits and then only Peak Mode was measured, but AVG Mode didn't perform. (above 1 GHz)
- i. For the actual test configuration, please refer to the related Item –EUT Test Photos.

#### 4.3 DEVIATION FROM TEST STANDARD

No deviation

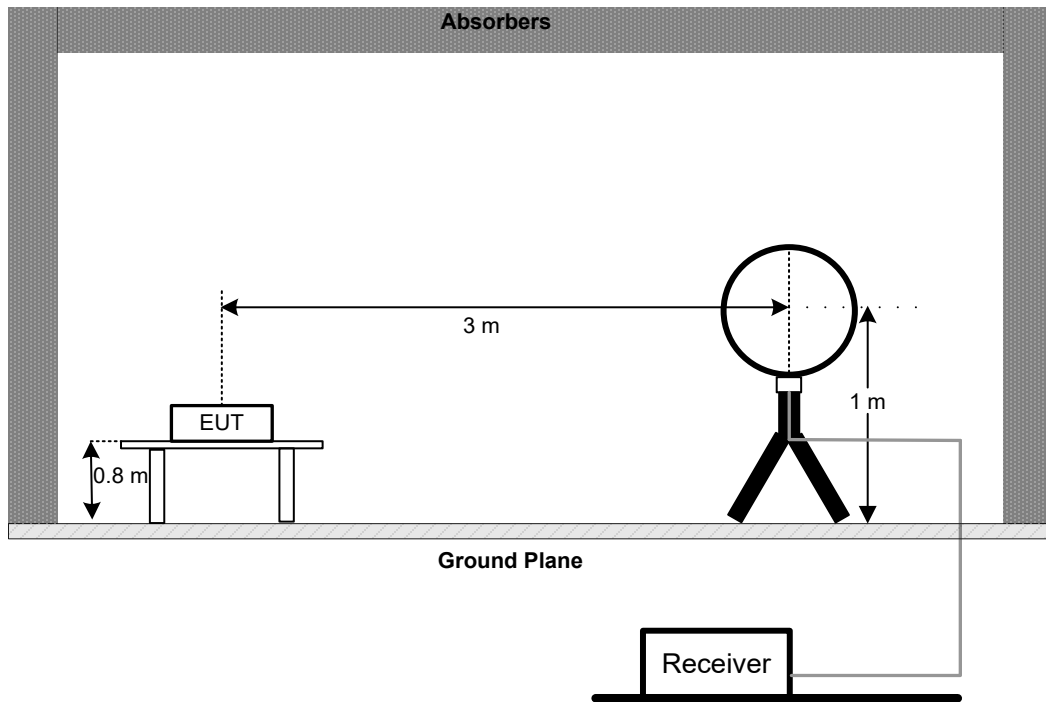
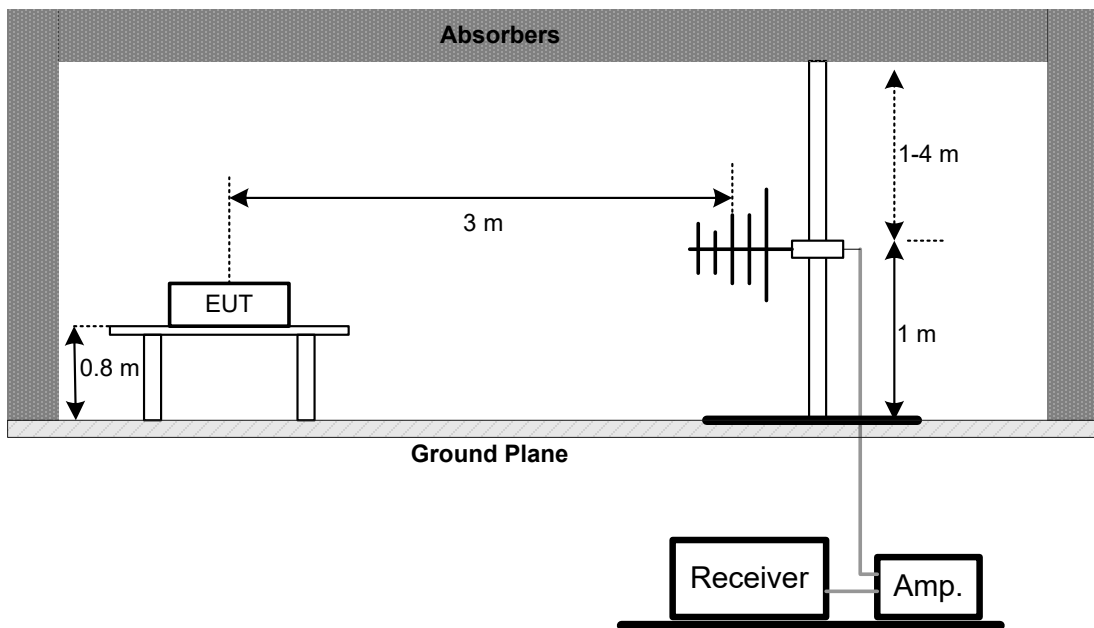
**4.4 TEST SETUP****9 kHz to 30 MHz****30 MHz to 1 GHz**

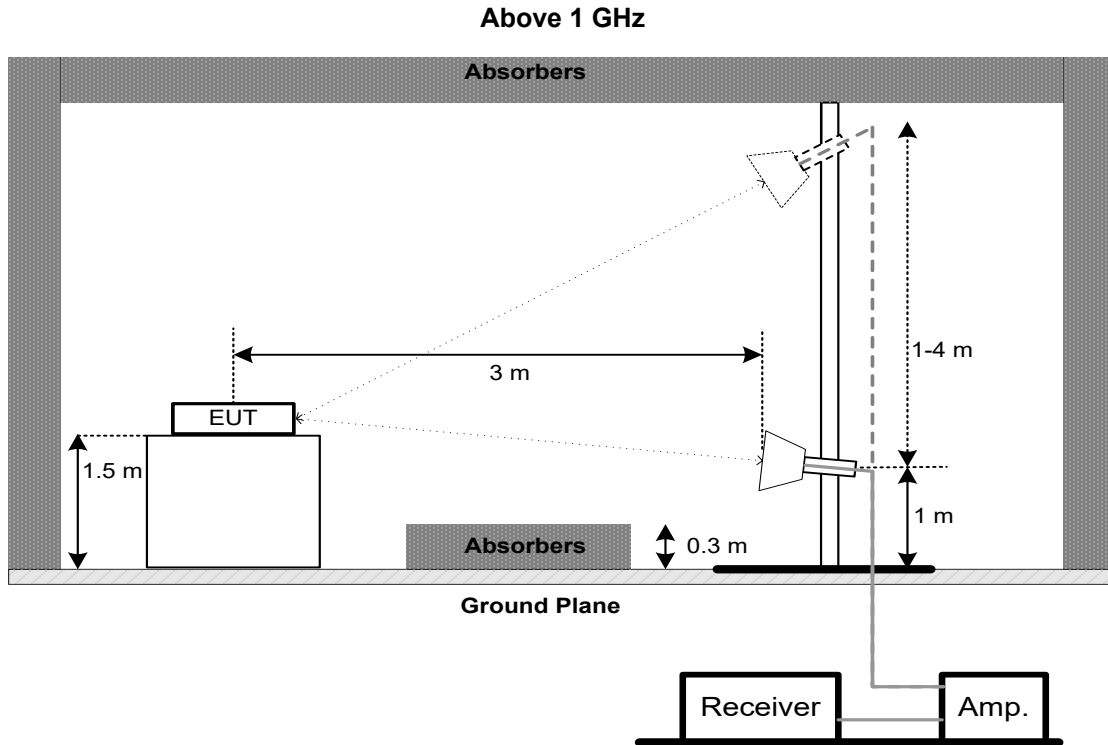

#### 4.5 EUT OPERATION CONDITIONS

The EUT tested system was configured as the statements of 3.5 unless otherwise a special operating condition is specified in the follows during the testing.

#### 4.6 TEST RESULTS - 9 KHZ to 30 MHZ

Please refer to the APPENDIX B

Remark:

- (1) Distance extrapolation factor =  $40 \log (\text{specific distance} / \text{test distance})$  (dB).
- (2) Limit line = specific limits (dBuV) + distance extrapolation factor.

#### 4.7 TEST RESULTS - 30 MHZ TO 1000 MHZ

Please refer to the APPENDIX C.

#### 4.8 TEST RESULTS - ABOVE 1000 MHZ

Please refer to the APPENDIX D.

Remark:

- (1) No limit: This is fundamental signal, the judgment is not applicable.  
For fundamental signal judgment was referred to Peak output test.

**5. BANDWIDTH TEST**

**5.1 LIMIT**

FCC Part15, Subpart E (15.407)			
Section	Test Item	Limit	Frequency Range (MHz)
15.407(a)	26 dB Bandwidth	-	5150-5250
15.407(e)	6 dB Bandwidth	Minimum 500 kHz	5725-5850

**5.2 TEST PROCEDURE**

- a. The EUT was directly connected to the spectrum analyzer and antenna output port as show in the block diagram below
- b. Spectrum Setting:  
For UNII-1:

Spectrum Parameter	Setting
Attenuation	Auto
Span Frequency	> 26 dB Bandwidth
RBW	300 kHz (Bandwidth 20 MHz and 40 MHz) 1 MHz (Bandwidth 80 MHz)
VBW	1 MHz (Bandwidth 20 MHz and 40 MHz) 3 MHz (Bandwidth 80 MHz)
Detector	Peak
Trace	Max Hold
Sweep Time	Auto

For UNII-3:

Spectrum Parameter	Setting
Attenuation	Auto
Span Frequency	6 dB Bandwidth
RBW	100 kHz
VBW	300 kHz
Detector	Peak
Trace	Max Hold
Sweep Time	Auto

- c. Measured the spectrum width with power higher than 26 dB / 6 dB below carrier.

**5.3 DEVIATION FROM STANDARD**

No deviation.

**5.4 TEST SETUP**

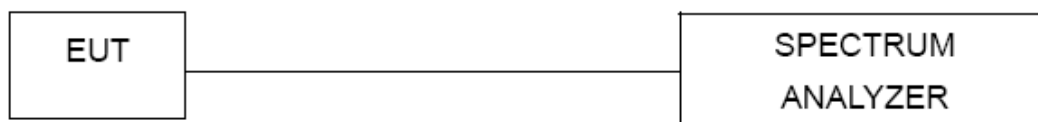

**5.5 EUT OPERATION CONDITIONS**

The EUT was programmed to be in continuously transmitting mode.

**5.6 TEST RESULTS**

Please refer to the APPENDIX E.



**6. MAXIMUM OUTPUT POWER TEST**

**6.1 LIMIT**

FCC Part15, Subpart E (15.407)			
Section	Test Item	Limit	Frequency Range (MHz)
15.407(a)	Maximum Output Power	AP device: 1 Watt (30 dBm) Client device: 250 mW (24 dBm)	5150-5250
		1 Watt (30dBm)	5725-5850

Note:

- a. For an indoor access point operating in the band 5.15-5.25 GHz, the maximum Output Power over the frequency band of operation shall not exceed 1 W provided the maximum antenna gain does not exceed 6 dBi. In addition, the maximum power spectral density shall not exceed 17 dBm in any 1 megahertz band. If transmitting antennas of directional gain greater than 6 dBi are used, both the maximum Output Power and the maximum power spectral density shall be reduced by the amount in dB that the directional gain of the antenna exceeds 6 dBi.

**6.2 TEST PROCEDURE**

- a. The EUT was directly connected to the power meter and antenna output port as show in the block diagram below.
- b. Test test was performed in accordance with method of FCC KDB 789033 D02 General UNII Test Procedures New Rules v02r01.

**6.3 DEVIATION FROM STANDARD**

No deviation.

**6.4 TEST SETUP**



**6.5 EUT OPERATION CONDITIONS**

The EUT was programmed to be in continuously transmitting mode.

**6.6 TEST RESULTS**

Please refer to the APPENDIX F.

## 7. POWER SPECTRAL DENSITY TEST

### 7.1 LIMIT

FCC Part15, Subpart E (15.407)			
Section	Test Item	Limit	Frequency Range (MHz)
15.407(a)	Power Spectral Density	AP device: 17 dBm/MHz	5150-5250
		Client device: 11 dBm/MHz	
		30 dBm/500 kHz	5725-5850

### 7.2 TEST PROCEDURE

- The EUT was directly connected to the spectrum analyzer and antenna output port as show in the block diagram below.
- Spectrum Setting

Spectrum Parameter	Setting
Attenuation	Auto
Span Frequency	Encompass the entire emissions bandwidth (EBW) of the signal
RBW	= 1 MHz.
VBW	≥ 3 MHz.
Detector	RMS
Trace average	100 trace
Sweep Time	Auto

Note:

- For UNII-3, according to KDB publication 789033 D02 General UNII Test Procedures New Rules v02r01, section II.F.5., it is acceptable to set RBW at 100kHz and VBW at 300kHz if the spectrum analyzer does not have 500 kHz RBW.
- The value measured with RBW=100kHz is to be added with  $10\log(500 \text{ kHz}/100\text{kHz})$  which is +7 dB. During the test, the offset has added 7 dB, For example, if the offset value is +3dB , then the converted value will be  $3+7=10\text{dB}$  using RBW=100kHz.

### 7.3 DEVIATION FROM STANDARD

No deviation.

### 7.4 TEST SETUP



### 7.5 EUT OPERATION CONDITIONS

The EUT was programmed to be in continuously transmitting mode.

### 7.6 TEST RESULTS

Please refer to the APPENDIX G.

## 8. FREQUENCY STABILITY MEASUREMENT

### 8.1 LIMIT

FCC Part15, Subpart E (15.407)			
Section	Test Item	Limit	Frequency Range (MHz)
15.407(g)	Frequency Stability	An emission is maintained within the band of operation under all conditions of normal operation as specified in the users manual.	5150-5250
			5725-5850

### 8.2 TEST PROCEDURE

- The EUT was directly connected to the spectrum analyzer and antenna output port as show in the block diagram below.
- Spectrum Setting:

Spectrum Parameter	Setting
Attenuation	Auto
Span Frequency	Entire absence of modulation emissions bandwidth
RBW	10 kHz
VBW	10 kHz
Sweep Time	Auto

- The test extreme voltage is to change the primary supply voltage from 85 to 115 percent of the nominal value.
- User manual temperature is 0°C~40°C.

### 8.3 DEVIATION FROM STANDARD

No deviation.

### 8.4 TEST SETUP

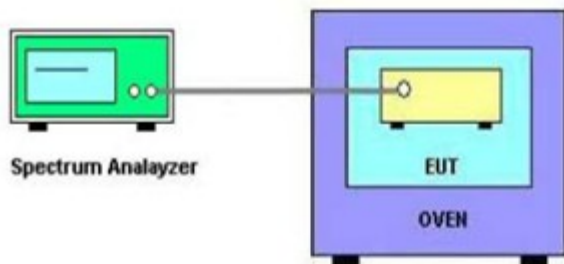

### 8.5 EUT OPERATION CONDITIONS

The EUT was programmed to be in continuously transmitting mode.

### 8.6 TEST RESULTS

Please refer to the APPENDIX H.

## 9. MEASUREMENT INSTRUMENTS LIST

AC Power Line Conducted Emissions					
Item	Kind of Equipment	Manufacturer	Type No.	Serial No.	Calibrated until
1	EMI Test Receiver	R&S	ESCI	100382	Feb. 28, 2021
2	LISN	EMCO	3816/2	52765	Mar. 01, 2021
3	TWO-LINE V-NETWORK	R&S	ENV216	101447	Feb. 28, 2021
4	50Ω Terminator	SHX	TF5-3	15041305	Mar. 01, 2021
5	Measurement Software	Farad	EZ-EMC Ver.NB-03A1-01	N/A	N/A
6	Cable	N/A	RG223	12m	Mar. 10, 2021
7	643 Shield Room	ETS	6*4*3m	N/A	N/A

Radiated Emissions - 9 kHz to 30 MHz					
Item	Kind of Equipment	Manufacturer	Type No.	Serial No.	Calibrated until
1	Antenna	EM	EM-6876-1	230	Apr. 16, 2021
2	Cable	N/A	RG 213/U	N/A	May 29, 2021
3	EMI Test Receiver	R&S	ESCI	100895	Feb. 28, 2021
4	Measurement Software	Farad	EZ-EMC Ver.NB-03A1-01	N/A	N/A
5	966 Chambe Room	RM	9*6*6m	N/A	Jul. 25, 2021

Radiated Emissions - 30 MHz to 1 GHz					
Item	Kind of Equipment	Manufacturer	Type No.	Serial No.	Calibrated until
1	Antenna	Schwarzbeck	VULB9160	9160-3232	Mar. 09, 2021
2*	Amplifier	HP	8447D	2944A09673	Aug. 11, 2021
3	Receiver	Agilent	N9038A	MY52130039	Jul. 25, 2021
4	Cable	emci	LMR-400(30MHz-1 GHz)(8m+5m)	N/A	May 22, 2021
5	Controller	CT	SC100	N/A	N/A
6	Controller	MF	MF-7802	MF780208416	N/A
7	Measurement Software	Farad	EZ-EMC Ver.NB-03A1-01	N/A	N/A
8	966 Chambe Room	RM	9*6*6m	N/A	Jul. 25, 2021

Radiated Emissions - Above 1 GHz					
Item	Kind of Equipment	Manufacturer	Type No.	Serial No.	Calibrated until
1	Double Ridged Guide Antenna	ETS	3115	75789	May 12, 2021
2	Broad-Band Horn Antenna	Schwarzbeck	BBHA 9170	9170319	Jul. 07, 2021
3	Amplifier	Agilent	8449B	3008A02333	Mar. 01, 2021
4	Microwave Preampifier With Adaptor	EMC INSTRUMENT	EMC2654045	980039 & HA01	Mar. 07, 2021
5	Receiver	Agilent	N9038A	MY52130039	Jul. 25, 2021
6	Controller	CT	SC100	N/A	N/A
7	Controller	MF	MF-7802	MF780208416	N/A
8	Cable	N/A	EMC104-SM-SM-6 000	N/A	May 09, 2021
9	Measurement Software	Farad	EZ-EMC Ver.NB-03A1-01	N/A	N/A
10	Band Reject Filter	Micro-Tronics	BRC50705-01	10	Feb. 28, 2021
11	Band Reject Filter	Micro-Tronics	BRC50703-01	7	Feb. 28, 2021
12	966 Chambe Room	RM	9*6*6m	N/A	Jul. 25, 2021

Bandwidth & Power Spectral Density					
Item	Kind of Equipment	Manufacturer	Type No.	Serial No.	Calibrated until
1	Spectrum Analyzer	R&S	FSP40	100185	Jul. 25, 2021
2	RF Cable	Tongkaichuan	N/A	N/A	N/A
3	DC Block	Mini	N/A	N/A	N/A

Maximum Output Power					
Item	Kind of Equipment	Manufacturer	Type No.	Serial No.	Calibrated until
1	Peak Power Analyzer	Keysight	8990B	MY51000506	Aug. 07, 2021
2	Wideband power sensor	Keysight	N1923A	MY58310004	Jul. 25, 2021
3	Attenuator	WOKEN	6SM3502	VAS1214NL	Feb. 11, 2021
4	RF Cable	Tongkaichuan	N/A	N/A	N/A

Frequency Stability					
Item	Kind of Equipment	Manufacturer	Type No.	Serial No.	Calibrated until
1	Spectrum Analyzer	R&S	FSP40	100185	Jul. 25, 2021
2	Precision Oven Tester	CEPREI	CEEC-M64T-40	15-008	Feb. 28, 2021
3	RF Cable	Tongkaichuan	N/A	N/A	N/A
4	DC Block	Mini	N/A	N/A	N/A

Remark: "N/A" denotes no model name, serial no. or calibration specified.

"\*" calibration period of equipment list is three year.

Except \* item, all calibration period of equipment list is one year.

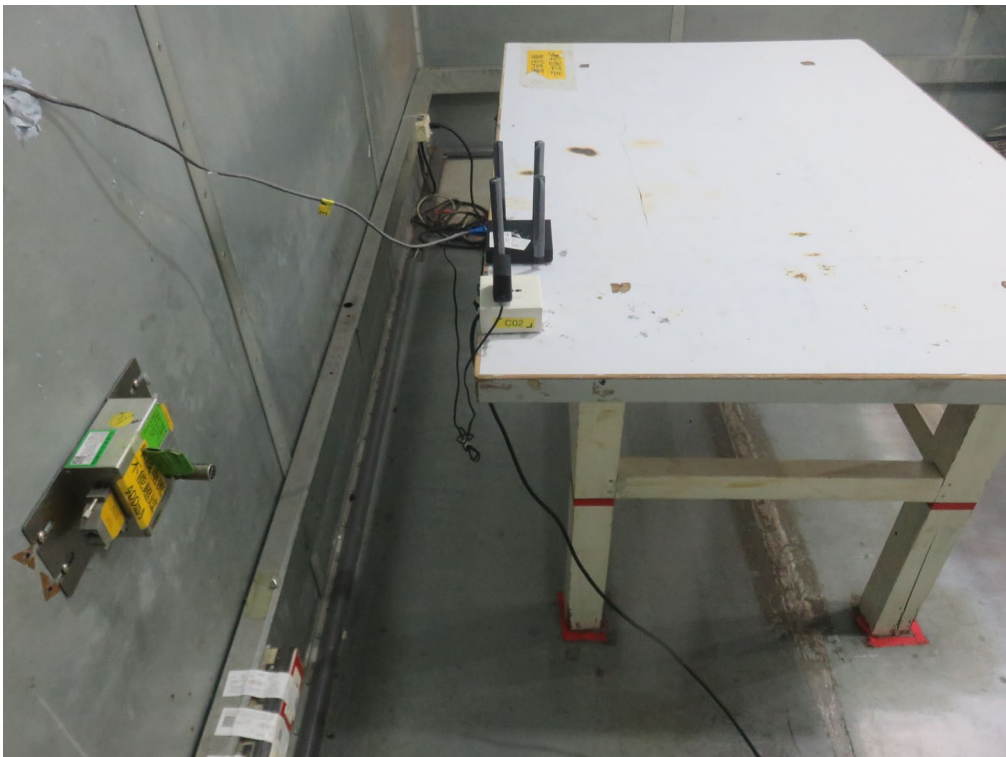
**10. EUT TEST PHOTOS****AC Power Line Conducted Emissions Test Photos**

**Radiated Emissions Test Photos**

**9 kHz to 30 MHz**



**Radiated Emissions Test Photos**

**30 MHz to 1 GHz**

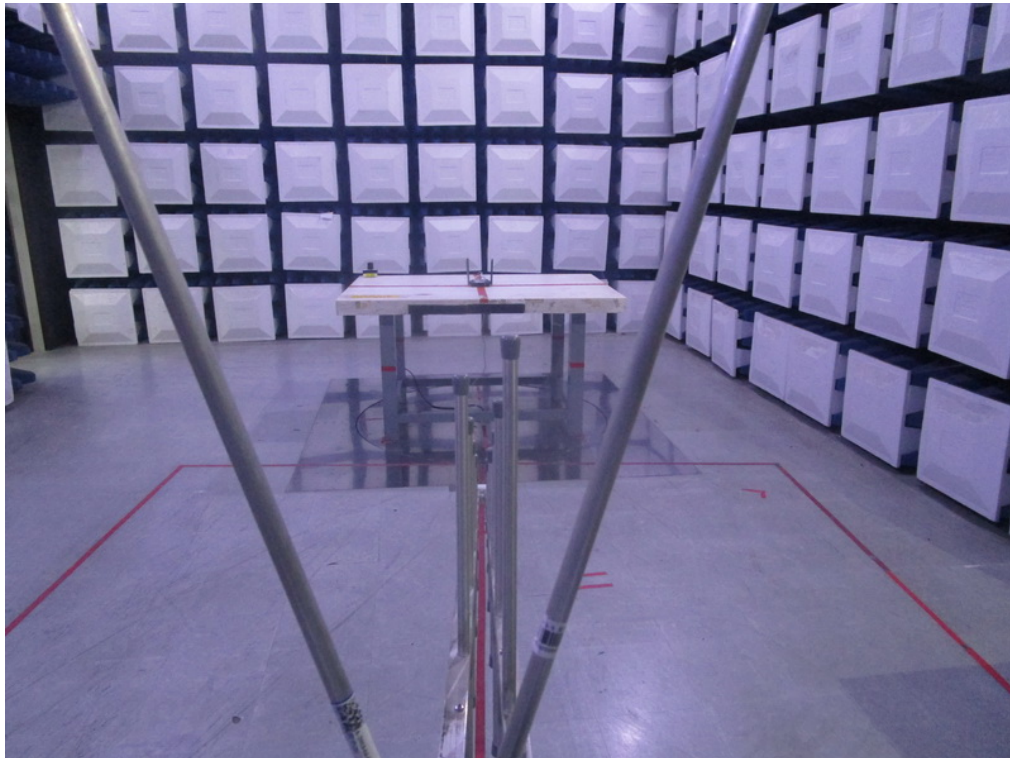



**Radiated Emissions Test Photos**

**Above 1 GHz**

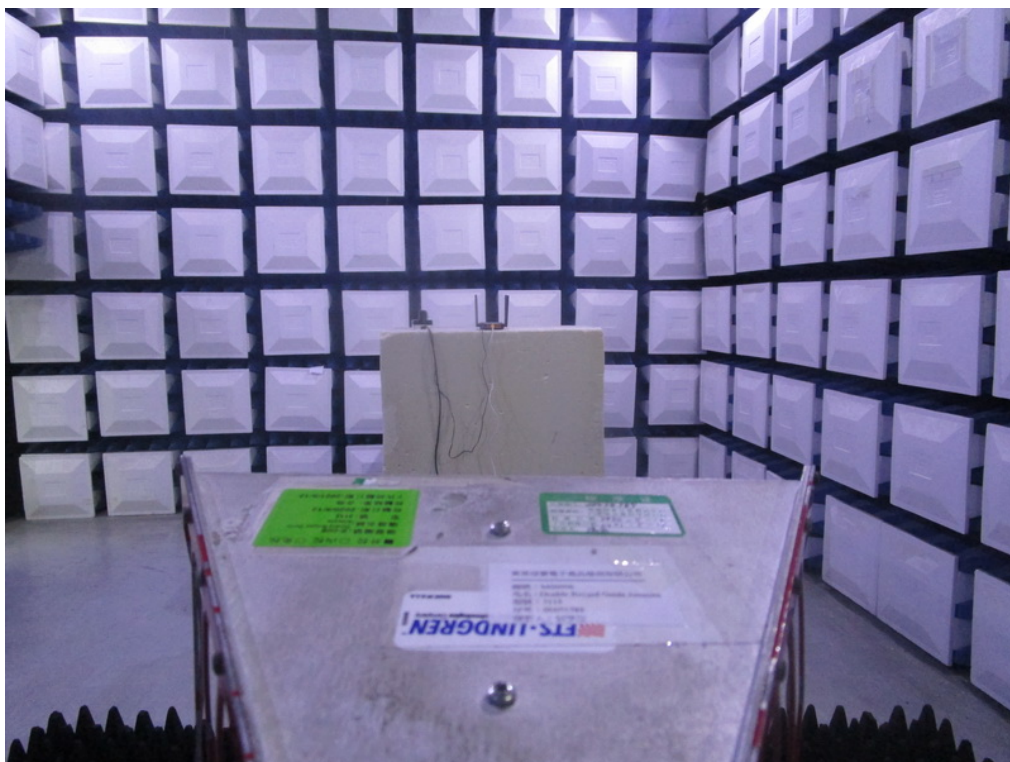

**Conducted Test Photos**

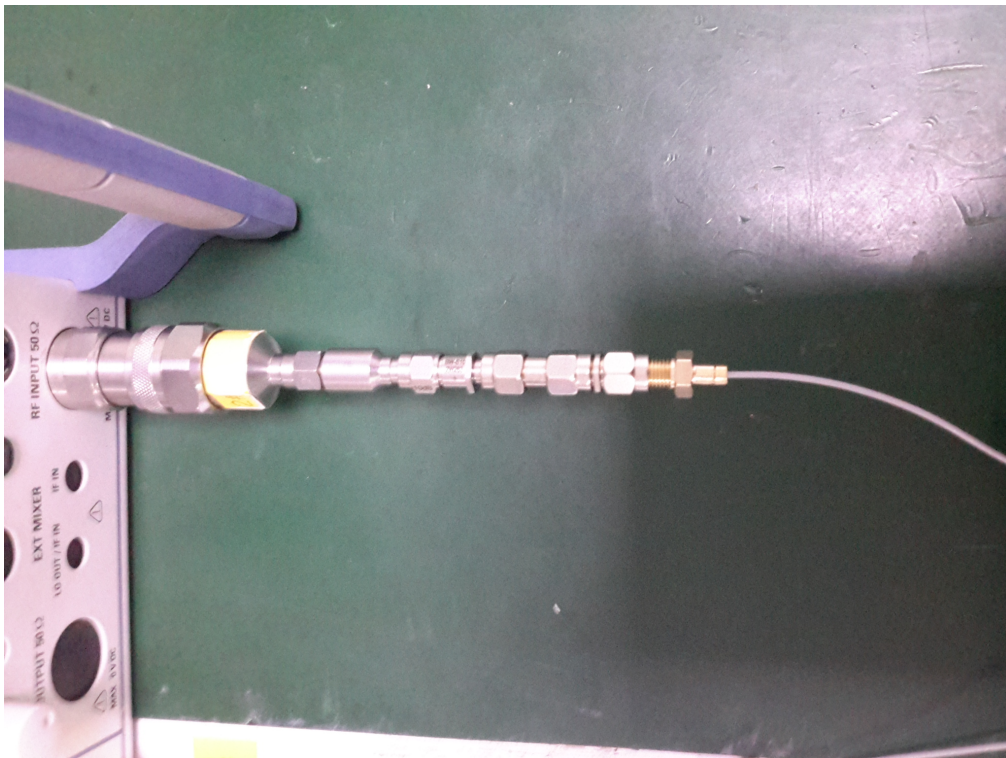

## **APPENDIX A - AC POWER LINE CONDUCTED EMISSIONS**

Test Mode: TX AC40 MODE CHANNEL 159

Line

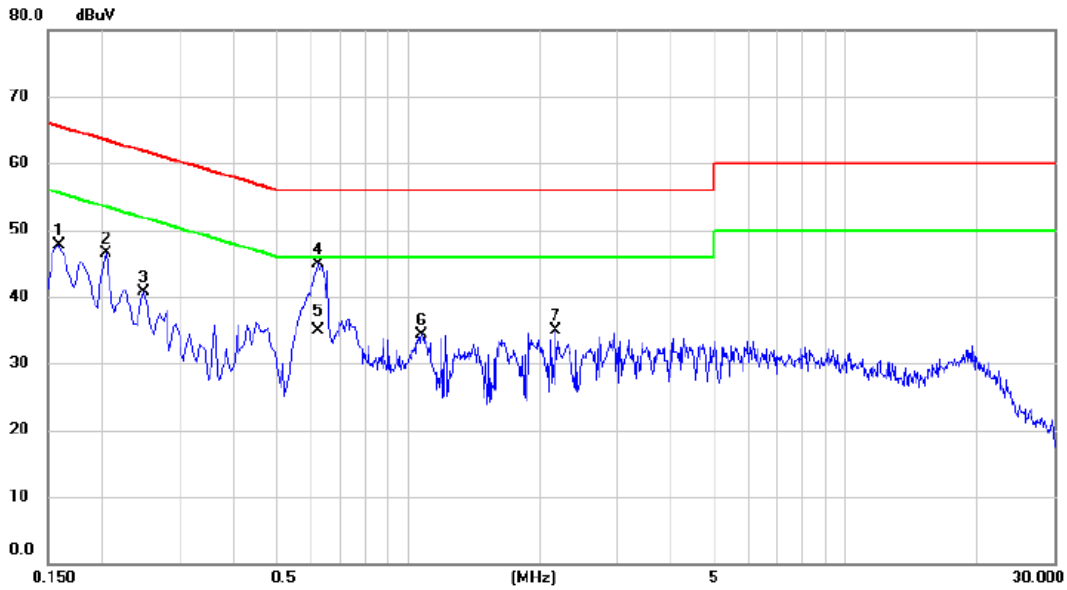

No.	Mk.	Freq. MHz	Reading Level dBuV	Correct Factor dB	Measure- ment dBuV	Limit dBuV	Margin dB	Detector	Comment
1		0.1590	37.97	9.73	47.70	65.52	-17.82	peak	
2		0.2040	36.52	9.91	46.43	63.45	-17.02	peak	
3		0.2490	30.82	9.87	40.69	61.79	-21.10	peak	
4		0.6225	34.98	9.94	44.92	56.00	-11.08	peak	
5	*	0.6225	25.00	9.94	34.94	46.00	-11.06	AVG	
6		1.0725	24.20	10.02	34.22	56.00	-21.78	peak	
7		2.1750	24.78	10.10	34.88	56.00	-21.12	peak	

REMARKS:

- (1) Measurement Value = Reading Level + Correct Factor.
- (2) Margin Level = Measurement Value - Limit Value.

Test Mode: TX AC40 MODE CHANNEL 159

### Neutral

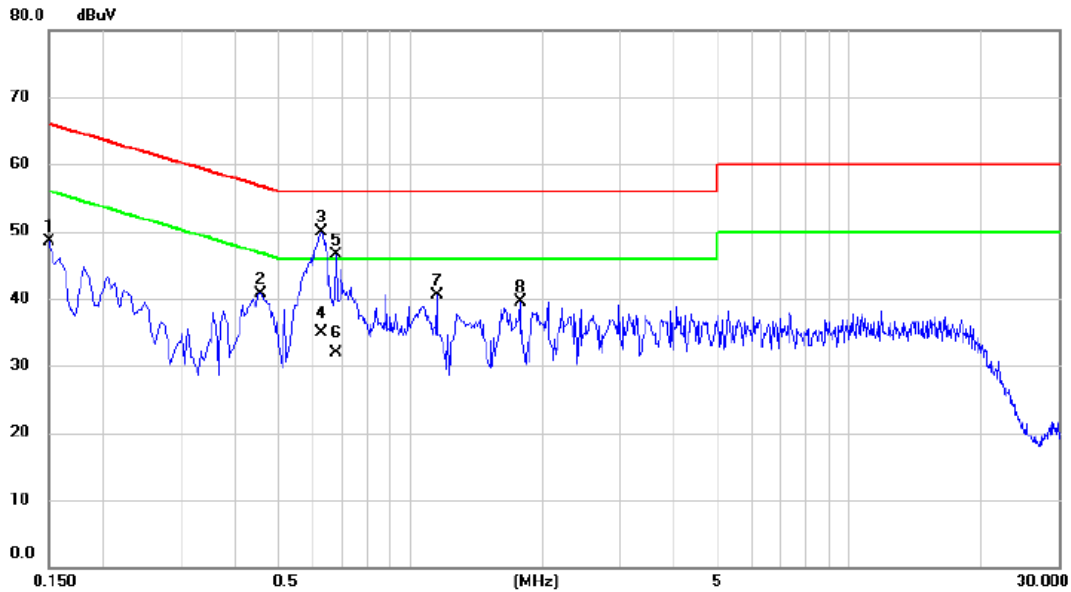

No.	Mk.	Freq. MHz	Reading Level dBuV	Correct Factor dB	Measure- ment dBuV	Limit dBuV	Margin dB	Detector	Comment
1		0.1500	38.86	9.74	48.60	66.00	-17.40	peak	
2		0.4560	30.52	10.12	40.64	56.77	-16.13	peak	
3	*	0.6270	39.79	10.17	49.96	56.00	-6.04	peak	
4		0.6270	24.80	10.17	34.97	46.00	-11.03	AVG	
5		0.6765	36.29	10.13	46.42	56.00	-9.58	peak	
6		0.6765	21.70	10.13	31.83	46.00	-14.17	AVG	
7		1.1490	30.17	10.32	40.49	56.00	-15.51	peak	
8		1.7790	29.16	10.39	39.55	56.00	-16.45	peak	

**REMARKS:**

- (1) Measurement Value = Reading Level + Correct Factor.
- (2) Margin Level = Measurement Value - Limit Value.

## **APPENDIX B - RADIATED EMISSION - 9 KHZ TO 30 MHZ**

Test Mode: TX AC40 MODE CHANNEL 159

Ant 0°

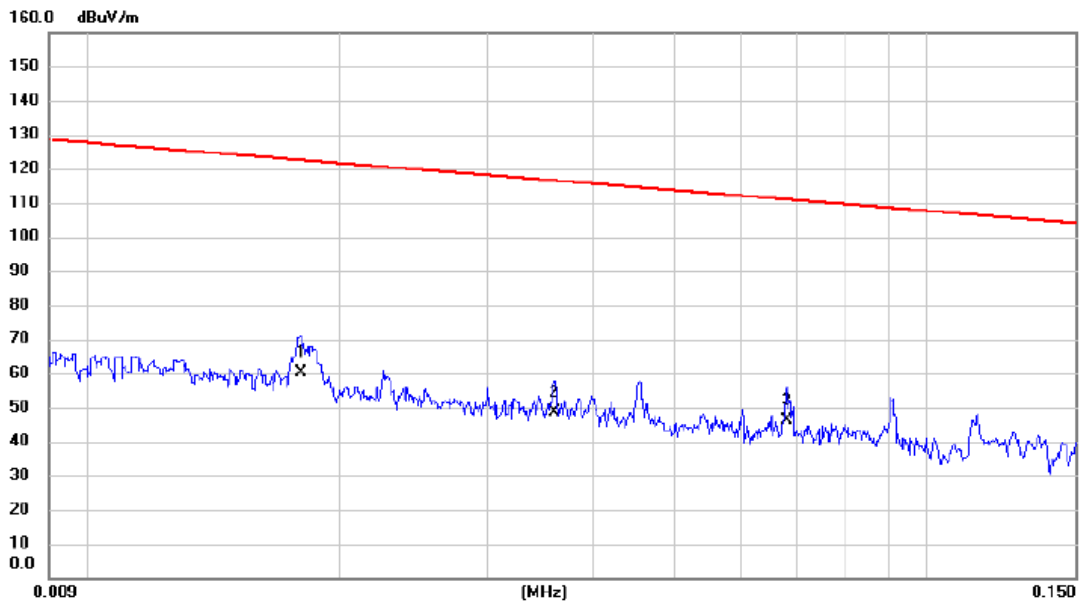

No.	Mk.	Freq. MHz	Reading Level dBuV	Correct Factor dB	Measure- ment dBuV/m	Limit dBuV/m	Margin dB	Detector	Comment
1	*	0.0180	46.36	13.84	60.20	122.50	-62.30	AVG	
2		0.0360	35.62	12.79	48.41	116.48	-68.07	AVG	
3		0.0680	33.55	12.53	46.08	110.95	-64.87	AVG	

REMARKS:

- (1) Measurement Value = Reading Level + Correct Factor.
- (2) Margin Level = Measurement Value - Limit Value.

Test Mode: TX AC40 MODE CHANNEL 159

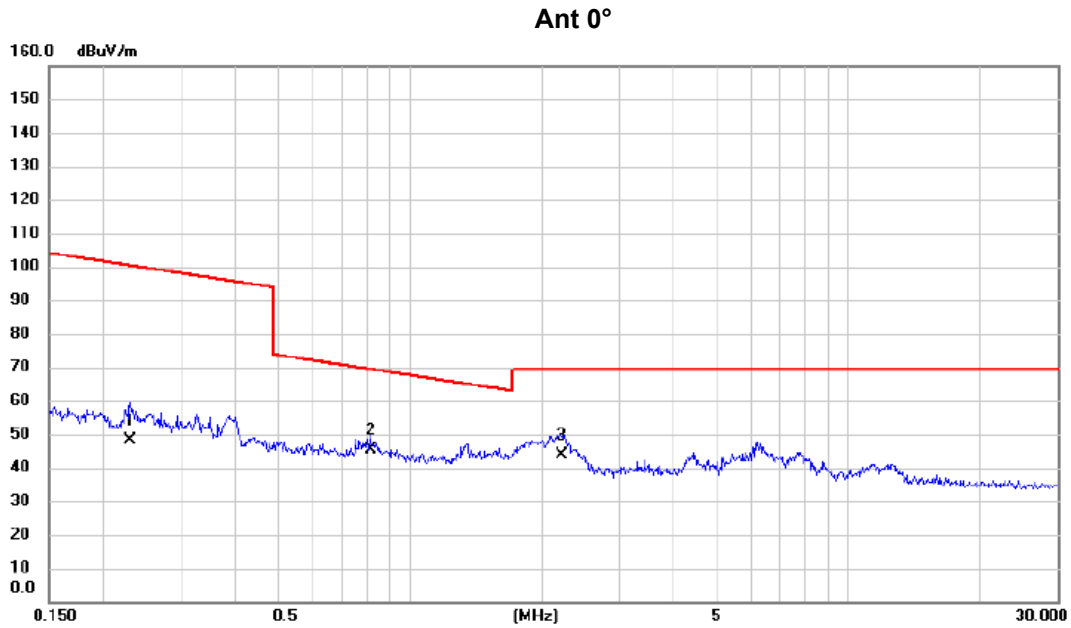

No.	Mk.	Freq. MHz	Reading Level dBuV	Correct Factor dB	Measure- ment dBuV/m	Limit dBuV/m	Margin dB	Detector	Comment
1		0.2304	35.71	12.69	48.40	100.36	-51.96	AVG	
2	*	0.8131	33.61	11.87	45.48	69.40	-23.92	QP	
3		2.2132	32.61	11.19	43.80	69.54	-25.74	QP	

**REMARKS:**

- (1) Measurement Value = Reading Level + Correct Factor.
- (2) Margin Level = Measurement Value - Limit Value.



Test Mode: TX AC40 MODE CHANNEL 159

Ant 90°

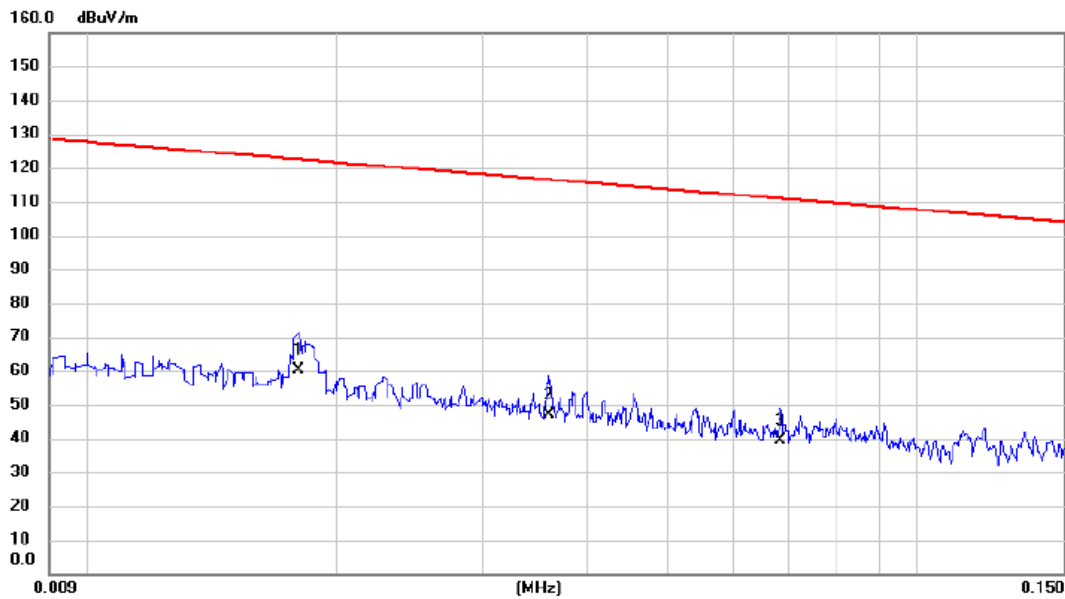

No.	Mk.	Freq.	Reading Level	Correct Factor	Measurement	Limit	Margin	Detector	Comment
		MHz	dBuV	dB	dBuV/m	dBuV/m	dB		
1	*	0.0180	46.34	13.84	60.18	122.50	-62.32	AVG	
2		0.0360	34.20	12.79	46.99	116.48	-69.49	AVG	
3		0.0684	26.79	12.53	39.32	110.90	-71.58	AVG	

REMARKS:

- (1) Measurement Value = Reading Level + Correct Factor.
- (2) Margin Level = Measurement Value - Limit Value.

Test Mode: TX AC40 MODE CHANNEL 159

Ant 90°

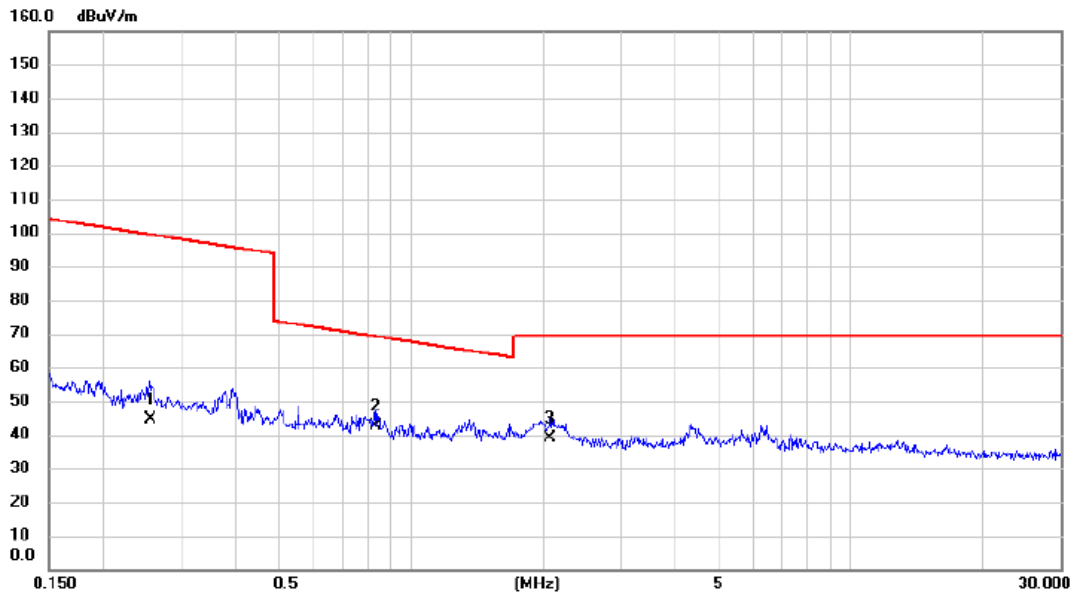

No.	Mk.	Freq. MHz	Reading Level dBuV	Correct Factor dB	Measure- ment dBuV/m	Limit dBuV/m	Margin dB	Detector	Comment
1		0.2548	32.15	12.63	44.78	99.48	-54.70	AVG	
2	*	0.8305	30.61	11.87	42.48	69.22	-26.74	QP	
3		2.0768	27.90	11.26	39.16	69.54	-30.38	QP	

REMARKS:

- (1) Measurement Value = Reading Level + Correct Factor.
- (2) Margin Level = Measurement Value - Limit Value.

## **APPENDIX C - RADIATED EMISSION - 30 MHZ TO 1 GHZ**

Test Mode: TX AC40 MODE CHANNEL 159

### Vertical

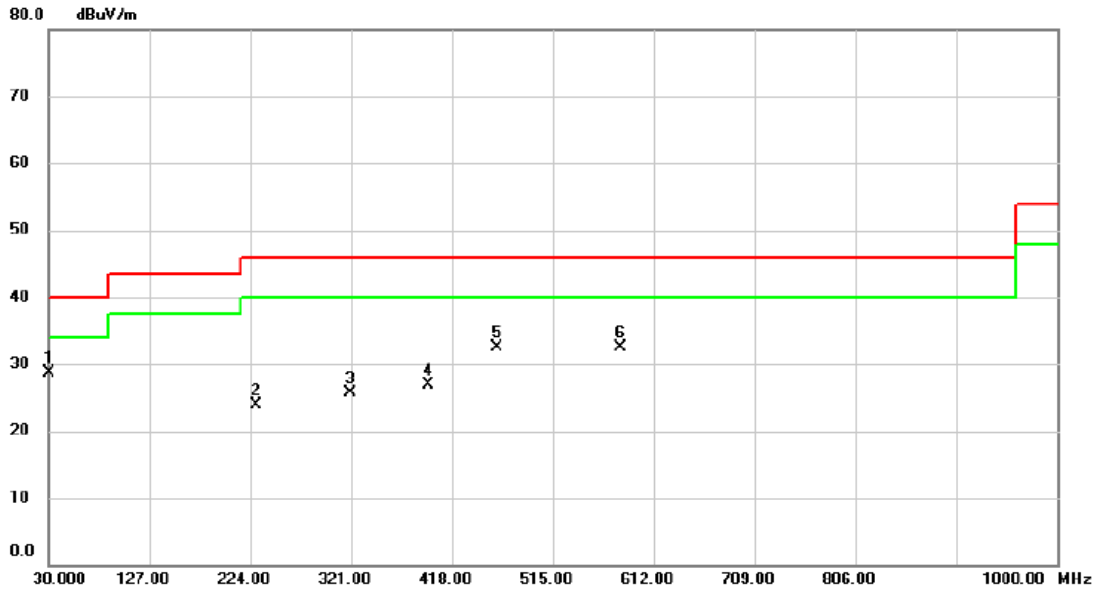

No. Mk.	Freq. MHz	Reading Level dBuV	Correct Factor dB	Measurement dBuV/m	Limit dBuV/m	Margin dB	Detector	Comment
1 *	30.000	43.34	-14.66	28.68	40.00	-11.32	peak	
2	229.820	37.85	-13.87	23.98	46.00	-22.02	peak	
3	320.030	36.33	-10.68	25.65	46.00	-20.35	peak	
4	395.690	35.95	-9.11	26.84	46.00	-19.16	peak	
5	460.680	39.99	-7.55	32.44	46.00	-13.56	peak	
6	579.990	38.38	-5.93	32.45	46.00	-13.55	peak	

**REMARKS:**

- (1) Measurement Value = Reading Level + Correct Factor.
- (2) Margin Level = Measurement Value - Limit Value.

Test Mode: TX AC40 MODE CHANNEL 159

### Horizontal

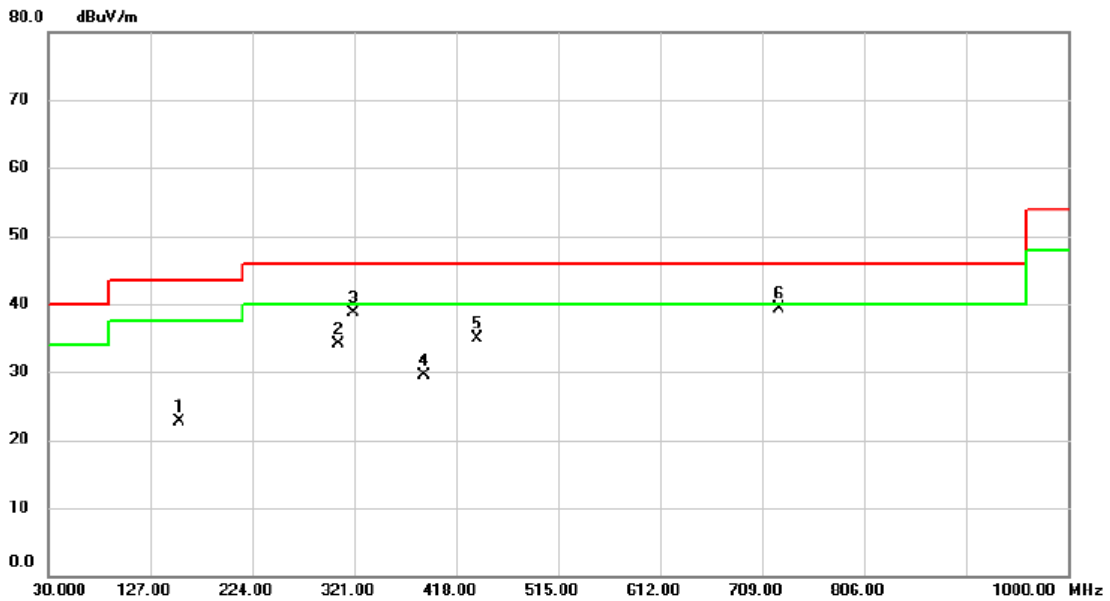

No. Mk.	Freq. MHz	Reading Level dBuV	Correct Factor dB	Measurement dBuV/m	Limit dBuV/m	Margin dB	Detector	Comment
1	155.130	33.93	-11.29	22.64	43.50	-20.86	peak	
2	305.480	45.12	-10.92	34.20	46.00	-11.80	peak	
3	320.030	49.43	-10.68	38.75	46.00	-7.25	peak	
4	386.960	38.75	-9.32	29.43	46.00	-16.57	peak	
5	438.370	42.79	-7.96	34.83	46.00	-11.17	peak	
6 *	724.520	42.78	-3.40	39.38	46.00	-6.62	peak	

**REMARKS:**

- (1) Measurement Value = Reading Level + Correct Factor.
- (2) Margin Level = Measurement Value - Limit Value.

## **APPENDIX D - RADIATED EMISSION - ABOVE 1000 MHZ**

## Non Beamforming

Orthogonal Axis	X
Test Mode	UNII-1_TX A Mode 5180 MHz

### Vertical

130 dBuV/m

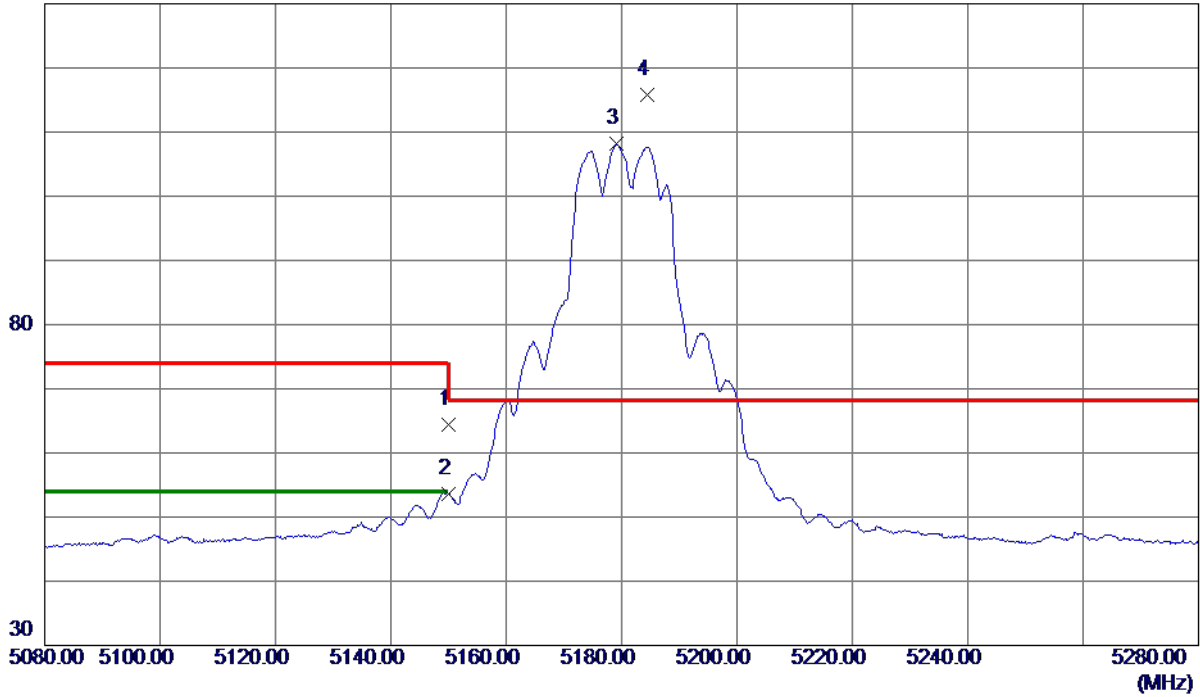

No.	Freq. MHz	Reading Level dBuV/m	Correct Factor dB	Measure ment dBuV/m	Limit dBuV/m	Margin dB	Detector	Comment
1	5150.0000	45.43	18.95	64.38	74.00	-9.62	Peak	
2	5150.0000	34.65	18.95	53.60	54.00	-0.40	AVG	
3	5179.2000	89.13	19.02	108.15	999.00	-890.85	AVG	No Limit
4 *	5184.5000	96.84	19.04	115.88	68.30	47.58	Peak	No Limit

**REMARKS:**

- (1) Measurement Value = Reading Level + Correct Factor.
- (2) Margin Level = Measurement Value - Limit Value.

Orthogonal Axis	X
Test Mode	UNII-1_TX A Mode 5180 MHz

### Vertical

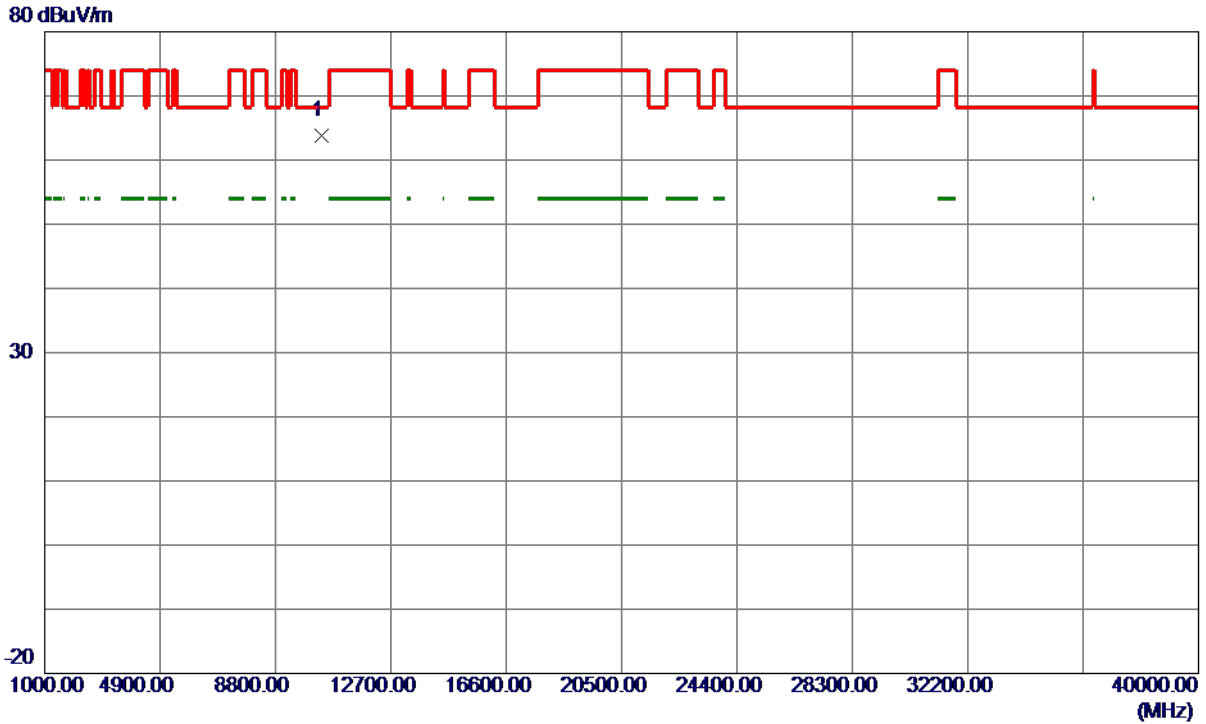

No.	Freq. MHz	Reading Level dBuV/m	Correct Factor dB	Measure ment dBuV/m	Limit dBuV/m	Margin dB	Detector	Comment
1 *	10362.9750	48.74	15.11	63.85	68.30	-4.45	Peak	

**REMARKS:**

- (1) Measurement Value = Reading Level + Correct Factor.
- (2) Margin Level = Measurement Value - Limit Value.



Orthogonal Axis	X
Test Mode	UNII-1_TX A Mode 5200 MHz

### Vertical

130 dBuV/m

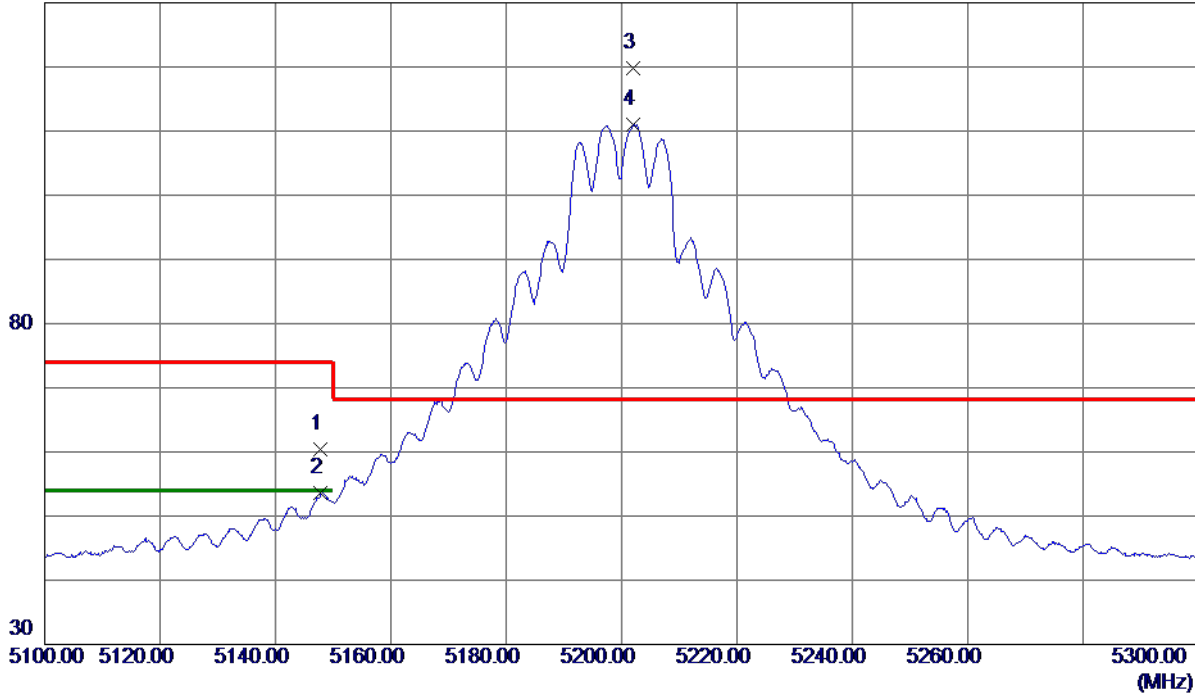

No.	Freq. MHz	Reading Level dBuV/m	Correct Factor dB	Measure ment dBuV/m	Limit dBuV/m	Margin dB	Detector	Comment
1	5147.8000	41.54	18.94	60.48	74.00	-13.52	Peak	
2	5147.8000	34.73	18.94	53.67	54.00	-0.33	AVG	
3 *	5202.1000	100.75	19.08	119.83	68.30	51.53	Peak	No Limit
4	5202.1000	91.96	19.08	111.04	999.00	-887.96	AVG	No Limit

**REMARKS:**

- (1) Measurement Value = Reading Level + Correct Factor.
- (2) Margin Level = Measurement Value - Limit Value.

Orthogonal Axis	X
Test Mode	UNII-1_TX A Mode 5200 MHz

**Vertical**

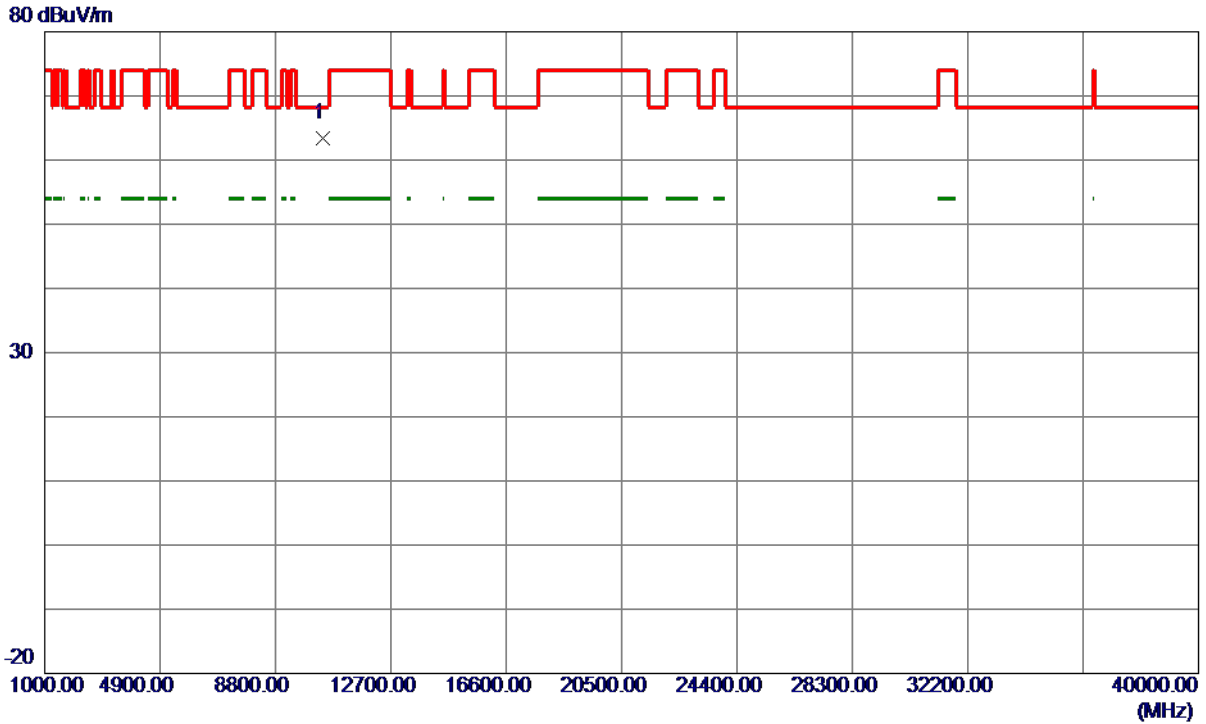

No.	Freq. MHz	Reading Level dBuV/m	Correct Factor dB	Measure ment dBuV/m	Limit dBuV/m	Margin dB	Detector	Comment
1 *	10400.8150	48.21	15.17	63.38	68.30	-4.92	Peak	

**REMARKS:**

- (1) Measurement Value = Reading Level + Correct Factor.
- (2) Margin Level = Measurement Value - Limit Value.

Orthogonal Axis	X
Test Mode	UNII-1_TX A Mode 5240 MHz

### Vertical

130 dBuV/m



No.	Freq. MHz	Reading Level dBuV/m	Correct Factor dB	Measure ment dBuV/m	Limit dBuV/m	Margin dB	Detector	Comment
1	5241.9000	90.76	19.19	109.95	999.00	-889.05	AVG	No Limit
2 *	5242.0000	99.31	19.19	118.50	68.30	50.20	Peak	No Limit

**REMARKS:**

- (1) Measurement Value = Reading Level + Correct Factor.
- (2) Margin Level = Measurement Value - Limit Value.

Orthogonal Axis	X
Test Mode	UNII-1_TX A Mode 5240 MHz

### Vertical

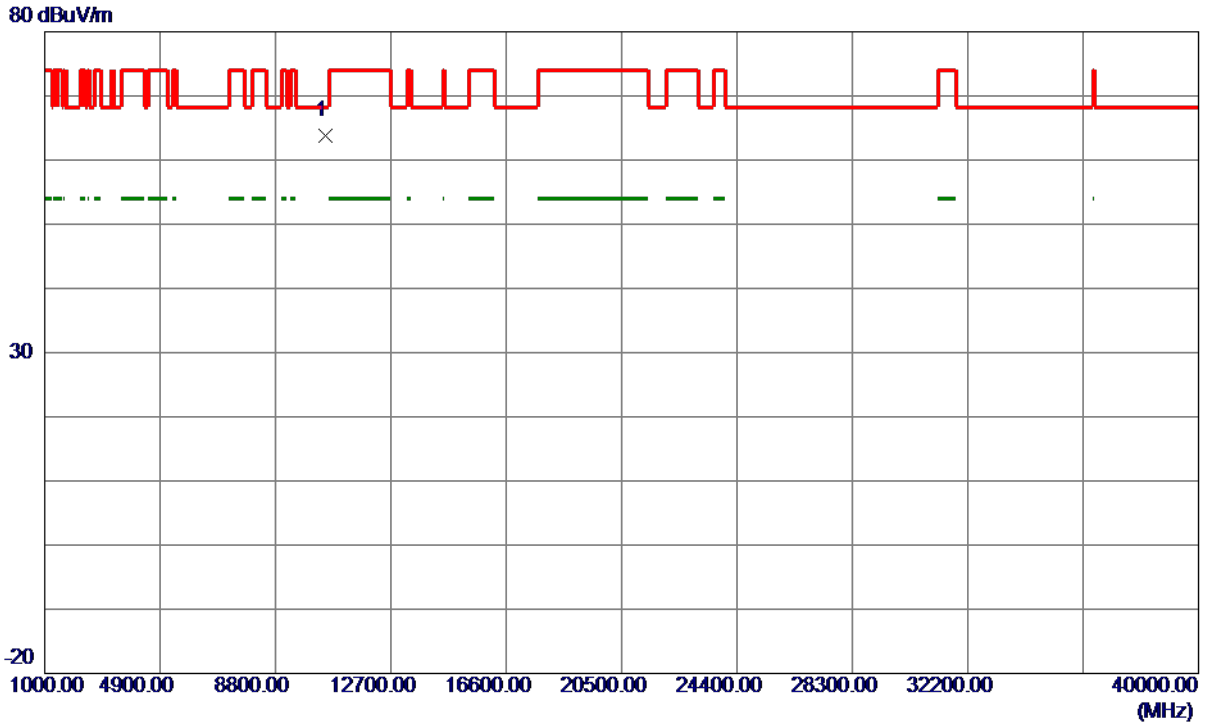

No.	Freq. MHz	Reading Level dBuV/m	Correct Factor dB	Measure ment dBuV/m	Limit dBuV/m	Margin dB	Detector	Comment
1 *	10483.7650	48.56	15.30	63.86	68.30	-4.44	Peak	

**REMARKS:**

- (1) Measurement Value = Reading Level + Correct Factor.
- (2) Margin Level = Measurement Value - Limit Value.

Orthogonal Axis	X
Test Mode	UNII-3_TX A Mode 5745 MHz

**Vertical**

130 dBuV/m

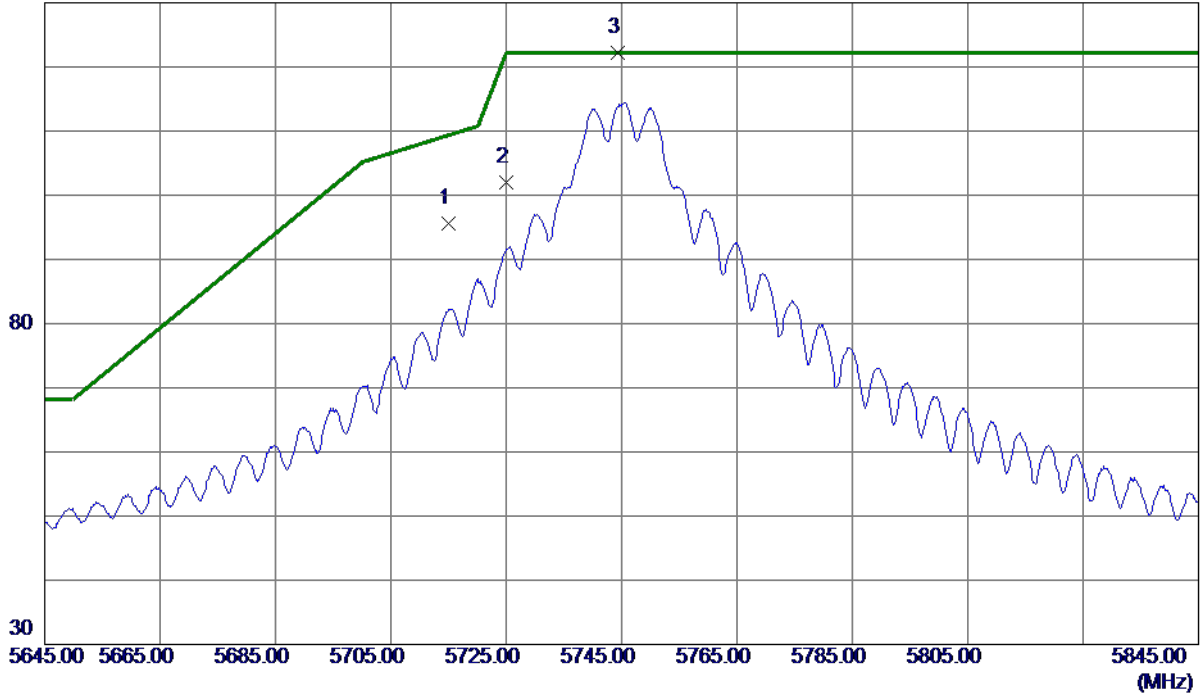

No.	Freq. MHz	Reading Level dBuV/m	Correct Factor dB	Measure ment dBuV/m	Limit dBuV/m	Margin dB	Detector	Comment
1	5715.0000	75.58	20.01	95.59	109.40	-13.81	Peak	
2	5725.0000	81.92	20.02	101.94	122.20	-20.26	Peak	
3 *	5744.3000	102.17	20.03	122.20	122.20	0.00	Peak	No Limit

**REMARKS:**

- (1) Measurement Value = Reading Level + Correct Factor.
- (2) Margin Level = Measurement Value - Limit Value.

Orthogonal Axis	X
Test Mode	UNII-3_TX A Mode 5745 MHz

### Vertical

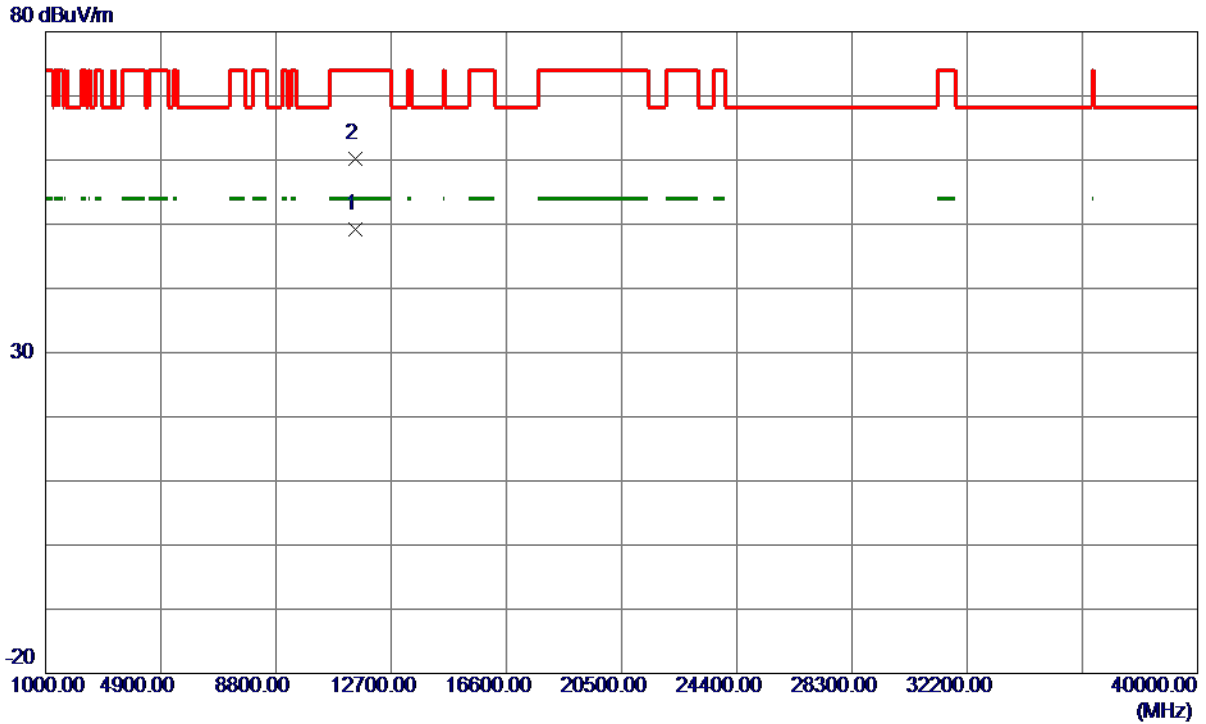

No.	Freq. MHz	Reading Level dBuV/m	Correct Factor dB	Measure ment dBuV/m	Limit dBuV/m	Margin dB	Detector	Comment
1 *	11487.7600	31.99	17.15	49.14	54.00	-4.86	AVG	
2	11488.6800	43.10	17.16	60.26	74.00	-13.74	Peak	

**REMARKS:**

- (1) Measurement Value = Reading Level + Correct Factor.
- (2) Margin Level = Measurement Value - Limit Value.

Orthogonal Axis	X
Test Mode	UNII-3_TX A Mode 5785 MHz

### Vertical

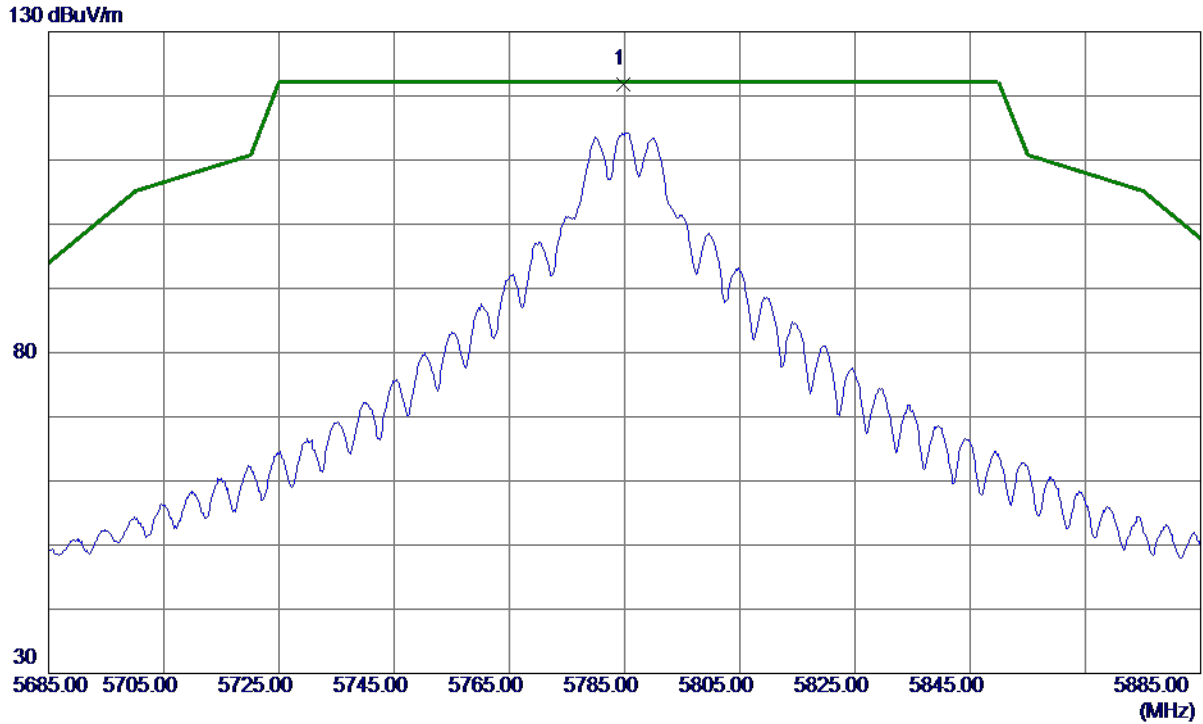

No.	Freq. MHz	Reading Level dBuV/m	Correct Factor dB	Measure ment dBuV/m	Limit dBuV/m	Margin dB	Detector	Comment
1 *	5784.7000	101.82	20.06	121.88	122.20	-0.32	Peak	No Limit

**REMARKS:**

- (1) Measurement Value = Reading Level + Correct Factor.
- (2) Margin Level = Measurement Value - Limit Value.

Orthogonal Axis	X
Test Mode	UNII-3_TX A Mode 5785 MHz

### Vertical

80 dBuV/m

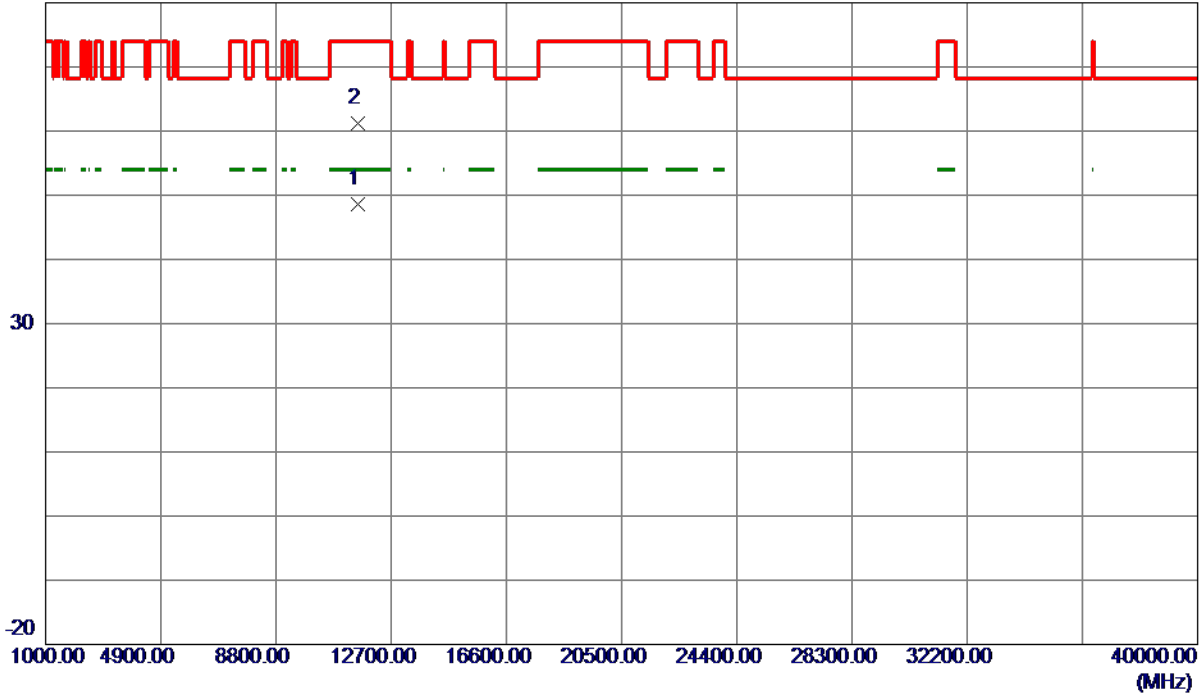

No.	Freq. MHz	Reading Level dBuV/m	Correct Factor dB	Measure ment dBuV/m	Limit dBuV/m	Margin dB	Detector	Comment
1 *	11572.3700	31.30	17.26	48.56	54.00	-5.44	AVG	
2	11572.8099	43.90	17.26	61.16	74.00	-12.84	Peak	

**REMARKS:**

- (1) Measurement Value = Reading Level + Correct Factor.
- (2) Margin Level = Measurement Value - Limit Value.



Orthogonal Axis	X
Test Mode	UNII-3_TX A Mode 5825 MHz

**Vertical**

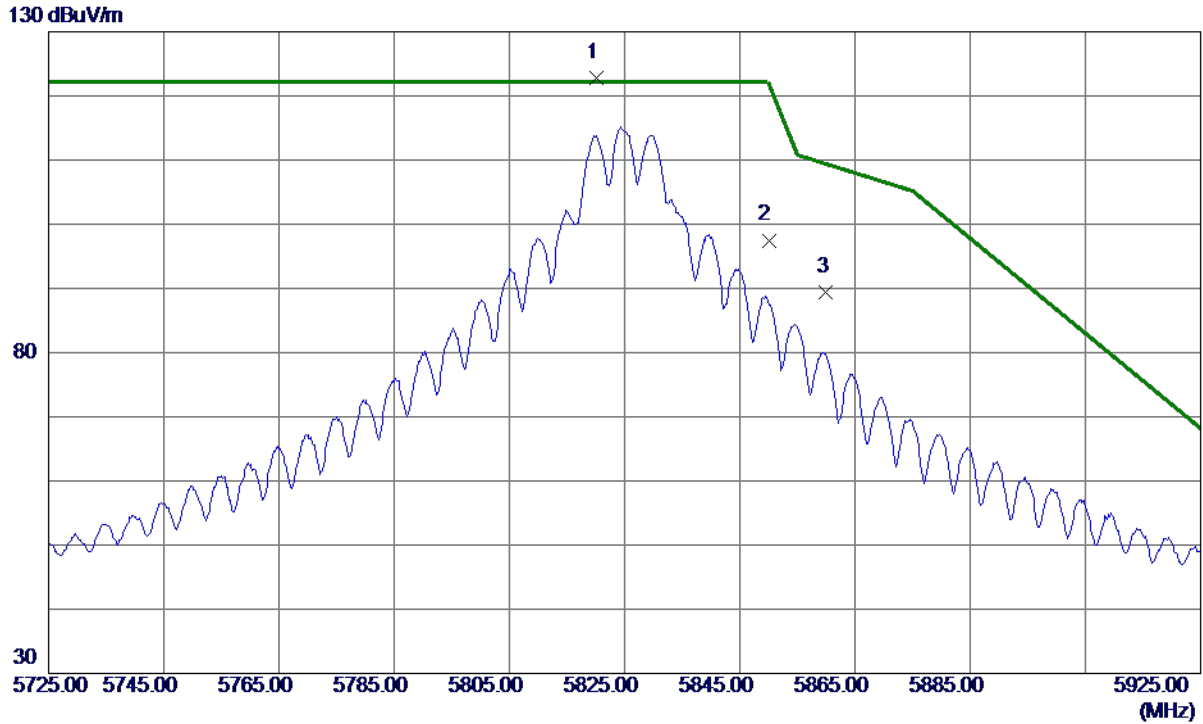

No.	Freq. MHz	Reading Level dBuV/m	Correct Factor dB	Measure ment dBuV/m	Limit dBuV/m	Margin dB	Detector	Comment
1 *	5820.2000	102.80	20.09	122.89	122.20	0.69	Peak	No Limit
2	5850.0000	77.39	20.11	97.50	122.20	-24.70	Peak	
3	5860.0000	69.20	20.12	89.32	109.40	-20.08	Peak	

**REMARKS:**

- (1) Measurement Value = Reading Level + Correct Factor.
- (2) Margin Level = Measurement Value - Limit Value.

Orthogonal Axis	X
Test Mode	UNII-3_TX A Mode 5825 MHz

### Vertical

80 dBuV/m

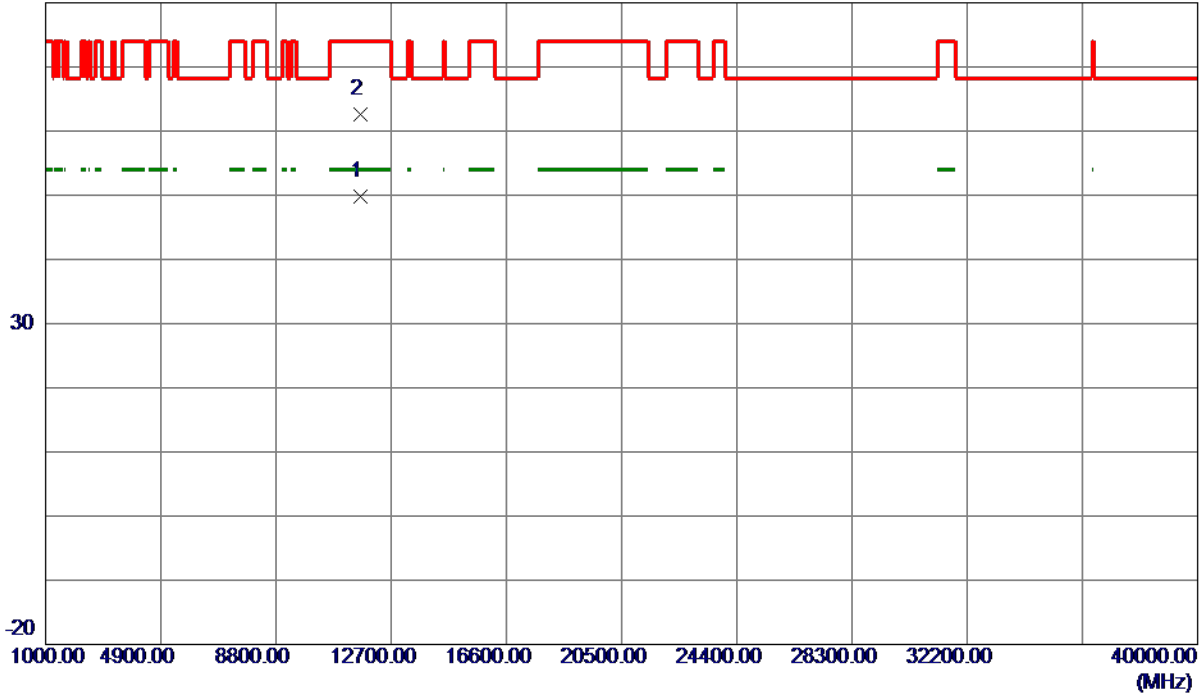

No.	Freq. MHz	Reading Level dBuV/m	Correct Factor dB	Measure ment dBuV/m	Limit dBuV/m	Margin dB	Detector	Comment
1 *	11647.7699	32.44	17.33	49.77	54.00	-4.23	AVG	
2	11651.0400	45.29	17.33	62.62	74.00	-11.38	Peak	

**REMARKS:**

- (1) Measurement Value = Reading Level + Correct Factor.
- (2) Margin Level = Measurement Value - Limit Value.

Orthogonal Axis	X
Test Mode	UNII-1_TX AC (VHT20) Mode 5180 MHz

### Vertical

130 dBuV/m

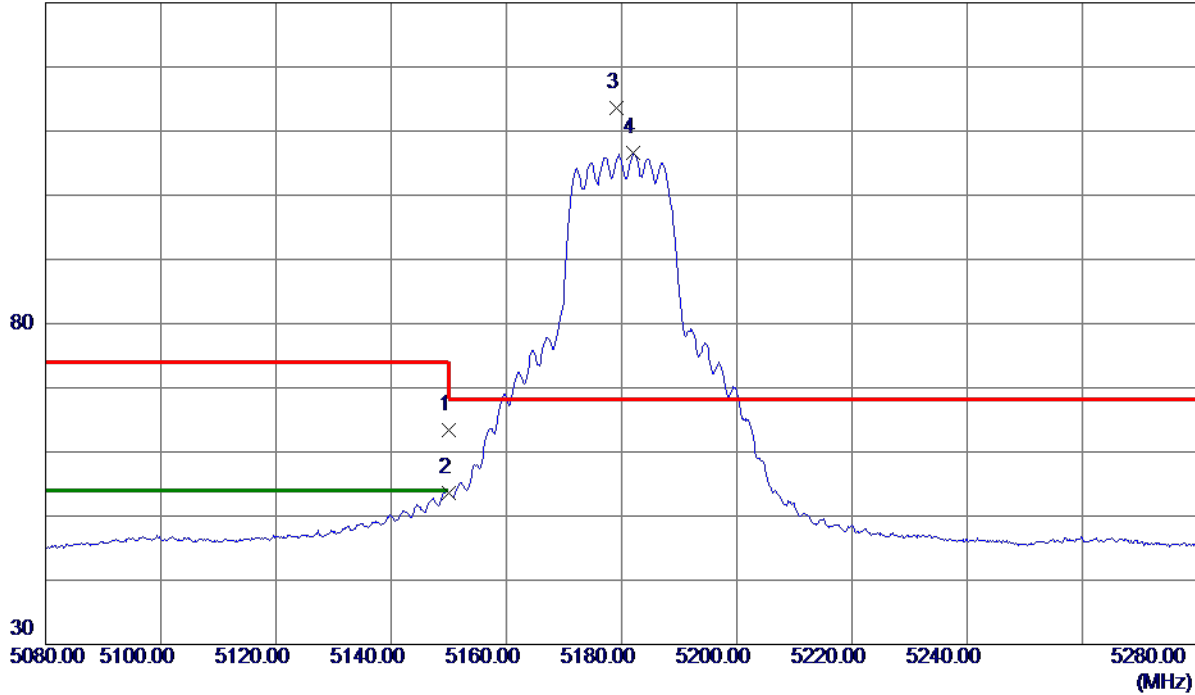

No.	Freq. MHz	Reading Level dBuV/m	Correct Factor dB	Measure ment dBuV/m	Limit dBuV/m	Margin dB	Detector	Comment
1	5150.0000	44.36	18.95	63.31	74.00	-10.69	Peak	
2	5150.0000	34.73	18.95	53.68	54.00	-0.32	AVG	
3 *	5179.2000	94.60	19.02	113.62	68.30	45.32	Peak	No Limit
4	5182.1000	87.66	19.03	106.69	999.00	-892.31	AVG	No Limit

**REMARKS:**

- (1) Measurement Value = Reading Level + Correct Factor.
- (2) Margin Level = Measurement Value - Limit Value.

Orthogonal Axis	X
Test Mode	UNII-1_TX AC (VHT20) Mode 5180 MHz

**Vertical**

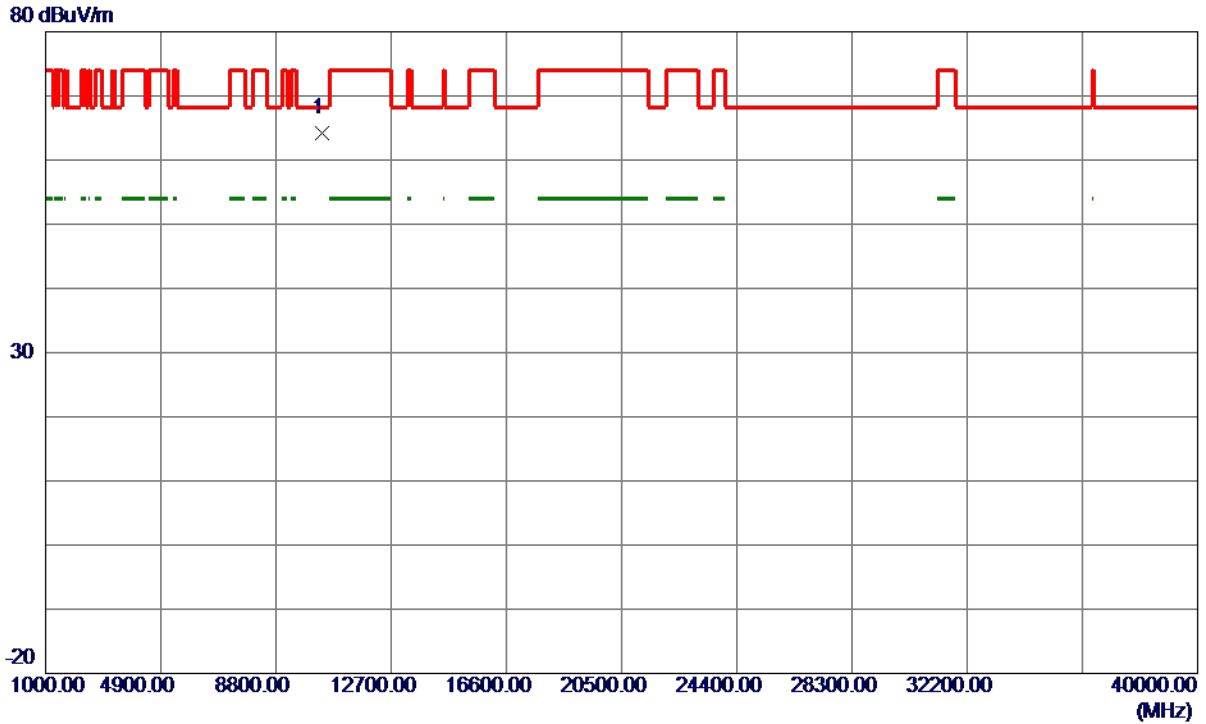

No.	Freq. MHz	Reading Level dBuV/m	Correct Factor dB	Measure ment dBuV/m	Limit dBuV/m	Margin dB	Detector	Comment
1 *	10358.7850	49.00	15.11	64.11	68.30	-4.19	Peak	

**REMARKS:**

- (1) Measurement Value = Reading Level + Correct Factor.
- (2) Margin Level = Measurement Value - Limit Value.

Orthogonal Axis	X
Test Mode	UNII-1_TX AC (VHT20) Mode 5200 MHz

**Vertical**

130 dBuV/m

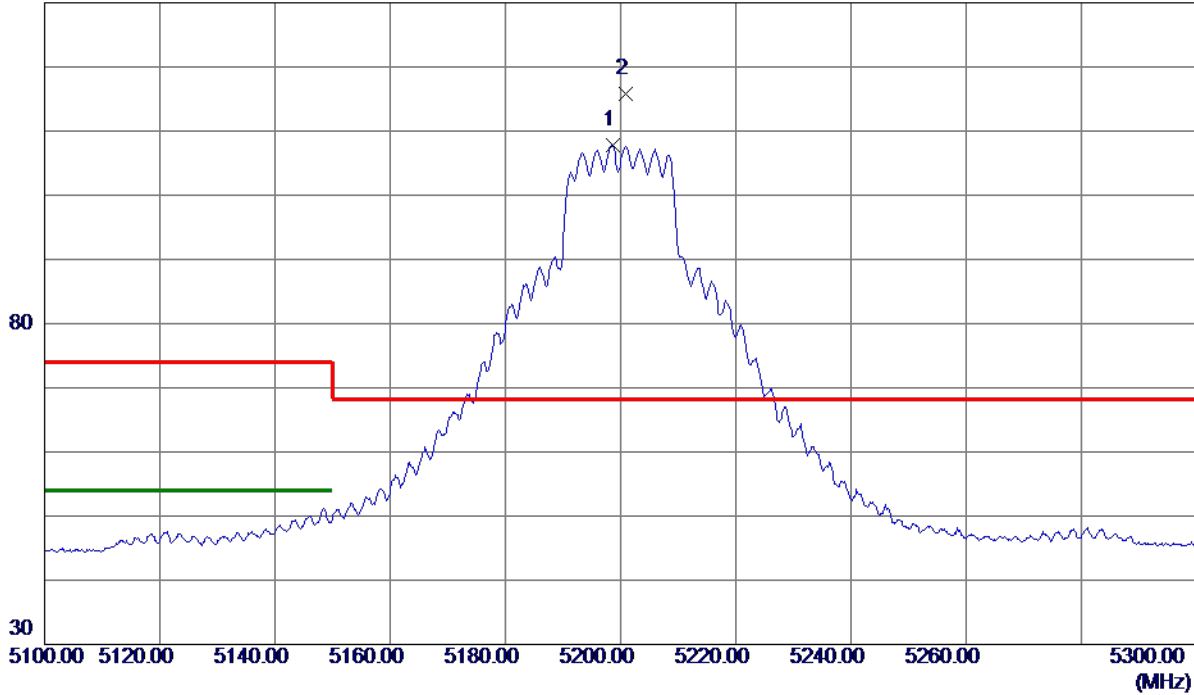

No.	Freq. MHz	Reading Level dBuV/m	Correct Factor dB	Measure ment dBuV/m	Limit dBuV/m	Margin dB	Detector	Comment
1	5198.6000	88.71	19.07	107.78	999.00	-891.22	AVG	No Limit
2 *	5200.8000	96.80	19.08	115.88	68.30	47.58	Peak	No Limit

**REMARKS:**

- (1) Measurement Value = Reading Level + Correct Factor.
- (2) Margin Level = Measurement Value - Limit Value.

Orthogonal Axis	X
Test Mode	UNII-1_TX AC (VHT20) Mode 5200 MHz

**Vertical**

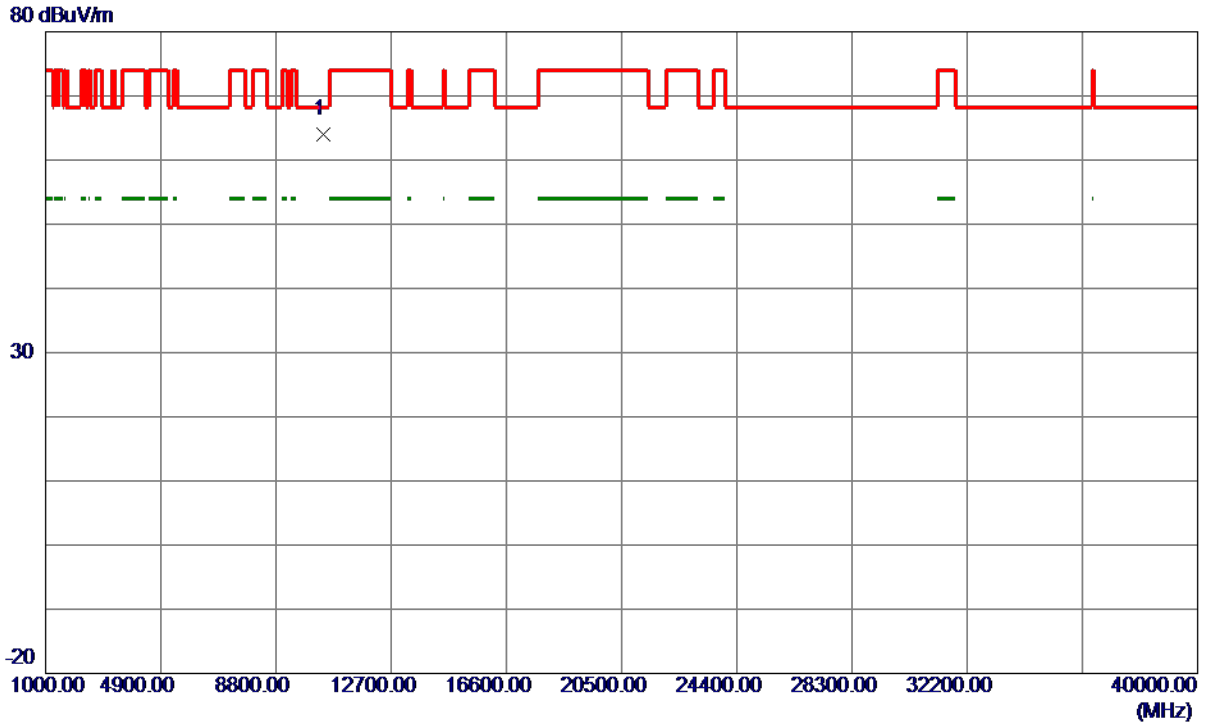

No.	Freq. MHz	Reading Level dBuV/m	Correct Factor dB	Measure ment dBuV/m	Limit dBuV/m	Margin dB	Detector	Comment
1 *	10398.0100	48.90	15.16	64.06	68.30	-4.24	Peak	

**REMARKS:**

- (1) Measurement Value = Reading Level + Correct Factor.
- (2) Margin Level = Measurement Value - Limit Value.

Orthogonal Axis	X
Test Mode	UNII-1_TX AC (VHT20) Mode 5240 MHz

### Vertical

130 dBuV/m

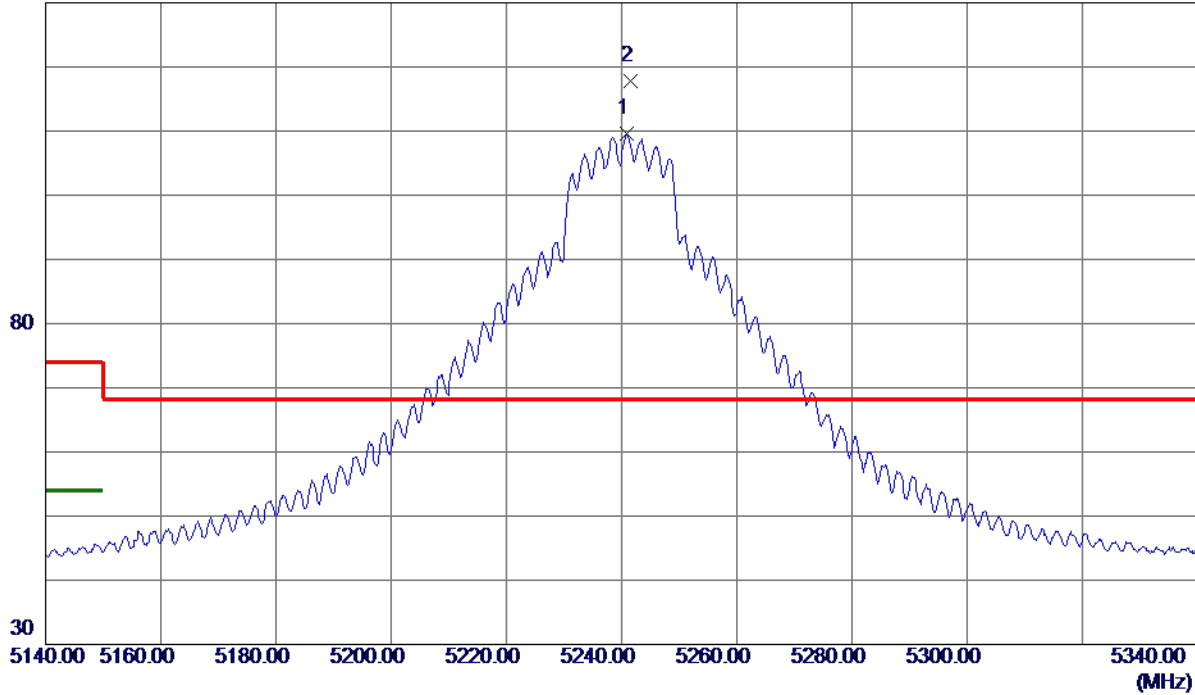

No.	Freq. MHz	Reading Level dBuV/m	Correct Factor dB	Measure ment dBuV/m	Limit dBuV/m	Margin dB	Detector	Comment
1	5240.9000	90.44	19.18	109.62	999.00	-889.38	AVG	No Limit
2 *	5241.6000	98.62	19.19	117.81	68.30	49.51	Peak	No Limit

**REMARKS:**

- (1) Measurement Value = Reading Level + Correct Factor.
- (2) Margin Level = Measurement Value - Limit Value.

Orthogonal Axis	X
Test Mode	UNII-1_TX AC (VHT20) Mode 5240 MHz

**Vertical**

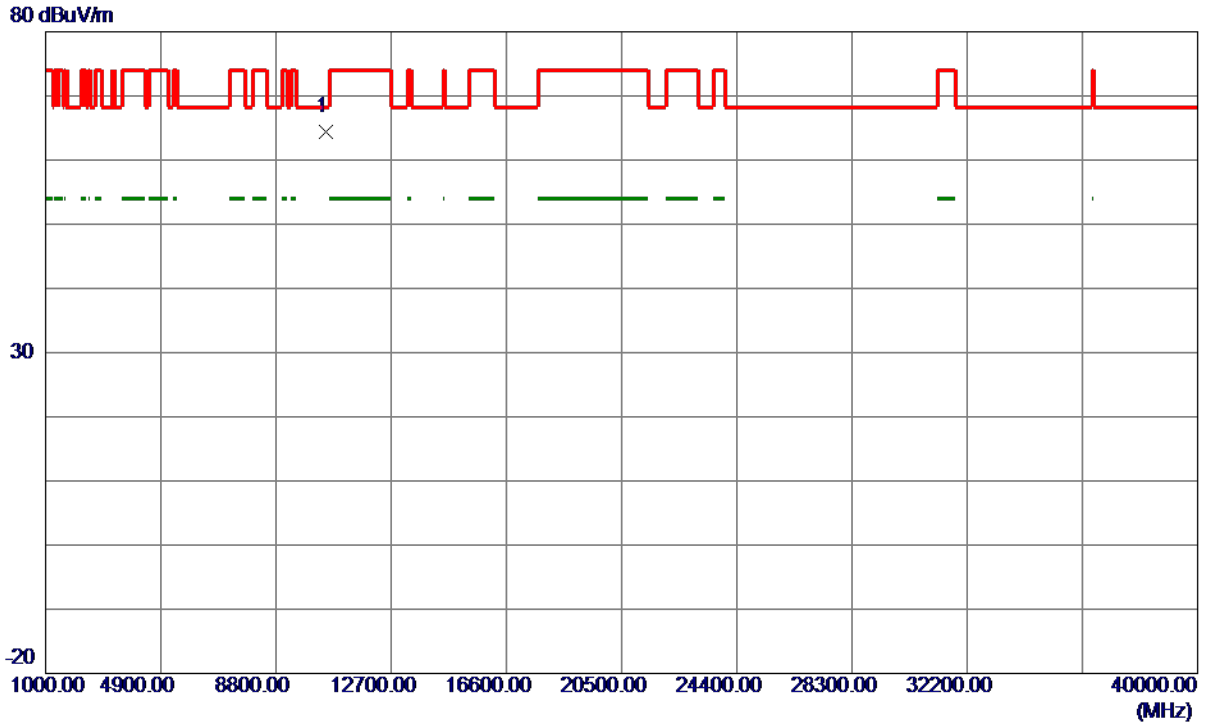

No.	Freq. MHz	Reading Level dBuV/m	Correct Factor dB	Measure ment dBuV/m	Limit dBuV/m	Margin dB	Detector	Comment
1 *	10478.2120	49.17	15.29	64.46	68.30	-3.84	Peak	

**REMARKS:**

- (1) Measurement Value = Reading Level + Correct Factor.
- (2) Margin Level = Measurement Value - Limit Value.



Orthogonal Axis	X
Test Mode	UNII-1_TX AC (VHT40) Mode 5190 MHz

### Vertical

130 dBuV/m

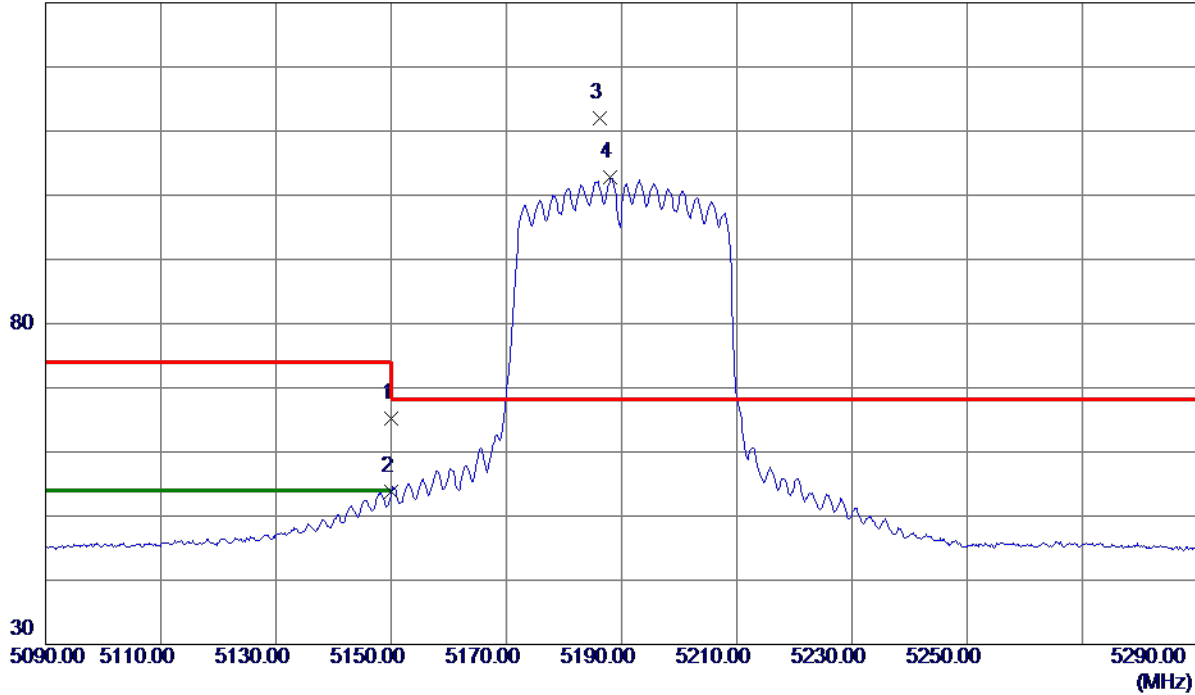

No.	Freq. MHz	Reading Level dBuV/m	Correct Factor dB	Measure ment dBuV/m	Limit dBuV/m	Margin dB	Detector	Comment
1	5150.0000	46.34	18.95	65.29	74.00	-8.71	Peak	
2	5150.0000	34.93	18.95	53.88	54.00	-0.12	AVG	
3 *	5186.3000	92.96	19.04	112.00	68.30	43.70	Peak	No Limit
4	5188.1000	83.69	19.05	102.74	999.00	-896.26	AVG	No Limit

**REMARKS:**

- (1) Measurement Value = Reading Level + Correct Factor.
- (2) Margin Level = Measurement Value - Limit Value.

Orthogonal Axis	X
Test Mode	UNII-1_TX AC (VHT40) Mode 5190 MHz

**Vertical**

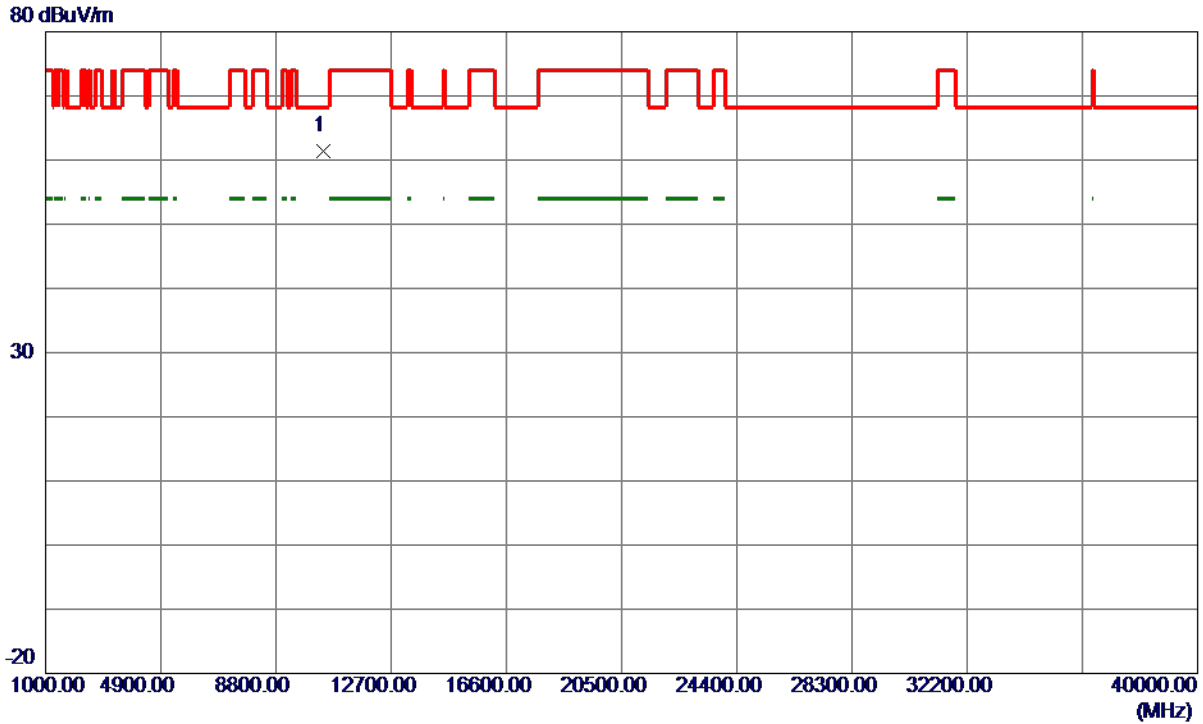

No.	Freq. MHz	Reading Level dBuV/m	Correct Factor dB	Measure ment dBuV/m	Limit dBuV/m	Margin dB	Detector	Comment
1 *	10388.4500	46.17	15.15	61.32	68.30	-6.98	Peak	

**REMARKS:**

- (1) Measurement Value = Reading Level + Correct Factor.
- (2) Margin Level = Measurement Value - Limit Value.

Orthogonal Axis	X
Test Mode	UNII-1_TX AC (VHT40) Mode 5230 MHz

### Vertical

130 dBuV/m

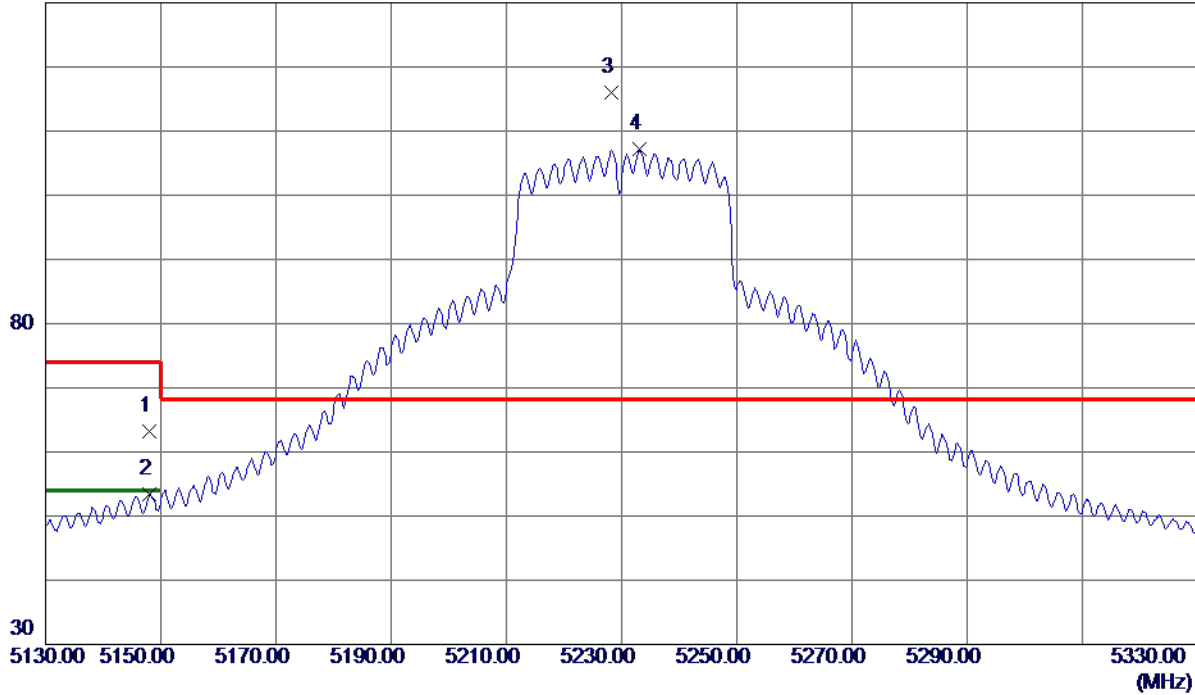

No.	Freq. MHz	Reading Level dBuV/m	Correct Factor dB	Measure ment dBuV/m	Limit dBuV/m	Margin dB	Detector	Comment
1	5148.1000	44.21	18.94	63.15	74.00	-10.85	Peak	
2	5148.1000	34.49	18.94	53.43	54.00	-0.57	AVG	
3 *	5228.2000	96.79	19.15	115.94	68.30	47.64	Peak	No Limit
4	5233.1000	87.96	19.16	107.12	999.00	-891.88	AVG	No Limit

**REMARKS:**

- (1) Measurement Value = Reading Level + Correct Factor.
- (2) Margin Level = Measurement Value - Limit Value.

Orthogonal Axis	X
Test Mode	UNII-1_TX AC (VHT40) Mode 5230 MHz

**Vertical**

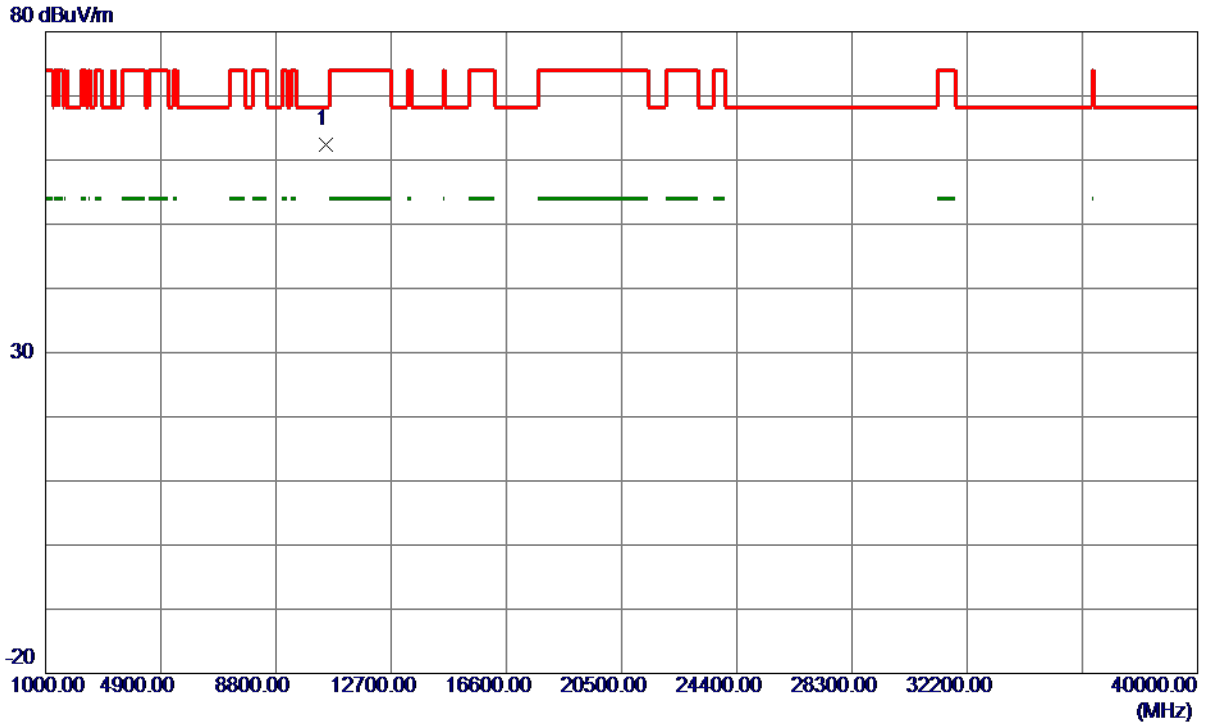

No.	Freq. MHz	Reading Level dBuV/m	Correct Factor dB	Measure ment dBuV/m	Limit dBuV/m	Margin dB	Detector	Comment
1 *	10471.9000	47.20	15.28	62.48	68.30	-5.82	Peak	

**REMARKS:**

- (1) Measurement Value = Reading Level + Correct Factor.
- (2) Margin Level = Measurement Value - Limit Value.

Orthogonal Axis	X
Test Mode	UNII-1_TX AC (VHT80) Mode 5210 MHz

### Vertical

130 dBuV/m

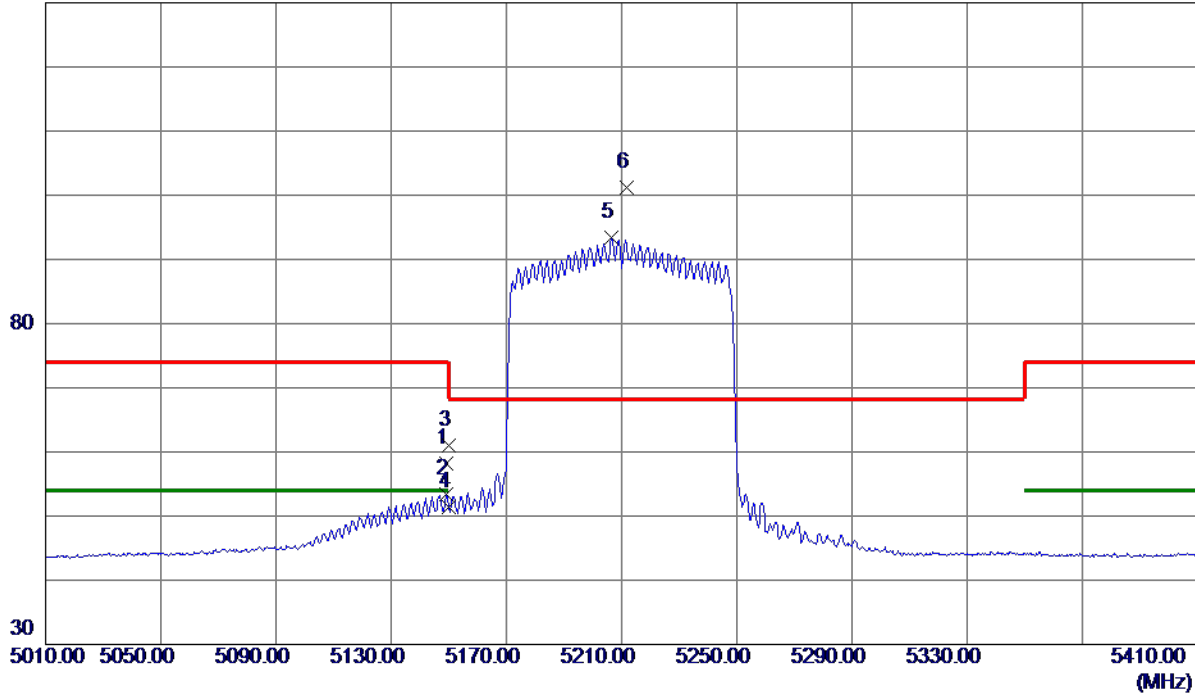

No.	Freq. MHz	Reading Level dBuV/m	Correct Factor dB	Measure ment dBuV/m	Limit dBuV/m	Margin dB	Detector	Comment
1	5149.0000	39.18	18.95	58.13	74.00	-15.87	Peak	
2	5149.0000	34.40	18.95	53.35	54.00	-0.65	AVG	
3	5150.0000	42.04	18.95	60.99	74.00	-13.01	Peak	
4	5150.0000	32.53	18.95	51.48	54.00	-2.52	AVG	
5	5206.6000	74.21	19.10	93.31	999.00	-905.69	AVG	No Limit
6 *	5211.6000	82.08	19.11	101.19	68.30	32.89	Peak	No Limit

**REMARKS:**

- (1) Measurement Value = Reading Level + Correct Factor.
- (2) Margin Level = Measurement Value - Limit Value.

Orthogonal Axis	X
Test Mode	UNII-1_TX AC (VHT80) Mode 5210 MHz

**Vertical**

80 dBuV/m

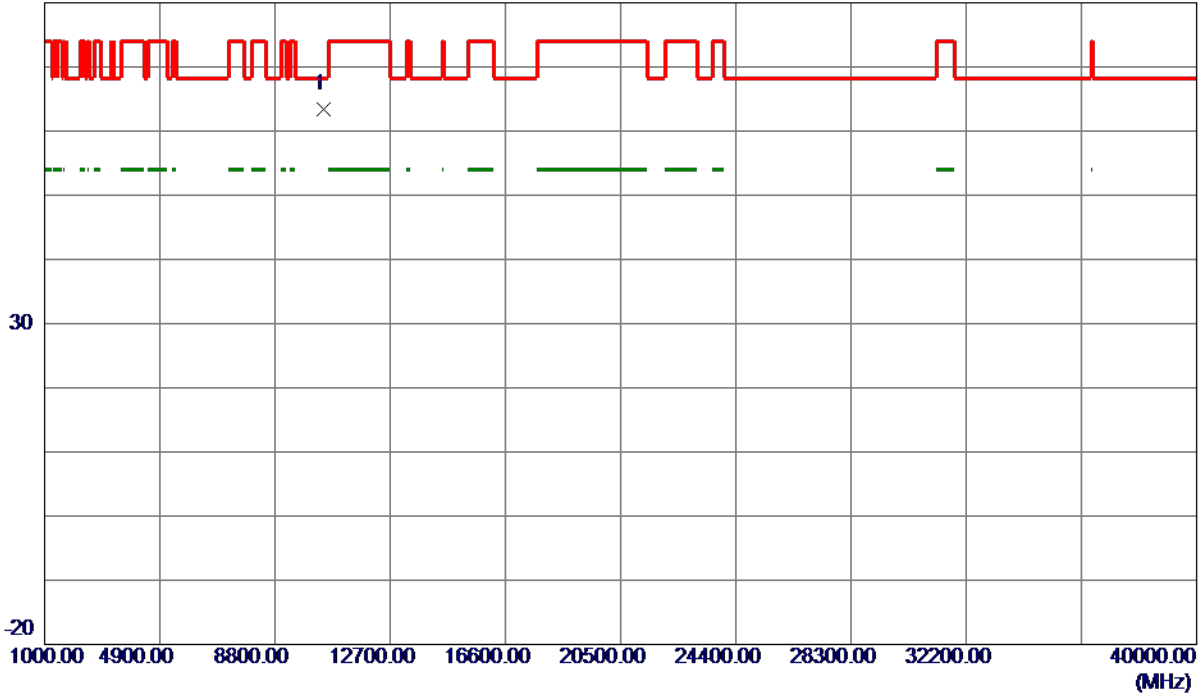

No.	Freq. MHz	Reading Level dBuV/m	Correct Factor dB	Measure ment dBuV/m	Limit dBuV/m	Margin dB	Detector	Comment
1 *	10429.0000	48.22	15.21	63.43	68.30	-4.87	Peak	

**REMARKS:**

- (1) Measurement Value = Reading Level + Correct Factor.
- (2) Margin Level = Measurement Value - Limit Value.

Orthogonal Axis	X
Test Mode	UNII-3_TX AC (VHT20) Mode 5745 MHz

**Vertical**

130 dBuV/m

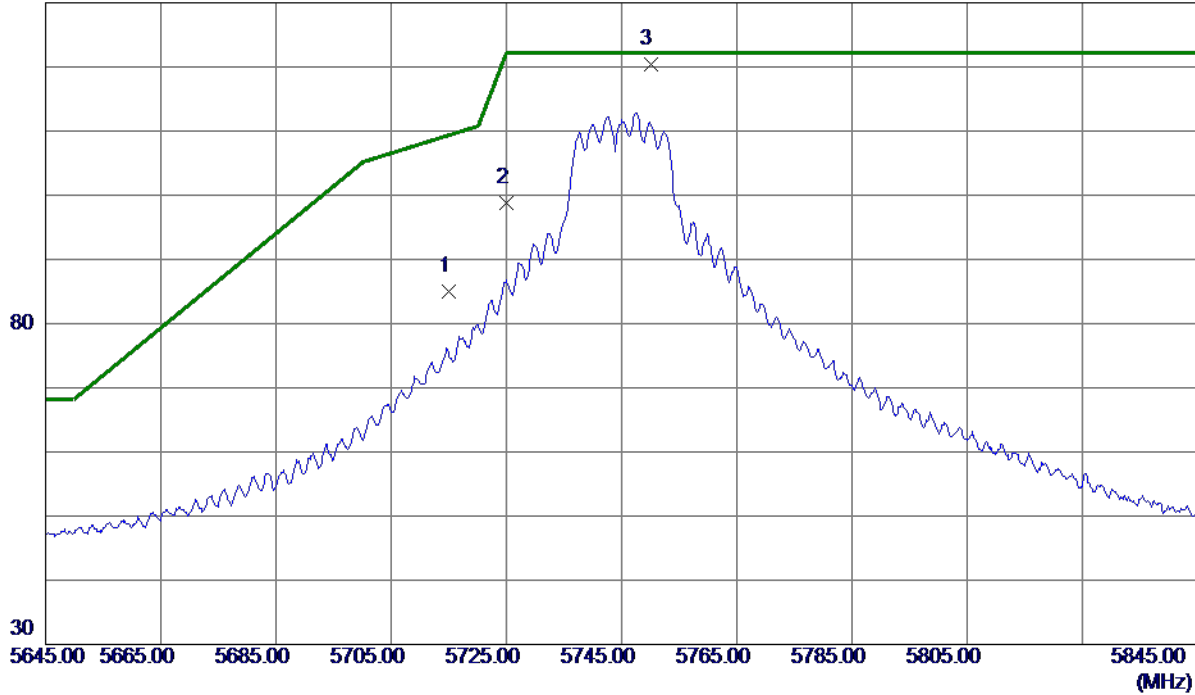

No.	Freq. MHz	Reading Level dBuV/m	Correct Factor dB	Measure ment dBuV/m	Limit dBuV/m	Margin dB	Detector	Comment
1	5715.0000	64.99	20.01	85.00	109.40	-24.40	Peak	
2	5725.0000	78.81	20.02	98.83	122.20	-23.37	Peak	
3 *	5750.0000	100.42	20.04	120.46	122.20	-1.74	Peak	No Limit

**REMARKS:**

- (1) Measurement Value = Reading Level + Correct Factor.
- (2) Margin Level = Measurement Value - Limit Value.

Orthogonal Axis	X
Test Mode	UNII-3_TX AC (VHT20) Mode 5745 MHz

### Vertical

80 dBuV/m

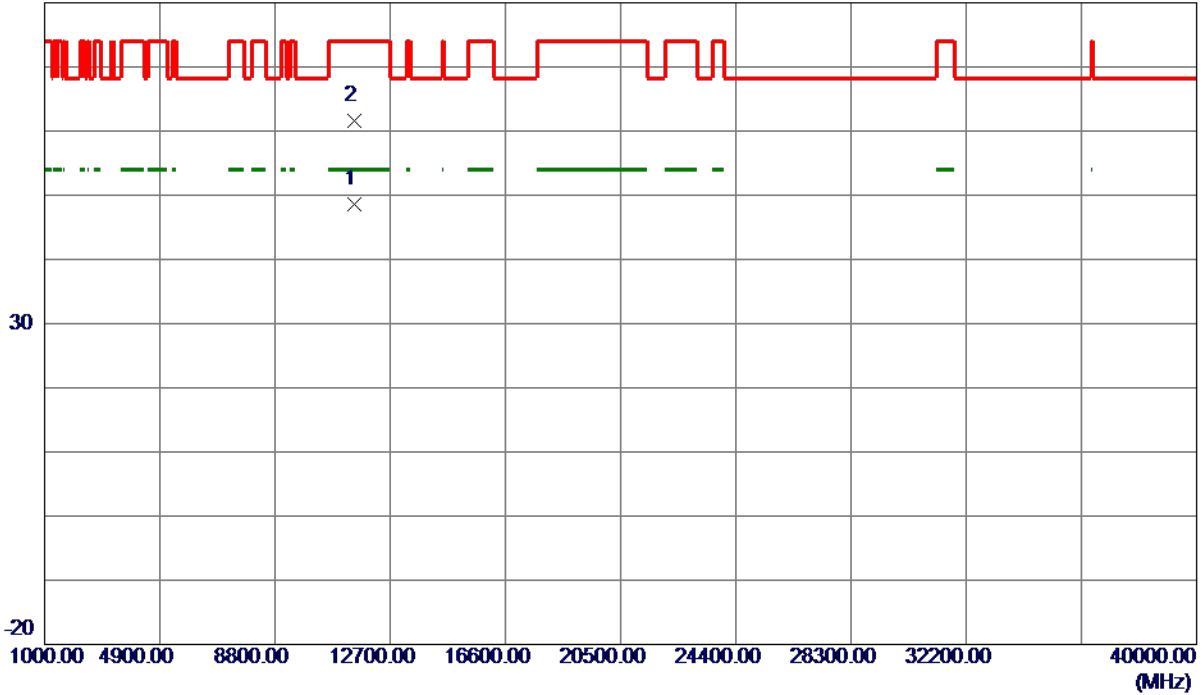

No.	Freq. MHz	Reading Level dBuV/m	Correct Factor dB	Measure ment dBuV/m	Limit dBuV/m	Margin dB	Detector	Comment
1 *	11490.9000	31.48	17.16	48.64	54.00	-5.36	AVG	
2	11493.3500	44.34	17.17	61.51	74.00	-12.49	Peak	

**REMARKS:**

- (1) Measurement Value = Reading Level + Correct Factor.
- (2) Margin Level = Measurement Value - Limit Value.



Orthogonal Axis	X
Test Mode	UNII-3_TX AC (VHT20) Mode 5785 MHz

**Vertical**

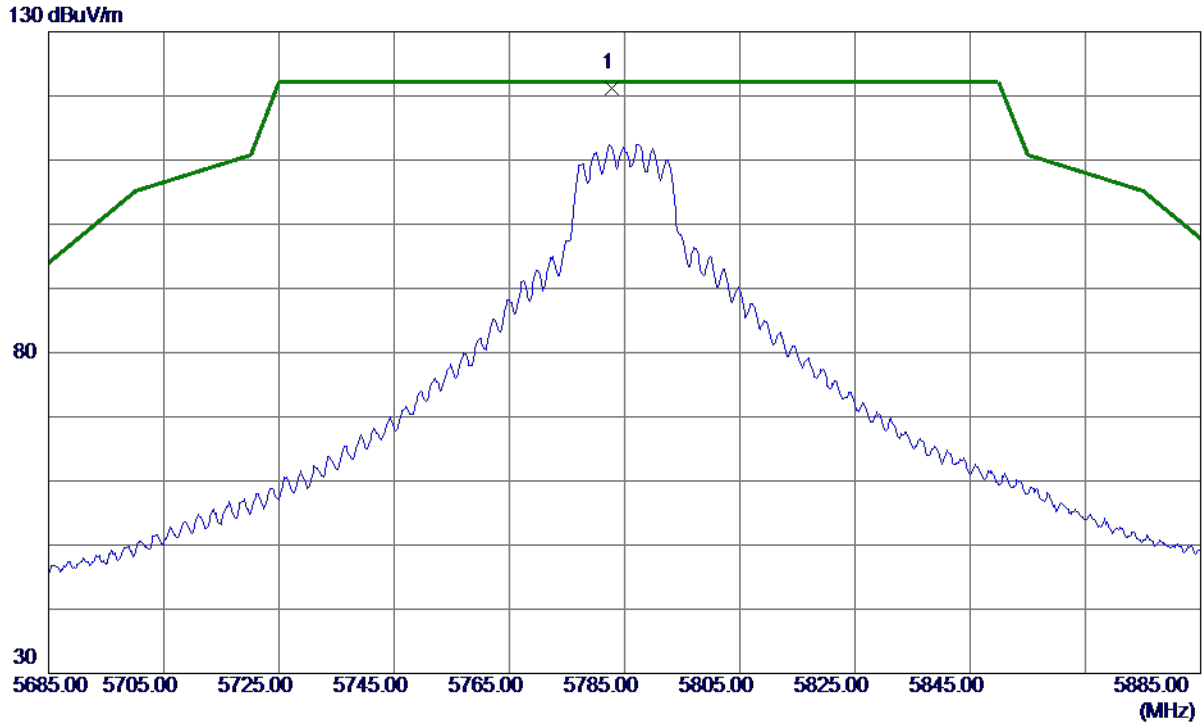

No.	Freq. MHz	Reading Level dBuV/m	Correct Factor dB	Measure ment dBuV/m	Limit dBuV/m	Margin dB	Detector	Comment
1 *	5782.7000	101.14	20.06	121.20	122.20	-1.00	Peak	No Limit

**REMARKS:**

- (1) Measurement Value = Reading Level + Correct Factor.
- (2) Margin Level = Measurement Value - Limit Value.

Orthogonal Axis	X
Test Mode	UNII-3_TX AC (VHT20) Mode 5785 MHz

**Vertical**

80 dBuV/m

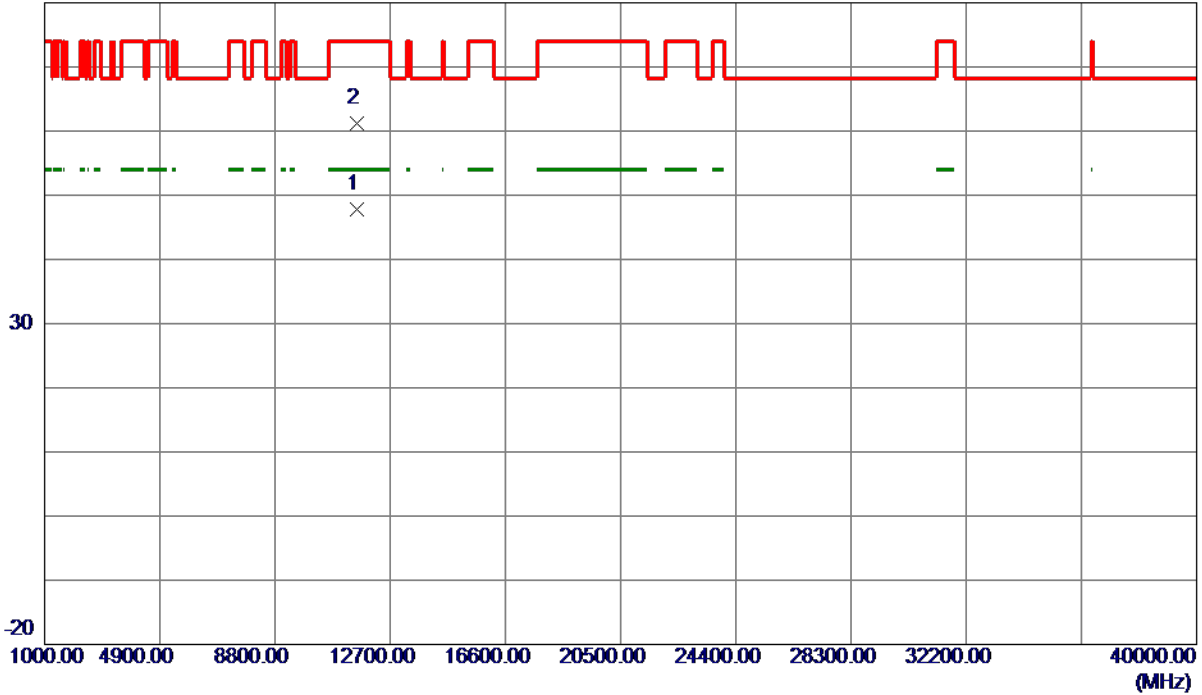

No.	Freq. MHz	Reading Level dBuV/m	Correct Factor dB	Measure ment dBuV/m	Limit dBuV/m	Margin dB	Detector	Comment
1 *	11568.2300	30.54	17.25	47.79	54.00	-6.21	AVG	
2	11568.4700	44.00	17.25	61.25	74.00	-12.75	Peak	

**REMARKS:**

- (1) Measurement Value = Reading Level + Correct Factor.
- (2) Margin Level = Measurement Value - Limit Value.

Orthogonal Axis	X
Test Mode	UNII-3_TX AC (VHT20) Mode 5825 MHz

**Vertical**

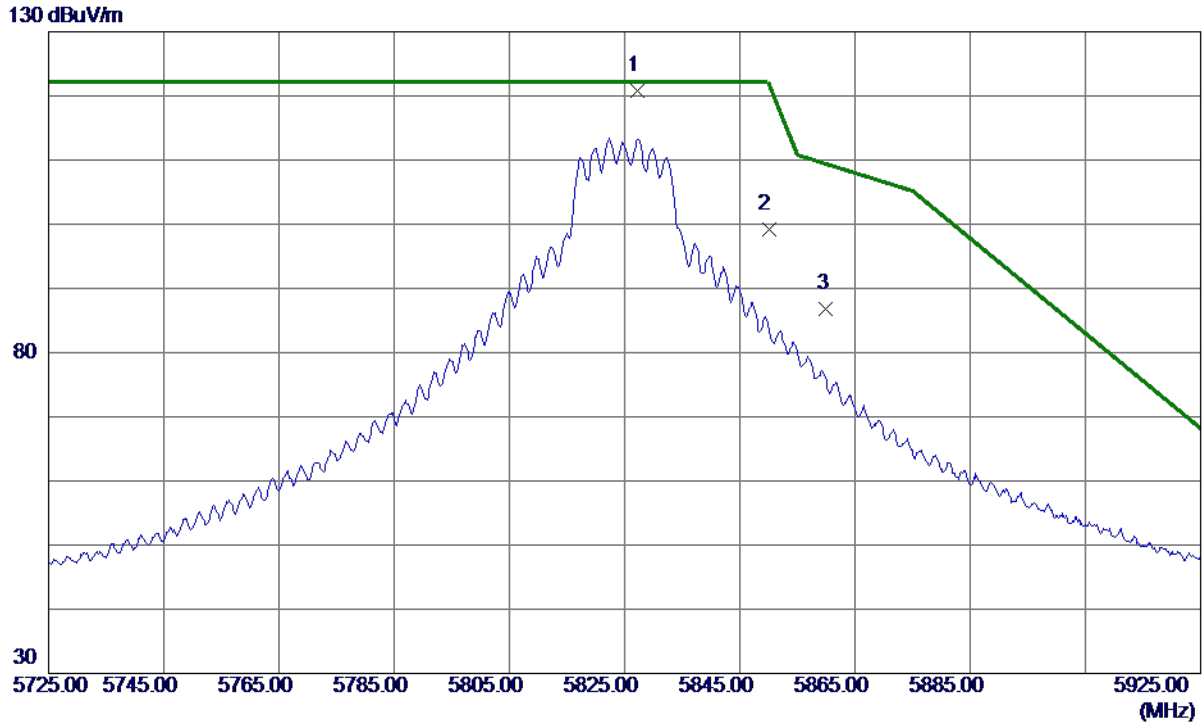

No.	Freq. MHz	Reading Level dBuV/m	Correct Factor dB	Measure ment dBuV/m	Limit dBuV/m	Margin dB	Detector	Comment
1 *	5827.3000	100.70	20.09	120.79	122.20	-1.41	Peak	No Limit
2	5850.0000	79.16	20.11	99.27	122.20	-22.93	Peak	
3	5860.0000	66.73	20.12	86.85	109.40	-22.55	Peak	

**REMARKS:**

- (1) Measurement Value = Reading Level + Correct Factor.
- (2) Margin Level = Measurement Value - Limit Value.

Orthogonal Axis	X
Test Mode	UNII-3_TX AC (VHT20) Mode 5825 MHz

**Vertical**

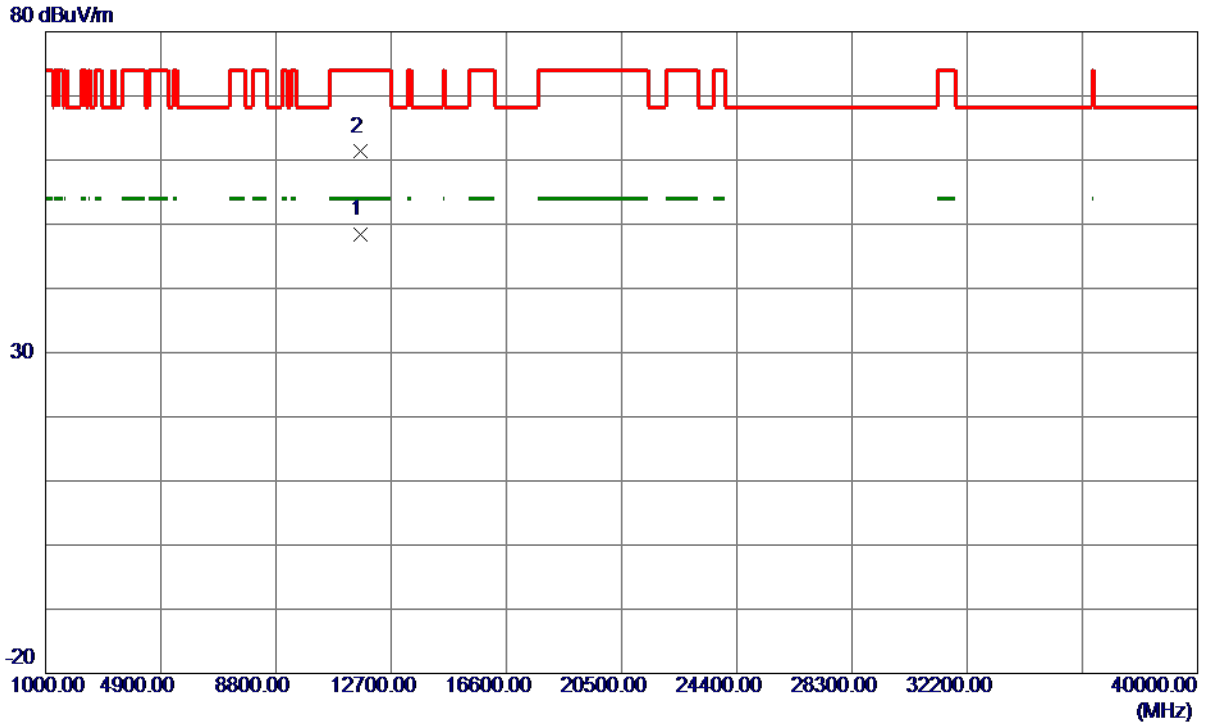

No.	Freq. MHz	Reading Level dBuV/m	Correct Factor dB	Measure ment dBuV/m	Limit dBuV/m	Margin dB	Detector	Comment
1 *	11648.3099	31.03	17.33	48.36	54.00	-5.64	AVG	
2	11648.5500	43.97	17.33	61.30	74.00	-12.70	Peak	

**REMARKS:**

- (1) Measurement Value = Reading Level + Correct Factor.
- (2) Margin Level = Measurement Value - Limit Value.

Orthogonal Axis	X
Test Mode	UNII-3_TX AC (VHT40) Mode 5755 MHz

**Vertical**

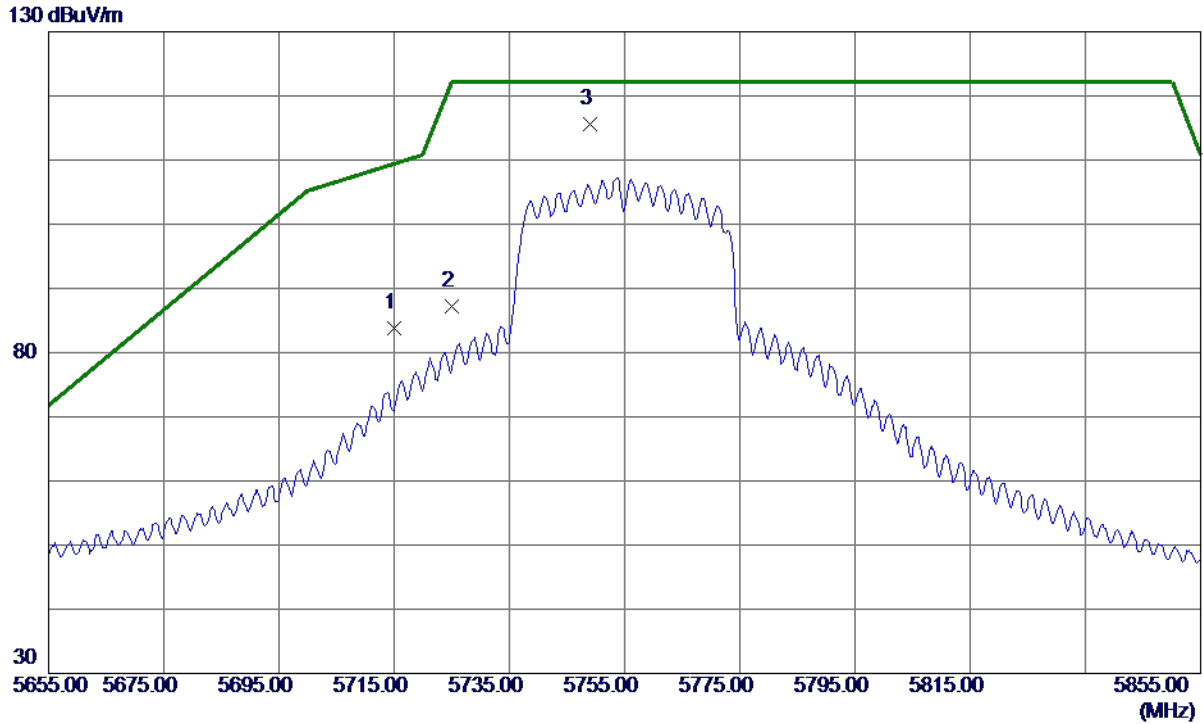

No.	Freq. MHz	Reading Level dBuV/m	Correct Factor dB	Measure ment dBuV/m	Limit dBuV/m	Margin dB	Detector	Comment
1	5715.0000	63.75	20.01	83.76	109.40	-25.64	Peak	
2	5725.0000	67.16	20.02	87.18	122.20	-35.02	Peak	
3 *	5748.9000	95.62	20.04	115.66	122.20	-6.54	Peak	No Limit

**REMARKS:**

- (1) Measurement Value = Reading Level + Correct Factor.
- (2) Margin Level = Measurement Value - Limit Value.

Orthogonal Axis	X
Test Mode	UNII-3_TX AC (VHT40) Mode 5755 MHz

### Vertical

80 dBuV/m

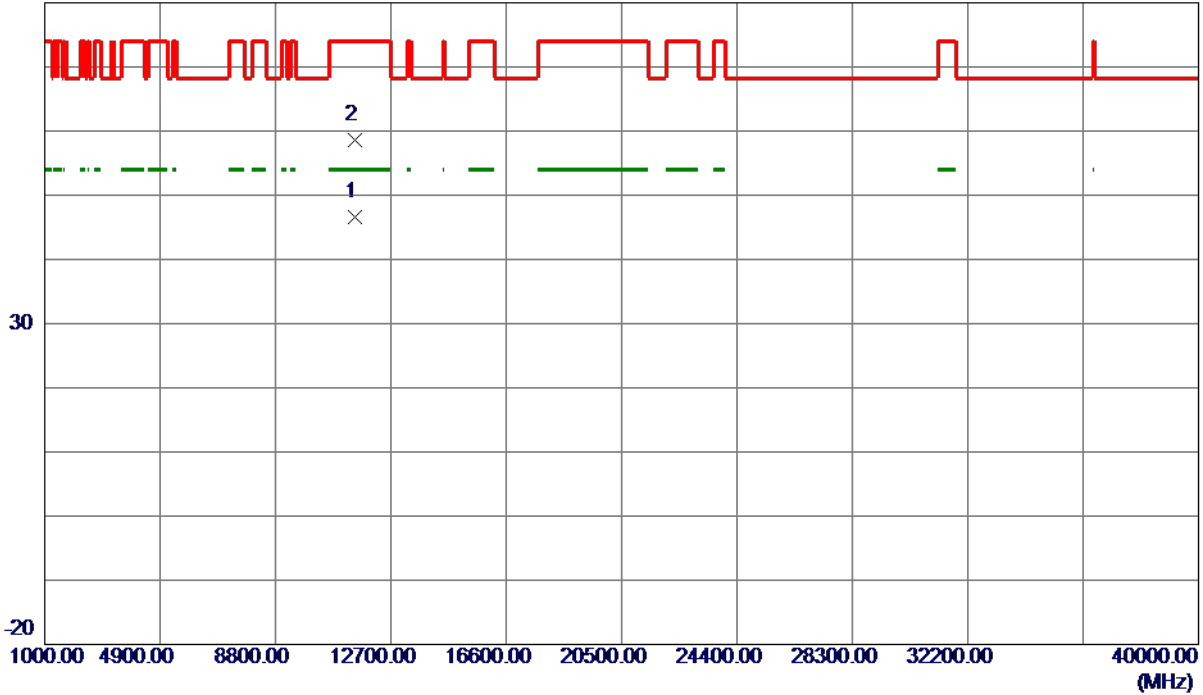

No.	Freq. MHz	Reading Level dBuV/m	Correct Factor dB	Measure ment dBuV/m	Limit dBuV/m	Margin dB	Detector	Comment
1 *	11503.7200	29.41	17.19	46.60	54.00	-7.40	AVG	
2	11508.0100	41.38	17.20	58.58	74.00	-15.42	Peak	

**REMARKS:**

- (1) Measurement Value = Reading Level + Correct Factor.
- (2) Margin Level = Measurement Value - Limit Value.

Orthogonal Axis	X
Test Mode	UNII-3_TX AC (VHT40) Mode 5795 MHz

### Vertical

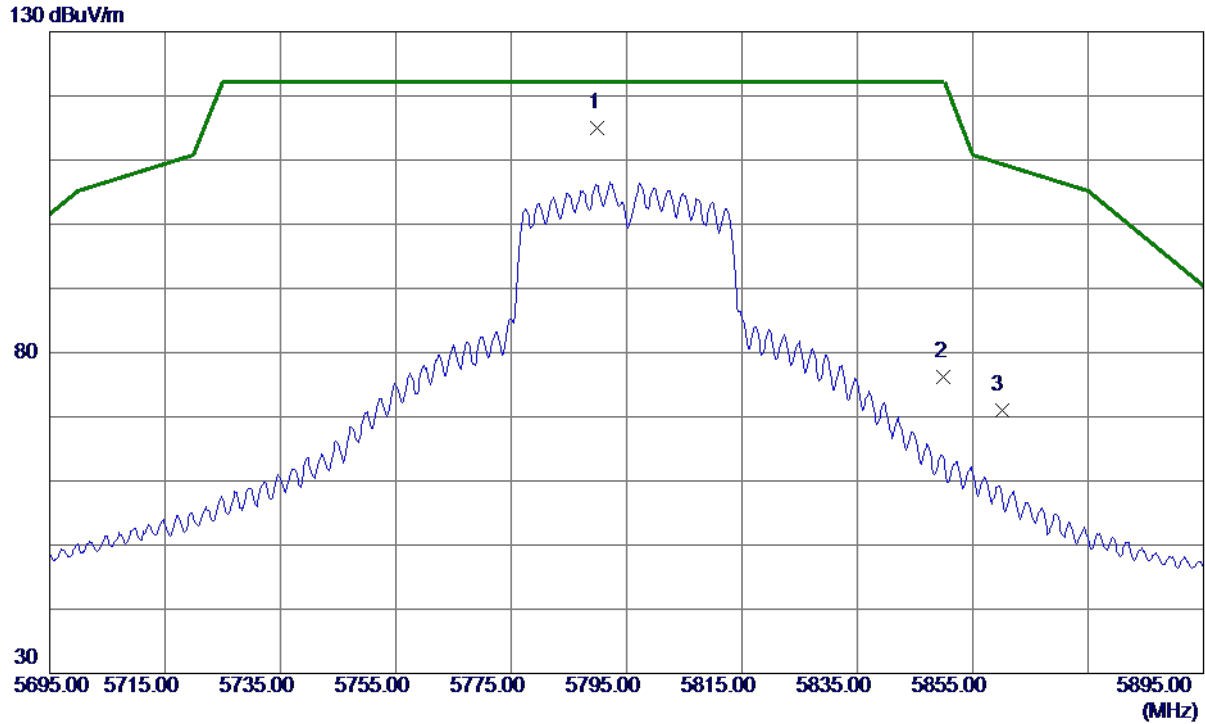

No.	Freq. MHz	Reading Level dBuV/m	Correct Factor dB	Measure ment dBuV/m	Limit dBuV/m	Margin dB	Detector	Comment
1 *	5790.0000	94.87	20.07	114.94	122.20	-7.26	Peak	No Limit
2	5850.0000	56.14	20.11	76.25	122.20	-45.95	Peak	
3	5860.0000	50.86	20.12	70.98	109.40	-38.42	Peak	

**REMARKS:**

- (1) Measurement Value = Reading Level + Correct Factor.
- (2) Margin Level = Measurement Value - Limit Value.

Orthogonal Axis	X
Test Mode	UNII-3_TX AC (VHT40) Mode 5795 MHz

**Vertical**

80 dBuV/m

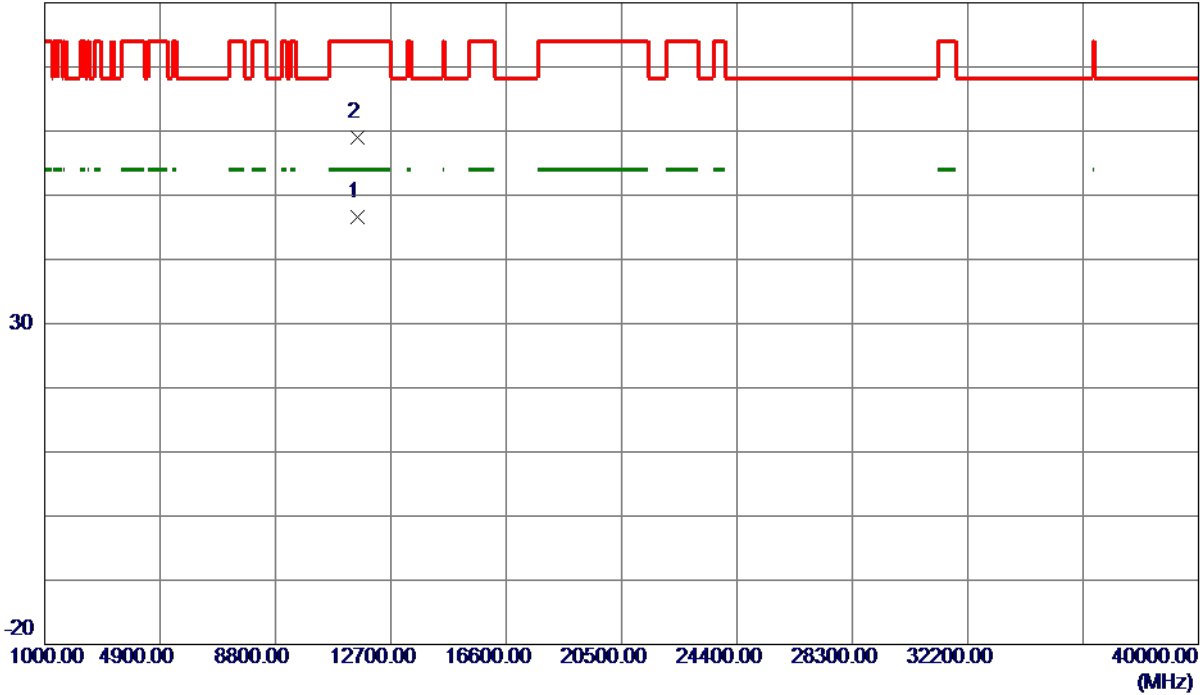

No.	Freq. MHz	Reading Level dBuV/m	Correct Factor dB	Measure ment dBuV/m	Limit dBuV/m	Margin dB	Detector	Comment
1 *	11583.4000	29.34	17.27	46.61	54.00	-7.39	AVG	
2	11585.7400	41.80	17.27	59.07	74.00	-14.93	Peak	

**REMARKS:**

- (1) Measurement Value = Reading Level + Correct Factor.
- (2) Margin Level = Measurement Value - Limit Value.



Orthogonal Axis	X
Test Mode	UNII-3_TX AC (VHT80) Mode 5775 MHz

### Vertical

130 dBuV/m

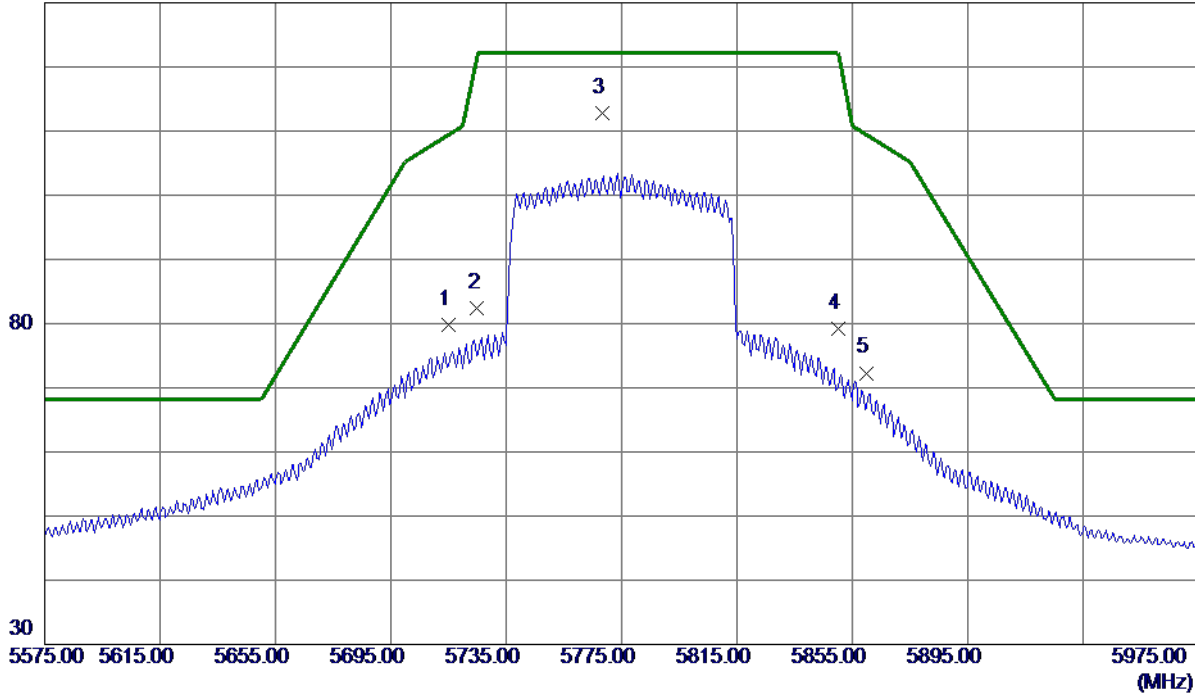

No.	Freq. MHz	Reading Level dBuV/m	Correct Factor dB	Measure ment dBuV/m	Limit dBuV/m	Margin dB	Detector	Comment
1	5715.0000	59.79	20.01	79.80	109.40	-29.60	Peak	
2	5725.0000	62.44	20.02	82.46	122.20	-39.74	Peak	
3 *	5768.2000	92.81	20.05	112.86	122.20	-9.34	Peak	No Limit
4	5850.0000	59.10	20.11	79.21	122.20	-42.99	Peak	
5	5860.0000	52.18	20.12	72.30	109.40	-37.10	Peak	

**REMARKS:**

- (1) Measurement Value = Reading Level + Correct Factor.
- (2) Margin Level = Measurement Value - Limit Value.

Orthogonal Axis	X
Test Mode	UNII-3_TX AC (VHT80) Mode 5775 MHz

**Vertical**

80 dBuV/m

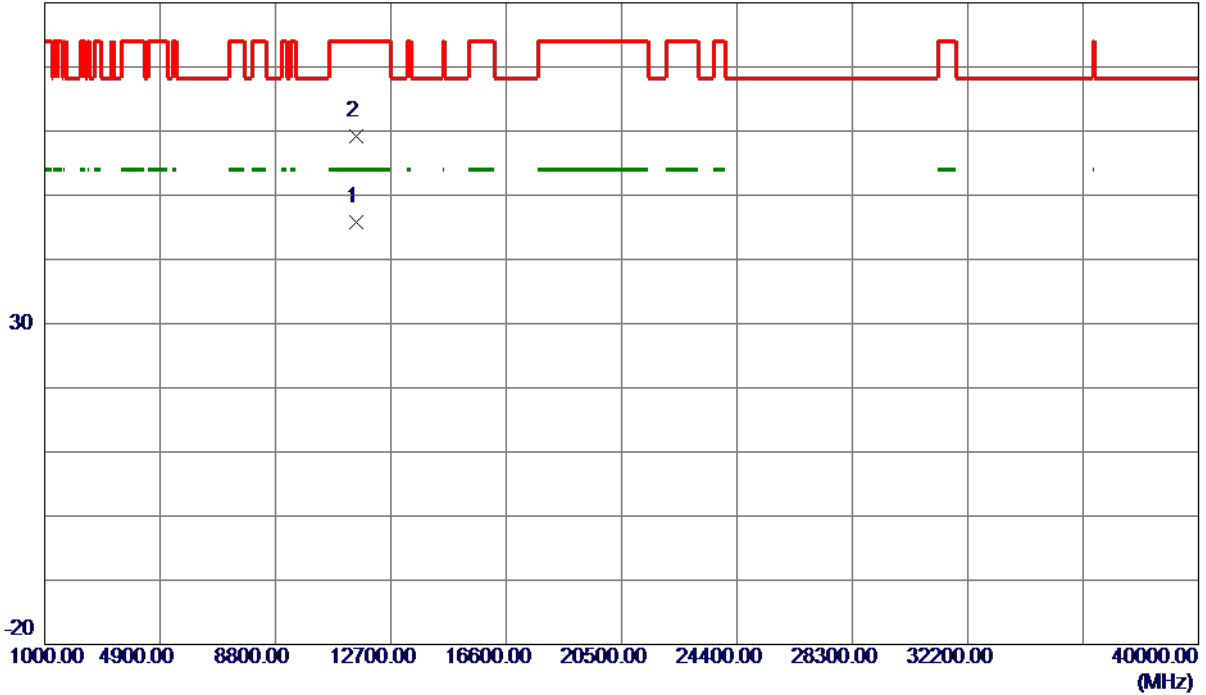

No.	Freq. MHz	Reading Level dBuV/m	Correct Factor dB	Measure ment dBuV/m	Limit dBuV/m	Margin dB	Detector	Comment
1 *	11549.4000	28.56	17.24	45.80	54.00	-8.20	AVG	
2	11549.8700	41.97	17.24	59.21	74.00	-14.79	Peak	

**REMARKS:**

- (1) Measurement Value = Reading Level + Correct Factor.
- (2) Margin Level = Measurement Value - Limit Value.

## Beamforming

Orthogonal Axis	X
Test Mode	UNII-1_TX AC (VHT20) Mode 5180 MHz

### Vertical

130 dBuV/m

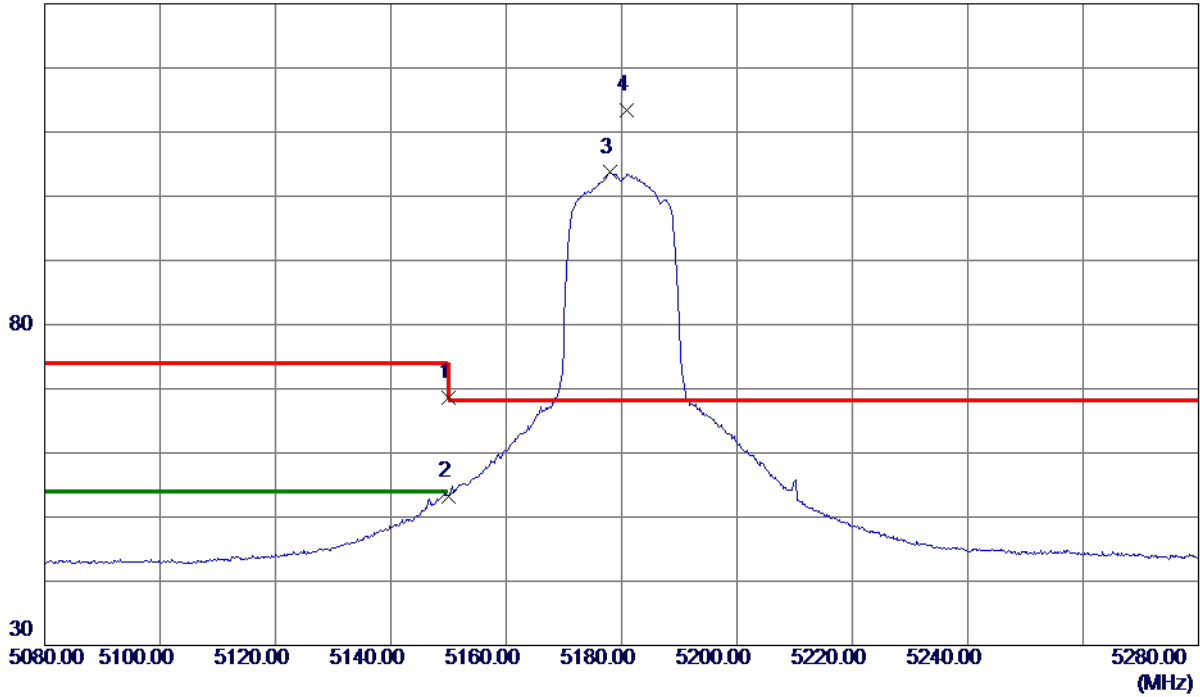

No.	Freq. MHz	Reading Level dBuV/m	Correct Factor dB	Measure ment dBuV/m	Limit dBuV/m	Margin dB	Detector	Comment
1	5150.0000	49.59	18.95	68.54	74.00	-5.46	Peak	
2	5150.0000	34.32	18.95	53.27	54.00	-0.73	AVG	
3	5177.9000	84.68	19.02	103.70	999.00	-895.30	AVG	No Limit
4 *	5180.9000	94.41	19.03	113.44	68.30	45.14	Peak	No Limit

**REMARKS:**

- (1) Measurement Value = Reading Level + Correct Factor.
- (2) Margin Level = Measurement Value - Limit Value.

Orthogonal Axis	X
Test Mode	UNII-1_TX AC (VHT20) Mode 5180 MHz

**Vertical**

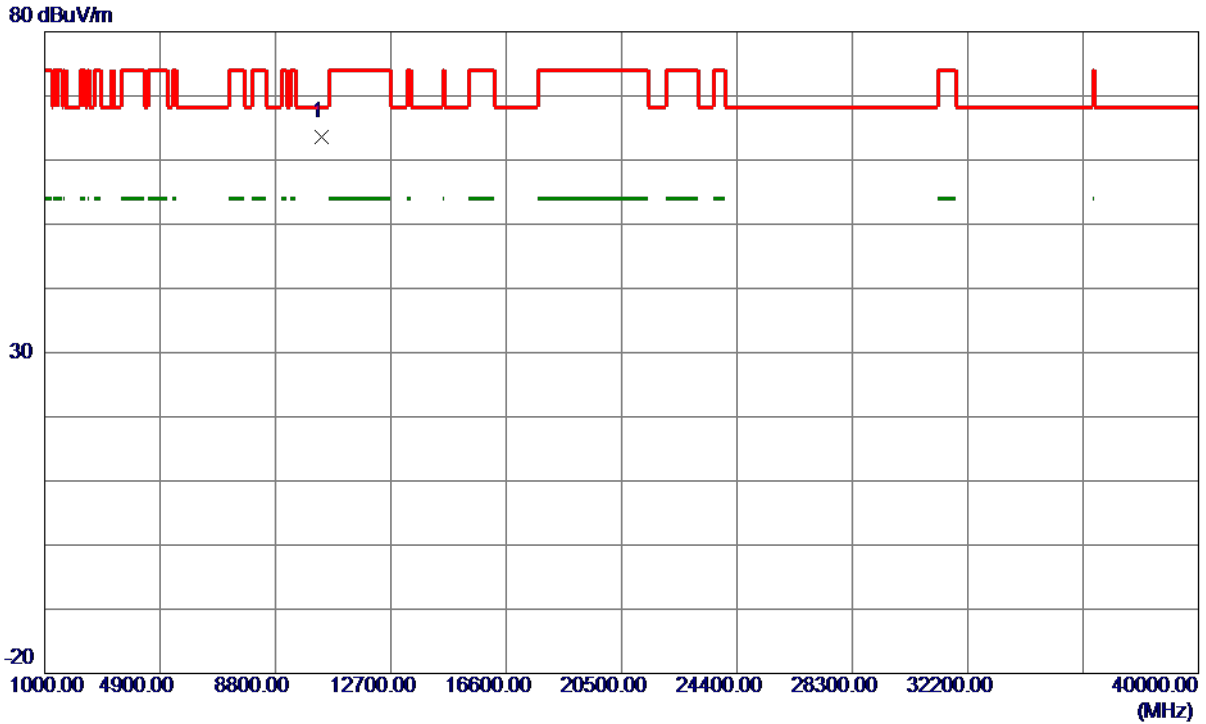

No.	Freq. MHz	Reading Level dBuV/m	Correct Factor dB	Measure ment dBuV/m	Limit dBuV/m	Margin dB	Detector	Comment
1 *	10364.0250	48.58	15.11	63.69	68.30	-4.61	Peak	

**REMARKS:**

- (1) Measurement Value = Reading Level + Correct Factor.
- (2) Margin Level = Measurement Value - Limit Value.

Orthogonal Axis	X
Test Mode	UNII-1_TX AC (VHT20) Mode 5200 MHz

**Vertical**

130 dBuV/m

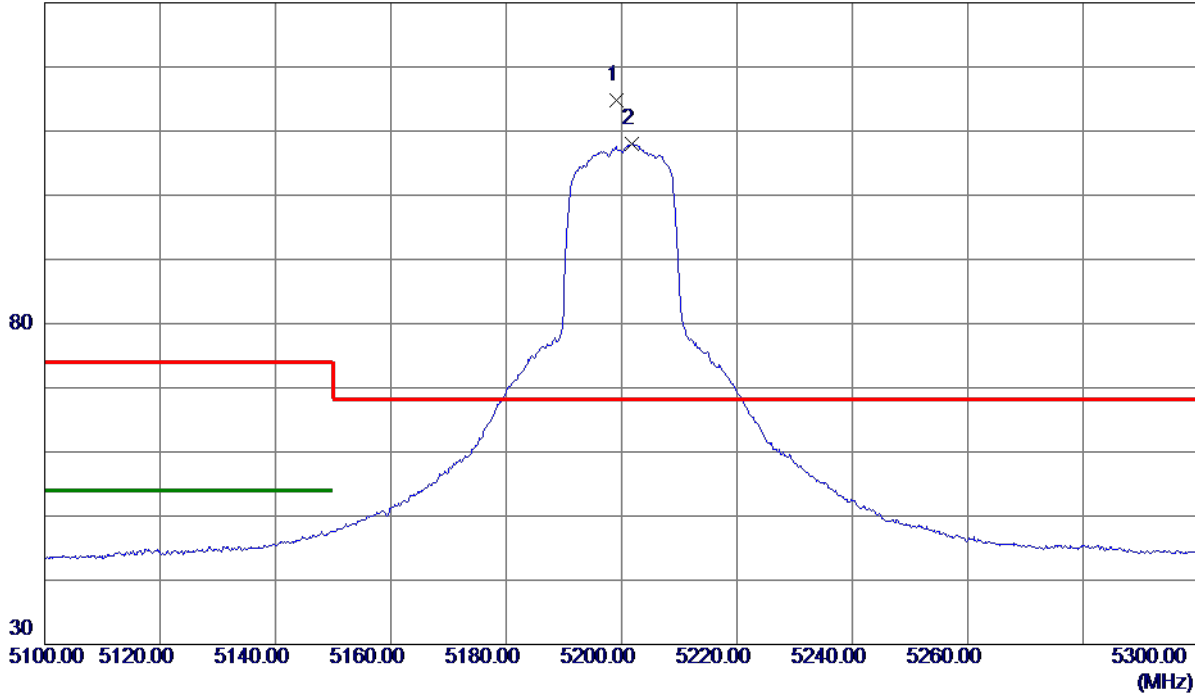

No.	Freq. MHz	Reading Level dBuV/m	Correct Factor dB	Measure ment dBuV/m	Limit dBuV/m	Margin dB	Detector	Comment
1 *	5199.2000	95.68	19.08	114.76	68.30	46.46	Peak	No Limit
2	5201.7000	89.00	19.08	108.08	999.00	-890.92	AVG	No Limit

**REMARKS:**

- (1) Measurement Value = Reading Level + Correct Factor.
- (2) Margin Level = Measurement Value - Limit Value.

Orthogonal Axis	X
Test Mode	UNII-1_TX AC (VHT20) Mode 5200 MHz

**Vertical**

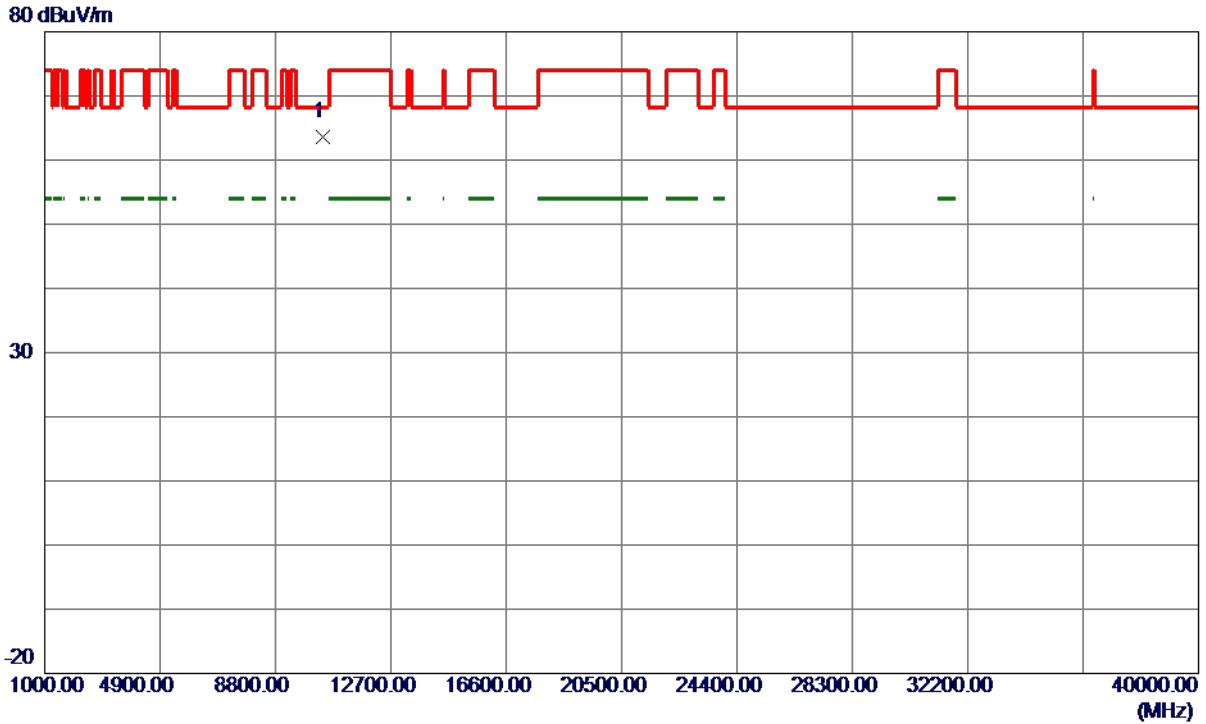

No.	Freq. MHz	Reading Level dBuV/m	Correct Factor dB	Measure ment dBuV/m	Limit dBuV/m	Margin dB	Detector	Comment
1 *	10398.5750	48.41	15.17	63.58	68.30	-4.72	Peak	

**REMARKS:**

- (1) Measurement Value = Reading Level + Correct Factor.
- (2) Margin Level = Measurement Value - Limit Value.

Orthogonal Axis	X
Test Mode	UNII-1_TX AC (VHT20) Mode 5240 MHz

### Vertical

130 dBuV/m

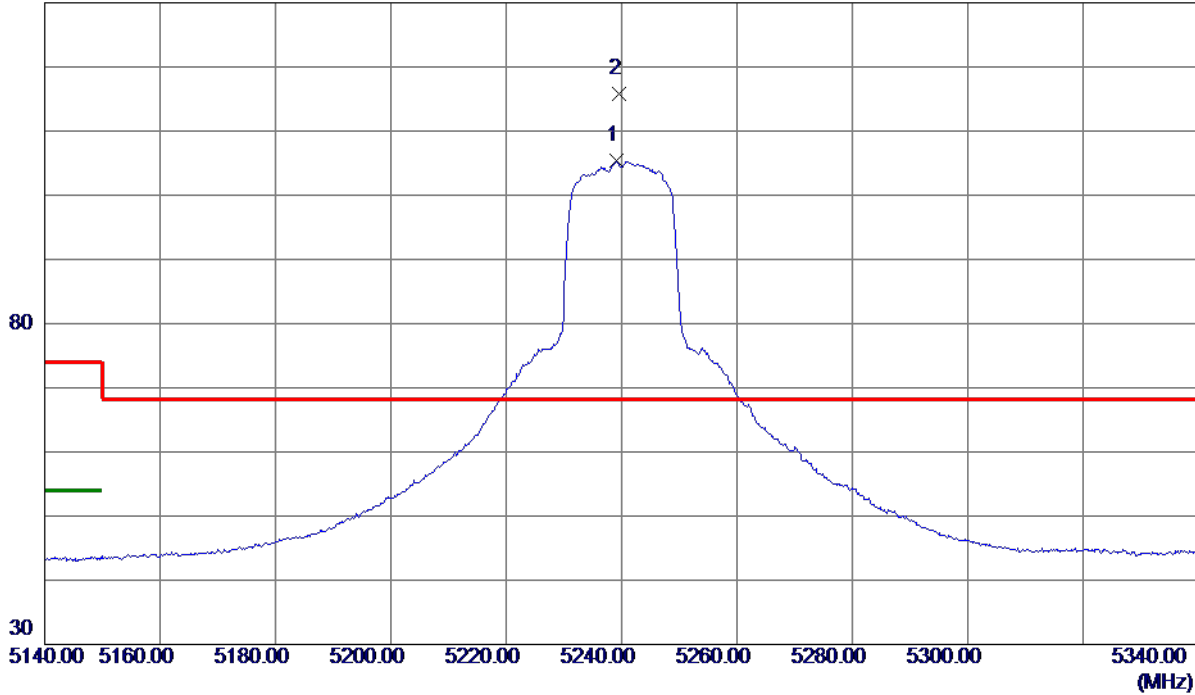

No.	Freq. MHz	Reading Level dBuV/m	Correct Factor dB	Measure ment dBuV/m	Limit dBuV/m	Margin dB	Detector	Comment
1	5239.2000	86.15	19.18	105.33	999.00	-893.67	AVG	No Limit
2 *	5239.5000	96.64	19.18	115.82	68.30	47.52	Peak	No Limit

**REMARKS:**

- (1) Measurement Value = Reading Level + Correct Factor.
- (2) Margin Level = Measurement Value - Limit Value.

Orthogonal Axis	X
Test Mode	UNII-1_TX AC (VHT20) Mode 5240 MHz

**Vertical**

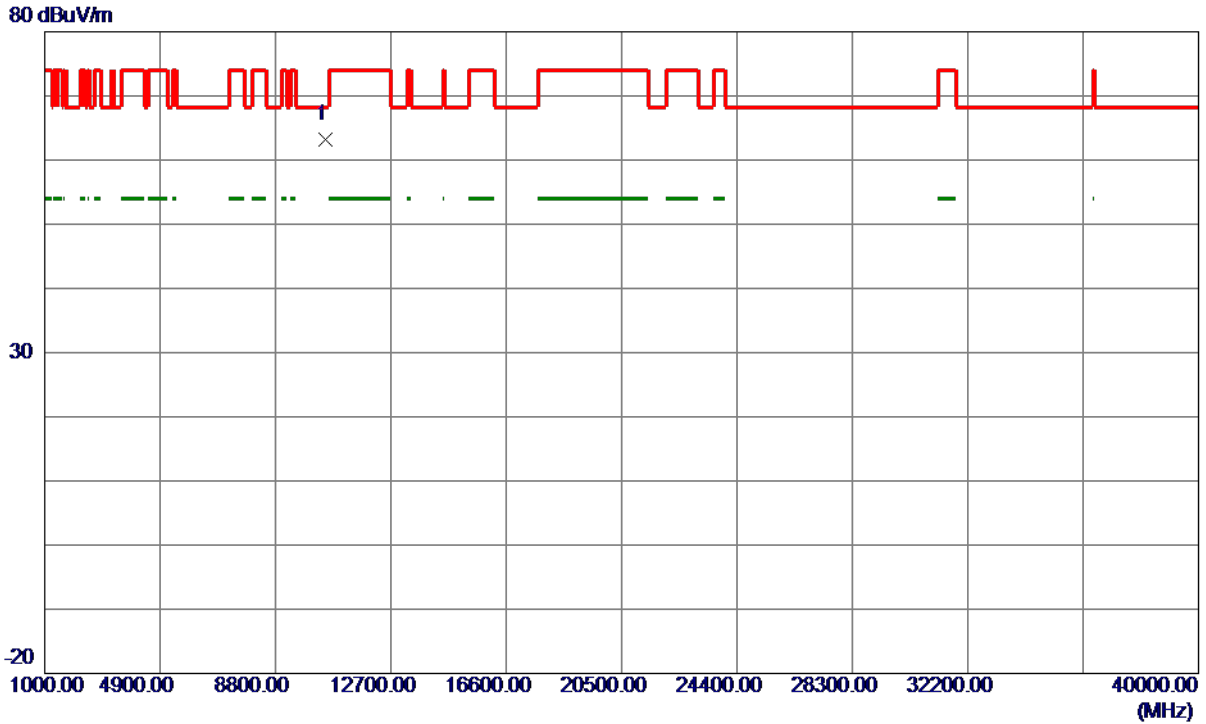

No.	Freq. MHz	Reading Level dBuV/m	Correct Factor dB	Measure ment dBuV/m	Limit dBuV/m	Margin dB	Detector	Comment
1 *	10477.7250	47.86	15.29	63.15	68.30	-5.15	Peak	

**REMARKS:**

- (1) Measurement Value = Reading Level + Correct Factor.
- (2) Margin Level = Measurement Value - Limit Value.



Orthogonal Axis	X
Test Mode	UNII-1_TX AC (VHT40) Mode 5190 MHz

### Vertical

130 dBuV/m

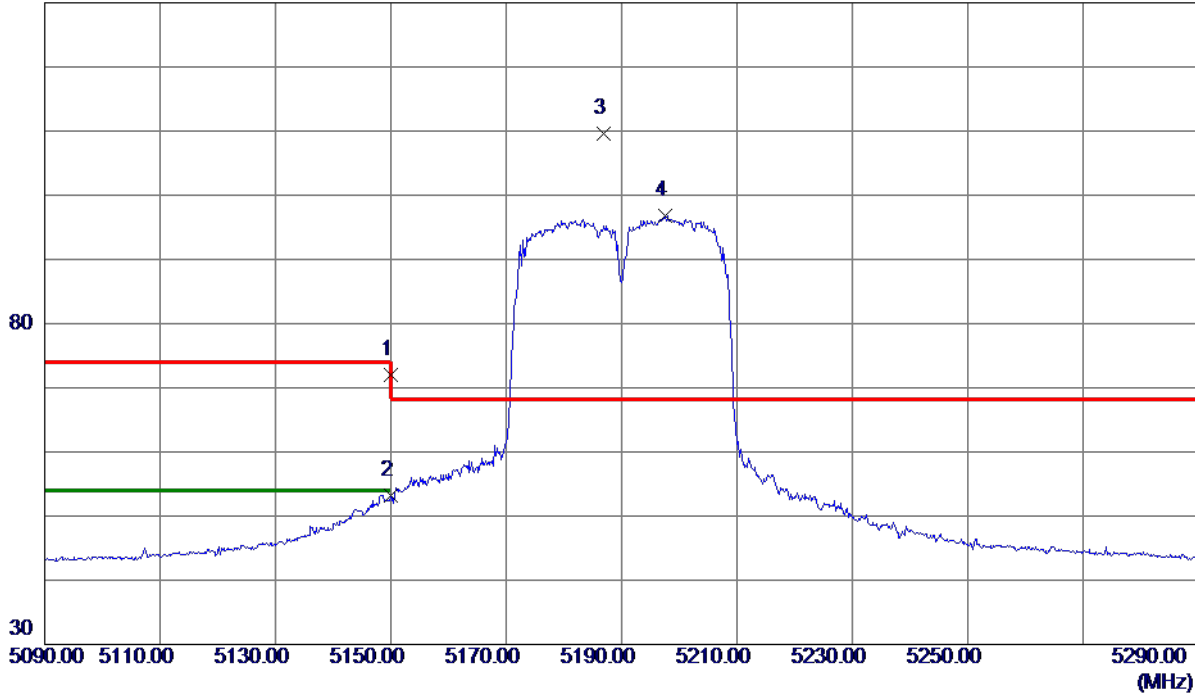

No.	Freq. MHz	Reading Level dBuV/m	Correct Factor dB	Measure ment dBuV/m	Limit dBuV/m	Margin dB	Detector	Comment
1	5150.0000	52.98	18.95	71.93	74.00	-2.07	Peak	
2	5150.0000	34.23	18.95	53.18	54.00	-0.82	AVG	
3 *	5186.9000	90.57	19.04	109.61	68.30	41.31	Peak	No Limit
4	5197.5000	77.66	19.07	96.73	999.00	-902.27	AVG	No Limit

**REMARKS:**

- (1) Measurement Value = Reading Level + Correct Factor.
- (2) Margin Level = Measurement Value - Limit Value.

Orthogonal Axis	X
Test Mode	UNII-1_TX AC (VHT40) Mode 5190 MHz

**Vertical**

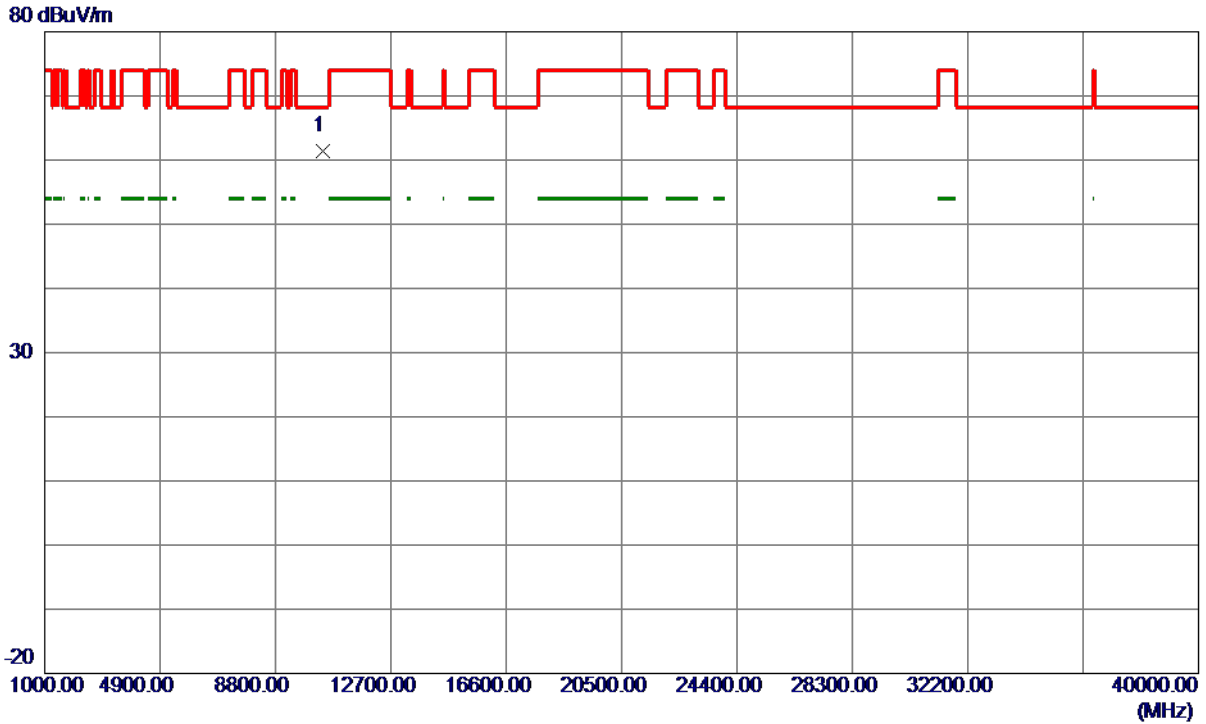

No.	Freq. MHz	Reading Level dBuV/m	Correct Factor dB	Measure ment dBuV/m	Limit dBuV/m	Margin dB	Detector	Comment
1 *	10398.9500	46.22	15.17	61.39	68.30	-6.91	Peak	

**REMARKS:**

- (1) Measurement Value = Reading Level + Correct Factor.
- (2) Margin Level = Measurement Value - Limit Value.

Orthogonal Axis	X
Test Mode	UNII-1_TX AC (VHT40) Mode 5230 MHz

### Vertical

130 dBuV/m

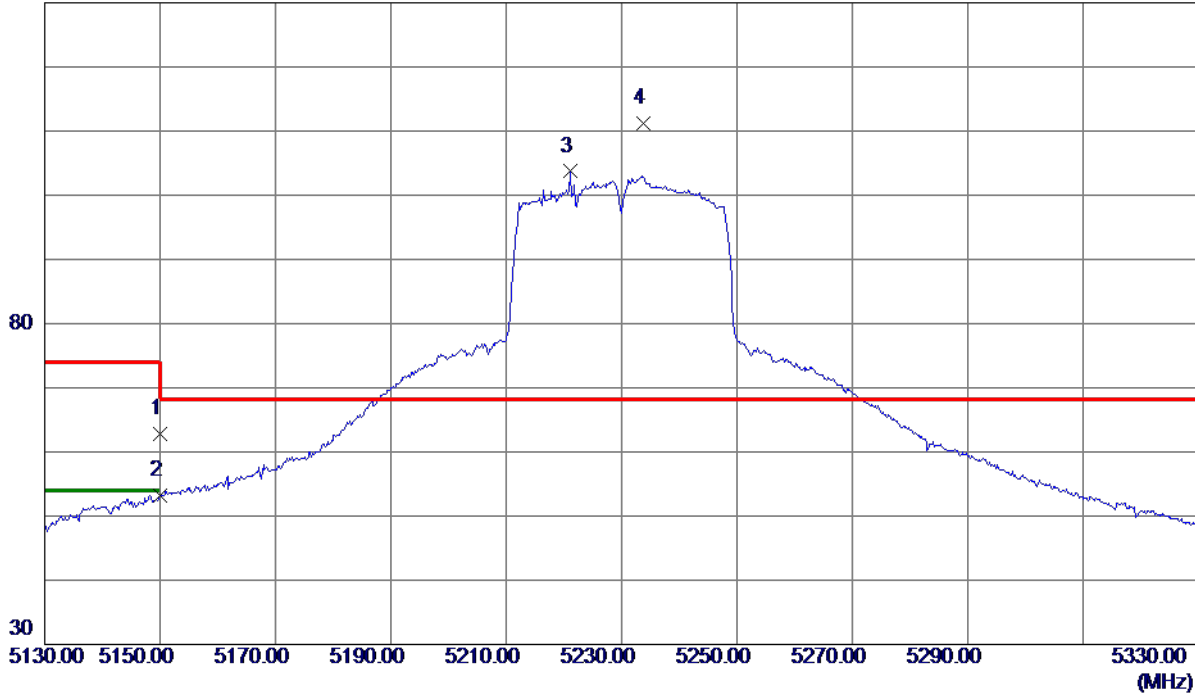

No.	Freq. MHz	Reading Level dBuV/m	Correct Factor dB	Measure ment dBuV/m	Limit dBuV/m	Margin dB	Detector	Comment
1	5150.0000	43.83	18.95	62.78	74.00	-11.22	Peak	
2	5150.0000	34.30	18.95	53.25	54.00	-0.75	AVG	
3	5221.1000	84.57	19.13	103.70	999.00	-895.30	AVG	No Limit
4 *	5233.7000	92.02	19.17	111.19	68.30	42.89	Peak	No Limit

**REMARKS:**

- (1) Measurement Value = Reading Level + Correct Factor.
- (2) Margin Level = Measurement Value - Limit Value.

Orthogonal Axis	X
Test Mode	UNII-1_TX AC (VHT40) Mode 5230 MHz

**Vertical**

80 dBuV/m

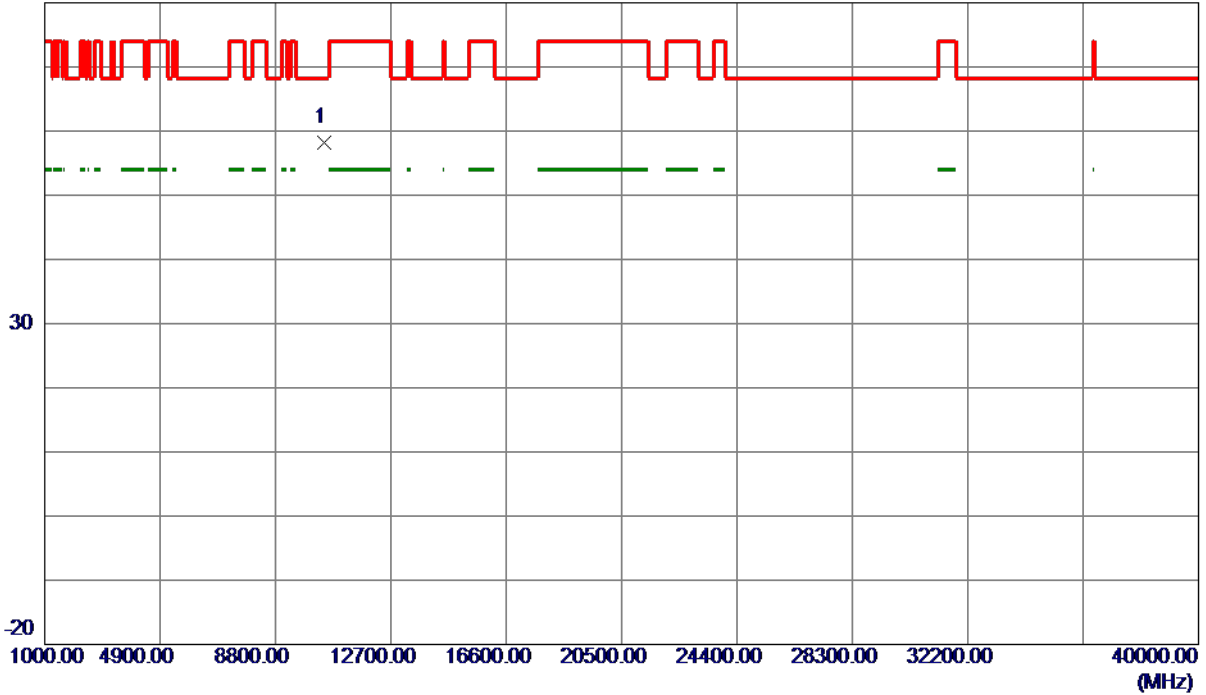

No.	Freq. MHz	Reading Level dBuV/m	Correct Factor dB	Measure ment dBuV/m	Limit dBuV/m	Margin dB	Detector	Comment
1 *	10464.8000	42.85	15.27	58.12	68.30	-10.18	Peak	

**REMARKS:**

- (1) Measurement Value = Reading Level + Correct Factor.
- (2) Margin Level = Measurement Value - Limit Value.

Orthogonal Axis	X
Test Mode	UNII-1_TX AC (VHT80) Mode 5210 MHz

### Vertical

130 dBuV/m

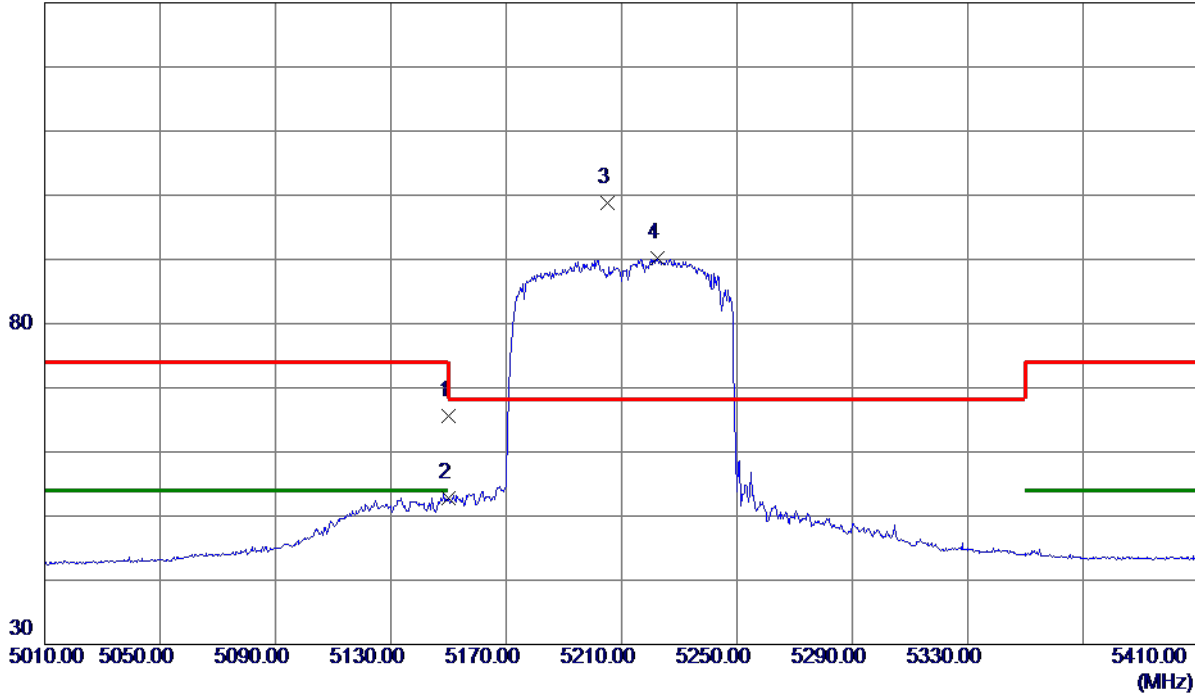

No.	Freq. MHz	Reading Level dBuV/m	Correct Factor dB	Measure ment dBuV/m	Limit dBuV/m	Margin dB	Detector	Comment
1	5150.0000	46.60	18.95	65.55	74.00	-8.45	Peak	
2	5150.0000	33.88	18.95	52.83	54.00	-1.17	AVG	
3 *	5205.2000	79.64	19.09	98.73	68.30	30.43	Peak	No Limit
4	5222.4000	70.98	19.14	90.12	999.00	-908.88	AVG	No Limit

**REMARKS:**

- (1) Measurement Value = Reading Level + Correct Factor.
- (2) Margin Level = Measurement Value - Limit Value.

Orthogonal Axis	X
Test Mode	UNII-1_TX AC (VHT80) Mode 5210 MHz

**Vertical**

80 dBuV/m

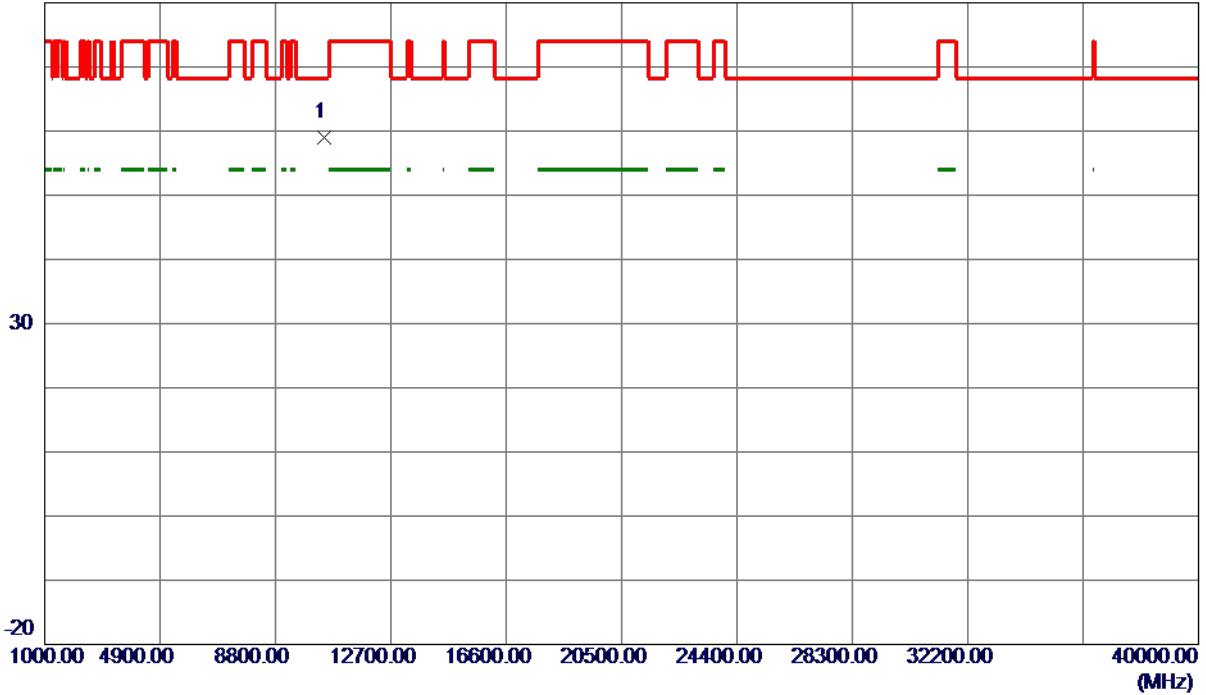

No.	Freq. MHz	Reading Level dBuV/m	Correct Factor dB	Measure ment dBuV/m	Limit dBuV/m	Margin dB	Detector	Comment
1 *	10436.6500	43.77	15.22	58.99	68.30	-9.31	Peak	

**REMARKS:**

- (1) Measurement Value = Reading Level + Correct Factor.
- (2) Margin Level = Measurement Value - Limit Value.

Orthogonal Axis	X
Test Mode	UNII-3_TX AC (VHT20) Mode 5745 MHz

**Vertical**

130 dBuV/m

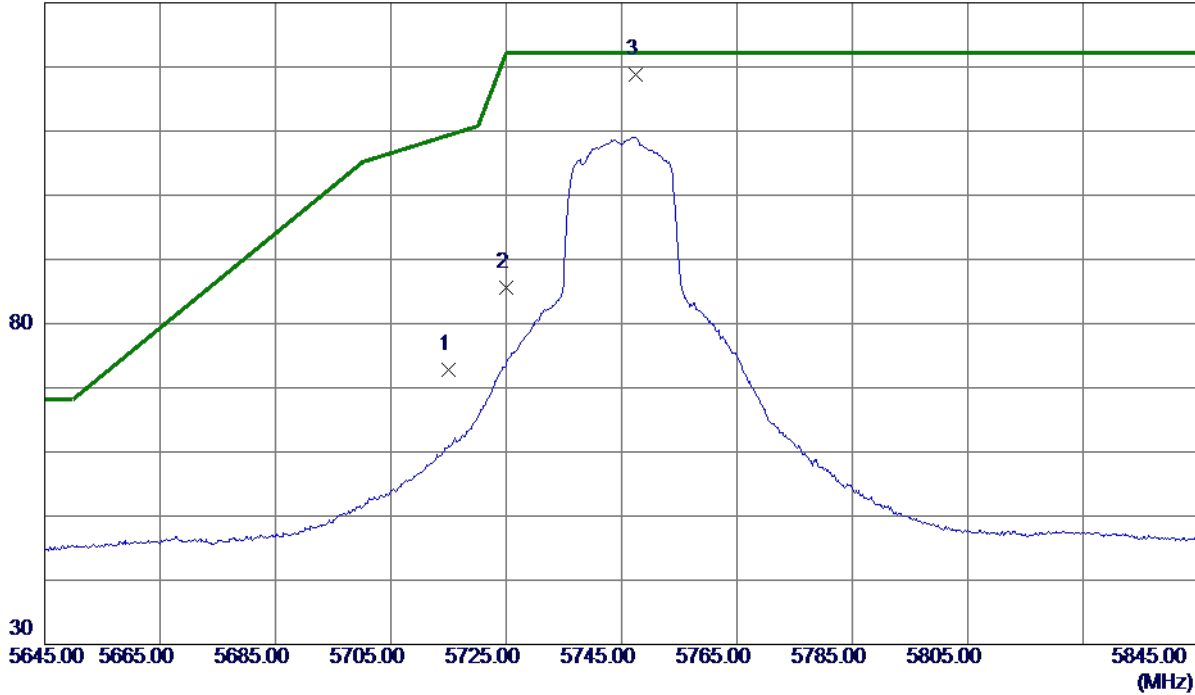

No.	Freq. MHz	Reading Level dBuV/m	Correct Factor dB	Measure ment dBuV/m	Limit dBuV/m	Margin dB	Detector	Comment
1	5715.0000	52.76	20.01	72.77	109.40	-36.63	Peak	
2	5725.0000	65.63	20.02	85.65	122.20	-36.55	Peak	
3 *	5747.4000	98.80	20.04	118.84	122.20	-3.36	Peak	No Limit

**REMARKS:**

- (1) Measurement Value = Reading Level + Correct Factor.
- (2) Margin Level = Measurement Value - Limit Value.

Orthogonal Axis	X
Test Mode	UNII-3_TX AC (VHT20) Mode 5745 MHz

**Vertical**

80 dBuV/m

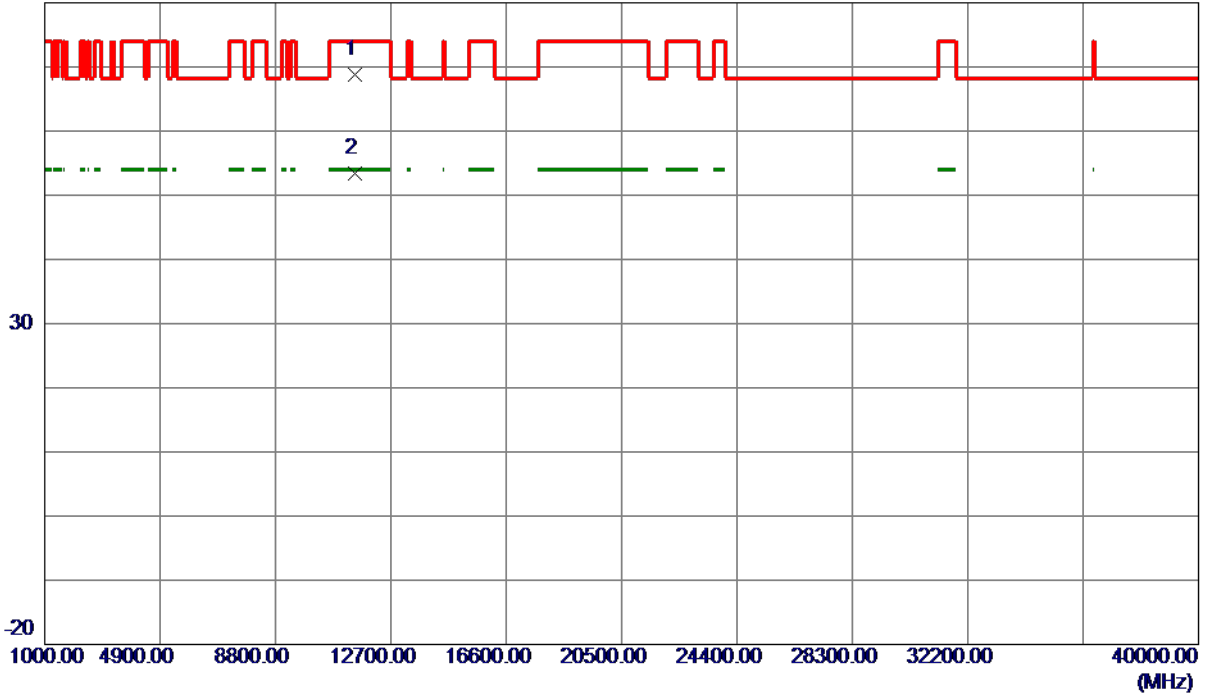

No.	Freq. MHz	Reading Level dBuV/m	Correct Factor dB	Measure ment dBuV/m	Limit dBuV/m	Margin dB	Detector	Comment
1	11490.1000	51.58	17.16	68.74	74.00	-5.26	Peak	
2 *	11490.9000	36.18	17.16	53.34	54.00	-0.66	AVG	

**REMARKS:**

- (1) Measurement Value = Reading Level + Correct Factor.
- (2) Margin Level = Measurement Value - Limit Value.



Orthogonal Axis	X
Test Mode	UNII-3_TX AC (VHT20) Mode 5785 MHz

**Vertical**

130 dBuV/m

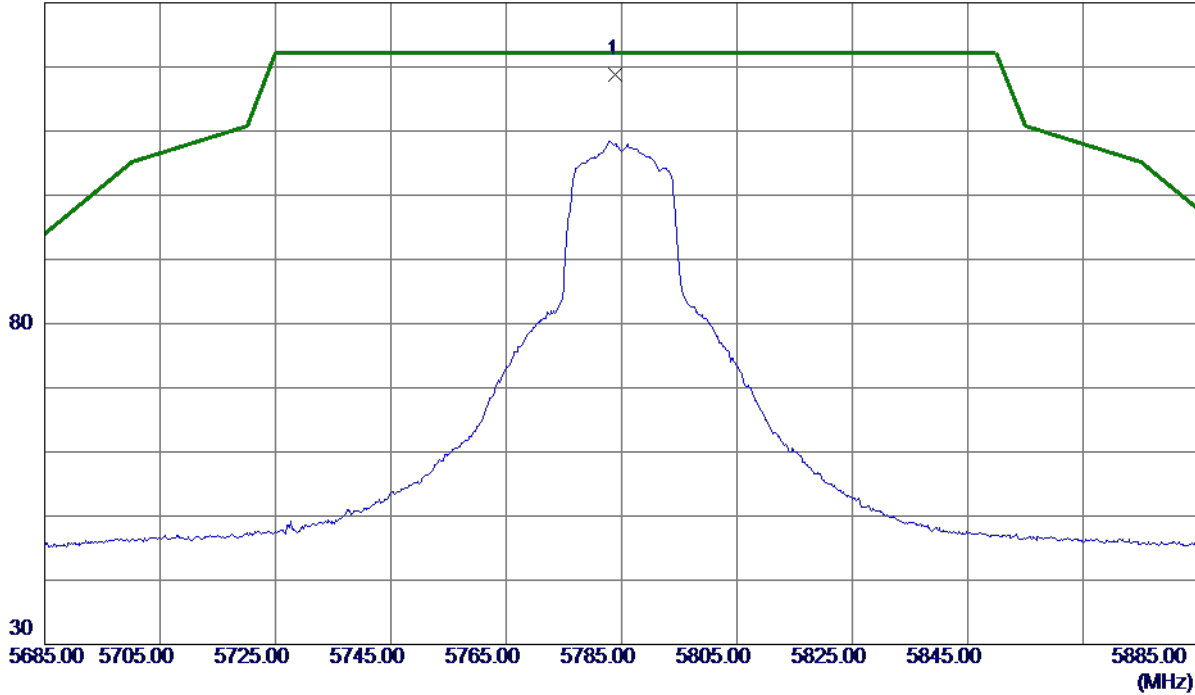

No.	Freq. MHz	Reading Level dBuV/m	Correct Factor dB	Measure ment dBuV/m	Limit dBuV/m	Margin dB	Detector	Comment
1 *	5784.0000	98.81	20.06	118.87	122.20	-3.33	Peak	No Limit

**REMARKS:**

- (1) Measurement Value = Reading Level + Correct Factor.
- (2) Margin Level = Measurement Value - Limit Value.

Orthogonal Axis	X
Test Mode	UNII-3_TX AC (VHT20) Mode 5785 MHz

### Vertical

80 dBuV/m

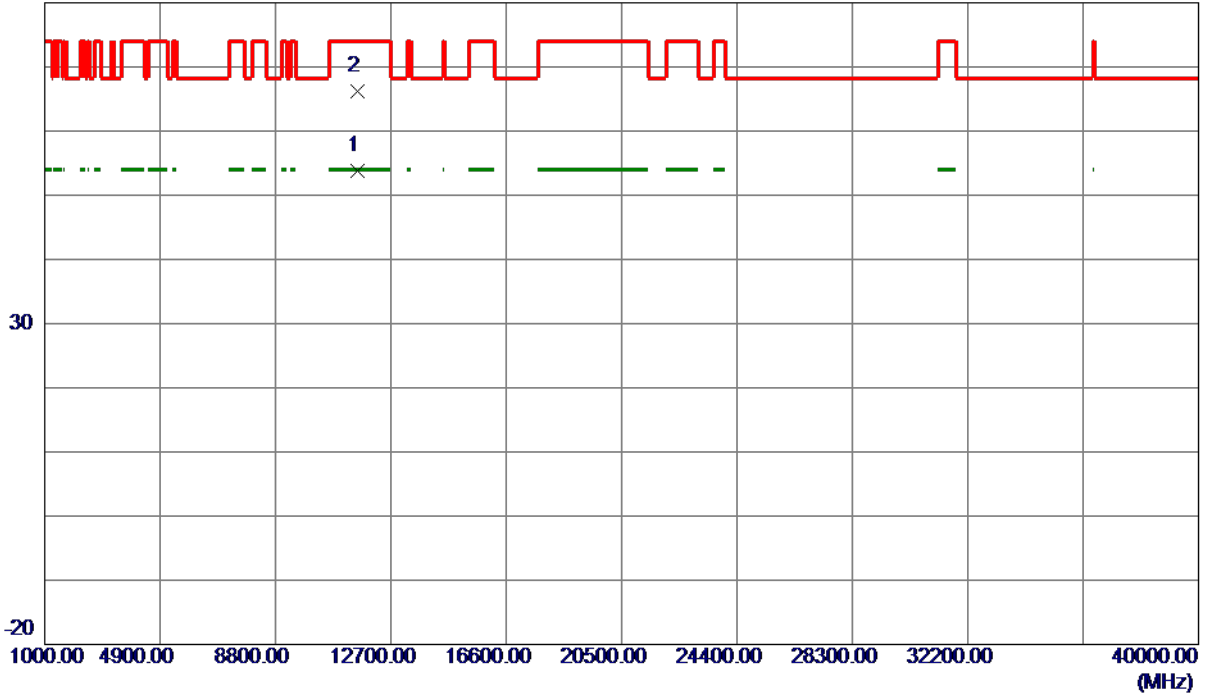

No.	Freq. MHz	Reading Level dBuV/m	Correct Factor dB	Measure ment dBuV/m	Limit dBuV/m	Margin dB	Detector	Comment
1 *	11572.0750	36.60	17.26	53.86	54.00	-0.14	AVG	
2	11575.3000	48.90	17.26	66.16	74.00	-7.84	Peak	

**REMARKS:**

- (1) Measurement Value = Reading Level + Correct Factor.
- (2) Margin Level = Measurement Value - Limit Value.

Orthogonal Axis	X
Test Mode	UNII-3_TX AC (VHT20) Mode 5825 MHz

**Vertical**

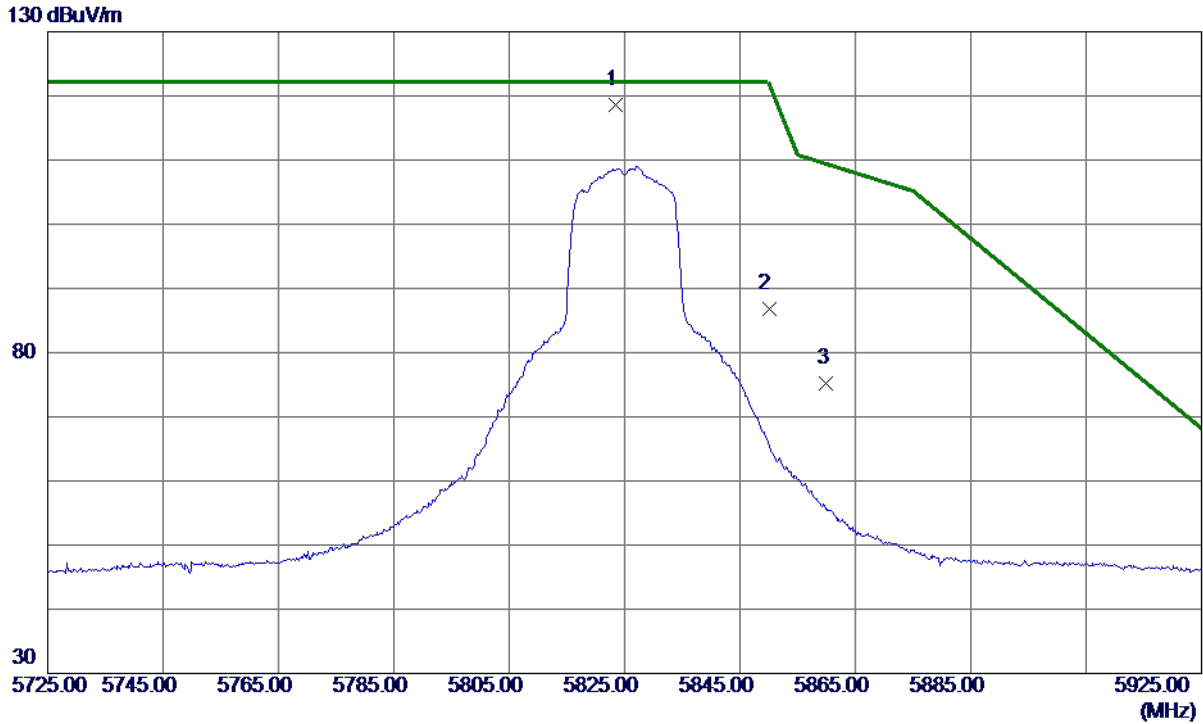

No.	Freq. MHz	Reading Level dBuV/m	Correct Factor dB	Measure ment dBuV/m	Limit dBuV/m	Margin dB	Detector	Comment
1 *	5823.5000	98.43	20.09	118.52	122.20	-3.68	Peak	No Limit
2	5850.0000	66.75	20.11	86.86	122.20	-35.34	Peak	
3	5860.0000	55.09	20.12	75.21	109.40	-34.19	Peak	

**REMARKS:**

- (1) Measurement Value = Reading Level + Correct Factor.
- (2) Margin Level = Measurement Value - Limit Value.

Orthogonal Axis	X
Test Mode	UNII-3_TX AC (VHT20) Mode 5825 MHz

**Vertical**

80 dBuV/m

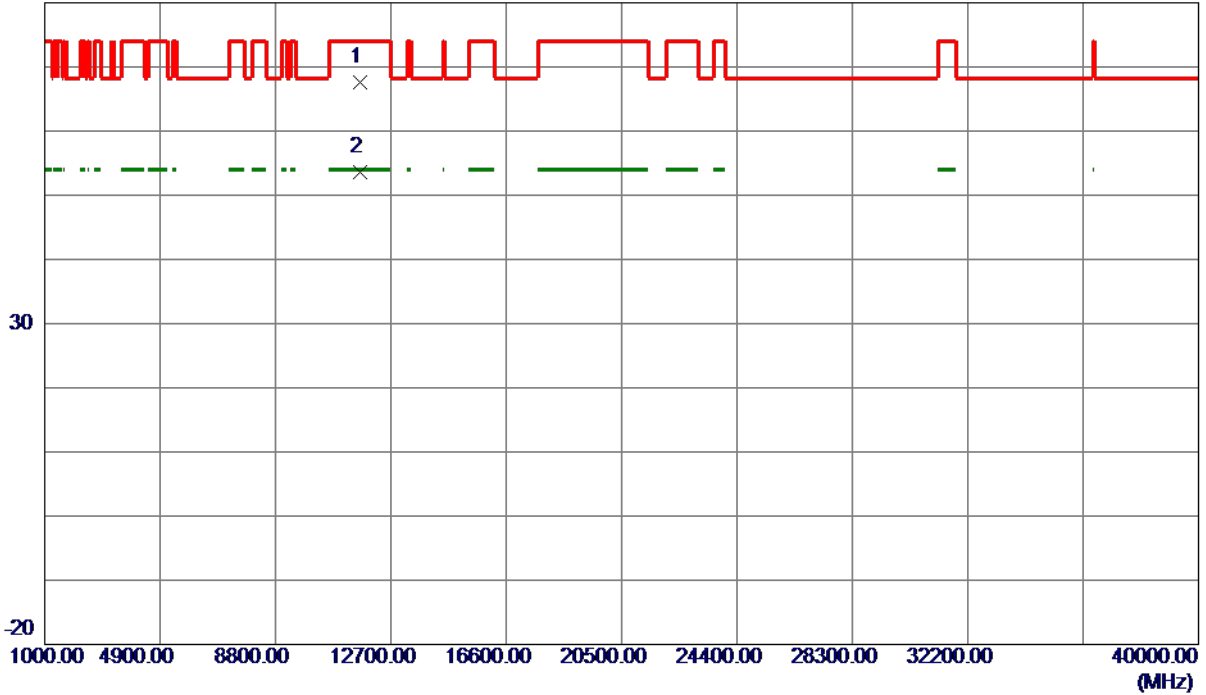

No.	Freq. MHz	Reading Level dBuV/m	Correct Factor dB	Measure ment dBuV/m	Limit dBuV/m	Margin dB	Detector	Comment
1	11650.7500	50.33	17.33	67.66	74.00	-6.34	Peak	
2 *	11652.4550	36.22	17.33	53.55	54.00	-0.45	AVG	

**REMARKS:**

- (1) Measurement Value = Reading Level + Correct Factor.
- (2) Margin Level = Measurement Value - Limit Value.

Orthogonal Axis	X
Test Mode	UNII-3_TX AC (VHT40) Mode 5755 MHz

**Vertical**

130 dBuV/m

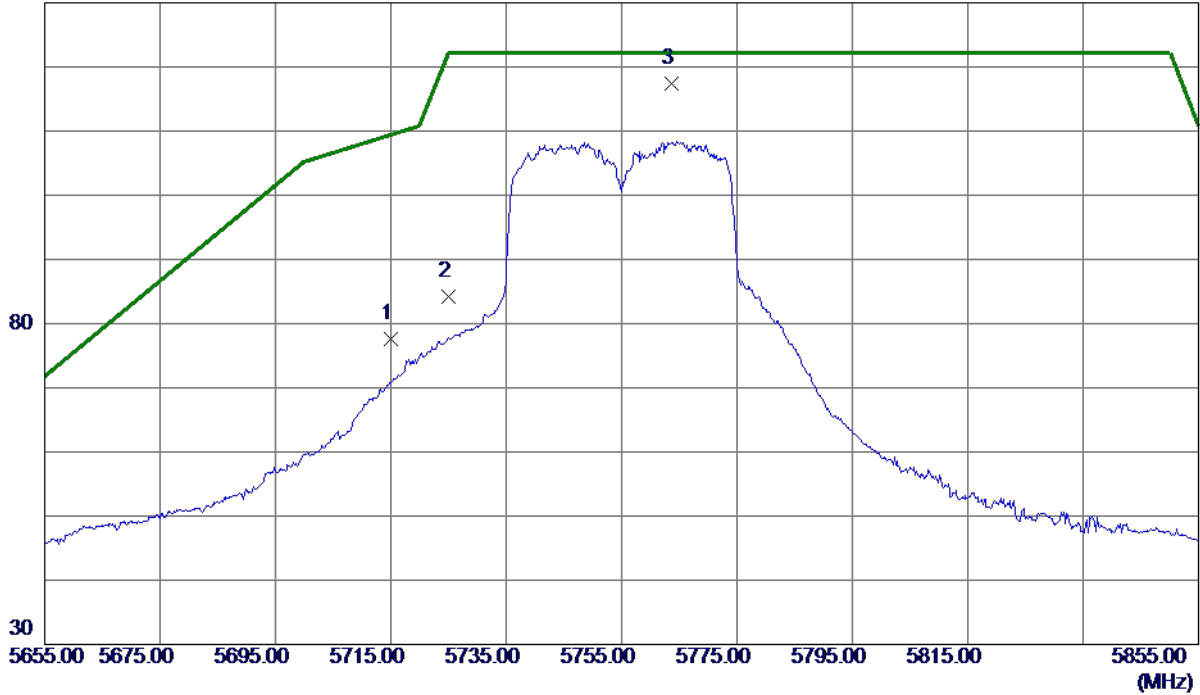

No.	Freq. MHz	Reading Level dBuV/m	Correct Factor dB	Measure ment dBuV/m	Limit dBuV/m	Margin dB	Detector	Comment
1	5715.0000	57.50	20.01	77.51	109.40	-31.89	Peak	
2	5725.0000	64.23	20.02	84.25	122.20	-37.95	Peak	
3 *	5763.6000	97.42	20.05	117.47	122.20	-4.73	Peak	No Limit

**REMARKS:**

- (1) Measurement Value = Reading Level + Correct Factor.
- (2) Margin Level = Measurement Value - Limit Value.

Orthogonal Axis	X
Test Mode	UNII-3_TX AC (VHT40) Mode 5755 MHz

### Vertical

80 dBuV/m

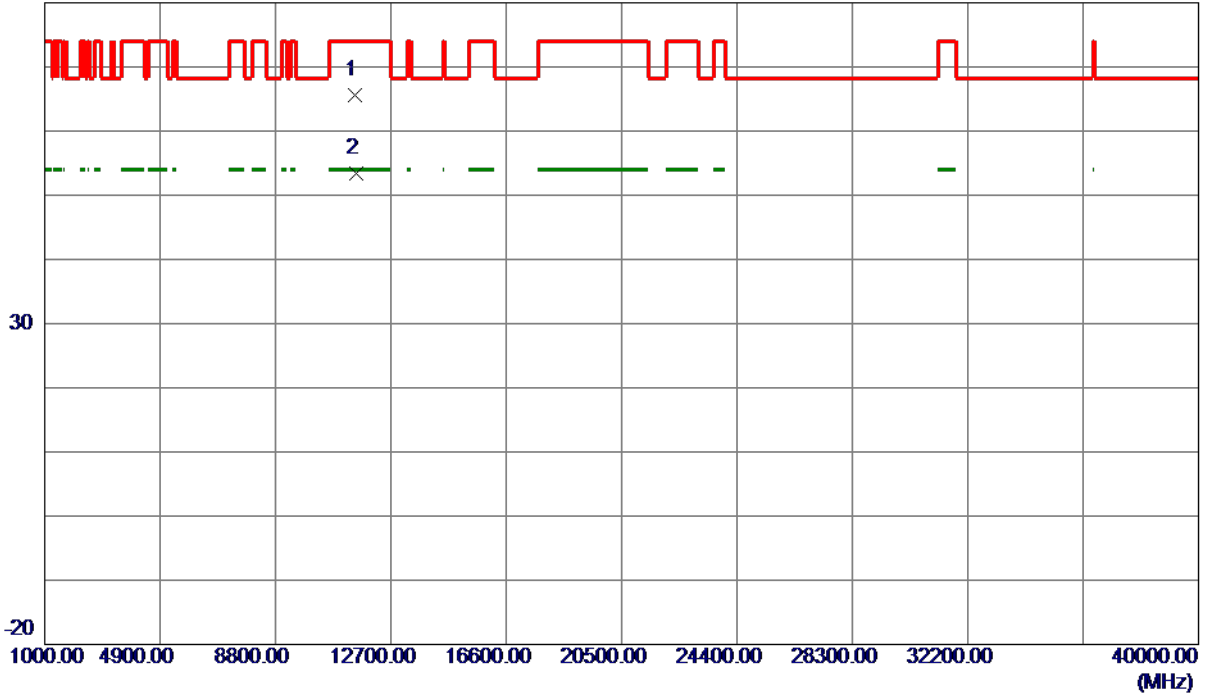

No.	Freq. MHz	Reading Level dBuV/m	Correct Factor dB	Measure ment dBuV/m	Limit dBuV/m	Margin dB	Detector	Comment
1	11506.7250	48.48	17.20	65.68	74.00	-8.32	Peak	
2 *	11508.9750	36.12	17.20	53.32	54.00	-0.68	AVG	

**REMARKS:**

- (1) Measurement Value = Reading Level + Correct Factor.
- (2) Margin Level = Measurement Value - Limit Value.

Orthogonal Axis	X
Test Mode	UNII-3_TX AC (VHT40) Mode 5795 MHz

**Vertical**

130 dBuV/m

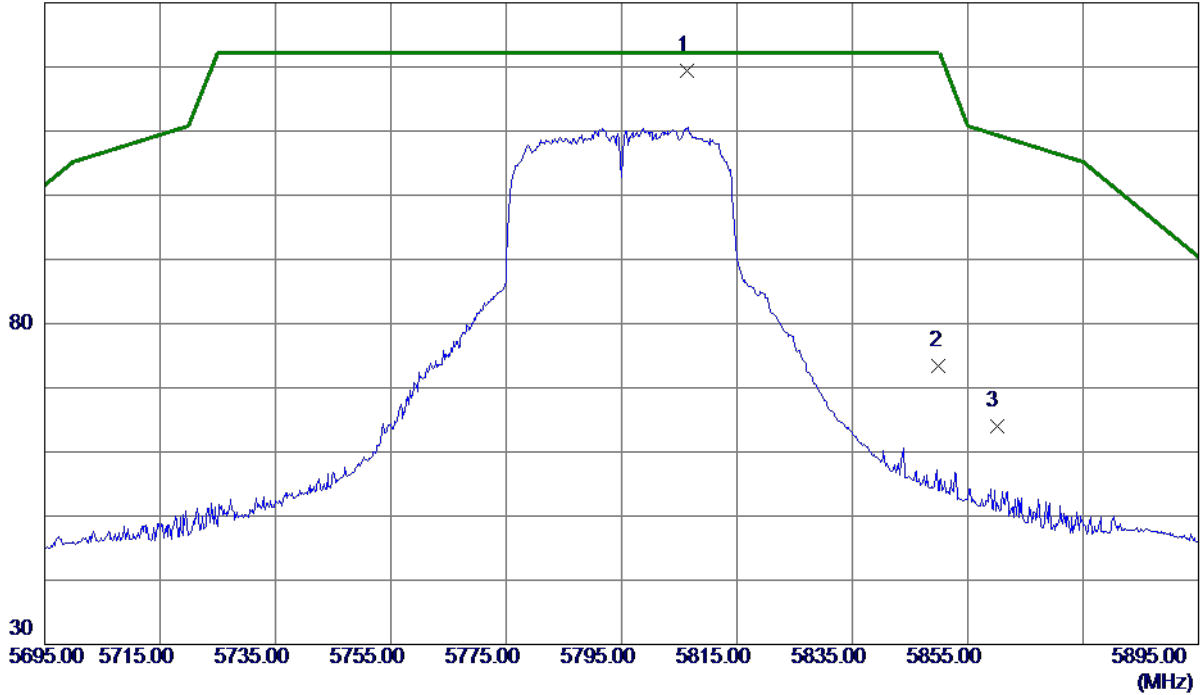

No.	Freq. MHz	Reading Level dBuV/m	Correct Factor dB	Measure ment dBuV/m	Limit dBuV/m	Margin dB	Detector	Comment
1 *	5806.4000	99.29	20.08	119.37	122.20	-2.83	Peak	No Limit
2	5850.0000	53.33	20.11	73.44	122.20	-48.76	Peak	
3	5860.0000	43.85	20.12	63.97	109.40	-45.43	Peak	

**REMARKS:**

- (1) Measurement Value = Reading Level + Correct Factor.
- (2) Margin Level = Measurement Value - Limit Value.

Orthogonal Axis	X
Test Mode	UNII-3_TX AC (VHT40) Mode 5795 MHz

### Vertical

80 dBuV/m

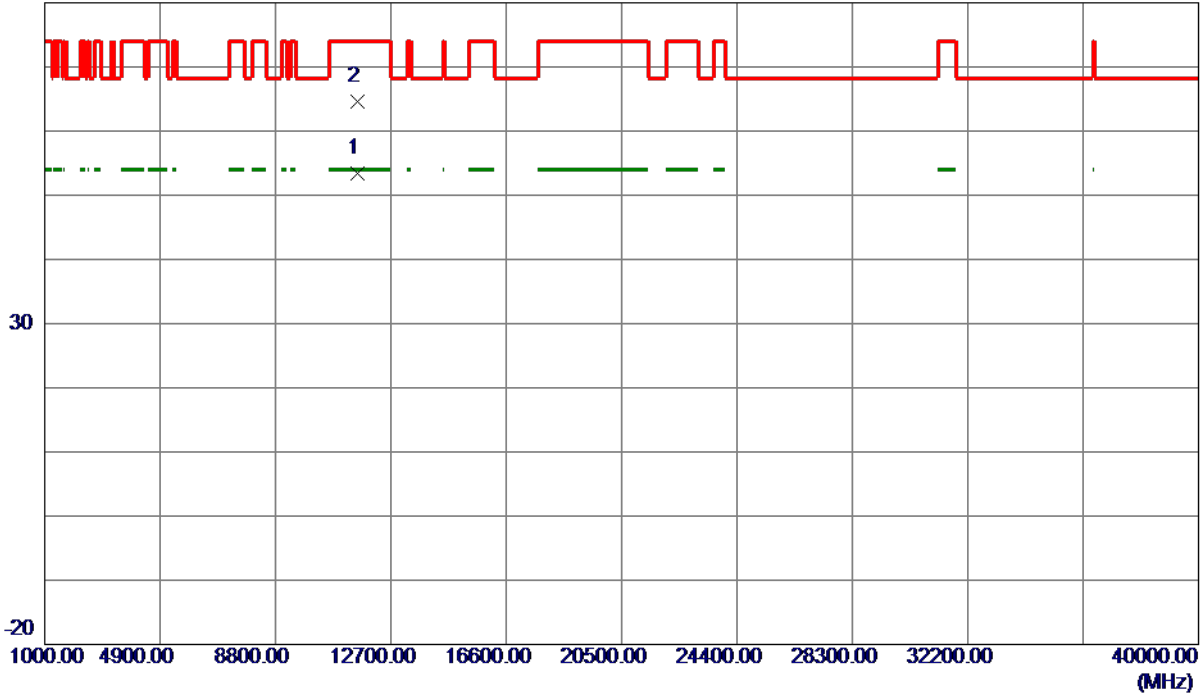

No.	Freq. MHz	Reading Level dBuV/m	Correct Factor dB	Measure ment dBuV/m	Limit dBuV/m	Margin dB	Detector	Comment
1 *	11588.9750	36.05	17.27	53.32	54.00	-0.68	AVG	
2	11590.7250	47.41	17.27	64.68	74.00	-9.32	Peak	

**REMARKS:**

- (1) Measurement Value = Reading Level + Correct Factor.
- (2) Margin Level = Measurement Value - Limit Value.



Orthogonal Axis	X
Test Mode	UNII-3_TX AC (VHT80) Mode 5775 MHz

### Vertical

130 dBuV/m

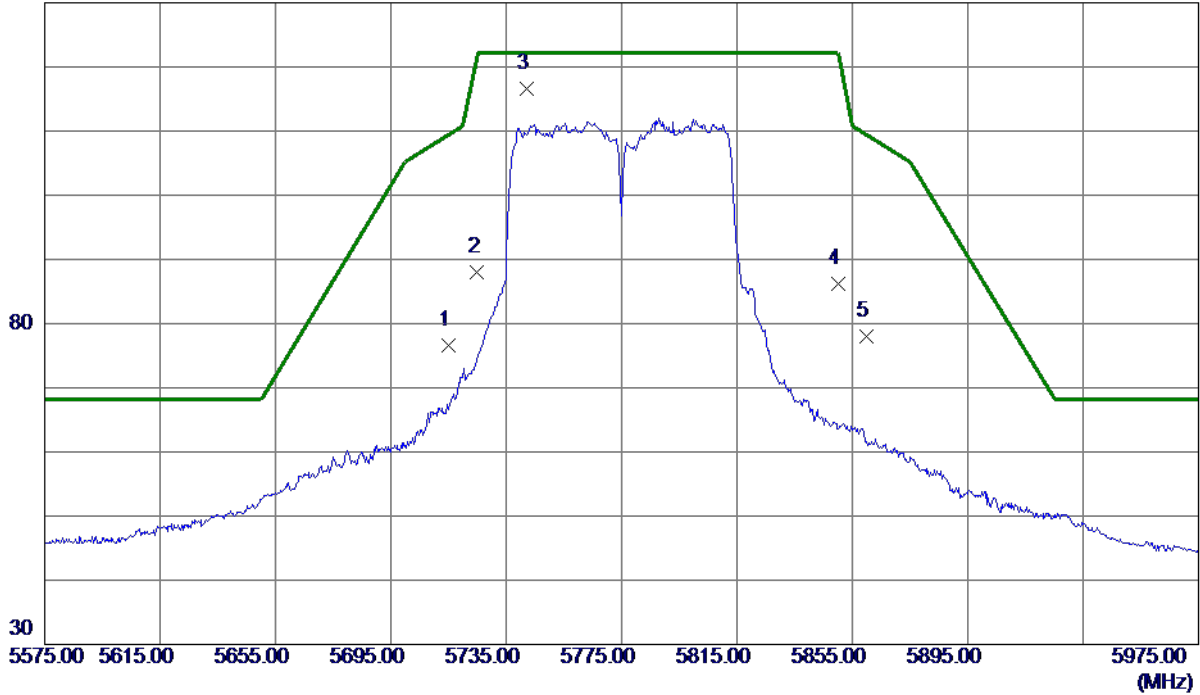

No.	Freq. MHz	Reading Level dBuV/m	Correct Factor dB	Measure ment dBuV/m	Limit dBuV/m	Margin dB	Detector	Comment
1	5715.0000	56.62	20.01	76.63	109.40	-32.77	Peak	
2	5725.0000	67.89	20.02	87.91	122.20	-34.29	Peak	
3 *	5742.2000	96.60	20.03	116.63	122.20	-5.57	Peak	No Limit
4	5850.0000	66.18	20.11	86.29	122.20	-35.91	Peak	
5	5860.0000	57.81	20.12	77.93	109.40	-31.47	Peak	

**REMARKS:**

- (1) Measurement Value = Reading Level + Correct Factor.
- (2) Margin Level = Measurement Value - Limit Value.

Orthogonal Axis	X
Test Mode	UNII-3_TX AC (VHT80) Mode 5775 MHz

**Vertical**

80 dBuV/m

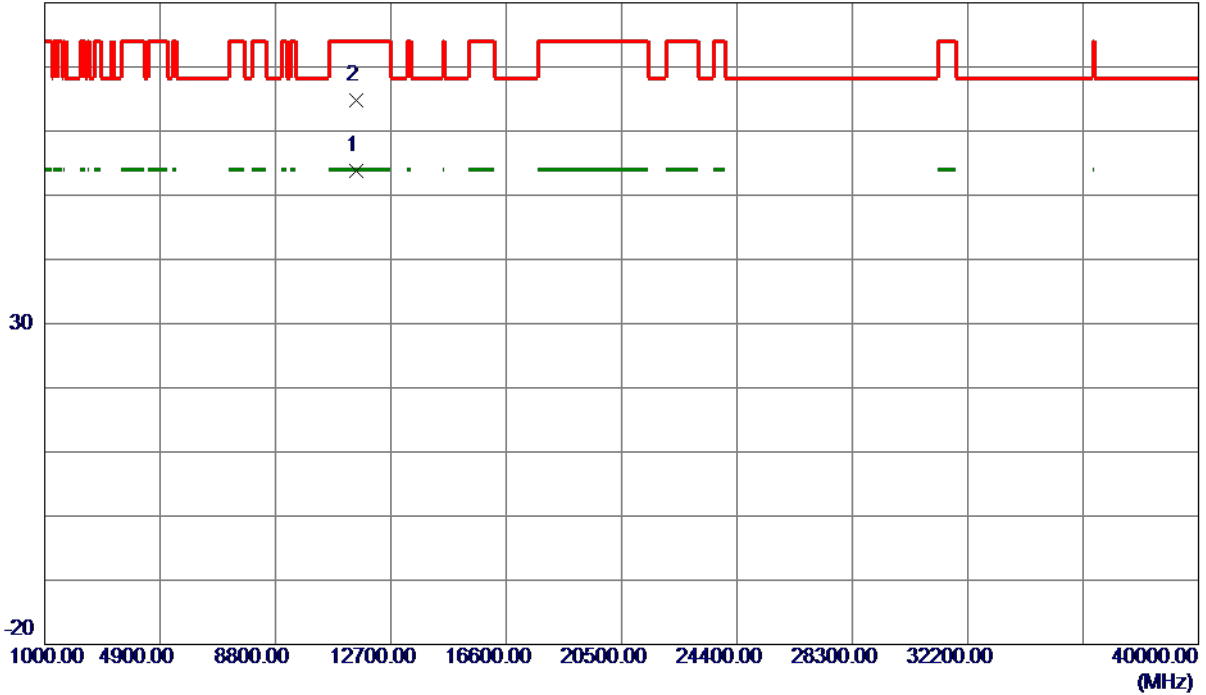

No.	Freq. MHz	Reading Level dBuV/m	Correct Factor dB	Measure ment dBuV/m	Limit dBuV/m	Margin dB	Detector	Comment
1 *	11549.7250	36.47	17.24	53.71	54.00	-0.29	AVG	
2	11550.5500	47.53	17.24	64.77	74.00	-9.23	Peak	

**REMARKS:**

- (1) Measurement Value = Reading Level + Correct Factor.
- (2) Margin Level = Measurement Value - Limit Value.

## APPENDIX E - BANDWIDTH

Test Mode	UNII-1_TX A Mode
-----------	------------------

Channel	Frequency (MHz)	26 dB Bandwidth (MHz)	99 % Emission Bandwidth (MHz)
36	5180	29.06	17.60
40	5200	45.90	31.30
48	5240	34.39	19.70

**CH36**

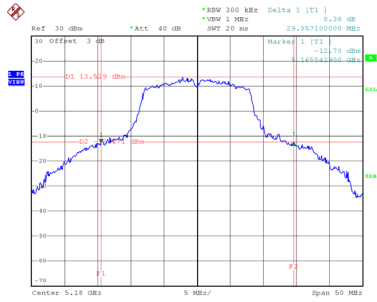

Date: 10\_OCT.2020 10:20:30

**CH40**  
26 dB Bandwidth

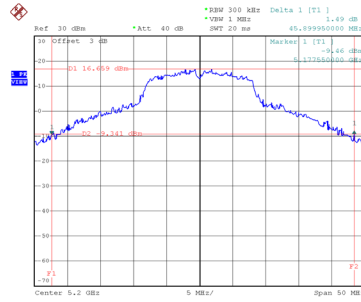

Date: 10\_OCT.2020 10:21:18

**CH48**

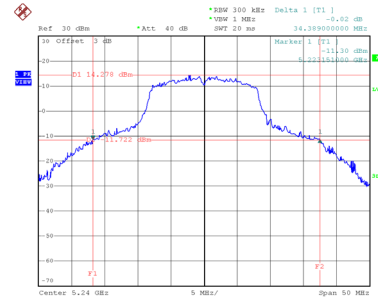

Date: 10\_OCT.2020 10:22:55

**99 % Emission Bandwidth**

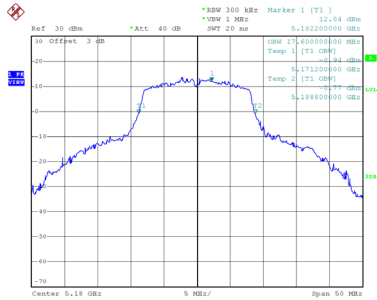

Date: 10\_OCT.2020 10:19:54

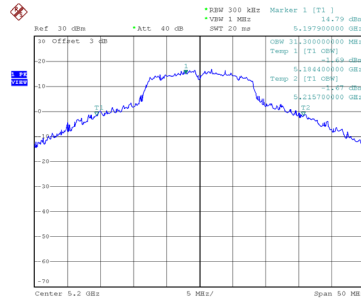

Date: 10\_OCT.2020 10:21:03

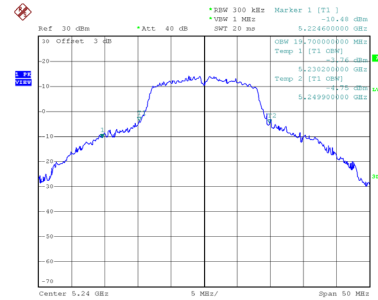

Date: 10\_OCT.2020 10:22:23

Test Mode	UNII-3_TX A Mode
-----------	------------------

Channel	Frequency (MHz)	6 dB Bandwidth (MHz)	99 % Emission Bandwidth (MHz)	6 dB Bandwidth Min. Limit (kHz)	Result
149	5745	15.79	34.00	500	Complies
157	5785	16.15	34.10	500	Complies
165	5825	16.35	34.10	500	Complies

### CH149

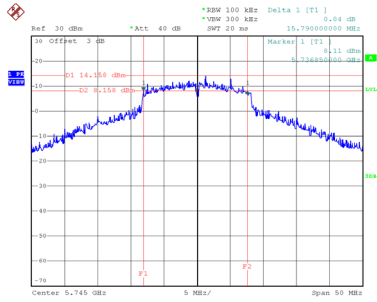

Date: 10\_OCT\_2020 10:27:43

### CH157 6 dB Bandwidth

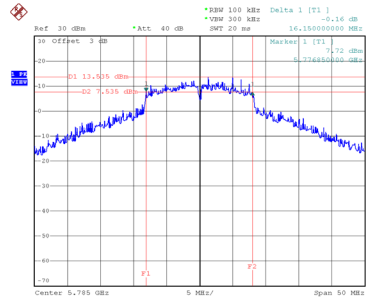

Date: 10\_OCT\_2020 10:29:49

### CH165

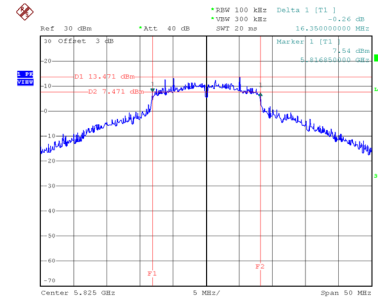

Date: 10\_OCT\_2020 10:32:59

### 99 % Emission Bandwidth

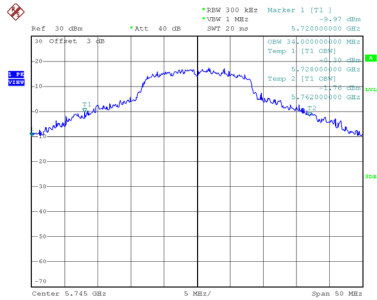

Date: 10\_OCT\_2020 10:26:52

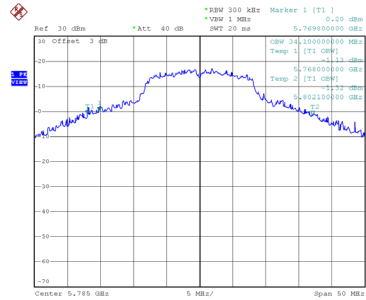

Date: 10\_OCT\_2020 10:29:01

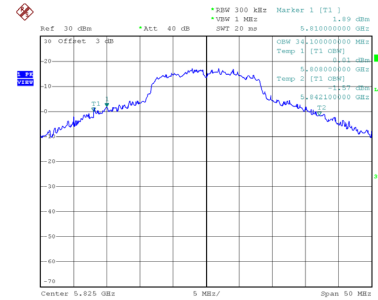

Date: 10\_OCT\_2020 10:32:10

Test Mode	UNII-1_TX AC (VHT20) Mode
-----------	---------------------------

Channel	Frequency (MHz)	26 dB Bandwidth (MHz)	99 % Emission Bandwidth (MHz)
36	5180	33.39	18.70
40	5200	49.20	32.50
48	5240	36.19	19.60

**CH36**

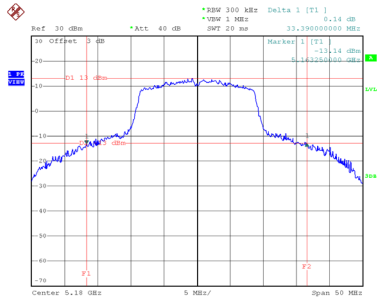

Date: 10\_OCT.2020 10:34:29

**CH40**  
26 dB Bandwidth

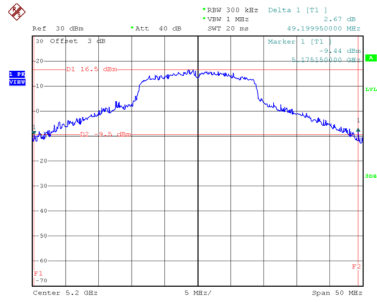

Date: 10\_OCT.2020 10:35:11

**CH48**

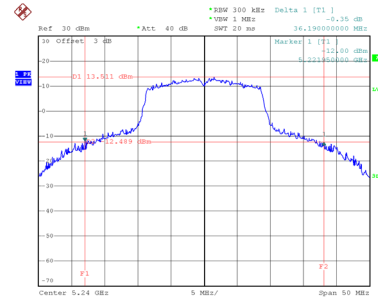

Date: 10\_OCT.2020 10:40:09

**99 % Emission Bandwidth**

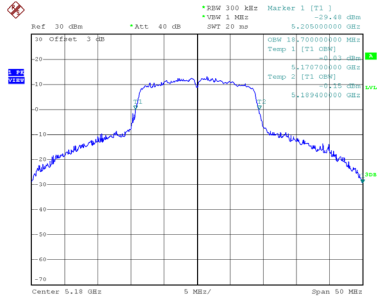

Date: 10\_OCT.2020 10:33:57

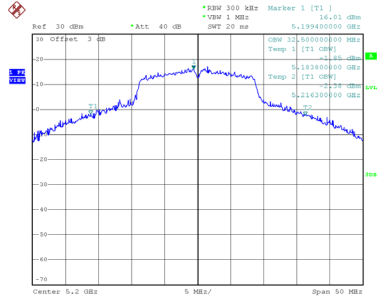

Date: 10\_OCT.2020 10:35:02

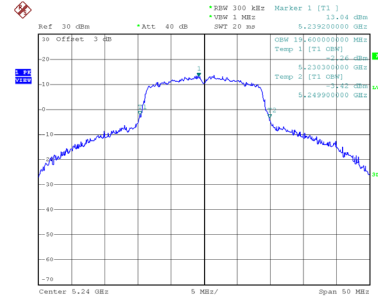

Date: 10\_OCT.2020 10:39:32

Test Mode	UNII-1_TX AC (VHT40) Mode
-----------	---------------------------

Channel	Frequency (MHz)	26 dB Bandwidth (MHz)	99 % Emission Bandwidth (MHz)
38	5190	40.60	36.80
46	5230	72.50	39.00

**CH38**

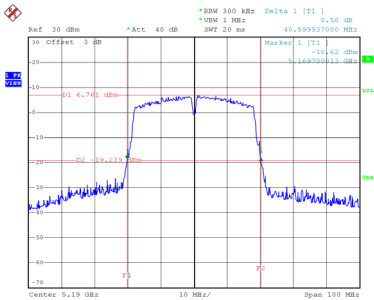

Date: 10.OCT.2020 10:46:21

**CH46**  
26 dB Bandwidth

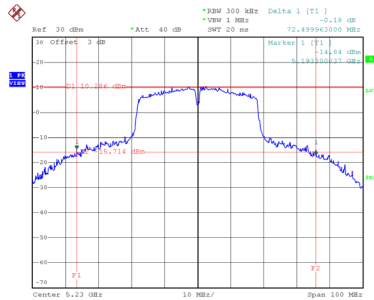

Date: 10.OCT.2020 10:50:03

**99 % Emission Bandwidth**

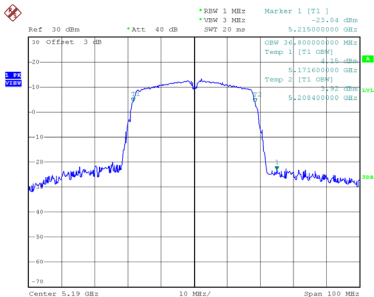

Date: 10.OCT.2020 10:45:36

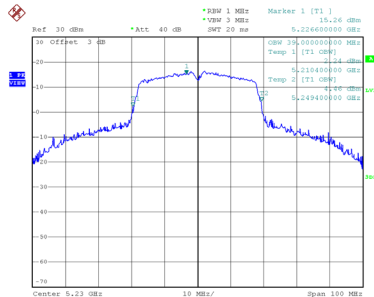

Date: 10.OCT.2020 10:49:35

Test Mode	UNII-1_TX AC (VHT80) Mode
-----------	---------------------------

Channel	Frequency (MHz)	26 dB Bandwidth (MHz)	99 % Emission Bandwidth (MHz)
42	5210	82.40	76.00

### CH42 26 dB Bandwidth

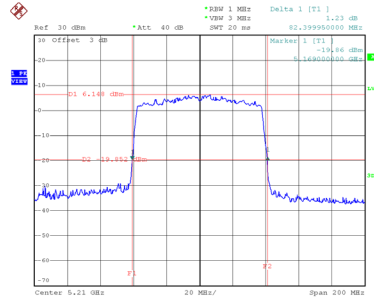

Date: 10\_OCT.2020 11:02:49

### 99 % Emission Bandwidth

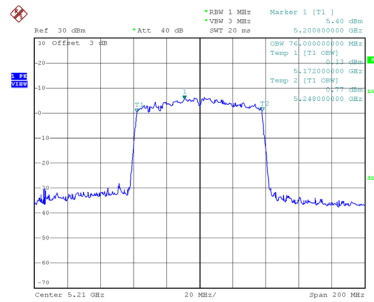

Date: 10\_OCT.2020 11:01:54