

9 Out of Band Conducted Emissions Measurement

9.1. Limit

In any 100 kHz bandwidth outside the frequency band in which the spread spectrum or digitally modulated intentional radiator is operating, the radio frequency power that is produced by the intentional radiator shall be at least 30 dB below that in the 100 kHz bandwidth within the band that contains the highest level of the desired power

9.2. Test Setup

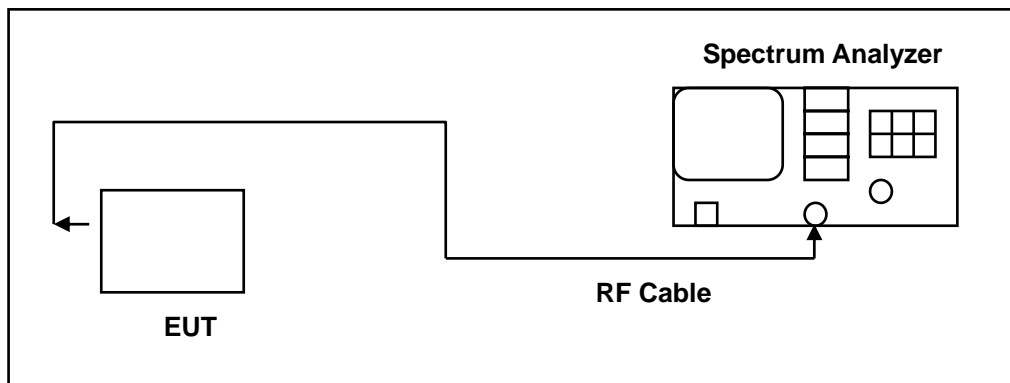

9.3. Test Instruments

Equipment	Manufacturer	Model Number	Serial Number	Cal. Date	Cal. Period
Spectrum Analyzer	Agilent	E4445A	MY45300744	12/15/2015	1 year
Spectrum Analyzer	Agilent	E4408B	MY45107753	08/08/2016	1 year
Microwave Cable	EMCI	EMC104-SM-SM-1500	140303	02/23/2016	1 year
Test Site	ATL	TE05	TE05	N.C.R.	-----

Note: N.C.R. = No Calibration Request.

9.4. Test Procedure

In any 100 kHz bandwidth outside the EUT pass band, the RF power produced by the modulation products of the spreading sequence, the information sequence, and the carrier frequency shall be at least 30 dB below that of the maximum in-band 100 kHz emission, antenna output of the EUT was coupled directly to spectrum analyzer; if an external attenuator and/or cable was used, these losses are compensated for with the analyzer OFFSET function.

All other types of emissions from the EUT shall meet the general limits for radiated frequencies outside the pass band.

The test was performed at 3 channels.



9.5. Test Graphs

Reference level

Mode 2: IEEE 802.11b link mode_ANT-0

<p>2412 MHz</p>	
<p>2437 MHz</p>	
<p>2462 MHz</p>	



Mode 3: IEEE 802.11g link mode_ANT-0

2412 MHz

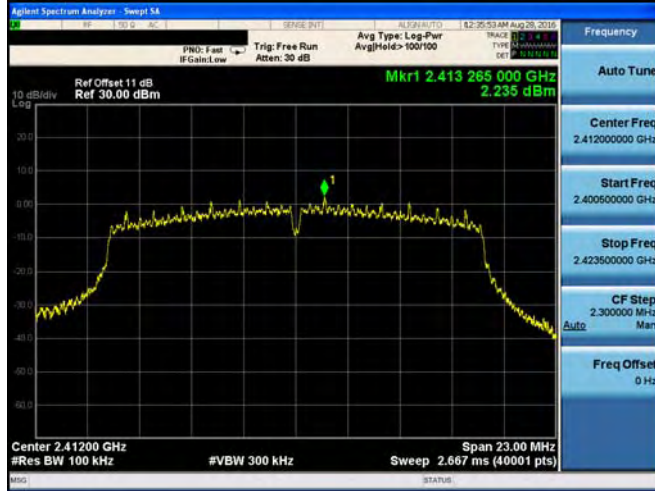

2437 MHz

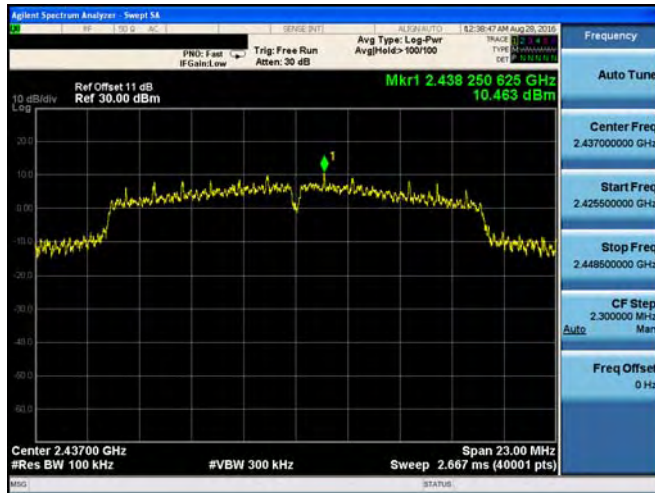

2462 MHz

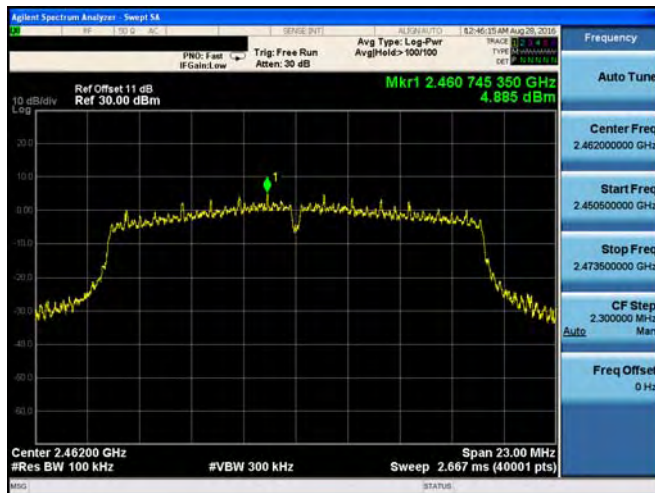



Mode 4: IEEE 802.11n 2.4GHz 20MHz link mode_ANT-0

2412 MHz



2437 MHz

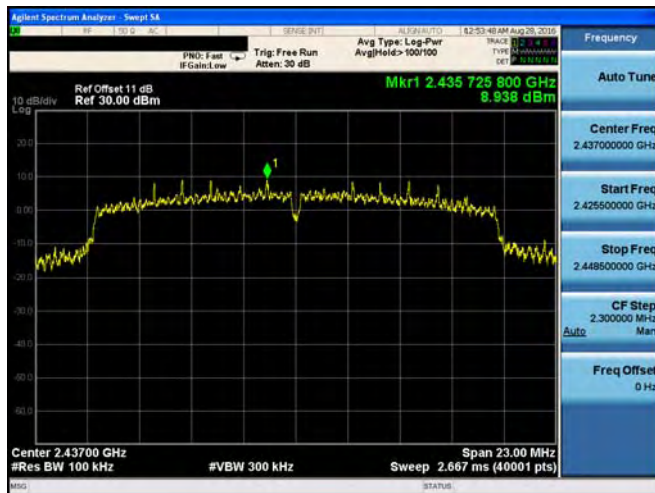

2462 MHz

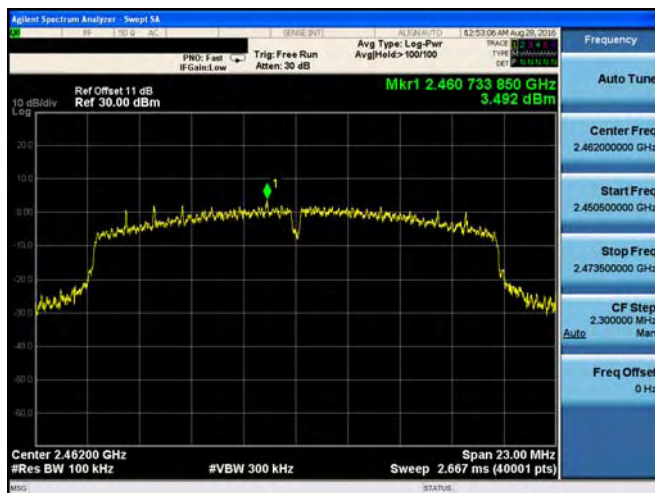



Mode 5: IEEE 802.11n 2.4GHz 40MHz link mode_ANT-0

2422 MHz

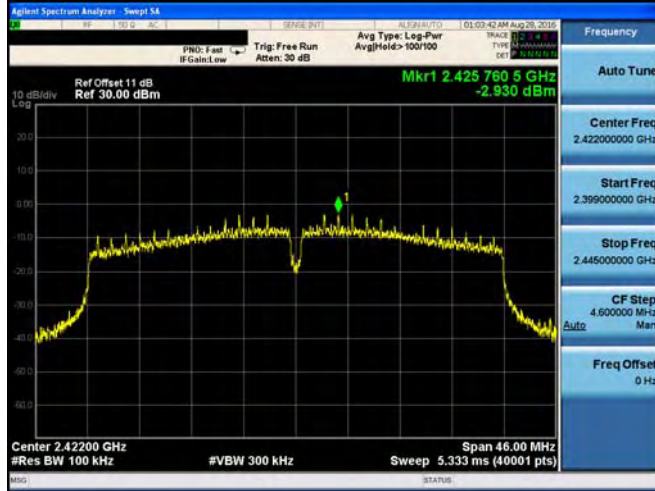

2437 MHz

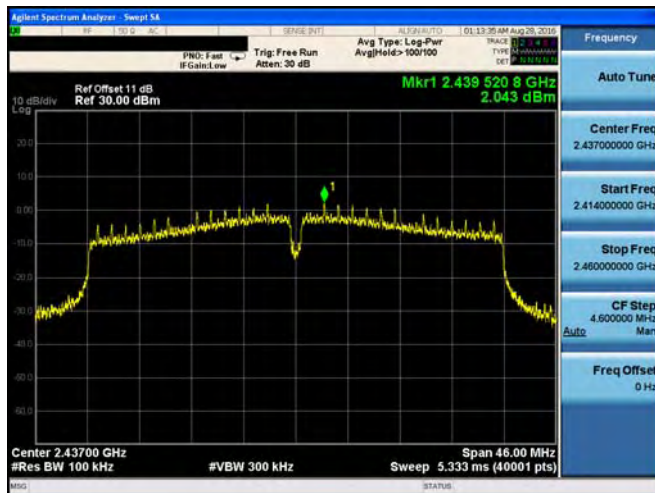

2452 MHz

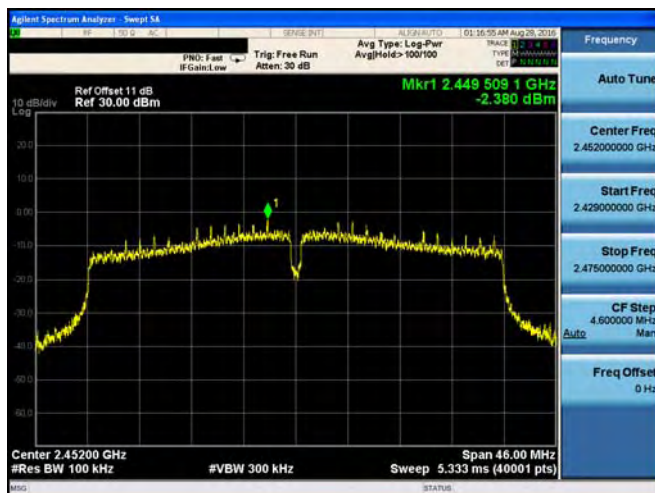



Mode 2: IEEE 802.11b link mode_ANT-1

2412 MHz



2437 MHz



2462 MHz





Mode 3: IEEE 802.11g link mode_ANT-1

2412 MHz



2437 MHz

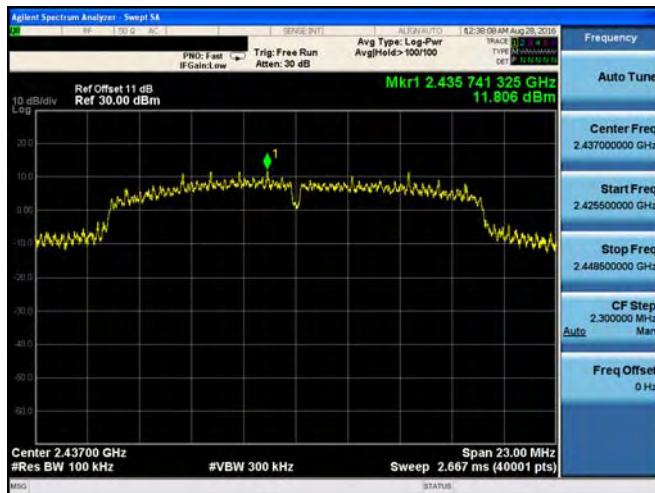

2462 MHz





Mode 4: IEEE 802.11n 2.4GHz 20MHz link mode_ANT-1

2412 MHz



2437 MHz

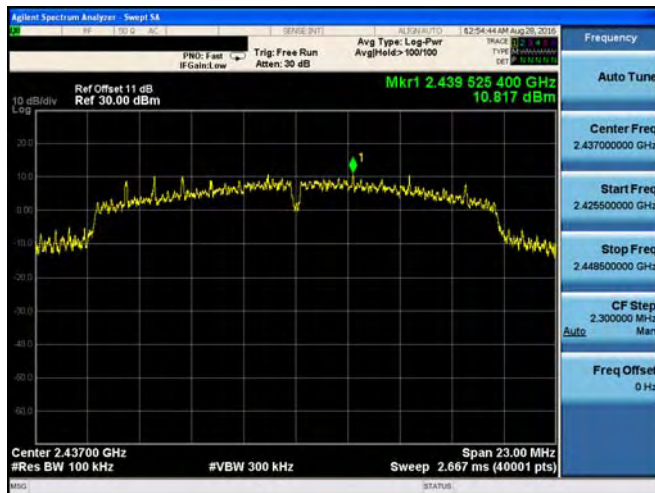

2462 MHz

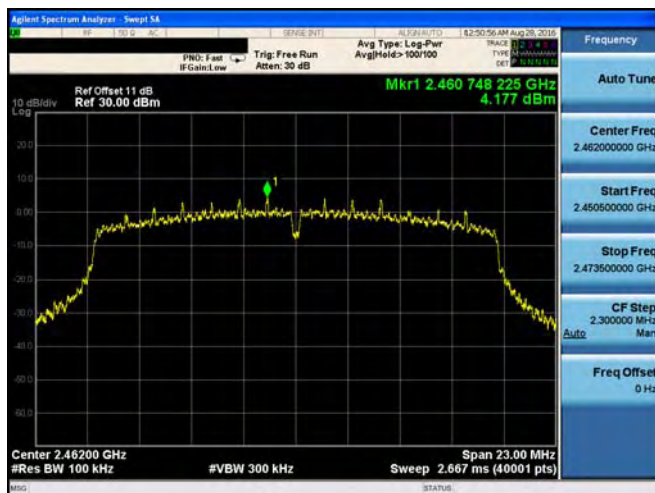



Mode 5: IEEE 802.11n 2.4GHz 40MHz link mode_ANT-1

2422 MHz

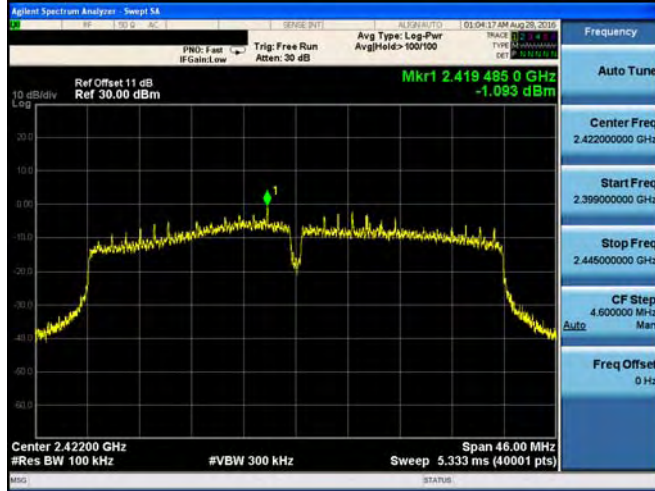

2437 MHz

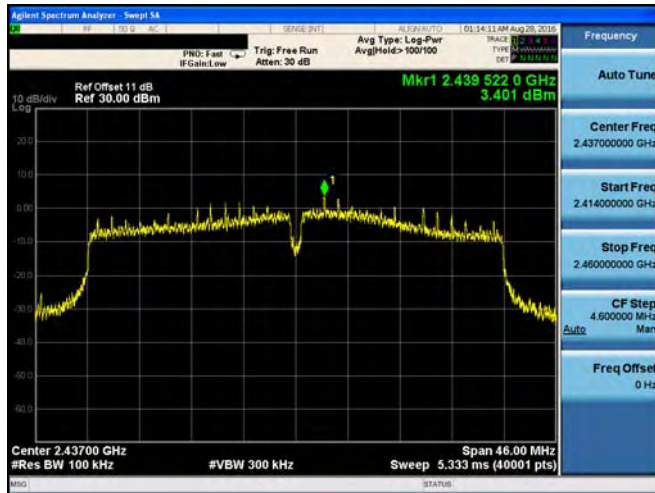

2452 MHz

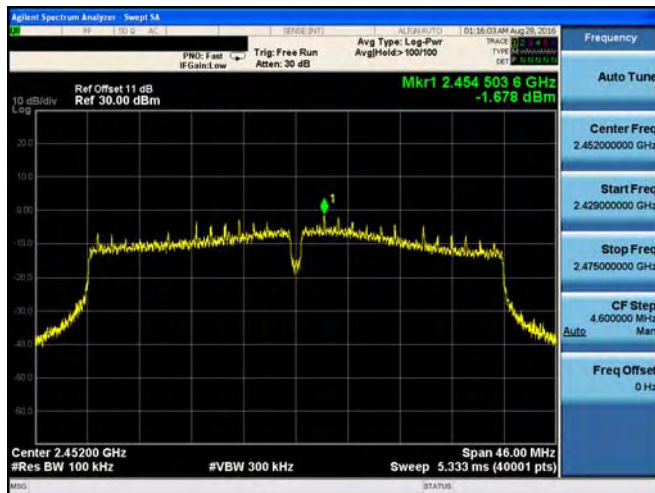



Mode 2: IEEE 802.11b link mode_ANT-2

2412 MHz



2437 MHz



2462 MHz





Mode 3: IEEE 802.11g link mode_ANT-2

2412 MHz



2437 MHz

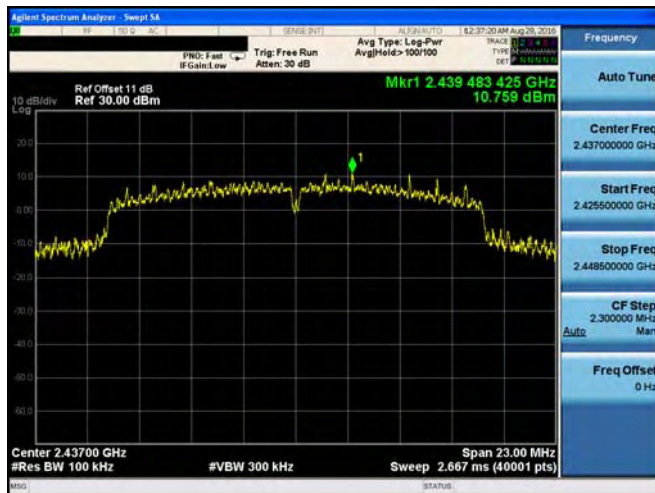

2462 MHz

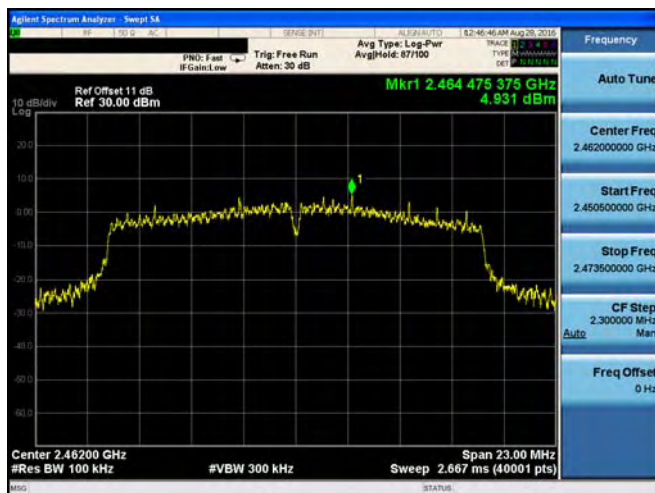



Mode 4: IEEE 802.11n 2.4GHz 20MHz link mode_ANT-2

2412 MHz

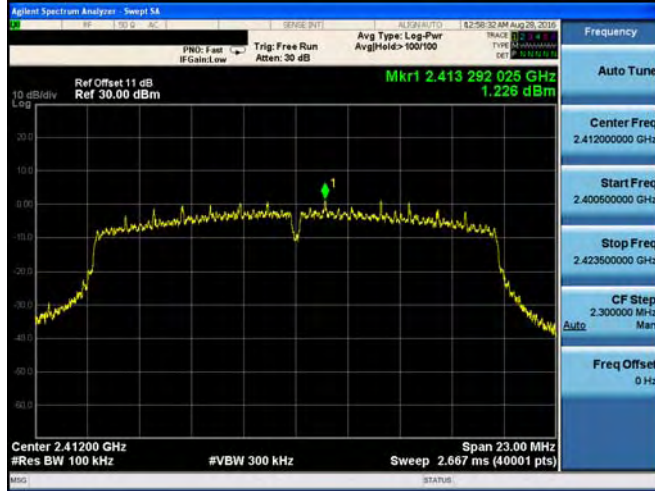

2437 MHz

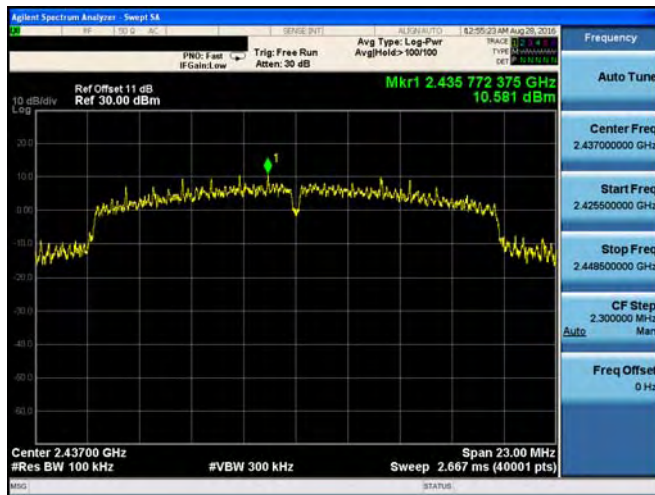

2462 MHz

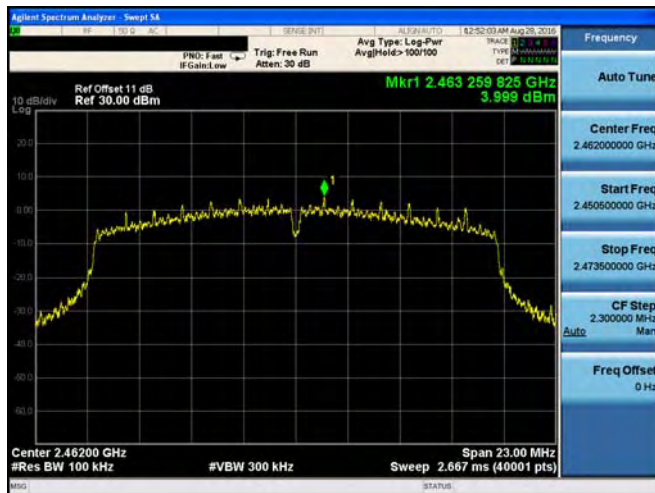



Mode 5: IEEE 802.11n 2.4GHz 40MHz link mode_ANT-2

2422 MHz



2437 MHz

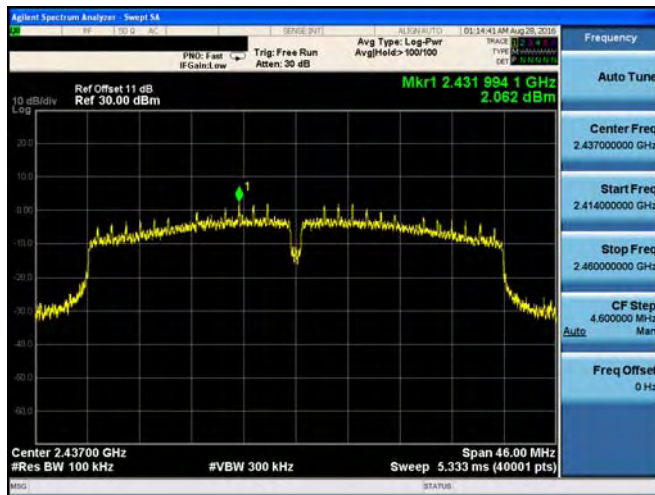

2452 MHz

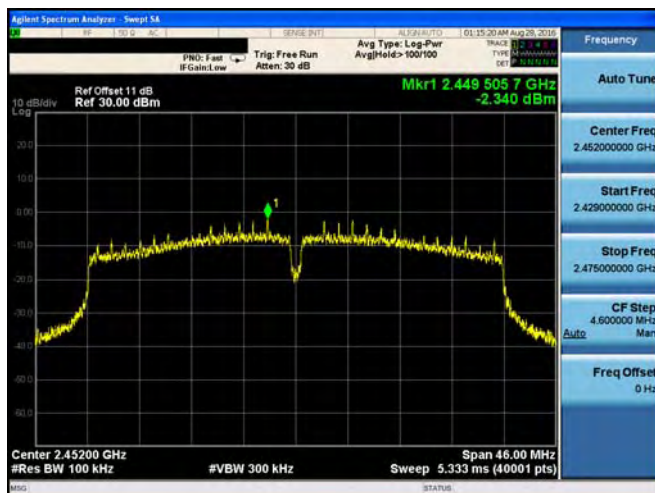



Out of Band Conducted Emissions

Mode 2: IEEE 802.11b link mode_ANT-0

2412 MHz	<table border="1"><thead><tr><th>Mk</th><th>Mode</th><th>Freq</th><th>Power</th></tr></thead><tbody><tr><td>1</td><td>1</td><td>2.412 GHz</td><td>8.890 dBm</td></tr></tbody></table>	Mk	Mode	Freq	Power	1	1	2.412 GHz	8.890 dBm
Mk	Mode	Freq	Power						
1	1	2.412 GHz	8.890 dBm						
2437 MHz	<table border="1"><thead><tr><th>Mk</th><th>Mode</th><th>Freq</th><th>Power</th></tr></thead><tbody><tr><td>1</td><td>1</td><td>2.437 GHz</td><td>10.104 dBm</td></tr></tbody></table>	Mk	Mode	Freq	Power	1	1	2.437 GHz	10.104 dBm
Mk	Mode	Freq	Power						
1	1	2.437 GHz	10.104 dBm						
2462 MHz	<table border="1"><thead><tr><th>Mk</th><th>Mode</th><th>Freq</th><th>Power</th></tr></thead><tbody><tr><td>1</td><td>1</td><td>2.462 GHz</td><td>6.843 dBm</td></tr></tbody></table>	Mk	Mode	Freq	Power	1	1	2.462 GHz	6.843 dBm
Mk	Mode	Freq	Power						
1	1	2.462 GHz	6.843 dBm						



Mode 3: IEEE 802.11g link mode_ANT-0

2412 MHz

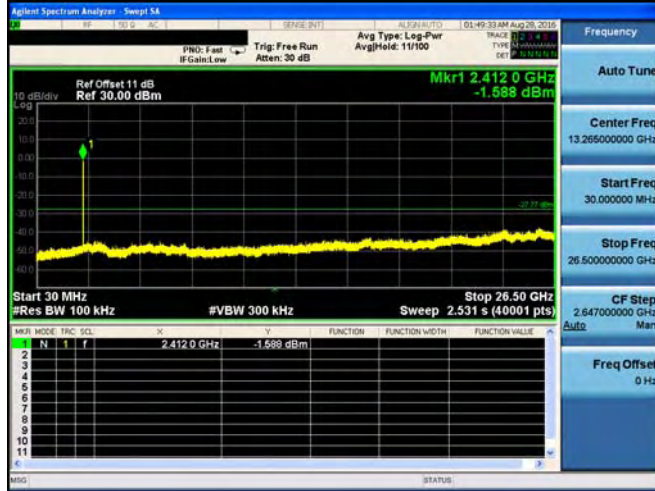

2437 MHz

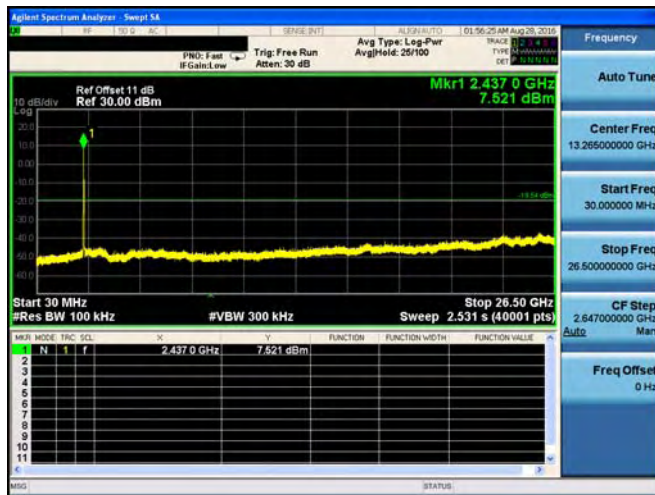

2462 MHz

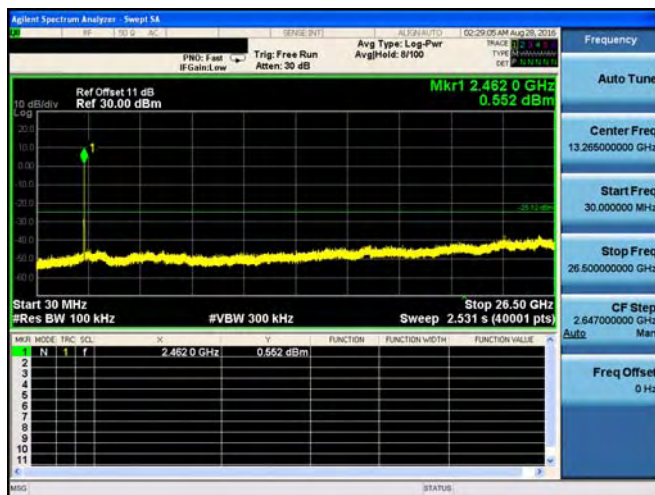



Mode 4: IEEE 802.11n 2.4GHz 20MHz link mode_ANT-0

2412 MHz



2437 MHz

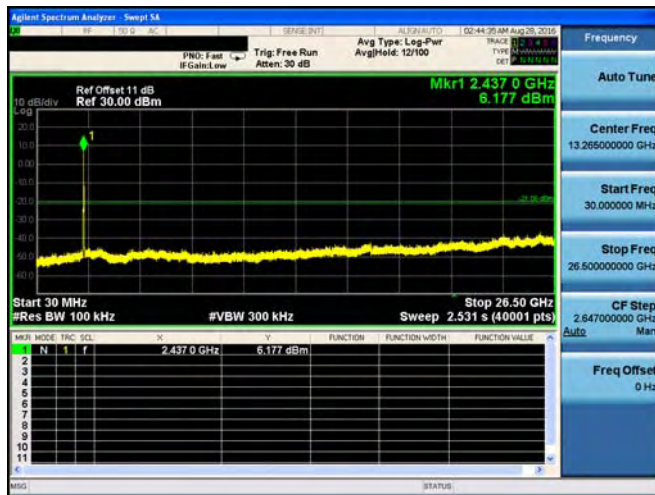

2462 MHz

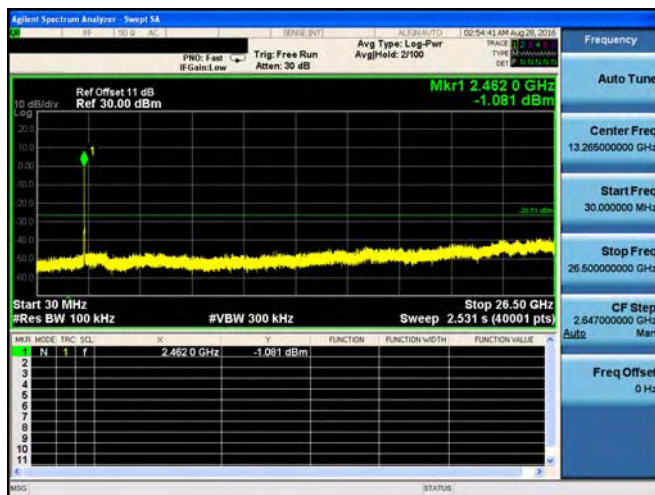



Mode 5: IEEE 802.11n 2.4GHz 40MHz link mode_ANT-0

2422 MHz

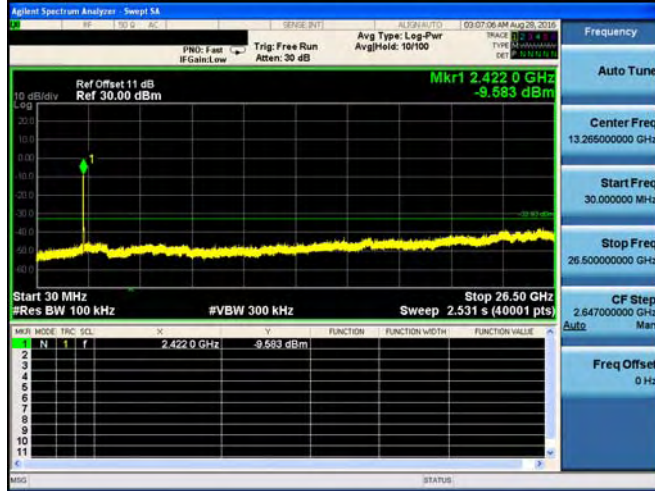

2437 MHz

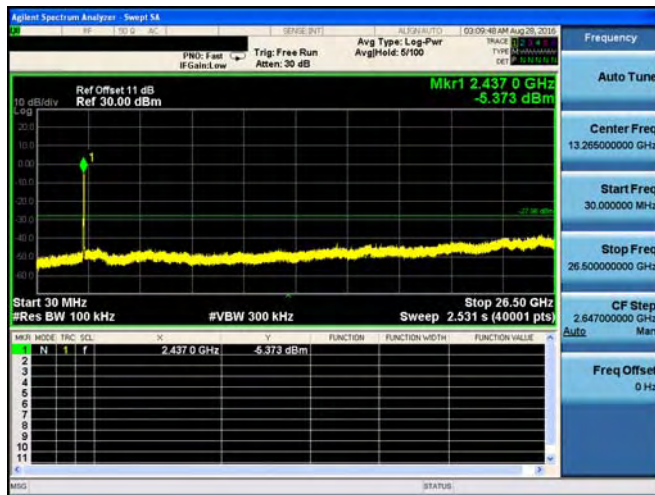

2452 MHz





Mode 2: IEEE 802.11b link mode_ANT-1

2412 MHz

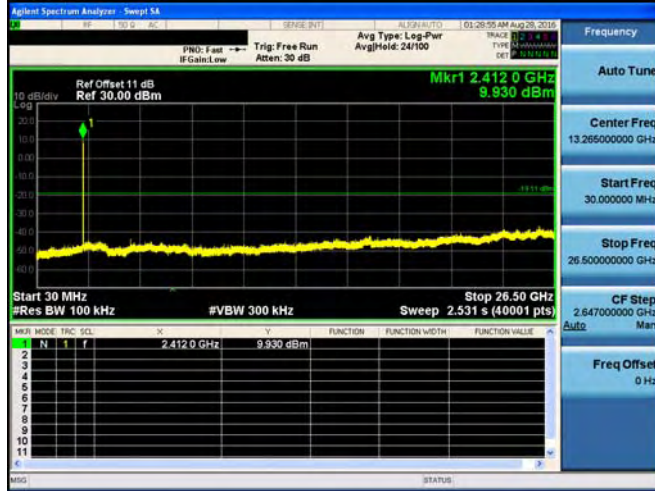

2437 MHz

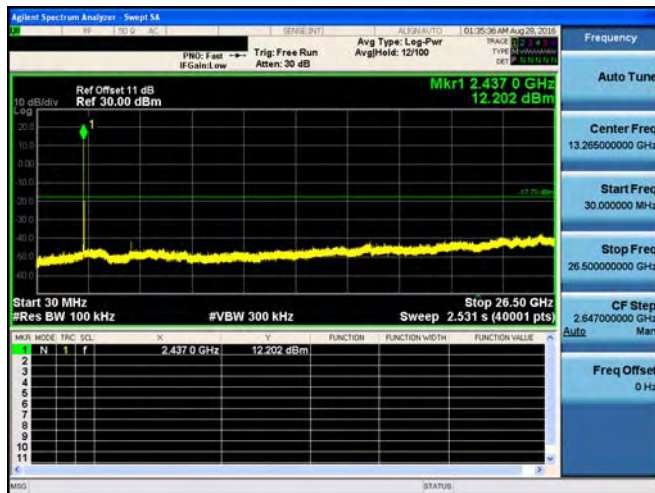

2462 MHz

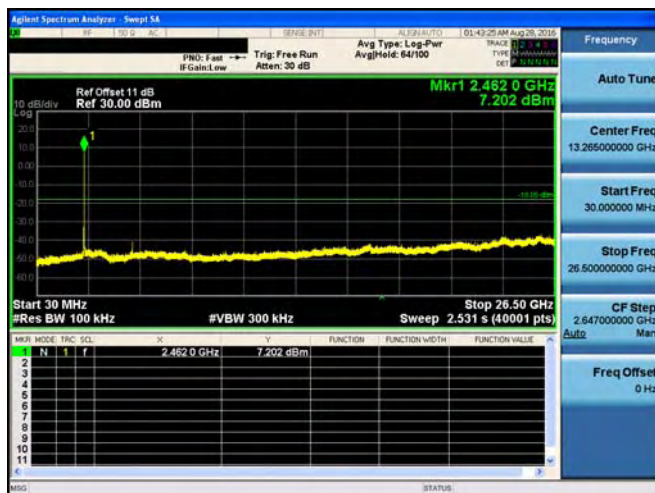



Mode 3: IEEE 802.11g link mode_ANT-1

2412 MHz

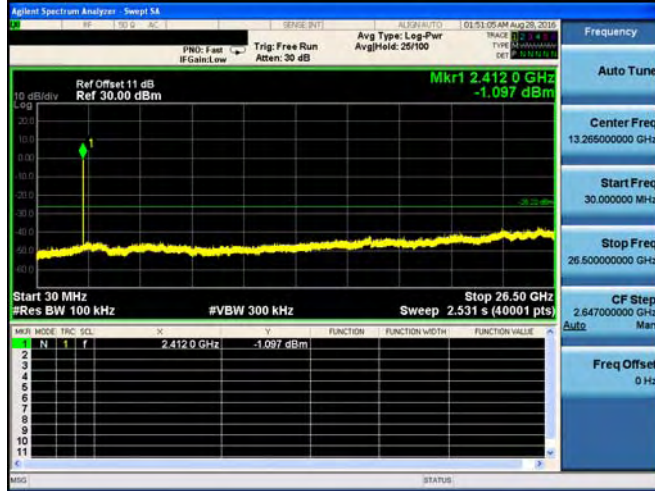

2437 MHz

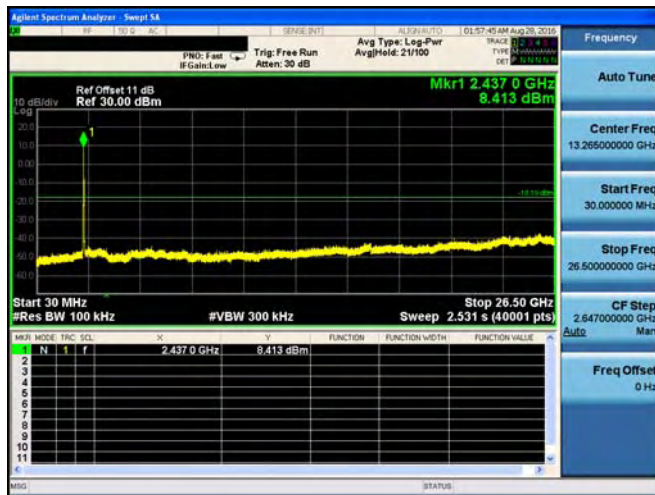

2462 MHz

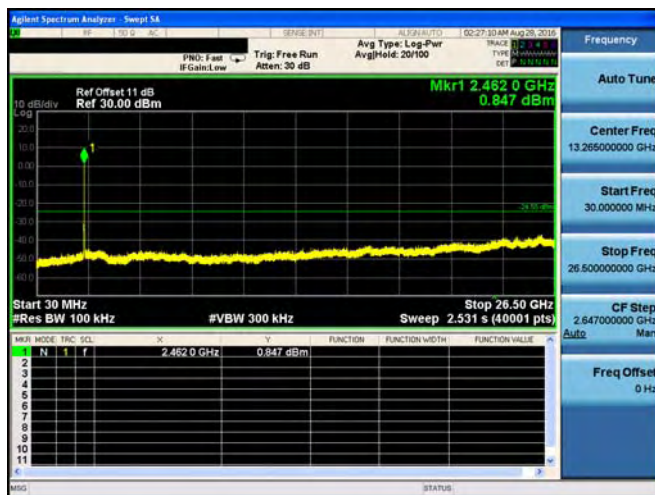



Mode 4: IEEE 802.11n 2.4GHz 20MHz link mode_ANT-1

2412 MHz



2437 MHz

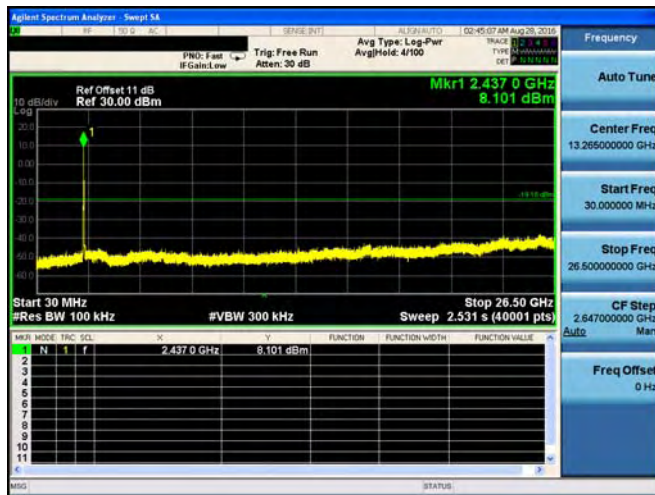

2462 MHz

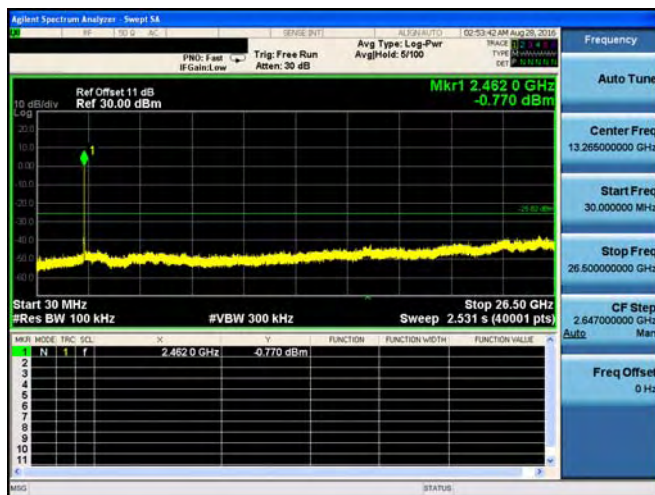



Mode 5: IEEE 802.11n 2.4GHz 40MHz link mode_ANT-1

2422 MHz

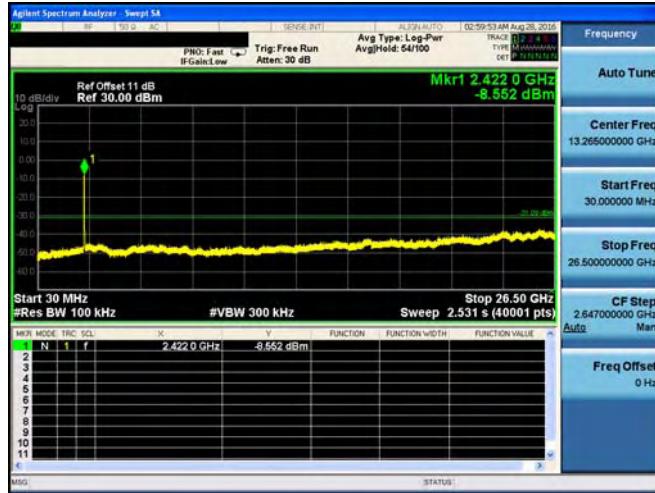

2437 MHz

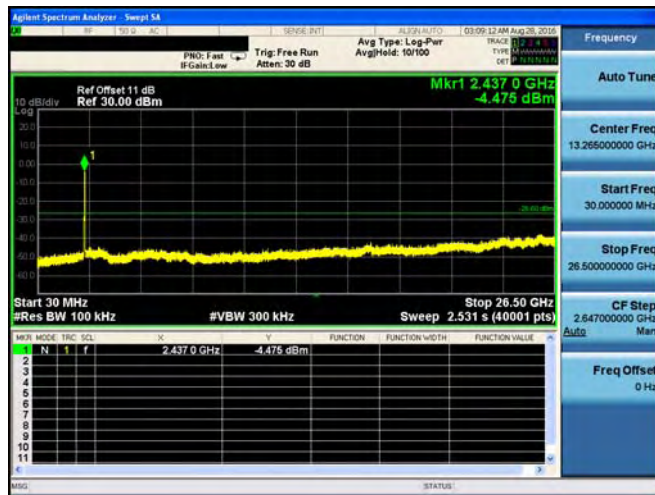

2452 MHz

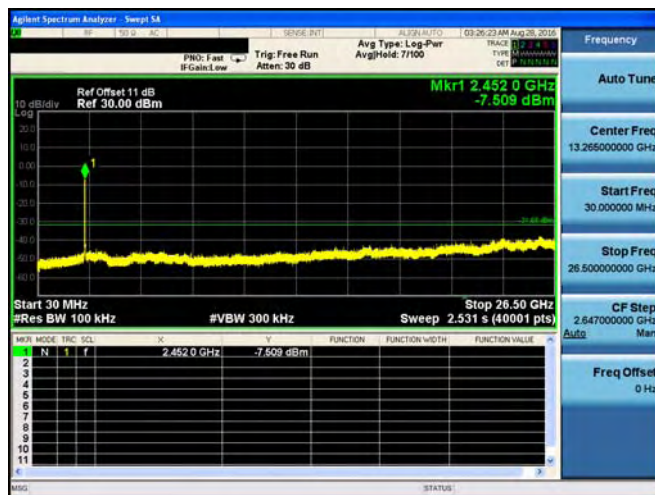



Mode 2: IEEE 802.11b link mode_ANT-2

2412 MHz

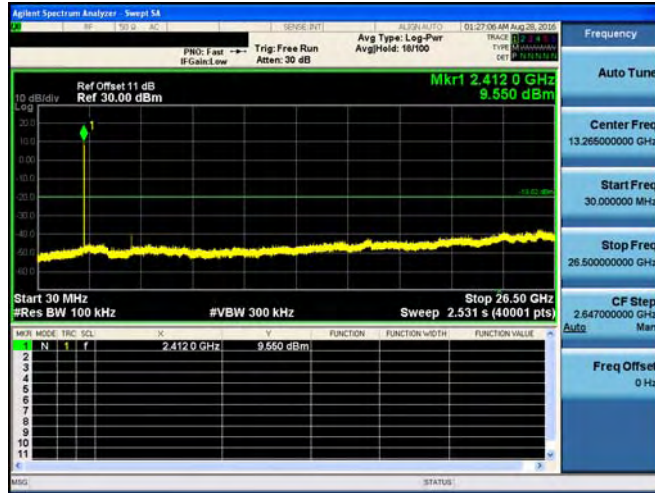

2437 MHz

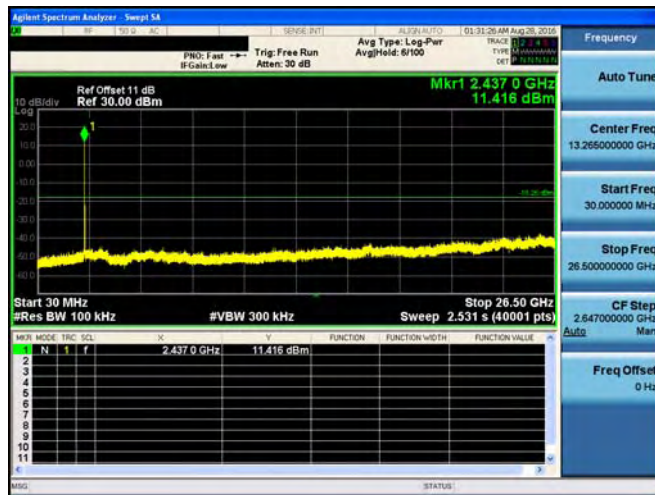

2462 MHz

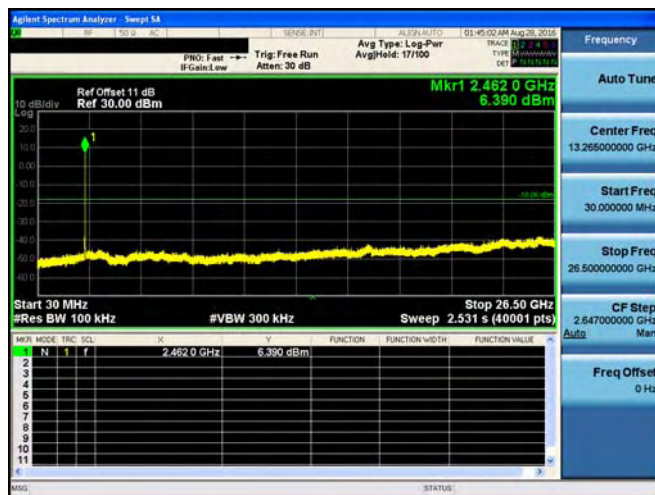



Mode 3: IEEE 802.11g link mode_ANT-2

2412 MHz

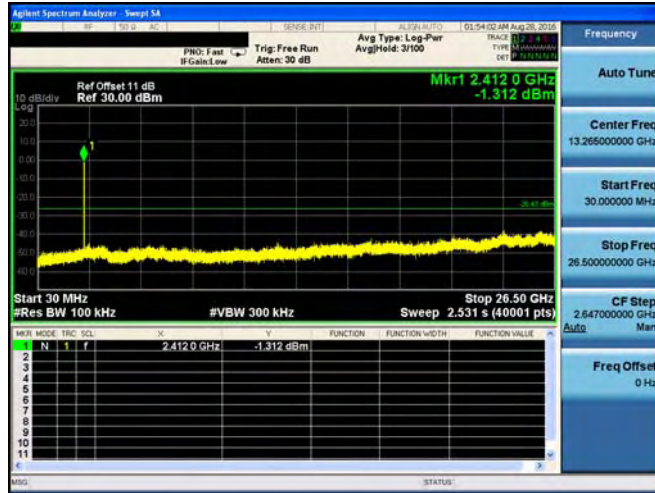

2437 MHz

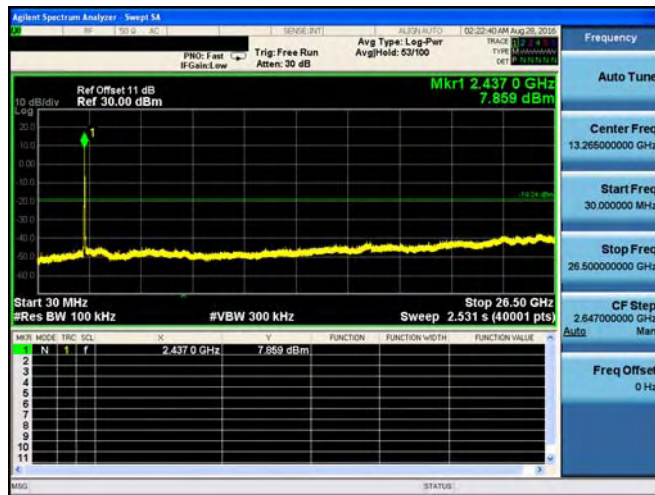

2462 MHz

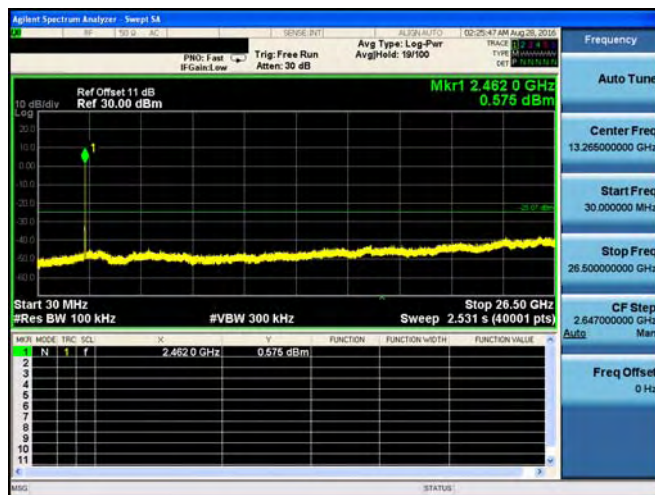



Mode 4: IEEE 802.11n 2.4GHz 20MHz link mode_ANT-2

2412 MHz



2437 MHz

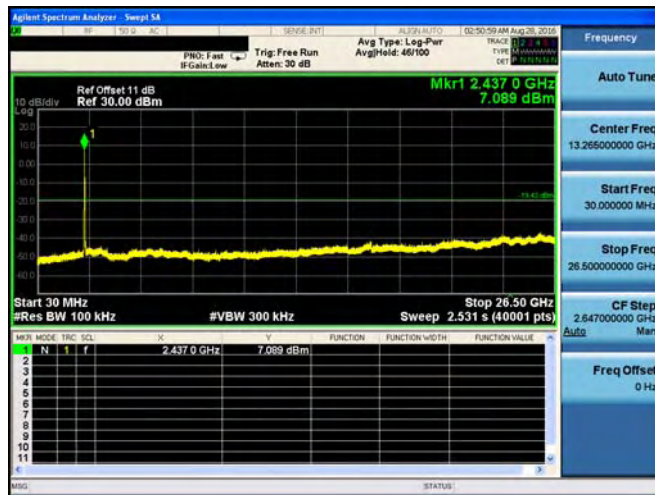

2462 MHz

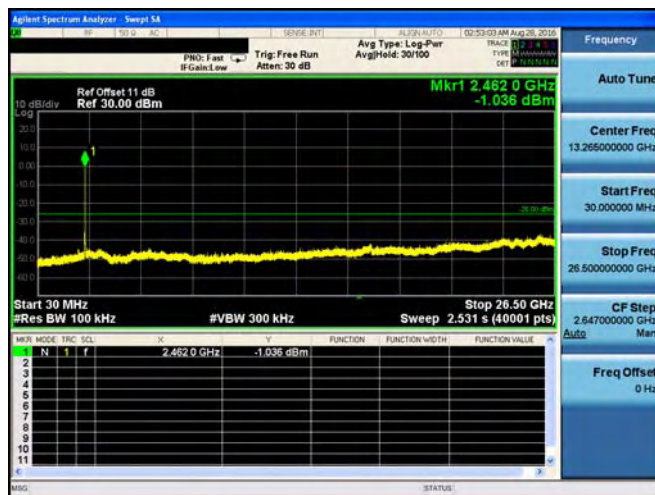



Mode 5: IEEE 802.11n 2.4GHz 40MHz link mode_ANT-2

2422 MHz



2437 MHz

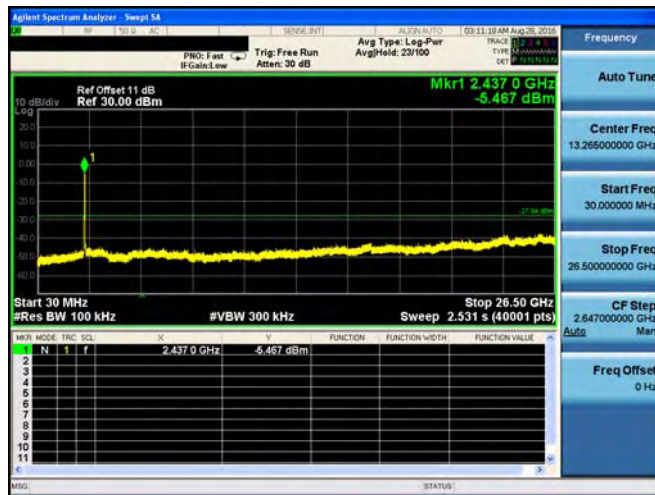

2452 MHz

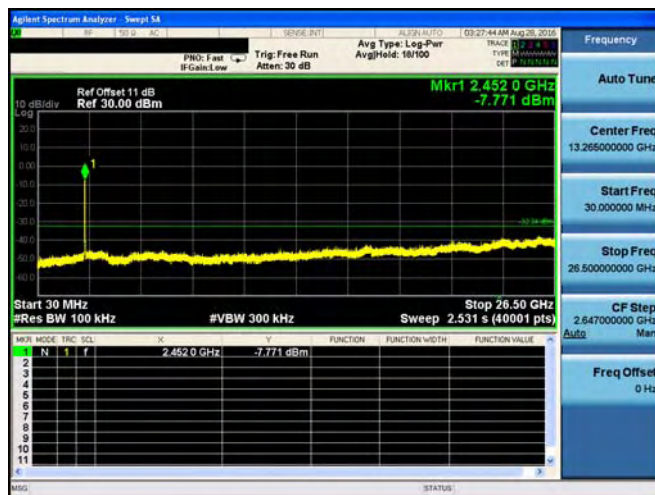



Conducted Band Edge

Mode 2: IEEE 802.11b link mode_ANT-0

2412 MHz

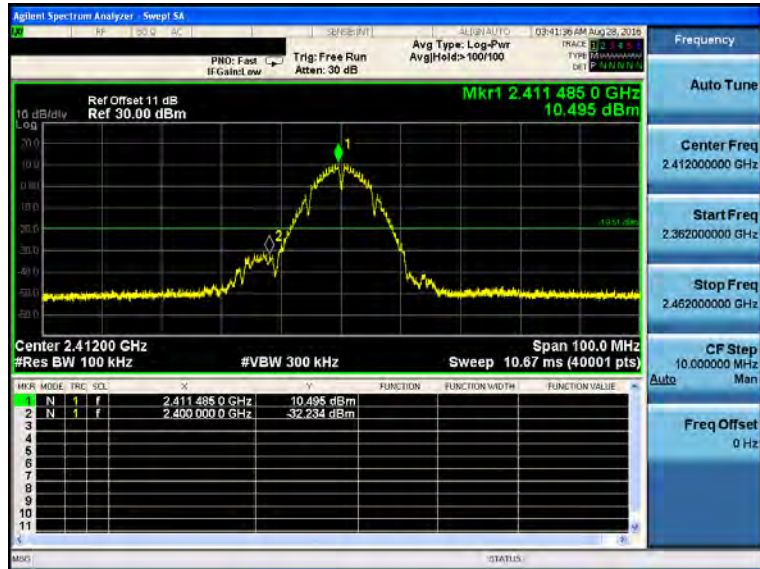

2462 MHz

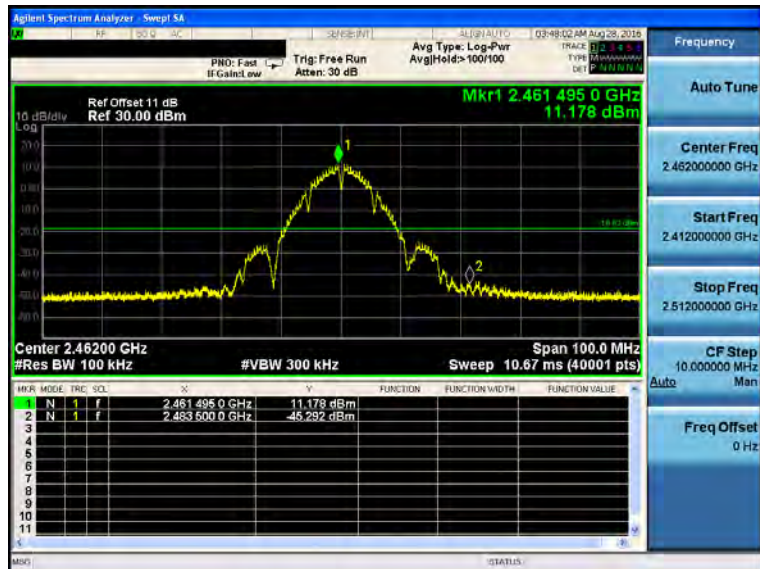



Mode 3: IEEE 802.11g link mode_ANT-0

2412 MHz

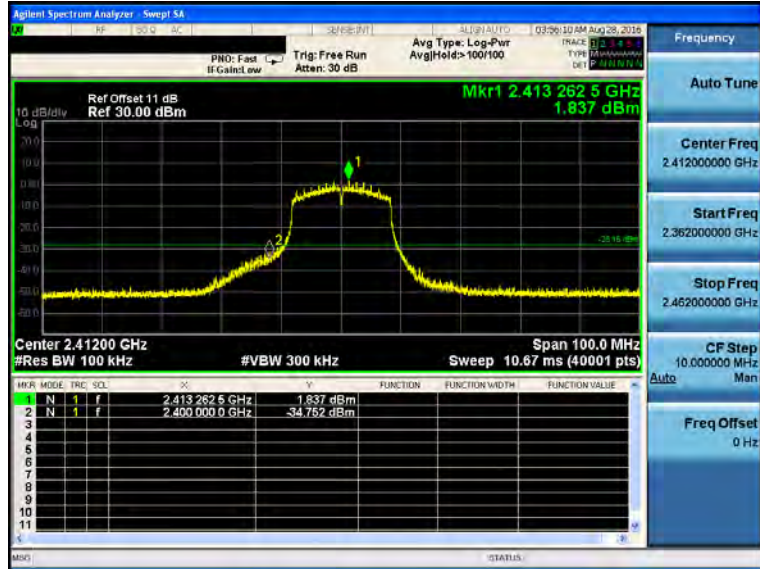

2462 MHz

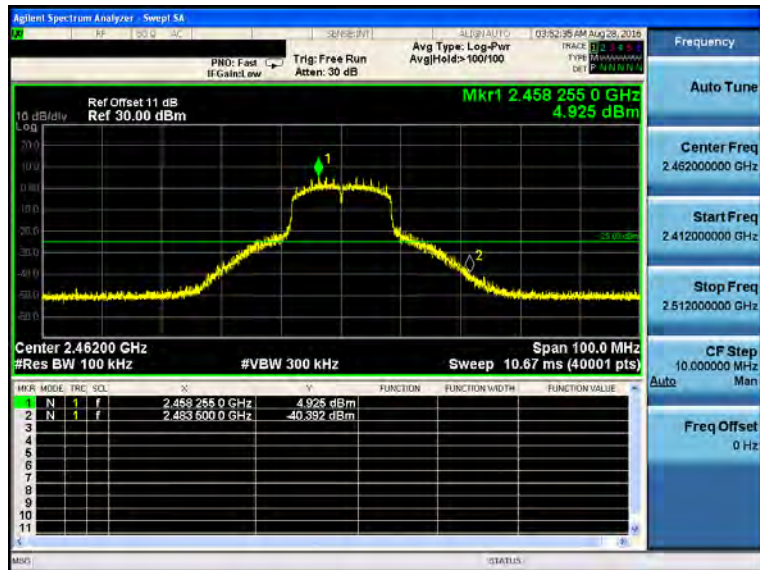

Mode 4: IEEE 802.11n 2.4GHz 20MHz link mode_ANT-0

2412 MHz

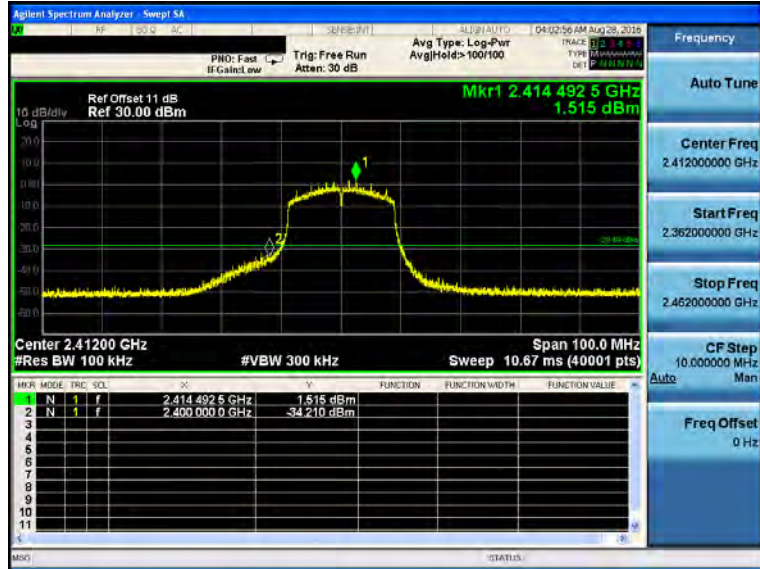

2462 MHz

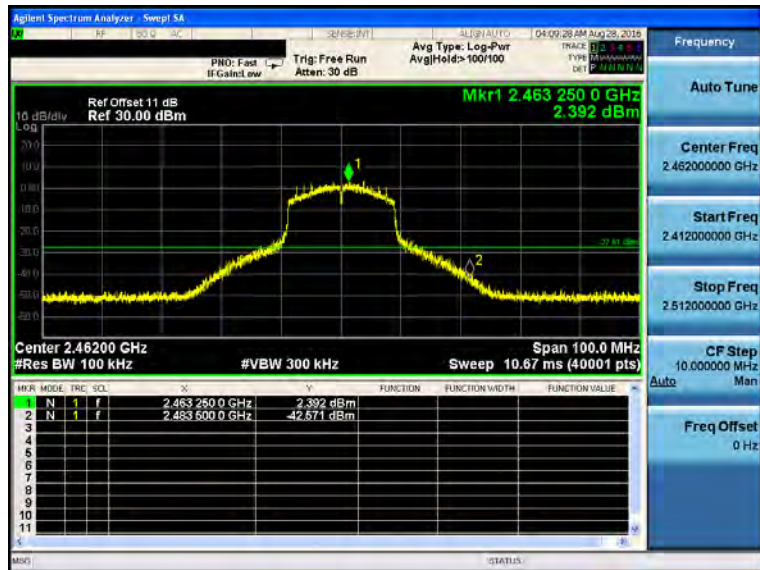



Mode 5: IEEE 802.11n 2.4GHz 40MHz link mode_ANT-0

2422 MHz

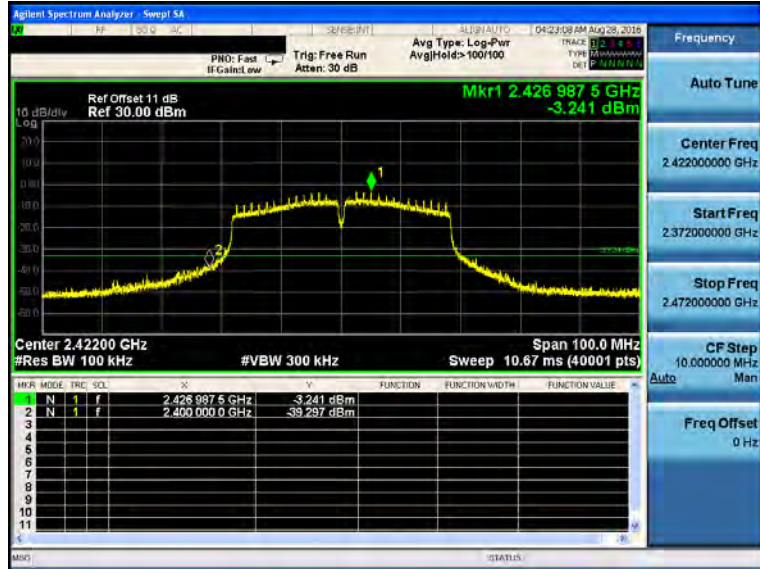

2452 MHz



Mode 2: IEEE 802.11b link mode_ANT-1

2412 MHz

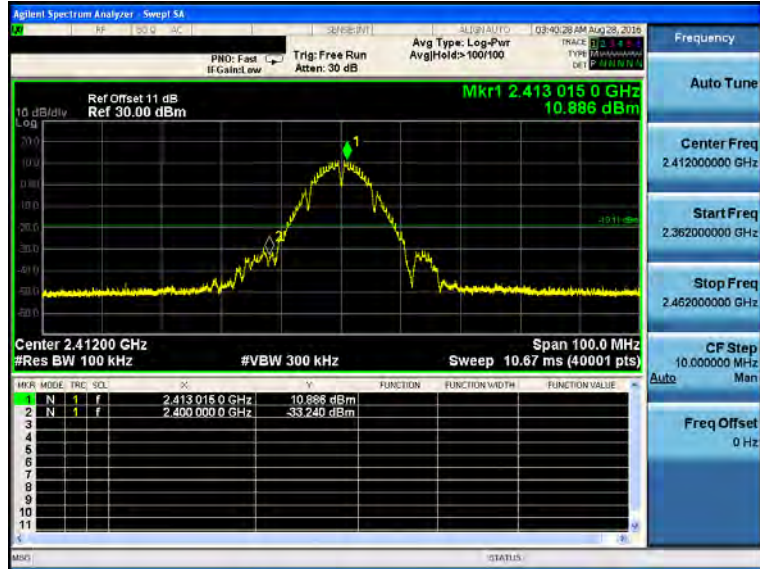

2462 MHz

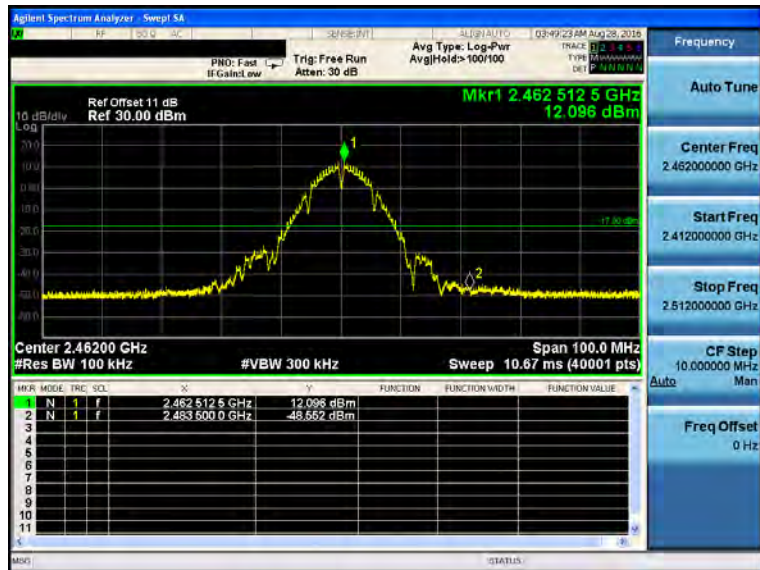

Mode 3: IEEE 802.11g link mode_ANT-1

2412 MHz

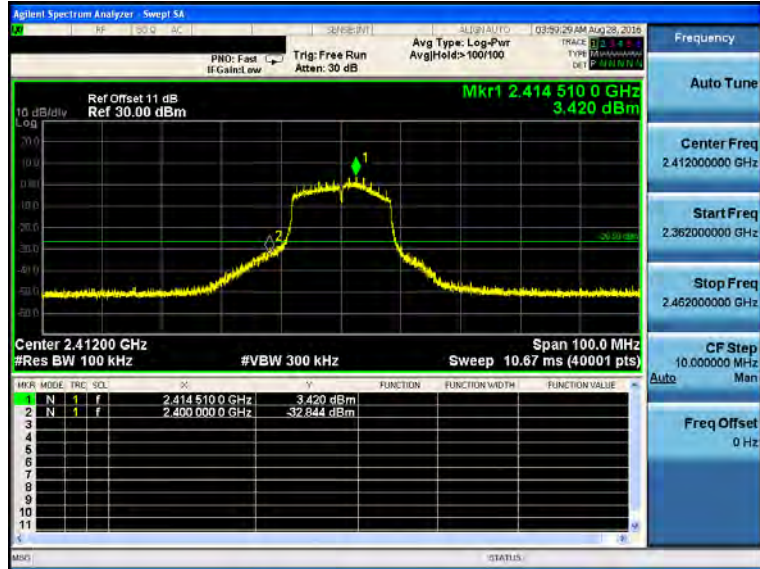

2462 MHz

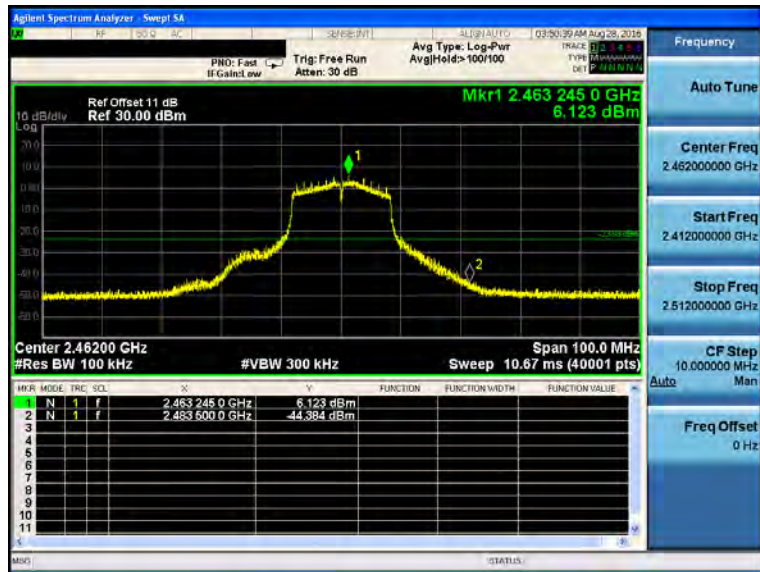

Mode 4: IEEE 802.11n 2.4GHz 20MHz link mode_ANT-1

2412 MHz

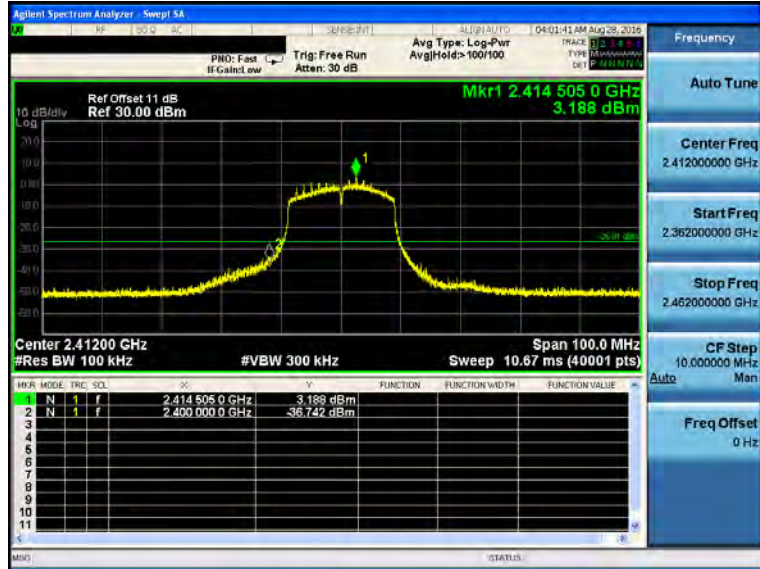

2462 MHz

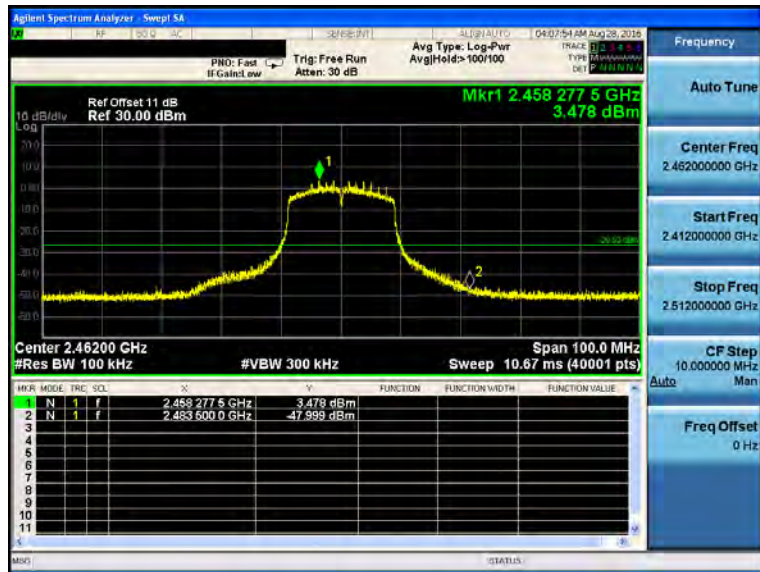



Mode 5: IEEE 802.11n 2.4GHz 40MHz link mode_ANT-1

2422 MHz

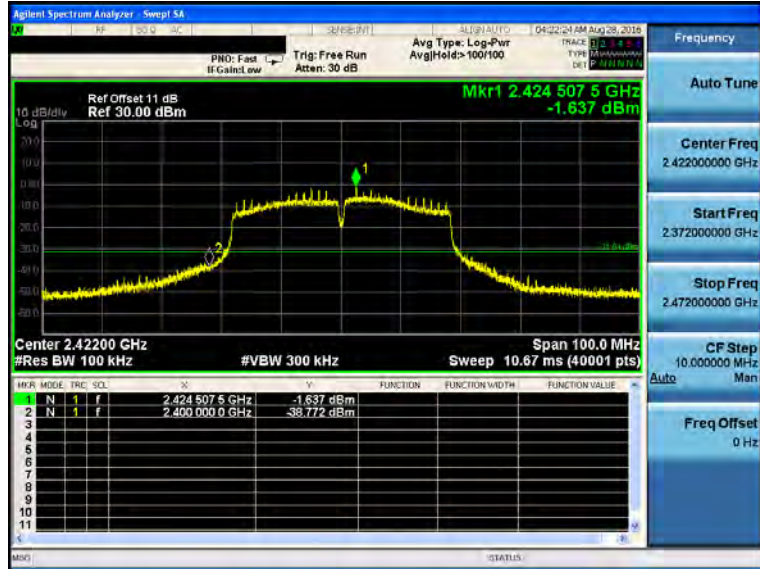

2452 MHz

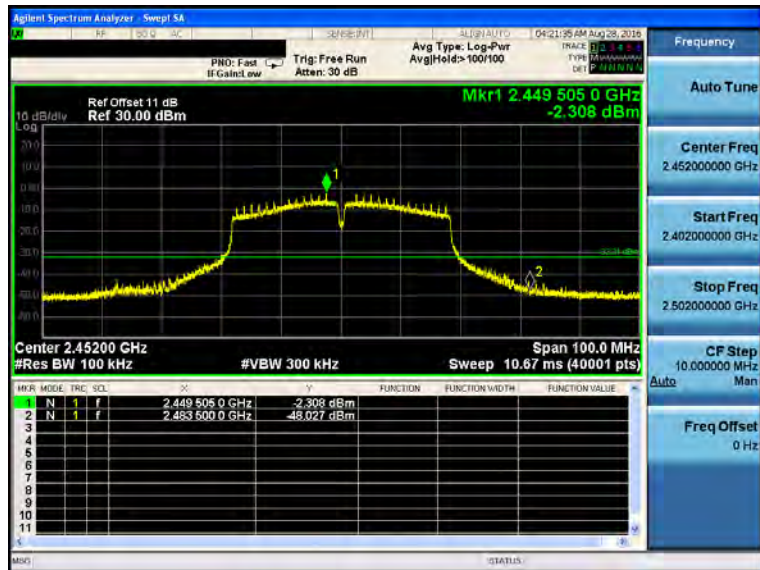

Mode 2: IEEE 802.11b link mode_ANT-2

2412 MHz

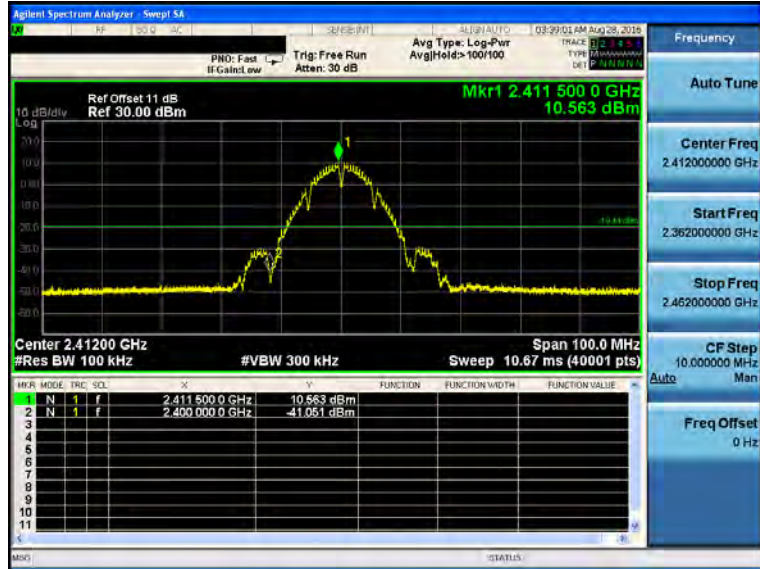

2462 MHz

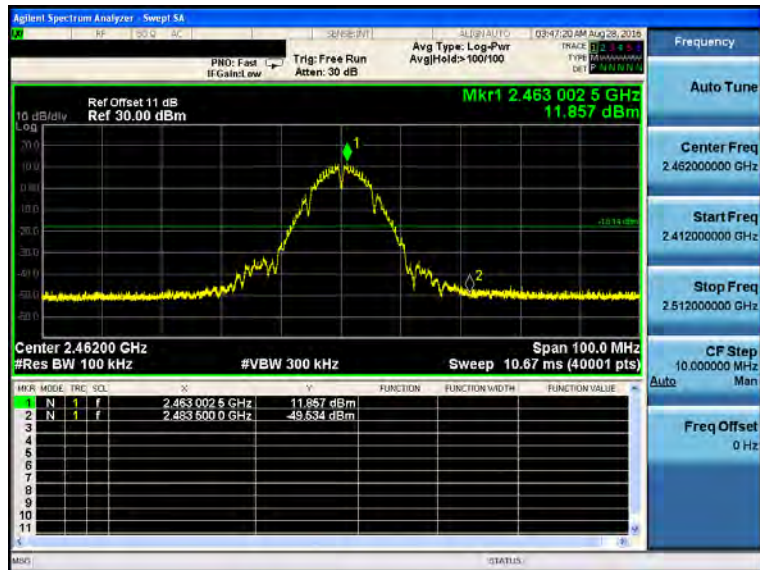



Mode 3: IEEE 802.11g link mode_ANT-2

2412 MHz

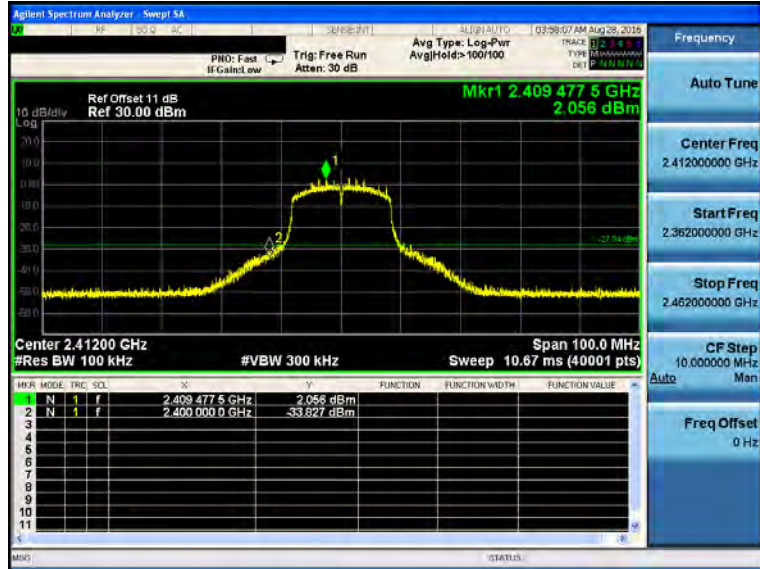

2462 MHz

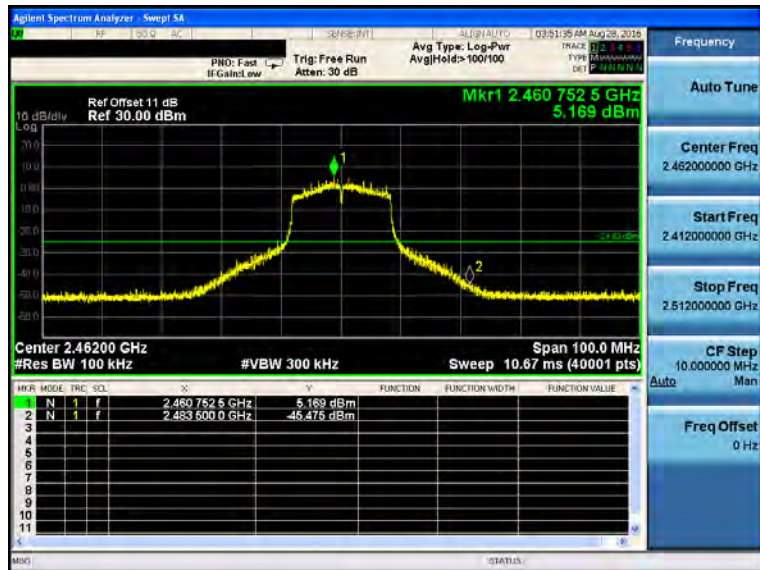

Mode 4: IEEE 802.11n 2.4GHz 20MHz link mode_ANT-2

2412 MHz

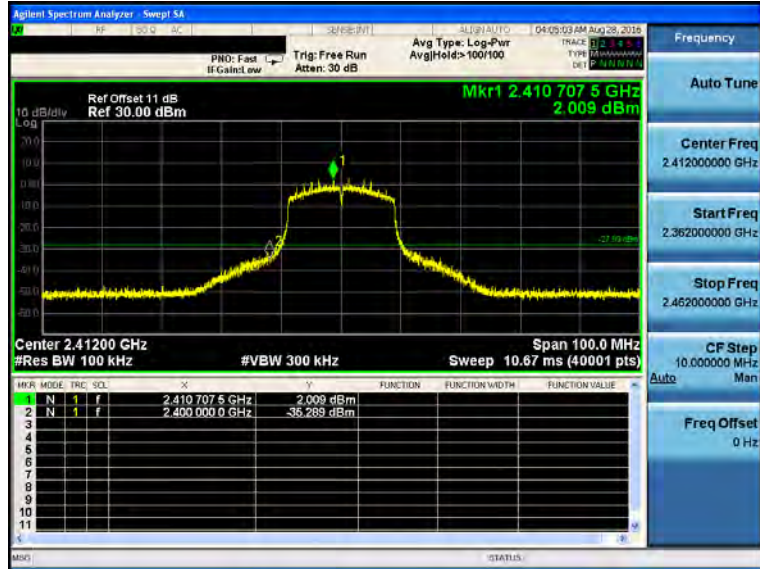

2462 MHz

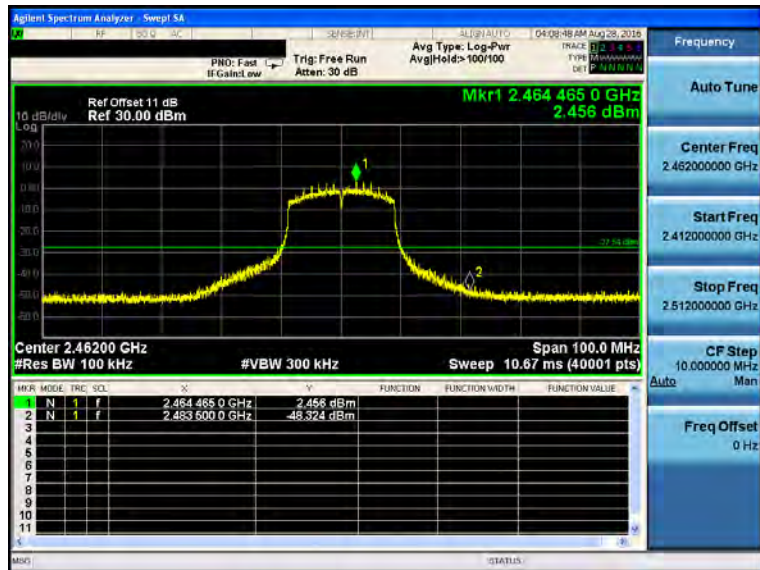



Mode 5: IEEE 802.11n 2.4GHz 40MHz link mode_ANT-2

2422 MHz

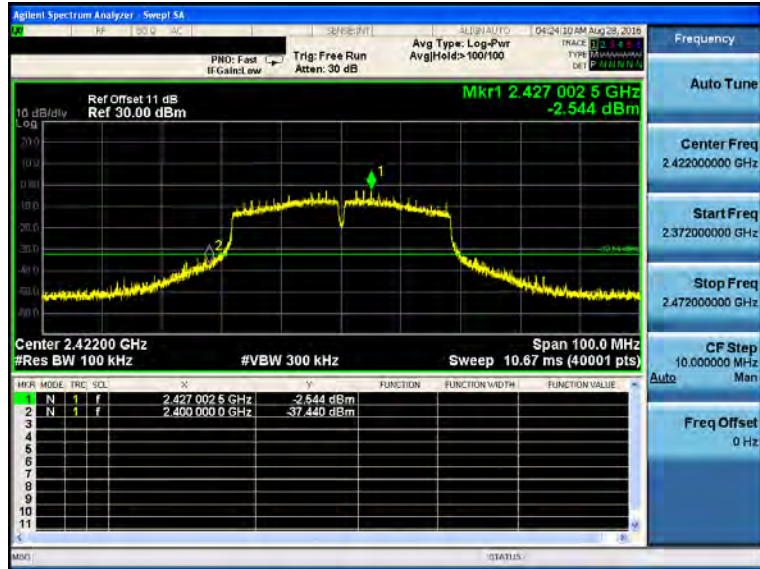

2452 MHz





10 Antenna Measurement

10.1.Limit

For intentional device, according to 15.203, an intentional radiator shall be designed to ensure that no antenna other than that furnished by the responsible party shall be used with the device.

And According to 15.247 (b), if transmitting antennas of directional gain greater than 6 dBi are used, the power shall be reduced by the amount in dB that the directional gain of the antenna exceeds 6dBi.

10.2.Antenna Description

See section 2 – antenna information.

10.3.Directiona Gain Calculated

For Maximum Conducted Output Power

$$\text{Directional Gain} = 10 \cdot \log\{[10^{(G1/10)} + 10^{(G2/10)} + \dots + 10^{(Gn/10)}] / NANT\}$$

Operate Freq. Band	Directional Gain (dBi)
IEEE 802.11b link mode	1.8
IEEE 802.11g link mode	1.8
IEEE 802.11n 2.4GHz 20MHz	1.8
IEEE 802.11n 2.4GHz 40MHz	1.8

For Maximum Power Density

$$\text{Directional Gain} = 10 \cdot \log\{[10^{(G1/20)} + 10^{(G2/20)} + \dots + 10^{(Gn/20)}]^2 / NANT\}$$

Operate Freq. Band	Directional Gain (dBi)
IEEE 802.11b link mode	6.65
IEEE 802.11g link mode	6.65
IEEE 802.11n 2.4GHz 20MHz	6.65
IEEE 802.11n 2.4GHz 40MHz	6.65