



## FCC 47 CFR PART 15 SUBPART C

### RF Test Report

Applicant : TP-LINK TECHNOLOGIES CO., LTD.  
Product Type : AC900 Wireless Dual Band Gigabit Router  
Trade Name : TP-LINK  
Model Number : Archer C2  
Applicable Standard : FCC 47 CFR PART 15 SUBPART C  
ANSI C63.10:2013  
Receive Date : Jul. 20, 2016  
Test Period : Jul. 26 ~ Oct. 18, 2016  
Issue Date : Oct. 18, 2016

#### Issue by

A Test Lab Techno Corp.  
No. 140-1, Changan Street, Bade District,  
Taoyuan City 33465, Taiwan (R.O.C)  
Tel : +886-3-2710188 / Fax : +886-3-2710190



Taiwan Accreditation Foundation accreditation number: 1330

**Note:** This report shall not be reproduced except in full, without the written approval of A Test Lab Techno Corp. This document may be altered or revised by A Test Lab Techno Corp. personnel only, and shall be noted in the revision section of the document. The client should not use it to claim product endorsement by TAF, or any government agencies. The test results in the report only apply to the tested sample.



**Revision History**

Rev.	Issue Date	Revisions	Revised By
00	Sep. 23, 2016	Initial Issue	Janice Huang
01	Oct. 18, 2016	Revised report information.	Snow Wang



# Verification of Compliance

Issued Date: Oct. 18, 2016

Applicant : TP-LINK TECHNOLOGIES CO., LTD.  
 Product Type : AC900 Wireless Dual Band Gigabit Router  
 Trade Name : TP-LINK  
 Model Number : Archer C2  
 FCC ID : TE7C2V3  
 EUT Rated Voltage : DC 12V, 1A  
 Test Voltage : 120 Vac / 60 Hz  
 Applicable Standard : FCC 47 CFR PART 15 SUBPART C  
 ANSI C63.10:2013

Test Result : Complied

Performing Lab. : A Test Lab Techno Corp.  
 No. 140-1, Changan Street, Bade District,  
 Taoyuan City 33465, Taiwan (R.O.C)  
 Tel : +886-3-2710188 / Fax : +886-3-2710190  
 Taiwan Accreditation Foundation accreditation number: 1330  
<http://www.atl-lab.com.tw/e-index.htm>



A Test Lab Techno Corp. tested the above equipment in accordance with the requirements set forth in the above standards. All indications of Pass/Fail in this report are opinions expressed by A Test Lab Techno Corp. based on interpretations and/or observations of test results. Measurement Uncertainties were not taken into account and are published for informational purposes only. The test results show that the equipment tested is capable of demonstrating compliance with the requirements as documented in this report.

Approved By : Fly Lu Reviewed By : Eric Ou Yang  
 (Manager) (Fly Lu) (Testing Engineer) (Eric Ou Yang)



## TABLE OF CONTENTS

<b>1</b>	<b>General Information</b>	<b>6</b>
<b>2</b>	<b>EUT Description</b>	<b>7</b>
<b>3</b>	<b>Test Methodology</b>	<b>8</b>
3.1.	Mode of Operation	8
3.2.	EUT Exercise Software	12
3.3.	Configuration of Test System Details	13
3.4.	Test Site Environment	14
<b>4</b>	<b>AC Power Line Conducted Emission Measurement</b>	<b>15</b>
4.1.	Limit	15
4.2.	Test Instruments	15
4.3.	Test Setup	15
4.4.	Test Procedure	16
4.5.	Test Result	17
<b>5</b>	<b>Radiated Emission Measurement</b>	<b>19</b>
5.1.	Limit	19
5.2.	Test Instruments	19
5.3.	Setup	20
5.4.	Test Procedure	21
5.5.	Test Result	23
<b>6</b>	<b>Maximum Conducted Output Power Measurement</b>	<b>57</b>
6.1.	Limit	57
6.2.	Test Setup	57
6.3.	Test Instruments	57
6.4.	Test Procedure	57
6.5.	Test Result	58
<b>7</b>	<b>6dB RF Bandwidth Measurement</b>	<b>66</b>
7.1.	Limit	66
7.2.	Test Setup	66
7.3.	Test Instruments	66
7.4.	Test Procedure	66
7.5.	Test Result	67
7.6.	Test Graphs	68
<b>8</b>	<b>Maximum Power Density Measurement</b>	<b>80</b>
8.1.	Limit	80
8.2.	Test Setup	80
8.3.	Test Instruments	80
8.4.	Test Procedure	81
8.5.	Test Result	82
8.6.	Test Graphs	83



<b>9</b>	<b>Out of Band Conducted Emissions Measurement .....</b>	<b>95</b>
9.1.	Limit .....	95
9.2.	Test Setup.....	95
9.3.	Test Instruments .....	95
9.4.	Test Procedure .....	95
9.5.	Test Graphs .....	96
<b>10</b>	<b>Antenna Measurement.....</b>	<b>132</b>
10.1.	Limit .....	132
10.2.	Antenna Description .....	132
10.3.	Directional Gain Calculated.....	132



# 1 General Information

## 1.1 Summary of Test Result

Standard	Item	Result	Remark
15.247			
15.207	AC Power Conducted Emission	PASS	-----
Standard	Item	Result	Remark
15.247			
15.247(d)	Transmitter Radiated Emissions	PASS	-----
15.247(b)(3)	Max. Output Power	PASS	-----
15.247(a)(2)	6dB RF Bandwidth	PASS	-----
15.247(e)	Power Spectral Density	PASS	-----
15.247(d)	Out of Band Conducted Spurious Emission	PASS	-----
15.203	Antenna Requirement	PASS	-----

The test results of this report relate only to the tested sample(s) identified in this report. Manufacturer or whom it may concern should recognize the pass or fail of the test result.

## 1.2 Measurement Uncertainty

Test Item	Frequency Range	Uncertainty (dB)
Conducted Emission	9kHz ~ 150KHz	2.7
	150kHz ~ 30MHz	2.8
Radiated Emission	9kHz ~ 30MHz	1.457
	30MHz ~ 1000MHz	6.300
	1000MHz ~ 18000MHz	5.474
	18000MHz ~ 26500MHz	5.630
	26500MHz ~ 40000MHz	5.054
Conducted Output Power	+0.27 dB / -0.28 dB	
RF Bandwidth	4.96%	
Power Spectral Density	+0.71 dB / -0.77 dB	



## 2 EUT Description

Applicant	TP-LINK TECHNOLOGIES CO., LTD. Building 24 (floors 1,3,4,5) and 28 (floors1-4) Central Science and Technology Park,Shennan Rd, Nanshan, Shenzhen,China			
Manufacturer	TP-LINK TECHNOLOGIES CO., LTD. Building 24 (floors 1,3,4,5) and 28 (floors1-4) Central Science and Technology Park,Shennan Rd, Nanshan, Shenzhen,China			
Product Type	AC900 Wireless Dual Band Gigabit Router			
Trade Name	TP-LINK			
Model Number	Archer C2			
FCC ID	TE7C2V3			
Operate Freq. Band	Frequency Range (MHz)	Modulation	Channel Bandwidth	Data Rate 400 GI (ns)
IEEE 802.11b	2412 ~ 2462	DSSS	20MHz	Up to 11Mbps
IEEE 802.11g	2412 ~ 2462	OFDM (64QAM)	20MHz	Up to 54Mbps
IEEE 802.11n 2.4GHz 20MHz	2412 ~ 2462	OFDM (64QAM)	20MHz	Up to 216.6Mbps
IEEE 802.11n 2.4GHz 40MHz	2422 ~ 2452	OFDM (64QAM)	40MHz	Up to 450Mbps
Antenna information	Type		Max. Gain (dBi)	
	Dipole Antenna		1.88	
Antenna Delivery	See section 3.1			

Frequency Band	Max. RF Output Power (W)
IEEE 802.11b	0.290
IEEE 802.11g	0.209
IEEE 802.11n 2.4GHz 20MHz	0.210
IEEE 802.11n 2.4GHz 40MHz	0.081

### 3 Test Methodology

#### 3.1. Mode of Operation

Decision of Test ATL has verified the construction and function in typical operation. All the test modes were carried out with the EUT in normal operation, which was shown in this test report and defined as:

Test Mode
Mode 1: Normal operation mode
Mode 2: IEEE 802.11b link mode
Mode 3: IEEE 802.11g link mode
Mode 4: IEEE 802.11n 2.4GHz 20MHz link mode
Mode 5: IEEE 802.11n 2.4GHz 40MHz link mode

Software used to control the EUT for staying in continuous transmitting mode was programmed.

After verification, all tests were carried out with the worst case test modes as shown below except radiated spurious emission below 1GHz and power line conducted emissions below 30MHz, which worst case was in normal link mode only.

By preliminary testing and verifying three axis (X, Y and Z) position of EUT transmitted status, it was found that "X axis" position was the worst, then the final test was executed the worst condition and test data were recorded in this report.

Test Mode	ANT-0	ANT-1	ANT-2	ANT-0+1+2
Mode 2: IEEE 802.11b link mode	V	V	V	V
Mode 3: IEEE 802.11g link mode	V	V	V	V
Mode 4: IEEE 802.11n 2.4GHz 20MHz link mode	V	V	V	V
Mode 5: IEEE 802.11n 2.4GHz 40MHz link mode	V	V	V	V

Test Mode	Antenna Delivery	Test Channel	Data Rate (Mbps)
Mode 2: IEEE 802.11b link mode	3TX / 3RX (CCD)	1, 2, 3, 6, 9, 10, 11	1
Mode 3: IEEE 802.11g link mode	3TX / 3RX (CCD)	1, 2, 3, 6, 9, 10, 11	6
Mode 4: IEEE 802.11n 2.4GHz 20MHz link mode	3TX / 3RX (CCD)	1, 2, 3, 6, 9, 10, 11	19.5
Mode 5: IEEE 802.11n 2.4GHz 40MHz link mode	3TX / 3RX (CCD)	3, 4, 5, 6, 7, 8, 9	40.5

#### Duty cycle

Test Mode	Frequency (MHz)	on time (ms)	on+off time (ms)	Duty cycle	Duty Factor (dB)	1/T Minimum VBW (kHz)
Mode 2: IEEE 802.11b link mode	2412.0	12.220	12.230	0.999	0.004	0.010
Mode 3: IEEE 802.11g link mode	2412.0	2.032	2.075	0.979	0.091	0.492
Mode 4: IEEE 802.11n 2.4GHz 20MHz link mode	2412.0	1.895	1.938	0.978	0.097	0.528
Mode 5: IEEE 802.11n 2.4GHz 40MHz link mode	2422.0	0.935	0.965	0.969	0.139	1.070



Duty Cycle Graphs

Mode 2: IEEE 802.11b link mode

On time



On+off time





Mode 3: IEEE 802.11g Mode

On time

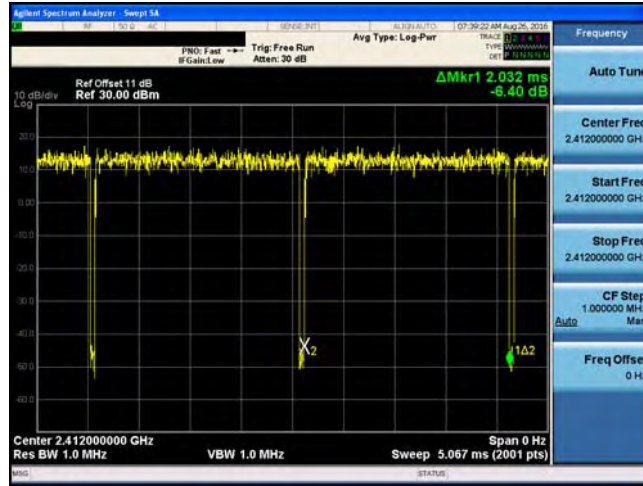

On+off time

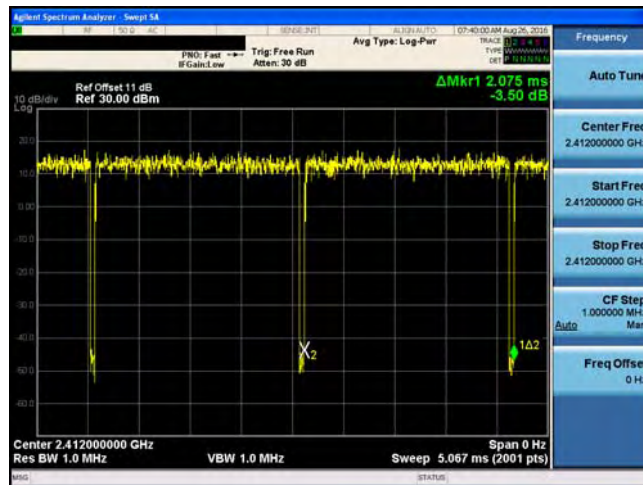



Mode 4: IEEE 802.11n 2.4GHz 20MHz Mode

On time

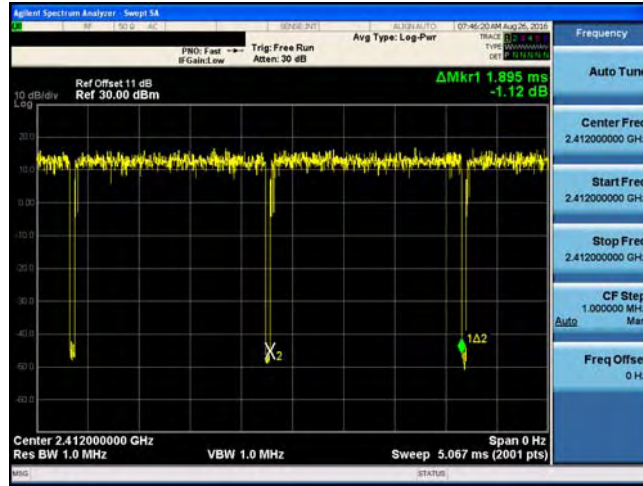

On+off time

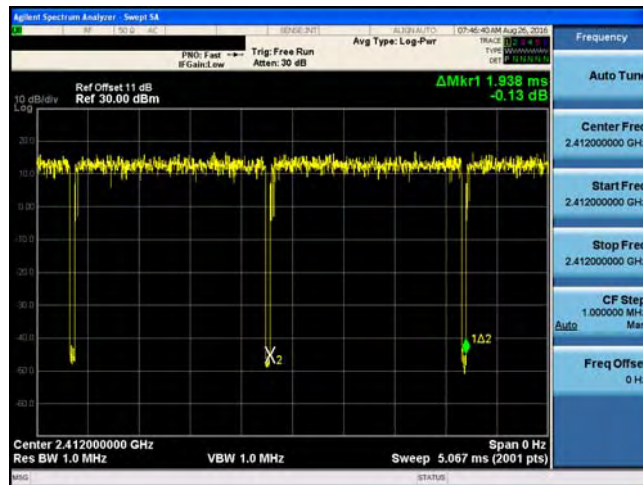

Mode 5: IEEE 802.11n 2.4GHz 40MHz Mode

<p>On time</p>	
<p>On+off time</p>	

### 3.2. EUT Exercise Software

1. Setup the EUT shown on 3.3.
2. Turn on the power of all equipment.
3. Turn Wi-Fi function link to AP
4. EUT run test program.

Measurement Software	
1	EZ-EMC Ver. ATL-03A1-1
2	EZ-EMC Ver ATL-ITC-3A1-1

### 3.3. Configuration of Test System Details

Conducted Emissions

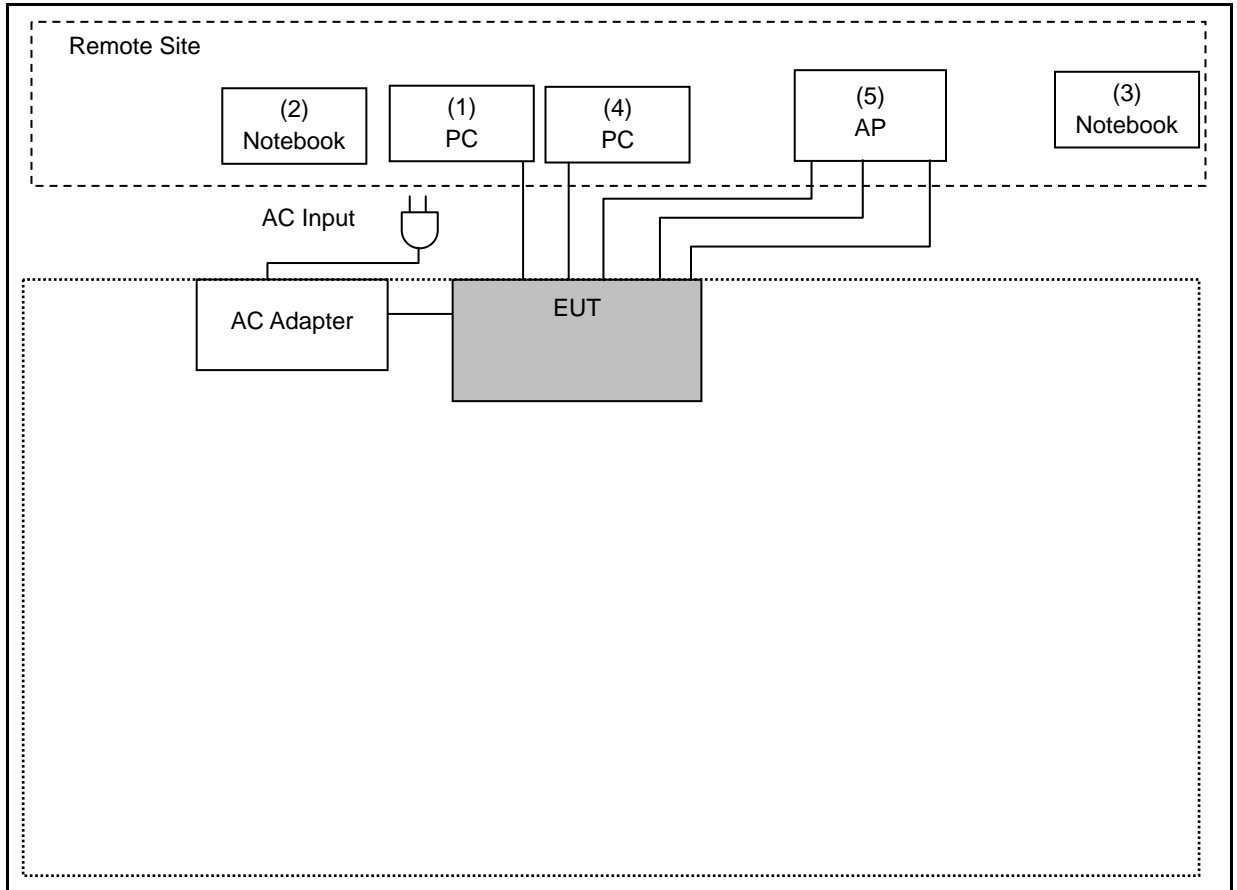

Devices Description					
	Product	Manufacturer	Model Number	Serial Number	Power Cord
1.	PC	DELL	9020	HJMBW02	Non-Shielded, 1.8m
2.	Notebook	DELL	LAPTITU	25627158361	Non-Shielded, 1.8m
3.	Notebook	DELL	LAPTITU	6699565657	Non-Shielded, 1.8m
4.	PC	DELL	T3610	F5XBW02	Non-Shielded, 1.8m
5.	AP	ASUS	MSQ-RTAC66U	D1IAGG000126	Non-Shielded, 1.8m

Radiated Emissions

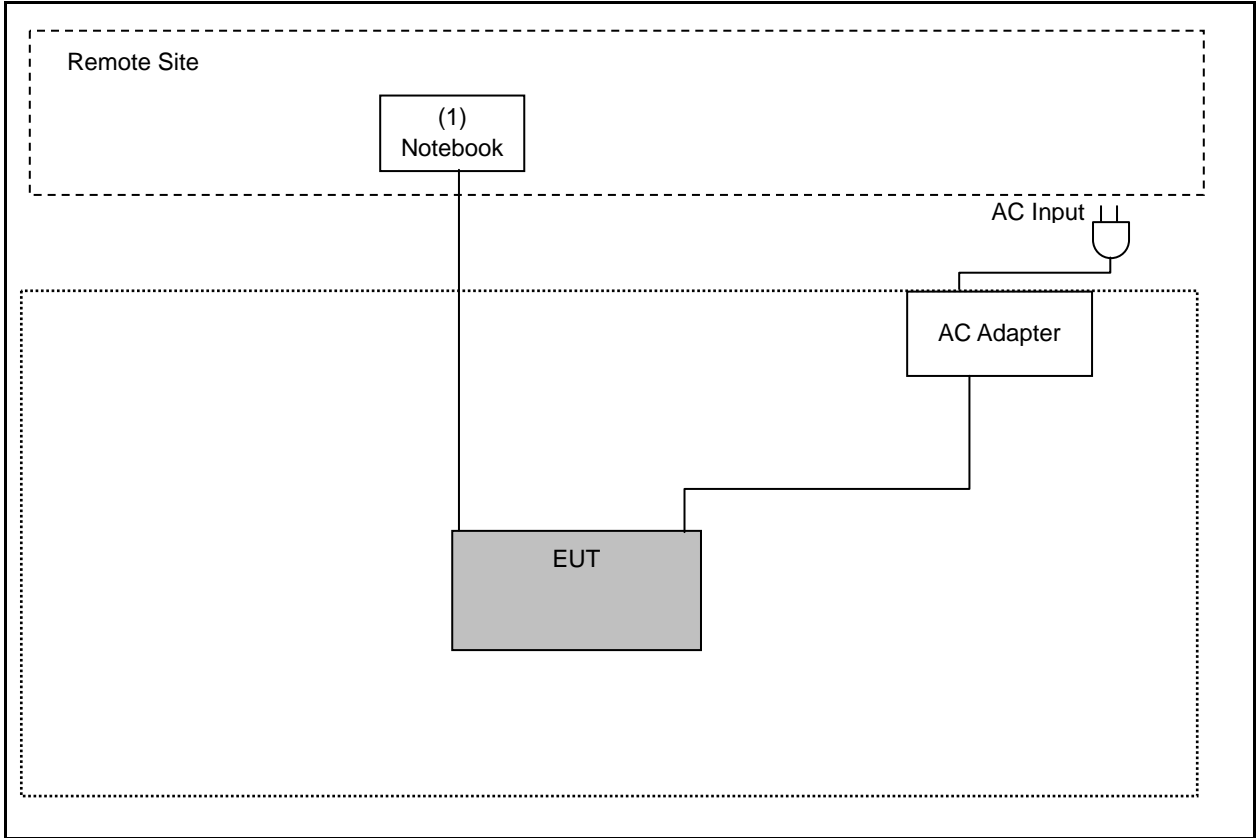

Devices Description					
	Product	Manufacturer	Model Number	Serial Number	Power Cord
(1)	Notebook	DELL	LAPTITU	6699565657	Non-Shielded, 0.8m

**3.4. Test Site Environment**

Items	Required (IEC 60068-1)	Actual
Temperature (°C)	15-35	26
Humidity (%RH)	25-75	60
Barometric pressure (mbar)	860-1060	950

## 4 AC Power Line Conducted Emission Measurement

### 4.1. Limit

Frequency (MHz)	Quasi-peak	Average
0.15 - 0.5	66 to 56	56 to 46
0.50 - 5.0	56	46
5.0 - 30.0	60	50

### 4.2. Test Instruments

Describe	Manufacturer	Model Number	Serial Number	Cal. Date	Cal. Period
Test Receiver	R&S	ESCI	100367	05/31/2016	1 year
LISN	R&S	ENV216	101040	03/15/2016	1 year
LISN	R&S	ENV216	101041	03/07/2016	1 year
RF Cable	Woken	00100D1380194M	TE-02-02	05/31/2016	1 year
Test Site	ATL	TE02	TE02	N.C.R.	-----

Note: N.C.R. = No Calibration Request.

### 4.3. Test Setup

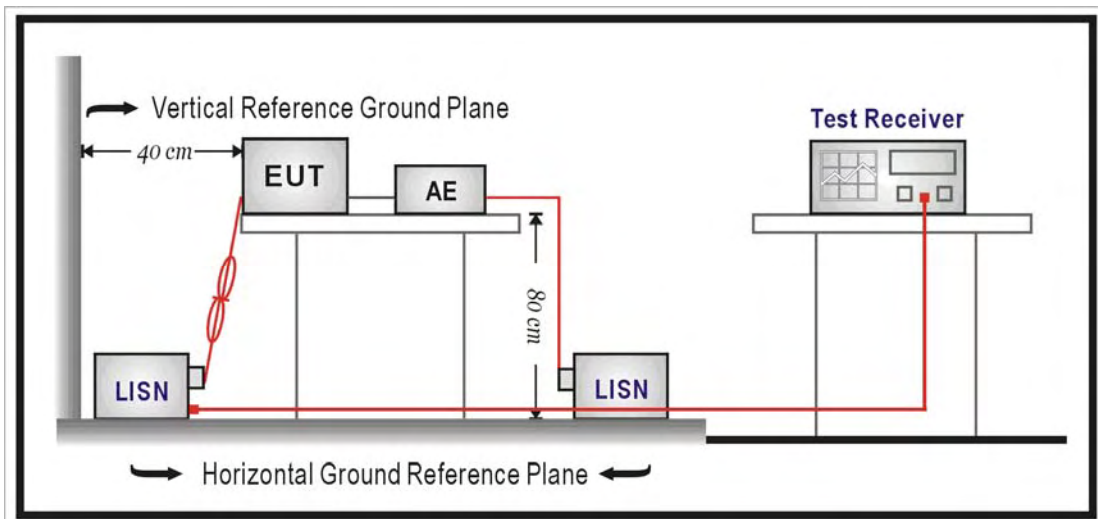

#### 4.4. Test Procedure

The EUT and simulators are connected to the main power through a line impedance stabilization network (L.I.S.N.). This provides a  $50\Omega//50\mu\text{H}$  coupling impedance for the measuring equipment. The peripheral devices are also connected to the main power through a LISN that provides a  $50\Omega//50\mu\text{H}$  coupling impedance with 50ohm termination.

Tabletop device shall be placed on a non-conducting platform, of nominal size 1 m by 1.5 m, raised 80 cm above the reference ground plane. The wall of screened room shall be located 40cm to the rear of the EUT. Other surfaces of tabletop or floor standing EUT shall be at least 80cm from any other ground conducting surface including one or more LISNs. For floor-standing device shall be placed under the EUT with a 12mm insulating material.

Conducted emissions were investigated over the frequency range from 0.15 MHz to 30 MHz using a resolution bandwidth of 9 kHz. The equipment under test (EUT) shall be meet the limits in section 4.1, as applicable, including the average limit and the quasi-peak limit when using respectively, an average detector and quasi-peak detector measured in accordance with the methods described of related standard. When all of peak value were complied with quasi-peak and average limit from 150kHz to 30MHz then quasi-peak and average measurement was unnecessary.

The AMN shall be placed 0,8 m from the boundary of the unit under test and bonded to a ground reference plane for AMNs mounted on top of the ground reference plane. This distance is between the closest points of the AMN and the EUT. All other units of the EUT and associated equipment shall be at least 0,8 m from the AMN. If the mains power cable is longer than 1m then the cable shall be folded back and forth at the centre of the lead to form a bundle no longer than 0.4m. All of interconnecting cables that hang closer than 40cm to the ground plane shall be folded back and forth in the center forming a bundle 30 cm to 40 cm long. All of EUT and AE shall be separate place more than 0.1m. All 50  $\Omega$  ports of the LISN shall be resistively terminated into 50  $\Omega$  loads when not connected to the measuring instrument.

If the reading of the measuring receiver shows fluctuations close to the limit, the reading shall be observed for at least 15 s at each measurement frequency; the higher reading shall be recorded with the exception of any brief isolated high reading which shall be ignored.





### 4.5. Test Result

Standard:	FCC Part 15C	Line:	L1
Test item:	Conducted Emission	Power:	AC 120V/60Hz
Model Number:	Archer C2	Temp.(°C)/Hum.(%RH):	26(°C)/60%RH
Mode:	Mode 1	Date:	07/26/2016
		Test By:	Eric Ou Yang
Description:			

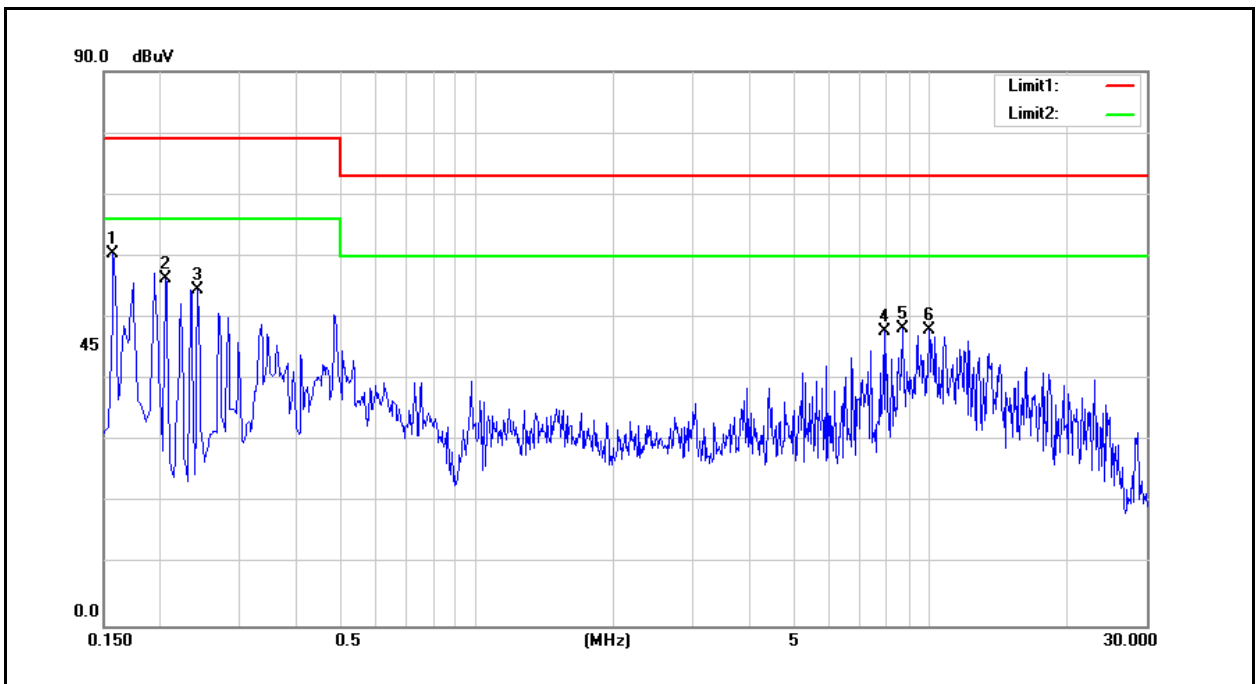

No.	Frequency (MHz)	QP reading (dBuV)	AVG reading (dBuV)	Correction factor (dB)	QP result (dBuV)	AVG result (dBuV)	QP limit (dBuV)	AVG limit (dBuV)	QP margin (dB)	AVG margin (dB)	Remark
1	0.1580	42.99	18.30	9.60	52.59	27.90	79.00	66.00	-26.41	-38.10	Pass
2	0.2060	38.85	12.29	9.59	48.44	21.88	79.00	66.00	-30.56	-44.12	Pass
3	0.2420	36.09	10.98	9.59	45.68	20.57	79.00	66.00	-33.32	-45.43	Pass
4	7.9220	36.67	28.10	9.84	46.51	37.94	73.00	60.00	-26.49	-22.06	Pass
5	8.7180	35.94	27.60	9.86	45.80	37.46	73.00	60.00	-27.20	-22.54	Pass
6	9.9380	35.80	26.95	9.89	45.69	36.84	73.00	60.00	-27.31	-23.16	Pass

Note: 1. Result (dBuV) = Correction factor (dB) + Reading(dBuV).

2. Correction factor (dB) = Cable loss (dB) + L.I.S.N. factor (dB).



Standard:	FCC Part 15C	Line:	N
Test item:	Conducted Emission	Power:	AC 120V/60Hz
Model Number:	Archer C2	Temp.(°C)/Hum.(%RH):	26(°C)/60%RH
Mode:	Mode 1	Date:	07/26/2016
		Test By:	Eric Ou Yang

Description:

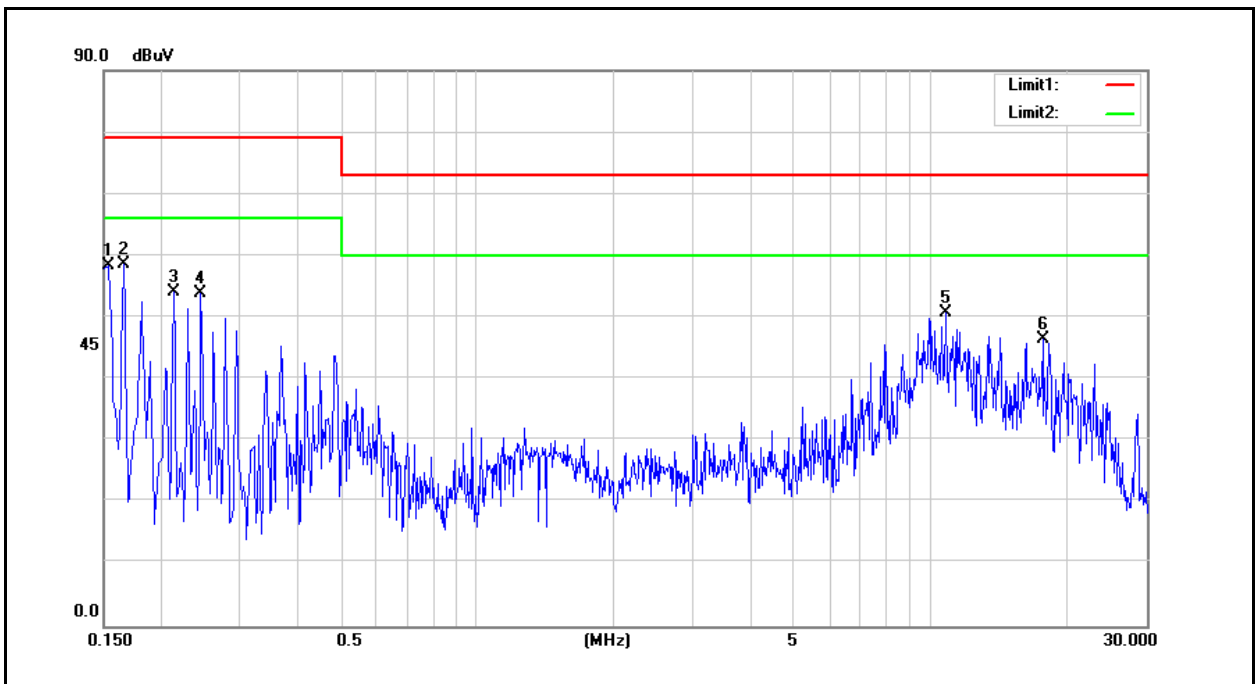

No.	Frequency (MHz)	QP reading (dBuV)	AVG reading (dBuV)	Correction factor (dB)	QP result (dBuV)	AVG result (dBuV)	QP limit (dBuV)	AVG limit (dBuV)	QP margin (dB)	AVG margin (dB)	Remark
1	0.1540	41.79	15.53	9.59	51.38	25.12	79.00	66.00	-27.62	-40.88	Pass
2	0.1660	42.34	13.93	9.59	51.93	23.52	79.00	66.00	-27.07	-42.48	Pass
3	0.2140	35.98	10.23	9.58	45.56	19.81	79.00	66.00	-33.44	-46.19	Pass
4	0.2460	36.39	8.24	9.58	45.97	17.82	79.00	66.00	-33.03	-48.18	Pass
5	10.7940	38.81	22.89	9.93	48.74	32.82	73.00	60.00	-24.26	-27.18	Pass
6	17.6940	34.66	25.93	10.07	44.73	36.00	73.00	60.00	-28.27	-24.00	Pass

Note: 1. Result (dBuV) = Correction factor (dB) + Reading(dBuV).

2. Correction factor (dB) = Cable loss (dB) + L.I.S.N. factor (dB).



## 5 Radiated Emission Measurement

### 5.1. Limit

According to §15.209(a), except as provided elsewhere in this subpart, the emissions from an intentional radiator shall not exceed the field strength levels specified in the following table:

Frequency (MHz)	Field Strength ( $\mu\text{V}/\text{m}$ at meter)	Measurement Distance (meters)
0.009 – 0.490	2400 / F (kHz)	300
0.490 – 1.705	24000 / F (kHz)	30
1.705 – 30.0	30	30
30 - 88	100**	3
88-216	150**	3
216-960	200**	3
Above 960	500	3

\*\* Except as provided in paragraph (g), fundamental emissions from intentional radiators operating under this Section shall not be located in the frequency bands 54-72 MHz, 76-88 MHz, 174-216 MHz or 470-806 MHz. However, operation within these frequency bands is permitted under other sections of this Part, e.g., Sections 15.231 and 15.241.

### 5.2. Test Instruments

3 Meter Chamber					
Equipment	Manufacturer	Model Number	Serial Number	Cal. Date	Cal. Period
RF Pre-selector	Agilent	N9039A	MY46520256	01/08/2016	1 year
Spectrum Analyzer	Agilent	E4446A	MY46180578	01/08/2016	1 year
Pre Amplifier	Agilent	8449B	3008A02237	10/07/2015	1 year
Pre Amplifier	Agilent	8447D	2944A11119	01/11/2016	1 year
Broadband Antenna	Schwarzbeck	VULB9168	416	09/25/2015	1 year
Horn Antenna (1~18GHz)	SCHWARZBECK MESS-ELEKTRONIK	BBHA9120D	9120D-550	06/06/2016	1 year
Horn Antenna (18~40GHz)	ETS	3116	86467	09/01/2015	1 year
Loop Antenna	COM-POWER CORPORATION	AL-130	121014	02/01/2016	1 year
Microwave Cable	EMCI	EMC102-KM-KM-14000	151001	10/15/2015	1 year
Microwave Cable	EMCI	EMC-104-SM-SM-14000	140202	10/15/2015	1 year
Microwave Cable	EMCI	EMC104-SM-SM-600	140301	10/15/2015	1 year
Test Site	ATL	TE01	TE01	08/29/2015	1 year

Note: N.C.R. = No Calibration Request.

### 5.3. Setup

9kHz ~ 30MHz

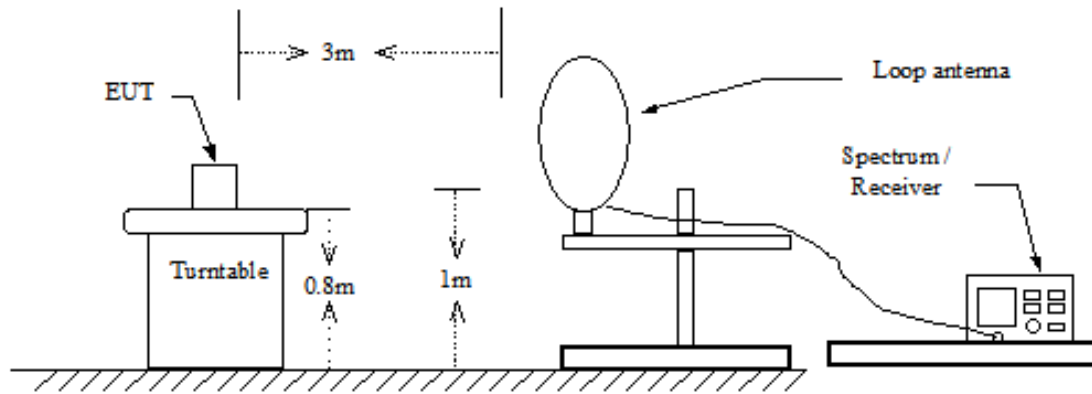

Below 1GHz

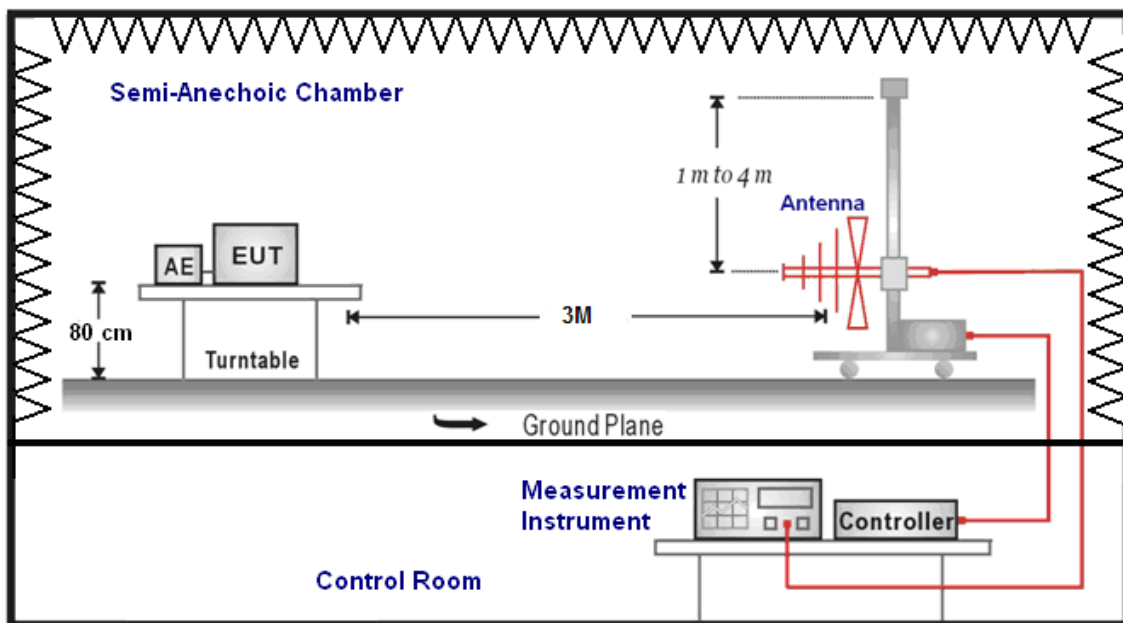

Above 1GHz

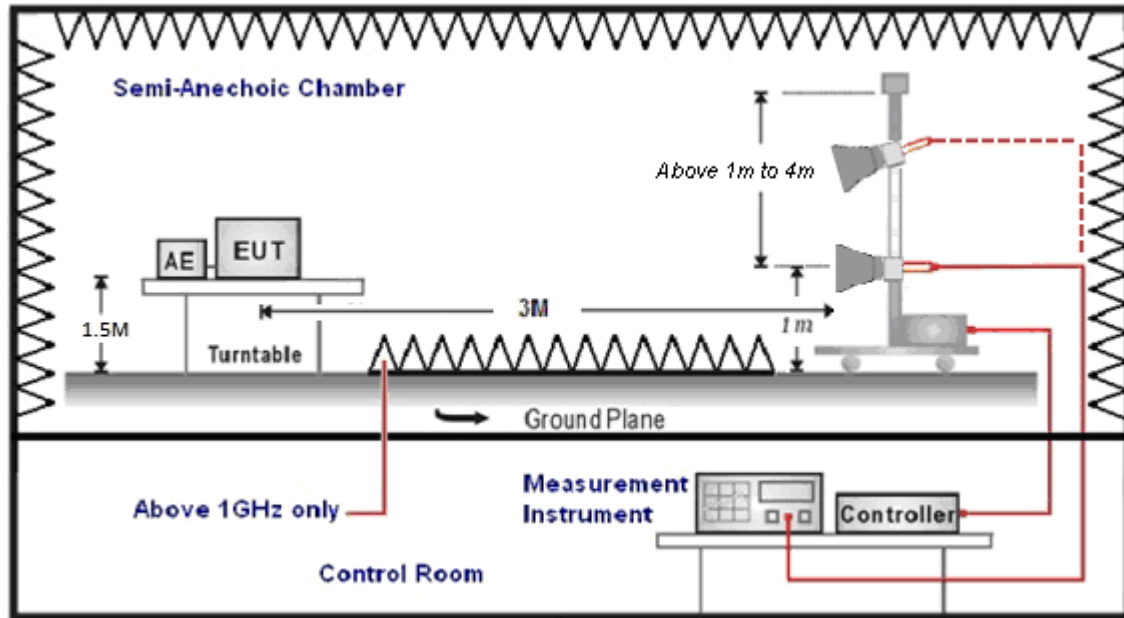

#### 5.4. Test Procedure

Final radiation measurements were made on a three-meter, Semi Anechoic Chamber. The EUT system was placed on a nonconductive turntable which is 0.8 or 1.5 meters height (below 1GHz use 0.8m turntable / above 1GHz use 1.5m turntable), top surface 1.0 x 1.5 meter. The spectrum was examined from 250 MHz to 2.5 GHz in order to cover the whole spectrum below 10th harmonic which could generate from the EUT. During the test, EUT was set to transmit continuously & Measurements spectrum range from 9 kHz to 26.5 GHz is investigated.

For measurements below 1 GHz the resolution bandwidth is set to 100 kHz for peak detection measurements or 120 kHz for quasi-peak detection measurements. Peak detection is used unless otherwise noted as quasi-peak.

For measurements above 1 GHz the resolution bandwidth is set to 1 MHz, and then the video bandwidth is set to 1 MHz for peak measurements and 10 Hz for average measurements when Duty cycle  $>0.98$  /  $1/T$  for average measurements when Duty cycle  $<0.98$ . A nonconductive material surrounded the EUT to supporting the EUT for standing on three orthogonal planes. At each condition, the EUT was rotated 360 degrees, and the antenna was raised and lowered from one to four meters to find the maximum emission levels. Measurements were taken using both horizontal and vertical antenna polarization.



SCHWARZBECK MESS-ELEKTRONIK Biconilog Antenna at 3 Meter and the SCHWARZBECK Double Ridged Guide Antenna was used in frequencies 1 –26.5 GHz at a distance of 3 meter. The antenna at an angle toward the source of the emission. All test results were extrapolated to equivalent signal at 3 meters utilizing an inverse linear distance extrapolation Factor (20dB/decade).

For testing above 1GHz, the emission level of the EUT in peak mode was 20dB lower than average limit (that means the emission level in peak mode also complies with the limit in average mode), then testing will be stopped and peak values of EUT will be reported, otherwise, the emissions will be measured in average mode again and reported.

Appropriate preamplifiers were used for improving sensitivity and precautions were taken to avoid overloading or desensitizing the spectrum analyzer. No post – detector video filters were used in the test.

The spectrum analyzer's 6 dB bandwidth was set to 1 MHz, and the analyzer was operated in the peak detection mode, for frequencies both below and up 1 GHz. The average levels were obtained by subtracting the duty cycle correction factor from the peak readings.

The following procedures were used to convert the emission levels measured in decibels referenced to 1 microvolt (dBuV) into field intensity in micro volts pre meter (uV/m).

The actual field intensity in decibels referenced to 1 microvolt in to field intensity in micro volts per meter (dBuV/m).

The actual field intensity in decibels referenced to 1 microvolt per meter (dBuV/m) is determined by algebraically adding the measured reading in dBuV, the antenna factor (dB), and cable loss (dB) and Subtracting the gain of preamplifier (dB) is auto calculate in spectrum analyzer.

$$(1) \text{ Amplitude (dBuV/m) = FI (dBuV) +AF (dBuV) +CL (dBuV)-Gain (dB)}$$

FI= Reading of the field intensity.

AF= Antenna factor.

CL= Cable loss.

P.S Amplitude is auto calculate in spectrum analyzer.

$$(2) \text{ Actual Amplitude (dBuV/m) = Amplitude (dBuV)-Dis(dB)}$$

The FCC specified emission limits were calculated according the EUT operating frequency and by following linear interpolation equations:

(a) For fundamental frequency : Transmitter Output < +30dBm

(b) For spurious frequency : Spurious emission limits = fundamental emission limit /10

Data of measurement within this frequency range without mark in the table above means the reading of emissions are attenuated more than 20dB below the permissible limits or the field strength is too small to be measured.

**5.5. Test Result****Below 1GHz**

Standard:	FCC Part 15C	Test Distance:	3m
Test item:	Radiated Emission	Power:	AC 120V/60Hz
Model Number:	Archer C2	Temp.(°C)/Hum.(%RH):	26(°C)/60%RH
Mode:	Mode 1	Date:	08/26/2016
		Test By:	Eric Ou Yang

Frequency (MHz)	Reading (dBuV)	Correct Factor (dB/m)	Result (dBuV/m)	Limit (dBuV/m)	Margin (dB)	Remark	Ant.Polar. H / V
220.5000	25.41	-7.36	18.05	46.00	-27.95	QP	H
313.0000	24.89	-3.20	21.69	46.00	-24.31	QP	H
412.0000	24.14	-1.33	22.81	46.00	-23.19	QP	H
558.5000	25.39	1.70	27.09	46.00	-18.91	QP	H
698.5000	25.70	4.64	30.34	46.00	-15.66	QP	H
873.5000	24.74	8.05	32.79	46.00	-13.21	QP	H
269.5000	23.41	-4.48	18.93	46.00	-27.07	QP	V
405.0000	24.65	-1.55	23.10	46.00	-22.90	QP	V
527.5000	26.51	1.14	27.65	46.00	-18.35	QP	V
656.5000	24.88	4.00	28.88	46.00	-17.12	QP	V
791.5000	25.92	6.56	32.48	46.00	-13.52	QP	V
873.5000	24.55	8.05	32.60	46.00	-13.40	QP	V

Note:1.Result (dBuV) = Correction factor (dB) + Reading(dBuV).

2. Correction factor (dB/m) = Antenna Factor (dB/m) + Cable loss (dB) – Pre-Amplifier gain (dB).

3.No emission found between lowest internal used/generated frequencies to 30MHz (9 kHz~30MHz).



**Above 1GHz**

Standard:	FCC Part 15C			Test Distance:	3m		
Test item:	Radiated Emission			Power:	AC 120V/60Hz		
Model Number:	Archer C2			Temp.(°C)/Hum.(%RH):	26(°C)/60%RH		
Mode:	Mode 2			Date:	08/28/2016		
Frequency:	2412MHz			Test By:	Eric Ou Yang		
Frequency (MHz)	Reading (dBuV)	Correct Factor (dB/m)	Result (dBuV/m)	Limit (dBuV/m)	Margin (dB)	Remark	Ant.Polar. H / V
4824.000	55.41	-7.96	47.45	74.00	-26.55	peak	H
4824.000	62.91	-7.96	54.95	74.00	-19.05	peak	V
4824.000	61.17	-7.96	53.21	54.00	-0.79	AVG	V

Standard:	FCC Part 15C			Test Distance:	3m		
Test item:	Radiated Emission			Power:	AC 120V/60Hz		
Model Number:	Archer C2			Temp.(°C)/Hum.(%RH):	26(°C)/60%RH		
Mode:	Mode 2			Date:	08/28/2016		
Frequency:	2437MHz			Test By:	Eric Ou Yang		
Frequency (MHz)	Reading (dBuV)	Correct Factor (dB/m)	Result (dBuV/m)	Limit (dBuV/m)	Margin (dB)	Remark	Ant.Polar. H / V
4874.000	55.15	-7.80	47.35	74.00	-26.65	peak	H
4874.000	66.09	-7.80	58.29	74.00	-15.71	peak	V
4874.000	61.50	-7.80	53.70	54.00	-0.30	AVG	V

Note:1.Result (dBuV/m) = Correction factor (dB/m) + Reading(dBuV).

2. Correction factor (dB/m) = Antenna Factor (dB/m) + Cable loss (dB) – Pre-Amplifier gain (dB).





Standard:	FCC Part 15C			Test Distance:	3m		
Test item:	Radiated Emission			Power:	AC 120V/60Hz		
Model Number:	Archer C2			Temp.(°C)/Hum.(%RH):	26(°C)/60%RH		
Mode:	Mode 2			Date:	08/28/2016		
Frequency:	2462MHz			Test By:	Eric Ou Yang		
Frequency (MHz)	Reading (dBuV)	Correct Factor (dB/m)	Result (dBuV/m)	Limit (dBuV/m)	Margin (dB)	Remark	Ant.Polar. H / V
4924.000	54.85	-7.65	47.20	74.00	-26.80	peak	H
4924.000	61.73	-7.65	54.08	74.00	-19.92	peak	V
4924.000	60.68	-7.65	53.03	54.00	-0.97	AVG	V

Standard:	FCC Part 15C			Test Distance:	3m		
Test item:	Radiated Emission			Power:	AC 120V/60Hz		
Model Number:	Archer C2			Temp.(°C)/Hum.(%RH):	26(°C)/60%RH		
Mode:	Mode 3			Date:	08/28/2016		
Frequency:	2412MHz			Test By:	Eric Ou Yang		
Frequency (MHz)	Reading (dBuV)	Correct Factor (dB/m)	Result (dBuV/m)	Limit (dBuV/m)	Margin (dB)	Remark	Ant.Polar. H / V
4824.000	48.82	-7.96	40.86	74.00	-33.14	peak	H
4824.000	52.40	-7.96	44.44	74.00	-29.56	peak	V

Note:1.Result (dBuV/m) = Correction factor (dB/m) + Reading(dBuV).

2.Correction factor (dB/m) = Antenna Factor (dB/m) + Cable loss (dB) – Pre-Amplifier gain (dB).



Standard:	FCC Part 15C			Test Distance:	3m		
Test item:	Radiated Emission			Power:	AC 120V/60Hz		
Model Number:	Archer C2			Temp.(°C)/Hum.(%RH):	26(°C)/60%RH		
Mode:	Mode 3			Date:	08/28/2016		
Frequency:	2437MHz			Test By:	Eric Ou Yang		
Frequency (MHz)	Reading (dBuV)	Correct Factor (dB/m)	Result (dBuV/m)	Limit (dBuV/m)	Margin (dB)	Remark	Ant.Polar. H / V
4874.000	52.52	-7.80	44.72	74.00	-29.28	peak	H
4874.000	60.06	-7.80	52.26	74.00	-21.74	peak	V
4874.000	51.27	-7.80	43.47	54.00	-10.53	AVG	V

Standard:	FCC Part 15C			Test Distance:	3m		
Test item:	Radiated Emission			Power:	AC 120V/60Hz		
Model Number:	Archer C2			Temp.(°C)/Hum.(%RH):	26(°C)/60%RH		
Mode:	Mode 3			Date:	08/28/2016		
Frequency:	2462MHz			Test By:	Eric Ou Yang		
Frequency (MHz)	Reading (dBuV)	Correct Factor (dB/m)	Result (dBuV/m)	Limit (dBuV/m)	Margin (dB)	Remark	Ant.Polar. H / V
4924.000	46.10	-7.65	38.45	74.00	-35.55	peak	H
4924.000	52.78	-7.65	45.13	74.00	-28.87	peak	V

Note:1.Result (dBuV/m) = Correction factor (dB/m) + Reading(dBuV).

2.Correction factor (dB/m) = Antenna Factor (dB/m) + Cable loss (dB) – Pre-Amplifier gain (dB).



Standard:	FCC Part 15C			Test Distance:	3m		
Test item:	Radiated Emission			Power:	AC 120V/60Hz		
Model Number:	Archer C2			Temp.(°C)/Hum.(%RH):	26(°C)/60%RH		
Mode:	Mode 4			Date:	08/28/2016		
Frequency:	2412MHz			Test By:	Eric Ou Yang		
Frequency (MHz)	Reading (dBuV)	Correct Factor (dB/m)	Result (dBuV/m)	Limit (dBuV/m)	Margin (dB)	Remark	Ant.Polar. H / V
4824.000	47.43	-7.96	39.47	74.00	-34.53	peak	H
4824.000	51.47	-7.96	43.51	74.00	-30.49	peak	V

Standard:	FCC Part 15C			Test Distance:	3m		
Test item:	Radiated Emission			Power:	AC 120V/60Hz		
Model Number:	Archer C2			Temp.(°C)/Hum.(%RH):	26(°C)/60%RH		
Mode:	Mode 4			Date:	08/28/2016		
Frequency:	2437MHz			Test By:	Eric Ou Yang		
Frequency (MHz)	Reading (dBuV)	Correct Factor (dB/m)	Result (dBuV/m)	Limit (dBuV/m)	Margin (dB)	Remark	Ant.Polar. H / V
4874.000	53.75	-7.80	45.95	74.00	-28.05	peak	H
4874.000	61.77	-7.80	53.97	74.00	-20.03	peak	V
4874.000	51.02	-7.80	43.22	54.00	-10.78	AVG	V

Note:1.Result (dBuV/m) = Correction factor (dB/m) + Reading(dBuV).

2.Correction factor (dB/m) = Antenna Factor (dB/m) + Cable loss (dB) – Pre-Amplifier gain (dB).



Standard:		FCC Part 15C		Test Distance:		3m	
Test item:		Radiated Emission		Power:		AC 120V/60Hz	
Model Number:		Archer C2		Temp.(°C)/Hum.(%RH):		26(°C)/60%RH	
Mode:		Mode 4		Date:		08/28/2016	
Frequency:		2462MHz		Test By:		Eric Ou Yang	
Frequency (MHz)	Reading (dBuV)	Correct Factor (dB/m)	Result (dBuV/m)	Limit (dBuV/m)	Margin (dB)	Remark	Ant.Polar. H / V
4924.000	47.23	-7.65	39.58	74.00	-34.42	peak	H
4924.000	51.81	-7.65	44.16	74.00	-29.84	peak	V

Standard:		FCC Part 15C		Test Distance:		3m	
Test item:		Radiated Emission		Power:		AC 120V/60Hz	
Model Number:		Archer C2		Temp.(°C)/Hum.(%RH):		26(°C)/60%RH	
Mode:		Mode 5		Date:		08/28/2016	
Frequency:		2422MHz		Test By:		Eric Ou Yang	
Frequency (MHz)	Reading (dBuV)	Correct Factor (dB/m)	Result (dBuV/m)	Limit (dBuV/m)	Margin (dB)	Remark	Ant.Polar. H / V
4844.000	44.80	-7.88	36.92	74.00	-37.08	peak	H
4844.000	47.60	-7.88	39.72	74.00	-34.28	peak	V

Note:1.Result (dBuV/m) = Correction factor (dB/m) + Reading(dBuV).

2.Correction factor (dB/m) = Antenna Factor (dB/m) + Cable loss (dB) – Pre-Amplifier gain (dB).



Standard:		FCC Part 15C		Test Distance:		3m	
Test item:		Radiated Emission		Power:		AC 120V/60Hz	
Model Number:		Archer C2		Temp.(°C)/Hum.(%RH):		26(°C)/60%RH	
Mode:		Mode 5		Date:		08/28/2016	
Frequency:		2437MHz		Test By:		Eric Ou Yang	
Frequency (MHz)	Reading (dBuV)	Correct Factor (dB/m)	Result (dBuV/m)	Limit (dBuV/m)	Margin (dB)	Remark	Ant.Polar. H / V
4874.000	48.92	-7.80	41.12	74.00	-32.88	peak	H
4874.000	49.63	-7.80	41.83	74.00	-32.17	peak	V

Standard:		FCC Part 15C		Test Distance:		3m	
Test item:		Radiated Emission		Power:		AC 120V/60Hz	
Model Number:		Archer C2		Temp.(°C)/Hum.(%RH):		26(°C)/60%RH	
Mode:		Mode 5		Date:		08/28/2016	
Frequency:		2452MHz		Test By:		Eric Ou Yang	
Frequency (MHz)	Reading (dBuV)	Correct Factor (dB/m)	Result (dBuV/m)	Limit (dBuV/m)	Margin (dB)	Remark	Ant.Polar. H / V
4904.000	45.29	-7.70	37.59	74.00	-36.41	peak	H
4904.000	48.40	-7.70	40.70	74.00	-33.30	peak	V

Note:1.Result (dBuV/m) = Correction factor (dB/m) + Reading(dBuV).

2.Correction factor (dB/m) = Antenna Factor (dB/m) + Cable loss (dB) – Pre-Amplifier gain (dB).



Standard:		FCC Part 15C		Test Distance:		3m	
Test item:		Radiated Emission		Power:		AC 120V/60Hz	
Model Number:		Archer C2		Temp.(°C)/Hum.(%RH):		26(°C)/60%RH	
Mode:		Simultaneous Transmitting (DTS+NII)		Date:		08/28/2016	
				Test By:		Eric Ou Yang	
Frequency (MHz)	Reading (dBuV)	Correct Factor (dB/m)	Result (dBuV/m)	Limit (dBuV/m)	Margin (dB)	Remark	Ant.Polar. H / V
2799.000	34.06	0.82	34.88	74.00	-39.12	peak	H
4290.000	31.72	5.84	37.56	74.00	-36.44	peak	H
7615.000	29.01	14.26	43.27	74.00	-30.73	peak	H
2813.000	32.98	0.85	33.83	74.00	-40.17	peak	V
4591.000	31.63	6.64	38.27	74.00	-35.73	peak	V
7650.000	28.73	14.30	43.03	74.00	-30.97	peak	V

Note:1.Result (dBuV) = Correction factor (dB) + Reading(dBuV).

2.Correction factor (dB/m) = Antenna Factor (dB/m) + Cable loss (dB) – Pre-Amplifier gain (dB).



**Band Edge**

Standard:	FCC Part 15C	Test Distance:	3m				
Test item:	Radiated Emission	Power:	AC 120V/60Hz				
Model Number:	Archer C2	Temp.(°C)/Hum.(%RH):	26(°C)/60%RH				
Mode:	Mode 2	Date:	08/26/2016				
Frequency:	2412 MHz	Test By:	Eric Ou Yang				
Frequency (MHz)	Reading (dBuV)	Correct Factor (dB/m)	Result (dBuV/m)	Limit (dBuV/m)	Margin (dB)	Remark	Ant.Polar. H / V
2386.670	51.02	-0.36	50.66	74.00	-23.34	peak	H
2390.000	50.34	-0.34	50.00	74.00	-24.00	peak	H
2388.320	72.17	-0.34	71.83	74.00	-2.17	peak	V
2388.320	53.24	-0.34	52.90	54.00	-1.10	AVG	V
2390.000	70.58	-0.34	70.24	74.00	-3.76	peak	V
2390.000	54.06	-0.34	53.72	54.00	-0.28	AVG	V

Note:1.Result (dBuV/m) = Correction factor (dB/m) + Reading(dBuV).

2.Correction factor (dB/m) = Antenna Factor (dB/m) + Cable loss (dB) – Pre-Amplifier gain (dB).



Standard:	FCC Part 15C	Test Distance:	3m				
Test item:	Radiated Emission	Power:	AC 120V/60Hz				
Model Number:	Archer C2	Temp.(°C)/Hum.(%RH):	26(°C)/60%RH				
Mode:	Mode 2	Date:	09/23/2016				
Frequency:	2417 MHz	Test By:	Eric Ou Yang				
Frequency (MHz)	Reading (dBuV)	Correct Factor (dB/m)	Result (dBuV/m)	Limit (dBuV/m)	Margin (dB)	Remark	Ant.Polar. H / V
2386.230	52.05	-0.36	51.69	74.00	-22.31	peak	H
2390.000	51.05	-0.34	50.71	74.00	-23.29	peak	H
2389.090	60.09	-0.34	59.75	74.00	-14.25	peak	V
2389.090	52.17	-0.34	51.83	54.00	-2.17	AVG	V
2390.000	60.15	-0.34	59.81	74.00	-14.19	peak	V
2390.000	52.06	-0.34	51.72	54.00	-2.28	AVG	V

Note:1.Result (dBuV/m) = Correction factor (dB/m) + Reading(dBuV).

2.Correction factor (dB/m) = Antenna Factor (dB/m) + Cable loss (dB) – Pre-Amplifier gain (dB).





Standard:		FCC Part 15C		Test Distance:		3m	
Test item:		Radiated Emission		Power:		AC 120V/60Hz	
Model Number:		Archer C2		Temp.(°C)/Hum.(%RH):		26(°C)/60%RH	
Mode:		Mode 2		Date:		08/26/2016	
Frequency:		2437 MHz		Test By:		Eric Ou Yang	
Frequency (MHz)	Reading (dBuV)	Correct Factor (dB/m)	Result (dBuV/m)	Limit (dBuV/m)	Margin (dB)	Remark	Ant.Polar. H / V
2384.860	51.05	-0.36	50.69	74.00	-23.31	peak	H
2390.000	49.68	-0.34	49.34	74.00	-24.66	peak	H
2483.500	50.27	0.03	50.30	74.00	-23.70	peak	H
2499.430	50.33	0.10	50.43	74.00	-23.57	peak	H
2332.420	55.37	-0.57	54.80	74.00	-19.20	peak	V
2332.420	44.50	-0.57	43.93	54.00	-10.07	AVG	V
2390.000	54.10	-0.34	53.76	74.00	-20.24	peak	V
2390.000	46.53	-0.34	46.19	54.00	-7.81	AVG	V
2483.500	53.99	0.03	54.02	74.00	-19.98	peak	V
2483.500	46.93	0.03	46.96	54.00	-7.04	AVG	V
2485.560	55.33	0.04	55.37	74.00	-18.63	peak	V
2485.560	46.14	0.04	46.18	54.00	-7.82	AVG	V

Note:1.Result (dBuV/m) = Correction factor (dB/m) + Reading(dBuV).

2. Correction factor (dB/m) = Antenna Factor (dB/m) + Cable loss (dB) – Pre-Amplifier gain (dB).



Standard:	FCC Part 15C	Test Distance:	3m
Test item:	Radiated Emission	Power:	AC 120V/60Hz
Model Number:	Archer C2	Temp.(°C)/Hum.(%RH):	26(°C)/60%RH
Mode:	Mode 2	Date:	09/23/2016
Frequency:	2457 MHz	Test By:	Eric Ou Yang

Frequency (MHz)	Reading (dBuV)	Correct Factor (dB/m)	Result (dBuV/m)	Limit (dBuV/m)	Margin (dB)	Remark	Ant.Polar. H / V
2483.500	51.79	0.03	51.82	74.00	-22.18	peak	H
2484.004	51.91	0.04	51.95	74.00	-22.05	peak	H
2483.500	57.84	0.03	57.87	74.00	-16.13	peak	V
2483.500	51.65	0.03	51.68	54.00	-2.32	AVG	V
2486.025	59.06	0.04	59.10	74.00	-14.90	peak	V
2486.025	50.21	0.04	50.25	54.00	-3.75	AVG	V

Note:1.Result (dBuV/m) = Correction factor (dB/m) + Reading(dBuV).

2.Correction factor (dB/m) = Antenna Factor (dB/m) + Cable loss (dB) – Pre-Amplifier gain (dB).



Standard:	FCC Part 15C	Test Distance:	3m				
Test item:	Radiated Emission	Power:	AC 120V/60Hz				
Model Number:	Archer C2	Temp.(°C)/Hum.(%RH):	26(°C)/60%RH				
Mode:	Mode 2	Date:	08/26/2016				
Frequency:	2462 MHz	Test By:	Eric Ou Yang				
Frequency (MHz)	Reading (dBuV)	Correct Factor (dB/m)	Result (dBuV/m)	Limit (dBuV/m)	Margin (dB)	Remark	Ant.Polar. H / V
2483.500	49.61	0.03	49.64	74.00	-24.36	peak	H
2485.480	51.77	0.04	51.81	74.00	-22.19	peak	H
2483.500	67.09	0.03	67.12	74.00	-6.88	peak	V
2483.500	50.85	0.03	50.88	54.00	-3.12	AVG	V
2484.160	68.32	0.04	68.36	74.00	-5.64	peak	V
2484.160	49.45	0.04	49.49	54.00	-4.51	AVG	V

Note:1.Result (dBuV/m) = Correction factor (dB/m) + Reading(dBuV).

2.Correction factor (dB/m) = Antenna Factor (dB/m) + Cable loss (dB) – Pre-Amplifier gain (dB).



Standard:		FCC Part 15C		Test Distance:		3m	
Test item:		Radiated Emission		Power:		AC 120V/60Hz	
Model Number:		Archer C2		Temp.(°C)/Hum.(%RH):		26(°C)/60%RH	
Mode:		Mode 3		Date:		08/26/2016	
Frequency:		2412 MHz		Test By:		Eric Ou Yang	
Frequency (MHz)	Reading (dBuV)	Correct Factor (dB/m)	Result (dBuV/m)	Limit (dBuV/m)	Margin (dB)	Remark	Ant.Polar. H / V
2386.120	54.74	-0.36	54.38	74.00	-19.62	peak	H
2386.120	44.41	-0.36	44.05	54.00	-9.95	AVG	H
2390.000	53.19	-0.34	52.85	74.00	-21.15	peak	H
2390.000	44.57	-0.34	44.23	54.00	-9.77	AVG	H
2389.750	73.24	-0.34	72.90	74.00	-1.10	peak	V
2389.750	49.98	-0.34	49.64	54.00	-4.36	AVG	V
2390.000	72.67	-0.34	72.33	74.00	-1.67	peak	V
2390.000	50.41	-0.34	50.07	54.00	-3.93	AVG	V

Note:1.Result (dBuV/m) = Correction factor (dB/m) + Reading(dBuV).

2.Correction factor (dB/m) = Antenna Factor (dB/m) + Cable loss (dB) – Pre-Amplifier gain (dB).



Standard:	FCC Part 15C	Test Distance:	3m
Test item:	Radiated Emission	Power:	AC 120V/60Hz
Model Number:	Archer C2	Temp.(°C)/Hum.(%RH):	26(°C)/60%RH
Mode:	Mode 3	Date:	09/23/2016
Frequency:	2417 MHz	Test By:	Eric Ou Yang

Frequency (MHz)	Reading (dBuV)	Correct Factor (dB/m)	Result (dBuV/m)	Limit (dBuV/m)	Margin (dB)	Remark	Ant.Polar. H / V
2387.000	51.69	-0.35	51.34	74.00	-22.66	peak	H
2390.000	49.73	-0.34	49.39	74.00	-24.61	peak	H
2389.530	64.32	-0.34	63.98	74.00	-10.02	peak	V
2389.530	46.26	-0.34	45.92	54.00	-8.08	AVG	V
2390.000	61.99	-0.34	61.65	74.00	-12.35	peak	V
2390.000	46.78	-0.34	46.44	54.00	-7.56	AVG	V

Note:1.Result (dBuV/m) = Correction factor (dB/m) + Reading(dBuV).

2.Correction factor (dB/m) = Antenna Factor (dB/m) + Cable loss (dB) – Pre-Amplifier gain (dB).



Standard:	FCC Part 15C			Test Distance:	3m		
Test item:	Radiated Emission			Power:	AC 120V/60Hz		
Model Number:	Archer C2			Temp.(°C)/Hum.(%RH):	26(°C)/60%RH		
Mode:	Mode 3			Date:	10/12/2016		
Frequency:	2422 MHz			Test By:	Eric Ou Yang		
Frequency (MHz)	Reading (dBuV)	Correct Factor (dB/m)	Result (dBuV/m)	Limit (dBuV/m)	Margin (dB)	Remark	Ant.Polar. H / V
2389.560	58.54	-1.88	56.66	74.00	-17.34	peak	H
2389.560	47.18	-1.88	45.30	54.00	-8.70	AVG	H
2390.000	59.68	-1.88	57.80	74.00	-16.20	peak	H
2390.000	47.51	-1.88	45.63	54.00	-8.37	AVG	H
2388.480	75.18	-1.88	73.30	74.00	-0.70	peak	V
2388.480	53.67	-1.88	51.79	54.00	-2.21	AVG	V
2390.000	71.39	-1.88	69.51	74.00	-4.49	peak	V
2390.000	55.44	-1.88	53.56	54.00	-0.44	AVG	V

Note:1.Result (dBuV/m) = Correction factor (dB/m) + Reading(dBuV).

2.Correction factor (dB/m) = Antenna Factor (dB/m) + Cable loss (dB) – Pre-Amplifier gain (dB).



Standard:	FCC Part 15C	Test Distance:	3m
Test item:	Radiated Emission	Power:	AC 120V/60Hz
Model Number:	Archer C2	Temp.(°C)/Hum.(%RH):	26(°C)/60%RH
Mode:	Mode 3	Date:	08/26/2016
Frequency:	2437 MHz	Test By:	Eric Ou Yang

Frequency (MHz)	Reading (dBuV)	Correct Factor (dB/m)	Result (dBuV/m)	Limit (dBuV/m)	Margin (dB)	Remark	Ant.Polar. H / V
2387.900	61.21	-0.34	60.87	74.00	-13.13	peak	H
2387.900	44.62	-0.34	44.28	54.00	-9.72	AVG	H
2390.000	60.74	-0.34	60.40	74.00	-13.60	peak	H
2390.000	45.13	-0.34	44.79	54.00	-9.21	AVG	H
2483.500	57.45	0.03	57.48	74.00	-16.52	peak	H
2483.500	44.86	0.03	44.89	54.00	-9.11	AVG	H
2489.930	58.56	0.06	58.62	74.00	-15.38	peak	H
2489.930	44.58	0.06	44.64	54.00	-9.36	AVG	H
2389.040	72.15	-0.34	71.81	74.00	-2.19	peak	V
2389.040	52.30	-0.34	51.96	54.00	-2.04	AVG	V
2390.000	69.92	-0.34	69.58	74.00	-4.42	peak	V
2390.000	53.79	-0.34	53.45	54.00	-0.55	AVG	V
2483.500	65.49	0.03	65.52	74.00	-8.48	peak	V
2483.500	53.02	0.03	53.05	54.00	-0.95	AVG	V
2487.460	67.79	0.04	67.83	74.00	-6.17	peak	V
2487.460	51.40	0.04	51.44	54.00	-2.56	AVG	V

Note:1.Result (dBuV/m) = Correction factor (dB/m) + Reading(dBuV).

2.Correction factor (dB/m) = Antenna Factor (dB/m) + Cable loss (dB) – Pre-Amplifier gain (dB).



Standard:	FCC Part 15C			Test Distance:	3m		
Test item:	Radiated Emission			Power:	AC 120V/60Hz		
Model Number:	Archer C2			Temp.(°C)/Hum.(%RH):	26(°C)/60%RH		
Mode:	Mode 3			Date:	10/12/2016		
Frequency:	2452 MHz			Test By:	Eric Ou Yang		
Frequency (MHz)	Reading (dBuV)	Correct Factor (dB/m)	Result (dBuV/m)	Limit (dBuV/m)	Margin (dB)	Remark	Ant.Polar. H / V
2483.500	57.28	-1.51	55.77	74.00	-18.23	peak	H
2483.500	47.60	-1.51	46.09	54.00	-7.91	AVG	H
2483.680	60.54	-1.51	59.03	74.00	-14.97	peak	H
2483.680	47.53	-1.51	46.02	54.00	-7.98	AVG	H
2483.500	71.19	-1.51	69.68	74.00	-4.32	peak	V
2483.500	55.11	-1.51	53.60	54.00	-0.40	AVG	V
2483.584	74.29	-1.51	72.78	74.00	-1.22	peak	V
2483.584	55.06	-1.51	53.55	54.00	-0.45	AVG	V

Note:1.Result (dBuV/m) = Correction factor (dB/m) + Reading(dBuV).

2.Correction factor (dB/m) = Antenna Factor (dB/m) + Cable loss (dB) – Pre-Amplifier gain (dB).





Standard:	FCC Part 15C			Test Distance:	3m		
Test item:	Radiated Emission			Power:	AC 120V/60Hz		
Model Number:	Archer C2			Temp.(°C)/Hum.(%RH):	26(°C)/60%RH		
Mode:	Mode 3			Date:	09/23/2016		
Frequency:	2457 MHz			Test By:	Eric Ou Yang		
Frequency (MHz)	Reading (dBuV)	Correct Factor (dB/m)	Result (dBuV/m)	Limit (dBuV/m)	Margin (dB)	Remark	Ant.Polar. H / V
2483.500	50.15	0.03	50.18	74.00	-23.82	peak	H
2485.294	55.03	0.04	55.07	74.00	-18.93	peak	H
2485.294	43.32	0.04	43.36	54.00	-10.64	AVG	H
2483.500	66.40	0.03	66.43	74.00	-7.57	peak	V
2483.500	49.22	0.03	49.25	54.00	-4.75	AVG	V
2484.692	70.38	0.04	70.42	74.00	-3.58	peak	V
2484.692	48.91	0.04	48.95	54.00	-5.05	AVG	V

Note:1.Result (dBuV/m) = Correction factor (dB/m) + Reading(dBuV).

2.Correction factor (dB/m) = Antenna Factor (dB/m) + Cable loss (dB) – Pre-Amplifier gain (dB).



Standard:		FCC Part 15C		Test Distance:		3m	
Test item:		Radiated Emission		Power:		AC 120V/60Hz	
Model Number:		Archer C2		Temp.(°C)/Hum.(%RH):		26(°C)/60%RH	
Mode:		Mode 3		Date:		08/26/2016	
Frequency:		2462 MHz		Test By:		Eric Ou Yang	
Frequency (MHz)	Reading (dBuV)	Correct Factor (dB/m)	Result (dBuV/m)	Limit (dBuV/m)	Margin (dB)	Remark	Ant.Polar. H / V
2483.500	56.85	0.03	56.88	74.00	-17.12	peak	H
2483.500	44.61	0.03	44.64	54.00	-9.36	AVG	H
2484.840	59.08	0.04	59.12	74.00	-14.88	peak	H
2484.840	44.15	0.04	44.19	54.00	-9.81	AVG	H
2483.500	68.19	0.03	68.22	74.00	-5.78	peak	V
2483.500	51.83	0.03	51.86	54.00	-2.14	AVG	V
2483.920	72.62	0.03	72.65	74.00	-1.35	peak	V
2483.920	51.39	0.03	51.42	54.00	-2.58	AVG	V

Note:1.Result (dBuV/m) = Correction factor (dB/m) + Reading(dBuV).

2.Correction factor (dB/m) = Antenna Factor (dB/m) + Cable loss (dB) – Pre-Amplifier gain (dB).



Standard:		FCC Part 15C		Test Distance:		3m	
Test item:		Radiated Emission		Power:		AC 120V/60Hz	
Model Number:		Archer C2		Temp.(°C)/Hum.(%RH):		26(°C)/60%RH	
Mode:		Mode 4		Date:		08/26/2016	
Frequency:		2412 MHz		Test By:		Eric Ou Yang	
Frequency (MHz)	Reading (dBuV)	Correct Factor (dB/m)	Result (dBuV/m)	Limit (dBuV/m)	Margin (dB)	Remark	Ant.Polar. H / V
2389.530	54.86	-0.34	54.52	74.00	-19.48	peak	H
2389.530	44.40	-0.34	44.06	54.00	-9.94	AVG	H
2390.000	54.58	-0.34	54.24	74.00	-19.76	peak	H
2390.000	44.46	-0.34	44.12	54.00	-9.88	AVG	H
2388.100	69.31	-0.34	68.97	74.00	-5.03	peak	V
2388.100	50.13	-0.34	49.79	54.00	-4.21	AVG	V
2390.000	66.05	-0.34	65.71	74.00	-8.29	peak	V
2390.000	53.20	-0.34	52.86	54.00	-1.14	AVG	V

Note:1.Result (dBuV/m) = Correction factor (dB/m) + Reading(dBuV).

2.Correction factor (dB/m) = Antenna Factor (dB/m) + Cable loss (dB) – Pre-Amplifier gain (dB).



Standard:	FCC Part 15C	Test Distance:	3m
Test item:	Radiated Emission	Power:	AC 120V/60Hz
Model Number:	Archer C2	Temp.(°C)/Hum.(%RH):	26(°C)/60%RH
Mode:	Mode 4	Date:	09/23/2016
Frequency:	2417 MHz	Test By:	Eric Ou Yang

Frequency (MHz)	Reading (dBuV)	Correct Factor (dB/m)	Result (dBuV/m)	Limit (dBuV/m)	Margin (dB)	Remark	Ant.Polar. H / V
2388.980	51.14	-0.34	50.80	74.00	-23.20	peak	H
2390.000	50.92	-0.34	50.58	74.00	-23.42	peak	H
2389.750	66.93	-0.34	66.59	74.00	-7.41	peak	V
2389.750	46.31	-0.34	45.97	54.00	-8.03	AVG	V
2390.000	59.56	-0.34	59.22	74.00	-14.78	peak	V
2390.000	46.39	-0.34	46.05	54.00	-7.95	AVG	V

Note:1.Result (dBuV/m) = Correction factor (dB/m) + Reading(dBuV).

2.Correction factor (dB/m) = Antenna Factor (dB/m) + Cable loss (dB) – Pre-Amplifier gain (dB).



Standard:		FCC Part 15C		Test Distance:		3m	
Test item:		Radiated Emission		Power:		AC 120V/60Hz	
Model Number:		Archer C2		Temp.(°C)/Hum.(%RH):		26(°C)/60%RH	
Mode:		Mode 4		Date:		10/12/2016	
Frequency:		2422 MHz		Test By:		Eric Ou Yang	
Frequency (MHz)	Reading (dBuV)	Correct Factor (dB/m)	Result (dBuV/m)	Limit (dBuV/m)	Margin (dB)	Remark	Ant.Polar. H / V
2382.840	59.35	-1.91	57.44	74.00	-16.56	peak	H
2382.840	46.57	-1.91	44.66	54.00	-9.34	AVG	H
2390.000	56.70	-1.88	54.82	74.00	-19.18	peak	H
2390.000	47.71	-1.88	45.83	54.00	-8.17	AVG	H
2386.440	74.00	-1.90	72.10	74.00	-1.90	peak	V
2386.440	51.68	-1.90	49.78	54.00	-4.22	AVG	V
2390.000	73.23	-1.88	71.35	74.00	-2.65	peak	V
2390.000	55.42	-1.88	53.54	54.00	-0.46	AVG	V

Note:1.Result (dBuV/m) = Correction factor (dB/m) + Reading(dBuV).

2.Correction factor (dB/m) = Antenna Factor (dB/m) + Cable loss (dB) – Pre-Amplifier gain (dB).



Standard:	FCC Part 15C	Test Distance:	3m
Test item:	Radiated Emission	Power:	AC 120V/60Hz
Model Number:	Archer C2	Temp.(°C)/Hum.(%RH):	26(°C)/60%RH
Mode:	Mode 4	Date:	08/26/2016
Frequency:	2437 MHz	Test By:	Eric Ou Yang

Frequency (MHz)	Reading (dBuV)	Correct Factor (dB/m)	Result (dBuV/m)	Limit (dBuV/m)	Margin (dB)	Remark	Ant.Polar. H / V
2387.330	60.80	-0.35	60.45	74.00	-13.55	peak	H
2387.330	43.62	-0.35	43.27	54.00	-10.73	AVG	H
2390.000	59.44	-0.34	59.10	74.00	-14.90	peak	H
2390.000	43.71	-0.34	43.37	54.00	-10.63	AVG	H
2483.500	57.99	0.03	58.02	74.00	-15.98	peak	H
2483.500	43.68	0.03	43.71	54.00	-10.29	AVG	H
2484.990	57.45	0.04	57.49	74.00	-16.51	peak	H
2484.990	43.51	0.04	43.55	54.00	-10.45	AVG	H
2387.520	71.64	-0.34	71.30	74.00	-2.70	peak	V
2387.520	51.48	-0.34	51.14	54.00	-2.86	AVG	V
2390.000	69.61	-0.34	69.27	74.00	-4.73	peak	V
2390.000	53.41	-0.34	53.07	54.00	-0.93	AVG	V
2483.500	67.44	0.03	67.47	74.00	-6.53	peak	V
2483.500	50.84	0.03	50.87	54.00	-3.13	AVG	V
2484.800	68.91	0.04	68.95	74.00	-5.05	peak	V
2484.800	49.11	0.04	49.15	54.00	-4.85	AVG	V

Note:1.Result (dBuV/m) = Correction factor (dB/m) + Reading(dBuV).

2.Correction factor (dB/m) = Antenna Factor (dB/m) + Cable loss (dB) – Pre-Amplifier gain (dB).



Standard:		FCC Part 15C		Test Distance:		3m	
Test item:		Radiated Emission		Power:		AC 120V/60Hz	
Model Number:		Archer C2		Temp.(°C)/Hum.(%RH):		26(°C)/60%RH	
Mode:		Mode 4		Date:		10/12/2016	
Frequency:		2452 MHz		Test By:		Eric Ou Yang	
Frequency (MHz)	Reading (dBuV)	Correct Factor (dB/m)	Result (dBuV/m)	Limit (dBuV/m)	Margin (dB)	Remark	Ant.Polar. H / V
2483.500	57.88	-1.51	56.37	74.00	-17.63	peak	H
2483.500	48.14	-1.51	46.63	54.00	-7.37	AVG	H
2483.824	59.74	-1.51	58.23	74.00	-15.77	peak	H
2483.824	48.06	-1.51	46.55	54.00	-7.45	AVG	H
2483.500	66.83	-1.51	65.32	74.00	-8.68	peak	V
2483.500	54.84	-1.51	53.33	54.00	-0.67	AVG	V
2483.776	70.34	-1.51	68.83	74.00	-5.17	peak	V
2483.776	54.63	-1.51	53.12	54.00	-0.88	AVG	V

Note:1.Result (dBuV/m) = Correction factor (dB/m) + Reading(dBuV).

2.Correction factor (dB/m) = Antenna Factor (dB/m) + Cable loss (dB) – Pre-Amplifier gain (dB).



Standard:	FCC Part 15C	Test Distance:	3m
Test item:	Radiated Emission	Power:	AC 120V/60Hz
Model Number:	Archer C2	Temp.(°C)/Hum.(%RH):	26(°C)/60%RH
Mode:	Mode 4	Date:	09/23/2016
Frequency:	2457 MHz	Test By:	Eric Ou Yang

Frequency (MHz)	Reading (dBuV)	Correct Factor (dB/m)	Result (dBuV/m)	Limit (dBuV/m)	Margin (dB)	Remark	Ant.Polar. H / V
2483.500	50.14	0.03	50.17	74.00	-23.83	peak	H
2484.262	54.50	0.04	54.54	74.00	-19.46	peak	H
2484.262	43.39	0.04	43.43	54.00	-10.57	AVG	H
2483.500	58.00	0.03	58.03	74.00	-15.97	peak	V
2483.500	46.71	0.03	46.74	54.00	-7.26	AVG	V
2485.337	67.50	0.04	67.54	74.00	-6.46	peak	V
2485.337	45.89	0.04	45.93	54.00	-8.07	AVG	V

Note:1.Result (dBuV/m) = Correction factor (dB/m) + Reading(dBuV).

2.Correction factor (dB/m) = Antenna Factor (dB/m) + Cable loss (dB) – Pre-Amplifier gain (dB).





Standard:	FCC Part 15C			Test Distance:	3m		
Test item:	Radiated Emission			Power:	AC 120V/60Hz		
Model Number:	Archer C2			Temp.(°C)/Hum.(%RH):	26(°C)/60%RH		
Mode:	Mode 4			Date:	08/26/2016		
Frequency:	2462 MHz			Test By:	Eric Ou Yang		
Frequency (MHz)	Reading (dBuV)	Correct Factor (dB/m)	Result (dBuV/m)	Limit (dBuV/m)	Margin (dB)	Remark	Ant.Polar. H / V
2483.500	55.69	0.03	55.72	74.00	-18.28	peak	H
2483.500	43.35	0.03	43.38	54.00	-10.62	AVG	H
2484.600	56.36	0.04	56.40	74.00	-17.60	peak	H
2484.600	43.21	0.04	43.25	54.00	-10.75	AVG	H
2483.500	71.37	0.03	71.40	74.00	-2.60	peak	V
2483.500	52.97	0.03	53.00	54.00	-1.00	AVG	V
2483.840	72.69	0.03	72.72	74.00	-1.28	peak	V
2483.840	52.24	0.03	52.27	54.00	-1.73	AVG	V

Note:1.Result (dBuV/m) = Correction factor (dB/m) + Reading(dBuV).

2.Correction factor (dB/m) = Antenna Factor (dB/m) + Cable loss (dB) – Pre-Amplifier gain (dB).



Standard:		FCC Part 15C		Test Distance:		3m	
Test item:		Radiated Emission		Power:		AC 120V/60Hz	
Model Number:		Archer C2		Temp.(°C)/Hum.(%RH):		26(°C)/60%RH	
Mode:		Mode 5		Date:		08/26/2016	
Frequency:		2422 MHz		Test By:		Eric Ou Yang	
Frequency (MHz)	Reading (dBuV)	Correct Factor (dB/m)	Result (dBuV/m)	Limit (dBuV/m)	Margin (dB)	Remark	Ant.Polar. H / V
2389.440	56.88	-0.34	56.54	74.00	-17.46	peak	H
2389.440	43.88	-0.34	43.54	54.00	-10.46	AVG	H
2390.000	55.83	-0.34	55.49	74.00	-18.51	peak	H
2390.000	44.27	-0.34	43.93	54.00	-10.07	AVG	H
2389.800	73.39	-0.34	73.05	74.00	-0.95	peak	V
2389.800	53.36	-0.34	53.02	54.00	-0.98	AVG	V
2390.000	72.66	-0.34	72.32	74.00	-1.68	peak	V
2390.000	54.00	-0.34	53.66	54.00	-0.34	AVG	V

Note:1.Result (dBuV/m) = Correction factor (dB/m) + Reading(dBuV).

2.Correction factor (dB/m) = Antenna Factor (dB/m) + Cable loss (dB) – Pre-Amplifier gain (dB).



Standard:		FCC Part 15C		Test Distance:		3m	
Test item:		Radiated Emission		Power:		AC 120V/60Hz	
Model Number:		Archer C2		Temp.(°C)/Hum.(%RH):		26(°C)/60%RH	
Mode:		Mode 5		Date:		09/23/2016	
Frequency:		2427 MHz		Test By:		Eric Ou Yang	
Frequency (MHz)	Reading (dBuV)	Correct Factor (dB/m)	Result (dBuV/m)	Limit (dBuV/m)	Margin (dB)	Remark	Ant.Polar. H / V
2389.326	57.07	-0.34	56.73	74.00	-17.27	peak	H
2389.326	44.04	-0.34	43.70	54.00	-10.30	AVG	H
2390.000	56.16	-0.34	55.82	74.00	-18.18	peak	H
2390.000	44.11	-0.34	43.77	54.00	-10.23	AVG	H
2389.209	67.18	-0.34	66.84	74.00	-7.16	peak	V
2389.209	51.37	-0.34	51.03	54.00	-2.97	AVG	V
2390.000	63.25	-0.34	62.91	74.00	-11.09	peak	V
2390.000	52.13	-0.34	51.79	54.00	-2.21	AVG	V

Note:1.Result (dBuV/m) = Correction factor (dB/m) + Reading(dBuV).

2.Correction factor (dB/m) = Antenna Factor (dB/m) + Cable loss (dB) – Pre-Amplifier gain (dB).



Standard:		FCC Part 15C		Test Distance:		3m	
Test item:		Radiated Emission		Power:		AC 120V/60Hz	
Model Number:		Archer C2		Temp.(°C)/Hum.(%RH):		26(°C)/60%RH	
Mode:		Mode 5		Date:		10/12/2016	
Frequency:		2432 MHz		Test By:		Eric Ou Yang	
Frequency (MHz)	Reading (dBuV)	Correct Factor (dB/m)	Result (dBuV/m)	Limit (dBuV/m)	Margin (dB)	Remark	Ant.Polar. H / V
2388.875	58.50	-1.88	56.62	74.00	-17.38	peak	H
2388.875	47.34	-1.88	45.46	54.00	-8.54	AVG	H
2390.000	58.03	-1.88	56.15	74.00	-17.85	peak	H
2390.000	48.79	-1.88	46.91	54.00	-7.09	AVG	H
2388.000	71.90	-1.88	70.02	74.00	-3.98	peak	V
2388.000	53.12	-1.88	51.24	54.00	-2.76	AVG	V
2390.000	70.36	-1.88	68.48	74.00	-5.52	peak	V
2390.000	55.49	-1.88	53.61	54.00	-0.39	AVG	V

Note:1.Result (dBuV/m) = Correction factor (dB/m) + Reading(dBuV).

2.Correction factor (dB/m) = Antenna Factor (dB/m) + Cable loss (dB) – Pre-Amplifier gain (dB).



Standard:	FCC Part 15C			Test Distance:	3m		
Test item:	Radiated Emission			Power:	AC 120V/60Hz		
Model Number:	Archer C2			Temp.(°C)/Hum.(%RH):	26(°C)/60%RH		
Mode:	Mode 5			Date:	08/26/2016		
Frequency:	2437 MHz			Test By:	Eric Ou Yang		
Frequency (MHz)	Reading (dBuV)	Correct Factor (dB/m)	Result (dBuV/m)	Limit (dBuV/m)	Margin (dB)	Remark	Ant.Polar. H / V
2384.290	56.84	-0.36	56.48	74.00	-17.52	peak	H
2384.290	43.65	-0.36	43.29	54.00	-10.71	AVG	H
2390.000	53.77	-0.34	53.43	74.00	-20.57	peak	H
2390.000	43.71	-0.34	43.37	54.00	-10.63	AVG	H
2483.500	56.41	0.03	56.44	74.00	-17.56	peak	H
2483.500	43.99	0.03	44.02	54.00	-9.98	AVG	H
2487.080	55.54	0.04	55.58	74.00	-18.42	peak	H
2487.080	43.75	0.04	43.79	54.00	-10.21	AVG	H
2384.670	70.88	-0.36	70.52	74.00	-3.48	peak	V
2384.670	49.31	-0.36	48.95	54.00	-5.05	AVG	V
2390.000	71.17	-0.34	70.83	74.00	-3.17	peak	V
2390.000	53.17	-0.34	52.83	54.00	-1.17	AVG	V
2483.500	65.66	0.03	65.69	74.00	-8.31	peak	V
2483.500	51.47	0.03	51.50	54.00	-2.50	AVG	V
2484.040	69.77	0.04	69.81	74.00	-4.19	peak	V
2484.040	51.35	0.04	51.39	54.00	-2.61	AVG	V

Note:1.Result (dBuV/m) = Correction factor (dB/m) + Reading(dBuV).

2.Correction factor (dB/m) = Antenna Factor (dB/m) + Cable loss (dB) – Pre-Amplifier gain (dB).



Standard:	FCC Part 15C			Test Distance:	3m		
Test item:	Radiated Emission			Power:	AC 120V/60Hz		
Model Number:	Archer C2			Temp.(°C)/Hum.(%RH):	26(°C)/60%RH		
Mode:	Mode 5			Date:	10/12/2016		
Frequency:	2442 MHz			Test By:	Eric Ou Yang		
Frequency (MHz)	Reading (dBuV)	Correct Factor (dB/m)	Result (dBuV/m)	Limit (dBuV/m)	Margin (dB)	Remark	Ant.Polar. H / V
2483.500	54.84	-1.51	53.33	74.00	-20.67	peak	H
2483.500	46.17	-1.51	44.66	54.00	-9.34	AVG	H
2486.312	57.18	-1.50	55.68	74.00	-18.32	peak	H
2486.312	46.04	-1.50	44.54	54.00	-9.46	AVG	H
2483.500	66.61	-1.51	65.10	74.00	-8.90	peak	V
2483.500	54.94	-1.51	53.43	54.00	-0.57	AVG	V
2483.876	67.59	-1.51	66.08	74.00	-7.92	peak	V
2483.876	55.03	-1.51	53.52	54.00	-0.48	AVG	V

Note:1.Result (dBuV/m) = Correction factor (dB/m) + Reading(dBuV).

2.Correction factor (dB/m) = Antenna Factor (dB/m) + Cable loss (dB) – Pre-Amplifier gain (dB).



Standard:	FCC Part 15C			Test Distance:	3m		
Test item:	Radiated Emission			Power:	AC 120V/60Hz		
Model Number:	Archer C2			Temp.(°C)/Hum.(%RH):	26(°C)/60%RH		
Mode:	Mode 5			Date:	09/23/2016		
Frequency:	2447 MHz			Test By:	Eric Ou Yang		
Frequency (MHz)	Reading (dBuV)	Correct Factor (dB/m)	Result (dBuV/m)	Limit (dBuV/m)	Margin (dB)	Remark	Ant.Polar. H / V
2483.500	51.98	0.03	52.01	74.00	-21.99	peak	H
2483.500	43.55	0.03	43.58	54.00	-10.42	AVG	H
2483.676	56.42	0.03	56.45	74.00	-17.55	peak	H
2483.676	43.49	0.03	43.52	54.00	-10.48	AVG	H
2483.500	62.65	0.03	62.68	74.00	-11.32	peak	V
2483.500	51.20	0.03	51.23	54.00	-2.77	AVG	V
2483.676	66.23	0.03	66.26	74.00	-7.74	peak	V
2483.676	51.02	0.03	51.05	54.00	-2.95	AVG	V

Note:1.Result (dBuV/m) = Correction factor (dB/m) + Reading(dBuV).

2.Correction factor (dB/m) = Antenna Factor (dB/m) + Cable loss (dB) – Pre-Amplifier gain (dB).



Standard:	FCC Part 15C			Test Distance:	3m		
Test item:	Radiated Emission			Power:	AC 120V/60Hz		
Model Number:	Archer C2			Temp.(°C)/Hum.(%RH):	26(°C)/60%RH		
Mode:	Mode 5			Date:	08/26/2016		
Frequency:	2452 MHz			Test By:	Eric Ou Yang		
Frequency (MHz)	Reading (dBuV)	Correct Factor (dB/m)	Result (dBuV/m)	Limit (dBuV/m)	Margin (dB)	Remark	Ant.Polar. H / V
2483.500	53.23	0.03	53.26	74.00	-20.74	peak	H
2483.500	43.28	0.03	43.31	54.00	-10.69	AVG	H
2484.650	55.67	0.04	55.71	74.00	-18.29	peak	H
2484.650	43.11	0.04	43.15	54.00	-10.85	AVG	H
2483.500	70.32	0.03	70.35	74.00	-3.65	peak	V
2483.500	53.32	0.03	53.35	54.00	-0.65	AVG	V
2484.300	72.96	0.04	73.00	74.00	-1.00	peak	V
2484.300	51.65	0.04	51.69	54.00	-2.31	AVG	V

Note:1.Result (dBuV/m) = Correction factor (dB/m) + Reading(dBuV).

2.Correction factor (dB/m) = Antenna Factor (dB/m) + Cable loss (dB) – Pre-Amplifier gain (dB).



## 6 Maximum Conducted Output Power Measurement

### 6.1. Limit

For systems using digital modulation in the 2400-2483.5MHz, the limit for maximum output power is 30dBm.

And According to 15.247 (b), if transmitting antennas of directional gain greater than 6 dBi are used, the power shall be reduced by the amount in dB that the directional gain of the antenna exceeds 6dBi.

Accordance with KDB662911 D01 Multiple Transmitter Output v02r01

- \* CDD mode : Directional Gain =  $10 \cdot \log\{[10^{(G1/10)} + 10^{(G2/10)} + \dots + 10^{(Gn/10)}] / NANT\}$
- \* CDD mode : Directional Gain =  $10 \cdot \log\{[10^{(G1/10)} + 10^{(G2/10)} + \dots + 10^{(Gn/10)}] / NANT\} = 1.8 \text{ dBi} < 6 \text{ dBi}$
- \* CDD mode power limit shall be reduced = 30 dBm.

### 6.2. Test Setup

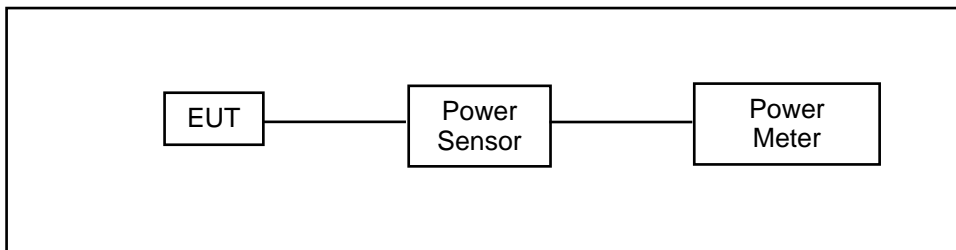

### 6.3. Test Instruments

Equipment	Manufacturer	Model Number	Serial Number	Cal. Date	Cal. Period
Power Sensor	Anritsu	MA2411B	1126022	08/24/2016	1 year
Power Meter	Anritsu	ML2495A	1135009	08/24/2016	1 year
Microwave Cable	EMCI	EMC104-SM-SM-1500	140303	02/23/2016	1 year
Test Site	ATL	TE05	TE05	N.C.R.	-----

Note: N.C.R. = No Calibration Request.

### 6.4. Test Procedure

The tests below are run with the EUT's transmitter set at high power in TX mode. The EUT is needed to force selection of output power level and channel number. While testing, EUT was set to transmit continuously. Remove the Subjective device's antenna and connect the RF output port to power sensor.



### 6.5. Test Result

Model Number	Archer C2				
Test Item	Maximum Conducted Output Power				
Date of Test	07/26/2016, 10/18/2016				
ANT-0					
Test Mode	Frequency (MHz)	Data Rate	Average Output Power		
			Measurement Results		Limit
			dBm	W	dBm
Mode 2	2412	1M	18.30	0.068	< 30
	2417		19.00	0.079	< 30
	2437		19.00	0.079	< 30
	2457		18.89	0.077	< 30
	2462		18.45	0.070	< 30
Mode 3	2412	6M	12.17	0.016	< 30
	2417		15.15	0.033	< 30
	2422		17.00	0.050	< 30
	2437		18.01	0.063	< 30
	2452		17.81	0.060	< 30
	2457		15.73	0.037	< 30
	2462		15.01	0.032	< 30

Note:1. The relevant measured result has the offset with cable loss already.

2. Evaluated high and low data rate, the report record worst case low data rate measurement results.



Model Number	Archer C2				
Test Item	Maximum Conducted Output Power				
Date of Test	07/26/2016, 10/18/2016				
ANT-1					
Test Mode	Frequency (MHz)	Data Rate	Average Output Power		
			Measurement Results		Limit
			dBm	W	dBm
Mode 2	2412	1M	19.26	0.084	< 30
	2417		19.87	0.097	< 30
	2437		20.36	0.109	< 30
	2457		20.26	0.106	< 30
	2462		19.82	0.096	< 30
Mode 3	2412	6M	13.47	0.022	< 30
	2417		16.01	0.040	< 30
	2422		18.00	0.063	< 30
	2437		18.95	0.079	< 30
	2452		18.73	0.075	< 30
	2457		16.20	0.042	< 30
	2462		15.56	0.036	< 30

Note:1. The relevant measured result has the offset with cable loss already.

2. Evaluated high and low data rate, the report record worst case low data rate measurement results.



Model Number	Archer C2				
Test Item	Maximum Conducted Output Power				
Date of Test	07/26/2016, 10/18/2016				
ANT-2					
Test Mode	Frequency (MHz)	Data Rate	Average Output Power		
			Measurement Results		Limit
			dBm	W	dBm
Mode 2	2412	1M	18.41	0.069	< 30
	2417		19.33	0.086	< 30
	2437		20.07	0.102	< 30
	2457		19.63	0.092	< 30
	2462		19.17	0.083	< 30
Mode 3	2412	6M	13.25	0.021	< 30
	2417		15.29	0.034	< 30
	2422		17.35	0.054	< 30
	2437		18.25	0.067	< 30
	2452		18.42	0.070	< 30
	2457		16.01	0.040	< 30
	2462		15.25	0.033	< 30

Note:1. The relevant measured result has the offset with cable loss already.

2. Evaluated high and low data rate, the report record worst case low data rate measurement results.



Model Number	Archer C2				
Test Item	Maximum Conducted Output Power				
Date of Test	07/26/2016, 10/18/2016				
ANT-0+1+2					
Test Mode	Frequency (MHz)	Data Rate	Average Output Power		
			Measurement Results		Limit
			dBm	W	dBm
Mode 2	2412	1M	23.45	0.221	< 30
	2417		24.19	0.262	< 30
	2437		24.62	<b>0.290</b>	< 30
	2457		24.40	0.275	< 30
	2462		23.95	0.249	< 30
Mode 3	2412	6M	17.77	0.060	< 30
	2417		20.27	0.106	< 30
	2422		22.24	0.168	< 30
	2437		23.19	<b>0.209</b>	< 30
	2452		23.11	0.205	< 30
	2457		20.76	0.119	< 30
	2462		20.05	0.101	< 30

Note:1. The relevant measured result has the offset with cable loss already.

2. Evaluated high and low data rate, the report record worst case low data rate measurement results.



Model Number	Archer C2				
Test Item	Maximum Conducted Output Power				
Date of Test	07/26/2016, 10/18/2016				
ANT-0					
Test Mode	Frequency (MHz)	Data Rate	Average Output Power		
			Measurement Results		Limit
			dBm	W	dBm
Mode 4	2412	19.5M	11.91	0.016	< 30
	2417		14.57	0.029	< 30
	2422		16.54	0.045	< 30
	2437		18.00	0.063	< 30
	2452		17.95	0.062	< 30
	2457		16.18	0.041	< 30
	2462		14.25	0.027	< 30
Mode 5	2422	40.5M	8.75	0.007	< 30
	2427		10.02	0.010	< 30
	2432		11.67	0.015	< 30
	2437		13.99	0.025	< 30
	2442		12.33	0.017	< 30
	2447		10.68	0.012	< 30
	2452		9.60	0.009	< 30

Note:1. The relevant measured result has the offset with cable loss already.

2. Evaluated high and low data rate, the report record worst case low data rate measurement results.



Model Number	Archer C2				
Test Item	Maximum Conducted Output Power				
Date of Test	07/26/2016, 10/18/2016				
ANT-1					
Test Mode	Frequency (MHz)	Data Rate	Average Output Power		
			Measurement Results		Limit
			dBm	W	dBm
Mode 4	2412	19.5M	13.13	0.021	< 30
	2417		15.95	0.039	< 30
	2422		17.33	0.054	< 30
	2437		18.93	0.078	< 30
	2452		18.33	0.068	< 30
	2457		16.60	0.046	< 30
	2462		14.68	0.029	< 30
Mode 5	2422	40.5M	9.80	0.010	< 30
	2427		10.91	0.012	< 30
	2432		12.36	0.017	< 30
	2437		14.78	0.030	< 30
	2442		12.56	0.018	< 30
	2447		10.79	0.012	< 30
	2452		9.99	0.010	< 30

Note:1. The relevant measured result has the offset with cable loss already.

2. Evaluated high and low data rate, the report record worst case low data rate measurement results.



Model Number	Archer C2				
Test Item	Maximum Conducted Output Power				
Date of Test	07/26/2016, 10/18/2016				
ANT-2					
Test Mode	Frequency (MHz)	Data Rate	Average Output Power		
			Measurement Results		Limit
			dBm	W	dBm
Mode 4	2412	19.5M	12.92	0.020	< 30
	2417		15.13	0.033	< 30
	2422		16.87	0.049	< 30
	2437		18.36	0.069	< 30
	2452		17.85	0.061	< 30
	2457		15.98	0.040	< 30
	2462		14.33	0.027	< 30
Mode 5	2422	40.5M	9.19	0.008	< 30
	2427		10.21	0.010	< 30
	2432		11.88	0.015	< 30
	2437		14.12	0.026	< 30
	2442		12.38	0.017	< 30
	2447		10.67	0.012	< 30
	2452		9.71	0.009	< 30

Note:1. The relevant measured result has the offset with cable loss already.

2. Evaluated high and low data rate, the report record worst case low data rate measurement results.





Model Number	Archer C2				
Test Item	Maximum Conducted Output Power				
Date of Test	07/26/2016, 10/18/2016				
ANT-0+1+2					
Test Mode	Frequency (MHz)	Data Rate	Average Output Power		
			Measurement Results		Limit
			dBm	W	dBm
Mode 4	2412	19.5M	17.46	0.056	< 30
	2417		20.03	0.101	< 30
	2422		21.70	0.148	< 30
	2437		23.22	<b>0.210</b>	< 30
	2452		22.82	0.191	< 30
	2457		21.03	0.127	< 30
	2462		19.20	0.083	< 30
Mode 5	2422	40.5M	14.04	0.025	< 30
	2427		15.17	0.033	< 30
	2432		16.75	0.047	< 30
	2437		19.08	<b>0.081</b>	< 30
	2442		17.20	0.052	< 30
	2447		15.48	0.035	< 30
	2452		14.54	0.028	< 30

Note:1. The relevant measured result has the offset with cable loss already.

2. Evaluated high and low data rate, the report record worst case low data rate measurement results.

## 7 6dB RF Bandwidth Measurement

### 7.1. Limit

6dB RF Bandwidth: Systems using digital modulation techniques may operate in the 2400–2483.5 MHz bands. The minimum 6 dB band-width shall be at least 500 kHz.

### 7.2. Test Setup

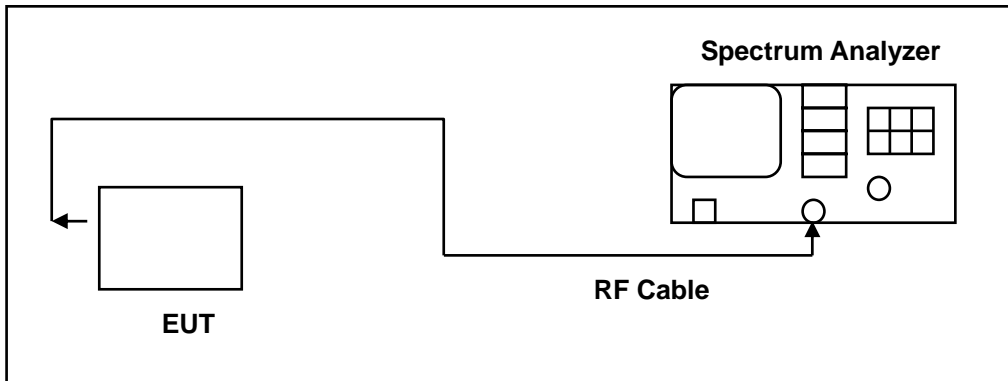

### 7.3. Test Instruments

Equipment	Manufacturer	Model Number	Serial Number	Cal. Date	Cal. Period
Spectrum Analyzer	Agilent	E4445A	MY45300744	12/15/2015	1 year
Microwave Cable	EMCI	EMC104-SM-SM-1500	140303	02/23/2016	1 year
Test Site	ATL	TE05	TE05	N.C.R.	-----

Note: N.C.R. = No Calibration Request.

### 7.4. Test Procedure

The EUT tested to DTS test procedure of KDB558074D01 for compliance to FCC 47CFR 15.247 requirements.

6dB RF Bandwidth: The antenna port of the EUT was connected to the input of a spectrum analyzer. Analyzer RBW was set to 100 kHz. For each RF output channel investigated, the spectrum analyzer center frequency was set to the channel carrier. A peak output reading was taken, a DISPLAY line was drawn 6 dB lower than peak level. The 6 dB bandwidth was determined from where the channel output spectrum intersected the display line.

The test was performed at 3 channels (Channel low, middle, high)



**7.5. Test Result**

Model Number	Archer C2				
Test Item	6dB RF Bandwidth				
Date of Test	08/26/2016				
Test Mode	Frequency (MHz)	Measurement (kHz)			Limit (kHz)
		ANT-0	ANT-1	ANT-2	
Mode 2	2412	7593	7088	7077	> 500
	2437	7088	6601	7106	> 500
	2462	6136	6626	7096	> 500
Mode 3	2412	13520	13820	15120	> 500
	2437	15130	15030	15100	> 500
	2462	15070	15130	15030	> 500
Mode 4	2412	14440	15110	13890	> 500
	2437	15070	13810	15110	> 500
	2462	15060	15100	15100	> 500
Mode 5	2422	30030	28830	27480	> 500
	2437	26370	26320	27580	> 500
	2452	30050	26360	27490	> 500



### 7.6. Test Graphs

Mode 2: IEEE 802.11b link mode\_ANT-0

<p>2412 MHz</p>	<p>Agilent Spectrum Analyzer - Occupied BW</p> <p>Center Freq: 2.41200000 GHz</p> <p>Ref Offset 11 dB Ref 20.00 dBm</p> <p>Center 2.412 GHz #Res BW 100 kHz</p> <p>Span 30 MHz #VBW 300 kHz Sweep 2.933 ms</p> <p>Occupied Bandwidth: <b>13.162 MHz</b></p> <p>Total Power: 25.5 dBm</p> <p>Transmit Freq Error: 13.873 kHz</p> <p>x dB Bandwidth: 7.593 MHz</p> <p>OBW Power: 99.0 %</p> <p>x dB: -6.00 dB</p>
<p>2437 MHz</p>	<p>Agilent Spectrum Analyzer - Occupied BW</p> <p>Center Freq: 2.43700000 GHz</p> <p>Ref Offset 11 dB Ref 20.00 dBm</p> <p>Center 2.437 GHz #Res BW 100 kHz</p> <p>Span 30 MHz #VBW 300 kHz Sweep 2.933 ms</p> <p>Occupied Bandwidth: <b>12.893 MHz</b></p> <p>Total Power: 25.6 dBm</p> <p>Transmit Freq Error: 8.259 kHz</p> <p>x dB Bandwidth: 7.088 MHz</p> <p>OBW Power: 99.0 %</p> <p>x dB: -6.00 dB</p>
<p>2462 MHz</p>	<p>Agilent Spectrum Analyzer - Occupied BW</p> <p>Center Freq: 2.46200000 GHz</p> <p>Ref Offset 11 dB Ref 20.00 dBm</p> <p>Center 2.462 GHz #Res BW 100 kHz</p> <p>Span 30 MHz #VBW 300 kHz Sweep 2.933 ms</p> <p>Occupied Bandwidth: <b>12.927 MHz</b></p> <p>Total Power: 25.8 dBm</p> <p>Transmit Freq Error: -18.380 kHz</p> <p>x dB Bandwidth: 6.136 MHz</p> <p>OBW Power: 99.0 %</p> <p>x dB: -6.00 dB</p>



Mode 3: IEEE 802.11g link mode\_ANT-0

2412 MHz

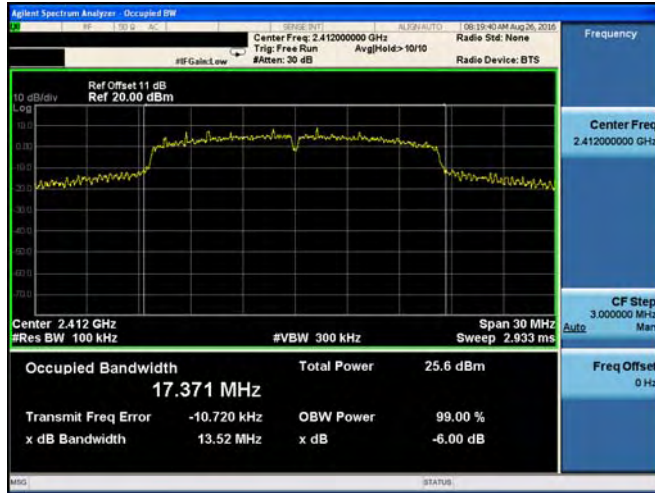

2437 MHz



2462 MHz





Mode 4: IEEE 802.11n 2.4GHz 20MHz link mode\_ANT-0

2412 MHz



2437 MHz



2462 MHz

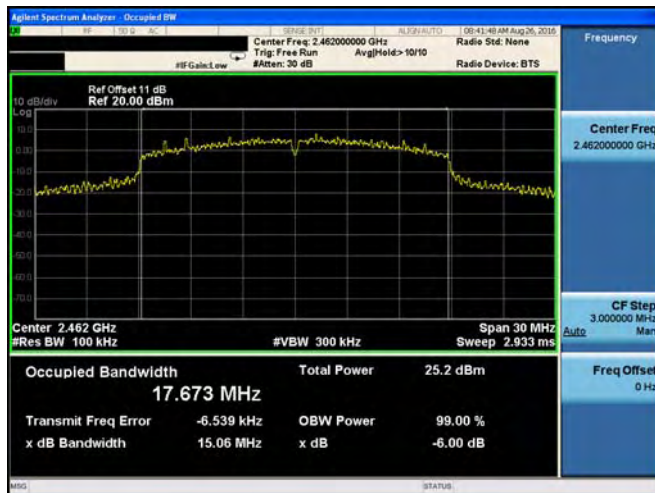



Mode 5: IEEE 802.11n 2.4GHz 40MHz link mode\_ANT-0

2422 MHz



2437 MHz



2452 MHz





Mode 2: IEEE 802.11b link mode\_ANT-1

2412 MHz



2437 MHz



2462 MHz







Mode 3: IEEE 802.11g link mode\_ANT-1

2412 MHz



2437 MHz

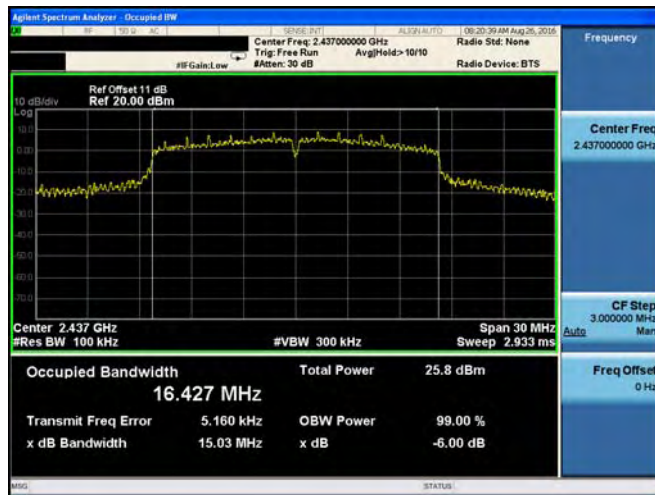

2462 MHz





Mode 4: IEEE 802.11n 2.4GHz 20MHz link mode\_ANT-1

2412 MHz



2437 MHz



2462 MHz





Mode 5: IEEE 802.11n 2.4GHz 40MHz link mode\_ANT-1

2422 MHz



2437 MHz



2452 MHz





Mode 2: IEEE 802.11b link mode\_ANT-2

2412 MHz

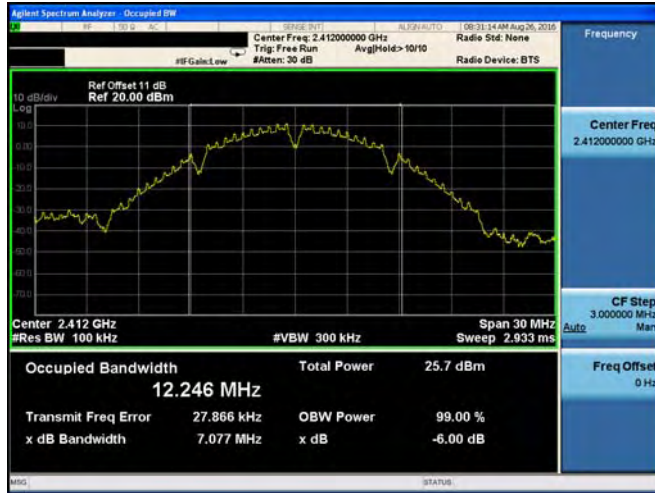

2437 MHz



2462 MHz





Mode 3: IEEE 802.11g link mode\_ANT-2

2412 MHz

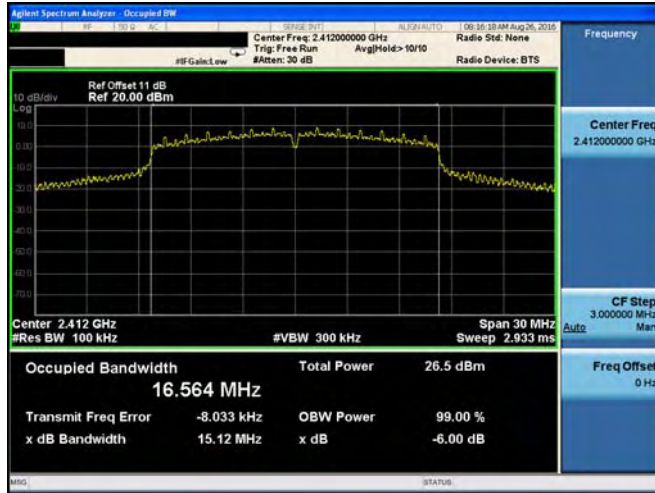

2437 MHz



2462 MHz





Mode 4: IEEE 802.11n 2.4GHz 20MHz link mode\_ANT-2

2412 MHz



2437 MHz



2462 MHz





Mode 5: IEEE 802.11n 2.4GHz 40MHz link mode\_ANT-2

2422 MHz



2437 MHz



2452 MHz



## 8 Maximum Power Density Measurement

### 8.1. Limit

For digitally modulated systems, the power spectral density conducted from the intentional radiator to the antenna shall not be greater than 8 dBm in any 3 kHz band during any time interval of continuous transmission.

Accordance with KDB662911 D01 Multiple Transmitter Output v02r01

- \* CDD mode : Directional Gain =  $10 \cdot \log\{[10^{G1/10} + 10^{G2/10} + \dots + 10^{Gn/10}] / NANT\}$
- \* CDD mode : Directional Gain =  $10 \cdot \log\{[10^{G1/10} + 10^{G2/10} + \dots + 10^{Gn/10}] / NANT\} = 6.65 \text{ dBi} > 6 \text{ dBi}$
- \* CDD mode power limit shall be reduced = 7.35 dBm.

### 8.2. Test Setup

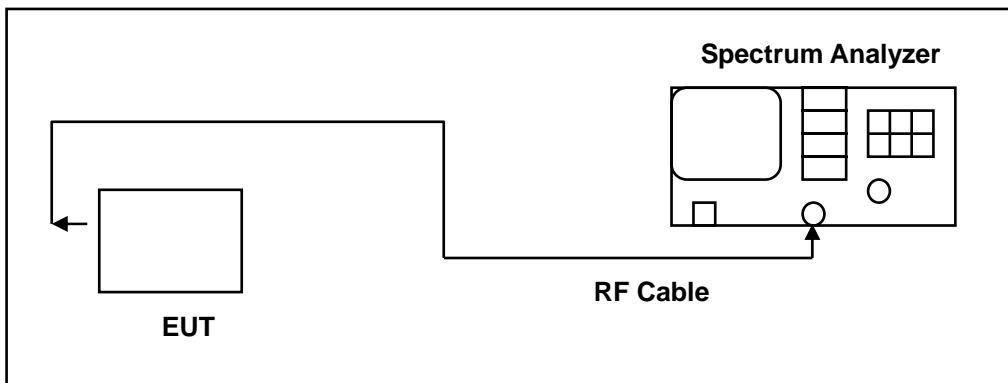

### 8.3. Test Instruments

Equipment	Manufacturer	Model Number	Serial Number	Cal. Date	Cal. Period
Spectrum Analyzer	Agilent	E4445A	MY45300744	12/15/2015	1 year
Microwave Cable	EMCI	EMC104-SM-SM-1500	140303	02/23/2016	1 year
Test Site	ATL	TE05	TE05	N.C.R.	-----

Note: N.C.R. = No Calibration Request.





## 8.4. Test Procedure

The EUT tested to DTS test procedure of KDB558074D01 for compliance to FCC 47CFR 15.247 requirements.

1. Set analyzer center frequency to DTS channel center frequency.
2. Set the span to 1.5 times the DTS bandwidth.
3. Set the RBW to:  $3 \text{ kHz} \leq \text{RBW} \leq 100 \text{ kHz}$ .
4. Set the VBW  $\geq 3 \times \text{RBW}$ .
5. Detector = peak.
6. Sweep time = auto couple.
7. Trace mode = max hold.
8. Allow trace to fully stabilize.
9. Use the peak marker function to determine the maximum amplitude level within the RBW.
10. If measured value exceeds limit, reduce RBW (no less than 3 kHz) and repeat.



**8.5. Test Result**

Model Number	Archer C2					
Test Item	Maximum Power Density					
Date of Test	08/27/2016					
Test Mode	Frequency (MHz)	Measurement (dBm/3KHz)				Limit (dBm/3KHz)
		ANT-0	ANT-1	ANT-2	ANT-0+1+2	
Mode 2	2412	-3.435	-2.125	-3.329	1.850	< 8
	2437	-2.813	-1.311	-1.619	2.904	< 8
	2462	-3.382	-1.303	-2.174	2.567	< 8
Mode 3	2412	-12.749	-10.937	-12.214	-7.127	< 8
	2437	-3.336	-2.259	-2.302	2.167	< 8
	2462	-8.986	-7.687	-8.651	-3.635	< 8
Mode 4	2412	-11.367	-10.719	-11.740	-6.483	< 8
	2437	-4.505	-3.228	-4.256	0.811	< 8
	2462	-10.925	-9.905	-10.786	-5.743	< 8
Mode 5	2422	-17.113	-16.158	-17.028	-11.973	< 8
	2437	-12.601	-11.510	-12.164	-7.297	< 8
	2452	-17.290	-15.939	-17.112	-11.967	< 8



### 8.6. Test Graphs

Mode 2: IEEE 802.11b link mode\_ANT-0

2412 MHz

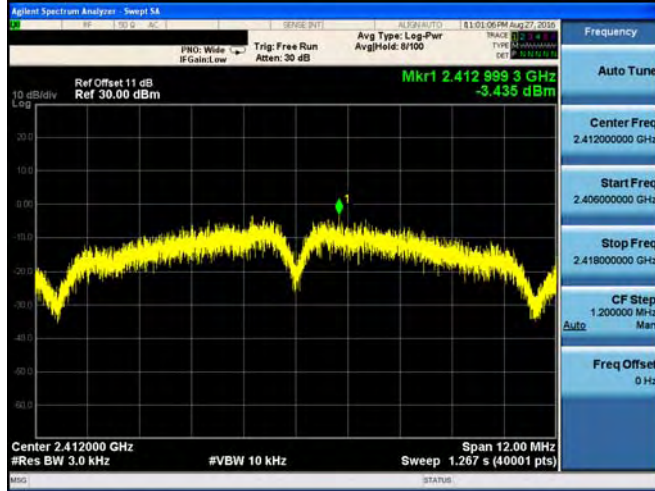

2437 MHz

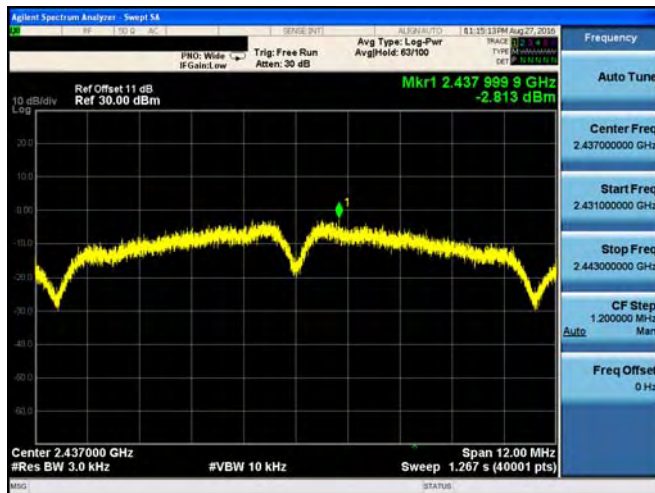

2462 MHz

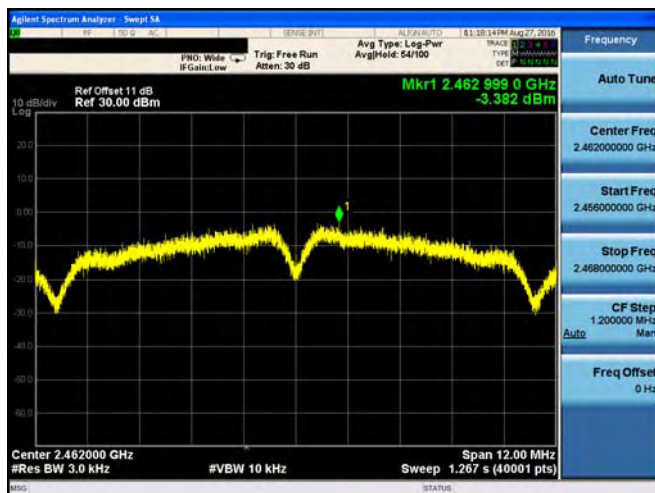

Mode 3: IEEE 802.11g link mode\_ANT-0

2412 MHz

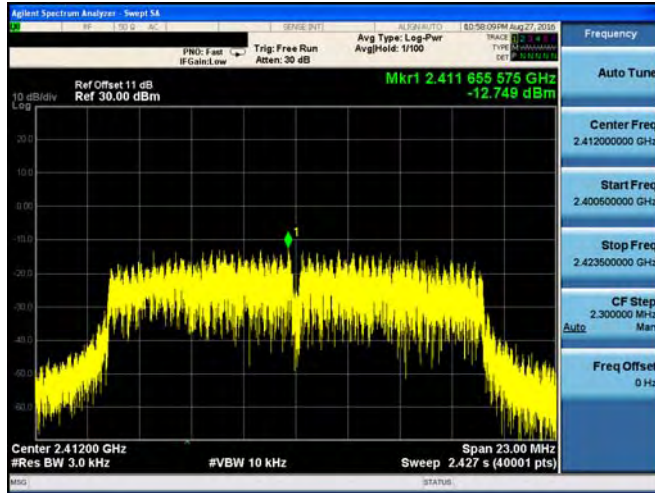

2437 MHz

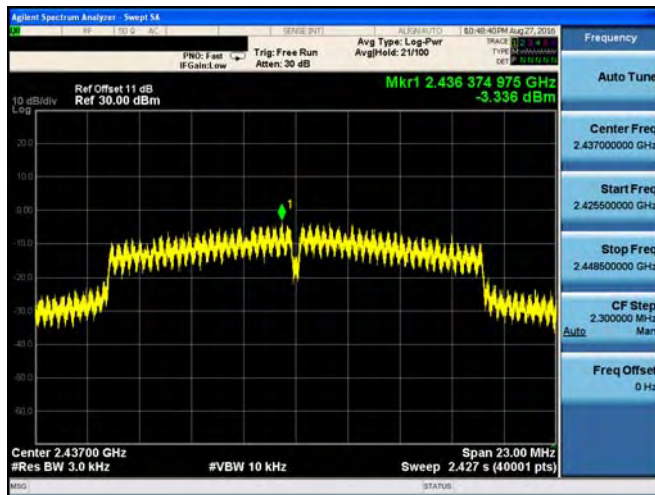

2462 MHz

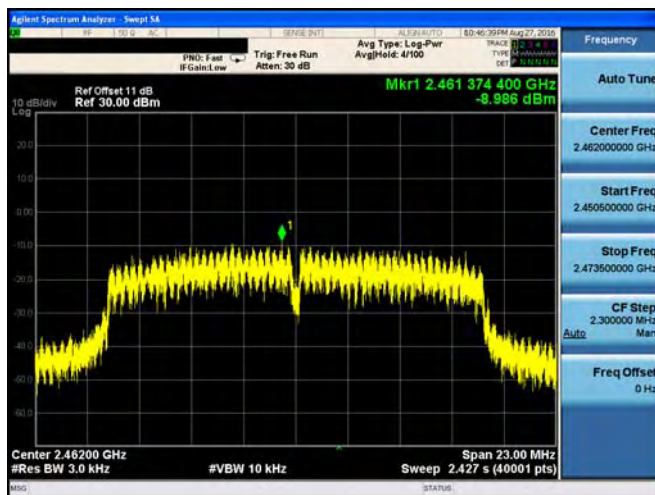



Mode 4: IEEE 802.11n 2.4GHz 20MHz link mode\_ANT-0

2412 MHz

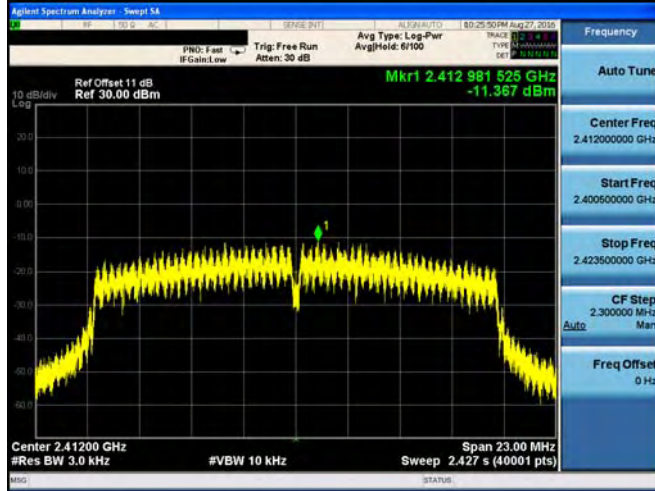

2437 MHz

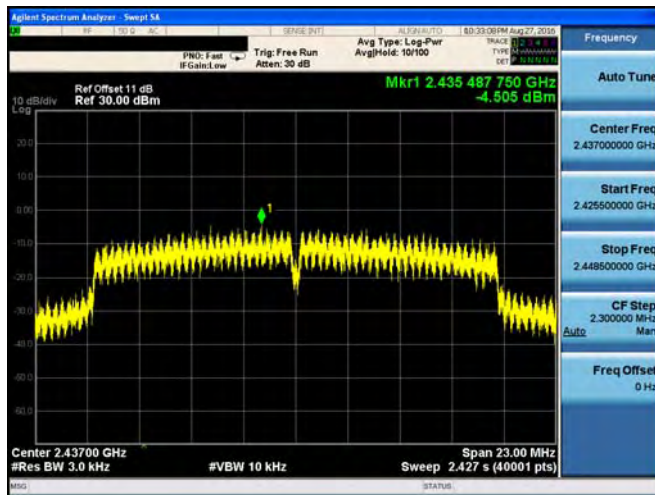

2462 MHz

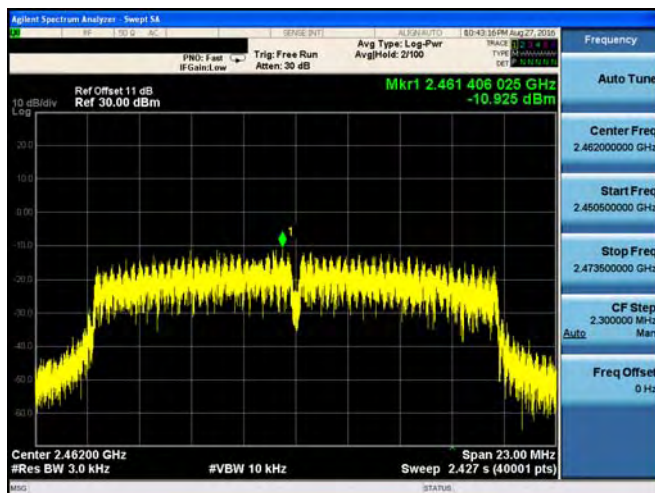



Mode 5: IEEE 802.11n 2.4GHz 40MHz link mode\_ANT-0

2422 MHz

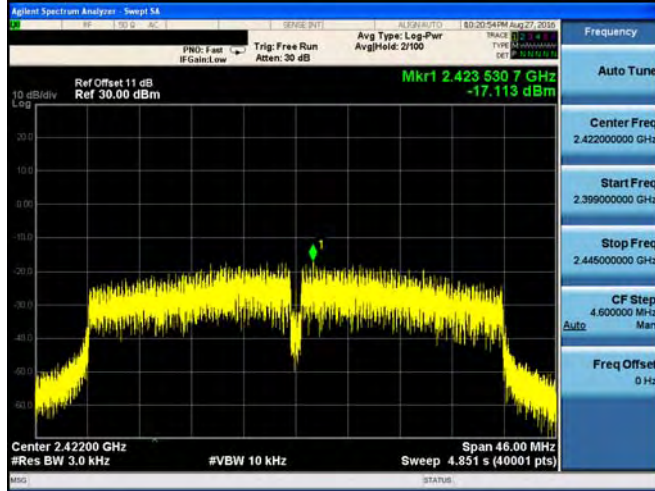

2437 MHz

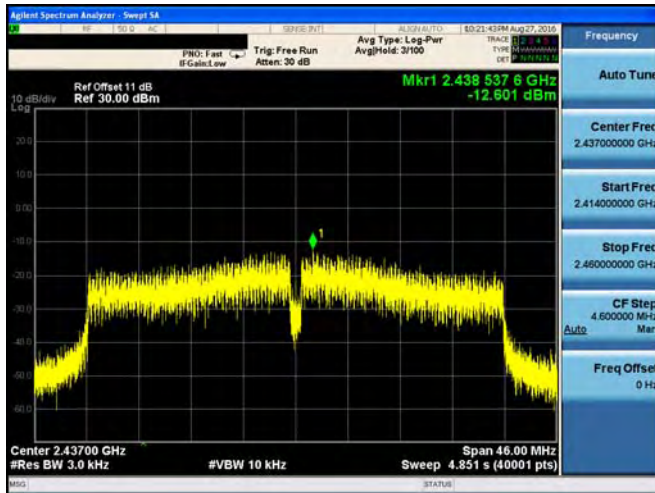

2452 MHz

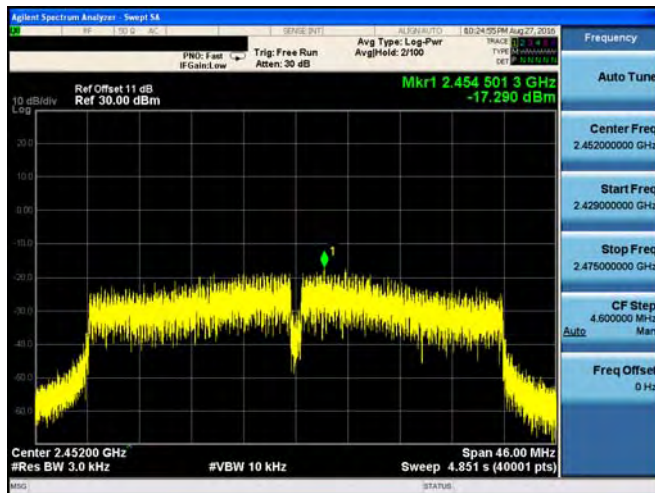



Mode 2: IEEE 802.11b link mode\_ANT-1

2412 MHz

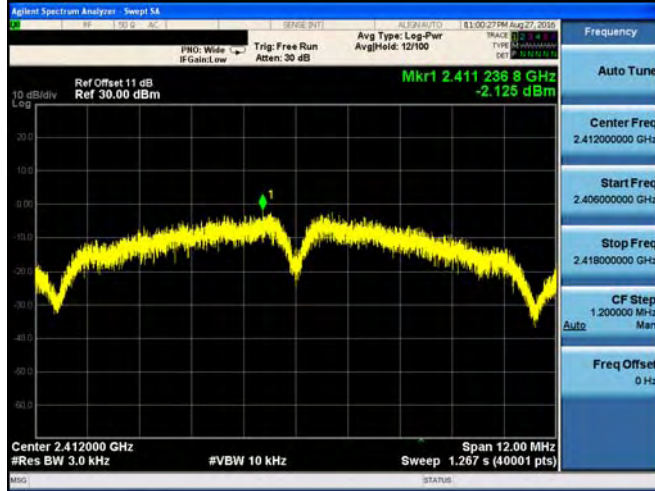

2437 MHz

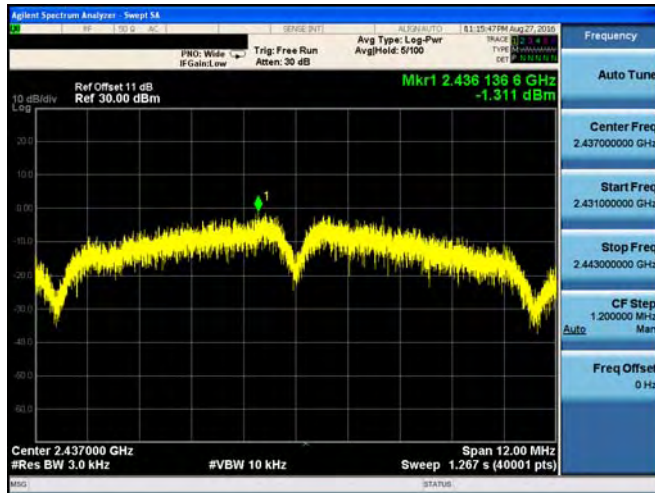

2462 MHz

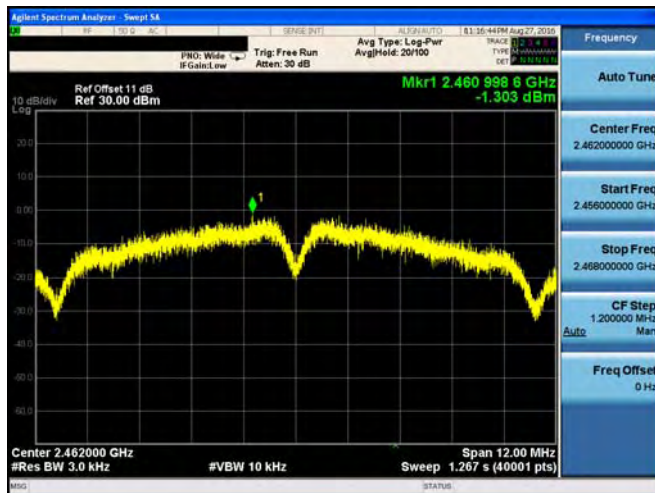



Mode 3: IEEE 802.11g link mode\_ANT-1

2412 MHz

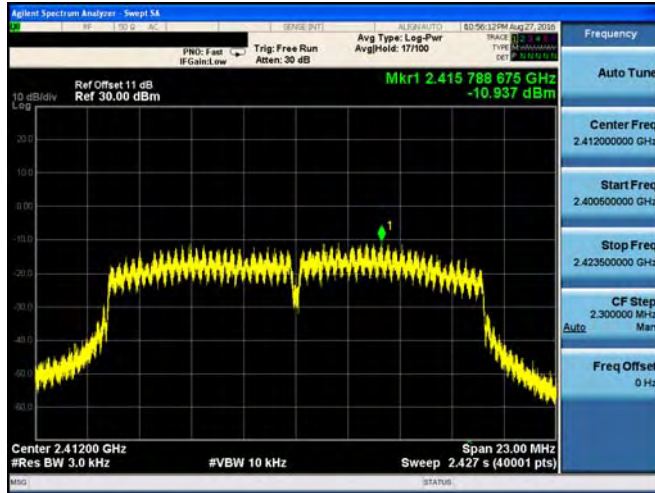

2437 MHz

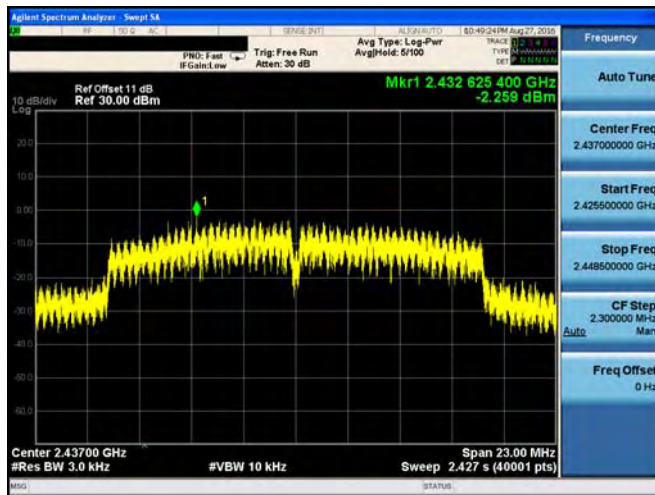

2462 MHz

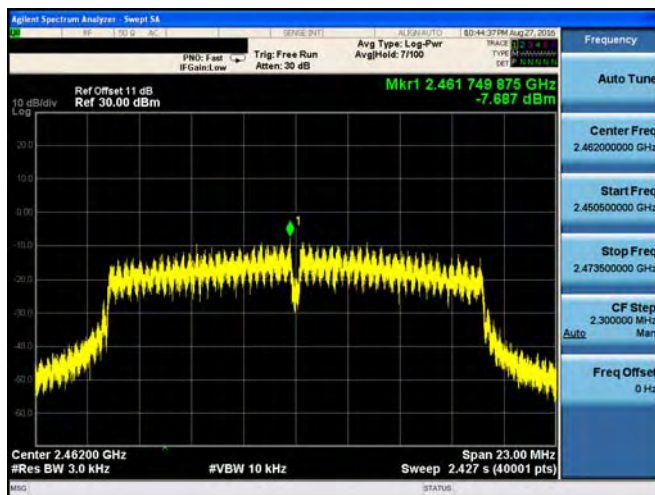





Mode 4: IEEE 802.11n 2.4GHz 20MHz link mode\_ANT-1

2412 MHz

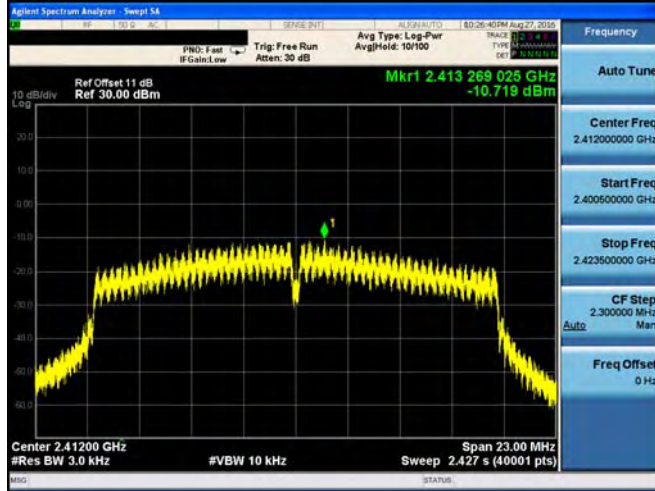

2437 MHz

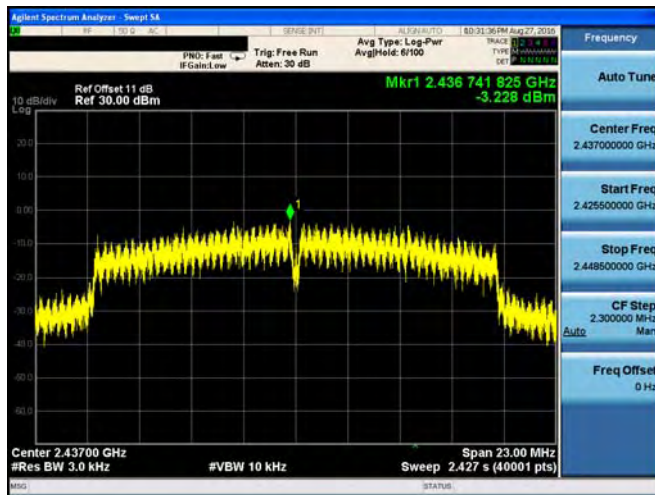

2462 MHz

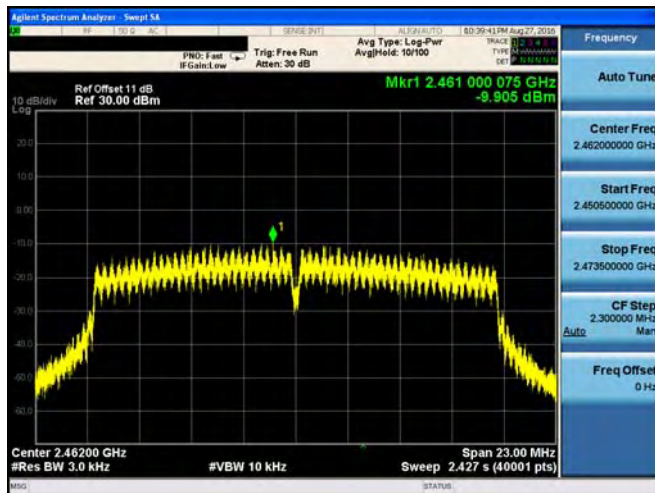



Mode 5: IEEE 802.11n 2.4GHz 40MHz link mode\_ANT-1

2422 MHz

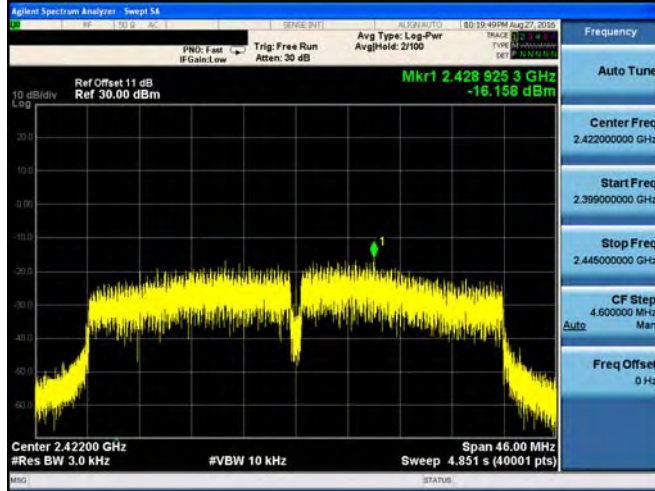

2437 MHz

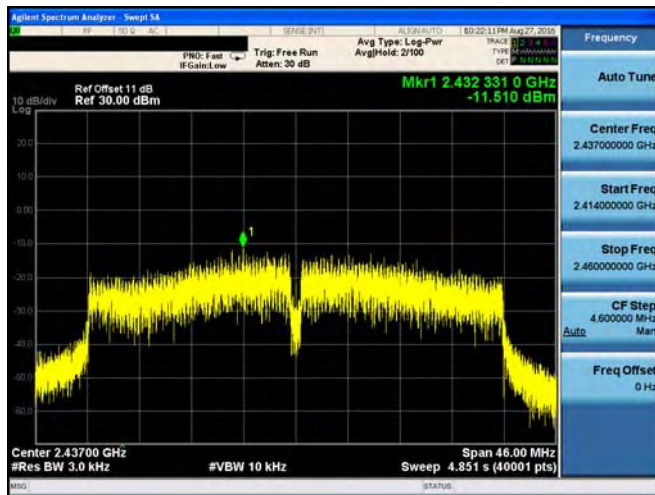

2452 MHz

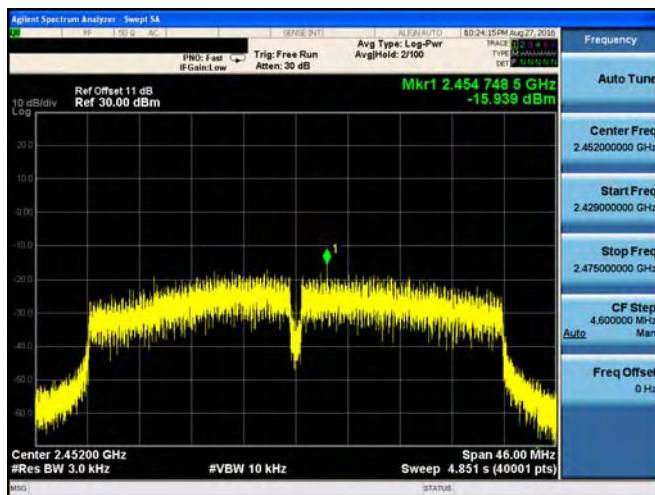



Mode 2: IEEE 802.11b link mode\_ANT-2

2412 MHz

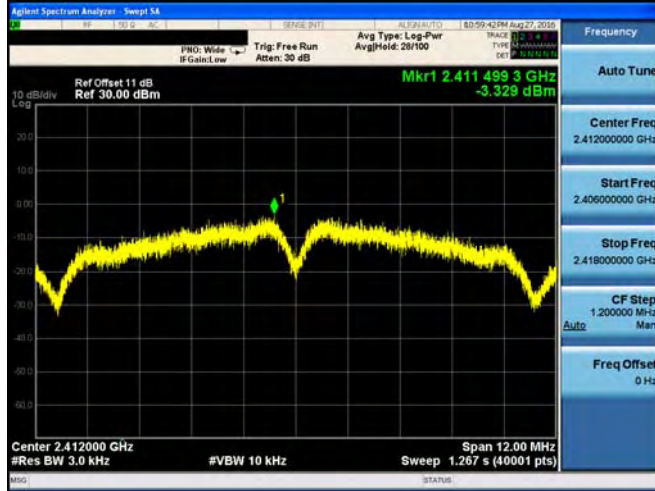

2437 MHz

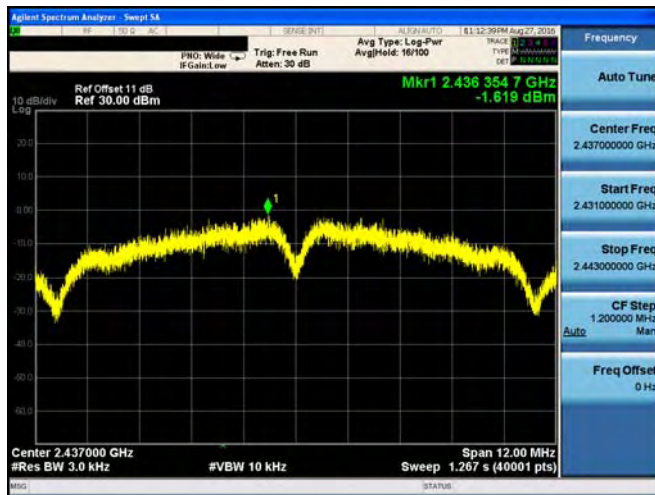

2462 MHz

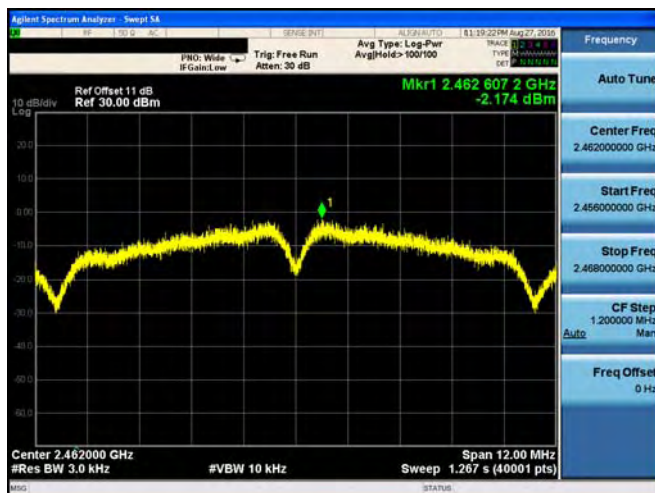



Mode 3: IEEE 802.11g link mode\_ANT-2

2412 MHz

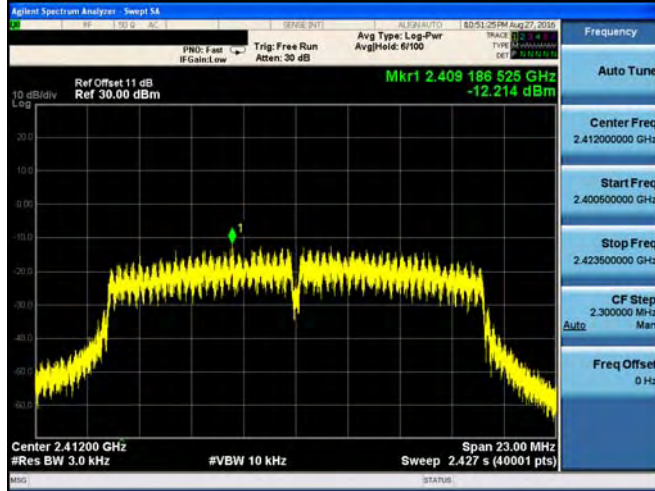

2437 MHz

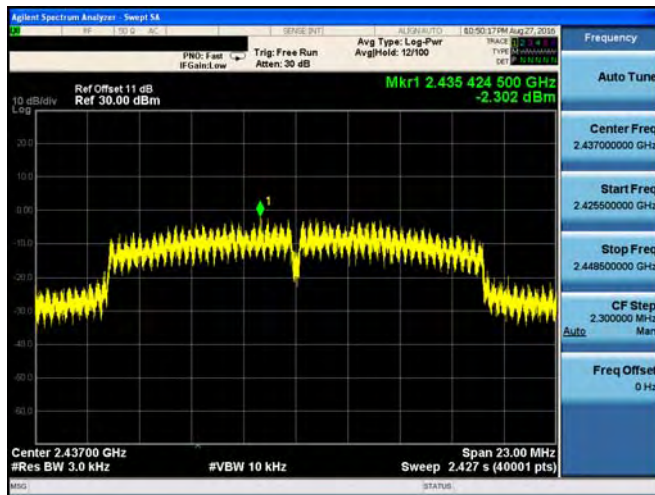

2462 MHz

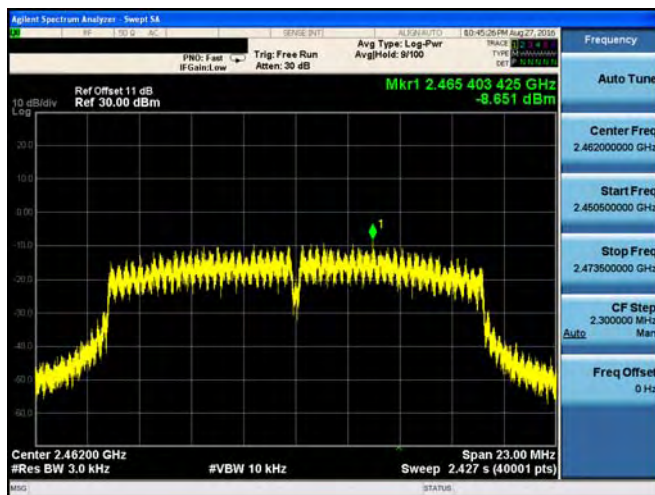



Mode 4: IEEE 802.11n 2.4GHz 20MHz link mode\_ANT-2

2412 MHz

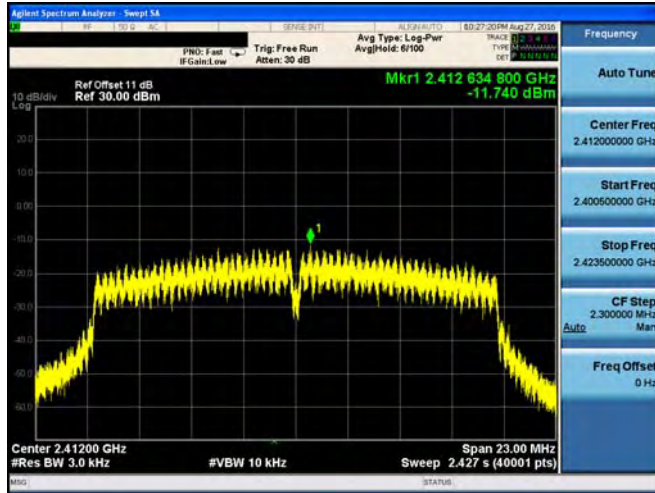

2437 MHz

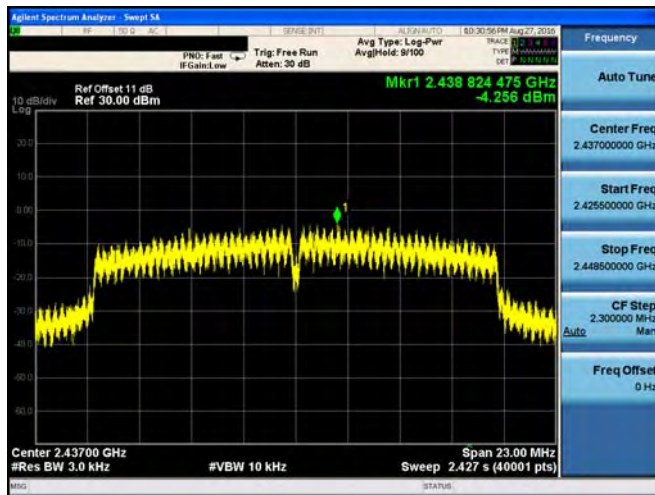

2462 MHz

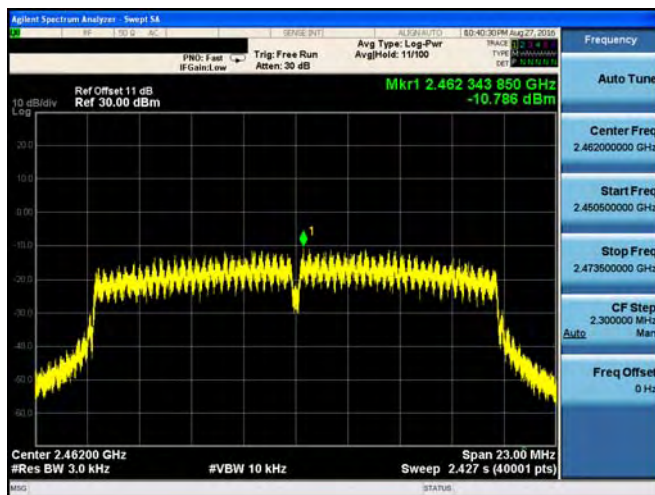



Mode 5: IEEE 802.11n 2.4GHz 40MHz link mode\_ANT-2

2422 MHz

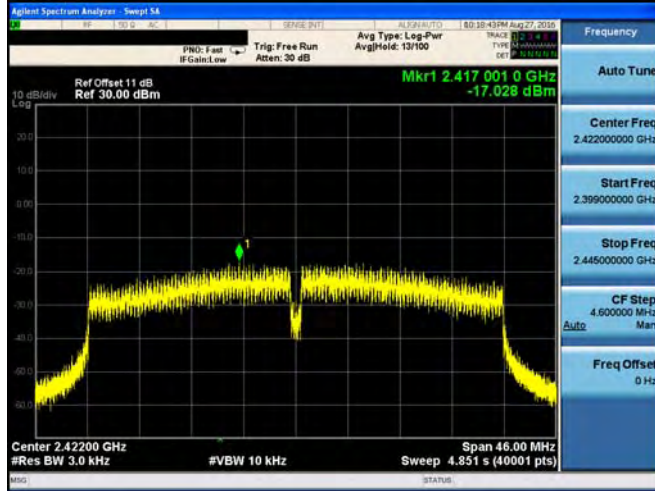

2437 MHz

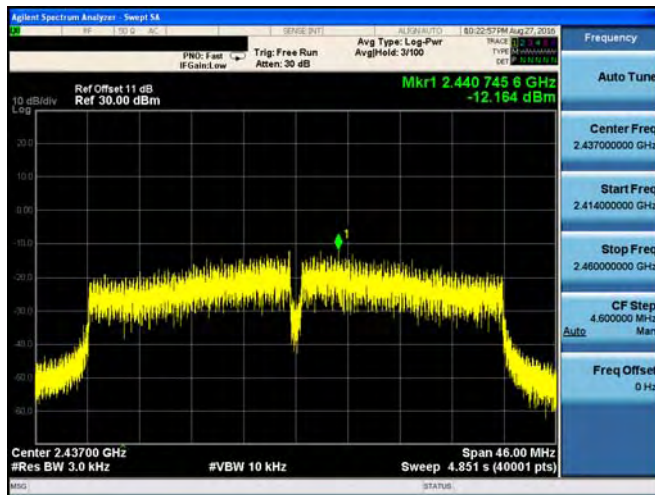

2452 MHz

