

FCC PART 15C TEST REPORT FOR CERTIFICATION
On Behalf of

TP-LINK TECHNOLOGIES CO., LTD.

AC750 Wireless Dual Band Router

Model Number: C20i

FCC ID: TE7C20I

Prepared for : TP-LINK TECHNOLOGIES CO., LTD.
Building 24(floors 1,3,4,5) and 28 (floors1-4) Central Science
and Technology Park, Shennan Rd, Nanshan, Shenzhen, China

Prepared By : Audix Technology (Shenzhen) Co., Ltd.
No. 6, Ke Feng Rd., 52 Block,
Shenzhen Science & Industrial Park,
Nantou, Shenzhen, Guangdong, China

Tel: (0755) 26639496

Report Number : ACS-F14182
Date of Test : May.20~Jun.07, 2014
Date of Report : Jun.10, 2014

TABLE OF CONTENTS

Description	Page
1. SUMMARY OF STANDARDS AND RESULTS	1-1
1.1. Description of Standards and Results	1-1
2. GENERAL INFORMATION	2-1
2.1. Description of Device (EUT)	2-1
2.2. Test Information	2-2
2.3. Tested Supporting System Details.....	2-2
2.4. Block Diagram of Test Setup	2-2
2.5. Test Facility	2-3
2.6. Measurement Uncertainty (95% confidence levels, k=2).....	2-4
3. POWER LINE CONDUCTED EMISSION TEST.....	3-1
3.1. Test Equipments	3-1
3.2. Block Diagram of Test Setup	3-1
3.3. Power Line Conducted Emission Test Limits	3-1
3.4. Configuration of EUT on Test.....	3-2
3.5. Operating Condition of EUT	3-2
3.6. Test Procedure	3-2
3.7. Power Line Conducted Emission Test Results	3-2
4. RADIATED EMISSION TEST	4-5
4.1. Test Equipment.....	4-5
4.2. Block Diagram of Test Setup	4-5
4.3. Radiated Emission Limit	4-6
4.4. EUT Configuration on Test.....	4-7
4.5. Operating Condition of EUT	4-7
4.6. Test Procedure	4-7
4.7. Radiated Emission Test Results	4-8
5. BAND EDGE COMPLIANCE TEST	5-1
5.1. Test Equipment.....	5-1
5.2. Limit	5-1
5.3. Test Produce	5-1
5.4. Test Results	5-1
6. 20dB & 26dB Bandwidth Test	6-1
6.1. Test Equipment.....	6-1
6.2. Limit	6-1
6.3. Test Procedure	6-1
6.4. Test Results	6-1
7. OUTPUT POWER TEST	7-1
7.1. Test Equipment.....	7-1
7.2. Limit	7-1
7.3. Test Procedure	7-1
7.4. Test Results	7-2
8. POWER SPECTRAL DENSITY TEST	8-1
8.1. Test Equipment.....	8-1
8.2. Limit	8-1
8.3. Test Procedure	8-1
8.4. Test Results	8-2
9. PEAK EXCURSION MEASUREMENT	9-1
9.1. Test Equipment.....	9-1

9.2.	Limit	9-1
9.3.	Test Procedure	9-1
9.4.	Test Results	9-2
10.	FREQUENCY STABILITY MEASUREMENT	10-1
10.1.	Test Equipment	10-1
10.2.	Limit	10-1
10.3.	Test Procedure	10-1
10.4.	Test Result	10-2
11.	MPE ESTIMATION	11-1
11.1.	Limit for General Population/ Uncontrolled Exposures	11-1
11.2.	Estimation Result	11-1
12.	NTENNA REQUIREMENT	12-1
12.1.	STANDARD APPLICABLE	12-1
12.2.	ANTENNA CONNECTED CONSTRUCTION	12-1
13.	DEVIATION TO TEST SPECIFICATIONS	13-1
14.	PHOTOGRAPH OF TEST	14-1
14.1.	Photos of Power Line Conducted Emission Test	14-1
14.2.	Photos of Radiated Emission Test	14-2

TEST REPORT CERTIFICATION

Applicant : TP-LINK TECHNOLOGIES CO., LTD.
Manufacturer : TP-LINK TECHNOLOGIES CO., LTD.
EUT Description : AC750 Wireless Dual Band Router
FCC ID : TE7C201
(A) MODEL NO. : C20i
(B) SERIAL NO. : N/A
(C) POWER SUPPLY : Input:100~240V~, 50/60Hz, 0.3A
Output: 12V---1A
(D) TEST VOLTAGE : DC 12V From Adapter input AC 120V/60Hz

Tested for comply with:
FCC Rules and Regulations Part 15 Subpart E: 2013

Test procedure used:
ANSI C63.10:2009
KDB789033D01: KDB644545D01

The device described above is tested by AUDIX TECHNOLOGY (SHENZHEN) CO., LTD. to confirm comply with all the FCC Part 15 Subpart C requirements. The test results are contained in this test report and AUDIX TECHNOLOGY (SHENZHEN) CO., LTD. is assumed full responsibility for the accuracy and completeness of these tests. Also, this report shows that the Equipment Under Test (EUT) is to be technically compliant with the FCC and IC requirements. This report contains data that are not covered by the NVLAP accreditation.

This Report is made under FCC Part 2.1075. No modifications were required during testing to bring this product into compliance.

This report applies to above tested sample only. This report shall not be reproduced in part without written approval of AUDIX TECHNOLOGY (SHENZHEN) CO., LTD.

The report must not be used by the client to claim product certification, approval, or endorsement by NVLAP, NIST, or any agency of the federal government.

Date of Test : May.20~Jun.07, 2014 Report of date: Jun.10, 2014

Prepared by : Sonia Lee Reviewed by : Sunny Lu
Sonia Lee / Assistant Manager Sunny Lu / Assistant Manager

Audix Technology (Shenzhen) Co., Ltd.

EMC 部門報告專用章

Stamp only for EMC Dept. Report

Signature: David Jin 6.10

Approved & Authorized Signer : David Jin
David Jin / Manager

1. SUMMARY OF STANDARDS AND RESULTS

1.1. Description of Standards and Results

The EUT have been tested according to the applicable standards as referenced below.

EMISSION		
Description of Test Item	Standard	Results
Power Line Conducted Emission	FCC Part 15: 15.207 ANSI C63.10: 2009	PASS
Radiated Emission	FCC Part 15: 15.209 ANSI C63.10: 2009	PASS
Band Edge Compliance	FCC Part 15: 15.247 ANSI C63.10: 2009	PASS
26dB Bandwidth Test	FCC Part 15: 15.407(a)	PASS
Output Power Test	FCC Part 15: 15.407(a)	PASS
Power Spectral Density Test	FCC Part 15: 15.407(a)	PASS
Peak Excursion	FCC Part 15: 15.407(a)	PASS
Frequency Stability	FCC Part 15: 15.407(g) ANSI C63.10: 2009	PASS
Antenna requirement	FCC Part 15: 15.203	PASS

2. GENERAL INFORMATION

2.1. Description of Device (EUT)

Product Name	: AC750 Wireless Dual Band Router
Model No.	: C20i
FCC ID	: TE7C20I
Radio	: IEEE802.11 a/b/g/n/ac
Operation Frequency	: IEEE 802.11a: 5180MHz—5240MHz, 5745MHz—5825MHz IEEE 802.11ac VHT20: 5180MHz—5240MHz, 5745MHz—5825MHz IEEE 802.11ac VHT40: 5190MHz—5230MHz, 5755MHz—5795MHz IEEE 802.11ac VHT80: 5210MHz, 5775MHz IEEE 802.11b: 2412MHz—2462MHz IEEE 802.11g: 2412MHz—2462MHz IEEE802.11nHT20: 2412MHz—2462MHz, 5180MHz—5240MHz, 5745MHz—5825MHz IEEE802.11nHT40: 2422MHz—2452MHz, 5190MHz—5230MHz, 5755MHz—5795MHz
Modulation Technology	: IEEE 802.11b: DSSS(CCK,DQPSK,DBPSK) IEEE 802.11a/g: OFDM(64QAM, 16QAM, QPSK, BPSK) IEEE 802.11ac VHT20, VHT40, VHT80: OFDM (16QAM, 64QAM, 256QAM, QPSK, BPSK) IEEE 802.11n HT20, HT40: OFDM (64QAM, 16QAM,QPSK,BPSK)
Antenna Assembly Gain	: Dipole antenna, 2.4GHz: 2dBi(max) 5GHz: 3.5dBi(max)
Applicant	: TP-LINK TECHNOLOGIES CO., LTD. Building 24(floors 1,3,4,5) and 28 (floors1-4) Central Science and Technology Park, Shennan Rd, Nanshan, Shenzhen, China
Manufacturer	: TP-LINK TECHNOLOGIES CO., LTD. Building 24(floors 1,3,4,5) and 28 (floors1-4) Central Science and Technology Park, Shennan Rd, Nanshan, Shenzhen, China
Power Adaptor	: Manufacture :TP-LINK, M/N:T120100-2B1 Input: 100-240V~, 50/60Hz, 0.3A Output: 12V—1A Power Cable: Unshielded, Detachable, 1.5m
Date of Test	: May.20~Jun.07, 2014
Date of Receipt	: May.14, 2014
Sample Type	: Prototype production

2.2. Test Information

A special test software was used to control EUT work in Continuous TX mode(100% duty cycle), and select test channel, wireless mode and data rate.

This device have two antennas , only antenna 0 use 5GHz band.

2.3. Tested Supporting System Details

No.	Description	ACS No.	Manufacturer	Model	Serial Number	Approved type
1.	Personal Computer	Test PC M	DELL	Studio 540	224XK2X	<input checked="" type="checkbox"/> FCC DoC <input checked="" type="checkbox"/> BSMI ID:R33002
		Power Cord: Unshielded, Detachable, 1.8m Display Card: HD3450 (DVI+VGA+HDMI)				
2.	USB Mouse	ACS-EMC-M04R	DELL	M0C5UO	512024282	<input checked="" type="checkbox"/> FCC DoC <input checked="" type="checkbox"/> BSMI ID: R41108
		Power Cord: shielded, Undetachable, 1.8m				
3.	USB Keyboard	ACS-EMC- K03R	DELL	SK-8115	CN-ODJ313-71 616-711-04WJ	<input checked="" type="checkbox"/> FCC DoC <input checked="" type="checkbox"/> BSMI ID: T3A002
		Power Cord: shielded, Undetachable, 2.0m				
4.	USB Disk	N/A	Kingston	N/A	N/A	4GB mini memory

2.4. Block Diagram of Test Setup

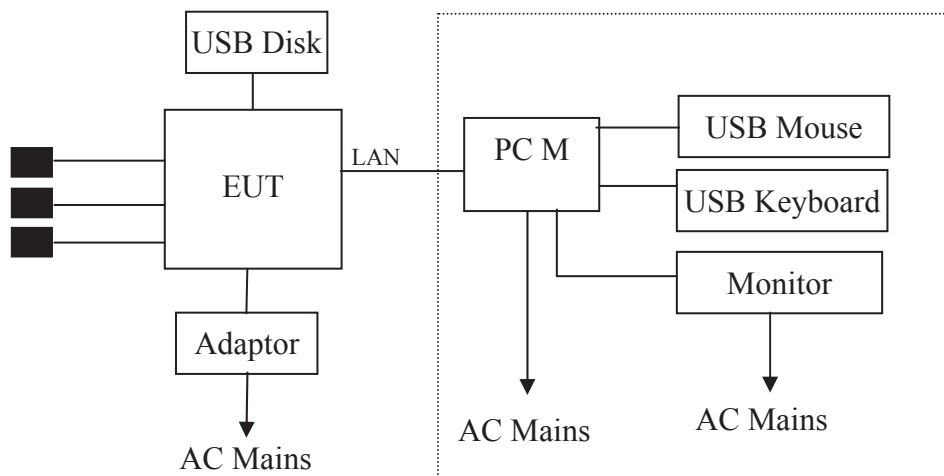

■ :100Ω

(EUT: AC750 Wireless Dual Band Router)

2.5. Test Facility

Site Description

Name of Firm

: Audix Technology (Shenzhen) Co., Ltd.
No. 6, Ke Feng Rd., 52 Block, Shenzhen
Science & Industrial Park, Nantou,
Shenzhen, Guangdong, China

3m Anechoic Chamber

: Certificated by FCC, USA
Registration Number: 90454
Valid Date: Feb.22, 2015

3m & 10m Anechoic Chamber

: Certificated by FCC, USA
Registration Number: 794232
Valid Date: Oct.31, 2015

EMC Lab.

: Certificated by Industry Canada
Registration Number: IC 5183A-1
Valid Date: Jun.13, 2014

: Certificated by DAkkS, Germany
Registration No: D-PL-12151-01-00
Valid Date: Dec.15, 2016

Accredited by NVLAP, USA
NVLAP Code: 200372-0
Valid Date: Mar.31, 2015

2.6. Measurement Uncertainty (95% confidence levels, k=2)

Test Item	Uncertainty	Memo
Uncertainty for Conducted emission test in No. 1 Conduction	± 3.10 dB	150KHz to 30MHz
Uncertainty for Radiated Emission test in 3m chamber	± 3.22 dB	30~200MHz, Polarization: H
	± 3.23 dB	30~200MHz, Polarization: V
	± 3.49 dB	200M~1GHz, Polarization: H
	± 3.39 dB	200M~1GHz, Polarization: V
Uncertainty for Radiated Emission test in 3m chamber (1GHz-18GHz)	± 4.97 dB	1~6GHz, Distance: 3m
	± 4.99 dB	6~18GHz, Distance: 3m
Uncertainty for Radiated Spurious Emission test	± 3.57 dB	
Uncertainty for Conducted Spurious emission test	± 2.00 dB	
Uncertainty for Output power test	± 0.73 dB	
Uncertainty for Power density test	± 2.00 dB	
Uncertainty for Temperature and humidity test for ETSI	$\pm 3\%$	
	$\pm 0.6^{\circ}\text{C}$	
Uncertainty for Radio Frequency	$\pm 7 \times 10^{-8}$	
Uncertainty for Bandwidth	± 83 KHz	
RF level uncertainty for given BER	± 0.2 dB	

3. POWER LINE CONDUCTED EMISSION TEST

3.1. Test Equipments

Item	Equipment	Manufacturer	Model No.	Serial No.	Last Cal.	Cal. Interval
1.	Test Receiver	Rohde & Schwarz	ESHS10	838693/001	Oct.31, 13	1 Year
2.	L.I.S.N.#1	Rohde & Schwarz	ESH2-Z5	100429	Jan.22, 14	1 Year
3.	L.I.S.N.#3	Kyoritsu	KNW-242C	8-1920-1	Apr. 28,14	1 Year
4.	Terminator	Hubersuhner	50Ω	No. 1	Apr. 28,14	1 Year
5.	Terminator	Hubersuhner	50Ω	No. 2	Apr. 28,14	1 Year
6.	RF Cable	Hubersuhner	RG58	0100.6954.20#	Jan.22, 14	1Year
7.	Pulse Limiter	Rohde & Schwarz	ESH3-Z2	101838	Jan.22, 14	1 Year

3.2. Block Diagram of Test Setup

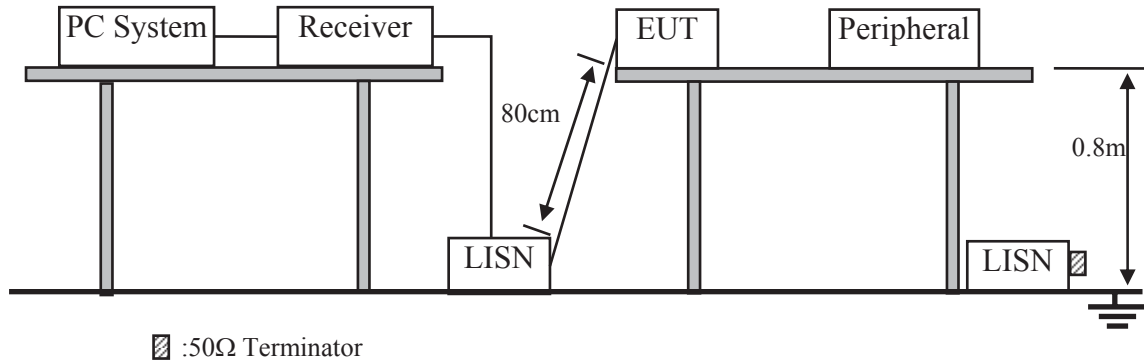

3.3. Power Line Conducted Emission Test Limits

Frequency	Maximum RF Line Voltage	
	Quasi-Peak Level dB(μV)	Average Level dB(μV)
150kHz ~ 500kHz	66 ~ 56*	56 ~ 46*
500kHz ~ 5MHz	56	46
5MHz ~ 30MHz	60	50

Notes: 1. * Decreasing linearly with logarithm of frequency.

2. The lower limit shall apply at the transition frequencies.

3.4. Configuration of EUT on Test

The following equipment are installed on Power Line Conducted Emission Test to meet the commission requirement and operating regulations in a manner which tends to maximize its emission characteristics in a normal application.

3.4.1. AC750 Wireless Dual Band Router (EUT)

Model Number : C20i

Serial Number : N/A

3.4.2. Support Equipment: As Tested Supporting System Details, in Section 2.2.

3.5. Operating Condition of EUT

3.5.1. Setup the EUT and simulator as shown as Section 3.2.

3.5.2. Turned on the power of all equipment.

3.5.3. PC run test software to control EUT work in Tx mode.

3.6. Test Procedure

The EUT was placed on a non-metallic table, 80cm above the ground plane. The EUT Power connected to the power mains through a line impedance stabilization network (L.I.S.N. 1#). This provides a 50 ohm coupling impedance for the EUT (Please refer the block diagram of the test setup and photographs). The AC line are checked to find out the maximum conducted emission. In order to find the maximum emission levels, the relative positions of equipment and all of the interface cables shall be changed according to ANSI C63.10: 2009 on Conducted Emission Test.

The bandwidth of test receiver (R & S ESHS10) is set at 9kHz.

The frequency range from 150kHz to 30MHz is checked.

3.7. Power Line Conducted Emission Test Results

PASS. (All emissions not reported below are too low against the prescribed limits.)

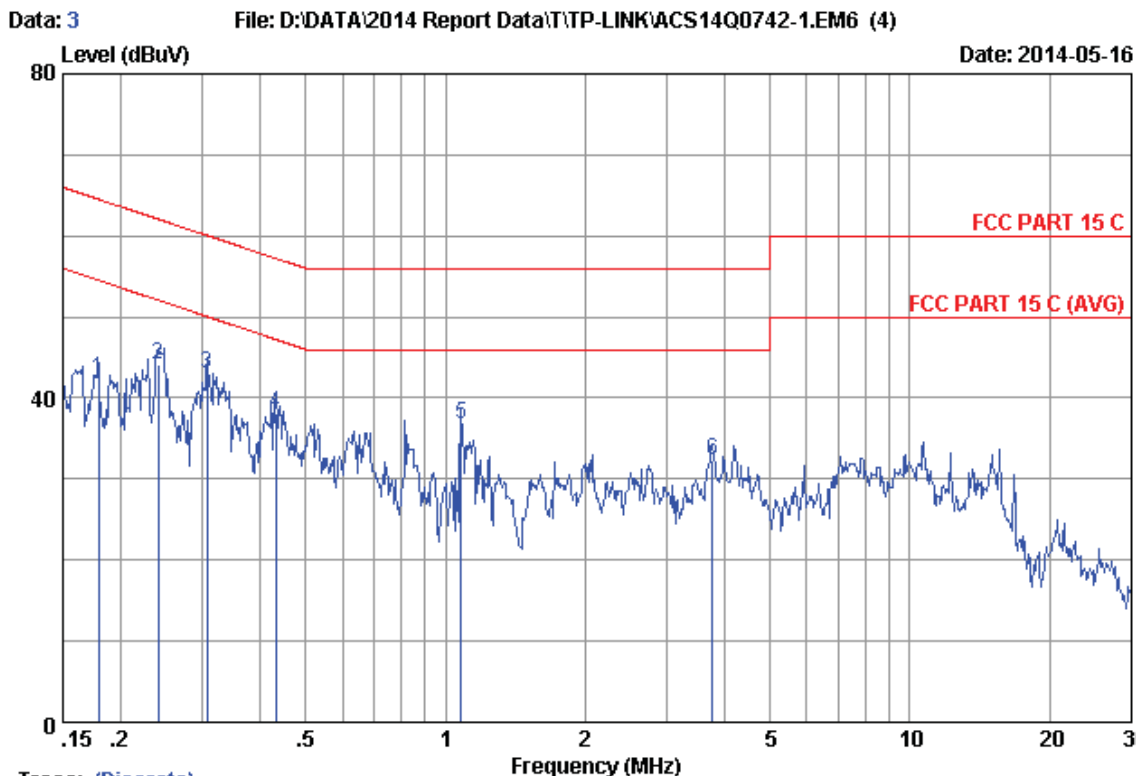

Trace: (Discrete)

Site no :1#conduction Data No :3
 Dis./Ant. :2014 ESH2-Z5 LINE
 Limit :FCC PART 15 C
 Env./Ins. :24.3°C/52% Engineer :Nick_Huang
 EUT :AC750 Wireless Dual Band Router M/N:C20i
 Power Rating :DC 12V From Adapter Input AC 120V/60Hz
 Test Mode :Tx Mode(5G)

No	Freq (MHz)	LISN Factor (dB)	Cable Loss (dB)	Reading (dBuV)	Emission Level (dBuV)	Limits (dBuV)	Margin (dB)	Remark
1	0.17866	0.13	9.88	32.34	42.35	64.55	22.20	QP
2	0.24037	0.13	9.88	34.07	44.08	62.08	18.00	QP
3	0.30671	0.14	9.88	33.07	43.09	60.06	16.97	QP
4	0.43052	0.15	9.88	28.02	38.05	57.24	19.19	QP
5	1.082	0.17	9.89	26.79	36.85	56.00	19.15	QP
6	3.759	0.24	9.93	22.19	32.36	56.00	23.64	QP

Remarks: 1.Emission Level=LISN Factor+Cable Loss(Include 10dB pulse limit)+Reading.
 2.If the average limit is met when using a quasi-peak detector. the EUT shall be deemed to meet both limits and measurement with average detector is unnecessary.

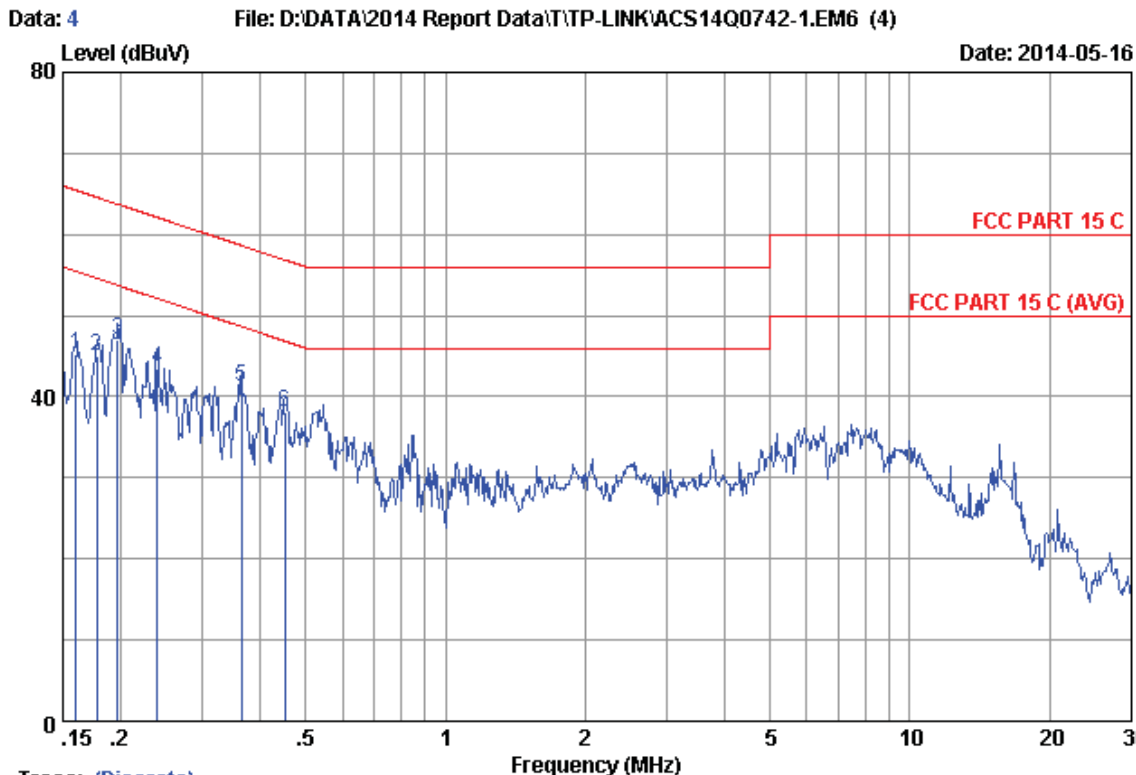

Trace: (Discrete)

Site no :1#conduction Data No :4
 Dis./Ant. :2014 ESH2-Z5 NEUTRAL
 Limit :FCC PART 15 C
 Env./Ins. :24.3*C/52% Engineer :Nick_Huang
 EUT :AC750 Wireless Dual Band Router M/N:C20i
 Power Rating :DC 12V From Adapter Input AC 120V/60Hz
 Test Mode :Tx Mode(5G)

No	Freq (MHz)	LISN Factor (dB)	Cable Loss (dB)	Reading (dBuV)	Emission Level (dBuV)	Limits (dBuV)	Margin (dB)	Remark
1	0.15985	0.13	9.87	35.33	45.33	65.47	20.14	QP
2	0.17772	0.13	9.88	34.95	44.96	64.59	19.63	QP
3	0.19654	0.13	9.88	37.01	47.02	63.76	16.74	QP
4	0.23910	0.13	9.88	33.47	43.48	62.13	18.65	QP
5	0.36338	0.14	9.88	31.31	41.33	58.65	17.32	QP
6	0.45155	0.15	9.88	28.05	38.08	56.85	18.77	QP

Remarks: 1.Emission Level=LISN Factor+Cable Loss(Include 10dB pulse limit)+Reading.
 2.If the average limit is met when using a quasi-peak detector, the EUT shall be deemed to meet both limits and measurement with average detector is unnecessary.

4. RADIATED EMISSION TEST

4.1. Test Equipment

4.1.1. For frequency range 30MHz~1000MHz (At Anechoic Chamber)

Item	Equipment	Manufacturer	Model No.	Serial No.	Last Cal.	Cal. Interval
1	3#Chamber	AUDIX	N/A	N/A	Nov.24, 13	1 Year
2	EMI Spectrum	Agilent	E4407B	MY41440292	Apr. 28,14	1 Year
3	Test Receiver	Rohde & Schwarz	ESVS10	834468/011	Apr. 28,14	1 Year
4	Amplifier	HP	8447D	2648A04738	Apr. 28,14	1 Year
5	Bilog Antenna	Schaffner	CBL6111C	2598	Apr. 08,14	1 Year
6	RF Cable	MIYAZAKI	CFD400-NL	3# Chamber No.1	Apr. 28,14	1 Year
7	Coaxial Switch	Anritsu	MP59B	M74389	Apr. 28,14	1 Year

4.1.2. For frequency range 1GHz~40GHz (At Anechoic Chamber)

Item	Equipment	Manufacturer	Model No.	Serial No.	Last Cal.	Cal. Interval
1	Spectrum Analyzer	Agilent	E4446A	US44300459	Apr. 28,14	1 Year
2	Horn Antenna	EMCO	3115	9607-4877	Aug.27, 13	1 Year
3	Amplifier	Agilent	8449B	3008A02495	Apr. 28,14	1 Year
4	RF Cable	Hubersuhner	SUCOFLEX106	77977/6	Apr. 28,14	1 Year
5	RF Cable	Hubersuhner	SUCOFLEX106	28616/2	Apr. 28,14	1 Year
6	Horn Antenna	EMCO	3116	00060089	Aug.27, 13	1 Year

4.2. Block Diagram of Test Setup

For frequency range 30MHz-1000MHz

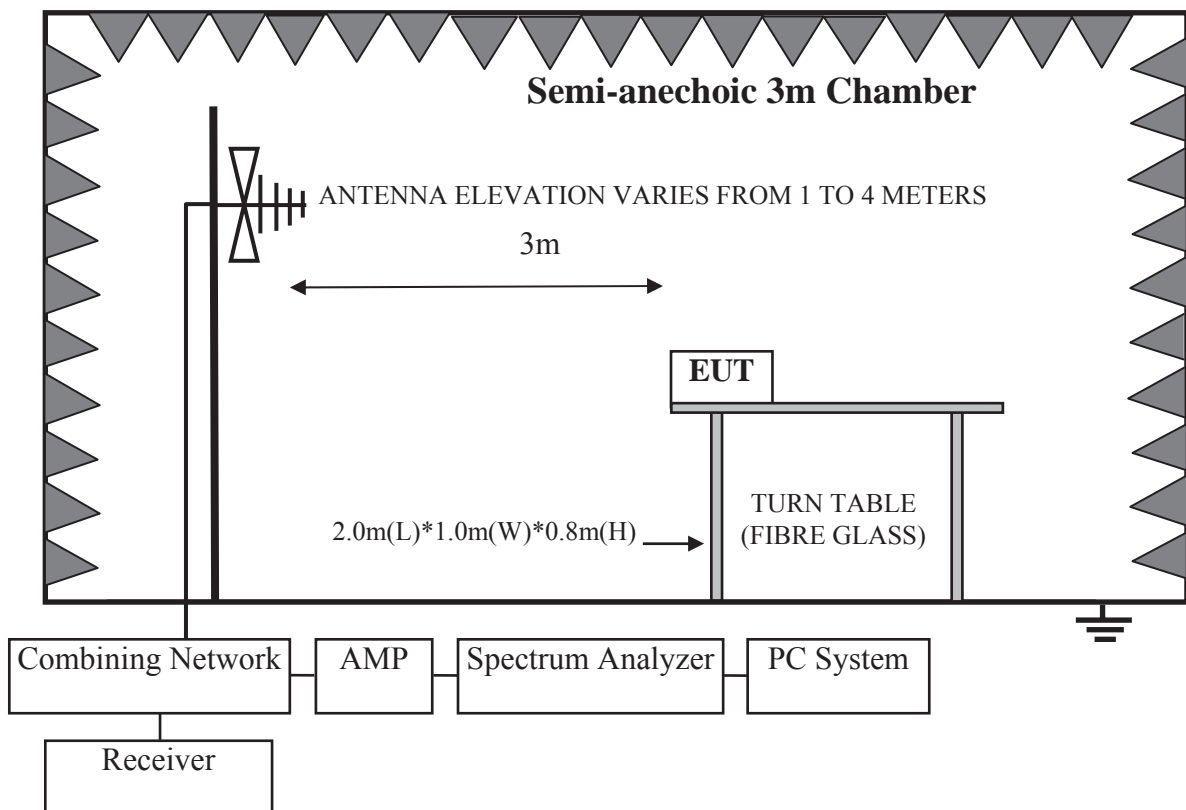

For frequency range 1GHz-40GHz

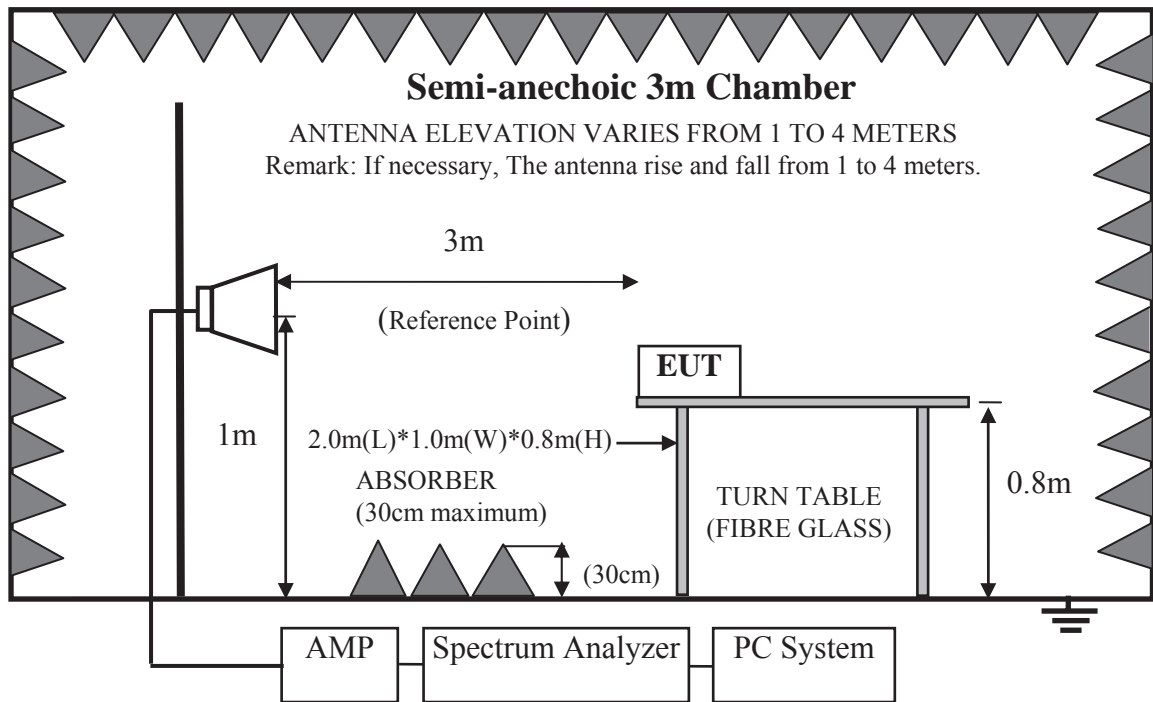

4.3. Radiated Emission Limit

For transmitters operating in the 5.15-5.25 GHz; 5.25-5.35GHz; 5.47-5.725GHz band: all emissions outside of those band shall not exceed an EIRP of -27 dBm/MHz.

Unwanted emissions below 1 GHz and those emissions appearing within 15.205 restricted frequency bands must comply with the general field strength limits set forth in Section 15.209

4.3.1. 15.209 limits

FREQUENCY MHz	DISTANCE Meters	FIELD STRENGTHS LIMIT	
		μV/m	dB(μV)/m
30 ~ 88	3	100	40.0
88 ~ 216	3	150	43.5
216 ~ 960	3	200	46.0
960 ~ 1000	3	500	54.0
Above 1000	3	74.0 dB(μV)/m (Peak) 54.0 dB(μV)/m (Average)	

Remark : (1) Emission level $dB\mu V = 20 \log$ Emission level $\mu V/m$

(2) The smaller limit shall apply at the cross point between two frequency bands.

(3) Distance is the distance in meters between the measuring instrument, antenna and the closest point of any part of the device or system.

4.3.2. 15.205 Restricted bands of operation

MHz	MHz	MHz	GHz
0.090 - 0.110	16.42 - 16.423	399.9 - 410	4.5 - 5.15
¹ 0.495 - 0.505	16.69475 - 16.69525	608 - 614	5.35 - 5.46
2.1735 - 2.1905	16.80425 - 16.80475	960 - 1240	7.25 - 7.75
4.125 - 4.128	25.5 - 25.67	1300 - 1427	8.025 - 8.5
4.17725 - 4.17775	37.5 - 38.25	1435 - 1626.5	9.0 - 9.2
4.20725 - 4.20775	73 - 74.6	1645.5 - 1646.5	9.3 - 9.5
6.215 - 6.218	74.8 - 75.2	1660 - 1710	10.6 - 12.7
6.26775 - 6.26825	108 - 121.94	1718.8 - 1722.2	13.25 - 13.4
6.31175 - 6.31225	123 - 138	2200 - 2300	14.47 - 14.5
8.291 - 8.294	149.9 - 150.05	2310 - 2390	15.35 - 16.2
8.362 - 8.366	156.52475 - 156.52525	2483.5 - 2500	17.7 - 21.4
8.37625 - 8.38675	156.7 - 156.9	2690 - 2900	22.01 - 23.12
8.41425 - 8.41475	162.0125 - 167.17	3260 - 3267	23.6 - 24.0
12.29 - 12.293	167.72 - 173.2	3332 - 3339	31.2 - 31.8
12.51975 - 12.52025	240 - 285	3345.8 - 3358	36.43 - 36.5
12.57675 - 12.57725	322 - 335.4	3600 - 4400	(²)

4.4.EUT Configuration on Test

The configurations of EUT are listed in Section 3.4.

4.5.Operating Condition of EUT

Same as Conducted Emission test that is listed in Section 3.5. except the test set up replaced by Section 4.2.

4.6.Test Procedure

EUT and its simulators are placed on a turn table, which is 0.8 meter high above ground. The turn table can rotate 360 degrees to determine the position of the maximum emission level. Power on the EUT and let it working in test mode, then test it. EUT is set 3 meters away from the receiving antenna, which is mounted on a antenna tower. The antenna can be moved up and down between 1 meter and 4 meters to find out the maximum emission level. Broadband antenna (calibrated bilog antenna) is used as receiving antenna. Both horizontal and vertical polarization of the antenna are set on test.

For emissions below 1GHz and those emissions appearing within 15.205 restricted frequency bands use below procedure:

The bandwidth of the EMI test receiver (R&S ESVS10) is set at 120kHz for frequency range from 30MHz to 1000 MHz.

The bandwidth of the Spectrum's VBW is set at 1MHz and RBW is set at 1MHz for peak emissions measurement above 1GHz and 1MHz RBW, 10Hz VBW for average emissions measure above 1GHz

For the emissions above 1GHz and not appearing within 15.205 restricted frequency bands use below procedure:

- (1).The maximum emission at 3m distance was measured and recorded with receive antenna in both vertical and horizontal by rotating the turntable and by lowering the receive antenna.
- (2).The EUT was then removed and replaced with a substitution antenna in the same position and the substitution antenna must have the same polarization with the receive antenna.
- (3). A signal which have the same frequency obtained in step 2 was fed to the substitution, the receive antenna was raised and lowered to obtain a maximum reading at the test receiver, the level of the signal generator was adjusted until the measured field strength level in step 2 was obtained, recorded the level of the signal generator.
- (4).Repeated step 4 with both antenna polarizations
- (5).The spurious emissions is equal to the power supplied by the signal generator and corrections due to the gain of the substitution antenna and the cable loss between the signal generator and the substitution antenna.
- (6).Per KDB789033 clause H 2)d).if the test distance is 3m,the $EIRP(dBm)=E(dB\mu v/m)-95.2$
Get the result of all unwanted emission outside the restricted band is less than the $-27dBm/MHz$.
We had checked frequency range that is 30MHz to 10th harmonic (40GHz) and no any emissions were found from 18GHz to 40GHz, so the radiated emission from 18GHz to 40GHz were not record.

4.7.Radiated Emission Test Results

PASS.

All the emissions from 30MHz to 1 GHz were comply with 15.209 limits.

No any emissions were found from 18GHz to 40GHz, So the Radiated emissions from 18GHz to 40GHz were not record.

All other emission comply with 15.407 (b)(1) requirements.

Duty cycle

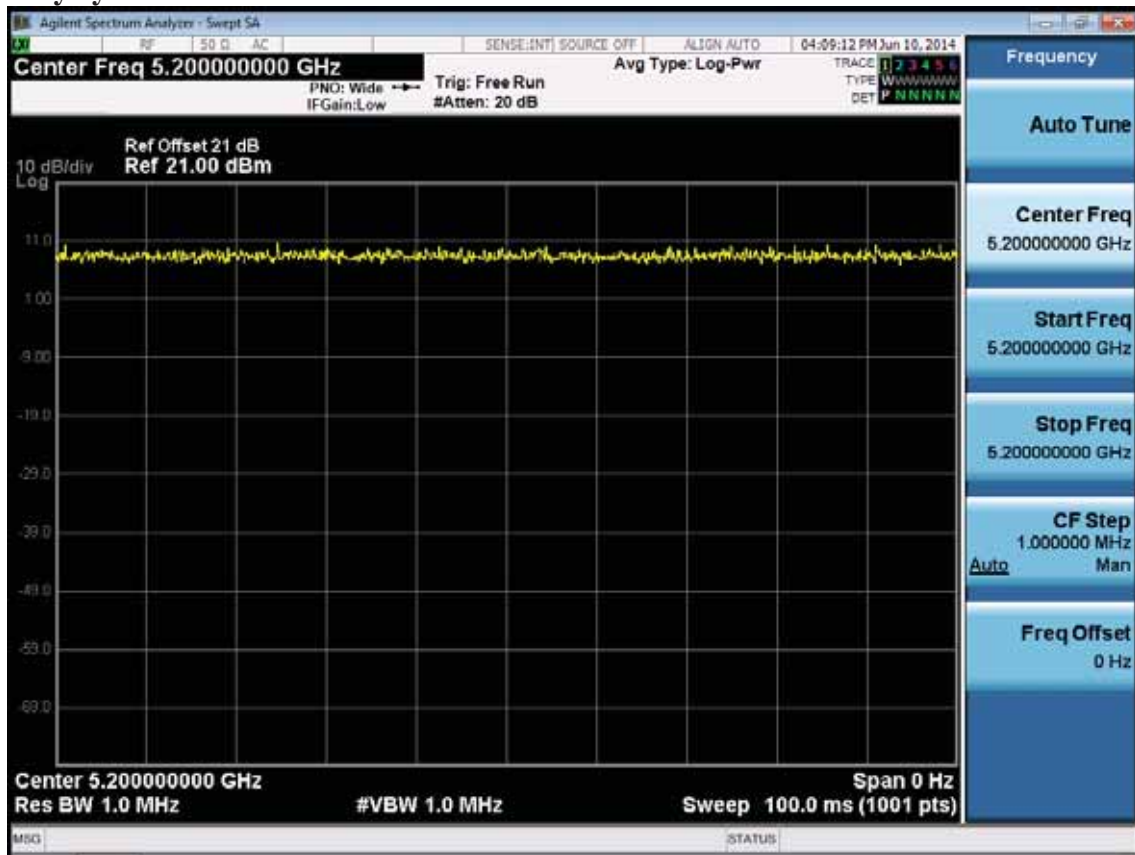

Note: The Duty Cycle is close to 100%.

Frequency: 30MHz~1GHz

Data: 4

File: E:\2014 Report Data\T\TP-LINK\ACS14Q0742.EM6 (4)

Date: 2014-05-17

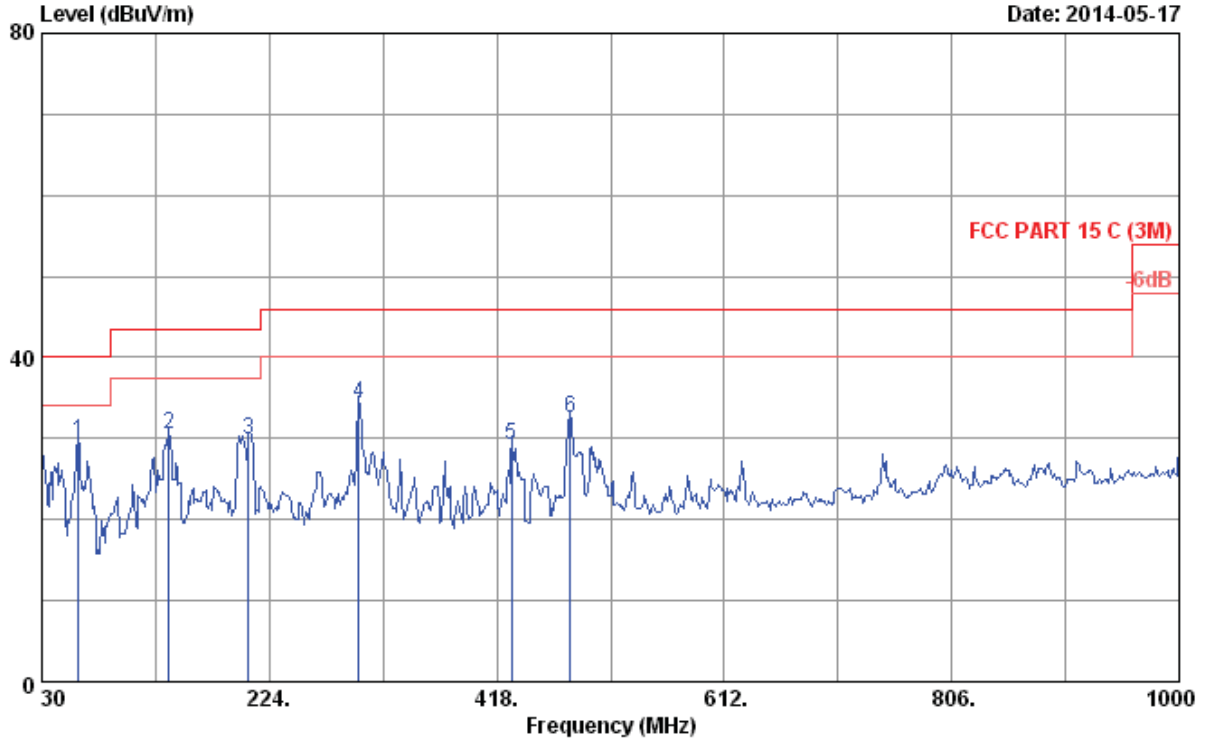

Site no. : 3m Chamber Data no. : 4
 Dis. / Ant. : 3m 2013 CBL6112D 35375 Ant. pol. : HORIZONTAL
 Limit : FCC PART 15 C (3M)
 Env. / Ins. : 22.5°C/47% Engineer : Even_Deng
 EUT : AC750 Wireless Dual Band Router
 Power rating : DC 12V From Adapter Input AC 120V/60Hz
 Test Mode : Tx Mode (5G)
 M/N:C20i

No.	Freq. (MHz)	Ant. Factor (dB/m)	Cable Loss (dB)	Reading (dBuV)	Emission Level (dBuV/m)	Limits (dBuV/m)	Margin (dB)	Remark
1	61.040	6.65	1.24	21.82	29.71	40.00	10.29	QP
2	138.640	12.20	1.56	16.71	30.47	43.50	13.03	QP
3	206.540	10.70	1.81	17.32	29.83	43.50	13.67	QP
4	300.630	14.01	2.17	18.03	34.21	46.00	11.79	QP
5	430.610	17.09	2.55	9.63	29.27	46.00	16.73	QP
6	481.050	17.80	2.70	12.03	32.53	46.00	13.47	QP

Remarks: 1. Emission Level= Antenna Factor + Cable Loss + Reading.
 2. The emission levels that are 20dB below the official limit are not reported.

Data: 3

File: E:\2014 Report Data\TP-LINK\ACS14Q0742.EM6 (4)

Date: 2014-05-17

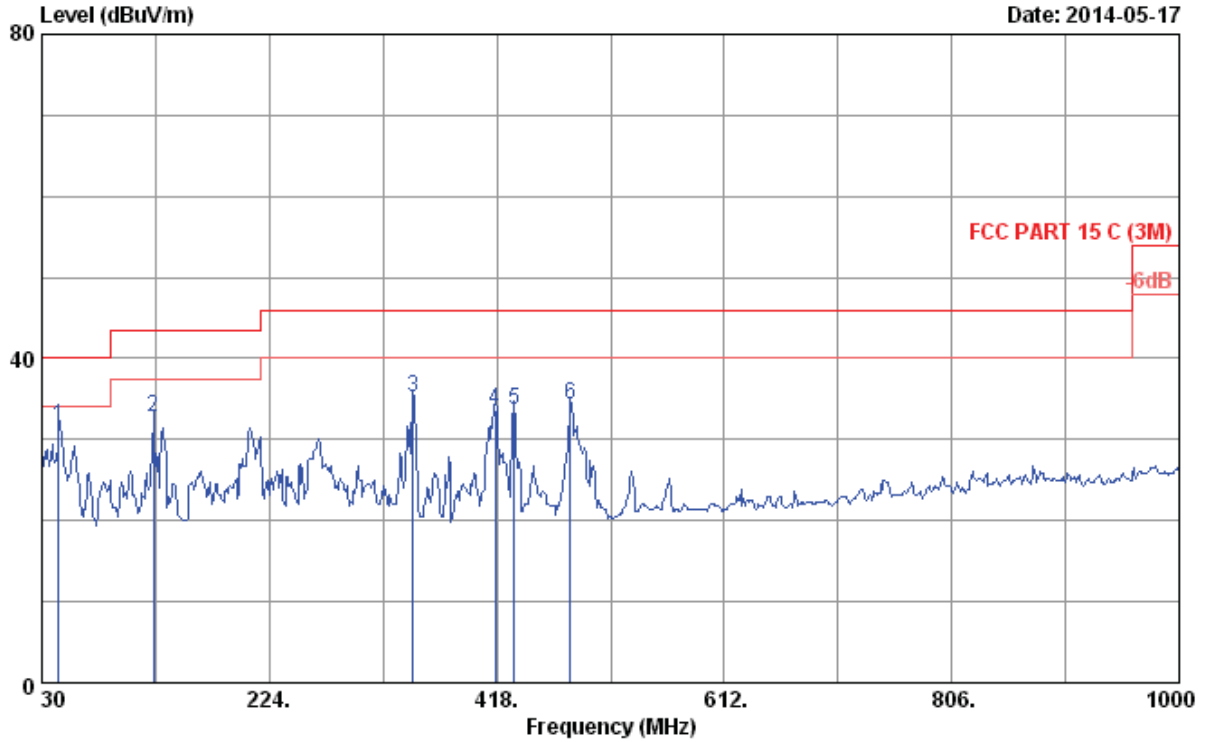

Site no. : 3m Chamber Data no. : 3
 Dis. / Ant. : 3m 2013 CBL6112D 35375 Ant. pol. : VERTICAL
 Limit : FCC PART 15 C (3M)
 Env. / Ins. : 22.5°C/47% Engineer : Even_Deng
 EUT : AC750 Wireless Dual Band Router
 Power rating : DC 12V From Adapter Input AC 120V/60Hz
 Test Mode : Tx Mode(5G)
 M/N:C20i

No.	Freq. (MHz)	Ant. Factor (dB/m)	Cable Loss (dB)	Reading (dBuV)	Emission Level (dBuV/m)	Limits (dBuV/m)	Margin (dB)	Remark
1	44.550	11.53	1.09	19.03	31.65	40.00	8.35	QP
2	125.060	12.90	1.51	18.27	32.68	43.50	10.82	QP
3	346.220	15.17	2.30	17.72	35.19	46.00	10.81	QP
4	417.030	17.34	2.51	13.73	33.58	46.00	12.42	QP
5	432.550	17.05	2.55	14.08	33.68	46.00	12.32	QP
6	481.050	17.80	2.70	13.73	34.23	46.00	11.77	QP

Remarks: 1. Emission Level= Antenna Factor + Cable Loss + Reading.
 2. The emission levels that are 20dB below the official limit are not reported.

Frequency: 1GHz~18GHz

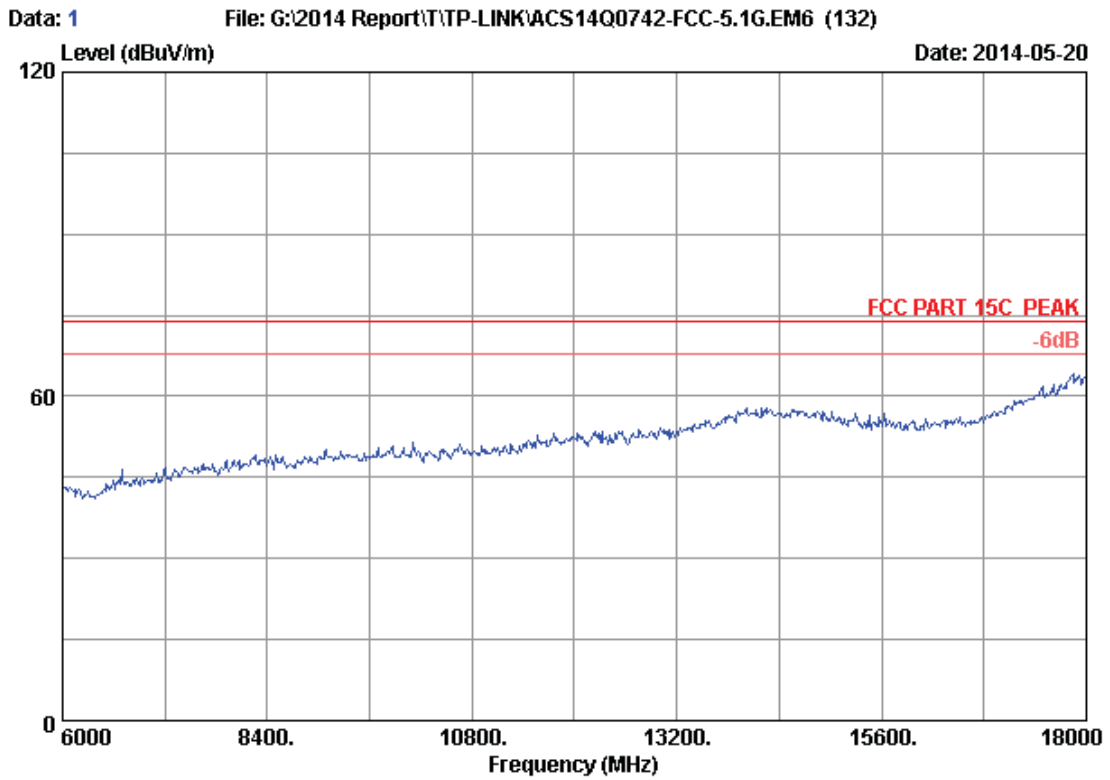

Site no. : 3m Chamber Data no. : 1
Dis. / Ant. : 3m 2013 3115 (4580) Ant. pol. : VERTICAL
Limit : FCC PART 15C PEAK
Env. / Ins. : 24°C/56% Engineer : Kevin_Hu
EUT : AC750 Wireless Dual Band Router
Power Rating : DC 12V From Adapter Input AC 120V/60Hz
Test Mode : IEEE802.11a CH36 5180MHz Tx
M/N : C20i

Data: 2 File: G:\2014 Report\T\TP-LINK\ACS14Q0742-FCC-5.1G.EM6 (132) Date: 2014-05-20

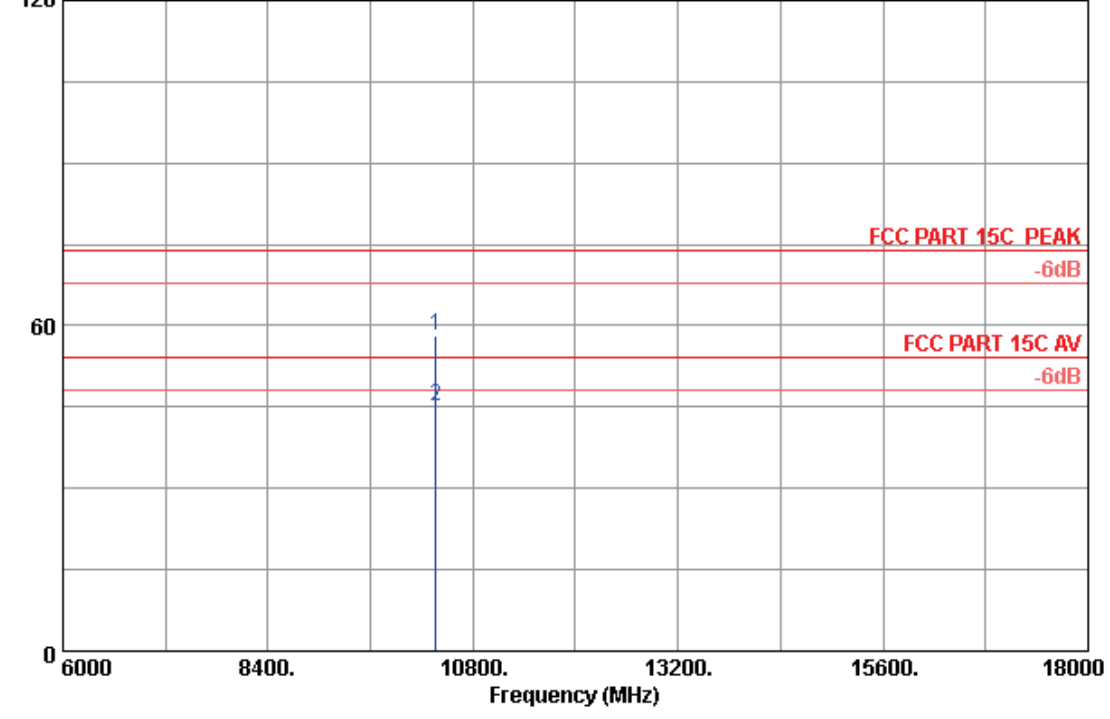

Site no. : 3m Chamber Data no. : 2
 Dis. / Ant. : 3m 2013 3115 (4580) Ant. pol. : VERTICAL
 Limit : FCC PART 15C PEAK
 Env. / Ins. : 24*C/56% Engineer : Kevin_Hu
 EUT : AC750 Wireless Dual Band Router
 Power Rating : DC 12V From Adapter Input AC 120V/60Hz
 Test Mode : IEEE802.11a CH36 5180MHz Tx
 M/N : C20i

No.	Freq. (MHz)	Ant. Factor (dB/m)	Cable Loss (dB)	AMP factor (dB)	Reading (dBuV)	Emission Level (dBuV/m)	Limits (dBuV/m)	Margin (dB)	Remark
1	10360.000	38.14	12.64	35.45	42.79	58.12	74.00	15.88	Peak
2	10360.000	38.14	12.64	35.45	29.69	45.02	54.00	8.98	Average

Remarks: 1. Emission Level= Antenna Factor + Cable Loss + Reading - Amp Factor
 2. The emission levels that are 20dB below the official limit are not reported.

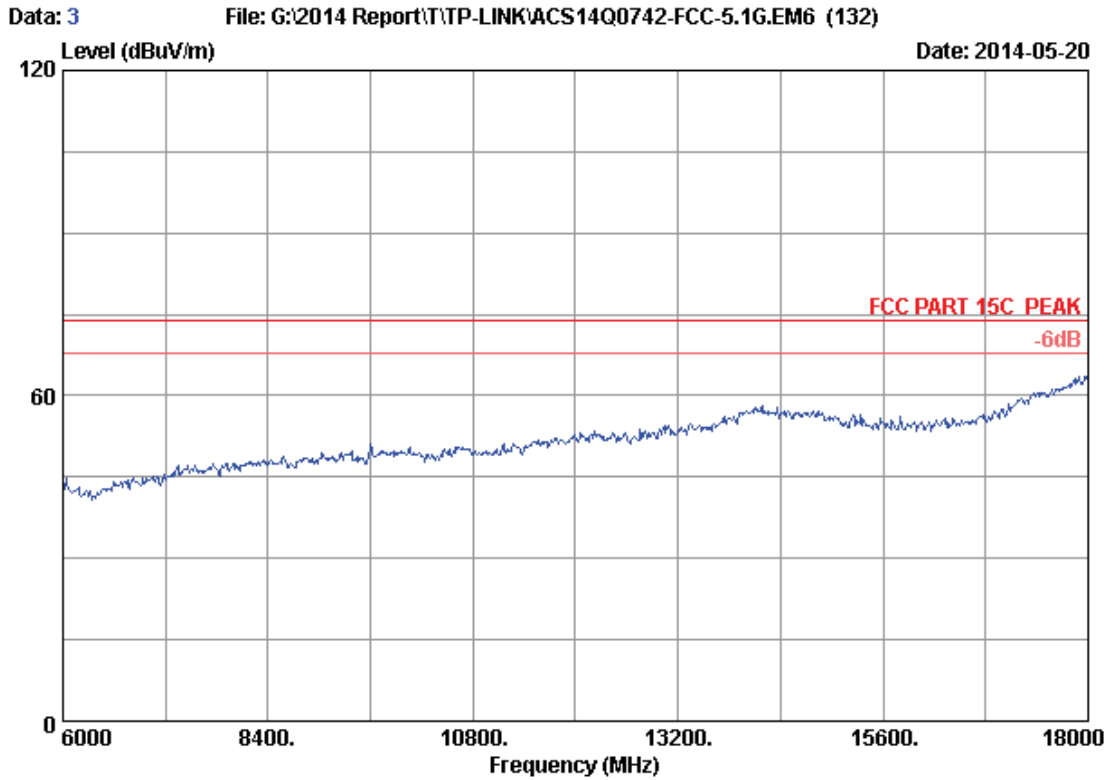

Site no. : 3m Chamber Data no. : 3
Dis. / Ant. : 3m 2013 3115 (4580) Ant. pol. : HORIZONTAL
Limit : FCC PART 15C PEAK
Env. / Ins. : 24*C/56% Engineer : Kevin_Hu
EUT : AC750 Wireless Dual Band Router
Power Rating : DC 12V From Adapter Input AC 120V/60Hz
Test Mode : IEEE802.11a CH36 5180MHz Tx
M/N : C20i

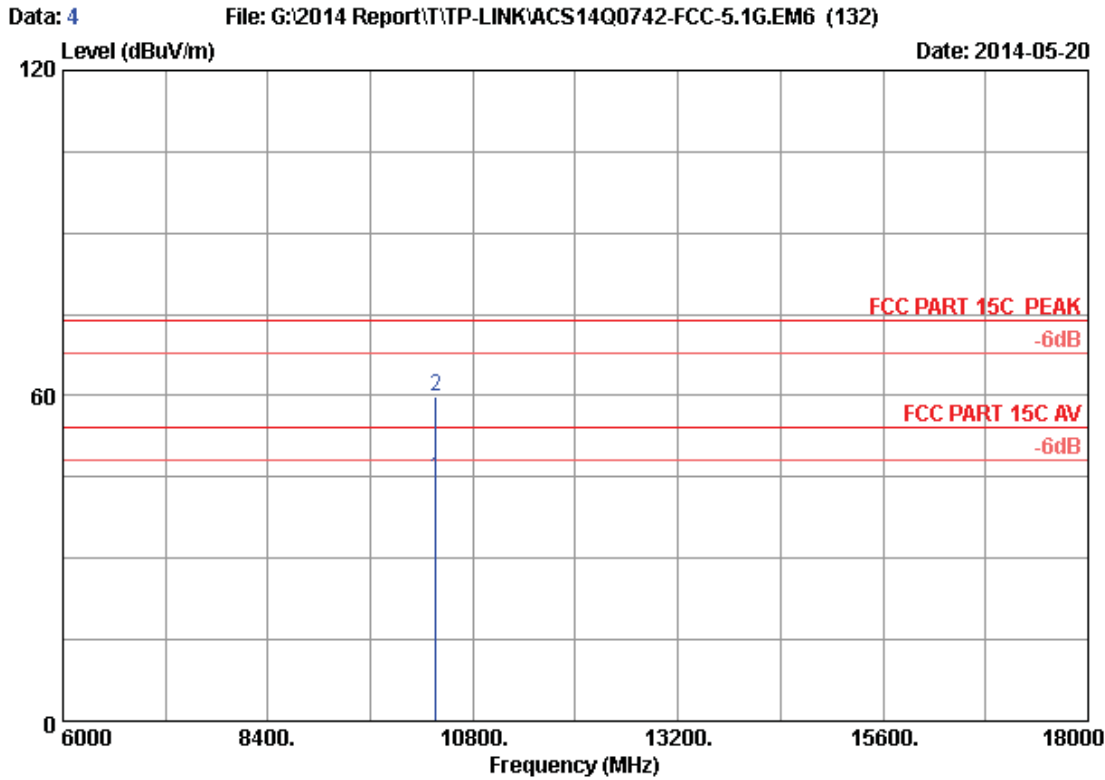

Site no. : 3m Chamber Data no. : 4
 Dis. / Ant. : 3m 2013 3115 (4580) Ant. pol. : HORIZONTAL
 Limit : FCC PART 15C PEAK
 Env. / Ins. : 24*C/56% Engineer : Kevin_Hu
 EUT : AC750 Wireless Dual Band Router
 Power Rating : DC 12V From Adapter Input AC 120V/60Hz
 Test Mode : IEEE802.11a CH36 5180MHz Tx
 M/N : C20i

No.	Freq. (MHz)	Ant. Factor (dB/m)	Cable Loss (dB)	AMP factor (dB)	Reading (dBuV)	Emission Level (dBuV/m)	Limits (dBuV/m)	Margin (dB)	Remark
1	10360.000	38.14	12.64	35.45	29.41	44.74	54.00	9.26	Average
2	10360.000	38.14	12.64	35.45	44.56	59.89	74.00	14.11	Peak

Remarks: 1. Emission Level= Antenna Factor + Cable Loss + Reading -Amp Factor
 2. The emission levels that are 20dB below the official limit are not reported.

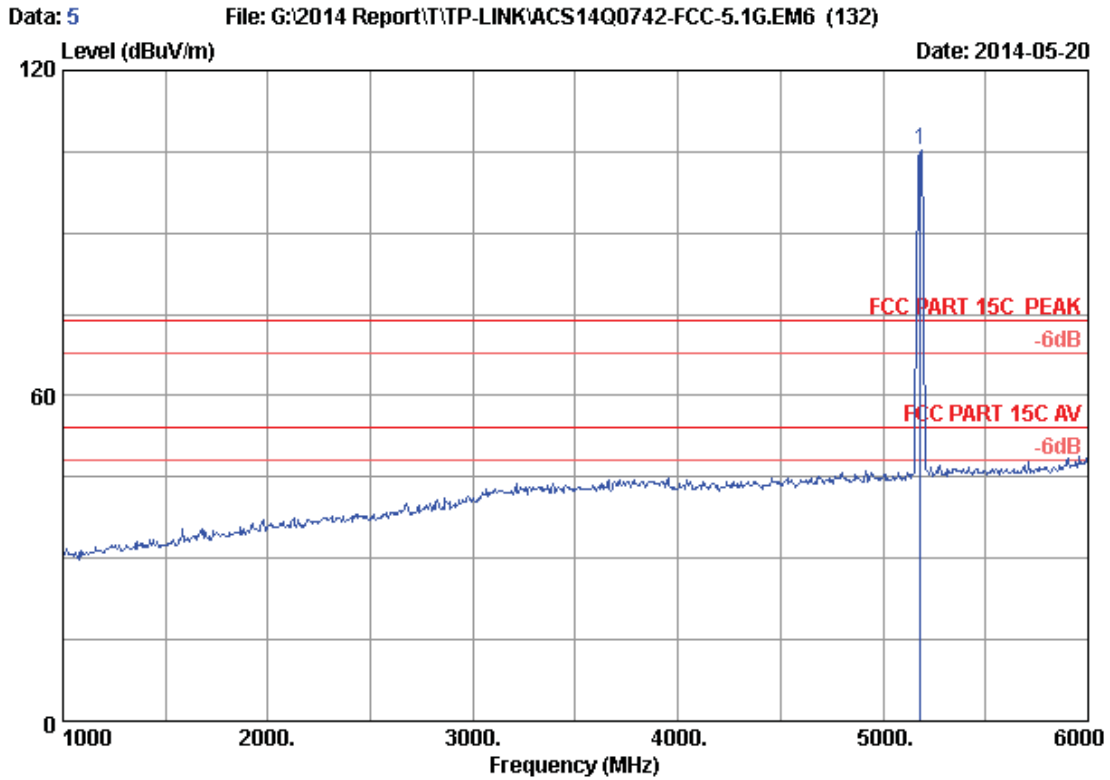

Site no. : 3m Chamber Data no. : 5
 Dis. / Ant. : 3m 2013 3115 (4580) Ant. pol. : HORIZONTAL
 Limit : FCC PART 15C PEAK
 Env. / Ins. : 24*C/56% Engineer : Kevin_Hu
 EUT : AC750 Wireless Dual Band Router
 Power Rating : DC 12V From Adapter Input AC 120V/60Hz
 Test Mode : IEEE802.11a CH36 5180MHz Tx
 M/N : C20i

No.	Freq. (MHz)	Ant. Factor (dB/m)	Cable Loss (dB)	AMP factor (dB)	Reading (dBUV)	Emission			Remark
						Level (dBUV/m)	Limits (dBUV/m)	Margin (dB)	
1	5180.000	33.49	8.95	35.70	98.56	105.30	74.00	-31.30	Peak

Remarks: 1. Emission Level= Antenna Factor + Cable Loss + Reading -Amp Factor
 2. The emission levels that are 20dB below the official limit are not reported.

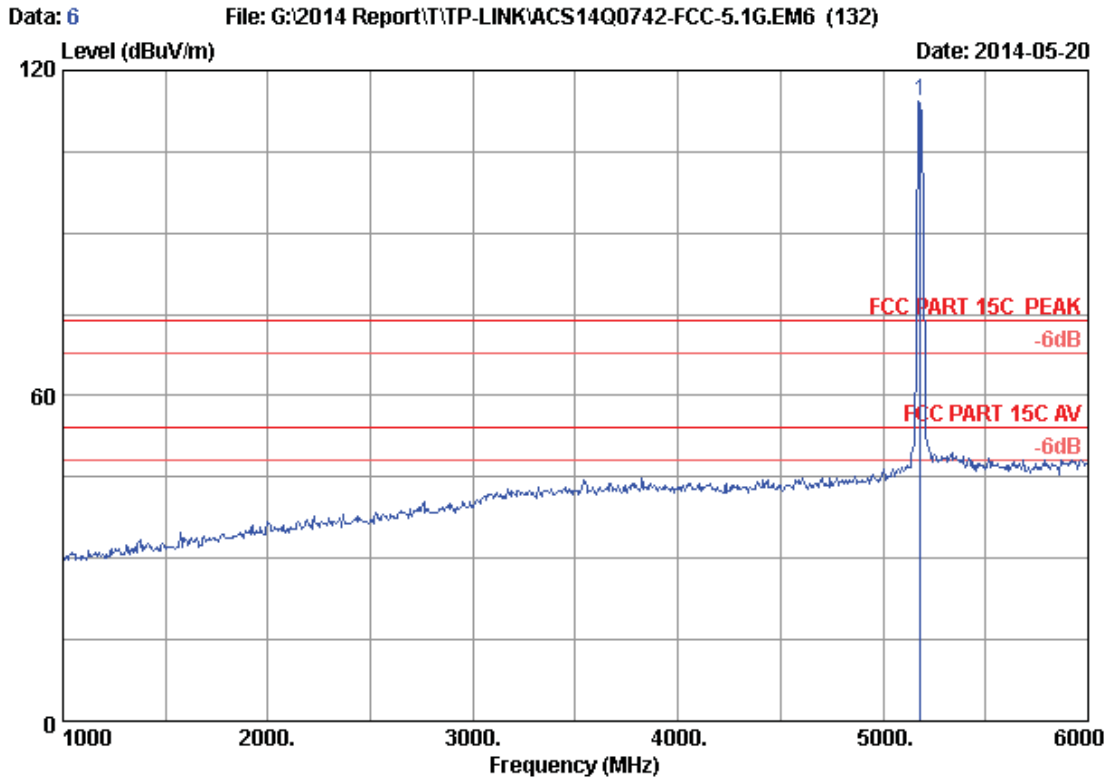

Site no. : 3m Chamber Data no. : 6
 Dis. / Ant. : 3m 2013 3115 (4580) Ant. pol. : VERTICAL
 Limit : FCC PART 15C PEAK
 Env. / Ins. : 24*C/56% Engineer : Kevin_Hu
 EUT : AC750 Wireless Dual Band Router
 Power Rating : DC 12V From Adapter Input AC 120V/60Hz
 Test Mode : IEEE802.11a CH36 5180MHz Tx
 M/N : C20i

No.	Freq. (MHz)	Ant. Factor (dB/m)	Cable Loss (dB)	AMP factor (dB)	Reading (dBUV)	Emission			Remark
						Level (dBUV/m)	Limits (dBUV/m)	Margin (dB)	
1	5180.000	33.49	8.95	35.70	107.69	114.43	74.00	-40.43	Peak

Remarks: 1. Emission Level= Antenna Factor + Cable Loss + Reading - Amp Factor
 2. The emission levels that are 20dB below the official limit are not reported.

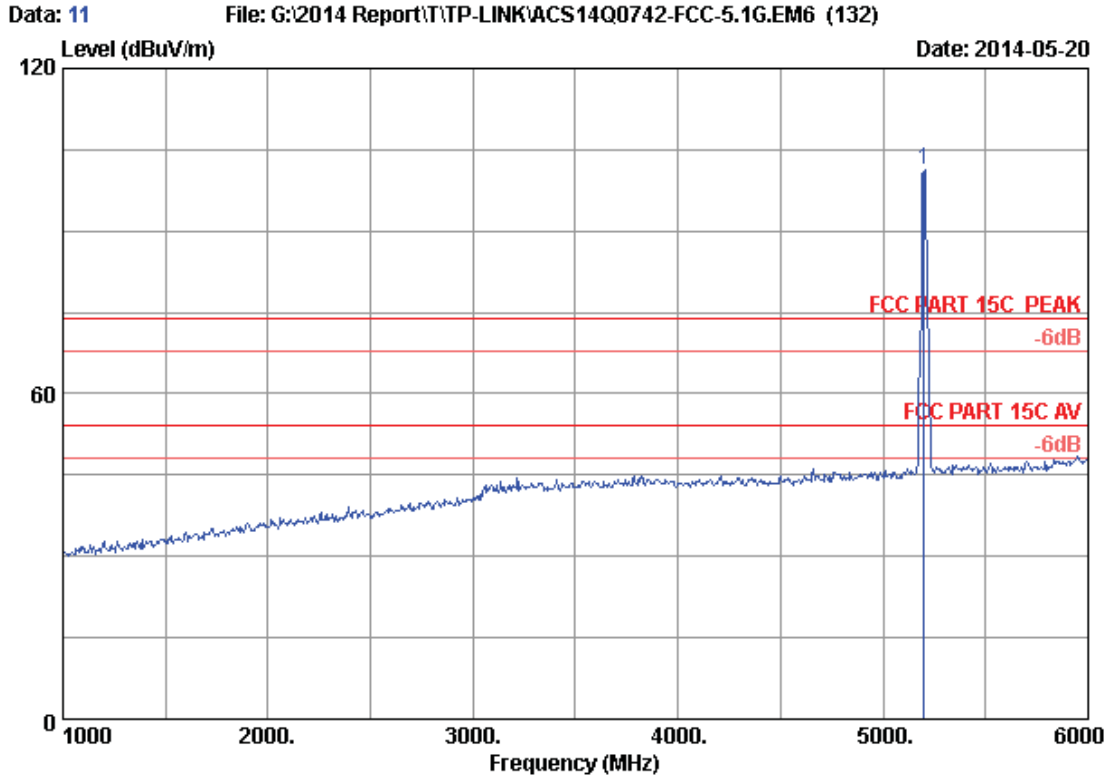

Site no. : 3m Chamber Data no. : 11
 Dis. / Ant. : 3m 2013 3115 (4580) Ant. pol. : HORIZONTAL
 Limit : FCC PART 15C PEAK
 Env. / Ins. : 24°C/56% Engineer : Kevin_Hu
 EUT : AC750 Wireless Dual Band Router
 Power Rating : DC 12V From Adapter Input AC 120V/60Hz
 Test Mode : IEEE802.11a CH40 5200MHz Tx
 M/N : C20i

No.	Freq. (MHz)	Ant. Factor (dB/m)	Cable Loss (dB)	AMP factor (dB)	Reading (dBuV)	Emission			Remark
						Level (dBuV/m)	Limits (dBuV/m)	Margin (dB)	
1	5200.000	33.52	8.97	35.70	94.37	101.16	74.00	-27.16	Peak

Remarks: 1. Emission Level= Antenna Factor + Cable Loss + Reading - Amp Factor
 2. The emission levels that are 20dB below the official limit are not reported.

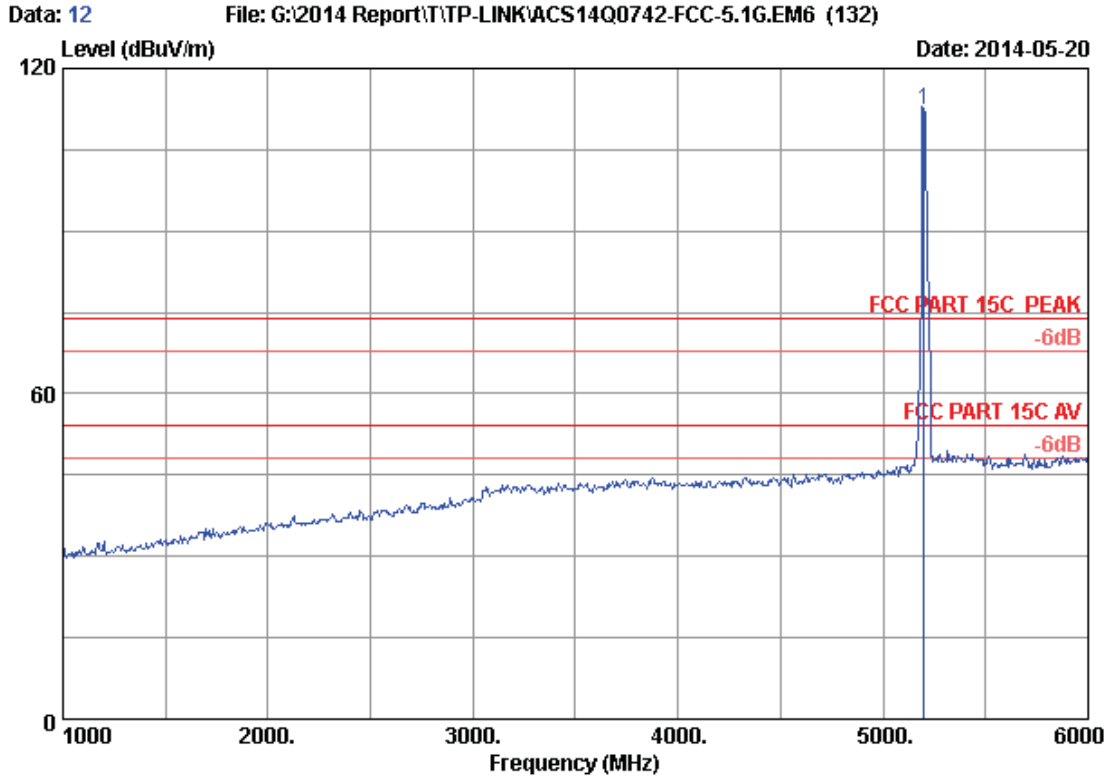

Site no. : 3m Chamber Data no. : 12
 Dis. / Ant. : 3m 2013 3115 (4580) Ant. pol. : VERTICAL
 Limit : FCC PART 15C PEAK
 Env. / Ins. : 24*C/56% Engineer : Kevin_Hu
 EUT : AC750 Wireless Dual Band Router
 Power Rating : DC 12V From Adapter Input AC 120V/60Hz
 Test Mode : IEEE802.11a CH40 5200MHz Tx
 M/N : C20i

No.	Freq. (MHz)	Ant. Factor (dB/m)	Cable Loss (dB)	AMP factor (dB)	Reading (dBuV)	Emission			Remark
						Level (dBuV/m)	Limits (dBuV/m)	Margin (dB)	
1	5200.000	33.52	8.97	35.70	105.56	112.35	74.00	-38.35	Peak

Remarks: 1. Emission Level= Antenna Factor + Cable Loss + Reading -Amp Factor
 2. The emission levels that are 20dB below the official limit are not reported.

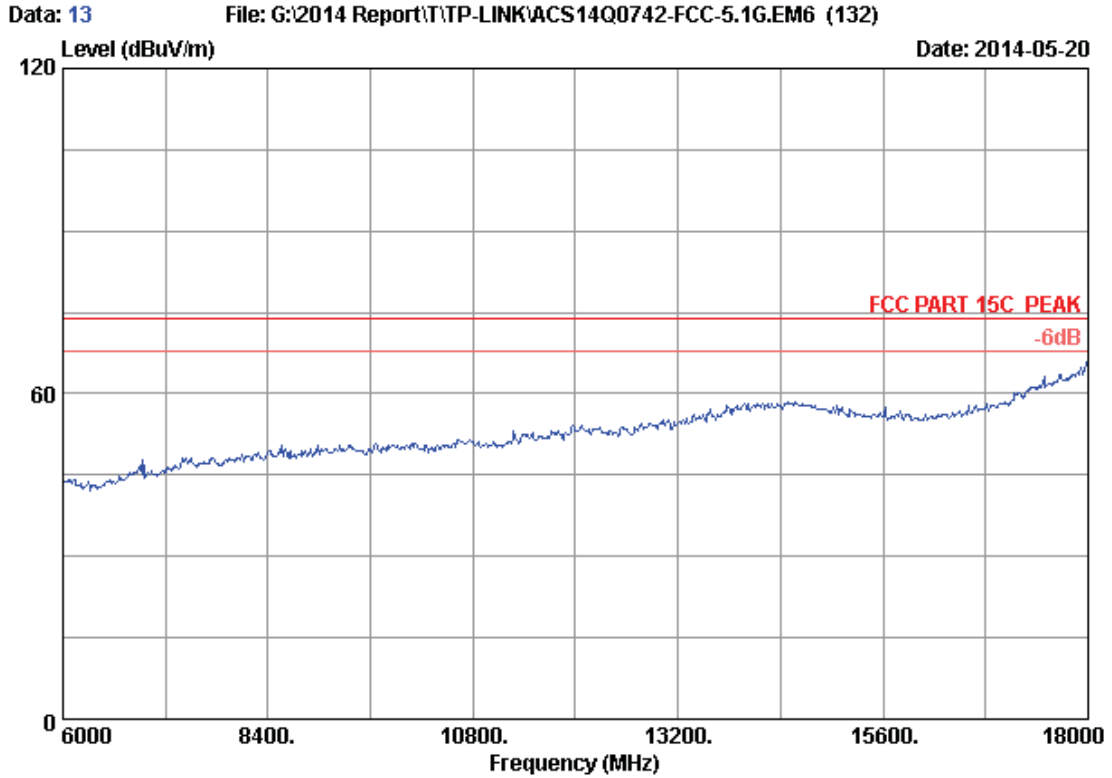

Site no. : 3m Chamber Data no. : 13
Dis. / Ant. : 3m 2013 3115 (4580) Ant. pol. : VERTICAL
Limit : FCC PART 15C PEAK
Env. / Ins. : 24*C/56% Engineer : Kevin_Hu
EUT : AC750 Wireless Dual Band Router
Power Rating : DC 12V From Adapter Input AC 120V/60Hz
Test Mode : IEEE802.11a CH40 5200MHz Tx
M/N : C20i

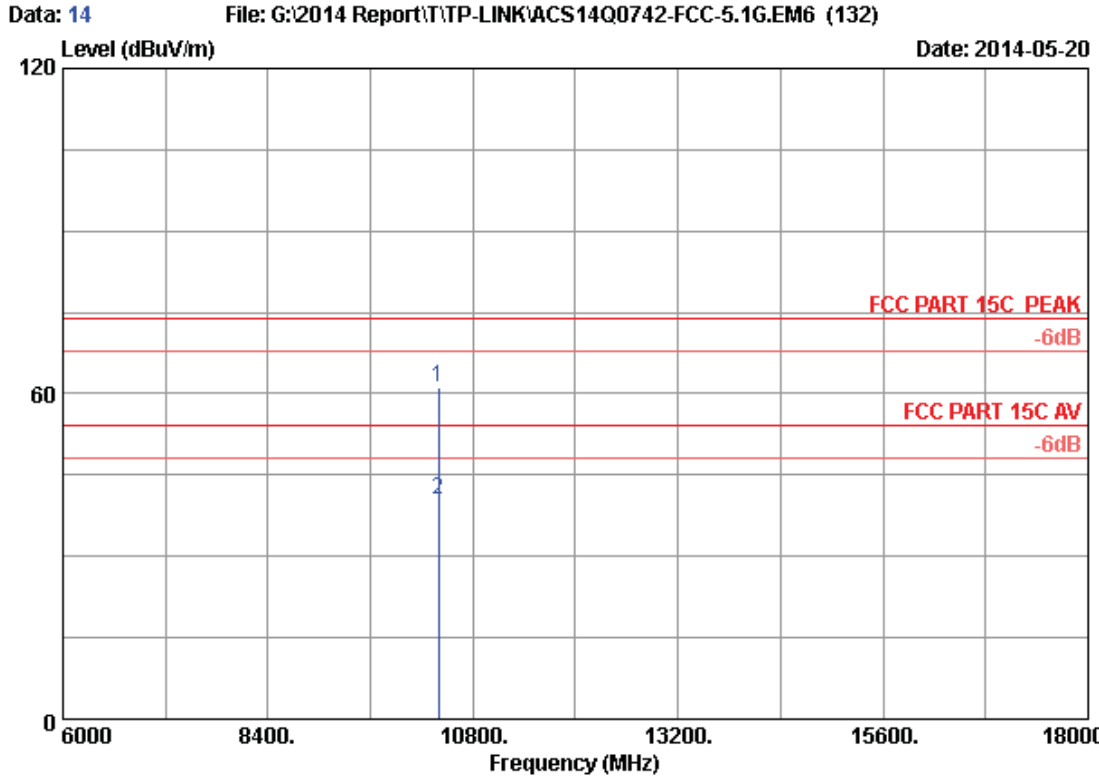

Site no. : 3m Chamber Data no. : 14
 Dis. / Ant. : 3m 2013 3115 (4580) Ant. pol. : VERTICAL
 Limit : FCC PART 15C PEAK
 Env. / Ins. : 24*C/56% Engineer : Kevin_Hu
 EUT : AC750 Wireless Dual Band Router
 Power Rating : DC 12V From Adapter Input AC 120V/60Hz
 Test Mode : IEEE802.11a CH40 5200MHz Tx
 M/N : C20i

No.	Freq. (MHz)	Ant. Factor (dB/m)	Cable Loss (dB)	AMP factor (dB)	Reading (dBuV)	Emission Level (dBuV/m)	Limits (dBuV/m)	Margin (dB)	Remark
1	10400.000	38.16	12.66	35.44	45.68	61.06	74.00	12.94	Peak
2	10400.000	38.16	12.66	35.44	25.06	40.44	54.00	13.56	Average

Remarks: 1. Emission Level= Antenna Factor + Cable Loss + Reading - Amp Factor
 2. The emission levels that are 20dB below the official limit are not reported.

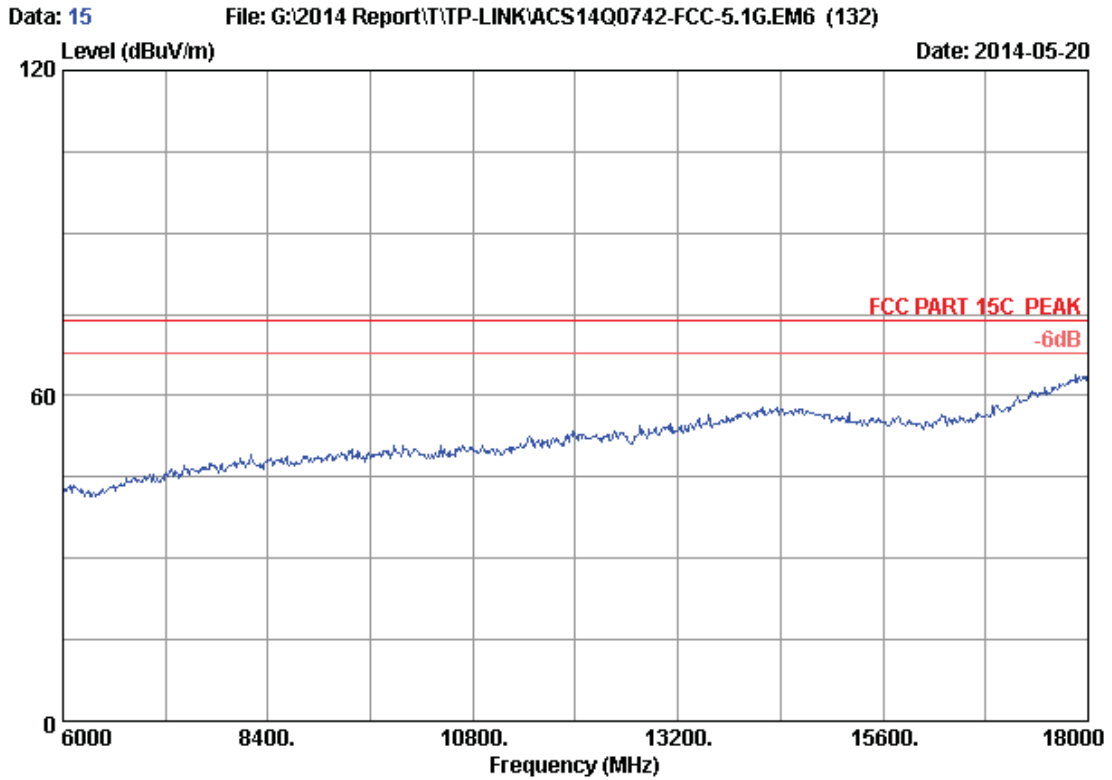

Site no. : 3m Chamber Data no. : 15
Dis. / Ant. : 3m 2013 3115 (4580) Ant. pol. : HORIZONTAL
Limit : FCC PART 15C PEAK
Env. / Ins. : 24*C/56% Engineer : Kevin_Hu
EUT : AC750 Wireless Dual Band Router
Power Rating : DC 12V From Adapter Input AC 120V/60Hz
Test Mode : IEEE802.11a CH40 5200MHz Tx
M/N : C20i

Data: 16 File: G:\2014 Report\T\TP-LINK\ACS14Q0742-FCC-5.1G.EM6 (132) Date: 2014-05-20

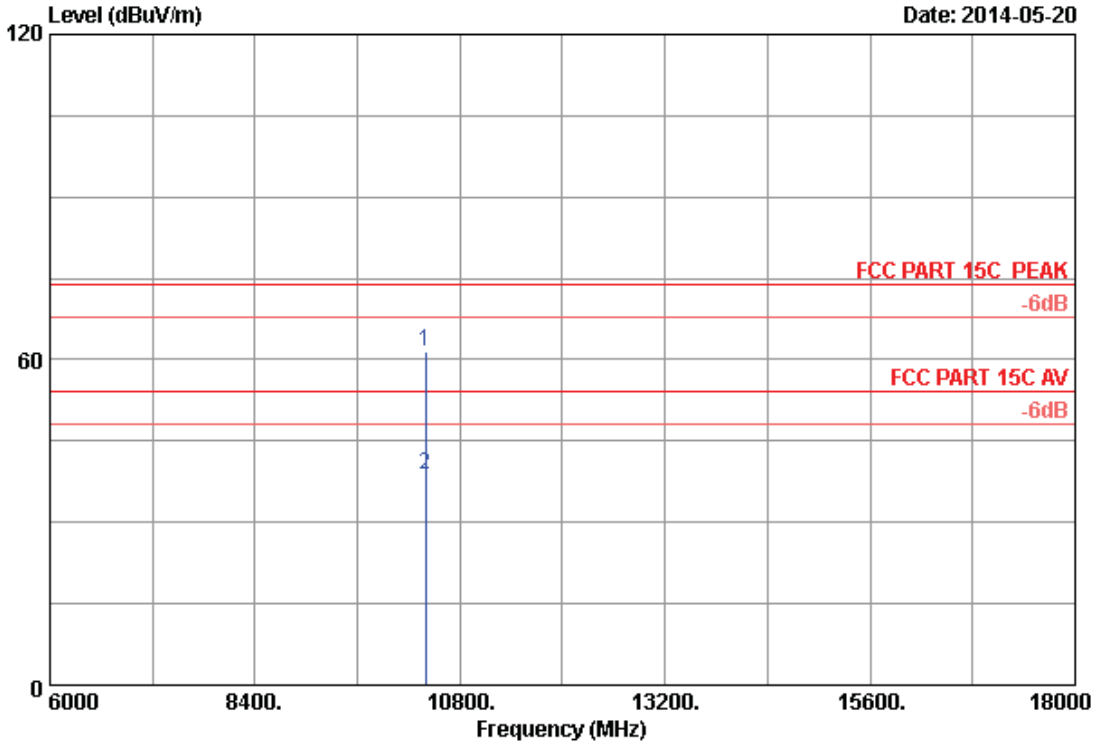

Site no. : 3m Chamber Data no. : 16
 Dis. / Ant. : 3m 2013 3115 (4580) Ant. pol. : HORIZONTAL
 Limit : FCC PART 15C PEAK
 Env. / Ins. : 24*C/56% Engineer : Kevin_Hu
 EUT : AC750 Wireless Dual Band Router
 Power Rating : DC 12V From Adapter Input AC 120V/60Hz
 Test Mode : IEEE802.11a CH40 5200MHz Tx
 M/N : C20i

No.	Freq. (MHz)	Ant. Factor (dB/m)	Cable Loss (dB)	AMP factor (dB)	Reading (dBuV)	Emission Level (dBuV/m)	Limits (dBuV/m)	Margin (dB)	Remark
1	10400.000	38.16	12.66	35.44	46.03	61.41	74.00	12.59	Peak
2	10400.000	38.16	12.66	35.44	23.42	38.80	54.00	15.20	Average

Remarks: 1. Emission Level= Antenna Factor + Cable Loss + Reading - Amp Factor
 2. The emission levels that are 20dB below the official limit are not reported.

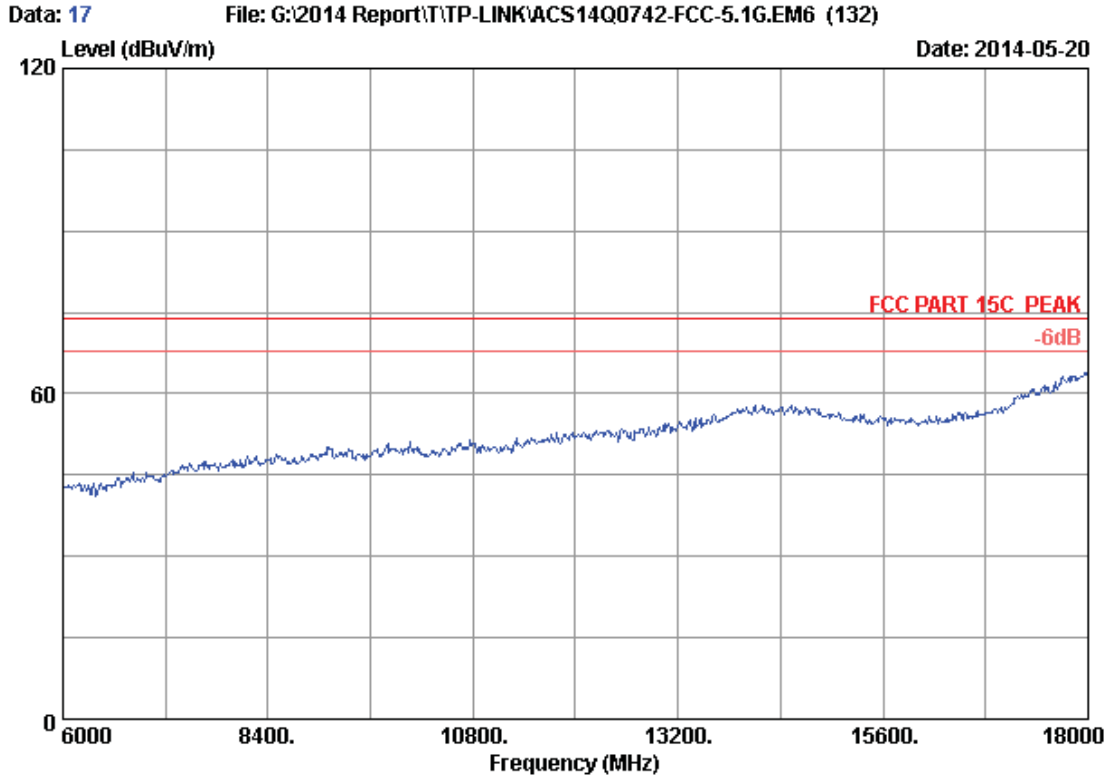

Site no. : 3m Chamber Data no. : 17
Dis. / Ant. : 3m 2013 3115 (4580) Ant. pol. : HORIZONTAL
Limit : FCC PART 15C PEAK
Env. / Ins. : 24°C/56% Engineer : Kevin_Hu
EUT : AC750 Wireless Dual Band Router
Power Rating : DC 12V From Adapter Input AC 120V/60Hz
Test Mode : IEEE802.11a CH48 5240MHz Tx
M/N : C20i

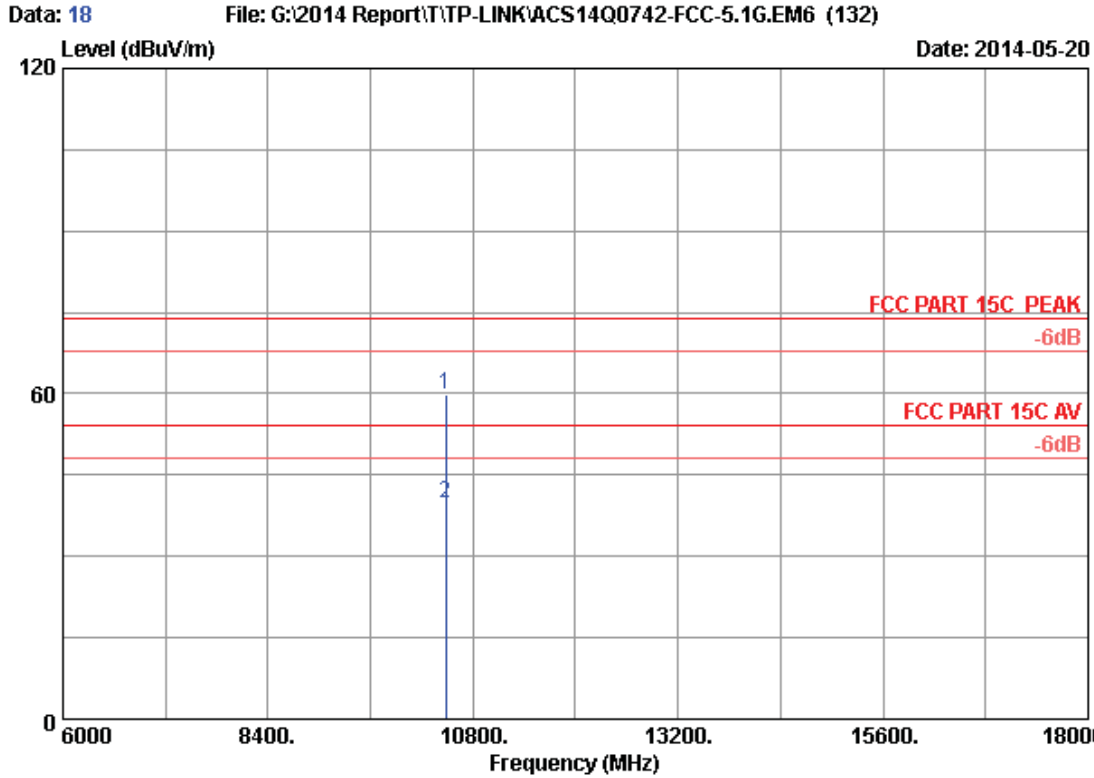

Site no. : 3m Chamber Data no. : 18
 Dis. / Ant. : 3m 2013 3115 (4580) Ant. pol. : HORIZONTAL
 Limit : FCC PART 15C PEAK
 Env. / Ins. : 24*C/56% Engineer : Kevin_Hu
 EUT : AC750 Wireless Dual Band Router
 Power Rating : DC 12V From Adapter Input AC 120V/60Hz
 Test Mode : IEEE802.11a CH48 5240MHz Tx
 M/N : C20i

No.	Freq. (MHz)	Ant. Factor (dB/m)	Cable Loss (dB)	AMP factor (dB)	Reading (dBuV)	Emission Level (dBuV/m)	Limits (dBuV/m)	Margin (dB)	Remark
1	10480.000	38.19	12.70	35.43	44.38	59.84	74.00	14.16	Peak
2	10480.000	38.19	12.70	35.43	24.17	39.63	54.00	14.37	Average

Remarks: 1. Emission Level= Antenna Factor + Cable Loss + Reading - Amp Factor
 2. The emission levels that are 20dB below the official limit are not reported.

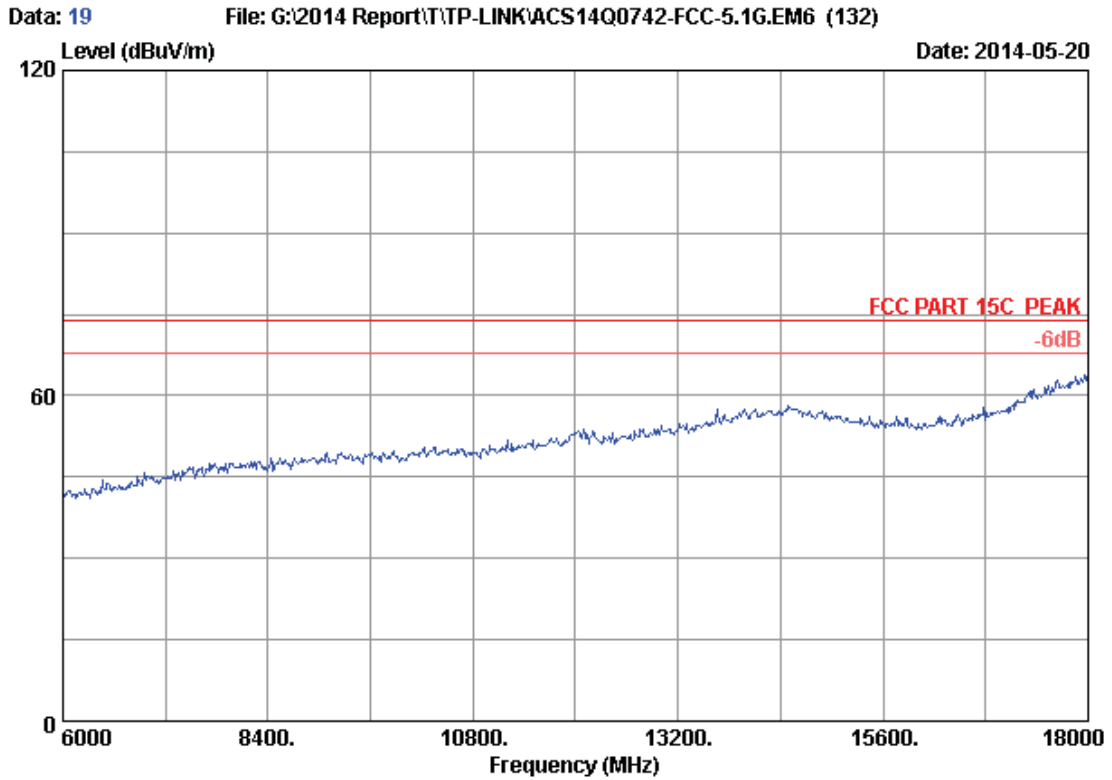

Site no. : 3m Chamber Data no. : 19
Dis. / Ant. : 3m 2013 3115 (4580) Ant. pol. : VERTICAL
Limit : FCC PART 15C PEAK
Env. / Ins. : 24*C/56% Engineer : Kevin_Hu
EUT : AC750 Wireless Dual Band Router
Power Rating : DC 12V From Adapter Input AC 120V/60Hz
Test Mode : IEEE802.11a CH48 5240MHz Tx
M/N : C20i

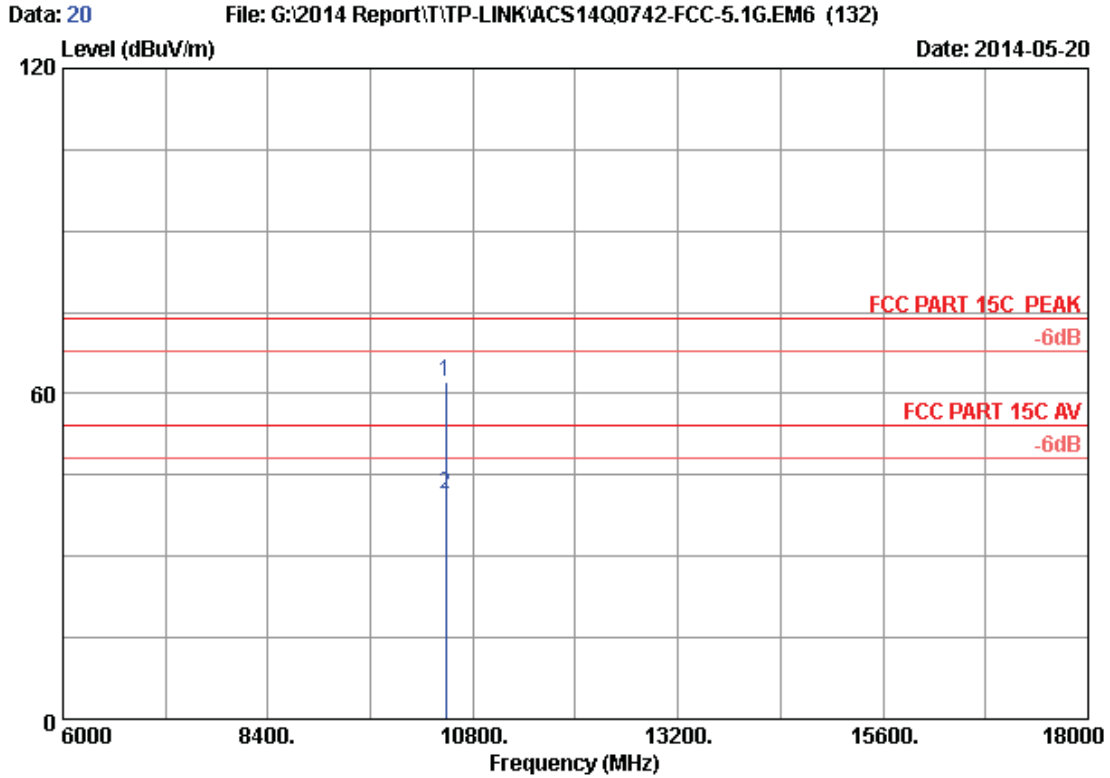

Site no. : 3m Chamber Data no. : 20
 Dis. / Ant. : 3m 2013 3115 (4580) Ant. pol. : VERTICAL
 Limit : FCC PART 15C PEAK
 Env. / Ins. : 24*C/56% Engineer : Kevin_Hu
 EUT : AC750 Wireless Dual Band Router
 Power Rating : DC 12V From Adapter Input AC 120V/60Hz
 Test Mode : IEEE802.11a CH48 5240MHz Tx
 M/N : C20i

No.	Freq. (MHz)	Ant. Factor (dB/m)	Cable Loss (dB)	AMP factor (dB)	Reading (dBUV)	Emission Level (dBUV/m)	Limits (dBUV/m)	Margin (dB)	Remark
1	10480.000	38.19	12.70	35.43	46.58	62.04	74.00	11.96	Peak
2	10480.000	38.19	12.70	35.43	26.08	41.54	54.00	12.46	Average

Remarks: 1. Emission Level= Antenna Factor + Cable Loss + Reading - Amp Factor
 2. The emission levels that are 20dB below the official limit are not reported.

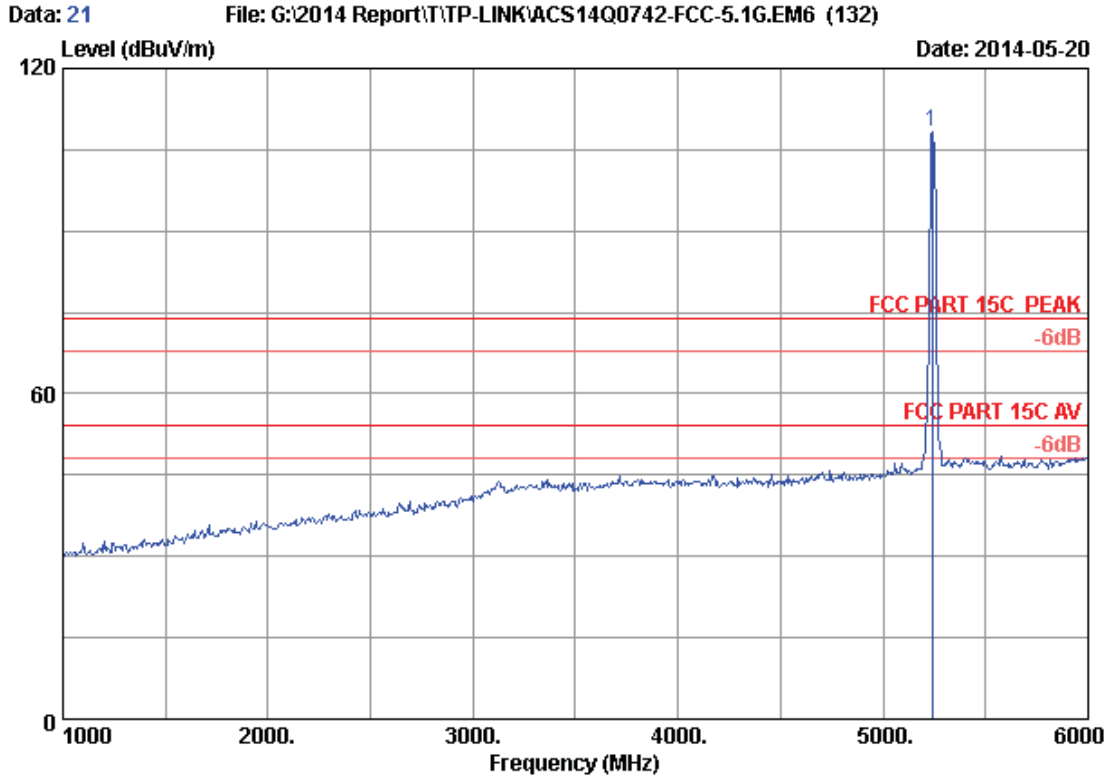

Site no. : 3m Chamber Data no. : 21
 Dis. / Ant. : 3m 2013 3115 (4580) Ant. pol. : VERTICAL
 Limit : FCC PART 15C PEAK
 Env. / Ins. : 24°C/56% Engineer : Kevin_Hu
 EUT : AC750 Wireless Dual Band Router
 Power Rating : DC 12V From Adapter Input AC 120V/60Hz
 Test Mode : IEEE802.11a CH48 5240MHz Tx
 M/N : C20i

No.	Freq. (MHz)	Ant. Factor (dB/m)	Cable Loss (dB)	AMP factor (dB)	Reading (dBUV)	Emission			Remark
						Level (dBUV/m)	Limits (dBUV/m)	Margin (dB)	
1	5240.000	33.58	9.02	35.70	101.28	108.18	74.00	-34.18	Peak

Remarks: 1. Emission Level= Antenna Factor + Cable Loss + Reading - Amp Factor
 2. The emission levels that are 20dB below the official limit are not reported.

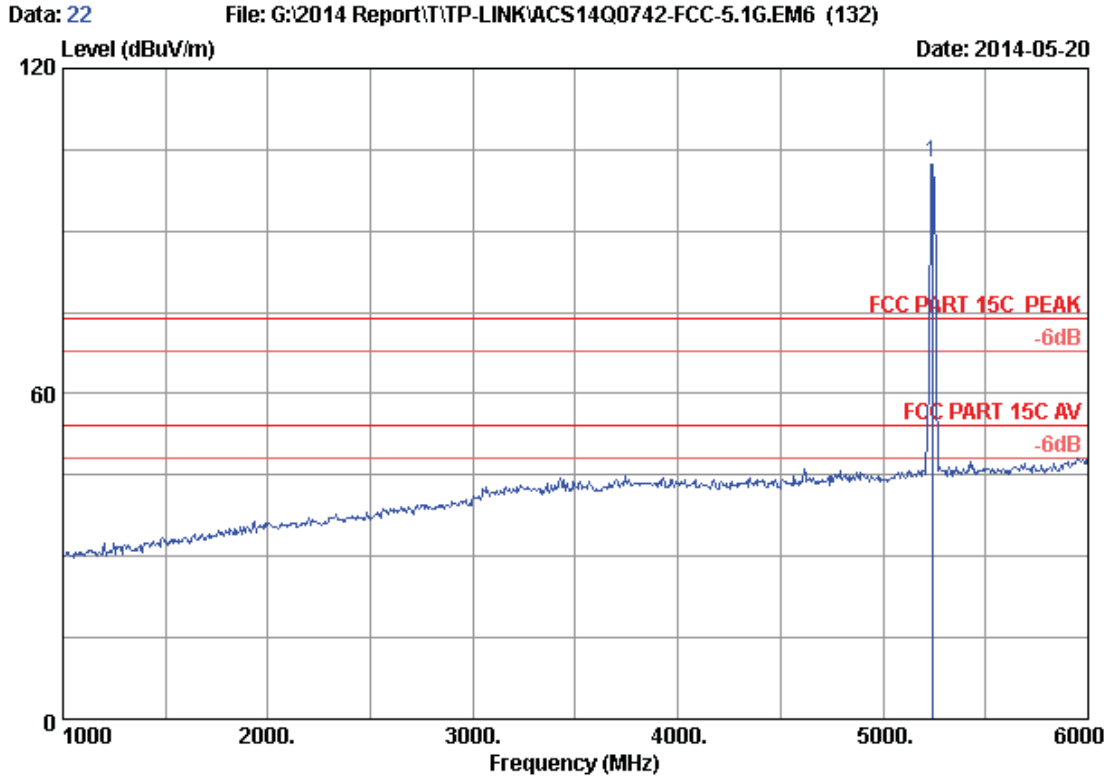

Site no. : 3m Chamber Data no. : 22
 Dis. / Ant. : 3m 2013 3115 (4580) Ant. pol. : HORIZONTAL
 Limit : FCC PART 15C PEAK
 Env. / Ins. : 24*C/56% Engineer : Kevin_Hu
 EUT : AC750 Wireless Dual Band Router
 Power Rating : DC 12V From Adapter Input AC 120V/60Hz
 Test Mode : IEEE802.11a CH48 5240MHz Tx
 M/N : C20i

No.	Freq. (MHz)	Ant. Factor (dB/m)	Cable Loss (dB)	AMP factor (dB)	Reading (dBuV)	Emission			Remark
						Level (dBuV/m)	Limits (dBuV/m)	Margin (dB)	
1	5240.000	33.58	9.02	35.70	95.75	102.65	74.00	-28.65	Peak

Remarks: 1. Emission Level= Antenna Factor + Cable Loss + Reading - Amp Factor
 2. The emission levels that are 20dB below the official limit are not reported.

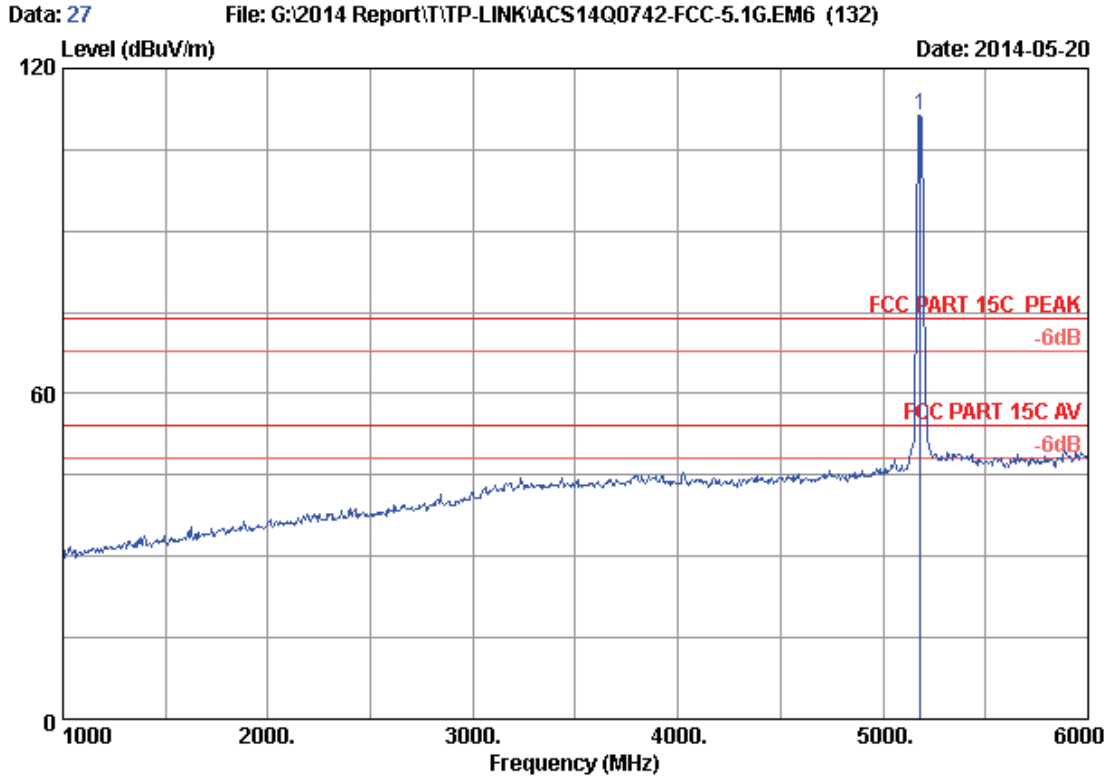

Site no. : 3m Chamber Data no. : 27
 Dis. / Ant. : 3m 2013 3115 (4580) Ant. pol. : VERTICAL
 Limit : FCC PART 15C PEAK
 Env. / Ins. : 24*C/56% Engineer : Kevin_Hu
 EUT : AC750 Wireless Dual Band Router
 Power Rating : DC 12V From Adapter Input AC 120V/60Hz
 Test Mode : IEEE802.11nHT20 CH36 5180MHz Tx
 M/N : C20i

No.	Freq. (MHz)	Ant. Factor (dB/m)	Cable Loss (dB)	AMP factor (dB)	Reading (dBUV)	Emission			Remark
						Level (dBUV/m)	Limits (dBUV/m)	Margin (dB)	
1	5180.000	33.49	8.95	35.70	104.67	111.41	74.00	-37.41	Peak

Remarks: 1. Emission Level= Antenna Factor + Cable Loss + Reading -Amp Factor
 2. The emission levels that are 20dB below the official limit are not reported.

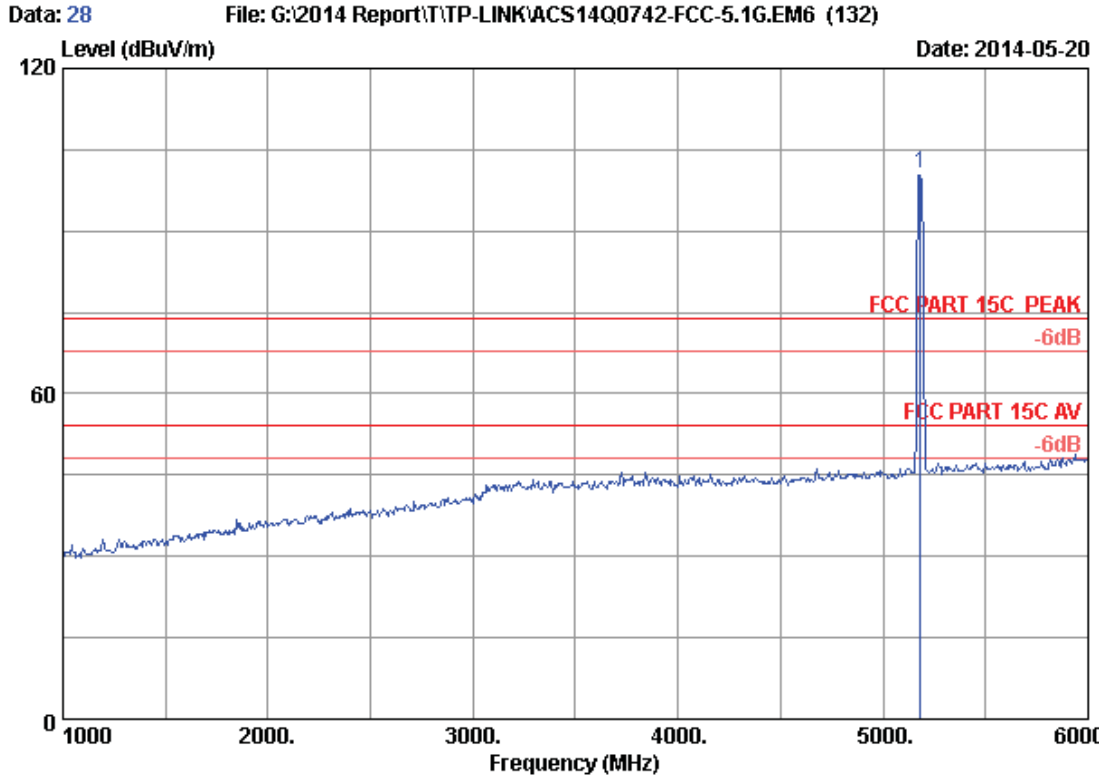

Site no. : 3m Chamber Data no. : 28
 Dis. / Ant. : 3m 2013 3115 (4580) Ant. pol. : HORIZONTAL
 Limit : FCC PART 15C PEAK
 Env. / Ins. : 24°C/56% Engineer : Kevin_Hu
 EUT : AC750 Wireless Dual Band Router
 Power Rating : DC 12V From Adapter Input AC 120V/60Hz
 Test Mode : IEEE802.11nHT20 CH36 5180MHz Tx
 M/N : C20i

No.	Freq. (MHz)	Ant. Factor (dB/m)	Cable Loss (dB)	AMP factor (dB)	Reading (dBUV)	Emission			Remark
						Level (dBUV/m)	Limits (dBUV/m)	Margin (dB)	
1	5180.000	33.49	8.95	35.70	93.87	100.61	74.00	-26.61	Peak

Remarks: 1. Emission Level= Antenna Factor + Cable Loss + Reading -Amp Factor
 2. The emission levels that are 20dB below the official limit are not reported.

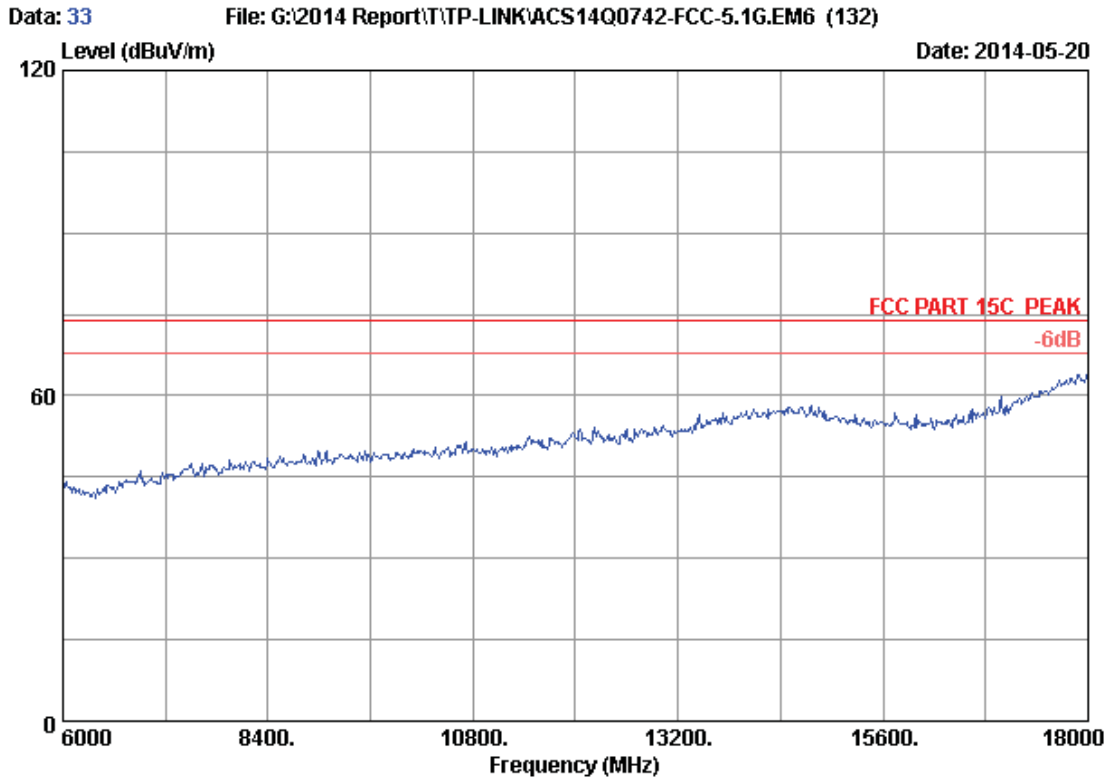

Site no. : 3m Chamber Data no. : 33
Dis. / Ant. : 3m 2013 3115 (4580) Ant. pol. : VERTICAL
Limit : FCC PART 15C PEAK
Env. / Ins. : 24*C/56% Engineer : Kevin_Hu
EUT : AC750 Wireless Dual Band Router
Power Rating : DC 12V From Adapter Input AC 120V/60Hz
Test Mode : IEEE802.11nHT20 CH36 5180MHz Tx
M/N : C20i

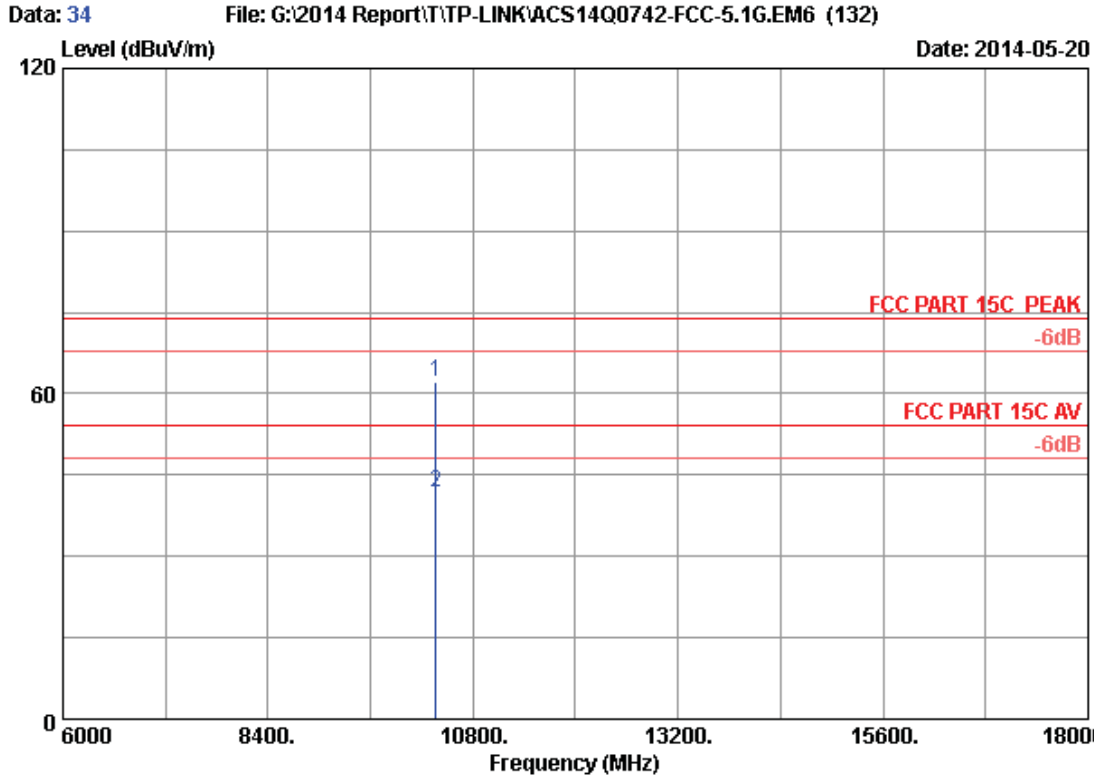

Site no. : 3m Chamber Data no. : 34
 Dis. / Ant. : 3m 2013 3115 (4580) Ant. pol. : VERTICAL
 Limit : FCC PART 15C PEAK
 Env. / Ins. : 24*C/56% Engineer : Kevin_Hu
 EUT : AC750 Wireless Dual Band Router
 Power Rating : DC 12V From Adapter Input AC 120V/60Hz
 Test Mode : IEEE802.11nHT20 CH36 5180MHz Tx
 M/N : C20i

No.	Freq. (MHz)	Ant. Factor (dB/m)	Cable Loss (dB)	AMP factor (dB)	Reading (dBUV)	Emission Level (dBUV/m)	Limits (dBUV/m)	Margin (dB)	Remark
1	10360.000	38.14	12.64	35.45	46.86	62.19	74.00	11.81	Peak
2	10360.000	38.14	12.64	35.45	26.45	41.78	54.00	12.22	Average

Remarks: 1. Emission Level= Antenna Factor + Cable Loss + Reading - Amp Factor
 2. The emission levels that are 20dB below the official limit are not reported.

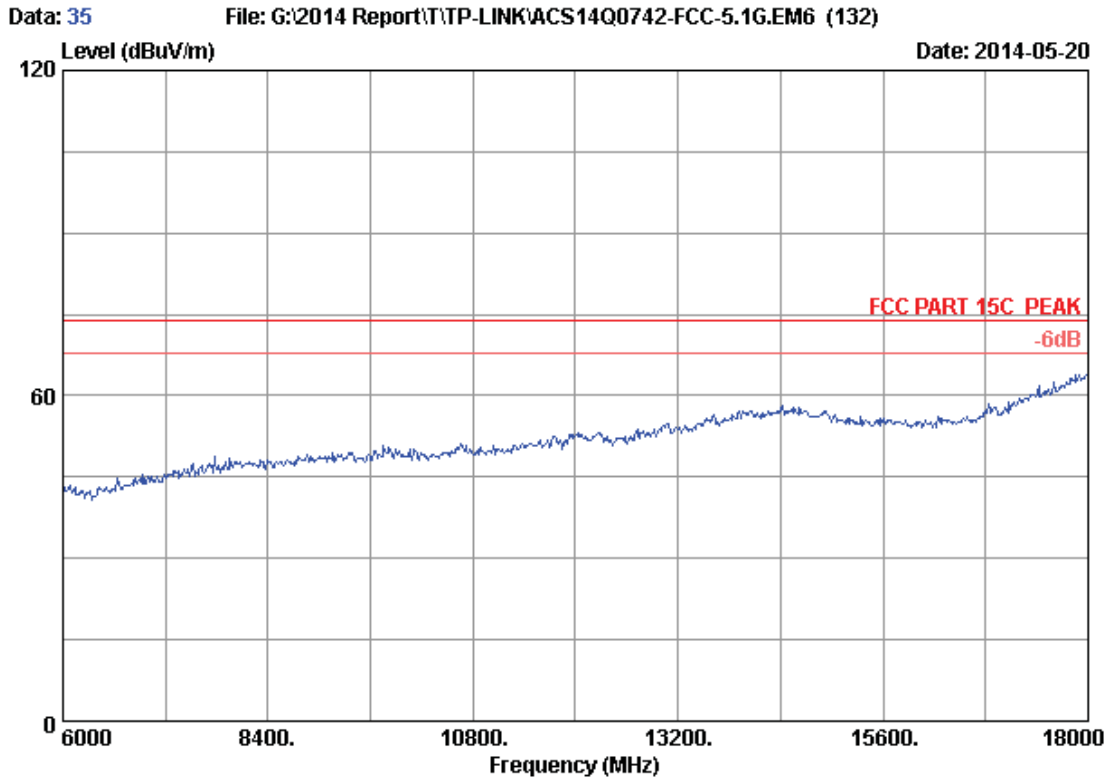

Site no. : 3m Chamber Data no. : 35
 Dis. / Ant. : 3m 2013 3115 (4580) Ant. pol. : HORIZONTAL
 Limit : FCC PART 15C PEAK
 Env. / Ins. : 24°C/56% Engineer : Kevin_Hu
 EUT : AC750 Wireless Dual Band Router
 Power Rating : DC 12V From Adapter Input AC 120V/60Hz
 Test Mode : IEEE802.11nHT20 CH36 5180MHz Tx
 M/N : C20i

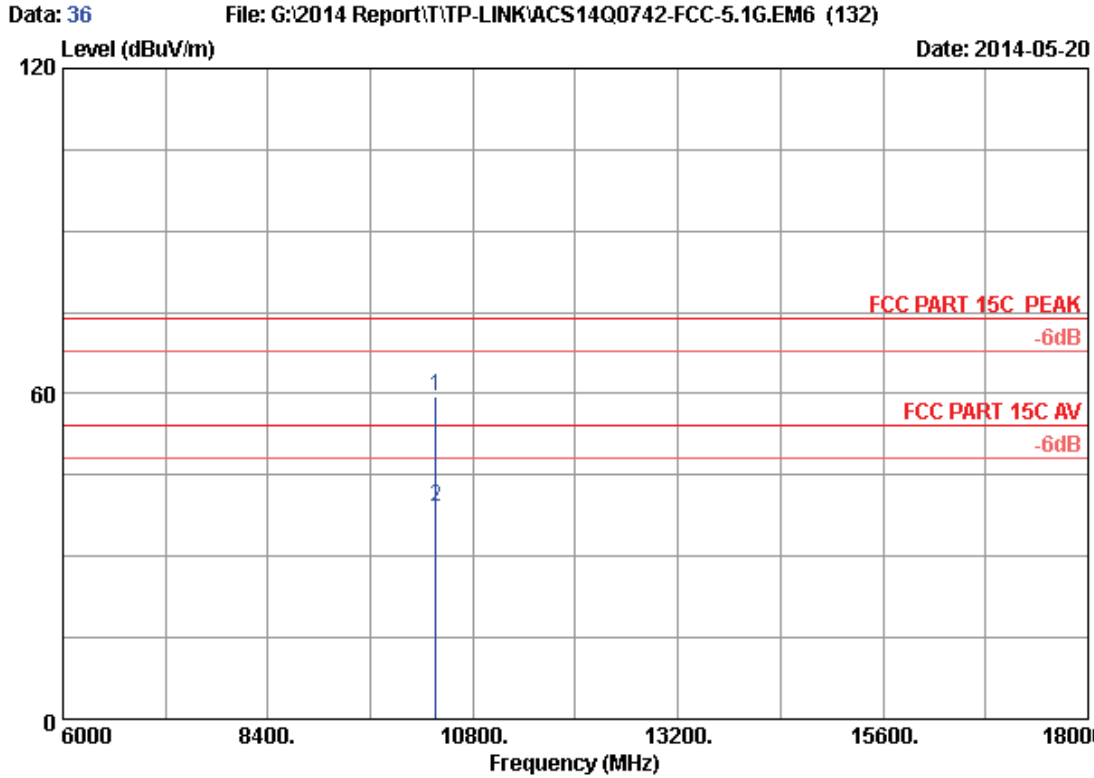

Site no. : 3m Chamber Data no. : 36
 Dis. / Ant. : 3m 2013 3115 (4580) Ant. pol. : HORIZONTAL
 Limit : FCC PART 15C PEAK
 Env. / Ins. : 24*C/56% Engineer : Kevin_Hu
 EUT : AC750 Wireless Dual Band Router
 Power Rating : DC 12V From Adapter Input AC 120V/60Hz
 Test Mode : IEEE802.11nHT20 CH36 5180MHz Tx
 M/N : C20i

No.	Freq. (MHz)	Ant. Factor (dB/m)	Cable Loss (dB)	AMP factor (dB)	Reading (dBUV)	Emission Level (dBUV/m)	Limits (dBUV/m)	Margin (dB)	Remark
1	10360.000	38.14	12.64	35.45	44.29	59.62	74.00	14.38	Peak
2	10360.000	38.14	12.64	35.45	23.75	39.08	54.00	14.92	Average

Remarks: 1. Emission Level= Antenna Factor + Cable Loss + Reading - Amp Factor
 2. The emission levels that are 20dB below the official limit are not reported.

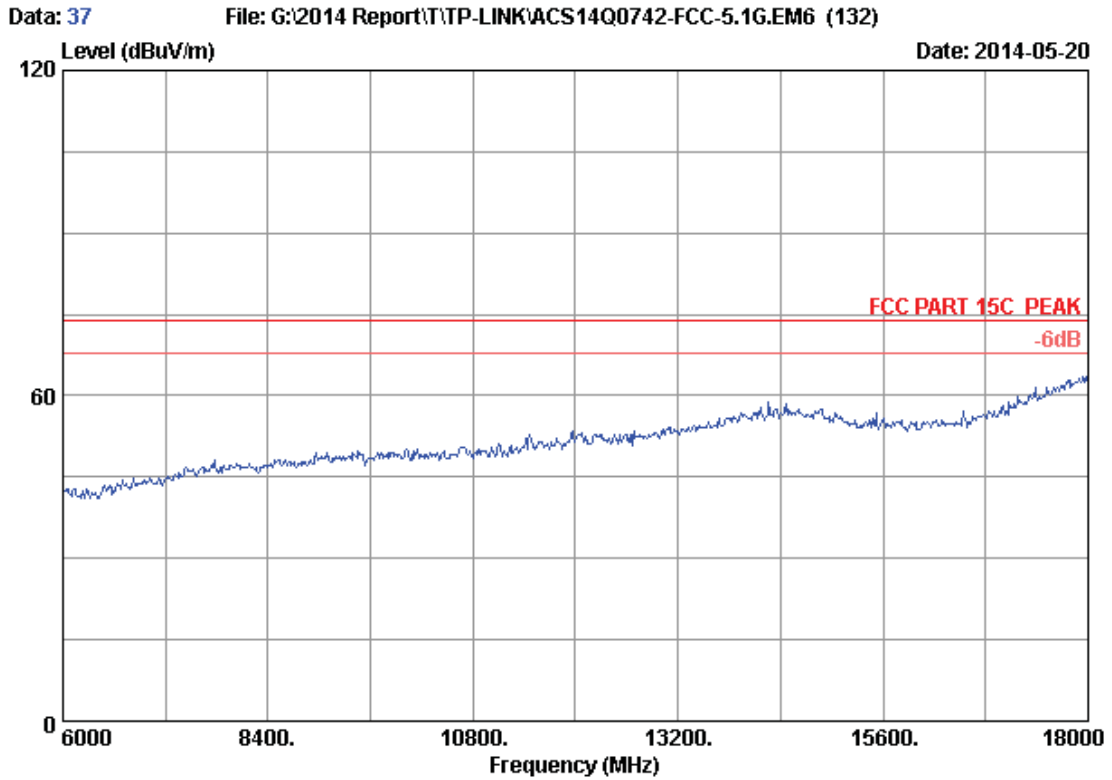

Site no. : 3m Chamber Data no. : 37
Dis. / Ant. : 3m 2013 3115 (4580) Ant. pol. : HORIZONTAL
Limit : FCC PART 15C PEAK
Env. / Ins. : 24*C/56% Engineer : Kevin_Hu
EUT : AC750 Wireless Dual Band Router
Power Rating : DC 12V From Adapter Input AC 120V/60Hz
Test Mode : IEEE802.11nHT20 CH40 5200MHz Tx
M/N : C20i

Data: 38 File: G:\2014 Report\T\TP-LINK\ACS14Q0742-FCC-5.1G.EM6 (132) Date: 2014-05-20

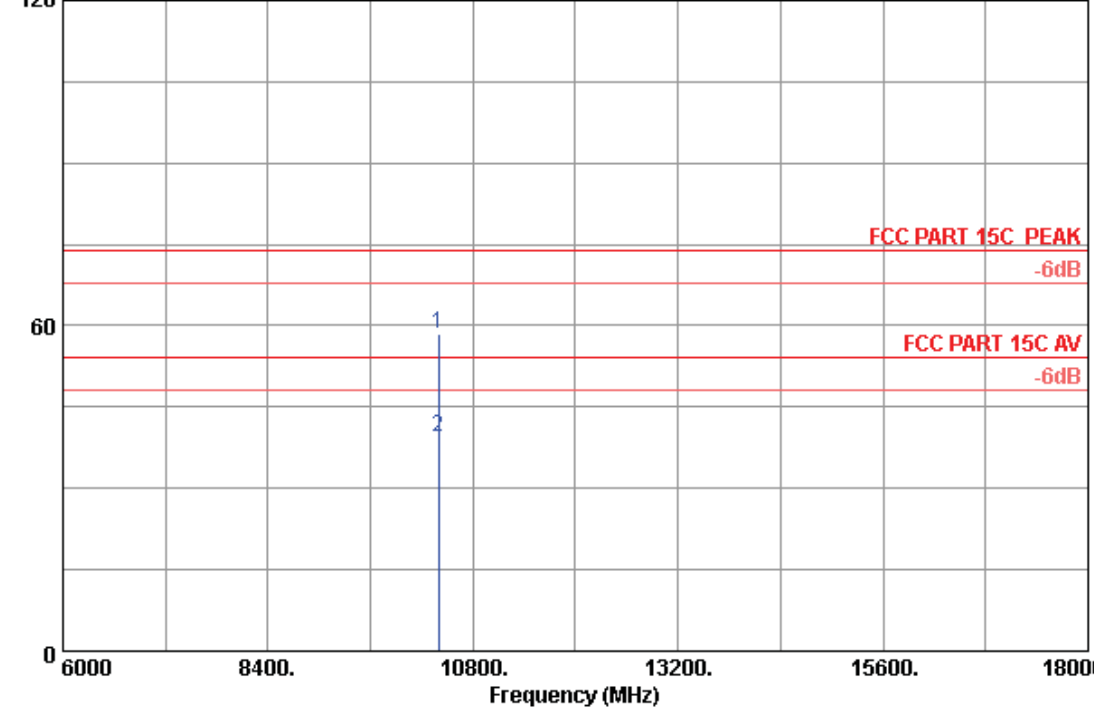

Site no. : 3m Chamber Data no. : 38
 Dis. / Ant. : 3m 2013 3115 (4580) Ant. pol. : HORIZONTAL
 Limit : FCC PART 15C PEAK
 Env. / Ins. : 24*C/56% Engineer : Kevin_Hu
 EUT : AC750 Wireless Dual Band Router
 Power Rating : DC 12V From Adapter Input AC 120V/60Hz
 Test Mode : IEEE802.11nHT20 CH40 5200MHz Tx
 M/N : C20i

No.	Freq. (MHz)	Ant. Factor (dB/m)	Cable Loss (dB)	AMP factor (dB)	Reading (dBuV)	Emission Level (dBuV/m)	Limits (dBuV/m)	Margin (dB)	Remark
1	10400.000	38.16	12.66	35.44	43.25	58.63	74.00	15.37	Peak
2	10400.000	38.16	12.66	35.44	24.01	39.39	54.00	14.61	Average

Remarks: 1. Emission Level= Antenna Factor + Cable Loss + Reading -Amp Factor
 2. The emission levels that are 20dB below the official limit are not reported.

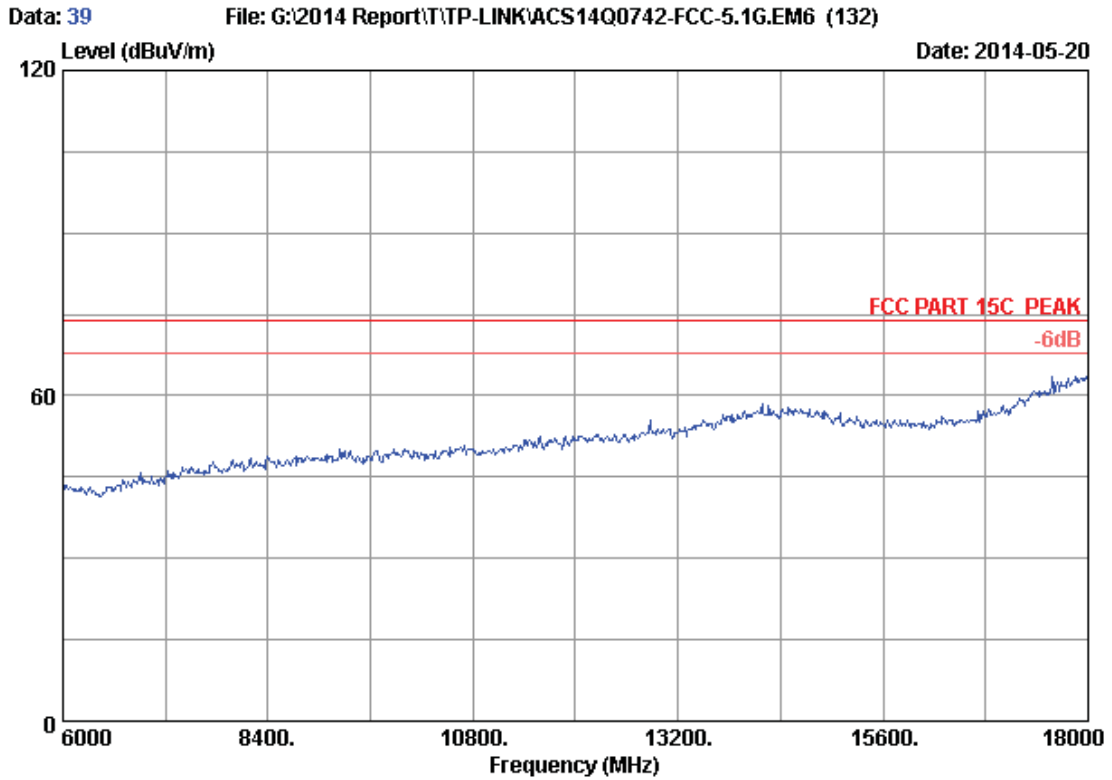

Site no. : 3m Chamber Data no. : 39
Dis. / Ant. : 3m 2013 3115 (4580) Ant. pol. : VERTICAL
Limit : FCC PART 15C PEAK
Env. / Ins. : 24*C/56% Engineer : Kevin_Hu
EUT : AC750 Wireless Dual Band Router
Power Rating : DC 12V From Adapter Input AC 120V/60Hz
Test Mode : IEEE802.11nHT20 CH40 5200MHz Tx
M/N : C20i

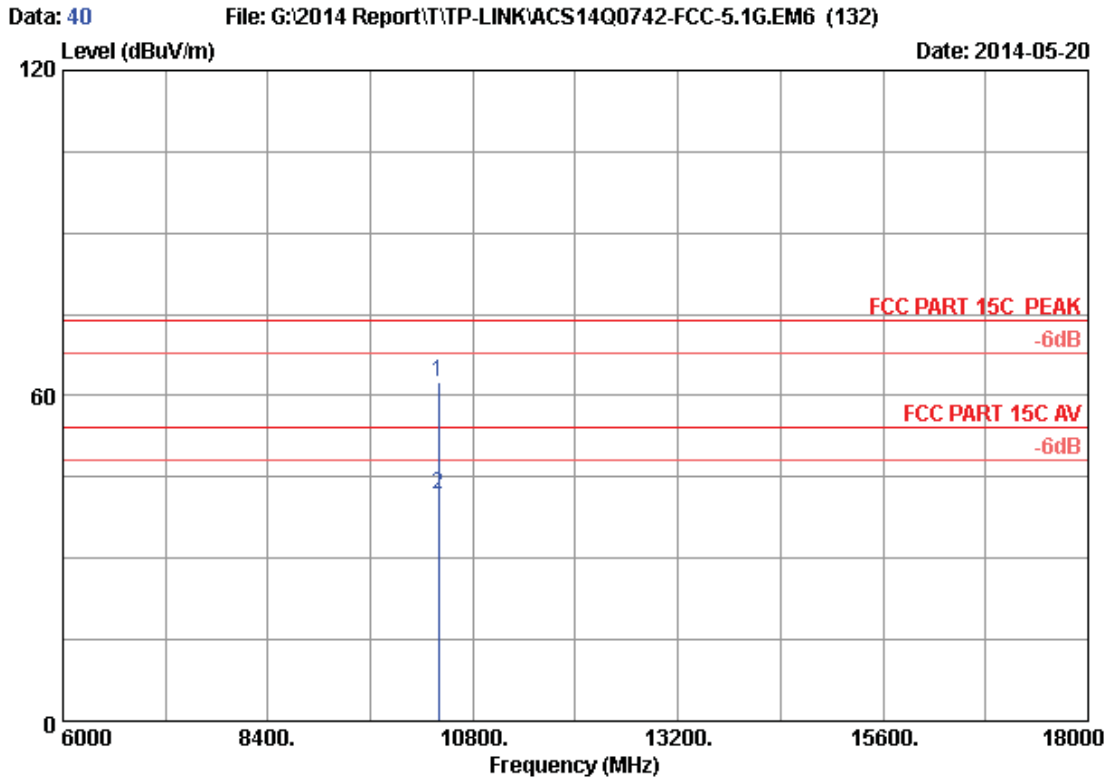

Site no. : 3m Chamber Data no. : 40
 Dis. / Ant. : 3m 2013 3115 (4580) Ant. pol. : VERTICAL
 Limit : FCC PART 15C PEAK
 Env. / Ins. : 24*C/56% Engineer : Kevin_Hu
 EUT : AC750 Wireless Dual Band Router
 Power Rating : DC 12V From Adapter Input AC 120V/60Hz
 Test Mode : IEEE802.11nHT20 CH40 5200MHz Tx
 M/N : C20i

No.	Freq. (MHz)	Ant. Factor (dB/m)	Cable Loss (dB)	AMP factor (dB)	Reading (dBuV)	Emission Level (dBuV/m)	Limits (dBuV/m)	Margin (dB)	Remark
1	10400.000	38.16	12.66	35.44	47.08	62.46	74.00	11.54	Peak
2	10400.000	38.16	12.66	35.44	26.49	41.87	54.00	12.13	Average

Remarks: 1. Emission Level= Antenna Factor + Cable Loss + Reading - Amp Factor
 2. The emission levels that are 20dB below the official limit are not reported.

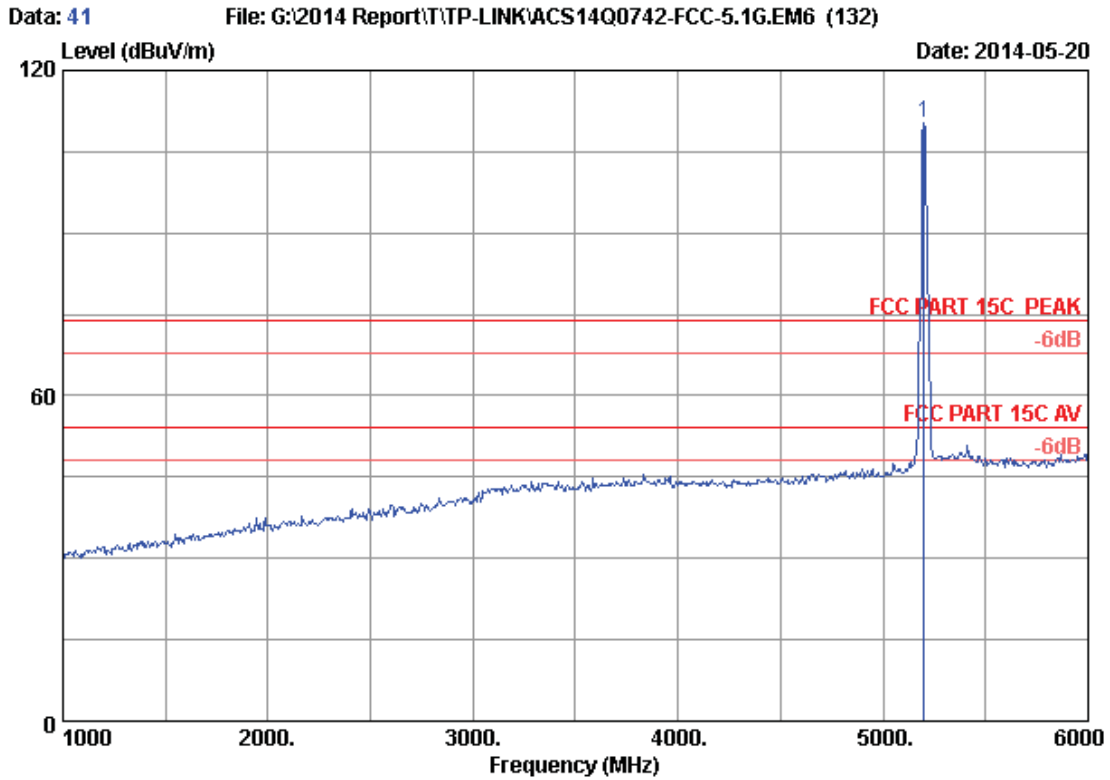

Site no. : 3m Chamber Data no. : 41
 Dis. / Ant. : 3m 2013 3115 (4580) Ant. pol. : VERTICAL
 Limit : FCC PART 15C PEAK
 Env. / Ins. : 24°C/56% Engineer : Kevin_Hu
 EUT : AC750 Wireless Dual Band Router
 Power Rating : DC 12V From Adapter Input AC 120V/60Hz
 Test Mode : IEEE802.11nHT20 CH40 5200MHz Tx
 M/N : C20i

No.	Freq. (MHz)	Ant. Factor (dB/m)	Cable Loss (dB)	AMP factor (dB)	Reading (dBuV)	Emission			Remark
						Level (dBuV/m)	Limits (dBuV/m)	Margin (dB)	
1	5200.000	33.52	8.97	35.70	103.67	110.46	74.00	-36.46	Peak

Remarks: 1. Emission Level= Antenna Factor + Cable Loss + Reading -Amp Factor
 2. The emission levels that are 20dB below the official limit are not reported.

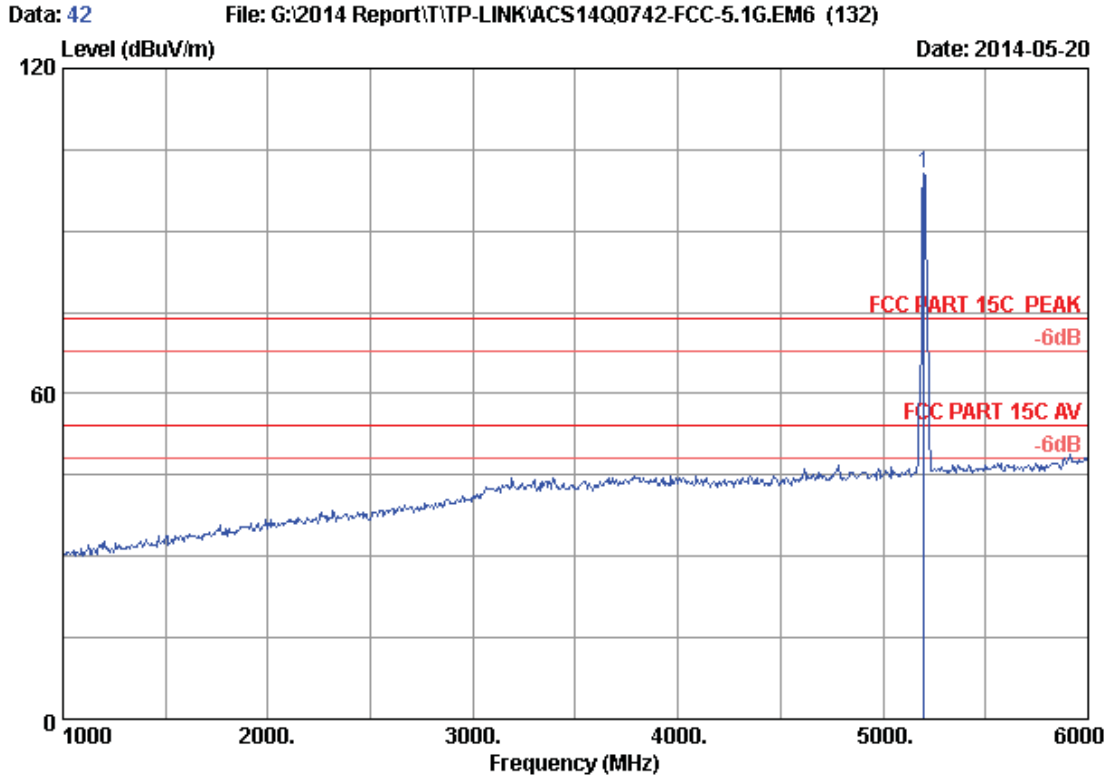

Site no. : 3m Chamber Data no. : 42
 Dis. / Ant. : 3m 2013 3115 (4580) Ant. pol. : HORIZONTAL
 Limit : FCC PART 15C PEAK
 Env. / Ins. : 24°C/56% Engineer : Kevin_Hu
 EUT : AC750 Wireless Dual Band Router
 Power Rating : DC 12V From Adapter Input AC 120V/60Hz
 Test Mode : IEEE802.11nHT20 CH40 5200MHz Tx
 M/N : C20i

No.	Freq. (MHz)	Ant. Factor (dB/m)	Cable Loss (dB)	AMP factor (dB)	Reading (dBuV)	Emission			Remark
						Level (dBuV/m)	Limits (dBuV/m)	Margin (dB)	
1	5200.000	33.52	8.97	35.70	93.75	100.54	74.00	-26.54	Peak

Remarks: 1. Emission Level= Antenna Factor + Cable Loss + Reading - Amp Factor
 2. The emission levels that are 20dB below the official limit are not reported.

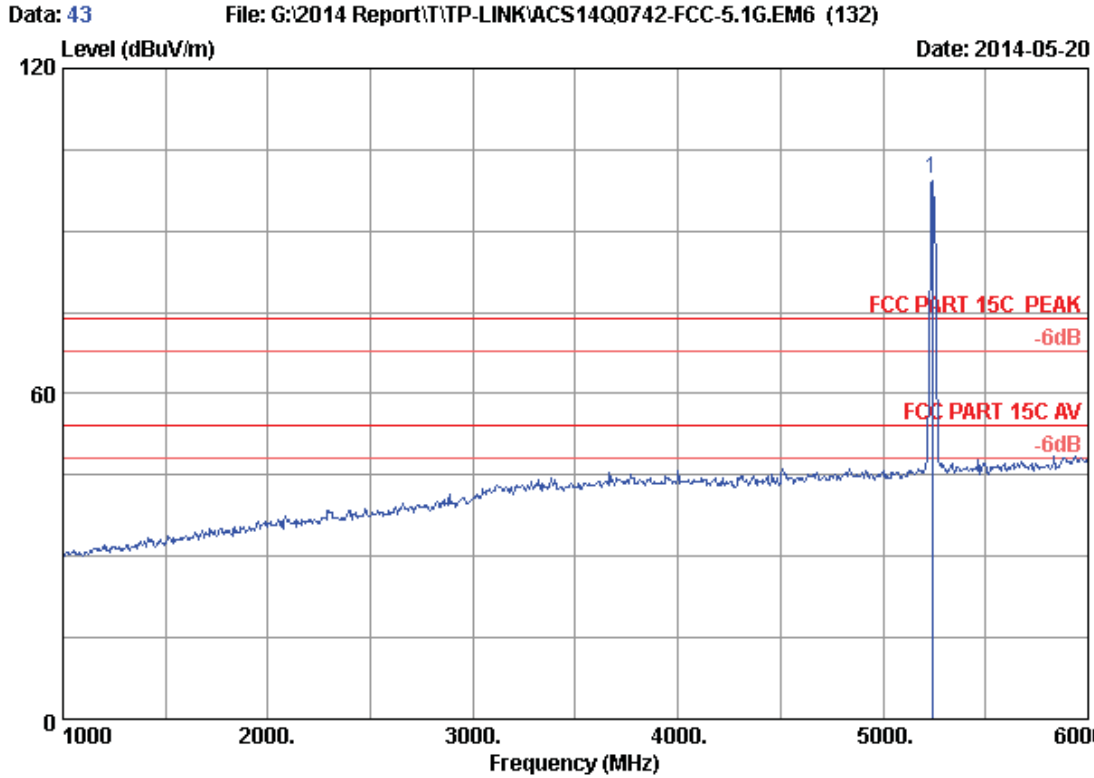

Site no. : 3m Chamber Data no. : 43
 Dis. / Ant. : 3m 2013 3115 (4580) Ant. pol. : HORIZONTAL
 Limit : FCC PART 15C PEAK
 Env. / Ins. : 24°C/56% Engineer : Kevin_Hu
 EUT : AC750 Wireless Dual Band Router
 Power Rating : DC 12V From Adapter Input AC 120V/60Hz
 Test Mode : IEEE802.11nHT20 CH48 5240MHz Tx
 M/N : C20i

No.	Freq. (MHz)	Ant. Factor (dB/m)	Cable Loss (dB)	AMP factor (dB)	Reading (dBUV)	Emission			Remark
						Level (dBUV/m)	Limits (dBUV/m)	Margin (dB)	
1	5240.000	33.58	9.02	35.70	92.78	99.68	74.00	-25.68	Peak

Remarks: 1. Emission Level= Antenna Factor + Cable Loss + Reading - Amp Factor
 2. The emission levels that are 20dB below the official limit are not reported.

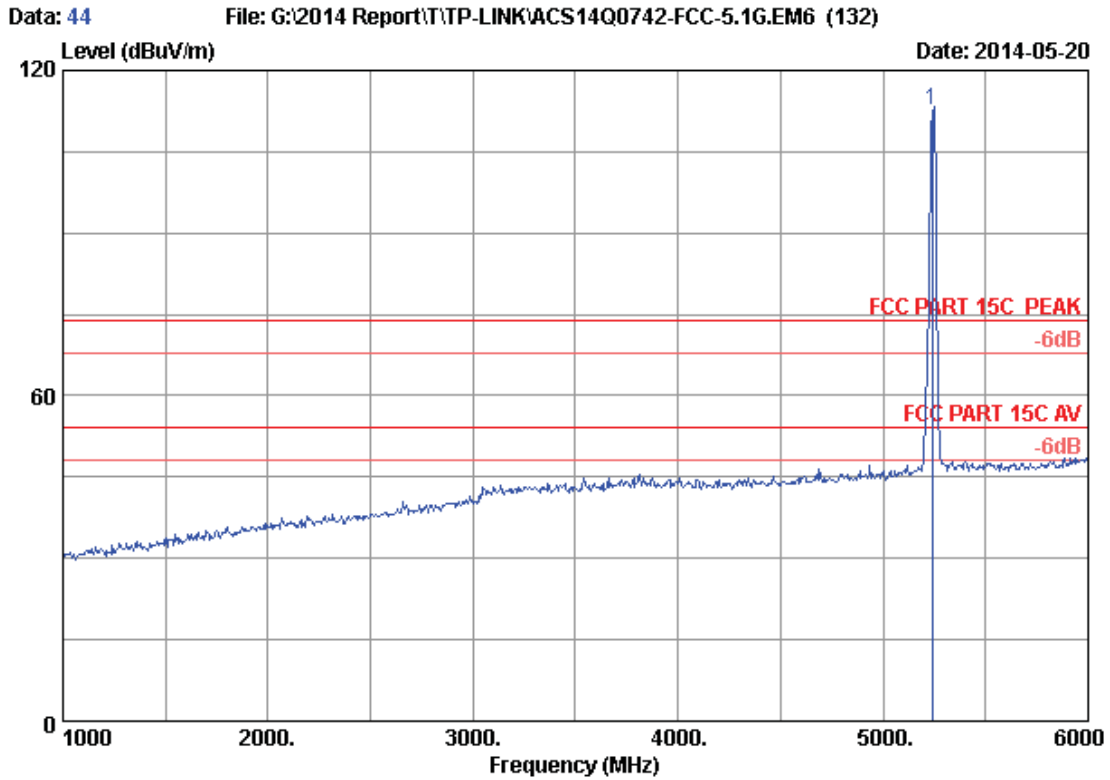

Site no. : 3m Chamber Data no. : 44
 Dis. / Ant. : 3m 2013 3115 (4580) Ant. pol. : VERTICAL
 Limit : FCC PART 15C PEAK
 Env. / Ins. : 24*C/56% Engineer : Kevin_Hu
 EUT : AC750 Wireless Dual Band Router
 Power Rating : DC 12V From Adapter Input AC 120V/60Hz
 Test Mode : IEEE802.11nHT20 CH48 5240MHz Tx
 M/N : C20i

No.	Freq. (MHz)	Ant. Factor (dB/m)	Cable Loss (dB)	AMP factor (dB)	Reading (dBUV)	Emission			Remark
						Level (dBUV/m)	Limits (dBUV/m)	Margin (dB)	
1	5240.000	33.58	9.02	35.70	105.75	112.65	74.00	-38.65	Peak

Remarks: 1. Emission Level= Antenna Factor + Cable Loss + Reading -Amp Factor
 2. The emission levels that are 20dB below the official limit are not reported.

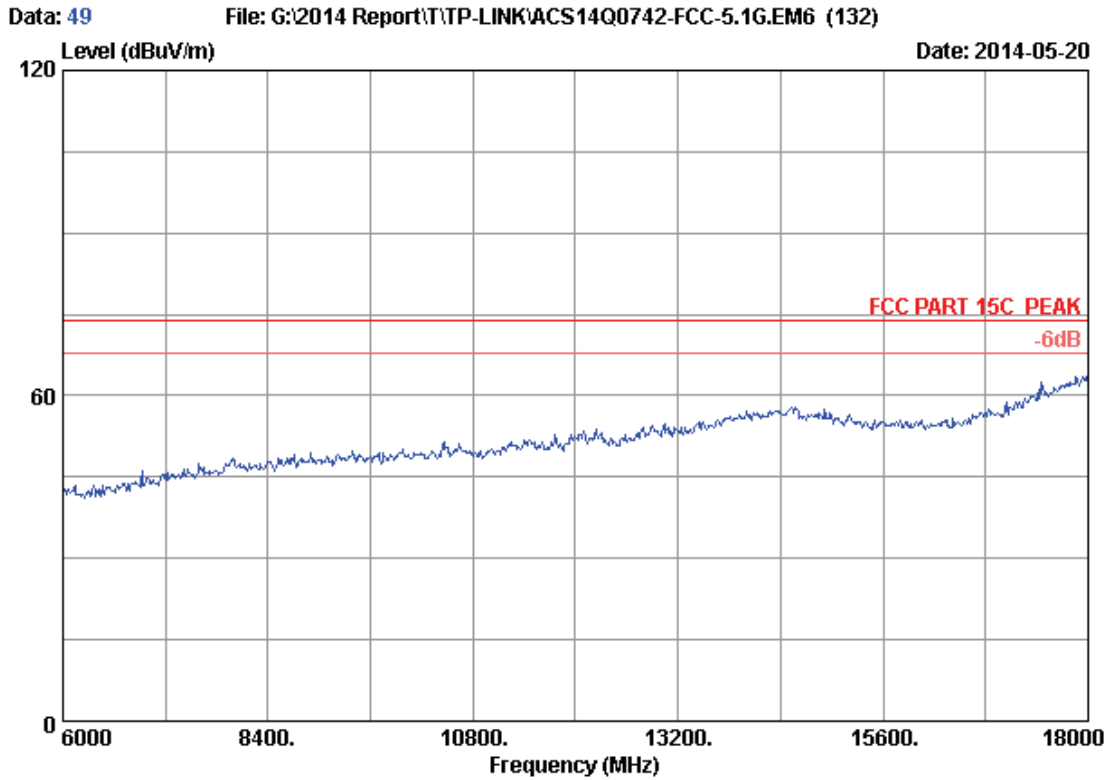

Site no. : 3m Chamber Data no. : 49
 Dis. / Ant. : 3m 2013 3115 (4580) Ant. pol. : HORIZONTAL
 Limit : FCC PART 15C PEAK
 Env. / Ins. : 24*C/56% Engineer : Kevin_Hu
 EUT : AC750 Wireless Dual Band Router
 Power Rating : DC 12V From Adapter Input AC 120V/60Hz
 Test Mode : IEEE802.11nHT20 CH48 5240MHz Tx
 M/N : C20i

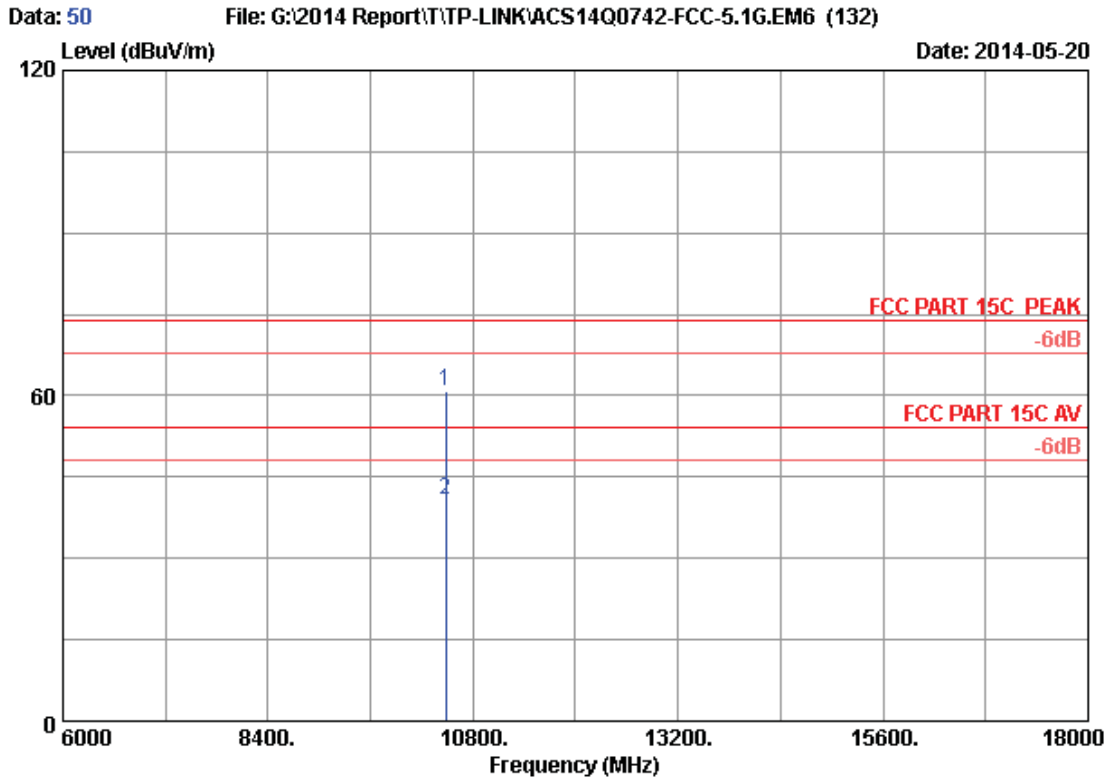

Site no. : 3m Chamber Data no. : 50
 Dis. / Ant. : 3m 2013 3115 (4580) Ant. pol. : HORIZONTAL
 Limit : FCC PART 15C PEAK
 Env. / Ins. : 24*C/56% Engineer : Kevin_Hu
 EUT : AC750 Wireless Dual Band Router
 Power Rating : DC 12V From Adapter Input AC 120V/60Hz
 Test Mode : IEEE802.11nHT20 CH48 5240MHz Tx
 M/N : C20i

No.	Freq. (MHz)	Ant. Factor (dB/m)	Cable Loss (dB)	AMP factor (dB)	Reading (dBUV)	Emission Level (dBUV/m)	Limits (dBUV/m)	Margin (dB)	Remark
1	10480.000	38.19	12.70	35.43	45.30	60.76	74.00	13.24	Peak
2	10480.000	38.19	12.70	35.43	25.38	40.84	54.00	13.16	Average

Remarks: 1. Emission Level= Antenna Factor + Cable Loss + Reading -Amp Factor
 2. The emission levels that are 20dB below the official limit are not reported.

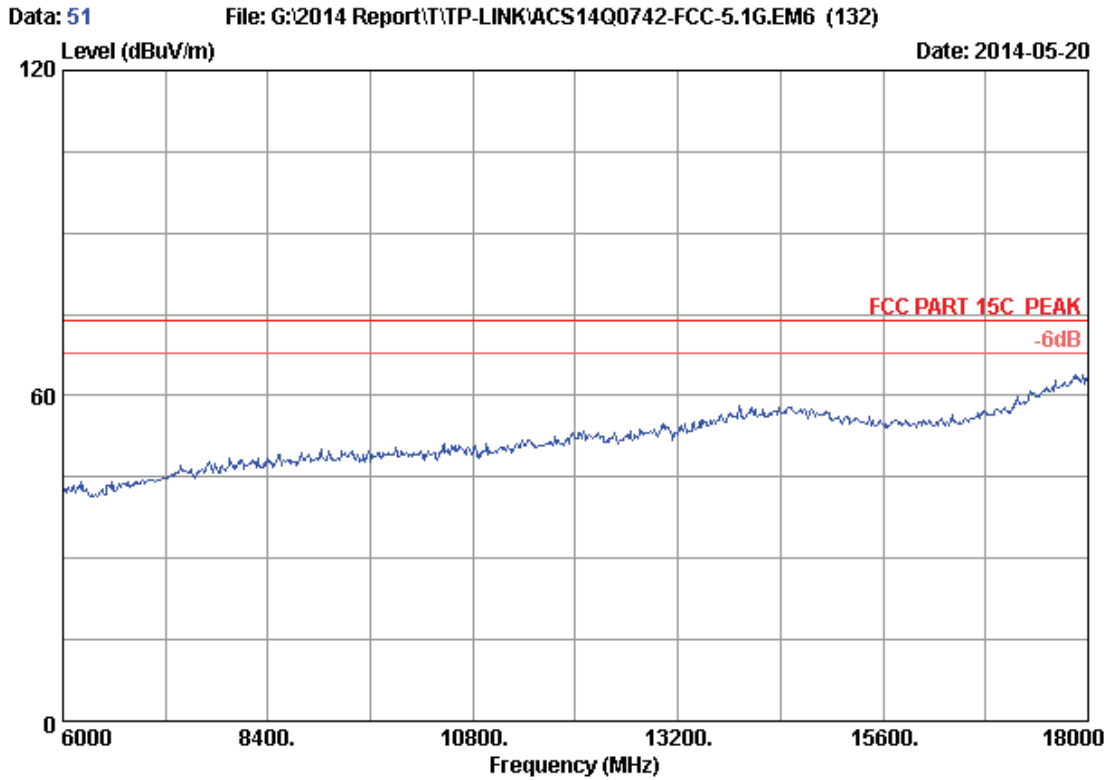

Site no. : 3m Chamber Data no. : 51
Dis. / Ant. : 3m 2013 3115 (4580) Ant. pol. : VERTICAL
Limit : FCC PART 15C PEAK
Env. / Ins. : 24*C/56% Engineer : Kevin_Hu
EUT : AC750 Wireless Dual Band Router
Power Rating : DC 12V From Adapter Input AC 120V/60Hz
Test Mode : IEEE802.11nHT20 CH48 5240MHz Tx
M/N : C20i

Data: 52 File: G:\2014 Report\T\TP-LINK\ACS14Q0742-FCC-5.1G.EM6 (132) Date: 2014-05-20

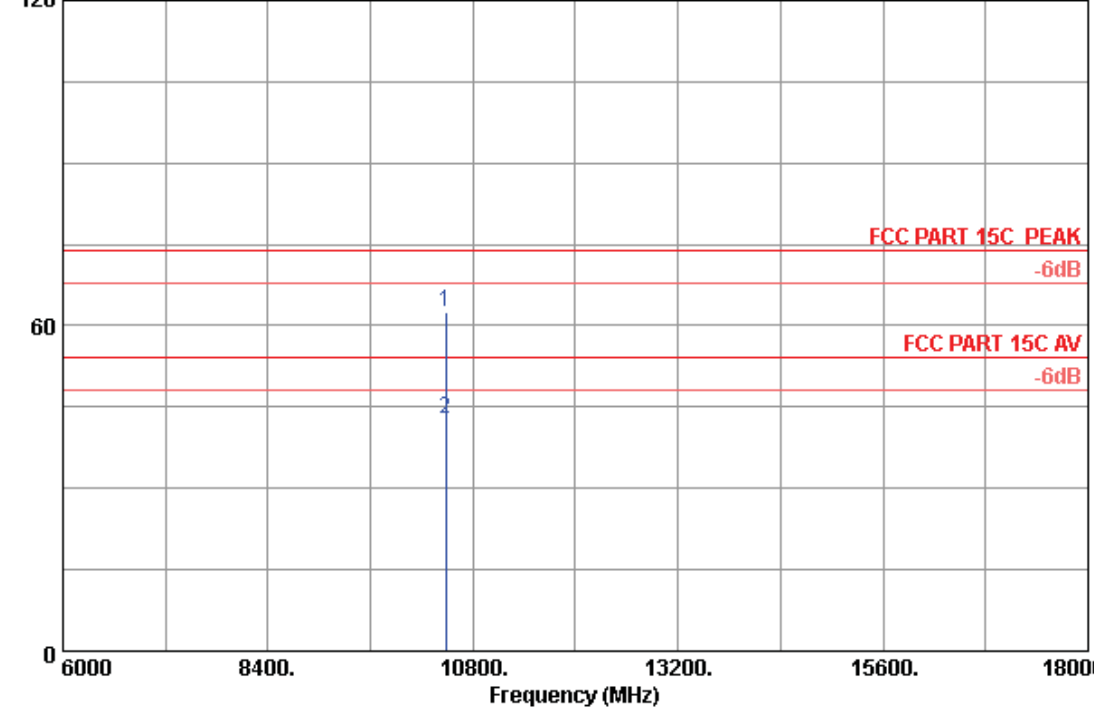

Site no. : 3m Chamber Data no. : 52
 Dis. / Ant. : 3m 2013 3115 (4580) Ant. pol. : VERTICAL
 Limit : FCC PART 15C PEAK
 Env. / Ins. : 24*C/56% Engineer : Kevin_Hu
 EUT : AC750 Wireless Dual Band Router
 Power Rating : DC 12V From Adapter Input AC 120V/60Hz
 Test Mode : IEEE802.11nHT20 CH48 5240MHz Tx
 M/N : C20i

No.	Freq. (MHz)	Ant. Factor (dB/m)	Cable Loss (dB)	AMP factor (dB)	Reading (dBuV)	Emission Level (dBuV/m)	Limits (dBuV/m)	Margin (dB)	Remark
1	10480.000	38.19	12.70	35.43	47.07	62.53	74.00	11.47	Peak
2	10480.000	38.19	12.70	35.43	27.17	42.63	54.00	11.37	Average

Remarks: 1. Emission Level= Antenna Factor + Cable Loss + Reading -Amp Factor
 2. The emission levels that are 20dB below the official limit are not reported.

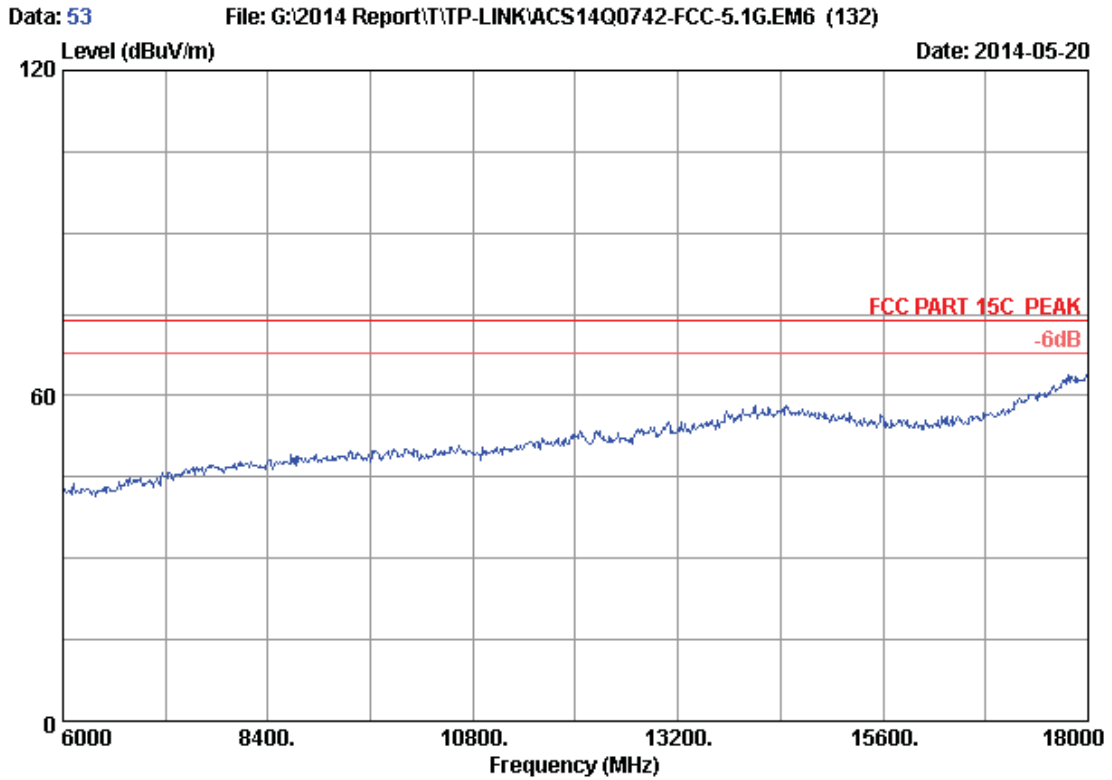

Site no. : 3m Chamber Data no. : 53
Dis. / Ant. : 3m 2013 3115 (4580) Ant. pol. : VERTICAL
Limit : FCC PART 15C PEAK
Env. / Ins. : 24*C/56% Engineer : Kevin_Hu
EUT : AC750 Wireless Dual Band Router
Power Rating : DC 12V From Adapter Input AC 120V/60Hz
Test Mode : IEEE802.11nHT40 CH38 5190MHz Tx
M/N : C20i

Data: 54 File: G:\2014 Report\T\TP-LINK\ACS14Q0742-FCC-5.1G.EM6 (132) Date: 2014-05-20

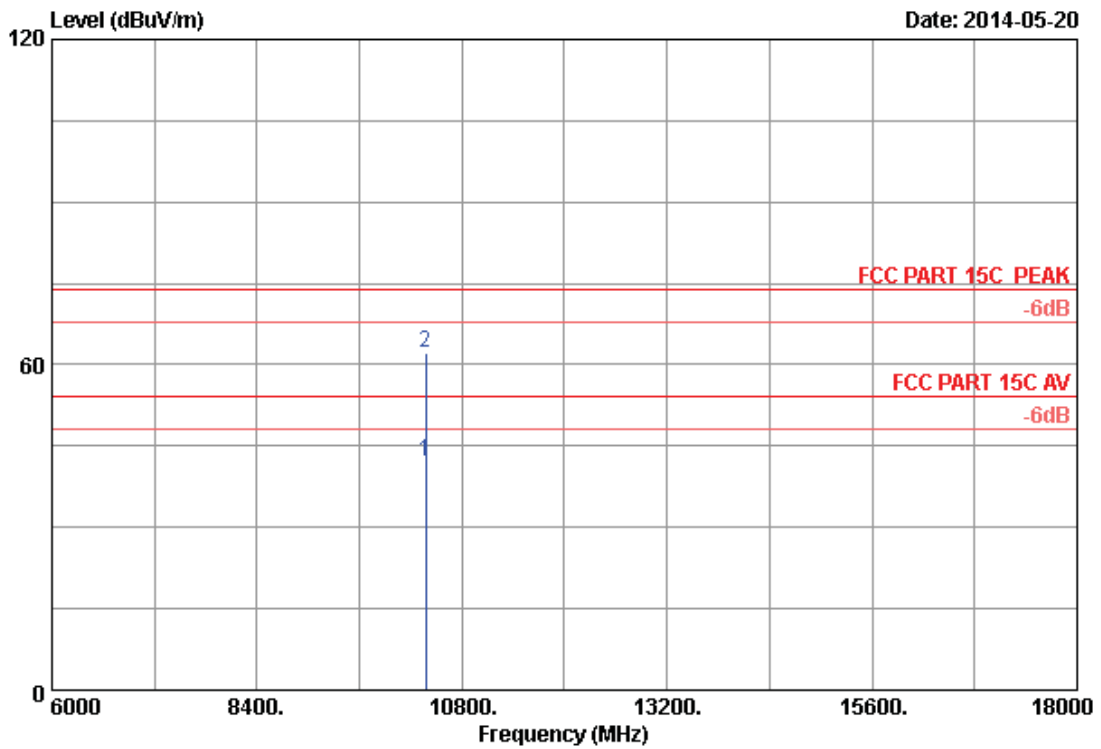

Site no. : 3m Chamber Data no. : 54
 Dis. / Ant. : 3m 2013 3115 (4580) Ant. pol. : VERTICAL
 Limit : FCC PART 15C PEAK
 Env. / Ins. : 24*C/56% Engineer : Kevin_Hu
 EUT : AC750 Wireless Dual Band Router
 Power Rating : DC 12V From Adapter Input AC 120V/60Hz
 Test Mode : IEEE802.11nHT40 CH38 5190MHz Tx
 M/N : C20i

No.	Freq. (MHz)	Ant. Factor (dB/m)	Cable Loss (dB)	AMP factor (dB)	Reading (dBUV)	Emission Level (dBUV/m)	Limits (dBUV/m)	Margin (dB)	Remark
1	10380.000	38.15	12.65	35.44	26.86	42.22	54.00	11.78	Average
2	10380.000	38.15	12.65	35.44	46.86	62.22	74.00	11.78	Peak

Remarks: 1. Emission Level= Antenna Factor + Cable Loss + Reading -Amp Factor
 2. The emission levels that are 20dB below the official limit are not reported.

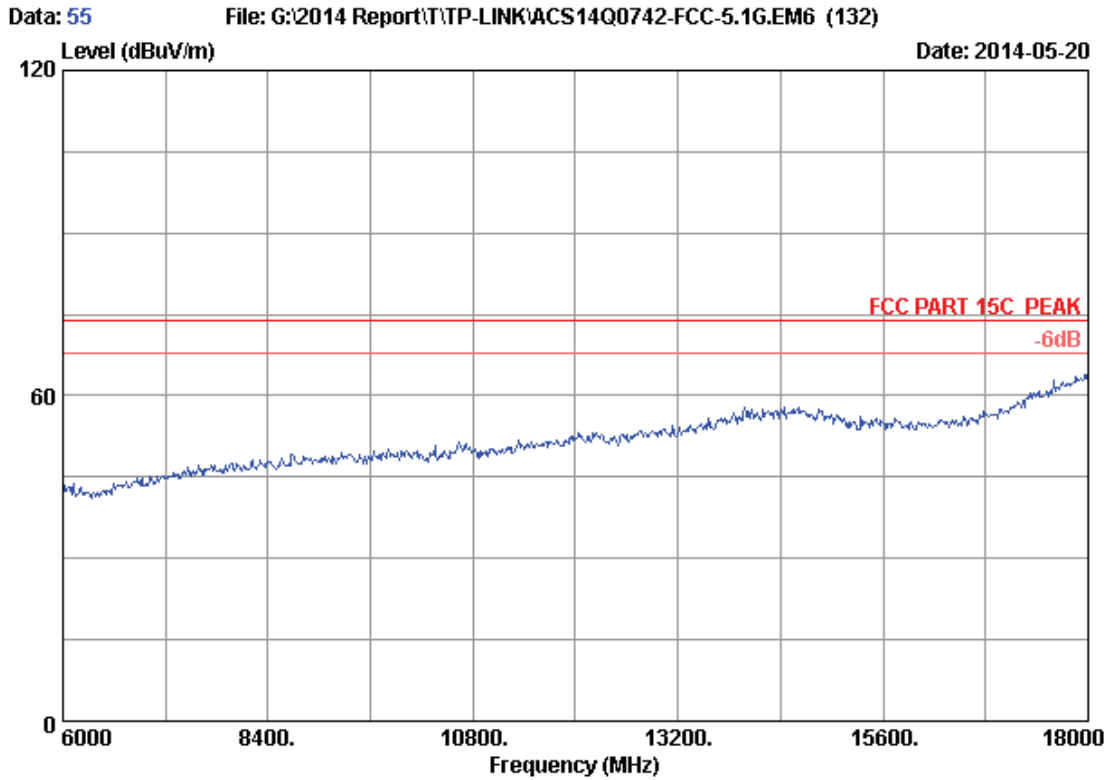

Site no. : 3m Chamber Data no. : 55
Dis. / Ant. : 3m 2013 3115 (4580) Ant. pol. : HORIZONTAL
Limit : FCC PART 15C PEAK
Env. / Ins. : 24*C/56% Engineer : Kevin_Hu
EUT : AC750 Wireless Dual Band Router
Power Rating : DC 12V From Adapter Input AC 120V/60Hz
Test Mode : IEEE802.11nHT40 CH38 5190MHz Tx
M/N : C20i

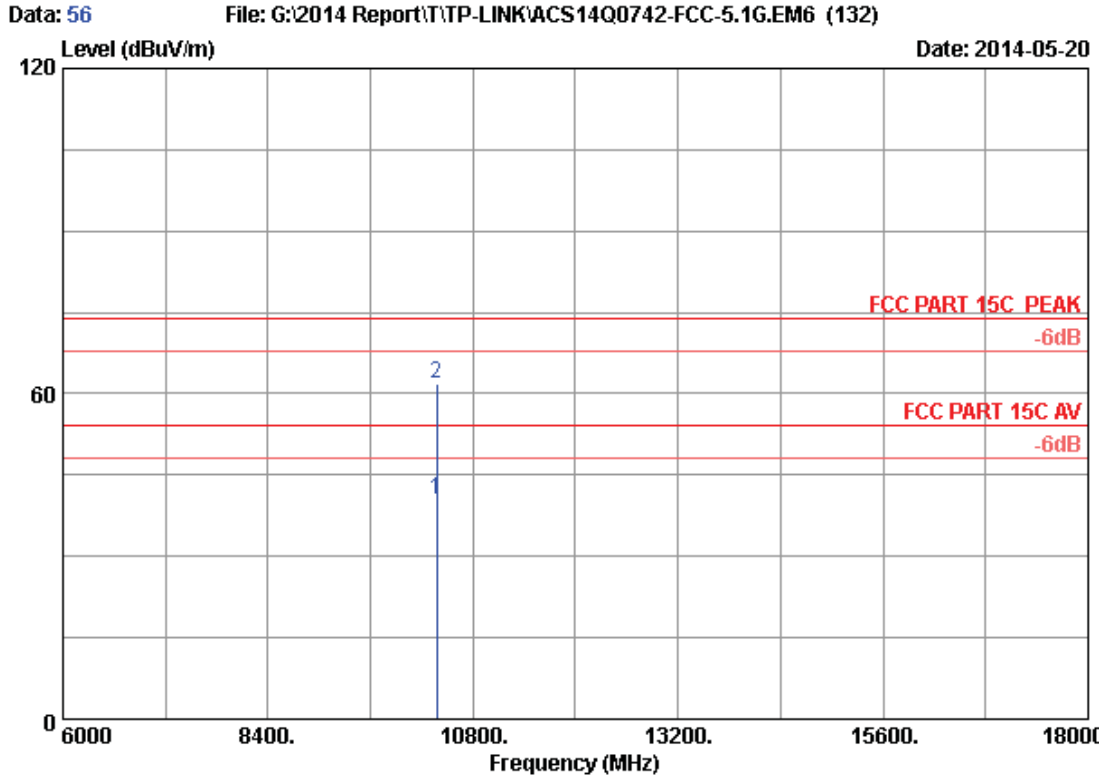

Site no. : 3m Chamber Data no. : 56
 Dis. / Ant. : 3m 2013 3115 (4580) Ant. pol. : HORIZONTAL
 Limit : FCC PART 15C PEAK
 Env. / Ins. : 24*C/56% Engineer : Kevin_Hu
 EUT : AC750 Wireless Dual Band Router
 Power Rating : DC 12V From Adapter Input AC 120V/60Hz
 Test Mode : IEEE802.11nHT40 CH38 5190MHz Tx
 M/N : C20i

No.	Freq. (MHz)	Ant. Factor (dB/m)	Cable Loss (dB)	AMP factor (dB)	Reading (dBUV)	Emission Level (dBUV/m)	Limits (dBUV/m)	Margin (dB)	Remark
1	10380.000	38.15	12.65	35.44	25.18	40.54	54.00	13.46	Average
2	10380.000	38.15	12.65	35.44	46.37	61.73	74.00	12.27	Peak

Remarks: 1. Emission Level= Antenna Factor + Cable Loss + Reading - Amp Factor
 2. The emission levels that are 20dB below the official limit are not reported.

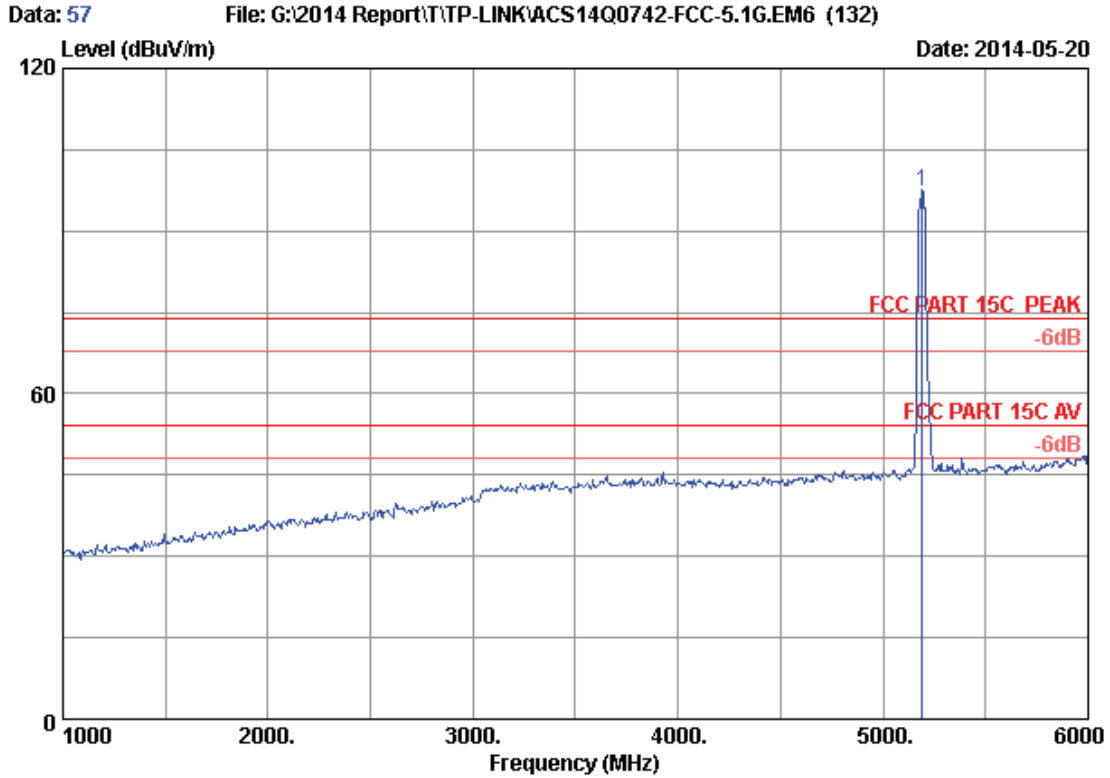

Site no. : 3m Chamber Data no. : 57
 Dis. / Ant. : 3m 2013 3115 (4580) Ant. pol. : HORIZONTAL
 Limit : FCC PART 15C PEAK
 Env. / Ins. : 24*C/56% Engineer : Kevin_Hu
 EUT : AC750 Wireless Dual Band Router
 Power Rating : DC 12V From Adapter Input AC 120V/60Hz
 Test Mode : IEEE802.11nHT40 CH38 5190MHz Tx
 M/N : C20i

No.	Freq. (MHz)	Ant. Factor (dB/m)	Cable Loss (dB)	AMP factor (dB)	Reading (dBuV)	Emission			Remark
						Level (dBuV/m)	Limits (dBuV/m)	Margin (dB)	
1	5190.000	33.50	8.96	35.70	90.46	97.22	74.00	-23.22	Peak

Remarks: 1. Emission Level= Antenna Factor + Cable Loss + Reading - Amp Factor
 2. The emission levels that are 20dB below the official limit are not reported.

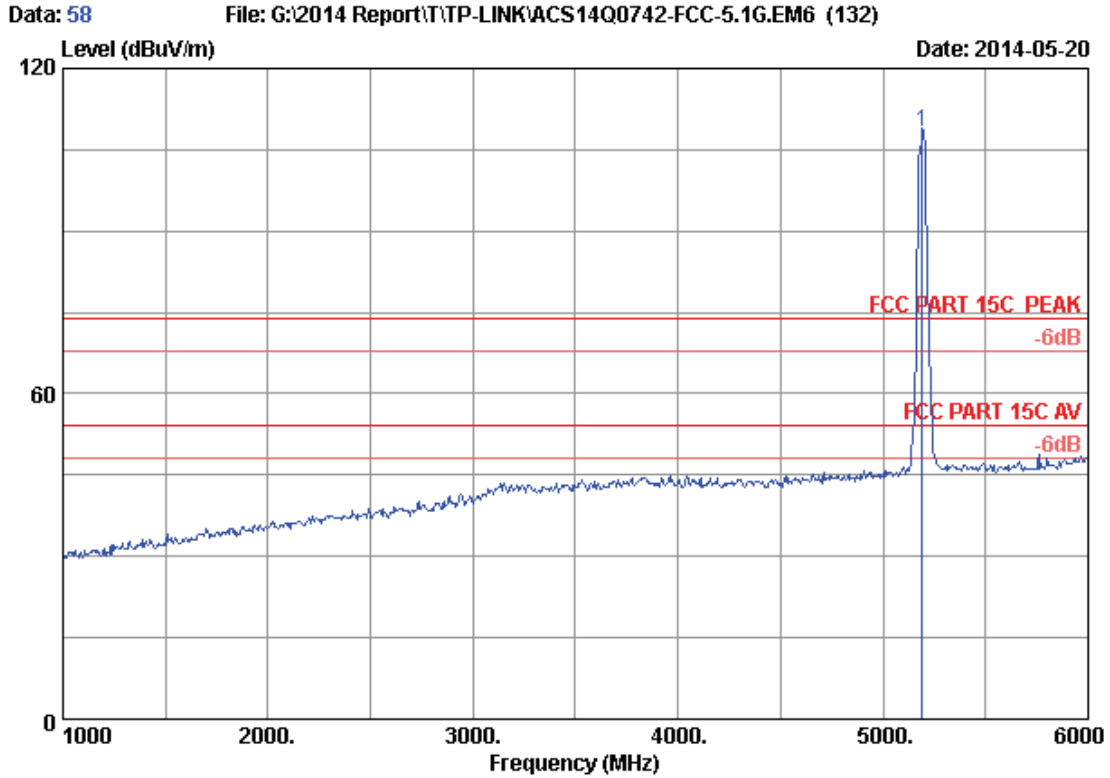

Site no. : 3m Chamber Data no. : 58
 Dis. / Ant. : 3m 2013 3115 (4580) Ant. pol. : VERTICAL
 Limit : FCC PART 15C PEAK
 Env. / Ins. : 24°C/56% Engineer : Kevin_Hu
 EUT : AC750 Wireless Dual Band Router
 Power Rating : DC 12V From Adapter Input AC 120V/60Hz
 Test Mode : IEEE802.11nHT40 CH38 5190MHz Tx
 M/N : C20i

No.	Freq. (MHz)	Ant. Factor (dB/m)	Cable Loss (dB)	AMP factor (dB)	Reading (dBuV)	Emission			Remark
						Level (dBuV/m)	Limits (dBuV/m)	Margin (dB)	
1	5190.000	33.50	8.96	35.70	101.68	108.44	74.00	-34.44	Peak

Remarks: 1. Emission Level= Antenna Factor + Cable Loss + Reading - Amp Factor
 2. The emission levels that are 20dB below the official limit are not reported.

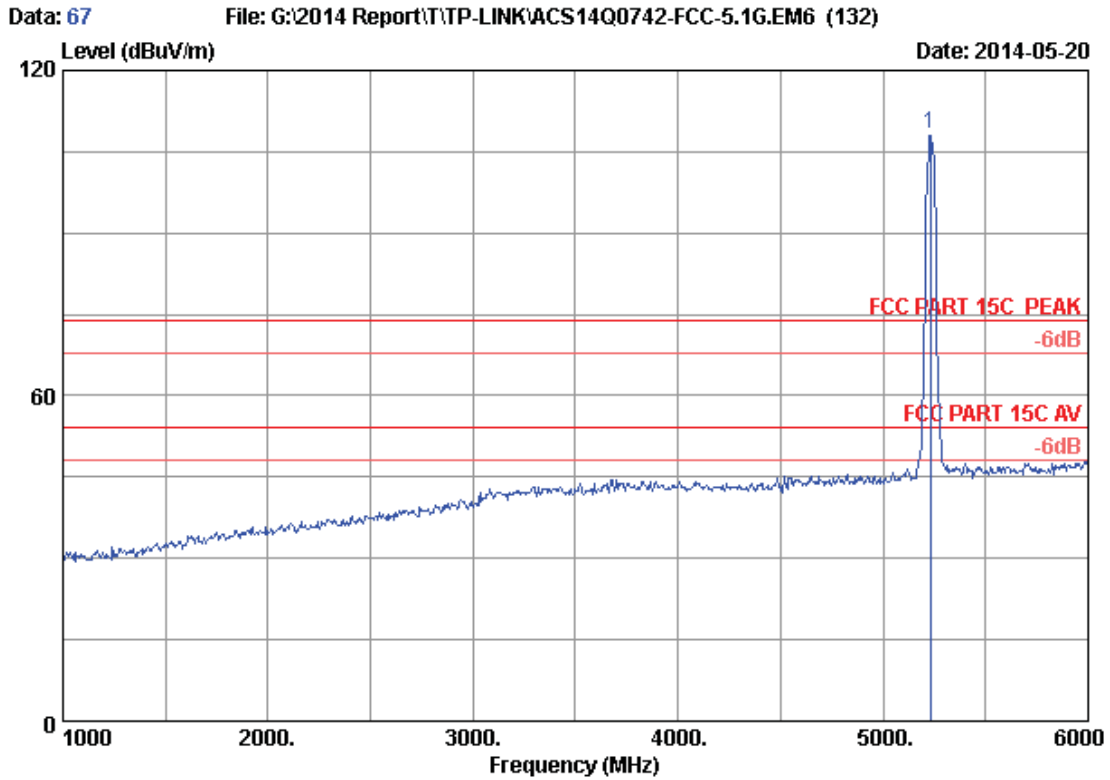

Site no. : 3m Chamber Data no. : 67
 Dis. / Ant. : 3m 2013 3115 (4580) Ant. pol. : VERTICAL
 Limit : FCC PART 15C PEAK
 Env. / Ins. : 24°C/56% Engineer : Kevin_Hu
 EUT : AC750 Wireless Dual Band Router
 Power Rating : DC 12V From Adapter Input AC 120V/60Hz
 Test Mode : IEEE802.11nHT40 CH46 5230MHz Tx
 M/N : C20i

No.	Freq. (MHz)	Ant. Factor (dB/m)	Cable Loss (dB)	AMP factor (dB)	Reading (dBuV)	Emission			Remark
						Level (dBuV/m)	Limits (dBuV/m)	Margin (dB)	
1	5230.000	33.57	9.01	35.70	101.28	108.16	74.00	-34.16	Peak

Remarks: 1. Emission Level= Antenna Factor + Cable Loss + Reading - Amp Factor
 2. The emission levels that are 20dB below the official limit are not reported.

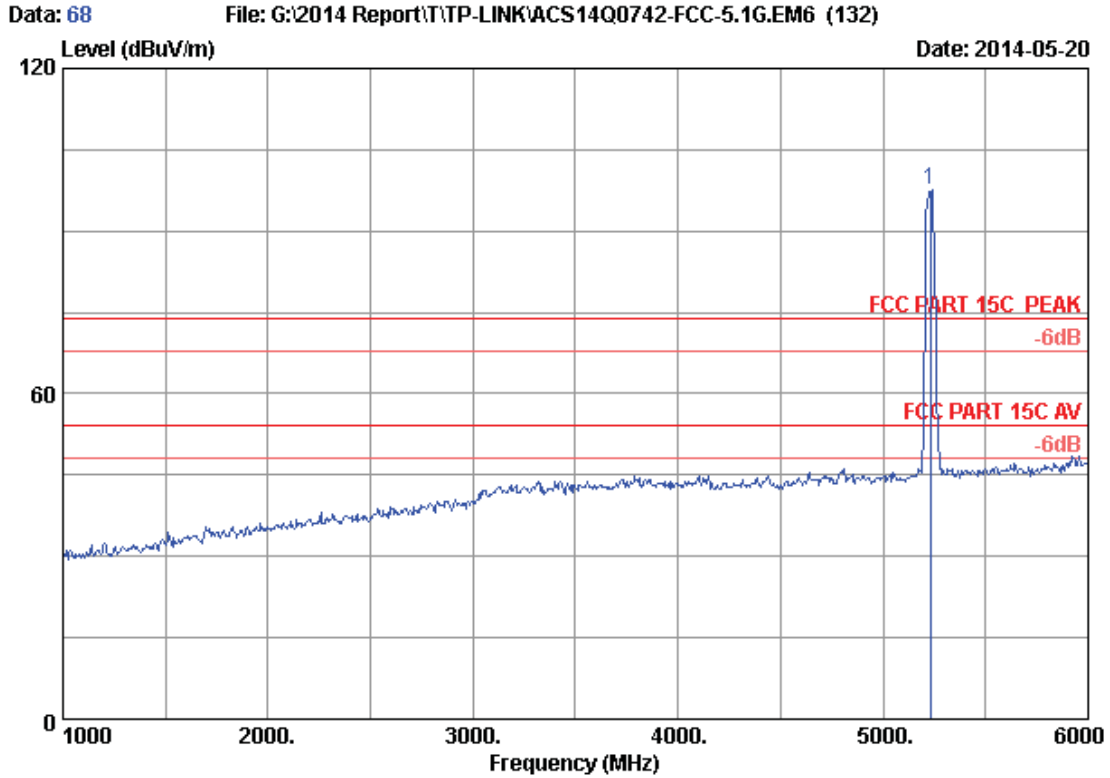

Site no. : 3m Chamber Data no. : 68
 Dis. / Ant. : 3m 2013 3115 (4580) Ant. pol. : HORIZONTAL
 Limit : FCC PART 15C PEAK
 Env. / Ins. : 24*C/56% Engineer : Kevin_Hu
 EUT : AC750 Wireless Dual Band Router
 Power Rating : DC 12V From Adapter Input AC 120V/60Hz
 Test Mode : IEEE802.11nHT40 CH46 5230MHz Tx
 M/N : C20i

No.	Freq. (MHz)	Ant. Factor (dB/m)	Cable Loss (dB)	AMP factor (dB)	Reading (dBUV)	Emission			Remark
						Level (dBUV/m)	Limits (dBUV/m)	Margin (dB)	
1	5230.000	33.57	9.01	35.70	90.74	97.62	74.00	-23.62	Peak

Remarks: 1. Emission Level= Antenna Factor + Cable Loss + Reading -Amp Factor
 2. The emission levels that are 20dB below the official limit are not reported.

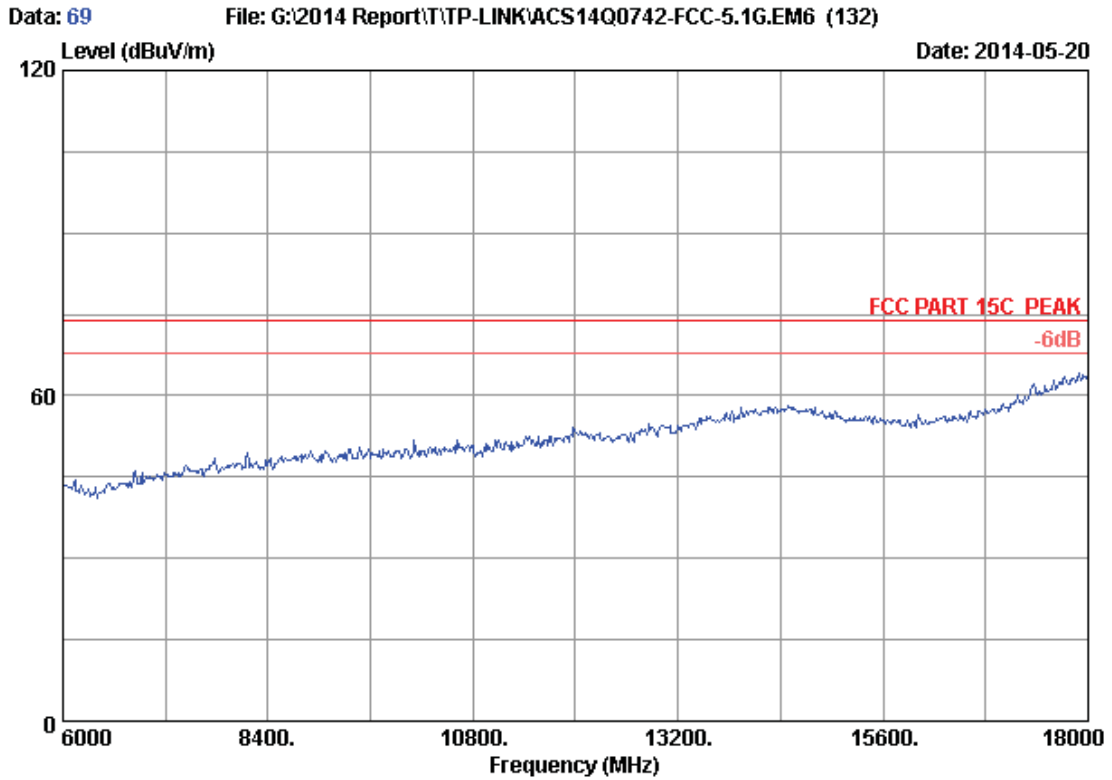

Site no. : 3m Chamber Data no. : 69
Dis. / Ant. : 3m 2013 3115 (4580) Ant. pol. : HORIZONTAL
Limit : FCC PART 15C PEAK
Env. / Ins. : 24*C/56% Engineer : Kevin_Hu
EUT : AC750 Wireless Dual Band Router
Power Rating : DC 12V From Adapter Input AC 120V/60Hz
Test Mode : IEEE802.11nHT40 CH46 5230MHz Tx
M/N : C20i

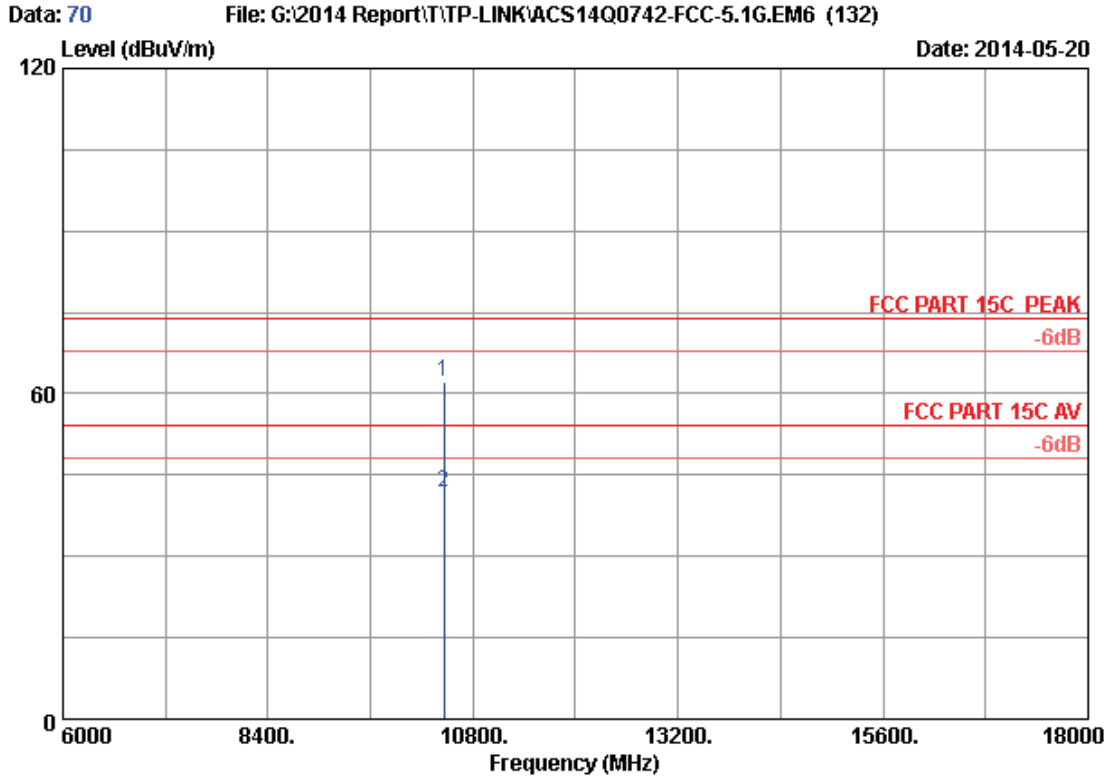

Site no. : 3m Chamber Data no. : 70
 Dis. / Ant. : 3m 2013 3115 (4580) Ant. pol. : HORIZONTAL
 Limit : FCC PART 15C PEAK
 Env. / Ins. : 24*C/56% Engineer : Kevin_Hu
 EUT : AC750 Wireless Dual Band Router
 Power Rating : DC 12V From Adapter Input AC 120V/60Hz
 Test Mode : IEEE802.11nHT40 CH46 5230MHz Tx
 M/N : C20i

No.	Freq. (MHz)	Ant. Factor (dB/m)	Cable Loss (dB)	AMP factor (dB)	Reading (dBuV)	Emission Level (dBuV/m)	Limits (dBuV/m)	Margin (dB)	Remark
1	10460.000	38.18	12.69	35.43	46.59	62.03	74.00	11.97	Peak
2	10460.000	38.18	12.69	35.43	26.36	41.80	54.00	12.20	Average

Remarks: 1. Emission Level= Antenna Factor + Cable Loss + Reading - Amp Factor
 2. The emission levels that are 20dB below the official limit are not reported.

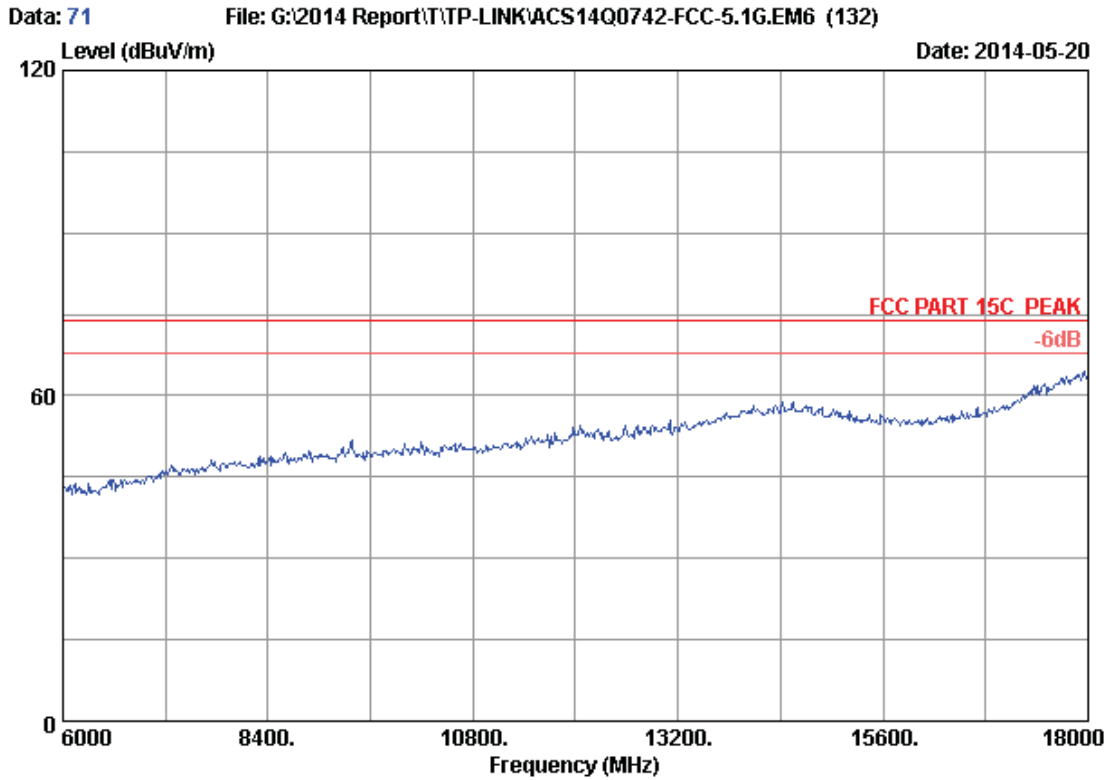

Site no. : 3m Chamber Data no. : 71
Dis. / Ant. : 3m 2013 3115 (4580) Ant. pol. : VERTICAL
Limit : FCC PART 15C PEAK
Env. / Ins. : 24*C/56% Engineer : Kevin_Hu
EUT : AC750 Wireless Dual Band Router
Power Rating : DC 12V From Adapter Input AC 120V/60Hz
Test Mode : IEEE802.11nHT40 CH46 5230MHz Tx
M/N : C20i

Data: 72 File: G:\2014 Report\T\TP-LINK\ACS14Q0742-FCC-5.1G.EM6 (132) Date: 2014-05-20

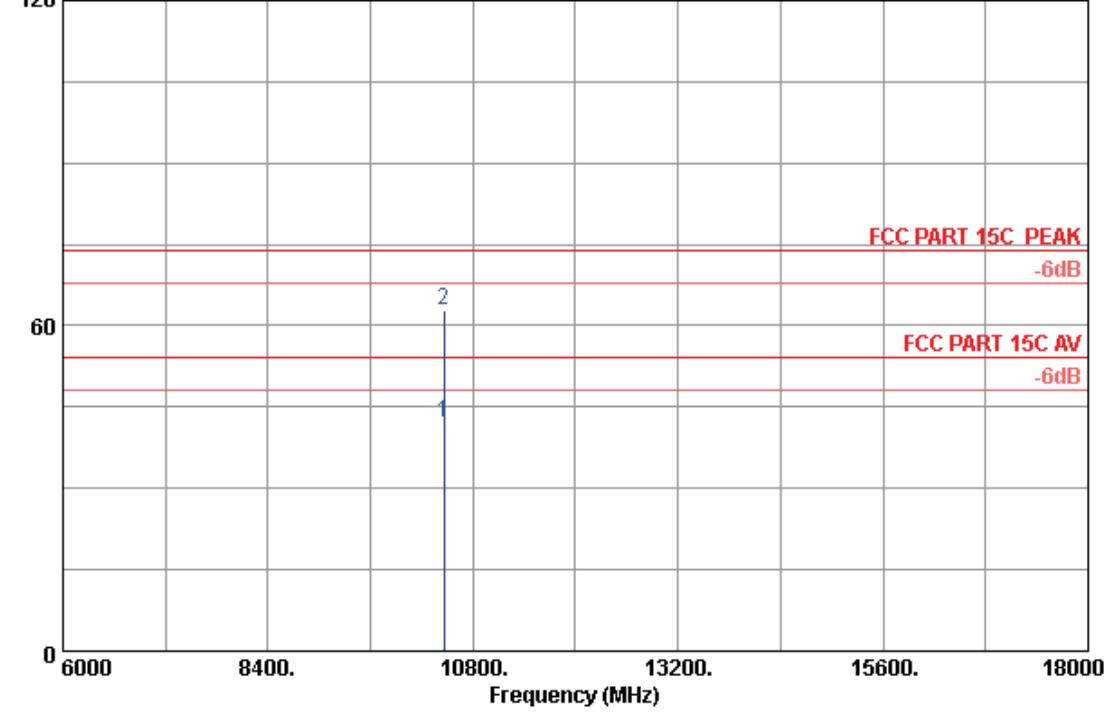

Site no. : 3m Chamber Data no. : 72
 Dis. / Ant. : 3m 2013 3115 (4580) Ant. pol. : VERTICAL
 Limit : FCC PART 15C PEAK
 Env. / Ins. : 24*C/56% Engineer : Kevin_Hu
 EUT : AC750 Wireless Dual Band Router
 Power Rating : DC 12V From Adapter Input AC 120V/60Hz
 Test Mode : IEEE802.11nHT40 CH46 5230MHz Tx
 M/N : C20i

No.	Freq. (MHz)	Ant. Factor (dB/m)	Cable Loss (dB)	AMP factor (dB)	Reading (dBuV)	Emission Level (dBuV/m)	Limits (dBuV/m)	Margin (dB)	Remark
1	10460.000	38.18	12.69	35.43	26.76	42.20	54.00	11.80	Average
2	10460.000	38.18	12.69	35.43	47.26	62.70	74.00	11.30	Peak

Remarks: 1. Emission Level= Antenna Factor + Cable Loss + Reading - Amp Factor
 2. The emission levels that are 20dB below the official limit are not reported.

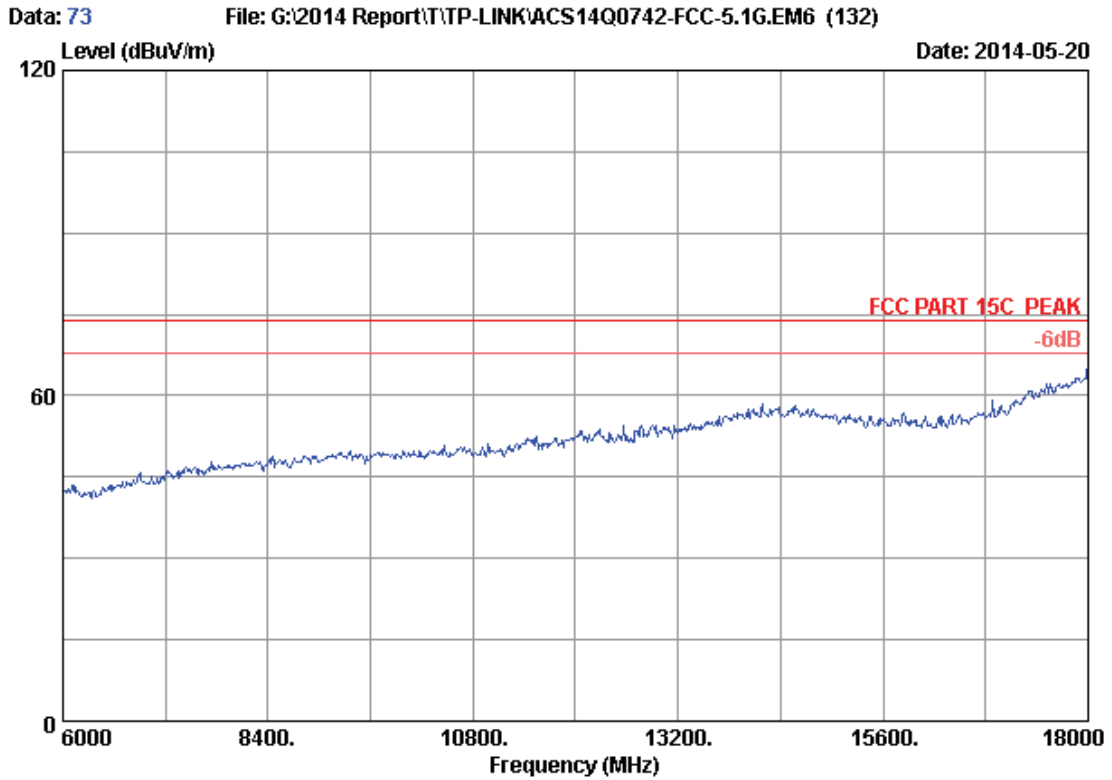

Site no. : 3m Chamber Data no. : 73
Dis. / Ant. : 3m 2013 3115 (4580) Ant. pol. : VERTICAL
Limit : FCC PART 15C PEAK
Env. / Ins. : 24*C/56% Engineer : Kevin_Hu
EUT : AC750 Wireless Dual Band Router
Power Rating : DC 12V From Adapter Input AC 120V/60Hz
Test Mode : IEEE802.11ac VHT20 CH36 5180MHz Tx
M/N : C20i

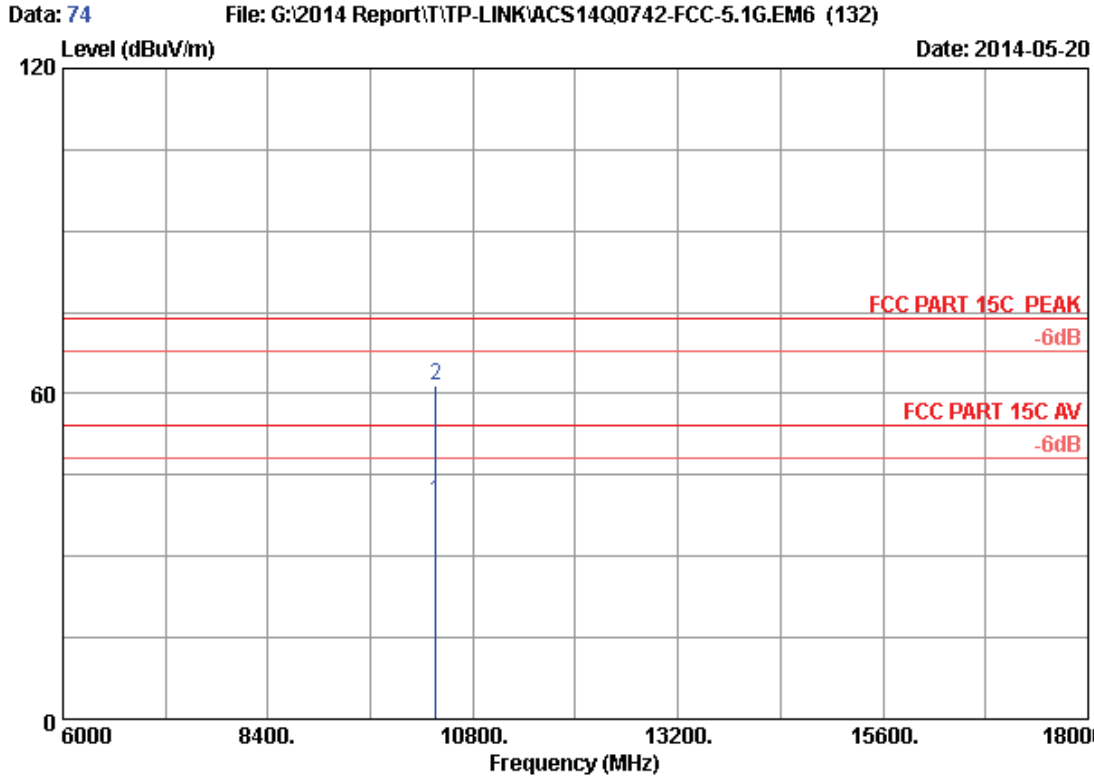

Site no. : 3m Chamber Data no. : 74
 Dis. / Ant. : 3m 2013 3115 (4580) Ant. pol. : VERTICAL
 Limit : FCC PART 15C PEAK
 Env. / Ins. : 24*C/56% Engineer : Kevin_Hu
 EUT : AC750 Wireless Dual Band Router
 Power Rating : DC 12V From Adapter Input AC 120V/60Hz
 Test Mode : IEEE802.11ac VHT20 CH36 5180MHz Tx
 M/N : C20i

No.	Freq. (MHz)	Ant. Factor (dB/m)	Cable Loss (dB)	AMP factor (dB)	Reading (dBuV)	Emission Level (dBuV/m)	Limits (dBuV/m)	Margin (dB)	Remark
1	10360.000	38.14	12.64	35.45	24.86	40.19	54.00	13.81	Average
2	10360.000	38.14	12.64	35.45	46.29	61.62	74.00	12.38	Peak

Remarks: 1. Emission Level= Antenna Factor + Cable Loss + Reading - Amp Factor
 2. The emission levels that are 20dB below the official limit are not reported.

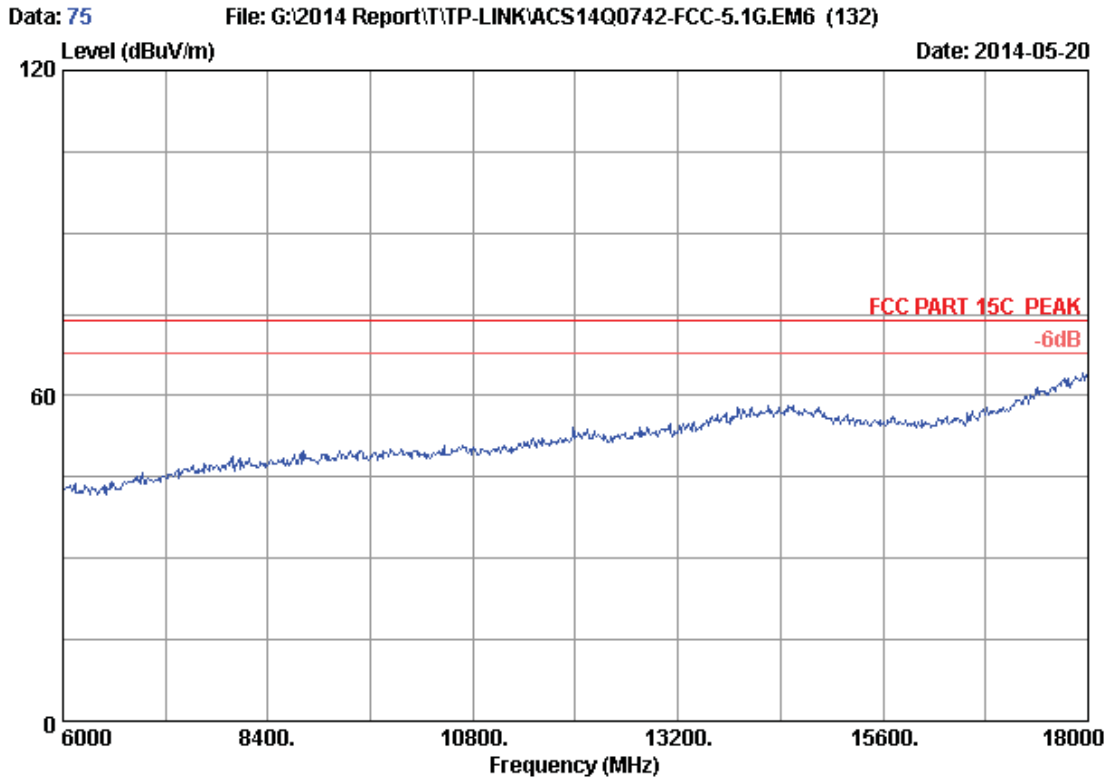

Site no. : 3m Chamber Data no. : 75
Dis. / Ant. : 3m 2013 3115 (4580) Ant. pol. : HORIZONTAL
Limit : FCC PART 15C PEAK
Env. / Ins. : 24*C/56% Engineer : Kevin_Hu
EUT : AC750 Wireless Dual Band Router
Power Rating : DC 12V From Adapter Input AC 120V/60Hz
Test Mode : IEEE802.11ac VHT20 CH36 5180MHz Tx
M/N : C20i

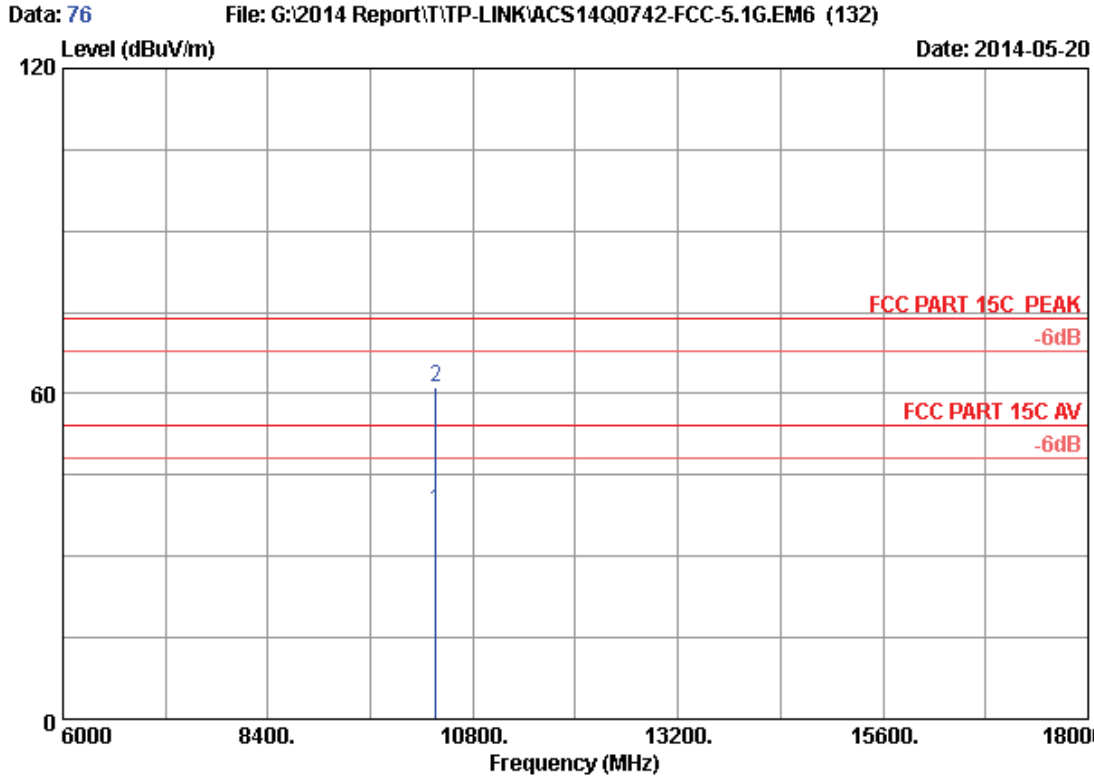

Site no. : 3m Chamber Data no. : 76
 Dis. / Ant. : 3m 2013 3115 (4580) Ant. pol. : HORIZONTAL
 Limit : FCC PART 15C PEAK
 Env. / Ins. : 24*C/56% Engineer : Kevin_Hu
 EUT : AC750 Wireless Dual Band Router
 Power Rating : DC 12V From Adapter Input AC 120V/60Hz
 Test Mode : IEEE802.11ac VHT20 CH36 5180MHz Tx
 M/N : C20i

No.	Freq. (MHz)	Ant. Factor (dB/m)	Cable Loss (dB)	AMP factor (dB)	Reading (dBUV)	Emission Level (dBUV/m)	Limits (dBUV/m)	Margin (dB)	Remark
1	10360.000	38.14	12.64	35.45	23.16	38.49	54.00	15.51	Average
2	10360.000	38.14	12.64	35.45	45.86	61.19	74.00	12.81	Peak

Remarks: 1. Emission Level= Antenna Factor + Cable Loss + Reading -Amp Factor
 2. The emission levels that are 20dB below the official limit are not reported.

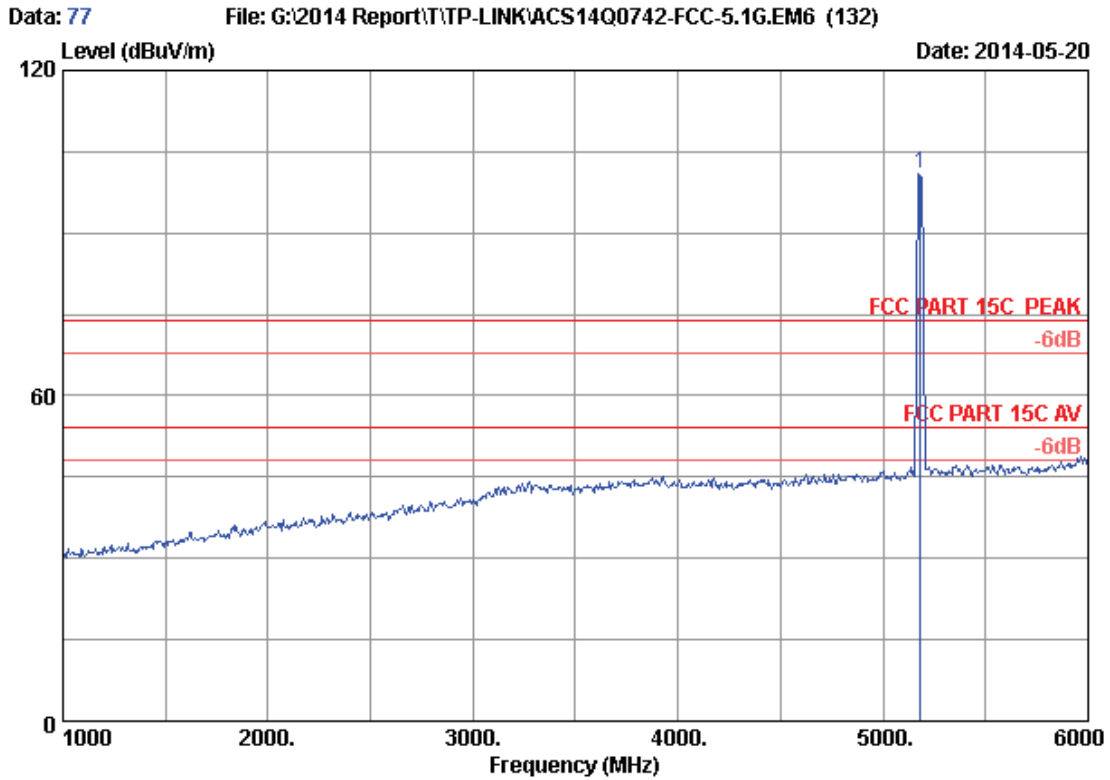

Site no. : 3m Chamber Data no. : 77
 Dis. / Ant. : 3m 2013 3115 (4580) Ant. pol. : HORIZONTAL
 Limit : FCC PART 15C PEAK
 Env. / Ins. : 24°C/56% Engineer : Kevin_Hu
 EUT : AC750 Wireless Dual Band Router
 Power Rating : DC 12V From Adapter Input AC 120V/60Hz
 Test Mode : IEEE802.11ac VHT20 CH36 5180MHz Tx
 M/N : C20i

No.	Freq. (MHz)	Ant. Factor (dB/m)	Cable Loss (dB)	AMP factor (dB)	Reading (dBuV)	Emission			Remark
						Level (dBuV/m)	Limits (dBuV/m)	Margin (dB)	
1	5180.000	33.49	8.95	35.70	94.16	100.90	74.00	-26.90	Peak

Remarks: 1. Emission Level= Antenna Factor + Cable Loss + Reading - Amp Factor
 2. The emission levels that are 20dB below the official limit are not reported.

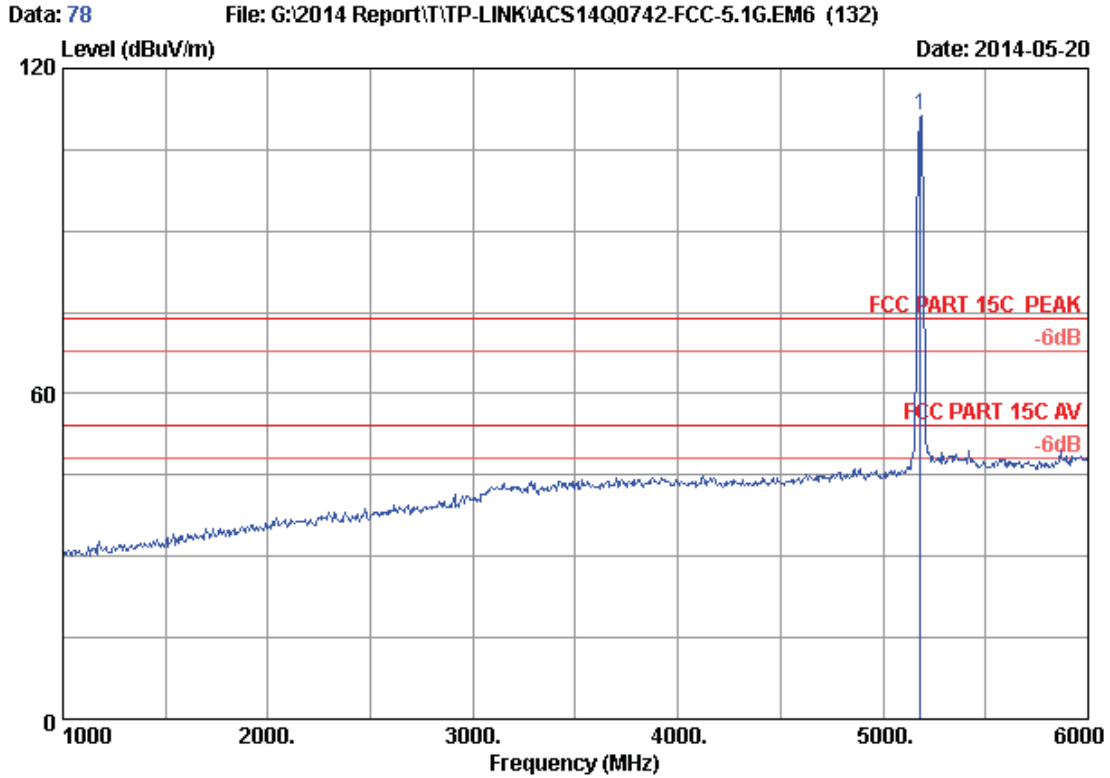

Site no. : 3m Chamber Data no. : 78
 Dis. / Ant. : 3m 2013 3115 (4580) Ant. pol. : VERTICAL
 Limit : FCC PART 15C PEAK
 Env. / Ins. : 24*C/56% Engineer : Kevin_Hu
 EUT : AC750 Wireless Dual Band Router
 Power Rating : DC 12V From Adapter Input AC 120V/60Hz
 Test Mode : IEEE802.11ac VHT20 CH36 5180MHz Tx
 M/N : C20i

No.	Freq. (MHz)	Ant. Factor (dB/m)	Cable Loss (dB)	AMP factor (dB)	Reading (dBuV)	Emission			Remark
						Level (dBuV/m)	Limits (dBuV/m)	Margin (dB)	
1	5180.000	33.49	8.95	35.70	104.67	111.41	74.00	-37.41	Peak

Remarks: 1. Emission Level= Antenna Factor + Cable Loss + Reading -Amp Factor
 2. The emission levels that are 20dB below the official limit are not reported.

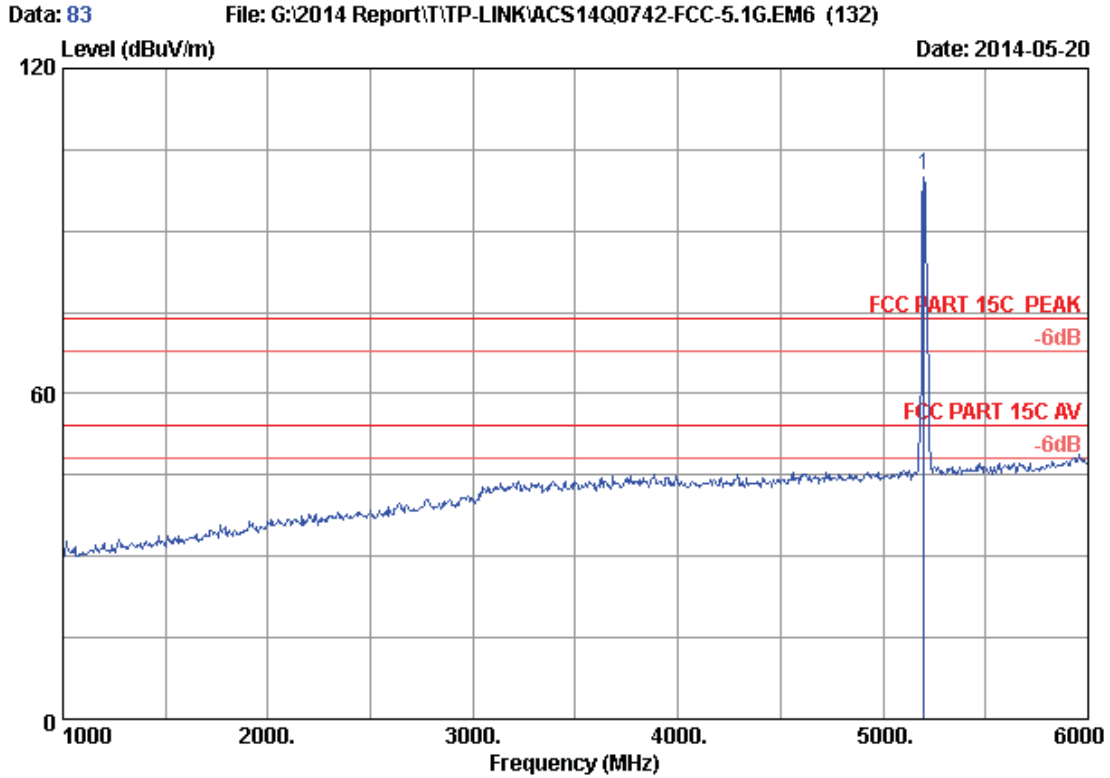

Site no. : 3m Chamber Data no. : 83
 Dis. / Ant. : 3m 2013 3115 (4580) Ant. pol. : HORIZONTAL
 Limit : FCC PART 15C PEAK
 Env. / Ins. : 24*C/56% Engineer : Kevin_Hu
 EUT : AC750 Wireless Dual Band Router
 Power Rating : DC 12V From Adapter Input AC 120V/60Hz
 Test Mode : IEEE802.11ac VHT20 CH40 5200MHz Tx
 M/N : C20i

No.	Freq. (MHz)	Ant. Factor (dB/m)	Cable Loss (dB)	AMP factor (dB)	Reading (dBUV)	Emission			Remark
						Level (dBUV/m)	Limits (dBUV/m)	Margin (dB)	
1	5200.000	33.52	8.97	35.70	93.45	100.24	74.00	-26.24	Peak

Remarks: 1. Emission Level= Antenna Factor + Cable Loss + Reading -Amp Factor
 2. The emission levels that are 20dB below the official limit are not reported.

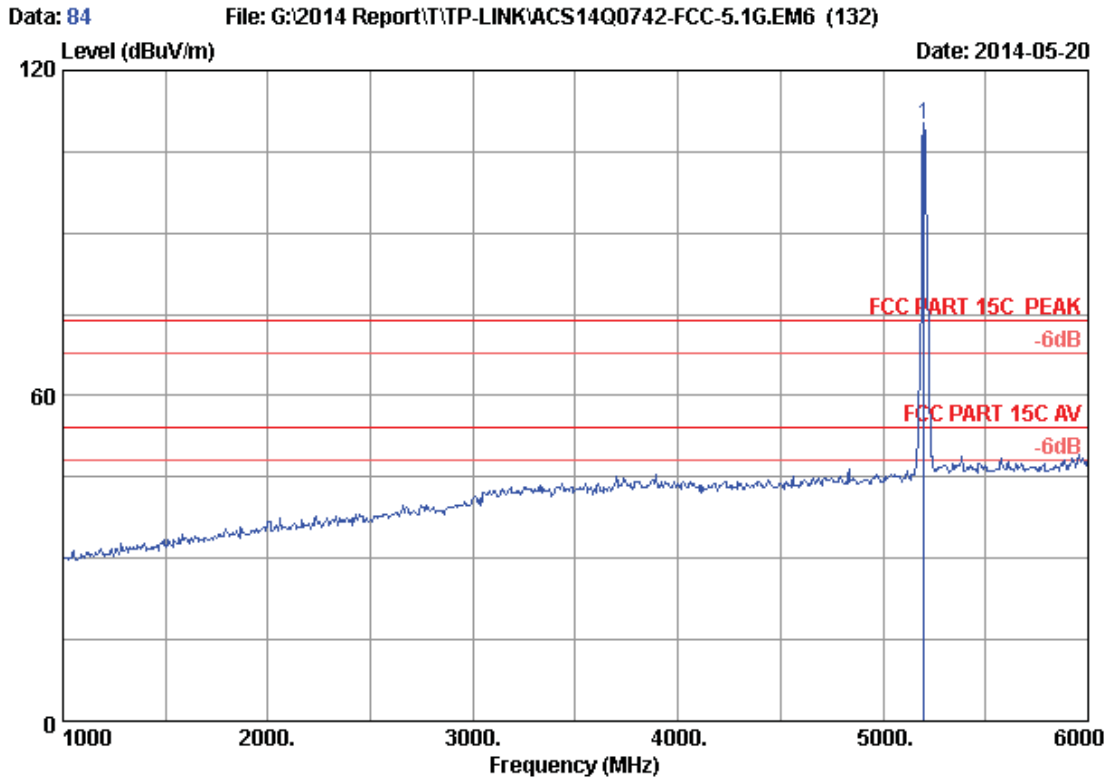

Site no. : 3m Chamber Data no. : 84
 Dis. / Ant. : 3m 2013 3115 (4580) Ant. pol. : VERTICAL
 Limit : FCC PART 15C PEAK
 Env. / Ins. : 24*C/56% Engineer : Kevin_Hu
 EUT : AC750 Wireless Dual Band Router
 Power Rating : DC 12V From Adapter Input AC 120V/60Hz
 Test Mode : IEEE802.11ac VHT20 CH40 5200MHz Tx
 M/N : C20i

No.	Freq. (MHz)	Ant. Factor (dB/m)	Cable Loss (dB)	AMP factor (dB)	Reading (dBUV)	Emission			Remark
						Level (dBUV/m)	Limits (dBUV/m)	Margin (dB)	
1	5200.000	33.52	8.97	35.70	103.21	110.00	74.00	-36.00	Peak

Remarks: 1. Emission Level= Antenna Factor + Cable Loss + Reading - Amp Factor
 2. The emission levels that are 20dB below the official limit are not reported.

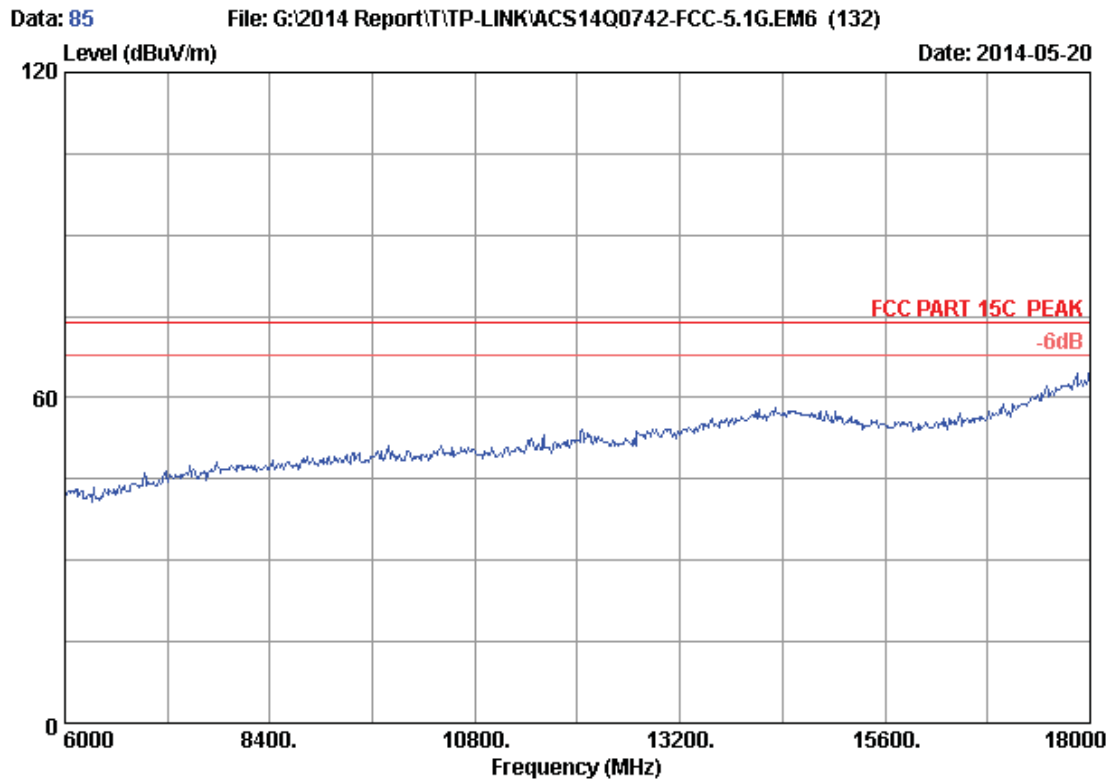

Site no. : 3m Chamber Data no. : 85
Dis. / Ant. : 3m 2013 3115 (4580) Ant. pol. : VERTICAL
Limit : FCC PART 15C PEAK
Env. / Ins. : 24*C/56% Engineer : Kevin_Hu
EUT : AC750 Wireless Dual Band Router
Power Rating : DC 12V From Adapter Input AC 120V/60Hz
Test Mode : IEEE802.11ac VHT20 CH40 5200MHz Tx
M/N : C20i

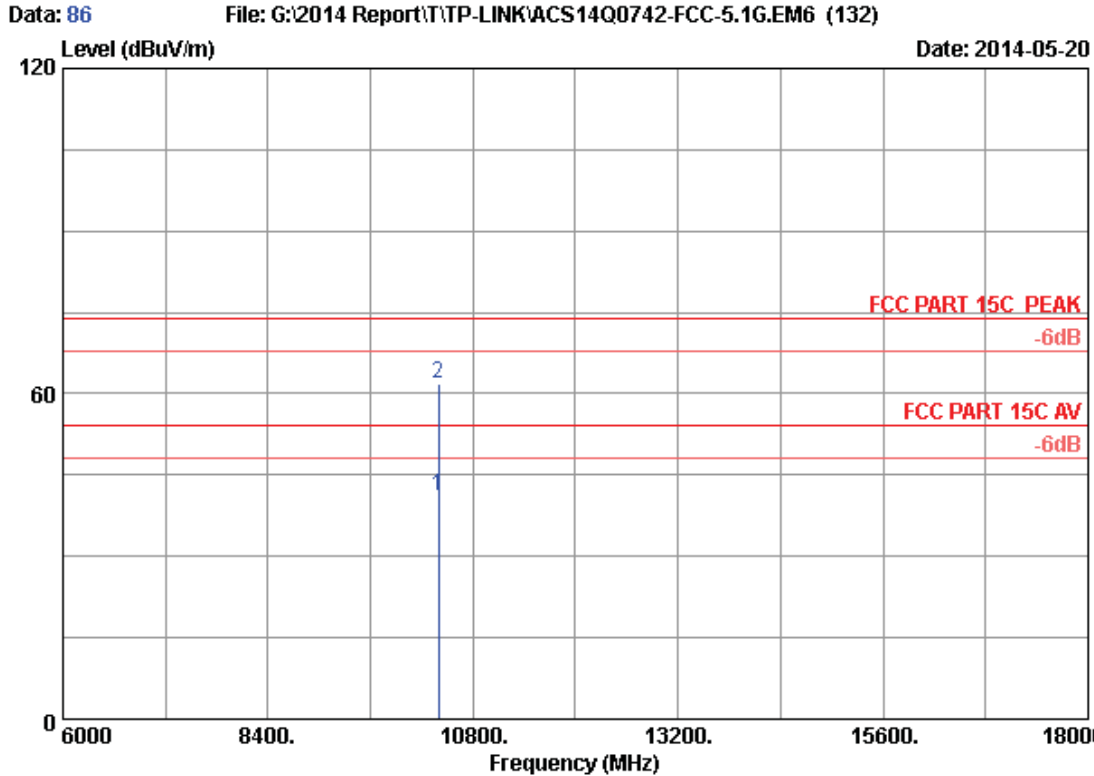

Site no. : 3m Chamber Data no. : 86
 Dis. / Ant. : 3m 2013 3115 (4580) Ant. pol. : VERTICAL
 Limit : FCC PART 15C PEAK
 Env. / Ins. : 24*C/56% Engineer : Kevin_Hu
 EUT : AC750 Wireless Dual Band Router
 Power Rating : DC 12V From Adapter Input AC 120V/60Hz
 Test Mode : IEEE802.11ac VHT20 CH40 5200MHz Tx
 M/N : C20i

No.	Freq. (MHz)	Ant. Factor (dB/m)	Cable Loss (dB)	AMP factor (dB)	Reading (dBuV)	Emission Level (dBuV/m)	Limits (dBuV/m)	Margin (dB)	Remark
1	10400.000	38.16	12.66	35.44	25.68	41.06	54.00	12.94	Average
2	10400.000	38.16	12.66	35.44	46.37	61.75	74.00	12.25	Peak

Remarks: 1. Emission Level= Antenna Factor + Cable Loss + Reading - Amp Factor
 2. The emission levels that are 20dB below the official limit are not reported.

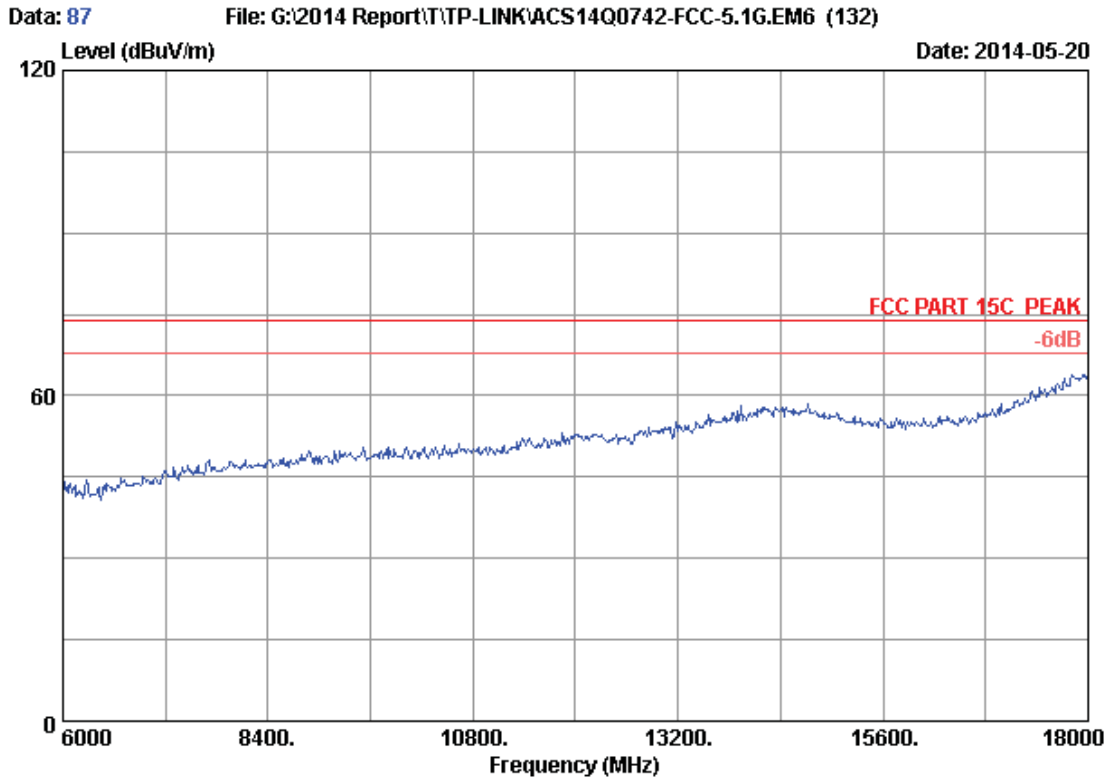

Site no. : 3m Chamber Data no. : 87
Dis. / Ant. : 3m 2013 3115 (4580) Ant. pol. : HORIZONTAL
Limit : FCC PART 15C PEAK
Env. / Ins. : 24*C/56% Engineer : Kevin_Hu
EUT : AC750 Wireless Dual Band Router
Power Rating : DC 12V From Adapter Input AC 120V/60Hz
Test Mode : IEEE802.11ac VHT20 CH40 5200MHz Tx
M/N : C20i

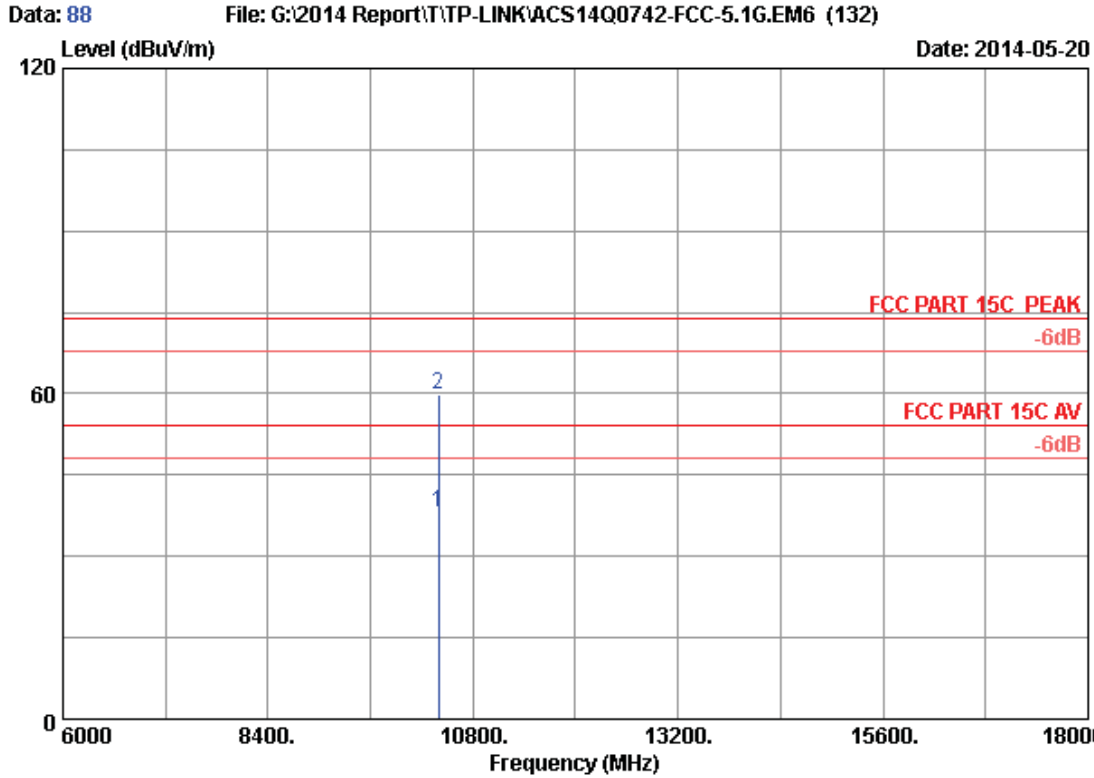

Site no. : 3m Chamber Data no. : 88
 Dis. / Ant. : 3m 2013 3115 (4580) Ant. pol. : HORIZONTAL
 Limit : FCC PART 15C PEAK
 Env. / Ins. : 24*C/56% Engineer : Kevin_Hu
 EUT : AC750 Wireless Dual Band Router
 Power Rating : DC 12V From Adapter Input AC 120V/60Hz
 Test Mode : IEEE802.11ac VHT20 CH40 5200MHz Tx
 M/N : C20i

No.	Freq. (MHz)	Ant. Factor (dB/m)	Cable Loss (dB)	AMP factor (dB)	Reading (dBuV)	Emission Level (dBuV/m)	Limits (dBuV/m)	Margin (dB)	Remark
1	10400.000	38.16	12.66	35.44	22.85	38.23	54.00	15.77	Average
2	10400.000	38.16	12.66	35.44	44.59	59.97	74.00	14.03	Peak

Remarks: 1. Emission Level= Antenna Factor + Cable Loss + Reading - Amp Factor
 2. The emission levels that are 20dB below the official limit are not reported.

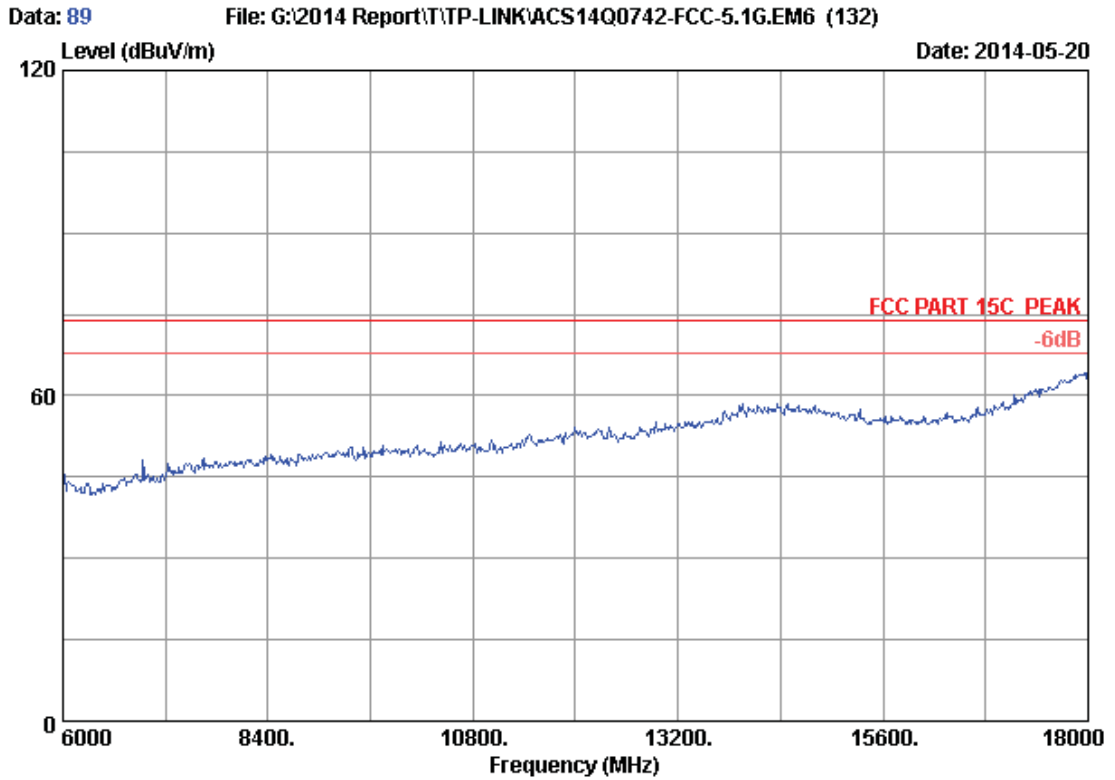

Site no. : 3m Chamber Data no. : 89
Dis. / Ant. : 3m 2013 3115 (4580) Ant. pol. : HORIZONTAL
Limit : FCC PART 15C PEAK
Env. / Ins. : 24*C/56% Engineer : Kevin_Hu
EUT : AC750 Wireless Dual Band Router
Power Rating : DC 12V From Adapter Input AC 120V/60Hz
Test Mode : IEEE802.11ac VHT20 CH48 5240MHz Tx
M/N : C20i

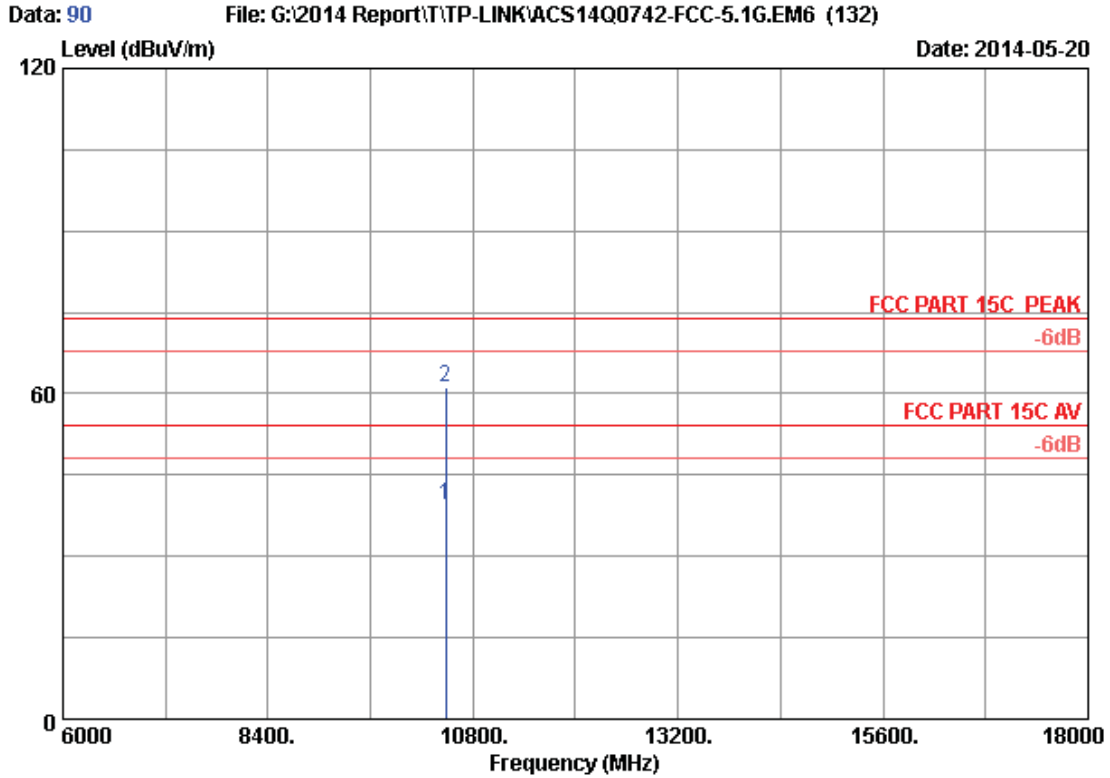

Site no. : 3m Chamber Data no. : 90
 Dis. / Ant. : 3m 2013 3115 (4580) Ant. pol. : HORIZONTAL
 Limit : FCC PART 15C PEAK
 Env. / Ins. : 24*C/56% Engineer : Kevin_Hu
 EUT : AC750 Wireless Dual Band Router
 Power Rating : DC 12V From Adapter Input AC 120V/60Hz
 Test Mode : IEEE802.11ac VHT20 CH48 5240MHz Tx
 M/N : C20i

No.	Freq. (MHz)	Ant. Factor (dB/m)	Cable Loss (dB)	AMP factor (dB)	Reading (dBUV)	Emission Level (dBUV/m)	Limits (dBUV/m)	Margin (dB)	Remark
1	10480.000	38.19	12.70	35.43	23.92	39.38	54.00	14.62	Average
2	10480.000	38.19	12.70	35.43	45.77	61.23	74.00	12.77	Peak

Remarks: 1. Emission Level= Antenna Factor + Cable Loss + Reading - Amp Factor
 2. The emission levels that are 20dB below the official limit are not reported.

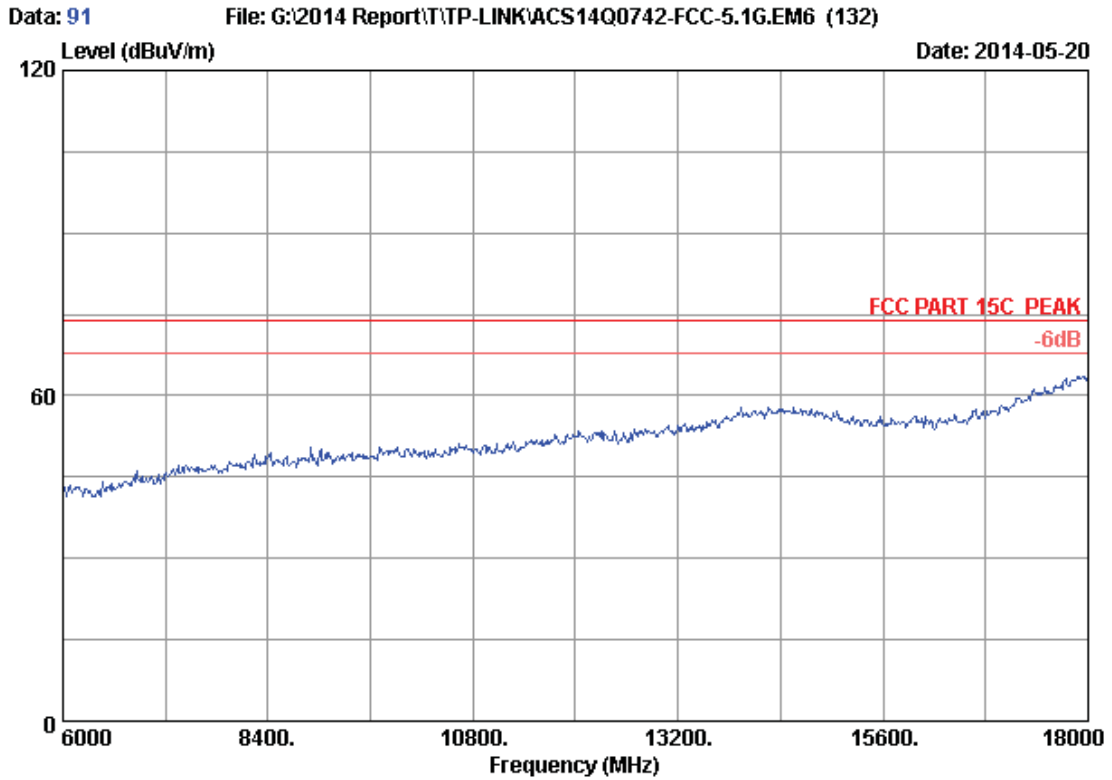

Site no. : 3m Chamber Data no. : 91
Dis. / Ant. : 3m 2013 3115 (4580) Ant. pol. : VERTICAL
Limit : FCC PART 15C PEAK
Env. / Ins. : 24*C/56% Engineer : Kevin_Hu
EUT : AC750 Wireless Dual Band Router
Power Rating : DC 12V From Adapter Input AC 120V/60Hz
Test Mode : IEEE802.11ac VHT20 CH48 5240MHz Tx
M/N : C20i

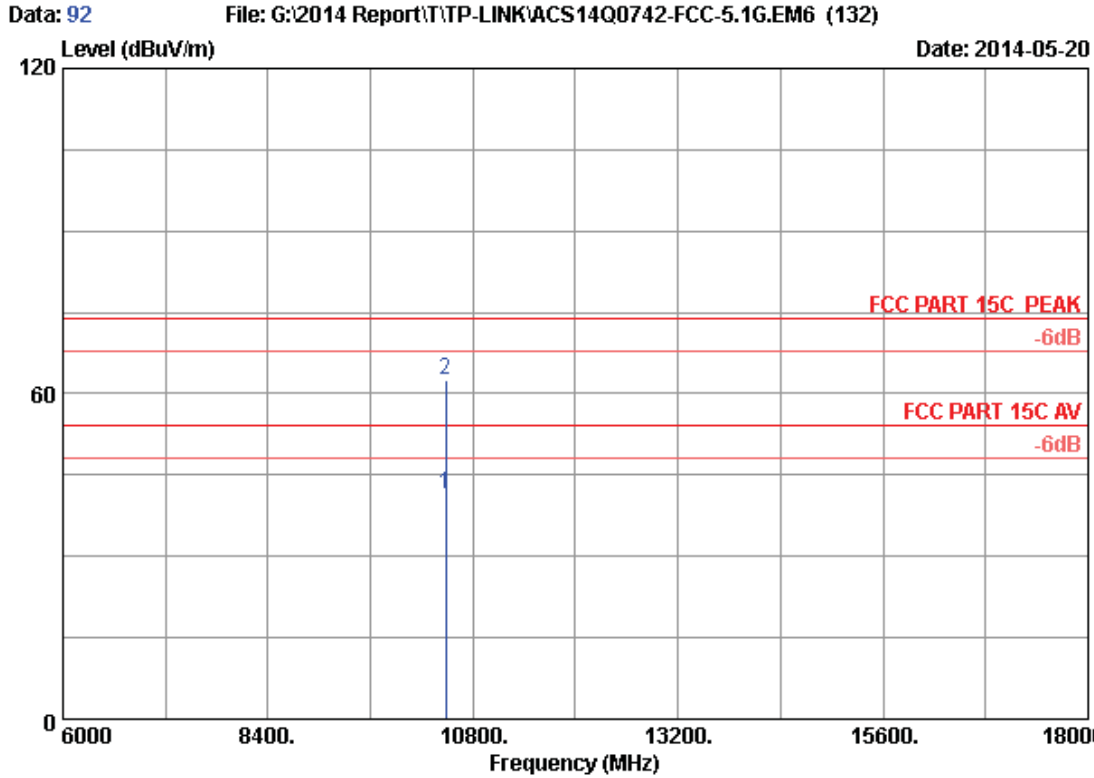

Site no. : 3m Chamber Data no. : 92
 Dis. / Ant. : 3m 2013 3115 (4580) Ant. pol. : VERTICAL
 Limit : FCC PART 15C PEAK
 Env. / Ins. : 24*C/56% Engineer : Kevin_Hu
 EUT : AC750 Wireless Dual Band Router
 Power Rating : DC 12V From Adapter Input AC 120V/60Hz
 Test Mode : IEEE802.11ac VHT20 CH48 5240MHz Tx
 M/N : C20i

No.	Freq. (MHz)	Ant. Factor (dB/m)	Cable Loss (dB)	AMP factor (dB)	Reading (dBUV)	Emission Level (dBUV/m)	Limits (dBUV/m)	Margin (dB)	Remark
1	10480.000	38.19	12.70	35.43	25.87	41.33	54.00	12.67	Average
2	10480.000	38.19	12.70	35.43	46.98	62.44	74.00	11.56	Peak

Remarks: 1. Emission Level= Antenna Factor + Cable Loss + Reading - Amp Factor
 2. The emission levels that are 20dB below the official limit are not reported.

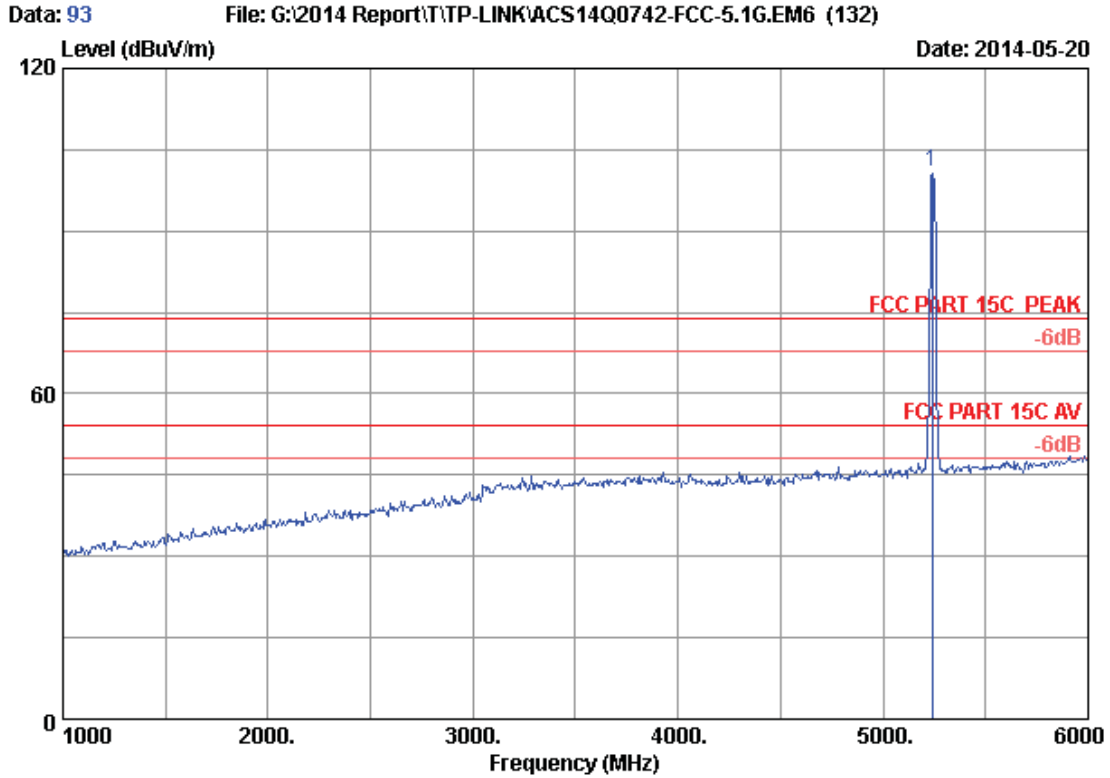

Site no. : 3m Chamber Data no. : 93
 Dis. / Ant. : 3m 2013 3115 (4580) Ant. pol. : HORIZONTAL
 Limit : FCC PART 15C PEAK
 Env. / Ins. : 24*C/56% Engineer : Kevin_Hu
 EUT : AC750 Wireless Dual Band Router
 Power Rating : DC 12V From Adapter Input AC 120V/60Hz
 Test Mode : IEEE802.11ac VHT20 CH48 5240MHz Tx
 M/N : C20i

No.	Freq. (MHz)	Ant. Factor (dB/m)	Cable Loss (dB)	AMP factor (dB)	Reading (dBUV)	Emission			Remark
						Level (dBUV/m)	Limits (dBUV/m)	Margin (dB)	
1	5240.000	33.58	9.02	35.70	94.06	100.96	74.00	-26.96	Peak

Remarks: 1. Emission Level= Antenna Factor + Cable Loss + Reading -Amp Factor
 2. The emission levels that are 20dB below the official limit are not reported.

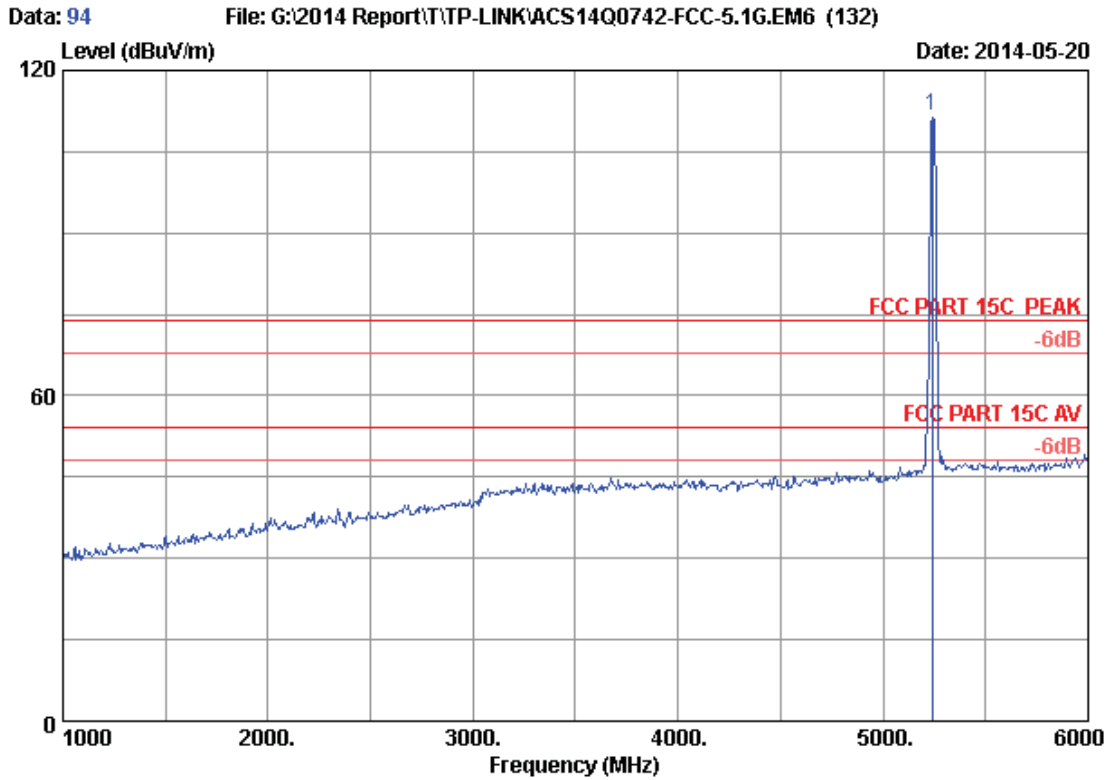

Site no. : 3m Chamber Data no. : 94
 Dis. / Ant. : 3m 2013 3115 (4580) Ant. pol. : VERTICAL
 Limit : FCC PART 15C PEAK
 Env. / Ins. : 24°C/56% Engineer : Kevin_Hu
 EUT : AC750 Wireless Dual Band Router
 Power Rating : DC 12V From Adapter Input AC 120V/60Hz
 Test Mode : IEEE802.11ac VHT20 CH48 5240MHz Tx
 M/N : C20i

No.	Freq. (MHz)	Ant. Factor (dB/m)	Cable Loss (dB)	AMP factor (dB)	Reading (dBUV)	Emission			Remark
						Level (dBUV/m)	Limits (dBUV/m)	Margin (dB)	
1	5240.000	33.58	9.02	35.70	104.67	111.57	74.00	-37.57	Peak

Remarks: 1. Emission Level= Antenna Factor + Cable Loss + Reading -Amp Factor
 2. The emission levels that are 20dB below the official limit are not reported.

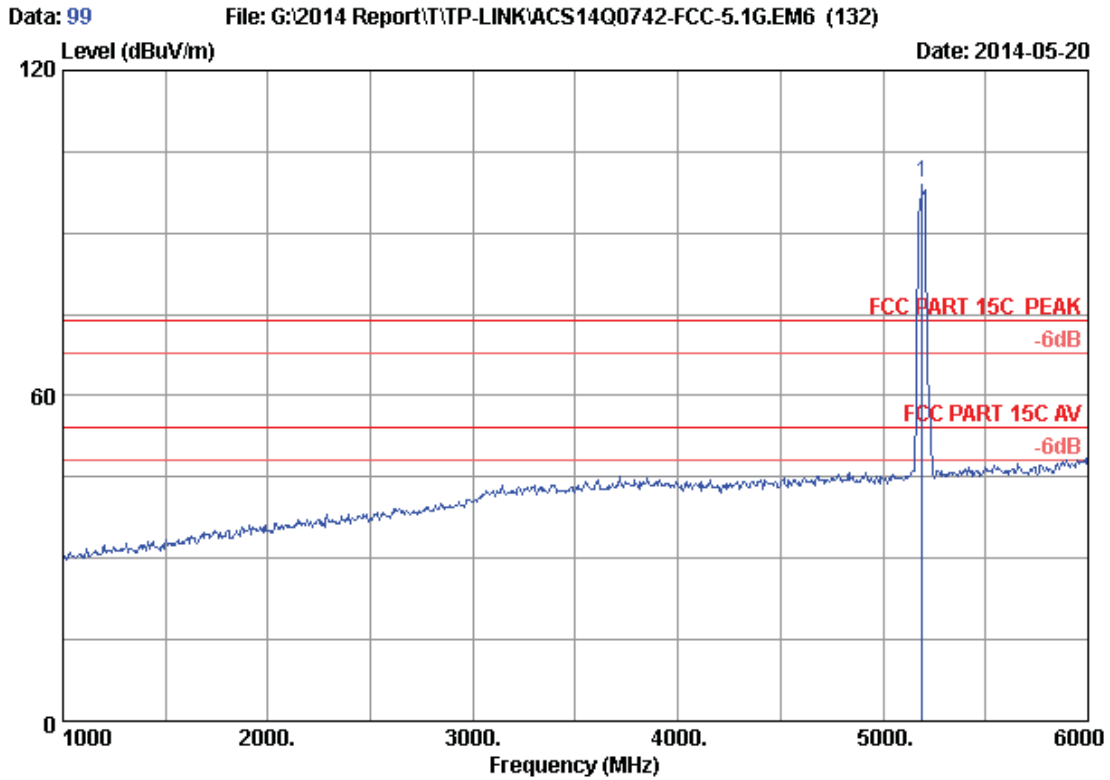

Site no. : 3m Chamber Data no. : 99
 Dis. / Ant. : 3m 2013 3115 (4580) Ant. pol. : HORIZONTAL
 Limit : FCC PART 15C PEAK
 Env. / Ins. : 24*C/56% Engineer : Kevin_Hu
 EUT : AC750 Wireless Dual Band Router
 Power Rating : DC 12V From Adapter Input AC 120V/60Hz
 Test Mode : IEEE802.11ac VHT40 CH38 5190MHz Tx
 M/N : C20i

No.	Freq. (MHz)	Ant. Factor (dB/m)	Cable Loss (dB)	AMP factor (dB)	Reading (dBUV)	Emission			Remark
						Level (dBUV/m)	Limits (dBUV/m)	Margin (dB)	
1	5190.000	33.50	8.96	35.70	92.46	99.22	74.00	-25.22	Peak

Remarks: 1. Emission Level= Antenna Factor + Cable Loss + Reading - Amp Factor
 2. The emission levels that are 20dB below the official limit are not reported.

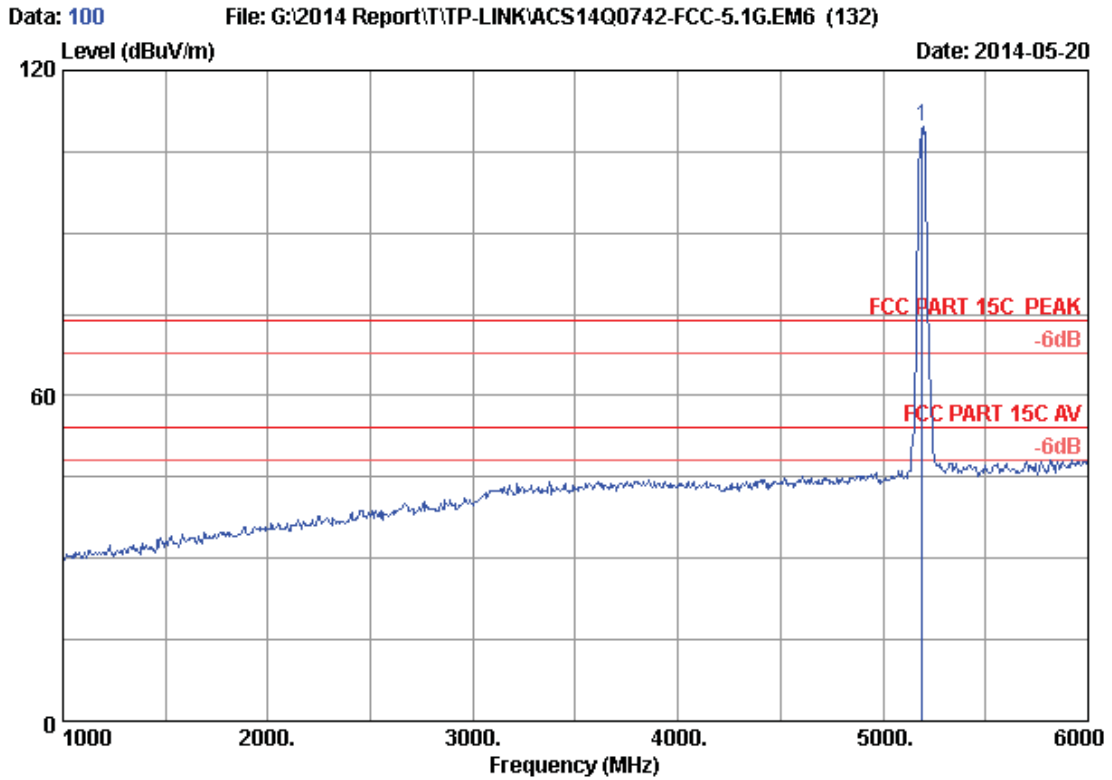

Site no. : 3m Chamber Data no. : 100
 Dis. / Ant. : 3m 2013 3115 (4580) Ant. pol. : VERTICAL
 Limit : FCC PART 15C PEAK
 Env. / Ins. : 24°C/56% Engineer : Kevin_Hu
 EUT : AC750 Wireless Dual Band Router
 Power Rating : DC 12V From Adapter Input AC 120V/60Hz
 Test Mode : IEEE802.11ac VHT40 CH38 5190MHz Tx
 M/N : C20i

No.	Freq. (MHz)	Ant. Factor (dB/m)	Cable Loss (dB)	AMP factor (dB)	Reading (dBuV)	Emission			Remark
						Level (dBuV/m)	Limits (dBuV/m)	Margin (dB)	
1	5190.000	33.50	8.96	35.70	102.76	109.52	74.00	-35.52	Peak

Remarks: 1. Emission Level= Antenna Factor + Cable Loss + Reading - Amp Factor
 2. The emission levels that are 20dB below the official limit are not reported.

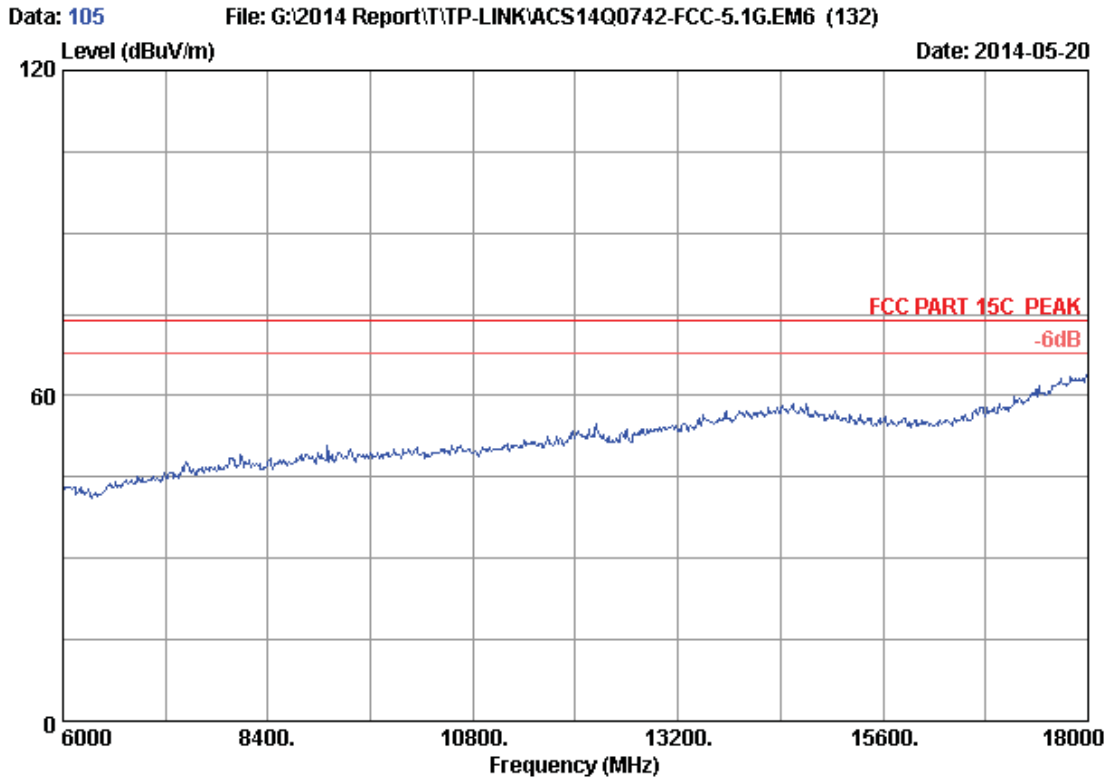

Site no. : 3m Chamber Data no. : 105
Dis. / Ant. : 3m 2013 3115 (4580) Ant. pol. : HORIZONTAL
Limit : FCC PART 15C PEAK
Env. / Ins. : 24*C/56% Engineer : Kevin_Hu
EUT : AC750 Wireless Dual Band Router
Power Rating : DC 12V From Adapter Input AC 120V/60Hz
Test Mode : IEEE802.11ac VHT40 CH38 5190MHz Tx
M/N : C20i

Data: 106 File: G:\2014 Report\T\TP-LINK\ACS14Q0742-FCC-5.1G.EM6 (132) Date: 2014-05-20

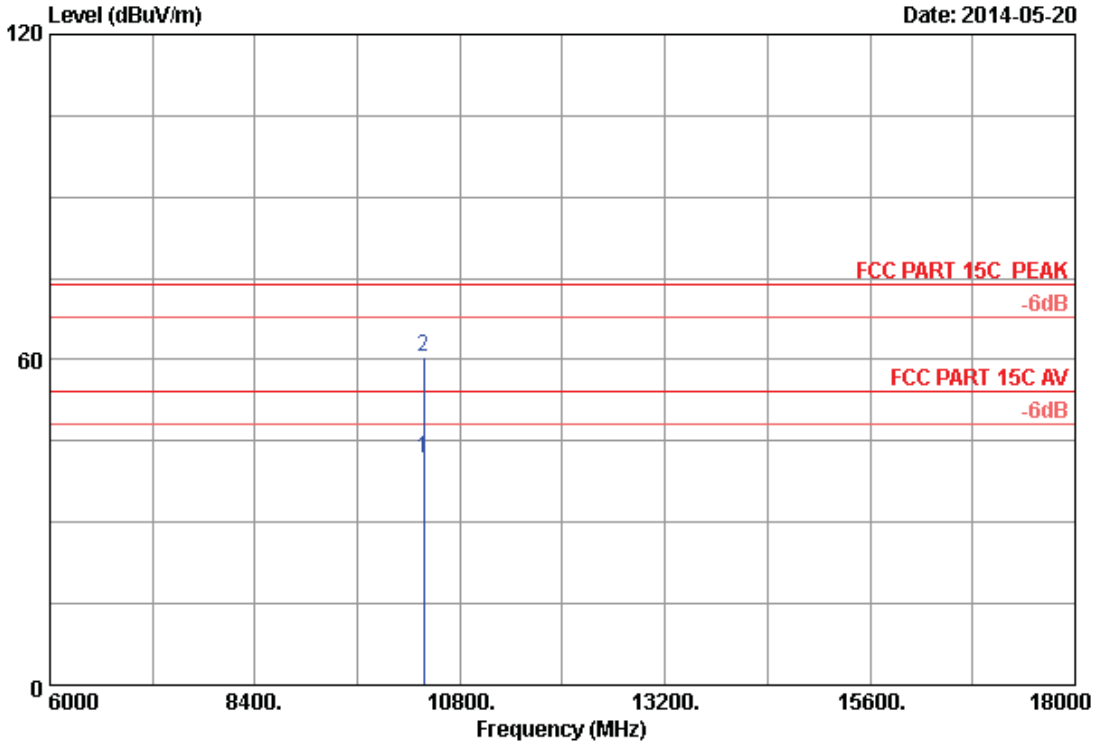

Site no. : 3m Chamber Data no. : 106
 Dis. / Ant. : 3m 2013 3115 (4580) Ant. pol. : HORIZONTAL
 Limit : FCC PART 15C PEAK
 Env. / Ins. : 24*C/56% Engineer : Kevin_Hu
 EUT : AC750 Wireless Dual Band Router
 Power Rating : DC 12V From Adapter Input AC 120V/60Hz
 Test Mode : IEEE802.11ac VHT40 CH38 5190MHz Tx
 M/N : C20i

No.	Freq. (MHz)	Ant. Factor (dB/m)	Cable Loss (dB)	AMP factor (dB)	Reading (dBuV)	Emission Level (dBuV/m)	Limits (dBuV/m)	Margin (dB)	Remark
1	10380.000	38.15	12.65	35.44	26.57	41.93	54.00	12.07	Average
2	10380.000	38.15	12.65	35.44	45.28	60.64	74.00	13.36	Peak

Remarks: 1. Emission Level= Antenna Factor + Cable Loss + Reading - Amp Factor
 2. The emission levels that are 20dB below the official limit are not reported.

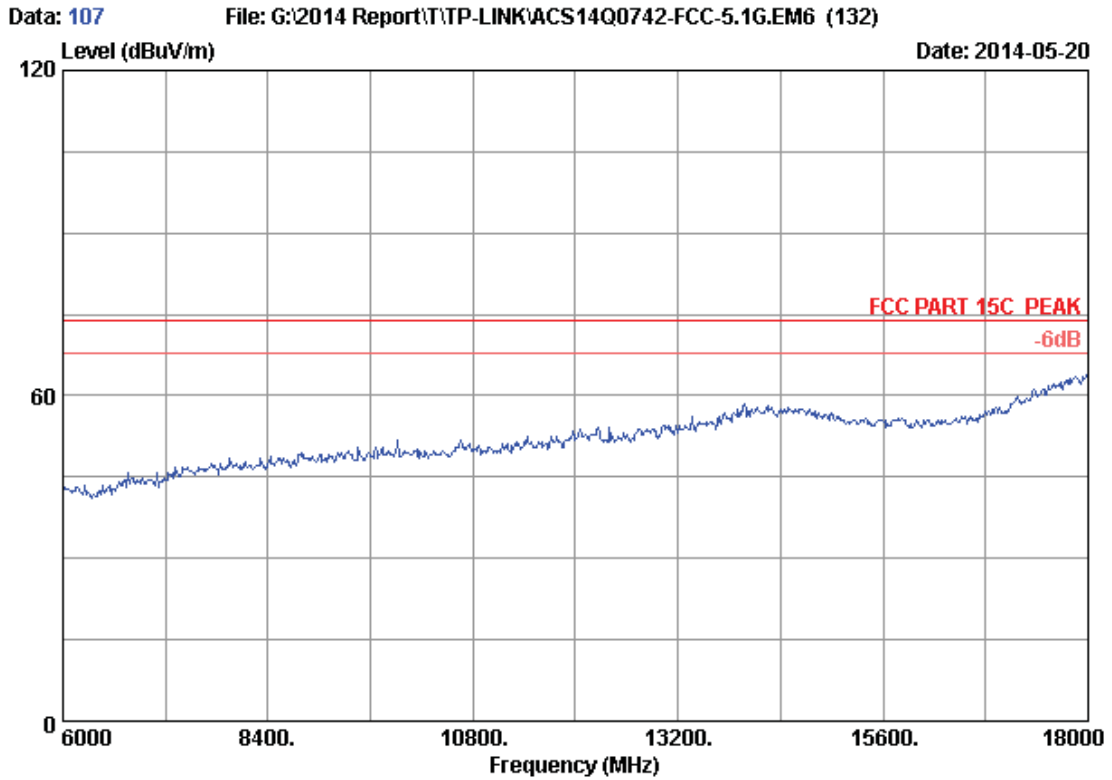

Site no. : 3m Chamber Data no. : 107
Dis. / Ant. : 3m 2013 3115 (4580) Ant. pol. : VERTICAL
Limit : FCC PART 15C PEAK
Env. / Ins. : 24*C/56% Engineer : Kevin_Hu
EUT : AC750 Wireless Dual Band Router
Power Rating : DC 12V From Adapter Input AC 120V/60Hz
Test Mode : IEEE802.11ac VHT40 CH38 5190MHz Tx
M/N : C20i

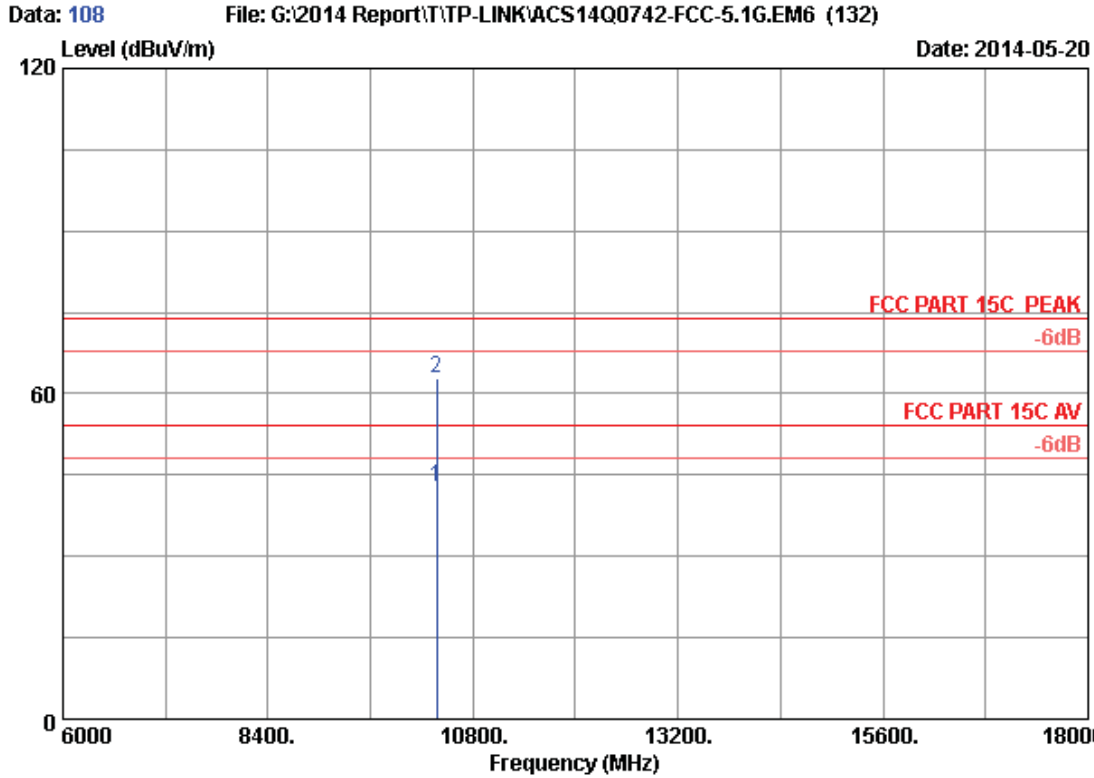

Site no. : 3m Chamber Data no. : 108
 Dis. / Ant. : 3m 2013 3115 (4580) Ant. pol. : VERTICAL
 Limit : FCC PART 15C PEAK
 Env. / Ins. : 24*C/56% Engineer : Kevin_Hu
 EUT : AC750 Wireless Dual Band Router
 Power Rating : DC 12V From Adapter Input AC 120V/60Hz
 Test Mode : IEEE802.11ac VHT40 CH38 5190MHz Tx
 M/N : C20i

No.	Freq. (MHz)	Ant. Factor (dB/m)	Cable Loss (dB)	AMP factor (dB)	Reading (dBuV)	Emission Level (dBuV/m)	Limits (dBuV/m)	Margin (dB)	Remark
1	10380.000	38.15	12.65	35.44	27.45	42.81	54.00	11.19	Average
2	10380.000	38.15	12.65	35.44	47.59	62.95	74.00	11.05	Peak

Remarks: 1. Emission Level= Antenna Factor + Cable Loss + Reading - Amp Factor
 2. The emission levels that are 20dB below the official limit are not reported.

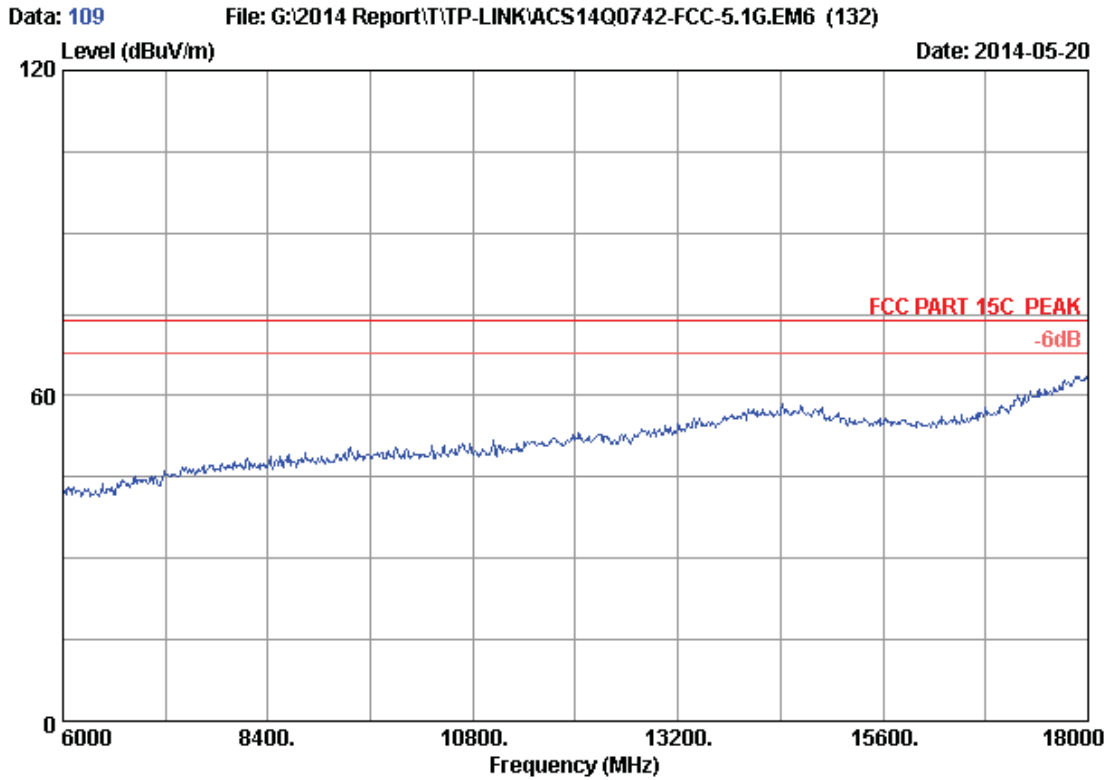

Site no. : 3m Chamber Data no. : 109
Dis. / Ant. : 3m 2013 3115 (4580) Ant. pol. : VERTICAL
Limit : FCC PART 15C PEAK
Env. / Ins. : 24*C/56% Engineer : Kevin_Hu
EUT : AC750 Wireless Dual Band Router
Power Rating : DC 12V From Adapter Input AC 120V/60Hz
Test Mode : IEEE802.11ac VHT40 CH46 5230MHz Tx
M/N : C20i

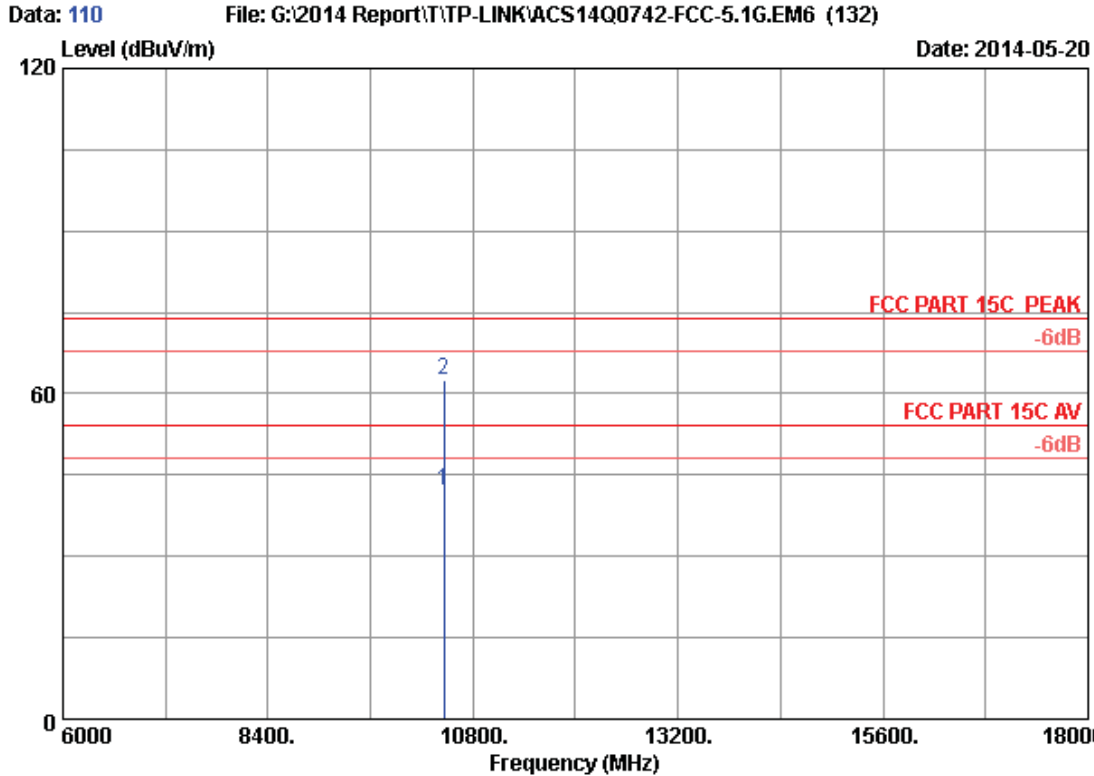

Site no. : 3m Chamber Data no. : 110
 Dis. / Ant. : 3m 2013 3115 (4580) Ant. pol. : VERTICAL
 Limit : FCC PART 15C PEAK
 Env. / Ins. : 24*C/56% Engineer : Kevin_Hu
 EUT : AC750 Wireless Dual Band Router
 Power Rating : DC 12V From Adapter Input AC 120V/60Hz
 Test Mode : IEEE802.11ac VHT40 CH46 5230MHz Tx
 M/N : C20i

No.	Freq. (MHz)	Ant. Factor (dB/m)	Cable Loss (dB)	AMP factor (dB)	Reading (dBuV)	Emission Level (dBuV/m)	Limits (dBuV/m)	Margin (dB)	Remark
1	10460.000	38.18	12.69	35.43	26.56	42.00	54.00	12.00	Average
2	10460.000	38.18	12.69	35.43	47.23	62.67	74.00	11.33	Peak

Remarks: 1. Emission Level= Antenna Factor + Cable Loss + Reading - Amp Factor
 2. The emission levels that are 20dB below the official limit are not reported.

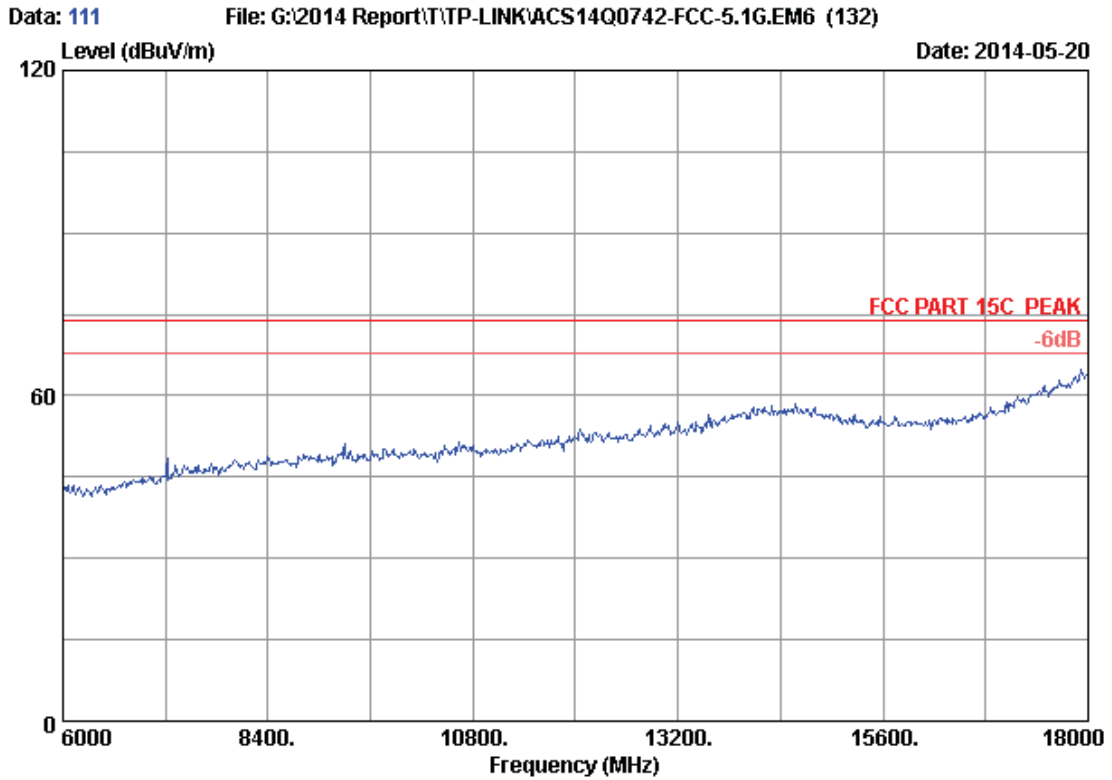

Site no. : 3m Chamber Data no. : 111
Dis. / Ant. : 3m 2013 3115 (4580) Ant. pol. : HORIZONTAL
Limit : FCC PART 15C PEAK
Env. / Ins. : 24*C/56% Engineer : Kevin_Hu
EUT : AC750 Wireless Dual Band Router
Power Rating : DC 12V From Adapter Input AC 120V/60Hz
Test Mode : IEEE802.11ac VHT40 CH46 5230MHz Tx
M/N : C20i

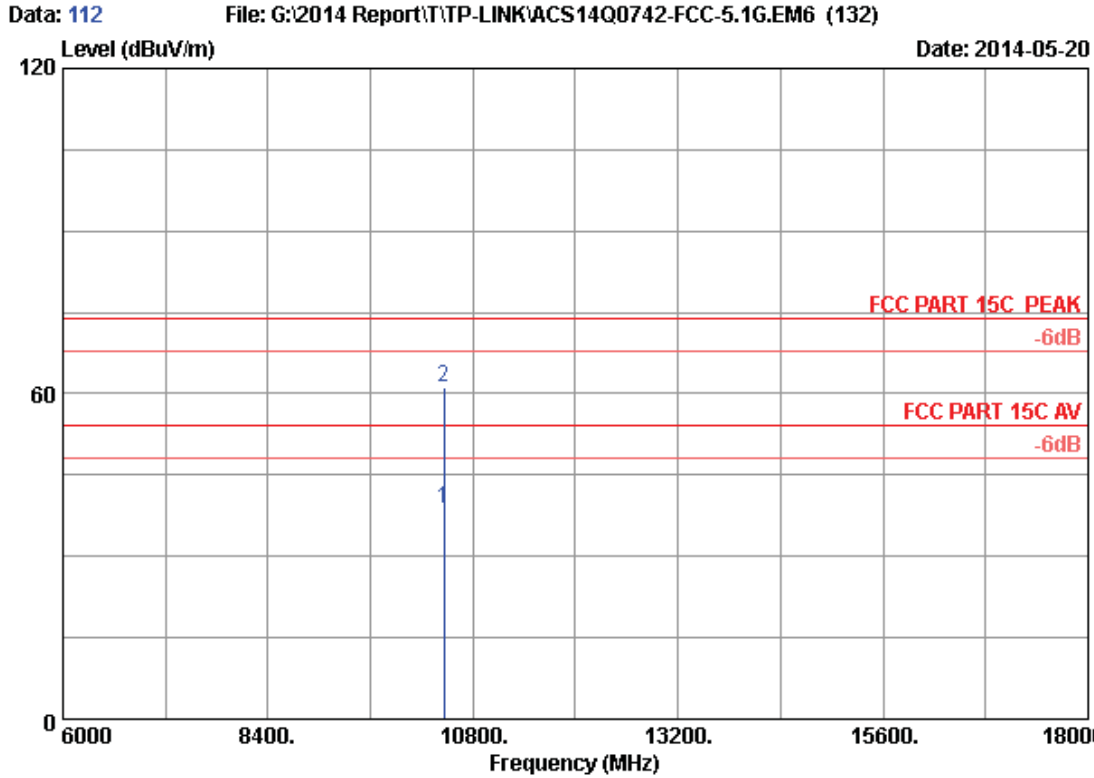

Site no. : 3m Chamber Data no. : 112
 Dis. / Ant. : 3m 2013 3115 (4580) Ant. pol. : HORIZONTAL
 Limit : FCC PART 15C PEAK
 Env. / Ins. : 24*C/56% Engineer : Kevin_Hu
 EUT : AC750 Wireless Dual Band Router
 Power Rating : DC 12V From Adapter Input AC 120V/60Hz
 Test Mode : IEEE802.11ac VHT40 CH46 5230MHz Tx
 M/N : C20i

No.	Freq. (MHz)	Ant. Factor (dB/m)	Cable Loss (dB)	AMP factor (dB)	Reading (dBuV)	Emission Level (dBuV/m)	Limits (dBuV/m)	Margin (dB)	Remark
1	10460.000	38.18	12.69	35.43	23.46	38.90	54.00	15.10	Average
2	10460.000	38.18	12.69	35.43	45.87	61.31	74.00	12.69	Peak

Remarks: 1. Emission Level= Antenna Factor + Cable Loss + Reading - Amp Factor
 2. The emission levels that are 20dB below the official limit are not reported.

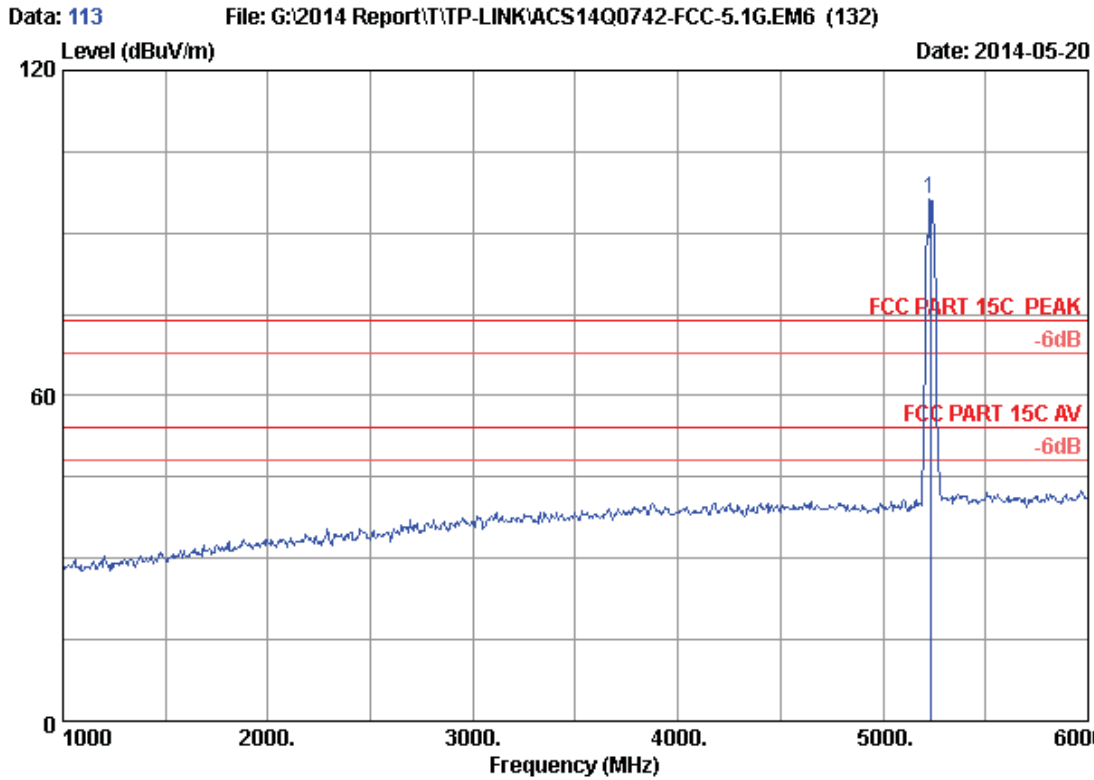

Site no. : 3m Chamber Data no. : 113
 Dis. / Ant. : 3m 2013 3115 (4580) Ant. pol. : HORIZONTAL
 Limit : FCC PART 15C PEAK
 Env. / Ins. : 24°C/56% Engineer : Kevin_Hu
 EUT : AC750 Wireless Dual Band Router
 Power Rating : DC 12V From Adapter Input AC 120V/60Hz
 Test Mode : IEEE802.11ac VHT40 CH46 5230MHz Tx
 M/N : C20i

No.	Freq. (MHz)	Ant. Factor (dB/m)	Cable Loss (dB)	AMP factor (dB)	Reading (dBuV)	Emission			Remark
						Level (dBuV/m)	Limits (dBuV/m)	Margin (dB)	
1	5230.000	33.57	9.01	35.70	89.44	96.32	74.00	-22.32	Peak

Remarks: 1. Emission Level= Antenna Factor + Cable Loss + Reading - Amp Factor
 2. The emission levels that are 20dB below the official limit are not reported.

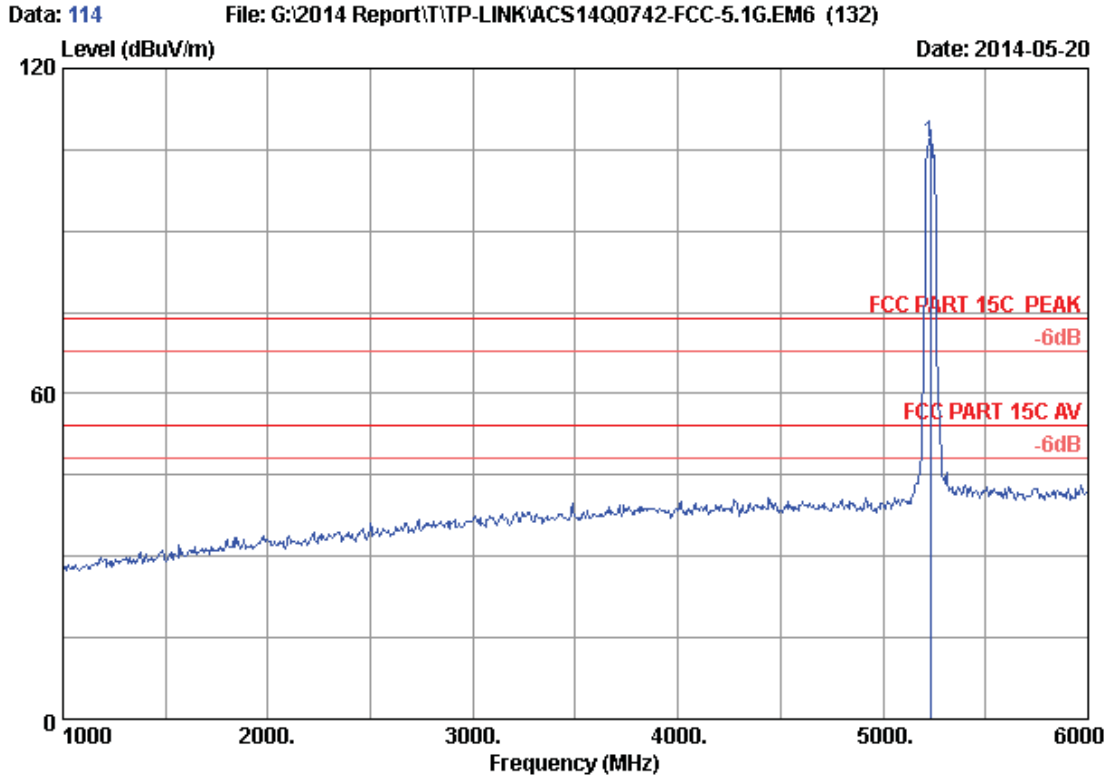

Site no. : 3m Chamber Data no. : 114
 Dis. / Ant. : 3m 2013 3115 (4580) Ant. pol. : VERTICAL
 Limit : FCC PART 15C PEAK
 Env. / Ins. : 24°C/56% Engineer : Kevin_Hu
 EUT : AC750 Wireless Dual Band Router
 Power Rating : DC 12V From Adapter Input AC 120V/60Hz
 Test Mode : IEEE802.11ac VHT40 CH46 5230MHz Tx
 M/N : C20i

No.	Freq. (MHz)	Ant. Factor (dB/m)	Cable Loss (dB)	AMP factor (dB)	Reading (dBuV)	Emission			Remark
						Level (dBuV/m)	Limits (dBuV/m)	Margin (dB)	
1	5230.000	33.57	9.01	35.70	99.44	106.32	74.00	-32.32	Peak

Remarks: 1. Emission Level= Antenna Factor + Cable Loss + Reading - Amp Factor
 2. The emission levels that are 20dB below the official limit are not reported.

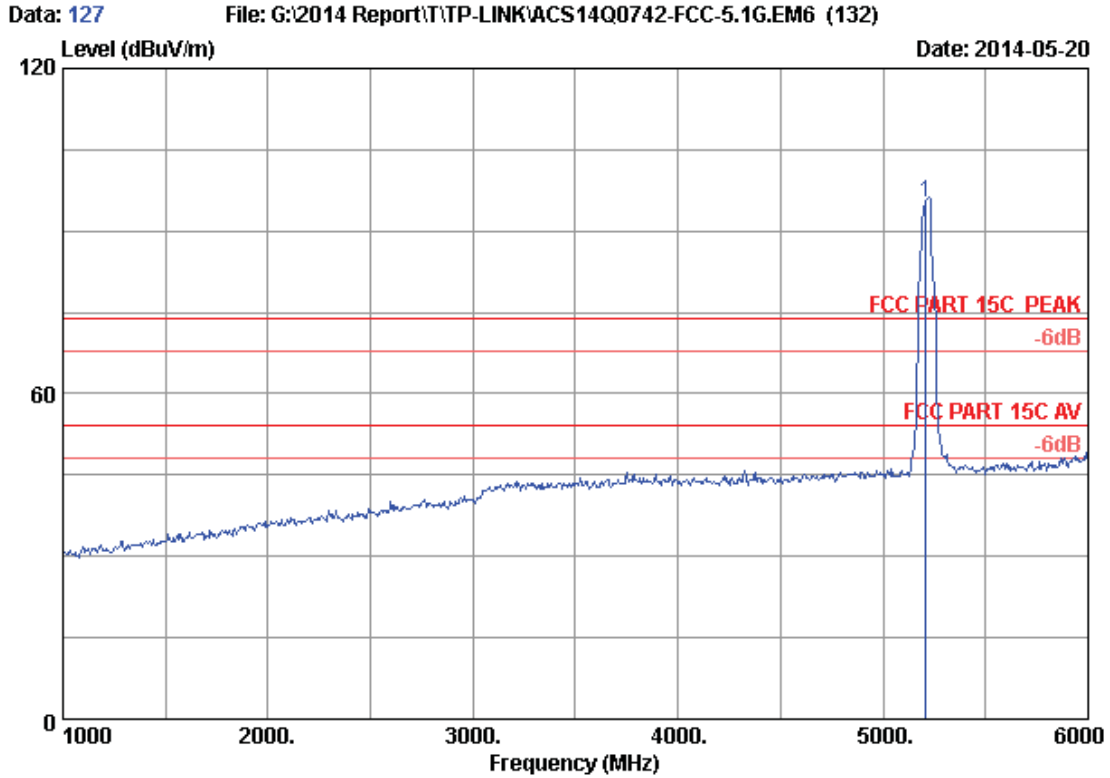

Site no. : 3m Chamber Data no. : 127
 Dis. / Ant. : 3m 2013 3115 (4580) Ant. pol. : HORIZONTAL
 Limit : FCC PART 15C PEAK
 Env. / Ins. : 24*C/56% Engineer : Kevin_Hu
 EUT : AC750 Wireless Dual Band Router
 Power Rating : DC 12V From Adapter Input AC 120V/60Hz
 Test Mode : IEEE802.11ac VHT80 CH42 5210MHz Tx
 M/N : C20i

No.	Freq. (MHz)	Ant. Factor (dB/m)	Cable Loss (dB)	AMP factor (dB)	Reading (dBuV)	Emission			Remark
						Level (dBuV/m)	Limits (dBuV/m)	Margin (dB)	
1	5210.000	33.54	8.98	35.70	88.59	95.41	74.00	-21.41	Peak

Remarks: 1. Emission Level= Antenna Factor + Cable Loss + Reading - Amp Factor
 2. The emission levels that are 20dB below the official limit are not reported.

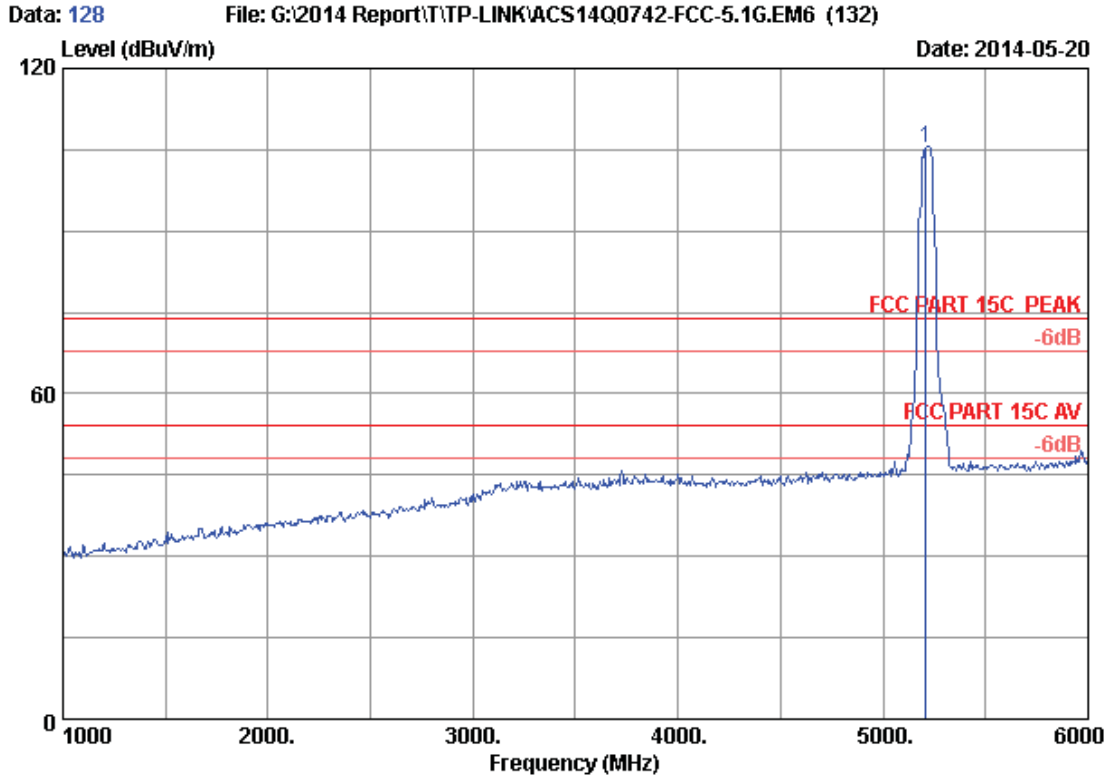

Site no. : 3m Chamber Data no. : 128
 Dis. / Ant. : 3m 2013 3115 (4580) Ant. pol. : VERTICAL
 Limit : FCC PART 15C PEAK
 Env. / Ins. : 24°C/56% Engineer : Kevin_Hu
 EUT : AC750 Wireless Dual Band Router
 Power Rating : DC 12V From Adapter Input AC 120V/60Hz
 Test Mode : IEEE802.11ac VHT80 CH42 5210MHz Tx
 M/N : C20i

No.	Freq. (MHz)	Ant. Factor (dB/m)	Cable Loss (dB)	AMP factor (dB)	Reading (dBuV)	Emission			Remark
						Level (dBuV/m)	Limits (dBuV/m)	Margin (dB)	
1	5210.000	33.54	8.98	35.70	98.56	105.38	74.00	-31.38	Peak

Remarks: 1. Emission Level= Antenna Factor + Cable Loss + Reading - Amp Factor
 2. The emission levels that are 20dB below the official limit are not reported.

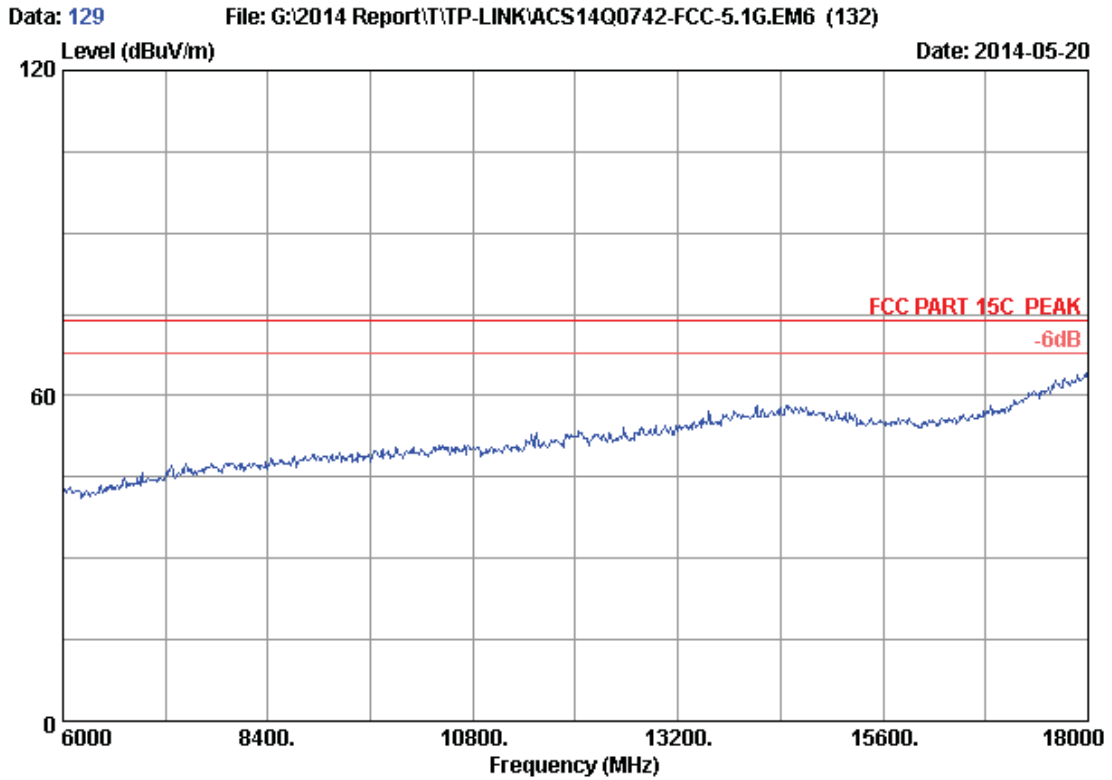

Site no. : 3m Chamber Data no. : 129
Dis. / Ant. : 3m 2013 3115 (4580) Ant. pol. : VERTICAL
Limit : FCC PART 15C PEAK
Env. / Ins. : 24*C/56% Engineer : Kevin_Hu
EUT : AC750 Wireless Dual Band Router
Power Rating : DC 12V From Adapter Input AC 120V/60Hz
Test Mode : IEEE802.11ac VHT80 CH42 5210MHz Tx
M/N : C20i

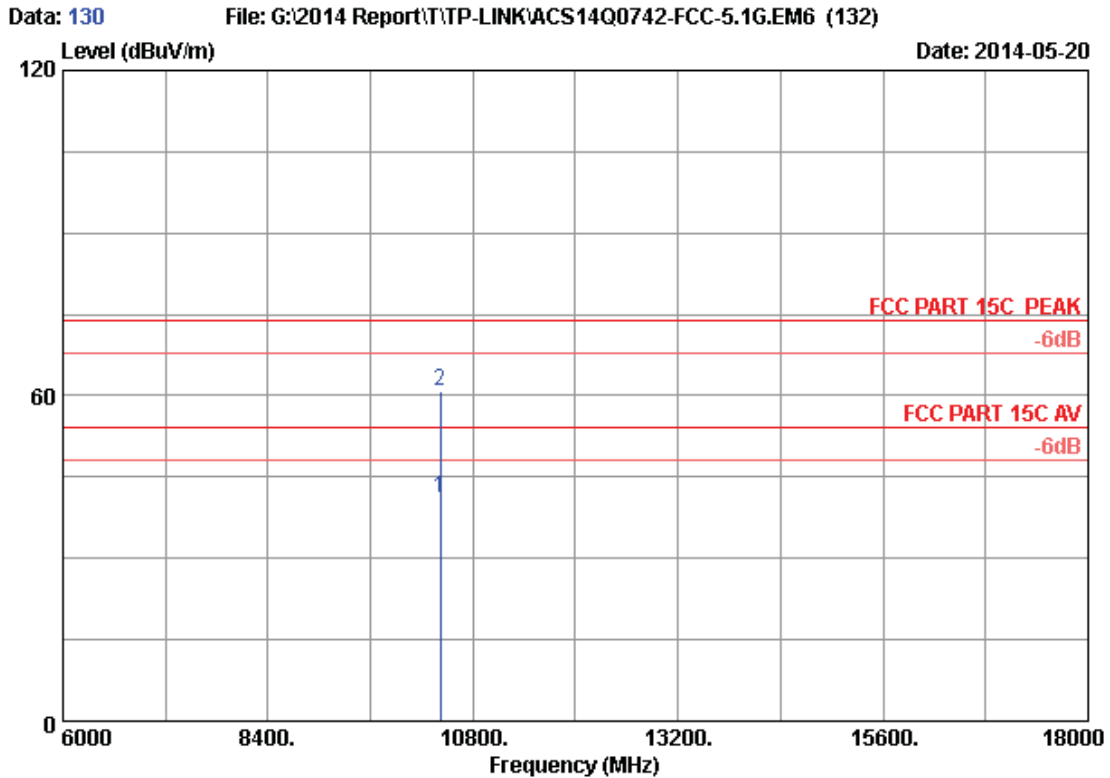

Site no. : 3m Chamber Data no. : 130
 Dis. / Ant. : 3m 2013 3115 (4580) Ant. pol. : VERTICAL
 Limit : FCC PART 15C PEAK
 Env. / Ins. : 24*C/56% Engineer : Kevin_Hu
 EUT : AC750 Wireless Dual Band Router
 Power Rating : DC 12V From Adapter Input AC 120V/60Hz
 Test Mode : IEEE802.11ac VHT80 CH42 5210MHz Tx
 M/N : C20i

No.	Freq. (MHz)	Ant. Factor (dB/m)	Cable Loss (dB)	AMP factor (dB)	Reading (dBuV)	Emission Level (dBuV/m)	Limits (dBuV/m)	Margin (dB)	Remark
1	10420.000	38.17	12.67	35.44	25.75	41.15	54.00	12.85	Average
2	10420.000	38.17	12.67	35.44	45.29	60.69	74.00	13.31	Peak

Remarks: 1. Emission Level= Antenna Factor + Cable Loss + Reading - Amp Factor
 2. The emission levels that are 20dB below the official limit are not reported.

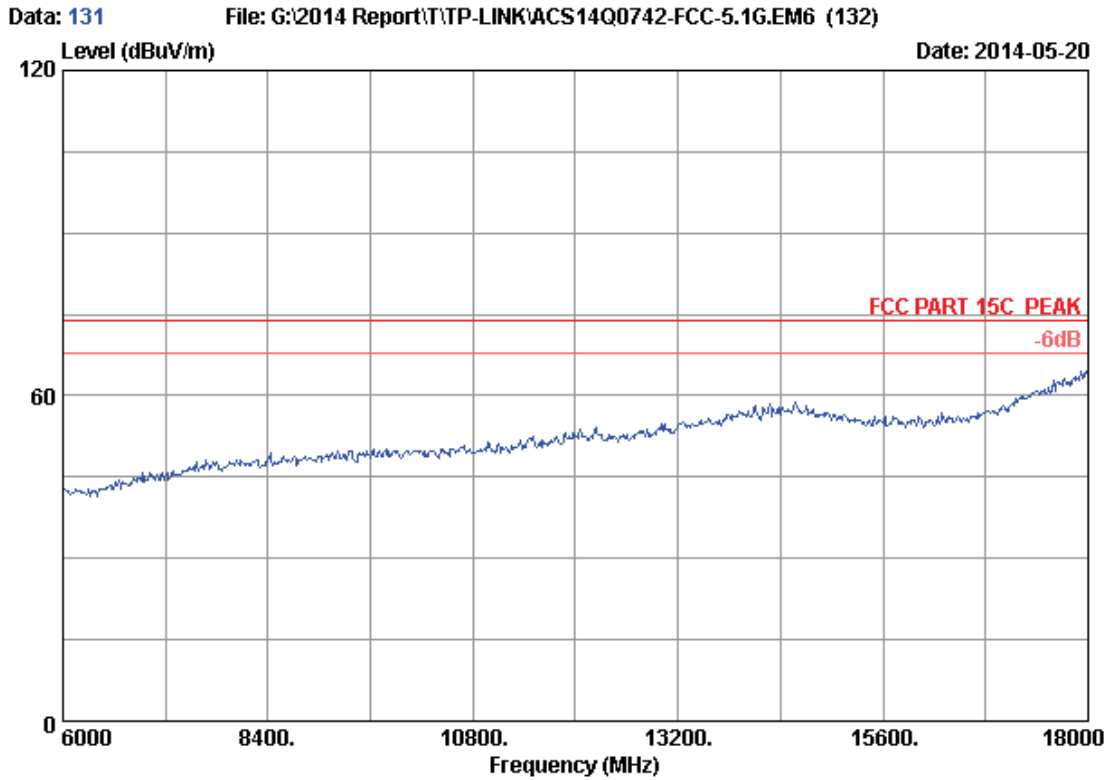

Site no. : 3m Chamber Data no. : 131
 Dis. / Ant. : 3m 2013 3115 (4580) Ant. pol. : HORIZONTAL
 Limit : FCC PART 15C PEAK
 Env. / Ins. : 24*C/56% Engineer : Kevin_Hu
 EUT : AC750 Wireless Dual Band Router
 Power Rating : DC 12V From Adapter Input AC 120V/60Hz
 Test Mode : IEEE802.11ac VHT80 CH42 5210MHz Tx
 M/N : C20i

Data: 132 File: G:\2014 Report\T\TP-LINK\ACS14Q0742-FCC-5.1G.EM6 (132) Date: 2014-05-20

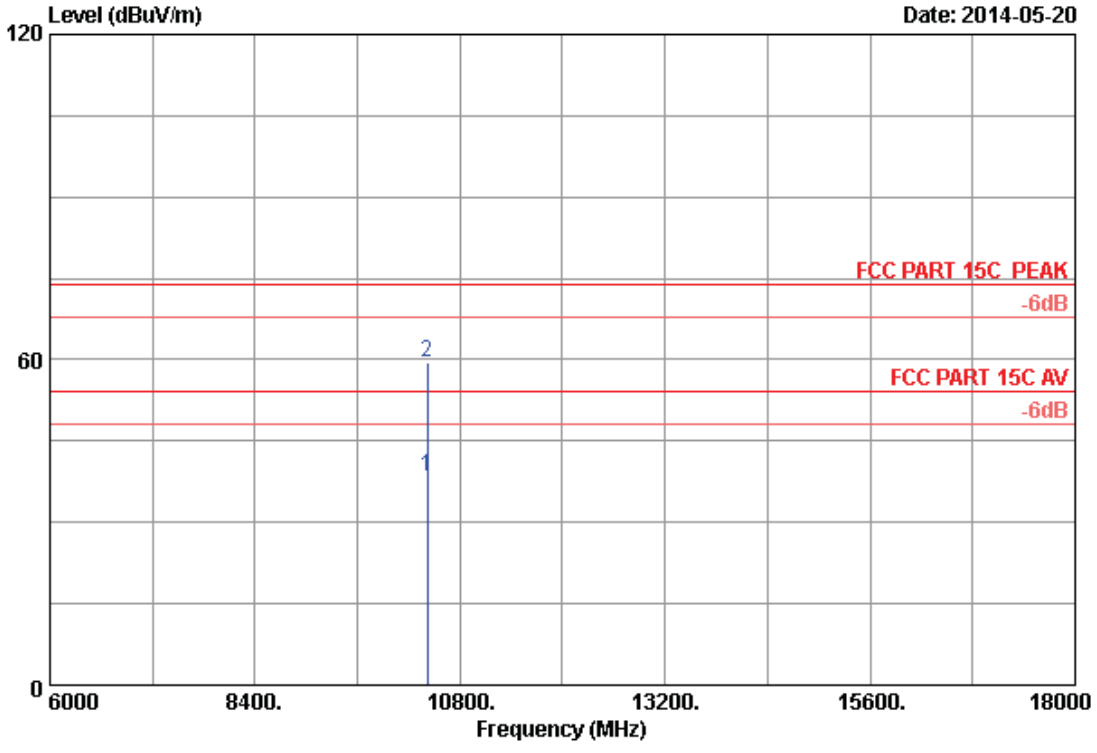

Site no. : 3m Chamber Data no. : 132
 Dis. / Ant. : 3m 2013 3115 (4580) Ant. pol. : HORIZONTAL
 Limit : FCC PART 15C PEAK
 Env. / Ins. : 24*C/56% Engineer : Kevin_Hu
 EUT : AC750 Wireless Dual Band Router
 Power Rating : DC 12V From Adapter Input AC 120V/60Hz
 Test Mode : IEEE802.11ac VHT80 CH42 5210MHz Tx
 M/N : C20i

No.	Freq. (MHz)	Ant. Factor (dB/m)	Cable Loss (dB)	AMP factor (dB)	Reading (dBuV)	Emission Level (dBuV/m)	Limits (dBuV/m)	Margin (dB)	Remark
1	10420.000	38.17	12.67	35.44	23.16	38.56	54.00	15.44	Average
2	10420.000	38.17	12.67	35.44	44.19	59.59	74.00	14.41	Peak

Remarks: 1. Emission Level= Antenna Factor + Cable Loss + Reading - Amp Factor
 2. The emission levels that are 20dB below the official limit are not reported.

5. BAND EDGE COMPLIANCE TEST

5.1. Test Equipment

Item	Equipment	Manufacturer	Model No.	Serial No.	Last Cal.	Cal. Interval
1.	Spectrum	Agilent	E4446A	US44300459	Apr. 28,14	1 Year
2.	Amp	HP	8449B	3008A02495	Apr. 28,14	1 Year
3.	Horn Antenna	EMCO	3115	9607-4877	Aug.27, 13	1 Year
4.	HF Cable	Hubersuhner	Sucoflex104	274094/4	Apr. 28,14	1 Year
5.	RF Cable	Hubersuhner	Sucoflex102	28610/2	Apr. 28,14	1 Year

5.2. Limit

All the lower and upper band-edges emissions appearing within restricted frequency bands shall not exceed the limits shown in 15.209, all the emissions outside operation frequency band shall comply with 15.407(b)(1) requirement.

5.3. Test Procedure

1. The EUT is placed on a turntable, which is 0.8m above the ground plane and worked at highest radiated power.
2. The turntable was rotated for 360 degrees to determine the position of maximum emission level.
3. EUT is set 3m away from the receiving antenna, which is varied from 1m to 4m to find out the highest emission.
4. Set the spectrum analyzer in the following setting in order to capture the lower and upper band-edges of the emission:
 - (a) PEAK: RBW=1MHz; VBW=3MHz; Sweep=AUTO
 - (b) AVERAGE: RBW=1MHz; VBW=10Hz; Sweep=AUTO
5. The maximum emission at 3m distance was measured and recorded with receive antenna in both vertical and horizontal by rotating the turntable and by lowering the receive antenna.
6. The EUT was then removed and replaced with a substitution antenna in the same position and the substitution antenna must have the same polarization with the receive antenna.
7. A signal which have the same frequency obtained in step 2 was fed to the substitution, the receive antenna was raised and lowered to obtain a maximum reading at the test receiver, the level of the signal generator was adjusted until the measured field strength level in step 2 was obtained, recorded the level of the signal generator.
8. Repeated step 4 with both antenna polarizations
9. The spurious emissions is equal to the power supplied by the signal generator and corrections due to the gain of the substitution antenna and the cable loss between the signal generator and the substitution antenna.

5.4. Test Results

Pass (The testing data was attached in the next pages.)

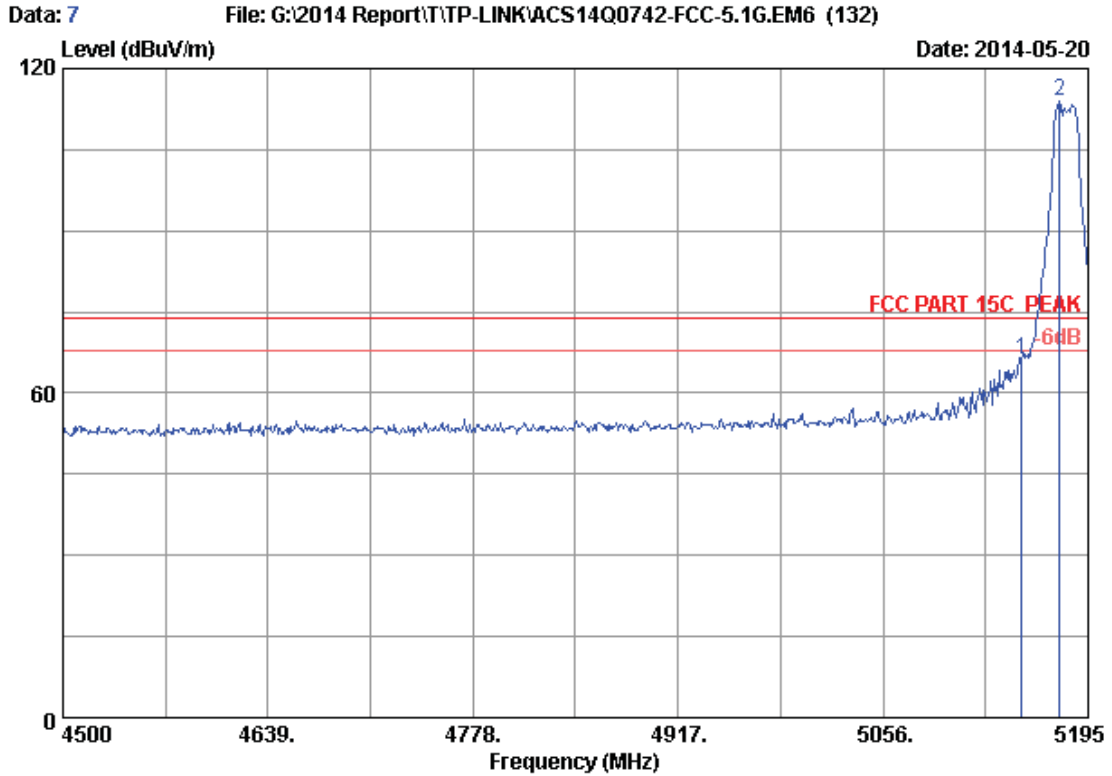

Site no. : 3m Chamber Data no. : 7
 Dis. / Ant. : 3m 2013 3115 (4580) Ant. pol. : VERTICAL
 Limit : FCC PART 15C PEAK
 Env. / Ins. : 24*C/56% Engineer : Kevin_Hu
 EUT : AC750 Wireless Dual Band Router
 Power Rating : DC 12V From Adapter Input AC 120V/60Hz
 Test Mode : IEEE802.11a CH36 5180MHz Tx
 M/N : C20i

No.	Freq. (MHz)	Ant. Factor (dB/m)	Cable Loss (dB)	AMP factor (dB)	Reading (dBuV)	Emission Level (dBuV/m)	Limits (dBuV/m)	Margin (dB)	Remark
1	5150.000	33.44	8.92	35.70	59.55	66.21	74.00	7.79	Peak
2	5175.540	33.48	8.95	35.70	107.40	114.13	74.00	-40.13	Peak

Remarks: 1. Emission Level= Antenna Factor + Cable Loss + Reading -Amp Factor
 2. The emission levels that are 20dB below the official limit are not reported.

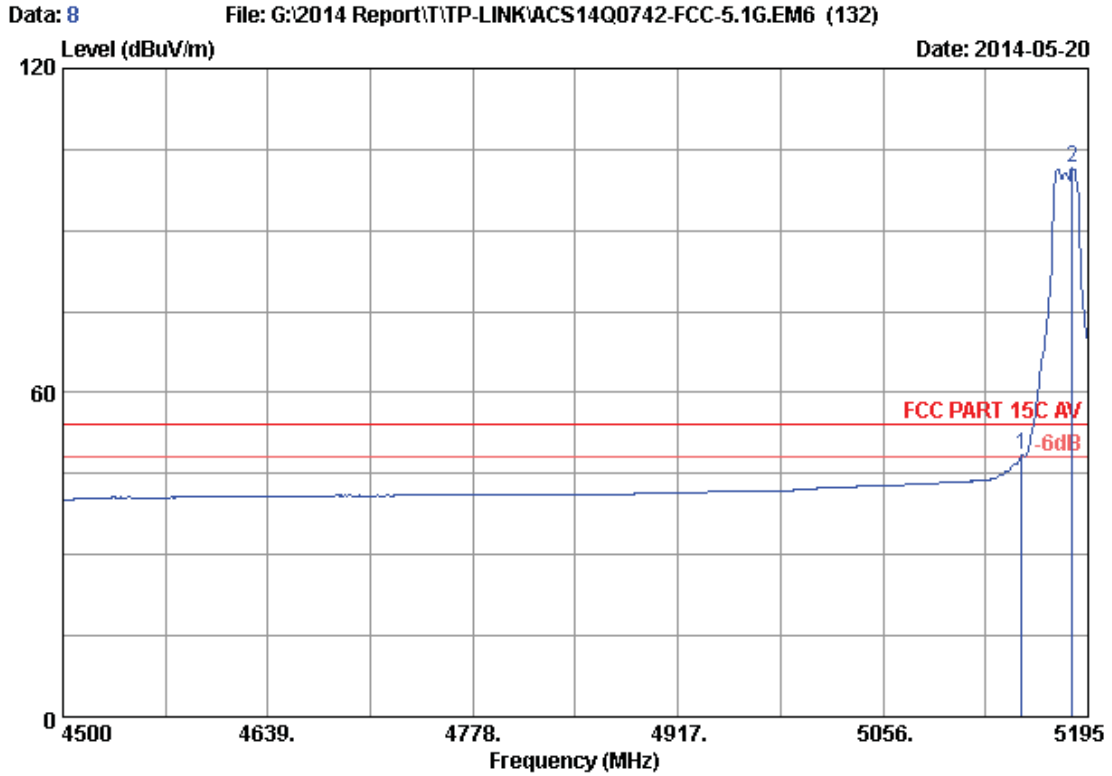

Site no. : 3m Chamber Data no. : 8
 Dis. / Ant. : 3m 2013 3115 (4580) Ant. pol. : VERTICAL
 Limit : FCC PART 15C AV
 Env. / Ins. : 24°C/56% Engineer : Kevin_Hu
 EUT : AC750 Wireless Dual Band Router
 Power Rating : DC 12V From Adapter Input AC 120V/60Hz
 Test Mode : IEEE802.11a CH36 5180MHz Tx
 M/N : C20i

No.	Freq. (MHz)	Ant. Factor (dB/m)	Cable Loss (dB)	AMP factor (dB)	Reading (dBuV)	Emission Level (dBuV/m)	Limits (dBuV/m)	Margin (dB)	Remark
1	5150.000	33.44	8.92	35.70	41.69	48.35	54.00	5.65	Average
2	5184.575	33.50	8.96	35.70	94.77	101.53	54.00	-47.53	Average

Remarks: 1. Emission Level= Antenna Factor + Cable Loss + Reading - Amp Factor
 2. The emission levels that are 20dB below the official limit are not reported.

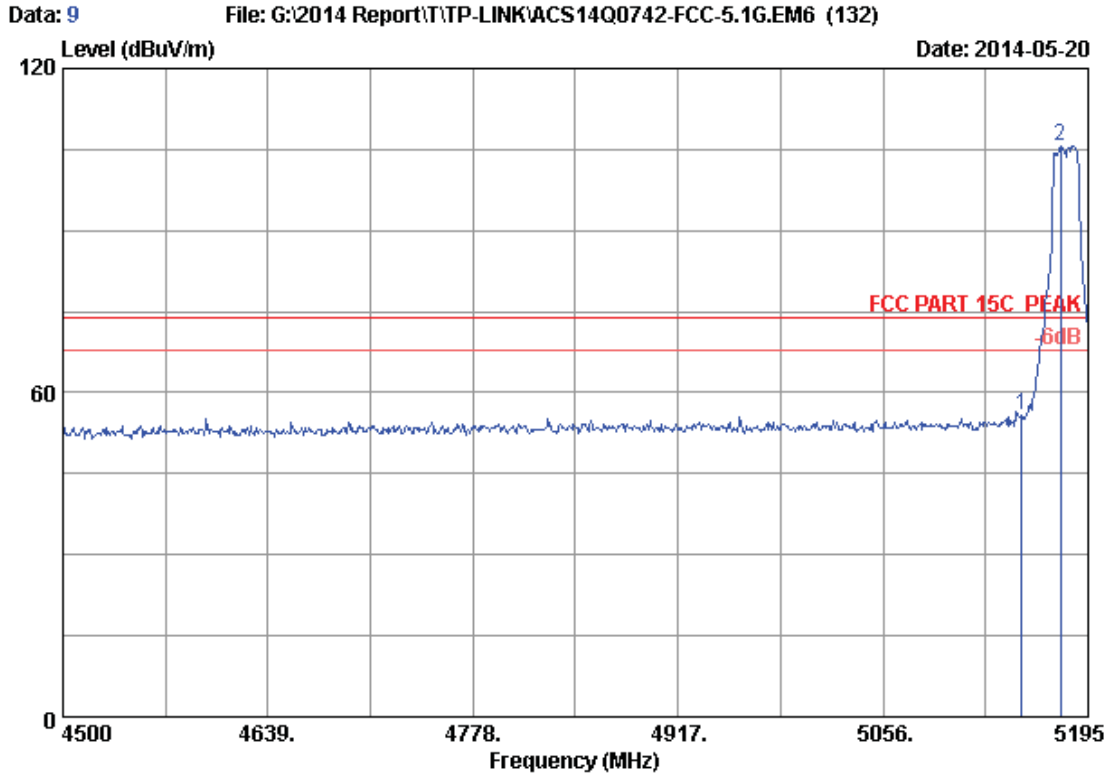

Site no. : 3m Chamber Data no. : 9
 Dis. / Ant. : 3m 2013 3115 (4580) Ant. pol. : HORIZONTAL
 Limit : FCC PART 15C PEAK
 Env. / Ins. : 24°C/56% Engineer : Kevin_Hu
 EUT : AC750 Wireless Dual Band Router
 Power Rating : DC 12V From Adapter Input AC 120V/60Hz
 Test Mode : IEEE802.11a CH36 5180MHz Tx
 M/N : C20i

No.	Freq. (MHz)	Ant. Factor (dB/m)	Cable Loss (dB)	AMP factor (dB)	Reading (dBuV)	Emission Level (dBuV/m)	Limits (dBuV/m)	Margin (dB)	Remark
1	5150.000	33.44	8.92	35.70	49.02	55.68	74.00	18.32	Peak
2	5176.235	33.48	8.95	35.70	99.05	105.78	74.00	-31.78	Peak

Remarks: 1. Emission Level= Antenna Factor + Cable Loss + Reading - Amp Factor
 2. The emission levels that are 20dB below the official limit are not reported.

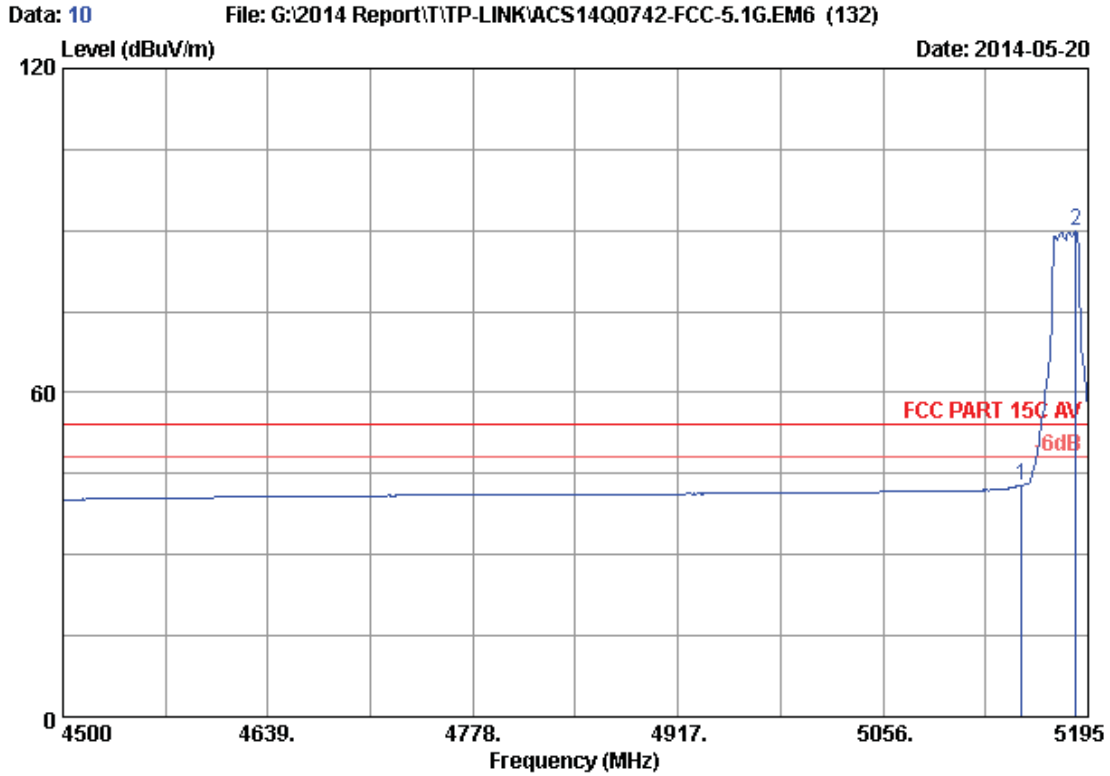

Site no. : 3m Chamber Data no. : 10
 Dis. / Ant. : 3m 2013 3115 (4580) Ant. pol. : HORIZONTAL
 Limit : FCC PART 15C AV
 Env. / Ins. : 24°C/56% Engineer : Kevin_Hu
 EUT : AC750 Wireless Dual Band Router
 Power Rating : DC 12V From Adapter Input AC 120V/60Hz
 Test Mode : IEEE802.11a CH36 5180MHz Tx
 M/N : C20i

No.	Freq. (MHz)	Ant. Factor (dB/m)	Cable Loss (dB)	AMP factor (dB)	Reading (dBuV)	Emission Level (dBuV/m)	Limits (dBuV/m)	Margin (dB)	Remark
1	5150.000	33.44	8.92	35.70	36.00	42.66	54.00	11.34	Average
2	5186.660	33.50	8.96	35.70	83.10	89.86	54.00	-35.86	Average

Remarks: 1. Emission Level= Antenna Factor + Cable Loss + Reading - Amp Factor
 2. The emission levels that are 20dB below the official limit are not reported.

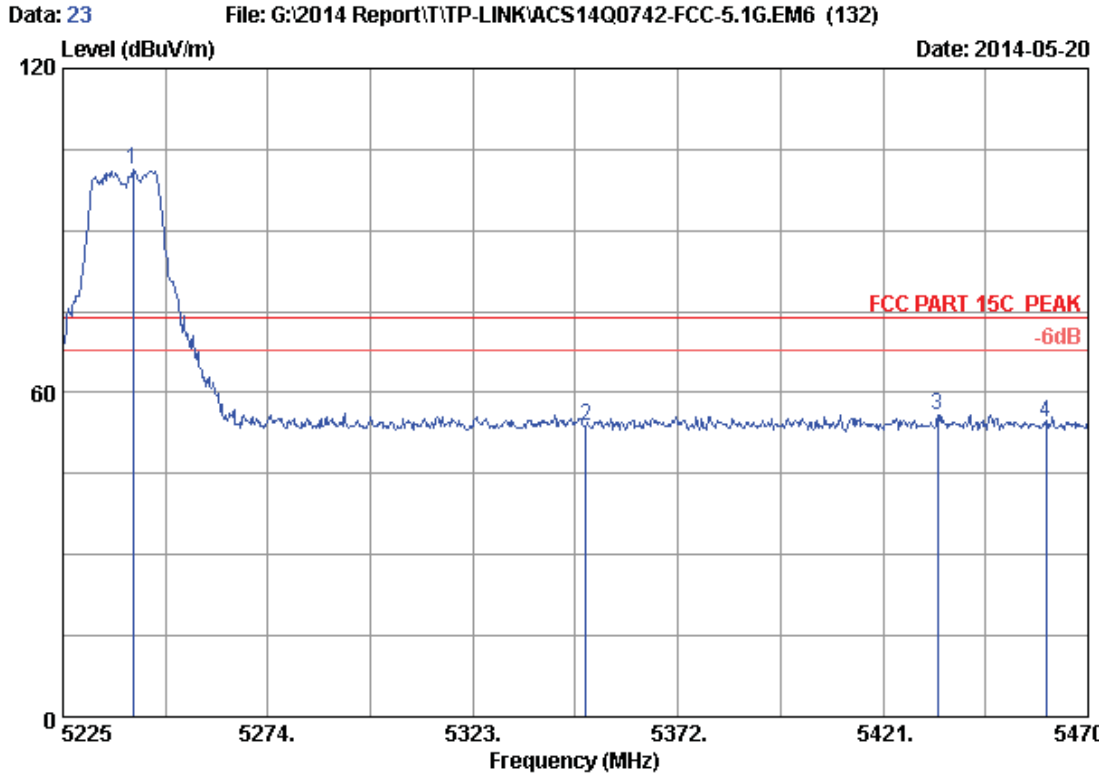

Site no. : 3m Chamber Data no. : 23
 Dis. / Ant. : 3m 2013 3115 (4580) Ant. pol. : HORIZONTAL
 Limit : FCC PART 15C PEAK
 Env. / Ins. : 24°C/56% Engineer : Kevin_Hu
 EUT : AC750 Wireless Dual Band Router
 Power Rating : DC 12V From Adapter Input AC 120V/60Hz
 Test Mode : IEEE802.11a CH48 5240MHz Tx
 M/N : C20i

No.	Freq. (MHz)	Ant. Factor (dB/m)	Cable Loss (dB)	AMP factor (dB)	Reading (dBUV)	Emission Level (dBUV/m)	Limits (dBUV/m)	Margin (dB)	Remark
1	5241.660	33.59	9.02	35.70	94.25	101.16	74.00	-27.16	Peak
2	5350.000	33.76	9.13	35.70	46.77	53.96	74.00	20.04	Peak
3	5433.985	33.89	9.22	35.70	48.40	55.81	74.00	18.19	Peak
4	5460.000	33.94	9.25	35.70	47.02	54.51	74.00	19.49	Peak

Remarks: 1. Emission Level= Antenna Factor + Cable Loss + Reading - Amp Factor
 2. The emission levels that are 20dB below the official limit are not reported.

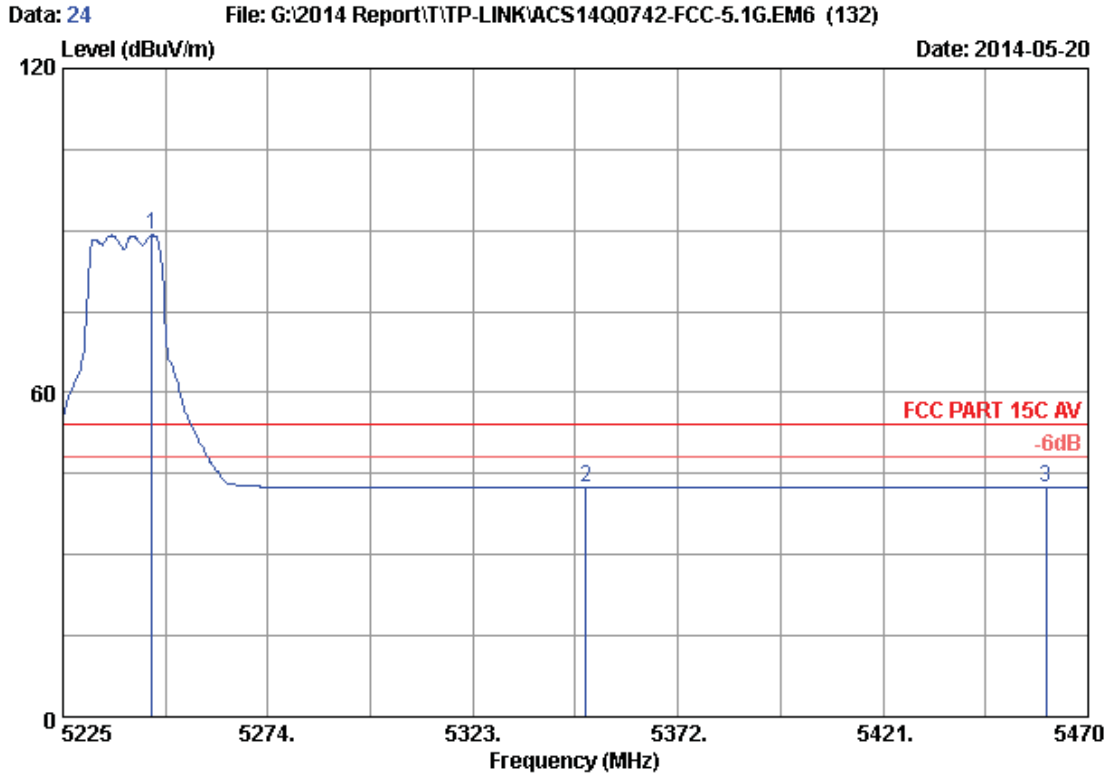

Site no. : 3m Chamber Data no. : 24
 Dis. / Ant. : 3m 2013 3115 (4580) Ant. pol. : HORIZONTAL
 Limit : FCC PART 15C AV
 Env. / Ins. : 24°C/56% Engineer : Kevin_Hu
 EUT : AC750 Wireless Dual Band Router
 Power Rating : DC 12V From Adapter Input AC 120V/60Hz
 Test Mode : IEEE802.11a CH48 5240MHz Tx
 M/N : C20i

No.	Freq. (MHz)	Ant. Factor (dB/m)	Cable Loss (dB)	AMP factor (dB)	Reading (dBUV)	Emission Level (dBUV/m)	Limits (dBUV/m)	Margin (dB)	Remark
1	5246.315	33.59	9.02	35.70	82.25	89.16	54.00	-35.16	Average
2	5350.000	33.76	9.13	35.70	35.14	42.33	54.00	11.67	Average
3	5460.000	33.94	9.25	35.70	34.86	42.35	54.00	11.65	Average

Remarks: 1. Emission Level= Antenna Factor + Cable Loss + Reading - Amp Factor
 2. The emission levels that are 20dB below the official limit are not reported.

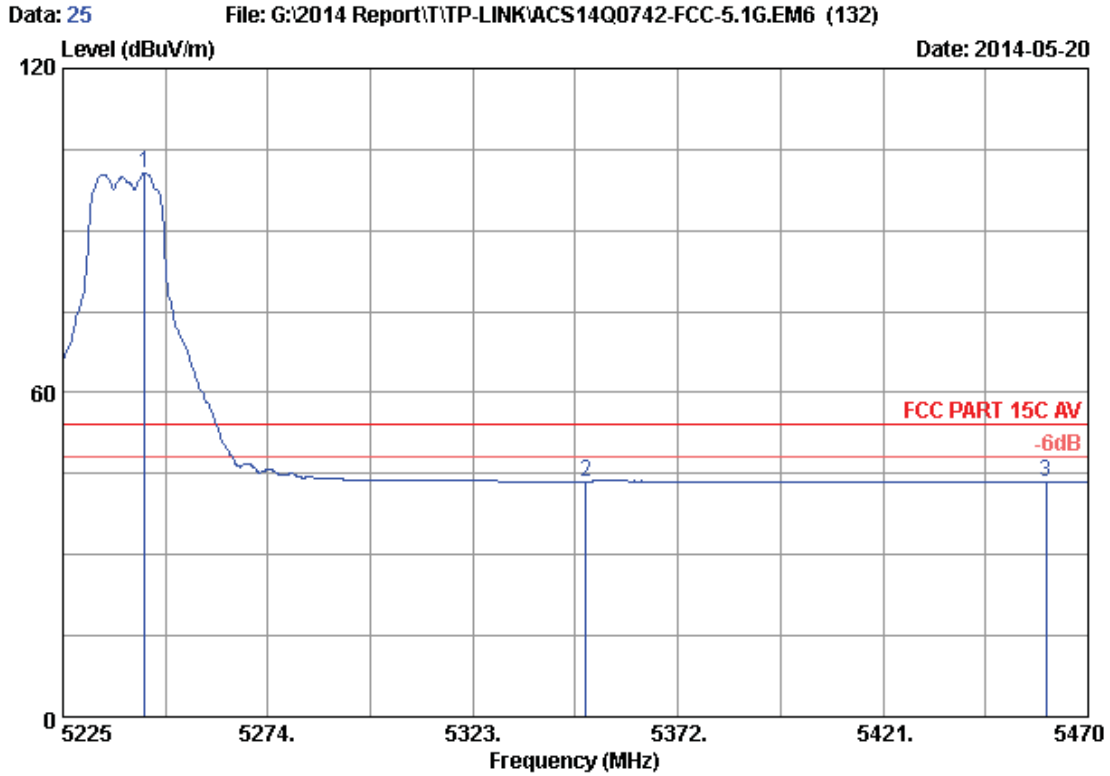

Site no. : 3m Chamber Data no. : 25
 Dis. / Ant. : 3m 2013 3115 (4580) Ant. pol. : VERTICAL
 Limit : FCC PART 15C AV
 Env. / Ins. : 24°C/56% Engineer : Kevin_Hu
 EUT : AC750 Wireless Dual Band Router
 Power Rating : DC 12V From Adapter Input AC 120V/60Hz
 Test Mode : IEEE802.11a CH48 5240MHz Tx
 M/N : C20i

No.	Freq. (MHz)	Ant. Factor (dB/m)	Cable Loss (dB)	AMP factor (dB)	Reading (dBuV)	Emission Level (dBuV/m)	Limits (dBuV/m)	Margin (dB)	Remark
1	5244.600	33.59	9.02	35.70	93.82	100.73	54.00	-46.73	Average
2	5350.000	33.76	9.13	35.70	36.40	43.59	54.00	10.41	Average
3	5460.000	33.94	9.25	35.70	35.92	43.41	54.00	10.59	Average

Remarks: 1. Emission Level= Antenna Factor + Cable Loss + Reading - Amp Factor
 2. The emission levels that are 20dB below the official limit are not reported.

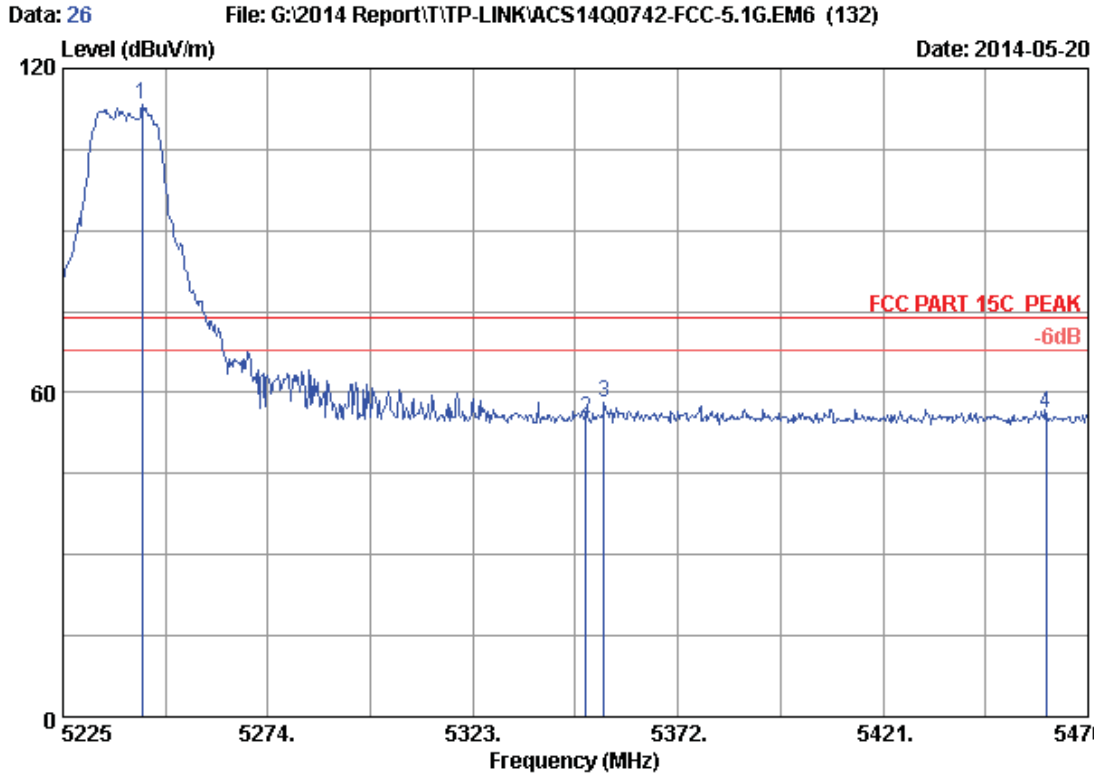

Site no. : 3m Chamber Data no. : 26
 Dis. / Ant. : 3m 2013 3115 (4580) Ant. pol. : VERTICAL
 Limit : FCC PART 15C PEAK
 Env. / Ins. : 24°C/56% Engineer : Kevin_Hu
 EUT : AC750 Wireless Dual Band Router
 Power Rating : DC 12V From Adapter Input AC 120V/60Hz
 Test Mode : IEEE802.11a CH48 5240MHz Tx
 M/N : C20i

No.	Freq. (MHz)	Ant. Factor (dB/m)	Cable Loss (dB)	AMP factor (dB)	Reading (dBUV)	Emission Level (dBUV/m)	Limits (dBUV/m)	Margin (dB)	Remark
1	5243.865	33.59	9.02	35.70	106.36	113.27	74.00	-39.27	Peak
2	5350.000	33.76	9.13	35.70	48.09	55.28	74.00	18.72	Peak
3	5354.360	33.77	9.14	35.70	50.92	58.13	74.00	15.87	Peak
4	5460.000	33.94	9.25	35.70	48.53	56.02	74.00	17.98	Peak

Remarks: 1. Emission Level= Antenna Factor + Cable Loss + Reading - Amp Factor
 2. The emission levels that are 20dB below the official limit are not reported.

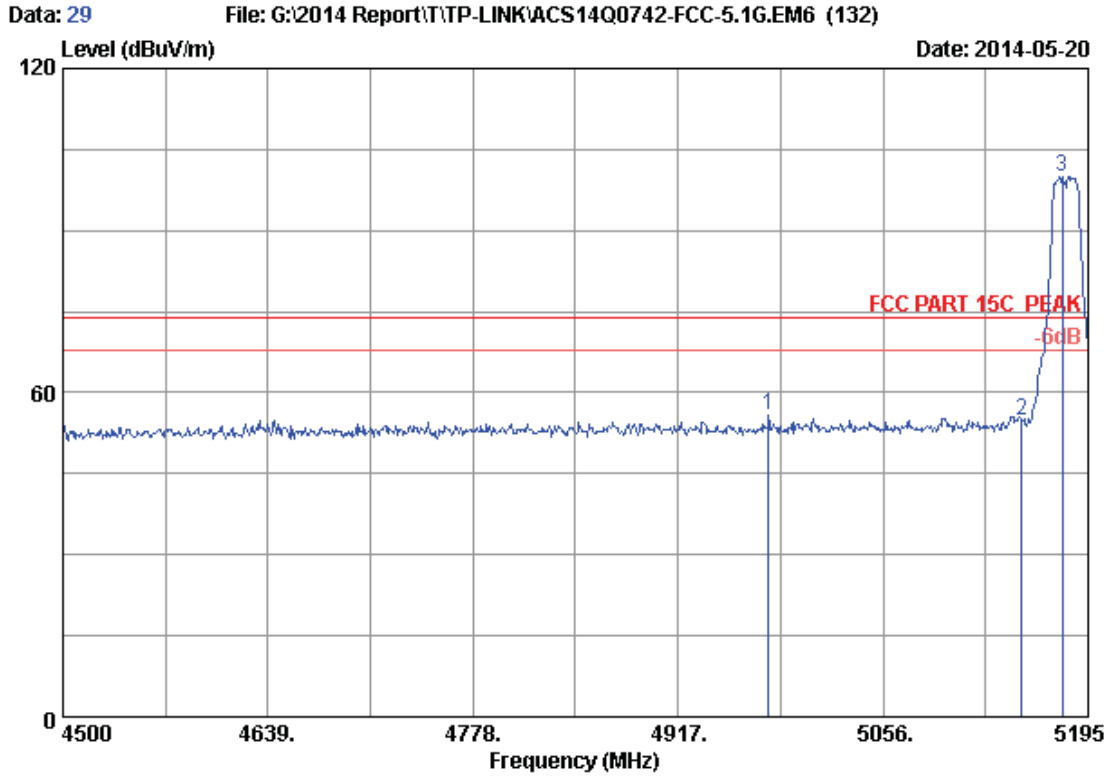

Site no. : 3m Chamber Data no. : 29
 Dis. / Ant. : 3m 2013 3115 (4580) Ant. pol. : HORIZONTAL
 Limit : FCC PART 15C PEAK
 Env. / Ins. : 24°C/56% Engineer : Kevin_Hu
 EUT : AC750 Wireless Dual Band Router
 Power Rating : DC 12V From Adapter Input AC 120V/60Hz
 Test Mode : IEEE802.11nHT20 CH36 5180MHz Tx
 M/N : C20i

No.	Freq. (MHz)	Ant. Factor (dB/m)	Cable Loss (dB)	AMP factor (dB)	Reading (dBuV)	Emission Level (dBuV/m)	Limits (dBuV/m)	Margin (dB)	Remark
1	4978.160	33.16	8.74	35.70	49.74	55.94	74.00	18.06	Peak
2	5150.000	33.44	8.92	35.70	48.08	54.74	74.00	19.26	Peak
3	5177.625	33.48	8.95	35.70	93.27	100.00	74.00	-26.00	Peak

Remarks: 1. Emission Level= Antenna Factor + Cable Loss + Reading - Amp Factor
 2. The emission levels that are 20dB below the official limit are not reported.

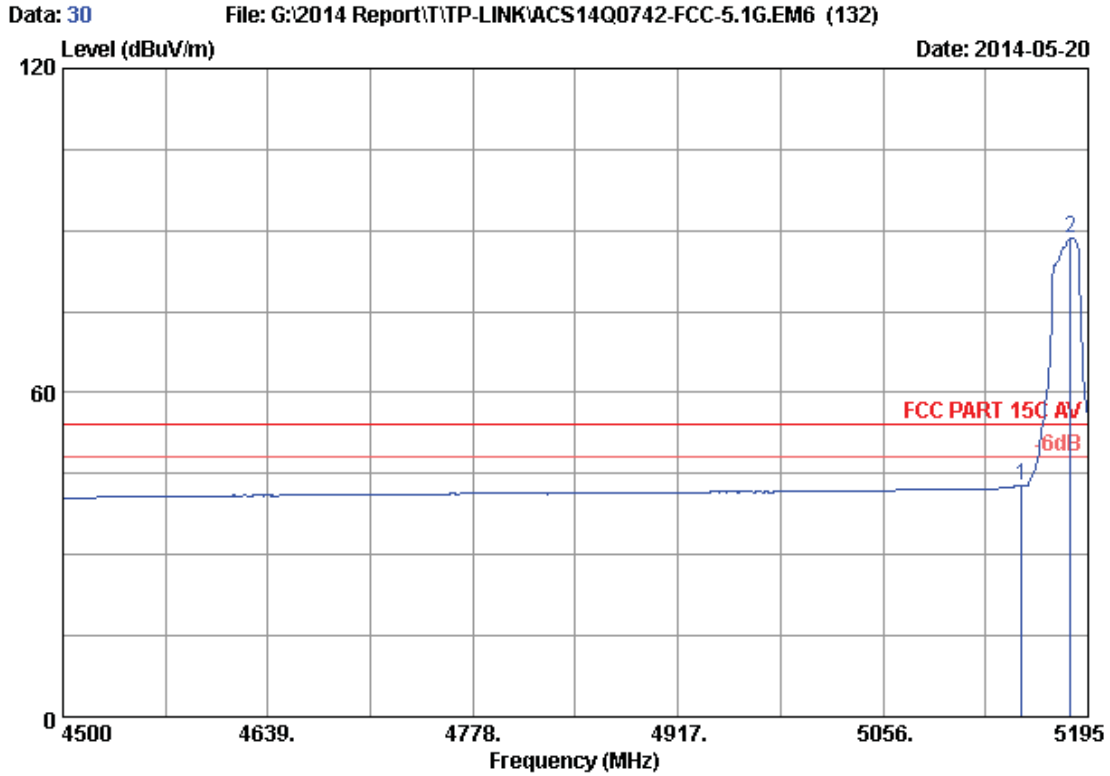

Site no. : 3m Chamber Data no. : 30
 Dis. / Ant. : 3m 2013 3115 (4580) Ant. pol. : HORIZONTAL
 Limit : FCC PART 15C AV
 Env. / Ins. : 24°C/56% Engineer : Kevin_Hu
 EUT : AC750 Wireless Dual Band Router
 Power Rating : DC 12V From Adapter Input AC 120V/60Hz
 Test Mode : IEEE802.11nHT20 CH36 5180MHz Tx
 M/N : C20i

No.	Freq. (MHz)	Ant. Factor (dB/m)	Cable Loss (dB)	AMP factor (dB)	Reading (dBuV)	Emission Level (dBuV/m)	Limits (dBuV/m)	Margin (dB)	Remark
1	5150.000	33.44	8.92	35.70	36.01	42.67	54.00	11.33	Average
2	5183.185	33.49	8.96	35.70	81.86	88.61	54.00	-34.61	Average

Remarks: 1. Emission Level= Antenna Factor + Cable Loss + Reading - Amp Factor
 2. The emission levels that are 20dB below the official limit are not reported.

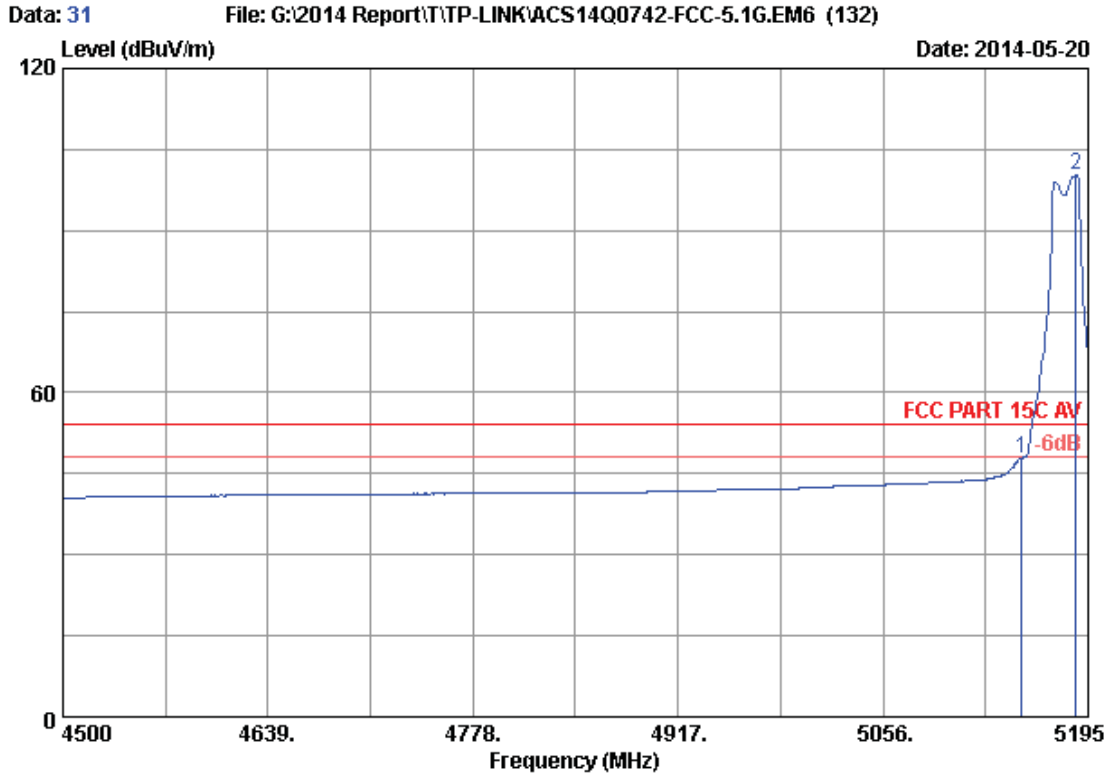

Site no. : 3m Chamber Data no. : 31
 Dis. / Ant. : 3m 2013 3115 (4580) Ant. pol. : VERTICAL
 Limit : FCC PART 15C AV
 Env. / Ins. : 24°C/56% Engineer : Kevin_Hu
 EUT : AC750 Wireless Dual Band Router
 Power Rating : DC 12V From Adapter Input AC 120V/60Hz
 Test Mode : IEEE802.11nHT20 CH36 5180MHz Tx
 M/N : C20i

No.	Freq. (MHz)	Ant. Factor (dB/m)	Cable Loss (dB)	AMP factor (dB)	Reading (dBuV)	Emission Level (dBuV/m)	Limits (dBuV/m)	Margin (dB)	Remark
1	5150.000	33.44	8.92	35.70	41.20	47.86	54.00	6.14	Average
2	5186.660	33.50	8.96	35.70	93.54	100.30	54.00	-46.30	Average

Remarks: 1. Emission Level= Antenna Factor + Cable Loss + Reading - Amp Factor
 2. The emission levels that are 20dB below the official limit are not reported.

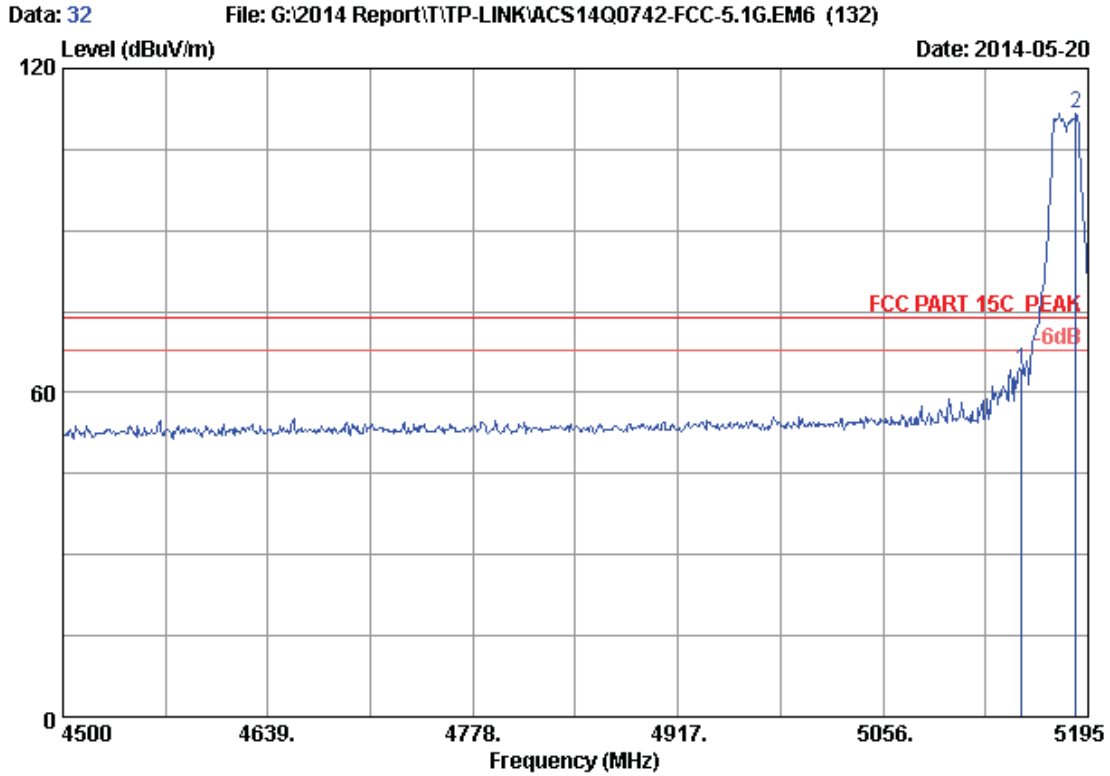

Site no. : 3m Chamber Data no. : 32
 Dis. / Ant. : 3m 2013 3115 (4580) Ant. pol. : VERTICAL
 Limit : FCC PART 15C PEAK
 Env. / Ins. : 24°C/56% Engineer : Kevin_Hu
 EUT : AC750 Wireless Dual Band Router
 Power Rating : DC 12V From Adapter Input AC 120V/60Hz
 Test Mode : IEEE802.11nHT20 CH36 5180MHz Tx
 M/N : C20i

No.	Freq. (MHz)	Ant. Factor (dB/m)	Cable Loss (dB)	AMP factor (dB)	Reading (dBUV)	Emission Level (dBUV/m)	Limits (dBUV/m)	Margin (dB)	Remark
1	5150.000	33.44	8.92	35.70	57.50	64.16	74.00	9.84	Peak
2	5186.660	33.50	8.96	35.70	104.96	111.72	74.00	-37.72	Peak

Remarks: 1. Emission Level= Antenna Factor + Cable Loss + Reading - Amp Factor
 2. The emission levels that are 20dB below the official limit are not reported.

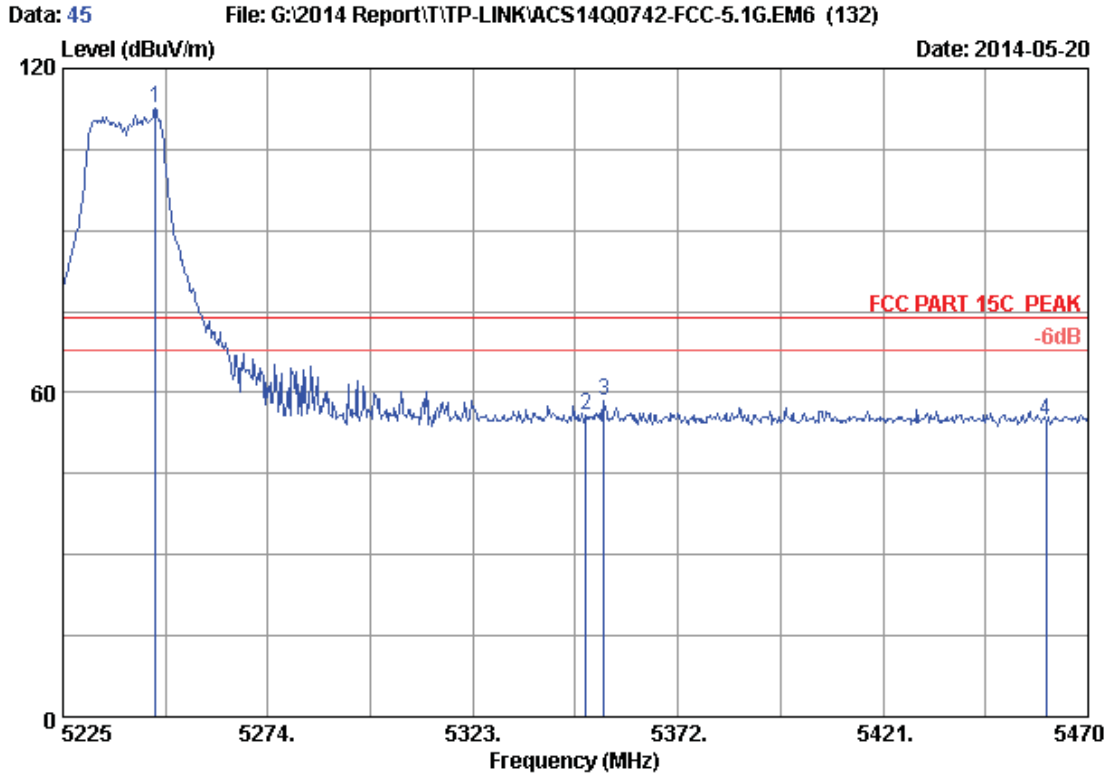

Site no. : 3m Chamber Data no. : 45
 Dis. / Ant. : 3m 2013 3115 (4580) Ant. pol. : VERTICAL
 Limit : FCC PART 15C PEAK
 Env. / Ins. : 24°C/56% Engineer : Kevin_Hu
 EUT : AC750 Wireless Dual Band Router
 Power Rating : DC 12V From Adapter Input AC 120V/60Hz
 Test Mode : IEEE802.11nHT20 CH48 5240MHz Tx
 M/N : C20i

No.	Freq. (MHz)	Ant. Factor (dB/m)	Cable Loss (dB)	AMP factor (dB)	Reading (dBUV)	Emission Level (dBUV/m)	Limits (dBUV/m)	Margin (dB)	Remark
1	5247.050	33.60	9.02	35.70	105.87	112.79	74.00	-38.79	Peak
2	5350.000	33.76	9.13	35.70	48.47	55.66	74.00	18.34	Peak
3	5354.360	33.77	9.14	35.70	51.12	58.33	74.00	15.67	Peak
4	5460.000	33.94	9.25	35.70	47.48	54.97	74.00	19.03	Peak

Remarks: 1. Emission Level= Antenna Factor + Cable Loss + Reading - Amp Factor
 2. The emission levels that are 20dB below the official limit are not reported.

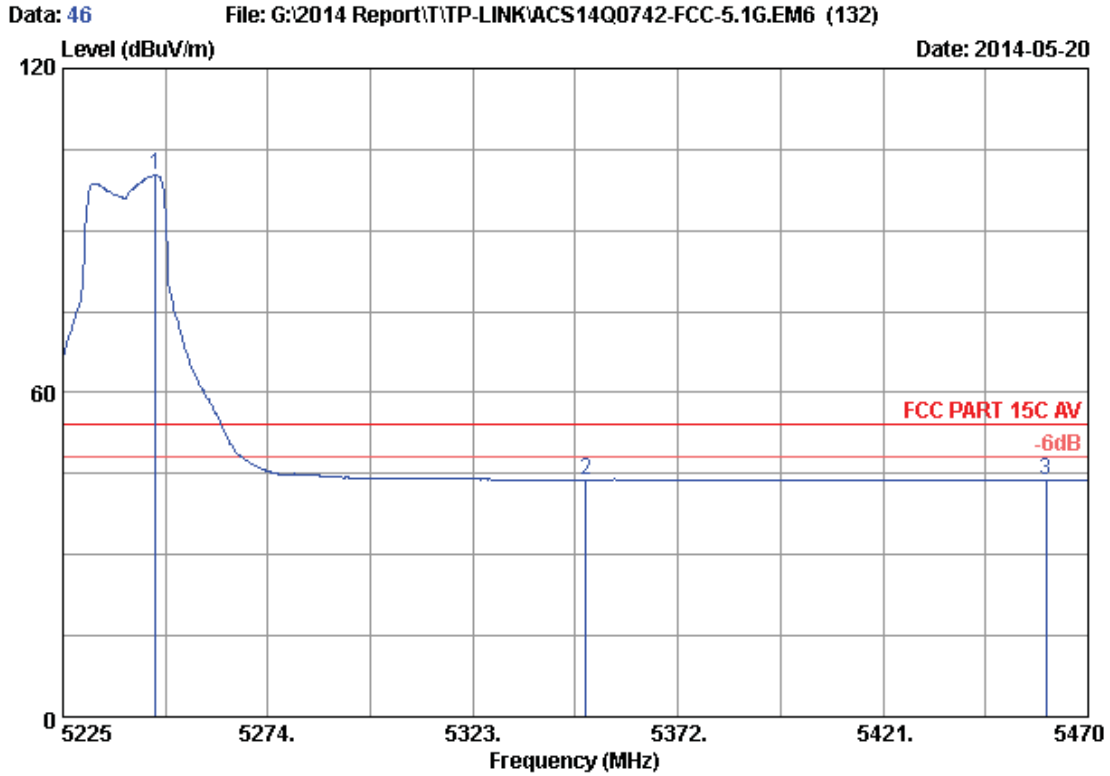

Site no. : 3m Chamber Data no. : 46
 Dis. / Ant. : 3m 2013 3115 (4580) Ant. pol. : VERTICAL
 Limit : FCC PART 15C AV
 Env. / Ins. : 24°C/56% Engineer : Kevin_Hu
 EUT : AC750 Wireless Dual Band Router
 Power Rating : DC 12V From Adapter Input AC 120V/60Hz
 Test Mode : IEEE802.11nHT20 CH48 5240MHz Tx
 M/N : C20i

No.	Freq. (MHz)	Ant. Factor (dB/m)	Cable Loss (dB)	AMP factor (dB)	Reading (dBuV)	Emission Level (dBuV/m)	Limits (dBuV/m)	Margin (dB)	Remark
1	5247.050	33.60	9.02	35.70	93.25	100.17	54.00	-46.17	Average
2	5350.000	33.76	9.13	35.70	36.68	43.87	54.00	10.13	Average
3	5460.000	33.94	9.25	35.70	36.24	43.73	54.00	10.27	Average

Remarks: 1. Emission Level= Antenna Factor + Cable Loss + Reading - Amp Factor
 2. The emission levels that are 20dB below the official limit are not reported.

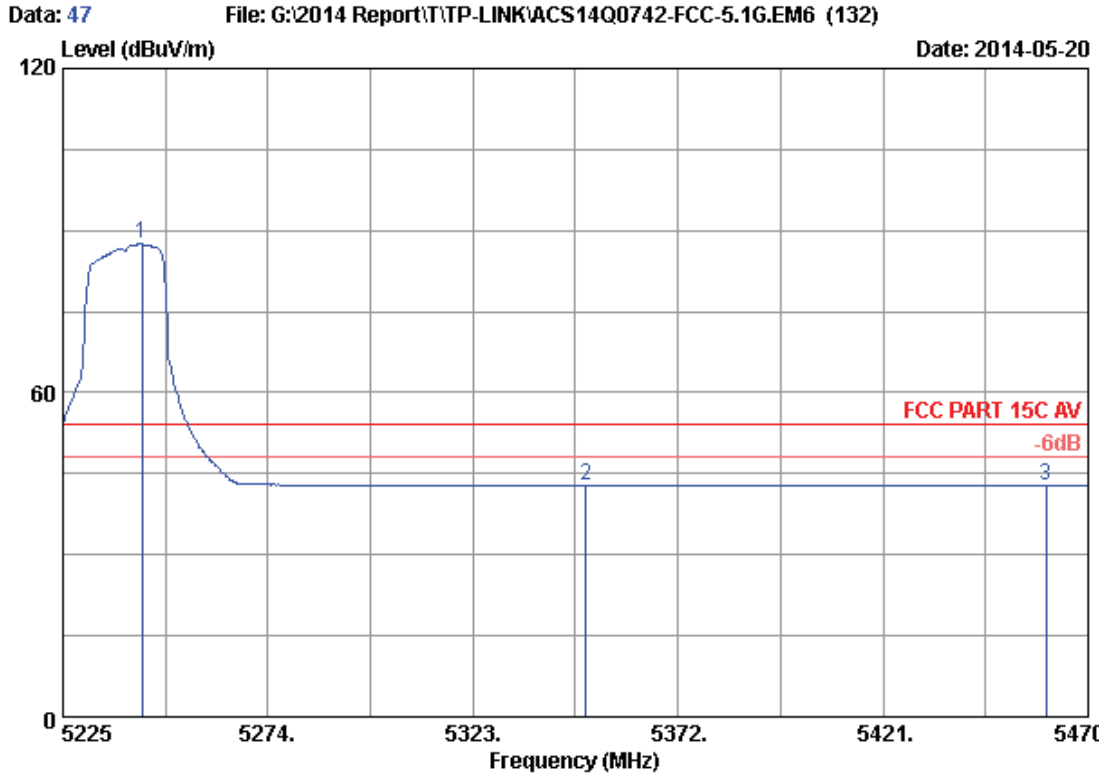

Site no. : 3m Chamber Data no. : 47
 Dis. / Ant. : 3m 2013 3115 (4580) Ant. pol. : HORIZONTAL
 Limit : FCC PART 15C AV
 Env. / Ins. : 24°C/56% Engineer : Kevin_Hu
 EUT : AC750 Wireless Dual Band Router
 Power Rating : DC 12V From Adapter Input AC 120V/60Hz
 Test Mode : IEEE802.11nHT20 CH48 5240MHz Tx
 M/N : C20i

No.	Freq. (MHz)	Ant. Factor (dB/m)	Cable Loss (dB)	AMP factor (dB)	Reading (dBuV)	Emission Level (dBuV/m)	Limits (dBuV/m)	Margin (dB)	Remark
1	5243.865	33.59	9.02	35.70	80.54	87.45	54.00	-33.45	Average
2	5350.000	33.76	9.13	35.70	35.55	42.74	54.00	11.26	Average
3	5460.000	33.94	9.25	35.70	35.26	42.75	54.00	11.25	Average

Remarks: 1. Emission Level= Antenna Factor + Cable Loss + Reading - Amp Factor
 2. The emission levels that are 20dB below the official limit are not reported.

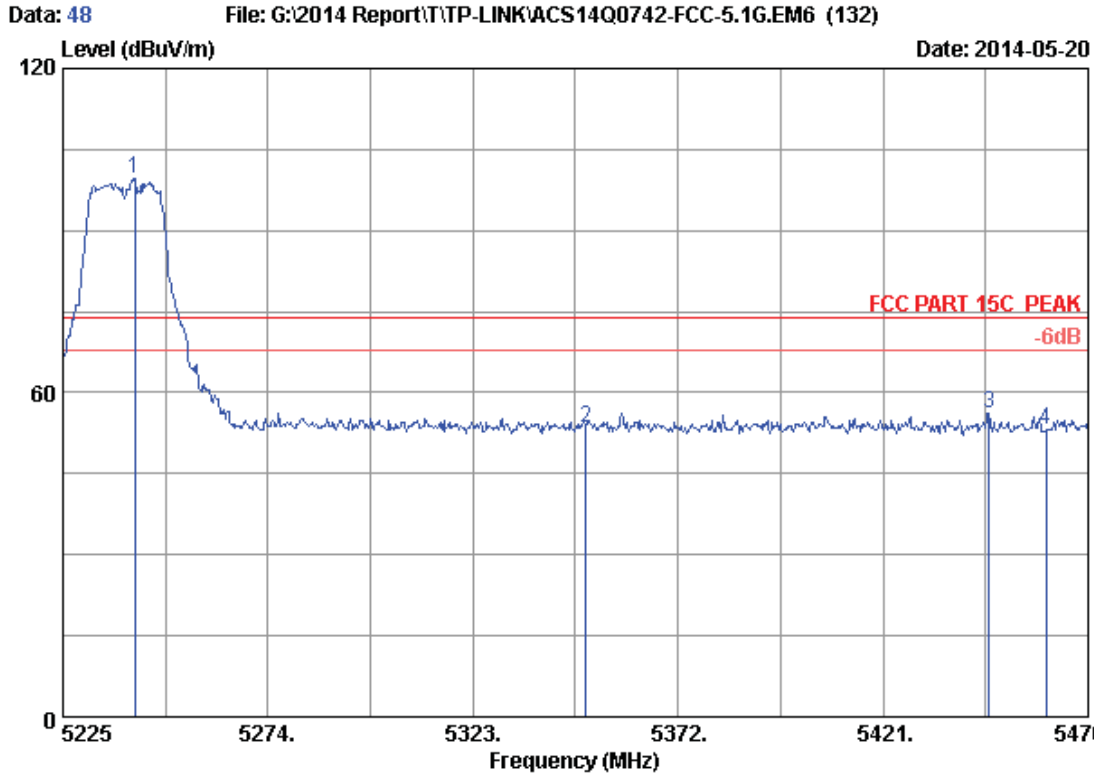

Site no. : 3m Chamber Data no. : 48
 Dis. / Ant. : 3m 2013 3115 (4580) Ant. pol. : HORIZONTAL
 Limit : FCC PART 15C PEAK
 Env. / Ins. : 24°C/56% Engineer : Kevin_Hu
 EUT : AC750 Wireless Dual Band Router
 Power Rating : DC 12V From Adapter Input AC 120V/60Hz
 Test Mode : IEEE802.11nHT20 CH48 5240MHz Tx
 M/N : C20i

No.	Freq. (MHz)	Ant. Factor (dB/m)	Cable Loss (dB)	AMP factor (dB)	Reading (dBUV)	Emission Level (dBUV/m)	Limits (dBUV/m)	Margin (dB)	Remark
1	5242.150	33.59	9.02	35.70	92.68	99.59	74.00	-25.59	Peak
2	5350.000	33.76	9.13	35.70	46.42	53.61	74.00	20.39	Peak
3	5446.235	33.91	9.23	35.70	48.71	56.15	74.00	17.85	Peak
4	5460.000	33.94	9.25	35.70	45.52	53.01	74.00	20.99	Peak

Remarks: 1. Emission Level= Antenna Factor + Cable Loss + Reading - Amp Factor
 2. The emission levels that are 20dB below the official limit are not reported.

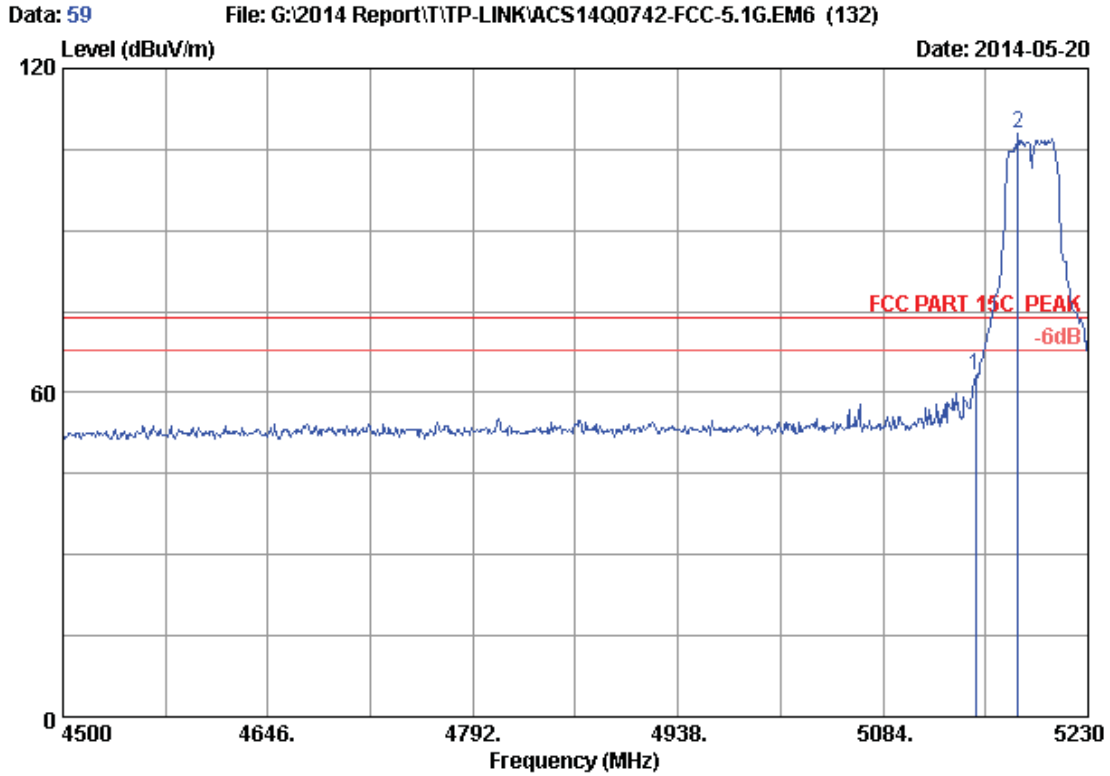

Site no. : 3m Chamber Data no. : 59
 Dis. / Ant. : 3m 2013 3115 (4580) Ant. pol. : VERTICAL
 Limit : FCC PART 15C PEAK
 Env. / Ins. : 24°C/56% Engineer : Kevin_Hu
 EUT : AC750 Wireless Dual Band Router
 Power Rating : DC 12V From Adapter Input AC 120V/60Hz
 Test Mode : IEEE802.11nHT40 CH38 5190MHz Tx
 M/N : C20i

No.	Freq. (MHz)	Ant. Factor (dB/m)	Cable Loss (dB)	AMP factor (dB)	Reading (dBuV)	Emission Level (dBuV/m)	Limits (dBuV/m)	Margin (dB)	Remark
1	5150.000	33.44	8.92	35.70	56.36	63.02	74.00	10.98	Peak
2	5180.360	33.49	8.95	35.70	101.15	107.89	74.00	-33.89	Peak

Remarks: 1. Emission Level= Antenna Factor + Cable Loss + Reading - Amp Factor
 2. The emission levels that are 20dB below the official limit are not reported.

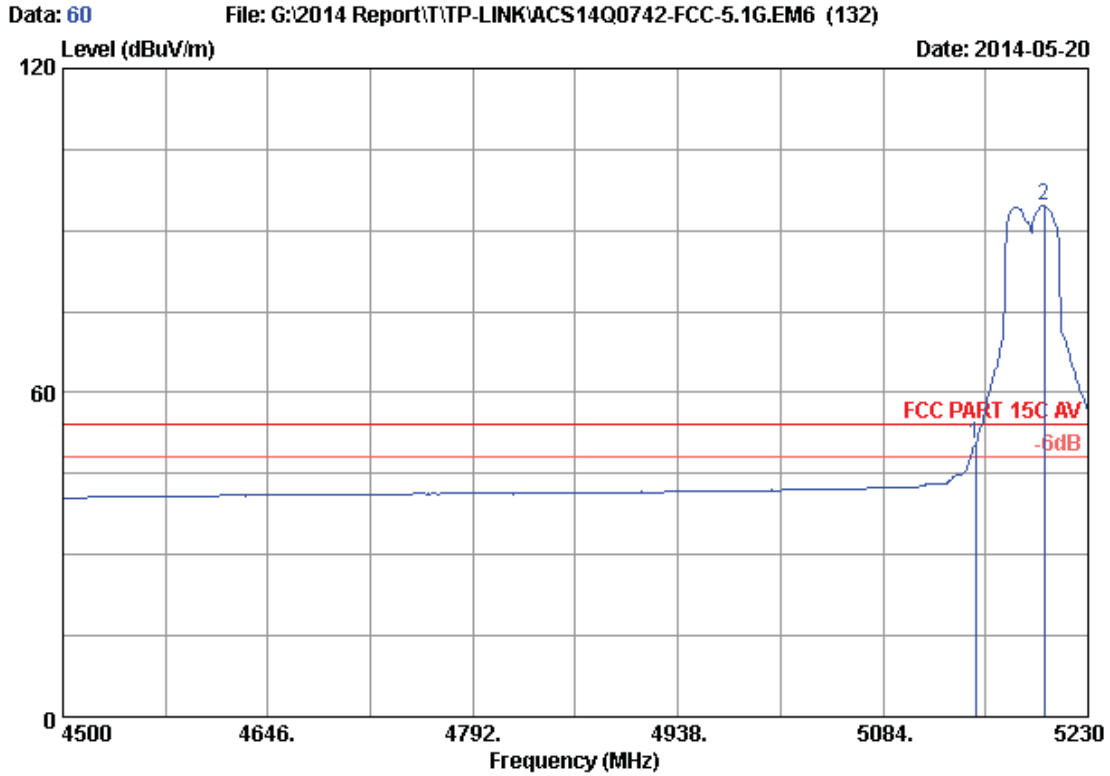

Site no. : 3m Chamber Data no. : 60
 Dis. / Ant. : 3m 2013 3115 (4580) Ant. pol. : VERTICAL
 Limit : FCC PART 15C AV
 Env. / Ins. : 24°C/56% Engineer : Kevin_Hu
 EUT : AC750 Wireless Dual Band Router
 Power Rating : DC 12V From Adapter Input AC 120V/60Hz
 Test Mode : IEEE802.11nHT40 CH38 5190MHz Tx
 M/N : C20i

No.	Freq. (MHz)	Ant. Factor (dB/m)	Cable Loss (dB)	AMP factor (dB)	Reading (dBuV)	Emission Level (dBuV/m)	Limits (dBuV/m)	Margin (dB)	Remark
1	5150.000	33.44	8.92	35.70	43.69	50.35	54.00	3.65	Average
2	5198.610	33.52	8.97	35.70	87.75	94.54	54.00	-40.54	Average

Remarks: 1. Emission Level= Antenna Factor + Cable Loss + Reading - Amp Factor
 2. The emission levels that are 20dB below the official limit are not reported.

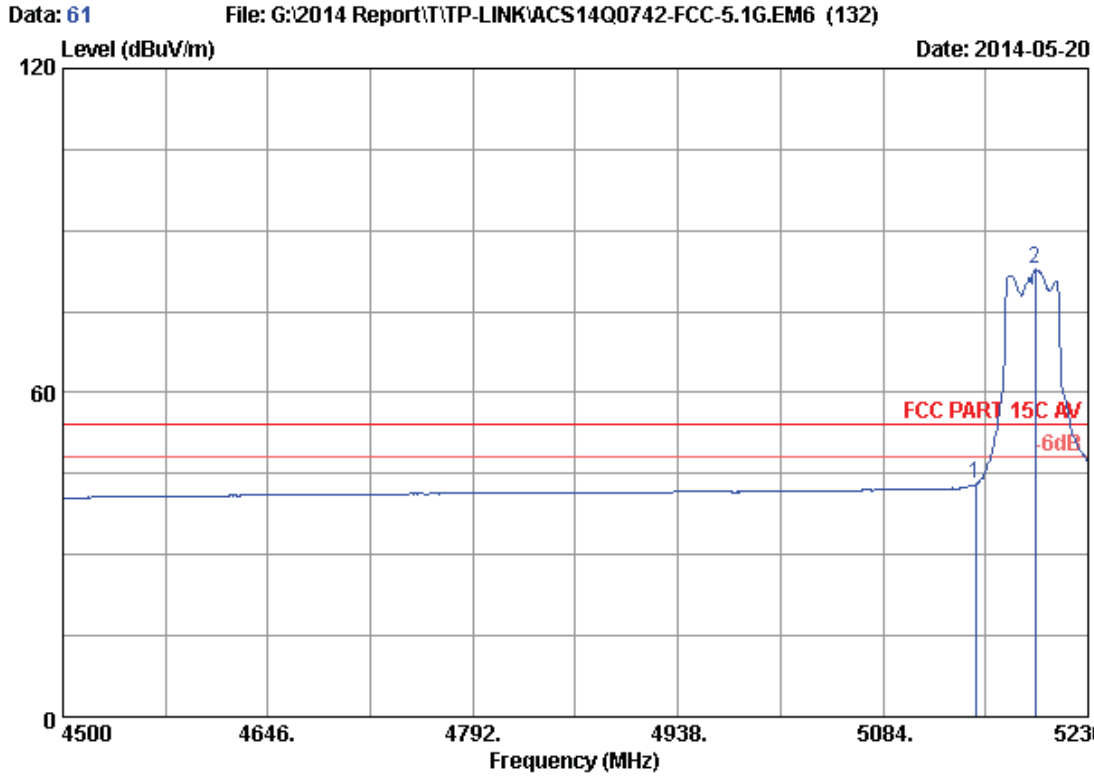

Site no. : 3m Chamber Data no. : 61
 Dis. / Ant. : 3m 2013 3115 (4580) Ant. pol. : HORIZONTAL
 Limit : FCC PART 15C AV
 Env. / Ins. : 24°C/56% Engineer : Kevin_Hu
 EUT : AC750 Wireless Dual Band Router
 Power Rating : DC 12V From Adapter Input AC 120V/60Hz
 Test Mode : IEEE802.11nHT40 CH38 5190MHz Tx
 M/N : C20i

No.	Freq. (MHz)	Ant. Factor (dB/m)	Cable Loss (dB)	AMP factor (dB)	Reading (dBuV)	Emission Level (dBuV/m)	Limits (dBuV/m)	Margin (dB)	Remark
1	5150.000	33.44	8.92	35.70	36.32	42.98	54.00	11.02	Average
2	5192.040	33.51	8.97	35.70	75.96	82.74	54.00	-28.74	Average

Remarks: 1. Emission Level= Antenna Factor + Cable Loss + Reading - Amp Factor
 2. The emission levels that are 20dB below the official limit are not reported.

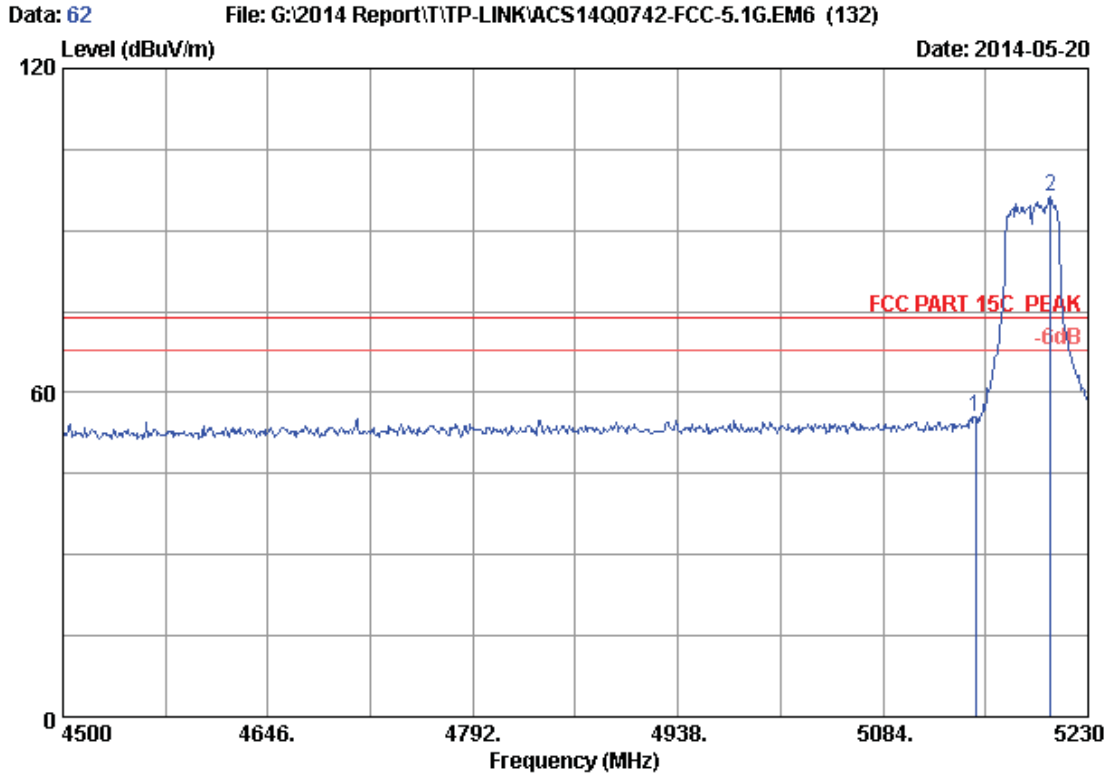

Site no. : 3m Chamber Data no. : 62
 Dis. / Ant. : 3m 2013 3115 (4580) Ant. pol. : HORIZONTAL
 Limit : FCC PART 15C PEAK
 Env. / Ins. : 24°C/56% Engineer : Kevin_Hu
 EUT : AC750 Wireless Dual Band Router
 Power Rating : DC 12V From Adapter Input AC 120V/60Hz
 Test Mode : IEEE802.11nHT40 CH38 5190MHz Tx
 M/N : C20i

No.	Freq. (MHz)	Ant. Factor (dB/m)	Cable Loss (dB)	AMP factor (dB)	Reading (dBuV)	Emission Level (dBuV/m)	Limits (dBuV/m)	Margin (dB)	Remark
1	5150.000	33.44	8.92	35.70	48.74	55.40	74.00	18.60	Peak
2	5202.990	33.52	8.98	35.70	89.62	96.42	74.00	-22.42	Peak

Remarks: 1. Emission Level= Antenna Factor + Cable Loss + Reading - Amp Factor
 2. The emission levels that are 20dB below the official limit are not reported.

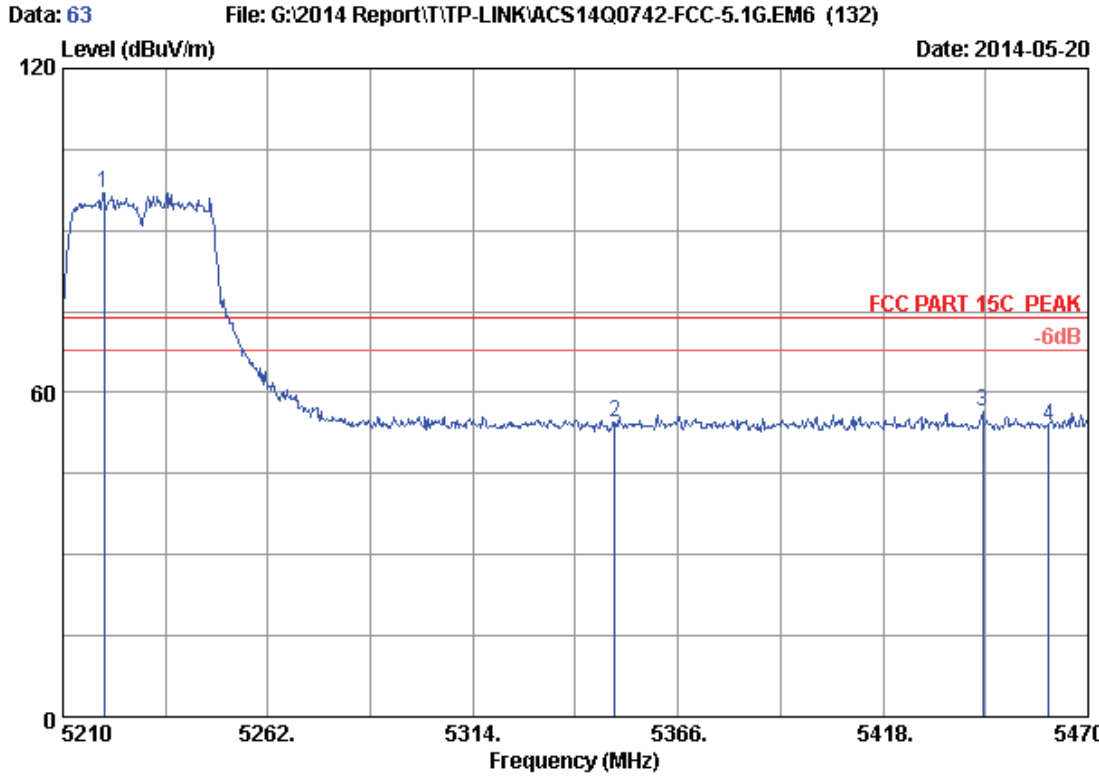

Site no. : 3m Chamber Data no. : 63
 Dis. / Ant. : 3m 2013 3115 (4580) Ant. pol. : HORIZONTAL
 Limit : FCC PART 15C PEAK
 Env. / Ins. : 24°C/56% Engineer : Kevin_Hu
 EUT : AC750 Wireless Dual Band Router
 Power Rating : DC 12V From Adapter Input AC 120V/60Hz
 Test Mode : IEEE802.11nHT40 CH46 5230MHz Tx
 M/N : C20i

No.	Freq. (MHz)	Ant. Factor (dB/m)	Cable Loss (dB)	AMP factor (dB)	Reading (dBUV)	Emission Level (dBUV/m)	Limits (dBUV/m)	Margin (dB)	Remark
1	5220.400	33.55	9.00	35.70	90.21	97.06	74.00	-23.06	Peak
2	5350.000	33.76	9.13	35.70	47.16	54.35	74.00	19.65	Peak
3	5443.220	33.91	9.23	35.70	49.08	56.52	74.00	17.48	Peak
4	5460.000	33.94	9.25	35.70	46.46	53.95	74.00	20.05	Peak

Remarks: 1. Emission Level= Antenna Factor + Cable Loss + Reading - Amp Factor
 2. The emission levels that are 20dB below the official limit are not reported.

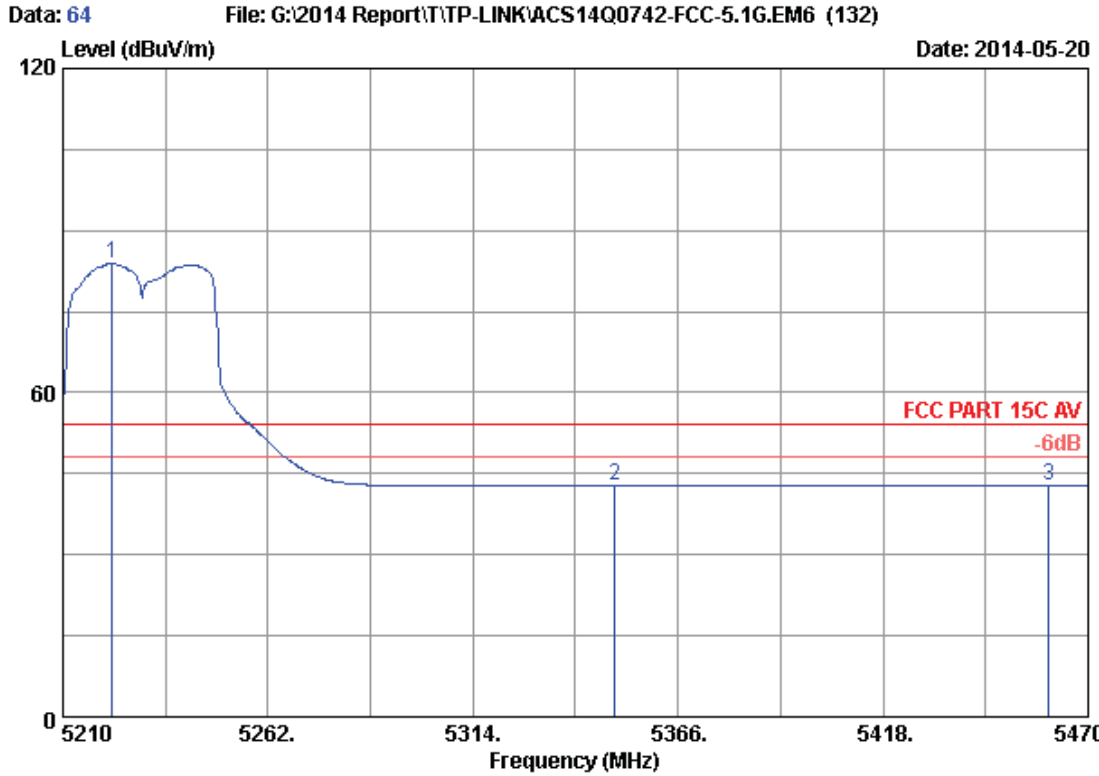

Site no. : 3m Chamber Data no. : 64
 Dis. / Ant. : 3m 2013 3115 (4580) Ant. pol. : HORIZONTAL
 Limit : FCC PART 15C AV
 Env. / Ins. : 24°C/56% Engineer : Kevin_Hu
 EUT : AC750 Wireless Dual Band Router
 Power Rating : DC 12V From Adapter Input AC 120V/60Hz
 Test Mode : IEEE802.11nHT40 CH46 5230MHz Tx
 M/N : C20i

No.	Freq. (MHz)	Ant. Factor (dB/m)	Cable Loss (dB)	AMP factor (dB)	Reading (dBUV)	Emission Level (dBUV/m)	Limits (dBUV/m)	Margin (dB)	Remark
1	5222.480	33.56	9.00	35.70	76.97	83.83	54.00	-29.83	Average
2	5350.000	33.76	9.13	35.70	35.53	42.72	54.00	11.28	Average
3	5460.000	33.94	9.25	35.70	35.24	42.73	54.00	11.27	Average

Remarks: 1. Emission Level= Antenna Factor + Cable Loss + Reading - Amp Factor
 2. The emission levels that are 20dB below the official limit are not reported.

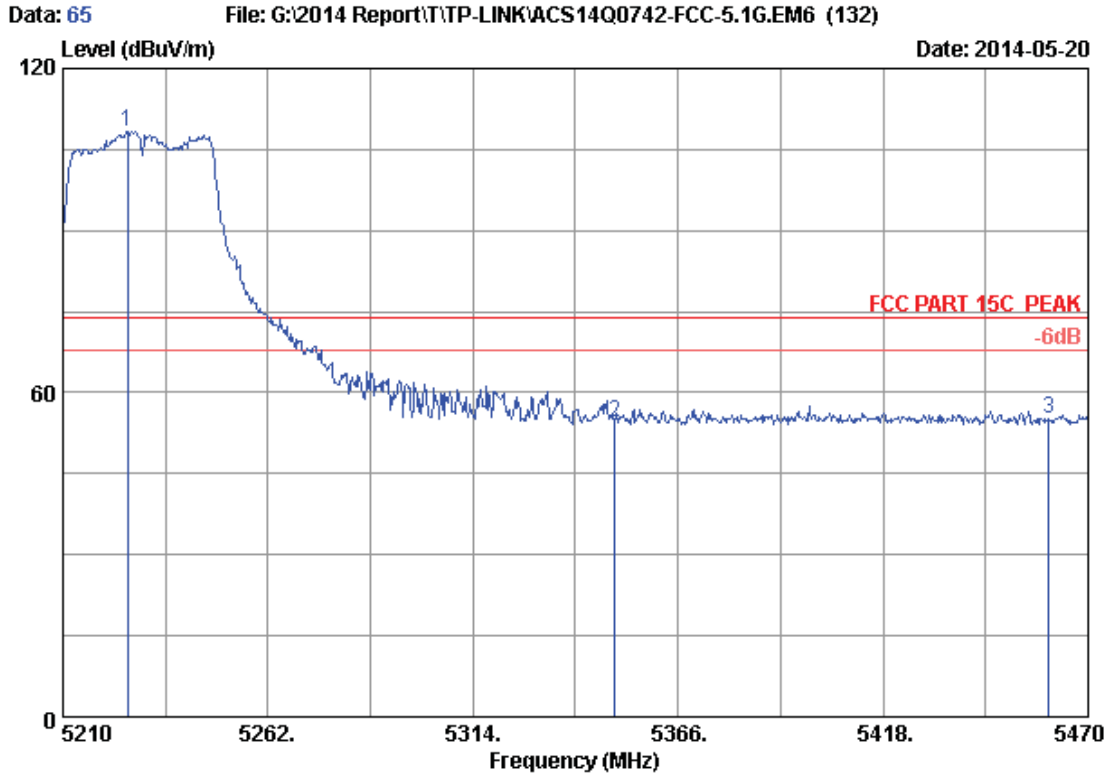

Site no. : 3m Chamber Data no. : 65
 Dis. / Ant. : 3m 2013 3115 (4580) Ant. pol. : VERTICAL
 Limit : FCC PART 15C PEAK
 Env. / Ins. : 24°C/56% Engineer : Kevin_Hu
 EUT : AC750 Wireless Dual Band Router
 Power Rating : DC 12V From Adapter Input AC 120V/60Hz
 Test Mode : IEEE802.11nHT40 CH46 5230MHz Tx
 M/N : C20i

No.	Freq. (MHz)	Ant. Factor (dB/m)	Cable Loss (dB)	AMP factor (dB)	Reading (dBuV)	Emission Level (dBuV/m)	Limits (dBuV/m)	Margin (dB)	Remark
1	5226.380	33.56	9.00	35.70	101.60	108.46	74.00	-34.46	Peak
2	5350.000	33.76	9.13	35.70	47.27	54.46	74.00	19.54	Peak
3	5460.000	33.94	9.25	35.70	47.59	55.08	74.00	18.92	Peak

Remarks: 1. Emission Level= Antenna Factor + Cable Loss + Reading - Amp Factor
 2. The emission levels that are 20dB below the official limit are not reported.

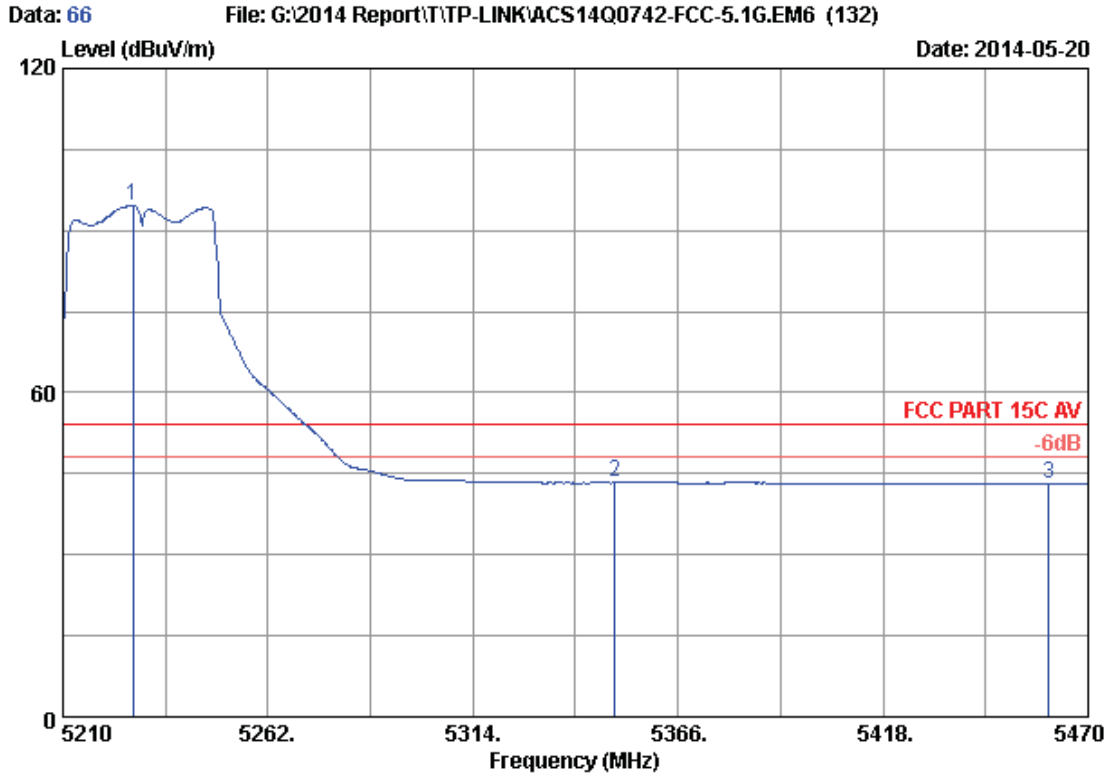

Site no. : 3m Chamber Data no. : 66
 Dis. / Ant. : 3m 2013 3115 (4580) Ant. pol. : VERTICAL
 Limit : FCC PART 15C AV
 Env. / Ins. : 24°C/56% Engineer : Kevin_Hu
 EUT : AC750 Wireless Dual Band Router
 Power Rating : DC 12V From Adapter Input AC 120V/60Hz
 Test Mode : IEEE802.11nHT40 CH46 5230MHz Tx
 M/N : C20i

No.	Freq. (MHz)	Ant. Factor (dB/m)	Cable Loss (dB)	AMP factor (dB)	Reading (dBuV)	Emission Level (dBuV/m)	Limits (dBuV/m)	Margin (dB)	Remark
1	5227.680	33.56	9.00	35.70	87.77	94.63	54.00	-40.63	Average
2	5350.000	33.76	9.13	35.70	36.13	43.32	54.00	10.68	Average
3	5460.000	33.94	9.25	35.70	35.67	43.16	54.00	10.84	Average

Remarks: 1. Emission Level= Antenna Factor + Cable Loss + Reading - Amp Factor
 2. The emission levels that are 20dB below the official limit are not reported.

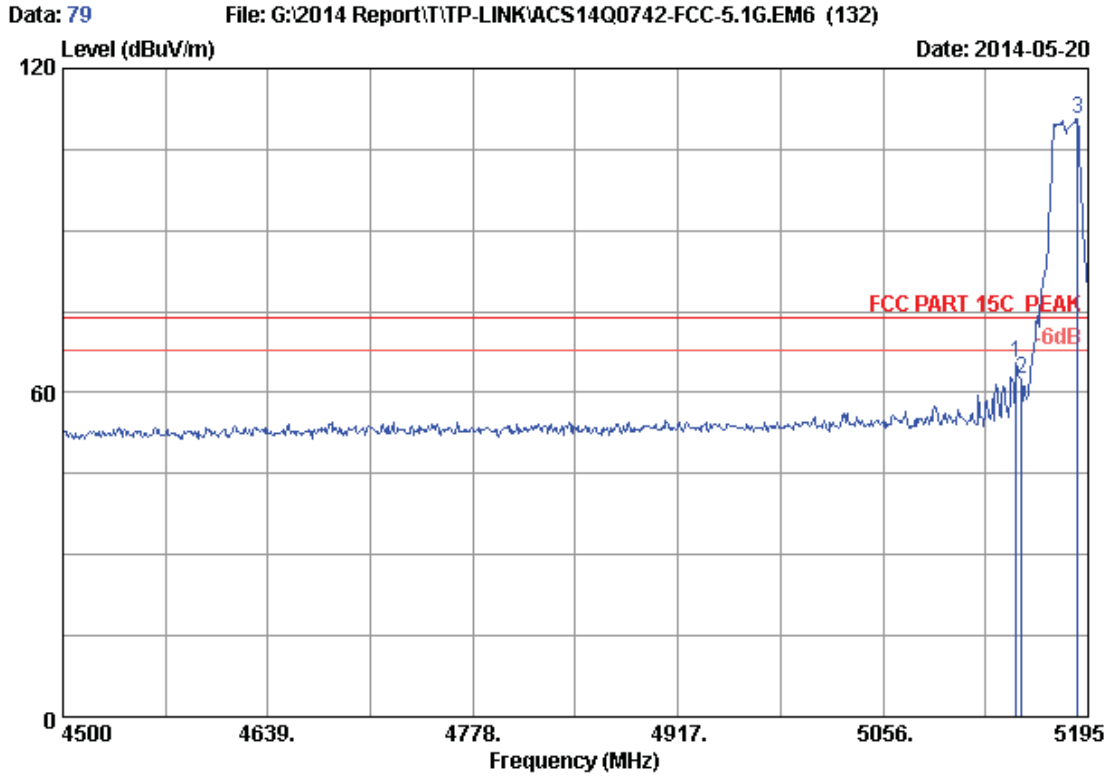

Site no. : 3m Chamber Data no. : 79
 Dis. / Ant. : 3m 2013 3115 (4580) Ant. pol. : VERTICAL
 Limit : FCC PART 15C PEAK
 Env. / Ins. : 24°C/56% Engineer : Kevin_Hu
 EUT : AC750 Wireless Dual Band Router
 Power Rating : DC 12V From Adapter Input AC 120V/60Hz
 Test Mode : IEEE802.11ac VHT20 CH36 5180MHz Tx
 M/N : C20i

No.	Freq. (MHz)	Ant. Factor (dB/m)	Cable Loss (dB)	AMP factor (dB)	Reading (dBuV)	Emission Level (dBuV/m)	Limits (dBuV/m)	Margin (dB)	Remark
1	5146.350	33.43	8.92	35.70	58.85	65.50	74.00	8.50	Peak
2	5150.000	33.44	8.92	35.70	55.80	62.46	74.00	11.54	Peak
3	5188.050	33.50	8.96	35.70	104.03	110.79	74.00	-36.79	Peak

Remarks: 1. Emission Level= Antenna Factor + Cable Loss + Reading - Amp Factor
 2. The emission levels that are 20dB below the official limit are not reported.

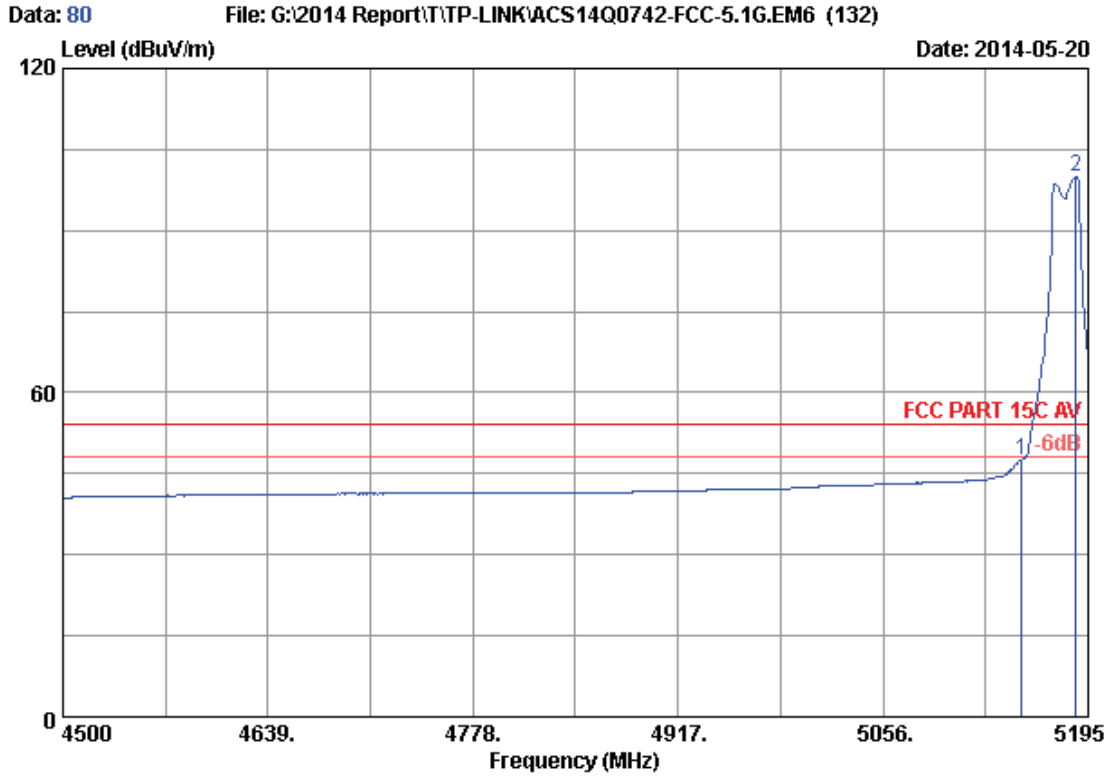

Site no. : 3m Chamber Data no. : 80
 Dis. / Ant. : 3m 2013 3115 (4580) Ant. pol. : VERTICAL
 Limit : FCC PART 15C AV
 Env. / Ins. : 24°C/56% Engineer : Kevin_Hu
 EUT : AC750 Wireless Dual Band Router
 Power Rating : DC 12V From Adapter Input AC 120V/60Hz
 Test Mode : IEEE802.11ac VHT20 CH36 5180MHz Tx
 M/N : C20i

No.	Freq. (MHz)	Ant. Factor (dB/m)	Cable Loss (dB)	AMP factor (dB)	Reading (dBuV)	Emission Level (dBuV/m)	Limits (dBuV/m)	Margin (dB)	Remark
1	5150.000	33.44	8.92	35.70	40.93	47.59	54.00	6.41	Average
2	5186.660	33.50	8.96	35.70	93.06	99.82	54.00	-45.82	Average

Remarks: 1. Emission Level= Antenna Factor + Cable Loss + Reading - Amp Factor
 2. The emission levels that are 20dB below the official limit are not reported.

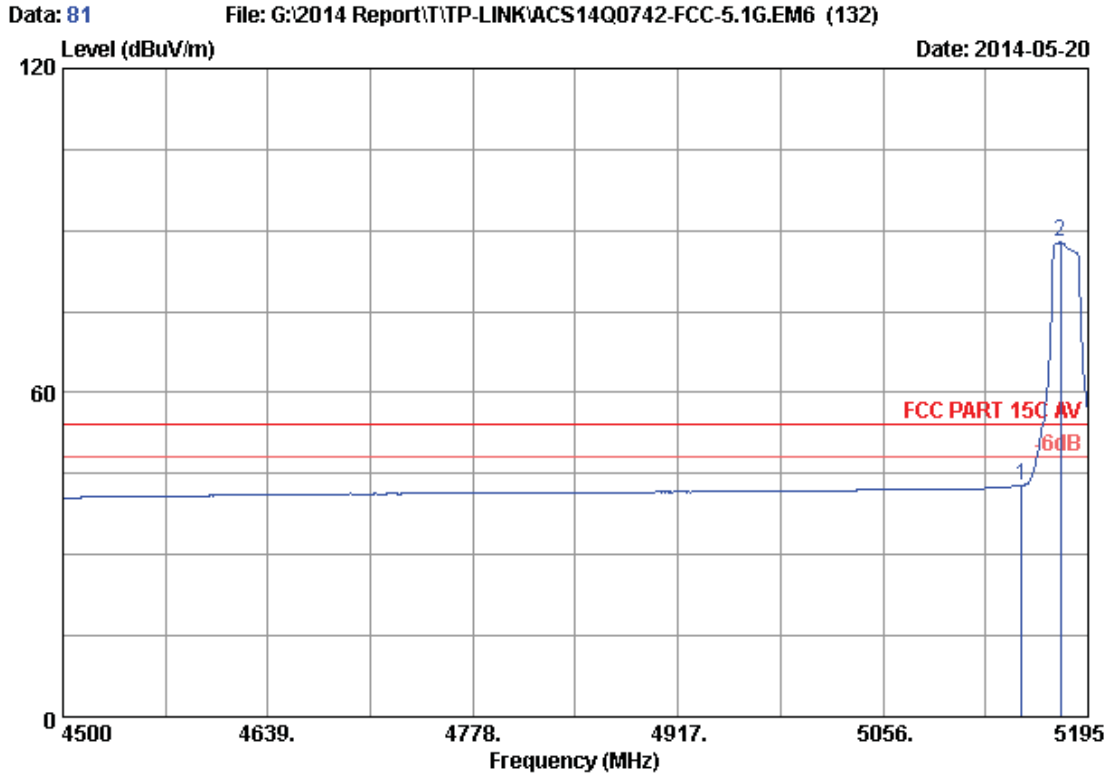

Site no. : 3m Chamber Data no. : 81
 Dis. / Ant. : 3m 2013 3115 (4580) Ant. pol. : HORIZONTAL
 Limit : FCC PART 15C AV
 Env. / Ins. : 24°C/56% Engineer : Kevin_Hu
 EUT : AC750 Wireless Dual Band Router
 Power Rating : DC 12V From Adapter Input AC 120V/60Hz
 Test Mode : IEEE802.11ac VHT20 CH36 5180MHz Tx
 M/N : C20i

No.	Freq. (MHz)	Ant. Factor (dB/m)	Cable Loss (dB)	AMP factor (dB)	Reading (dBuV)	Emission Level (dBuV/m)	Limits (dBuV/m)	Margin (dB)	Remark
1	5150.000	33.44	8.92	35.70	36.13	42.79	54.00	11.21	Average
2	5176.235	33.48	8.95	35.70	81.05	87.78	54.00	-33.78	Average

Remarks: 1. Emission Level= Antenna Factor + Cable Loss + Reading - Amp Factor
 2. The emission levels that are 20dB below the official limit are not reported.

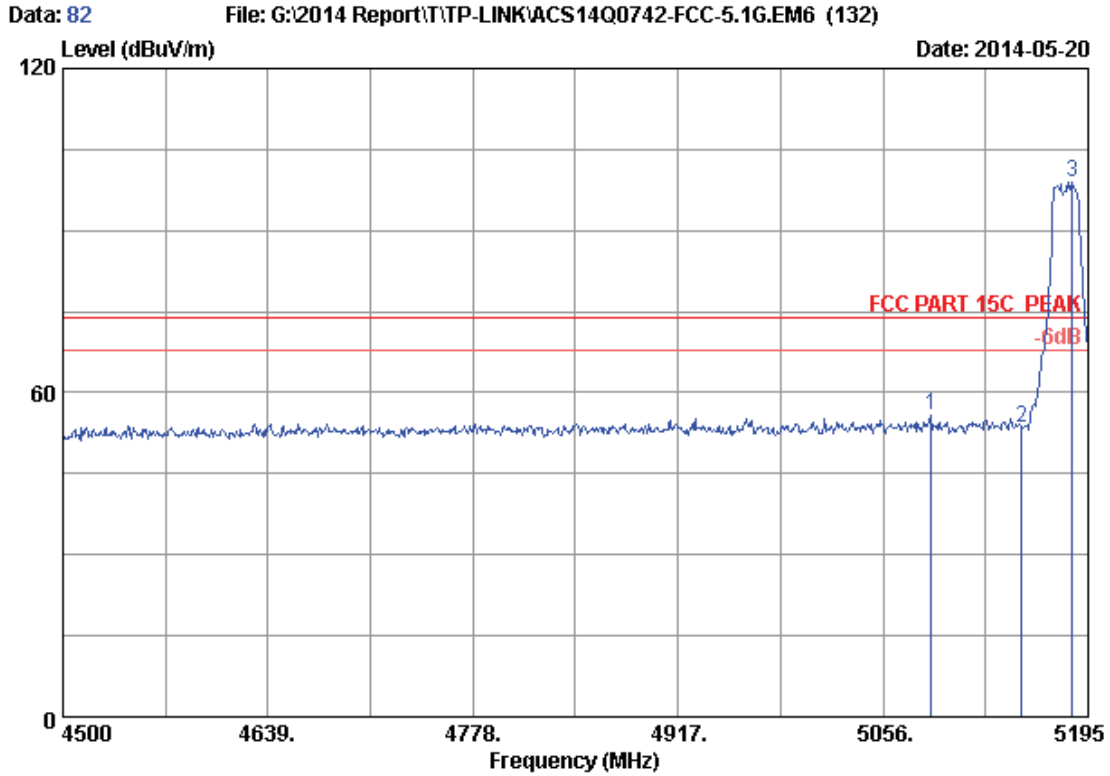

Site no. : 3m Chamber Data no. : 82
 Dis. / Ant. : 3m 2013 3115 (4580) Ant. pol. : HORIZONTAL
 Limit : FCC PART 15C PEAK
 Env. / Ins. : 24°C/56% Engineer : Kevin_Hu
 EUT : AC750 Wireless Dual Band Router
 Power Rating : DC 12V From Adapter Input AC 120V/60Hz
 Test Mode : IEEE802.11ac VHT20 CH36 5180MHz Tx
 M/N : C20i

No.	Freq. (MHz)	Ant. Factor (dB/m)	Cable Loss (dB)	AMP factor (dB)	Reading (dBuV)	Emission Level (dBuV/m)	Limits (dBuV/m)	Margin (dB)	Remark
1	5088.665	33.34	8.86	35.70	49.46	55.96	74.00	18.04	Peak
2	5150.000	33.44	8.92	35.70	46.78	53.44	74.00	20.56	Peak
3	5184.575	33.50	8.96	35.70	92.24	99.00	74.00	-25.00	Peak

Remarks: 1. Emission Level= Antenna Factor + Cable Loss + Reading - Amp Factor
 2. The emission levels that are 20dB below the official limit are not reported.

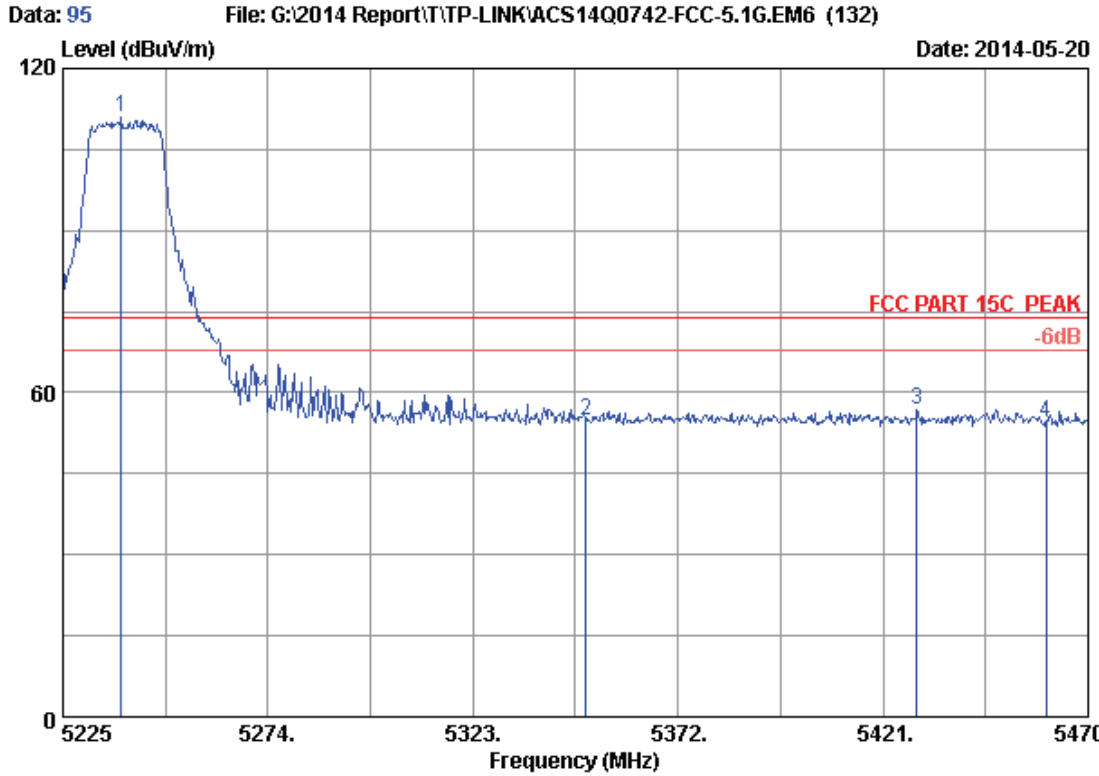

Site no. : 3m Chamber Data no. : 95
 Dis. / Ant. : 3m 2013 3115 (4580) Ant. pol. : VERTICAL
 Limit : FCC PART 15C PEAK
 Env. / Ins. : 24°C/56% Engineer : Kevin_Hu
 EUT : AC750 Wireless Dual Band Router
 Power Rating : DC 12V From Adapter Input AC 120V/60Hz
 Test Mode : IEEE802.11ac VHT20 CH48 5240MHz Tx
 M/N : C20i

No.	Freq. (MHz)	Ant. Factor (dB/m)	Cable Loss (dB)	AMP factor (dB)	Reading (dBUV)	Emission Level (dBUV/m)	Limits (dBUV/m)	Margin (dB)	Remark
1	5238.965	33.58	9.02	35.70	104.15	111.05	74.00	-37.05	Peak
2	5350.000	33.76	9.13	35.70	47.68	54.87	74.00	19.13	Peak
3	5429.085	33.89	9.21	35.70	49.57	56.97	74.00	17.03	Peak
4	5460.000	33.94	9.25	35.70	47.09	54.58	74.00	19.42	Peak

Remarks: 1. Emission Level= Antenna Factor + Cable Loss + Reading -Amp Factor
 2. The emission levels that are 20dB below the official limit are not reported.

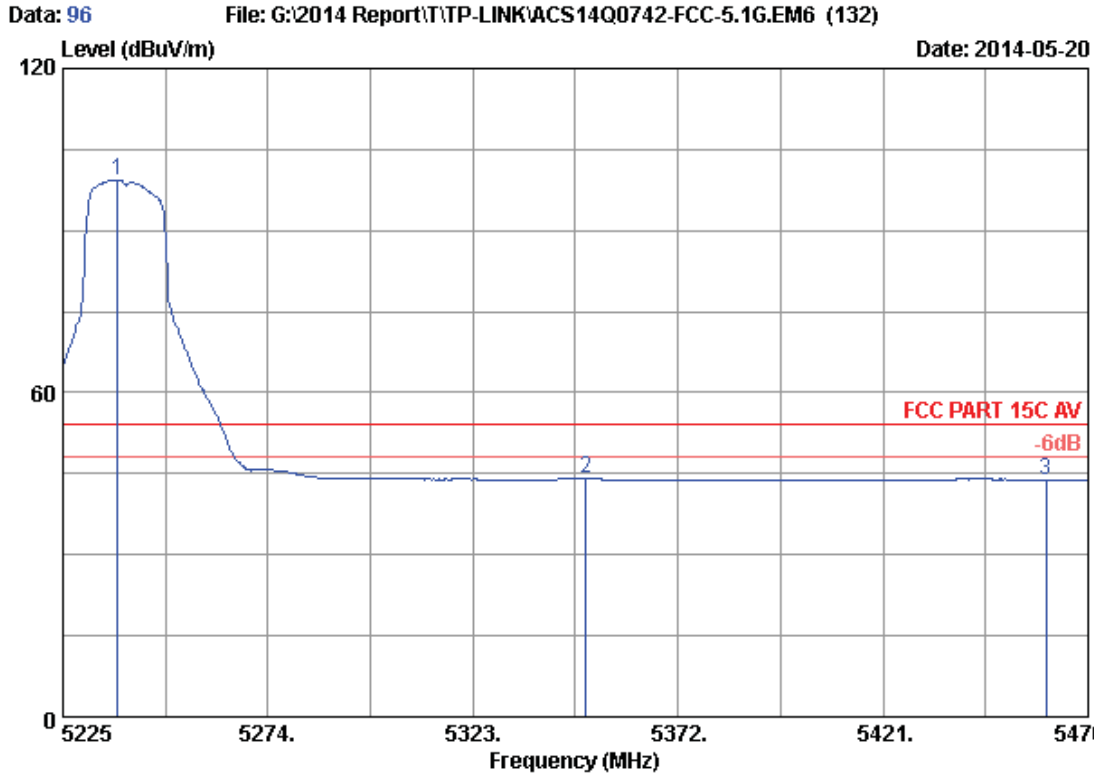

Site no. : 3m Chamber Data no. : 96
 Dis. / Ant. : 3m 2013 3115 (4580) Ant. pol. : VERTICAL
 Limit : FCC PART 15C AV
 Env. / Ins. : 24°C/56% Engineer : Kevin_Hu
 EUT : AC750 Wireless Dual Band Router
 Power Rating : DC 12V From Adapter Input AC 120V/60Hz
 Test Mode : IEEE802.11ac VHT20 CH48 5240MHz Tx
 M/N : C20i

No.	Freq. (MHz)	Ant. Factor (dB/m)	Cable Loss (dB)	AMP factor (dB)	Reading (dBuV)	Emission Level (dBuV/m)	Limits (dBuV/m)	Margin (dB)	Remark
1	5237.985	33.58	9.01	35.70	92.54	99.43	54.00	-45.43	Average
2	5350.000	33.76	9.13	35.70	36.86	44.05	54.00	9.95	Average
3	5460.000	33.94	9.25	35.70	36.34	43.83	54.00	10.17	Average

Remarks: 1. Emission Level= Antenna Factor + Cable Loss + Reading - Amp Factor
 2. The emission levels that are 20dB below the official limit are not reported.

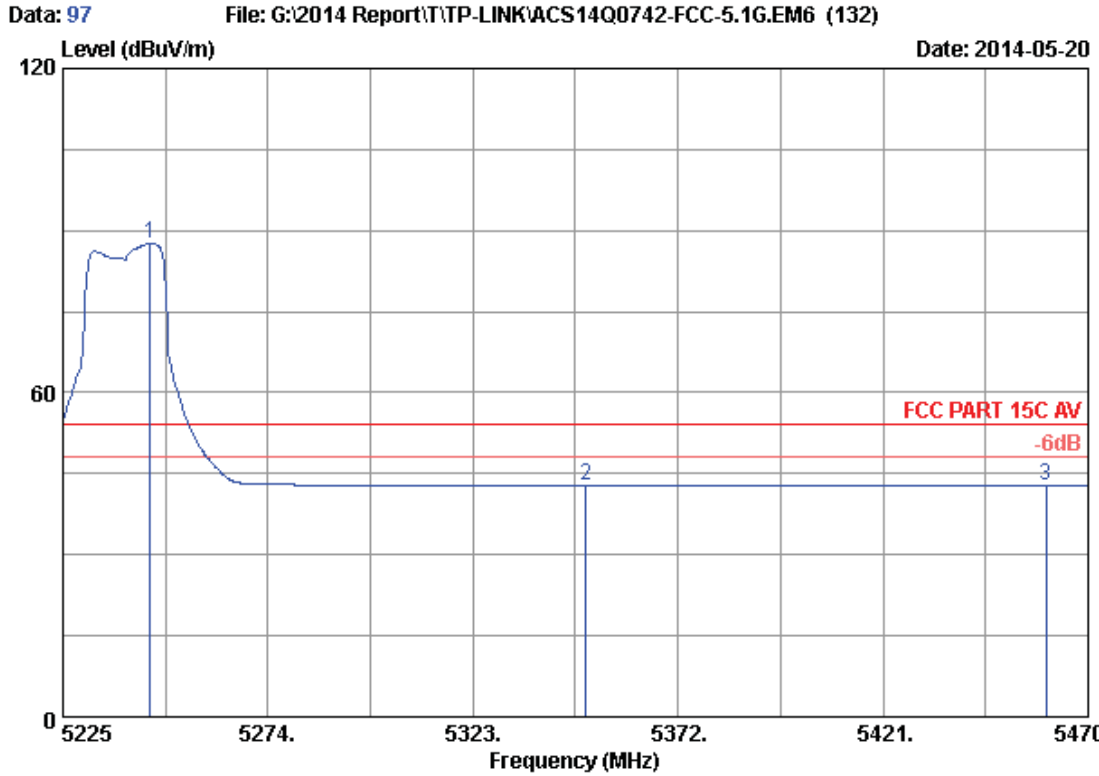

Site no. : 3m Chamber Data no. : 97
 Dis. / Ant. : 3m 2013 3115 (4580) Ant. pol. : HORIZONTAL
 Limit : FCC PART 15C AV
 Env. / Ins. : 24°C/56% Engineer : Kevin_Hu
 EUT : AC750 Wireless Dual Band Router
 Power Rating : DC 12V From Adapter Input AC 120V/60Hz
 Test Mode : IEEE802.11ac VHT20 CH48 5240MHz Tx
 M/N : C20i

No.	Freq. (MHz)	Ant. Factor (dB/m)	Cable Loss (dB)	AMP factor (dB)	Reading (dBuV)	Emission Level (dBuV/m)	Limits (dBuV/m)	Margin (dB)	Remark
1	5245.825	33.59	9.02	35.70	80.61	87.52	54.00	-33.52	Average
2	5350.000	33.76	9.13	35.70	35.64	42.83	54.00	11.17	Average
3	5460.000	33.94	9.25	35.70	35.34	42.83	54.00	11.17	Average

Remarks: 1. Emission Level= Antenna Factor + Cable Loss + Reading - Amp Factor
 2. The emission levels that are 20dB below the official limit are not reported.

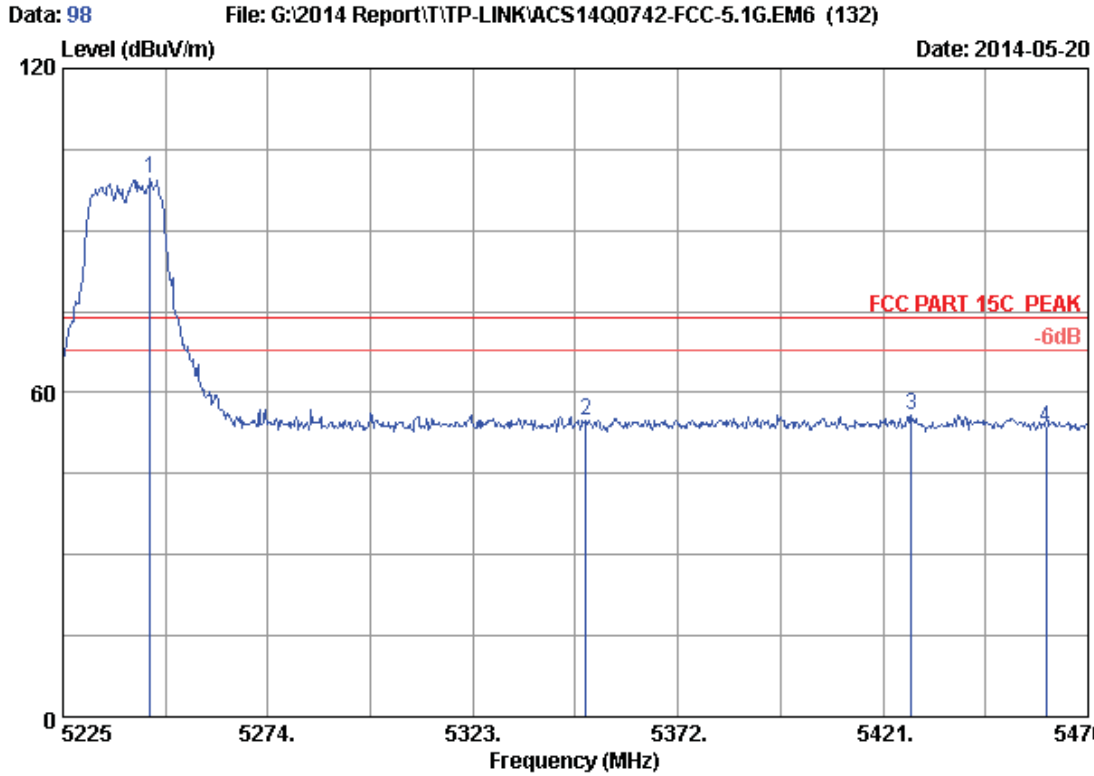

Site no. : 3m Chamber Data no. : 98
 Dis. / Ant. : 3m 2013 3115 (4580) Ant. pol. : HORIZONTAL
 Limit : FCC PART 15C PEAK
 Env. / Ins. : 24°C/56% Engineer : Kevin_Hu
 EUT : AC750 Wireless Dual Band Router
 Power Rating : DC 12V From Adapter Input AC 120V/60Hz
 Test Mode : IEEE802.11ac VHT20 CH48 5240MHz Tx
 M/N : C20i

No.	Freq. (MHz)	Ant. Factor (dB/m)	Cable Loss (dB)	AMP factor (dB)	Reading (dBuV)	Emission Level (dBuV/m)	Limits (dBuV/m)	Margin (dB)	Remark
1	5245.825	33.59	9.02	35.70	92.64	99.55	74.00	-25.55	Peak
2	5350.000	33.76	9.13	35.70	47.56	54.75	74.00	19.25	Peak
3	5427.860	33.88	9.21	35.70	48.38	55.77	74.00	18.23	Peak
4	5460.000	33.94	9.25	35.70	46.10	53.59	74.00	20.41	Peak

Remarks: 1. Emission Level= Antenna Factor + Cable Loss + Reading - Amp Factor
 2. The emission levels that are 20dB below the official limit are not reported.

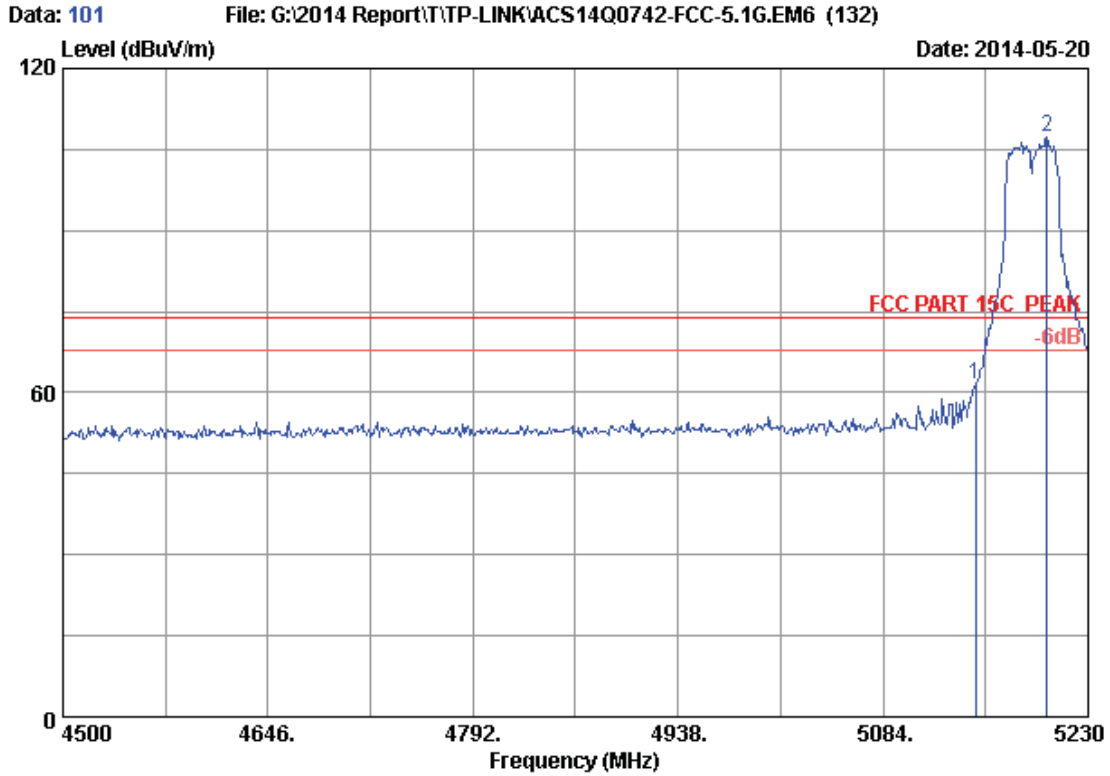

Site no. : 3m Chamber Data no. : 101
 Dis. / Ant. : 3m 2013 3115 (4580) Ant. pol. : VERTICAL
 Limit : FCC PART 15C PEAK
 Env. / Ins. : 24°C/56% Engineer : Kevin_Hu
 EUT : AC750 Wireless Dual Band Router
 Power Rating : DC 12V From Adapter Input AC 120V/60Hz
 Test Mode : IEEE802.11ac VHT40 CH38 5190MHz Tx
 M/N : C20i

No.	Freq. (MHz)	Ant. Factor (dB/m)	Cable Loss (dB)	AMP factor (dB)	Reading (dBUV)	Emission Level (dBUV/m)	Limits (dBUV/m)	Margin (dB)	Remark
1	5150.000	33.44	8.92	35.70	54.79	61.45	74.00	12.55	Peak
2	5200.800	33.52	8.98	35.70	100.43	107.23	74.00	-33.23	Peak

Remarks: 1. Emission Level= Antenna Factor + Cable Loss + Reading - Amp Factor
 2. The emission levels that are 20dB below the official limit are not reported.



Site no. : 3m Chamber Data no. : 102
 Dis. / Ant. : 3m 2013 3115 (4580) Ant. pol. : VERTICAL
 Limit : FCC PART 15C AV
 Env. / Ins. : 24°C/56% Engineer : Kevin_Hu
 EUT : AC750 Wireless Dual Band Router
 Power Rating : DC 12V From Adapter Input AC 120V/60Hz
 Test Mode : IEEE802.11ac VHT40 CH38 5190MHz Tx
 M/N : C20i

No.	Freq. (MHz)	Ant. Factor (dB/m)	Cable Loss (dB)	AMP factor (dB)	Reading (dBuV)	Emission Level (dBuV/m)	Limits (dBuV/m)	Margin (dB)	Remark
1	5150.000	33.44	8.92	35.70	43.70	50.36	54.00	3.64	Average
2	5198.610	33.52	8.97	35.70	87.72	94.51	54.00	-40.51	Average

Remarks: 1. Emission Level= Antenna Factor + Cable Loss + Reading - Amp Factor
 2. The emission levels that are 20dB below the official limit are not reported.

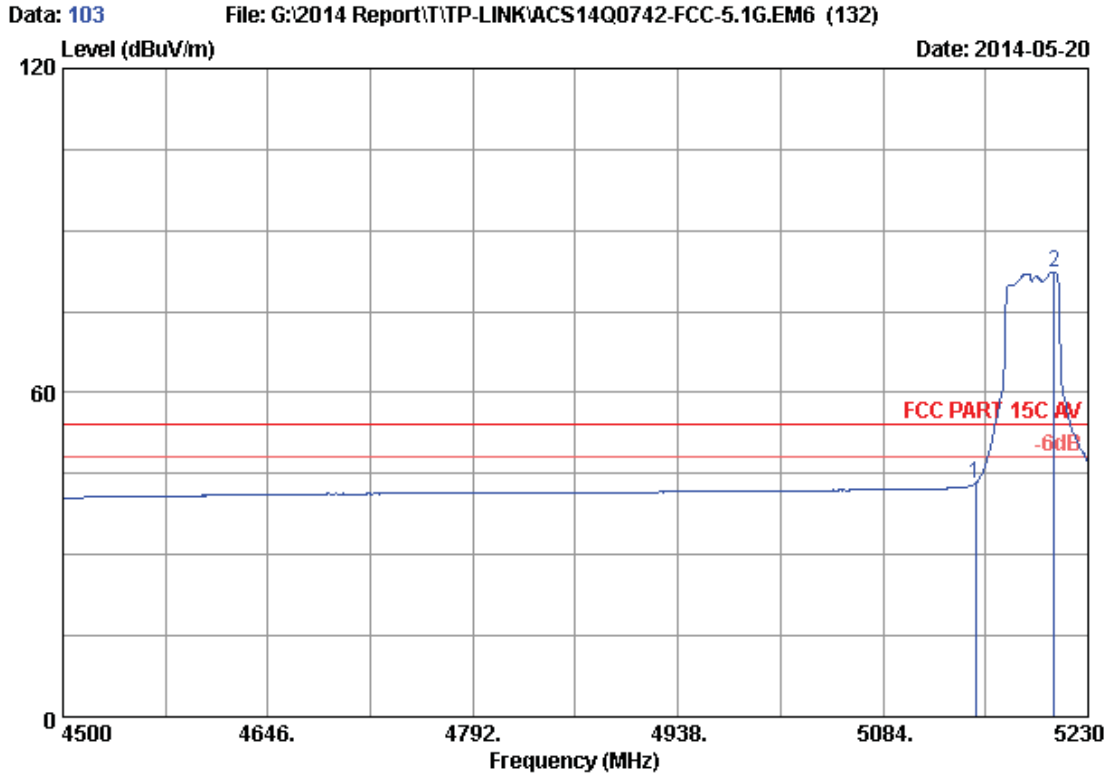

Site no. : 3m Chamber Data no. : 103
 Dis. / Ant. : 3m 2013 3115 (4580) Ant. pol. : HORIZONTAL
 Limit : FCC PART 15C AV
 Env. / Ins. : 24°C/56% Engineer : Kevin_Hu
 EUT : AC750 Wireless Dual Band Router
 Power Rating : DC 12V From Adapter Input AC 120V/60Hz
 Test Mode : IEEE802.11ac VHT40 CH38 5190MHz Tx
 M/N : C20i

No.	Freq. (MHz)	Ant. Factor (dB/m)	Cable Loss (dB)	AMP factor (dB)	Reading (dBuV)	Emission Level (dBuV/m)	Limits (dBuV/m)	Margin (dB)	Remark
1	5150.000	33.44	8.92	35.70	36.46	43.12	54.00	10.88	Average
2	5205.910	33.53	8.98	35.70	75.58	82.39	54.00	-28.39	Average

Remarks: 1. Emission Level= Antenna Factor + Cable Loss + Reading - Amp Factor
 2. The emission levels that are 20dB below the official limit are not reported.

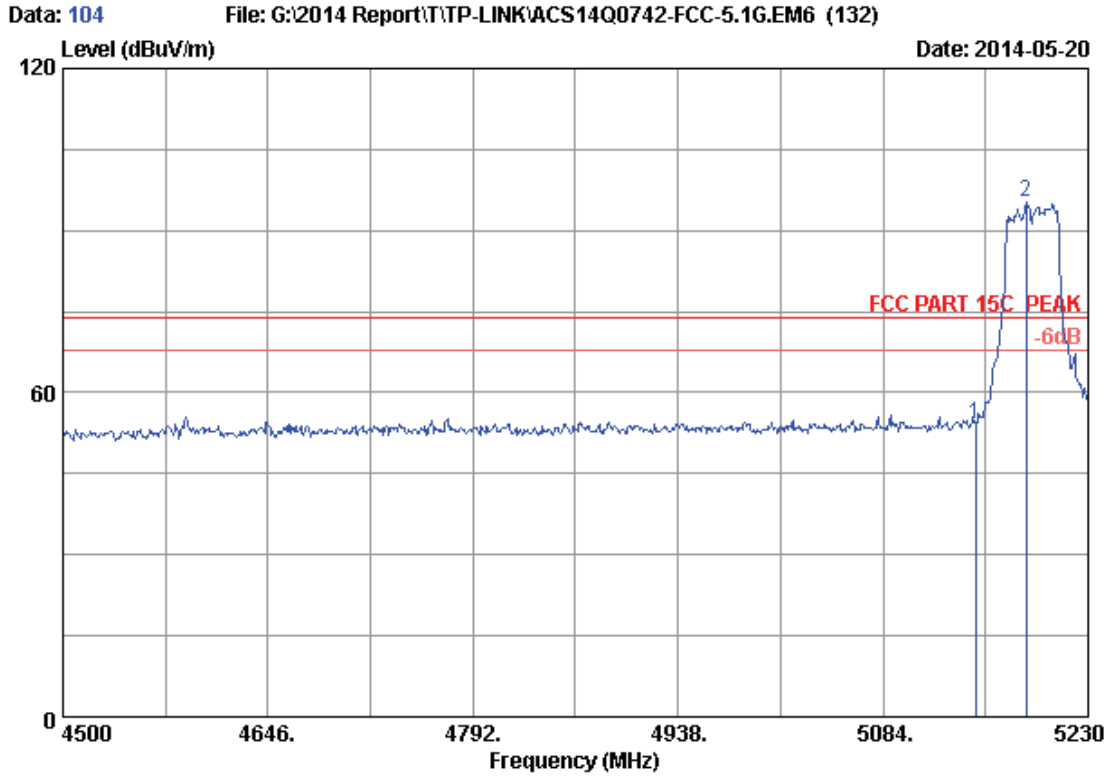

Site no. : 3m Chamber Data no. : 104
 Dis. / Ant. : 3m 2013 3115 (4580) Ant. pol. : HORIZONTAL
 Limit : FCC PART 15C PEAK
 Env. / Ins. : 24°C/56% Engineer : Kevin_Hu
 EUT : AC750 Wireless Dual Band Router
 Power Rating : DC 12V From Adapter Input AC 120V/60Hz
 Test Mode : IEEE802.11ac VHT40 CH38 5190MHz Tx
 M/N : C20i

No.	Freq. (MHz)	Ant. Factor (dB/m)	Cable Loss (dB)	AMP factor (dB)	Reading (dBuV)	Emission Level (dBuV/m)	Limits (dBuV/m)	Margin (dB)	Remark
1	5150.000	33.44	8.92	35.70	47.54	54.20	74.00	19.80	Peak
2	5186.200	33.50	8.96	35.70	88.39	95.15	74.00	-21.15	Peak

Remarks: 1. Emission Level= Antenna Factor + Cable Loss + Reading - Amp Factor
 2. The emission levels that are 20dB below the official limit are not reported.

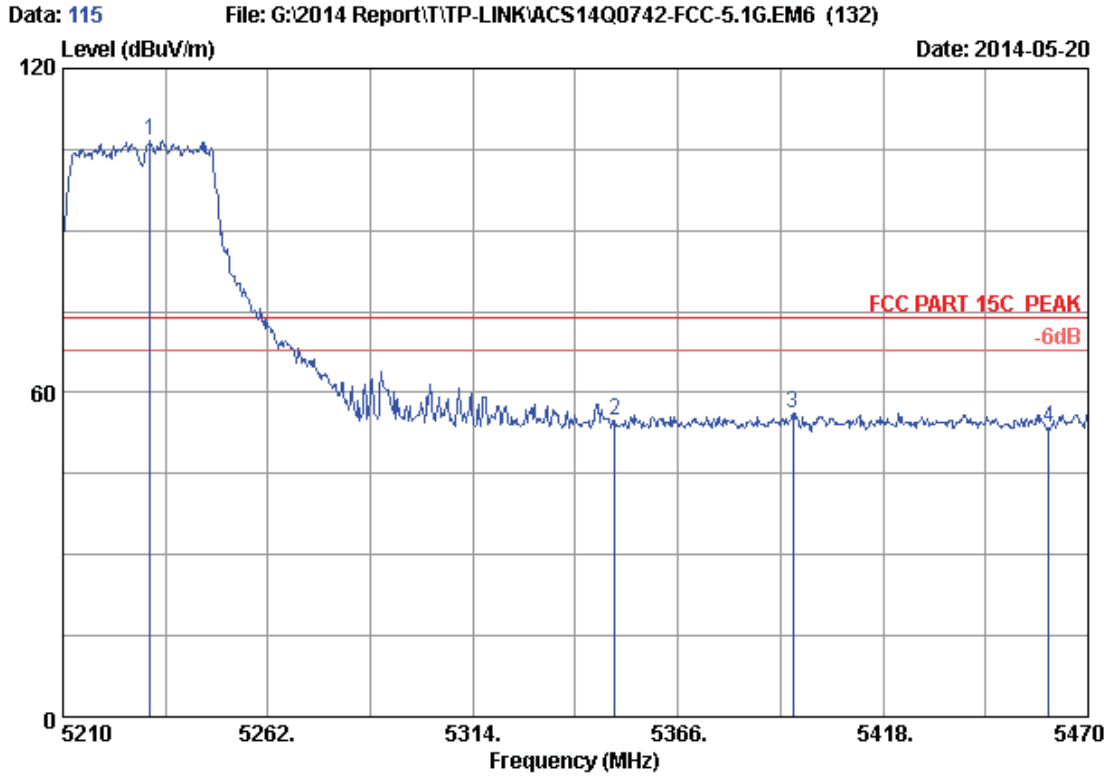

Site no. : 3m Chamber Data no. : 115
 Dis. / Ant. : 3m 2013 3115 (4580) Ant. pol. : VERTICAL
 Limit : FCC PART 15C PEAK
 Env. / Ins. : 24°C/56% Engineer : Kevin_Hu
 EUT : AC750 Wireless Dual Band Router
 Power Rating : DC 12V From Adapter Input AC 120V/60Hz
 Test Mode : IEEE802.11ac VHT40 CH46 5230MHz Tx
 M/N : C20i

No.	Freq. (MHz)	Ant. Factor (dB/m)	Cable Loss (dB)	AMP factor (dB)	Reading (dBuV)	Emission Level (dBuV/m)	Limits (dBuV/m)	Margin (dB)	Remark
1	5232.100	33.57	9.01	35.70	99.89	106.77	74.00	-32.77	Peak
2	5350.000	33.76	9.13	35.70	47.49	54.68	74.00	19.32	Peak
3	5395.120	33.83	9.18	35.70	48.93	56.24	74.00	17.76	Peak
4	5460.000	33.94	9.25	35.70	46.08	53.57	74.00	20.43	Peak

Remarks: 1. Emission Level= Antenna Factor + Cable Loss + Reading - Amp Factor
 2. The emission levels that are 20dB below the official limit are not reported.

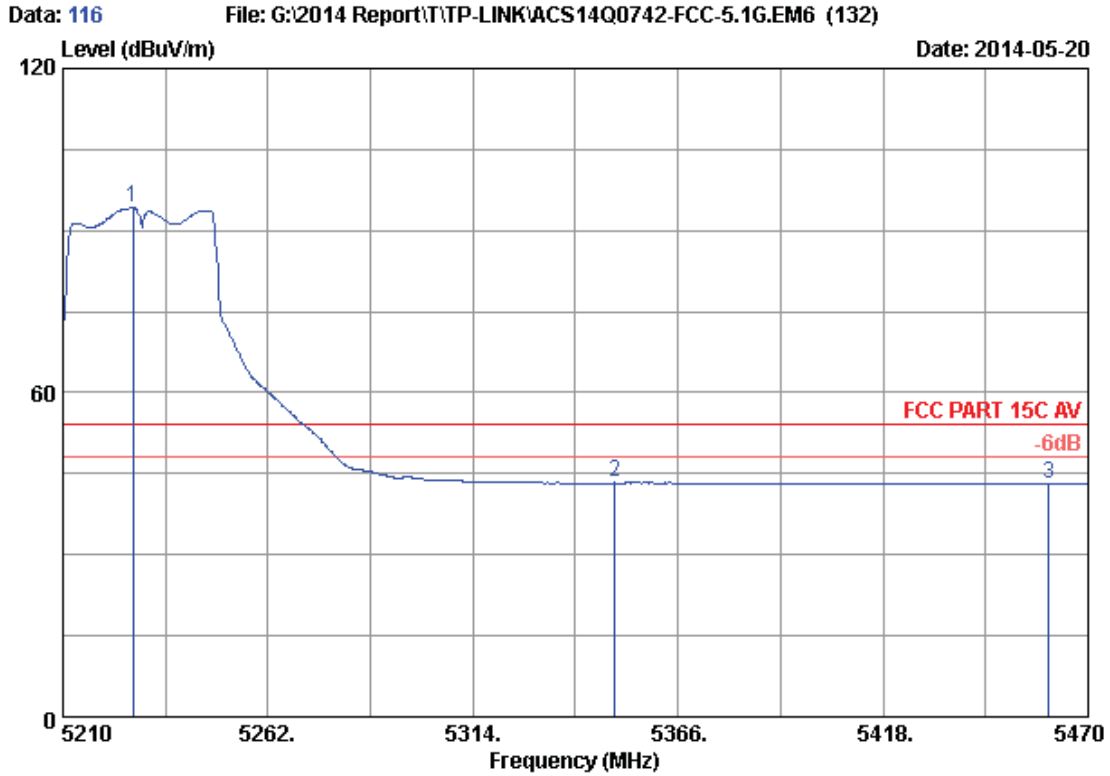

Site no. : 3m Chamber Data no. : 116
 Dis. / Ant. : 3m 2013 3115 (4580) Ant. pol. : VERTICAL
 Limit : FCC PART 15C AV
 Env. / Ins. : 24°C/56% Engineer : Kevin_Hu
 EUT : AC750 Wireless Dual Band Router
 Power Rating : DC 12V From Adapter Input AC 120V/60Hz
 Test Mode : IEEE802.11ac VHT40 CH46 5230MHz Tx
 M/N : C20i

No.	Freq. (MHz)	Ant. Factor (dB/m)	Cable Loss (dB)	AMP factor (dB)	Reading (dBUV)	Emission Level (dBUV/m)	Limits (dBUV/m)	Margin (dB)	Remark
1	5227.680	33.56	9.00	35.70	87.35	94.21	54.00	-40.21	Average
2	5350.000	33.76	9.13	35.70	36.10	43.29	54.00	10.71	Average
3	5460.000	33.94	9.25	35.70	35.65	43.14	54.00	10.86	Average

Remarks: 1. Emission Level= Antenna Factor + Cable Loss + Reading - Amp Factor
 2. The emission levels that are 20dB below the official limit are not reported.

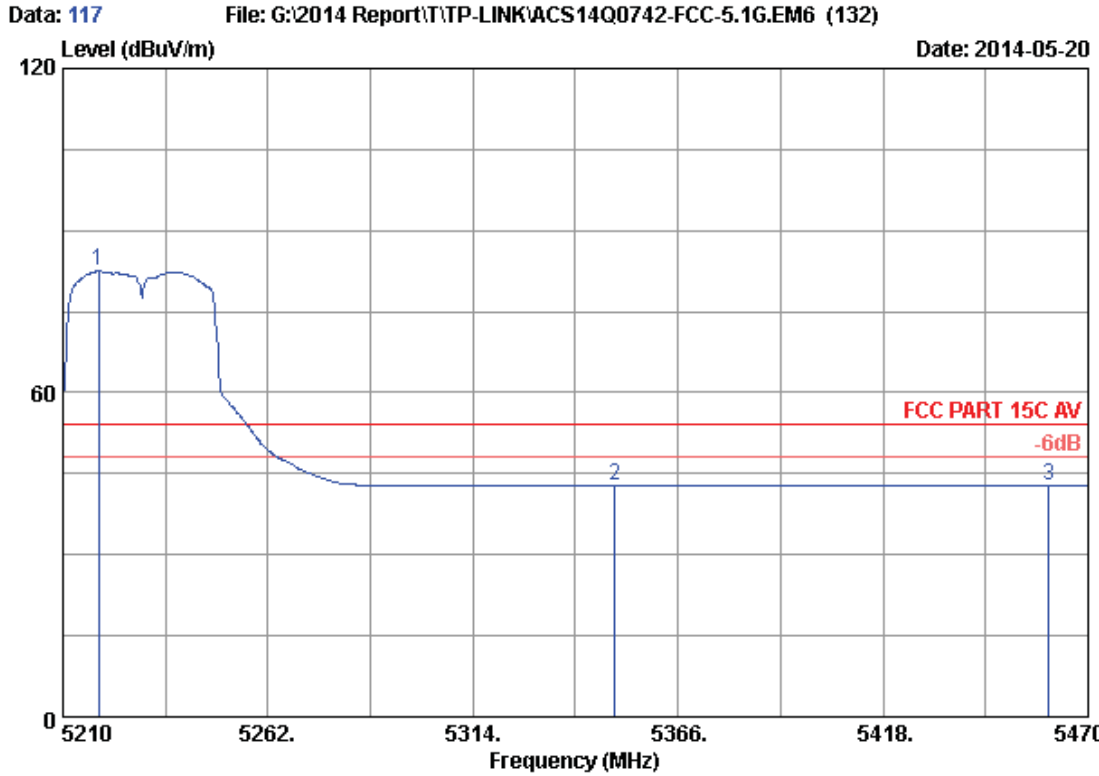

Site no. : 3m Chamber Data no. : 117
 Dis. / Ant. : 3m 2013 3115 (4580) Ant. pol. : HORIZONTAL
 Limit : FCC PART 15C AV
 Env. / Ins. : 24°C/56% Engineer : Kevin_Hu
 EUT : AC750 Wireless Dual Band Router
 Power Rating : DC 12V From Adapter Input AC 120V/60Hz
 Test Mode : IEEE802.11ac VHT40 CH46 5230MHz Tx
 M/N : C20i

No.	Freq. (MHz)	Ant. Factor (dB/m)	Cable Loss (dB)	AMP factor (dB)	Reading (dBUV)	Emission Level (dBUV/m)	Limits (dBUV/m)	Margin (dB)	Remark
1	5219.100	33.55	8.99	35.70	75.66	82.50	54.00	-28.50	Average
2	5350.000	33.76	9.13	35.70	35.55	42.74	54.00	11.26	Average
3	5460.000	33.94	9.25	35.70	35.24	42.73	54.00	11.27	Average

Remarks: 1. Emission Level= Antenna Factor + Cable Loss + Reading - Amp Factor
 2. The emission levels that are 20dB below the official limit are not reported.

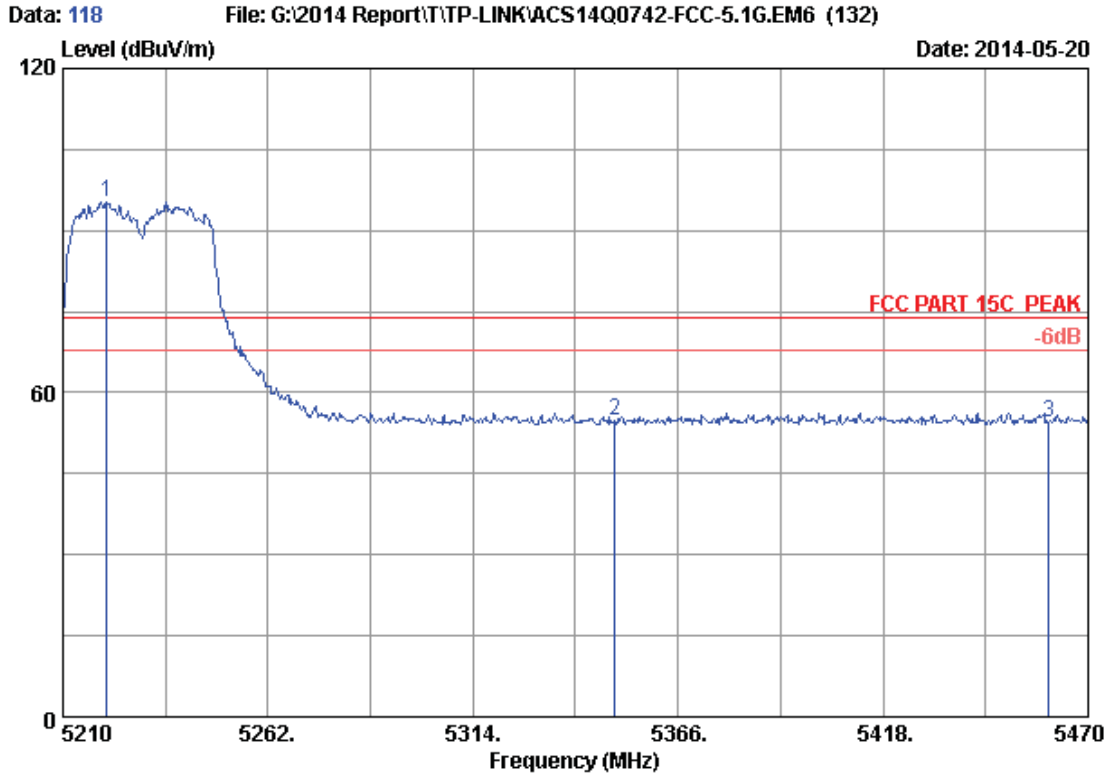

Site no. : 3m Chamber Data no. : 118
 Dis. / Ant. : 3m 2013 3115 (4580) Ant. pol. : HORIZONTAL
 Limit : FCC PART 15C PEAK
 Env. / Ins. : 24°C/56% Engineer : Kevin_Hu
 EUT : AC750 Wireless Dual Band Router
 Power Rating : DC 12V From Adapter Input AC 120V/60Hz
 Test Mode : IEEE802.11ac VHT40 CH46 5230MHz Tx
 M/N : C20i

No.	Freq. (MHz)	Ant. Factor (dB/m)	Cable Loss (dB)	AMP factor (dB)	Reading (dBUV)	Emission Level (dBUV/m)	Limits (dBUV/m)	Margin (dB)	Remark
1	5221.180	33.55	9.00	35.70	88.46	95.31	74.00	-21.31	Peak
2	5350.000	33.76	9.13	35.70	47.51	54.70	74.00	19.30	Peak
3	5460.000	33.94	9.25	35.70	47.00	54.49	74.00	19.51	Peak

Remarks: 1. Emission Level= Antenna Factor + Cable Loss + Reading - Amp Factor
 2. The emission levels that are 20dB below the official limit are not reported.

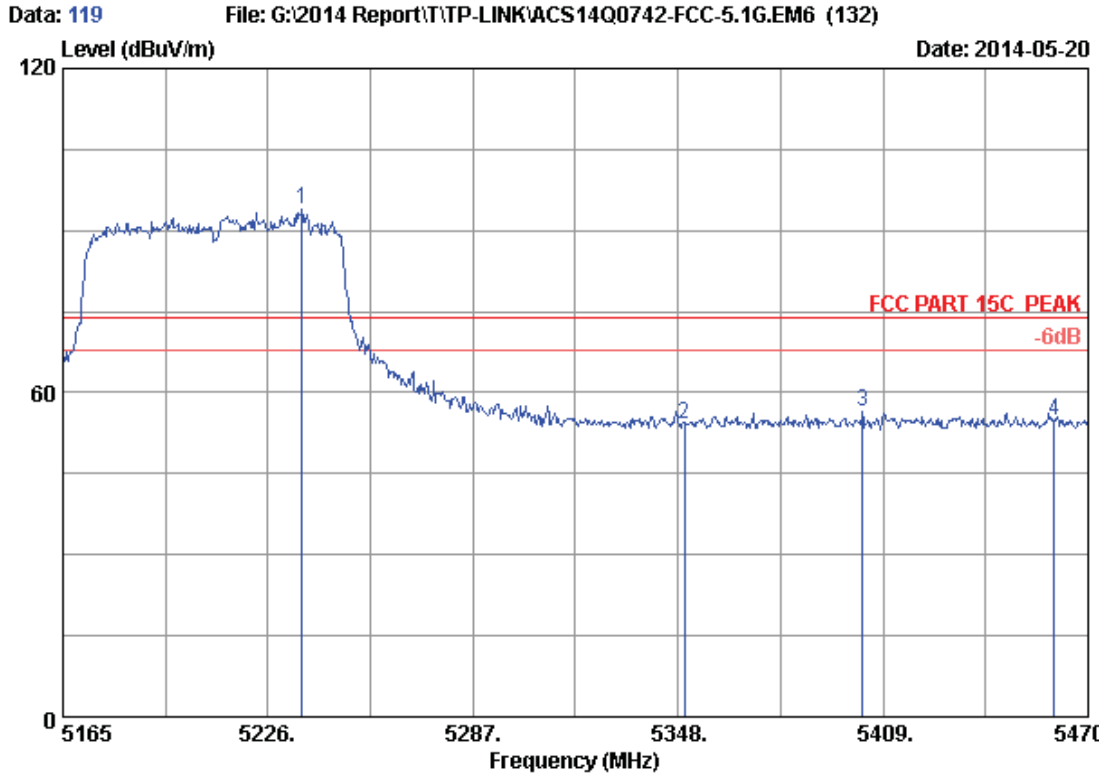

Site no. : 3m Chamber Data no. : 119
 Dis. / Ant. : 3m 2013 3115 (4580) Ant. pol. : HORIZONTAL
 Limit : FCC PART 15C PEAK
 Env. / Ins. : 24°C/56% Engineer : Kevin_Hu
 EUT : AC750 Wireless Dual Band Router
 Power Rating : DC 12V From Adapter Input AC 120V/60Hz
 Test Mode : IEEE802.11ac VHT80 CH42 5210MHz Tx
 M/N : C20i

No.	Freq. (MHz)	Ant. Factor (dB/m)	Cable Loss (dB)	AMP factor (dB)	Reading (dBUV)	Emission Level (dBUV/m)	Limits (dBUV/m)	Margin (dB)	Remark
1	5236.065	33.58	9.01	35.70	87.13	94.02	74.00	-20.02	Peak
2	5350.000	33.76	9.13	35.70	46.87	54.06	74.00	19.94	Peak
3	5402.900	33.84	9.19	35.70	49.10	56.43	74.00	17.57	Peak
4	5460.000	33.94	9.25	35.70	47.18	54.67	74.00	19.33	Peak

Remarks: 1. Emission Level= Antenna Factor + Cable Loss + Reading - Amp Factor
 2. The emission levels that are 20dB below the official limit are not reported.

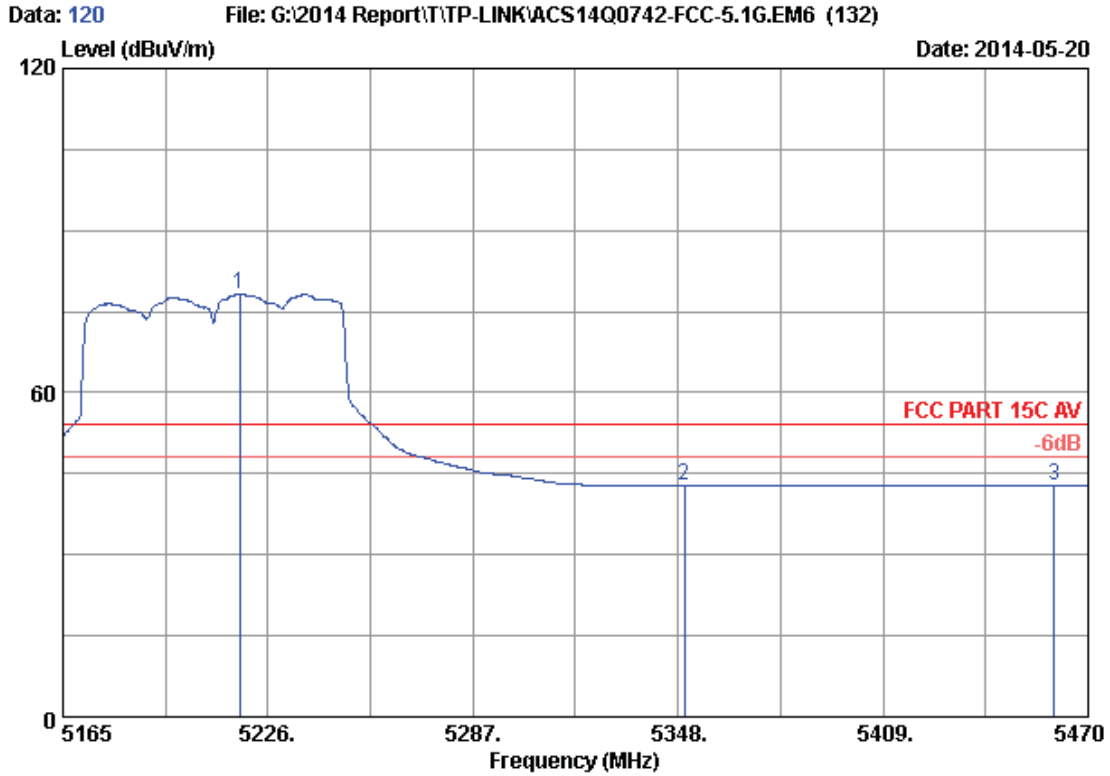

Site no. : 3m Chamber Data no. : 120
 Dis. / Ant. : 3m 2013 3115 (4580) Ant. pol. : HORIZONTAL
 Limit : FCC PART 15C AV
 Env. / Ins. : 24°C/56% Engineer : Kevin_Hu
 EUT : AC750 Wireless Dual Band Router
 Power Rating : DC 12V From Adapter Input AC 120V/60Hz
 Test Mode : IEEE802.11ac VHT80 CH42 5210MHz Tx
 M/N : C20i

No.	Freq. (MHz)	Ant. Factor (dB/m)	Cable Loss (dB)	AMP factor (dB)	Reading (dBuV)	Emission Level (dBuV/m)	Limits (dBuV/m)	Margin (dB)	Remark
1	5217.460	33.55	8.99	35.70	71.47	78.31	54.00	-24.31	Average
2	5350.000	33.76	9.13	35.70	35.56	42.75	54.00	11.25	Average
3	5460.000	33.94	9.25	35.70	35.24	42.73	54.00	11.27	Average

Remarks: 1. Emission Level= Antenna Factor + Cable Loss + Reading - Amp Factor
 2. The emission levels that are 20dB below the official limit are not reported.

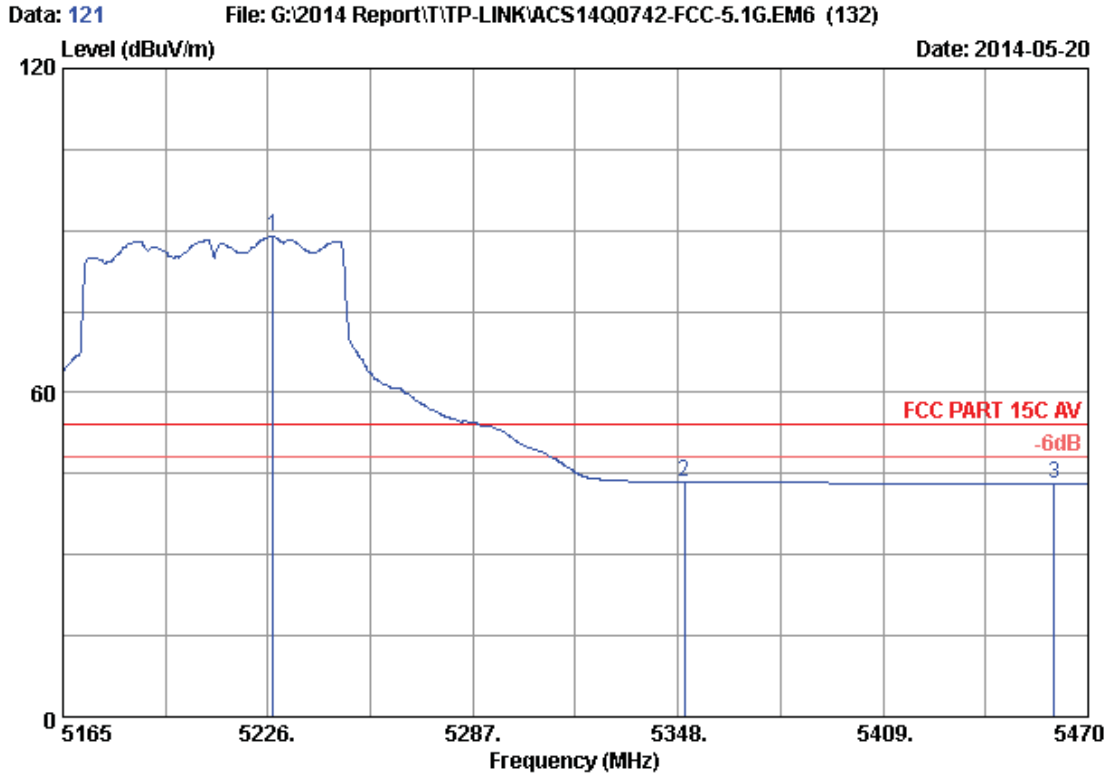

Site no. : 3m Chamber Data no. : 121
 Dis. / Ant. : 3m 2013 3115 (4580) Ant. pol. : VERTICAL
 Limit : FCC PART 15C AV
 Env. / Ins. : 24°C/56% Engineer : Kevin_Hu
 EUT : AC750 Wireless Dual Band Router
 Power Rating : DC 12V From Adapter Input AC 120V/60Hz
 Test Mode : IEEE802.11ac VHT80 CH42 5210MHz Tx
 M/N : C20i

No.	Freq. (MHz)	Ant. Factor (dB/m)	Cable Loss (dB)	AMP factor (dB)	Reading (dBuV)	Emission Level (dBuV/m)	Limits (dBuV/m)	Margin (dB)	Remark
1	5227.525	33.56	9.00	35.70	82.10	88.96	54.00	-34.96	Average
2	5350.000	33.76	9.13	35.70	36.30	43.49	54.00	10.51	Average
3	5460.000	33.94	9.25	35.70	35.67	43.16	54.00	10.84	Average

Remarks: 1. Emission Level= Antenna Factor + Cable Loss + Reading -Amp Factor
 2. The emission levels that are 20dB below the official limit are not reported.

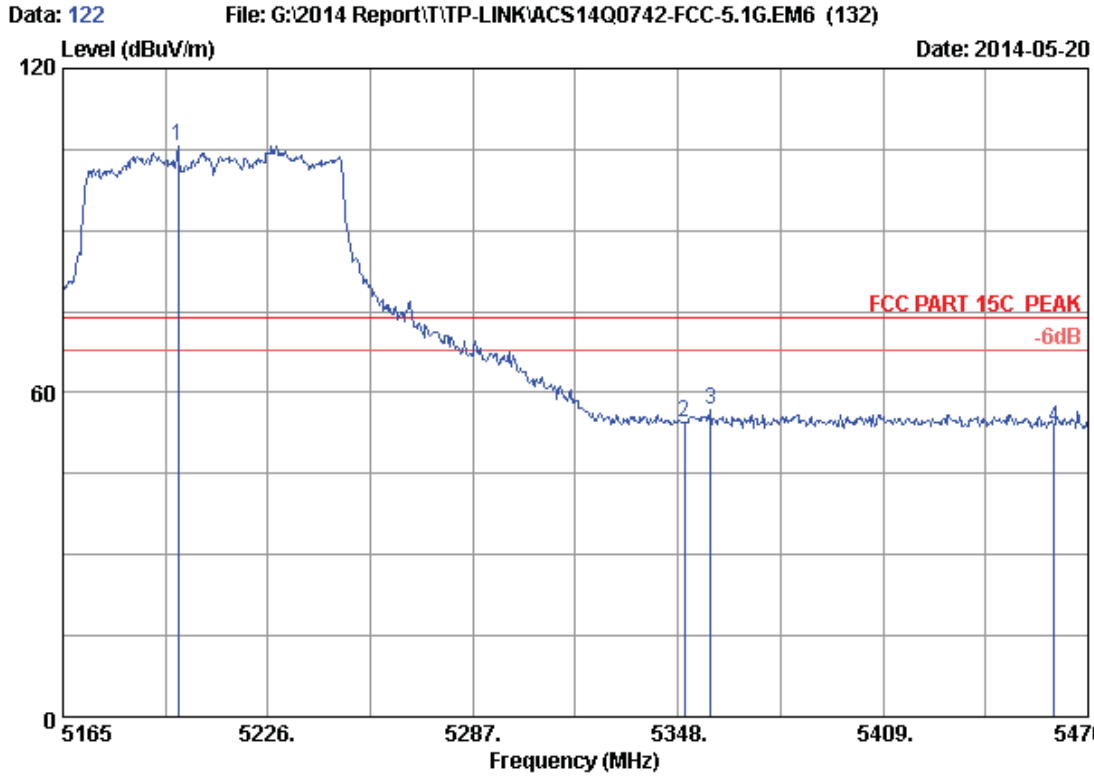

Site no. : 3m Chamber Data no. : 122
 Dis. / Ant. : 3m 2013 3115 (4580) Ant. pol. : VERTICAL
 Limit : FCC PART 15C PEAK
 Env. / Ins. : 24°C/56% Engineer : Kevin_Hu
 EUT : AC750 Wireless Dual Band Router
 Power Rating : DC 12V From Adapter Input AC 120V/60Hz
 Test Mode : IEEE802.11ac VHT80 CH42 5210MHz Tx
 M/N : C20i

No.	Freq. (MHz)	Ant. Factor (dB/m)	Cable Loss (dB)	AMP factor (dB)	Reading (dBuV)	Emission Level (dBuV/m)	Limits (dBuV/m)	Margin (dB)	Remark
1	5199.160	33.52	8.97	35.70	98.90	105.69	74.00	-31.69	Peak
2	5350.000	33.76	9.13	35.70	47.41	54.60	74.00	19.40	Peak
3	5357.760	33.77	9.14	35.70	49.72	56.93	74.00	17.07	Peak
4	5460.000	33.94	9.25	35.70	45.95	53.44	74.00	20.56	Peak

Remarks: 1. Emission Level= Antenna Factor + Cable Loss + Reading - Amp Factor
 2. The emission levels that are 20dB below the official limit are not reported.

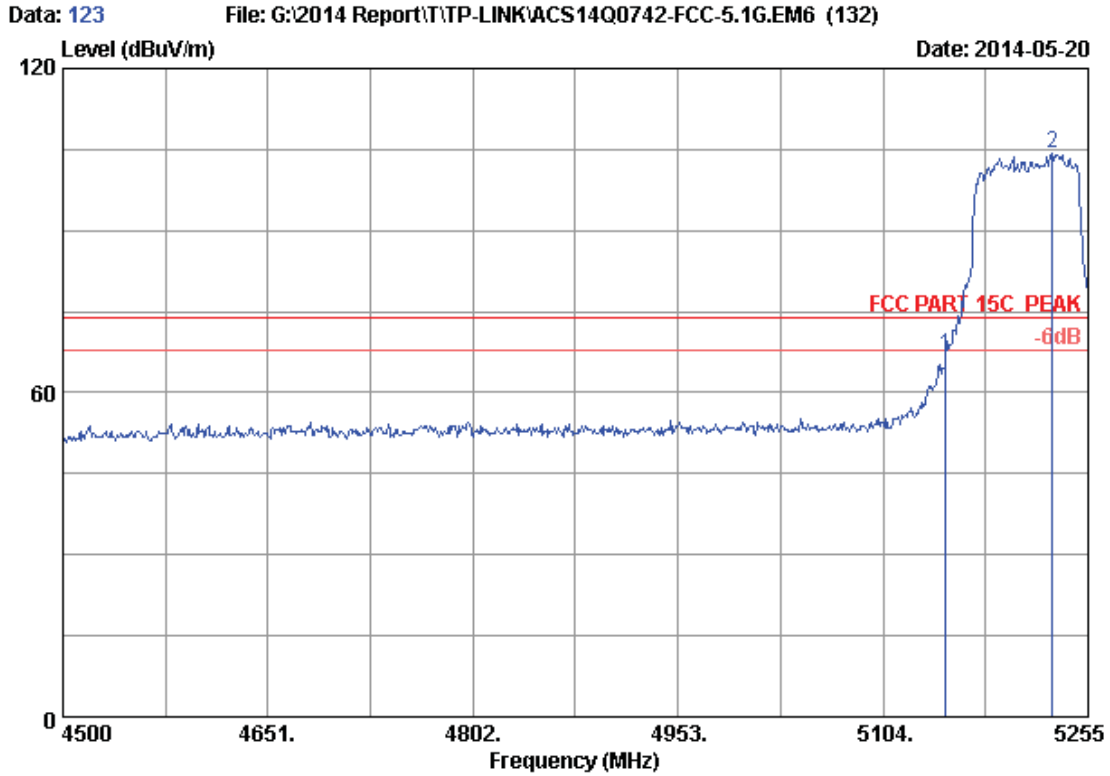

Site no. : 3m Chamber Data no. : 123
 Dis. / Ant. : 3m 2013 3115 (4580) Ant. pol. : VERTICAL
 Limit : FCC PART 15C PEAK
 Env. / Ins. : 24°C/56% Engineer : Kevin_Hu
 EUT : AC750 Wireless Dual Band Router
 Power Rating : DC 12V From Adapter Input AC 120V/60Hz
 Test Mode : IEEE802.11ac VHT80 CH42 5210MHz Tx
 M/N : C20i

No.	Freq. (MHz)	Ant. Factor (dB/m)	Cable Loss (dB)	AMP factor (dB)	Reading (dBuV)	Emission Level (dBuV/m)	Limits (dBuV/m)	Margin (dB)	Remark
1	5150.000	33.44	8.92	35.70	60.20	66.86	74.00	7.14	Peak
2	5228.575	33.57	9.00	35.70	97.36	104.23	74.00	-30.23	Peak

Remarks: 1. Emission Level= Antenna Factor + Cable Loss + Reading - Amp Factor
 2. The emission levels that are 20dB below the official limit are not reported.

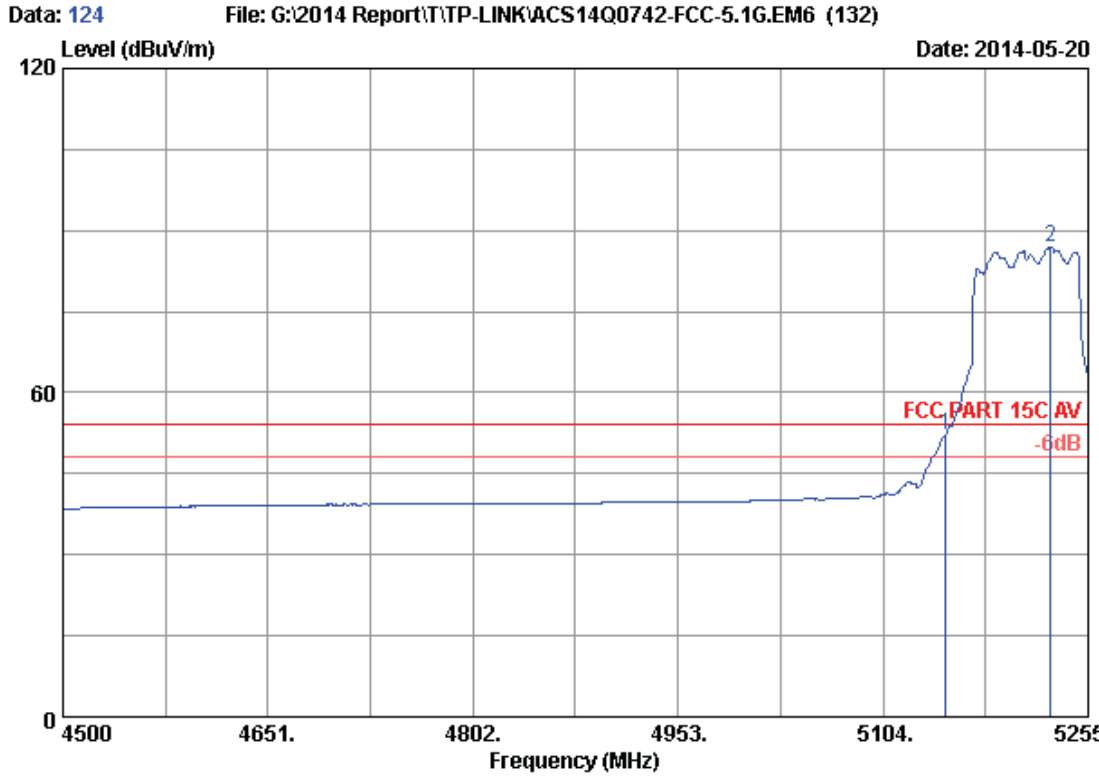

Site no. : 3m Chamber Data no. : 124
 Dis. / Ant. : 3m 2013 3115 (4580) Ant. pol. : VERTICAL
 Limit : FCC PART 15C AV
 Env. / Ins. : 24°C/56% Engineer : Kevin_Hu
 EUT : AC750 Wireless Dual Band Router
 Power Rating : DC 12V From Adapter Input AC 120V/60Hz
 Test Mode : IEEE802.11ac VHT80 CH42 5210MHz Tx
 M/N : C20i

No.	Freq. (MHz)	Ant. Factor (dB/m)	Cable Loss (dB)	AMP factor (dB)	Reading (dBuV)	Emission Level (dBuV/m)	Limits (dBuV/m)	Margin (dB)	Remark
1	5150.000	33.44	8.92	35.70	45.54	52.20	54.00	1.80	Average
2	5227.065	33.56	9.00	35.70	80.15	87.01	54.00	-33.01	Average

Remarks: 1. Emission Level= Antenna Factor + Cable Loss + Reading - Amp Factor
 2. The emission levels that are 20dB below the official limit are not reported.

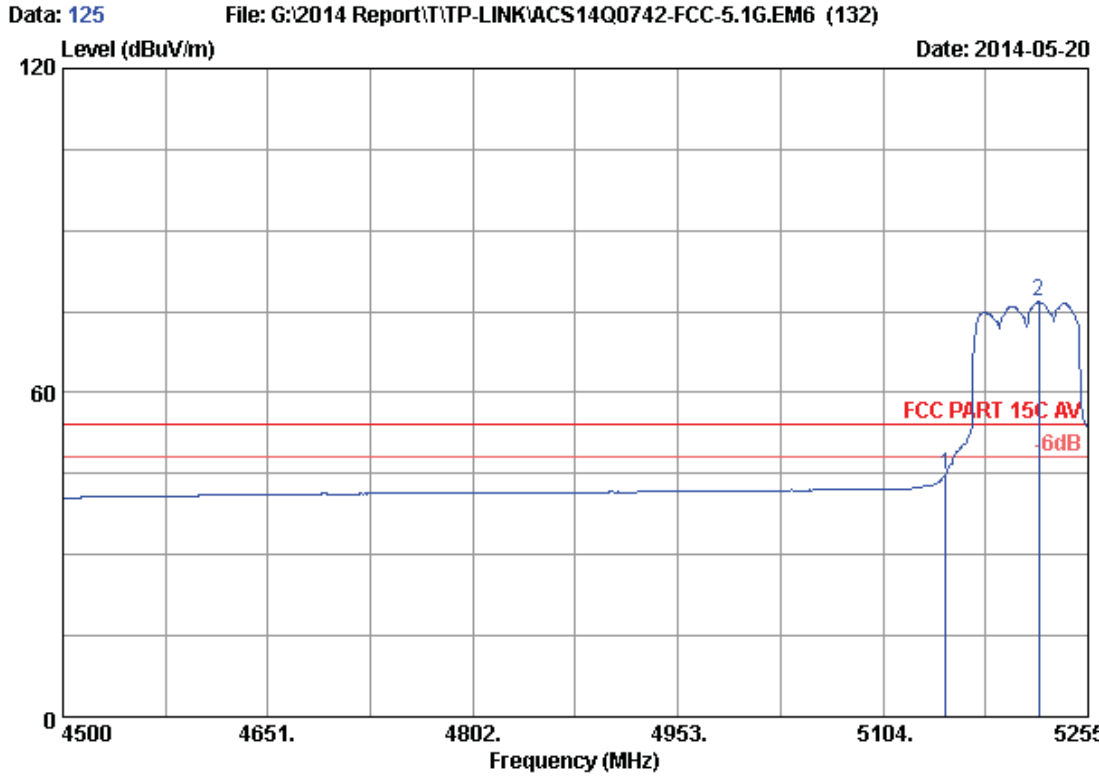

Site no. : 3m Chamber Data no. : 125
 Dis. / Ant. : 3m 2013 3115 (4580) Ant. pol. : HORIZONTAL
 Limit : FCC PART 15C AV
 Env. / Ins. : 24°C/56% Engineer : Kevin_Hu
 EUT : AC750 Wireless Dual Band Router
 Power Rating : DC 12V From Adapter Input AC 120V/60Hz
 Test Mode : IEEE802.11ac VHT80 CH42 5210MHz Tx
 M/N : C20i

No.	Freq. (MHz)	Ant. Factor (dB/m)	Cable Loss (dB)	AMP factor (dB)	Reading (dBuV)	Emission Level (dBuV/m)	Limits (dBuV/m)	Margin (dB)	Remark
1	5150.000	33.44	8.92	35.70	38.16	44.82	54.00	9.18	Average
2	5218.760	33.55	8.99	35.70	69.92	76.76	54.00	-22.76	Average

Remarks: 1. Emission Level= Antenna Factor + Cable Loss + Reading - Amp Factor
 2. The emission levels that are 20dB below the official limit are not reported.

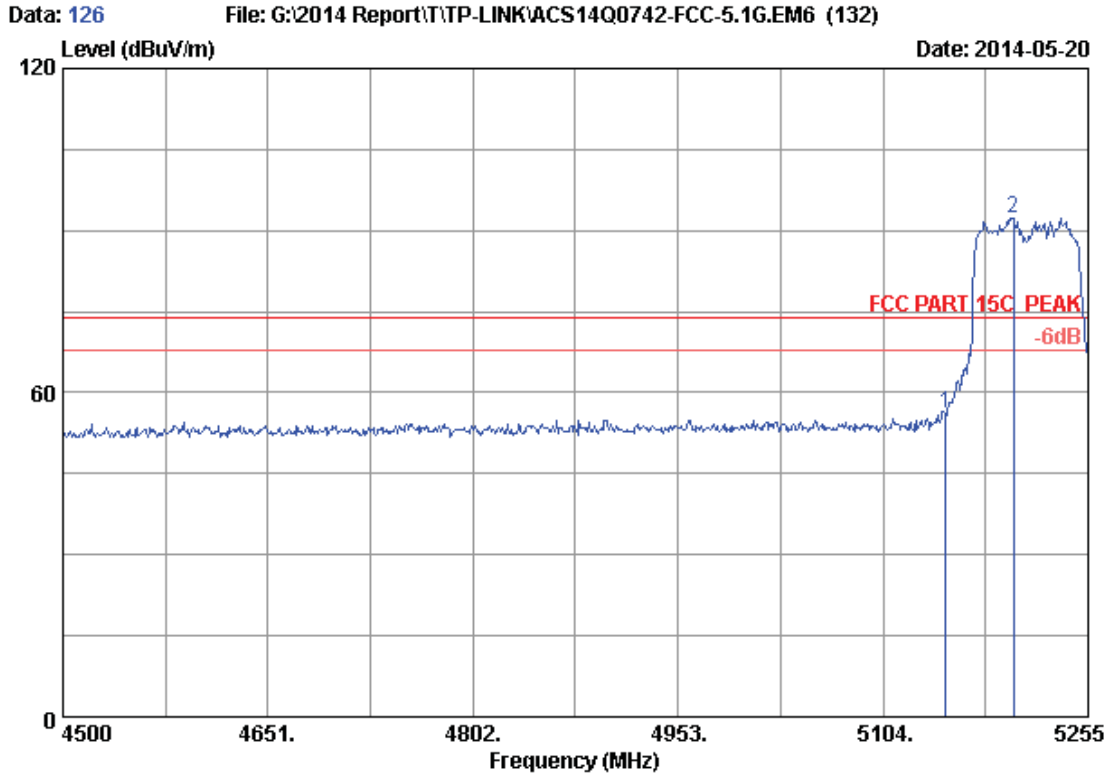

Site no. : 3m Chamber Data no. : 126
 Dis. / Ant. : 3m 2013 3115 (4580) Ant. pol. : HORIZONTAL
 Limit : FCC PART 15C PEAK
 Env. / Ins. : 24°C/56% Engineer : Kevin_Hu
 EUT : AC750 Wireless Dual Band Router
 Power Rating : DC 12V From Adapter Input AC 120V/60Hz
 Test Mode : IEEE802.11ac VHT80 CH42 5210MHz Tx
 M/N : C20i

No.	Freq. (MHz)	Ant. Factor (dB/m)	Cable Loss (dB)	AMP factor (dB)	Reading (dBuV)	Emission Level (dBuV/m)	Limits (dBuV/m)	Margin (dB)	Remark
1	5150.000	33.44	8.92	35.70	49.41	56.07	74.00	17.93	Peak
2	5199.885	33.52	8.97	35.70	85.60	92.39	74.00	-18.39	Peak

Remarks: 1. Emission Level= Antenna Factor + Cable Loss + Reading - Amp Factor
 2. The emission levels that are 20dB below the official limit are not reported.

6. 20dB & 26dB Bandwidth Test

6.1. Test Equipment

Item	Equipment	Manufacturer	Model No.	Serial No.	Last Cal.	Cal. Interval
1.	Spectrum	Agilent	N9030A	MY51380221	Oct.31, 13	1 Year
2.	Attenuator (20dB)	Agilent	8491B	MY39262165	Apr. 28,14	1 Year
3.	RF Cable	Hubersuhner	SUCOFLEX102	28620/2	Apr. 28,14	1 Year

6.2. Limit

No limit

6.3. Test Procedure

The transmitter output was connected to a spectrum analyzer, The bandwidth of the fundamental frequency was measured by spectrum analyzer with 300kHz RBW and 1 MHz VBW. The 26dB bandwidth is defined as the total spectrum the power of which is higher than peak power minus 26dB.

6.4. Test Results

20dB bandwidth

EUT:AC750 Wireless Dual Band Router		
M/N:C20i		
Test date: 2014-05-21	Pressure: 101.3±1.0 kpa	Humidity:53.4±3.0%
Tested by: Kevin_Hu	Test site: RF site	Temperature:21.8±0.6 °C

Cable loss: 1 dB		Attenuator loss: 20 dB	
Test Mode	Frequency (MHz)	20dB bandwidth (MHz)	Limit (kHz)
11a	5180	18.63	N/A
	5200	18.86	N/A
	5240	18.64	N/A
11n HT20	5180	19.30	N/A
	5200	22.85	N/A
	5240	19.31	N/A
11n HT40	5190	38.93	N/A
	5230	39.50	N/A
11ac VHT20	5180	19.26	N/A
	5200	19.56	N/A
	5240	19.36	N/A
11ac VHT40	5190	38.90	N/A
	5230	38.94	N/A
11ac VHT80	5210	79.93	N/A
Conclusion : PASS			

26dB bandwidth

EUT:AC750 Wireless Dual Band Router		
M/N:C20i		
Test date: 2014-05-21	Pressure: 101.3±1.0 kpa	Humidity:53.4±3.0%
Tested by: Kevin_Hu	Test site: RF site	Temperature:21.8±0.6 °C

Cable loss: 1 dB		Attenuator loss: 20 dB	
Test Mode	Frequency (MHz)	26dB bandwidth (MHz)	Limit (KHz)
11a	5180	20.81	N/A
	5200	23.04	N/A
	5240	20.76	N/A
11n HT20	5180	22.28	N/A
	5200	29.99	N/A
	5240	23.15	N/A
11n HT40	5190	40.41	N/A
	5230	59.83	N/A
11ac VHT20	5180	24.92	N/A
	5200	24.11	N/A
	5240	22.37	N/A
11ac VHT40	5190	40.56	N/A
	5230	50.20	N/A
11ac VHT80	5210	93.65	N/A
Conclusion : PASS			

20dB bandwidth

11a

5180MHz



5200MHz



5240MHz

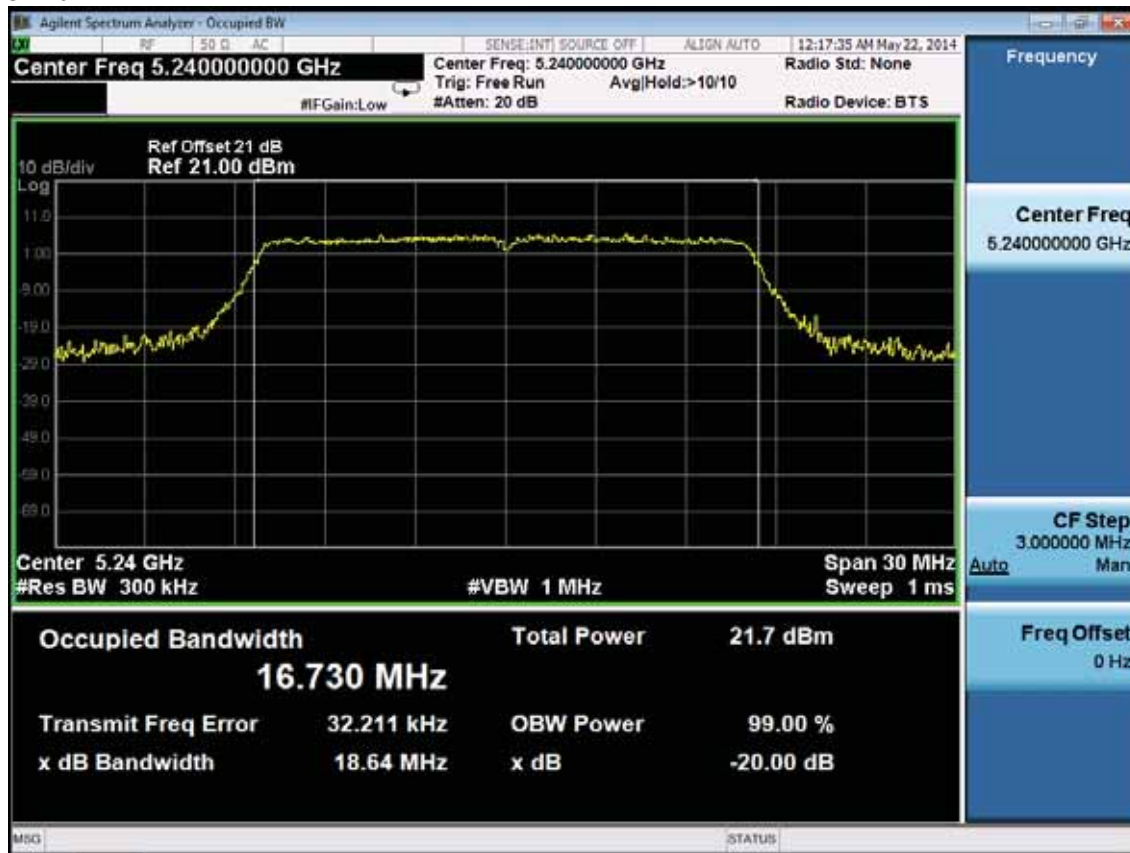

11n HT20

5180MHz

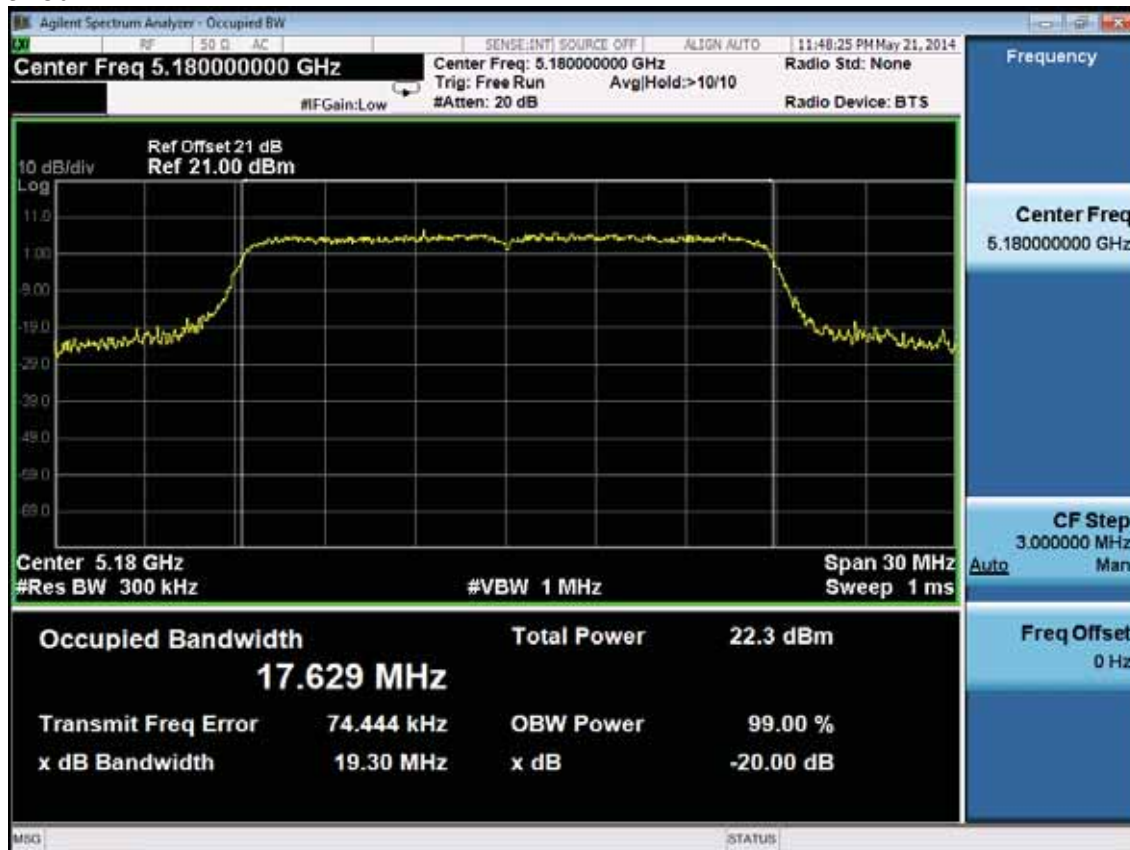

5200MHz

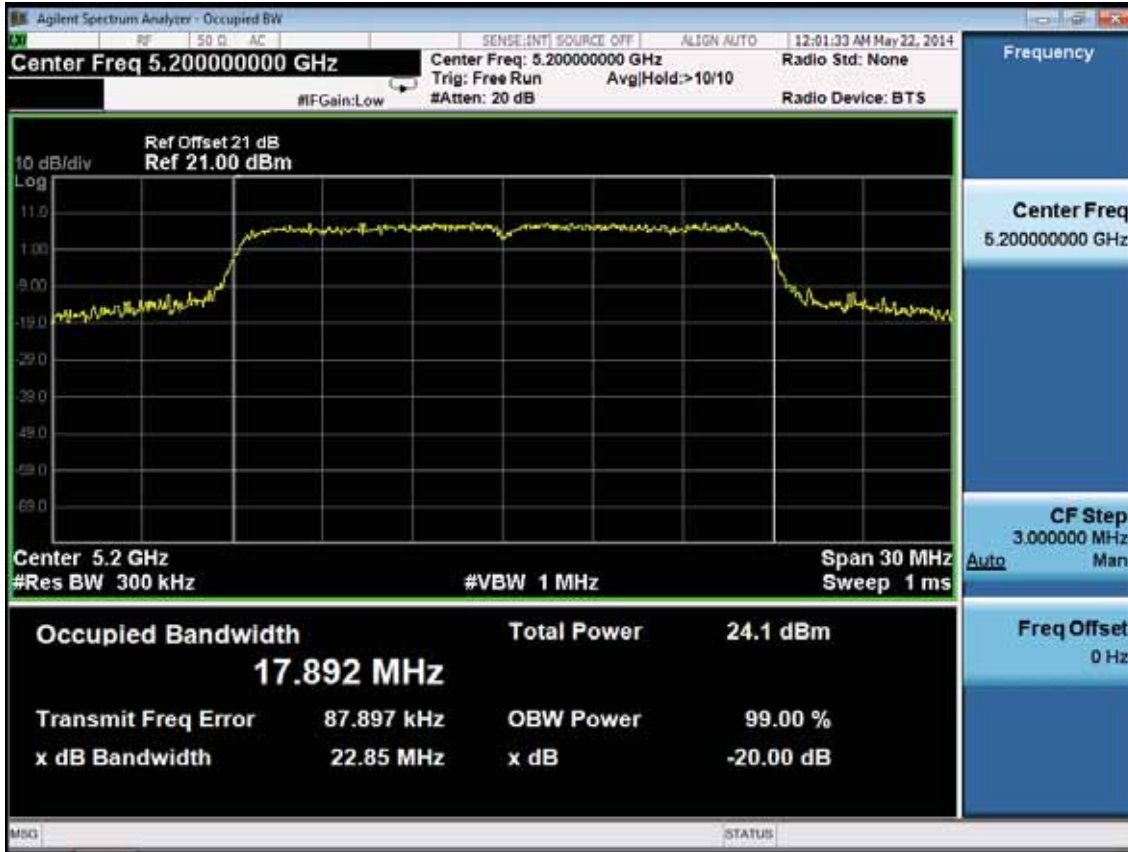

5240MHz

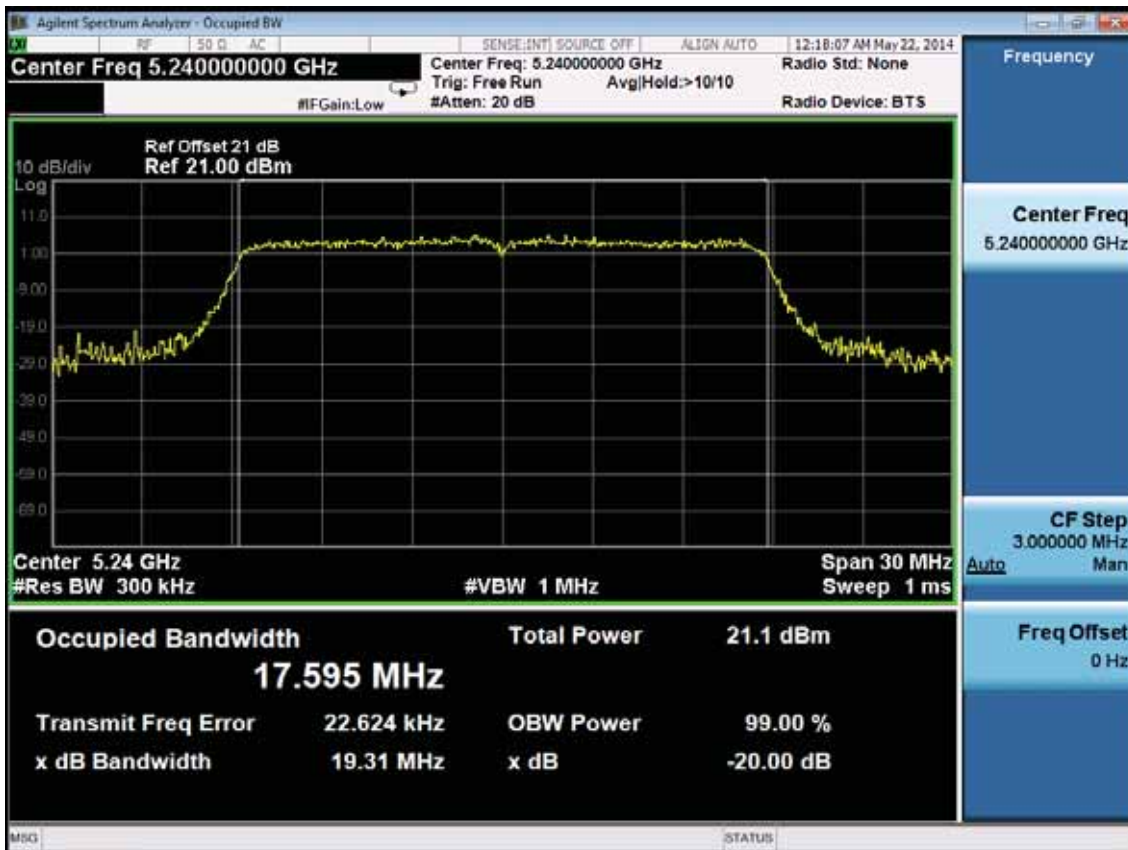

11n HT40
5190MHz

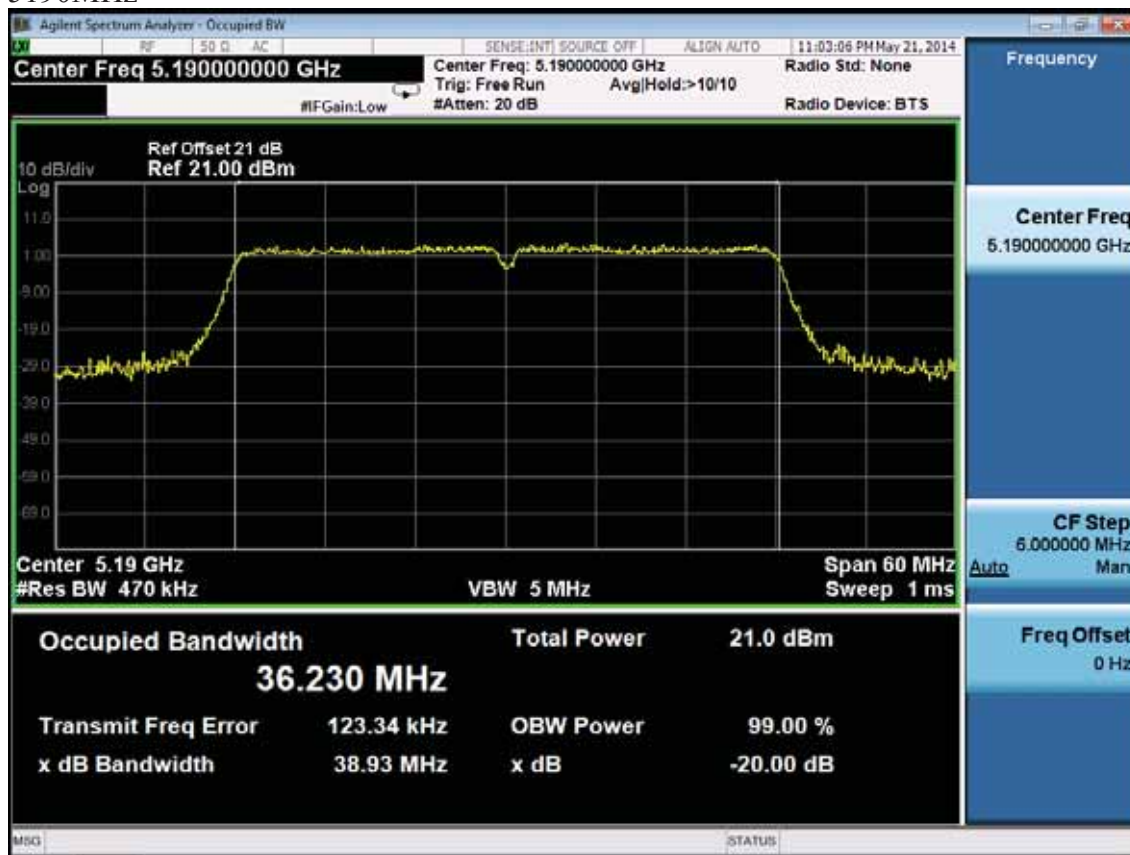

5230MHz

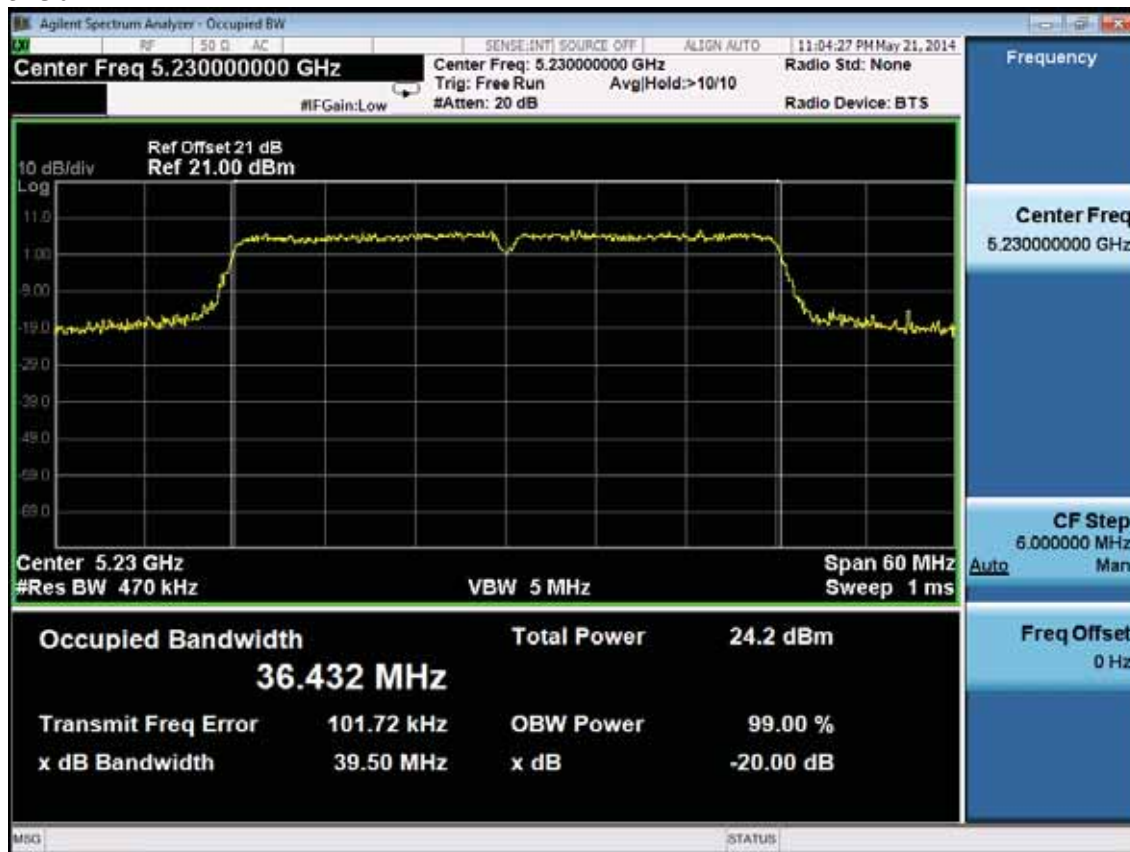

11ac VHT40
5180MHz

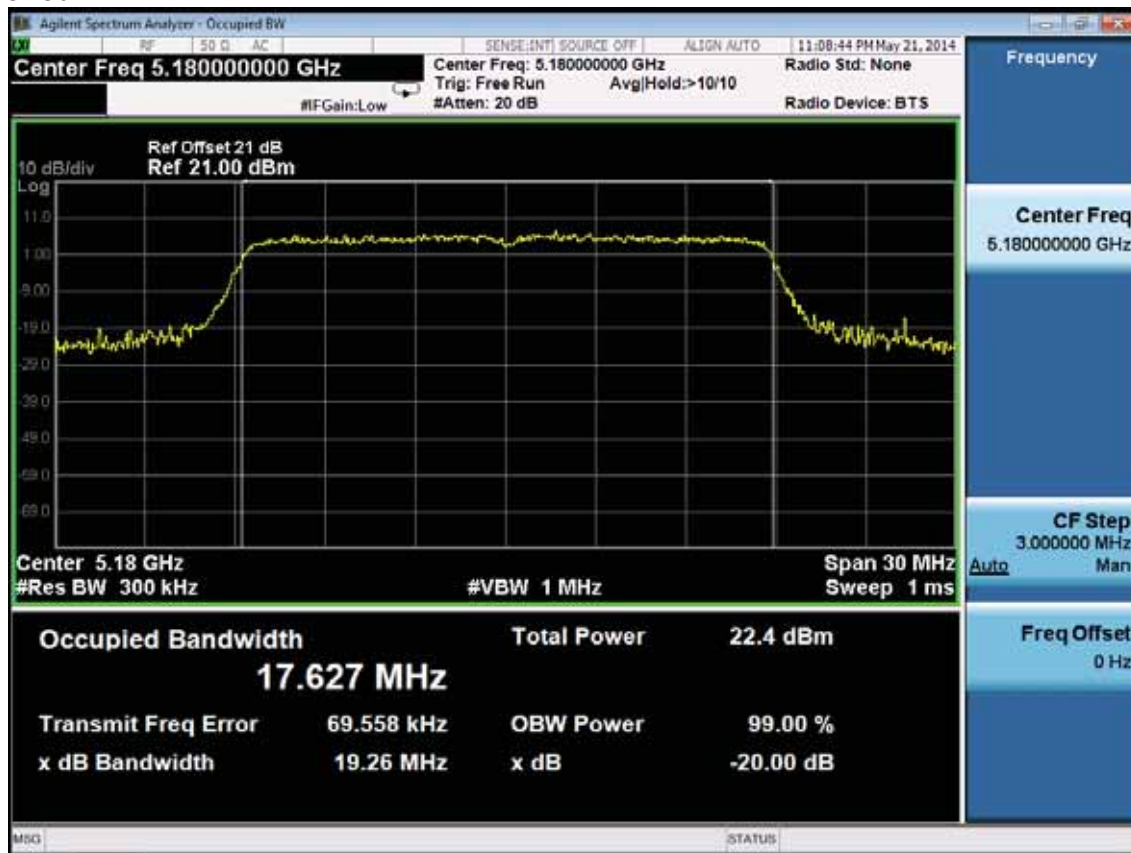

5200MHz



5240MHz

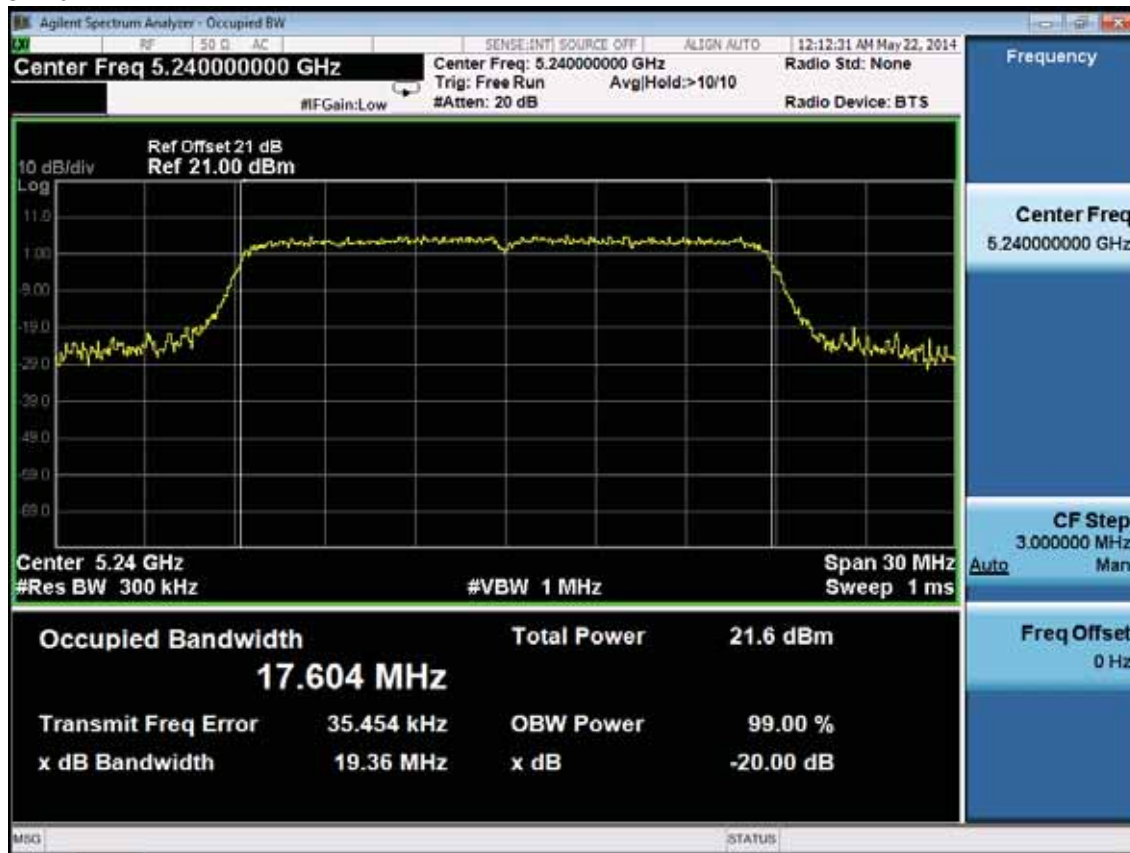

11ac VHT40

5190MHz

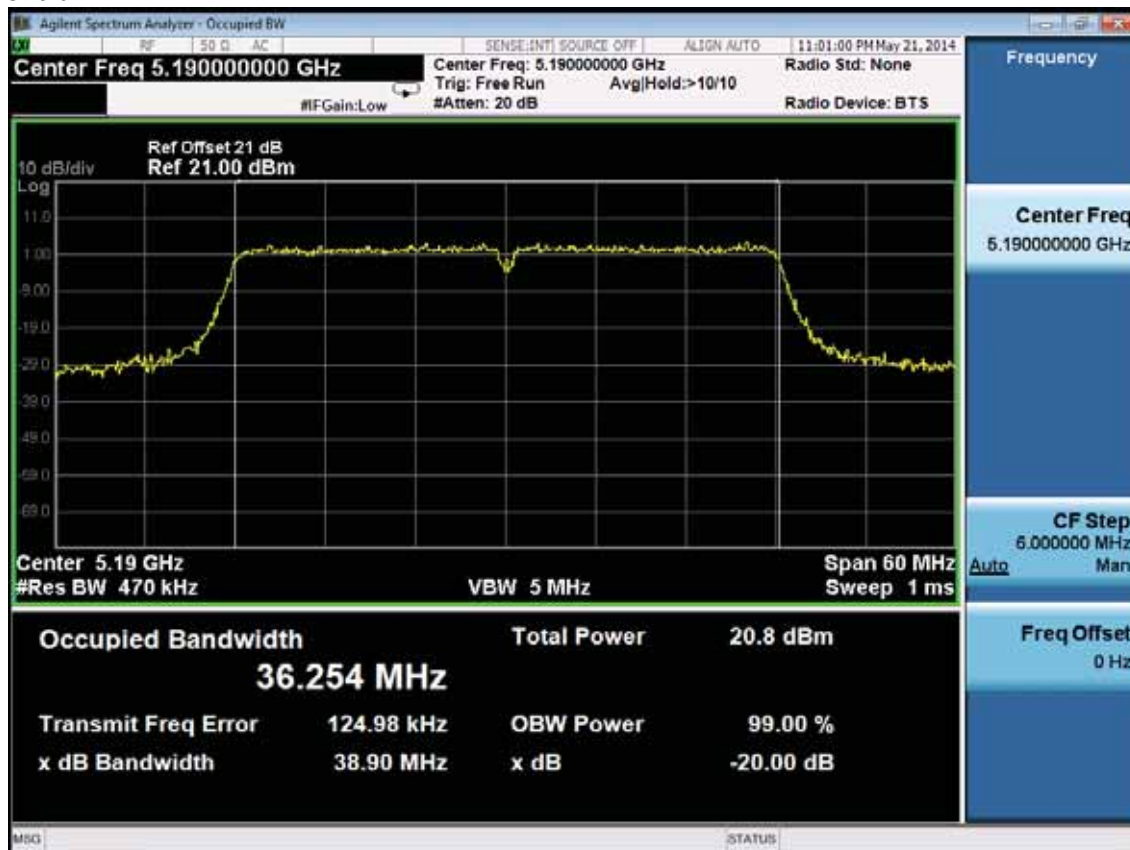

5230MHz

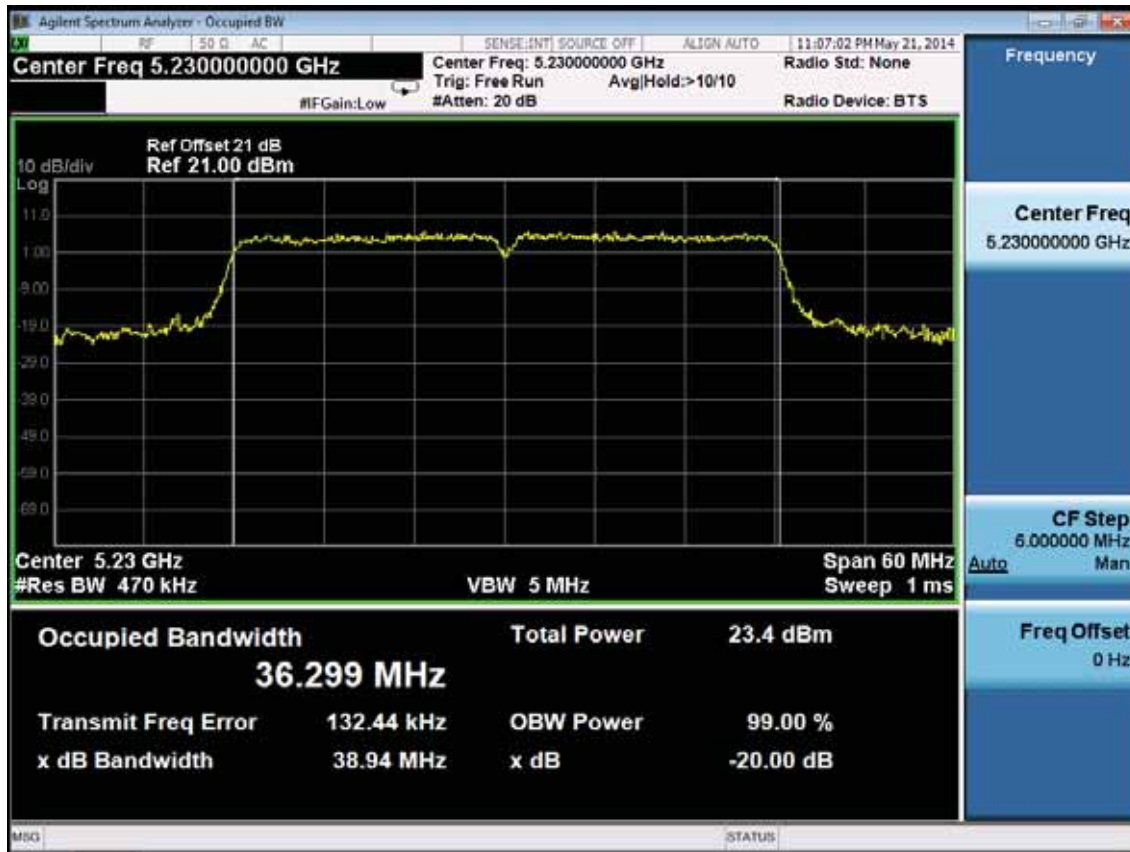

11ac VHT80

5210MHz

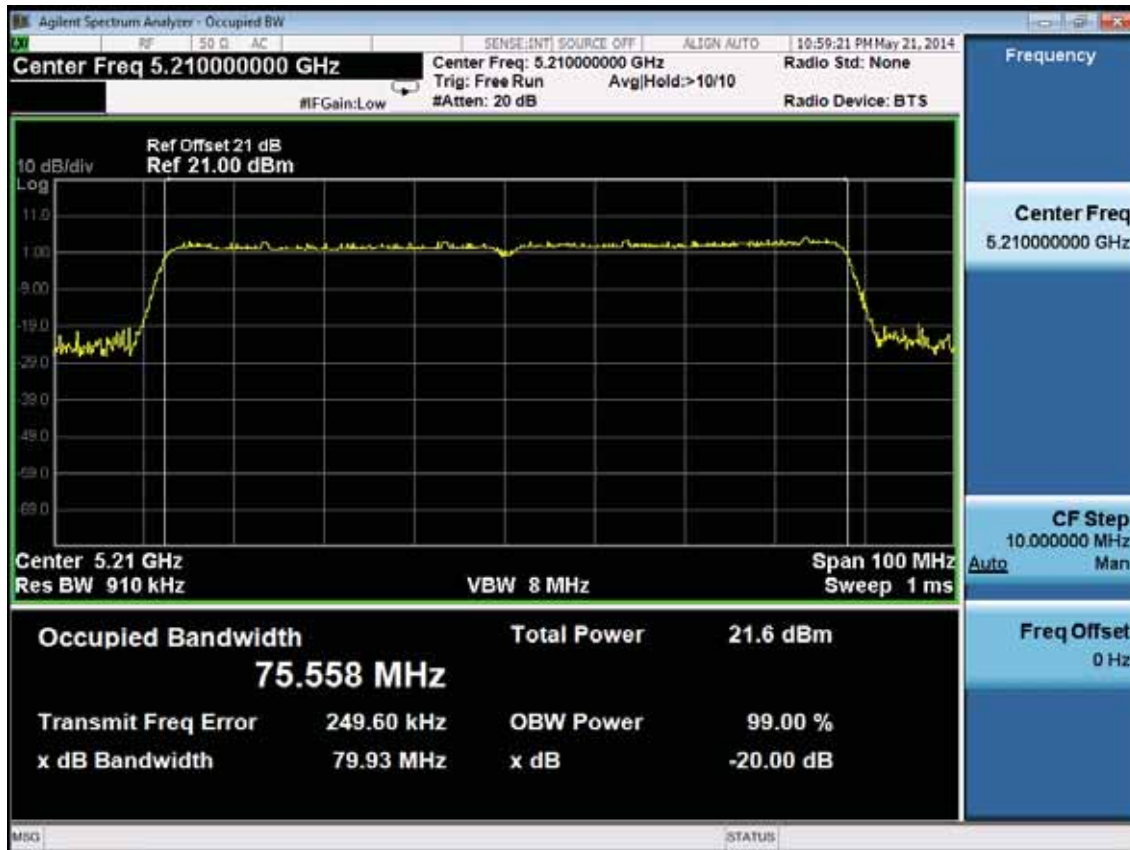

26dB bandwidth:
11a
5180MHz

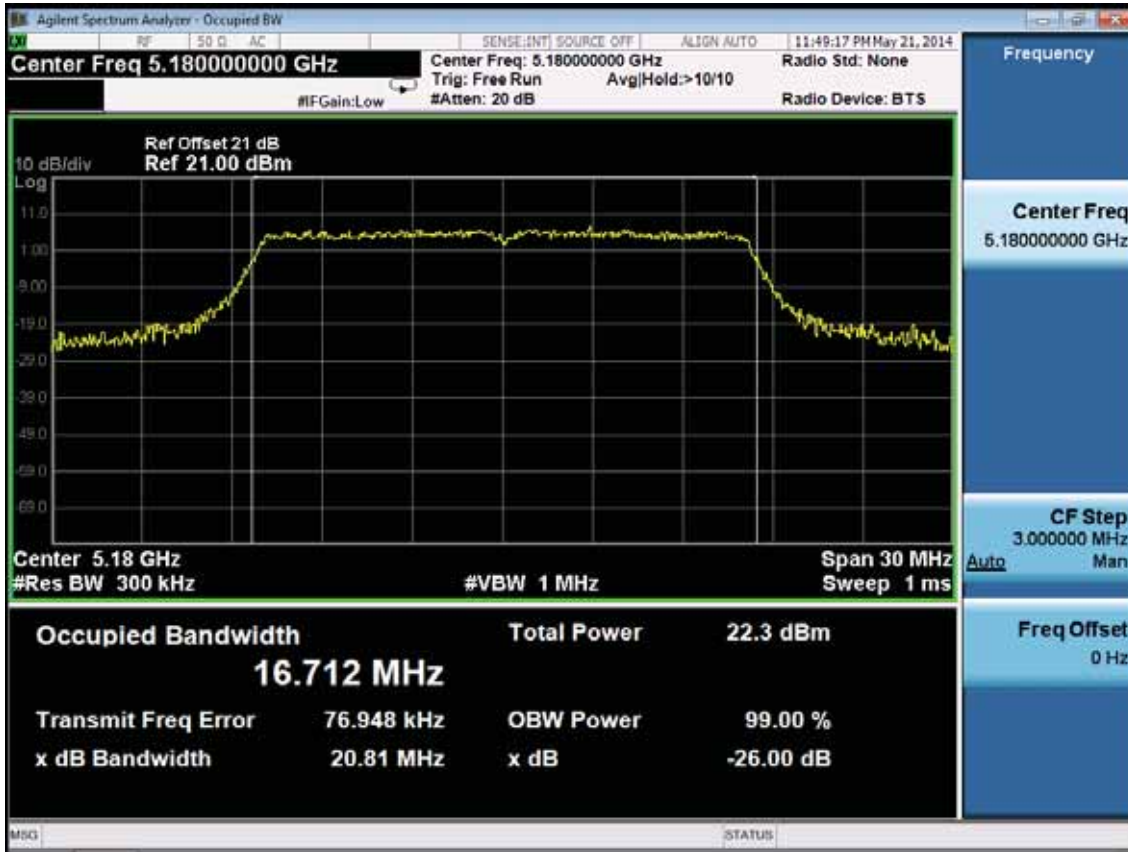

5200MHz

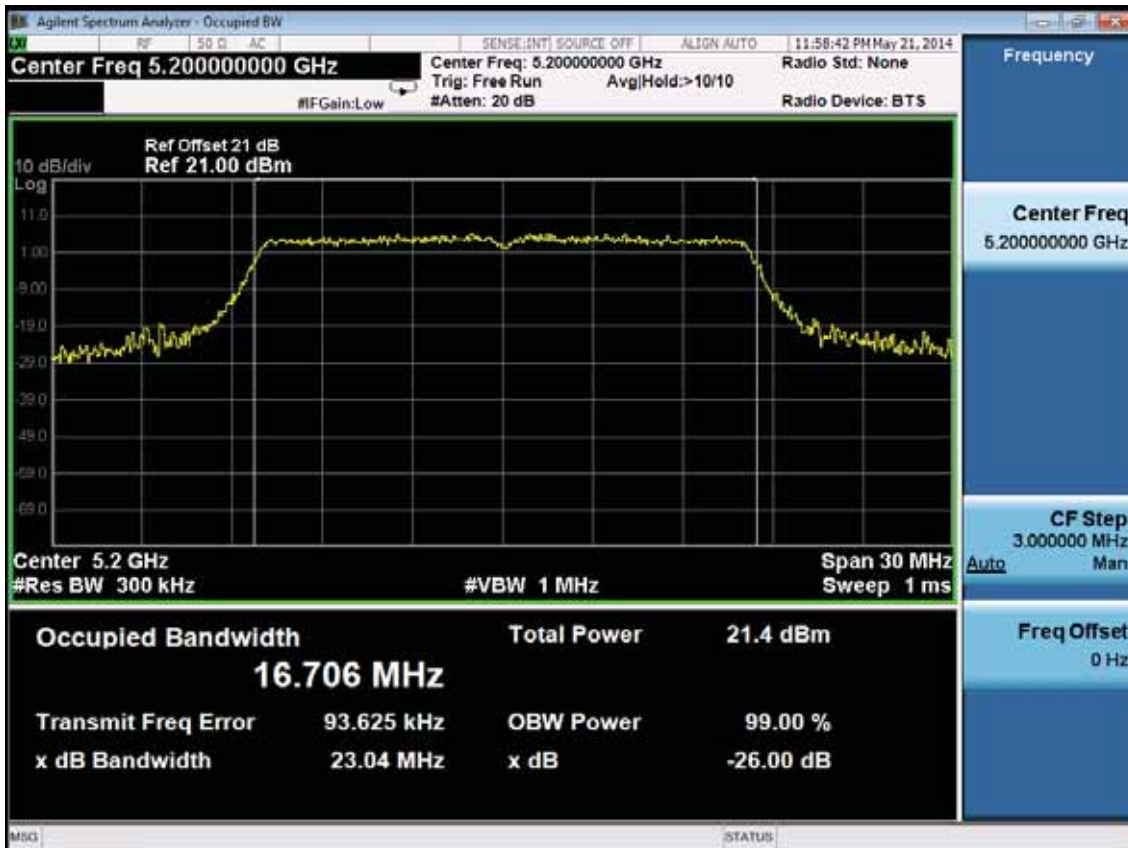

5240MHz

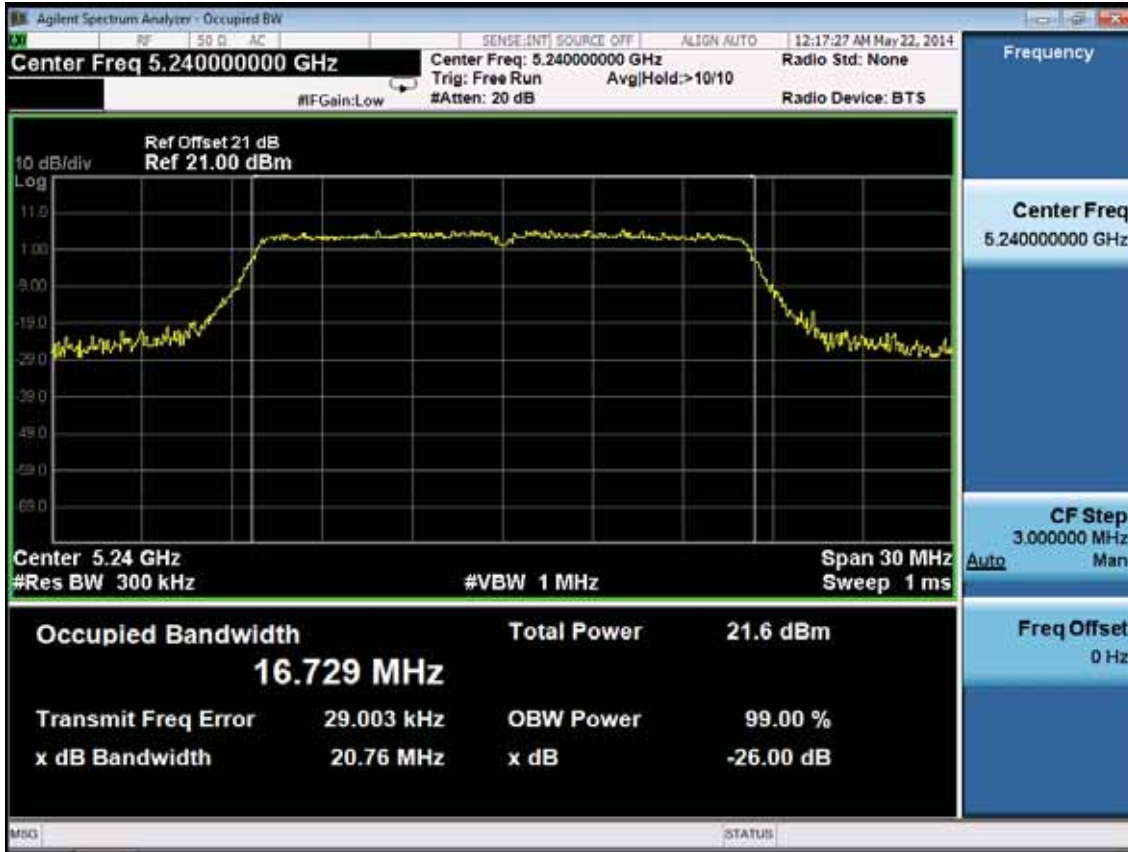

11n HT20

5180MHz

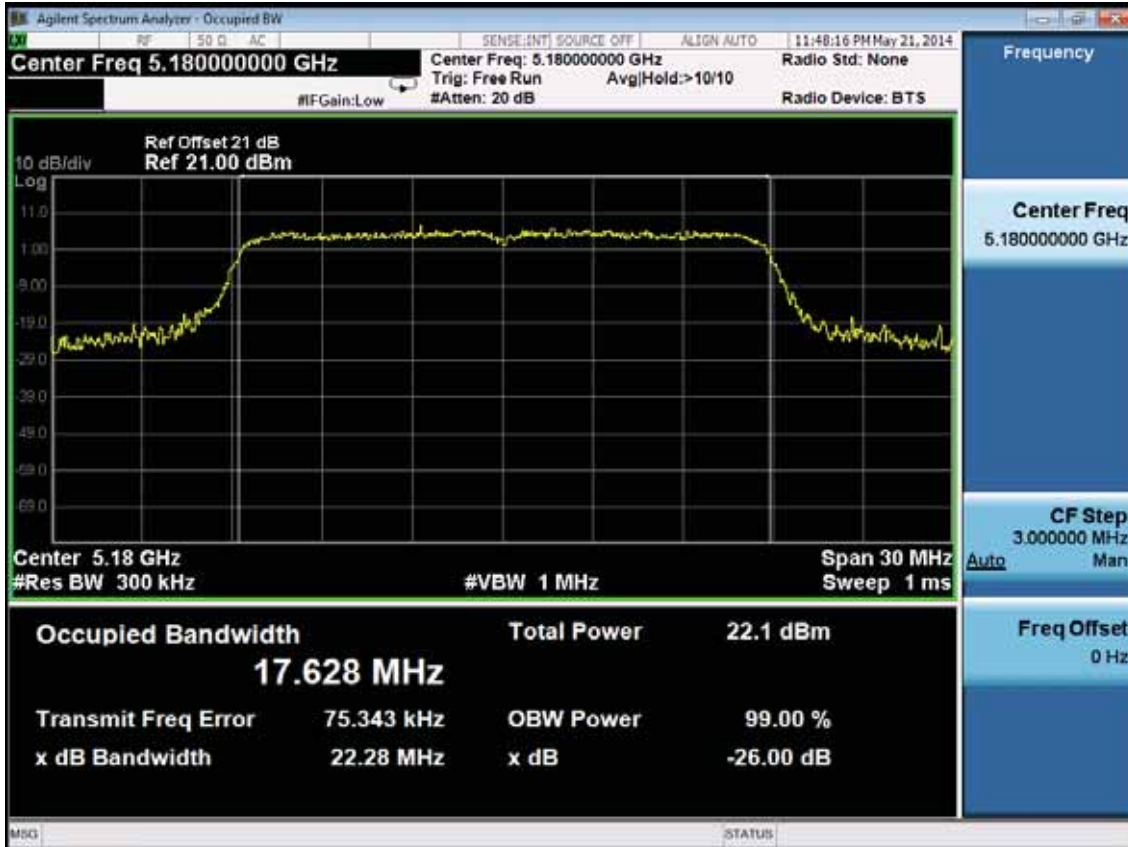

5200MHz



5240MHz

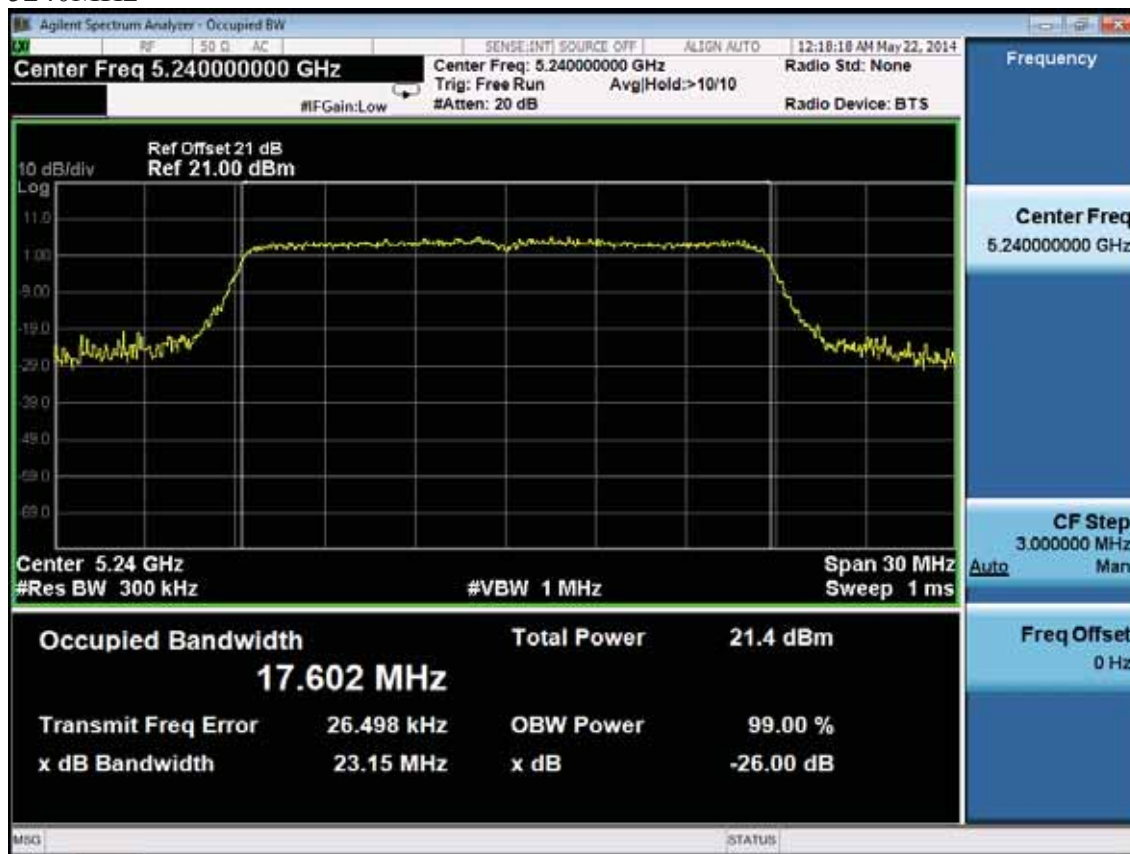

11n HT40

5190MHz

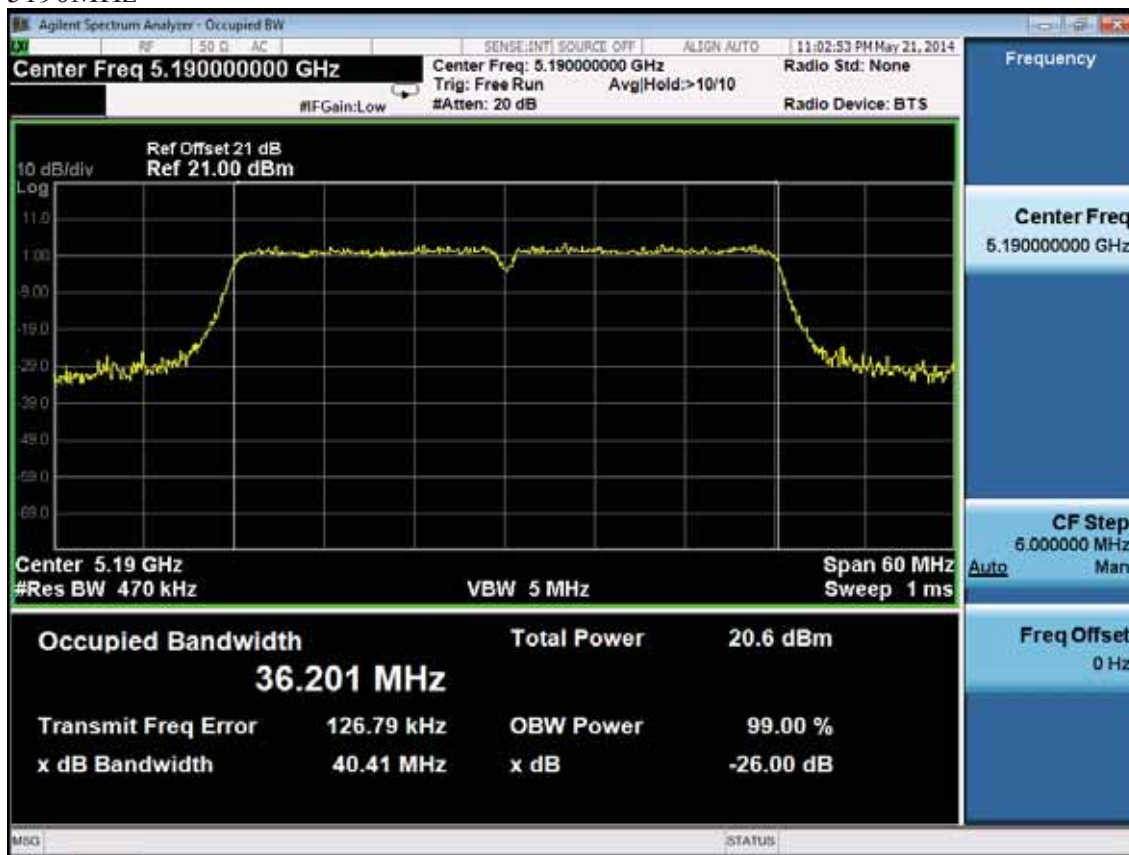

5230MHz

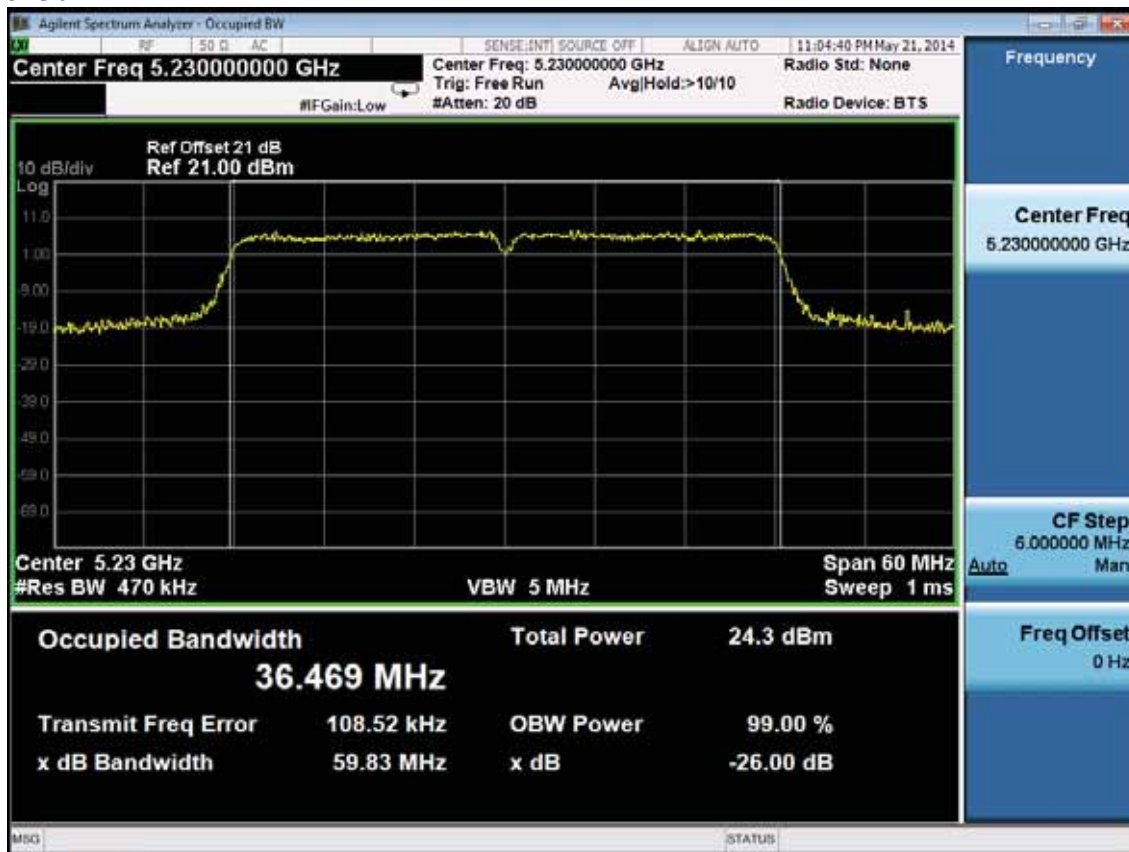

11ac VHT20
5180MHz

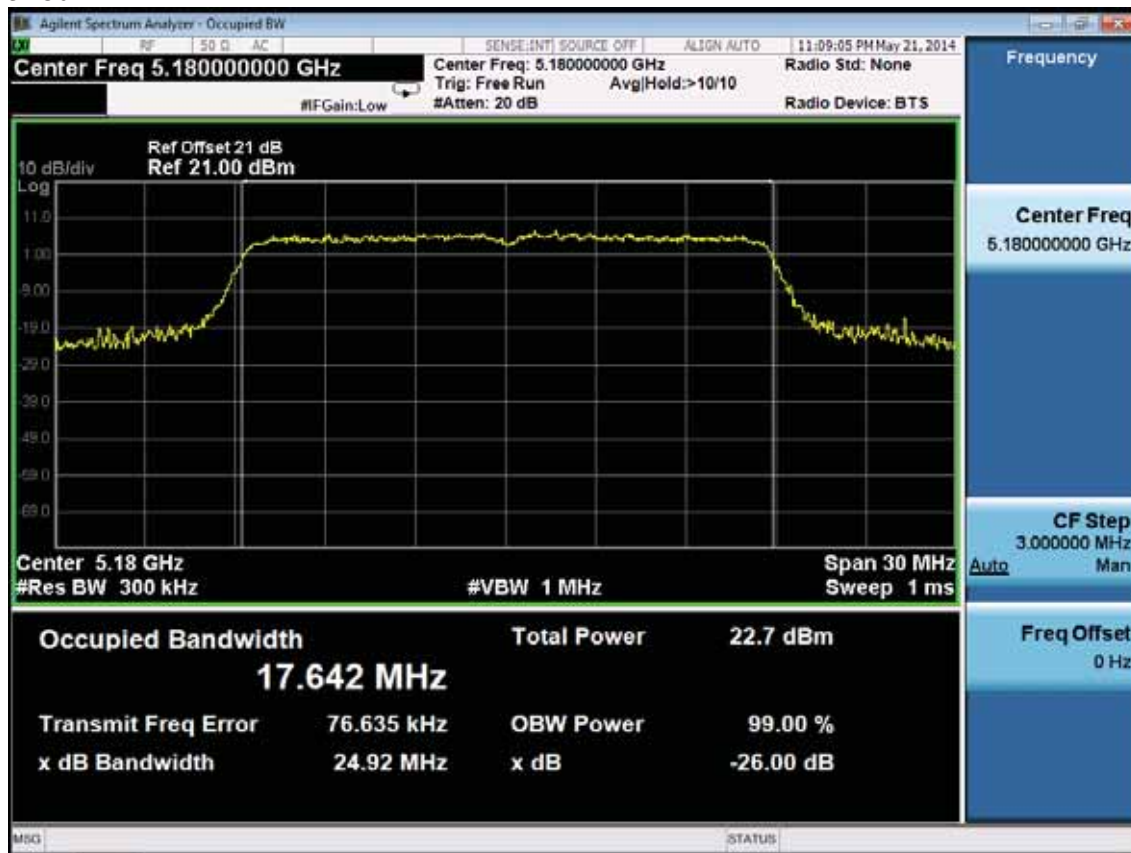

5200MHz

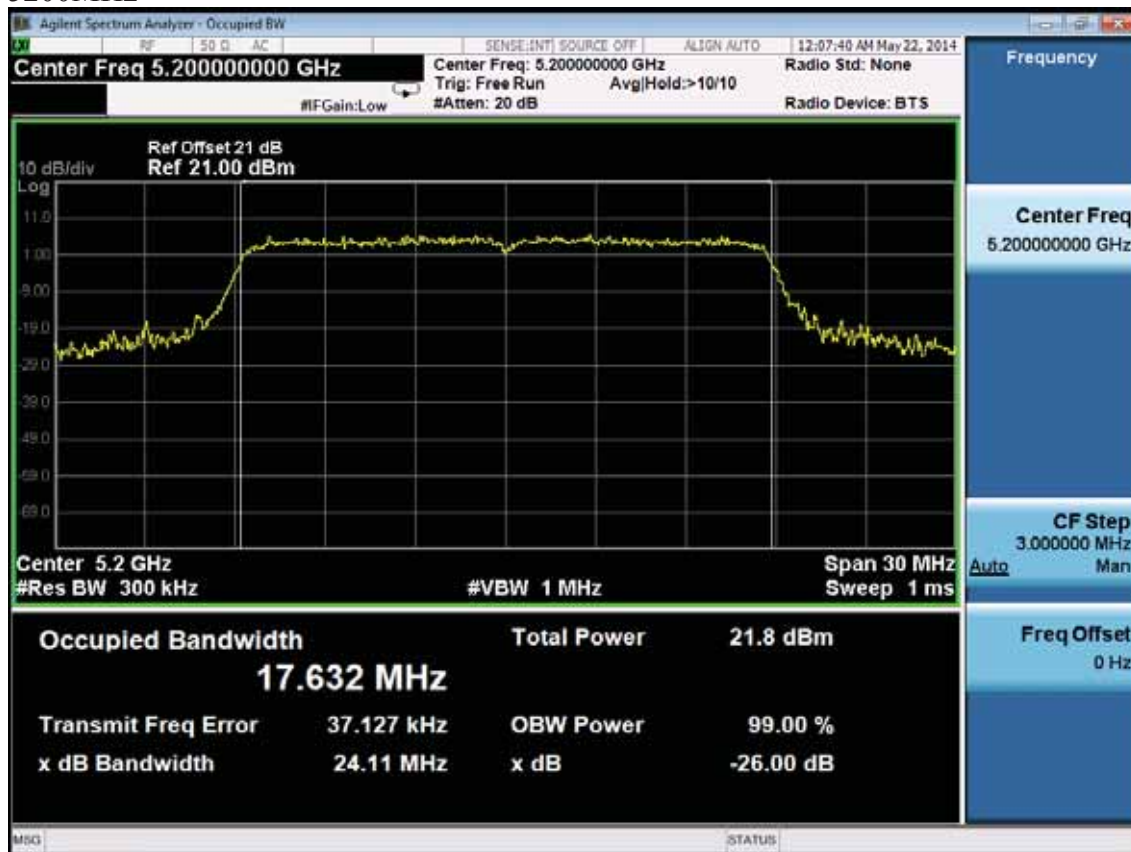

5240MHz



11ac VHT40

5190MHz

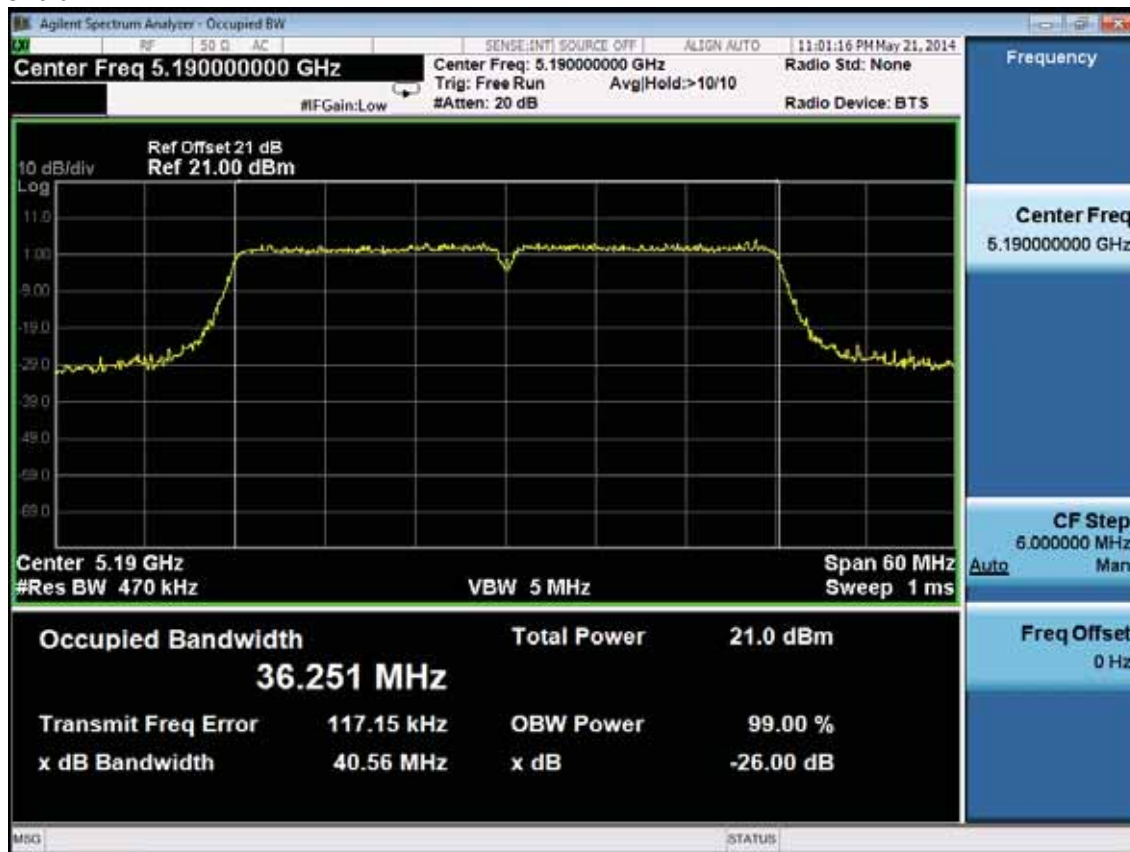

5230MHz

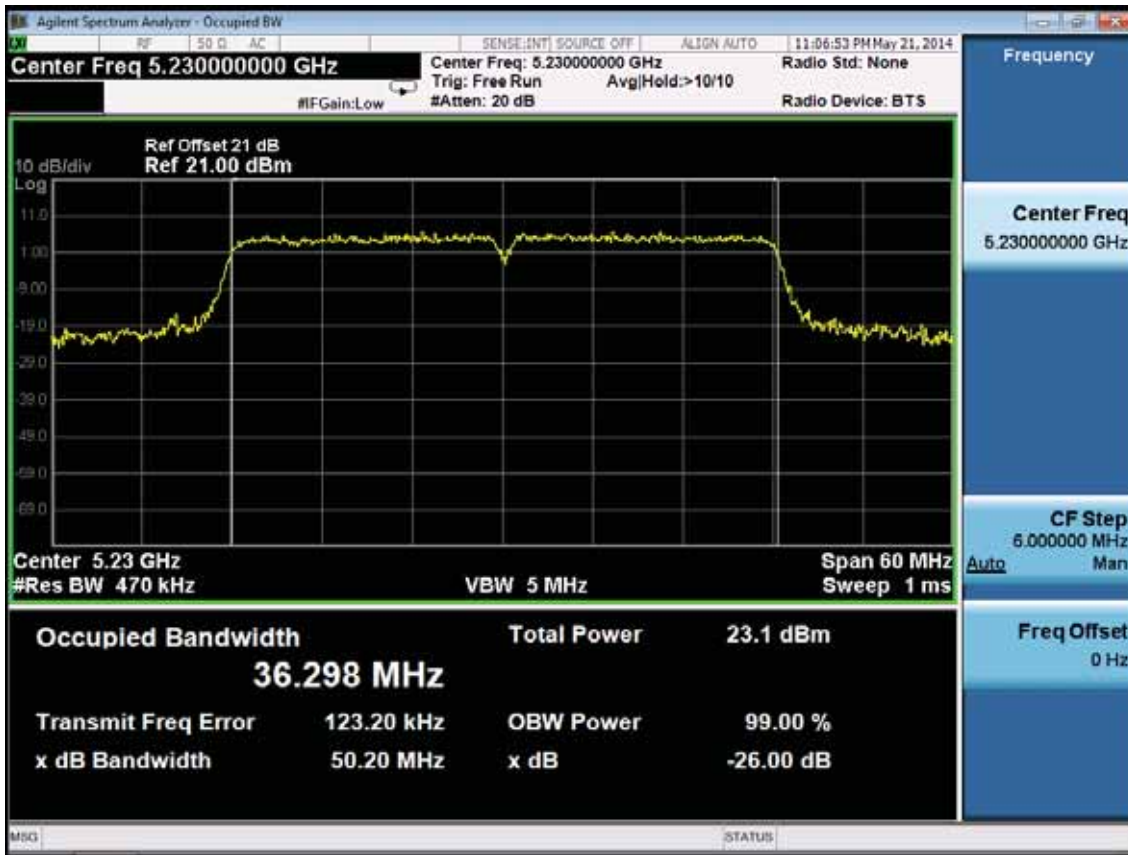

11ac VHT80

5210MHz



7. OUTPUT POWER TEST

7.1. Test Equipment

Item	Equipment	Manufacturer	Model No.	Serial No.	Last Cal.	Cal. Interval
1.	Spectrum	Agilent	N9030A	MY51380221	Oct.31, 13	1Year
2.	Power meter	Anritsu	ML2487A	6K00002472	Apr. 28,14	1Year
3.	Power sensor	Anritsu	MA2491A	0033005	Apr. 28,14	1Year
4.	Attenuator (20dB)	Agilent	8491B	MY39262165	Apr. 28,14	1 Year
5.	RF Cable	Hubersuhner	SUCOFLEX102	28620/2	Apr. 28,14	1 Year

7.2. Limit

For the band 5.15-5.25 GHz, the maximum conducted output power over the frequency band of operation shall not exceed the lesser of 50 mW or 4 dBm + 10log B, For the 5250-5350MHz and 5.47-5.725GHz the maximum conducted output power over the frequency band of operation shall not exceed the lesser of 250Mw or 11dBm+10 log B. where B is the 26-dB emission bandwidth in MHz, If transmitting antennas of directional gain greater than 6 dBi are used, the maximum conducted output power shall be reduced by the amount in dB that the directional gain of the antenna exceeds 6 dBi.

7.3. Test Procedure

1. Connected the EUT's antenna port to measure device by 26dB attenuator.
2. For IEEE 802.11a and IEEE802.11n HT20 and 802.11ac VHT20 mode, use a PK power meter which's bandwidth is 20MHz and above 26dB bandwidth of signal to measure out each test modes' PK output power.
3. For IEEE802.11n HT40 and 802.11ac VHT40 & 80 mode, because the signal's bandwidth is about 40MHz and above 20MHz bandwidth of power sensor ML2491A. So use the test method described in KBD789033 clause E Method SA-1
 - 1) Connect the antenna port to the spectrum analyzer and Set span of the spectrum to encompass the entire 26-dB emission bandwidth (EBW) of the signal.
 - 2) Set the RBW=1MHz and VBW =3MHz
 - 3) Number of points in sweep ≥ 2 Span / RBW
 - 4) Detector = RMS
 - 5) Sweep time = auto couple
 - 6) Allow the sweep to "free run" and set the Trace average at least 100 traces in power averaging (i.e., RMS) mode.
 - 7) Compute power by integrating the spectrum across the 26 dB EBW of the signal using the instrument's band power measurement function with band limits set equal to the EBW band edges.

Note: The cable loss and attenuator loss were offset into measure device as an amplitude offset.

7.4. Test Results

EUT: AC750 Wireless Dual Band Router			
M/N:C20i			
Test date: 2014-06-07		Pressure: 101.3±1.0 kpa	Humidity: 52.6±3.0%
Tested by: Kevin_Hu		Test site: RF site	Temperature:22.3±0.6 °C
Cable loss: 1 dB		Attenuator loss: 20 dB	
Test Mode	Frequency (MHz)	Maximum Conducted Output Power (dBm)	Limit (dBm)
11a	5180	14.34	17
	5200	14.17	17
	5240	13.97	17
11n HT20	5180	15.02	17
	5200	14.38	17
	5240	14.18	17
11n HT40	5190	14.66	17
	5230	16.37	17
11ac VHT20	5180	15.11	17
	5200	14.38	17
	5240	14.19	17
11ac VHT40	5190	14.75	17
	5230	15.28	17
11ac VHT80	5210	13.41	17
Conclusion: PASS			

**11n HT40
5190MHz**



5230MHz



**11ac VHT40
5190MHz**



5230MHz



11ac VHT80
5210MHz

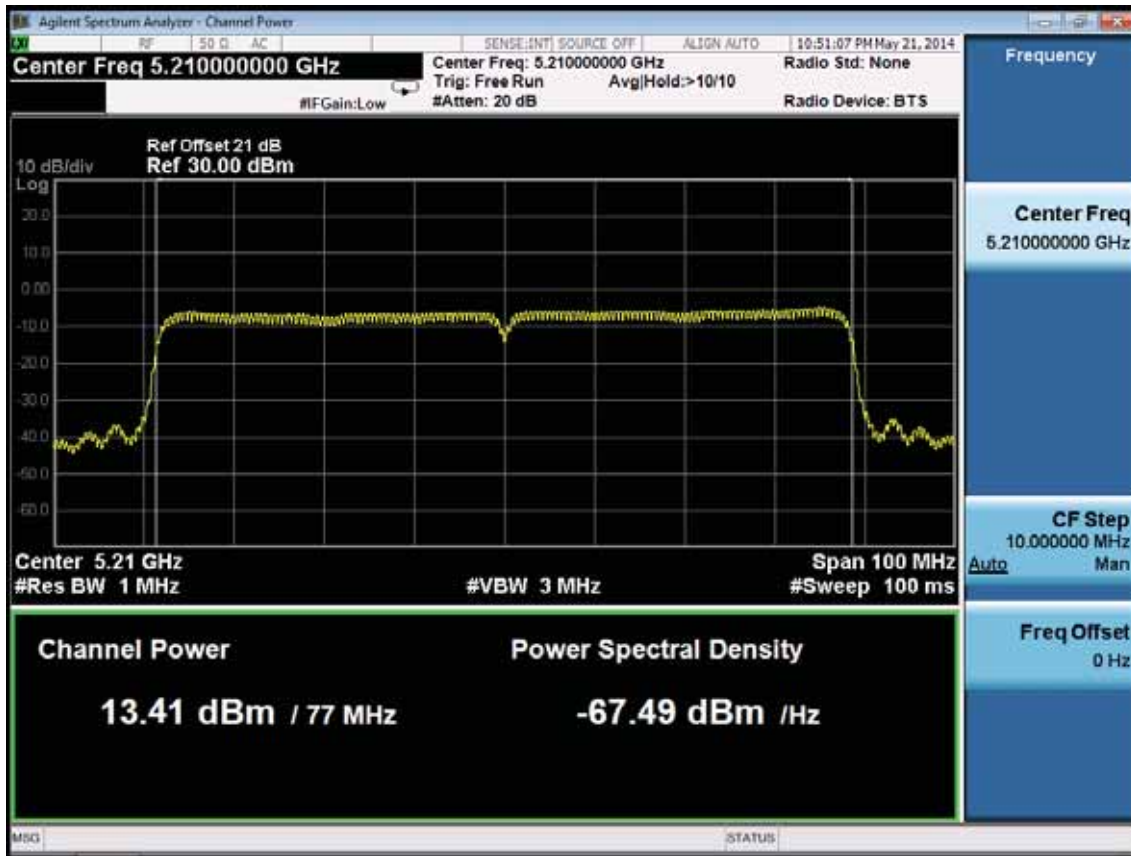

8. POWER SPECTRAL DENSITY TEST

8.1. Test Equipment

Item	Equipment	Manufacturer	Model No.	Serial No.	Last Cal.	Cal. Interval
1.	Spectrum	Agilent	N9030A	MY51380221	Oct.31, 13	1 Year
2.	Spectrum	Agilent	N9030A	MY51380221	Oct.31, 13	1 Year
4.	Attenuator (20dB)	Agilent	8491B	MY39262165	Apr. 28,14	1 Year
5	RF Cable	Hubersuhner	SUCOFLEX102	28610/2	Apr. 28,14	1 Year

8.2. Limit

For the band 5.15-5.25 GHz, the peak power spectral density shall not exceed 4 dBm in any 1-MHz band. If transmitting antennas of directional gain greater than 6 dBi are used, the peak power spectral density shall be reduced by the amount in dB that the directional gain of the antenna exceeds 6 dBi. 5250-5350MHz, 5470-5725MHz shall not exceed 11dBm in any 1-MHz band.

8.3. Test Procedure

The transmitter output was connected to a spectrum analyzer. Power density was measured by spectrum analyzer with 1MHz RBW and 3MHz VBW, RMS Detector.

So use the test method described in KDB789033 clause E

- 1) Set span of the spectrum to encompass the entire 26-dB emission bandwidth (EBW) of the signal.
- 2) Set the RBW=1MHz and VBW =3MHz
- 3) Number of points in sweep ≥ 2 Span / RBW
- 4) Detector = RMS
- 5) Sweep time = auto couple
- 6) Allow the sweep to “free run” and set the Trace average at least 100 traces in power averaging (i.e., RMS) mode.
- 7) Use the peak search function find the max value as the power density in 1MHz.

Note: The cable loss and attenuator loss were offset into measure device as an amplitude offset.

8.4. Test Results

EUT:AC750 Wireless Dual Band Router		
M/N:C20i		
Test date: 2014-05-21	Pressure: 101.3±1.0 kpa	Humidity:52.6±3.0%
Tested by:Kevin_Hu	Test site: RF site	Temperature:22.7±0.6 °C

Cable loss: 1 dB		Attenuator loss: 20 dB	
Test Mode	Frequency (MHz)	Power density (dBm/MHz)	Limit
			(dBm/MHz)
11a	5180	3.223	4
	5200	3.091	4
	5240	2.986	4
11n HT20	5180	3.102	4
	5200	3.089	4
	5240	3.293	4
11n HT40	5190	-2.048	4
	5230	1.455	4
11ac VHT20	5180	3.289	4
	5200	3.259	4
	5240	2.998	4
11ac VHT40	5190	-1.849	4
	5230	0.471	4
11ac VHT80	5210	-6.138	4
Conclusion: PASS			

11a
5180MHz

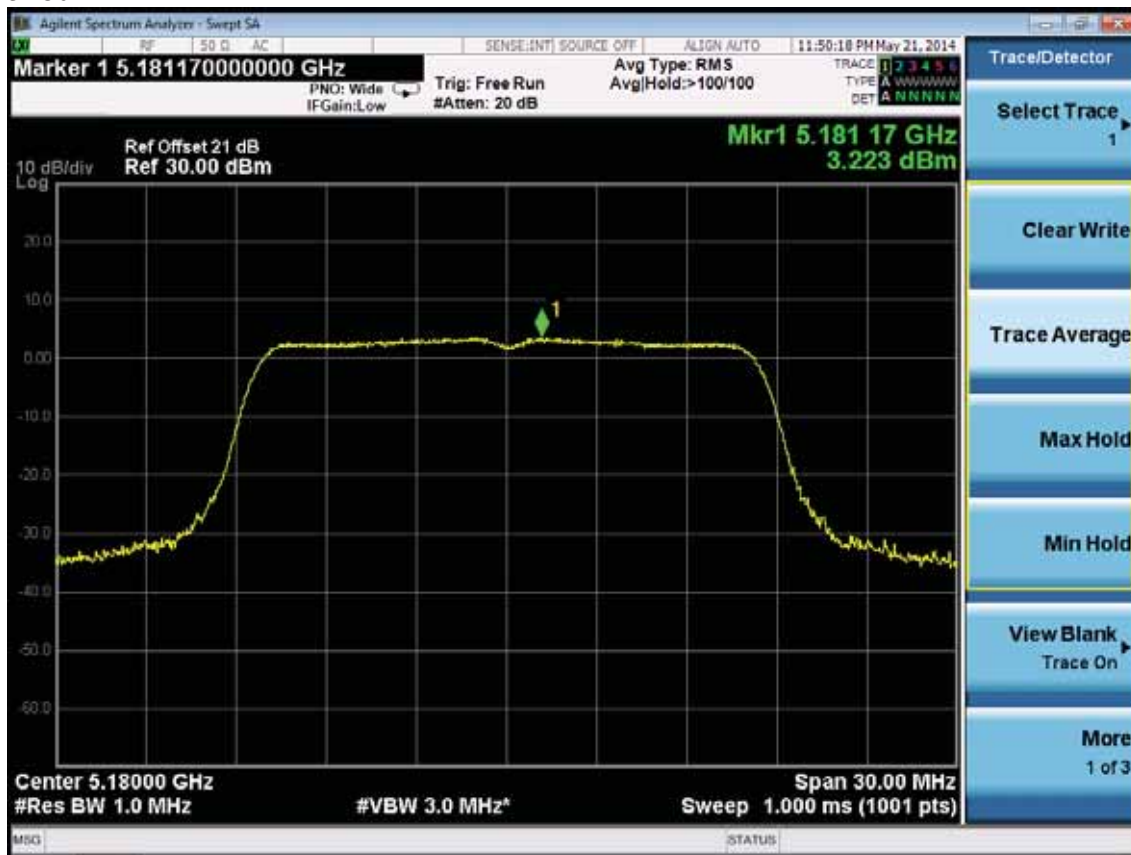

5210MHz

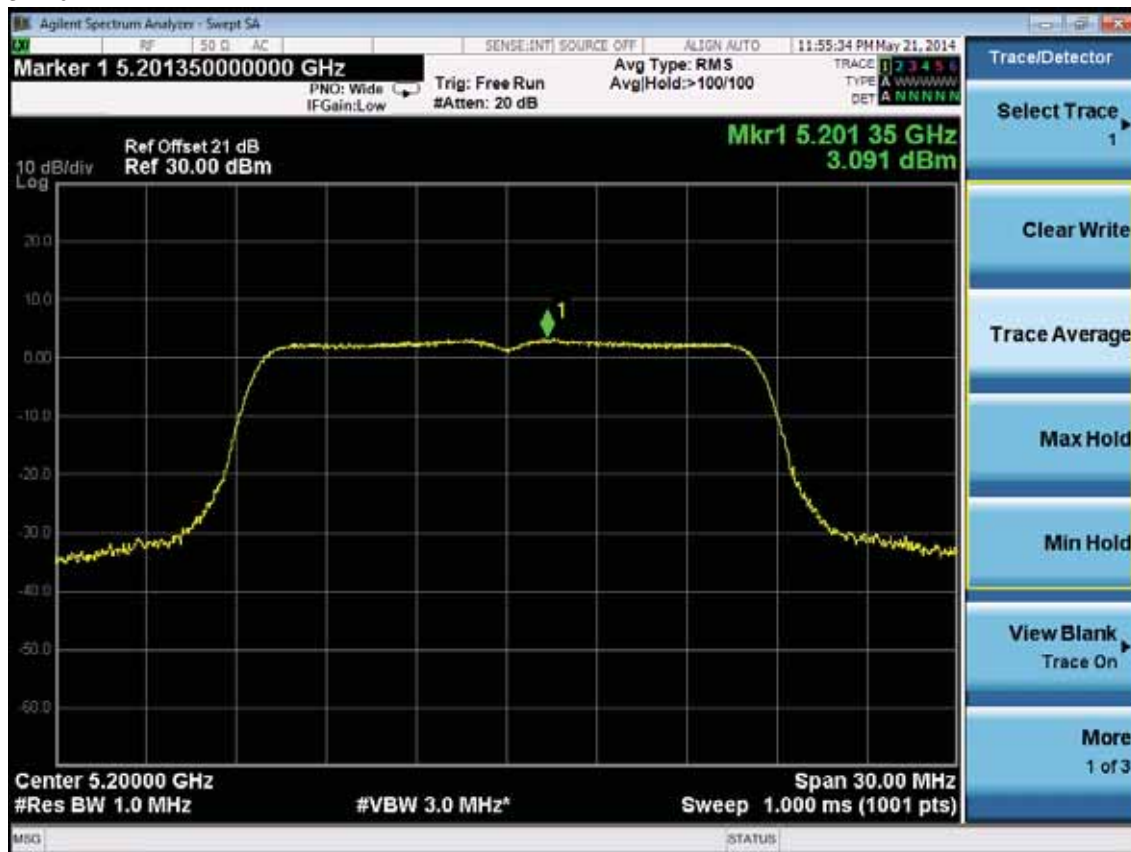

5240MHz



11nHT20

5180MHz

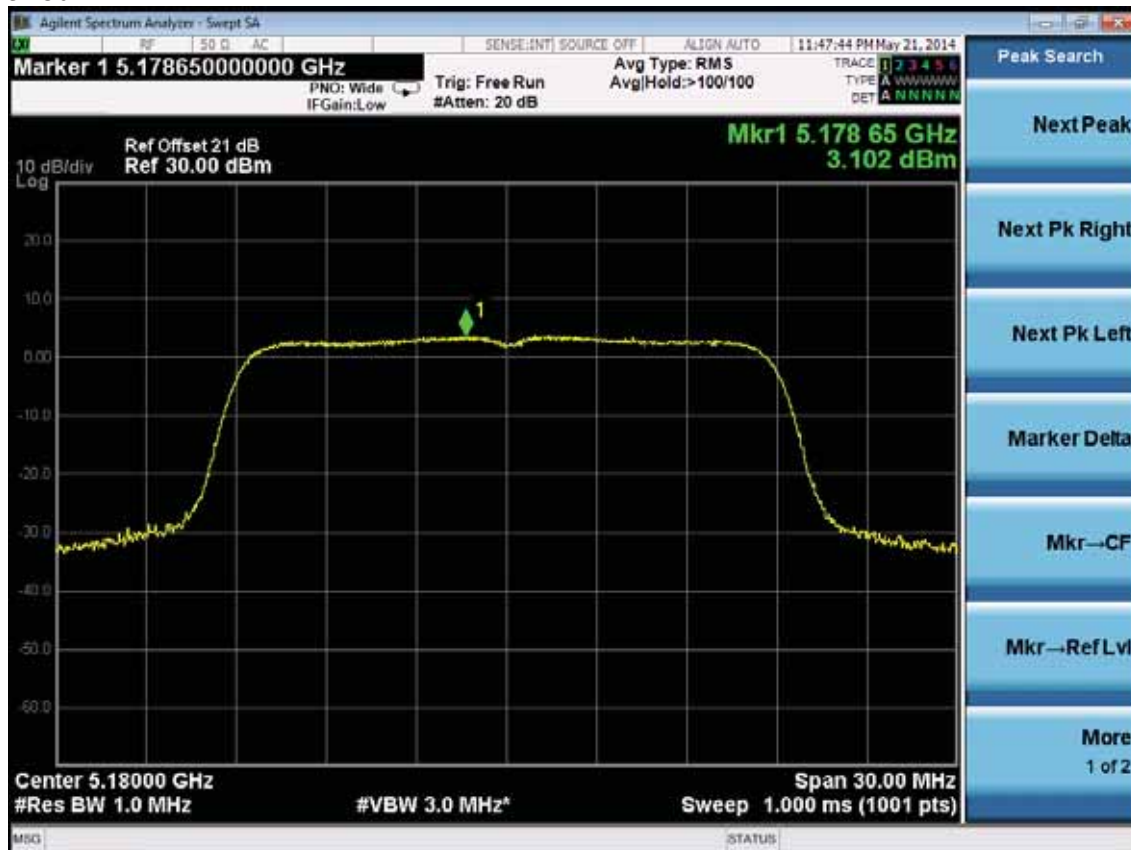

5210MHz

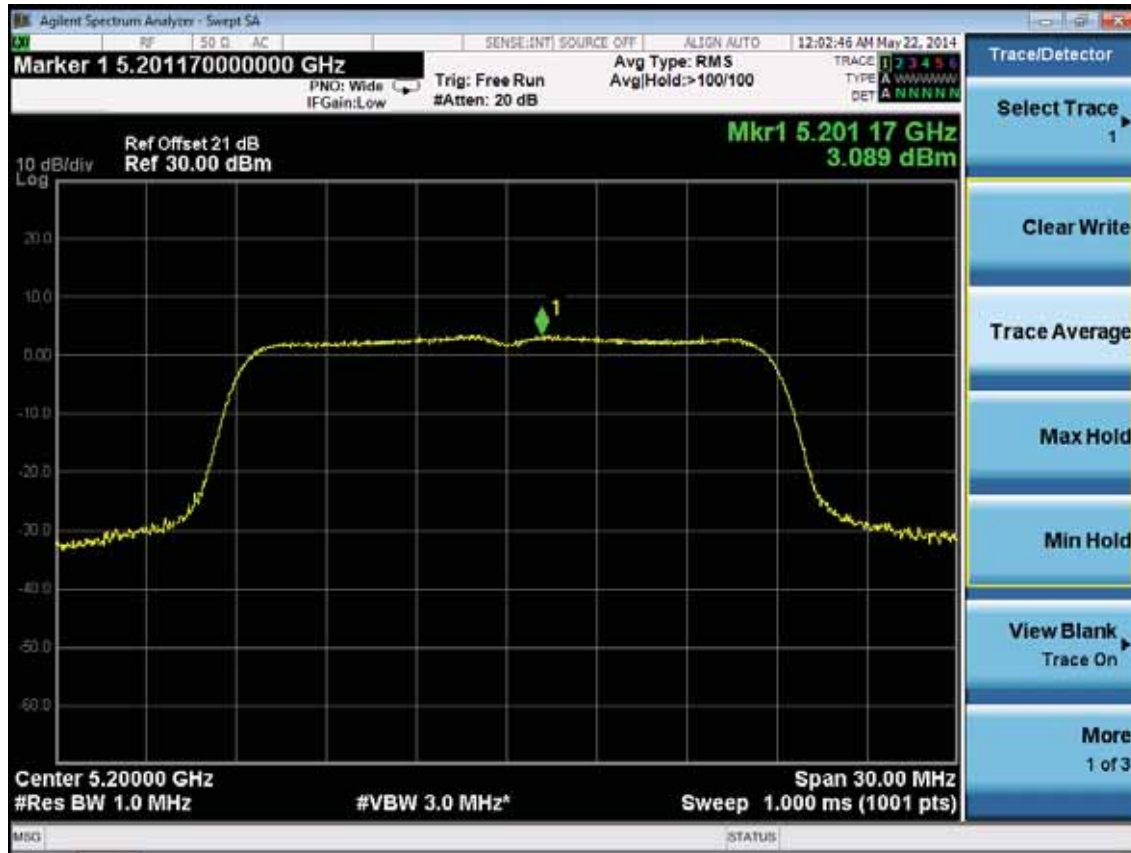

5240MHz

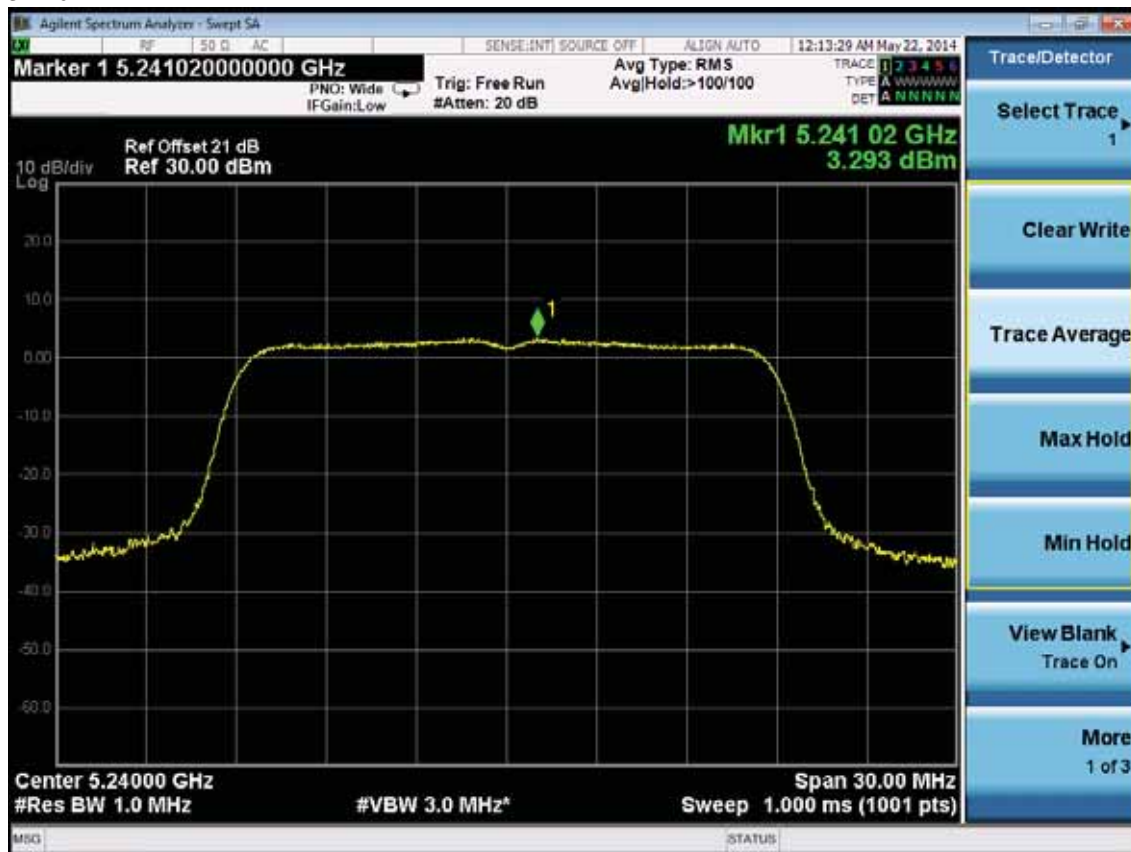

11nHT40
5190MHz

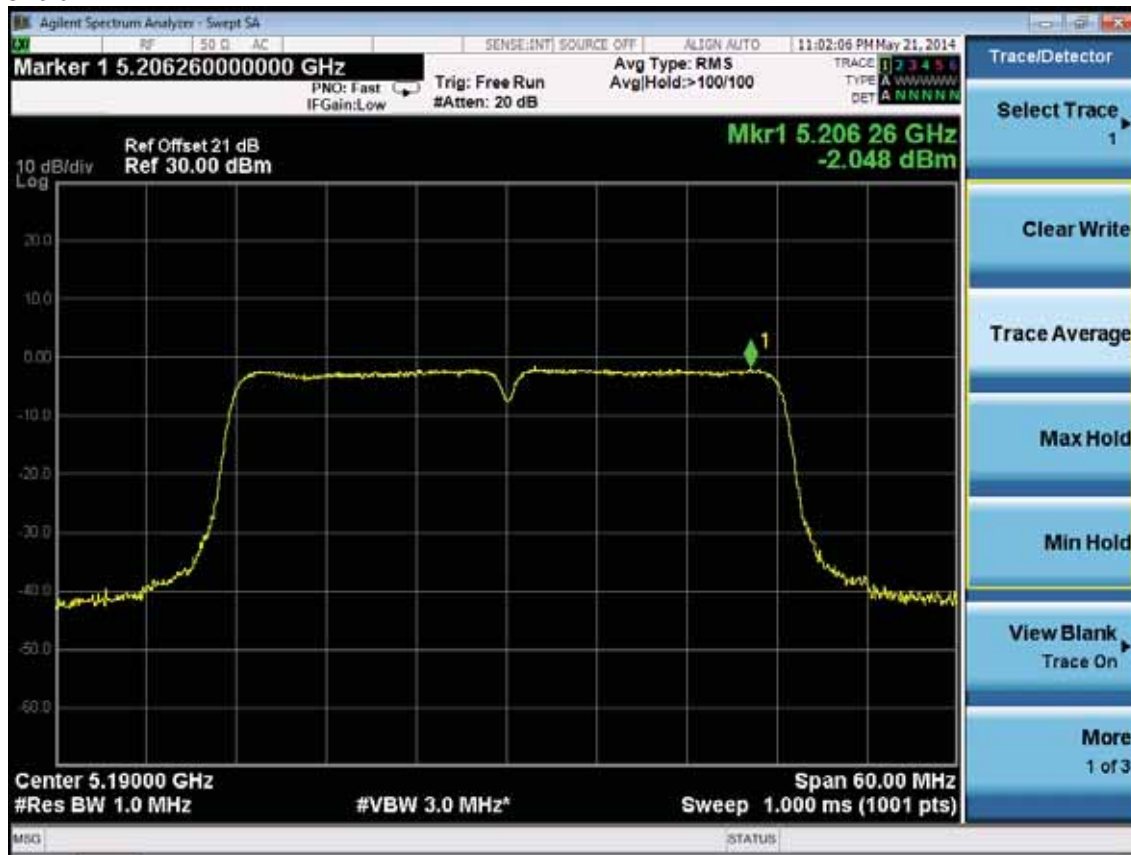

5230MHz

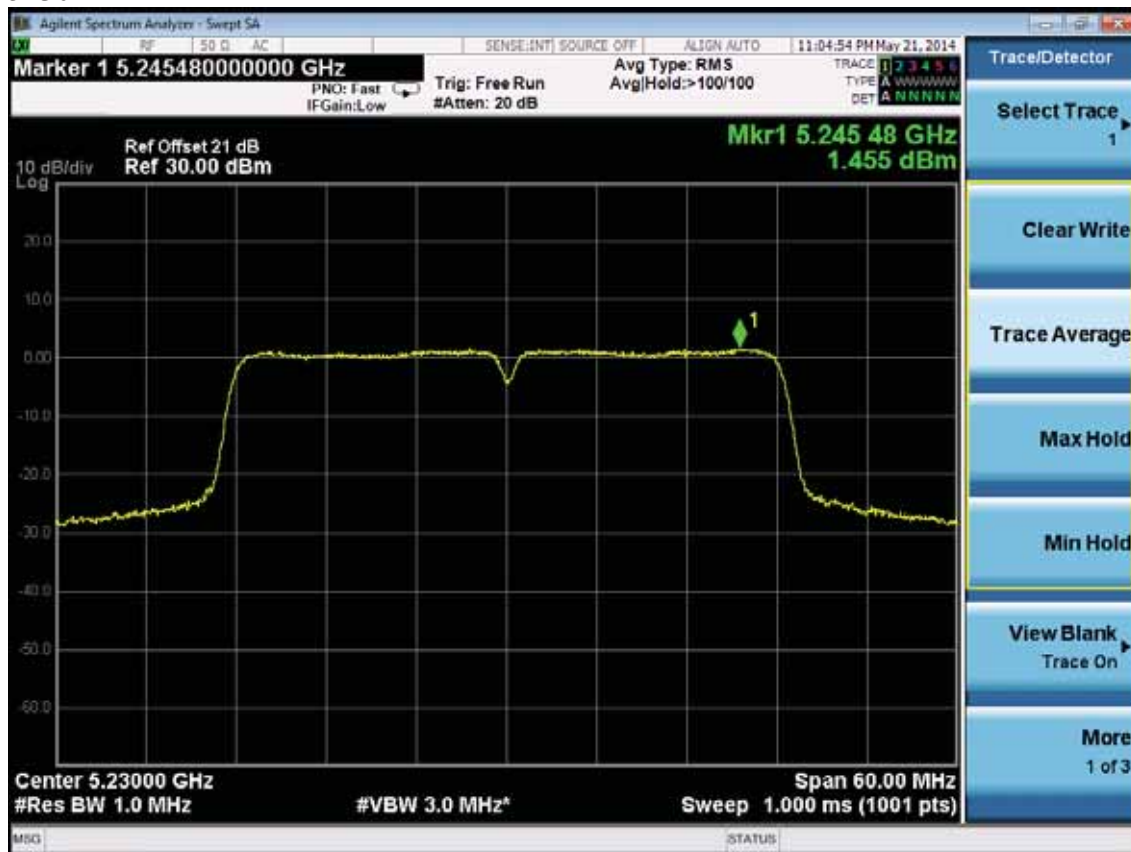

11ac VHT20
5180MHz

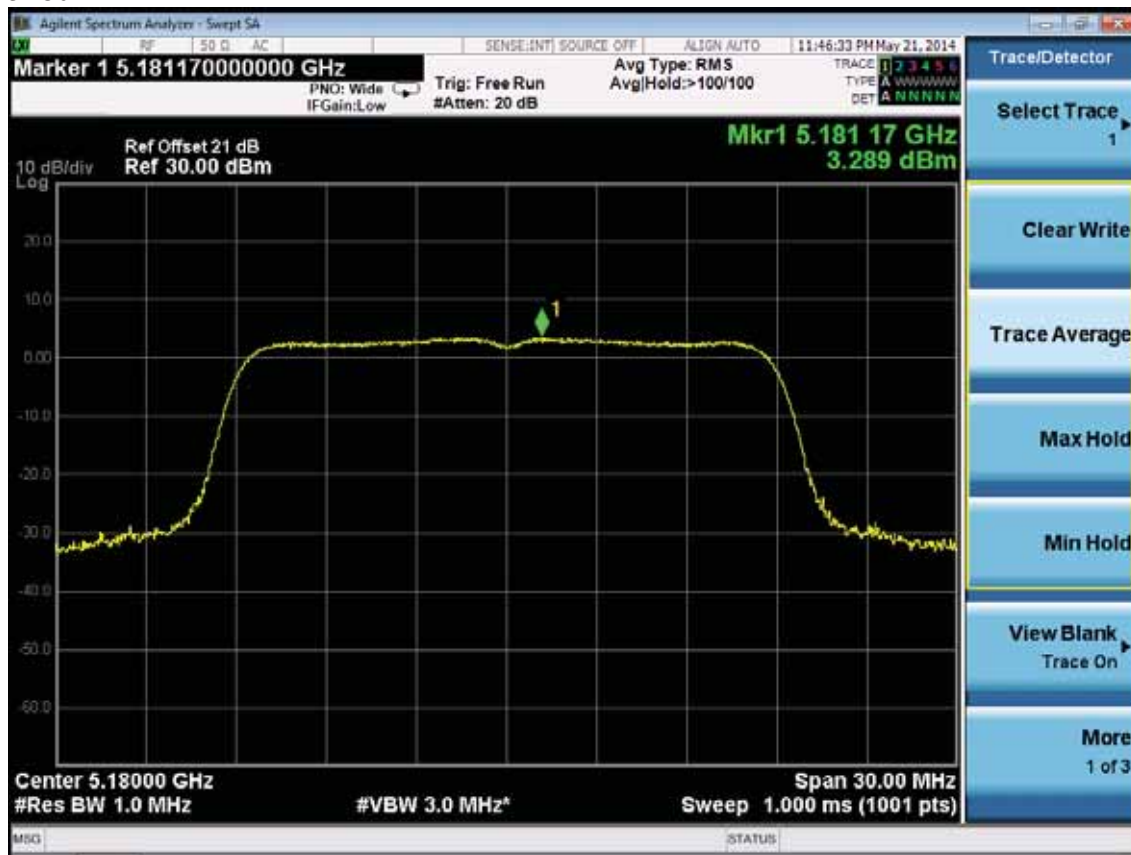

5200MHz

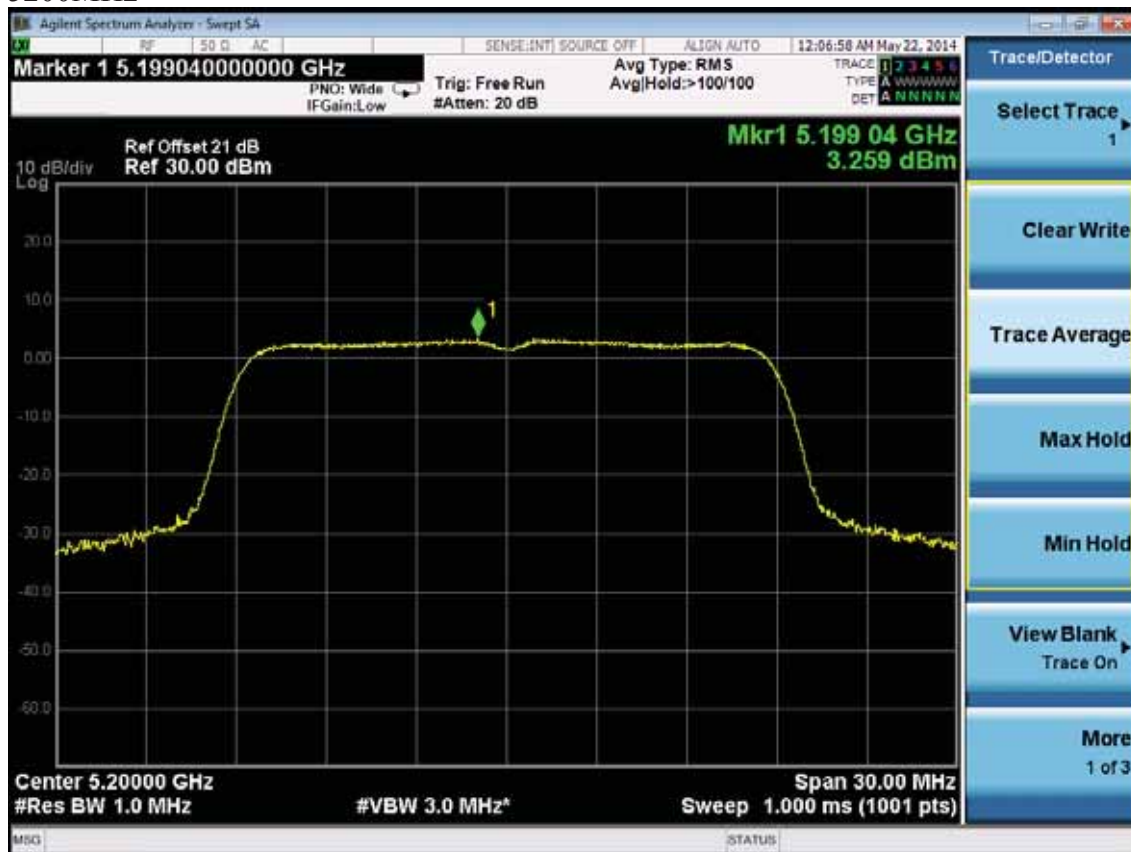

5240MHz

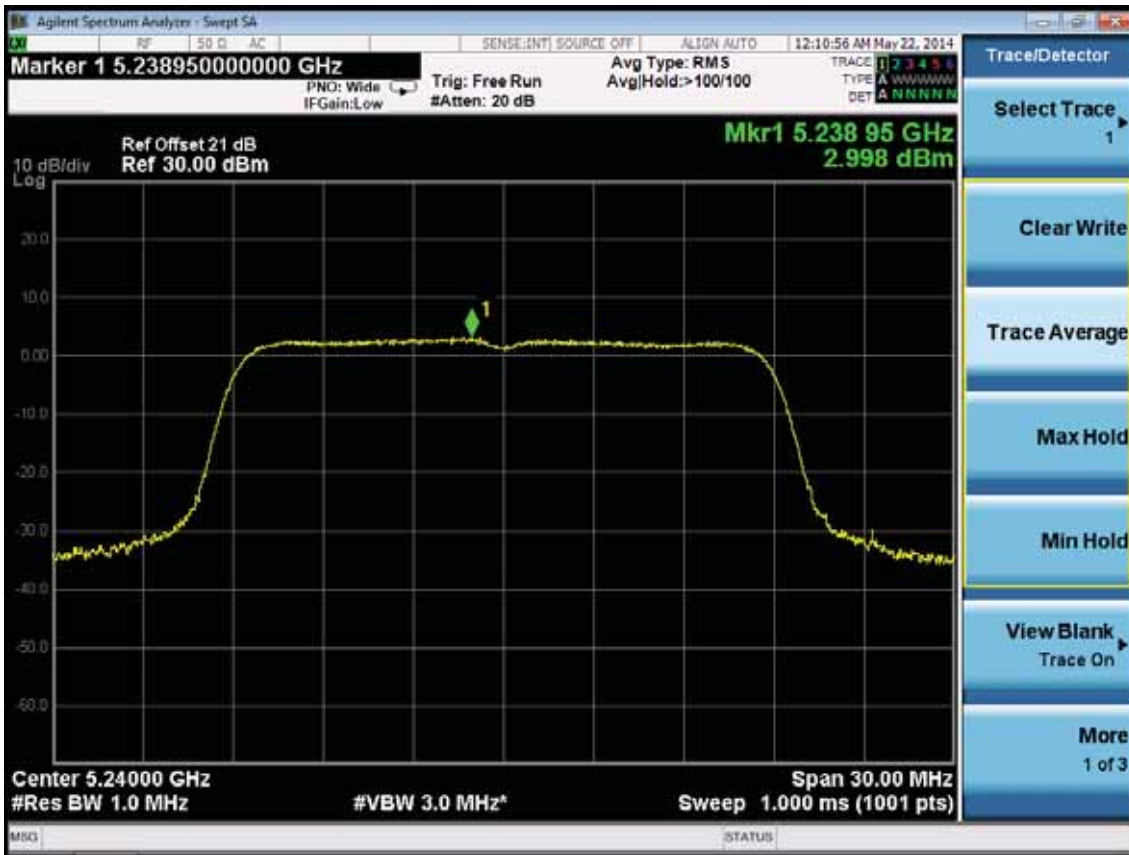

11nc VHT40

5190MHz

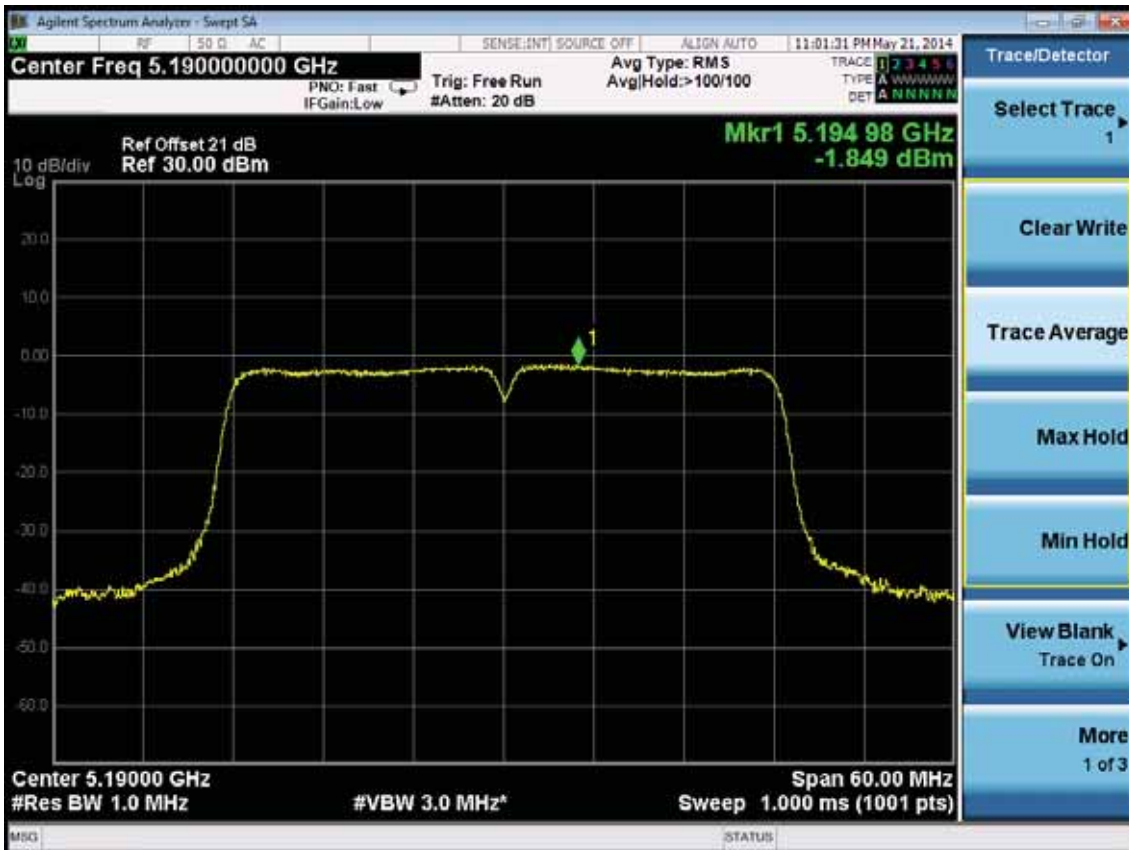

5230MHz



11ac VHT80

5210MHz

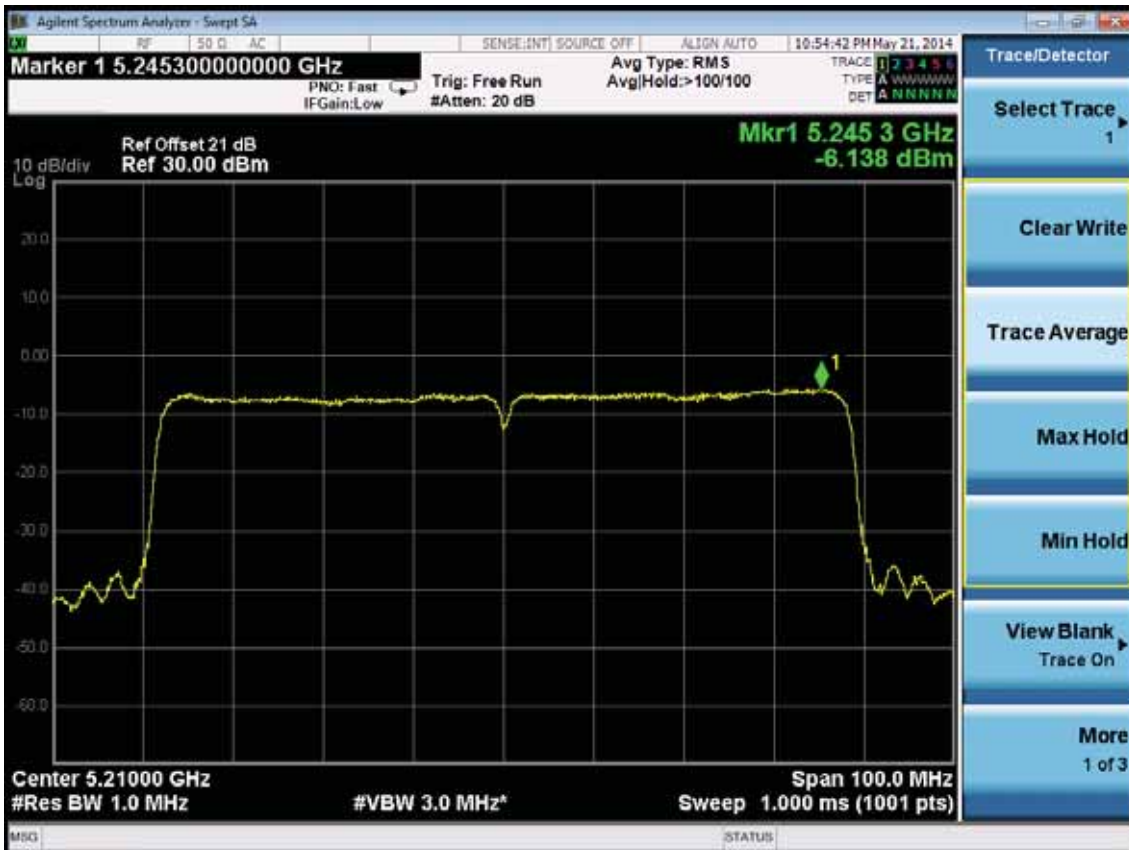

9. PEAK EXCURSION MEASUREMENT

9.1. Test Equipment

Item	Equipment	Manufacturer	Model No.	Serial No.	Last Cal.	Cal. Interval
1.	Spectrum	Agilent	N9030A	MY51380221	Oct.31, 13	1 Year
2.	Amp	HP	8449B	3008A02495	Apr. 28,14	1 Year
3.	Horn Antenna	EMCO	3115	9510-4580	May.28, 13	1 Year
4.	HF Cable	Hubersuhne	SUCOFLEX104	274094/4	Apr. 28,14	1 Year
5.	RF Cable	Hubersuhner	SUCOFLEX102	28618/2	Apr. 28,14	1 Year

9.2. Limit

The ratio of the peak excursion of modulation envelope (measured using a peak hold function) to the maximum conducted power (measured as specified above) shall not exceed 13 dB across any 1MHz bandwidth whichever is less.

9.3. Test Procedure

1. The transmitter output (antenna port) was connected to the spectrum analyzer.
2. Set the spectrum analyzer span to view the entire emissions bandwidth. The largest difference between the following two traces (Peak Trace and Average Trace) must be ≤ 13 dB for all frequencies across the emissions bandwidth. Submit a plot.
3. Peak Trace: Set RBW = 1 MHz, VBW ≥ 3 MHz with peak detector and max-hold settings.
4. Average Trace: Method #3—video averaging with max hold--and sum power across the band. Set span to encompass the entire emissions bandwidth (EBW) of the signal. Set sweep trigger to “free run”. Set RBW = 1 MHz. Set VBW $\geq 1/T$ (Draft n VBW = 300kHz $\geq 1/4 \mu$ s). Use sample detector mode if bin width (i.e., span/number of points in spectrum) < 0.5 RBW. Otherwise use peak detector mode. Set max hold. Allow max hold to run for 60 seconds.

9.4. Test Results

EUT:AC750 Wireless Dual Band Router		
M/N:C20i		
Test date: 2014-05-26	Pressure: 101.1±1.0 kpa	Humidity: 51.3±3.0%
Tested by: Kevin_Hu	Test site: RF Site	Temperature : 22.5±0.6°C

Cable loss: 1 dB		Attenuator loss: 20 dB	
Test Mode	Frequency (MHz)	Power excursion (dB)	Limit (dB)
11a	5180	3.426	13
	5200	3.317	13
	5240	3.299	13
11nHT20	5180	3.654	13
	5200	3.312	13
	5240	2.97	13
11nHT40	5190	3.156	13
	5230	2.233	13
11ac VTH20	5180	3.488	13
	5200	3.340	13
	5240	3.635	13
11ac VTH40	5190	3.546	13
	5230	3.574	13
11ac VTH80	5210	3.699	13
Conclusion : PASS			

11a
5180MHz



5200MHz



5240MHz



11nHT20

5180MHz



5200MHz



5240MHz

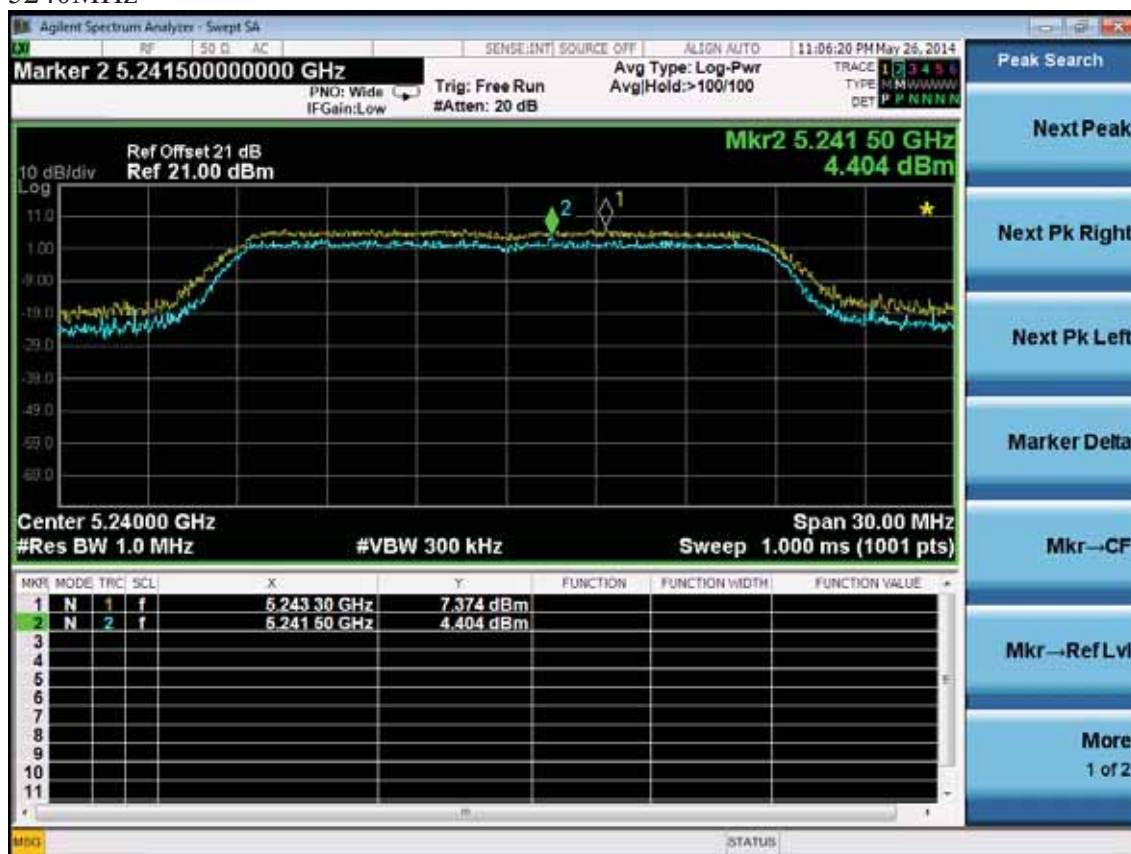

11nHT40
5190MHz

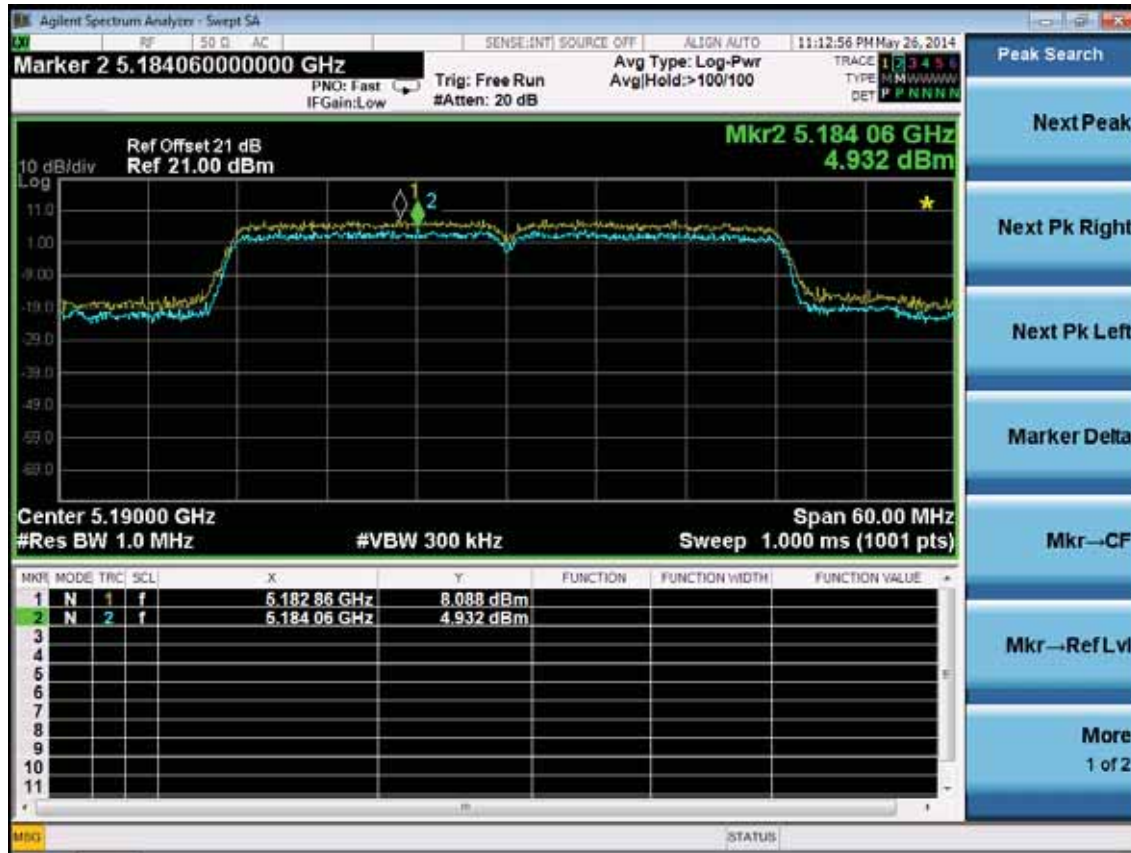

5230MHz

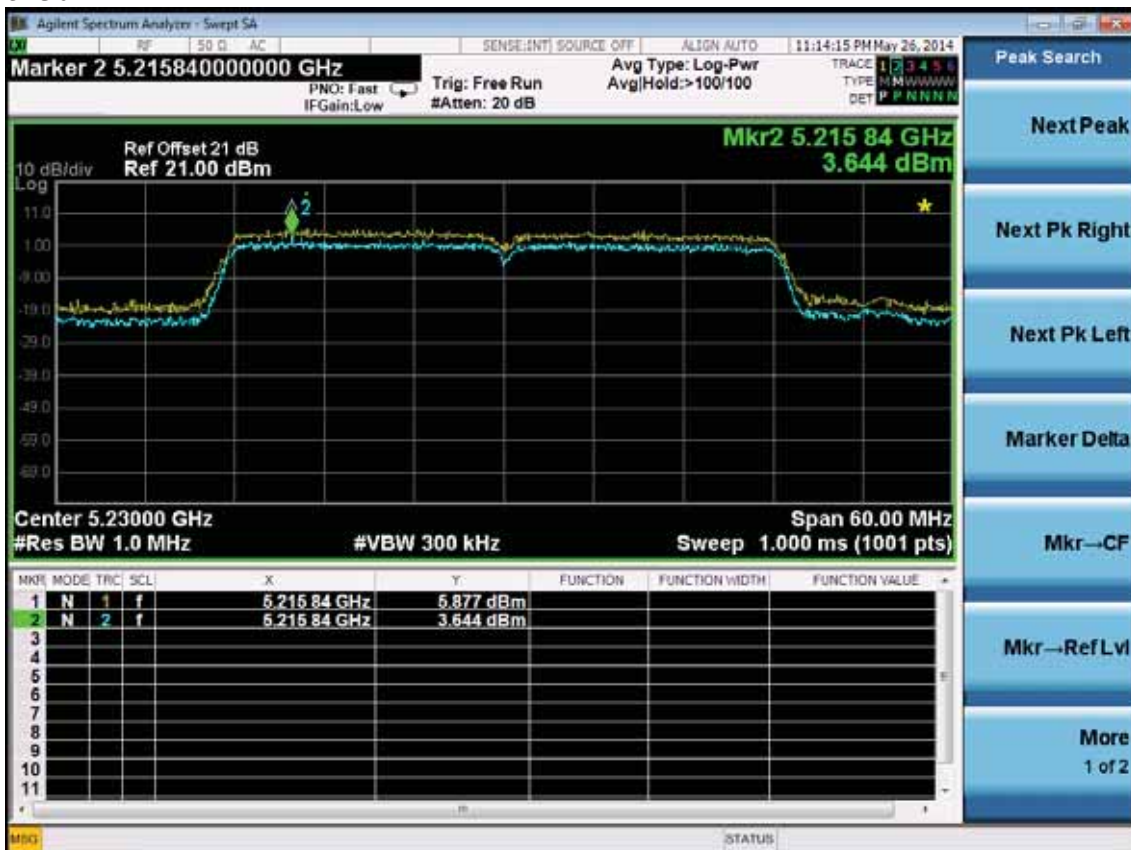

11ac VHT20
5180MHz



5200MHz



5240MHz

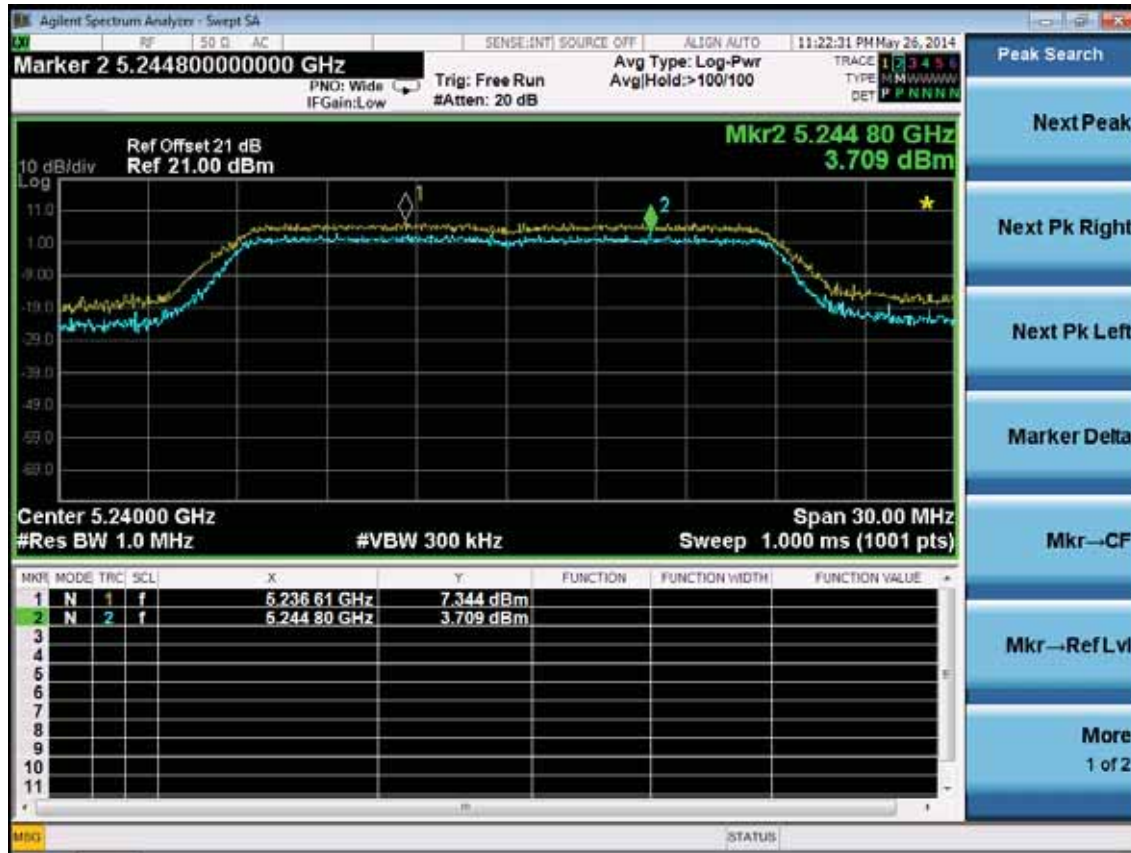

11ac VHT40

5190MHz



5230MHz

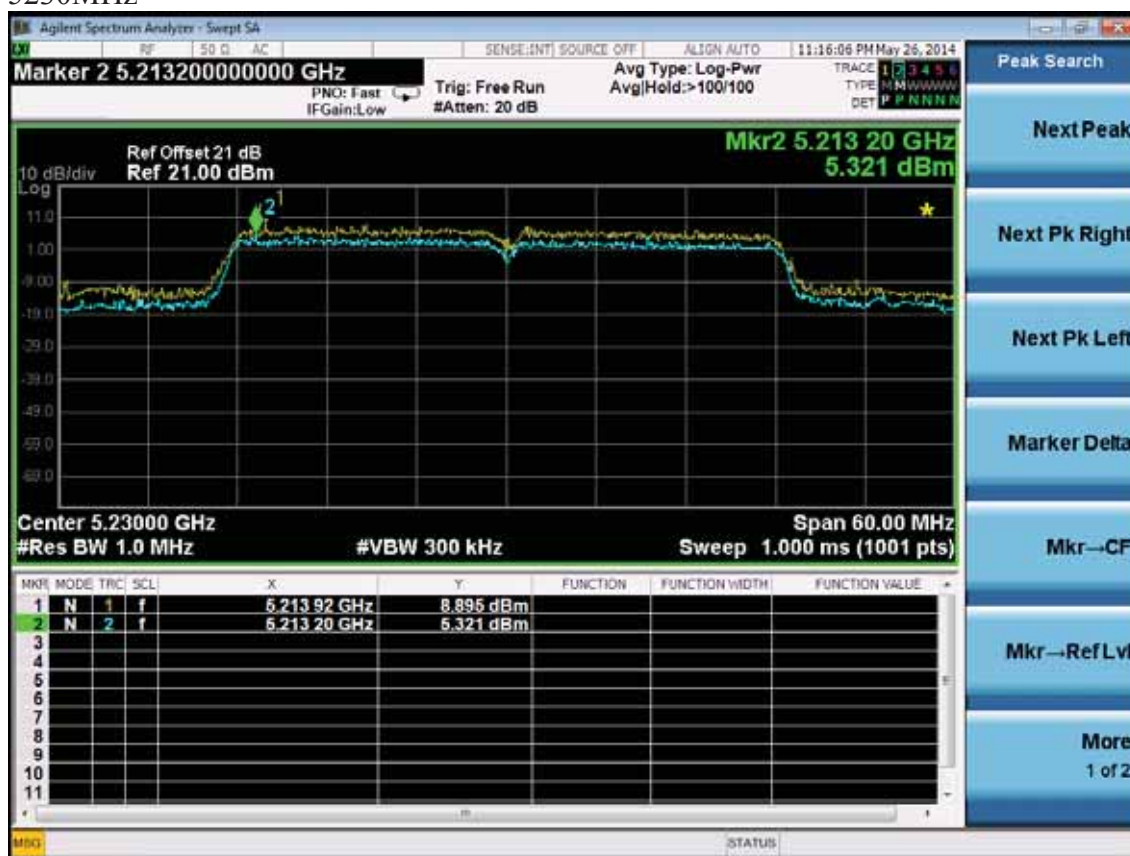

11ac VHT80

5210MHz



10. FREQUENCY STABILITY MEASUREMENT

10.1. Test Equipment

Item	Equipment	Manufacturer	Model No.	Serial No.	Last Cal.	Cal. Interval
1.	Spectrum	Agilent	E4446A	US44300459	Apr. 28,14	1 Year
2.	Horn Antenna	EMCO	3115	9510-4580	May.28, 13	1 Year
3.	HF Cable	Hubersuhne	SUCOFLEX 104	274094/4	Apr. 28,14	1 Year

10.2. Limit

Manufacturers of U-NII devices are responsible for ensuring frequency stability such that an emissions is maintained within the band of operation under all conditions of normal operation as specified in the user's manual or ± 20 ppm

10.3. Test Procedure

1. The transmitter output (antenna port) was connected to the spectrum analyser. EUT have transmitted absence of modulation signal and fixed channelize. Set the spectrum analyzer span to view the entire absence of modulation emissions bandwidth. Set RBW = 10 kHz, VBW = 10 kHz with peak detector and maxhold settings. f_c is declaring of channel frequency. Then the frequency error formula is $(f_c - f) / f_c \times 10^6$ ppm and the limit is less than ± 20 ppm The test extreme voltage is to change the primary supply voltage from 85 to 115 percent of the nominal value
2. Extreme temperature rule is 0°C~50°C.

10.4.Test Result

EUT:AC750 Wireless Dual Band Router						
M/N:C20i						
Power: DC 12V From Adapter Input AC 120V/60Hz						
Test Date: 2014-05-26		Test site: RF Chamber		Tested by: Kevin_Hu		
Ambient Temperature: 21.2±1.0℃		Relative Humidity: 53.1±1.0%		Pressure:101.2±1.0 kpa		
Frequency stability VS Voltage (Temperature:20℃)						
Supply Voltage (V)	Test frequency (MHz)	Test result (MHz)	Max Deviation (MHz)	Max Deviation (ppm)	Limit (ppm)	Conclusion
102V	5180	5179.9155	0.0845	-16.31	+/-20	PASS
120V	5180	5179.9953				
138V	5180	5179.9987				
102V	5200	5199.9241	0.0759	-14.60	+/-20	
120V	5200	5199.9897				
138V	5200	5199.9940				
102V	5240	5239.9041	0.0959	-18.30	+/-20	
120V	5240	5239.9890				
138V	5240	5239.9946				
Frequency stability VS Temperature (supply voltage AC 120V/60Hz)						
Temperature (℃)	Test frequency (MHz)	Test result (MHz)	Max Deviation (MHz)	Max Deviation (ppm)	Limit (ppm)	Conclusion
-30℃	5180	5179.9104	0.0896	-17.30	+/-20	PASS
-20℃	5180	5179.9221				
-10℃	5180	5179.9312				
0℃	5180	5179.9384				
10℃	5180	5179.9551				
20℃	5180	5179.9953				
30℃	5180	5180.0145				
40℃	5180	5180.0207				
50℃	5180	5180.0315				

Frequency stability VS Temperature (supply voltage AC 120V/60Hz)						
Temperature (°C)	Test frequency (MHz)	Test result (MHz)	Max Deviation (MHz)	Max Deviation (ppm)	Limit (ppm)	Conclusion
-30°C	5200	5199.9120	0.088	-16.92	+/-20	PASS
-20°C	5200	5199.9308				
-10°C	5200	5199.9416				
0°C	5200	5199.9589				
10°C	5200	5199.9761				
20°C	5200	5199.9897				
30°C	5200	5200.0261				
40°C	5200	5200.0337				
50°C	5200	5200.0398				

Frequency stability VS Temperature (supply voltage AC 120V/60Hz)						
Temperature (°C)	Test frequency (MHz)	Test result (MHz)	Max Deviation (MHz)	Max Deviation (ppm)	Limit (ppm)	Conclusion
-30°C	5240	5239.9095	0.0905	-17.27	+/-20	PASS
-20°C	5240	5239.9210				
-10°C	5240	5239.9326				
0°C	5240	5239.9467				
10°C	5240	5239.9656				
20°C	5240	5239.9890				
30°C	5240	5240.0128				
40°C	5240	5240.0387				
50°C	5240	5240.0612				

11.MPE ESTIMATION

11.1.Limit for General Population/ Uncontrolled Exposures

Frequency	Power density (mW/ cm ²)	Averaging time(minutes)
300MHz----1.5GHz	F/1500	30
1.5GHz---100GHz	1.0	30

Frequency(MHz)	Power density (mW/ cm ²)	Averaging time(minutes)
2412	1	30
2437	1	30
2462	1	30

Note: F= Frequency in MHz

11.2. Estimation Result

EUT:AC750 Wireless Dual Band Router		
M/N:C20i		
Test date: 2014-06-07	Pressure: 101.6±1.0 kpa	Humidity: 48.4±3.0%
Tested by: Kevin_Hu	Test site: RF site	Temperature:22.7±0.6 °C

Cable loss: 1 dB		Attenuator loss: 20 dB			Antenna Gain: 3.5dBi		
Test Mode	CH	Frequency (MHz)	Maximum Conducted Output Power (dBm)	Output Power (mW)	Antenna Gain (dBi)	Antenna Gain (Linear)	MPE
11a	CH36	5180	14.34	27.16	3.5	2.24	0.0121
	CH40	5200	14.17	26.12	3.5	2.24	0.0116
	CH48	5240	13.97	24.95	3.5	2.24	0.0111
11n HT20	CH36	5180	15.02	31.77	3.5	2.24	0.0142
	CH40	5200	14.38	27.42	3.5	2.24	0.0122
	CH48	5240	14.18	26.18	3.5	2.24	0.0117
11n HT40	CH38	5190	14.66	29.24	3.5	2.24	0.0130
	CH46	5230	16.37	43.35	3.5	2.24	0.0193
11ac VHT20	CH36	5180	15.11	32.43	3.5	2.24	0.0145
	CH40	5200	14.38	27.42	3.5	2.24	0.0122
	CH48	5240	14.19	26.24	3.5	2.24	0.0117
11ac VHT40	CH38	5190	14.75	29.85	3.5	2.24	0.0133
	CH46	5230	15.28	33.73	3.5	2.24	0.0150
11ac VHT80	CH42	5210	13.41	21.93	3.5	2.24	0.0098

$$MPE = \frac{PG}{4\pi R^2} \quad (R=20cm)$$

12. ANTENNA REQUIREMENT

12.1. STANDARD APPLICABLE

For intentional device, according to FCC 47 CFR Section 15.203, an intentional radiator shall be designed to ensure that no antenna other than that furnished by the responsible party shall be used with the device. And according to FCC 47 CFR Section 15.407 (a), if transmitting antennas of directional gain greater than 6dBi are used, the power shall be reduced by the amount in dB that the directional gain of the antenna exceeds 6dBi.

12.2. ANTENNA CONNECTED CONSTRUCTION

The antennas used for this product are dipole antenna that no antenna other than that furnished by the responsible party shall be used with the device, the maximum peak gain of the transmit antenna is 3.5dBi.

13.DEVIATION TO TEST SPECIFICATIONS

[NONE]