

FCC PART 15C TEST REPORT FOR CERTIFICATION
On Behalf of

TP-LINK TECHNOLOGIES CO., LTD.

AC750 Wireless Dual Band Router

Model Number: C20i

FCC ID: TE7C20I

Prepared for : TP-LINK TECHNOLOGIES CO., LTD.
Building 24(floors 1,3,4,5) and 28 (floors1-4) Central Science
and Technology Park, Shennan Rd, Nanshan, Shenzhen, China

Prepared By : Audix Technology (Shenzhen) Co., Ltd.
No. 6, Ke Feng Rd., 52 Block,
Shenzhen Science & Industrial Park,
Nantou, Shenzhen, Guangdong, China

Tel: (0755) 26639496

Report Number : ACS-F14181
Date of Test : May.15~Jun.07, 2014
Date of Report : Jun.10, 2014

TABLE OF CONTENTS

Description	Page
1. SUMMARY OF STANDARDS AND RESULTS	1-1
1.1. Description of Standards and Results	1-1
2. GENERAL INFORMATION	2-1
2.1. Description of Device (EUT)	2-1
2.2. Test Information	2-2
2.3. Tested Supporting System Details.....	2-3
2.4. Block Diagram of Test Setup	2-3
2.5. Test Facility	2-4
2.6. Measurement Uncertainty (95% confidence levels, k=2).....	2-4
3. POWER LINE CONDUCTED EMISSION TEST.....	3-1
3.1. Test Equipments	3-1
3.2. Block Diagram of Test Setup	3-1
3.3. Power Line Conducted Emission Test Limits	3-1
3.4. Configuration of EUT on Test.....	3-2
3.5. Operating Condition of EUT	3-2
3.6. Test Procedure	3-2
3.7. Power Line Conducted Emission Test Results	3-2
4. RADIATED EMISSION TEST	4-1
4.1. Test Equipment.....	4-1
4.2. Block Diagram of Test Setup	4-2
4.3. Radiated Emission Limit	4-3
4.4. EUT Configuration on Test.....	4-3
4.5. Operating Condition of EUT	4-3
4.6. Test Procedure	4-4
4.7. Radiated Emission Test Results	4-4
5. CONDUCTED SPURIOUS EMISSIONS	5-1
5.1. Test Equipment.....	5-1
5.2. Limit	5-1
5.3. Test Procedure	5-1
5.4. Test result	5-1
6. BAND EDGE COMPLIANCE TEST	6-1
6.1. Test Equipment.....	6-1
6.2. Limit	6-1
6.3. Test Produce	6-1
6.4. Test Results	6-1
7. 6dB Bandwidth Test	7-1
7.1. Test Equipment.....	7-1
7.2. Limit	7-1
7.3. Test Procedure	7-1
7.4. Test Results	7-1
8. OUTPUT POWER TEST	8-1
8.1. Test Equipment.....	8-1
8.2. Limit (FCC Part 15C 15.247 b(3))	8-1
8.3. Test Procedure	8-1
8.4. Test Results	8-2
9. POWER SPECTRAL DENSITY TEST	9-1
9.1. Test Equipment.....	9-1

9.2.	Limit	9-1
9.3.	Test Procedure	9-1
9.4.	Test Results	9-2
10.	MPE ESTIMATION	10-1
10.1.	Limit for General Population/ Uncontrolled Exposures	10-1
10.2.	Estimation Result.....	10-1
11.	ANTENNA REQUIREMENT	11-3
11.1.	STANDARD APPLICABLE	11-3
11.2.	ANTENNA CONNECTED CONSTRUCTION	11-3
12.	DEVIATION TO TEST SPECIFICATIONS	12-1
13.	PHOTOGRAPH OF TEST.....	13-1
13.1.	Photos of Power Line Conducted Emission Test	13-1
13.2.	Photos of Radiated Emission Test.....	13-2

TEST REPORT CERTIFICATION

Applicant : TP-LINK TECHNOLOGIES CO., LTD.
Manufacturer : TP-LINK TECHNOLOGIES CO., LTD.
EUT Description : AC750 Wireless Dual Band Router
FCC ID : TE7C201
(A) MODEL NO. : C20i
(B) SERIAL NO. : N/A
(C) POWER SUPPLY : Input:100~240V~, 50/60Hz, 0.3A
Output: 12V---1A
(D) TEST VOLTAGE : DC 12V From Adapter input AC 120V/60Hz

Tested for comply with:
FCC Rules and Regulations Part 15 Subpart E: 2013

Test procedure used:
ANSI C63.10:2009
KDB789033D01: KDB644545D01

The device described above is tested by AUDIX TECHNOLOGY (SHENZHEN) CO., LTD. to confirm comply with all the FCC Part 15 Subpart C requirements. The test results are contained in this test report and AUDIX TECHNOLOGY (SHENZHEN) CO., LTD. is assumed full responsibility for the accuracy and completeness of these tests. Also, this report shows that the Equipment Under Test (EUT) is to be technically compliant with the FCC and IC requirements. This report contains data that are not covered by the NVLAP accreditation.

This Report is made under FCC Part 2.1075. No modifications were required during testing to bring this product into compliance.

This report applies to above tested sample only. This report shall not be reproduced in part without written approval of AUDIX TECHNOLOGY (SHENZHEN) CO., LTD.

The report must not be used by the client to claim product certification, approval, or endorsement by NVLAP, NIST, or any agency of the federal government.

Date of Test : May.20~Jun.07, 2014 Report of date: Jun.10, 2014

Prepared by : Sonia Lee Reviewed by : Sunny Lu
Sonia Lee / Assistant Manager Sunny Lu / Assistant Manager

Audix Technology (Shenzhen) Co., Ltd.

EMC 部門報告專用章

Stamp only for EMC Dept. Report

Signature: David Jin 6.10

Approved & Authorized Signer : David Jin
David Jin / Manager

1. SUMMARY OF STANDARDS AND RESULTS

1.1. Description of Standards and Results

The EUT have been tested according to the applicable standards as referenced below.

EMISSION		
Description of Test Item	Standard	Results
Power Line Conducted Emission	FCC Part 15: 15.207 ANSI C63.10: 2009	PASS
Radiated Emission	FCC Part 15: 15.209 ANSI C63.10: 2009	PASS
Band Edge Compliance	FCC Part 15: 15.247 ANSI C63.10: 2009	PASS
Conducted spurious emissions	FCC Part 15: 15.247 ANSI C63.10: 2009	PASS
6dB Bandwidth	FCC Part 15: 15.247 ANSI C63.10: 2009	PASS
Peak Output Power	FCC Part 15: 15.247 ANSI C63.10: 2009	PASS
Power Spectral Density	FCC Part 15: 15.247 ANSI C63.10: 2009	PASS
Antenna requirement	FCC Part 15: 15.203	PASS

2. GENERAL INFORMATION

2.1. Description of Device (EUT)

Product Name	: AC750 Wireless Dual Band Router
Model No.	: C20i
FCC ID	: TE7C20I
Radio	: IEEE802.11 a/b/g/n/ac
Operation Frequency	: IEEE 802.11a: 5180MHz—5240MHz,5745MHz—5825MHz IEEE 802.11ac VHT20: 5180MHz—5240MHz,5745MHz—5825MHz IEEE 802.11ac VHT40: 5190MHz—5230MHz,5755MHz—5795MHz IEEE 802.11ac VHT80: 5210MHz, 5775MHz IEEE 802.11b: 2412MHz—2462MHz IEEE 802.11g: 2412MHz—2462MHz IEEE802.11nHT20: 2412MHz—2462MHz,5180MHz—5240MHz, 5745MHz—5825MHz IEEE802.11nHT40: 2422MHz—2452MHz,5190MHz—5230MHz, 5755MHz—5795MHz
Modulation Technology	: IEEE 802.11b: DSSS(CCK,DQPSK,DBPSK) IEEE 802.11a/g: OFDM(64QAM, 16QAM, QPSK, BPSK) IEEE 802.11ac VHT20, VHT40, VHT80: OFDM (16QAM, 64QAM, 256QAM, QPSK, BPSK) IEEE 802.11n HT20, HT40: OFDM (64QAM, 16QAM,QPSK,BPSK)
Antenna Assembly Gain	: Dipole antenna, 2.4GHz: 2dBi(max) 5GHz: 3.5dBi(max)
Applicant	: TP-LINK TECHNOLOGIES CO., LTD. Building 24(floors 1,3,4,5) and 28 (floors1-4) Central Science and Technology Park, Shennan Rd, Nanshan, Shenzhen, China
Manufacturer	: TP-LINK TECHNOLOGIES CO., LTD. Building 24(floors 1,3,4,5) and 28 (floors1-4) Central Science and Technology Park, Shennan Rd, Nanshan, Shenzhen, China
Power Adaptor	: Manufacture :TP-LINK, M/N:T120100-2B1 Input: 100-240V~, 50/60Hz, 0.3A Output: 12V—1A Power Cable: Unshielded, Detachable, 1.5m
Date of Test	: May.15~Jun.07, 2014
Date of Receipt	: May.14, 2014
Sample Type	: Prototype production

2.2. Test Information

A special test software was used to control EUT work in Continuous TX mode(100% duty cycle), and select test channel, wireless mode and data rate.

Tested mode, channel, and data rate information			
Mode	data rate (Mbps)(see Note)	Channel	Frequency (MHz)
IEEE 802.11b	1	Low :CH1	2412
	1	Middle: CH6	2437
	1	High: CH11	2462
IEEE 802.11g	6	Low :CH1	2412
	6	Middle: CH6	2437
	6	High: CH11	2462
IEEE 802.11n HT20	6.5	Low :CH1	2412
	6.5	Middle: CH6	2437
	6.5	High: CH11	2462
IEEE 802.11n HT40	13.5	Low :CH3	2422
	13.5	Middle: CH6	2437
	13.5	High: CH9	2452

Note 1: According exploratory test, EUT will have maximum output power in those data rate, so those data rate were used for all test.

Note 2: IEEE802.11b/g/n use CDD mode test with two antenna transmit simultaneously.

Tested mode, channel, and data rate information			
Mode	data rate (Mbps)(see Note)	Channel	Frequency (MHz)
IEEE 802.11a	6	Low :CH149	5745
	6	Middle: CH157	5785
	6	High: CH165	5825
IEEE 802.11ac VHT20	6	Low :CH149	5745
	6	Middle: CH157	5785
	6	High: CH165	5825
IEEE 802.11ac VHT40	6	Low :CH151	5755
	6	High: CH159	5795
IEEE 802.11ac VHT80	6	Low :CH155	5775
IEEE 802.11n HT20	6.5	Low :CH149	5745
	6.5	Middle: CH157	5785
	6.5	High: CH165	5825
IEEE 802.11n HT40	13.5	Low :CH151	5755
	13.5	High : CH159	5795

Note : According exploratory test, EUT will have maximum output power in those data rate, so those data rate were used for all test.

2.3. Tested Supporting System Details

No.	Description	ACS No.	Manufacturer	Model	Serial Number	Approved type
1.	Personal Computer	Test PC M	DELL	Studio 540	224XK2X	<input checked="" type="checkbox"/> FCC DoC <input checked="" type="checkbox"/> BSMI ID:R33002
		Power Cord: Unshielded, Detachable, 1.8m Display Card: HD3450 (DVI+VGA+HDMI)				
2.	USB Mouse	ACS-EMC-M04R	DELL	M0C5UO	512024282	<input checked="" type="checkbox"/> FCC DoC <input checked="" type="checkbox"/> BSMI ID: R41108
		Power Cord: shielded, Undetachable, 1.8m				
3.	USB Keyboard	ACS-EMC- K03R	DELL	SK-8115	CN-ODJ313-71 616-711-04WJ	<input checked="" type="checkbox"/> FCC DoC <input checked="" type="checkbox"/> BSMI ID: T3A002
		Power Cord: shielded, Undetachable, 2.0m				
4.	USB Disk	N/A	Kingston	N/A	N/A	4GB mini memory

2.4. Block Diagram of Test Setup

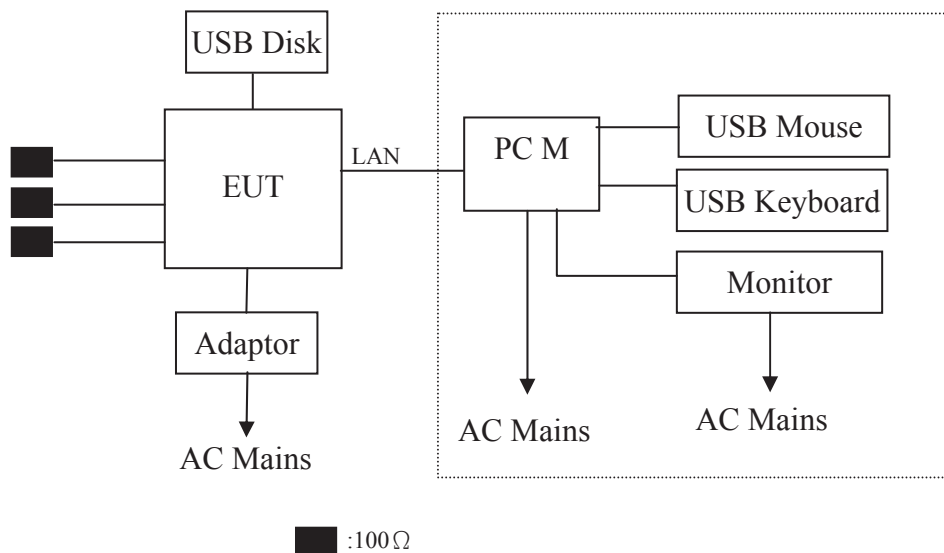

(EUT: AC750 Wireless Dual Band Router)

2.5. Test Facility

Site Description

Name of Firm : Audix Technology (Shenzhen) Co., Ltd.
No. 6, Ke Feng Rd., 52 Block, Shenzhen
Science & Industrial Park, Nantou,
Shenzhen, Guangdong, China

3m Anechoic Chamber : Certificated by FCC, USA
Registration Number: 90454
Valid Date: Feb.22, 2015

3m & 10m Anechoic Chamber : Certificated by FCC, USA
Registration Number: 794232
Valid Date: Oct.31, 2015

EMC Lab. : Certificated by Industry Canada
Registration Number: IC 5183A-1
Valid Date: Jun.13, 2014

: Certificated by DAkkS, Germany
Registration No: D-PL-12151-01-00
Valid Date: Dec.15, 2016

Accredited by NVLAP, USA
NVLAP Code: 200372-0
Valid Date: Mar.31, 2015

2.6. Measurement Uncertainty (95% confidence levels, k=2)

Test Item	Uncertainty	Memo
Uncertainty for Conducted emission test in No. 1 Conduction	±3.10 dB	150KHz to 30MHz
Uncertainty for Radiated Emission test in 3m chamber	±3.22 dB	30~200MHz, Polarization: H
	±3.23 dB	30~200MHz, Polarization: V
	±3.49 dB	200M~1GHz, Polarization: H
	±3.39 dB	200M~1GHz, Polarization: V
Uncertainty for Radiated Emission test in 3m chamber (1GHz-18GHz)	±4.97 dB	1~6GHz, Distance: 3m
	±4.99 dB	6~18GHz, Distance: 3m
Uncertainty for Radiated Spurious Emission test	±3.57 dB	
Uncertainty for Conducted Spurious emission test	±2.00 dB	
Uncertainty for Output power test	±0.73 dB	
Uncertainty for Power density test	±2.00 dB	
Uncertainty for Temperature and humidity test for ETSI	±3%	
	±0.6°C	
Uncertainty for Radio Frequency	±7x10 ⁻⁸	
Uncertainty for Bandwidth	±83 KHz	
RF level uncertainty for given BER	±0.2 dB	

3. POWER LINE CONDUCTED EMISSION TEST

3.1. Test Equipments

Item	Equipment	Manufacturer	Model No.	Serial No.	Last Cal.	Cal. Interval
1.	Test Receiver	Rohde & Schwarz	ESHS10	838693/001	Oct.31, 13	1 Year
2.	L.I.S.N.#1	Rohde & Schwarz	ESH2-Z5	100429	Jan.22, 14	1 Year
3.	L.I.S.N.#3	Kyoritsu	KNW-242C	8-1920-1	Apr. 28,14	1 Year
4.	Terminator	Hubersuhner	50Ω	No. 1	Apr. 28,14	1 Year
5.	Terminator	Hubersuhner	50Ω	No. 2	Apr. 28,14	1 Year
6.	RF Cable	Hubersuhner	RG58	0100.6954.20#	Jan.22, 14	1Year
7.	Pulse Limiter	Rohde & Schwarz	ESH3-Z2	101838	Jan.22, 14	1 Year

3.2. Block Diagram of Test Setup

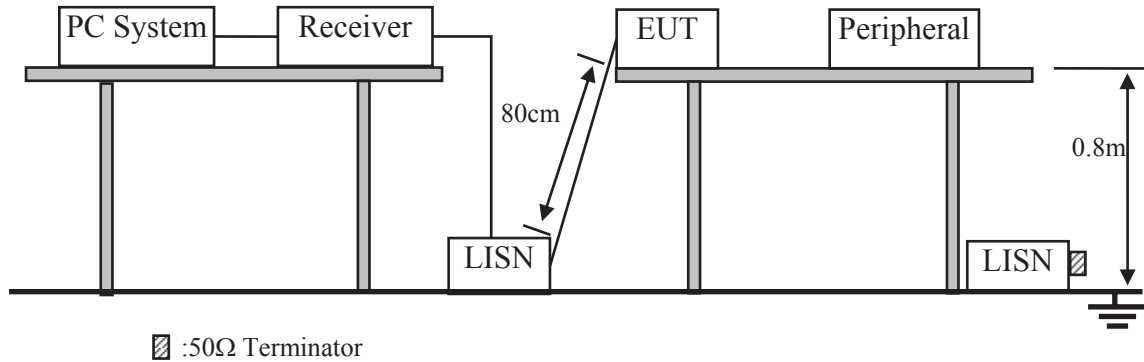

3.3. Power Line Conducted Emission Test Limits

Frequency	Maximum RF Line Voltage	
	Quasi-Peak Level dB(μV)	Average Level dB(μV)
150kHz ~ 500kHz	66 ~ 56*	56 ~ 46*
500kHz ~ 5MHz	56	46
5MHz ~ 30MHz	60	50

Notes: 1. * Decreasing linearly with logarithm of frequency.

2. The lower limit shall apply at the transition frequencies.

3.4. Configuration of EUT on Test

The following equipment are installed on Power Line Conducted Emission Test to meet the commission requirement and operating regulations in a manner which tends to maximize its emission characteristics in a normal application.

3.4.1. AC750 Wireless Dual Band Router (EUT)

Model Number : C20i

Serial Number : N/A

3.4.2. Support Equipment: As Tested Supporting System Details, in Section 2.2.

3.5. Operating Condition of EUT

3.5.1. Setup the EUT and simulator as shown as Section 3.2.

3.5.2. Turned on the power of all equipment.

3.5.3. PC run test software to control EUT work in Tx mode.

3.6. Test Procedure

The EUT was placed on a non-metallic table, 80cm above the ground plane. The EUT Power Via PC connected to the power mains through a line impedance stabilization network (L.I.S.N. 1#). This provides a 50 ohm coupling impedance for the EUT (Please refer the block diagram of the test setup and photographs). The AC line are checked to find out the maximum conducted emission. In order to find the maximum emission levels, the relative positions of equipment and all of the interface cables shall be changed according to ANSI C63.10: 2009 on Conducted Emission Test.

The bandwidth of test receiver (R & S ESHS10) is set at 9kHz.

The frequency range from 150kHz to 30MHz is checked.

3.7. Power Line Conducted Emission Test Results

PASS. (All emissions not reported below are too low against the prescribed limits.)

2.4G:

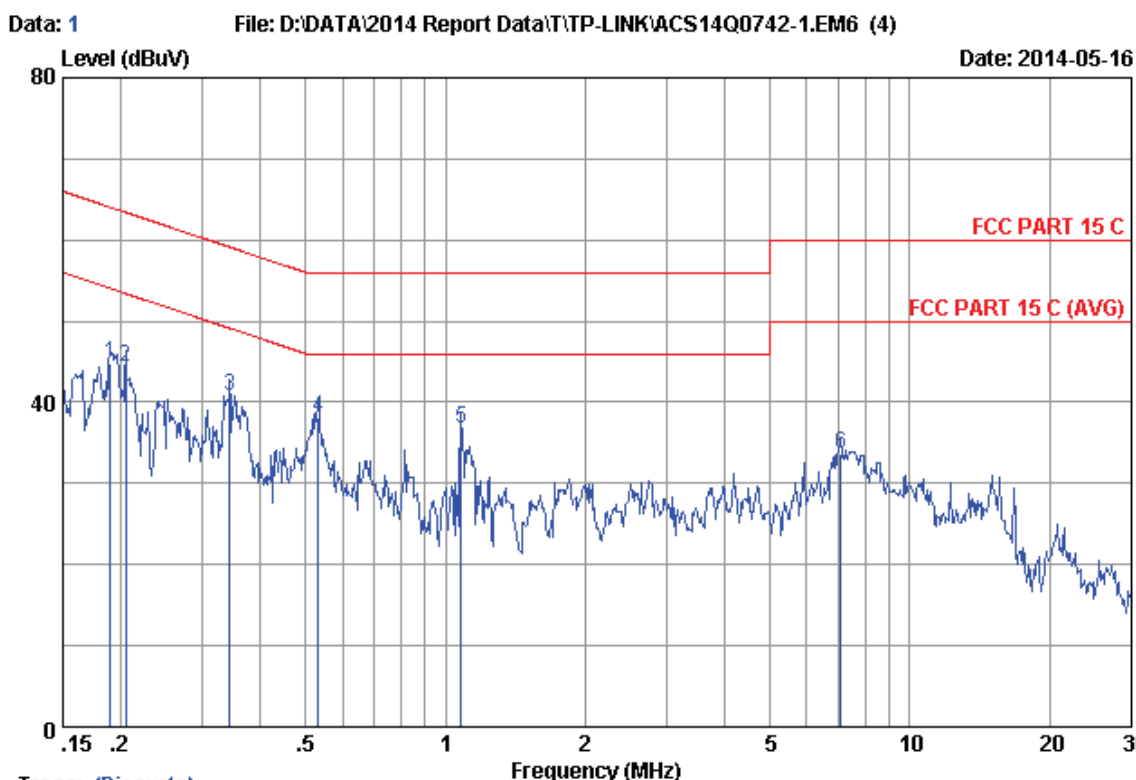

Trace: (Discrete)

Site no :1#conduction Data No :1

Dis./Ant. :2014 ESH2-Z5 LINE

Limit :FCC PART 15 C

Env./Ins. :24.3*C/52% Engineer :Nick_Huang

EUT :AC750 Wireless Dual Band Router M/N:C20i

Power Rating :DC 12V From Adapter Input AC 120V/60Hz

Test Mode :Tx Mode(2.4G)

No	Freq (MHz)	LISN Factor (dB)	Cable Loss (dB)	Reading (dBuV)	Emission Level (dBuV)	Limits (dBuV)	Margin (dB)	Remark
1	0.18938	0.13	9.88	34.76	44.77	64.06	19.29	QP
2	0.20505	0.13	9.88	34.39	44.40	63.40	19.00	QP
3	0.34281	0.14	9.88	30.74	40.76	59.13	18.37	QP
4	0.53215	0.15	9.88	28.10	38.13	56.00	17.87	QP
5	1.082	0.17	9.89	26.79	36.85	56.00	19.15	QP
6	7.100	0.33	9.97	23.40	33.70	60.00	26.30	QP

Remarks: 1.Emission Level=LISN Factor+Cable Loss(Include 10dB pulse limit)+Reading.
 2.If the average limit is met when using a quasi-peak detector, the EUT shall be deemed to meet both limits and measurement with average detector is unnecessary.

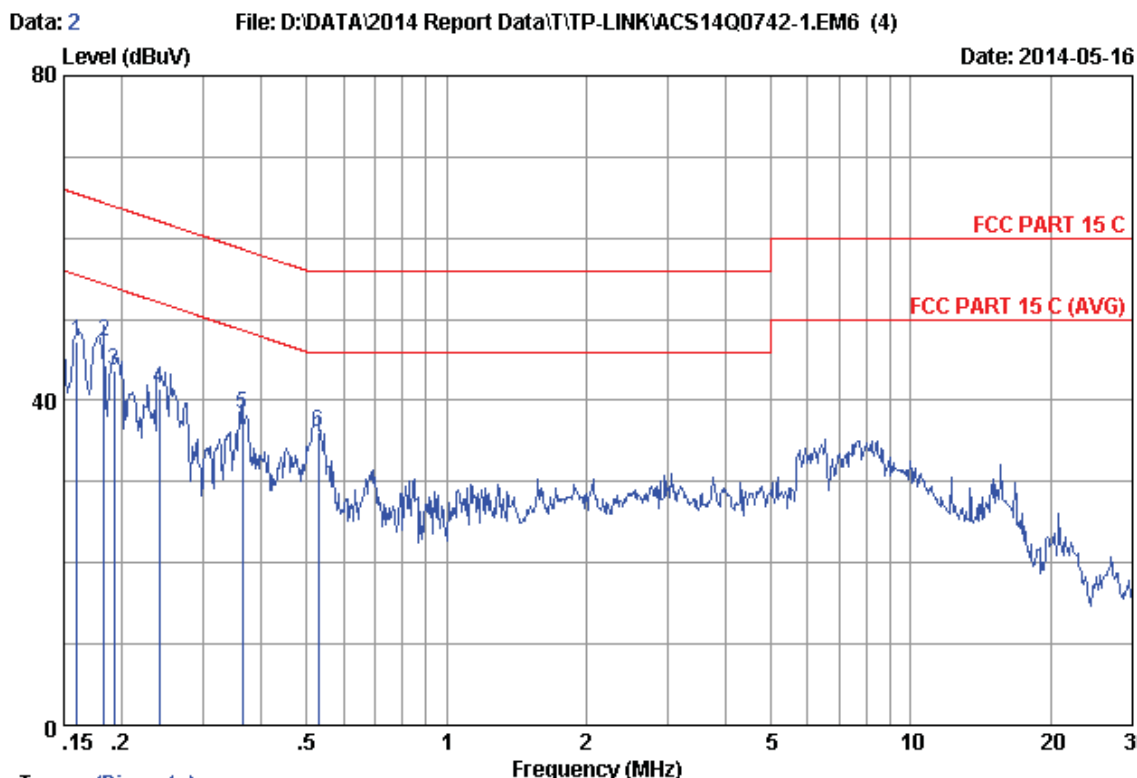

Trace: (Discrete)

Site no :1#conduction Data No :2

Dis./Ant. :2014 ESH2-25 NEUTRAL

Limit :FCC PART 15 C

Env./Ins. :24.3°C/52% Engineer :Nick_Huang

EUT :AC750 Wireless Dual Band Router M/N:C20i

Power Rating :DC 12V From Adapter Input AC 120V/60Hz

Test Mode :Tx Mode(2.4G)

No	Freq (MHz)	LISN Factor (dB)	Cable Loss (dB)	Reading (dBUV)	Emission Level (dBUV)	Limits (dBUV)	Margin (dB)	Remark
1	0.15985	0.13	9.87	37.33	47.33	65.47	18.14	QP
2	0.18346	0.13	9.88	37.33	47.34	64.33	16.99	QP
3	0.19242	0.13	9.88	33.61	43.62	63.93	20.31	QP
4	0.24037	0.13	9.88	31.52	41.53	62.08	20.55	QP
5	0.36338	0.14	9.88	28.31	38.33	58.65	20.32	QP
6	0.52934	0.15	9.88	26.18	36.21	56.00	19.79	QP

Remarks: 1.Emission Level=LISN Factor+Cable Loss(Include 10dB pulse limit)+Reading.
 2.If the average limit is met when using a quasi-peak detector, the EUT shall be deemed to meet both limits and measurement with average detector is unnecessary.

UNII Band 4:

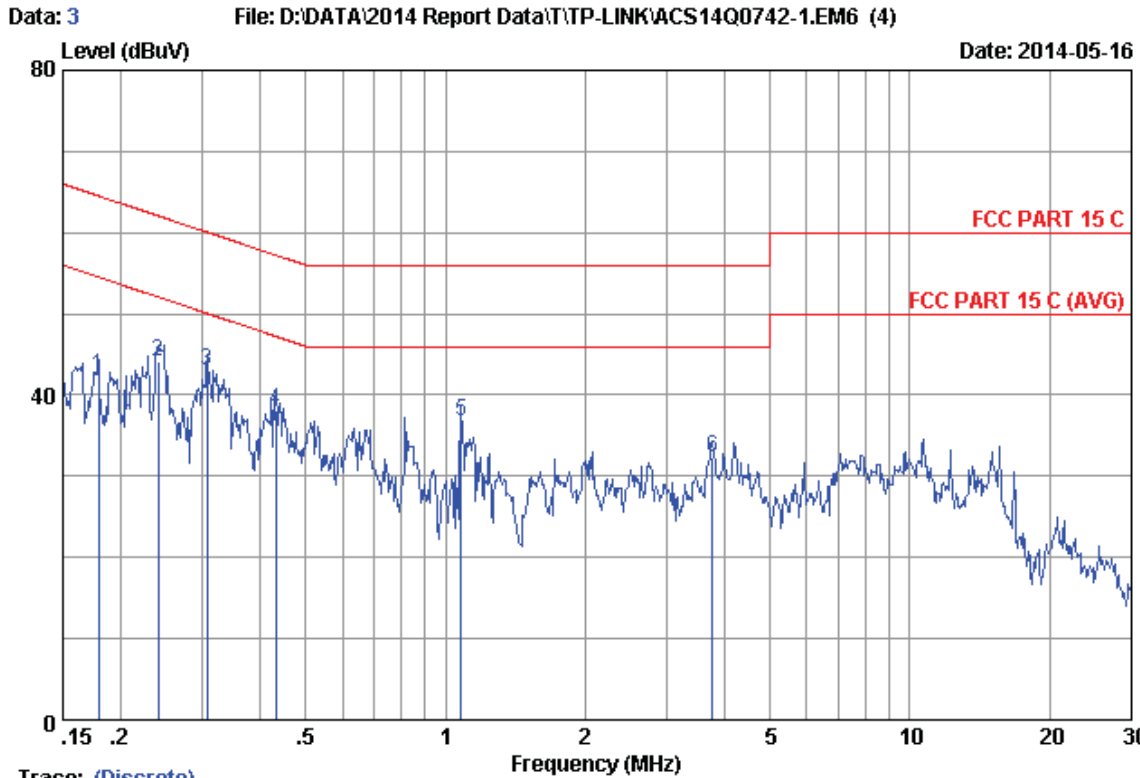

Trace: (Discrete)

Site no :1#conduction Data No :3

Dis./Ant. :2014 ESH2-25 LINE

Limit :FCC PART 15 C

Env./Ins. :24.3°C/52% Engineer :Nick_Huang

EUT :AC750 Wireless Dual Band Router M/N:C20i

Power Rating :DC 12V From Adapter Input AC 120V/60Hz

Test Mode :Tx Mode(5G)

No	Freq (MHz)	LISN Factor (dB)	Cable Loss (dB)	Reading (dBuV)	Emission Level (dBuV)	Limits (dBuV)	Margin (dB)	Remark
1	0.17866	0.13	9.88	32.34	42.35	64.55	22.20	QP
2	0.24037	0.13	9.88	34.07	44.08	62.08	18.00	QP
3	0.30671	0.14	9.88	33.07	43.09	60.06	16.97	QP
4	0.43052	0.15	9.88	28.02	38.05	57.24	19.19	QP
5	1.082	0.17	9.89	26.79	36.85	56.00	19.15	QP
6	3.759	0.24	9.93	22.19	32.36	56.00	23.64	QP

Remarks: 1.Emission Level=LISN Factor+Cable Loss(Include 10dB pulse limit) +Reading.

2.If the average limit is met when using a quasi-peak detector. the EUT shall be deemed to meet both limits and measurement with average detector is unnecessary.

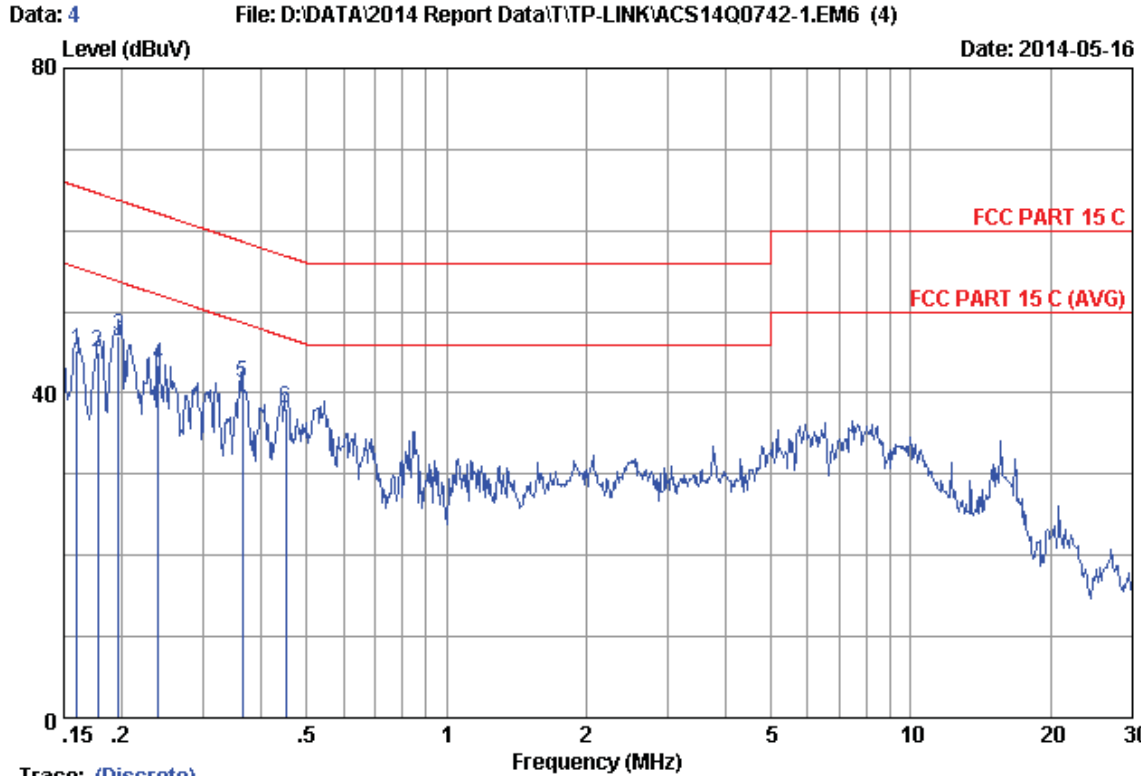

Trace: (Discrete)

Site no :1#conduction Data No :4
 Dis./Ant. :2014 ESH2-Z5 NEUTRAL
 Limit :FCC PART 15 C
 Env./Ins. :24.3*C/52% Engineer :Nick_Huang
 EUT :AC750 Wireless Dual Band Router M/N:C20i
 Power Rating :DC 12V From Adapter Input AC 120V/60Hz
 Test Mode :Tx Mode(5G)

No	Freq (MHz)	LISN Factor (dB)	Cable Loss (dB)	Reading (dBuV)	Emission Level (dBuV)	Limits (dBuV)	Margin (dB)	Remark
1	0.15985	0.13	9.87	35.33	45.33	65.47	20.14	QP
2	0.17772	0.13	9.88	34.95	44.96	64.59	19.63	QP
3	0.19654	0.13	9.88	37.01	47.02	63.76	16.74	QP
4	0.23910	0.13	9.88	33.47	43.48	62.13	18.65	QP
5	0.36338	0.14	9.88	31.31	41.33	58.65	17.32	QP
6	0.45155	0.15	9.88	28.05	38.08	56.85	18.77	QP

Remarks: 1.Emission Level=LISN Factor+Cable Loss(Include 10dB pulse limit) +Reading.
 2.If the average limit is met when using a quasi-peak detector, the EUT shall be deemed to meet both limits and measurement with average detector is unnecessary.

4. RADIATED EMISSION TEST

4.1. Test Equipment

4.1.1. For frequency range 30MHz~1000MHz (At Anechoic Chamber)

Item	Equipment	Manufacturer	Model No.	Serial No.	Last Cal.	Cal. Interval
1	3#Chamber	AUDIX	N/A	N/A	Nov.24, 13	1 Year
2	EMI Spectrum	Agilent	E4407B	MY41440292	Apr. 28,14	1 Year
3	Test Receiver	Rohde & Schwarz	ESVS10	834468/011	Apr. 28,14	1 Year
4	Amplifier	HP	8447D	2648A04738	Apr. 28,14	1 Year
5	Bilog Antenna	Schaffner	CBL6111C	2598	Apr. 08,14	1 Year
6	RF Cable	MIYAZAKI	CFD400-NL	3# Chamber No.1	Apr. 28,14	1 Year
7	Coaxial Switch	Anritsu	MP59B	M74389	Apr. 28,14	1 Year

4.1.2. For frequency range 1GHz~40GHz (At Anechoic Chamber)

Item	Equipment	Manufacturer	Model No.	Serial No.	Last Cal.	Cal. Interval
1	Spectrum Analyzer	Agilent	E4446A	US44300459	Apr. 28,14	1 Year
2	Horn Antenna	EMCO	3115	9607-4877	Aug.27, 13	1 Year
3	Amplifier	Agilent	8449B	3008A02495	Apr. 28,14	1 Year
4	RF Cable	Hubersuhner	SUCOFLEX106	77977/6	Apr. 28,14	1 Year
5	RF Cable	Hubersuhner	SUCOFLEX106	28616/2	Apr. 28,14	1 Year
6	Horn Antenna	EMCO	3116	00060089	Aug.27, 13	1 Year

4.2. Block Diagram of Test Setup

For frequency range 30MHz-1000MHz

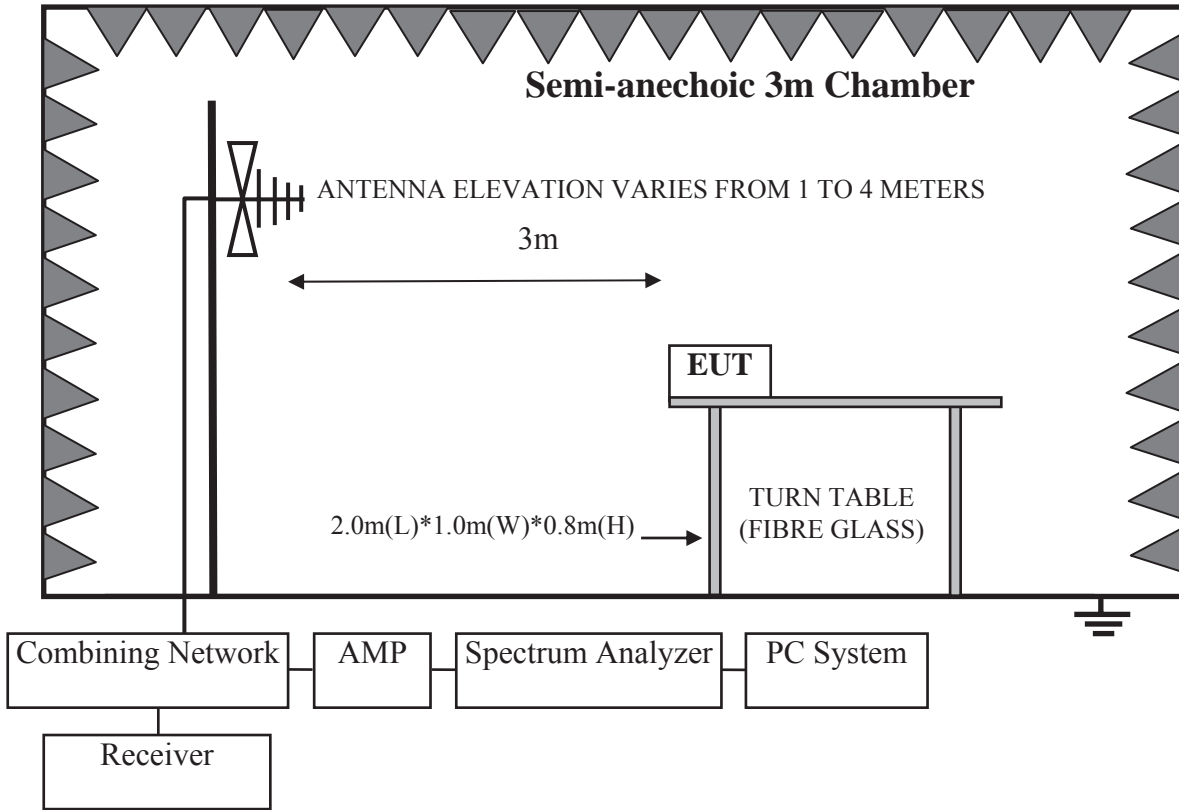

For frequency range 1GHz-40GHz

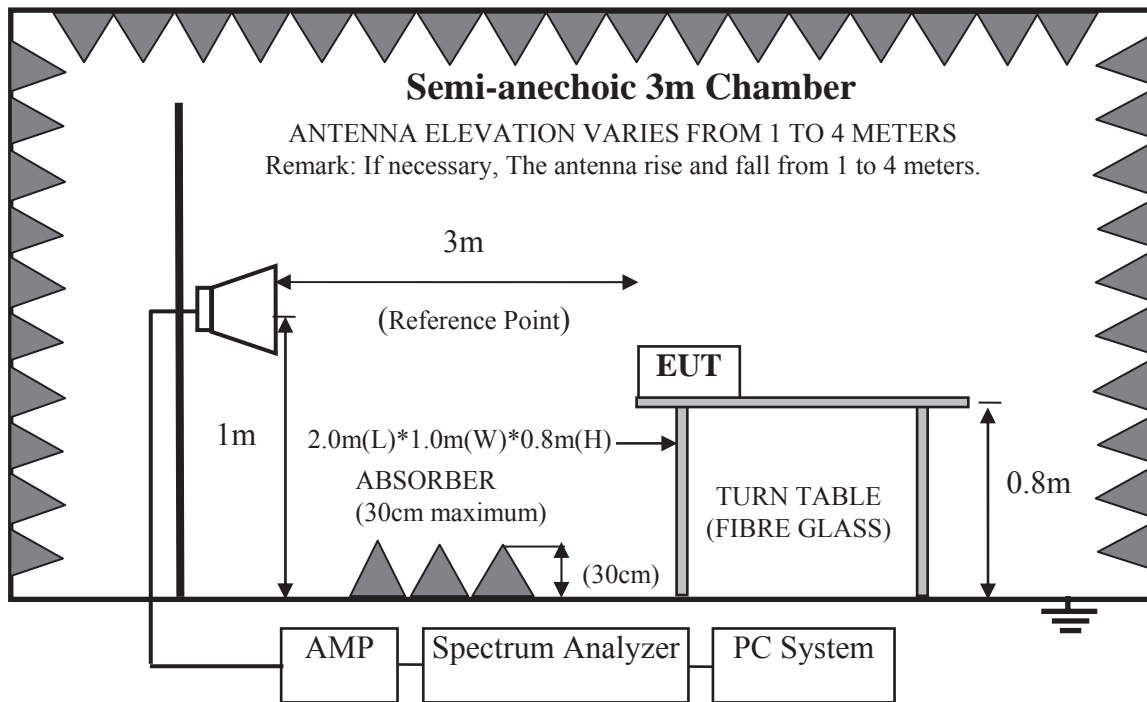

4.3. Radiated Emission Limit

4.3.1. 15.247&209 limits

FREQUENCY MHz	DISTANCE Meters	FIELD STRENGTHS LIMIT	
		μV/m	dB(μV)/m
30 ~ 88	3	100	40.0
88 ~ 216	3	150	43.5
216 ~ 960	3	200	46.0
960 ~ 1000	3	500	54.0
Above 1000	3	74.0 dB(μV)/m (Peak) 54.0 dB(μV)/m (Average)	

Remark : (1) Emission level dBμV = 20 log Emission level μV/m

(2) The smaller limit shall apply at the cross point between two frequency bands.

(3) Distance is the distance in meters between the measuring instrument, antenna and the closest point of any part of the device or system.

4.3.2. 15.205 Restricted bands of operation

MHz	MHz	MHz	GHz
0.090 - 0.110	16.42 - 16.423	399.9 - 410	4.5 - 5.15
¹ 0.495 - 0.505	16.69475 - 16.69525	608 - 614	5.35 - 5.46
2.1735 - 2.1905	16.80425 - 16.80475	960 - 1240	7.25 - 7.75
4.125 - 4.128	25.5 - 25.67	1300 - 1427	8.025 - 8.5
4.17725 - 4.17775	37.5 - 38.25	1435 - 1626.5	9.0 - 9.2
4.20725 - 4.20775	73 - 74.6	1645.5 - 1646.5	9.3 - 9.5
6.215 - 6.218	74.8 - 75.2	1660 - 1710	10.6 - 12.7
6.26775 - 6.26825	108 - 121.94	1718.8 - 1722.2	13.25 - 13.4
6.31175 - 6.31225	123 - 138	2200 - 2300	14.47 - 14.5
8.291 - 8.294	149.9 - 150.05	2310 - 2390	15.35 - 16.2
8.362 - 8.366	156.52475 - 156.52525	2483.5 - 2500	17.7 - 21.4
8.37625 - 8.38675	156.7 - 156.9	2690 - 2900	22.01 - 23.12
8.41425 - 8.41475	162.0125 - 167.17	3260 - 3267	23.6 - 24.0
12.29 - 12.293	167.72 - 173.2	3332 - 3339	31.2 - 31.8
12.51975 - 12.52025	240 - 285	3345.8 - 3358	36.43 - 36.5
12.57675 - 12.57725	322 - 335.4	3600 - 4400	(²)

All the emissions appearing within 15.205 restricted frequency bands shall not exceed the limits shown in 15.209, all the other emissions shall be at least 20dB below the fundamental emissions, or comply with 15.209 limits.

4.4. EUT Configuration on Test

The configurations of EUT are listed in Section 3.4.

4.5. Operating Condition of EUT

Same as Conducted Emission test that is listed in Section 3.5. except the test set up replaced by Section 4.2.

4.6. Test Procedure

EUT and its simulators are placed on a turn table, which is 0.8 meter high above ground. The turn table can rotate 360 degrees to determine the position of the maximum emission level. Power on the EUT and let it working in test mode, then test it. EUT is set 3 meters away from the receiving antenna, which is mounted on a antenna tower. The antenna can be moved up and down between 1 meter and 4 meters to find out the maximum emission level. Broadband antenna (calibrated bilog antenna) is used as receiving antenna. Both horizontal and vertical polarization of the antenna are set on test.

This test was performed with EUT in X, Y, Z position, and the worse case was found when EUT in X position as test photo indicated.

The bandwidth of the EMI test receiver (R&S ESVS10) is set at 120kHz for frequency range from 30MHz to 1000 MHz.

The bandwidth of the Spectrum's VBW is set at 3MHz and RBW is set at 1MHz for peak emissions measurement above 1GHz and 1MHz RBW, 10Hz VBW for average emissions measure above 1GHz

The frequency range from 30MHz to 10th harmonic (40GHz) are checked. and no any emissions were found from 18GHz to 40 GHz, So the radiated emissions from 18GHz to 40GHz were not record.

4.7. Radiated Emission Test Results

PASS.

All the emissions from 30MHz to 40 GHz were comply with 15.209 limits.

Note: For emissions above 1GHz, if peak level comply with average limit, then the average level is deemed to comply with average limit.

2.4G Duty cycle

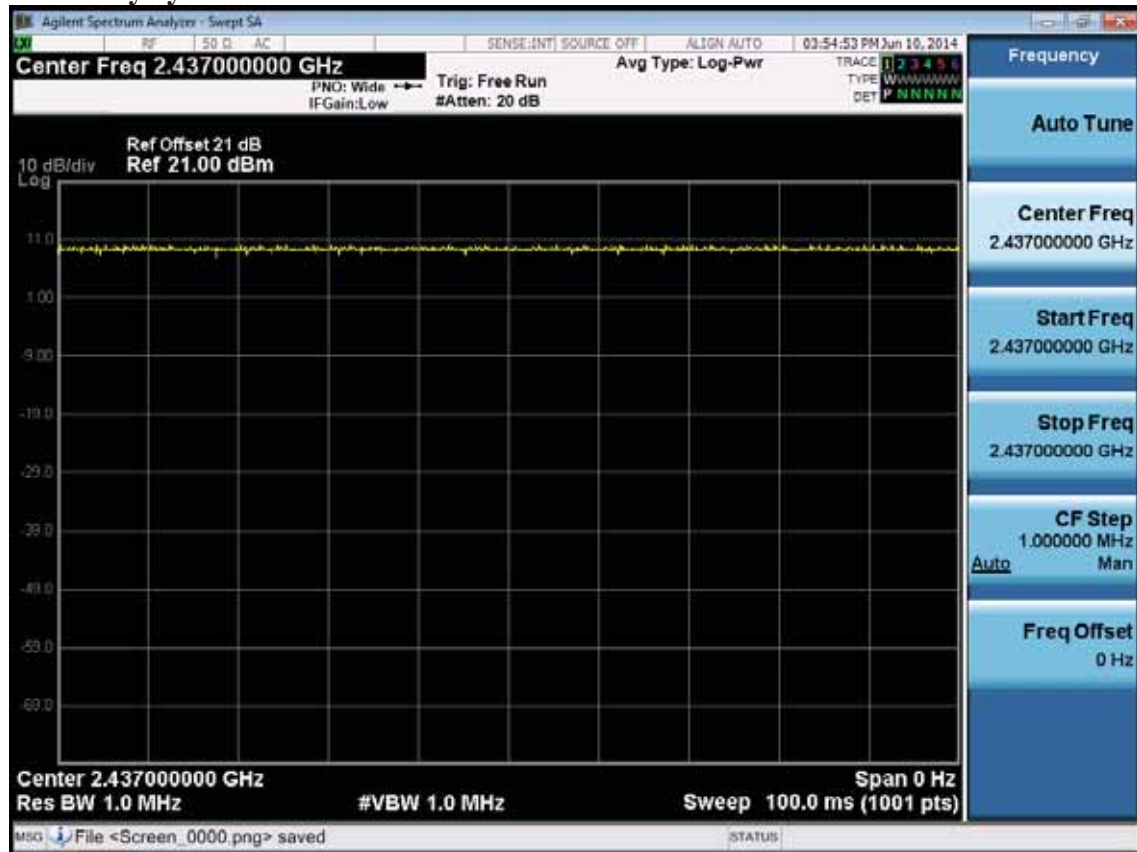

Band 4 Duty cycle

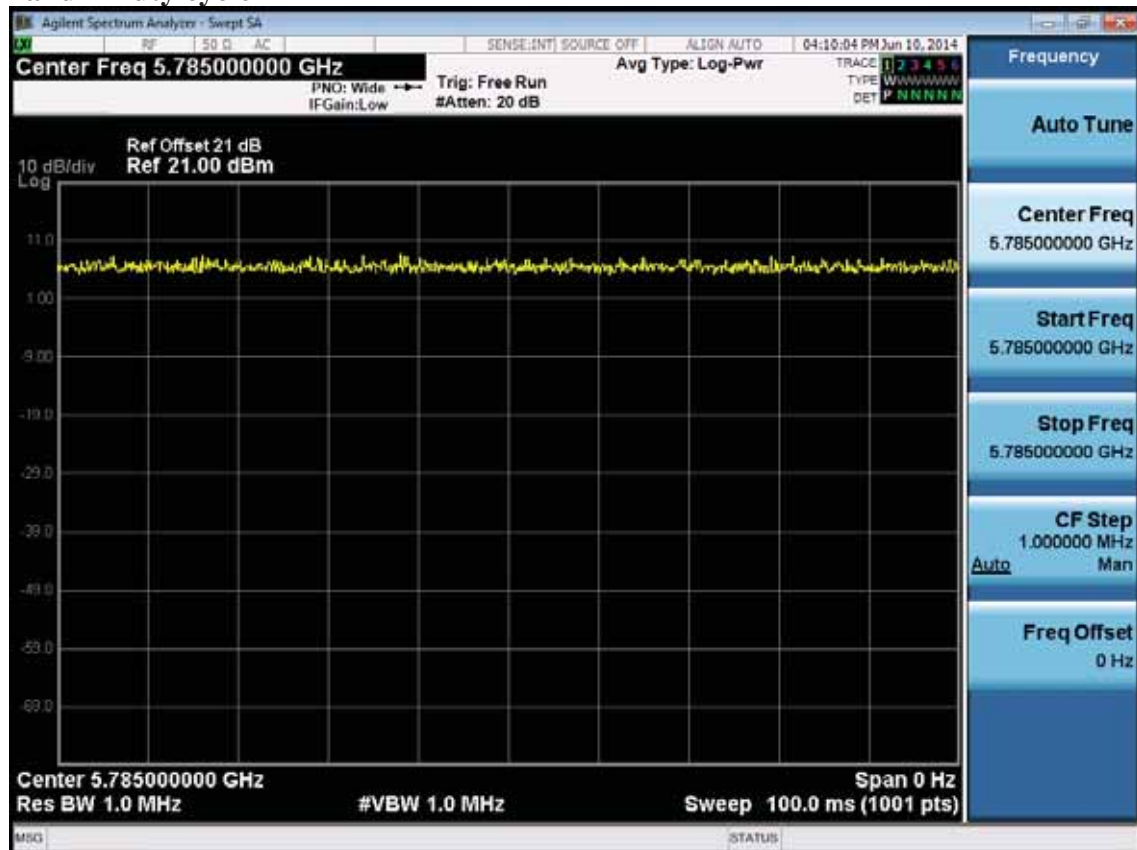

Note: The Duty Cycle is close to 100%.

2.4G:
Frequency: 30MHz~1GHz

Data: 2 File: E:\2014 Report Data\TTP-LINK\ACS14Q0742.EM6 (4)

Date: 2014-05-17

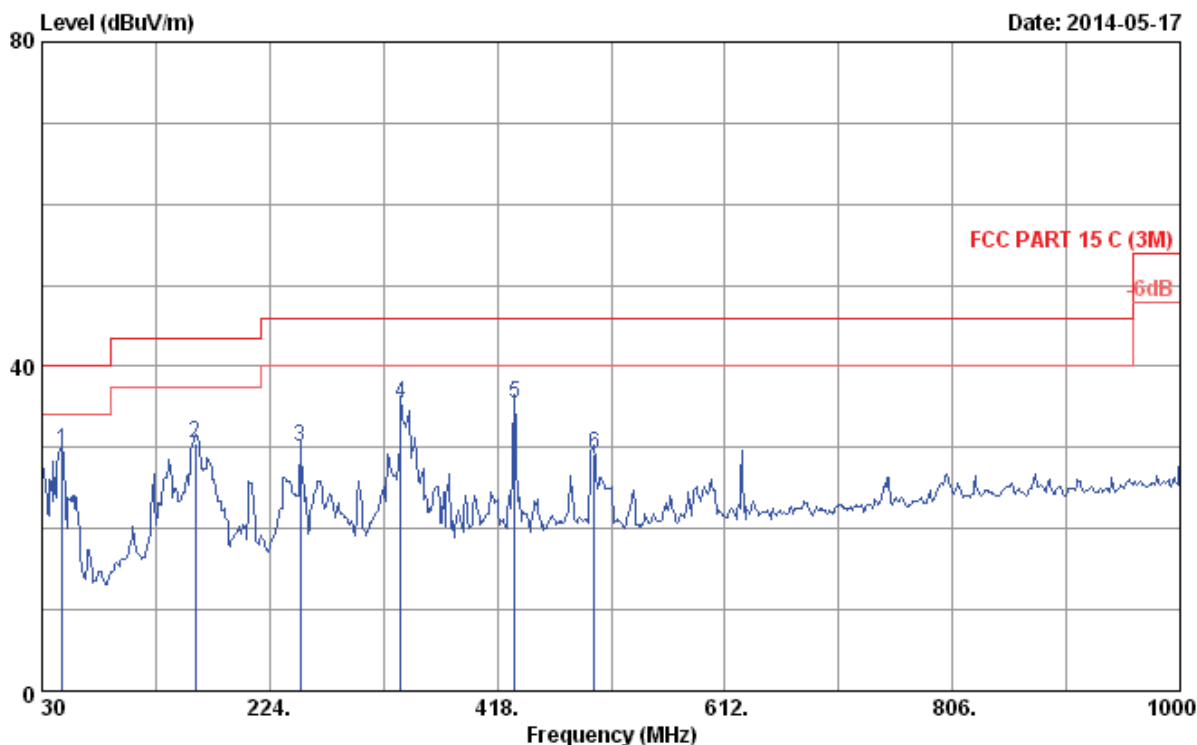

Site no. : 3m Chamber Data no. : 2
 Dis. / Ant. : 3m 2013 CBL6112D 35375 Ant. pol. : HORIZONTAL
 Limit : FCC PART 15 C (3M)
 Env. / Ins. : 22.5°C/47% Engineer : Even_Deng
 EUT : AC750 Wireless Dual Band Router
 Power rating : DC 12V From Adapter Input AC 120V/60Hz
 Test Mode : Tx Mode(2.4G)
 M/N:C20i

No.	Freq. (MHz)	Ant. Factor (dB/m)	Cable Loss (dB)	Reading (dBuV)	Emission Level (dBuV/m)	Limits (dBuV/m)	Margin (dB)	Remark
1	47.460	10.14	1.14	18.40	29.68	40.00	10.32	QP
2	160.950	10.75	1.64	18.19	30.58	43.50	12.92	QP
3	250.190	13.11	1.98	14.97	30.06	46.00	15.94	QP
4	335.550	14.82	2.27	18.34	35.43	46.00	10.57	QP
5	432.550	17.05	2.55	15.87	35.47	46.00	10.53	QP
6	500.450	18.01	2.75	8.50	29.26	46.00	16.74	QP

Remarks: 1. Emission Level= Antenna Factor + Cable Loss + Reading.
 2. The emission levels that are 20dB below the official limit are not reported.

Data: 1

File: E:\2014 Report Data\TP-LINK\ACS14Q0742.EM6 (4)

Date: 2014-05-17

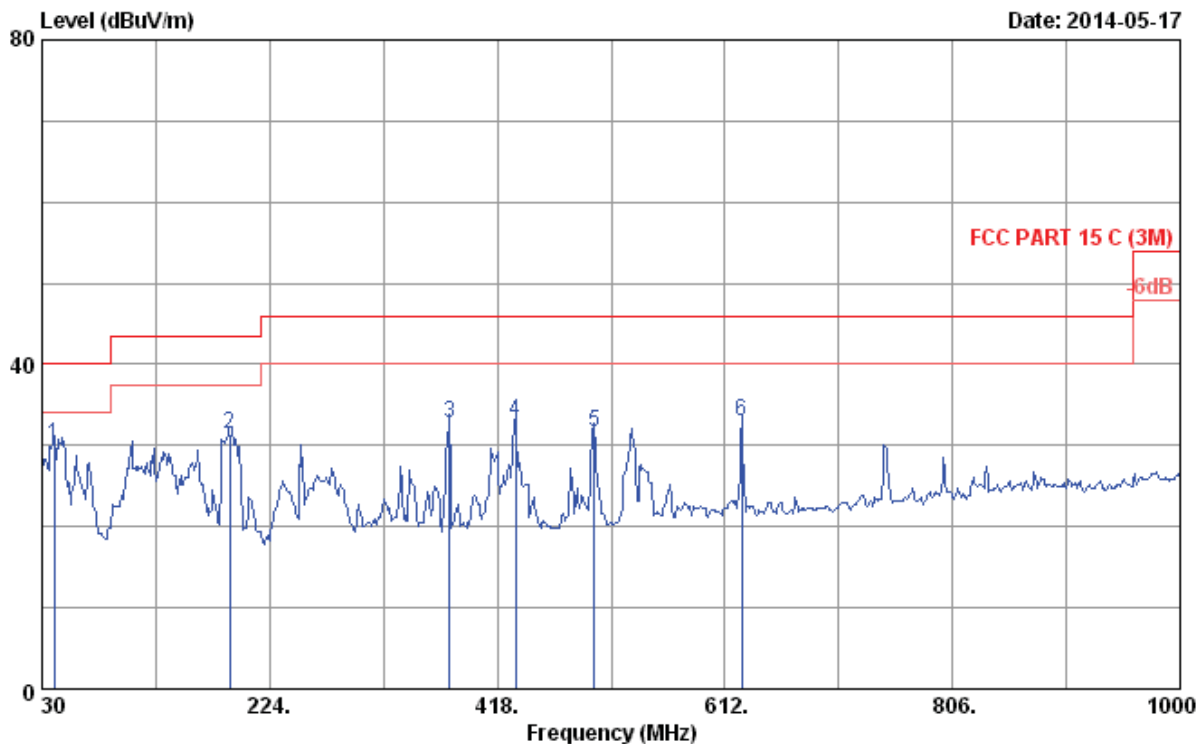

Site no. : 3m Chamber Data no. : 1
 Dis. / Ant. : 3m 2013 CBL6112D 35375 Ant. pol. : VERTICAL
 Limit : FCC PART 15 C (3M)
 Env. / Ins. : 22.5°C/47% Engineer : Even_Deng
 EUT : AC750 Wireless Dual Band Router
 Power rating : DC 12V From Adapter Input AC 120V/60Hz
 Test Mode : Tx Mode (2.4G)
 M/N:C20i

No.	Freq. (MHz)	Ant. Factor (dB/m)	Cable Loss (dB)	Reading (dBuV)	Emission Level (dBuV/m)	Limits (dBuV/m)	Margin (dB)	Remark
1	40.670	13.70	1.02	15.46	30.18	40.00	9.82	QP
2	190.050	9.70	1.75	19.94	31.39	43.50	12.11	QP
3	377.260	15.85	2.39	14.53	32.77	46.00	13.23	QP
4	433.520	17.03	2.56	13.33	32.92	46.00	13.08	QP
5	500.450	18.01	2.75	10.98	31.74	46.00	14.26	QP
6	626.550	19.53	3.11	10.26	32.90	46.00	13.10	QP

Remarks: 1. Emission Level= Antenna Factor + Cable Loss + Reading.
 2. The emission levels that are 20dB below the official limit are not reported.

UNII Band 4:
Frequency: 30MHz~1GHz

Data: 4 File: E:\2014 Report Data\TP-LINK\ACS14Q0742.EM6 (4)

Date: 2014-05-17

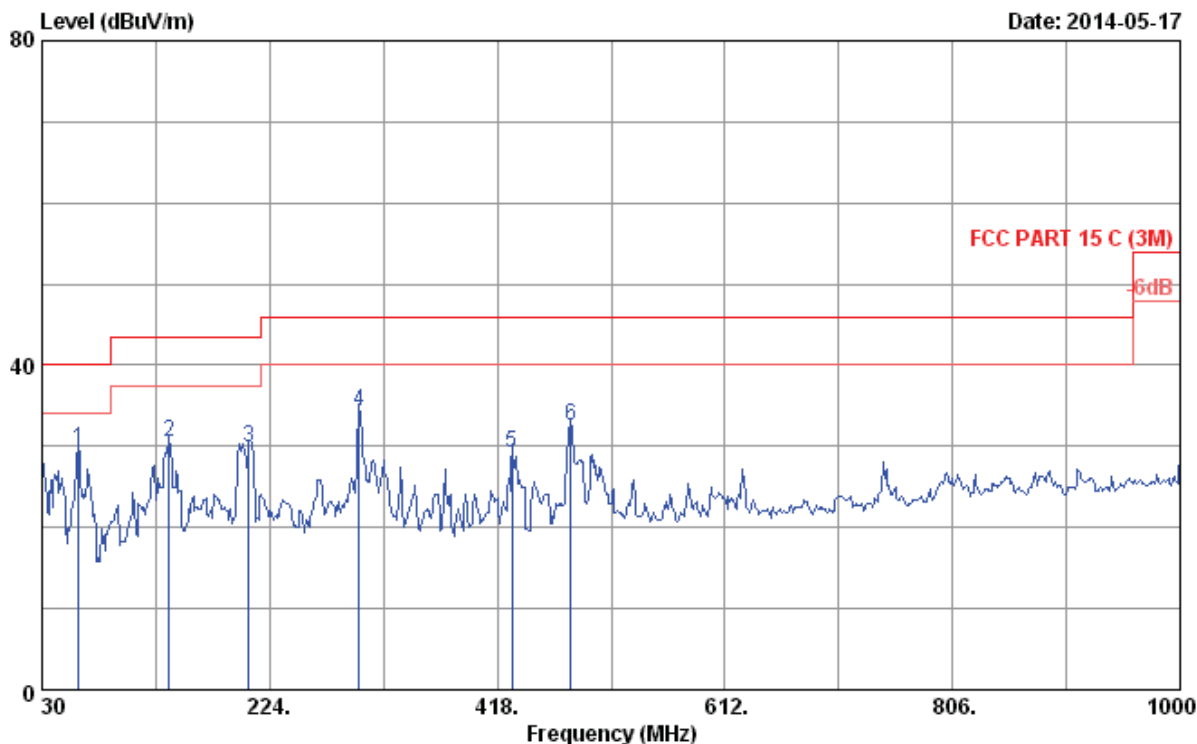

Site no. : 3m Chamber Data no. : 4
 Dis. / Ant. : 3m 2013 CBL6112D 35375 Ant. pol. : HORIZONTAL
 Limit : FCC PART 15 C (3M)
 Env. / Ins. : 22.5°C/47% Engineer : Even_Deng
 EUT : AC750 Wireless Dual Band Router
 Power rating : DC 12V From Adapter Input AC 120V/60Hz
 Test Mode : Tx Mode (5G)
 M/N:C20i

No.	Freq. (MHz)	Ant. Factor (dB/m)	Cable Loss (dB)	Reading (dBuV)	Emission Level (dBuV/m)	Limits (dBuV/m)	Margin (dB)	Remark
1	61.040	6.65	1.24	21.82	29.71	40.00	10.29	QP
2	138.640	12.20	1.56	16.71	30.47	43.50	13.03	QP
3	206.540	10.70	1.81	17.32	29.83	43.50	13.67	QP
4	300.630	14.01	2.17	18.03	34.21	46.00	11.79	QP
5	430.610	17.09	2.55	9.63	29.27	46.00	16.73	QP
6	481.050	17.80	2.70	12.03	32.53	46.00	13.47	QP

Remarks: 1. Emission Level= Antenna Factor + Cable Loss + Reading.
 2. The emission levels that are 20dB below the official limit are not reported.

Data: 3

File: E:\2014 Report Data\TP-LINK\ACS14Q0742.EM6 (4)

Date: 2014-05-17

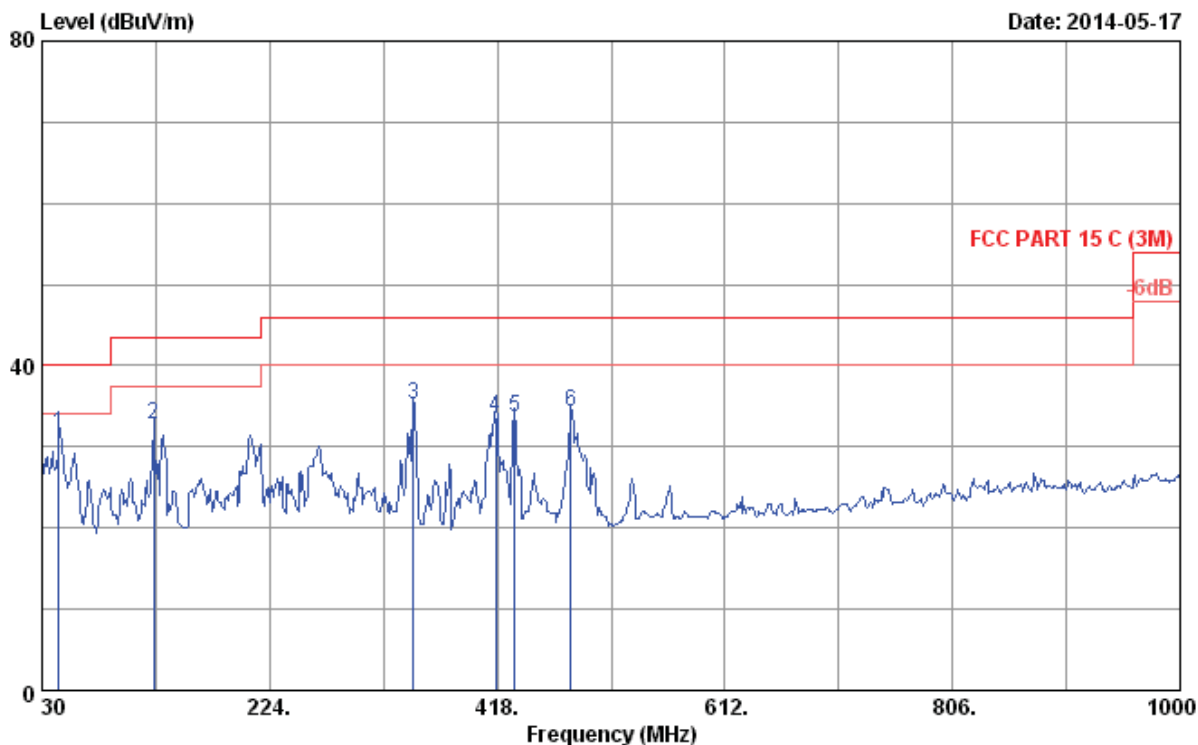

Site no. : 3m Chamber Data no. : 3
 Dis. / Ant. : 3m 2013 CBL6112D 35375 Ant. pol. : VERTICAL
 Limit : FCC PART 15 C (3M)
 Env. / Ins. : 22.5°C/47% Engineer : Even_Deng
 EUT : AC750 Wireless Dual Band Router
 Power rating : DC 12V From Adapter Input AC 120V/60Hz
 Test Mode : Tx Mode (5G)
 M/N:C20i

No.	Freq. (MHz)	Ant. Factor (dB/m)	Cable Loss (dB)	Reading (dBuV)	Emission Level (dBuV/m)	Limits (dBuV/m)	Margin (dB)	Remark
1	44.550	11.53	1.09	19.03	31.65	40.00	8.35	QP
2	125.060	12.90	1.51	18.27	32.68	43.50	10.82	QP
3	346.220	15.17	2.30	17.72	35.19	46.00	10.81	QP
4	417.030	17.34	2.51	13.73	33.58	46.00	12.42	QP
5	432.550	17.05	2.55	14.08	33.68	46.00	12.32	QP
6	481.050	17.80	2.70	13.73	34.23	46.00	11.77	QP

Remarks: 1. Emission Level= Antenna Factor + Cable Loss + Reading.
 2. The emission levels that are 20dB below the official limit are not reported.

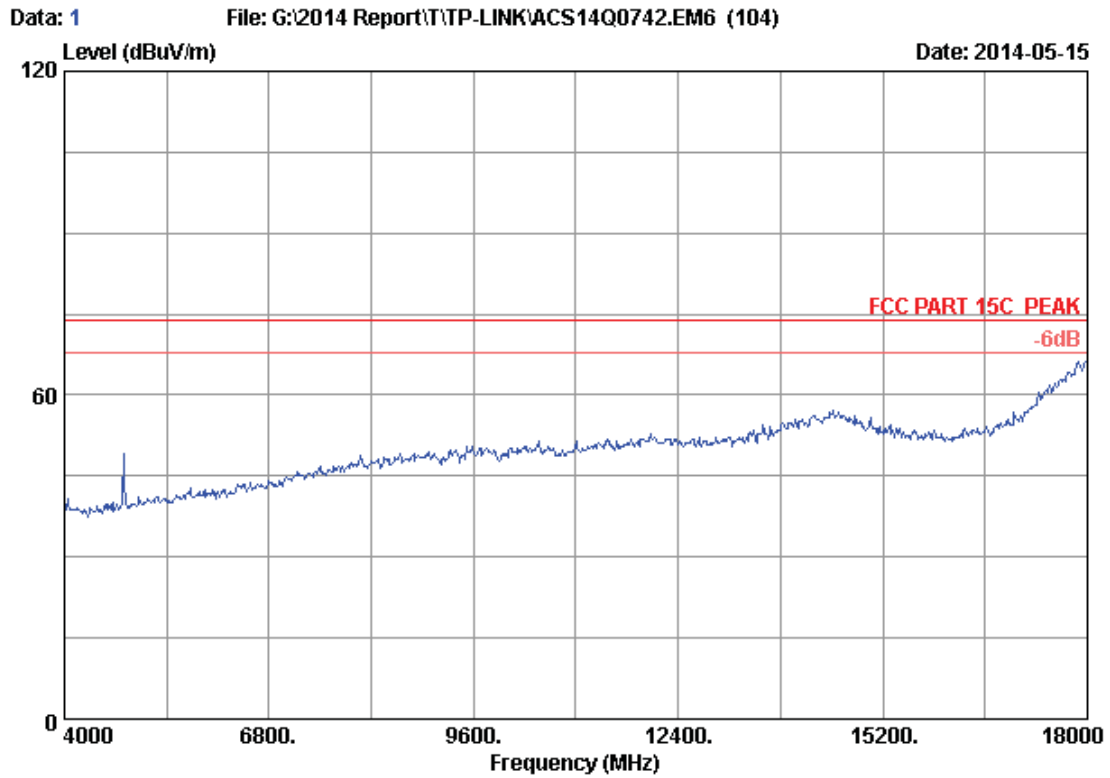
2.4G:**Frequency: 1GHz~18GHz**

Site no. : 3m Chamber Data no. : 1
Dis. / Ant. : 3m 2013 3115 (4580) Ant. pol. : VERTICAL
Limit : FCC PART 15C PEAK
Env. / Ins. : 24°C/56% Engineer : Kevin_Hu
EUT : AC750 Wireless Dual Band Router
Power Rating : DC 12V From Adapter Input AC 120V/60Hz
Test Mode : IEEE802.11b 2412MHz Tx Mode
M/N : C20i

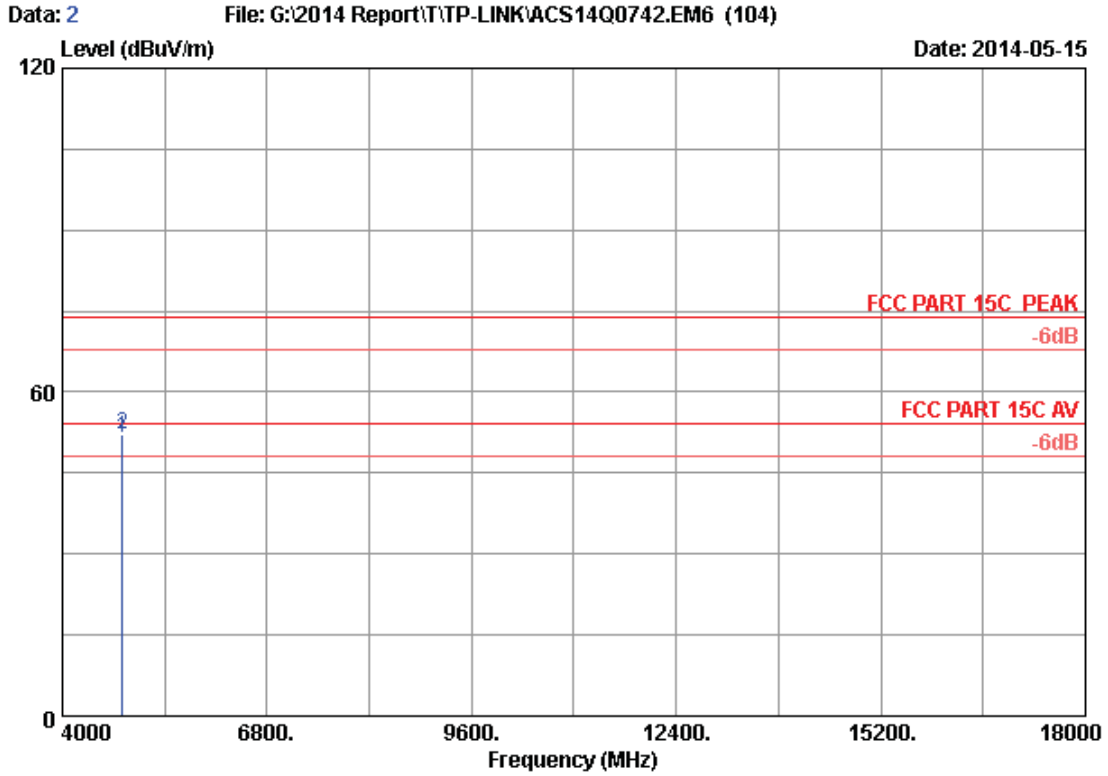

Site no. : 3m Chamber Data no. : 2
 Dis. / Ant. : 3m 2013 3115 (4580) Ant. pol. : VERTICAL
 Limit : FCC PART 15C PEAK
 Env. / Ins. : 24*C/56% Engineer : Kevin_Hu
 EUT : AC750 Wireless Dual Band Router
 Power Rating : DC 12V From Adapter Input AC 120V/60Hz
 Test Mode : IEEE802.11b 2412MHz Tx Mode
 M/N : C20i

No.	Freq. (MHz)	Ant. Factor (dB/m)	Cable Loss (dB)	AMP factor (dB)	Reading (dBuV)	Emission Level (dBuV/m)	Limits (dBuV/m)	Margin (dB)	Remark
1	4824.000	32.88	8.58	35.70	45.84	51.60	54.00	2.40	Average
2	4824.000	32.88	8.58	35.70	46.45	52.21	74.00	21.79	Peak

Remarks: 1. Emission Level= Antenna Factor + Cable Loss + Reading -Amp Factor
 2. The emission levels that are 20dB below the official limit are not reported.

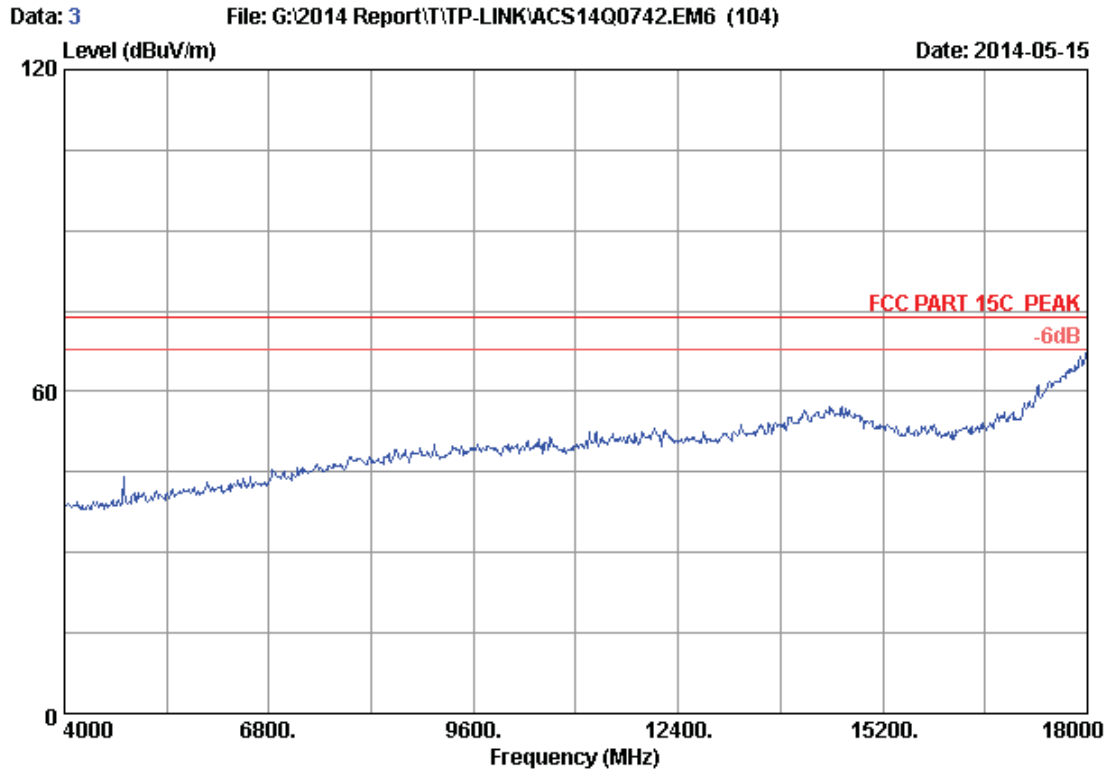

Site no. : 3m Chamber Data no. : 3
Dis. / Ant. : 3m 2013 3115 (4580) Ant. pol. : HORIZONTAL
Limit : FCC PART 15C PEAK
Env. / Ins. : 24°C/56% Engineer : Kevin_Hu
EUT : AC750 Wireless Dual Band Router
Power Rating : DC 12V From Adapter Input AC 120V/60Hz
Test Mode : IEEE802.11b 2412MHz Tx Mode
M/N : C20i

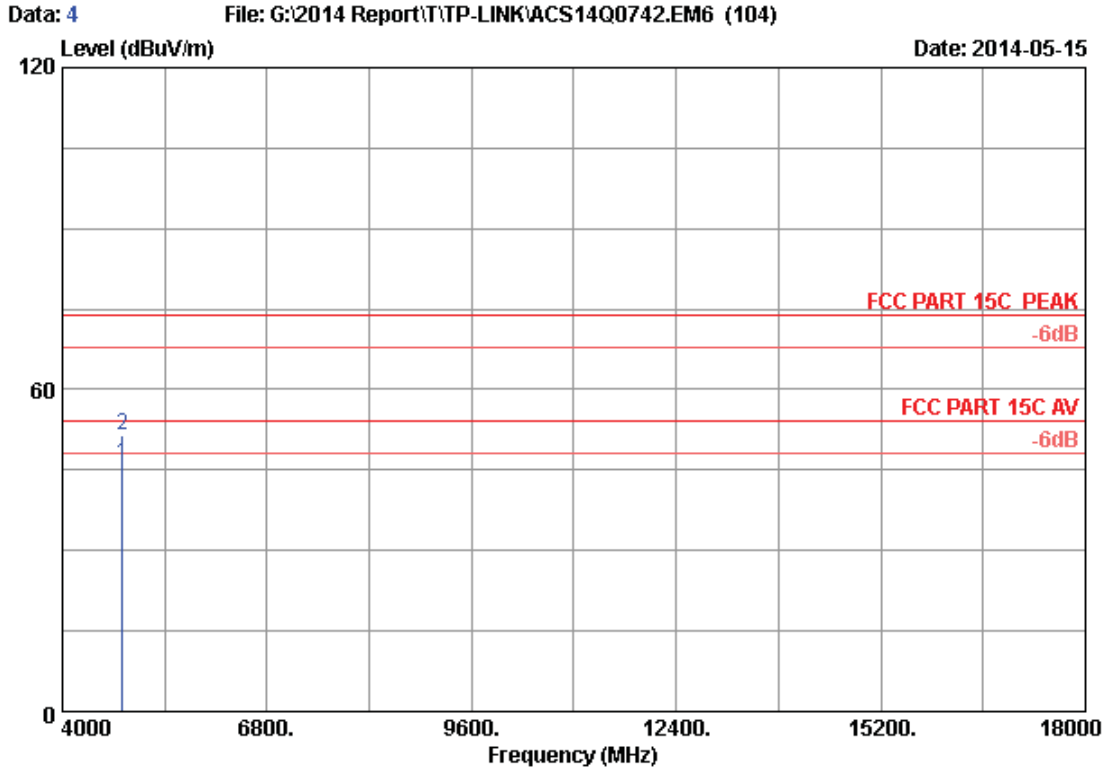

Site no. : 3m Chamber Data no. : 4
 Dis. / Ant. : 3m 2013 3115 (4580) Ant. pol. : HORIZONTAL
 Limit : FCC PART 15C PEAK
 Env. / Ins. : 24°C/56% Engineer : Kevin_Hu
 EUT : AC750 Wireless Dual Band Router
 Power Rating : DC 12V From Adapter Input AC 120V/60Hz
 Test Mode : IEEE802.11b 2412MHz Tx Mode
 M/N : C20i

No.	Freq. (MHz)	Ant. Factor (dB/m)	Cable Loss (dB)	AMP factor (dB)	Reading (dBUV)	Emission Level (dBUV/m)	Limits (dBUV/m)	Margin (dB)	Remark
1	4824.000	32.88	8.58	35.70	40.47	46.23	54.00	7.77	Average
2	4824.000	32.88	8.58	35.70	45.61	51.37	74.00	22.63	Peak

Remarks: 1. Emission Level= Antenna Factor + Cable Loss + Reading - Amp Factor
 2. The emission levels that are 20dB below the official limit are not reported.

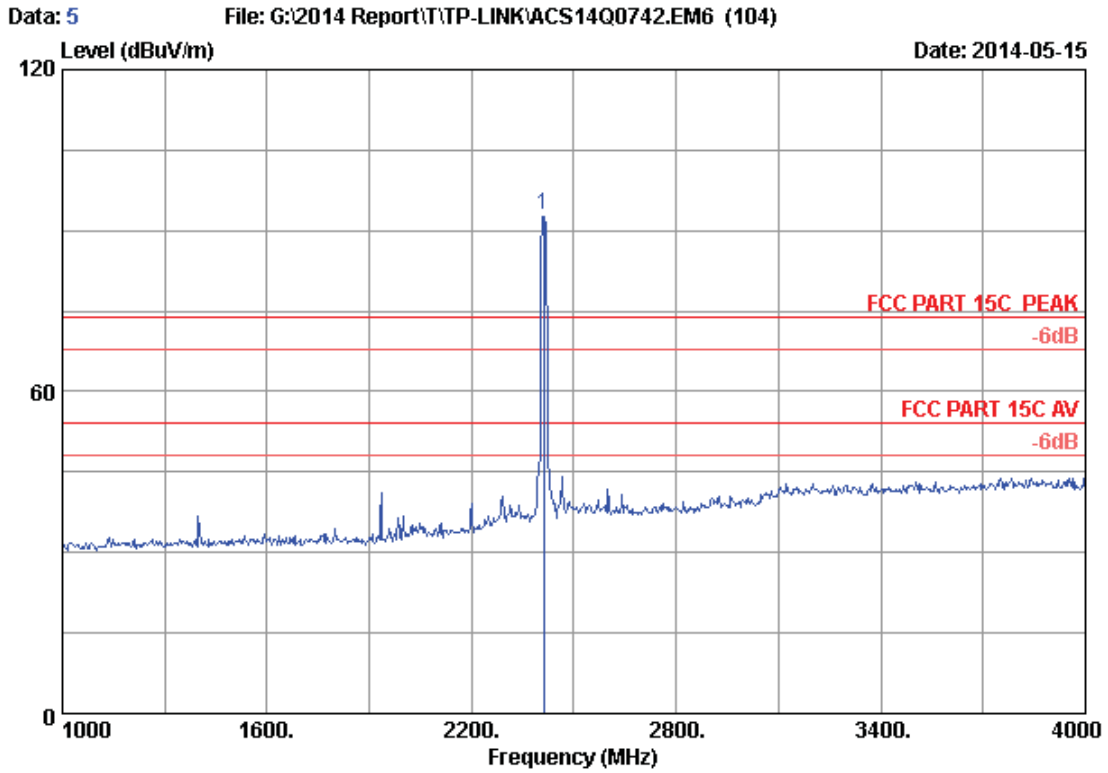

Site no. : 3m Chamber Data no. : 5
 Dis. / Ant. : 3m 2013 3115 (4580) Ant. pol. : VERTICAL
 Limit : FCC PART 15C PEAK
 Env. / Ins. : 24°C/56% Engineer : Kevin_Hu
 EUT : AC750 Wireless Dual Band Router
 Power Rating : DC 12V From Adapter Input AC 120V/60Hz
 Test Mode : IEEE802.11b 2412MHz Tx Mode
 M/N : C20i

No.	Freq. (MHz)	Ant. Factor (dB/m)	Cable Loss (dB)	AMP factor (dB)	Reading (dBuV)	Emission Level (dBuV/m)	Limits (dBuV/m)	Margin (dB)	Remark
1	2412.000	28.21	5.81	35.70	94.56	92.88	74.00	-18.88	Peak

Remarks: 1. Emission Level= Antenna Factor + Cable Loss + Reading - Amp Factor
 2. The emission levels that are 20dB below the official limit are not reported.

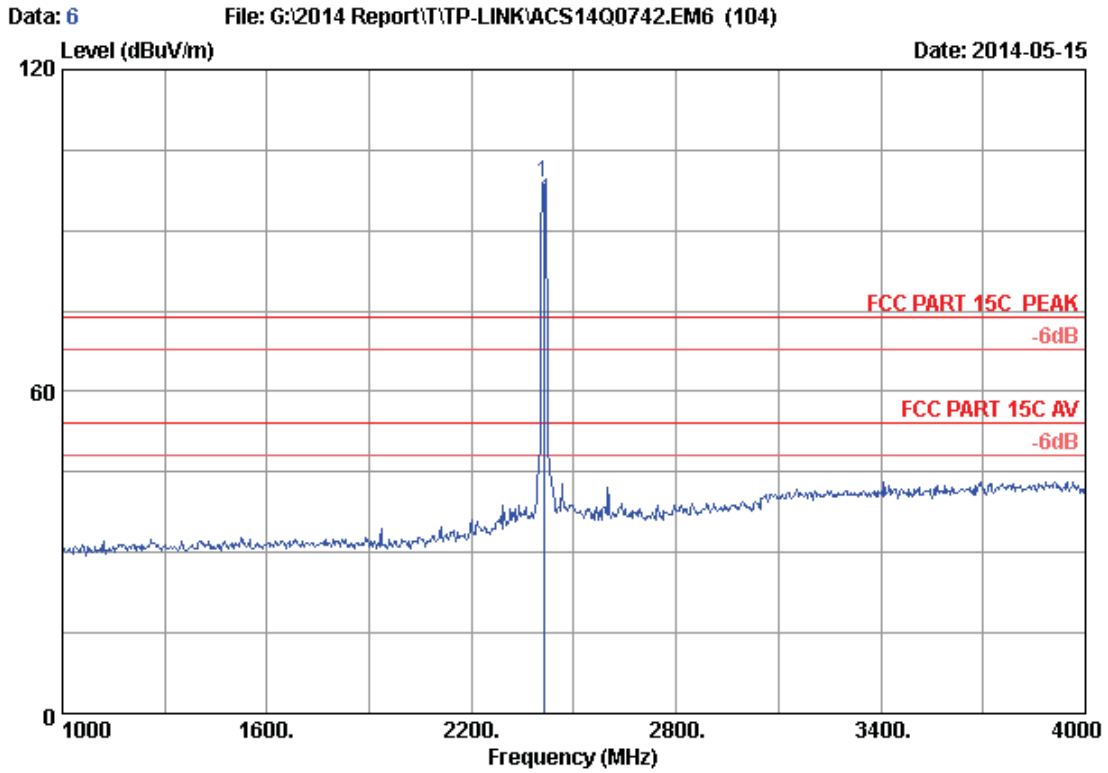

Site no. : 3m Chamber Data no. : 6
 Dis. / Ant. : 3m 2013 3115 (4580) Ant. pol. : HORIZONTAL
 Limit : FCC PART 15C PEAK
 Env. / Ins. : 24°C/56% Engineer : Kevin_Hu
 EUT : AC750 Wireless Dual Band Router
 Power Rating : DC 12V From Adapter Input AC 120V/60Hz
 Test Mode : IEEE802.11b 2412MHz Tx Mode
 M/N : C20i

No.	Freq. (MHz)	Ant. Factor (dB/m)	Cable Loss (dB)	AMP factor (dB)	Reading (dBuV)	Emission Level (dBuV/m)	Limits (dBuV/m)	Margin (dB)	Remark
1	2412.000	28.21	5.81	35.70	100.67	98.99	74.00	-24.99	Peak

Remarks: 1. Emission Level= Antenna Factor + Cable Loss + Reading - Amp Factor
 2. The emission levels that are 20dB below the official limit are not reported.

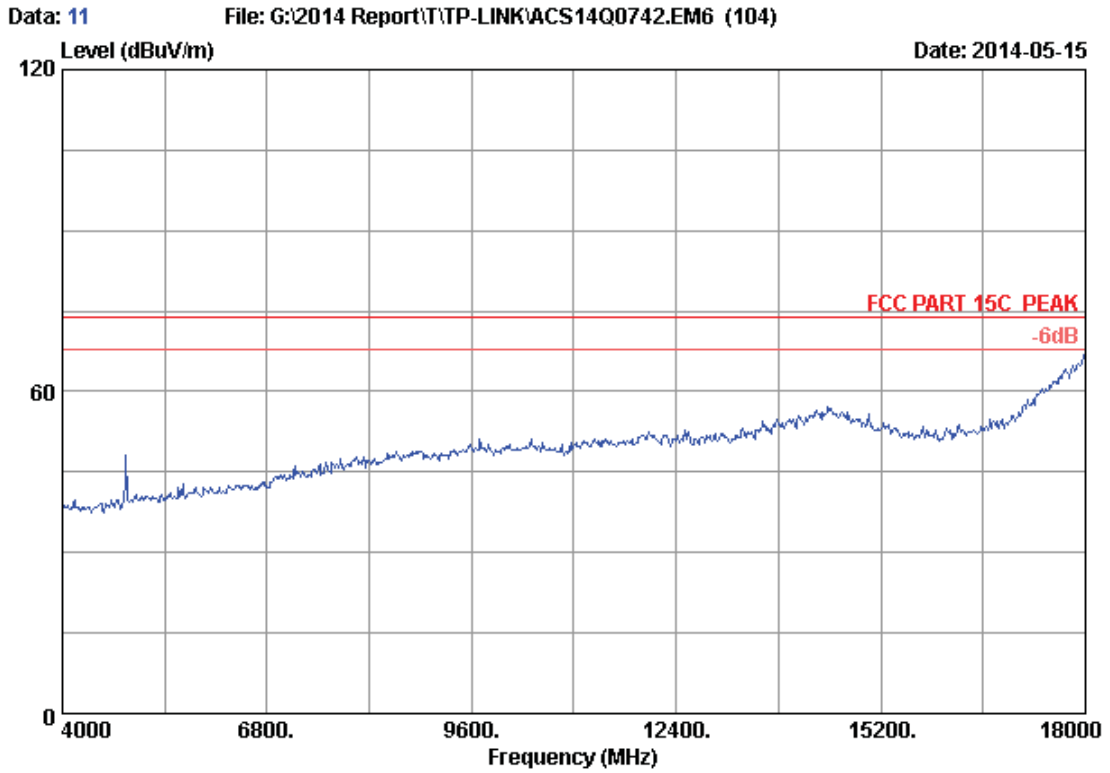

Site no. : 3m Chamber Data no. : 11
Dis. / Ant. : 3m 2013 3115 (4580) Ant. pol. : HORIZONTAL
Limit : FCC PART 15C PEAK
Env. / Ins. : 24°C/56% Engineer : Kevin_Hu
EUT : AC750 Wireless Dual Band Router
Power Rating : DC 12V From Adapter Input AC 120V/60Hz
Test Mode : IEEE802.11b 2437MHz Tx Mode
M/N : C20i

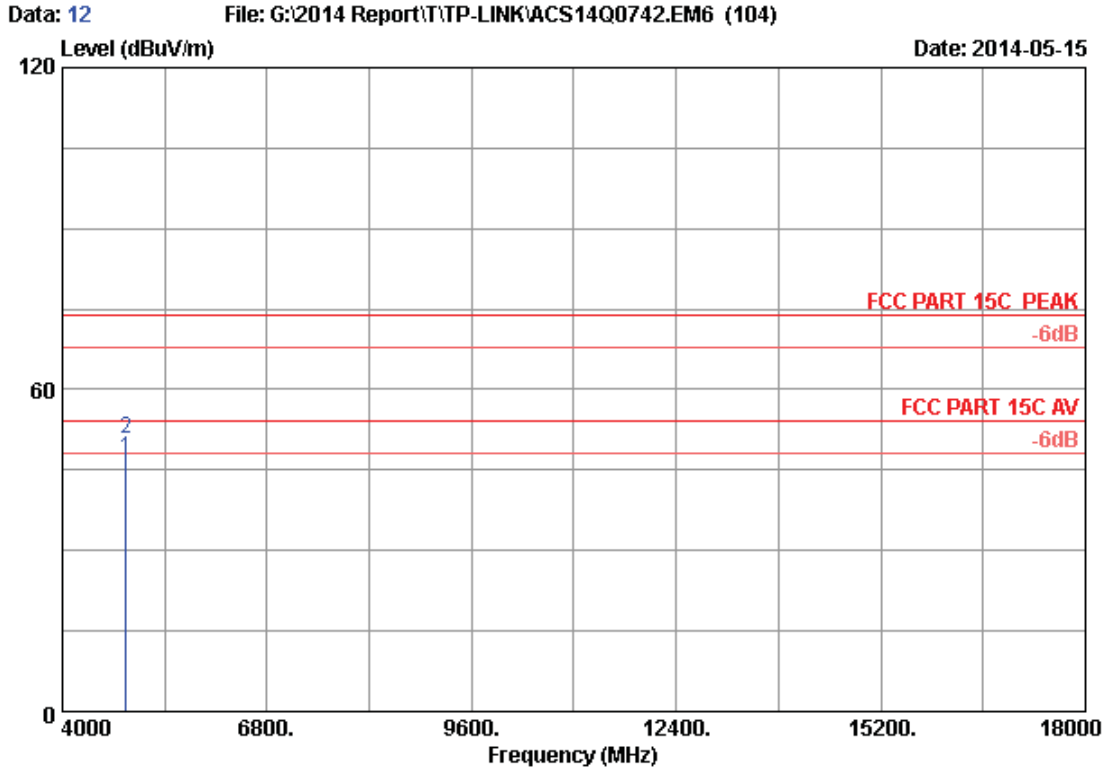

Site no. : 3m Chamber Data no. : 12
 Dis. / Ant. : 3m 2013 3115 (4580) Ant. pol. : HORIZONTAL
 Limit : FCC PART 15C PEAK
 Env. / Ins. : 24°C/56% Engineer : Kevin_Hu
 EUT : AC750 Wireless Dual Band Router
 Power Rating : DC 12V From Adapter Input AC 120V/60Hz
 Test Mode : IEEE802.11b 2437MHz Tx Mode
 M/N : C20i

No.	Freq. (MHz)	Ant. Factor (dB/m)	Cable Loss (dB)	AMP factor (dB)	Reading (dBuV)	Emission Level (dBuV/m)	Limits (dBuV/m)	Margin (dB)	Remark
1	4874.000	32.97	8.63	35.70	41.15	47.05	54.00	6.95	Average
2	4874.000	32.97	8.63	35.70	44.96	50.86	74.00	23.14	Peak

Remarks: 1. Emission Level= Antenna Factor + Cable Loss + Reading - Amp Factor
 2. The emission levels that are 20dB below the official limit are not reported.

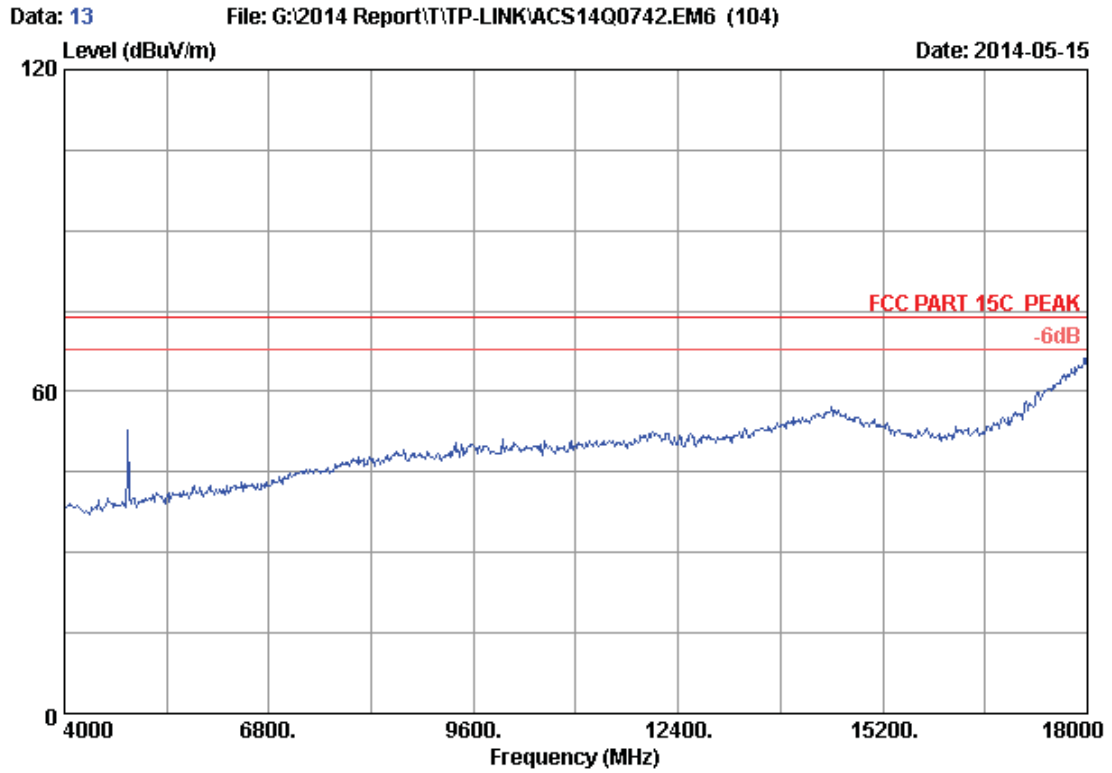

Site no. : 3m Chamber Data no. : 13
Dis. / Ant. : 3m 2013 3115 (4580) Ant. pol. : VERTICAL
Limit : FCC PART 15C PEAK
Env. / Ins. : 24°C/56% Engineer : Kevin_Hu
EUT : AC750 Wireless Dual Band Router
Power Rating : DC 12V From Adapter Input AC 120V/60Hz
Test Mode : IEEE802.11b 2437MHz Tx Mode
M/N : C20i

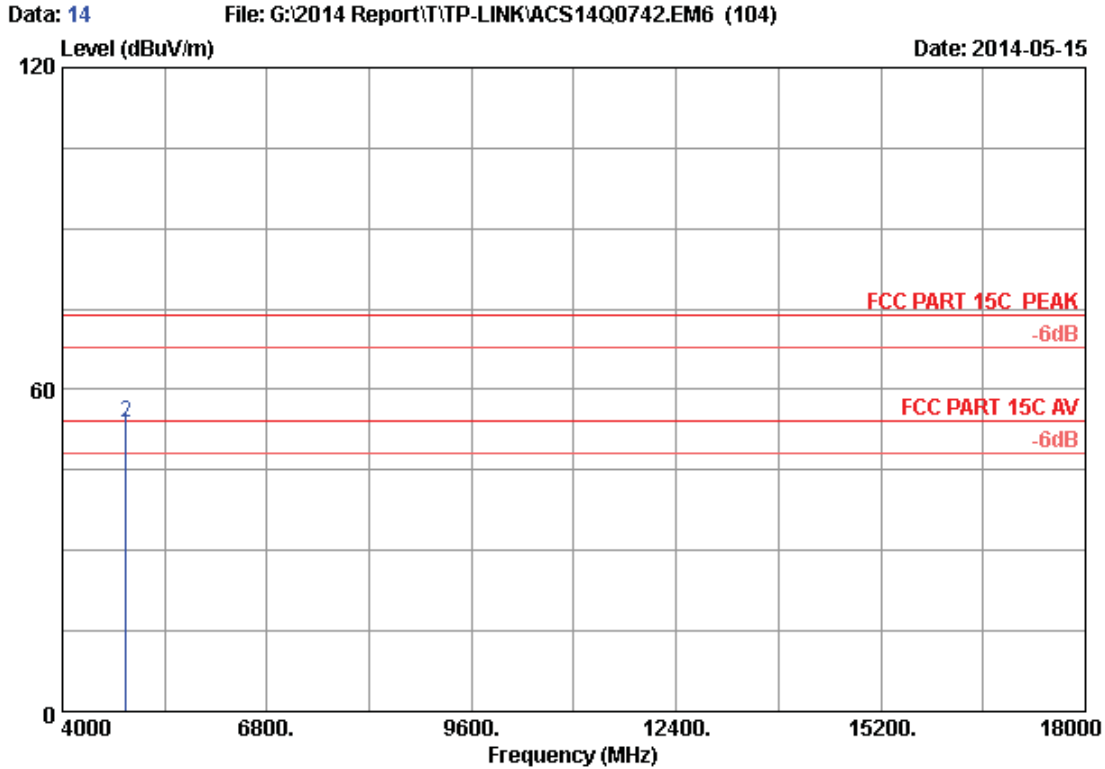

Site no. : 3m Chamber Data no. : 14
 Dis. / Ant. : 3m 2013 3115 (4580) Ant. pol. : VERTICAL
 Limit : FCC PART 15C PEAK
 Env. / Ins. : 24°C/56% Engineer : Kevin_Hu
 EUT : AC750 Wireless Dual Band Router
 Power Rating : DC 12V From Adapter Input AC 120V/60Hz
 Test Mode : IEEE802.11b 2437MHz Tx Mode
 M/N : C20i

No.	Freq. (MHz)	Ant. Factor (dB/m)	Cable Loss (dB)	AMP factor (dB)	Reading (dBuV)	Emission Level (dBuV/m)	Limits (dBuV/m)	Margin (dB)	Remark
1	4874.000	32.97	8.63	35.70	45.76	51.66	54.00	2.34	Average
2	4874.000	32.97	8.63	35.70	47.96	53.86	74.00	20.14	Peak

Remarks: 1. Emission Level= Antenna Factor + Cable Loss + Reading - Amp Factor
 2. The emission levels that are 20dB below the official limit are not reported.

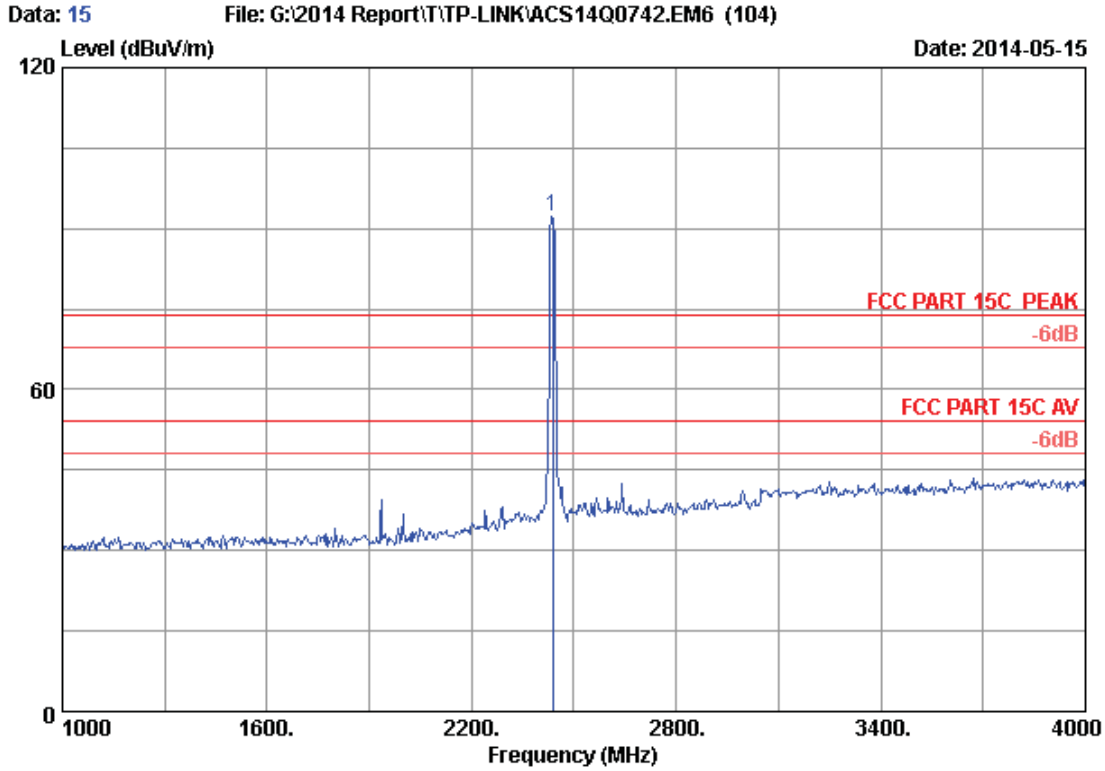

Site no. : 3m Chamber Data no. : 15
 Dis. / Ant. : 3m 2013 3115 (4580) Ant. pol. : VERTICAL
 Limit : FCC PART 15C PEAK
 Env. / Ins. : 24°C/56% Engineer : Kevin_Hu
 EUT : AC750 Wireless Dual Band Router
 Power Rating : DC 12V From Adapter Input AC 120V/60Hz
 Test Mode : IEEE802.11b 2437MHz Tx Mode
 M/N : C20i

No.	Freq. (MHz)	Ant. Factor (dB/m)	Cable Loss (dB)	AMP factor (dB)	Reading (dBuV)	Emission Level (dBuV/m)	Limits (dBuV/m)	Margin (dB)	Remark
1	2437.000	28.26	5.85	35.70	93.73	92.14	74.00	-18.14	Peak

Remarks: 1. Emission Level= Antenna Factor + Cable Loss + Reading - Amp Factor
 2. The emission levels that are 20dB below the official limit are not reported.

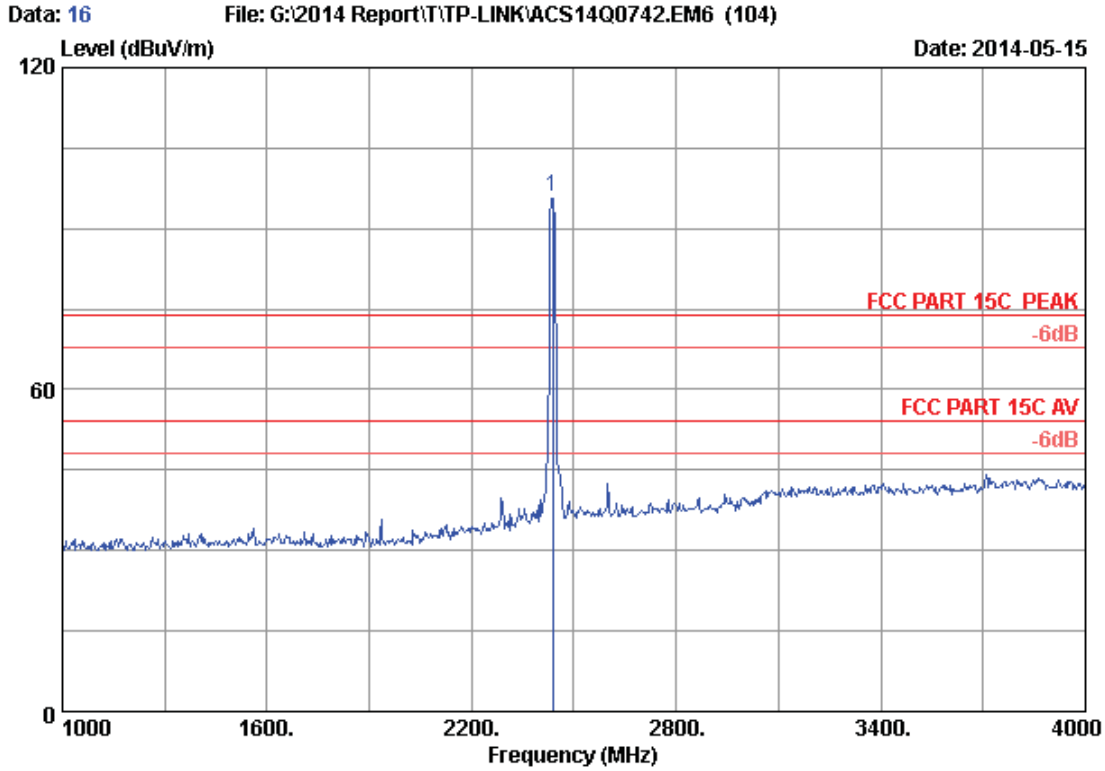

Site no. : 3m Chamber Data no. : 16
 Dis. / Ant. : 3m 2013 3115 (4580) Ant. pol. : HORIZONTAL
 Limit : FCC PART 15C PEAK
 Env. / Ins. : 24°C/56% Engineer : Kevin_Hu
 EUT : AC750 Wireless Dual Band Router
 Power Rating : DC 12V From Adapter Input AC 120V/60Hz
 Test Mode : IEEE802.11b 2437MHz Tx Mode
 M/N : C20i

No.	Freq. (MHz)	Ant. Factor (dB/m)	Cable Loss (dB)	AMP factor (dB)	Reading (dBuV)	Emission Level (dBuV/m)	Limits (dBuV/m)	Margin (dB)	Remark
1	2437.000	28.26	5.85	35.70	97.59	96.00	74.00	-22.00	Peak

Remarks: 1. Emission Level= Antenna Factor + Cable Loss + Reading - Amp Factor
 2. The emission levels that are 20dB below the official limit are not reported.

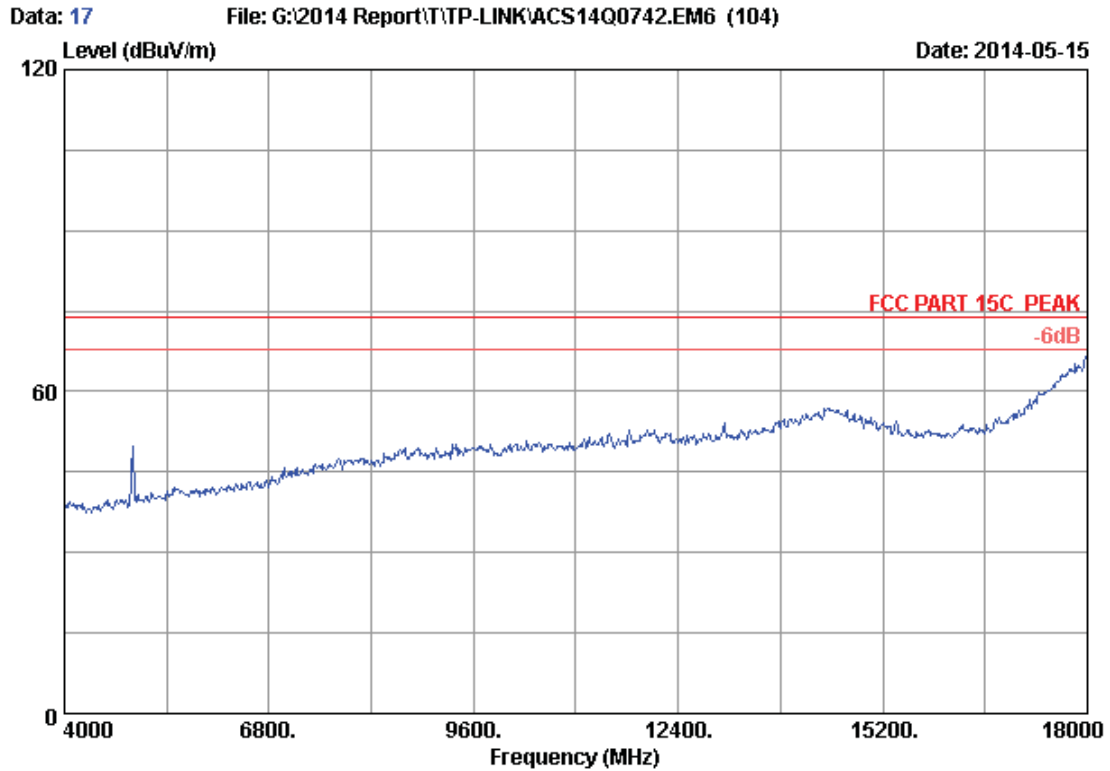

Site no. : 3m Chamber Data no. : 17
Dis. / Ant. : 3m 2013 3115 (4580) Ant. pol. : VERTICAL
Limit : FCC PART 15C PEAK
Env. / Ins. : 24°C/56% Engineer : Kevin_Hu
EUT : AC750 Wireless Dual Band Router
Power Rating : DC 12V From Adapter Input AC 120V/60Hz
Test Mode : IEEE802.11b 2462MHz Tx Mode
M/N : C20i

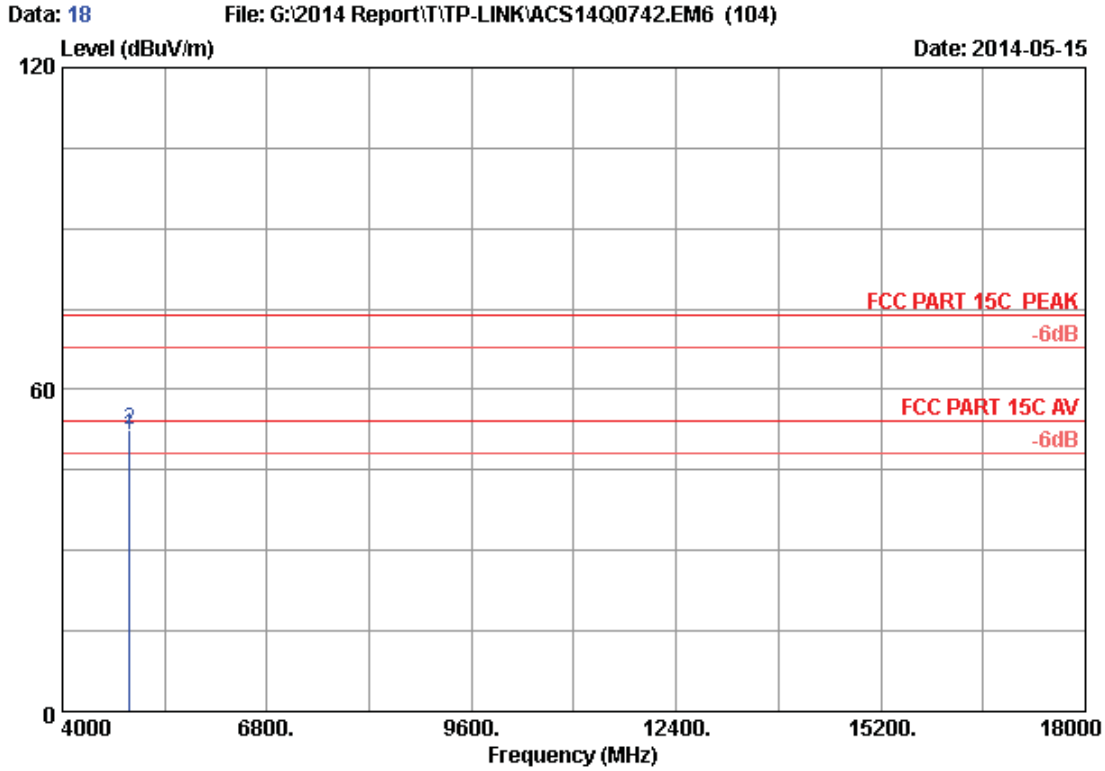

Site no. : 3m Chamber Data no. : 18
 Dis. / Ant. : 3m 2013 3115 (4580) Ant. pol. : VERTICAL
 Limit : FCC PART 15C PEAK
 Env. / Ins. : 24°C/56% Engineer : Kevin_Hu
 EUT : AC750 Wireless Dual Band Router
 Power Rating : DC 12V From Adapter Input AC 120V/60Hz
 Test Mode : IEEE802.11b 2462MHz Tx Mode
 M/N : C20i

No.	Freq. (MHz)	Ant. Factor (dB/m)	Cable Loss (dB)	AMP factor (dB)	Reading (dBuV)	Emission Level (dBuV/m)	Limits (dBuV/m)	Margin (dB)	Remark
1	4924.000	33.06	8.69	35.70	45.36	51.41	54.00	2.59	Average
2	4924.000	33.06	8.69	35.70	46.41	52.46	74.00	21.54	Peak

Remarks: 1. Emission Level= Antenna Factor + Cable Loss + Reading - Amp Factor
 2. The emission levels that are 20dB below the official limit are not reported.

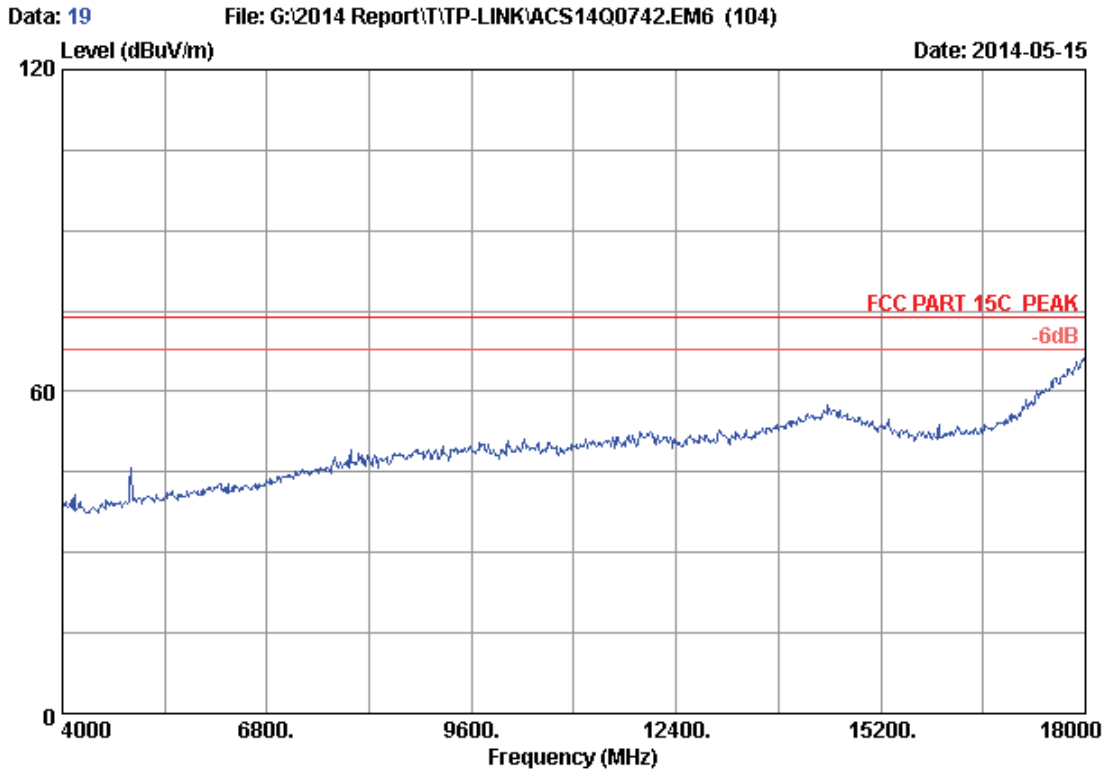

Site no.	: 3m Chamber	Data no.	: 19
Dis. / Ant.	: 3m 2013 3115 (4580)	Ant. pol.	: HORIZONTAL
Limit	: FCC PART 15C PEAK		
Env. / Ins.	: 24°C/56%	Engineer	: Kevin_Hu
EUT	: AC750 Wireless Dual Band Router		
Power Rating	: DC 12V From Adapter Input AC 120V/60Hz		
Test Mode	: IEEE802.11b 2462MHz Tx Mode		
M/N	: C20i		

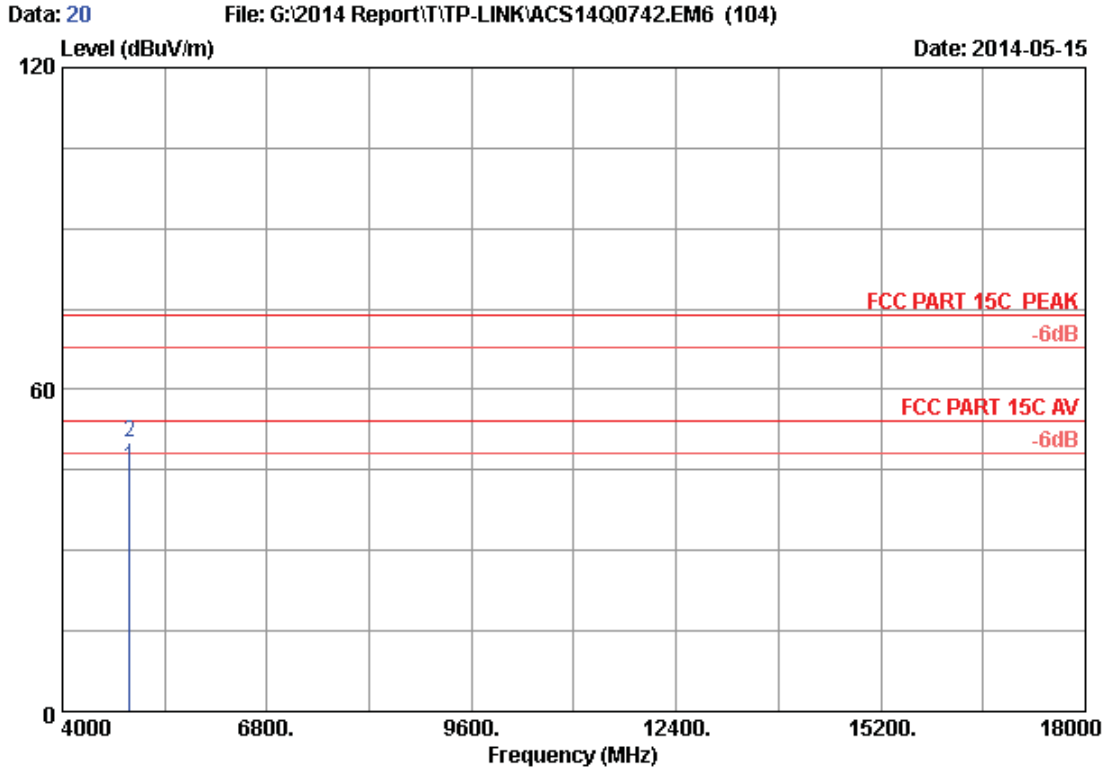

Site no. : 3m Chamber Data no. : 20
 Dis. / Ant. : 3m 2013 3115 (4580) Ant. pol. : HORIZONTAL
 Limit : FCC PART 15C PEAK
 Env. / Ins. : 24°C/56% Engineer : Kevin_Hu
 EUT : AC750 Wireless Dual Band Router
 Power Rating : DC 12V From Adapter Input AC 120V/60Hz
 Test Mode : IEEE802.11b 2462MHz Tx Mode
 M/N : C20i

No.	Freq. (MHz)	Ant. Factor (dB/m)	Cable Loss (dB)	AMP factor (dB)	Reading (dBuV)	Emission Level (dBuV/m)	Limits (dBuV/m)	Margin (dB)	Remark
1	4924.000	33.06	8.69	35.70	39.41	45.46	54.00	8.54	Average
2	4924.000	33.06	8.69	35.70	44.01	50.06	74.00	23.94	Peak

Remarks: 1. Emission Level= Antenna Factor + Cable Loss + Reading - Amp Factor
 2. The emission levels that are 20dB below the official limit are not reported.

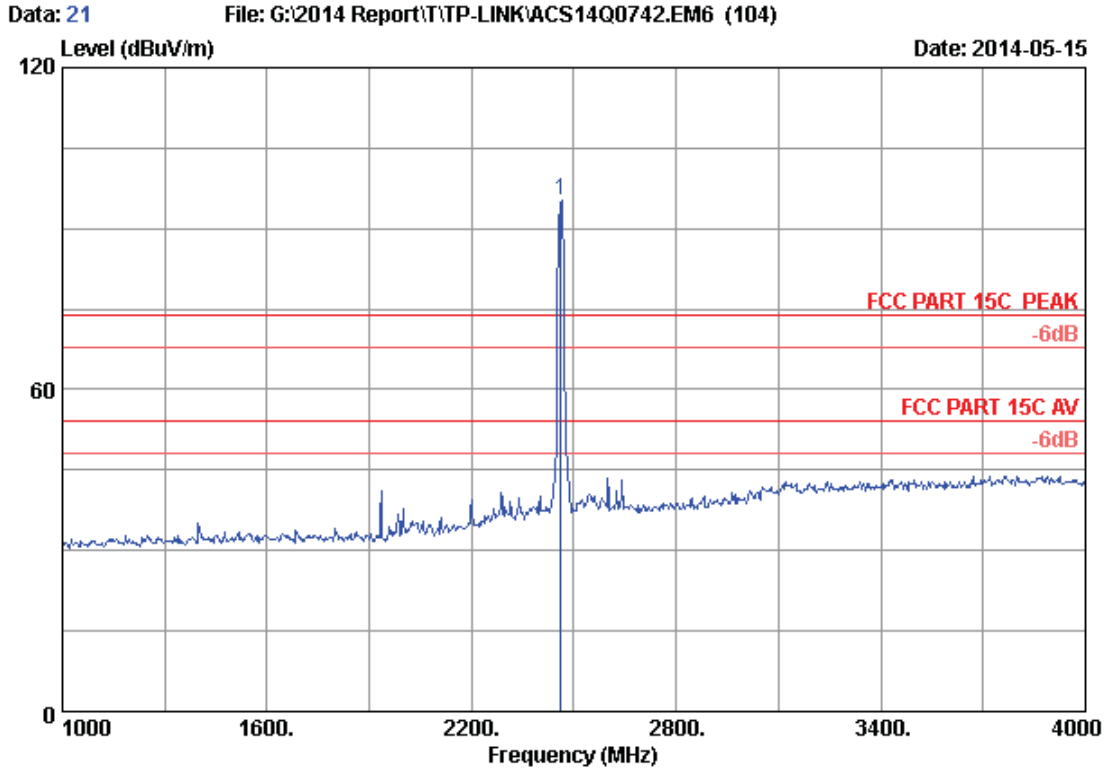

Site no. : 3m Chamber Data no. : 21
 Dis. / Ant. : 3m 2013 3115 (4580) Ant. pol. : VERTICAL
 Limit : FCC PART 15C PEAK
 Env. / Ins. : 24°C/56% Engineer : Kevin_Hu
 EUT : AC750 Wireless Dual Band Router
 Power Rating : DC 12V From Adapter Input AC 120V/60Hz
 Test Mode : IEEE802.11b 2462MHz Tx Mode
 M/N : C20i

No.	Freq. (MHz)	Ant. Factor (dB/m)	Cable Loss (dB)	AMP factor (dB)	Reading (dBuV)	Emission Level (dBuV/m)	Limits (dBuV/m)	Margin (dB)	Remark
1	2462.000	28.32	5.89	35.70	96.79	95.30	74.00	-21.30	Peak

Remarks: 1. Emission Level= Antenna Factor + Cable Loss + Reading - Amp Factor
 2. The emission levels that are 20dB below the official limit are not reported.

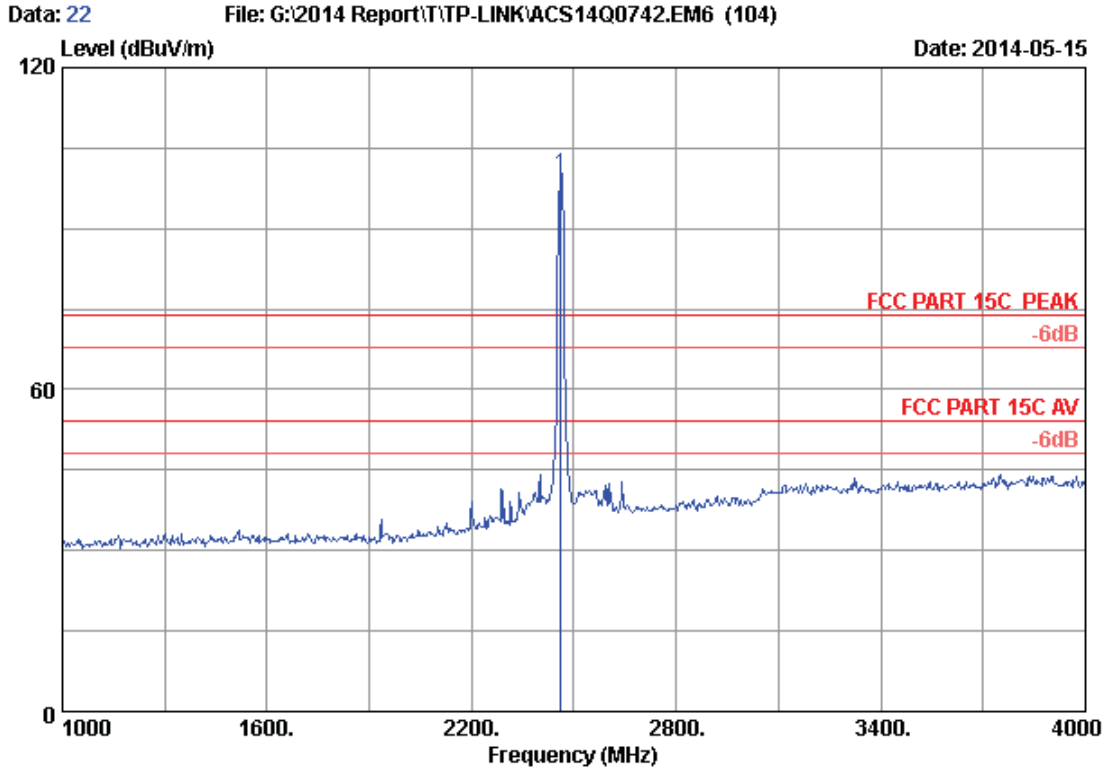

Site no. : 3m Chamber Data no. : 22
 Dis. / Ant. : 3m 2013 3115 (4580) Ant. pol. : HORIZONTAL
 Limit : FCC PART 15C PEAK
 Env. / Ins. : 24°C/56% Engineer : Kevin_Hu
 EUT : AC750 Wireless Dual Band Router
 Power Rating : DC 12V From Adapter Input AC 120V/60Hz
 Test Mode : IEEE802.11b 2462MHz Tx Mode
 M/N : C20i

No.	Freq. (MHz)	Ant. Factor (dB/m)	Cable Loss (dB)	AMP factor (dB)	Reading (dBUV)	Emission Level (dBUV/m)	Limits (dBUV/m)	Margin (dB)	Remark
1	2462.000	28.32	5.89	35.70	101.29	99.80	74.00	-25.80	Peak

Remarks: 1. Emission Level= Antenna Factor + Cable Loss + Reading - Amp Factor
 2. The emission levels that are 20dB below the official limit are not reported.

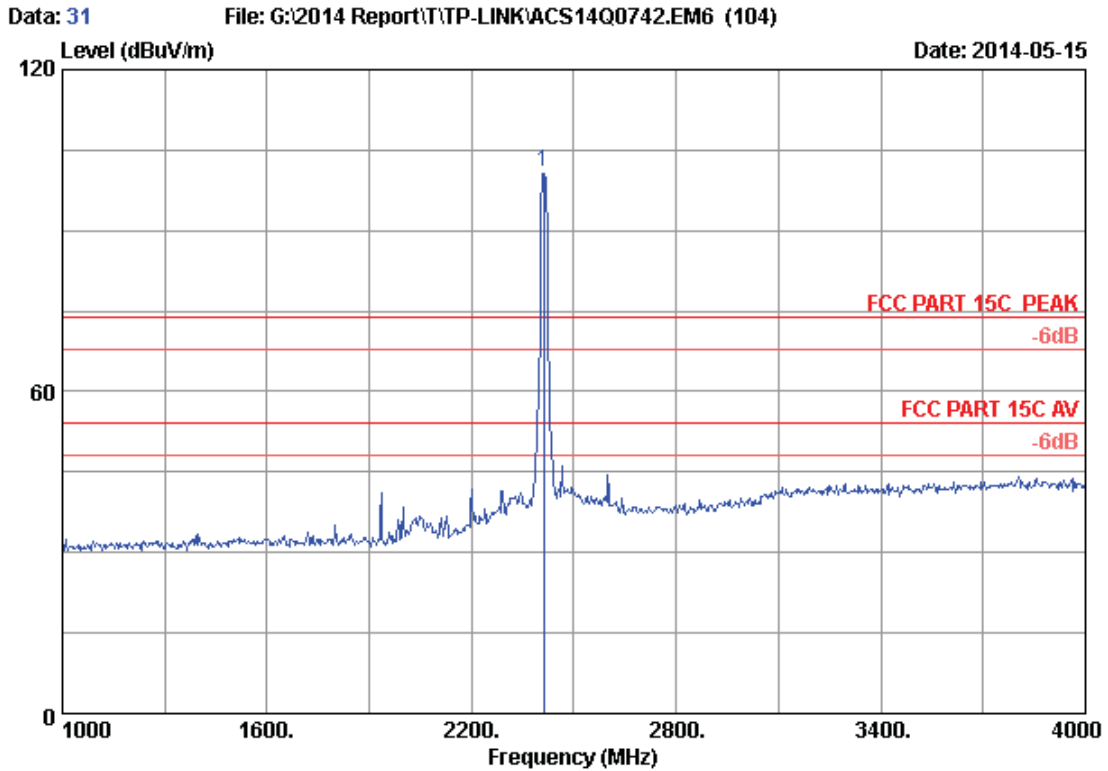

Site no. : 3m Chamber Data no. : 31
 Dis. / Ant. : 3m 2013 3115 (4580) Ant. pol. : VERTICAL
 Limit : FCC PART 15C PEAK
 Env. / Ins. : 24°C/56% Engineer : Kevin_Hu
 EUT : AC750 Wireless Dual Band Router
 Power Rating : DC 12V From Adapter Input AC 120V/60Hz
 Test Mode : IEEE802.11g 2412MHz Tx Mode
 M/N : C20i

No.	Freq. (MHz)	Ant. Factor (dB/m)	Cable Loss (dB)	AMP factor (dB)	Reading (dBuV)	Emission Level (dBuV/m)	Limits (dBuV/m)	Margin (dB)	Remark
1	2412.000	28.21	5.81	35.70	102.76	101.08	74.00	-27.08	Peak

Remarks: 1. Emission Level= Antenna Factor + Cable Loss + Reading - Amp Factor
 2. The emission levels that are 20dB below the official limit are not reported.

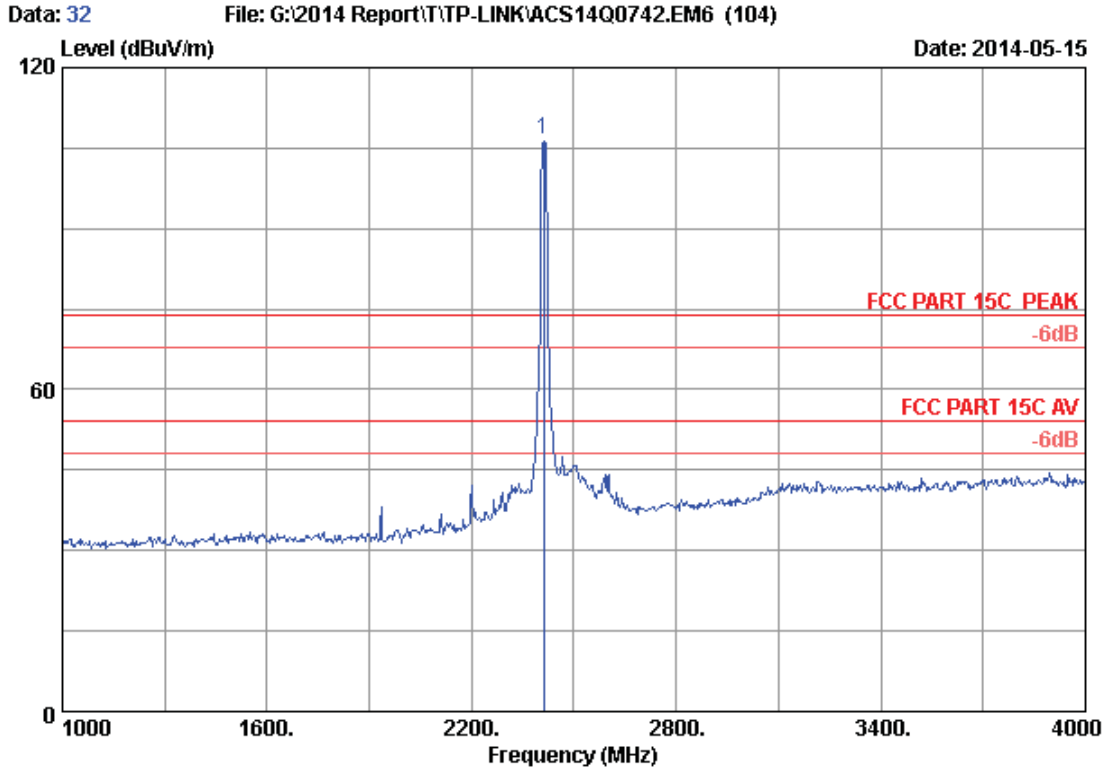

Site no. : 3m Chamber Data no. : 32
 Dis. / Ant. : 3m 2013 3115 (4580) Ant. pol. : HORIZONTAL
 Limit : FCC PART 15C PEAK
 Env. / Ins. : 24°C/56% Engineer : Kevin_Hu
 EUT : AC750 Wireless Dual Band Router
 Power Rating : DC 12V From Adapter Input AC 120V/60Hz
 Test Mode : IEEE802.11g 2412MHz Tx Mode
 M/N : C20i

No.	Freq. (MHz)	Ant. Factor (dB/m)	Cable Loss (dB)	AMP factor (dB)	Reading (dBuV)	Emission Level (dBuV/m)	Limits (dBuV/m)	Margin (dB)	Remark
1	2412.000	28.21	5.81	35.70	108.26	106.58	74.00	-32.58	Peak

Remarks: 1. Emission Level= Antenna Factor + Cable Loss + Reading - Amp Factor
 2. The emission levels that are 20dB below the official limit are not reported.

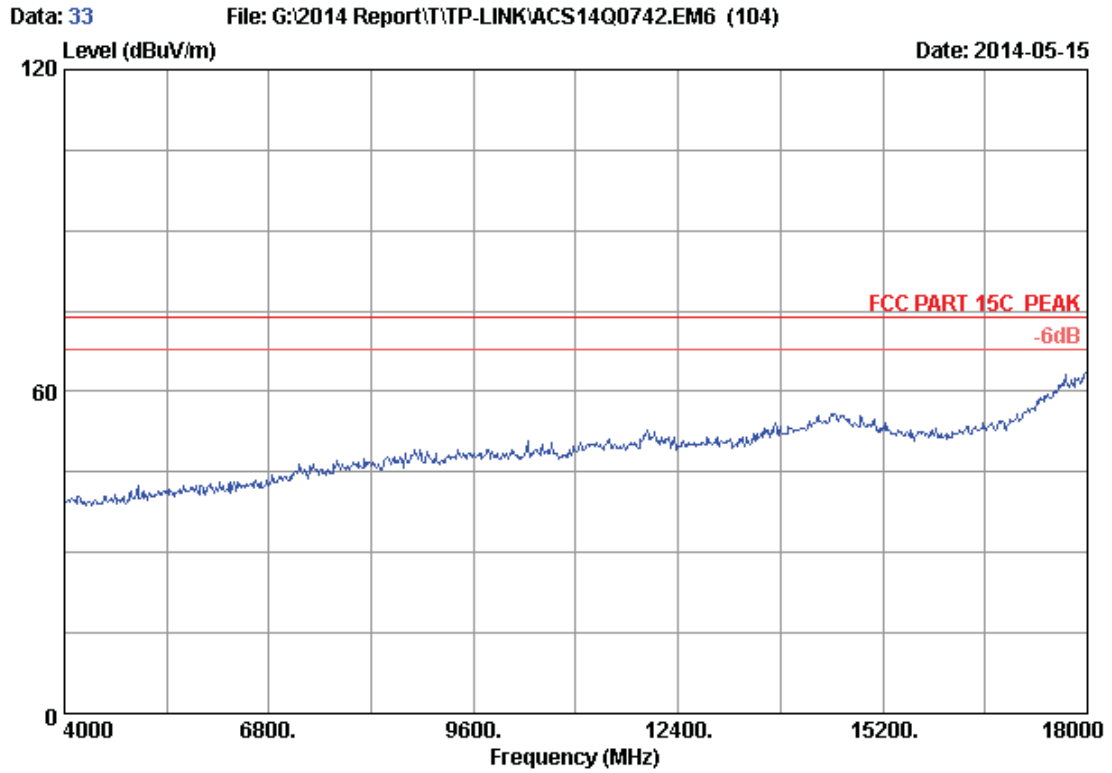

Site no. : 3m Chamber Data no. : 33
Dis. / Ant. : 3m 2013 3115 (4580) Ant. pol. : VERTICAL
Limit : FCC PART 15C PEAK
Env. / Ins. : 24°C/56% Engineer : Kevin_Hu
EUT : AC750 Wireless Dual Band Router
Power Rating : DC 12V From Adapter Input AC 120V/60Hz
Test Mode : IEEE802.11g 2412MHz Tx Mode
M/N : C20i

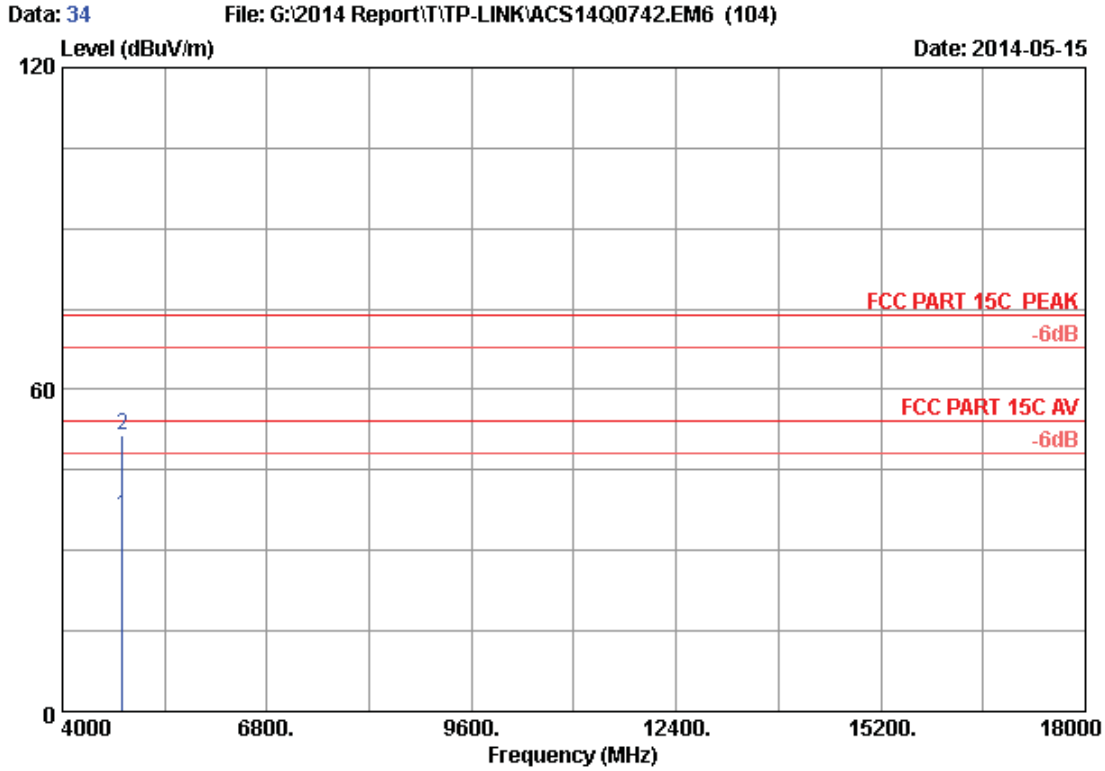

Site no. : 3m Chamber Data no. : 34
 Dis. / Ant. : 3m 2013 3115 (4580) Ant. pol. : VERTICAL
 Limit : FCC PART 15C PEAK
 Env. / Ins. : 24°C/56% Engineer : Kevin_Hu
 EUT : AC750 Wireless Dual Band Router
 Power Rating : DC 12V From Adapter Input AC 120V/60Hz
 Test Mode : IEEE802.11g 2412MHz Tx Mode
 M/N : C20i

No.	Freq. (MHz)	Ant. Factor (dB/m)	Cable Loss (dB)	AMP factor (dB)	Reading (dBuV)	Emission Level (dBuV/m)	Limits (dBuV/m)	Margin (dB)	Remark
1	4824.000	32.88	8.58	35.70	30.78	36.54	54.00	17.46	Average
2	4824.000	32.88	8.58	35.70	45.66	51.42	74.00	22.58	Peak

Remarks: 1. Emission Level= Antenna Factor + Cable Loss + Reading - Amp Factor
 2. The emission levels that are 20dB below the official limit are not reported.

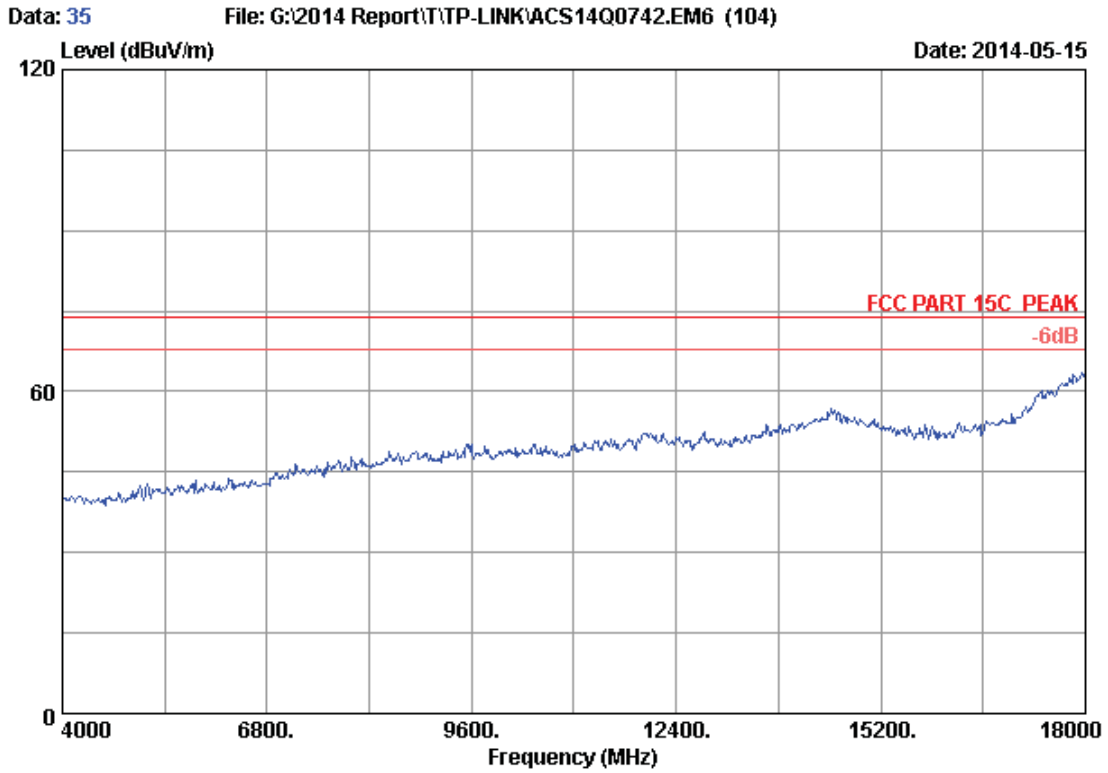

Site no.	: 3m Chamber	Data no.	: 35
Dis. / Ant.	: 3m 2013 3115 (4580)	Ant. pol.	: HORIZONTAL
Limit	: FCC PART 15C PEAK		
Env. / Ins.	: 24°C/56%	Engineer	: Kevin_Hu
EUT	: AC750 Wireless Dual Band Router		
Power Rating	: DC 12V From Adapter Input AC 120V/60Hz		
Test Mode	: IEEE802.11g 2412MHz Tx Mode		
M/N	: C20i		

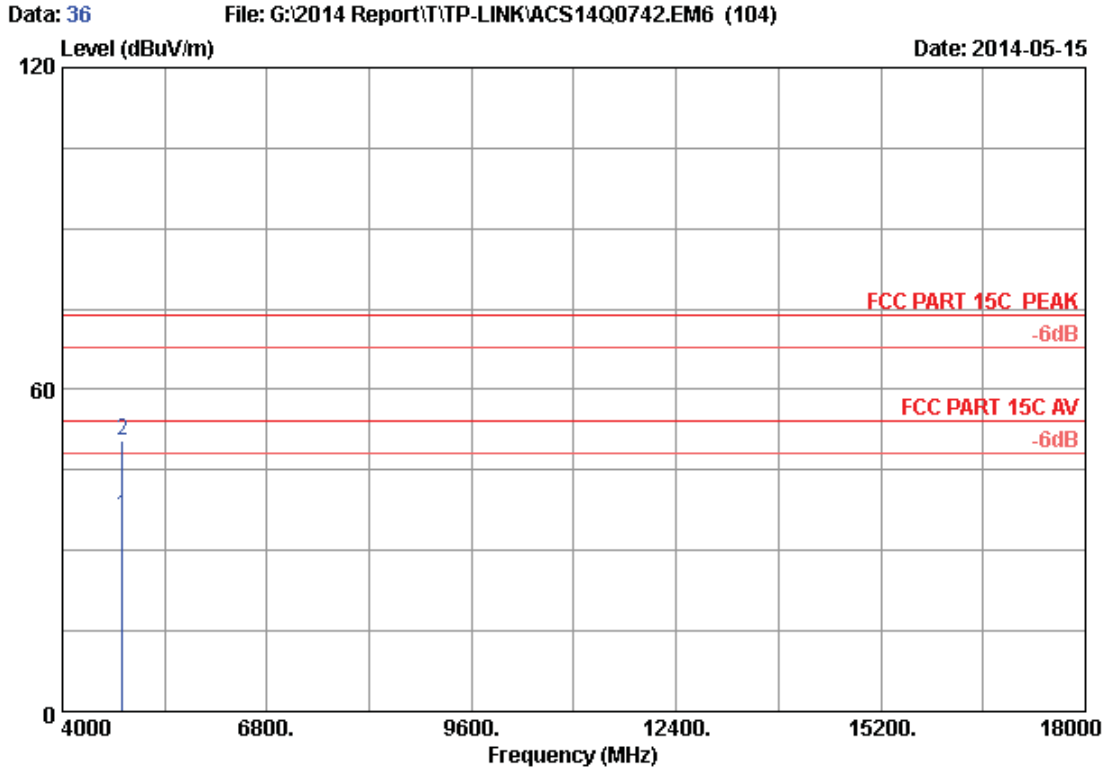

Site no. : 3m Chamber Data no. : 36
 Dis. / Ant. : 3m 2013 3115 (4580) Ant. pol. : HORIZONTAL
 Limit : FCC PART 15C PEAK
 Env. / Ins. : 24°C/56% Engineer : Kevin_Hu
 EUT : AC750 Wireless Dual Band Router
 Power Rating : DC 12V From Adapter Input AC 120V/60Hz
 Test Mode : IEEE802.11g 2412MHz Tx Mode
 M/N : C20i

No.	Freq. (MHz)	Ant. Factor (dB/m)	Cable Loss (dB)	AMP factor (dB)	Reading (dBuV)	Emission Level (dBuV/m)	Limits (dBuV/m)	Margin (dB)	Remark
1	4824.000	32.88	8.58	35.70	30.52	36.28	54.00	17.72	Average
2	4824.000	32.88	8.58	35.70	44.57	50.33	74.00	23.67	Peak

Remarks: 1. Emission Level= Antenna Factor + Cable Loss + Reading - Amp Factor
 2. The emission levels that are 20dB below the official limit are not reported.

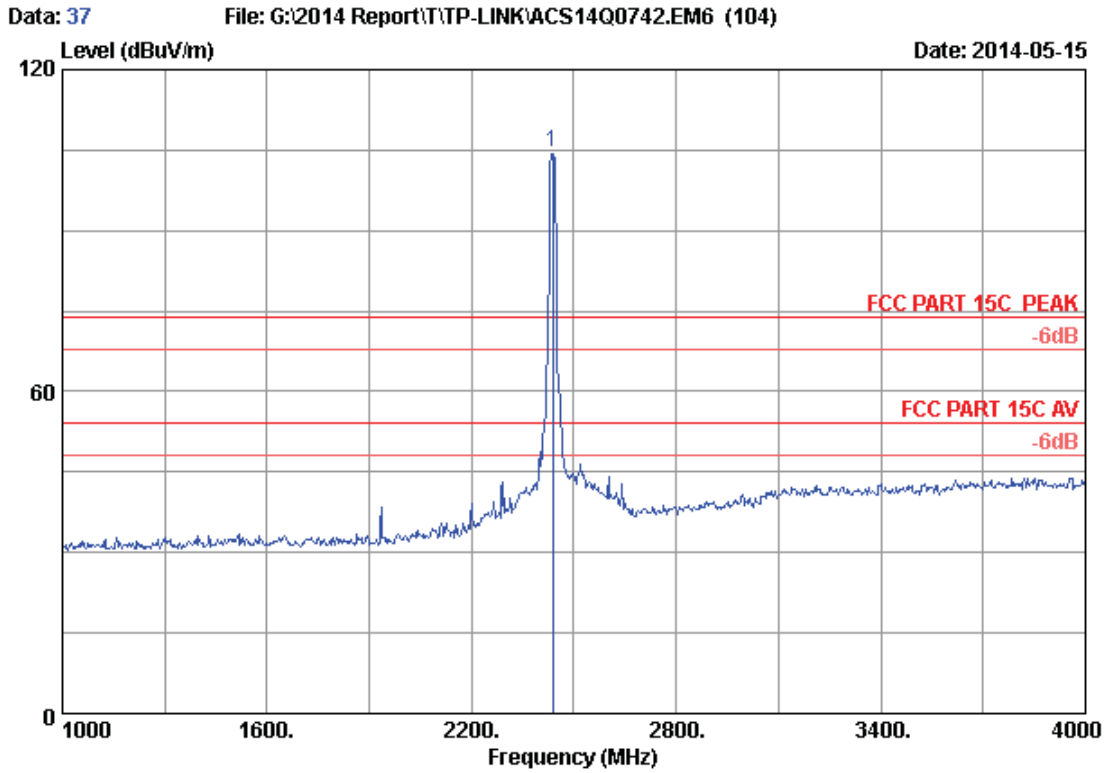

Site no. : 3m Chamber Data no. : 37
 Dis. / Ant. : 3m 2013 3115 (4580) Ant. pol. : HORIZONTAL
 Limit : FCC PART 15C PEAK
 Env. / Ins. : 24°C/56% Engineer : Kevin_Hu
 EUT : AC750 Wireless Dual Band Router
 Power Rating : DC 12V From Adapter Input AC 120V/60Hz
 Test Mode : IEEE802.11g 2437MHz Tx Mode
 M/N : C20i

No.	Freq. (MHz)	Ant. Factor (dB/m)	Cable Loss (dB)	AMP factor (dB)	Reading (dBuV)	Emission Level (dBuV/m)	Limits (dBuV/m)	Margin (dB)	Remark
1	2437.000	28.26	5.85	35.70	106.21	104.62	74.00	-30.62	Peak

Remarks: 1. Emission Level= Antenna Factor + Cable Loss + Reading - Amp Factor
 2. The emission levels that are 20dB below the official limit are not reported.

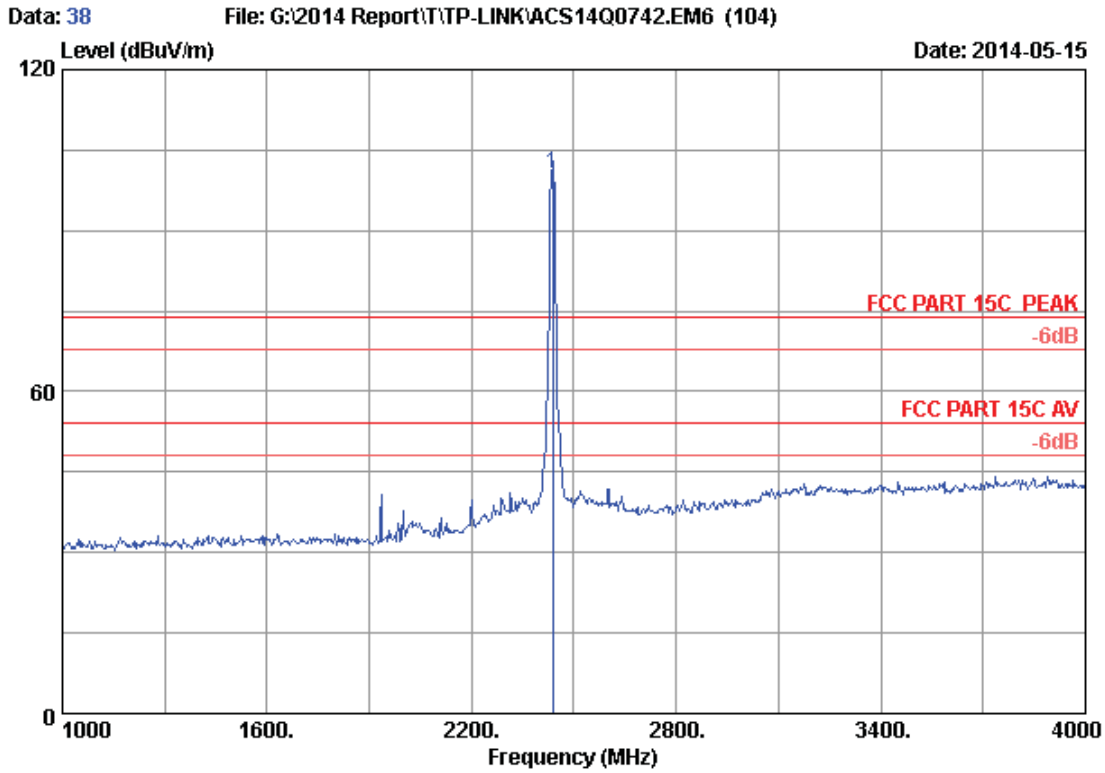

Site no. : 3m Chamber Data no. : 38
 Dis. / Ant. : 3m 2013 3115 (4580) Ant. pol. : VERTICAL
 Limit : FCC PART 15C PEAK
 Env. / Ins. : 24°C/56% Engineer : Kevin_Hu
 EUT : AC750 Wireless Dual Band Router
 Power Rating : DC 12V From Adapter Input AC 120V/60Hz
 Test Mode : IEEE802.11g 2437MHz Tx Mode
 M/N : C20i

No.	Freq. (MHz)	Ant. Factor (dB/m)	Cable Loss (dB)	AMP factor (dB)	Reading (dBuV)	Emission Level (dBuV/m)	Limits (dBuV/m)	Margin (dB)	Remark
1	2437.000	28.26	5.85	35.70	102.19	100.60	74.00	-26.60	Peak

Remarks: 1. Emission Level= Antenna Factor + Cable Loss + Reading - Amp Factor
 2. The emission levels that are 20dB below the official limit are not reported.

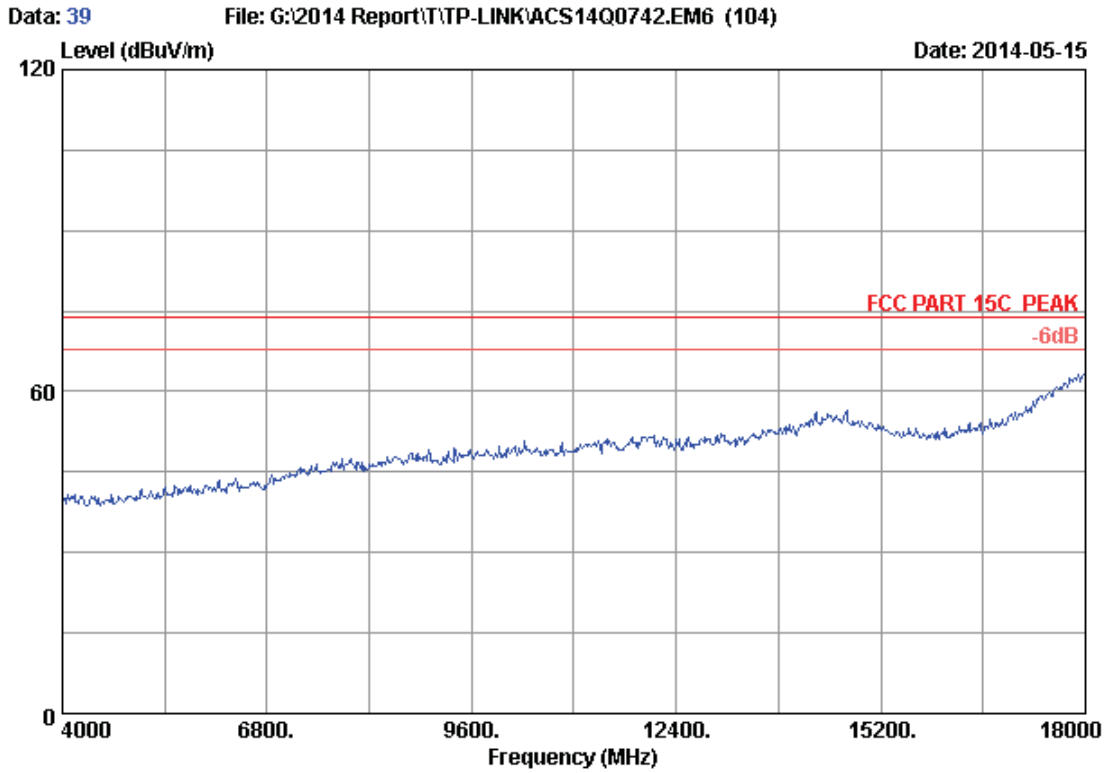

Site no. : 3m Chamber Data no. : 39
Dis. / Ant. : 3m 2013 3115 (4580) Ant. pol. : HORIZONTAL
Limit : FCC PART 15C PEAK
Env. / Ins. : 24°C/56% Engineer : Kevin_Hu
EUT : AC750 Wireless Dual Band Router
Power Rating : DC 12V From Adapter Input AC 120V/60Hz
Test Mode : IEEE802.11g 2437MHz Tx Mode
M/N : C20i

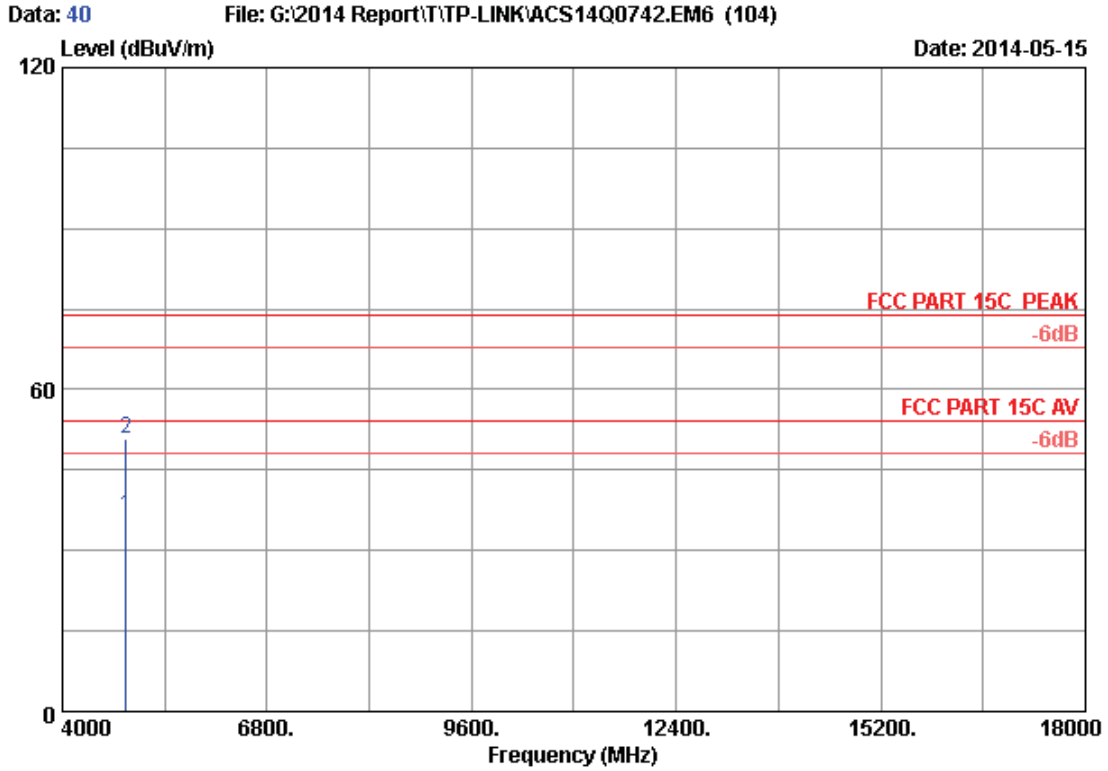

Site no. : 3m Chamber Data no. : 40
 Dis. / Ant. : 3m 2013 3115 (4580) Ant. pol. : HORIZONTAL
 Limit : FCC PART 15C PEAK
 Env. / Ins. : 24°C/56% Engineer : Kevin_Hu
 EUT : AC750 Wireless Dual Band Router
 Power Rating : DC 12V From Adapter Input AC 120V/60Hz
 Test Mode : IEEE802.11g 2437MHz Tx Mode
 M/N : C20i

No.	Freq. (MHz)	Ant. Factor (dB/m)	Cable Loss (dB)	AMP factor (dB)	Reading (dBuV)	Emission Level (dBuV/m)	Limits (dBuV/m)	Margin (dB)	Remark
1	4874.000	32.97	8.63	35.70	30.57	36.47	54.00	17.53	Average
2	4874.000	32.97	8.63	35.70	44.96	50.86	74.00	23.14	Peak

Remarks: 1. Emission Level= Antenna Factor + Cable Loss + Reading - Amp Factor
 2. The emission levels that are 20dB below the official limit are not reported.

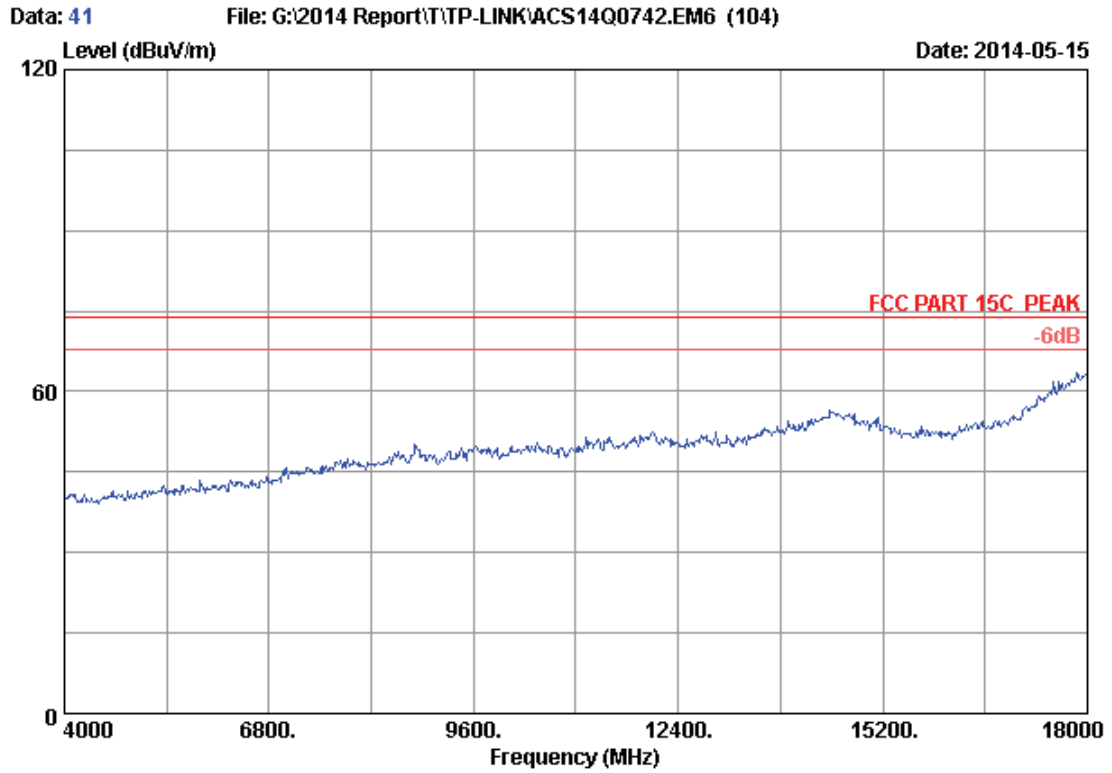

Site no. : 3m Chamber Data no. : 41
Dis. / Ant. : 3m 2013 3115 (4580) Ant. pol. : VERTICAL
Limit : FCC PART 15C PEAK
Env. / Ins. : 24°C/56% Engineer : Kevin_Hu
EUT : AC750 Wireless Dual Band Router
Power Rating : DC 12V From Adapter Input AC 120V/60Hz
Test Mode : IEEE802.11g 2437MHz Tx Mode
M/N : C20i

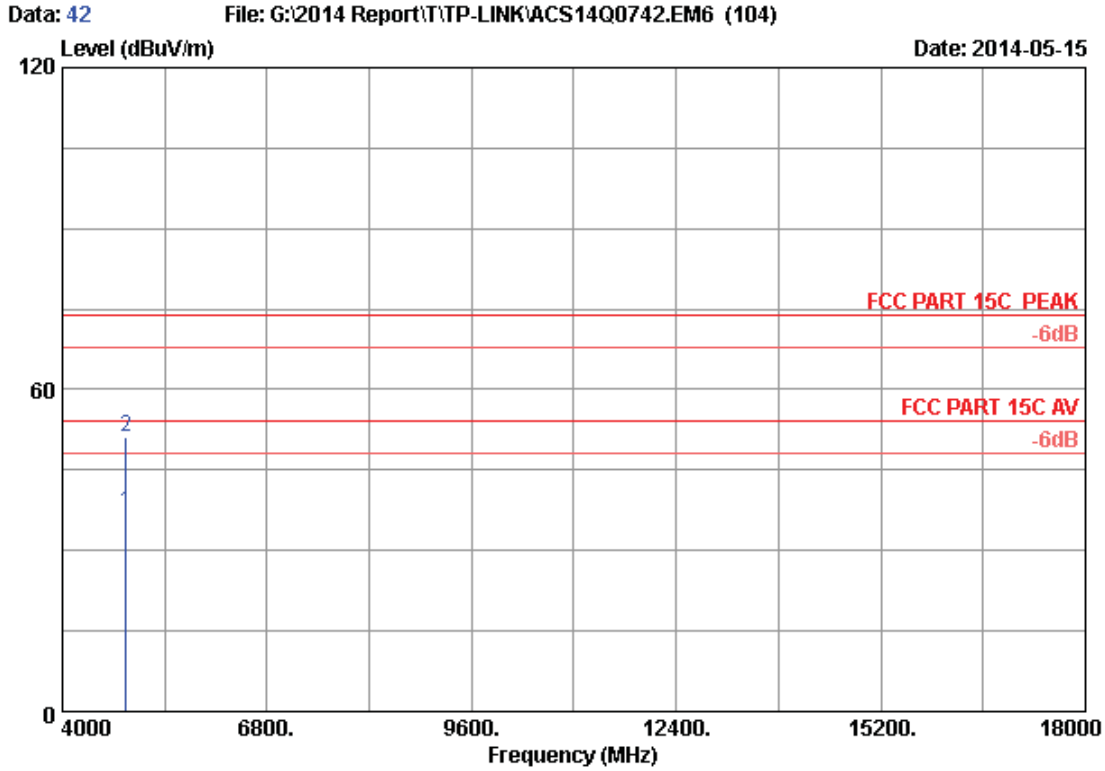

Site no. : 3m Chamber Data no. : 42
 Dis. / Ant. : 3m 2013 3115 (4580) Ant. pol. : VERTICAL
 Limit : FCC PART 15C PEAK
 Env. / Ins. : 24°C/56% Engineer : Kevin_Hu
 EUT : AC750 Wireless Dual Band Router
 Power Rating : DC 12V From Adapter Input AC 120V/60Hz
 Test Mode : IEEE802.11g 2437MHz Tx Mode
 M/N : C20i

No.	Freq. (MHz)	Ant. Factor (dB/m)	Cable Loss (dB)	AMP factor (dB)	Reading (dBUV)	Emission Level (dBUV/m)	Limits (dBUV/m)	Margin (dB)	Remark
1	4874.000	32.97	8.63	35.70	31.25	37.15	54.00	16.85	Average
2	4874.000	32.97	8.63	35.70	45.29	51.19	74.00	22.81	Peak

Remarks: 1. Emission Level= Antenna Factor + Cable Loss + Reading - Amp Factor
 2. The emission levels that are 20dB below the official limit are not reported.

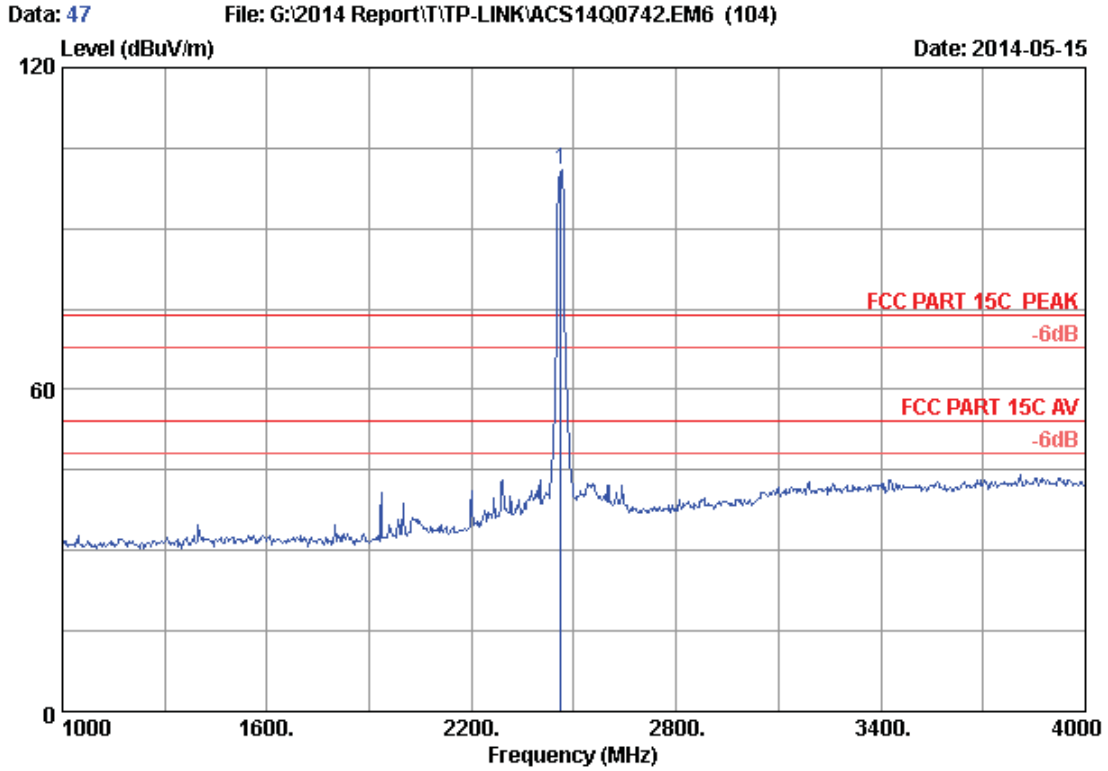

Site no. : 3m Chamber Data no. : 47
 Dis. / Ant. : 3m 2013 3115 (4580) Ant. pol. : VERTICAL
 Limit : FCC PART 15C PEAK
 Env. / Ins. : 24°C/56% Engineer : Kevin_Hu
 EUT : AC750 Wireless Dual Band Router
 Power Rating : DC 12V From Adapter Input AC 120V/60Hz
 Test Mode : IEEE802.11g 2462MHz Tx Mode
 M/N : C20i

No.	Freq. (MHz)	Ant. Factor (dB/m)	Cable Loss (dB)	AMP factor (dB)	Reading (dBuV)	Emission Level (dBuV/m)	Limits (dBuV/m)	Margin (dB)	Remark
1	2462.000	28.32	5.89	35.70	102.45	100.96	74.00	-26.96	Peak

Remarks: 1. Emission Level= Antenna Factor + Cable Loss + Reading - Amp Factor
 2. The emission levels that are 20dB below the official limit are not reported.

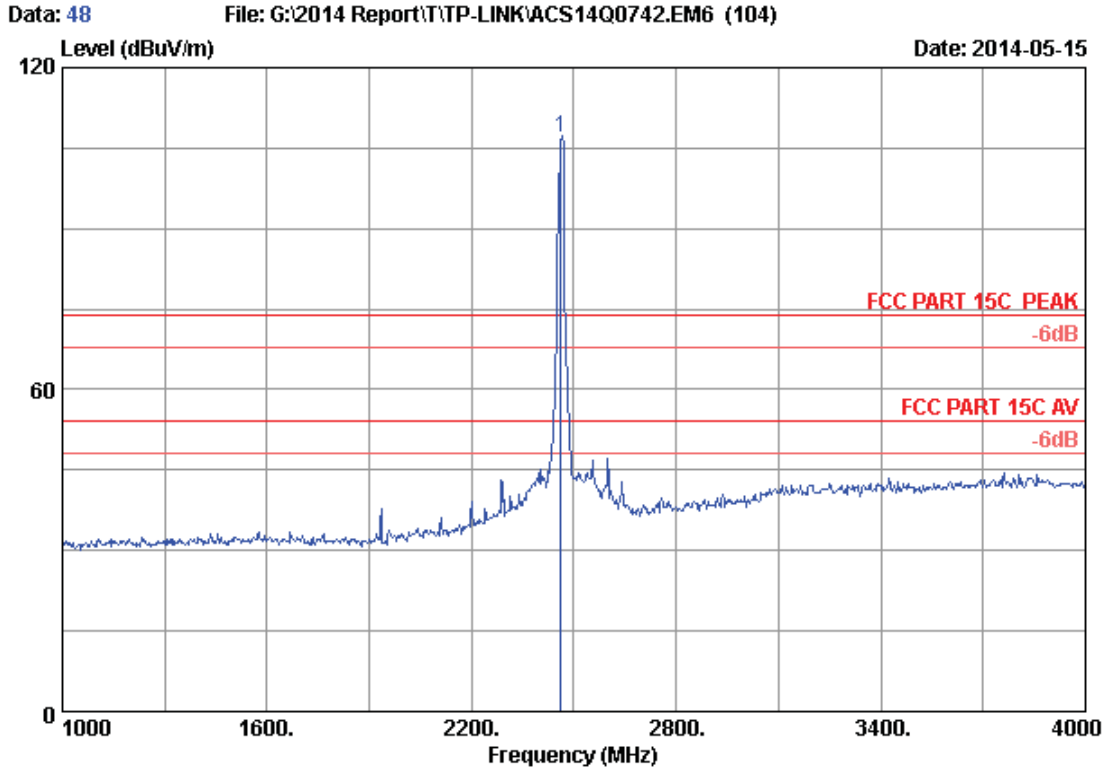

Site no. : 3m Chamber Data no. : 48
 Dis. / Ant. : 3m 2013 3115 (4580) Ant. pol. : HORIZONTAL
 Limit : FCC PART 15C PEAK
 Env. / Ins. : 24°C/56% Engineer : Kevin_Hu
 EUT : AC750 Wireless Dual Band Router
 Power Rating : DC 12V From Adapter Input AC 120V/60Hz
 Test Mode : IEEE802.11g 2462MHz Tx Mode
 M/N : C20i

No.	Freq. (MHz)	Ant. Factor (dB/m)	Cable Loss (dB)	AMP factor (dB)	Reading (dBuV)	Emission Level (dBuV/m)	Limits (dBuV/m)	Margin (dB)	Remark
1	2462.000	28.32	5.89	35.70	108.43	106.94	74.00	-32.94	Peak

Remarks: 1. Emission Level= Antenna Factor + Cable Loss + Reading - Amp Factor
 2. The emission levels that are 20dB below the official limit are not reported.

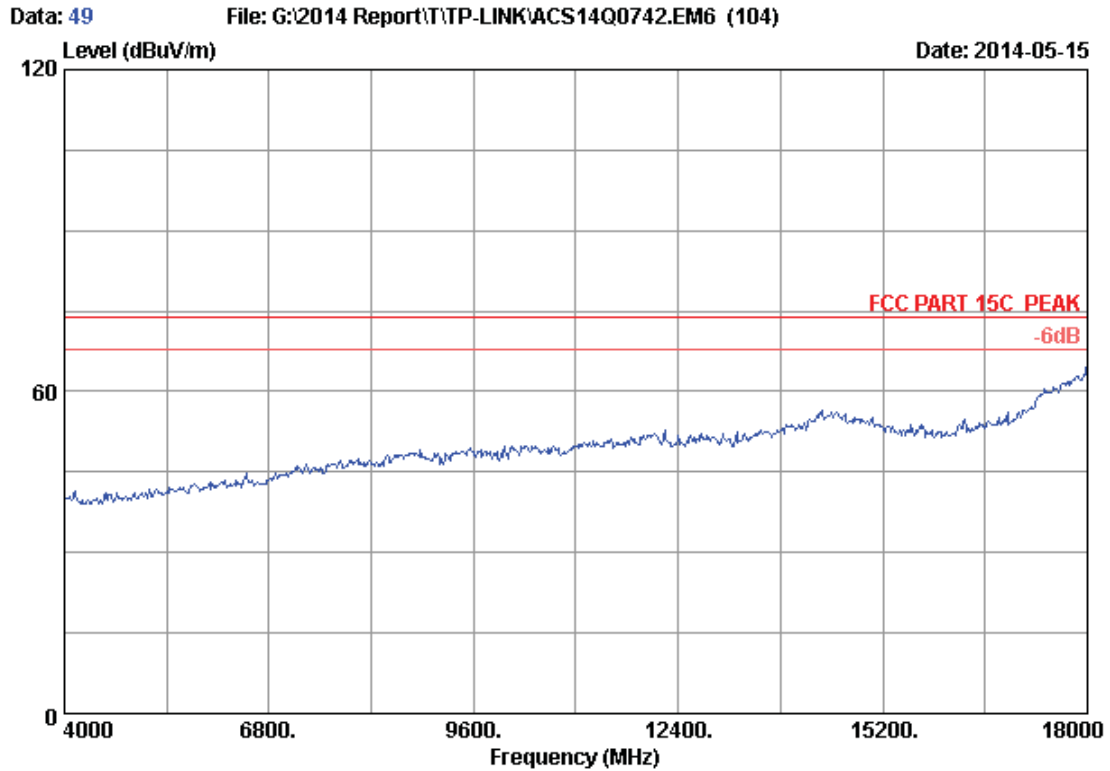

Site no. : 3m Chamber Data no. : 49
Dis. / Ant. : 3m 2013 3115 (4580) Ant. pol. : VERTICAL
Limit : FCC PART 15C PEAK
Env. / Ins. : 24°C/56% Engineer : Kevin_Hu
EUT : AC750 Wireless Dual Band Router
Power Rating : DC 12V From Adapter Input AC 120V/60Hz
Test Mode : IEEE802.11g 2462MHz Tx Mode
M/N : C20i

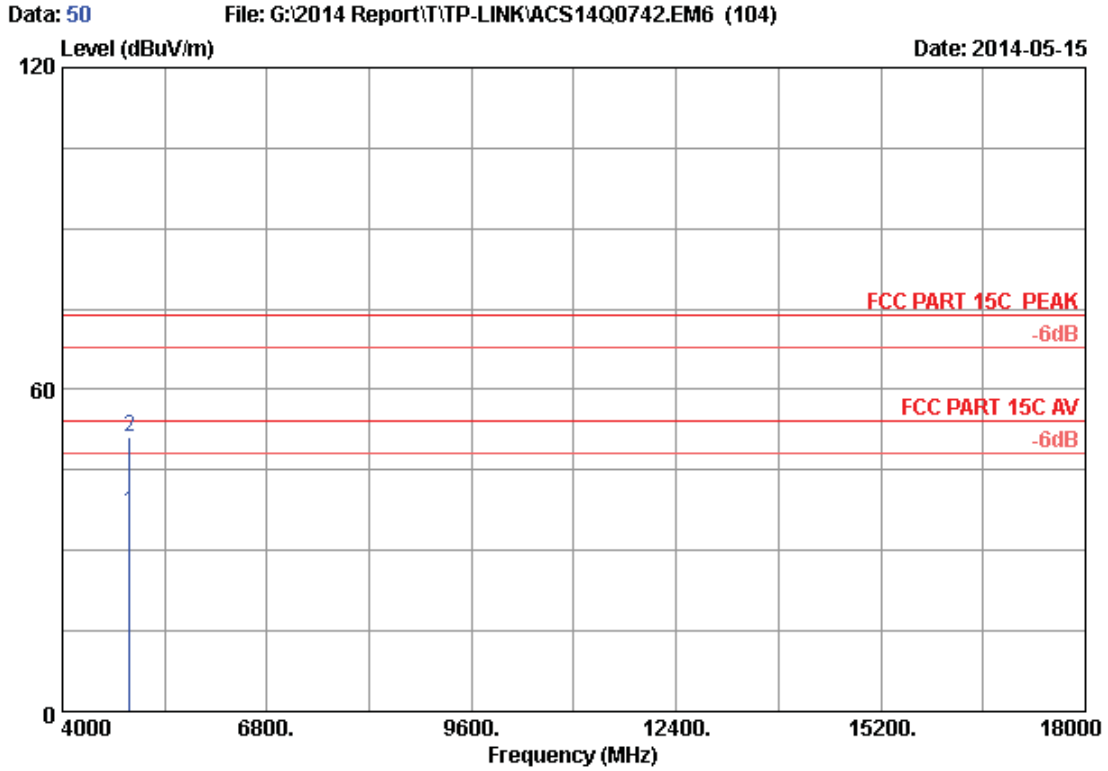

Site no. : 3m Chamber Data no. : 50
 Dis. / Ant. : 3m 2013 3115 (4580) Ant. pol. : VERTICAL
 Limit : FCC PART 15C PEAK
 Env. / Ins. : 24°C/56% Engineer : Kevin_Hu
 EUT : AC750 Wireless Dual Band Router
 Power Rating : DC 12V From Adapter Input AC 120V/60Hz
 Test Mode : IEEE802.11g 2462MHz Tx Mode
 M/N : C20i

No.	Freq. (MHz)	Ant. Factor (dB/m)	Cable Loss (dB)	AMP factor (dB)	Reading (dBuV)	Emission Level (dBuV/m)	Limits (dBuV/m)	Margin (dB)	Remark
1	4924.000	33.06	8.69	35.70	31.02	37.07	54.00	16.93	Average
2	4924.000	33.06	8.69	35.70	45.23	51.28	74.00	22.72	Peak

Remarks: 1. Emission Level= Antenna Factor + Cable Loss + Reading - Amp Factor
 2. The emission levels that are 20dB below the official limit are not reported.

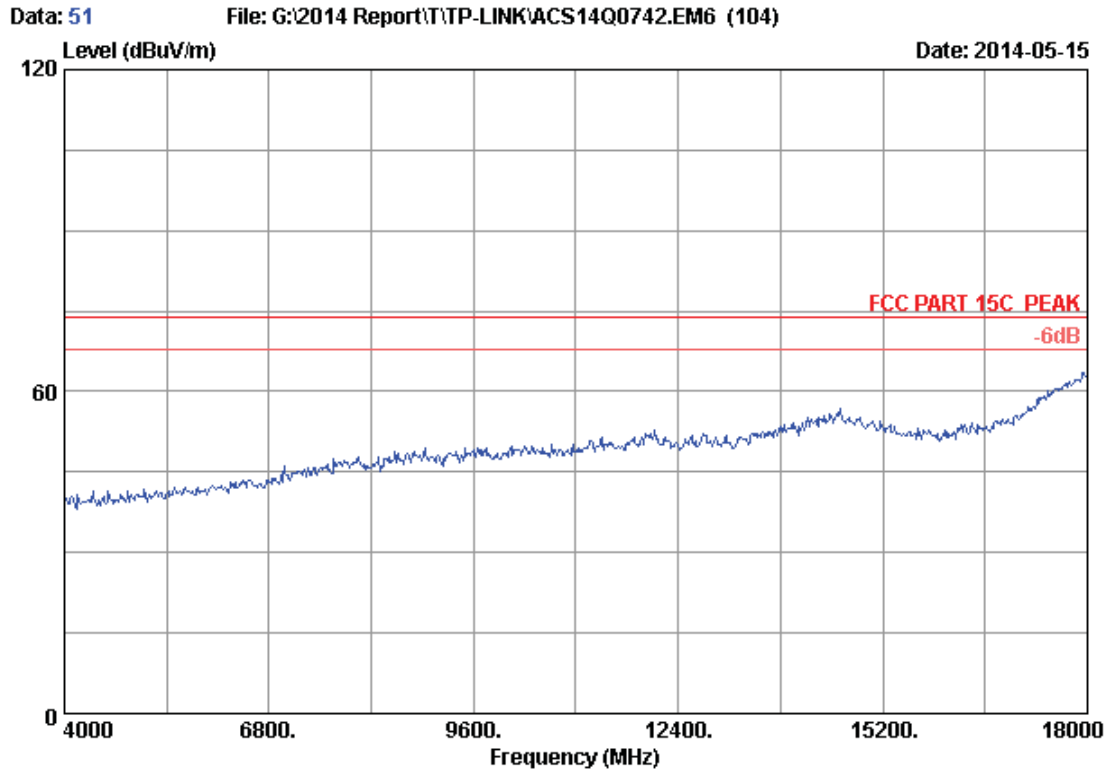

Site no. : 3m Chamber Data no. : 51
Dis. / Ant. : 3m 2013 3115 (4580) Ant. pol. : HORIZONTAL
Limit : FCC PART 15C PEAK
Env. / Ins. : 24°C/56% Engineer : Kevin_Hu
EUT : AC750 Wireless Dual Band Router
Power Rating : DC 12V From Adapter Input AC 120V/60Hz
Test Mode : IEEE802.11g 2462MHz Tx Mode
M/N : C20i

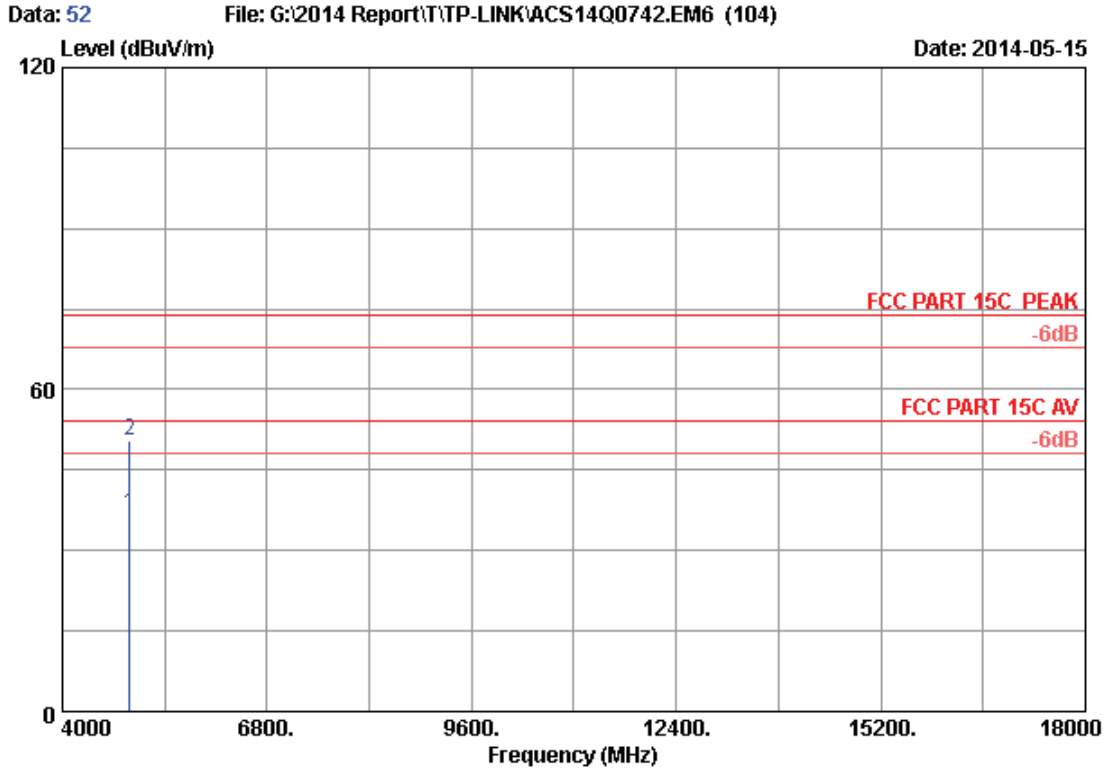

Site no. : 3m Chamber Data no. : 52
 Dis. / Ant. : 3m 2013 3115 (4580) Ant. pol. : HORIZONTAL
 Limit : FCC PART 15C PEAK
 Env. / Ins. : 24°C/56% Engineer : Kevin_Hu
 EUT : AC750 Wireless Dual Band Router
 Power Rating : DC 12V From Adapter Input AC 120V/60Hz
 Test Mode : IEEE802.11g 2462MHz Tx Mode
 M/N : C20i

No.	Freq. (MHz)	Ant. Factor (dB/m)	Cable Loss (dB)	AMP factor (dB)	Reading (dBuV)	Emission Level (dBuV/m)	Limits (dBuV/m)	Margin (dB)	Remark
1	4924.000	33.06	8.69	35.70	30.71	36.76	54.00	17.24	Average
2	4924.000	33.06	8.69	35.70	44.59	50.64	74.00	23.36	Peak

Remarks: 1. Emission Level= Antenna Factor + Cable Loss + Reading - Amp Factor
 2. The emission levels that are 20dB below the official limit are not reported.

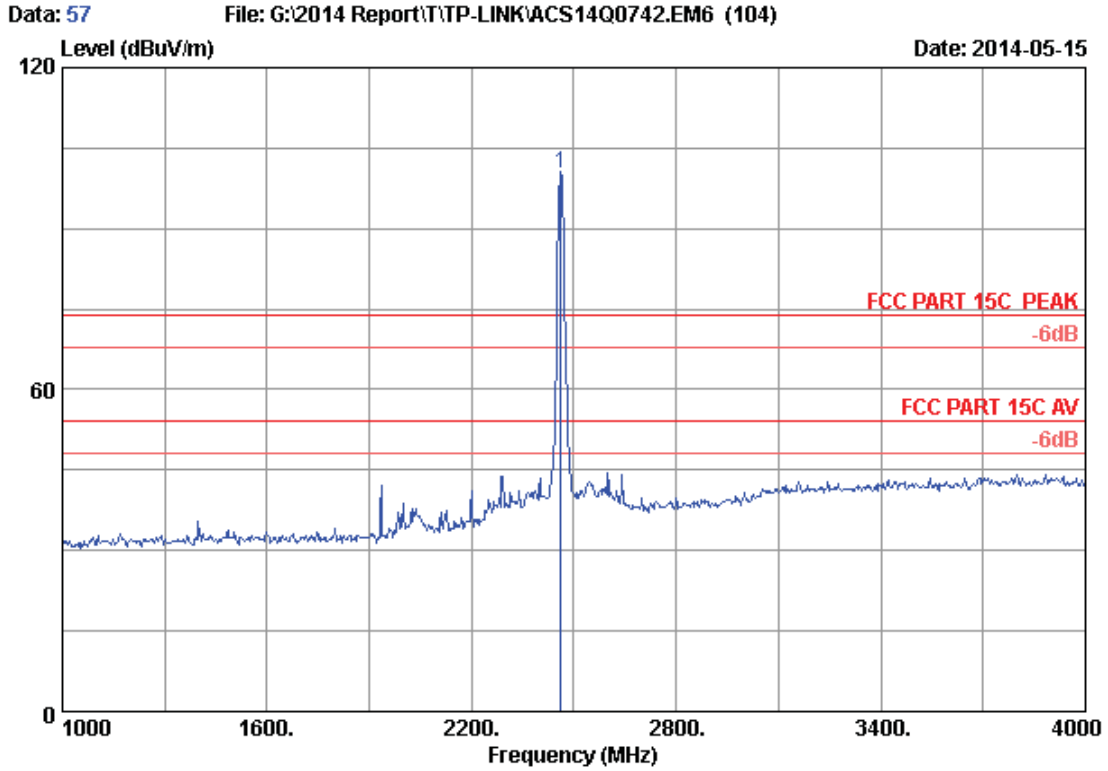

Site no. : 3m Chamber Data no. : 57
 Dis. / Ant. : 3m 2013 3115 (4580) Ant. pol. : VERTICAL
 Limit : FCC PART 15C PEAK
 Env. / Ins. : 24°C/56% Engineer : Kevin_Hu
 EUT : AC750 Wireless Dual Band Router
 Power Rating : DC 12V From Adapter Input AC 120V/60Hz
 Test Mode : IEEE802.11nHT20 2462MHz Tx Mode
 M/N : C20i

No.	Freq. (MHz)	Ant. Factor (dB/m)	Cable Loss (dB)	AMP factor (dB)	Reading (dBuV)	Emission Level (dBuV/m)	Limits (dBuV/m)	Margin (dB)	Remark
1	2462.000	28.32	5.89	35.70	101.89	100.40	74.00	-26.40	Peak

Remarks: 1. Emission Level= Antenna Factor + Cable Loss + Reading - Amp Factor
 2. The emission levels that are 20dB below the official limit are not reported.

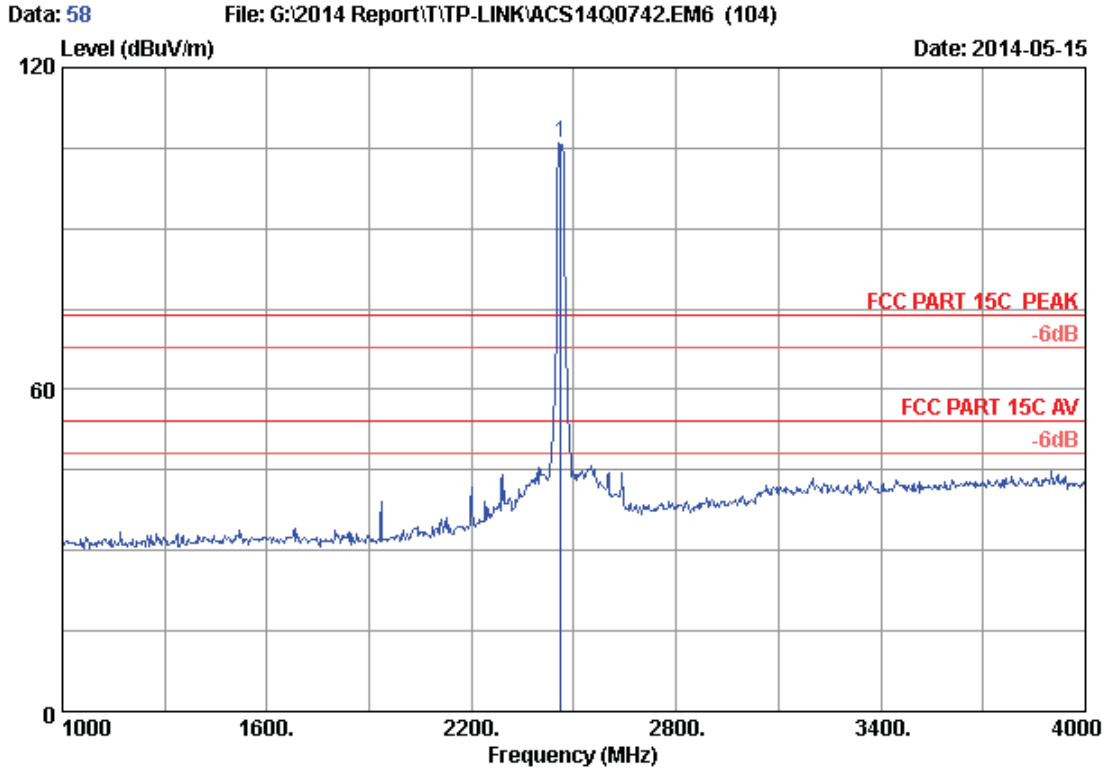

Site no. : 3m Chamber Data no. : 58
 Dis. / Ant. : 3m 2013 3115 (4580) Ant. pol. : HORIZONTAL
 Limit : FCC PART 15C PEAK
 Env. / Ins. : 24°C/56% Engineer : Kevin_Hu
 EUT : AC750 Wireless Dual Band Router
 Power Rating : DC 12V From Adapter Input AC 120V/60Hz
 Test Mode : IEEE802.11nHT20 2462MHz Tx Mode
 M/N : C20i

No.	Freq. (MHz)	Ant. Factor (dB/m)	Cable Loss (dB)	AMP factor (dB)	Reading (dBuV)	Emission Level (dBuV/m)	Limits (dBuV/m)	Margin (dB)	Remark
1	2462.000	28.32	5.89	35.70	107.56	106.07	74.00	-32.07	Peak

Remarks: 1. Emission Level= Antenna Factor + Cable Loss + Reading - Amp Factor
 2. The emission levels that are 20dB below the official limit are not reported.

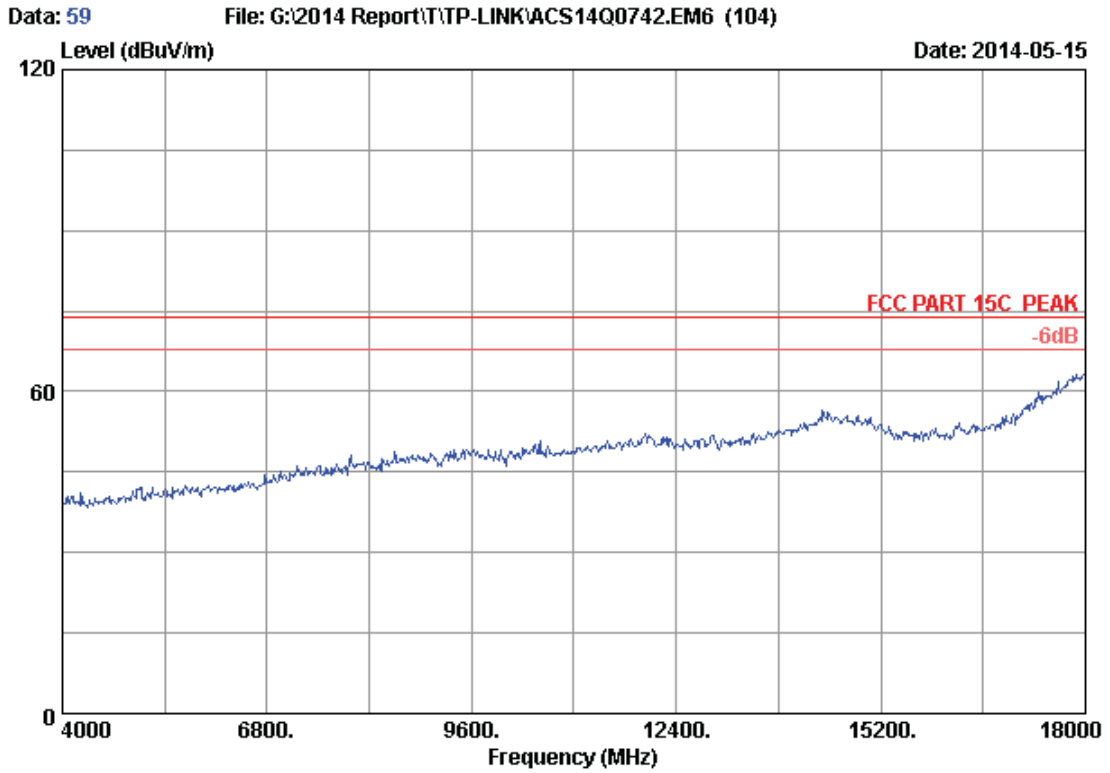

Site no. : 3m Chamber Data no. : 59
Dis. / Ant. : 3m 2013 3115 (4580) Ant. pol. : HORIZONTAL
Limit : FCC PART 15C PEAK
Env. / Ins. : 24°C/56% Engineer : Kevin_Hu
EUT : AC750 Wireless Dual Band Router
Power Rating : DC 12V From Adapter Input AC 120V/60Hz
Test Mode : IEEE802.11nHT20 2462MHz Tx Mode
M/N : C20i

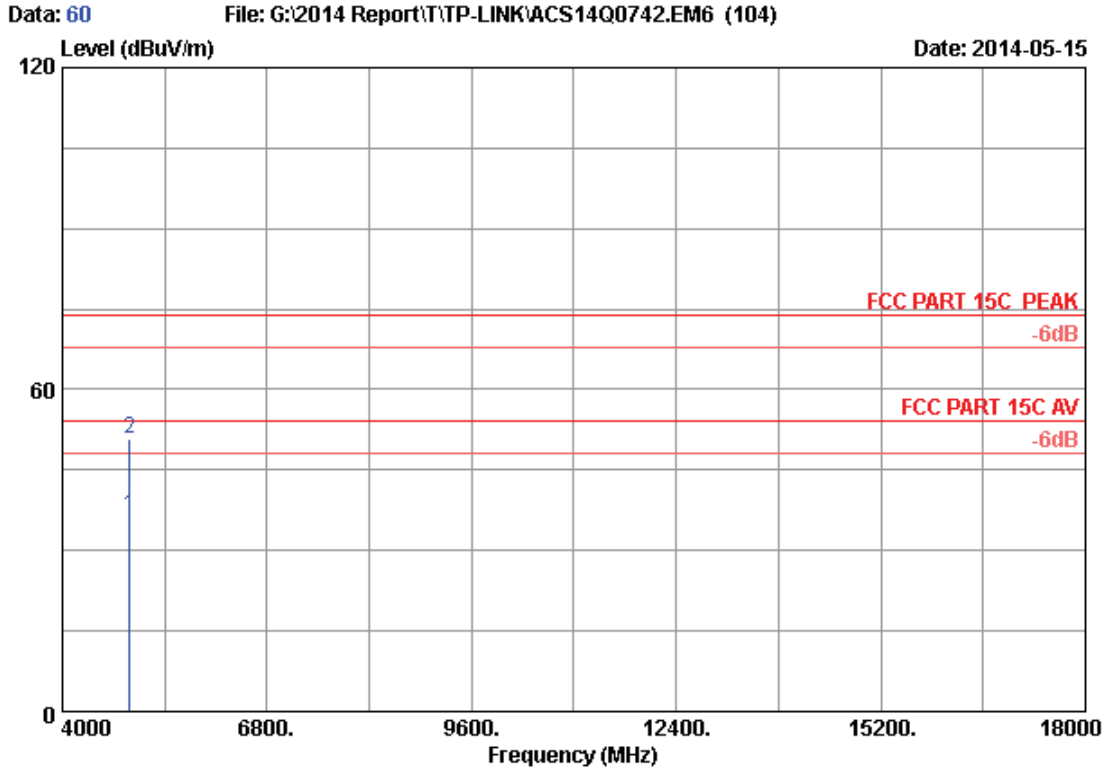

Site no. : 3m Chamber Data no. : 60
 Dis. / Ant. : 3m 2013 3115 (4580) Ant. pol. : HORIZONTAL
 Limit : FCC PART 15C PEAK
 Env. / Ins. : 24°C/56% Engineer : Kevin_Hu
 EUT : AC750 Wireless Dual Band Router
 Power Rating : DC 12V From Adapter Input AC 120V/60Hz
 Test Mode : IEEE802.11nHT20 2462MHz Tx Mode
 M/N : C20i

No.	Freq. (MHz)	Ant. Factor (dB/m)	Cable Loss (dB)	AMP factor (dB)	Reading (dBUV)	Emission Level (dBUV/m)	Limits (dBUV/m)	Margin (dB)	Remark
1	4924.000	33.06	8.69	35.70	30.55	36.60	54.00	17.40	Average
2	4924.000	33.06	8.69	35.70	44.81	50.86	74.00	23.14	Peak

Remarks: 1. Emission Level= Antenna Factor + Cable Loss + Reading - Amp Factor
 2. The emission levels that are 20dB below the official limit are not reported.

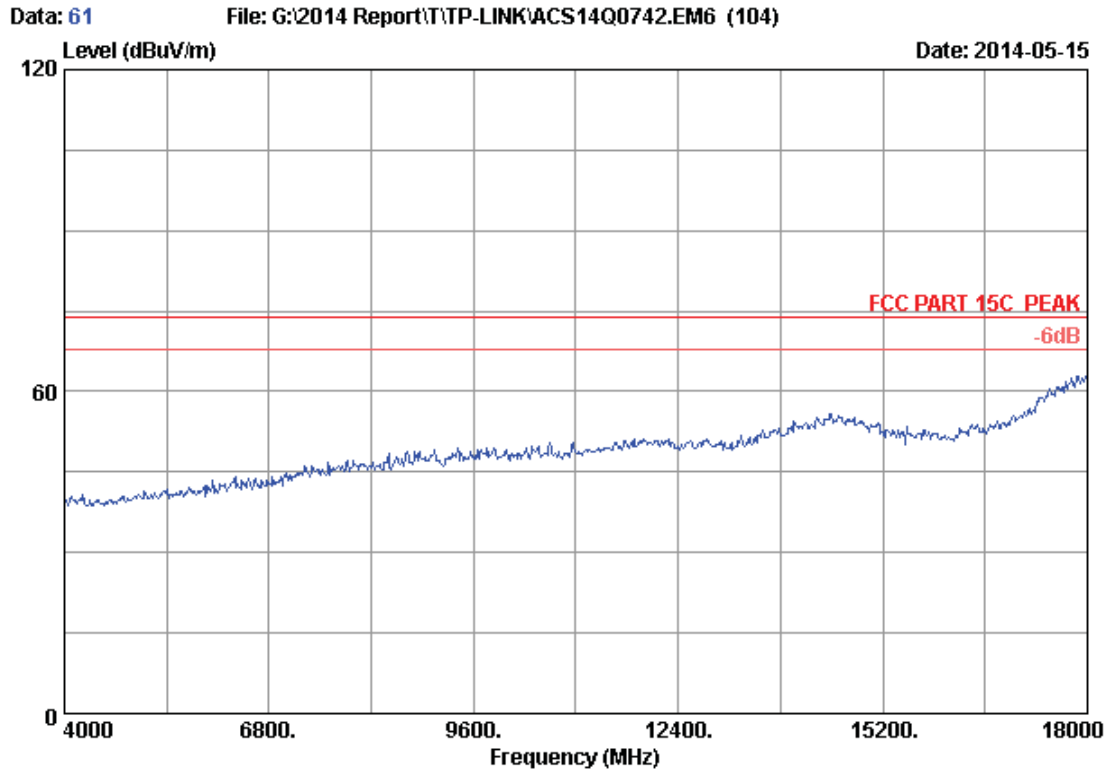

Site no. : 3m Chamber Data no. : 61
Dis. / Ant. : 3m 2013 3115 (4580) Ant. pol. : VERTICAL
Limit : FCC PART 15C PEAK
Env. / Ins. : 24°C/56% Engineer : Kevin_Hu
EUT : AC750 Wireless Dual Band Router
Power Rating : DC 12V From Adapter Input AC 120V/60Hz
Test Mode : IEEE802.11nHT20 2462MHz Tx Mode
M/N : C20i

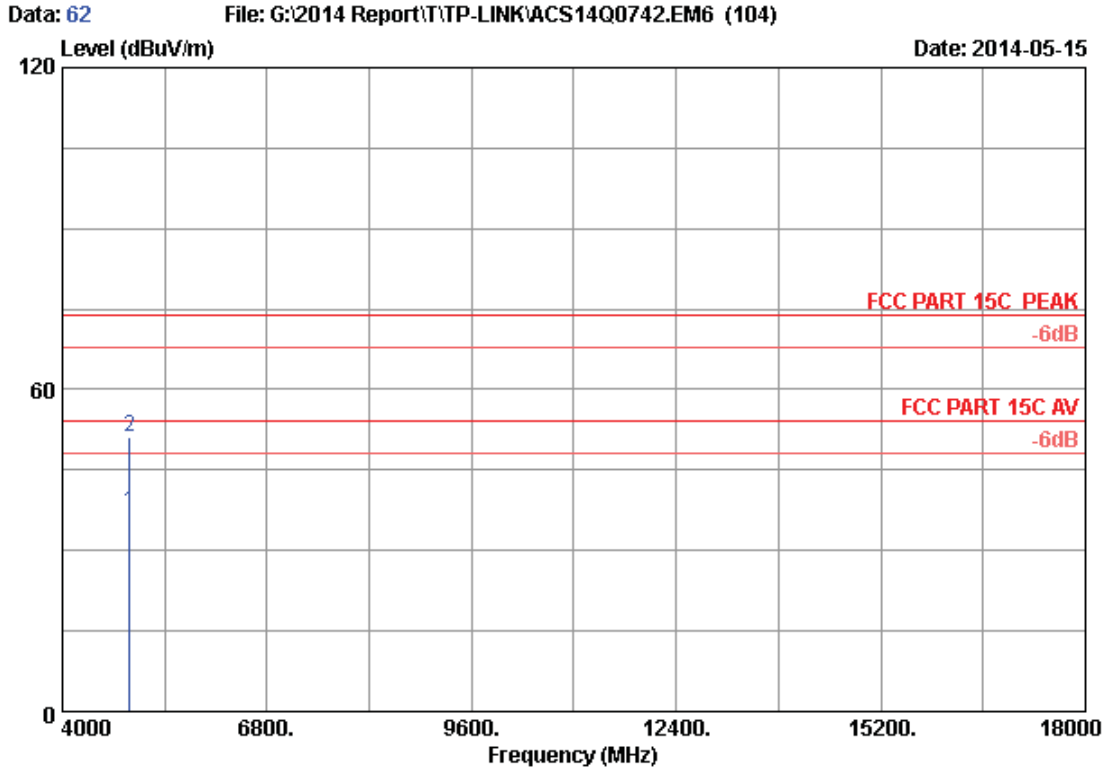

Site no. : 3m Chamber Data no. : 62
 Dis. / Ant. : 3m 2013 3115 (4580) Ant. pol. : VERTICAL
 Limit : FCC PART 15C PEAK
 Env. / Ins. : 24°C/56% Engineer : Kevin_Hu
 EUT : AC750 Wireless Dual Band Router
 Power Rating : DC 12V From Adapter Input AC 120V/60Hz
 Test Mode : IEEE802.11nHT20 2462MHz Tx Mode
 M/N : C20i

No.	Freq. (MHz)	Ant. Factor (dB/m)	Cable Loss (dB)	AMP factor (dB)	Reading (dBuV)	Emission Level (dBuV/m)	Limits (dBuV/m)	Margin (dB)	Remark
1	4924.000	33.06	8.69	35.70	30.98	37.03	54.00	16.97	Average
2	4924.000	33.06	8.69	35.70	45.13	51.18	74.00	22.82	Peak

Remarks: 1. Emission Level= Antenna Factor + Cable Loss + Reading - Amp Factor
 2. The emission levels that are 20dB below the official limit are not reported.

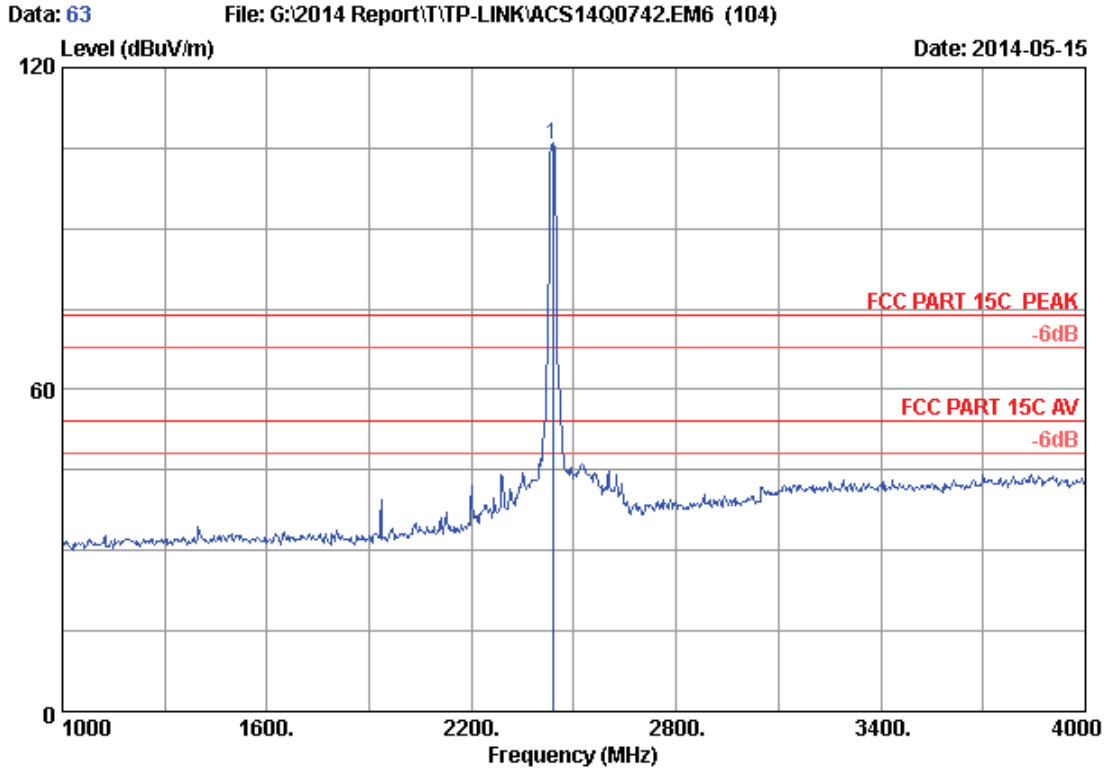

Site no. : 3m Chamber Data no. : 63
 Dis. / Ant. : 3m 2013 3115 (4580) Ant. pol. : HORIZONTAL
 Limit : FCC PART 15C PEAK
 Env. / Ins. : 24°C/56% Engineer : Kevin_Hu
 EUT : AC750 Wireless Dual Band Router
 Power Rating : DC 12V From Adapter Input AC 120V/60Hz
 Test Mode : IEEE802.11nHT20 2437MHz Tx Mode
 M/N : C20i

No.	Freq. (MHz)	Ant. Factor (dB/m)	Cable Loss (dB)	AMP factor (dB)	Reading (dBuV)	Emission Level (dBuV/m)	Limits (dBuV/m)	Margin (dB)	Remark
1	2437.000	28.26	5.85	35.70	107.35	105.76	74.00	-31.76	Peak

Remarks: 1. Emission Level= Antenna Factor + Cable Loss + Reading - Amp Factor
 2. The emission levels that are 20dB below the official limit are not reported.

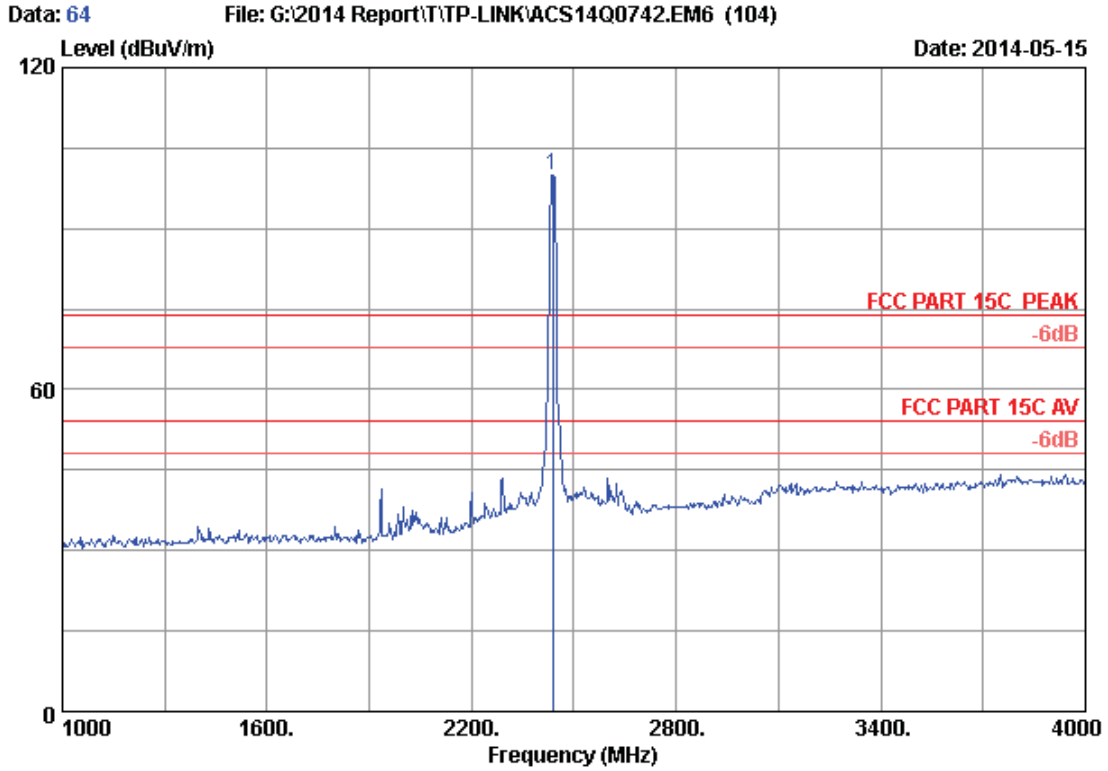

Site no. : 3m Chamber Data no. : 64
 Dis. / Ant. : 3m 2013 3115 (4580) Ant. pol. : VERTICAL
 Limit : FCC PART 15C PEAK
 Env. / Ins. : 24°C/56% Engineer : Kevin_Hu
 EUT : AC750 Wireless Dual Band Router
 Power Rating : DC 12V From Adapter Input AC 120V/60Hz
 Test Mode : IEEE802.11nHT20 2437MHz Tx Mode
 M/N : C20i

No.	Freq. (MHz)	Ant. Factor (dB/m)	Cable Loss (dB)	AMP factor (dB)	Reading (dBuV)	Emission Level (dBuV/m)	Limits (dBuV/m)	Margin (dB)	Remark
1	2437.000	28.26	5.85	35.70	101.67	100.08	74.00	-26.08	Peak

Remarks: 1. Emission Level= Antenna Factor + Cable Loss + Reading - Amp Factor
 2. The emission levels that are 20dB below the official limit are not reported.

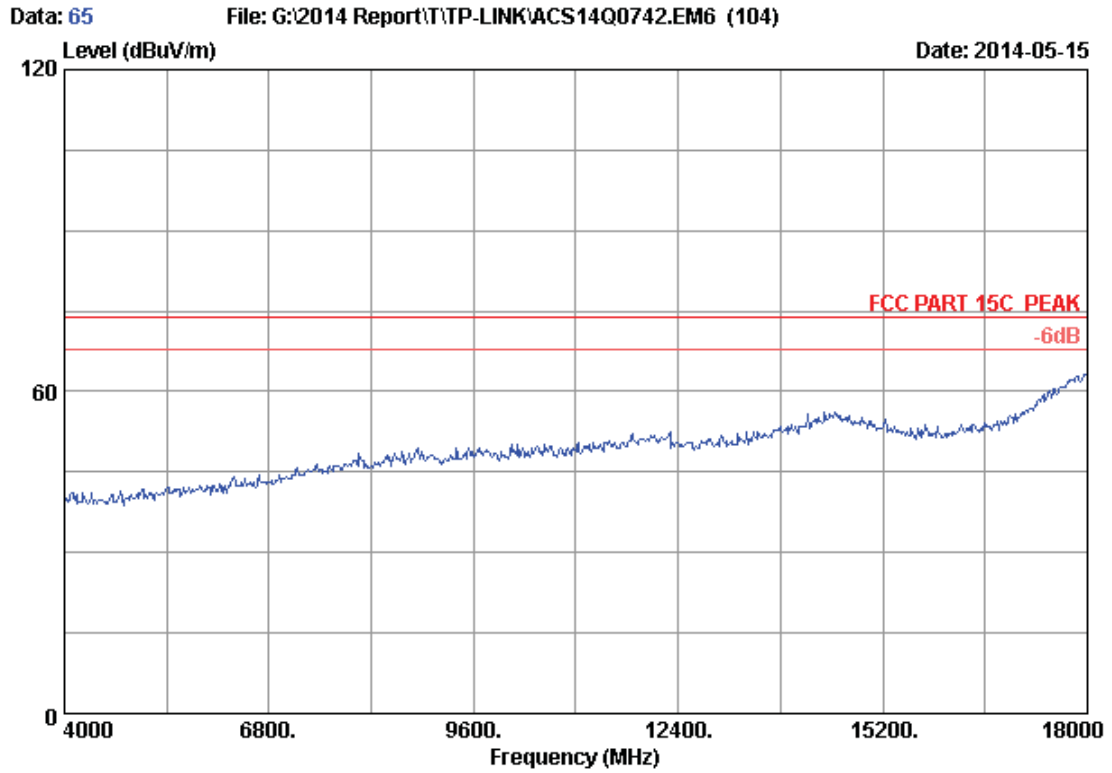

Site no. : 3m Chamber Data no. : 65
Dis. / Ant. : 3m 2013 3115 (4580) Ant. pol. : VERTICAL
Limit : FCC PART 15C PEAK
Env. / Ins. : 24°C/56% Engineer : Kevin_Hu
EUT : AC750 Wireless Dual Band Router
Power Rating : DC 12V From Adapter Input AC 120V/60Hz
Test Mode : IEEE802.11nHT20 2437MHz Tx Mode
M/N : C20i

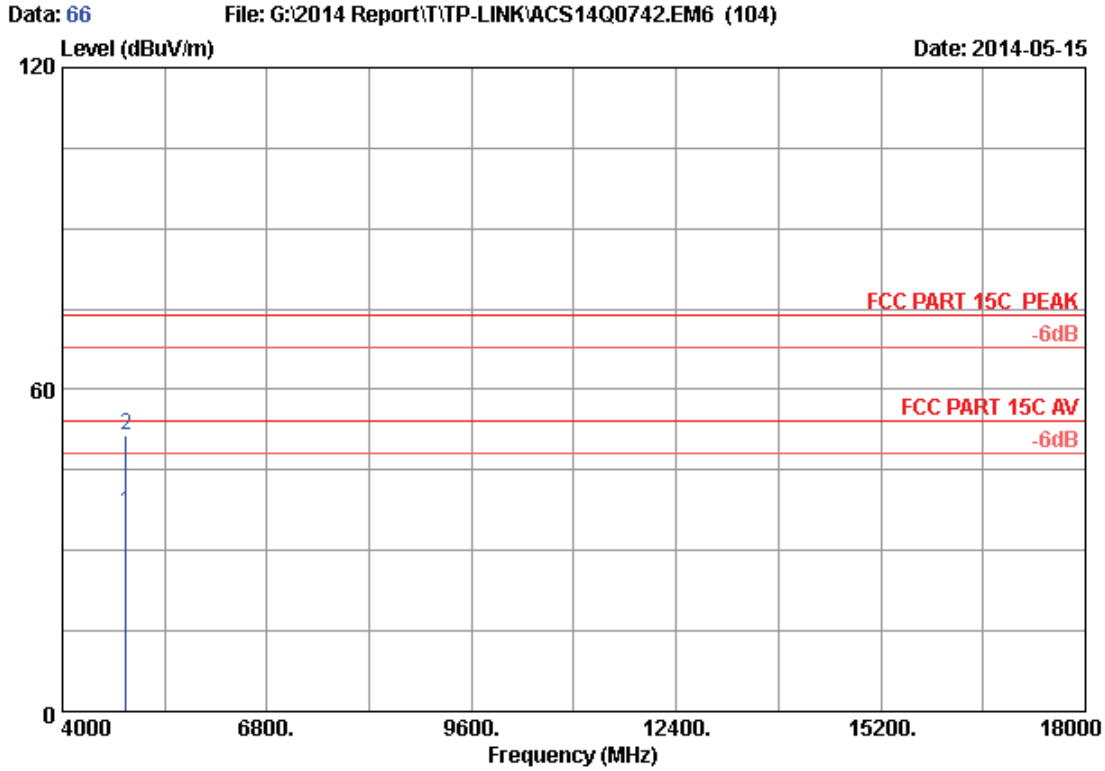

Site no. : 3m Chamber Data no. : 66
 Dis. / Ant. : 3m 2013 3115 (4580) Ant. pol. : VERTICAL
 Limit : FCC PART 15C PEAK
 Env. / Ins. : 24°C/56% Engineer : Kevin_Hu
 EUT : AC750 Wireless Dual Band Router
 Power Rating : DC 12V From Adapter Input AC 120V/60Hz
 Test Mode : IEEE802.11nHT20 2437MHz Tx Mode
 M/N : C20i

No.	Freq. (MHz)	Ant. Factor (dB/m)	Cable Loss (dB)	AMP factor (dB)	Reading (dBuV)	Emission Level (dBuV/m)	Limits (dBuV/m)	Margin (dB)	Remark
1	4874.000	32.97	8.63	35.70	31.10	37.00	54.00	17.00	Average
2	4874.000	32.97	8.63	35.70	45.49	51.39	74.00	22.61	Peak

Remarks: 1. Emission Level= Antenna Factor + Cable Loss + Reading - Amp Factor
 2. The emission levels that are 20dB below the official limit are not reported.

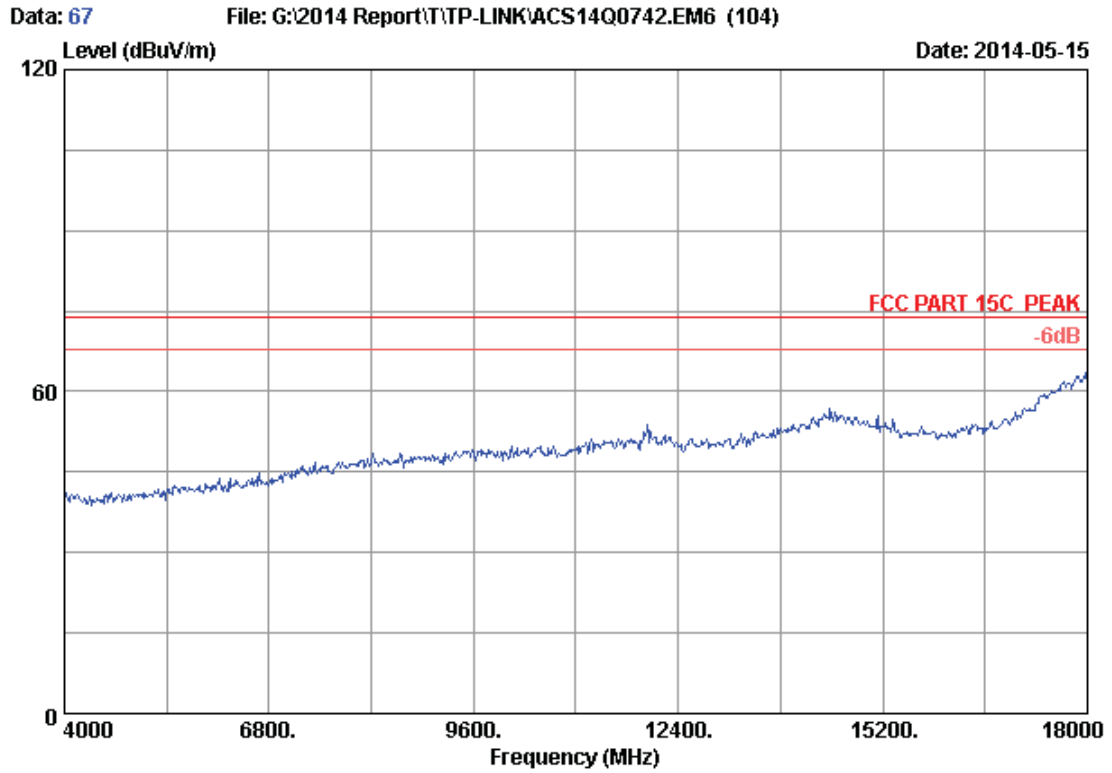

Site no. : 3m Chamber Data no. : 67
Dis. / Ant. : 3m 2013 3115 (4580) Ant. pol. : HORIZONTAL
Limit : FCC PART 15C PEAK
Env. / Ins. : 24°C/56% Engineer : Kevin_Hu
EUT : AC750 Wireless Dual Band Router
Power Rating : DC 12V From Adapter Input AC 120V/60Hz
Test Mode : IEEE802.11nHT20 2437MHz Tx Mode
M/N : C20i

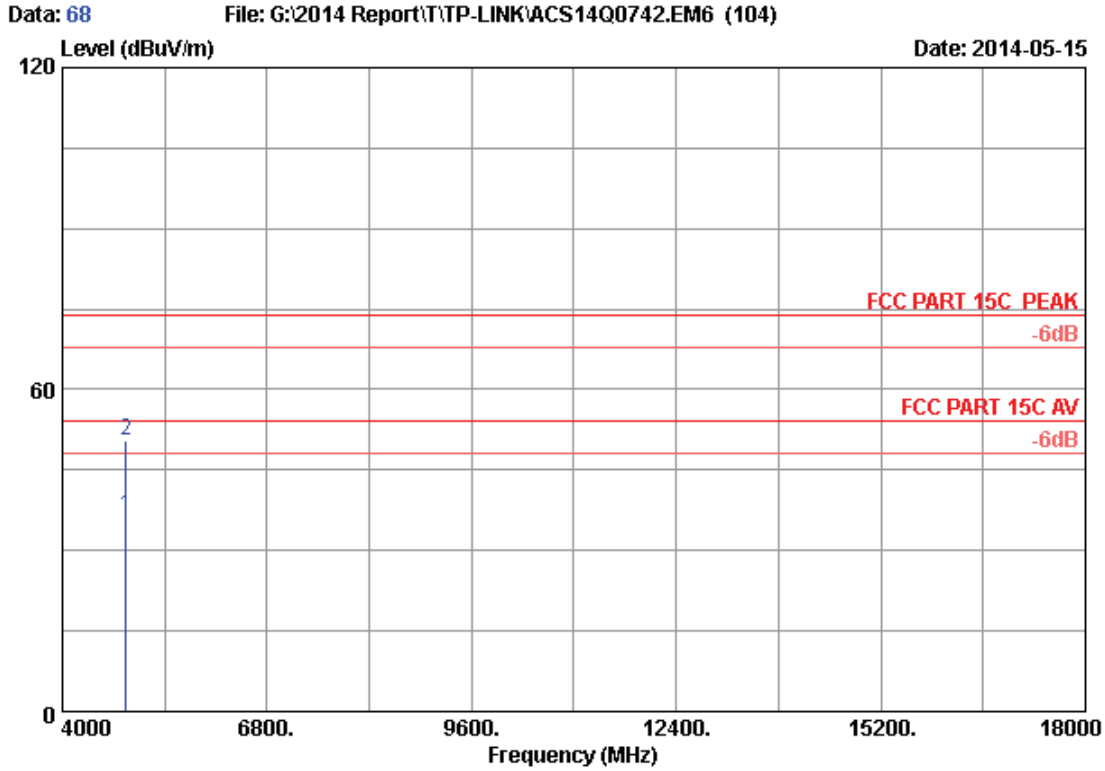

Site no. : 3m Chamber Data no. : 68
 Dis. / Ant. : 3m 2013 3115 (4580) Ant. pol. : HORIZONTAL
 Limit : FCC PART 15C PEAK
 Env. / Ins. : 24°C/56% Engineer : Kevin_Hu
 EUT : AC750 Wireless Dual Band Router
 Power Rating : DC 12V From Adapter Input AC 120V/60Hz
 Test Mode : IEEE802.11nHT20 2437MHz Tx Mode
 M/N : C20i

No.	Freq. (MHz)	Ant. Factor (dB/m)	Cable Loss (dB)	AMP factor (dB)	Reading (dBUV)	Emission Level (dBUV/m)	Limits (dBUV/m)	Margin (dB)	Remark
1	4874.000	32.97	8.63	35.70	30.48	36.38	54.00	17.62	Average
2	4874.000	32.97	8.63	35.70	44.69	50.59	74.00	23.41	Peak

Remarks: 1. Emission Level= Antenna Factor + Cable Loss + Reading - Amp Factor
 2. The emission levels that are 20dB below the official limit are not reported.

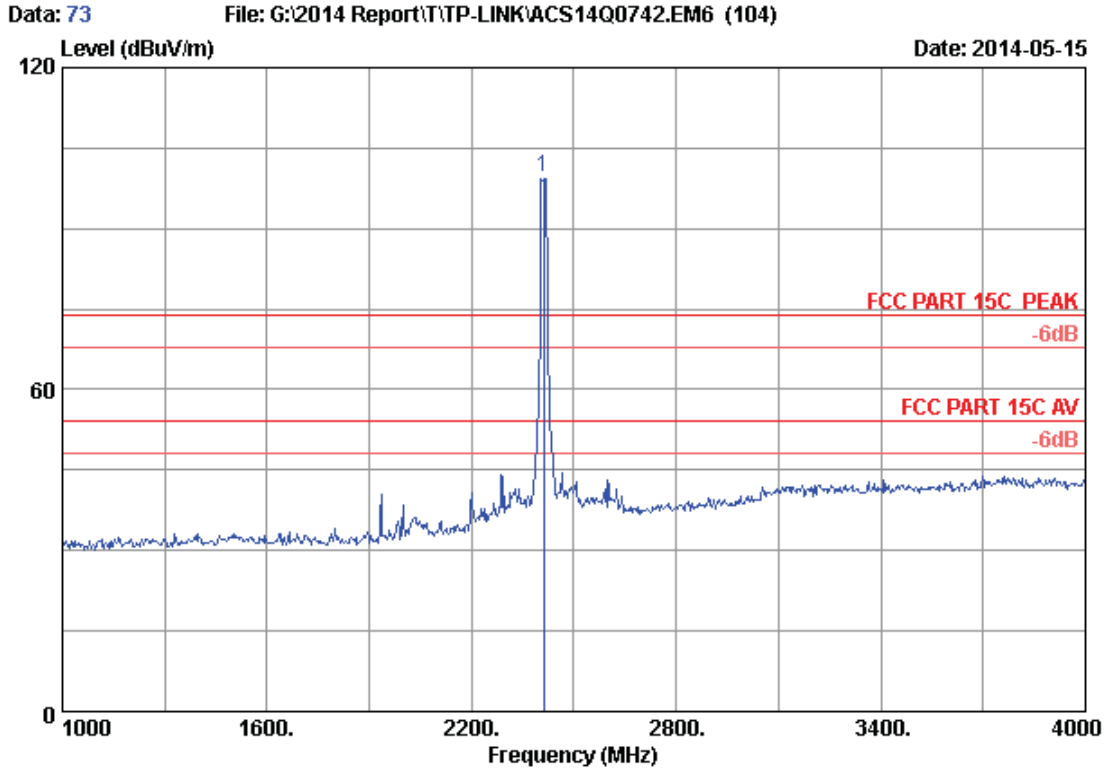

Site no. : 3m Chamber Data no. : 73
 Dis. / Ant. : 3m 2013 3115 (4580) Ant. pol. : VERTICAL
 Limit : FCC PART 15C PEAK
 Env. / Ins. : 24°C/56% Engineer : Kevin_Hu
 EUT : AC750 Wireless Dual Band Router
 Power Rating : DC 12V From Adapter Input AC 120V/60Hz
 Test Mode : IEEE802.11nHT20 2412MHz Tx Mode
 M/N : C20i

No.	Freq. (MHz)	Ant. Factor (dB/m)	Cable Loss (dB)	AMP factor (dB)	Reading (dBuV)	Emission Level (dBuV/m)	Limits (dBuV/m)	Margin (dB)	Remark
1	2412.000	28.21	5.81	35.70	101.24	99.56	74.00	-25.56	Peak

Remarks: 1. Emission Level= Antenna Factor + Cable Loss + Reading - Amp Factor
 2. The emission levels that are 20dB below the official limit are not reported.

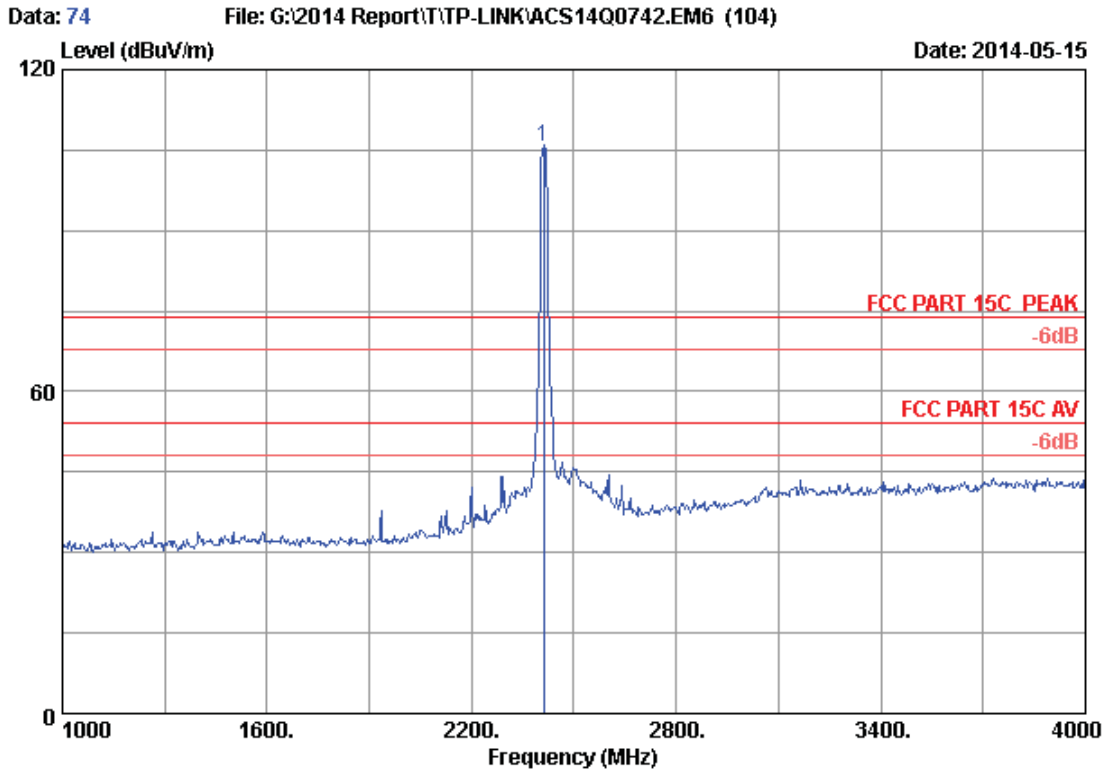

Site no. : 3m Chamber Data no. : 74
 Dis. / Ant. : 3m 2013 3115 (4580) Ant. pol. : HORIZONTAL
 Limit : FCC PART 15C PEAK
 Env. / Ins. : 24°C/56% Engineer : Kevin_Hu
 EUT : AC750 Wireless Dual Band Router
 Power Rating : DC 12V From Adapter Input AC 120V/60Hz
 Test Mode : IEEE802.11nHT20 2412MHz Tx Mode
 M/N : C20i

No.	Freq. (MHz)	Ant. Factor (dB/m)	Cable Loss (dB)	AMP factor (dB)	Reading (dBuV)	Emission Level (dBuV/m)	Limits (dBuV/m)	Margin (dB)	Remark
1	2412.000	28.21	5.81	35.70	107.41	105.73	74.00	-31.73	Peak

Remarks: 1. Emission Level= Antenna Factor + Cable Loss + Reading - Amp Factor
 2. The emission levels that are 20dB below the official limit are not reported.

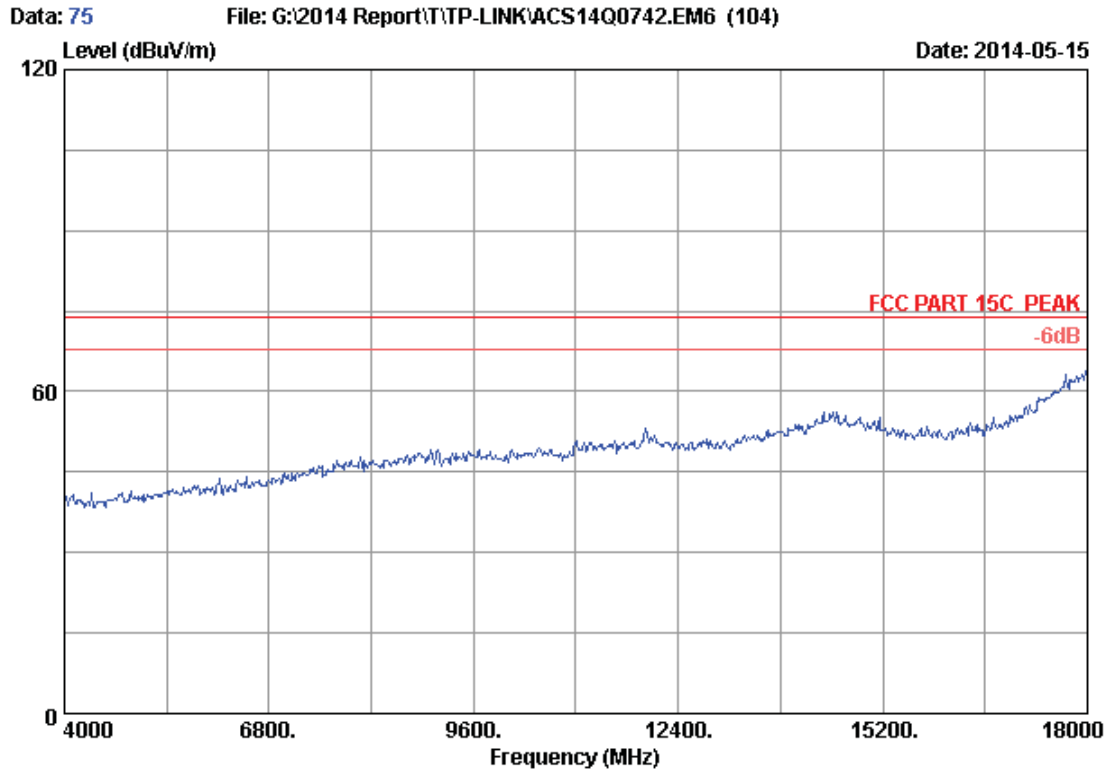

Site no. : 3m Chamber Data no. : 75
Dis. / Ant. : 3m 2013 3115 (4580) Ant. pol. : HORIZONTAL
Limit : FCC PART 15C PEAK
Env. / Ins. : 24°C/56% Engineer : Kevin_Hu
EUT : AC750 Wireless Dual Band Router
Power Rating : DC 12V From Adapter Input AC 120V/60Hz
Test Mode : IEEE802.11nHT20 2412MHz Tx Mode
M/N : C20i

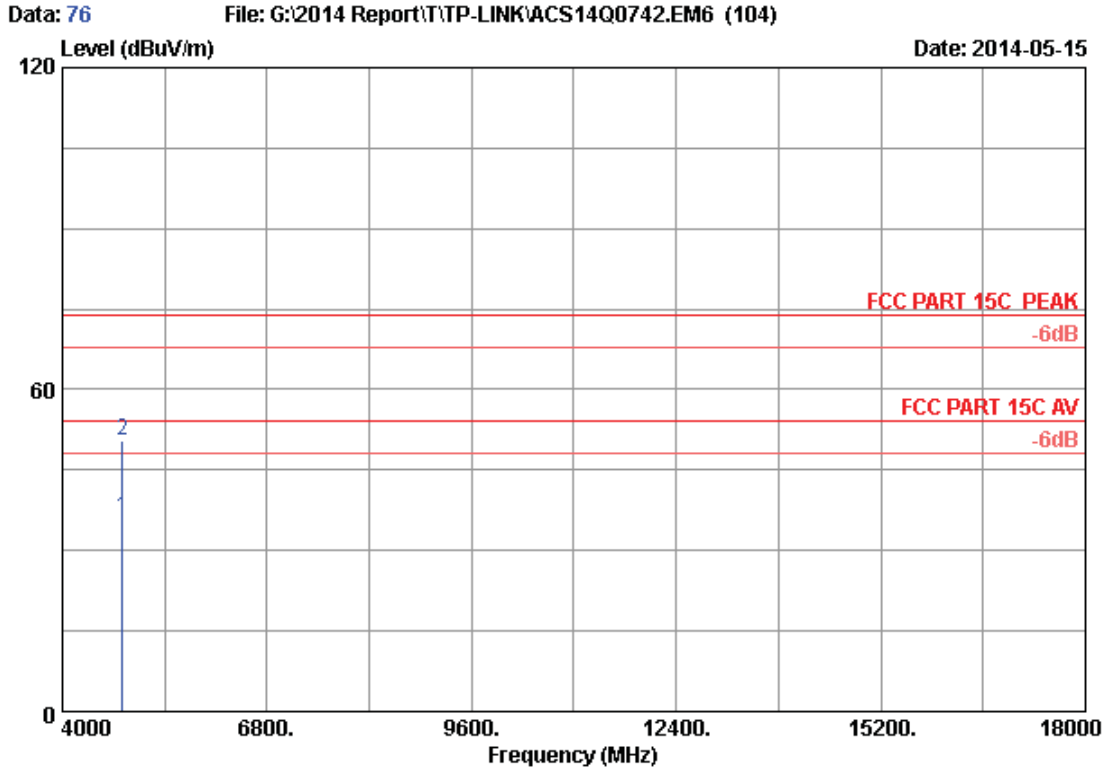

Site no. : 3m Chamber Data no. : 76
 Dis. / Ant. : 3m 2013 3115 (4580) Ant. pol. : HORIZONTAL
 Limit : FCC PART 15C PEAK
 Env. / Ins. : 24°C/56% Engineer : Kevin_Hu
 EUT : AC750 Wireless Dual Band Router
 Power Rating : DC 12V From Adapter Input AC 120V/60Hz
 Test Mode : IEEE802.11nHT20 2412MHz Tx Mode
 M/N : C20i

No.	Freq. (MHz)	Ant. Factor (dB/m)	Cable Loss (dB)	AMP factor (dB)	Reading (dBuV)	Emission Level (dBuV/m)	Limits (dBuV/m)	Margin (dB)	Remark
1	4824.000	32.88	8.58	35.70	30.41	36.17	54.00	17.83	Average
2	4824.000	32.88	8.58	35.70	44.73	50.49	74.00	23.51	Peak

Remarks: 1. Emission Level= Antenna Factor + Cable Loss + Reading - Amp Factor
 2. The emission levels that are 20dB below the official limit are not reported.

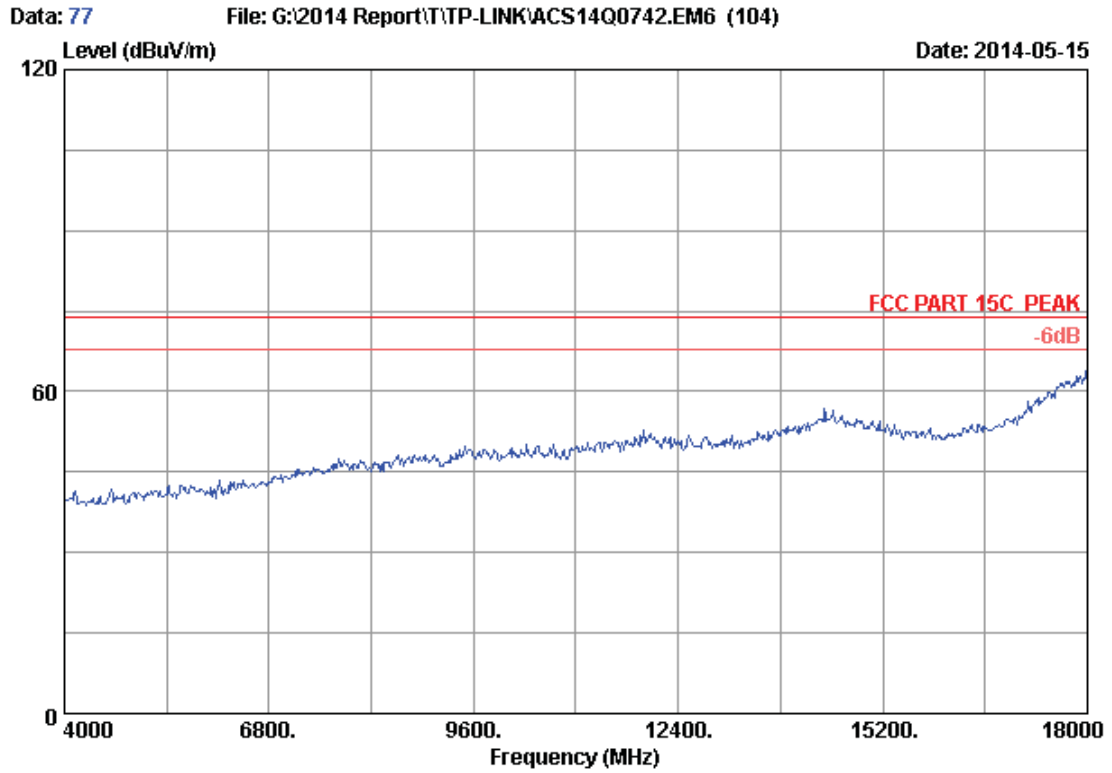

Site no. : 3m Chamber Data no. : 77
Dis. / Ant. : 3m 2013 3115 (4580) Ant. pol. : VERTICAL
Limit : FCC PART 15C PEAK
Env. / Ins. : 24°C/56% Engineer : Kevin_Hu
EUT : AC750 Wireless Dual Band Router
Power Rating : DC 12V From Adapter Input AC 120V/60Hz
Test Mode : IEEE802.11nHT20 2412MHz Tx Mode
M/N : C20i

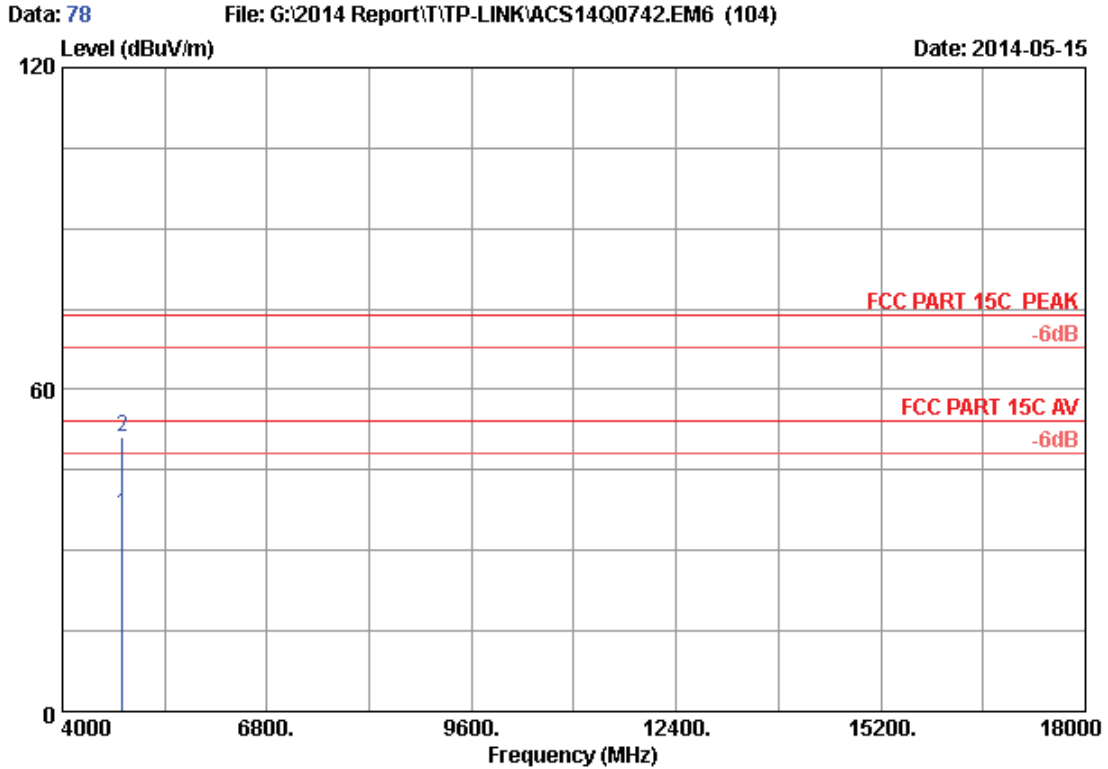

Site no. : 3m Chamber Data no. : 78
 Dis. / Ant. : 3m 2013 3115 (4580) Ant. pol. : VERTICAL
 Limit : FCC PART 15C PEAK
 Env. / Ins. : 24°C/56% Engineer : Kevin_Hu
 EUT : AC750 Wireless Dual Band Router
 Power Rating : DC 12V From Adapter Input AC 120V/60Hz
 Test Mode : IEEE802.11nHT20 2412MHz Tx Mode
 M/N : C20i

No.	Freq. (MHz)	Ant. Factor (dB/m)	Cable Loss (dB)	AMP factor (dB)	Reading (dBUV)	Emission Level (dBUV/m)	Limits (dBUV/m)	Margin (dB)	Remark
1	4824.000	32.88	8.58	35.70	31.12	36.88	54.00	17.12	Average
2	4824.000	32.88	8.58	35.70	45.33	51.09	74.00	22.91	Peak

Remarks: 1. Emission Level= Antenna Factor + Cable Loss + Reading - Amp Factor
 2. The emission levels that are 20dB below the official limit are not reported.

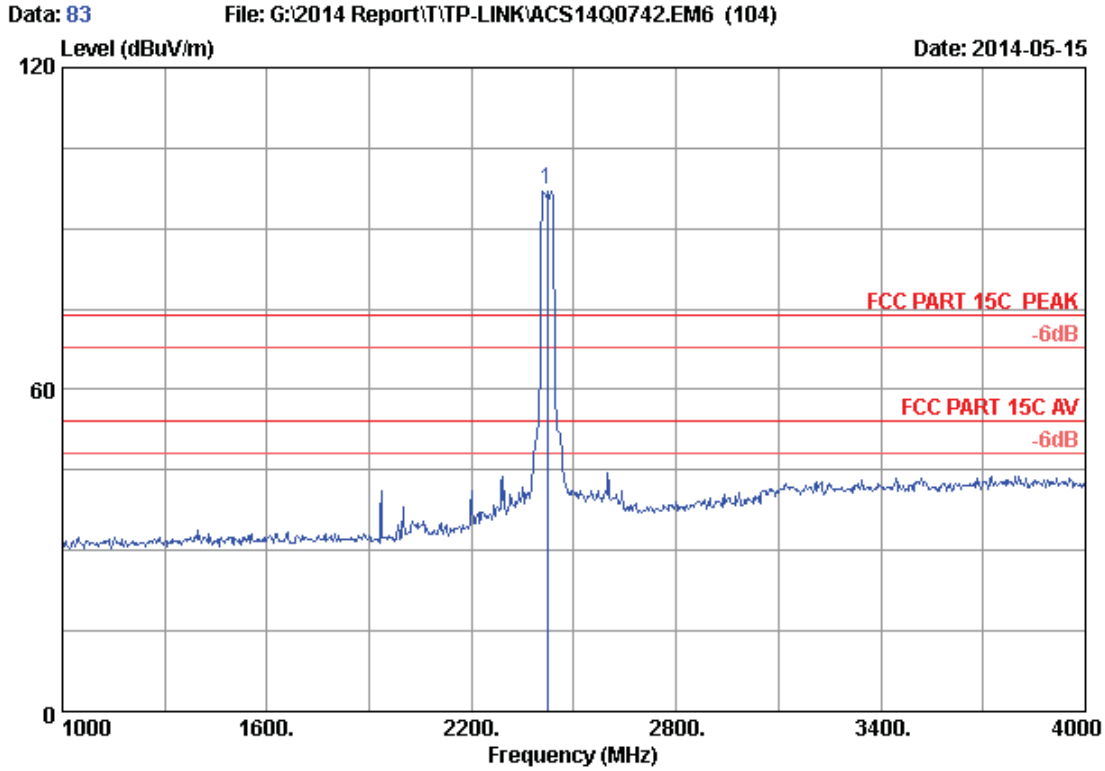

Site no. : 3m Chamber Data no. : 83
 Dis. / Ant. : 3m 2013 3115 (4580) Ant. pol. : VERTICAL
 Limit : FCC PART 15C PEAK
 Env. / Ins. : 24°C/56% Engineer : Kevin_Hu
 EUT : AC750 Wireless Dual Band Router
 Power Rating : DC 12V From Adapter Input AC 120V/60Hz
 Test Mode : IEEE802.11nHT40 2422MHz Tx Mode
 M/N : C20i

No.	Freq. (MHz)	Ant. Factor (dB/m)	Cable Loss (dB)	AMP factor (dB)	Reading (dBuV)	Emission Level (dBuV/m)	Limits (dBuV/m)	Margin (dB)	Remark
1	2422.000	28.23	5.83	35.70	98.78	97.14	74.00	-23.14	Peak

Remarks: 1. Emission Level= Antenna Factor + Cable Loss + Reading - Amp Factor
 2. The emission levels that are 20dB below the official limit are not reported.

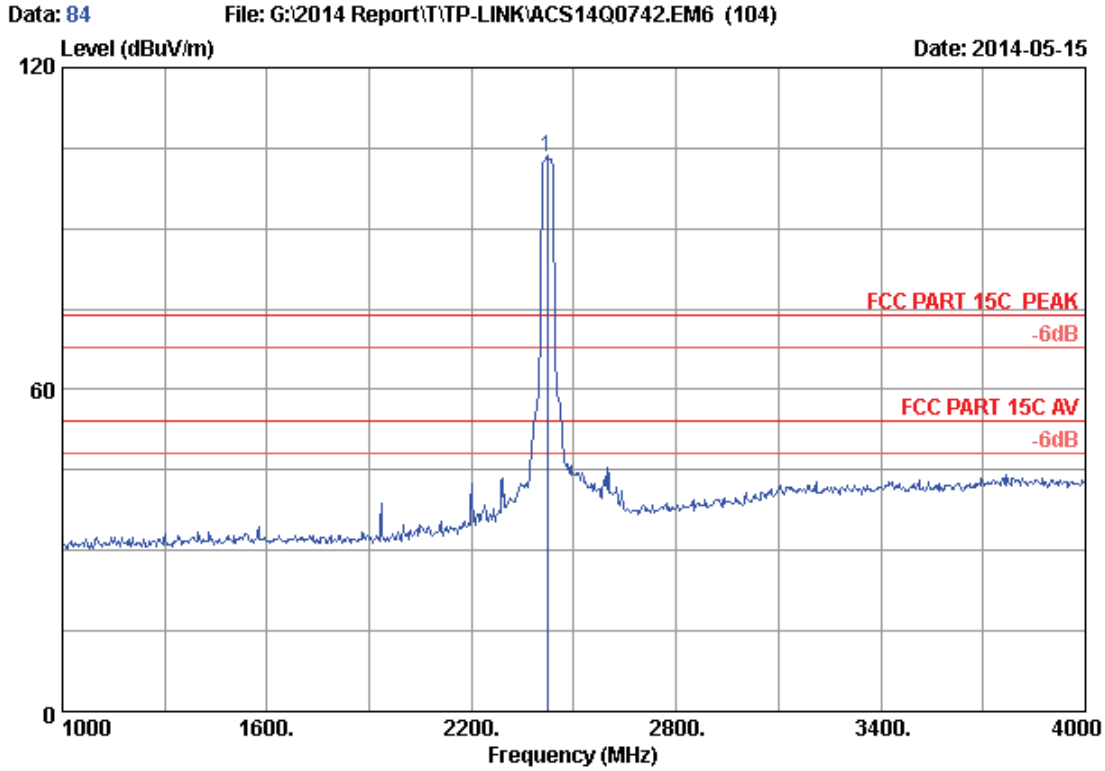

Site no. : 3m Chamber Data no. : 84
 Dis. / Ant. : 3m 2013 3115 (4580) Ant. pol. : HORIZONTAL
 Limit : FCC PART 15C PEAK
 Env. / Ins. : 24°C/56% Engineer : Kevin_Hu
 EUT : AC750 Wireless Dual Band Router
 Power Rating : DC 12V From Adapter Input AC 120V/60Hz
 Test Mode : IEEE802.11nHT40 2422MHz Tx Mode
 M/N : C20i

No.	Freq. (MHz)	Ant. Factor (dB/m)	Cable Loss (dB)	AMP factor (dB)	Reading (dBuV)	Emission Level (dBuV/m)	Limits (dBuV/m)	Margin (dB)	Remark
1	2422.000	28.23	5.83	35.70	104.77	103.13	74.00	-29.13	Peak

Remarks: 1. Emission Level= Antenna Factor + Cable Loss + Reading
 -Amp Factor
 2. The emission levels that are 20dB below the official
 limit are not reported.

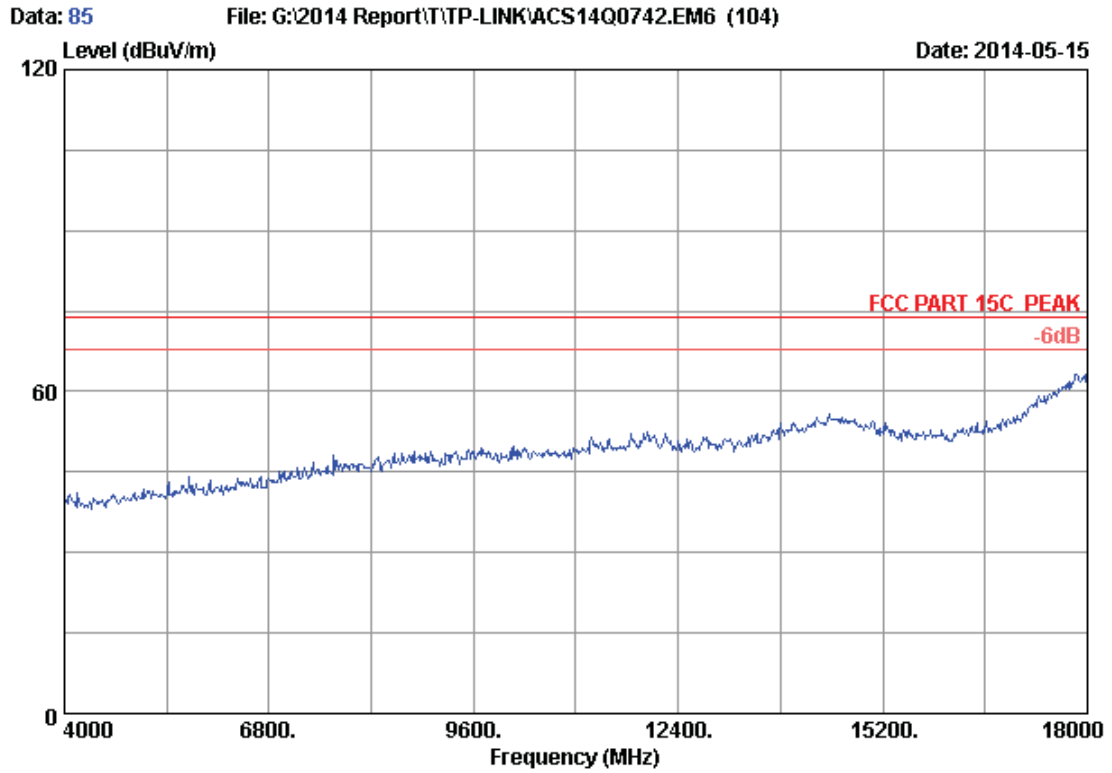

Site no. : 3m Chamber Data no. : 85
Dis. / Ant. : 3m 2013 3115 (4580) Ant. pol. : VERTICAL
Limit : FCC PART 15C PEAK
Env. / Ins. : 24°C/56% Engineer : Kevin_Hu
EUT : AC750 Wireless Dual Band Router
Power Rating : DC 12V From Adapter Input AC 120V/60Hz
Test Mode : IEEE802.11nHT40 2422MHz Tx Mode
M/N : C20i

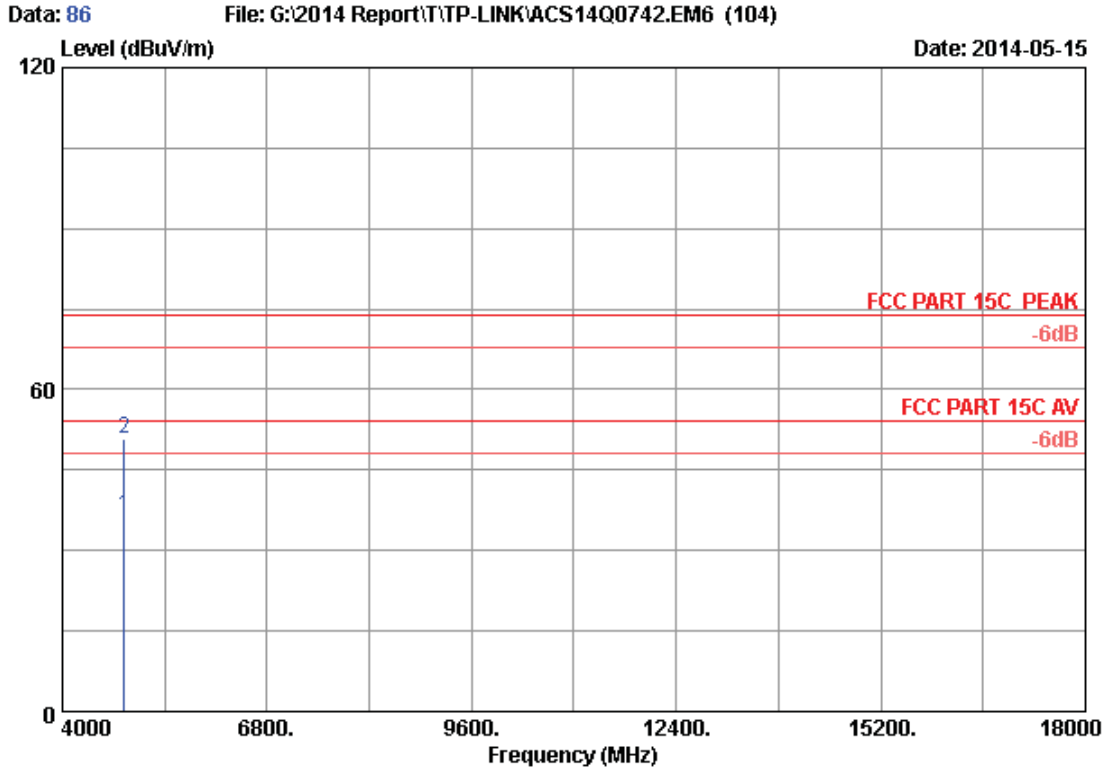

Site no. : 3m Chamber Data no. : 86
 Dis. / Ant. : 3m 2013 3115 (4580) Ant. pol. : VERTICAL
 Limit : FCC PART 15C PEAK
 Env. / Ins. : 24°C/56% Engineer : Kevin_Hu
 EUT : AC750 Wireless Dual Band Router
 Power Rating : DC 12V From Adapter Input AC 120V/60Hz
 Test Mode : IEEE802.11nHT40 2422MHz Tx Mode
 M/N : C20i

No.	Freq. (MHz)	Ant. Factor (dB/m)	Cable Loss (dB)	AMP factor (dB)	Reading (dBuV)	Emission Level (dBuV/m)	Limits (dBuV/m)	Margin (dB)	Remark
1	4844.000	32.92	8.60	35.70	30.75	36.57	54.00	17.43	Average
2	4844.000	32.92	8.60	35.70	44.83	50.65	74.00	23.35	Peak

Remarks: 1. Emission Level= Antenna Factor + Cable Loss + Reading - Amp Factor
 2. The emission levels that are 20dB below the official limit are not reported.

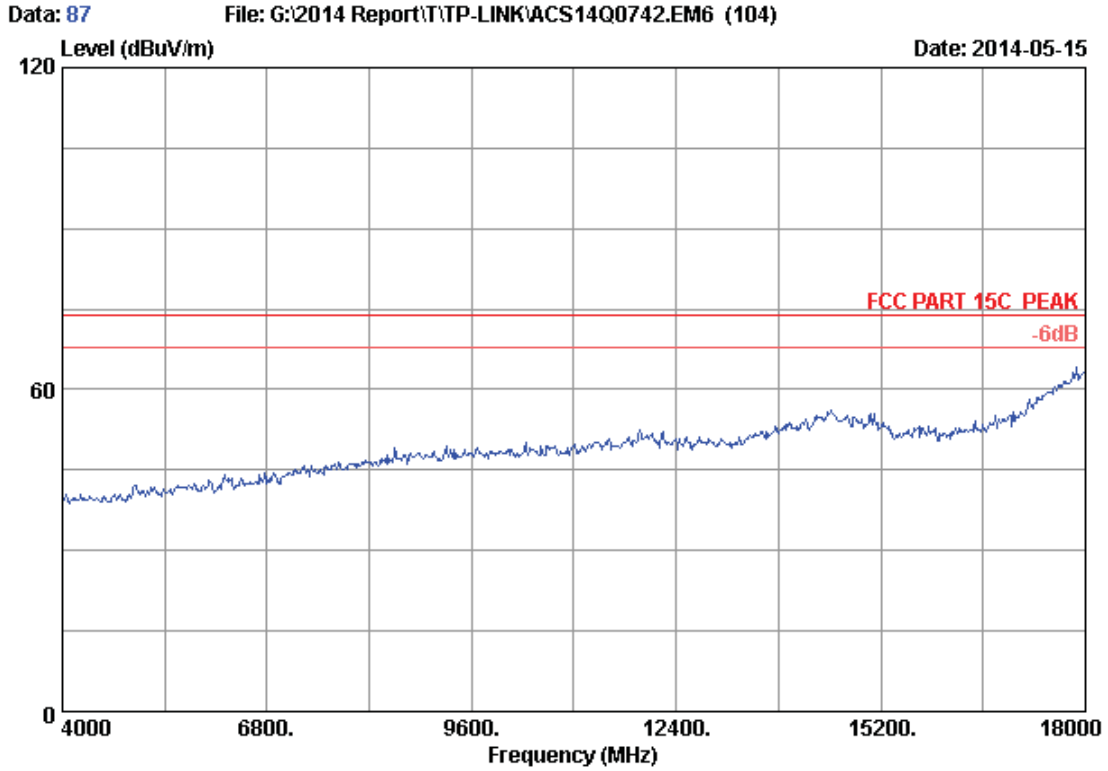

Site no.	: 3m Chamber	Data no.	: 87
Dis. / Ant.	: 3m 2013 3115 (4580)	Ant. pol.	: HORIZONTAL
Limit	: FCC PART 15C PEAK		
Env. / Ins.	: 24°C/56%	Engineer	: Kevin_Hu
EUT	: AC750 Wireless Dual Band Router		
Power Rating	: DC 12V From Adapter Input AC 120V/60Hz		
Test Mode	: IEEE802.11nHT40 2422MHz Tx Mode		
M/N	: C20i		

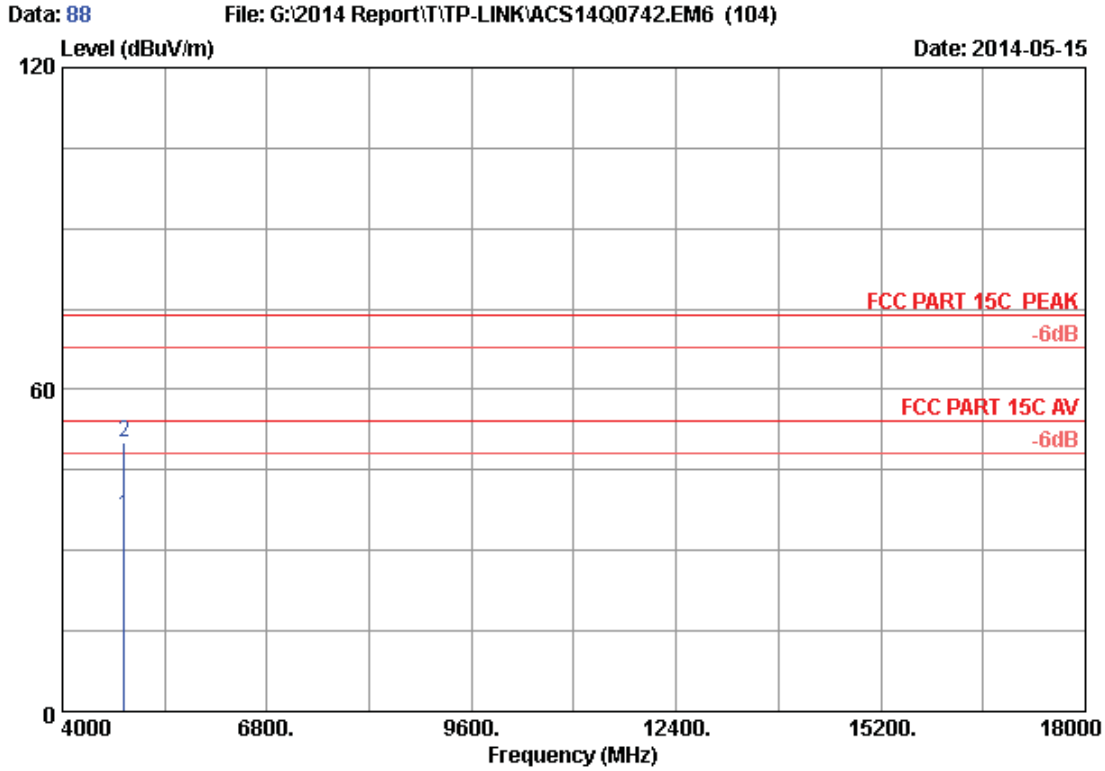

Site no. : 3m Chamber Data no. : 88
 Dis. / Ant. : 3m 2013 3115 (4580) Ant. pol. : HORIZONTAL
 Limit : FCC PART 15C PEAK
 Env. / Ins. : 24°C/56% Engineer : Kevin_Hu
 EUT : AC750 Wireless Dual Band Router
 Power Rating : DC 12V From Adapter Input AC 120V/60Hz
 Test Mode : IEEE802.11nHT40 2422MHz Tx Mode
 M/N : C20i

No.	Freq. (MHz)	Ant. Factor (dB/m)	Cable Loss (dB)	AMP factor (dB)	Reading (dBuV)	Emission Level (dBuV/m)	Limits (dBuV/m)	Margin (dB)	Remark
1	4844.000	32.92	8.60	35.70	30.51	36.33	54.00	17.67	Average
2	4844.000	32.92	8.60	35.70	44.38	50.20	74.00	23.80	Peak

Remarks: 1. Emission Level= Antenna Factor + Cable Loss + Reading - Amp Factor
 2. The emission levels that are 20dB below the official limit are not reported.

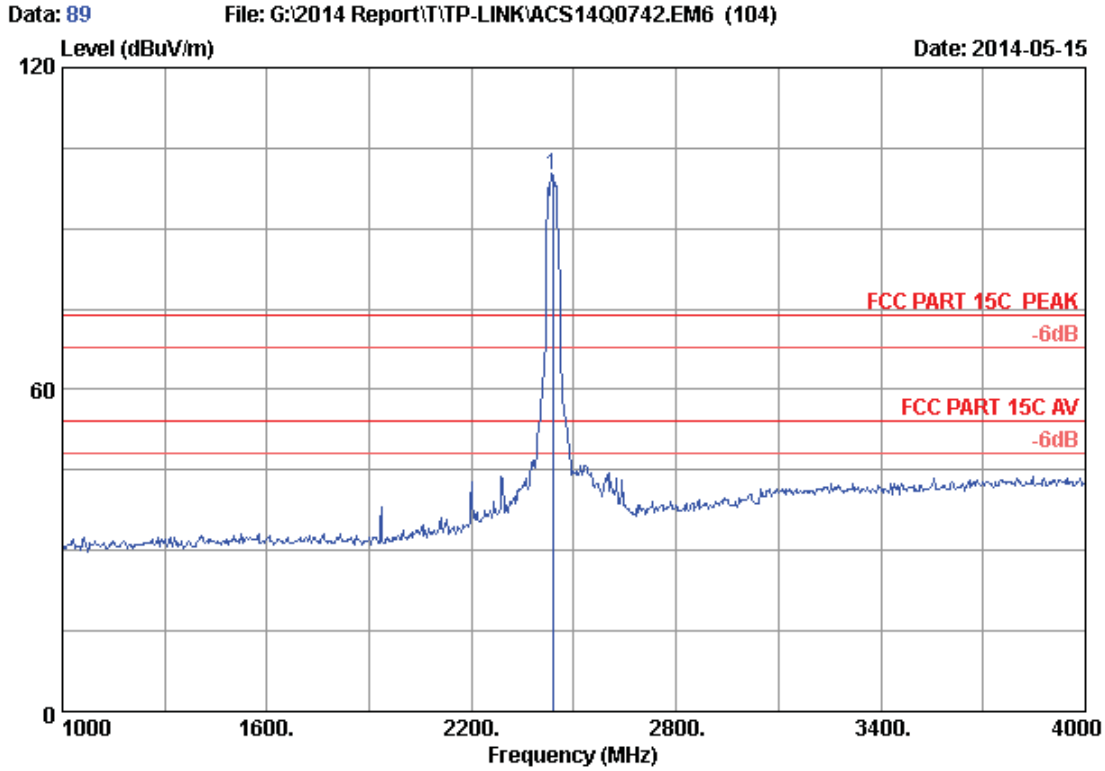

Site no. : 3m Chamber Data no. : 89
 Dis. / Ant. : 3m 2013 3115 (4580) Ant. pol. : HORIZONTAL
 Limit : FCC PART 15C PEAK
 Env. / Ins. : 24°C/56% Engineer : Kevin_Hu
 EUT : AC750 Wireless Dual Band Router
 Power Rating : DC 12V From Adapter Input AC 120V/60Hz
 Test Mode : IEEE802.11nHT40 2437MHz Tx Mode
 M/N : C20i

No.	Freq. (MHz)	Ant. Factor (dB/m)	Cable Loss (dB)	AMP factor (dB)	Reading (dBuV)	Emission Level (dBuV/m)	Limits (dBuV/m)	Margin (dB)	Remark
1	2437.000	28.26	5.85	35.70	101.59	100.00	74.00	-26.00	Peak

Remarks: 1. Emission Level= Antenna Factor + Cable Loss + Reading - Amp Factor
 2. The emission levels that are 20dB below the official limit are not reported.

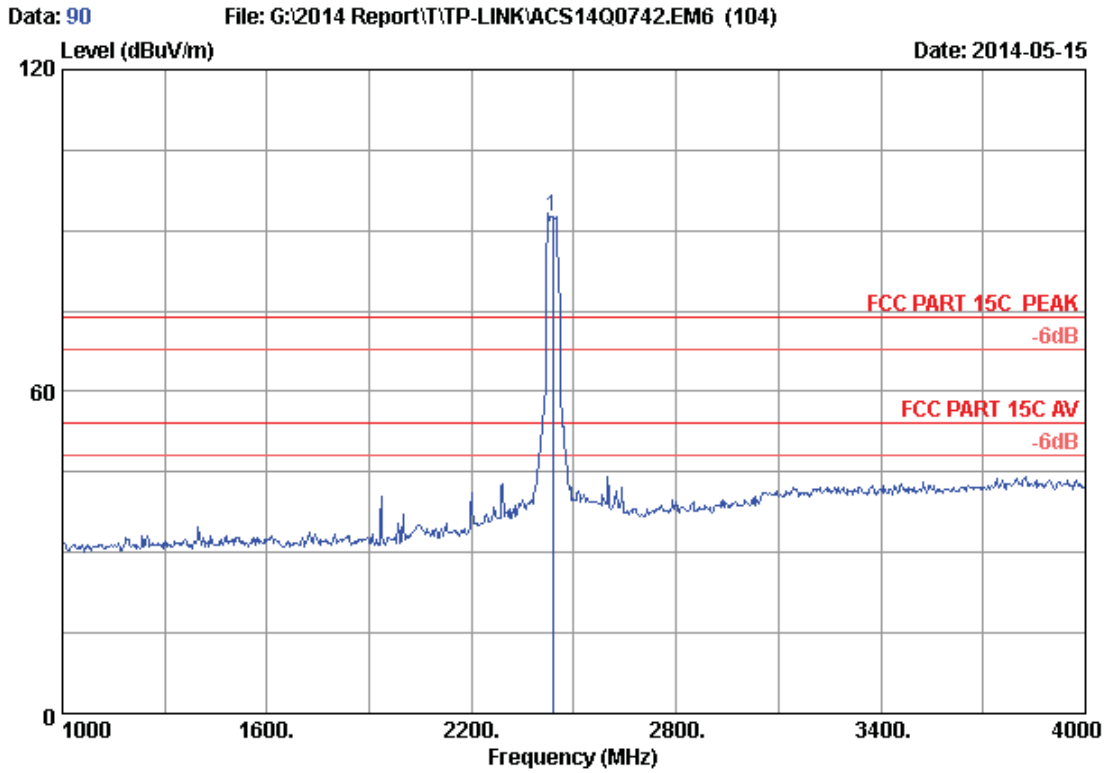

Site no. : 3m Chamber Data no. : 90
 Dis. / Ant. : 3m 2013 3115 (4580) Ant. pol. : VERTICAL
 Limit : FCC PART 15C PEAK
 Env. / Ins. : 24°C/56% Engineer : Kevin_Hu
 EUT : AC750 Wireless Dual Band Router
 Power Rating : DC 12V From Adapter Input AC 120V/60Hz
 Test Mode : IEEE802.11nHT40 2437MHz Tx Mode
 M/N : C20i

No.	Freq. (MHz)	Ant. Factor (dB/m)	Cable Loss (dB)	AMP factor (dB)	Reading (dBUV)	Emission Level (dBUV/m)	Limits (dBUV/m)	Margin (dB)	Remark
1	2437.000	28.26	5.85	35.70	94.15	92.56	74.00	-18.56	Peak

Remarks: 1. Emission Level= Antenna Factor + Cable Loss + Reading - Amp Factor
 2. The emission levels that are 20dB below the official limit are not reported.

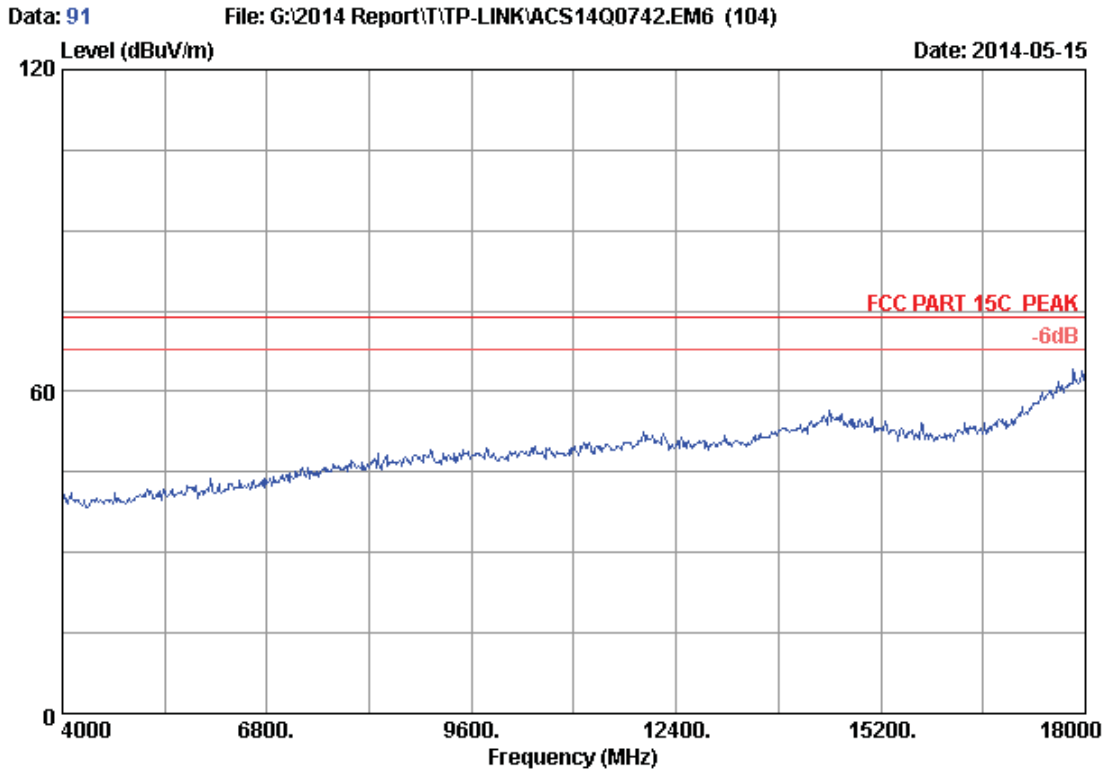

Site no. : 3m Chamber Data no. : 91
Dis. / Ant. : 3m 2013 3115 (4580) Ant. pol. : HORIZONTAL
Limit : FCC PART 15C PEAK
Env. / Ins. : 24°C/56% Engineer : Kevin_Hu
EUT : AC750 Wireless Dual Band Router
Power Rating : DC 12V From Adapter Input AC 120V/60Hz
Test Mode : IEEE802.11nHT40 2437MHz Tx Mode
M/N : C20i

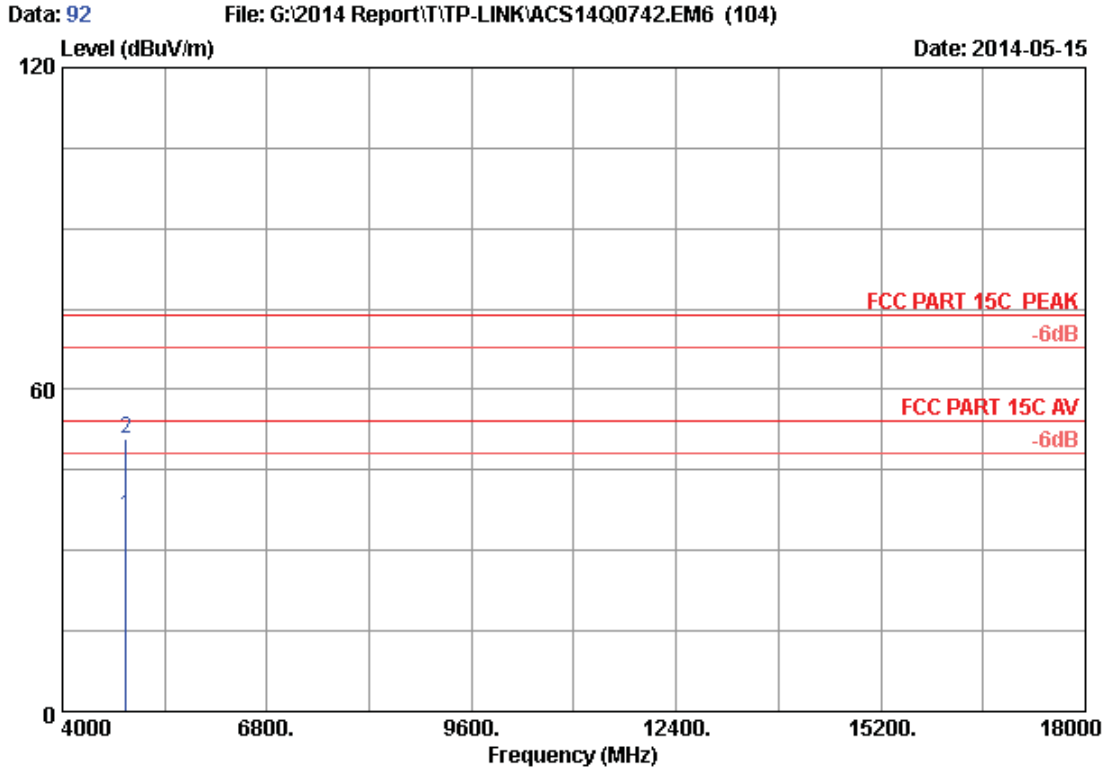

Site no. : 3m Chamber Data no. : 92
 Dis. / Ant. : 3m 2013 3115 (4580) Ant. pol. : HORIZONTAL
 Limit : FCC PART 15C PEAK
 Env. / Ins. : 24°C/56% Engineer : Kevin_Hu
 EUT : AC750 Wireless Dual Band Router
 Power Rating : DC 12V From Adapter Input AC 120V/60Hz
 Test Mode : IEEE802.11nHT40 2437MHz Tx Mode
 M/N : C20i

No.	Freq. (MHz)	Ant. Factor (dB/m)	Cable Loss (dB)	AMP factor (dB)	Reading (dBUV)	Emission Level (dBUV/m)	Limits (dBUV/m)	Margin (dB)	Remark
1	4874.000	32.97	8.63	35.70	30.60	36.50	54.00	17.50	Average
2	4874.000	32.97	8.63	35.70	44.79	50.69	74.00	23.31	Peak

Remarks: 1. Emission Level= Antenna Factor + Cable Loss + Reading - Amp Factor
 2. The emission levels that are 20dB below the official limit are not reported.

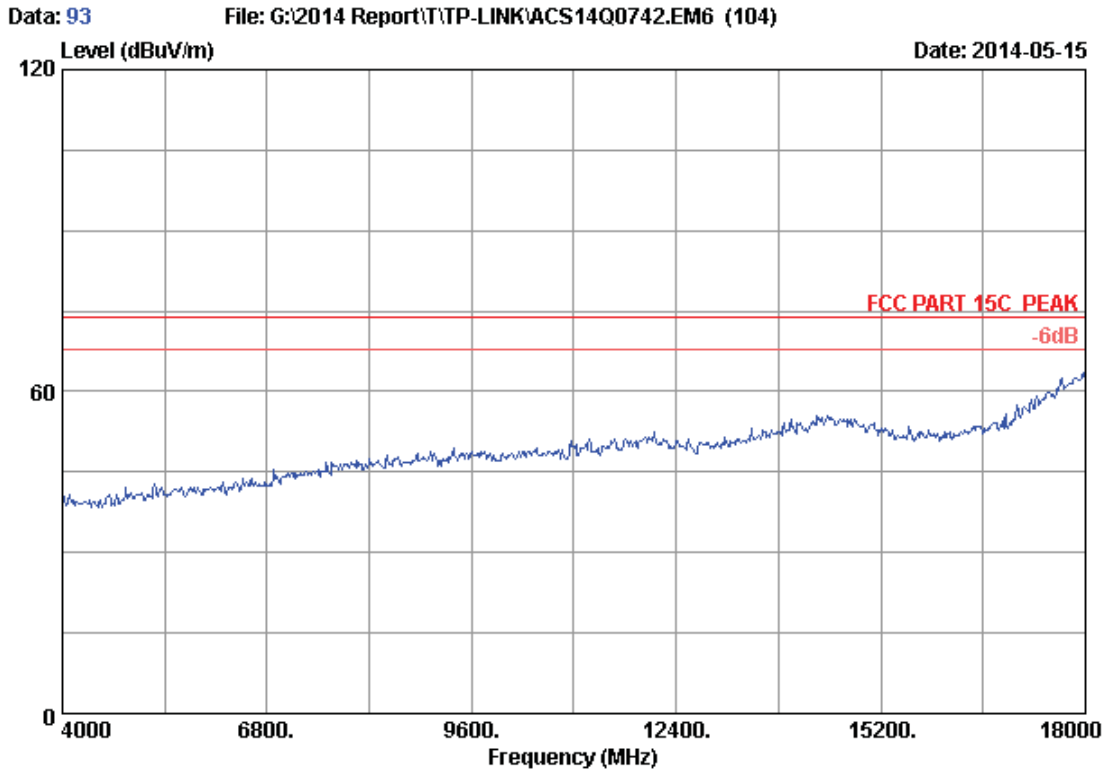

Site no. : 3m Chamber Data no. : 93
Dis. / Ant. : 3m 2013 3115 (4580) Ant. pol. : VERTICAL
Limit : FCC PART 15C PEAK
Env. / Ins. : 24°C/56% Engineer : Kevin_Hu
EUT : AC750 Wireless Dual Band Router
Power Rating : DC 12V From Adapter Input AC 120V/60Hz
Test Mode : IEEE802.11nHT40 2437MHz Tx Mode
M/N : C20i

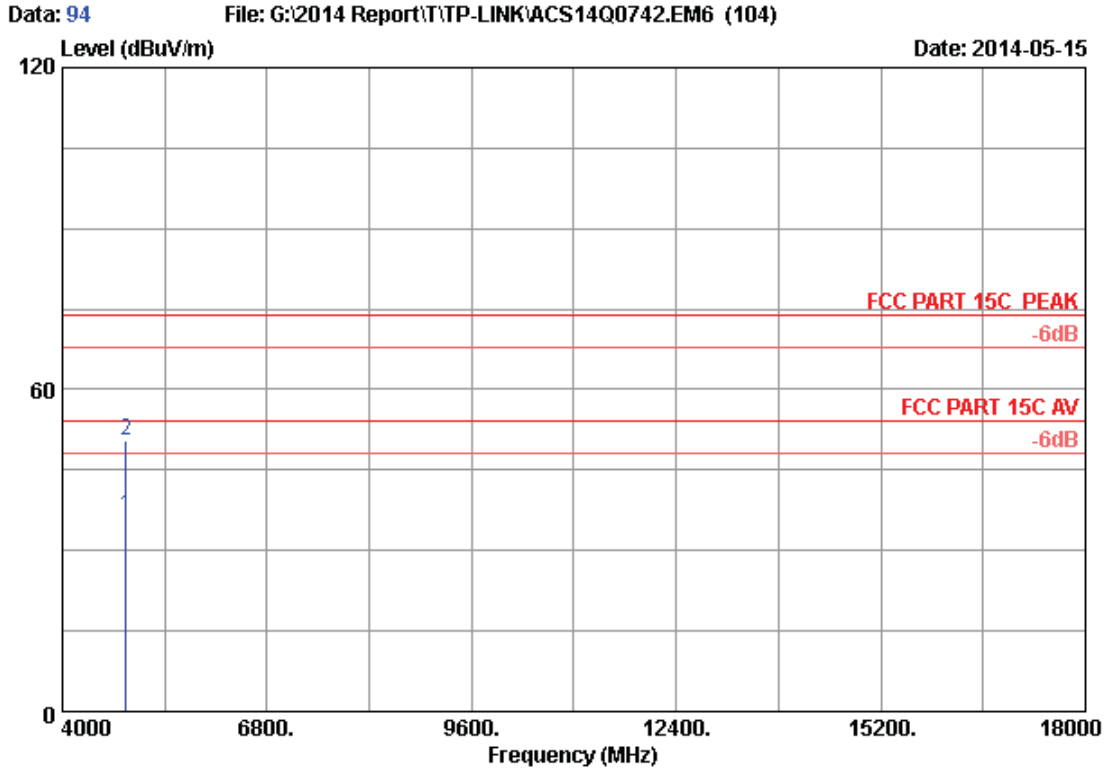

Site no. : 3m Chamber Data no. : 94
 Dis. / Ant. : 3m 2013 3115 (4580) Ant. pol. : VERTICAL
 Limit : FCC PART 15C PEAK
 Env. / Ins. : 24°C/56% Engineer : Kevin_Hu
 EUT : AC750 Wireless Dual Band Router
 Power Rating : DC 12V From Adapter Input AC 120V/60Hz
 Test Mode : IEEE802.11nHT40 2437MHz Tx Mode
 M/N : C20i

No.	Freq. (MHz)	Ant. Factor (dB/m)	Cable Loss (dB)	AMP factor (dB)	Reading (dBuV)	Emission Level (dBuV/m)	Limits (dBuV/m)	Margin (dB)	Remark
1	4874.000	32.97	8.63	35.70	30.52	36.42	54.00	17.58	Average
2	4874.000	32.97	8.63	35.70	44.70	50.60	74.00	23.40	Peak

Remarks: 1. Emission Level= Antenna Factor + Cable Loss + Reading - Amp Factor
 2. The emission levels that are 20dB below the official limit are not reported.

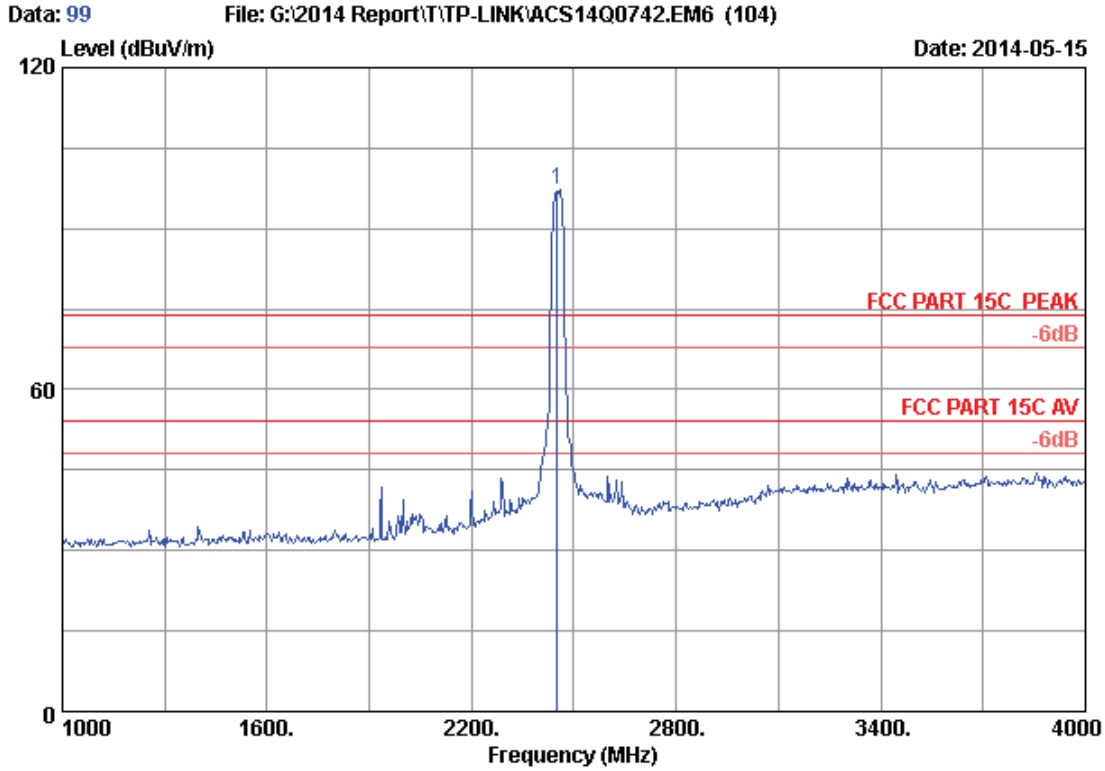

Site no. : 3m Chamber Data no. : 99
 Dis. / Ant. : 3m 2013 3115 (4580) Ant. pol. : VERTICAL
 Limit : FCC PART 15C PEAK
 Env. / Ins. : 24°C/56% Engineer : Kevin_Hu
 EUT : AC750 Wireless Dual Band Router
 Power Rating : DC 12V From Adapter Input AC 120V/60Hz
 Test Mode : IEEE802.11nHT40 2452MHz Tx Mode
 M/N : C20i

No.	Freq. (MHz)	Ant. Factor (dB/m)	Cable Loss (dB)	AMP factor (dB)	Reading (dBuV)	Emission Level (dBuV/m)	Limits (dBuV/m)	Margin (dB)	Remark
1	2452.000	28.29	5.87	35.70	98.90	97.36	74.00	-23.36	Peak

Remarks: 1. Emission Level= Antenna Factor + Cable Loss + Reading - Amp Factor
 2. The emission levels that are 20dB below the official limit are not reported.

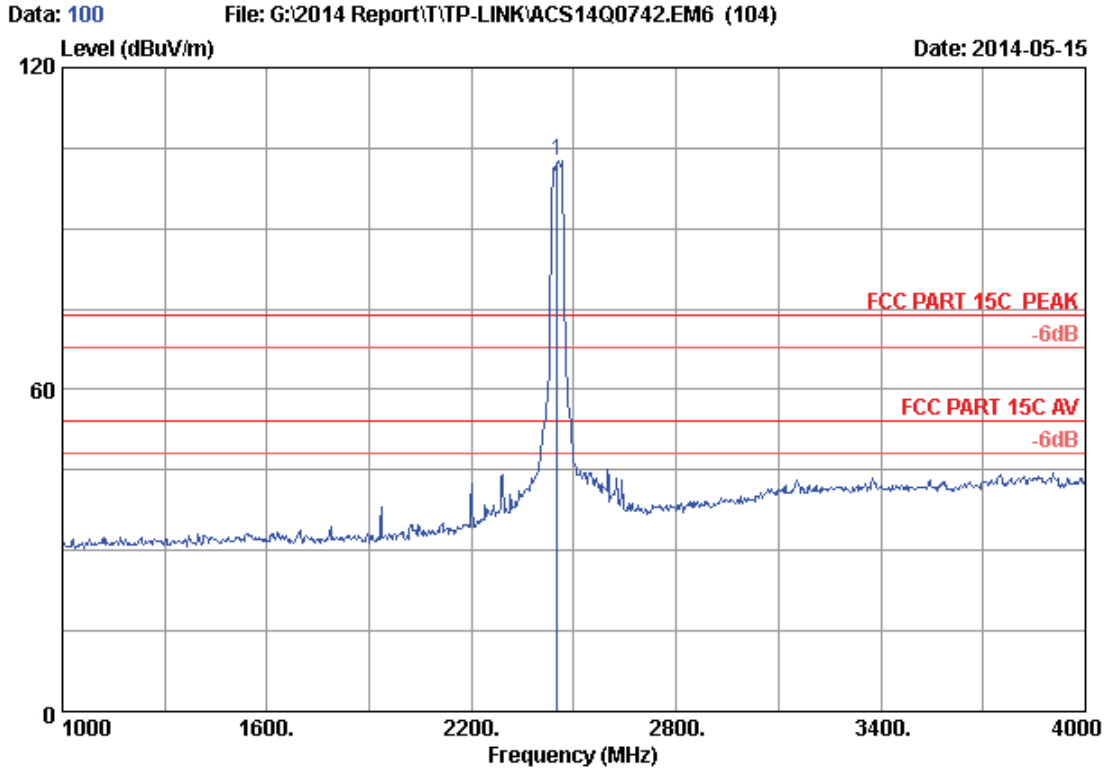

Site no. : 3m Chamber Data no. : 100
 Dis. / Ant. : 3m 2013 3115 (4580) Ant. pol. : HORIZONTAL
 Limit : FCC PART 15C PEAK
 Env. / Ins. : 24°C/56% Engineer : Kevin_Hu
 EUT : AC750 Wireless Dual Band Router
 Power Rating : DC 12V From Adapter Input AC 120V/60Hz
 Test Mode : IEEE802.11nHT40 2452MHz Tx Mode
 M/N : C20i

No.	Freq. (MHz)	Ant. Factor (dB/m)	Cable Loss (dB)	AMP factor (dB)	Reading (dBuV)	Emission Level (dBuV/m)	Limits (dBuV/m)	Margin (dB)	Remark
1	2452.000	28.29	5.87	35.70	104.27	102.73	74.00	-28.73	Peak

Remarks: 1. Emission Level= Antenna Factor + Cable Loss + Reading
 -Amp Factor
 2. The emission levels that are 20dB below the official
 limit are not reported.

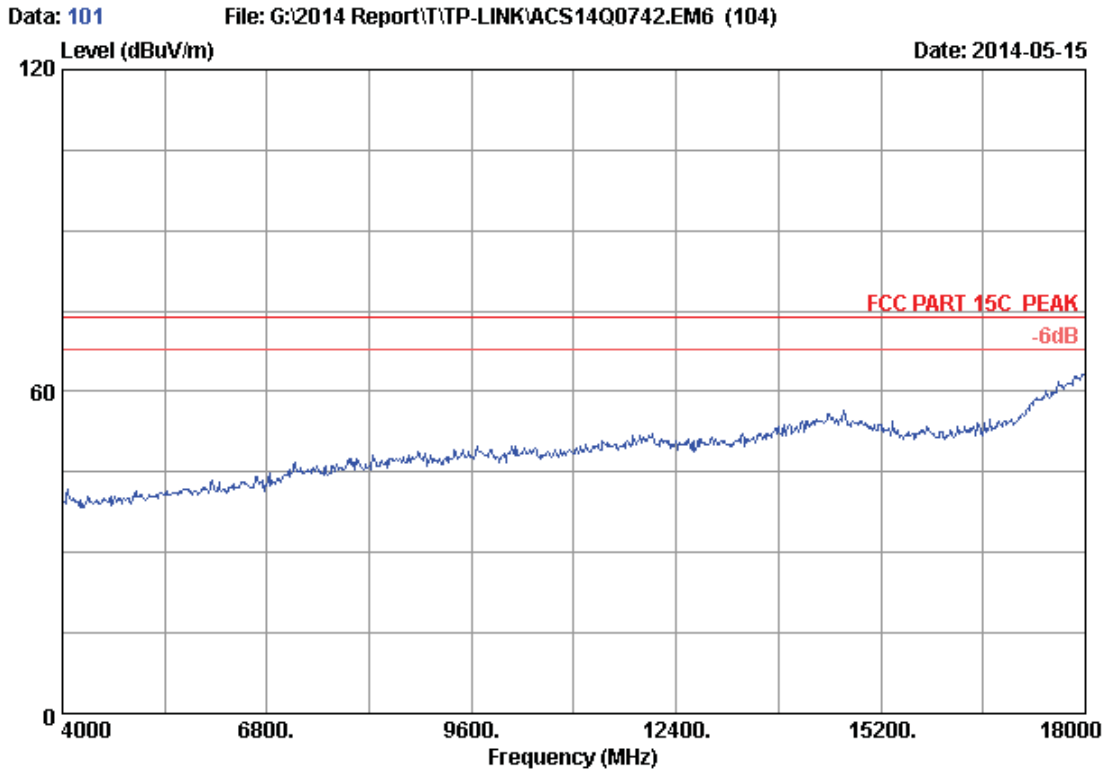

Site no. : 3m Chamber Data no. : 101
Dis. / Ant. : 3m 2013 3115 (4580) Ant. pol. : VERTICAL
Limit : FCC PART 15C PEAK
Env. / Ins. : 24°C/56% Engineer : Kevin_Hu
EUT : AC750 Wireless Dual Band Router
Power Rating : DC 12V From Adapter Input AC 120V/60Hz
Test Mode : IEEE802.11nHT40 2452MHz Tx Mode
M/N : C20i

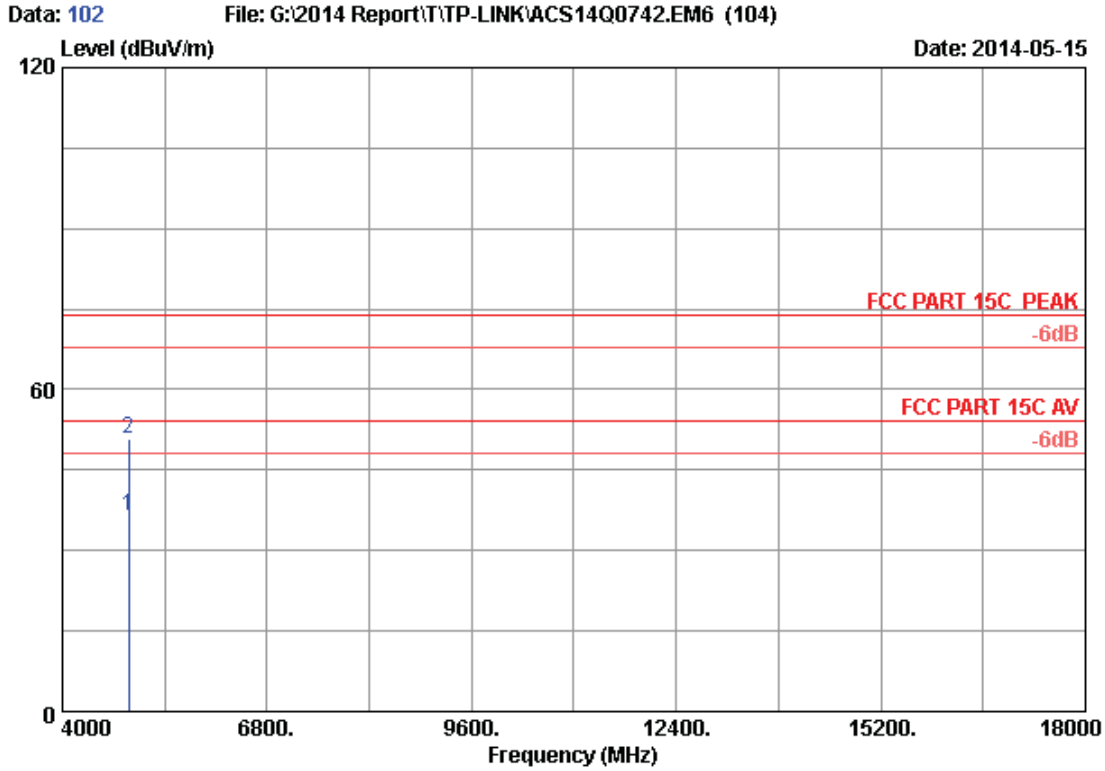

Site no. : 3m Chamber Data no. : 102
 Dis. / Ant. : 3m 2013 3115 (4580) Ant. pol. : VERTICAL
 Limit : FCC PART 15C PEAK
 Env. / Ins. : 24°C/56% Engineer : Kevin_Hu
 EUT : AC750 Wireless Dual Band Router
 Power Rating : DC 12V From Adapter Input AC 120V/60Hz
 Test Mode : IEEE802.11nHT40 2452MHz Tx Mode
 M/N : C20i

No.	Freq. (MHz)	Ant. Factor (dB/m)	Cable Loss (dB)	AMP factor (dB)	Reading (dBUV)	Emission Level (dBUV/m)	Limits (dBUV/m)	Margin (dB)	Remark
1	4904.000	33.03	8.66	35.70	30.37	36.36	54.00	17.64	Average
2	4904.000	33.03	8.66	35.70	44.73	50.72	74.00	23.28	Peak

Remarks: 1. Emission Level= Antenna Factor + Cable Loss + Reading - Amp Factor
 2. The emission levels that are 20dB below the official limit are not reported.

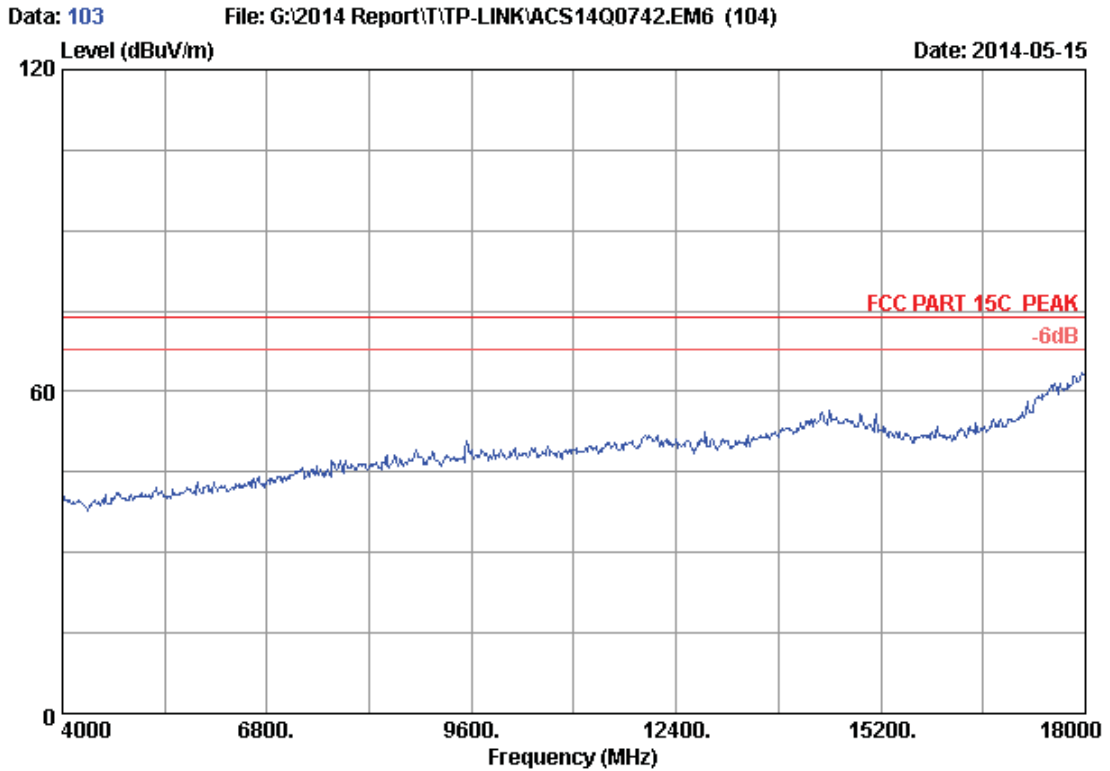

Site no. : 3m Chamber Data no. : 103
Dis. / Ant. : 3m 2013 3115 (4580) Ant. pol. : HORIZONTAL
Limit : FCC PART 15C PEAK
Env. / Ins. : 24°C/56% Engineer : Kevin_Hu
EUT : AC750 Wireless Dual Band Router
Power Rating : DC 12V From Adapter Input AC 120V/60Hz
Test Mode : IEEE802.11nHT40 2452MHz Tx Mode
M/N : C20i

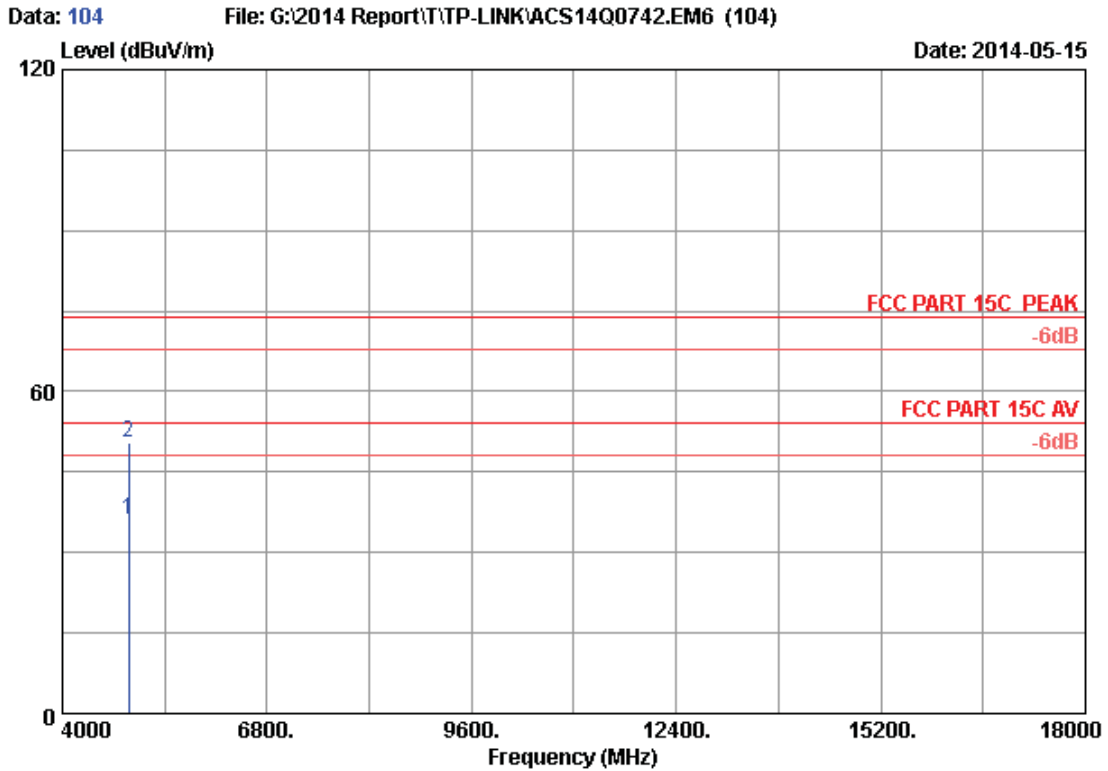

Site no. : 3m Chamber Data no. : 104
 Dis. / Ant. : 3m 2013 3115 (4580) Ant. pol. : HORIZONTAL
 Limit : FCC PART 15C PEAK
 Env. / Ins. : 24°C/56% Engineer : Kevin_Hu
 EUT : AC750 Wireless Dual Band Router
 Power Rating : DC 12V From Adapter Input AC 120V/60Hz
 Test Mode : IEEE802.11nHT40 2452MHz Tx Mode
 M/N : C20i

No.	Freq. (MHz)	Ant. Factor (dB/m)	Cable Loss (dB)	AMP factor (dB)	Reading (dBUV)	Emission Level (dBUV/m)	Limits (dBUV/m)	Margin (dB)	Remark
1	4904.000	33.03	8.66	35.70	30.19	36.18	54.00	17.82	Average
2	4904.000	33.03	8.66	35.70	44.36	50.35	74.00	23.65	Peak

Remarks: 1. Emission Level= Antenna Factor + Cable Loss + Reading - Amp Factor
 2. The emission levels that are 20dB below the official limit are not reported.

UNII Band 4:
Frequency: 1GHz ~18GHz

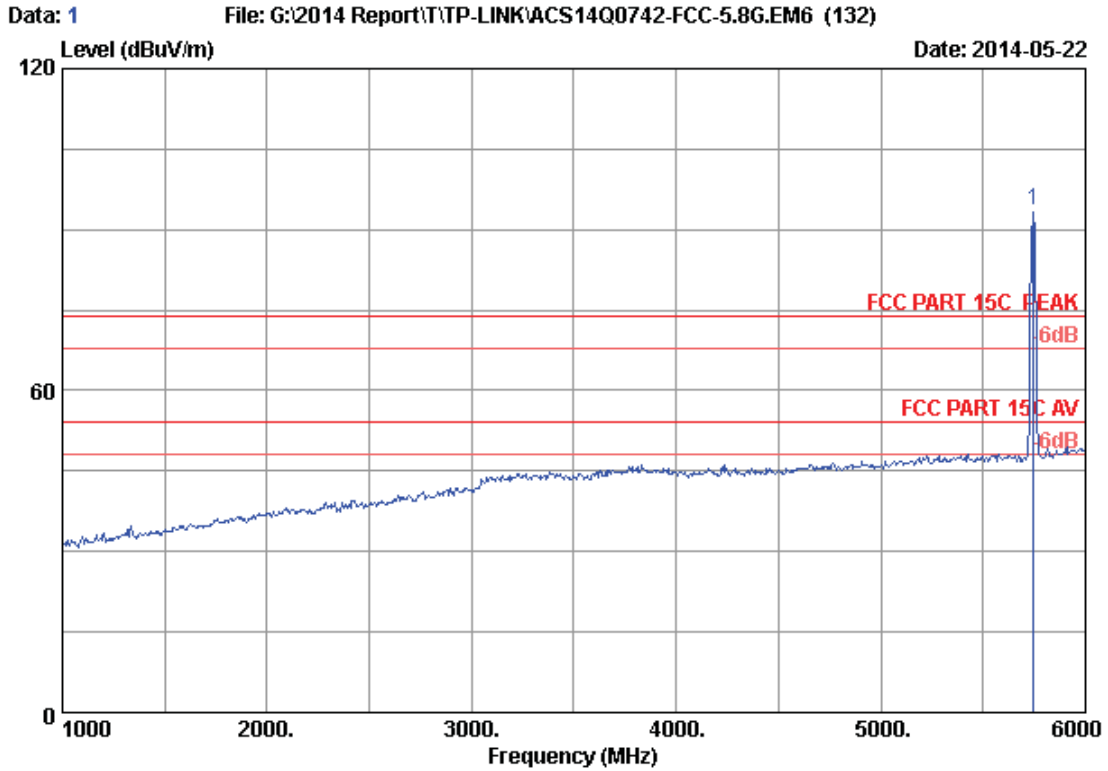

Site no. : 3m Chamber Data no. : 1
 Dis. / Ant. : 3m 2013 3115 (4580) Ant. pol. : HORIZONTAL
 Limit : FCC PART 15C PEAK
 Env. / Ins. : 24°C/56% Engineer : Kevin_Hu
 EUT : AC750 Wireless Dual Band Router
 Power Rating : DC 12V From Adapter Input AC 120V/60Hz
 Test Mode : IEEE802.11a CH149 5745MHz Tx
 M/N : C20i

No.	Freq. (MHz)	Ant. Factor (dB/m)	Cable Loss (dB)	AMP factor (dB)	Reading (dBUV)	Emission			Remark
						Level (dBUV/m)	Limits (dBUV/m)	Margin (dB)	
1	5745.000	34.10	9.55	35.70	85.64	93.59	74.00	-19.59	Peak

Remarks: 1. Emission Level= Antenna Factor + Cable Loss + Reading
 -Amp Factor
 2. The emission levels that are 20dB below the official
 limit are not reported.

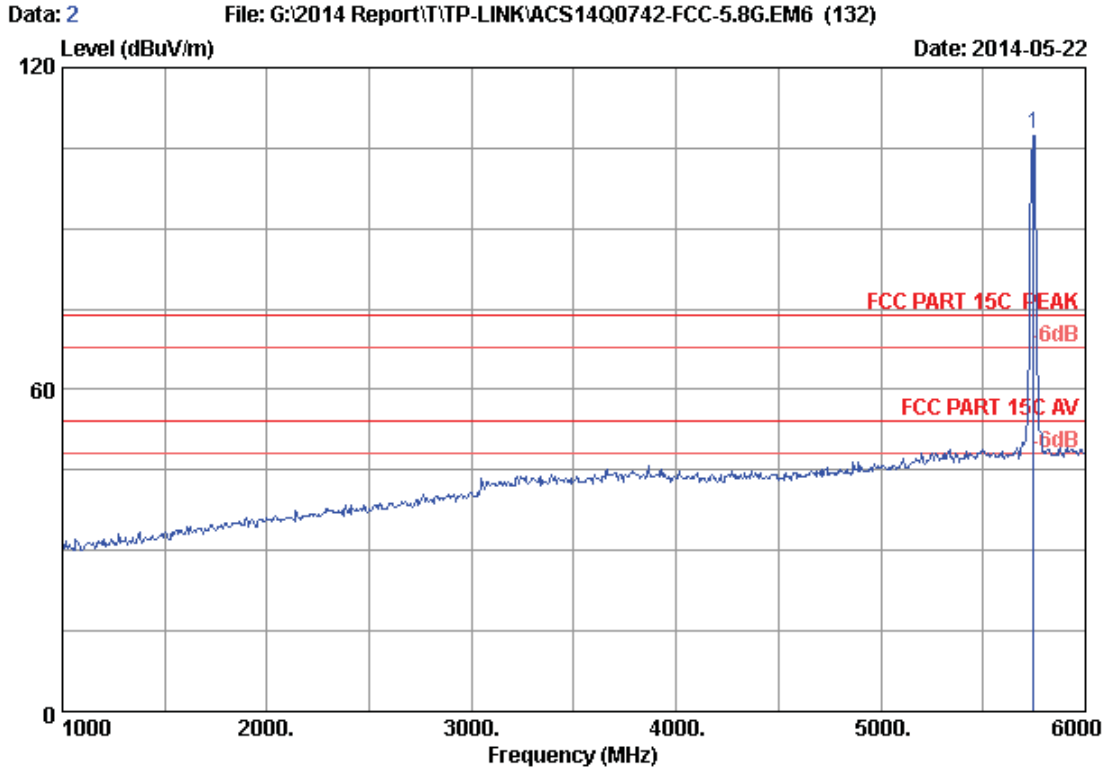

Site no. : 3m Chamber Data no. : 2
 Dis. / Ant. : 3m 2013 3115 (4580) Ant. pol. : VERTICAL
 Limit : FCC PART 15C PEAK
 Env. / Ins. : 24°C/56% Engineer : Kevin_Hu
 EUT : AC750 Wireless Dual Band Router
 Power Rating : DC 12V From Adapter Input AC 120V/60Hz
 Test Mode : IEEE802.11a CH149 5745MHz Tx
 M/N : C20i

No.	Freq. (MHz)	Ant. Factor (dB/m)	Cable Loss (dB)	AMP factor (dB)	Reading (dBuV)	Emission Level (dBuV/m)	Limits (dBuV/m)	Margin (dB)	Remark
1	5745.000	34.10	9.55	35.70	99.84	107.79	74.00	-33.79	Peak

Remarks: 1. Emission Level= Antenna Factor + Cable Loss + Reading - Amp Factor
 2. The emission levels that are 20dB below the official limit are not reported.

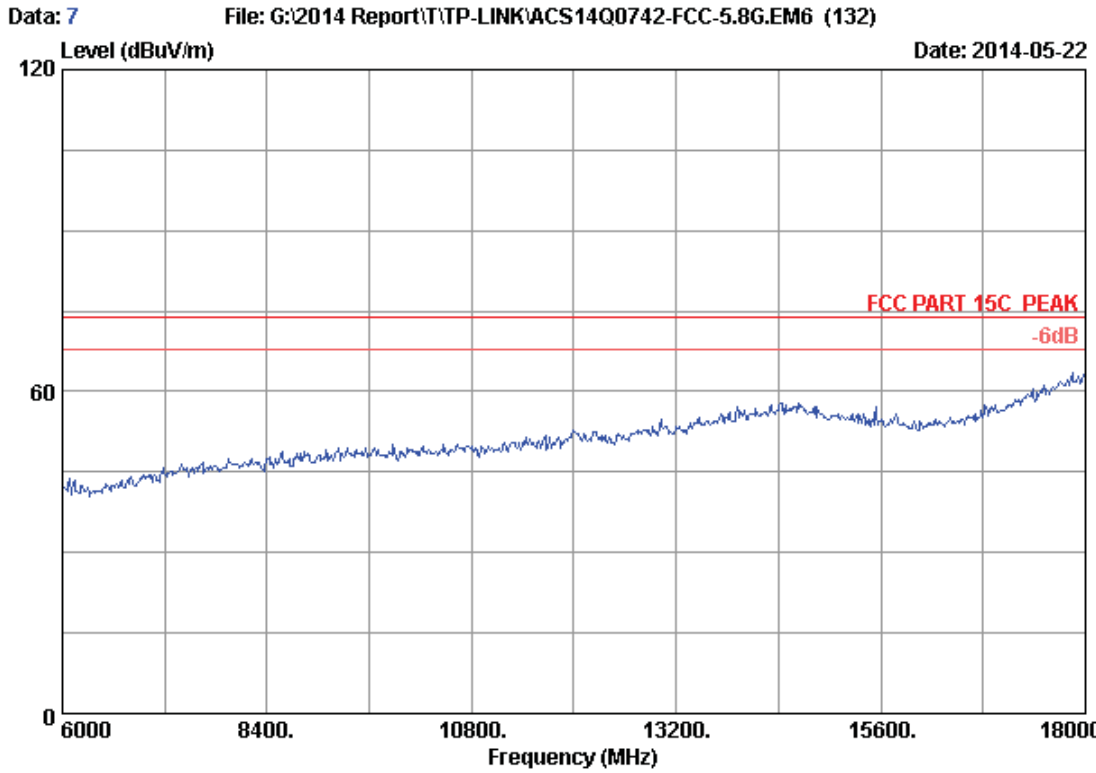

Site no. : 3m Chamber Data no. : 7
Dis. / Ant. : 3m 2013 3115 (4580) Ant. pol. : HORIZONTAL
Limit : FCC PART 15C PEAK
Env. / Ins. : 24°C/56% Engineer : Kevin_Hu
EUT : AC750 Wireless Dual Band Router
Power Rating : DC 12V From Adapter Input AC 120V/60Hz
Test Mode : IEEE802.11a CH149 5745MHz Tx
M/N : C20i

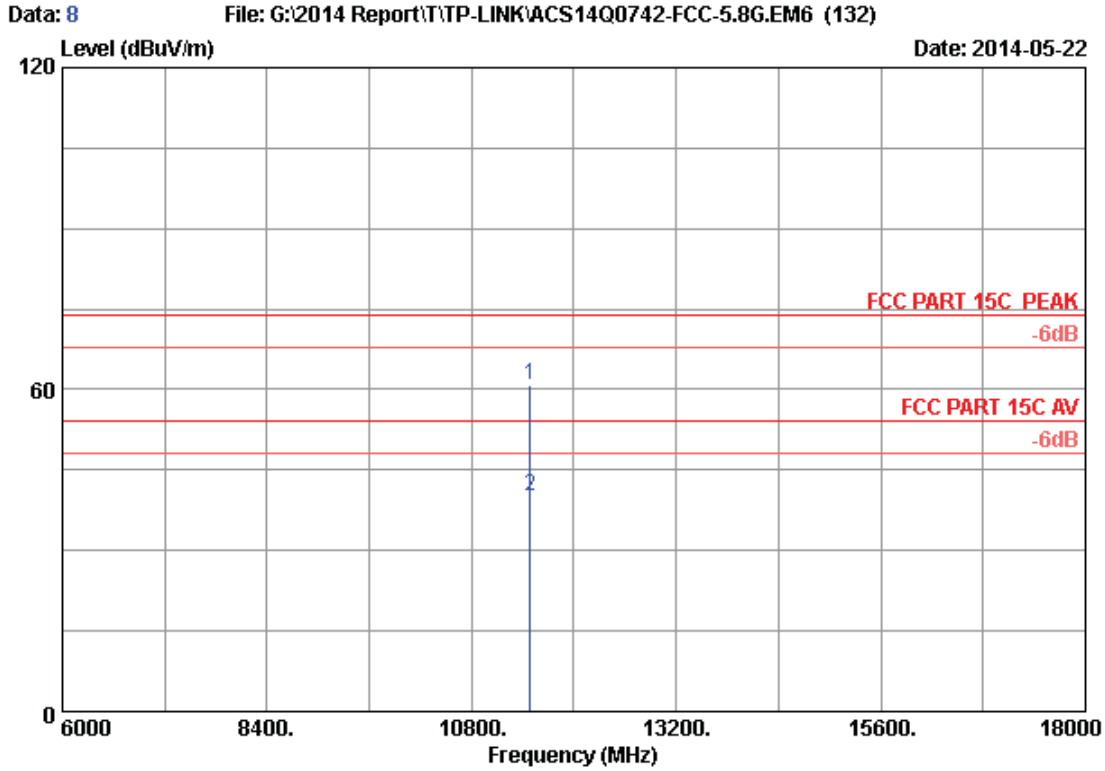

Site no. : 3m Chamber Data no. : 8
 Dis. / Ant. : 3m 2013 3115 (4580) Ant. pol. : HORIZONTAL
 Limit : FCC PART 15C PEAK
 Env. / Ins. : 24°C/56% Engineer : Kevin_Hu
 EUT : AC750 Wireless Dual Band Router
 Power Rating : DC 12V From Adapter Input AC 120V/60Hz
 Test Mode : IEEE802.11a CH149 5745MHz Tx
 M/N : C20i

No.	Freq. (MHz)	Ant. Factor (dB/m)	Cable Loss (dB)	AMP factor (dB)	Reading (dBUV)	Emission Level (dBUV/m)	Limits (dBUV/m)	Margin (dB)	Remark
1	11490.000	38.69	13.28	35.28	44.29	60.98	74.00	13.02	Peak
2	11490.000	38.69	13.28	35.28	23.55	40.24	54.00	13.76	Average

Remarks: 1. Emission Level= Antenna Factor + Cable Loss + Reading - Amp Factor
 2. The emission levels that are 20dB below the official limit are not reported.

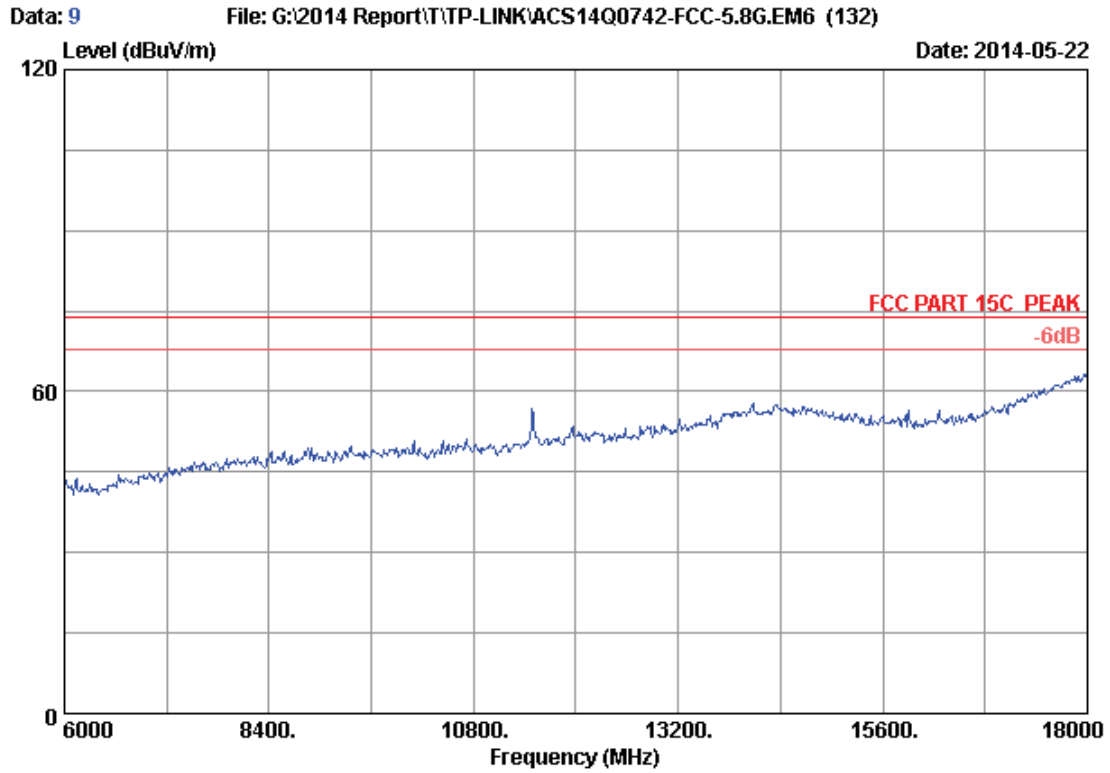

Site no. : 3m Chamber Data no. : 9
Dis. / Ant. : 3m 2013 3115 (4580) Ant. pol. : VERTICAL
Limit : FCC PART 15C PEAK
Env. / Ins. : 24°C/56% Engineer : Kevin_Hu
EUT : AC750 Wireless Dual Band Router
Power Rating : DC 12V From Adapter Input AC 120V/60Hz
Test Mode : IEEE802.11a CH149 5745MHz Tx
M/N : C20i

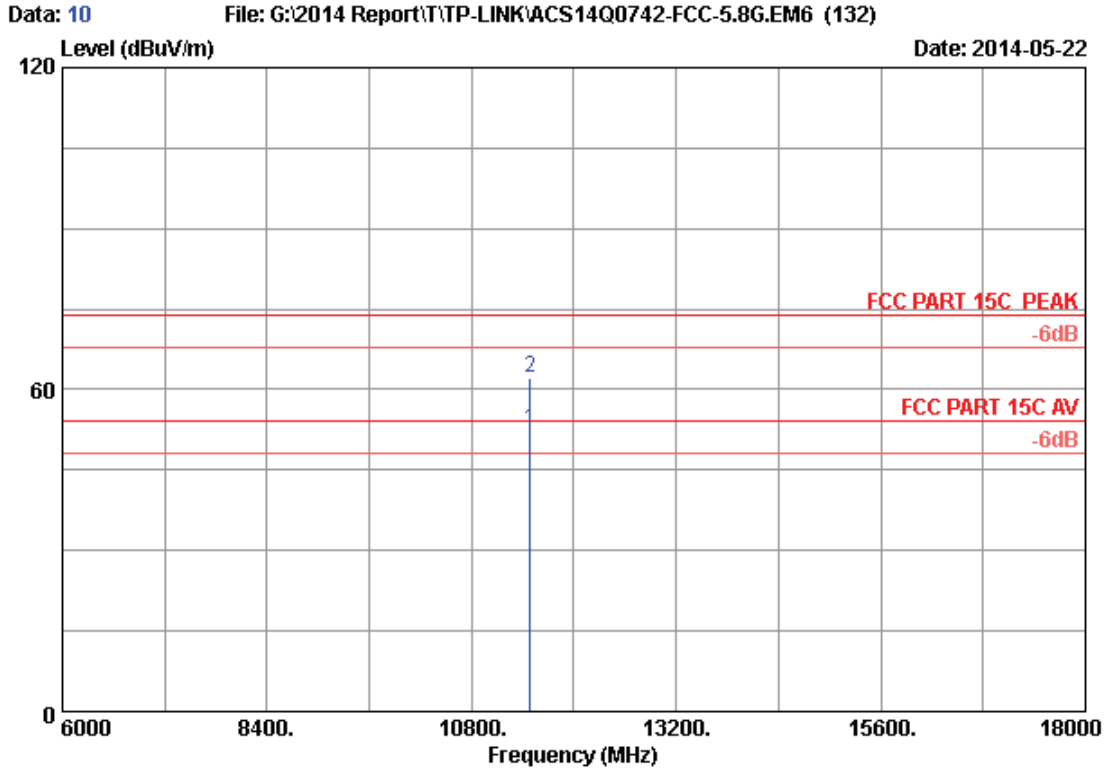

Site no. : 3m Chamber Data no. : 10
 Dis. / Ant. : 3m 2013 3115 (4580) Ant. pol. : VERTICAL
 Limit : FCC PART 15C PEAK
 Env. / Ins. : 24°C/56% Engineer : Kevin_Hu
 EUT : AC750 Wireless Dual Band Router
 Power Rating : DC 12V From Adapter Input AC 120V/60Hz
 Test Mode : IEEE802.11a CH149 5745MHz Tx
 M/N : C20i

No.	Freq. (MHz)	Ant. Factor (dB/m)	Cable Loss (dB)	AMP factor (dB)	Reading (dBuV)	Emission Level (dBuV/m)	Limits (dBuV/m)	Margin (dB)	Remark
1	11490.000	38.69	13.28	35.28	35.84	52.53	54.00	1.47	Average
2	11490.000	38.69	13.28	35.28	45.37	62.06	74.00	11.94	Peak

Remarks: 1. Emission Level= Antenna Factor + Cable Loss + Reading - Amp Factor
 2. The emission levels that are 20dB below the official limit are not reported.

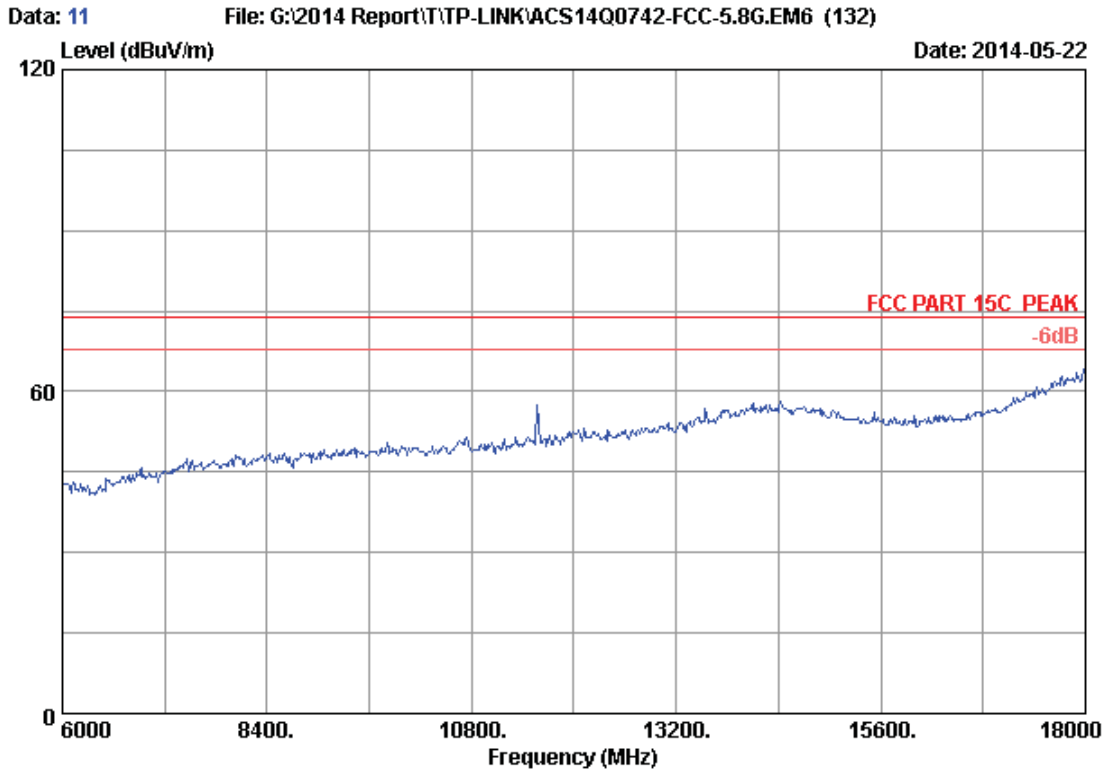

Site no. : 3m Chamber Data no. : 11
Dis. / Ant. : 3m 2013 3115 (4580) Ant. pol. : VERTICAL
Limit : FCC PART 15C PEAK
Env. / Ins. : 24°C/56% Engineer : Kevin_Hu
EUT : AC750 Wireless Dual Band Router
Power Rating : DC 12V From Adapter Input AC 120V/60Hz
Test Mode : IEEE802.11a CH157 5785MHz Tx
M/N : C20i

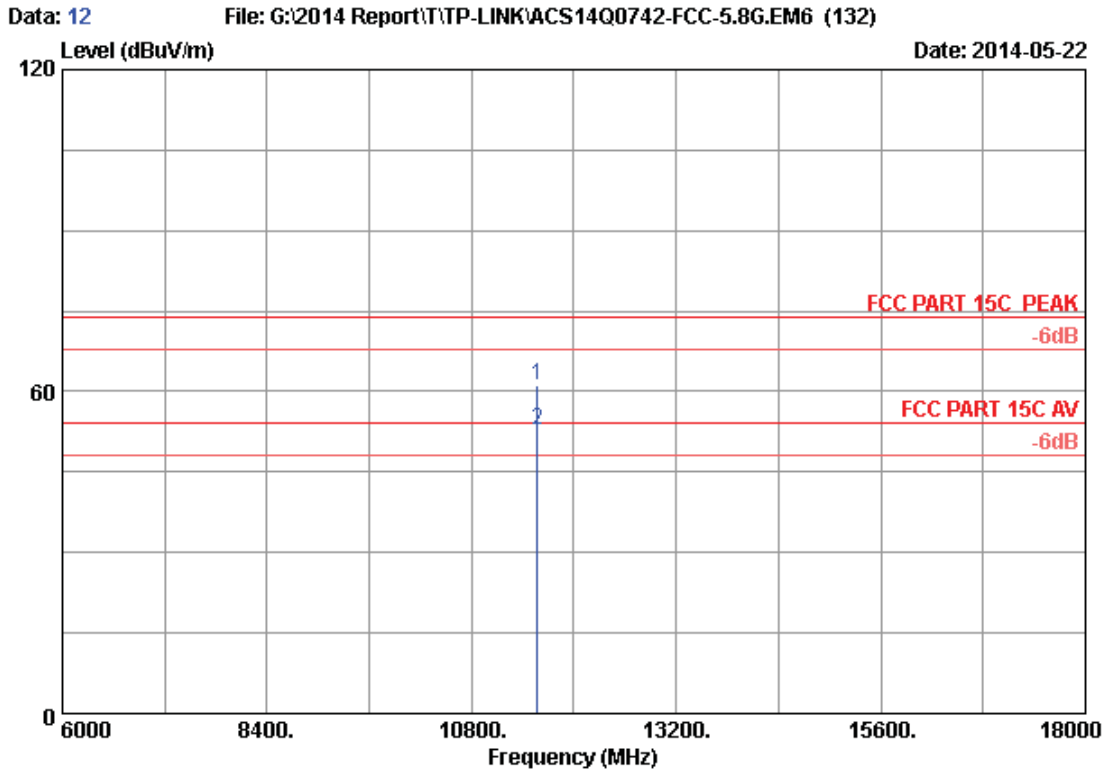

Site no. : 3m Chamber Data no. : 12
 Dis. / Ant. : 3m 2013 3115 (4580) Ant. pol. : VERTICAL
 Limit : FCC PART 15C PEAK
 Env. / Ins. : 24°C/56% Engineer : Kevin_Hu
 EUT : AC750 Wireless Dual Band Router
 Power Rating : DC 12V From Adapter Input AC 120V/60Hz
 Test Mode : IEEE802.11a CH157 5785MHz Tx
 M/N : C20i

No.	Freq. (MHz)	Ant. Factor (dB/m)	Cable Loss (dB)	AMP factor (dB)	Reading (dBUV)	Emission Level (dBUV/m)	Limits (dBUV/m)	Margin (dB)	Remark
1	11570.000	38.80	13.32	35.26	44.32	61.18	74.00	12.82	Peak
2	11570.000	38.80	13.32	35.26	35.82	52.68	54.00	1.32	Average

Remarks: 1. Emission Level= Antenna Factor + Cable Loss + Reading - Amp Factor
 2. The emission levels that are 20dB below the official limit are not reported.

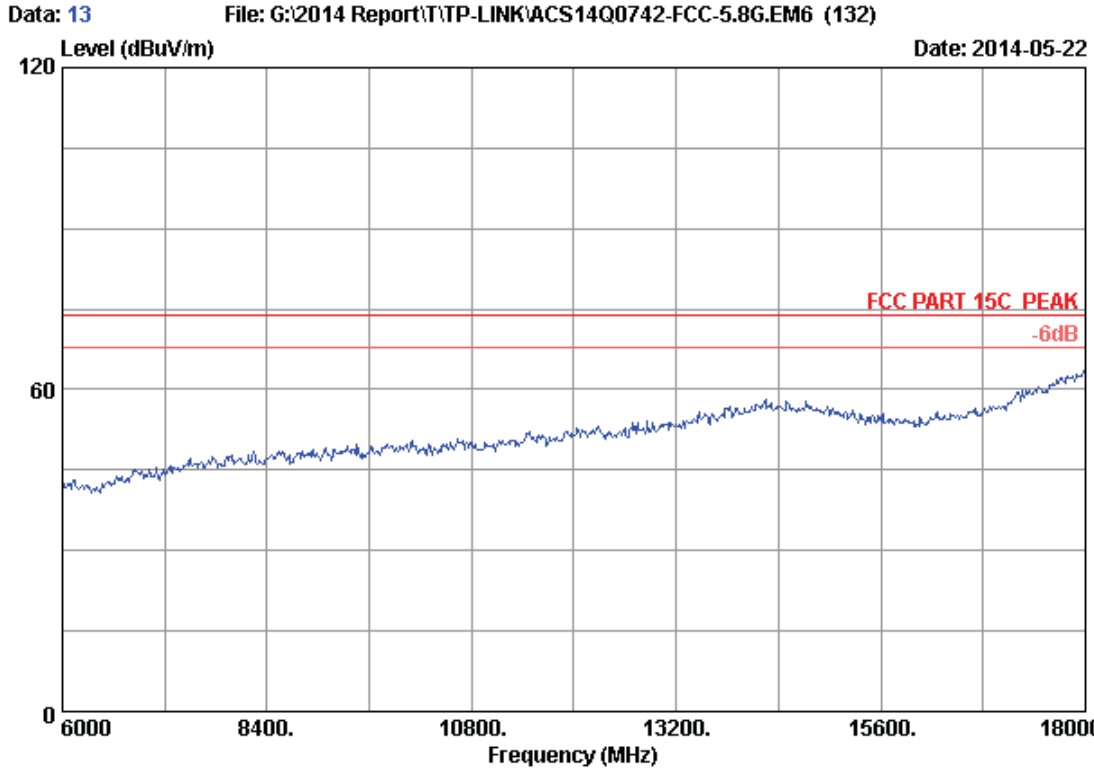

Site no.	: 3m Chamber	Data no.	: 13
Dis. / Ant.	: 3m 2013 3115 (4580)	Ant. pol.	: HORIZONTAL
Limit	: FCC PART 15C PEAK		
Env. / Ins.	: 24°C/56%	Engineer	: Kevin_Hu
EUT	: AC750 Wireless Dual Band Router		
Power Rating	: DC 12V From Adapter Input AC 120V/60Hz		
Test Mode	: IEEE802.11a CH157 5785MHz Tx		
M/N	: C20i		

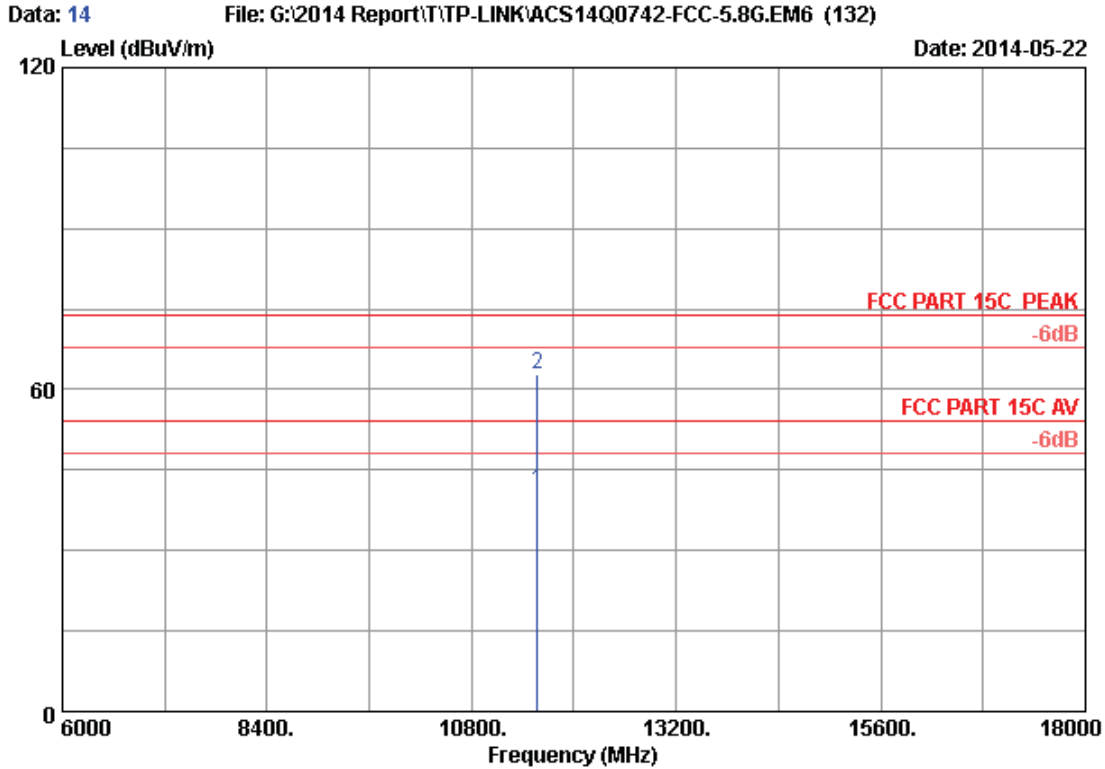

Site no. : 3m Chamber Data no. : 14
 Dis. / Ant. : 3m 2013 3115 (4580) Ant. pol. : HORIZONTAL
 Limit : FCC PART 15C PEAK
 Env. / Ins. : 24°C/56% Engineer : Kevin_Hu
 EUT : AC750 Wireless Dual Band Router
 Power Rating : DC 12V From Adapter Input AC 120V/60Hz
 Test Mode : IEEE802.11a CH157 5785MHz Tx
 M/N : C20i

No.	Freq. (MHz)	Ant. Factor (dB/m)	Cable Loss (dB)	AMP factor (dB)	Reading (dBUV)	Emission Level (dBUV/m)	Limits (dBUV/m)	Margin (dB)	Remark
1	11570.000	38.80	13.32	35.26	24.16	41.02	54.00	12.98	Average
2	11570.000	38.80	13.32	35.26	45.86	62.72	74.00	11.28	Peak

Remarks: 1. Emission Level= Antenna Factor + Cable Loss + Reading - Amp Factor
 2. The emission levels that are 20dB below the official limit are not reported.

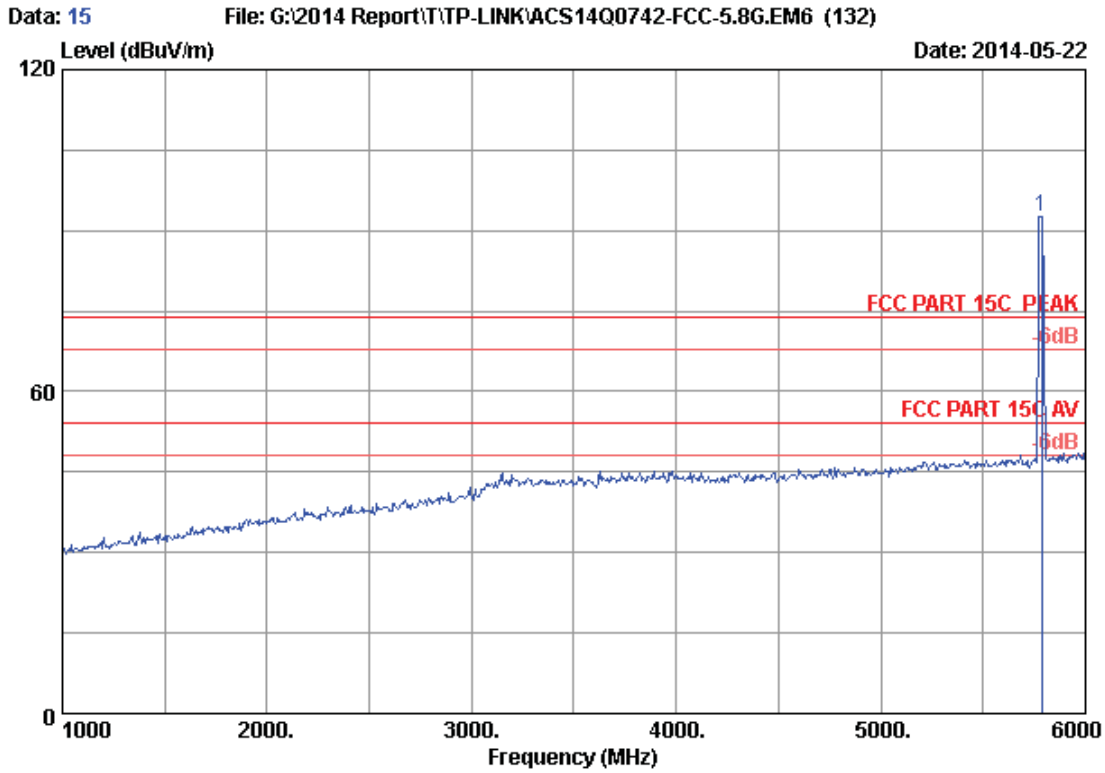

Site no. : 3m Chamber Data no. : 15
 Dis. / Ant. : 3m 2013 3115 (4580) Ant. pol. : HORIZONTAL
 Limit : FCC PART 15C PEAK
 Env. / Ins. : 24°C/56% Engineer : Kevin_Hu
 EUT : AC750 Wireless Dual Band Router
 Power Rating : DC 12V From Adapter Input AC 120V/60Hz
 Test Mode : IEEE802.11a CH157 5785MHz Tx
 M/N : C20i

No.	Freq. (MHz)	Ant. Factor (dB/m)	Cable Loss (dB)	AMP factor (dB)	Reading (dBUV)	Emission Level (dBUV/m)	Limits (dBUV/m)	Margin (dB)	Remark
1	5785.000	34.11	9.59	35.70	84.59	92.59	74.00	-18.59	Peak

Remarks: 1. Emission Level= Antenna Factor + Cable Loss + Reading
 -Amp Factor
 2. The emission levels that are 20dB below the official
 limit are not reported.

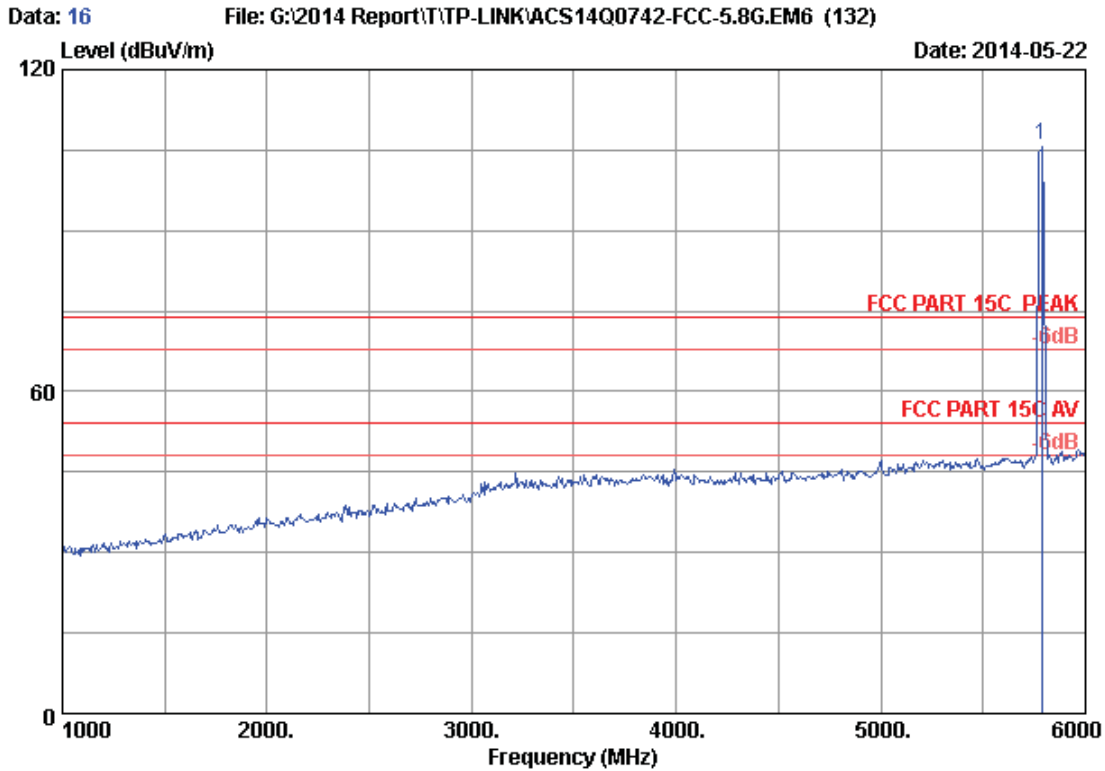

Site no. : 3m Chamber Data no. : 16
 Dis. / Ant. : 3m 2013 3115 (4580) Ant. pol. : VERTICAL
 Limit : FCC PART 15C PEAK
 Env. / Ins. : 24°C/56% Engineer : Kevin_Hu
 EUT : AC750 Wireless Dual Band Router
 Power Rating : DC 12V From Adapter Input AC 120V/60Hz
 Test Mode : IEEE802.11a CH157 5785MHz Tx
 M/N : C20i

No.	Freq. (MHz)	Ant. Factor (dB/m)	Cable Loss (dB)	AMP factor (dB)	Reading (dBUV)	Emission Level (dBUV/m)	Limits (dBUV/m)	Margin (dB)	Remark
1	5785.000	34.11	9.59	35.70	97.86	105.86	74.00	-31.86	Peak

Remarks: 1. Emission Level= Antenna Factor + Cable Loss + Reading - Amp Factor
 2. The emission levels that are 20dB below the official limit are not reported.

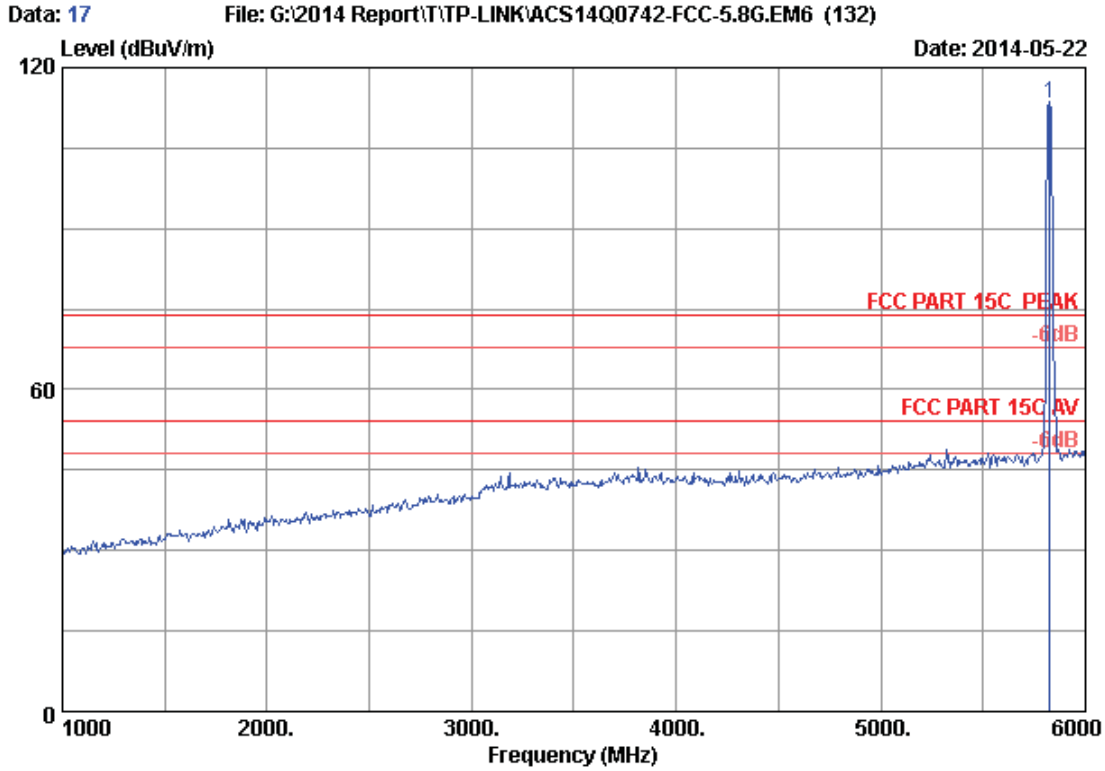

Site no. : 3m Chamber Data no. : 17
 Dis. / Ant. : 3m 2013 3115 (4580) Ant. pol. : VERTICAL
 Limit : FCC PART 15C PEAK
 Env. / Ins. : 24°C/56% Engineer : Kevin_Hu
 EUT : AC750 Wireless Dual Band Router
 Power Rating : DC 12V From Adapter Input AC 120V/60Hz
 Test Mode : IEEE802.11a CH165 5825MHz Tx
 M/N : C20i

No.	Freq. (MHz)	Ant. Factor (dB/m)	Cable Loss (dB)	AMP factor (dB)	Reading (dBuV)	Emission Level (dBuV/m)	Limits (dBuV/m)	Margin (dB)	Remark
1	5825.000	34.13	9.63	35.70	105.42	113.48	74.00	-39.48	Peak

Remarks: 1. Emission Level= Antenna Factor + Cable Loss + Reading - Amp Factor
 2. The emission levels that are 20dB below the official limit are not reported.

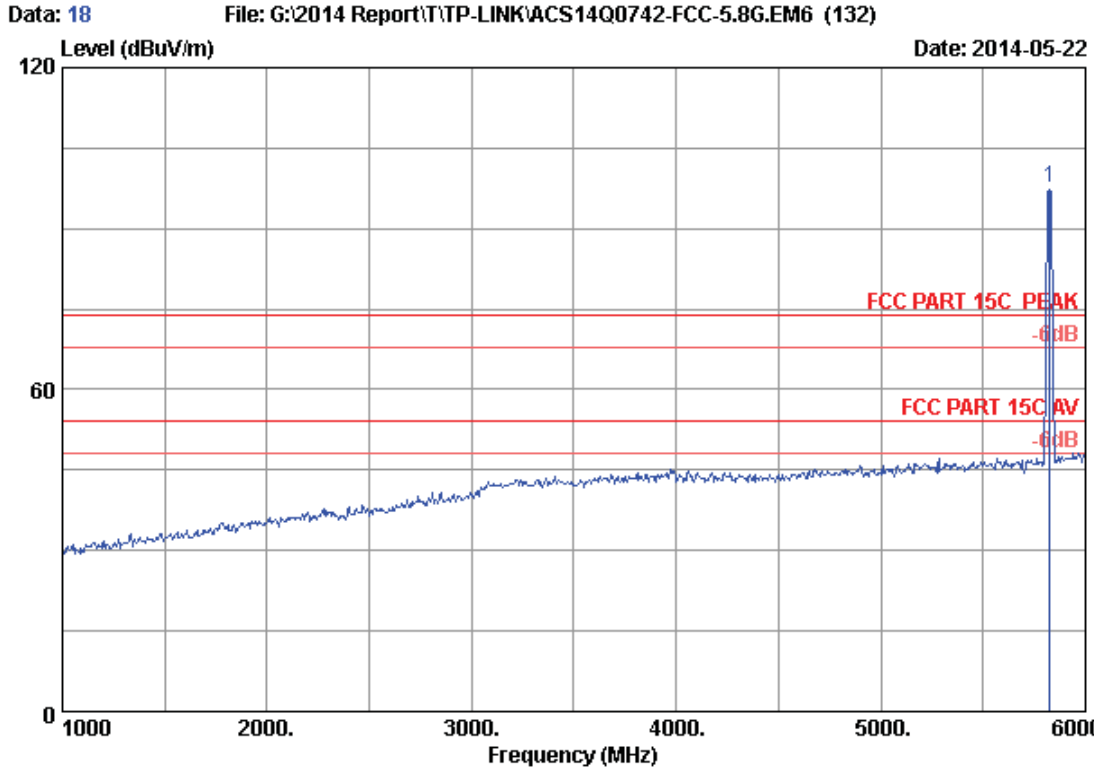

Site no. : 3m Chamber Data no. : 18
 Dis. / Ant. : 3m 2013 3115 (4580) Ant. pol. : HORIZONTAL
 Limit : FCC PART 15C PEAK
 Env. / Ins. : 24°C/56% Engineer : Kevin_Hu
 EUT : AC750 Wireless Dual Band Router
 Power Rating : DC 12V From Adapter Input AC 120V/60Hz
 Test Mode : IEEE802.11a CH165 5825MHz Tx
 M/N : C20i

No.	Freq. (MHz)	Ant. Factor (dB/m)	Cable Loss (dB)	AMP factor (dB)	Reading (dBuV)	Emission Level (dBuV/m)	Limits (dBuV/m)	Margin (dB)	Remark
1	5825.000	34.13	9.63	35.70	89.63	97.69	74.00	-23.69	Peak

Remarks: 1. Emission Level= Antenna Factor + Cable Loss + Reading - Amp Factor
 2. The emission levels that are 20dB below the official limit are not reported.

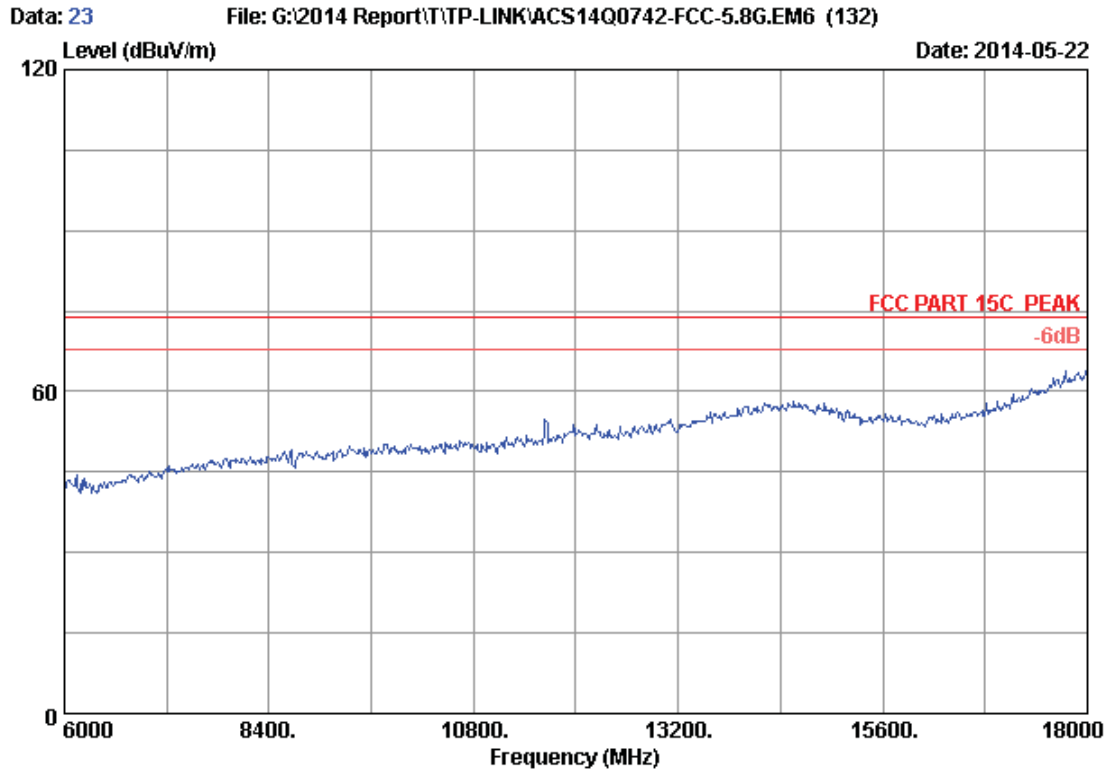

Site no. : 3m Chamber Data no. : 23
Dis. / Ant. : 3m 2013 3115 (4580) Ant. pol. : VERTICAL
Limit : FCC PART 15C PEAK
Env. / Ins. : 24°C/56% Engineer : Kevin_Hu
EUT : AC750 Wireless Dual Band Router
Power Rating : DC 12V From Adapter Input AC 120V/60Hz
Test Mode : IEEE802.11a CH165 5825MHz Tx
M/N : C20i

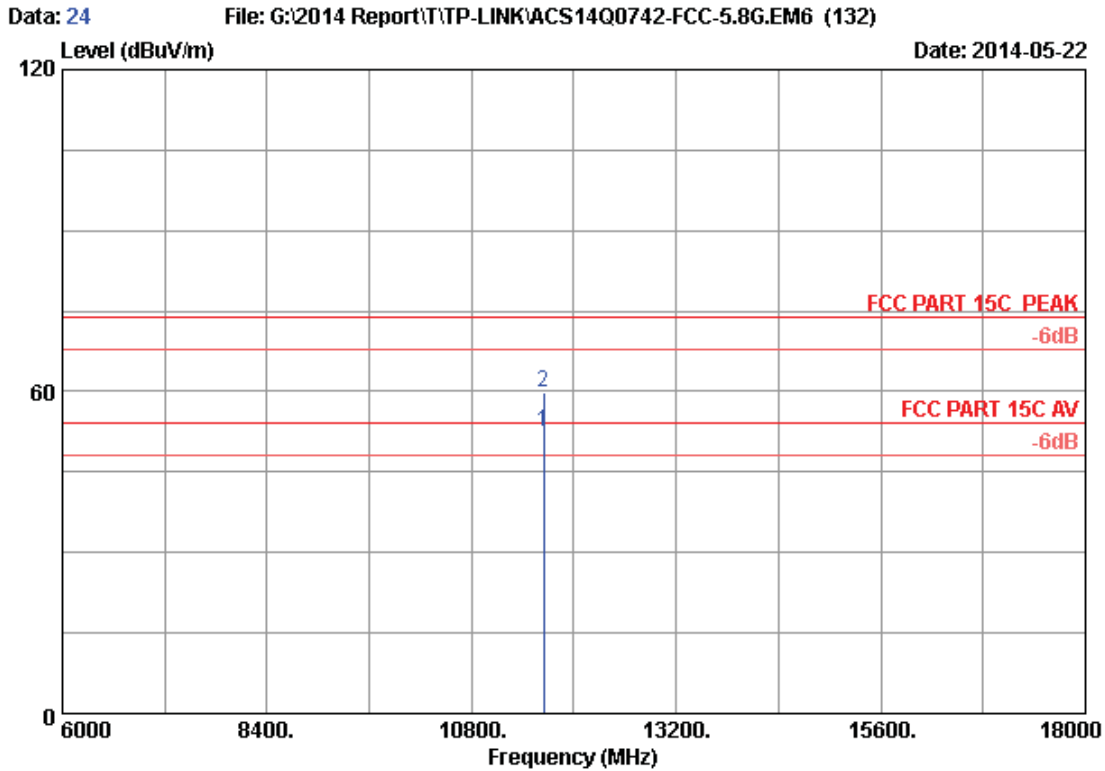

Site no. : 3m Chamber Data no. : 24
 Dis. / Ant. : 3m 2013 3115 (4580) Ant. pol. : VERTICAL
 Limit : FCC PART 15C PEAK
 Env. / Ins. : 24°C/56% Engineer : Kevin_Hu
 EUT : AC750 Wireless Dual Band Router
 Power Rating : DC 12V From Adapter Input AC 120V/60Hz
 Test Mode : IEEE802.11a CH165 5825MHz Tx
 M/N : C20i

No.	Freq. (MHz)	Ant. Factor (dB/m)	Cable Loss (dB)	AMP factor (dB)	Reading (dBuV)	Emission Level (dBuV/m)	Limits (dBuV/m)	Margin (dB)	Remark
1	11650.000	38.91	13.37	35.25	35.40	52.43	54.00	1.57	Average
2	11650.000	38.91	13.37	35.25	42.97	60.00	74.00	14.00	Peak

Remarks: 1. Emission Level= Antenna Factor + Cable Loss + Reading - Amp Factor
 2. The emission levels that are 20dB below the official limit are not reported.

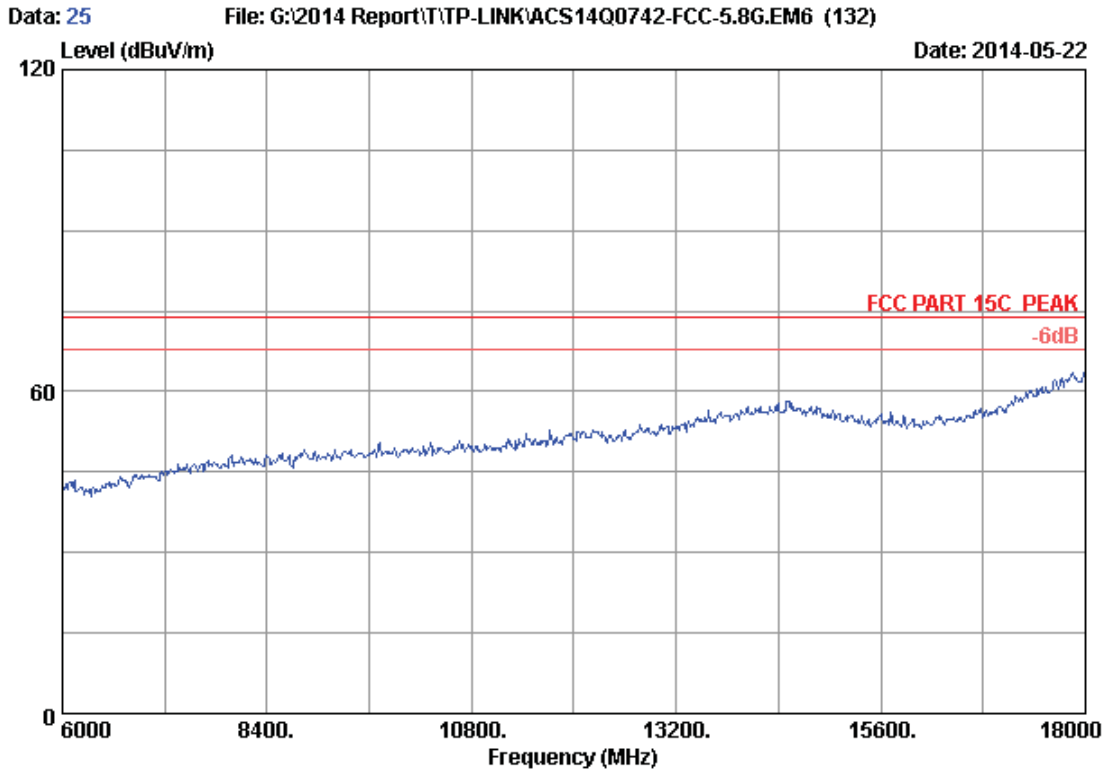

Site no.	: 3m Chamber	Data no.	: 25
Dis. / Ant.	: 3m 2013 3115 (4580)	Ant. pol.	: HORIZONTAL
Limit	: FCC PART 15C PEAK		
Env. / Ins.	: 24°C/56%	Engineer	: Kevin_Hu
EUT	: AC750 Wireless Dual Band Router		
Power Rating	: DC 12V From Adapter Input AC 120V/60Hz		
Test Mode	: IEEE802.11a CH165 5825MHz Tx		
M/N	: C20i		

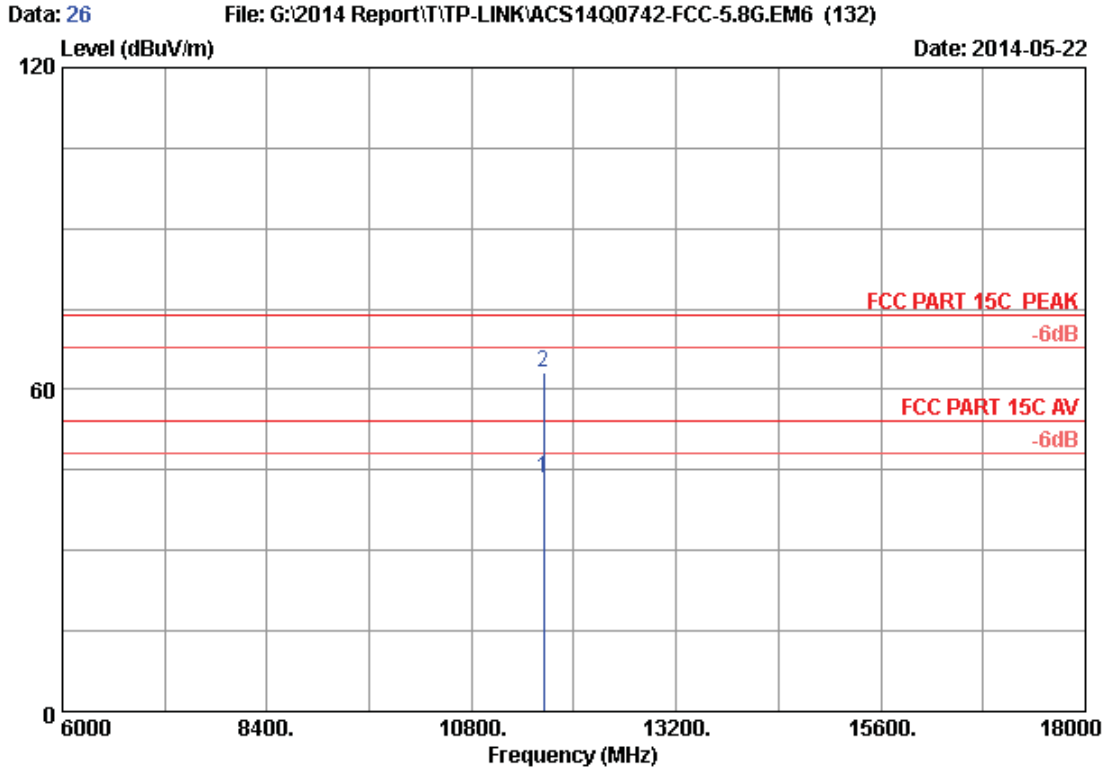

Site no. : 3m Chamber Data no. : 26
 Dis. / Ant. : 3m 2013 3115 (4580) Ant. pol. : HORIZONTAL
 Limit : FCC PART 15C PEAK
 Env. / Ins. : 24°C/56% Engineer : Kevin_Hu
 EUT : AC750 Wireless Dual Band Router
 Power Rating : DC 12V From Adapter Input AC 120V/60Hz
 Test Mode : IEEE802.11a CH165 5825MHz Tx
 M/N : C20i

No.	Freq. (MHz)	Ant. Factor (dB/m)	Cable Loss (dB)	AMP factor (dB)	Reading (dBuV)	Emission Level (dBuV/m)	Limits (dBuV/m)	Margin (dB)	Remark
1	11650.000	38.91	13.37	35.25	26.54	43.57	54.00	10.43	Average
2	11650.000	38.91	13.37	35.25	46.25	63.28	74.00	10.72	Peak

Remarks: 1. Emission Level= Antenna Factor + Cable Loss + Reading - Amp Factor
 2. The emission levels that are 20dB below the official limit are not reported.

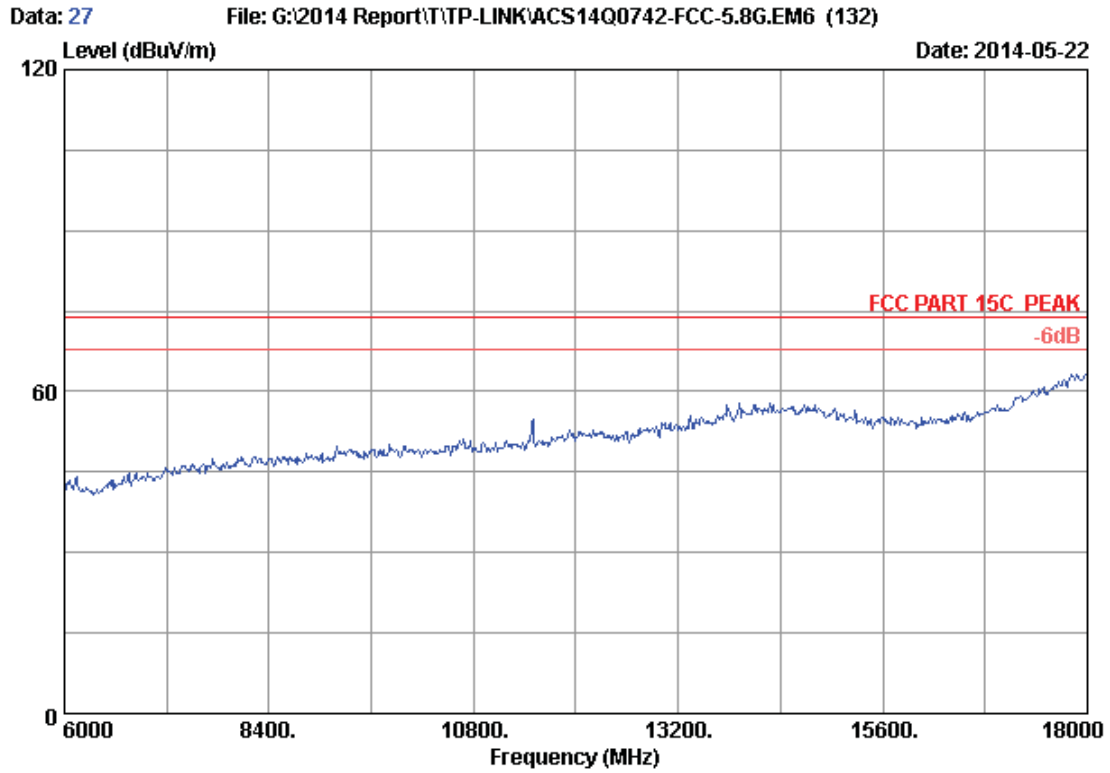

Site no. : 3m Chamber Data no. : 27
Dis. / Ant. : 3m 2013 3115 (4580) Ant. pol. : VERTICAL
Limit : FCC PART 15C PEAK
Env. / Ins. : 24°C/56% Engineer : Kevin_Hu
EUT : AC750 Wireless Dual Band Router
Power Rating : DC 12V From Adapter Input AC 120V/60Hz
Test Mode : IEEE802.11nHT20 CH149 5745MHz Tx
M/N : C20i

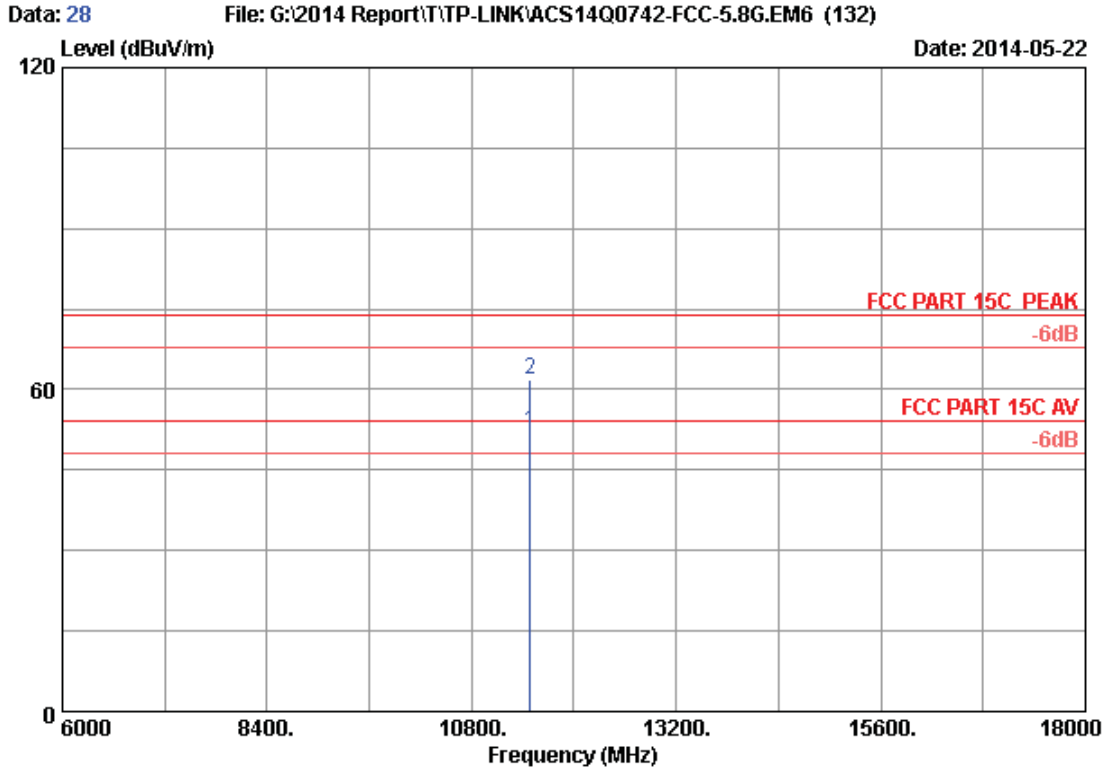

Site no. : 3m Chamber Data no. : 28
 Dis. / Ant. : 3m 2013 3115 (4580) Ant. pol. : VERTICAL
 Limit : FCC PART 15C PEAK
 Env. / Ins. : 24°C/56% Engineer : Kevin_Hu
 EUT : AC750 Wireless Dual Band Router
 Power Rating : DC 12V From Adapter Input AC 120V/60Hz
 Test Mode : IEEE802.11nHT20 CH149 5745MHz Tx
 M/N : C20i

No.	Freq. (MHz)	Ant. Factor (dB/m)	Cable Loss (dB)	AMP factor (dB)	Reading (dBuV)	Emission Level (dBuV/m)	Limits (dBuV/m)	Margin (dB)	Remark
1	11490.000	38.69	13.28	35.28	35.55	52.24	54.00	1.76	Average
2	11490.000	38.69	13.28	35.28	45.14	61.83	74.00	12.17	Peak

Remarks: 1. Emission Level= Antenna Factor + Cable Loss + Reading - Amp Factor
 2. The emission levels that are 20dB below the official limit are not reported.

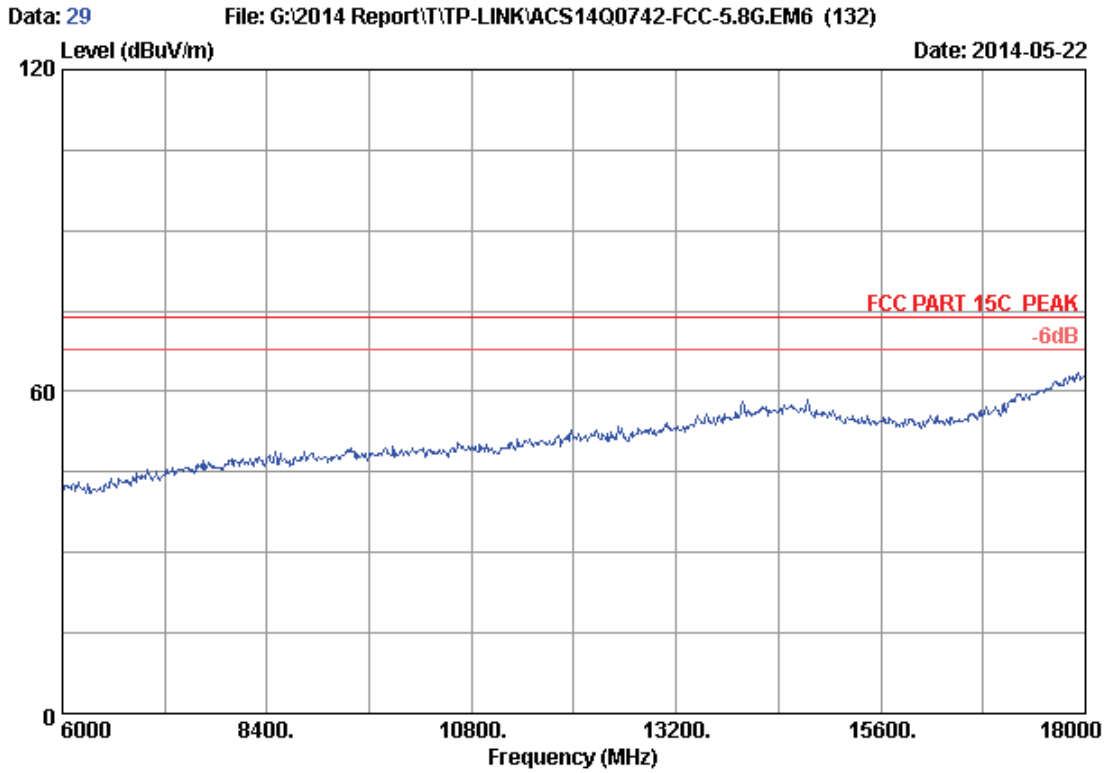

Site no. : 3m Chamber Data no. : 29
Dis. / Ant. : 3m 2013 3115 (4580) Ant. pol. : HORIZONTAL
Limit : FCC PART 15C PEAK
Env. / Ins. : 24°C/56% Engineer : Kevin_Hu
EUT : AC750 Wireless Dual Band Router
Power Rating : DC 12V From Adapter Input AC 120V/60Hz
Test Mode : IEEE802.11nHT20 CH149 5745MHz Tx
M/N : C20i

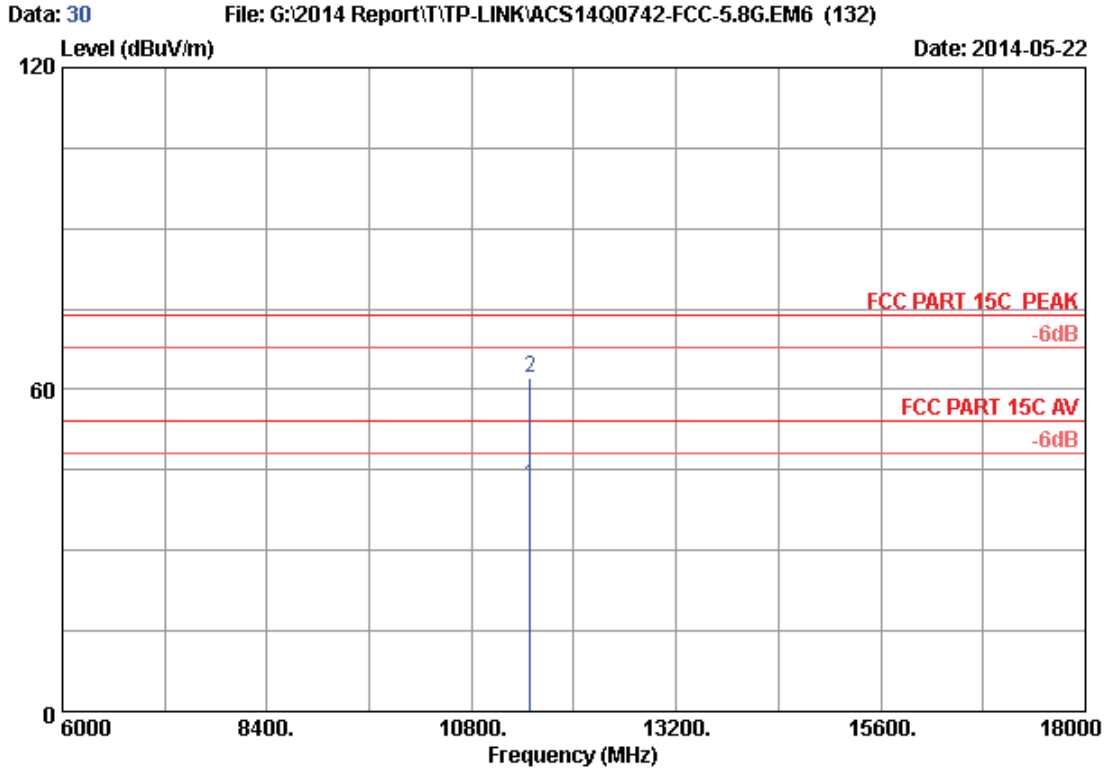

Site no. : 3m Chamber Data no. : 30
 Dis. / Ant. : 3m 2013 3115 (4580) Ant. pol. : HORIZONTAL
 Limit : FCC PART 15C PEAK
 Env. / Ins. : 24°C/56% Engineer : Kevin_Hu
 EUT : AC750 Wireless Dual Band Router
 Power Rating : DC 12V From Adapter Input AC 120V/60Hz
 Test Mode : IEEE802.11nHT20 CH149 5745MHz Tx
 M/N : C20i

No.	Freq. (MHz)	Ant. Factor (dB/m)	Cable Loss (dB)	AMP factor (dB)	Reading (dBuV)	Emission Level (dBuV/m)	Limits (dBuV/m)	Margin (dB)	Remark
1	11490.000	38.69	13.28	35.28	25.46	42.15	54.00	11.85	Average
2	11490.000	38.69	13.28	35.28	45.64	62.33	74.00	11.67	Peak

Remarks: 1. Emission Level= Antenna Factor + Cable Loss + Reading - Amp Factor
 2. The emission levels that are 20dB below the official limit are not reported.

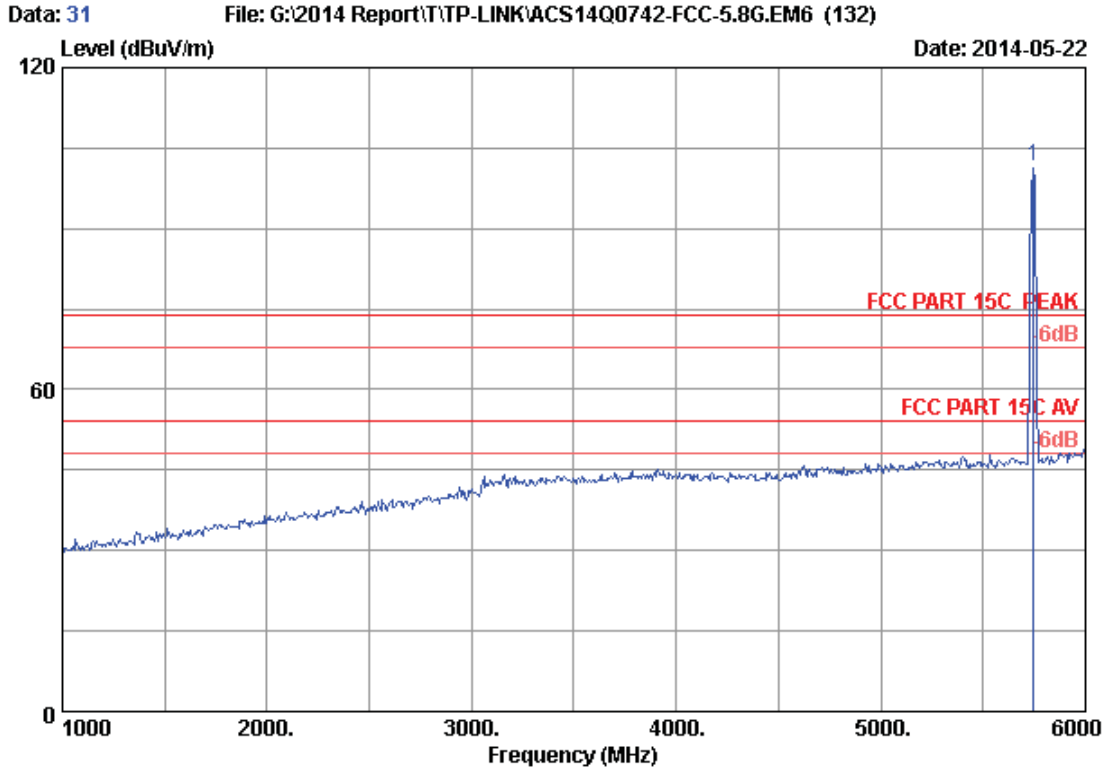

Site no. : 3m Chamber Data no. : 31
 Dis. / Ant. : 3m 2013 3115 (4580) Ant. pol. : HORIZONTAL
 Limit : FCC PART 15C PEAK
 Env. / Ins. : 24°C/56% Engineer : Kevin_Hu
 EUT : AC750 Wireless Dual Band Router
 Power Rating : DC 12V From Adapter Input AC 120V/60Hz
 Test Mode : IEEE802.11nHT20 CH149 5745MHz Tx
 M/N : C20i

No.	Freq. (MHz)	Ant. Factor (dB/m)	Cable Loss (dB)	AMP factor (dB)	Reading (dBUV)	Emission Level (dBUV/m)	Limits (dBUV/m)	Margin (dB)	Remark
1	5745.000	34.10	9.55	35.70	93.55	101.50	74.00	-27.50	Peak

Remarks: 1. Emission Level= Antenna Factor + Cable Loss + Reading
 -Amp Factor
 2. The emission levels that are 20dB below the official
 limit are not reported.

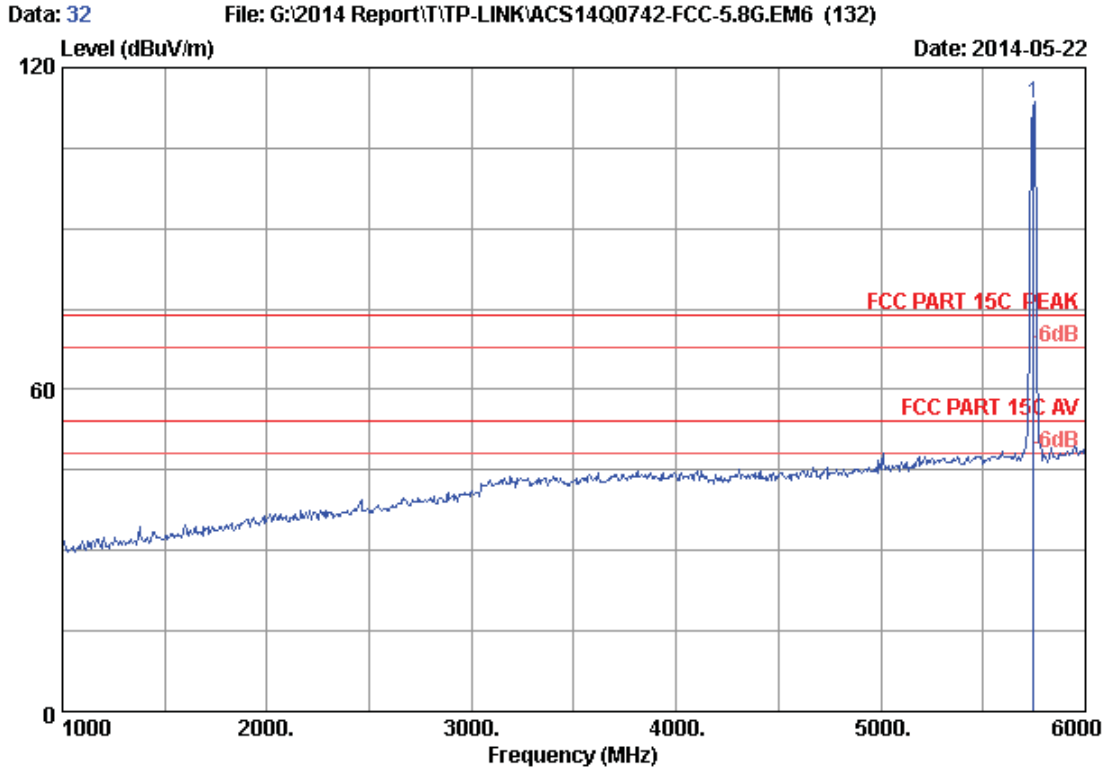

Site no. : 3m Chamber Data no. : 32
 Dis. / Ant. : 3m 2013 3115 (4580) Ant. pol. : VERTICAL
 Limit : FCC PART 15C PEAK
 Env. / Ins. : 24°C/56% Engineer : Kevin_Hu
 EUT : AC750 Wireless Dual Band Router
 Power Rating : DC 12V From Adapter Input AC 120V/60Hz
 Test Mode : IEEE802.11nHT20 CH149 5745MHz Tx
 M/N : C20i

No.	Freq. (MHz)	Ant. Factor (dB/m)	Cable Loss (dB)	AMP factor (dB)	Reading (dBUV)	Emission Level (dBUV/m)	Limits (dBUV/m)	Margin (dB)	Remark
1	5745.000	34.10	9.55	35.70	105.22	113.17	74.00	-39.17	Peak

Remarks: 1. Emission Level= Antenna Factor + Cable Loss + Reading - Amp Factor
 2. The emission levels that are 20dB below the official limit are not reported.

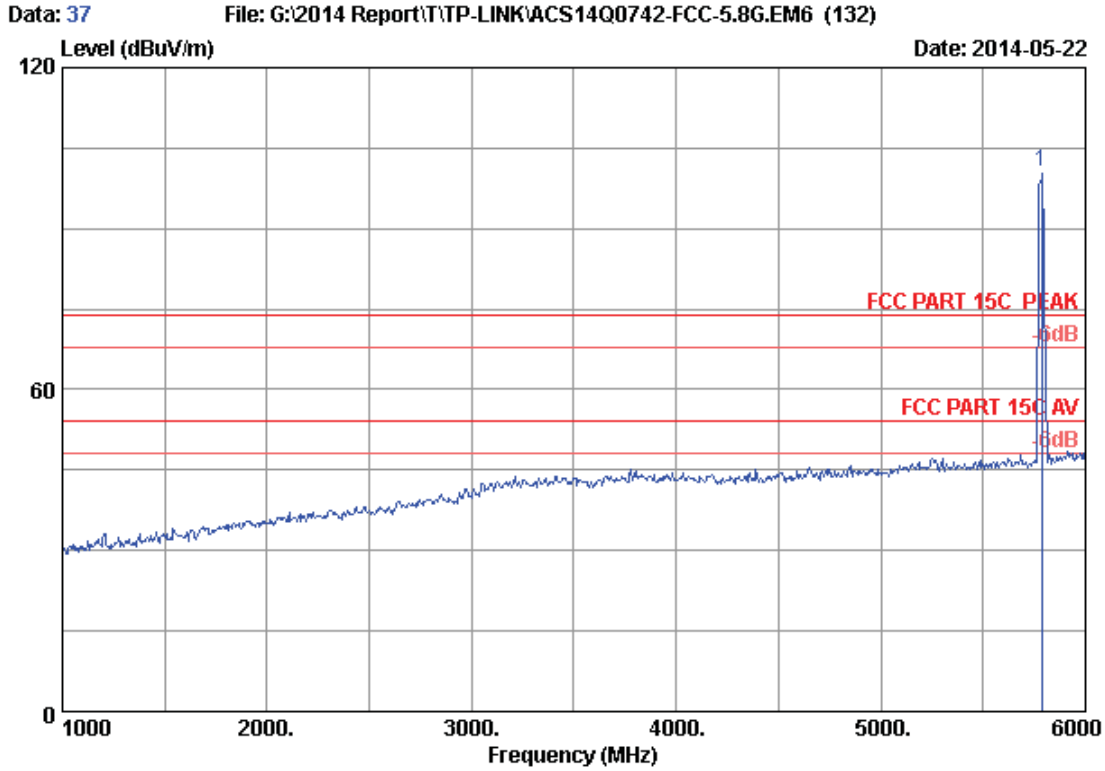

Site no. : 3m Chamber Data no. : 37
 Dis. / Ant. : 3m 2013 3115 (4580) Ant. pol. : HORIZONTAL
 Limit : FCC PART 15C PEAK
 Env. / Ins. : 24°C/56% Engineer : Kevin_Hu
 EUT : AC750 Wireless Dual Band Router
 Power Rating : DC 12V From Adapter Input AC 120V/60Hz
 Test Mode : IEEE802.11nHT20 CH157 5785MHz Tx
 M/N : C20i

No.	Freq. (MHz)	Ant. Factor (dB/m)	Cable Loss (dB)	AMP factor (dB)	Reading (dBuV)	Emission Level (dBuV/m)	Limits (dBuV/m)	Margin (dB)	Remark
1	5785.000	34.11	9.59	35.70	92.56	100.56	74.00	-26.56	Peak

Remarks: 1. Emission Level= Antenna Factor + Cable Loss + Reading
 -Amp Factor
 2. The emission levels that are 20dB below the official
 limit are not reported.

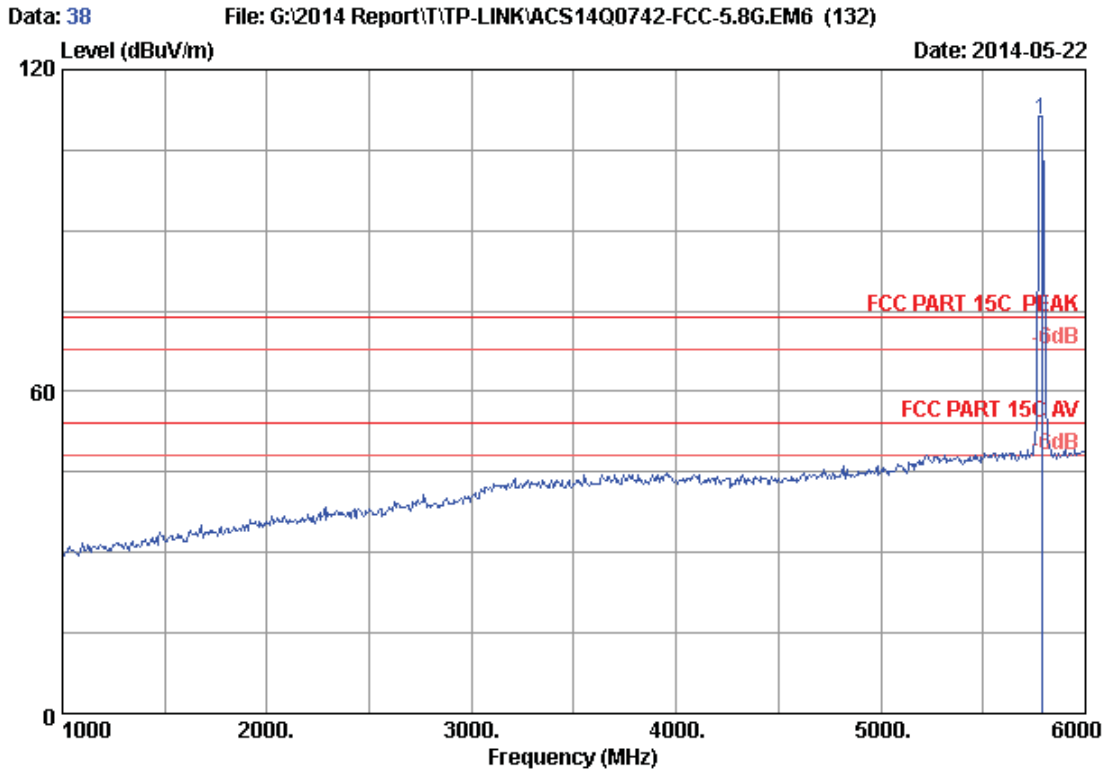

Site no. : 3m Chamber Data no. : 38
 Dis. / Ant. : 3m 2013 3115 (4580) Ant. pol. : VERTICAL
 Limit : FCC PART 15C PEAK
 Env. / Ins. : 24°C/56% Engineer : Kevin_Hu
 EUT : AC750 Wireless Dual Band Router
 Power Rating : DC 12V From Adapter Input AC 120V/60Hz
 Test Mode : IEEE802.11nHT20 CH157 5785MHz Tx
 M/N : C20i

No.	Freq. (MHz)	Ant. Factor (dB/m)	Cable Loss (dB)	AMP factor (dB)	Reading (dBuV)	Emission Level (dBuV/m)	Limits (dBuV/m)	Margin (dB)	Remark
1	5785.000	34.11	9.59	35.70	102.68	110.68	74.00	-36.68	Peak

Remarks: 1. Emission Level= Antenna Factor + Cable Loss + Reading - Amp Factor
 2. The emission levels that are 20dB below the official limit are not reported.

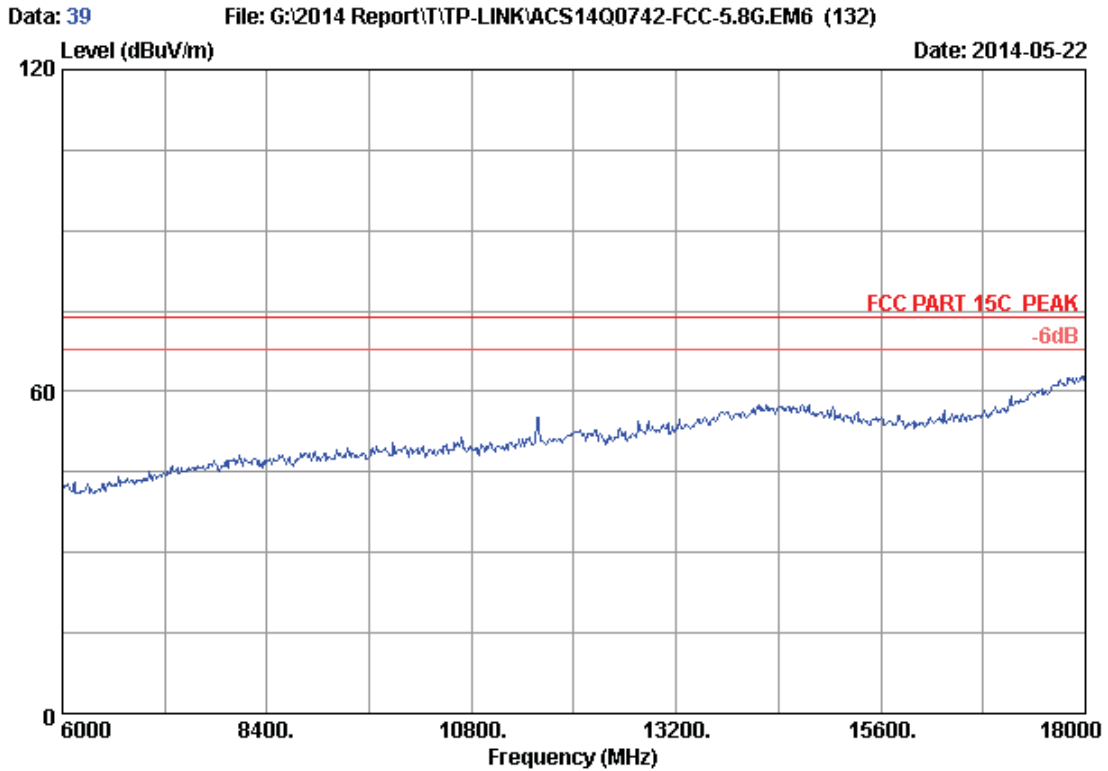

Site no. : 3m Chamber Data no. : 39
Dis. / Ant. : 3m 2013 3115 (4580) Ant. pol. : VERTICAL
Limit : FCC PART 15C PEAK
Env. / Ins. : 24°C/56% Engineer : Kevin_Hu
EUT : AC750 Wireless Dual Band Router
Power Rating : DC 12V From Adapter Input AC 120V/60Hz
Test Mode : IEEE802.11nHT20 CH157 5785MHz Tx
M/N : C20i

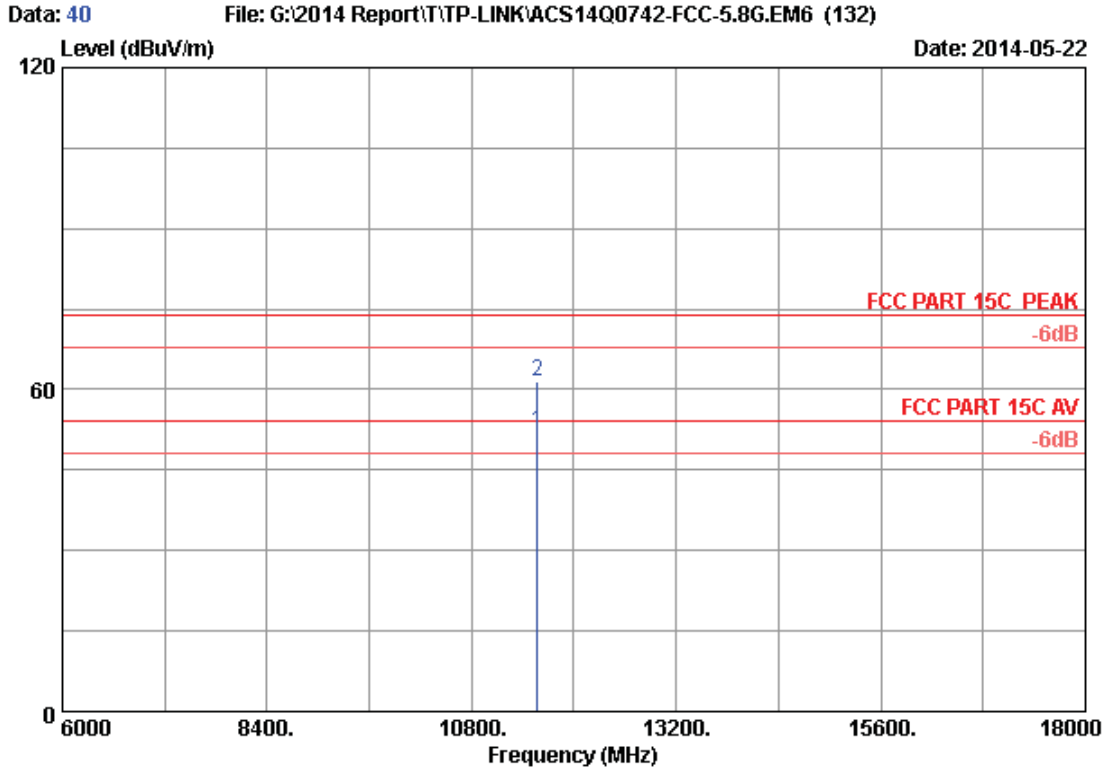

Site no. : 3m Chamber Data no. : 40
 Dis. / Ant. : 3m 2013 3115 (4580) Ant. pol. : VERTICAL
 Limit : FCC PART 15C PEAK
 Env. / Ins. : 24°C/56% Engineer : Kevin_Hu
 EUT : AC750 Wireless Dual Band Router
 Power Rating : DC 12V From Adapter Input AC 120V/60Hz
 Test Mode : IEEE802.11nHT20 CH157 5785MHz Tx
 M/N : C20i

No.	Freq. (MHz)	Ant. Factor (dB/m)	Cable Loss (dB)	AMP factor (dB)	Reading (dBuV)	Emission Level (dBuV/m)	Limits (dBuV/m)	Margin (dB)	Remark
1	11570.000	38.80	13.32	35.26	35.24	52.10	54.00	1.90	Average
2	11570.000	38.80	13.32	35.26	44.78	61.64	74.00	12.36	Peak

Remarks: 1. Emission Level= Antenna Factor + Cable Loss + Reading - Amp Factor
 2. The emission levels that are 20dB below the official limit are not reported.

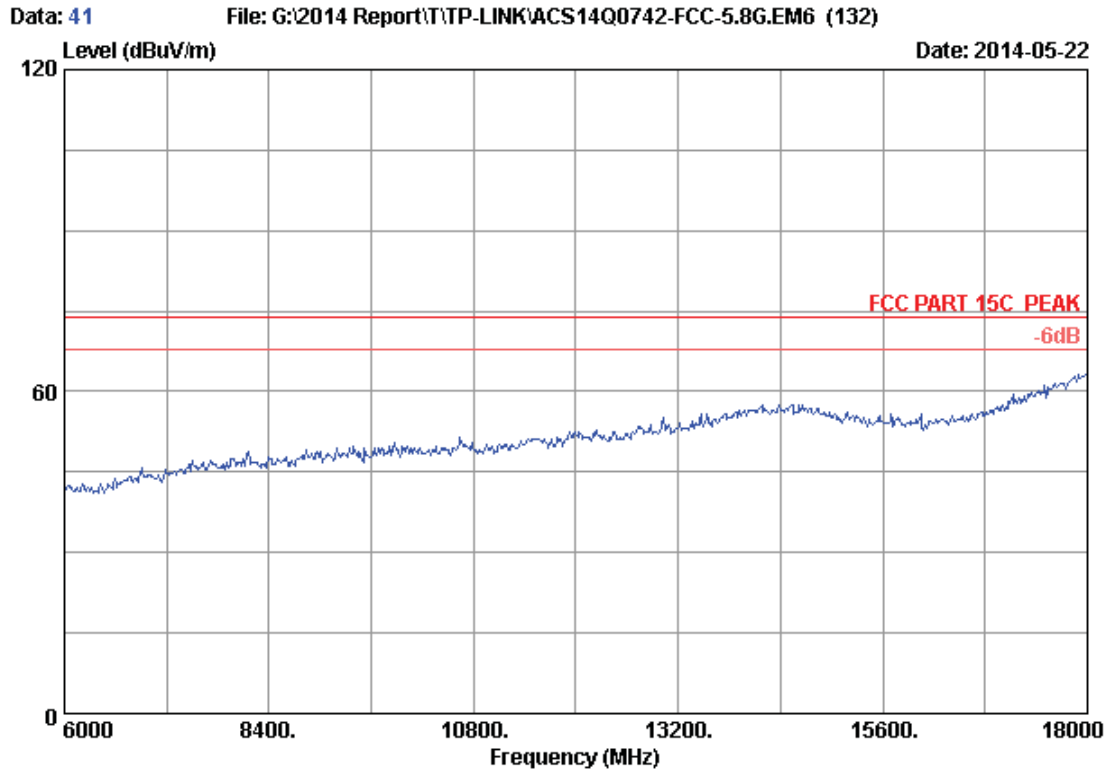

Site no. : 3m Chamber Data no. : 41
Dis. / Ant. : 3m 2013 3115 (4580) Ant. pol. : HORIZONTAL
Limit : FCC PART 15C PEAK
Env. / Ins. : 24°C/56% Engineer : Kevin_Hu
EUT : AC750 Wireless Dual Band Router
Power Rating : DC 12V From Adapter Input AC 120V/60Hz
Test Mode : IEEE802.11nHT20 CH157 5785MHz Tx
M/N : C20i

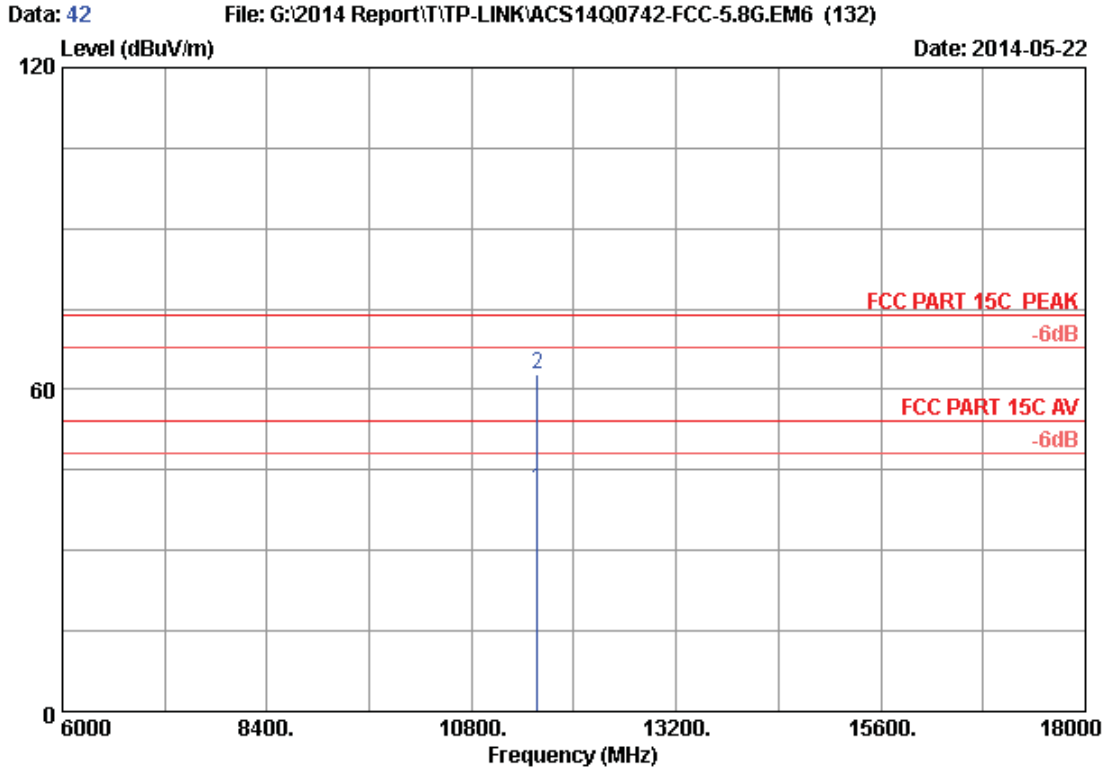

Site no. : 3m Chamber Data no. : 42
 Dis. / Ant. : 3m 2013 3115 (4580) Ant. pol. : HORIZONTAL
 Limit : FCC PART 15C PEAK
 Env. / Ins. : 24°C/56% Engineer : Kevin_Hu
 EUT : AC750 Wireless Dual Band Router
 Power Rating : DC 12V From Adapter Input AC 120V/60Hz
 Test Mode : IEEE802.11nHT20 CH157 5785MHz Tx
 M/N : C20i

No.	Freq. (MHz)	Ant. Factor (dB/m)	Cable Loss (dB)	AMP factor (dB)	Reading (dBUV)	Emission Level (dBUV/m)	Limits (dBUV/m)	Margin (dB)	Remark
1	11570.000	38.80	13.32	35.26	24.56	41.42	54.00	12.58	Average
2	11570.000	38.80	13.32	35.26	45.86	62.72	74.00	11.28	Peak

Remarks: 1. Emission Level= Antenna Factor + Cable Loss + Reading - Amp Factor
 2. The emission levels that are 20dB below the official limit are not reported.

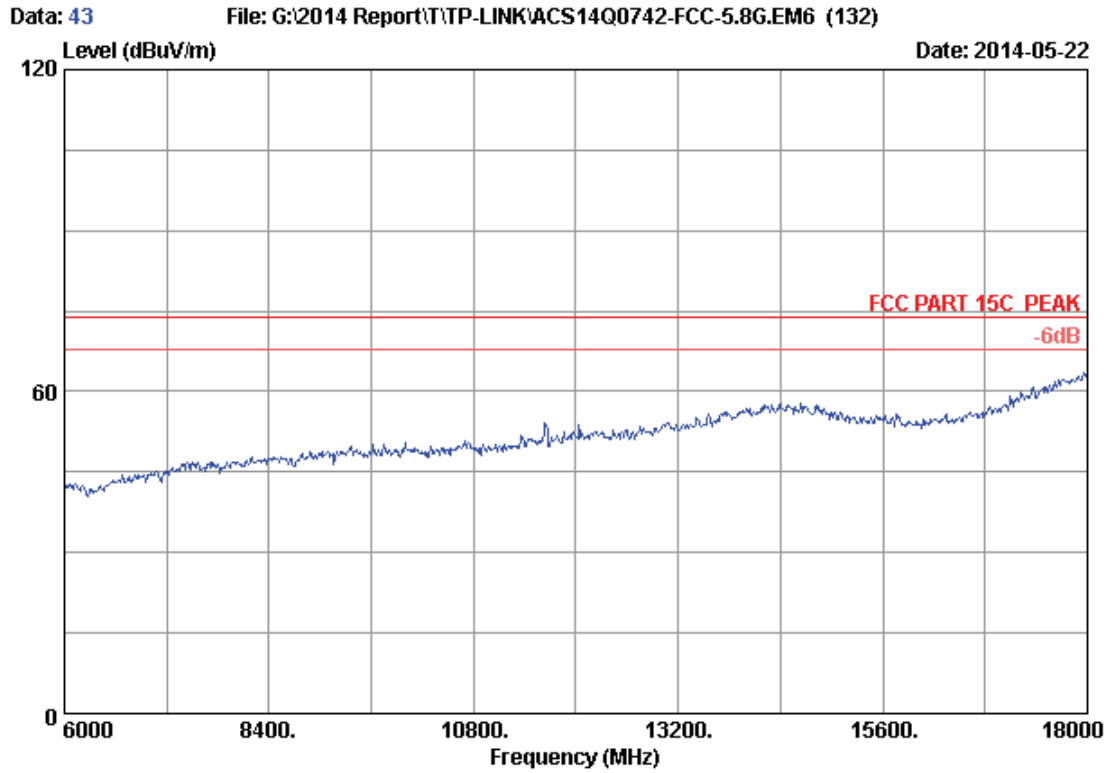

Site no. : 3m Chamber Data no. : 43
Dis. / Ant. : 3m 2013 3115 (4580) Ant. pol. : VERTICAL
Limit : FCC PART 15C PEAK
Env. / Ins. : 24°C/56% Engineer : Kevin_Hu
EUT : AC750 Wireless Dual Band Router
Power Rating : DC 12V From Adapter Input AC 120V/60Hz
Test Mode : IEEE802.11nHT20 CH165 5825MHz Tx
M/N : C20i

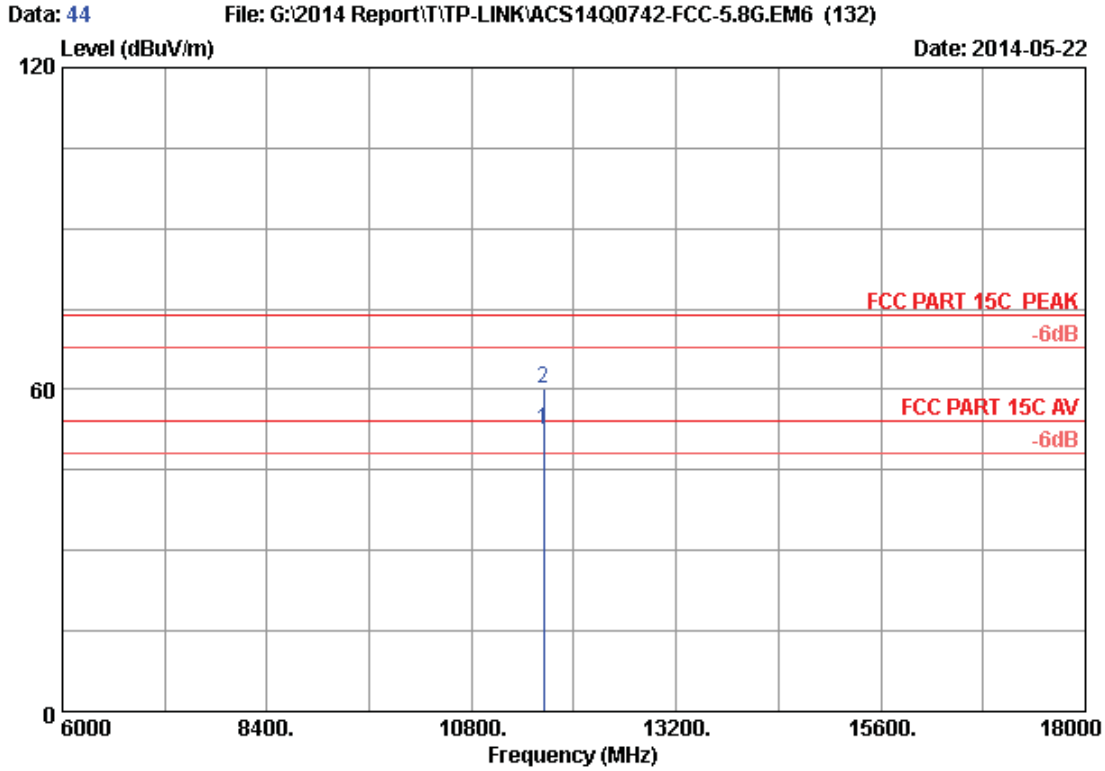

Site no. : 3m Chamber Data no. : 44
 Dis. / Ant. : 3m 2013 3115 (4580) Ant. pol. : VERTICAL
 Limit : FCC PART 15C PEAK
 Env. / Ins. : 24°C/56% Engineer : Kevin_Hu
 EUT : AC750 Wireless Dual Band Router
 Power Rating : DC 12V From Adapter Input AC 120V/60Hz
 Test Mode : IEEE802.11nHT20 CH165 5825MHz Tx
 M/N : C20i

No.	Freq. (MHz)	Ant. Factor (dB/m)	Cable Loss (dB)	AMP factor (dB)	Reading (dBUV)	Emission Level (dBUV/m)	Limits (dBUV/m)	Margin (dB)	Remark
1	11650.000	38.91	13.37	35.25	35.42	52.45	54.00	1.55	Average
2	11650.000	38.91	13.37	35.25	43.28	60.31	74.00	13.69	Peak

Remarks: 1. Emission Level= Antenna Factor + Cable Loss + Reading - Amp Factor
 2. The emission levels that are 20dB below the official limit are not reported.

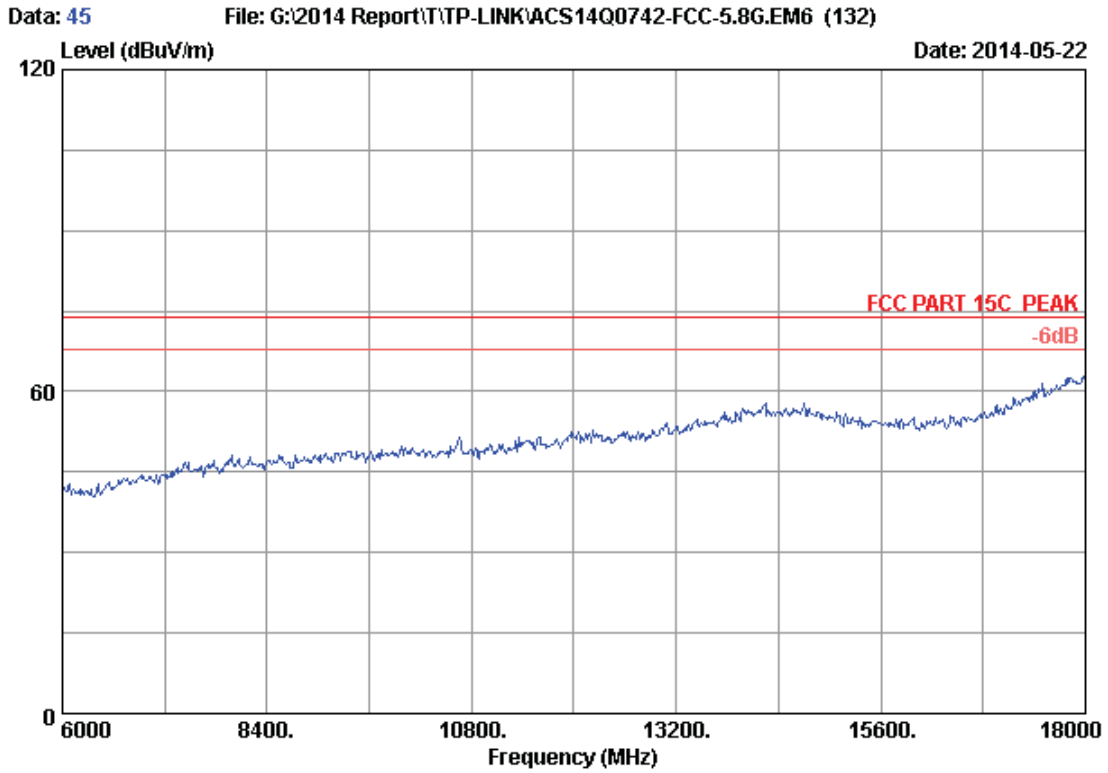

Site no. : 3m Chamber Data no. : 45
Dis. / Ant. : 3m 2013 3115 (4580) Ant. pol. : HORIZONTAL
Limit : FCC PART 15C PEAK
Env. / Ins. : 24°C/56% Engineer : Kevin_Hu
EUT : AC750 Wireless Dual Band Router
Power Rating : DC 12V From Adapter Input AC 120V/60Hz
Test Mode : IEEE802.11nHT20 CH165 5825MHz Tx
M/N : C20i

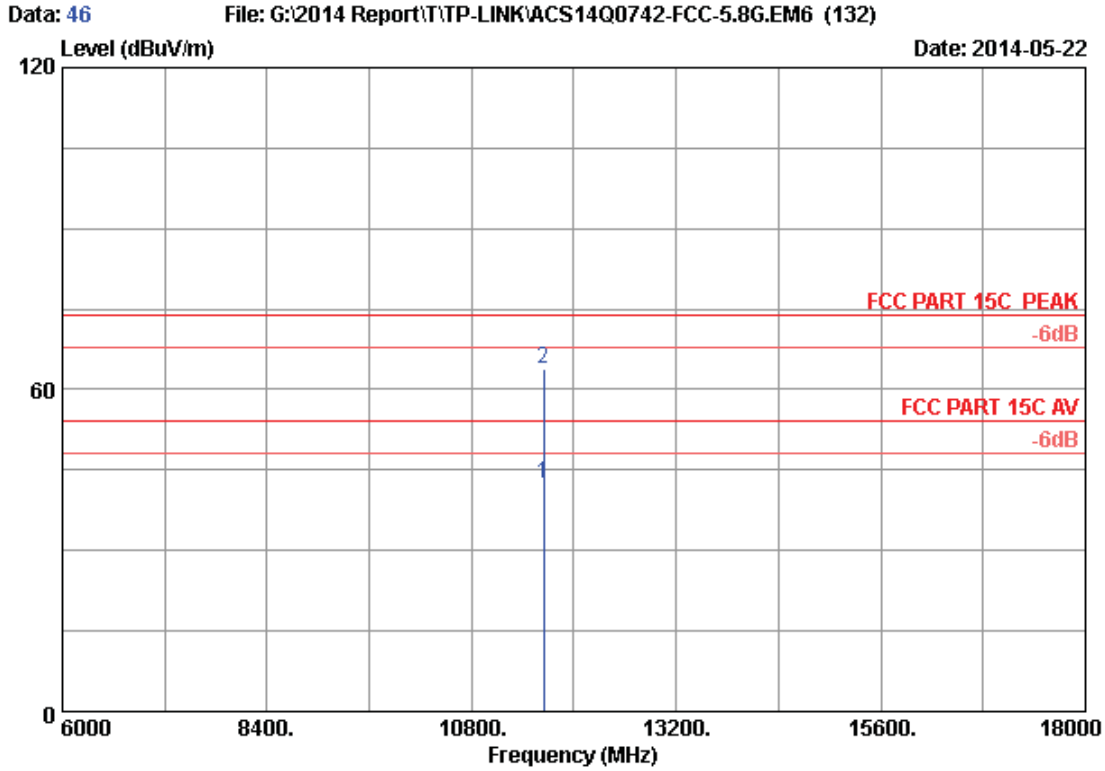

Site no. : 3m Chamber Data no. : 46
 Dis. / Ant. : 3m 2013 3115 (4580) Ant. pol. : HORIZONTAL
 Limit : FCC PART 15C PEAK
 Env. / Ins. : 24°C/56% Engineer : Kevin_Hu
 EUT : AC750 Wireless Dual Band Router
 Power Rating : DC 12V From Adapter Input AC 120V/60Hz
 Test Mode : IEEE802.11nHT20 CH165 5825MHz Tx
 M/N : C20i

No.	Freq. (MHz)	Ant. Factor (dB/m)	Cable Loss (dB)	AMP factor (dB)	Reading (dBUV)	Emission Level (dBUV/m)	Limits (dBUV/m)	Margin (dB)	Remark
1	11650.000	38.91	13.37	35.25	25.49	42.52	54.00	11.48	Average
2	11650.000	38.91	13.37	35.25	46.75	63.78	74.00	10.22	Peak

Remarks: 1. Emission Level= Antenna Factor + Cable Loss + Reading - Amp Factor
 2. The emission levels that are 20dB below the official limit are not reported.

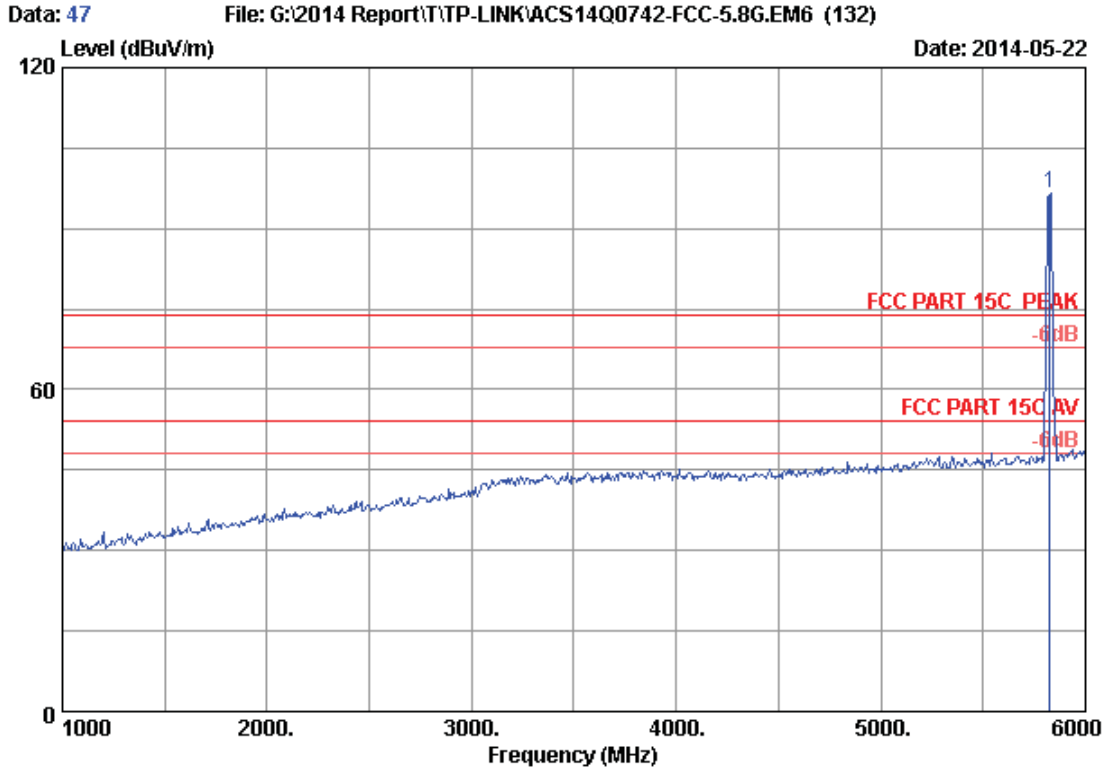

Site no. : 3m Chamber Data no. : 47
 Dis. / Ant. : 3m 2013 3115 (4580) Ant. pol. : HORIZONTAL
 Limit : FCC PART 15C PEAK
 Env. / Ins. : 24°C/56% Engineer : Kevin_Hu
 EUT : AC750 Wireless Dual Band Router
 Power Rating : DC 12V From Adapter Input AC 120V/60Hz
 Test Mode : IEEE802.11nHT20 CH165 5825MHz Tx
 M/N : C20i

No.	Freq. (MHz)	Ant. Factor (dB/m)	Cable Loss (dB)	AMP factor (dB)	Reading (dBUV)	Emission Level (dBUV/m)	Limits (dBUV/m)	Margin (dB)	Remark
1	5825.000	34.13	9.63	35.70	88.57	96.63	74.00	-22.63	Peak

Remarks: 1. Emission Level= Antenna Factor + Cable Loss + Reading - Amp Factor
 2. The emission levels that are 20dB below the official limit are not reported.

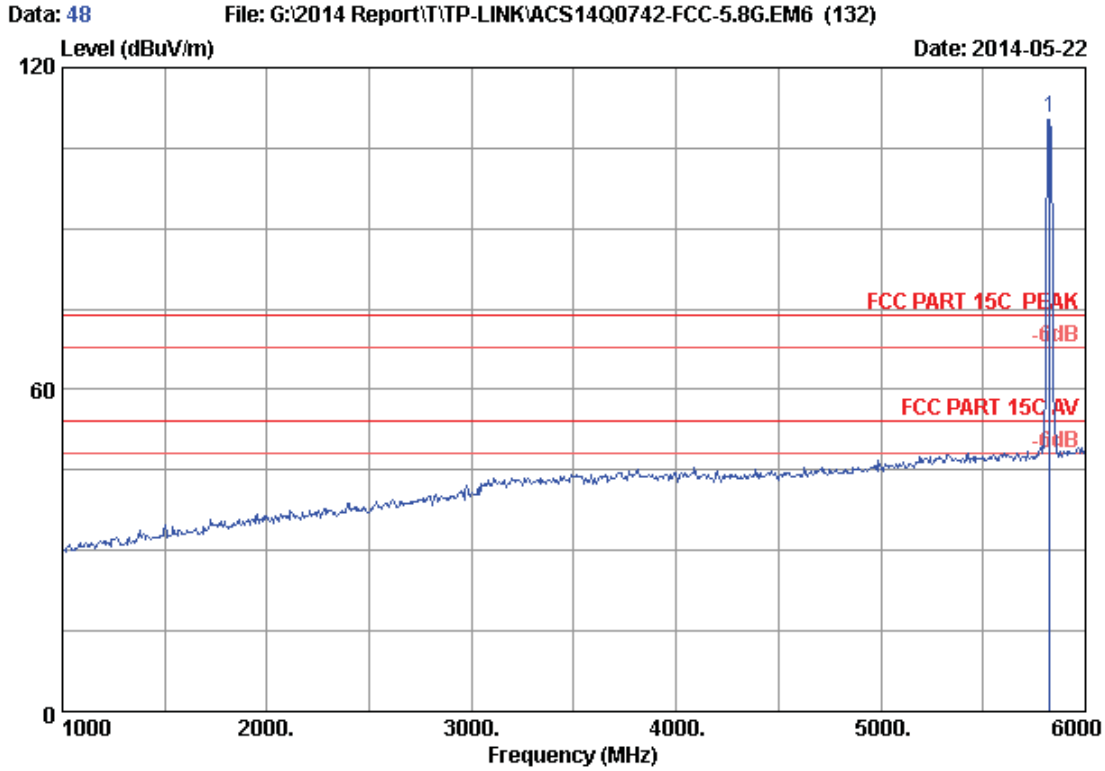

Site no. : 3m Chamber Data no. : 48
 Dis. / Ant. : 3m 2013 3115 (4580) Ant. pol. : VERTICAL
 Limit : FCC PART 15C PEAK
 Env. / Ins. : 24°C/56% Engineer : Kevin_Hu
 EUT : AC750 Wireless Dual Band Router
 Power Rating : DC 12V From Adapter Input AC 120V/60Hz
 Test Mode : IEEE802.11nHT20 CH165 5825MHz Tx
 M/N : C20i

No.	Freq. (MHz)	Ant. Factor (dB/m)	Cable Loss (dB)	AMP factor (dB)	Reading (dBuV)	Emission Level (dBuV/m)	Limits (dBuV/m)	Margin (dB)	Remark
1	5825.000	34.13	9.63	35.70	102.45	110.51	74.00	-36.51	Peak

Remarks: 1. Emission Level= Antenna Factor + Cable Loss + Reading - Amp Factor
 2. The emission levels that are 20dB below the official limit are not reported.

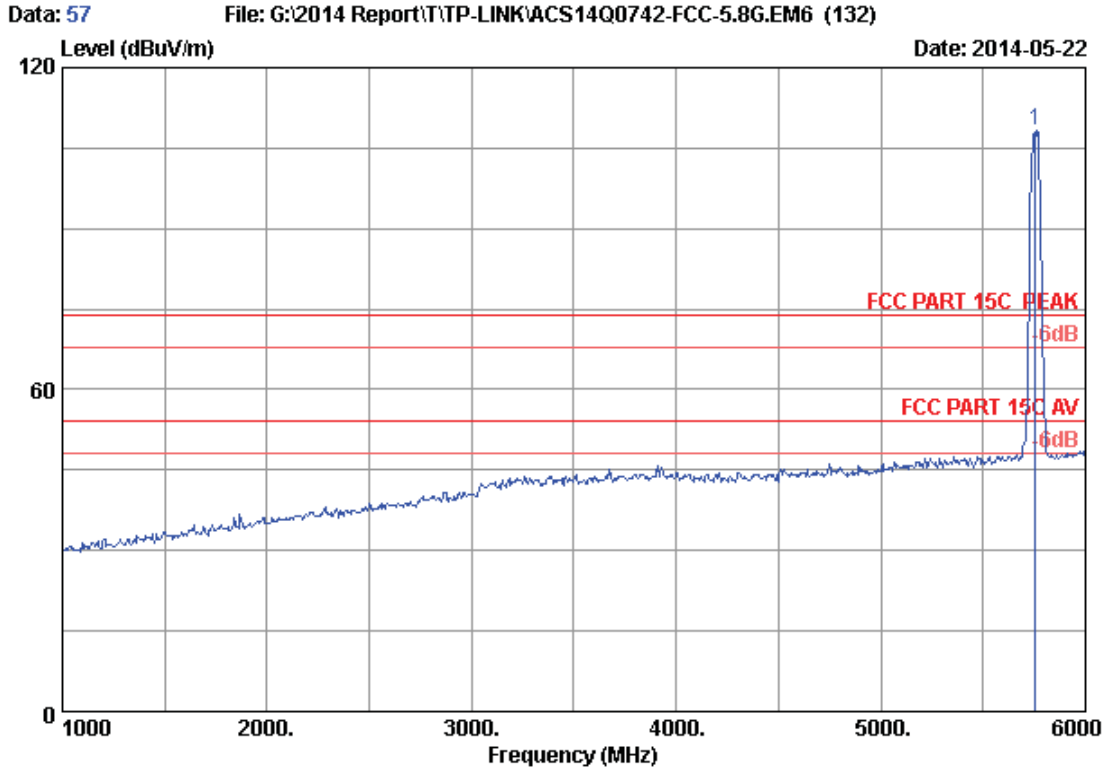

Site no. : 3m Chamber Data no. : 57
 Dis. / Ant. : 3m 2013 3115 (4580) Ant. pol. : VERTICAL
 Limit : FCC PART 15C PEAK
 Env. / Ins. : 24°C/56% Engineer : Kevin_Hu
 EUT : AC750 Wireless Dual Band Router
 Power Rating : DC 12V From Adapter Input AC 120V/60Hz
 Test Mode : IEEE802.11nHT40 CH151 5755MHz Tx
 M/N : C20i

No.	Freq. (MHz)	Ant. Factor (dB/m)	Cable Loss (dB)	AMP factor (dB)	Reading (dBUV)	Emission Level (dBUV/m)	Limits (dBUV/m)	Margin (dB)	Remark
1	5755.000	34.10	9.56	35.70	100.26	108.22	74.00	-34.22	Peak

Remarks: 1. Emission Level= Antenna Factor + Cable Loss + Reading - Amp Factor
 2. The emission levels that are 20dB below the official limit are not reported.

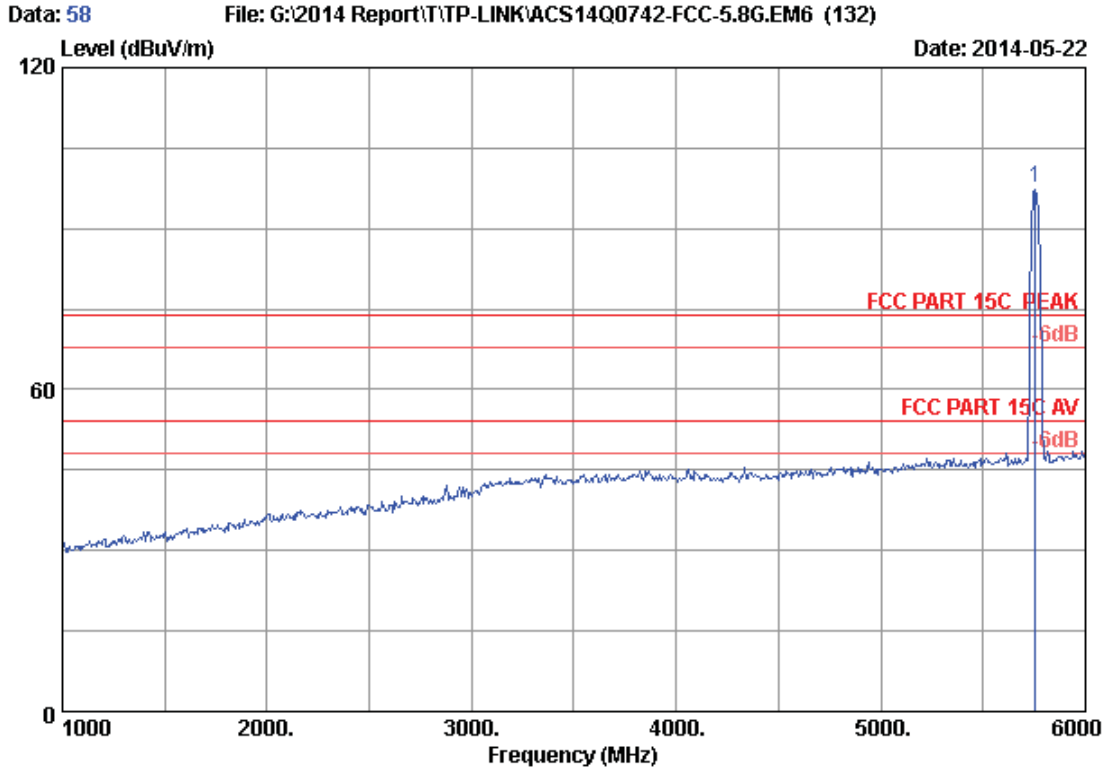

Site no. : 3m Chamber Data no. : 58
 Dis. / Ant. : 3m 2013 3115 (4580) Ant. pol. : HORIZONTAL
 Limit : FCC PART 15C PEAK
 Env. / Ins. : 24°C/56% Engineer : Kevin_Hu
 EUT : AC750 Wireless Dual Band Router
 Power Rating : DC 12V From Adapter Input AC 120V/60Hz
 Test Mode : IEEE802.11nHT40 CH151 5755MHz Tx
 M/N : C20i

No.	Freq. (MHz)	Ant. Factor (dB/m)	Cable Loss (dB)	AMP factor (dB)	Reading (dBuV)	Emission Level (dBuV/m)	Limits (dBuV/m)	Margin (dB)	Remark
1	5755.000	34.10	9.56	35.70	89.67	97.63	74.00	-23.63	Peak

Remarks: 1. Emission Level= Antenna Factor + Cable Loss + Reading
 -Amp Factor
 2. The emission levels that are 20dB below the official
 limit are not reported.

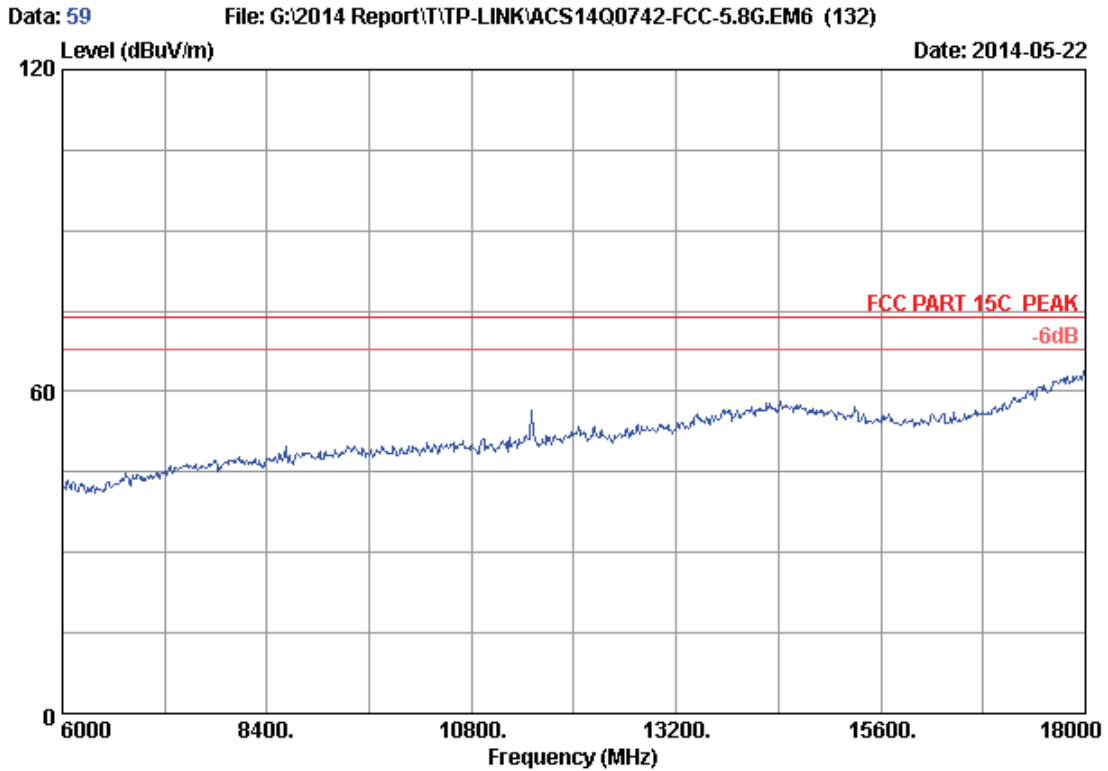

Site no. : 3m Chamber Data no. : 59
Dis. / Ant. : 3m 2013 3115 (4580) Ant. pol. : VERTICAL
Limit : FCC PART 15C PEAK
Env. / Ins. : 24°C/56% Engineer : Kevin_Hu
EUT : AC750 Wireless Dual Band Router
Power Rating : DC 12V From Adapter Input AC 120V/60Hz
Test Mode : IEEE802.11nHT40 CH151 5755MHz Tx
M/N : C20i

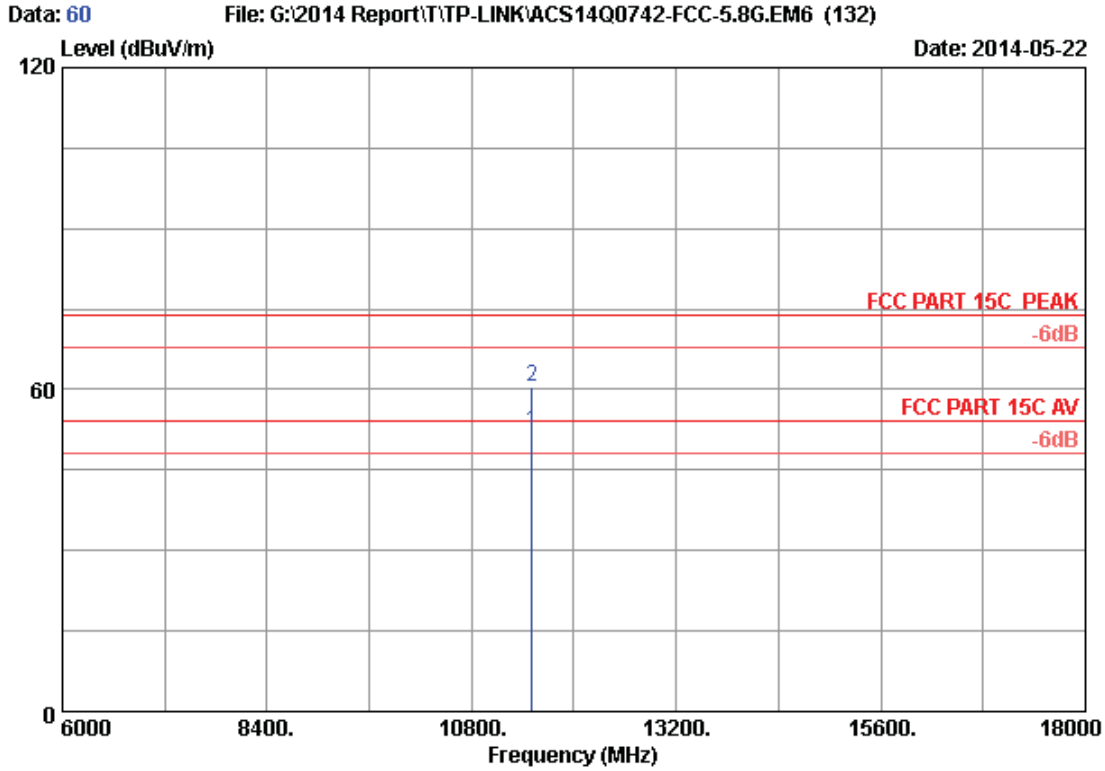

Site no. : 3m Chamber Data no. : 60
 Dis. / Ant. : 3m 2013 3115 (4580) Ant. pol. : VERTICAL
 Limit : FCC PART 15C PEAK
 Env. / Ins. : 24°C/56% Engineer : Kevin_Hu
 EUT : AC750 Wireless Dual Band Router
 Power Rating : DC 12V From Adapter Input AC 120V/60Hz
 Test Mode : IEEE802.11nHT40 CH151 5755MHz Tx
 M/N : C20i

No.	Freq. (MHz)	Ant. Factor (dB/m)	Cable Loss (dB)	AMP factor (dB)	Reading (dBUV)	Emission Level (dBUV/m)	Limits (dBUV/m)	Margin (dB)	Remark
1	11510.000	38.71	13.29	35.27	35.40	52.13	54.00	1.87	Average
2	11510.000	38.71	13.29	35.27	43.81	60.54	74.00	13.46	Peak

Remarks: 1. Emission Level= Antenna Factor + Cable Loss + Reading - Amp Factor
 2. The emission levels that are 20dB below the official limit are not reported.

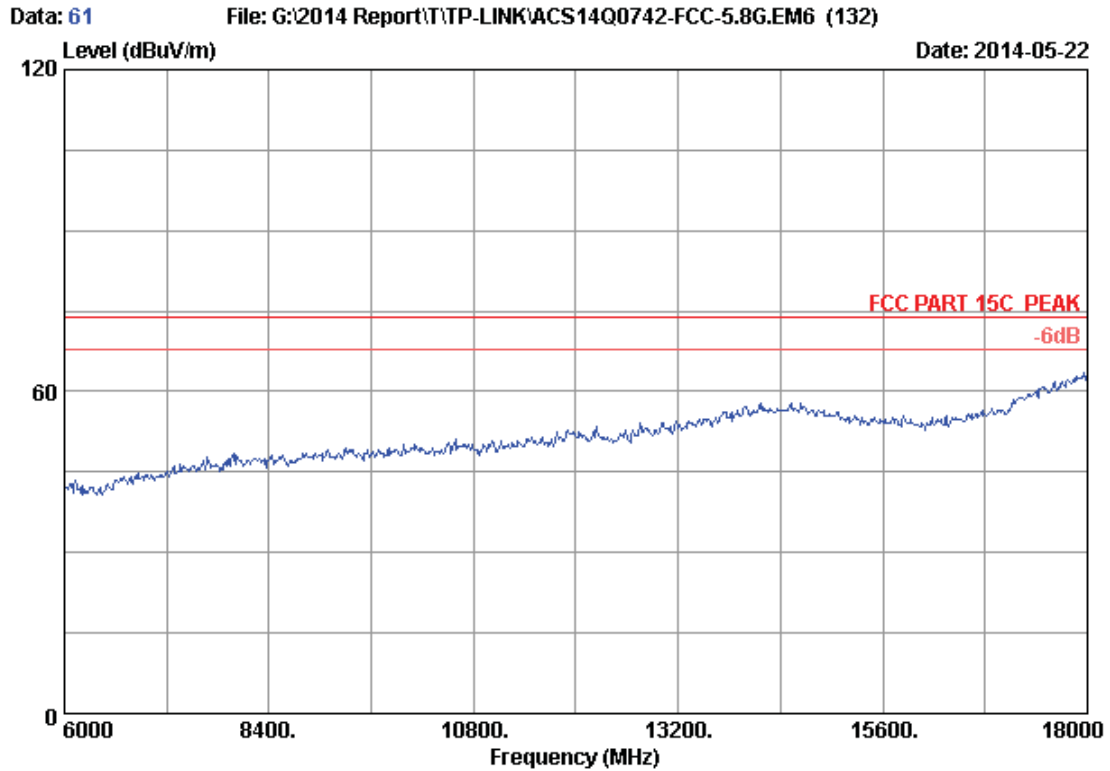

Site no. : 3m Chamber Data no. : 61
Dis. / Ant. : 3m 2013 3115 (4580) Ant. pol. : HORIZONTAL
Limit : FCC PART 15C PEAK
Env. / Ins. : 24°C/56% Engineer : Kevin_Hu
EUT : AC750 Wireless Dual Band Router
Power Rating : DC 12V From Adapter Input AC 120V/60Hz
Test Mode : IEEE802.11nHT40 CH151 5755MHz Tx
M/N : C20i

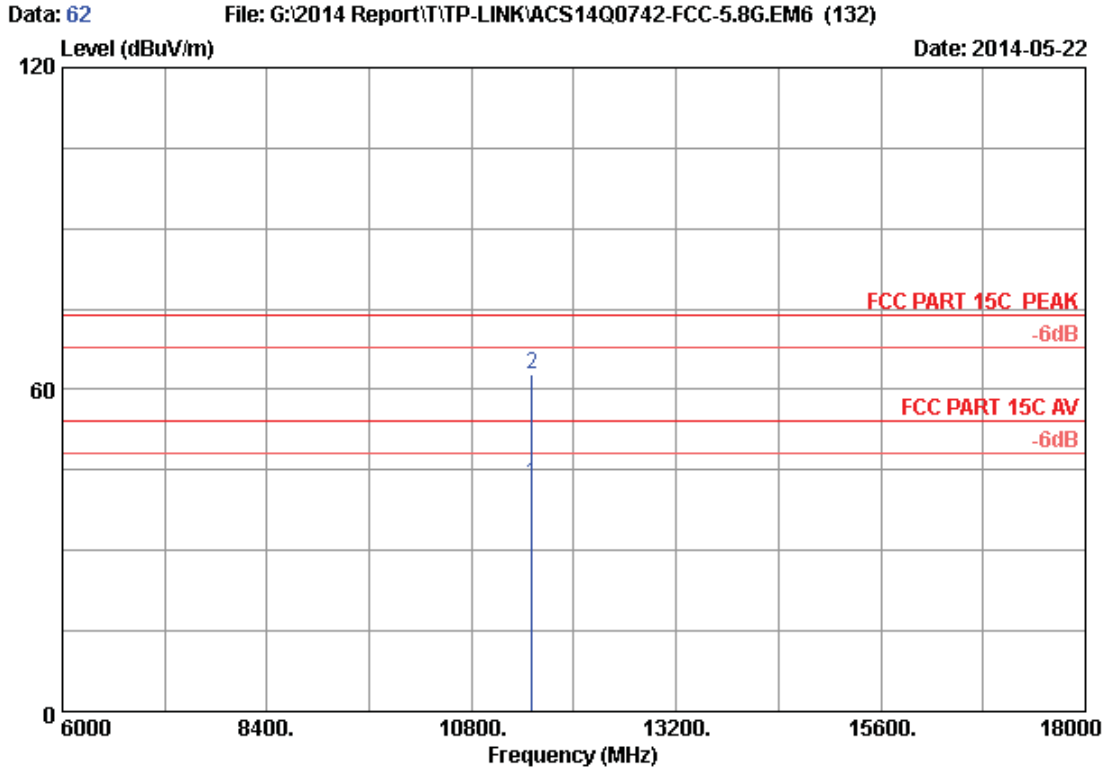

Site no. : 3m Chamber Data no. : 62
 Dis. / Ant. : 3m 2013 3115 (4580) Ant. pol. : HORIZONTAL
 Limit : FCC PART 15C PEAK
 Env. / Ins. : 24°C/56% Engineer : Kevin_Hu
 EUT : AC750 Wireless Dual Band Router
 Power Rating : DC 12V From Adapter Input AC 120V/60Hz
 Test Mode : IEEE802.11nHT40 CH151 5755MHz Tx
 M/N : C20i

No.	Freq. (MHz)	Ant. Factor (dB/m)	Cable Loss (dB)	AMP factor (dB)	Reading (dBuV)	Emission Level (dBuV/m)	Limits (dBuV/m)	Margin (dB)	Remark
1	11510.000	38.71	13.29	35.27	25.86	42.59	54.00	11.41	Average
2	11510.000	38.71	13.29	35.27	46.12	62.85	74.00	11.15	Peak

Remarks: 1. Emission Level= Antenna Factor + Cable Loss + Reading - Amp Factor
 2. The emission levels that are 20dB below the official limit are not reported.

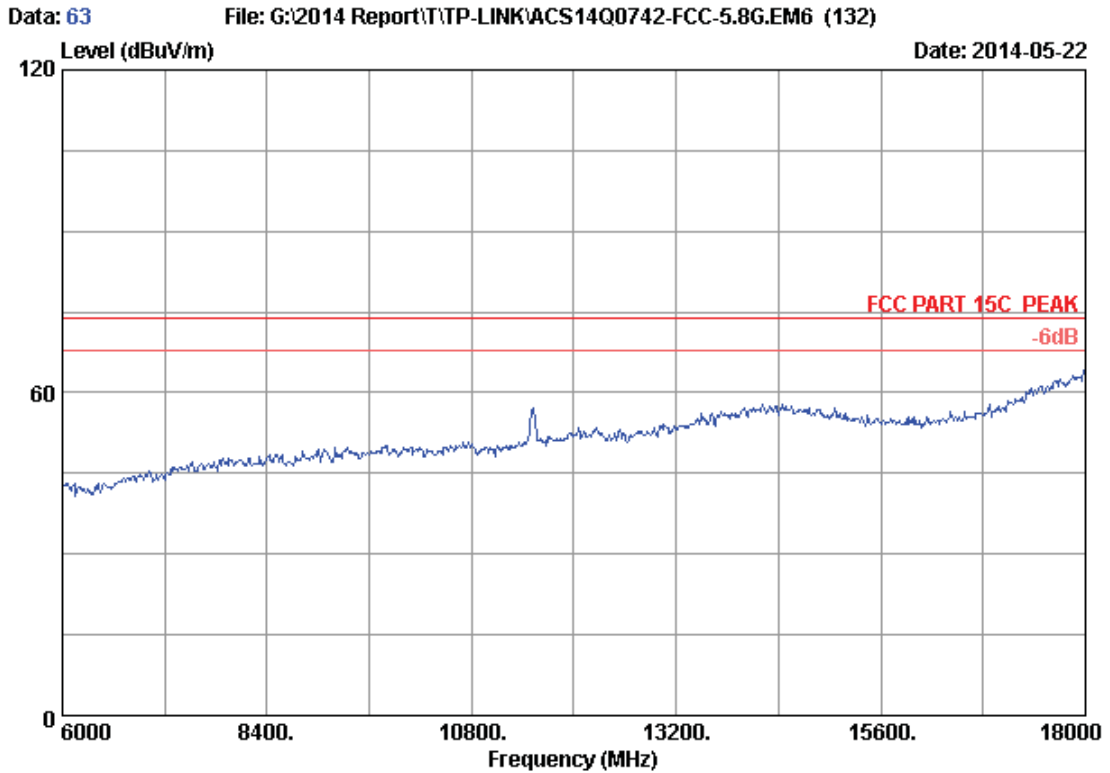

Site no. : 3m Chamber Data no. : 63
Dis. / Ant. : 3m 2013 3115 (4580) Ant. pol. : VERTICAL
Limit : FCC PART 15C PEAK
Env. / Ins. : 24°C/56% Engineer : Kevin_Hu
EUT : AC750 Wireless Dual Band Router
Power Rating : DC 12V From Adapter Input AC 120V/60Hz
Test Mode : IEEE802.11nHT40 CH159 5795MHz Tx
M/N : C20i

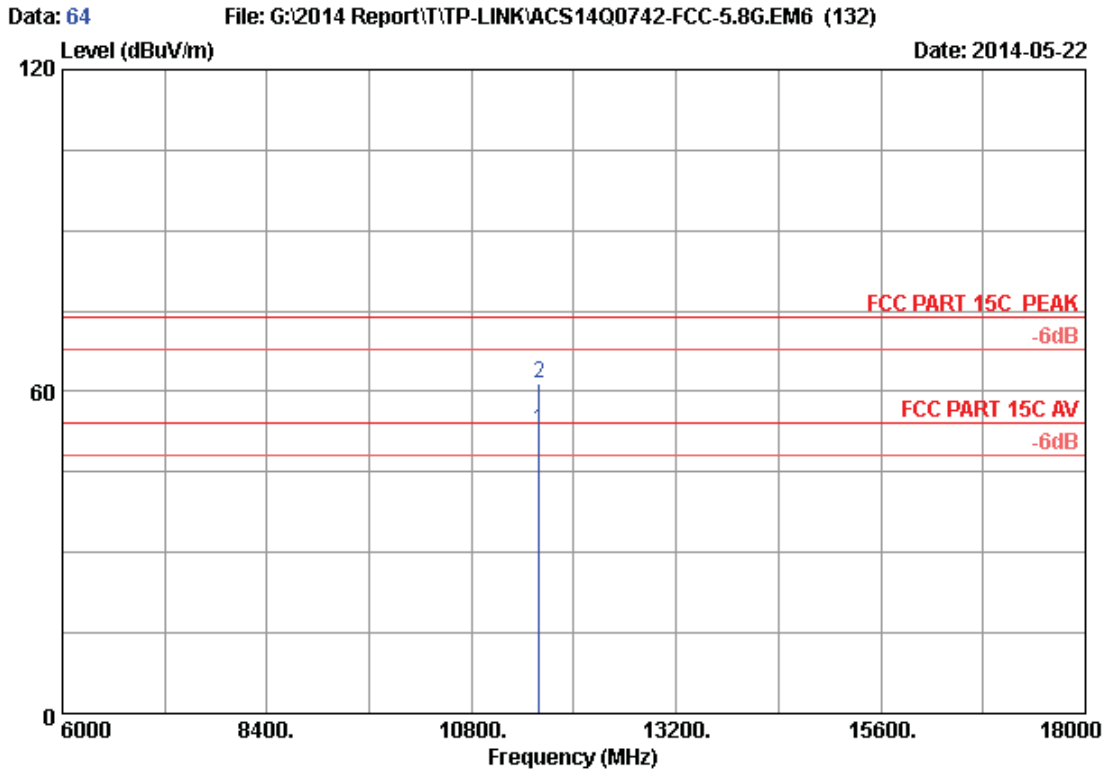

Site no. : 3m Chamber Data no. : 64
 Dis. / Ant. : 3m 2013 3115 (4580) Ant. pol. : VERTICAL
 Limit : FCC PART 15C PEAK
 Env. / Ins. : 24°C/56% Engineer : Kevin_Hu
 EUT : AC750 Wireless Dual Band Router
 Power Rating : DC 12V From Adapter Input AC 120V/60Hz
 Test Mode : IEEE802.11nHT40 CH159 5795MHz Tx
 M/N : C20i

No.	Freq. (MHz)	Ant. Factor (dB/m)	Cable Loss (dB)	AMP factor (dB)	Reading (dBuV)	Emission Level (dBuV/m)	Limits (dBuV/m)	Margin (dB)	Remark
1	11590.000	38.83	13.34	35.26	35.82	52.73	54.00	1.27	Average
2	11590.000	38.83	13.34	35.26	44.67	61.58	74.00	12.42	Peak

Remarks: 1. Emission Level= Antenna Factor + Cable Loss + Reading - Amp Factor
 2. The emission levels that are 20dB below the official limit are not reported.

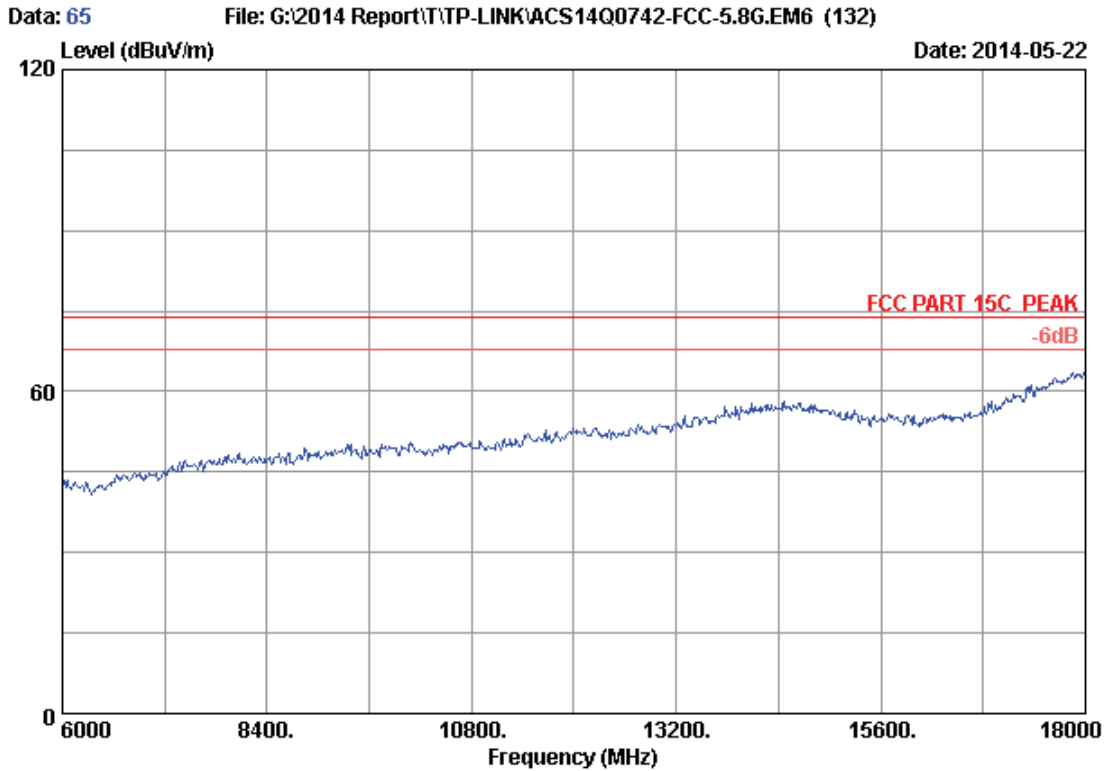

Site no. : 3m Chamber Data no. : 65
Dis. / Ant. : 3m 2013 3115 (4580) Ant. pol. : HORIZONTAL
Limit : FCC PART 15C PEAK
Env. / Ins. : 24°C/56% Engineer : Kevin_Hu
EUT : AC750 Wireless Dual Band Router
Power Rating : DC 12V From Adapter Input AC 120V/60Hz
Test Mode : IEEE802.11nHT40 CH159 5795MHz Tx
M/N : C20i

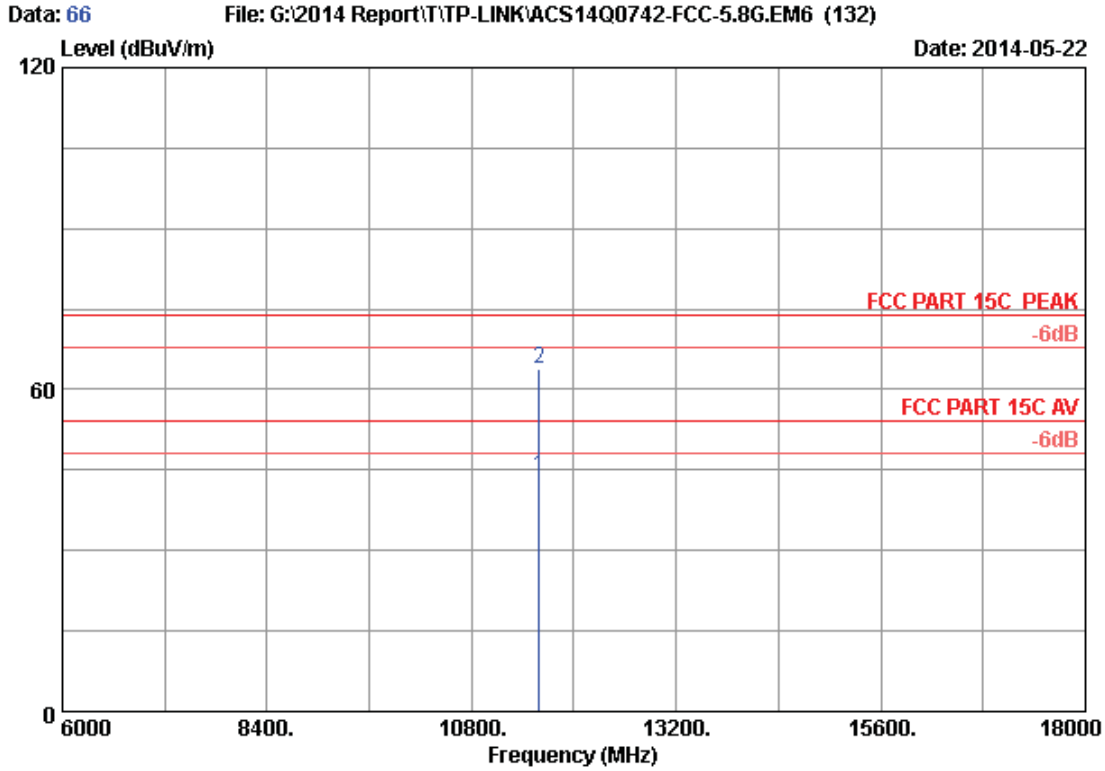

Site no. : 3m Chamber Data no. : 66
 Dis. / Ant. : 3m 2013 3115 (4580) Ant. pol. : HORIZONTAL
 Limit : FCC PART 15C PEAK
 Env. / Ins. : 24°C/56% Engineer : Kevin_Hu
 EUT : AC750 Wireless Dual Band Router
 Power Rating : DC 12V From Adapter Input AC 120V/60Hz
 Test Mode : IEEE802.11nHT40 CH159 5795MHz Tx
 M/N : C20i

No.	Freq. (MHz)	Ant. Factor (dB/m)	Cable Loss (dB)	AMP factor (dB)	Reading (dBuV)	Emission Level (dBuV/m)	Limits (dBuV/m)	Margin (dB)	Remark
1	11590.000	38.83	13.34	35.26	26.84	43.75	54.00	10.25	Average
2	11590.000	38.83	13.34	35.26	47.04	63.95	74.00	10.05	Peak

Remarks: 1. Emission Level= Antenna Factor + Cable Loss + Reading - Amp Factor
 2. The emission levels that are 20dB below the official limit are not reported.

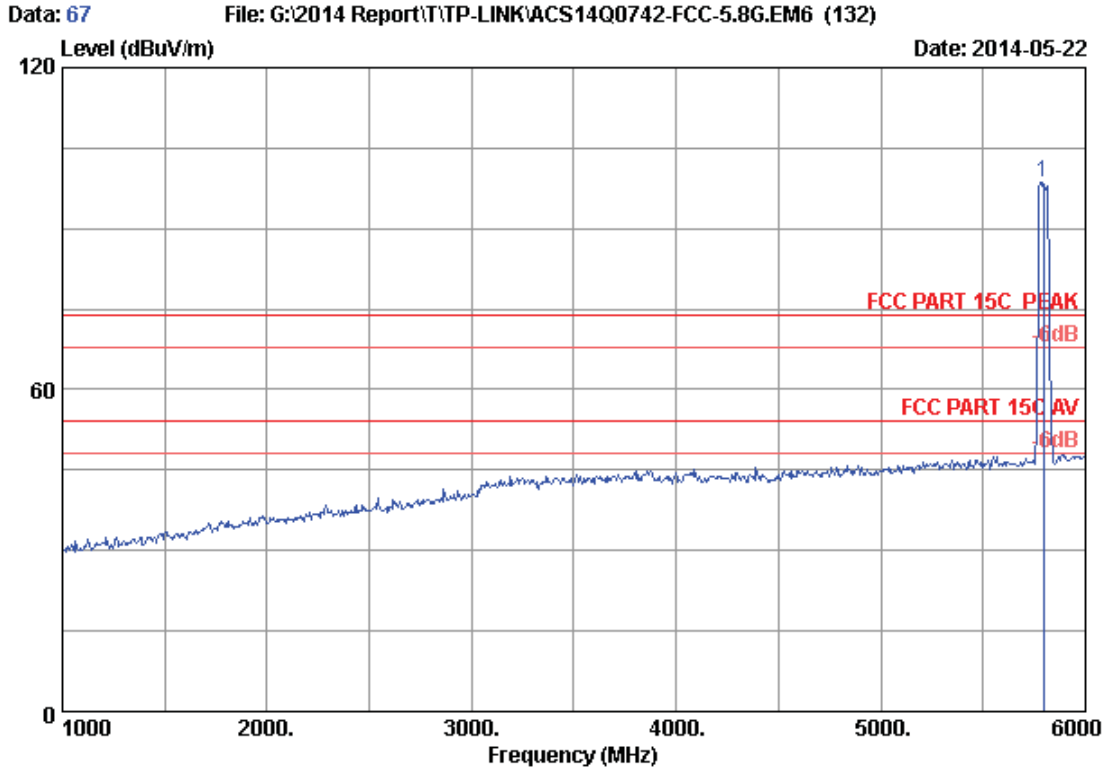

Site no. : 3m Chamber Data no. : 67
 Dis. / Ant. : 3m 2013 3115 (4580) Ant. pol. : HORIZONTAL
 Limit : FCC PART 15C PEAK
 Env. / Ins. : 24°C/56% Engineer : Kevin_Hu
 EUT : AC750 Wireless Dual Band Router
 Power Rating : DC 12V From Adapter Input AC 120V/60Hz
 Test Mode : IEEE802.11nHT40 CH159 5795MHz Tx
 M/N : C20i

No.	Freq. (MHz)	Ant. Factor (dB/m)	Cable Loss (dB)	AMP factor (dB)	Reading (dBuV)	Emission Level (dBuV/m)	Limits (dBuV/m)	Margin (dB)	Remark
1	5795.000	34.12	9.60	35.70	90.68	98.70	74.00	-24.70	Peak

Remarks: 1. Emission Level= Antenna Factor + Cable Loss + Reading
 -Amp Factor
 2. The emission levels that are 20dB below the official
 limit are not reported.

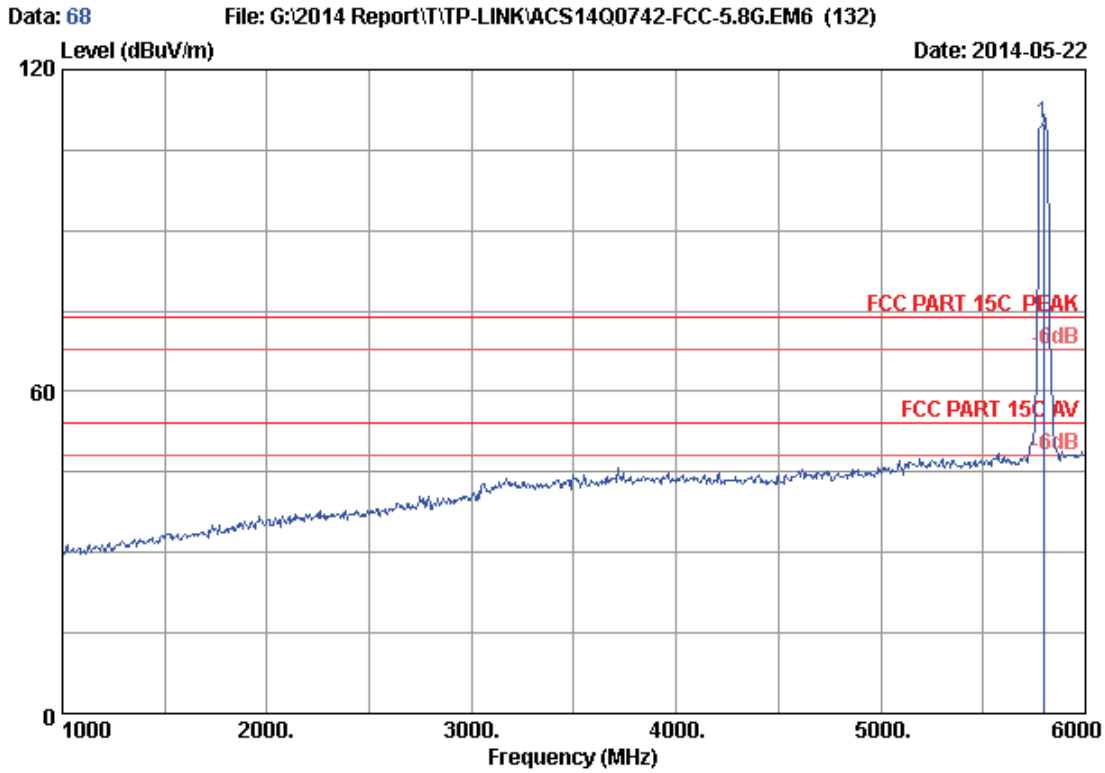

Site no. : 3m Chamber Data no. : 68
 Dis. / Ant. : 3m 2013 3115 (4580) Ant. pol. : VERTICAL
 Limit : FCC PART 15C PEAK
 Env. / Ins. : 24°C/56% Engineer : Kevin_Hu
 EUT : AC750 Wireless Dual Band Router
 Power Rating : DC 12V From Adapter Input AC 120V/60Hz
 Test Mode : IEEE802.11nHT40 CH159 5795MHz Tx
 M/N : C20i

No.	Freq. (MHz)	Ant. Factor (dB/m)	Cable Loss (dB)	AMP factor (dB)	Reading (dBuV)	Emission Level (dBuV/m)	Limits (dBuV/m)	Margin (dB)	Remark
1	5795.000	34.12	9.60	35.70	102.05	110.07	74.00	-36.07	Peak

Remarks: 1. Emission Level= Antenna Factor + Cable Loss + Reading
 -Amp Factor
 2. The emission levels that are 20dB below the official
 limit are not reported.

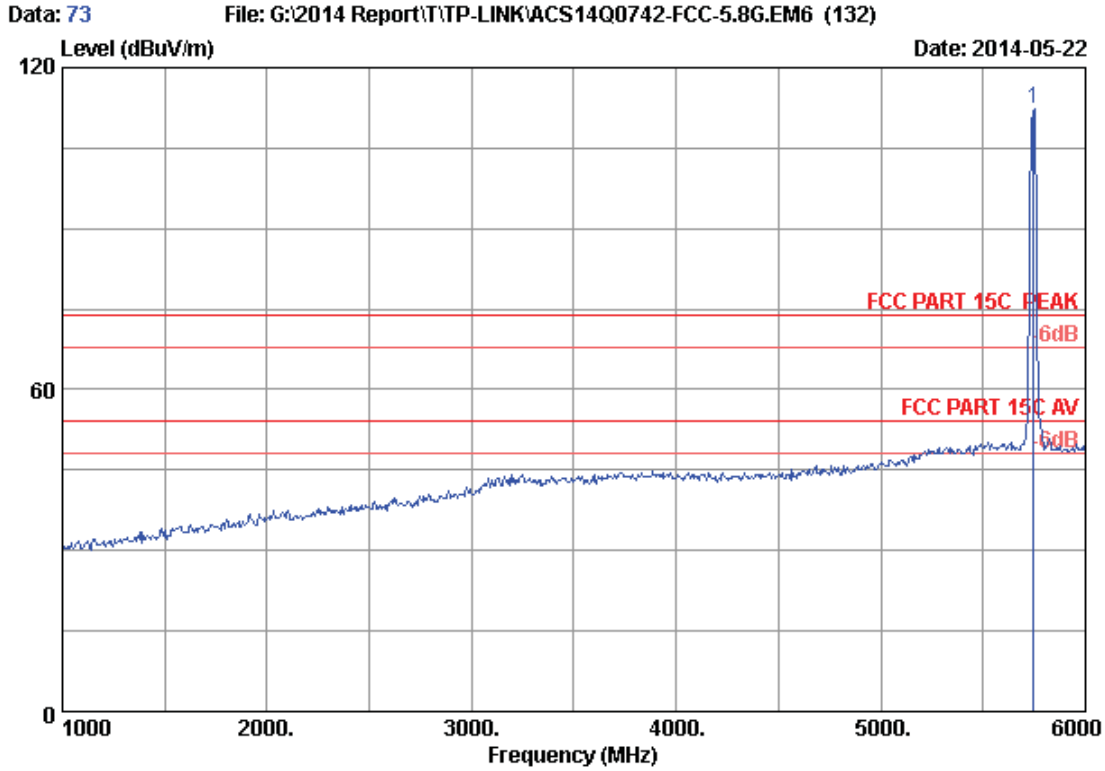

Site no. : 3m Chamber Data no. : 73
 Dis. / Ant. : 3m 2013 3115 (4580) Ant. pol. : VERTICAL
 Limit : FCC PART 15C PEAK
 Env. / Ins. : 24°C/56% Engineer : Kevin_Hu
 EUT : AC750 Wireless Dual Band Router
 Power Rating : DC 12V From Adapter Input AC 120V/60Hz
 Test Mode : IEEE802.11ac VHT20 CH149 5745MHz Tx
 M/N : C20i

No.	Freq. (MHz)	Ant. Factor (dB/m)	Cable Loss (dB)	AMP factor (dB)	Reading (dBuV)	Emission Level (dBuV/m)	Limits (dBuV/m)	Margin (dB)	Remark
1	5745.000	34.10	9.55	35.70	104.36	112.31	74.00	-38.31	Peak

Remarks: 1. Emission Level= Antenna Factor + Cable Loss + Reading - Amp Factor
 2. The emission levels that are 20dB below the official limit are not reported.

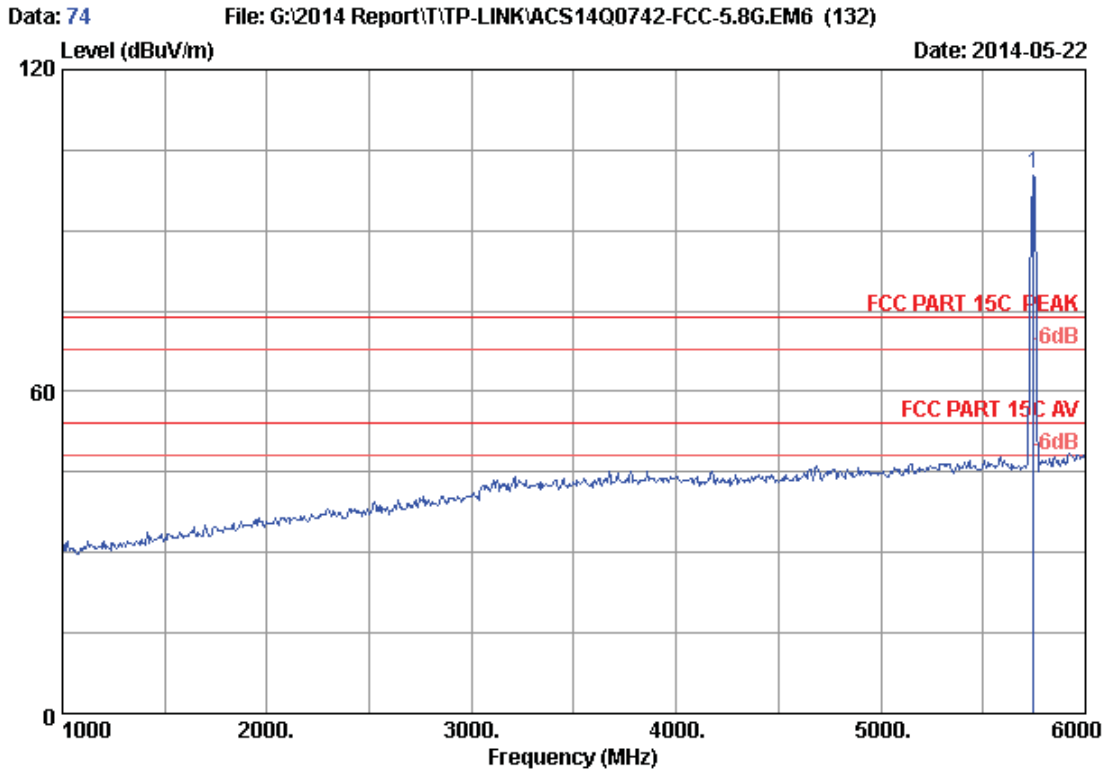

Site no. : 3m Chamber Data no. : 74
 Dis. / Ant. : 3m 2013 3115 (4580) Ant. pol. : HORIZONTAL
 Limit : FCC PART 15C PEAK
 Env. / Ins. : 24°C/56% Engineer : Kevin_Hu
 EUT : AC750 Wireless Dual Band Router
 Power Rating : DC 12V From Adapter Input AC 120V/60Hz
 Test Mode : IEEE802.11ac VHT20 CH149 5745MHz Tx
 M/N : C20i

No.	Freq. (MHz)	Ant. Factor (dB/m)	Cable Loss (dB)	AMP factor (dB)	Reading (dBUV)	Emission Level (dBUV/m)	Limits (dBUV/m)	Margin (dB)	Remark
1	5745.000	34.10	9.55	35.70	92.74	100.69	74.00	-26.69	Peak

Remarks: 1. Emission Level= Antenna Factor + Cable Loss + Reading - Amp Factor
 2. The emission levels that are 20dB below the official limit are not reported.

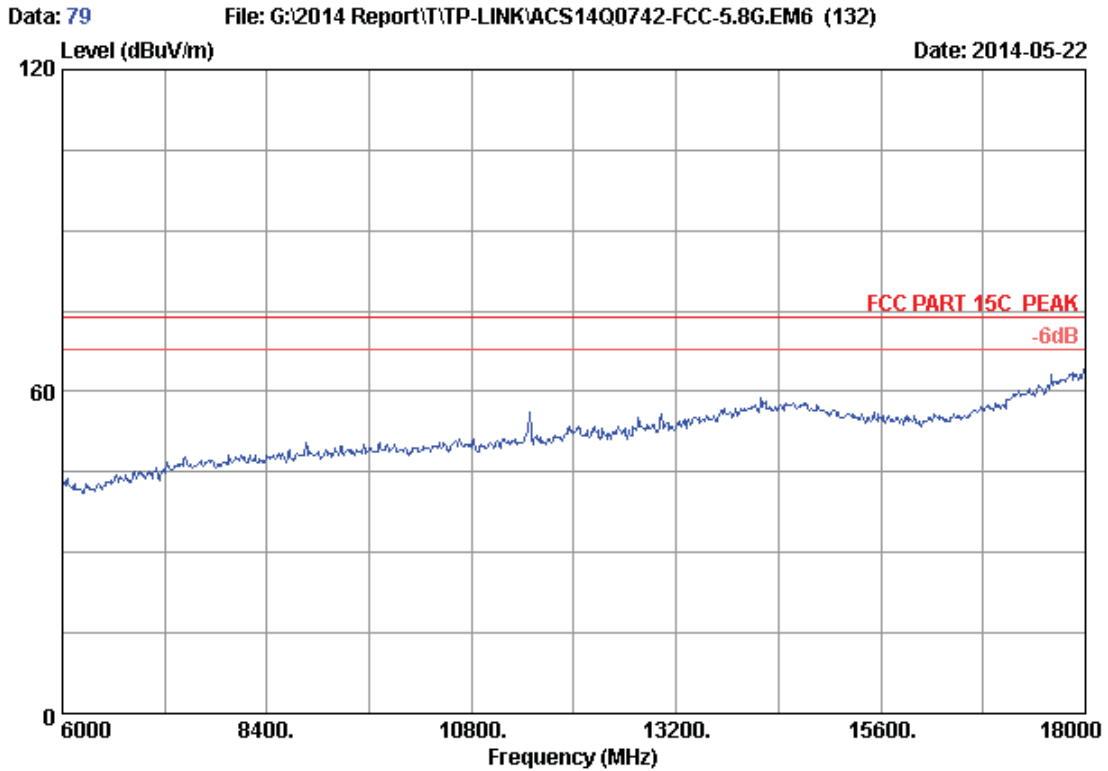

Site no. : 3m Chamber Data no. : 79
Dis. / Ant. : 3m 2013 3115 (4580) Ant. pol. : VERTICAL
Limit : FCC PART 15C PEAK
Env. / Ins. : 24°C/56% Engineer : Kevin_Hu
EUT : AC750 Wireless Dual Band Router
Power Rating : DC 12V From Adapter Input AC 120V/60Hz
Test Mode : IEEE802.11ac VHT20 CH149 5745MHz Tx
M/N : C20i

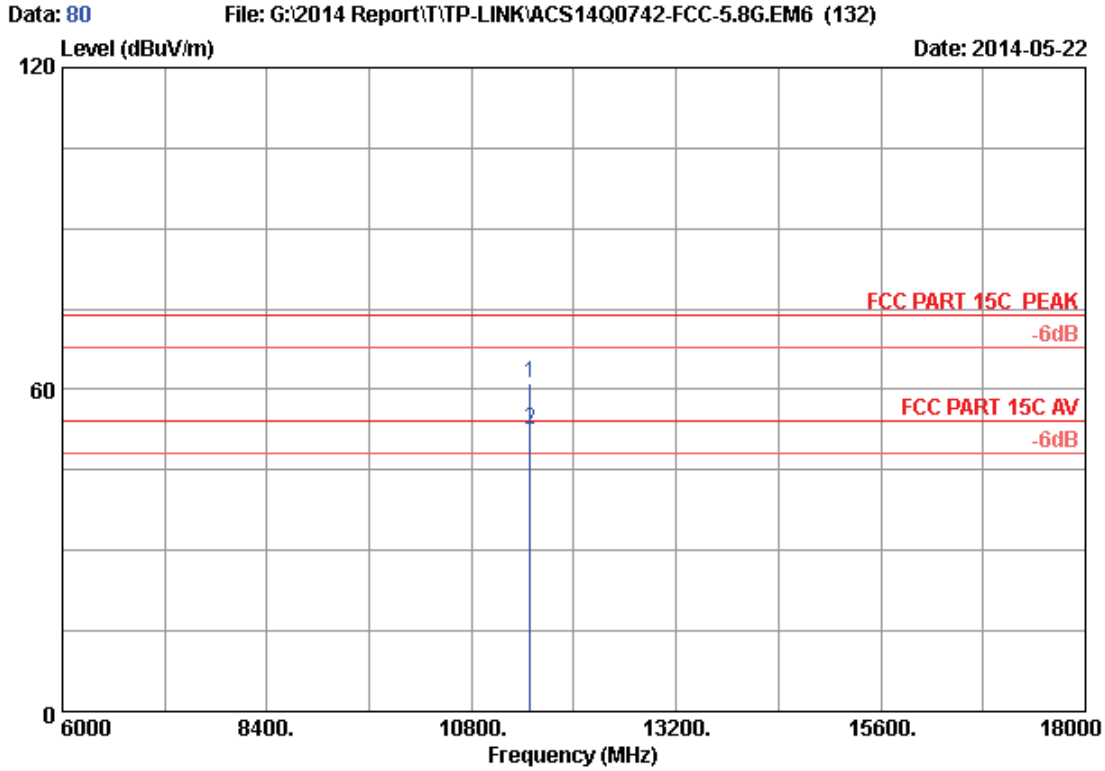

Site no. : 3m Chamber Data no. : 80
 Dis. / Ant. : 3m 2013 3115 (4580) Ant. pol. : VERTICAL
 Limit : FCC PART 15C PEAK
 Env. / Ins. : 24°C/56% Engineer : Kevin_Hu
 EUT : AC750 Wireless Dual Band Router
 Power Rating : DC 12V From Adapter Input AC 120V/60Hz
 Test Mode : IEEE802.11ac VHT20 CH149 5745MHz Tx
 M/N : C20i

No.	Freq. (MHz)	Ant. Factor (dB/m)	Cable Loss (dB)	AMP factor (dB)	Reading (dBuV)	Emission Level (dBuV/m)	Limits (dBuV/m)	Margin (dB)	Remark
1	11490.000	38.69	13.28	35.28	44.38	61.07	74.00	12.93	Peak
2	11490.000	38.69	13.28	35.28	35.77	52.46	54.00	1.54	Average

Remarks: 1. Emission Level= Antenna Factor + Cable Loss + Reading - Amp Factor
 2. The emission levels that are 20dB below the official limit are not reported.

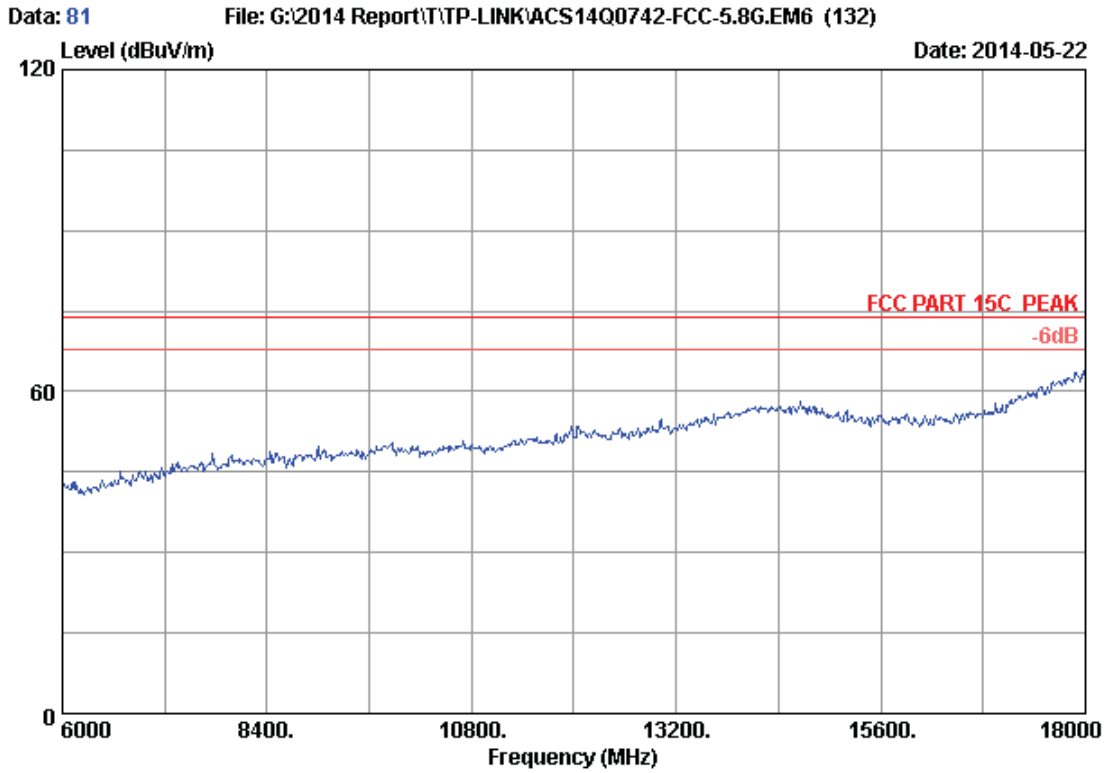

Site no.	: 3m Chamber	Data no.	: 81
Dis. / Ant.	: 3m 2013 3115 (4580)	Ant. pol.	: HORIZONTAL
Limit	: FCC PART 15C PEAK		
Env. / Ins.	: 24°C/56%	Engineer	: Kevin_Hu
EUT	: AC750 Wireless Dual Band Router		
Power Rating	: DC 12V From Adapter Input AC 120V/60Hz		
Test Mode	: IEEE802.11ac VHT20 CH149 5745MHz Tx		
M/N	: C20i		

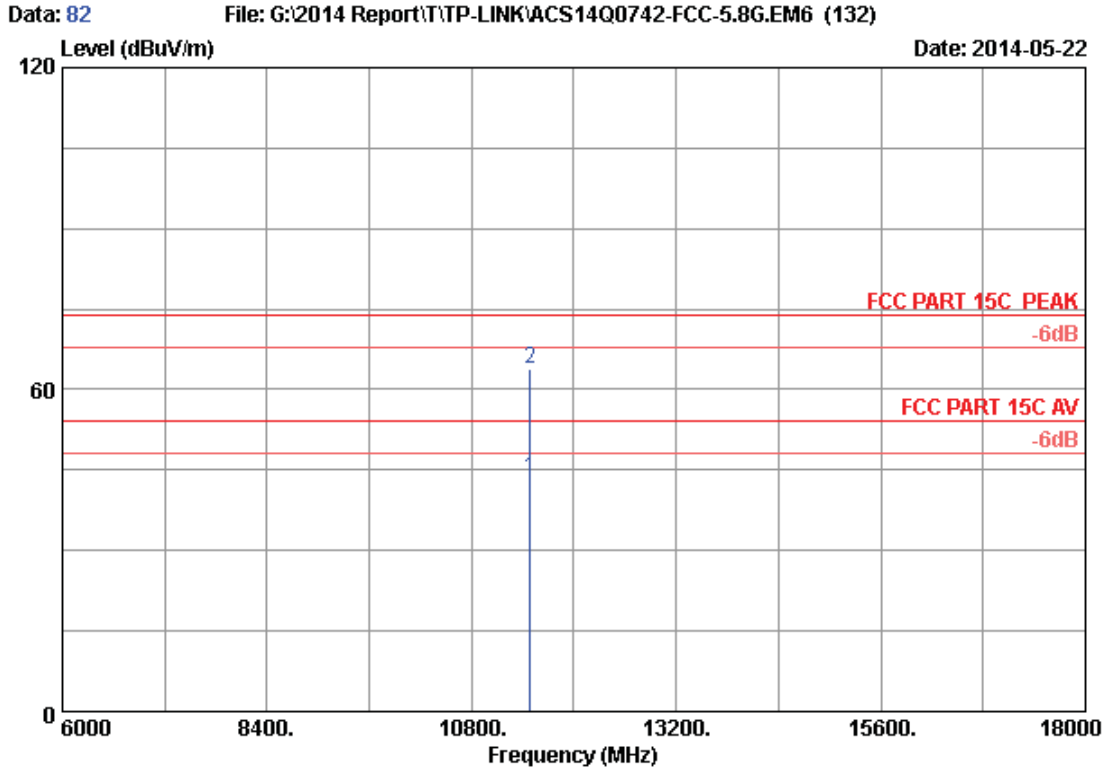

Site no. : 3m Chamber Data no. : 82
 Dis. / Ant. : 3m 2013 3115 (4580) Ant. pol. : HORIZONTAL
 Limit : FCC PART 15C PEAK
 Env. / Ins. : 24°C/56% Engineer : Kevin_Hu
 EUT : AC750 Wireless Dual Band Router
 Power Rating : DC 12V From Adapter Input AC 120V/60Hz
 Test Mode : IEEE802.11ac VHT20 CH149 5745MHz Tx
 M/N : C20i

No.	Freq. (MHz)	Ant. Factor (dB/m)	Cable Loss (dB)	AMP factor (dB)	Reading (dBUV)	Emission Level (dBUV/m)	Limits (dBUV/m)	Margin (dB)	Remark
1	11490.000	38.69	13.28	35.28	26.86	43.55	54.00	10.45	Average
2	11490.000	38.69	13.28	35.28	47.07	63.76	74.00	10.24	Peak

Remarks: 1. Emission Level= Antenna Factor + Cable Loss + Reading - Amp Factor
 2. The emission levels that are 20dB below the official limit are not reported.

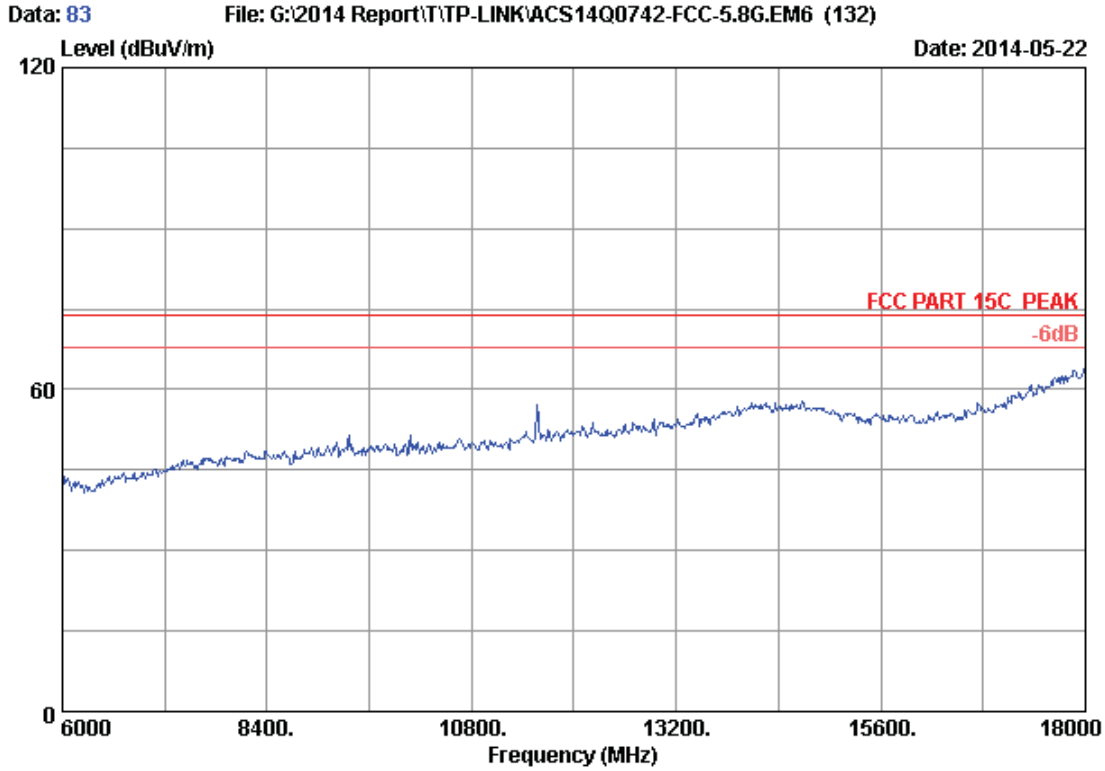

Site no.	: 3m Chamber	Data no.	: 83
Dis. / Ant.	: 3m 2013 3115 (4580)	Ant. pol.	: VERTICAL
Limit	: FCC PART 15C PEAK		
Env. / Ins.	: 24°C/56%	Engineer	: Kevin_Hu
EUT	: AC750 Wireless Dual Band Router		
Power Rating	: DC 12V From Adapter Input AC 120V/60Hz		
Test Mode	: IEEE802.11ac VHT20 CH157 5785MHz Tx		
M/N	: C20i		

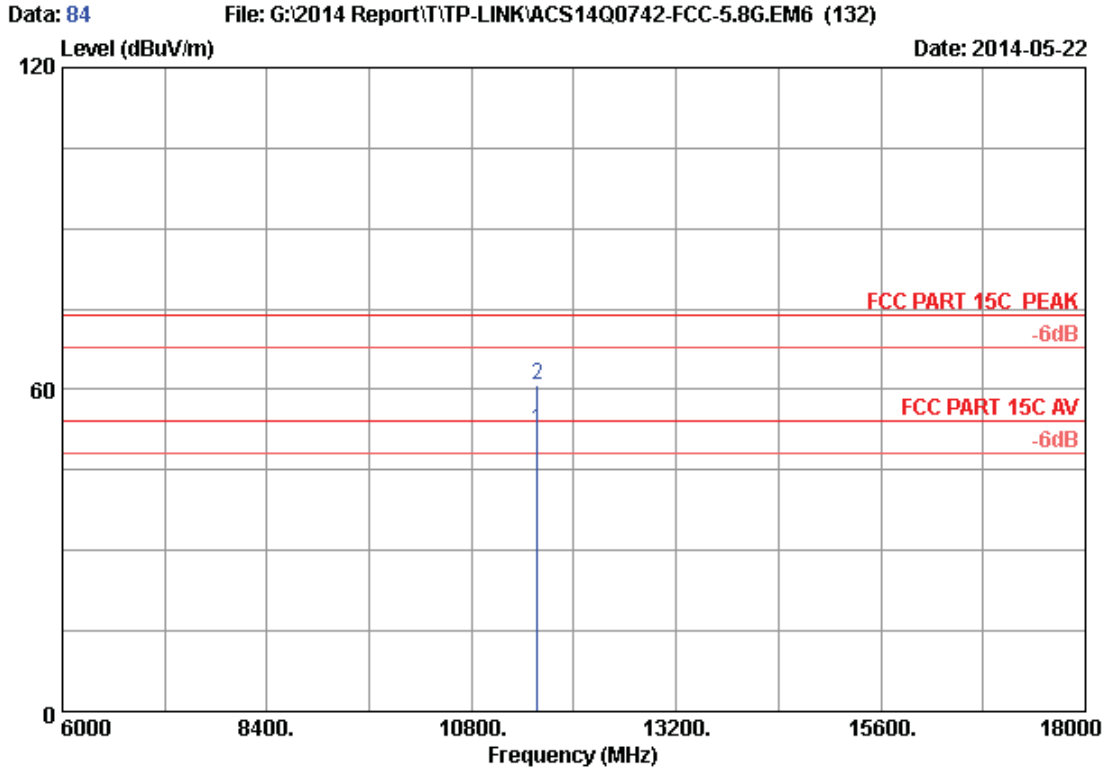

Site no. : 3m Chamber Data no. : 84
 Dis. / Ant. : 3m 2013 3115 (4580) Ant. pol. : VERTICAL
 Limit : FCC PART 15C PEAK
 Env. / Ins. : 24°C/56% Engineer : Kevin_Hu
 EUT : AC750 Wireless Dual Band Router
 Power Rating : DC 12V From Adapter Input AC 120V/60Hz
 Test Mode : IEEE802.11ac VHT20 CH157 5785MHz Tx
 M/N : C20i

No.	Freq. (MHz)	Ant. Factor (dB/m)	Cable Loss (dB)	AMP factor (dB)	Reading (dBuV)	Emission Level (dBuV/m)	Limits (dBuV/m)	Margin (dB)	Remark
1	11570.000	38.80	13.32	35.26	35.50	52.36	54.00	1.64	Average
2	11570.000	38.80	13.32	35.26	43.87	60.73	74.00	13.27	Peak

Remarks: 1. Emission Level= Antenna Factor + Cable Loss + Reading - Amp Factor
 2. The emission levels that are 20dB below the official limit are not reported.

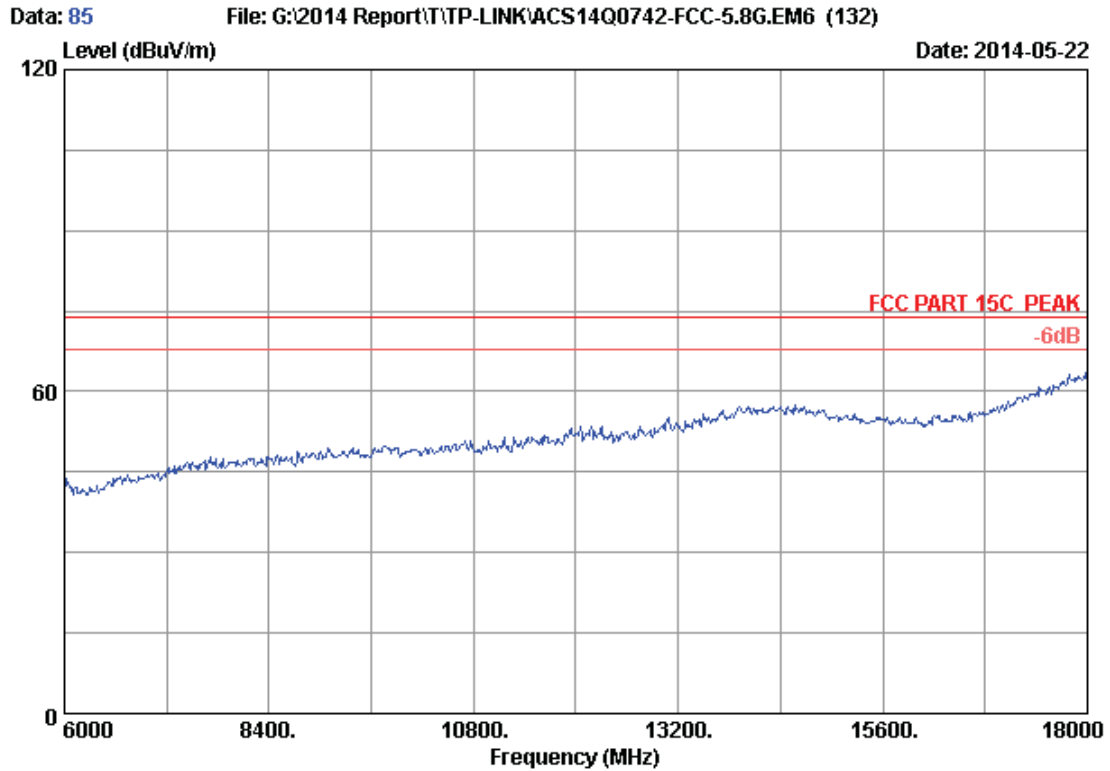

Site no. : 3m Chamber Data no. : 85
Dis. / Ant. : 3m 2013 3115 (4580) Ant. pol. : HORIZONTAL
Limit : FCC PART 15C PEAK
Env. / Ins. : 24°C/56% Engineer : Kevin_Hu
EUT : AC750 Wireless Dual Band Router
Power Rating : DC 12V From Adapter Input AC 120V/60Hz
Test Mode : IEEE802.11ac VHT20 CH157 5785MHz Tx
M/N : C20i

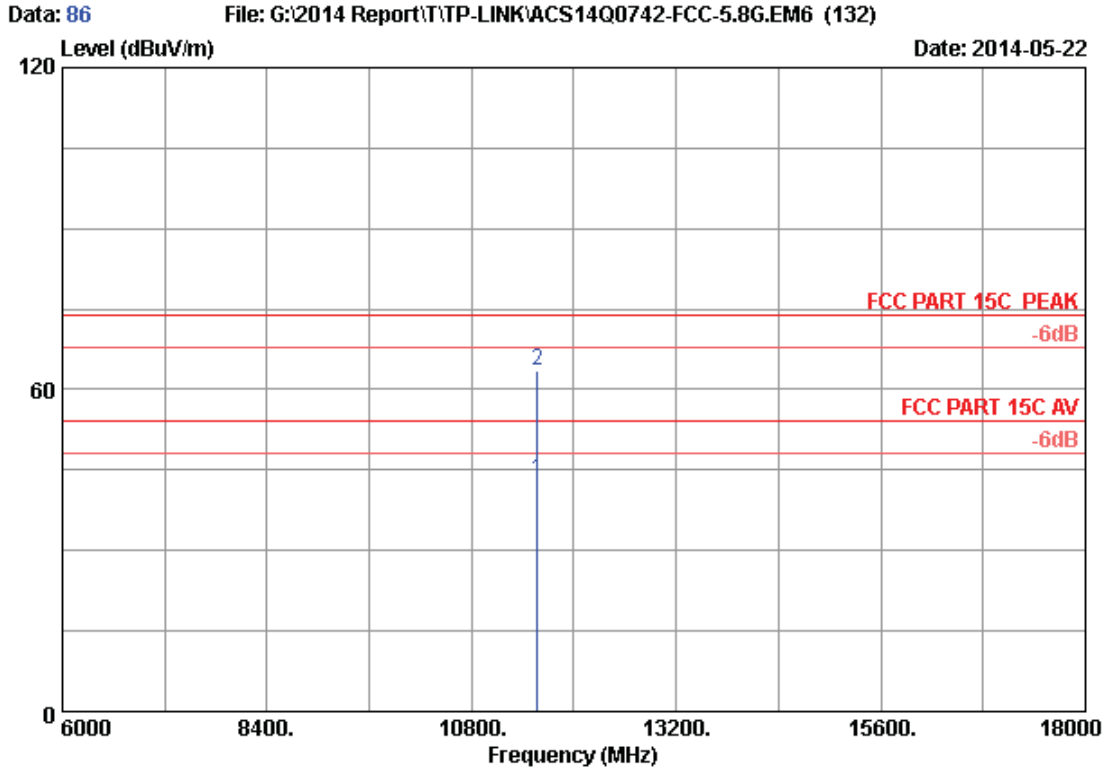

Site no. : 3m Chamber Data no. : 86
 Dis. / Ant. : 3m 2013 3115 (4580) Ant. pol. : HORIZONTAL
 Limit : FCC PART 15C PEAK
 Env. / Ins. : 24°C/56% Engineer : Kevin_Hu
 EUT : AC750 Wireless Dual Band Router
 Power Rating : DC 12V From Adapter Input AC 120V/60Hz
 Test Mode : IEEE802.11ac VHT20 CH157 5785MHz Tx
 M/N : C20i

No.	Freq. (MHz)	Ant. Factor (dB/m)	Cable Loss (dB)	AMP factor (dB)	Reading (dBuV)	Emission Level (dBuV/m)	Limits (dBuV/m)	Margin (dB)	Remark
1	11570.000	38.80	13.32	35.26	26.39	43.25	54.00	10.75	Average
2	11570.000	38.80	13.32	35.26	46.59	63.45	74.00	10.55	Peak

Remarks: 1. Emission Level= Antenna Factor + Cable Loss + Reading - Amp Factor
 2. The emission levels that are 20dB below the official limit are not reported.

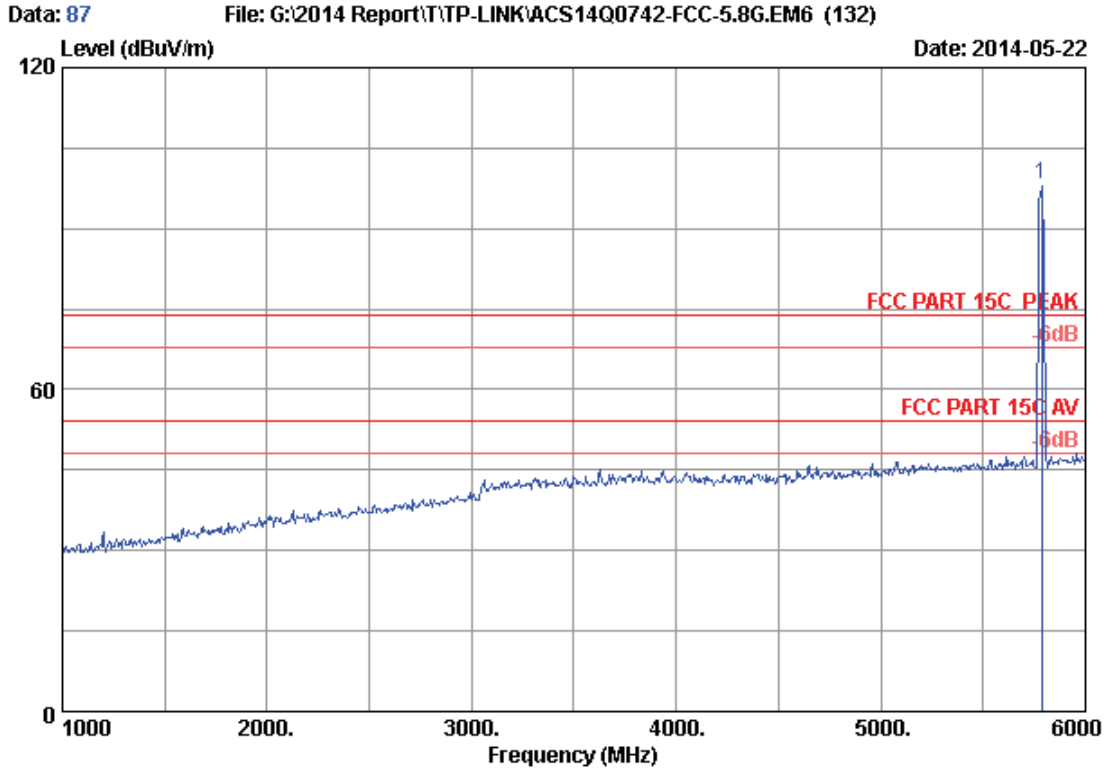

Site no. : 3m Chamber Data no. : 87
 Dis. / Ant. : 3m 2013 3115 (4580) Ant. pol. : HORIZONTAL
 Limit : FCC PART 15C PEAK
 Env. / Ins. : 24°C/56% Engineer : Kevin_Hu
 EUT : AC750 Wireless Dual Band Router
 Power Rating : DC 12V From Adapter Input AC 120V/60Hz
 Test Mode : IEEE802.11ac VHT20 CH157 5785MHz Tx
 M/N : C20i

No.	Freq. (MHz)	Ant. Factor (dB/m)	Cable Loss (dB)	AMP factor (dB)	Reading (dBUV)	Emission Level (dBUV/m)	Limits (dBUV/m)	Margin (dB)	Remark
1	5785.000	34.11	9.59	35.70	90.26	98.26	74.00	-24.26	Peak

Remarks: 1. Emission Level= Antenna Factor + Cable Loss + Reading - Amp Factor
 2. The emission levels that are 20dB below the official limit are not reported.

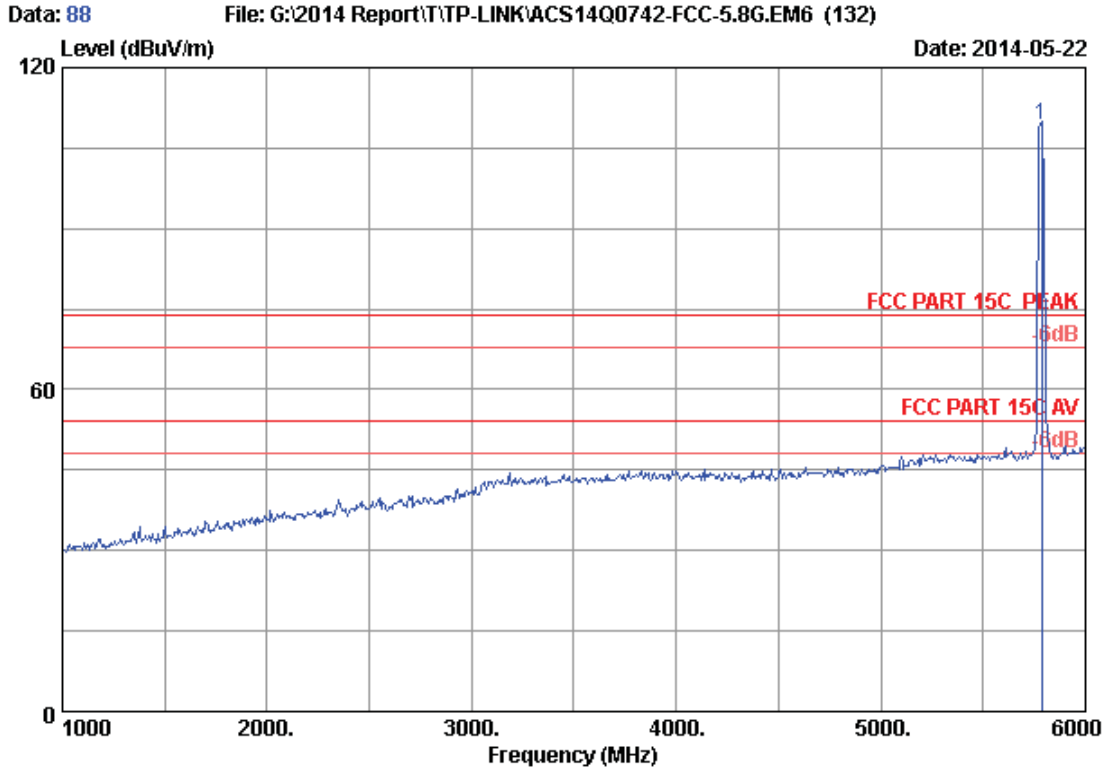

Site no. : 3m Chamber Data no. : 88
 Dis. / Ant. : 3m 2013 3115 (4580) Ant. pol. : VERTICAL
 Limit : FCC PART 15C PEAK
 Env. / Ins. : 24°C/56% Engineer : Kevin_Hu
 EUT : AC750 Wireless Dual Band Router
 Power Rating : DC 12V From Adapter Input AC 120V/60Hz
 Test Mode : IEEE802.11ac VHT20 CH157 5785MHz Tx
 M/N : C20i

No.	Freq. (MHz)	Ant. Factor (dB/m)	Cable Loss (dB)	AMP factor (dB)	Reading (dBuV)	Emission Level (dBuV/m)	Limits (dBuV/m)	Margin (dB)	Remark
1	5785.000	34.11	9.59	35.70	101.26	109.26	74.00	-35.26	Peak

Remarks: 1. Emission Level= Antenna Factor + Cable Loss + Reading - Amp Factor
 2. The emission levels that are 20dB below the official limit are not reported.

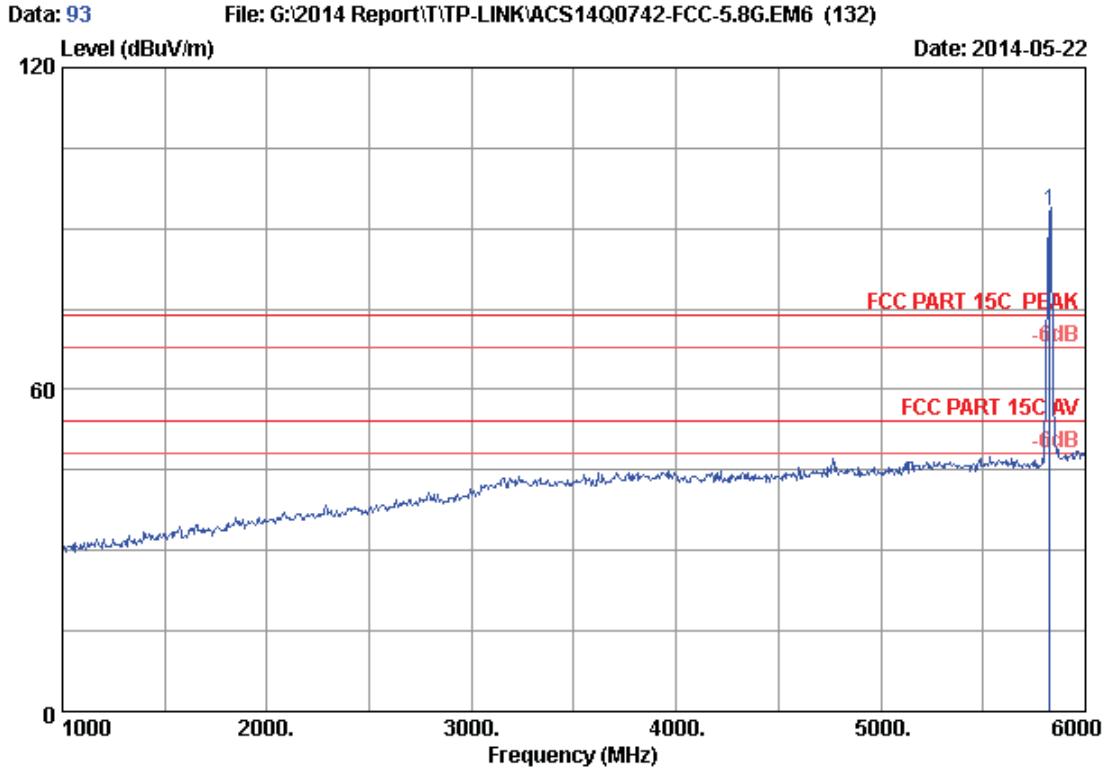

Site no. : 3m Chamber Data no. : 93
 Dis. / Ant. : 3m 2013 3115 (4580) Ant. pol. : HORIZONTAL
 Limit : FCC PART 15C PEAK
 Env. / Ins. : 24°C/56% Engineer : Kevin_Hu
 EUT : AC750 Wireless Dual Band Router
 Power Rating : DC 12V From Adapter Input AC 120V/60Hz
 Test Mode : IEEE802.11ac VHT20 CH165 5825MHz Tx
 M/N : C20i

No.	Freq. (MHz)	Ant. Factor (dB/m)	Cable Loss (dB)	AMP factor (dB)	Reading (dBUV)	Emission Level (dBUV/m)	Limits (dBUV/m)	Margin (dB)	Remark
1	5825.000	34.13	9.63	35.70	85.26	93.32	74.00	-19.32	Peak

Remarks: 1. Emission Level= Antenna Factor + Cable Loss + Reading - Amp Factor
 2. The emission levels that are 20dB below the official limit are not reported.

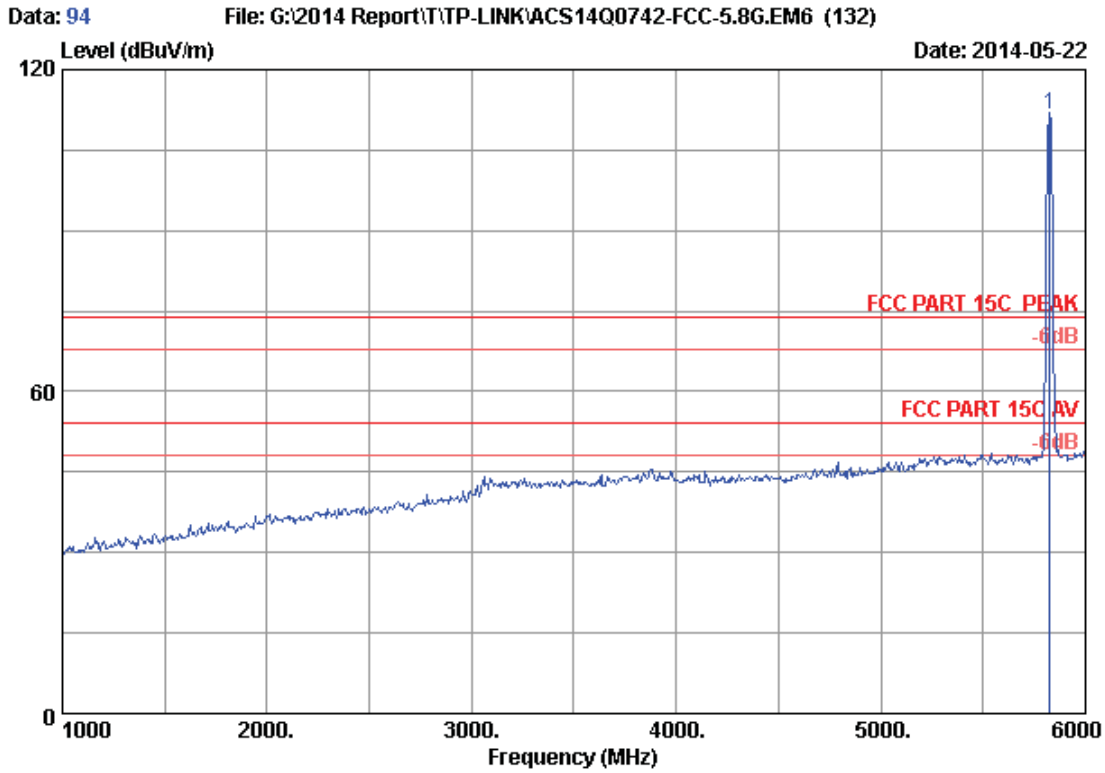

Site no. : 3m Chamber Data no. : 94
 Dis. / Ant. : 3m 2013 3115 (4580) Ant. pol. : VERTICAL
 Limit : FCC PART 15C PEAK
 Env. / Ins. : 24°C/56% Engineer : Kevin_Hu
 EUT : AC750 Wireless Dual Band Router
 Power Rating : DC 12V From Adapter Input AC 120V/60Hz
 Test Mode : IEEE802.11ac VHT20 CH165 5825MHz Tx
 M/N : C20i

No.	Freq. (MHz)	Ant. Factor (dB/m)	Cable Loss (dB)	AMP factor (dB)	Reading (dBUV)	Emission Level (dBUV/m)	Limits (dBUV/m)	Margin (dB)	Remark
1	5825.000	34.13	9.63	35.70	103.68	111.74	74.00	-37.74	Peak

Remarks: 1. Emission Level= Antenna Factor + Cable Loss + Reading
 -Amp Factor
 2. The emission levels that are 20dB below the official
 limit are not reported.

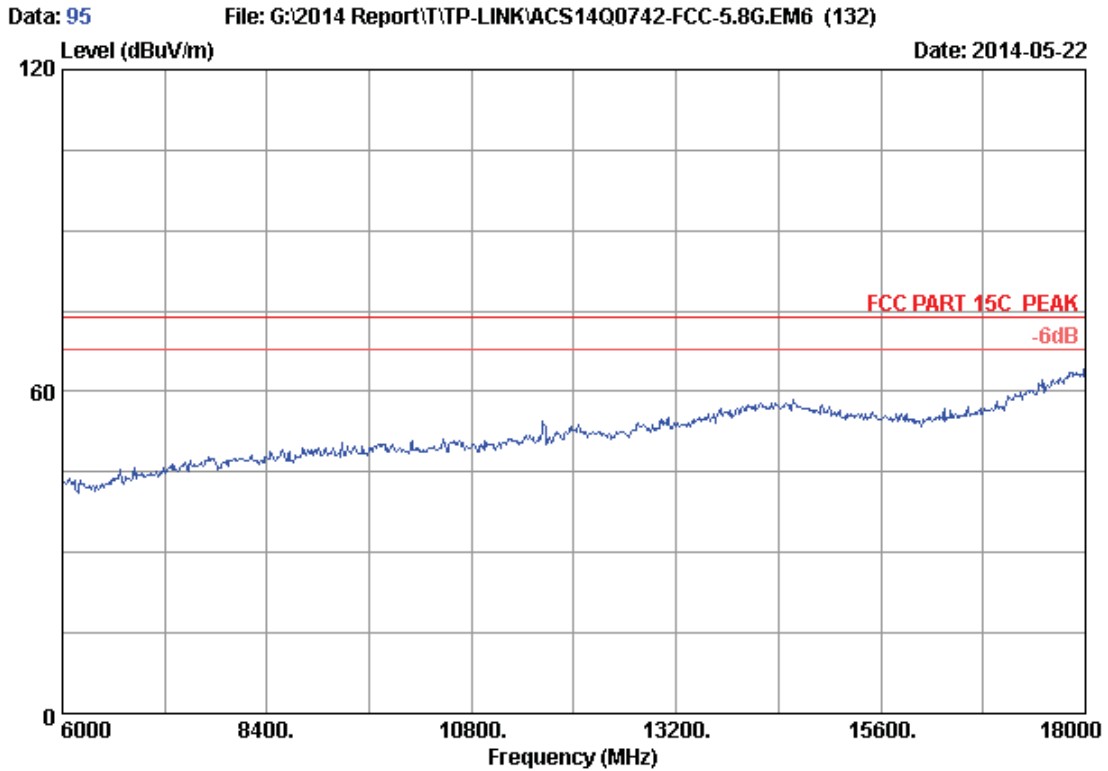

Site no. : 3m Chamber Data no. : 95
Dis. / Ant. : 3m 2013 3115 (4580) Ant. pol. : VERTICAL
Limit : FCC PART 15C PEAK
Env. / Ins. : 24°C/56% Engineer : Kevin_Hu
EUT : AC750 Wireless Dual Band Router
Power Rating : DC 12V From Adapter Input AC 120V/60Hz
Test Mode : IEEE802.11ac VHT20 CH165 5825MHz Tx
M/N : C20i

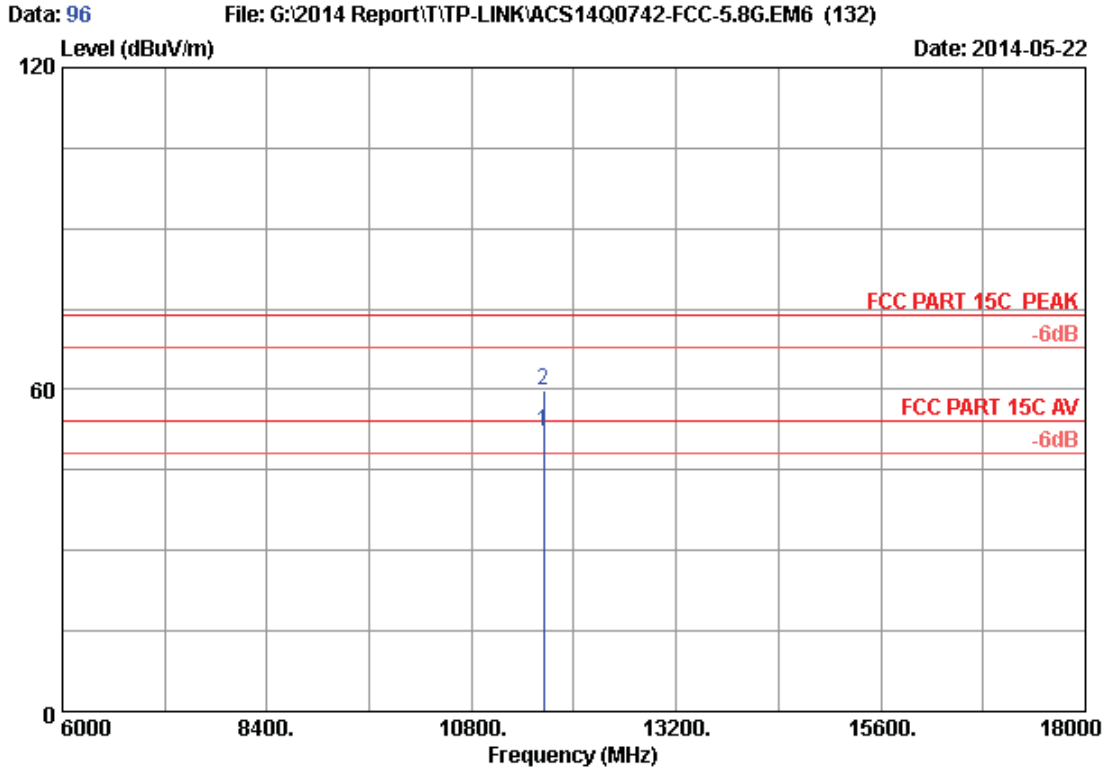

Site no. : 3m Chamber Data no. : 96
 Dis. / Ant. : 3m 2013 3115 (4580) Ant. pol. : VERTICAL
 Limit : FCC PART 15C PEAK
 Env. / Ins. : 24°C/56% Engineer : Kevin_Hu
 EUT : AC750 Wireless Dual Band Router
 Power Rating : DC 12V From Adapter Input AC 120V/60Hz
 Test Mode : IEEE802.11ac VHT20 CH165 5825MHz Tx
 M/N : C20i

No.	Freq. (MHz)	Ant. Factor (dB/m)	Cable Loss (dB)	AMP factor (dB)	Reading (dBUV)	Emission Level (dBUV/m)	Limits (dBUV/m)	Margin (dB)	Remark
1	11650.000	38.91	13.37	35.25	35.18	52.21	54.00	1.79	Average
2	11650.000	38.91	13.37	35.25	42.71	59.74	74.00	14.26	Peak

Remarks: 1. Emission Level= Antenna Factor + Cable Loss + Reading - Amp Factor
 2. The emission levels that are 20dB below the official limit are not reported.

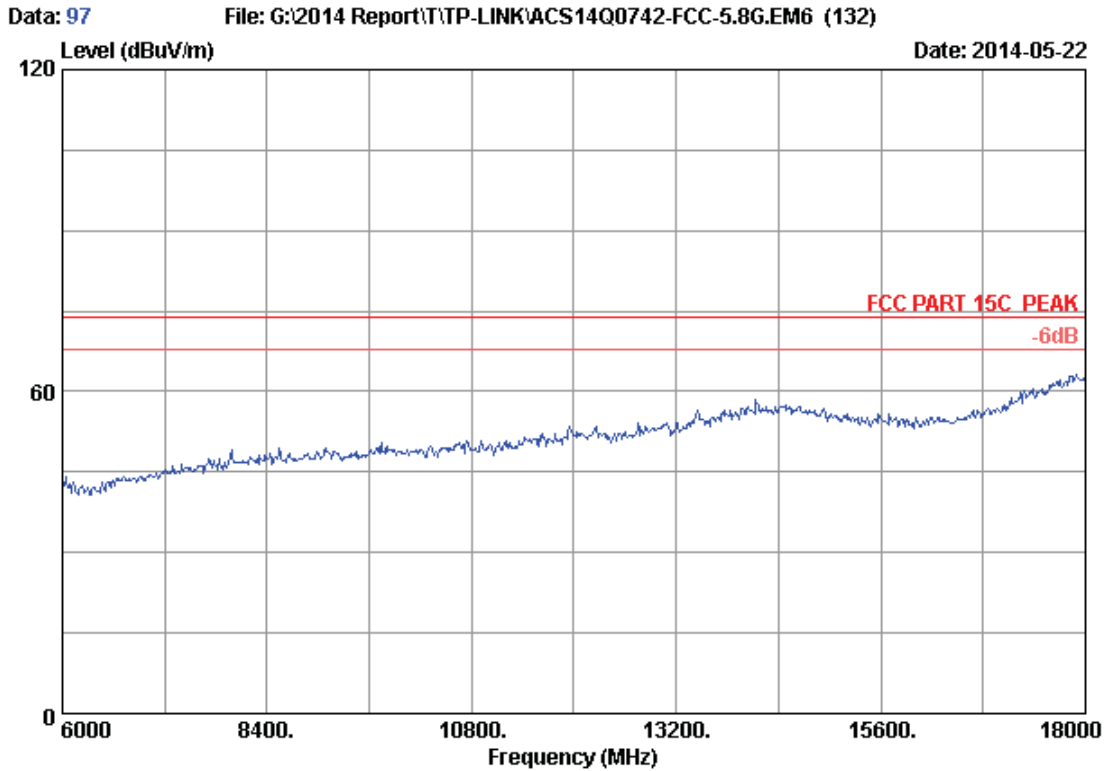

Site no. : 3m Chamber Data no. : 97
Dis. / Ant. : 3m 2013 3115 (4580) Ant. pol. : HORIZONTAL
Limit : FCC PART 15C PEAK
Env. / Ins. : 24°C/56% Engineer : Kevin_Hu
EUT : AC750 Wireless Dual Band Router
Power Rating : DC 12V From Adapter Input AC 120V/60Hz
Test Mode : IEEE802.11ac VHT20 CH165 5825MHz Tx
M/N : C20i

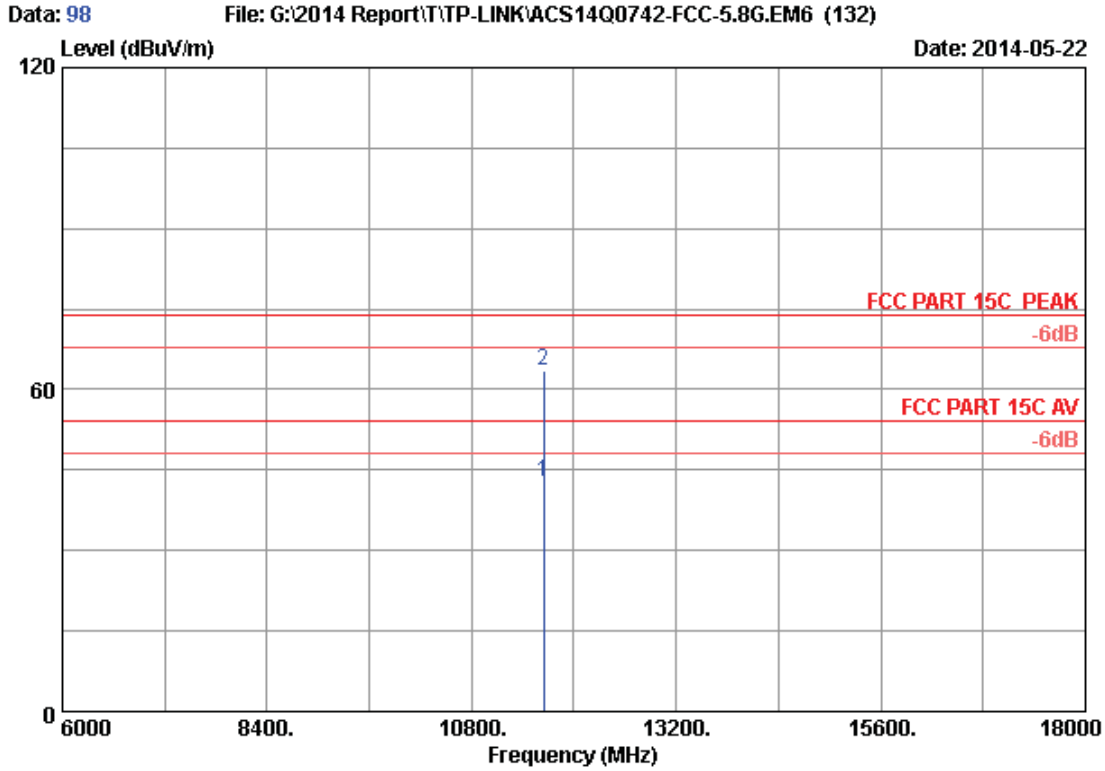

Site no. : 3m Chamber Data no. : 98
 Dis. / Ant. : 3m 2013 3115 (4580) Ant. pol. : HORIZONTAL
 Limit : FCC PART 15C PEAK
 Env. / Ins. : 24°C/56% Engineer : Kevin_Hu
 EUT : AC750 Wireless Dual Band Router
 Power Rating : DC 12V From Adapter Input AC 120V/60Hz
 Test Mode : IEEE802.11ac VHT20 CH165 5825MHz Tx
 M/N : C20i

No.	Freq. (MHz)	Ant. Factor (dB/m)	Cable Loss (dB)	AMP factor (dB)	Reading (dBUV)	Emission Level (dBUV/m)	Limits (dBUV/m)	Margin (dB)	Remark
1	11650.000	38.91	13.37	35.25	25.86	42.89	54.00	11.11	Average
2	11650.000	38.91	13.37	35.25	46.59	63.62	74.00	10.38	Peak

Remarks: 1. Emission Level= Antenna Factor + Cable Loss + Reading - Amp Factor
 2. The emission levels that are 20dB below the official limit are not reported.

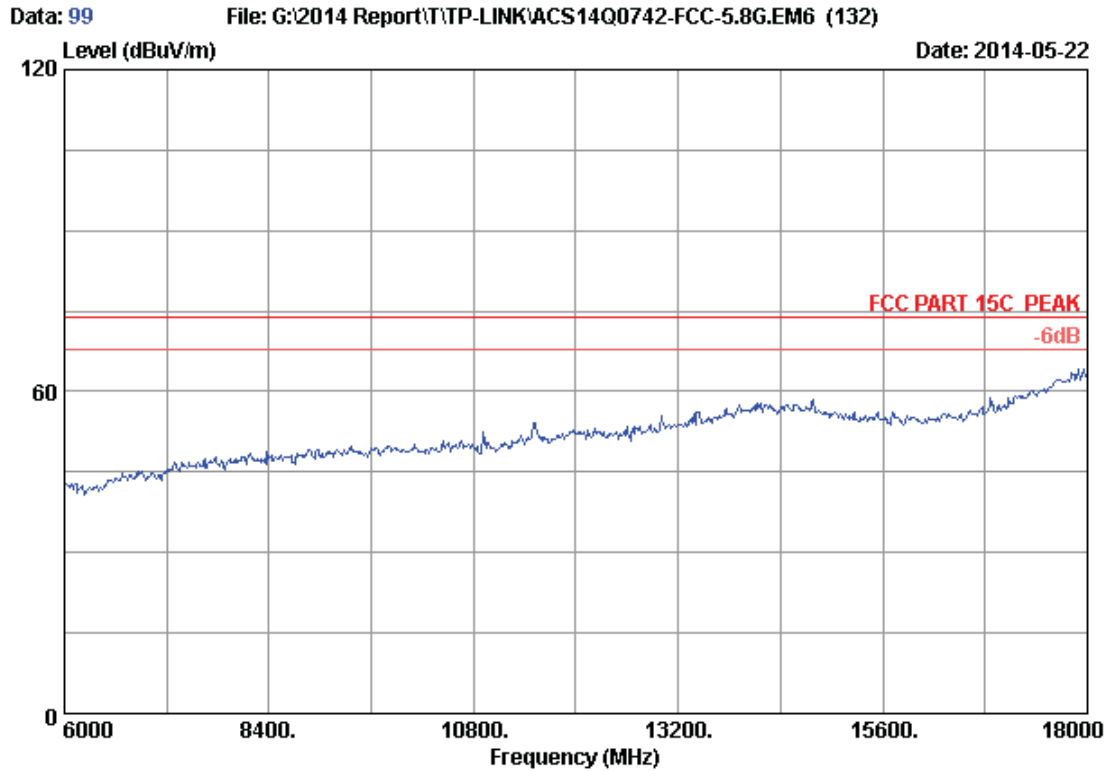

Site no. : 3m Chamber Data no. : 99
Dis. / Ant. : 3m 2013 3115 (4580) Ant. pol. : VERTICAL
Limit : FCC PART 15C PEAK
Env. / Ins. : 24°C/56% Engineer : Kevin_Hu
EUT : AC750 Wireless Dual Band Router
Power Rating : DC 12V From Adapter Input AC 120V/60Hz
Test Mode : IEEE802.11ac VHT40 CH151 5755MHz Tx
M/N : C20i

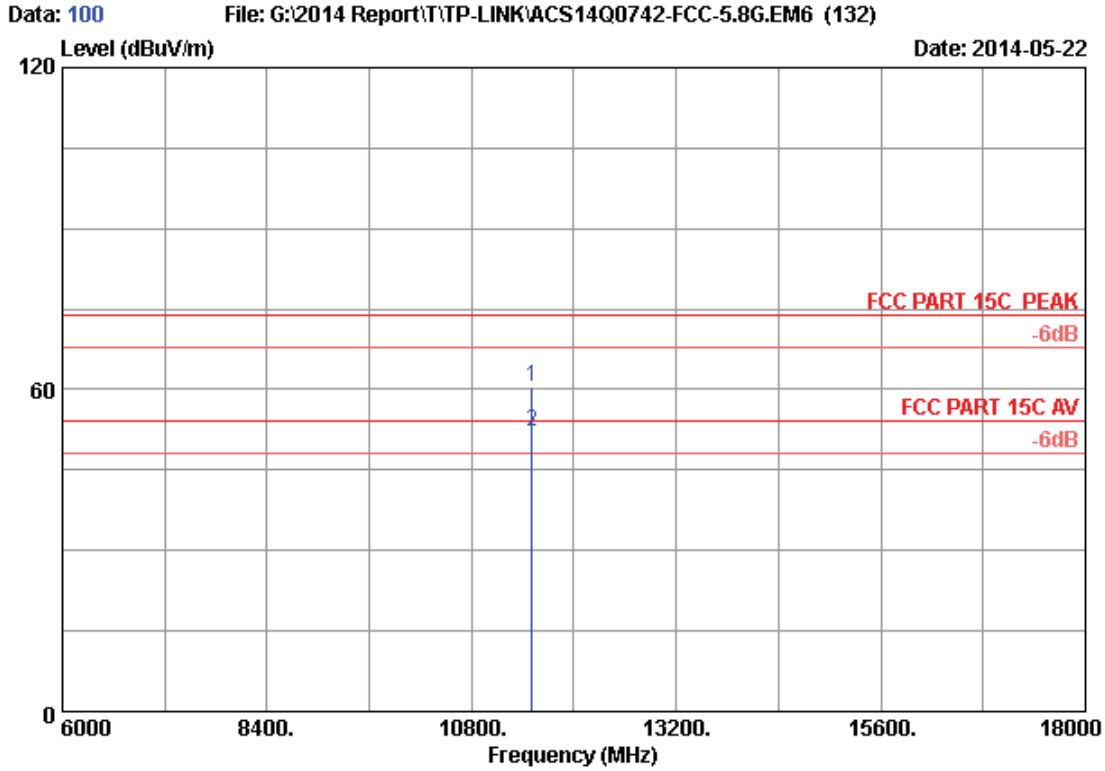

Site no. : 3m Chamber Data no. : 100
 Dis. / Ant. : 3m 2013 3115 (4580) Ant. pol. : VERTICAL
 Limit : FCC PART 15C PEAK
 Env. / Ins. : 24°C/56% Engineer : Kevin_Hu
 EUT : AC750 Wireless Dual Band Router
 Power Rating : DC 12V From Adapter Input AC 120V/60Hz
 Test Mode : IEEE802.11ac VHT40 CH151 5755MHz Tx
 M/N : C20i

No.	Freq. (MHz)	Ant. Factor (dB/m)	Cable Loss (dB)	AMP factor (dB)	Reading (dBuV)	Emission Level (dBuV/m)	Limits (dBuV/m)	Margin (dB)	Remark
1	11510.000	38.71	13.29	35.27	43.66	60.39	74.00	13.61	Peak
2	11510.000	38.71	13.29	35.27	35.28	52.01	54.00	1.99	Average

Remarks: 1. Emission Level= Antenna Factor + Cable Loss + Reading - Amp Factor
 2. The emission levels that are 20dB below the official limit are not reported.

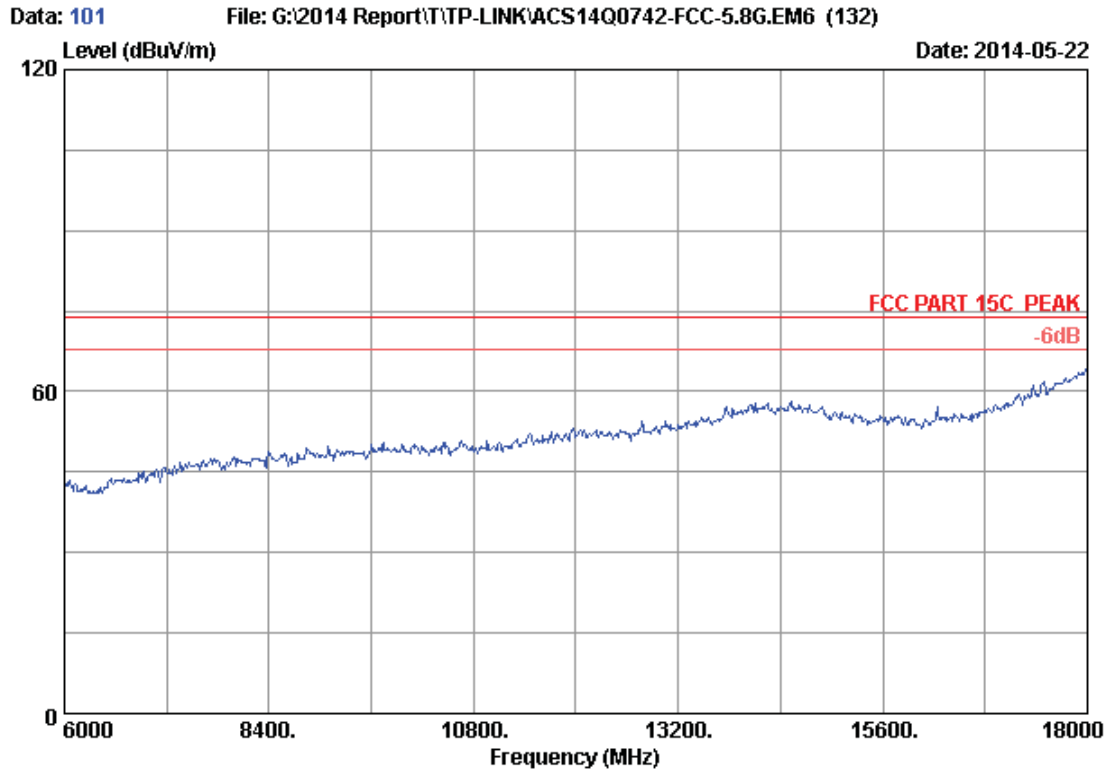

Site no. : 3m Chamber Data no. : 101
Dis. / Ant. : 3m 2013 3115 (4580) Ant. pol. : HORIZONTAL
Limit : FCC PART 15C PEAK
Env. / Ins. : 24°C/56% Engineer : Kevin_Hu
EUT : AC750 Wireless Dual Band Router
Power Rating : DC 12V From Adapter Input AC 120V/60Hz
Test Mode : IEEE802.11ac VHT40 CH151 5755MHz Tx
M/N : C20i

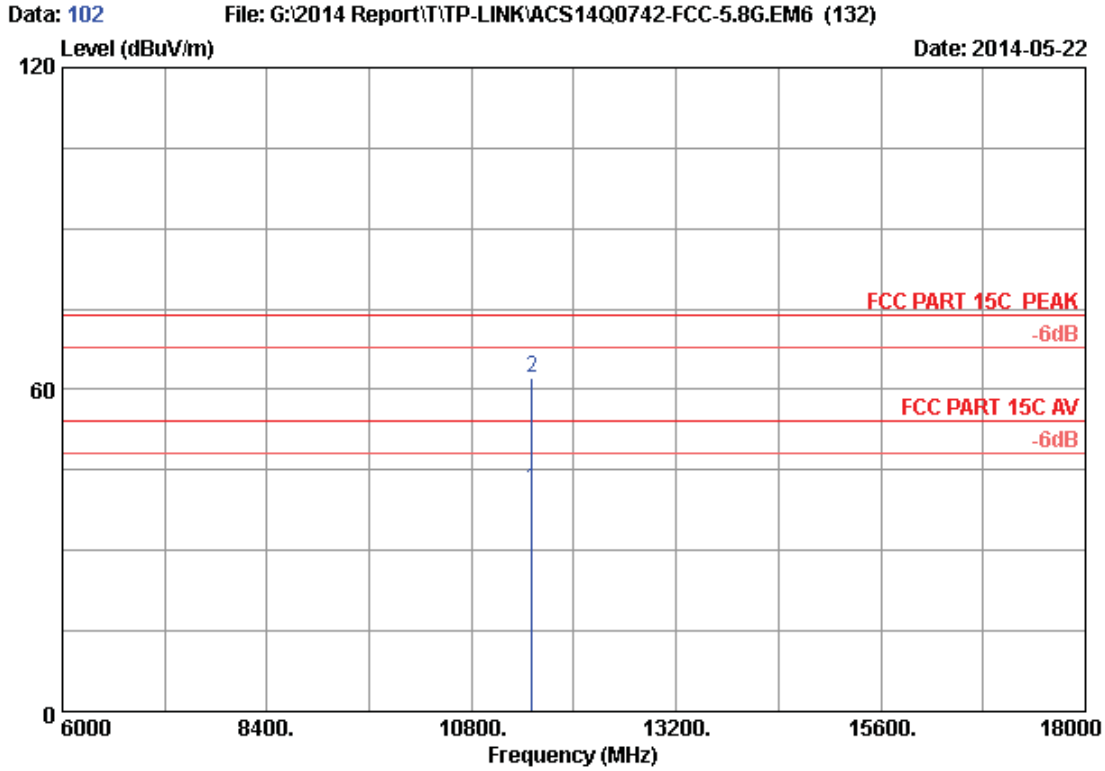

Site no. : 3m Chamber Data no. : 102
 Dis. / Ant. : 3m 2013 3115 (4580) Ant. pol. : HORIZONTAL
 Limit : FCC PART 15C PEAK
 Env. / Ins. : 24°C/56% Engineer : Kevin_Hu
 EUT : AC750 Wireless Dual Band Router
 Power Rating : DC 12V From Adapter Input AC 120V/60Hz
 Test Mode : IEEE802.11ac VHT40 CH151 5755MHz Tx
 M/N : C20i

No.	Freq. (MHz)	Ant. Factor (dB/m)	Cable Loss (dB)	AMP factor (dB)	Reading (dBuV)	Emission Level (dBuV/m)	Limits (dBuV/m)	Margin (dB)	Remark
1	11510.000	38.71	13.29	35.27	24.56	41.29	54.00	12.71	Average
2	11510.000	38.71	13.29	35.27	45.29	62.02	74.00	11.98	Peak

Remarks: 1. Emission Level= Antenna Factor + Cable Loss + Reading - Amp Factor
 2. The emission levels that are 20dB below the official limit are not reported.

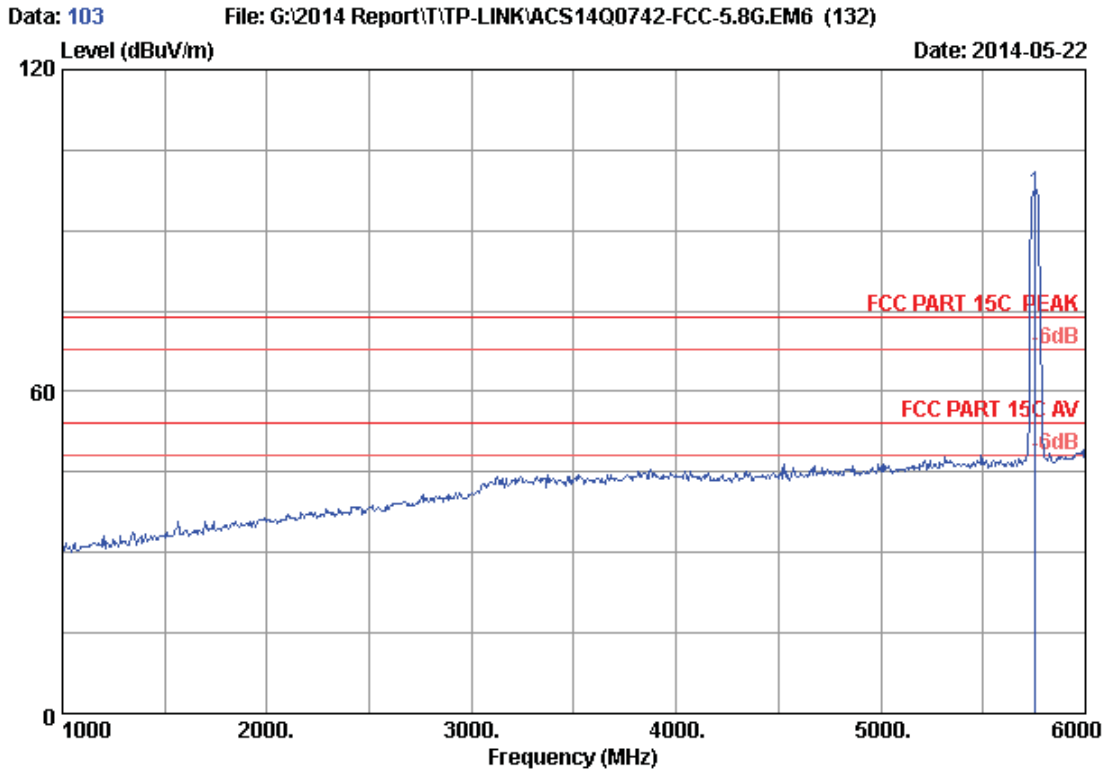

Site no. : 3m Chamber Data no. : 103
 Dis. / Ant. : 3m 2013 3115 (4580) Ant. pol. : HORIZONTAL
 Limit : FCC PART 15C PEAK
 Env. / Ins. : 24°C/56% Engineer : Kevin_Hu
 EUT : AC750 Wireless Dual Band Router
 Power Rating : DC 12V From Adapter Input AC 120V/60Hz
 Test Mode : IEEE802.11ac VHT40 CH151 5755MHz Tx
 M/N : C20i

No.	Freq. (MHz)	Ant. Factor (dB/m)	Cable Loss (dB)	AMP factor (dB)	Reading (dBUV)	Emission Level (dBUV/m)	Limits (dBUV/m)	Margin (dB)	Remark
1	5755.000	34.10	9.56	35.70	89.06	97.02	74.00	-23.02	Peak

Remarks: 1. Emission Level= Antenna Factor + Cable Loss + Reading - Amp Factor
 2. The emission levels that are 20dB below the official limit are not reported.

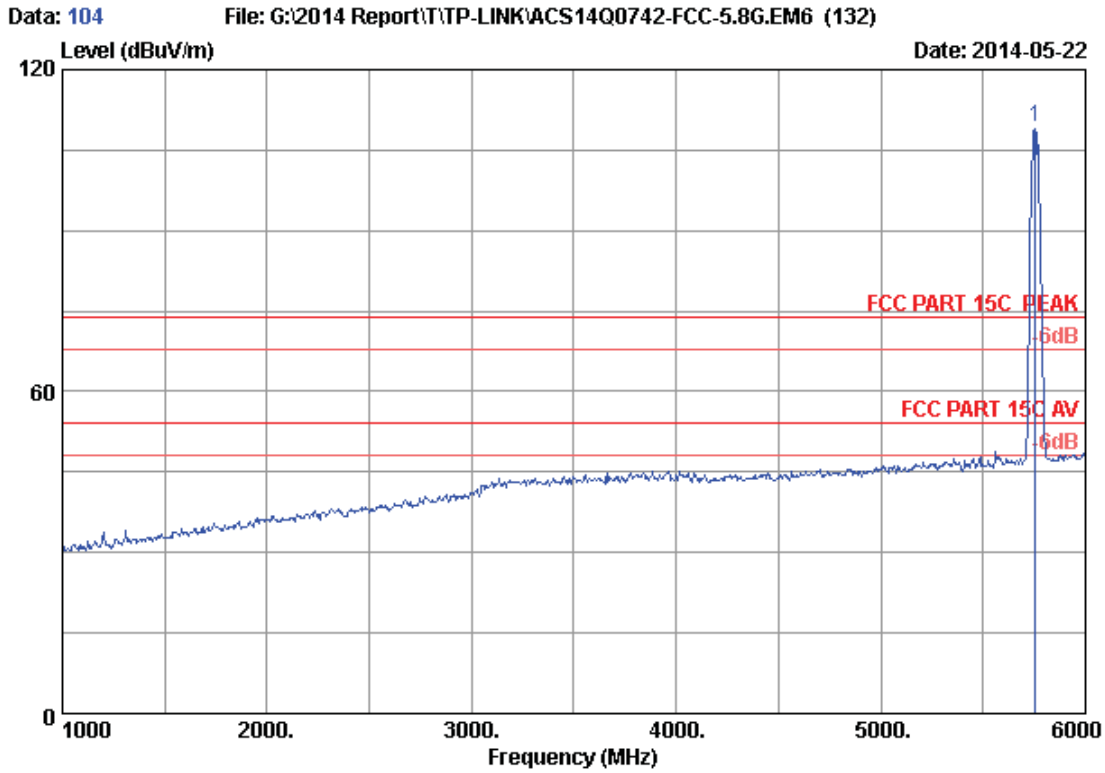

Site no. : 3m Chamber Data no. : 104
 Dis. / Ant. : 3m 2013 3115 (4580) Ant. pol. : VERTICAL
 Limit : FCC PART 15C PEAK
 Env. / Ins. : 24°C/56% Engineer : Kevin_Hu
 EUT : AC750 Wireless Dual Band Router
 Power Rating : DC 12V From Adapter Input AC 120V/60Hz
 Test Mode : IEEE802.11ac VHT40 CH151 5755MHz Tx
 M/N : C20i

No.	Freq. (MHz)	Ant. Factor (dB/m)	Cable Loss (dB)	AMP factor (dB)	Reading (dBUV)	Emission Level (dBUV/m)	Limits (dBUV/m)	Margin (dB)	Remark
1	5755.000	34.10	9.56	35.70	101.36	109.32	74.00	-35.32	Peak

Remarks: 1. Emission Level= Antenna Factor + Cable Loss + Reading
 -Amp Factor
 2. The emission levels that are 20dB below the official
 limit are not reported.

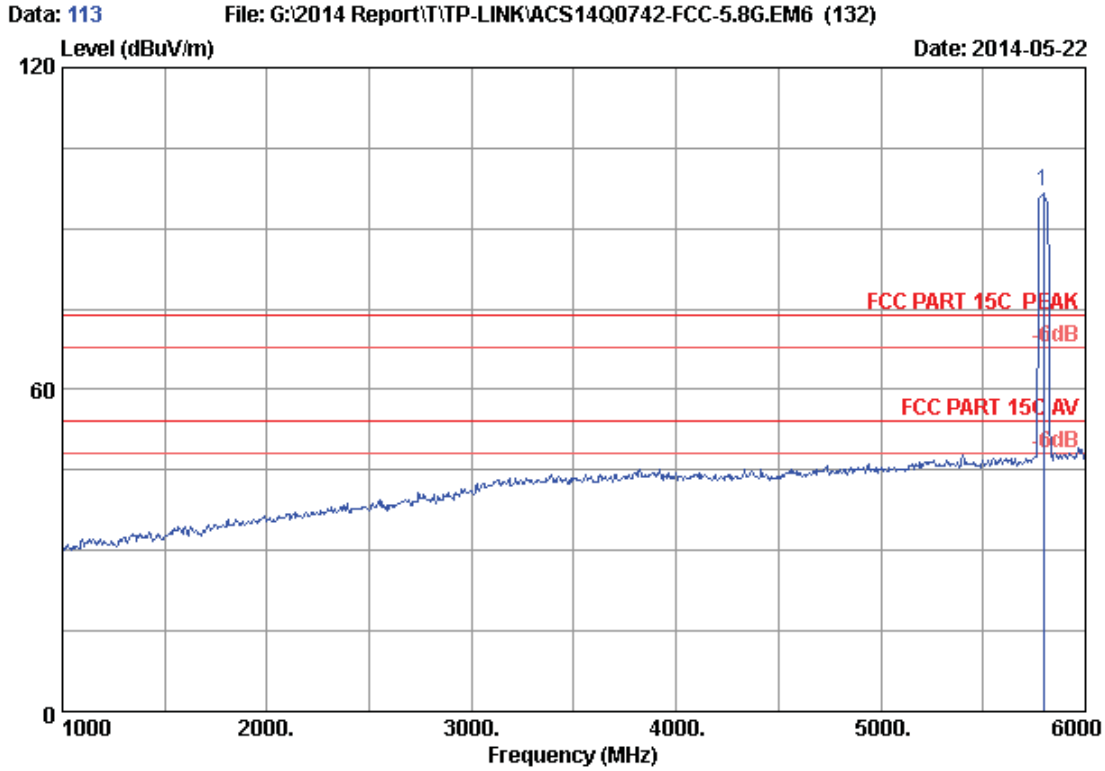

Site no. : 3m Chamber Data no. : 113
 Dis. / Ant. : 3m 2013 3115 (4580) Ant. pol. : HORIZONTAL
 Limit : FCC PART 15C PEAK
 Env. / Ins. : 24°C/56% Engineer : Kevin_Hu
 EUT : AC750 Wireless Dual Band Router
 Power Rating : DC 12V From Adapter Input AC 120V/60Hz
 Test Mode : IEEE802.11ac VHT40 CH159 5795MHz Tx
 M/N : C20i

No.	Freq. (MHz)	Ant. Factor (dB/m)	Cable Loss (dB)	AMP factor (dB)	Reading (dBUV)	Emission Level (dBUV/m)	Limits (dBUV/m)	Margin (dB)	Remark
1	5795.000	34.12	9.60	35.70	88.79	96.81	74.00	-22.81	Peak

Remarks: 1. Emission Level= Antenna Factor + Cable Loss + Reading
 -Amp Factor
 2. The emission levels that are 20dB below the official
 limit are not reported.

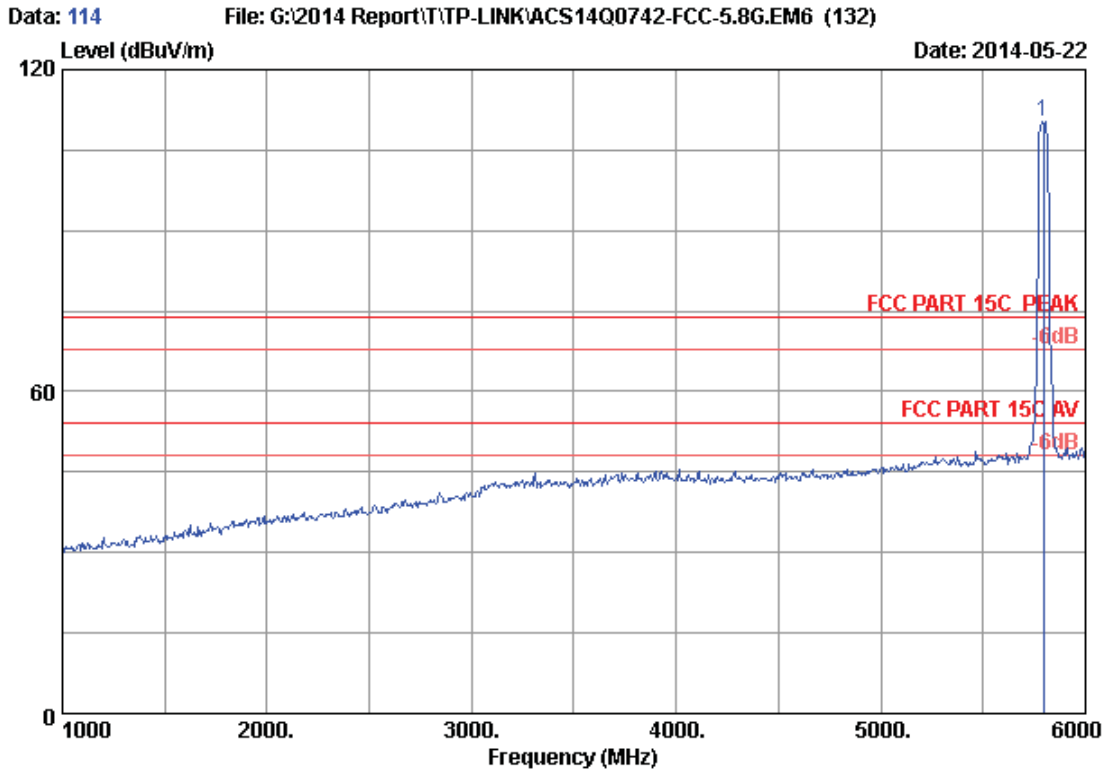

Site no. : 3m Chamber Data no. : 114
 Dis. / Ant. : 3m 2013 3115 (4580) Ant. pol. : VERTICAL
 Limit : FCC PART 15C PEAK
 Env. / Ins. : 24°C/56% Engineer : Kevin_Hu
 EUT : AC750 Wireless Dual Band Router
 Power Rating : DC 12V From Adapter Input AC 120V/60Hz
 Test Mode : IEEE802.11ac VHT40 CH159 5795MHz Tx
 M/N : C20i

No.	Freq. (MHz)	Ant. Factor (dB/m)	Cable Loss (dB)	AMP factor (dB)	Reading (dBUV)	Emission Level (dBUV/m)	Limits (dBUV/m)	Margin (dB)	Remark
1	5795.000	34.12	9.60	35.70	102.35	110.37	74.00	-36.37	Peak

Remarks: 1. Emission Level= Antenna Factor + Cable Loss + Reading - Amp Factor
 2. The emission levels that are 20dB below the official limit are not reported.

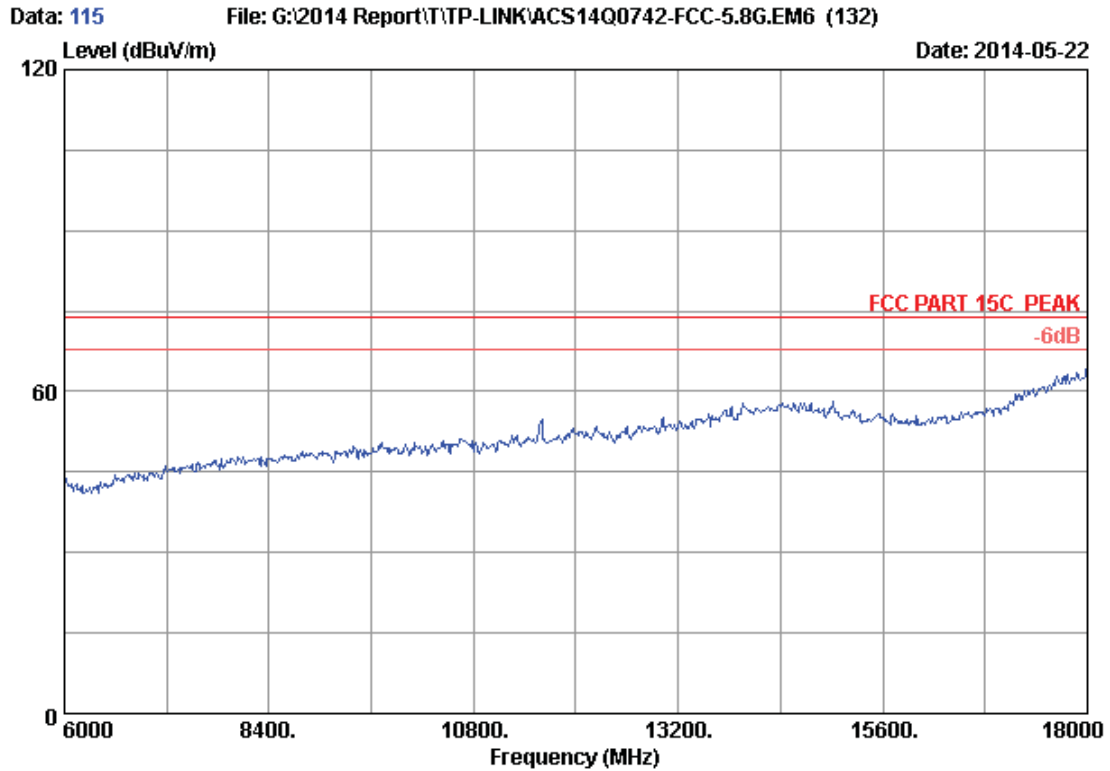

Site no. : 3m Chamber Data no. : 115
Dis. / Ant. : 3m 2013 3115 (4580) Ant. pol. : VERTICAL
Limit : FCC PART 15C PEAK
Env. / Ins. : 24°C/56% Engineer : Kevin_Hu
EUT : AC750 Wireless Dual Band Router
Power Rating : DC 12V From Adapter Input AC 120V/60Hz
Test Mode : IEEE802.11ac VHT40 CH159 5795MHz Tx
M/N : C20i

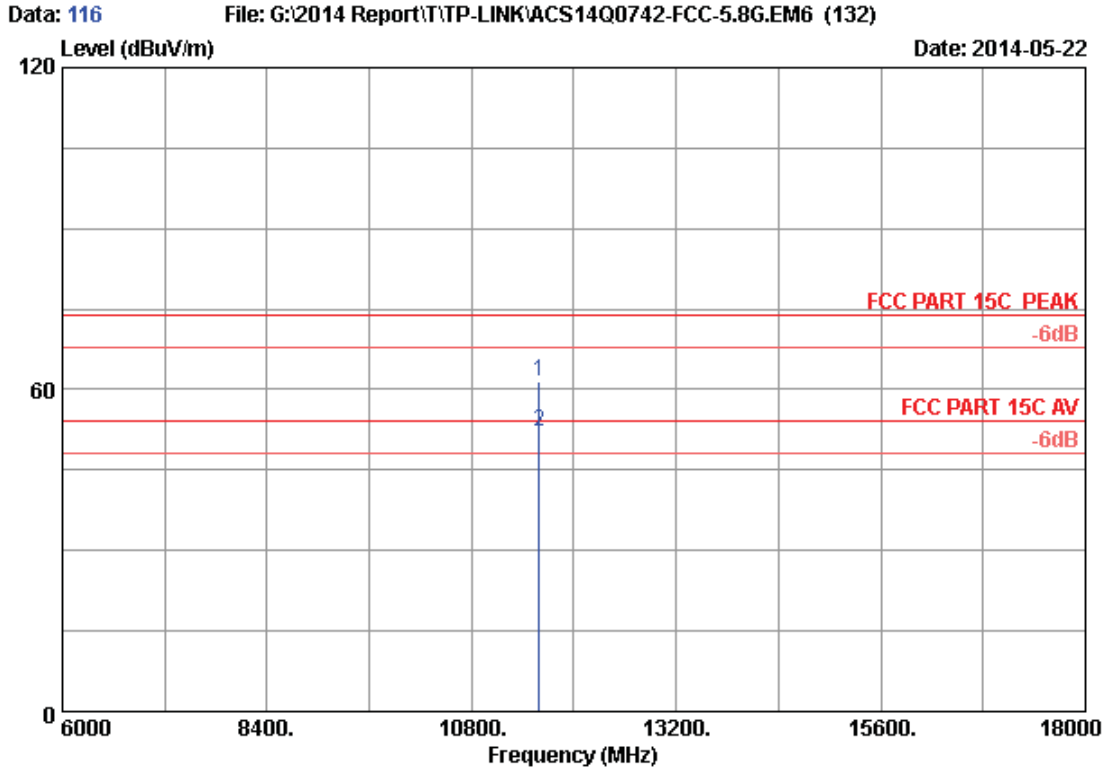

Site no. : 3m Chamber Data no. : 116
 Dis. / Ant. : 3m 2013 3115 (4580) Ant. pol. : VERTICAL
 Limit : FCC PART 15C PEAK
 Env. / Ins. : 24°C/56% Engineer : Kevin_Hu
 EUT : AC750 Wireless Dual Band Router
 Power Rating : DC 12V From Adapter Input AC 120V/60Hz
 Test Mode : IEEE802.11ac VHT40 CH159 5795MHz Tx
 M/N : C20i

No.	Freq. (MHz)	Ant. Factor (dB/m)	Cable Loss (dB)	AMP factor (dB)	Reading (dBUV)	Emission Level (dBUV/m)	Limits (dBUV/m)	Margin (dB)	Remark
1	11590.000	38.83	13.34	35.26	44.56	61.47	74.00	12.53	Peak
2	11590.000	38.83	13.34	35.26	35.28	52.19	54.00	1.81	Average

Remarks: 1. Emission Level= Antenna Factor + Cable Loss + Reading - Amp Factor
 2. The emission levels that are 20dB below the official limit are not reported.

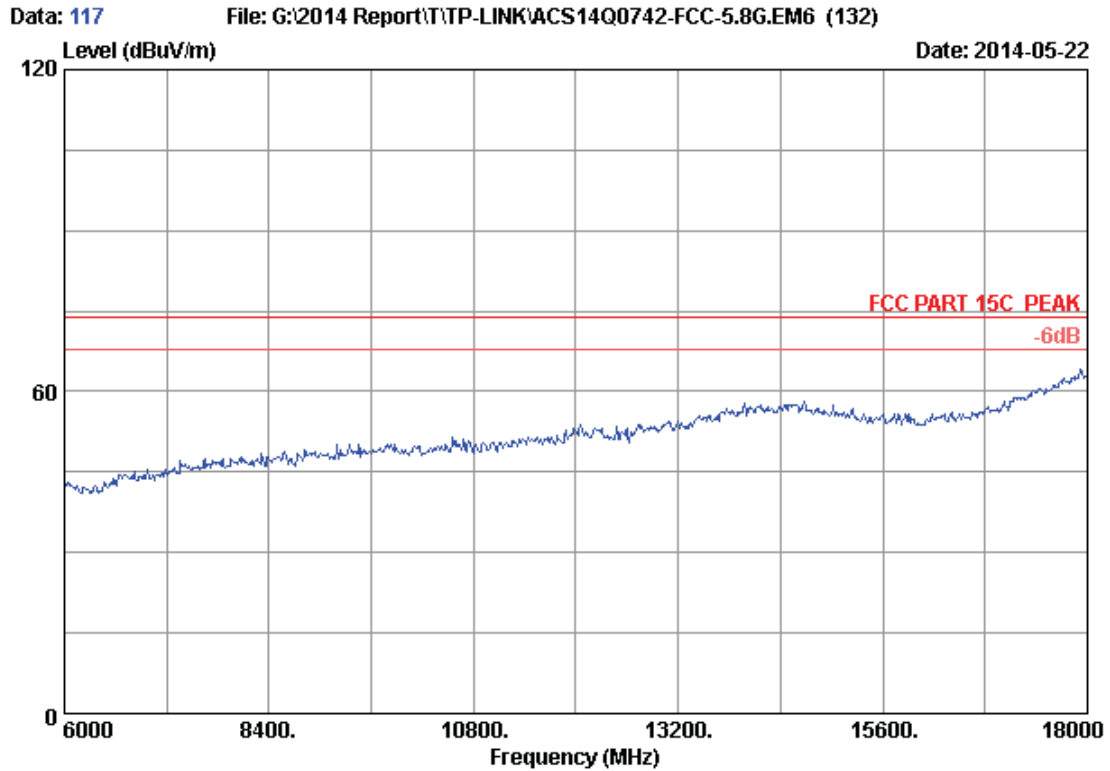

Site no. : 3m Chamber Data no. : 117
Dis. / Ant. : 3m 2013 3115 (4580) Ant. pol. : HORIZONTAL
Limit : FCC PART 15C PEAK
Env. / Ins. : 24°C/56% Engineer : Kevin_Hu
EUT : AC750 Wireless Dual Band Router
Power Rating : DC 12V From Adapter Input AC 120V/60Hz
Test Mode : IEEE802.11ac VHT40 CH159 5795MHz Tx
M/N : C20i

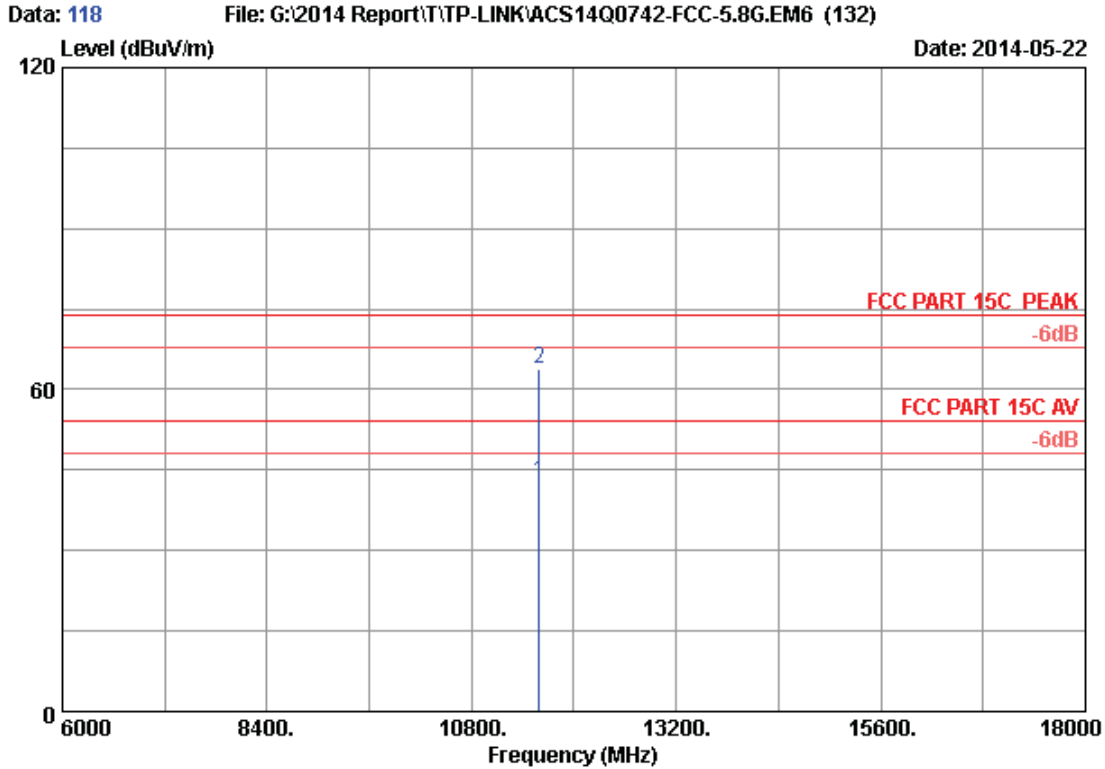

Site no. : 3m Chamber Data no. : 118
 Dis. / Ant. : 3m 2013 3115 (4580) Ant. pol. : HORIZONTAL
 Limit : FCC PART 15C PEAK
 Env. / Ins. : 24°C/56% Engineer : Kevin_Hu
 EUT : AC750 Wireless Dual Band Router
 Power Rating : DC 12V From Adapter Input AC 120V/60Hz
 Test Mode : IEEE802.11ac VHT40 CH159 5795MHz Tx
 M/N : C20i

No.	Freq. (MHz)	Ant. Factor (dB/m)	Cable Loss (dB)	AMP factor (dB)	Reading (dBUV)	Emission Level (dBUV/m)	Limits (dBUV/m)	Margin (dB)	Remark
1	11590.000	38.83	13.34	35.26	25.85	42.76	54.00	11.24	Average
2	11590.000	38.83	13.34	35.26	46.86	63.77	74.00	10.23	Peak

Remarks: 1. Emission Level= Antenna Factor + Cable Loss + Reading - Amp Factor
 2. The emission levels that are 20dB below the official limit are not reported.

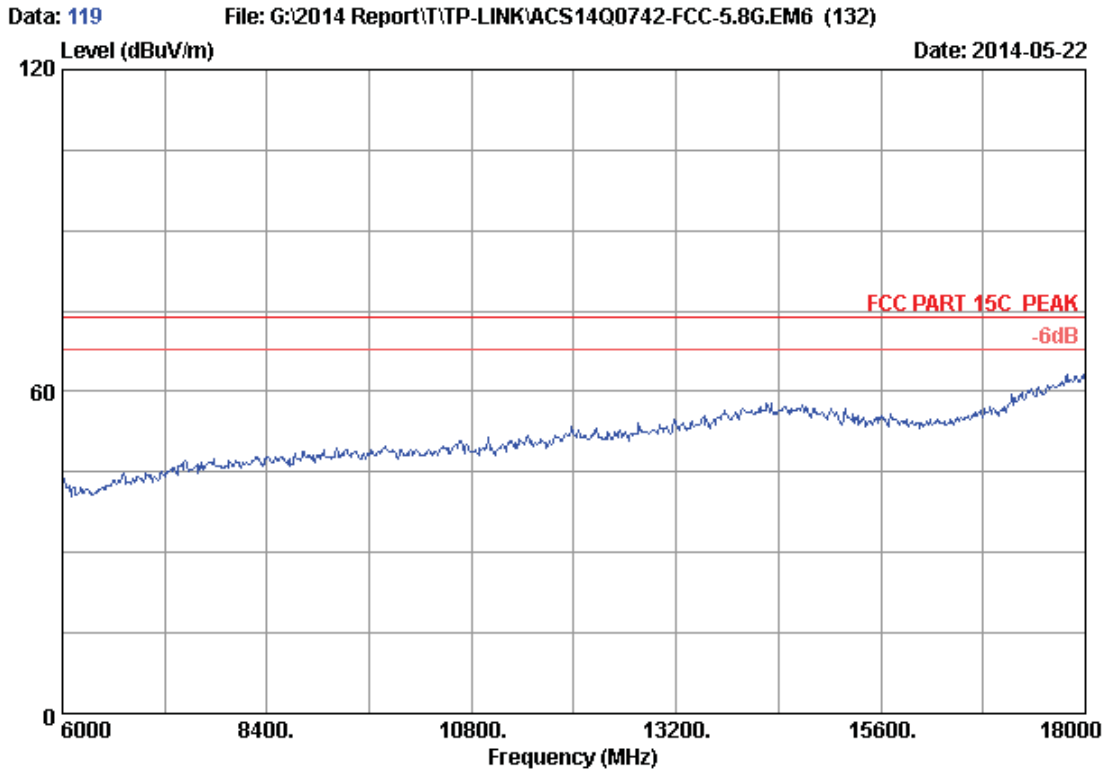

Site no.	: 3m Chamber	Data no.	: 119
Dis. / Ant.	: 3m 2013 3115 (4580)	Ant. pol.	: HORIZONTAL
Limit	: FCC PART 15C PEAK		
Env. / Ins.	: 24°C/56%	Engineer	: Kevin_Hu
EUT	: AC750 Wireless Dual Band Router		
Power Rating	: DC 12V From Adapter Input AC 120V/60Hz		
Test Mode	: IEEE802.11ac VHT80 CH155 5775MHz Tx		
M/N	: C20i		

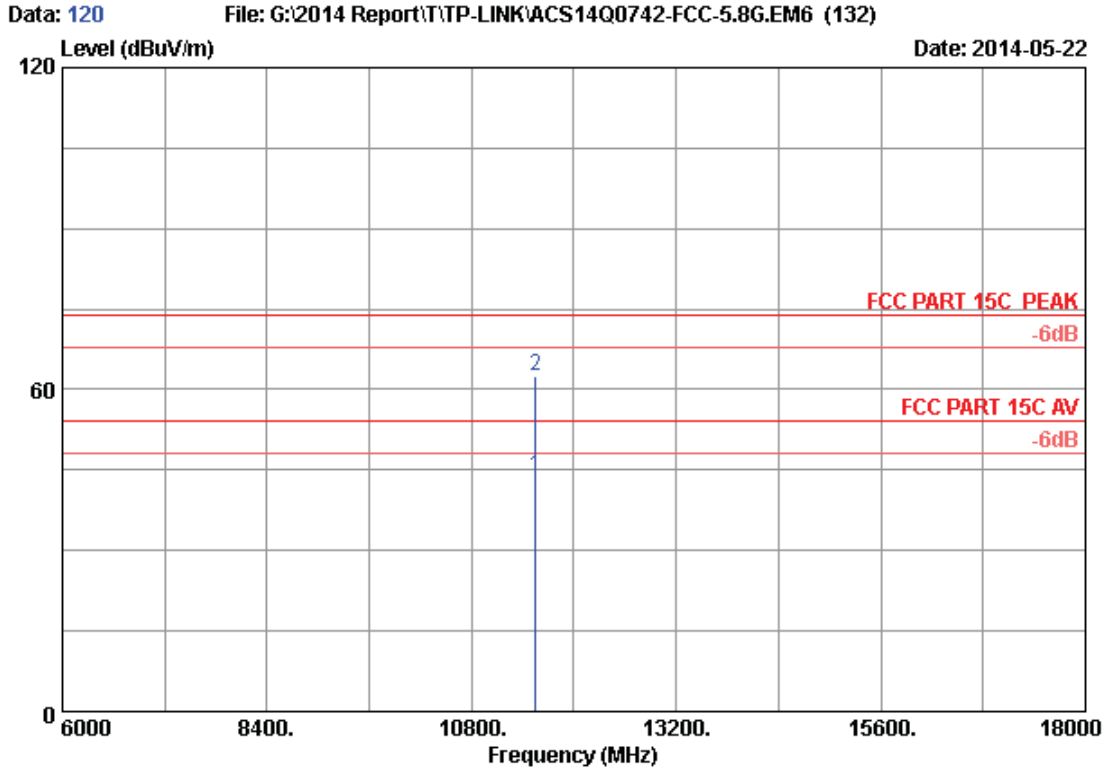

Site no. : 3m Chamber Data no. : 120
 Dis. / Ant. : 3m 2013 3115 (4580) Ant. pol. : HORIZONTAL
 Limit : FCC PART 15C PEAK
 Env. / Ins. : 24°C/56% Engineer : Kevin_Hu
 EUT : AC750 Wireless Dual Band Router
 Power Rating : DC 12V From Adapter Input AC 120V/60Hz
 Test Mode : IEEE802.11ac VHT80 CH155 5775MHz Tx
 M/N : C20i

No.	Freq. (MHz)	Ant. Factor (dB/m)	Cable Loss (dB)	AMP factor (dB)	Reading (dBUV)	Emission Level (dBUV/m)	Limits (dBUV/m)	Margin (dB)	Remark
1	11550.000	38.77	13.31	35.27	26.97	43.78	54.00	10.22	Average
2	11550.000	38.77	13.31	35.27	45.73	62.54	74.00	11.46	Peak

Remarks: 1. Emission Level= Antenna Factor + Cable Loss + Reading - Amp Factor
 2. The emission levels that are 20dB below the official limit are not reported.

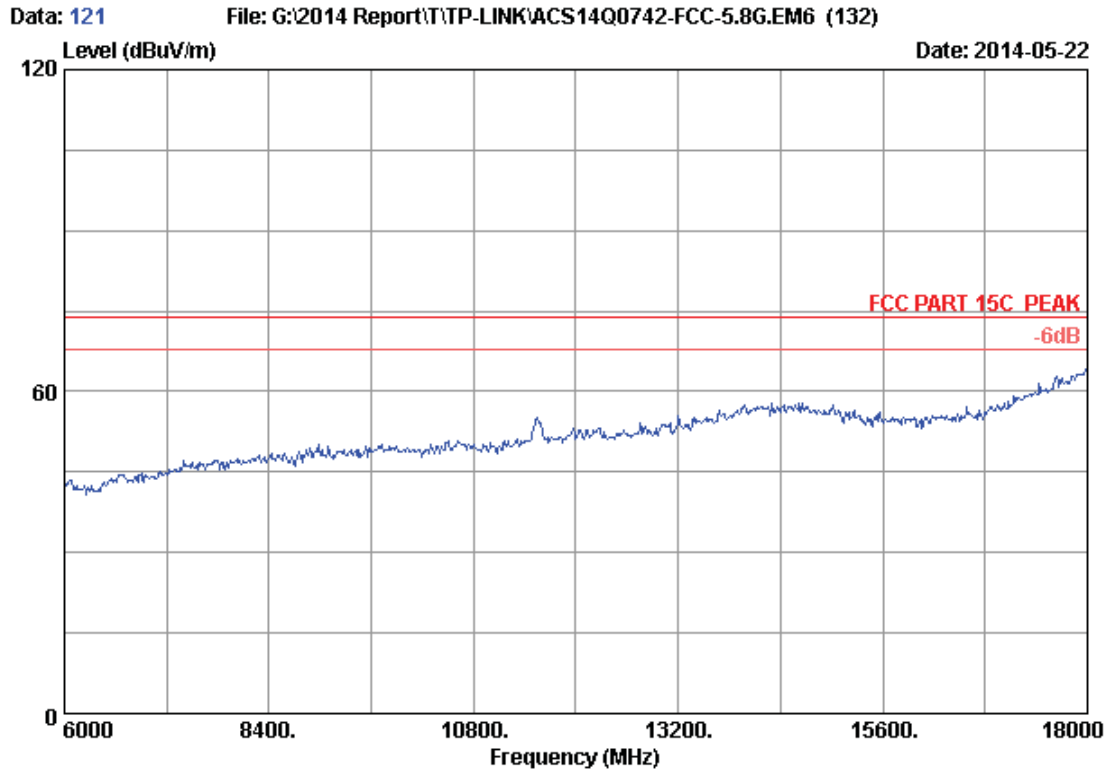

Site no. : 3m Chamber Data no. : 121
Dis. / Ant. : 3m 2013 3115 (4580) Ant. pol. : VERTICAL
Limit : FCC PART 15C PEAK
Env. / Ins. : 24°C/56% Engineer : Kevin_Hu
EUT : AC750 Wireless Dual Band Router
Power Rating : DC 12V From Adapter Input AC 120V/60Hz
Test Mode : IEEE802.11ac VHT80 CH155 5775MHz Tx
M/N : C20i

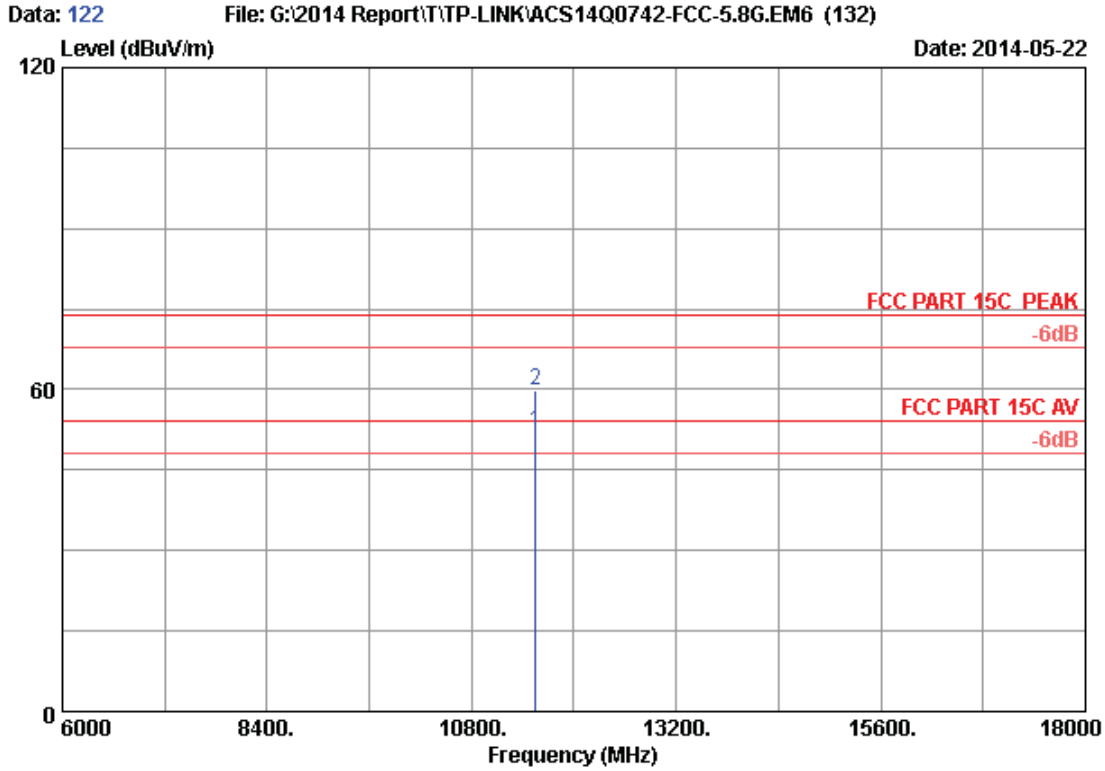

Site no. : 3m Chamber Data no. : 122
 Dis. / Ant. : 3m 2013 3115 (4580) Ant. pol. : VERTICAL
 Limit : FCC PART 15C PEAK
 Env. / Ins. : 24°C/56% Engineer : Kevin_Hu
 EUT : AC750 Wireless Dual Band Router
 Power Rating : DC 12V From Adapter Input AC 120V/60Hz
 Test Mode : IEEE802.11ac VHT80 CH155 5775MHz Tx
 M/N : C20i

No.	Freq. (MHz)	Ant. Factor (dB/m)	Cable Loss (dB)	AMP factor (dB)	Reading (dBUV)	Emission Level (dBUV/m)	Limits (dBUV/m)	Margin (dB)	Remark
1	11550.000	38.77	13.31	35.27	35.31	52.12	54.00	1.88	Average
2	11550.000	38.77	13.31	35.27	42.99	59.80	74.00	14.20	Peak

Remarks: 1. Emission Level= Antenna Factor + Cable Loss + Reading - Amp Factor
 2. The emission levels that are 20dB below the official limit are not reported.

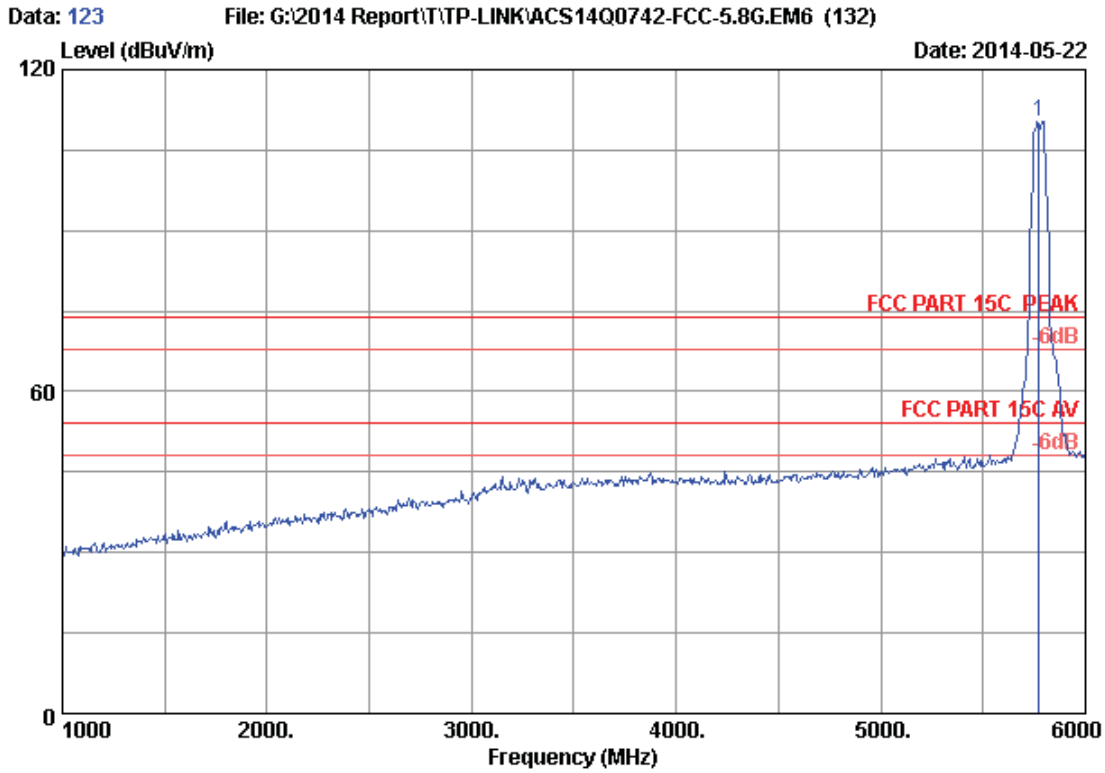

Site no. : 3m Chamber Data no. : 123
 Dis. / Ant. : 3m 2013 3115 (4580) Ant. pol. : VERTICAL
 Limit : FCC PART 15C PEAK
 Env. / Ins. : 24°C/56% Engineer : Kevin_Hu
 EUT : AC750 Wireless Dual Band Router
 Power Rating : DC 12V From Adapter Input AC 120V/60Hz
 Test Mode : IEEE802.11ac VHT80 CH155 5775MHz Tx
 M/N : C20i

No.	Freq. (MHz)	Ant. Factor (dB/m)	Cable Loss (dB)	AMP factor (dB)	Reading (dBuV)	Emission Level (dBuV/m)	Limits (dBuV/m)	Margin (dB)	Remark
1	5775.000	34.11	9.58	35.70	102.16	110.15	74.00	-36.15	Peak

Remarks: 1. Emission Level= Antenna Factor + Cable Loss + Reading - Amp Factor
 2. The emission levels that are 20dB below the official limit are not reported.

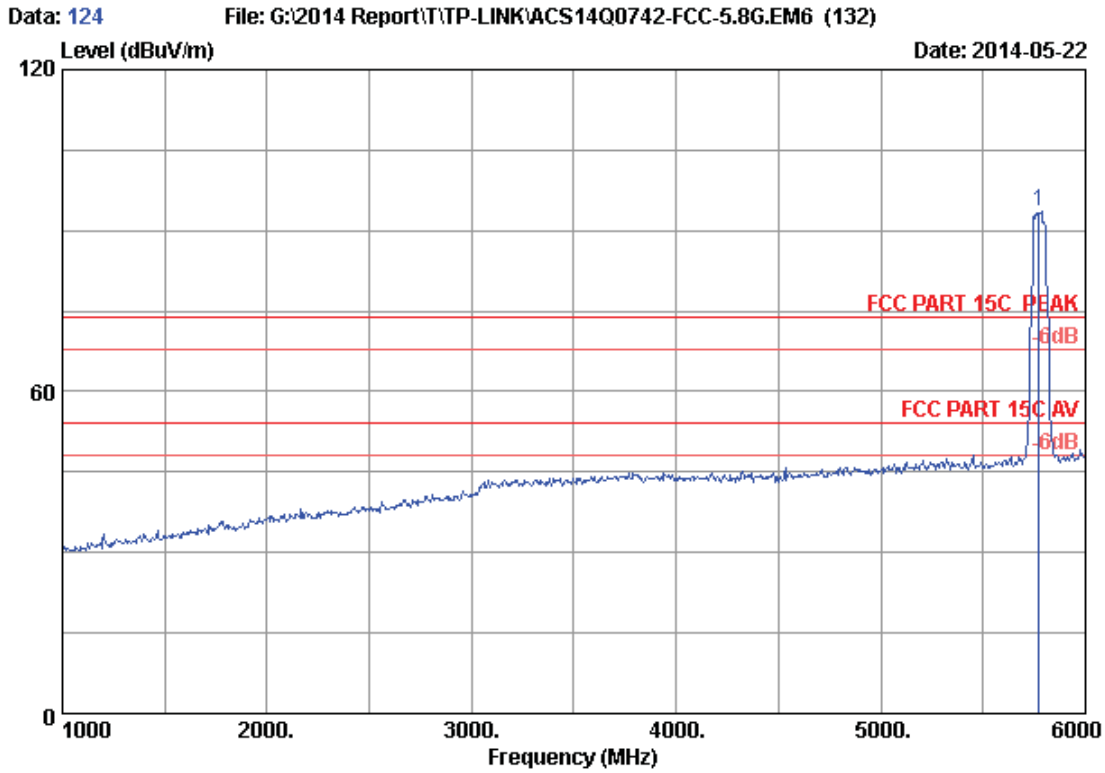

Site no. : 3m Chamber Data no. : 124
 Dis. / Ant. : 3m 2013 3115 (4580) Ant. pol. : HORIZONTAL
 Limit : FCC PART 15C PEAK
 Env. / Ins. : 24°C/56% Engineer : Kevin_Hu
 EUT : AC750 Wireless Dual Band Router
 Power Rating : DC 12V From Adapter Input AC 120V/60Hz
 Test Mode : IEEE802.11ac VHT80 CH155 5775MHz Tx
 M/N : C20i

No.	Freq. (MHz)	Ant. Factor (dB/m)	Cable Loss (dB)	AMP factor (dB)	Reading (dBuV)	Emission Level (dBuV/m)	Limits (dBuV/m)	Margin (dB)	Remark
1	5775.000	34.11	9.58	35.70	85.67	93.66	74.00	-19.66	Peak

Remarks: 1. Emission Level= Antenna Factor + Cable Loss + Reading
 -Amp Factor
 2. The emission levels that are 20dB below the official
 limit are not reported.

5. CONDUCTED SPURIOUS EMISSIONS

5.1. Test Equipment

Item	Equipment	Manufacturer	Model No.	Serial No.	Last Cal.	Cal. Interval
1.	Spectrum Analyzer	Agilent	E7403A	MY42000106	Apr. 28,14	1 Year
2.	Matching Transformer	Anritsu	MP614A	NO.2	NCR	NCR
3.	TV SG	Philip	PM5418	LO625020	Apr. 28,14	1 Year

5.2. Limit

In any 100kHz bandwidth outside the frequency bands in which the spread spectrum intentional radiator is operating, the radio frequency power that is produced by the intentional radiator shall be at least 20dB below that in the 100kHz bandwidth within the band that contains the highest level of the desired power.

5.3. Test Procedure

The transmitter output was connected to a spectrum analyzer, The resolution bandwidth is set to 100 kHz, The video bandwidth is set to 300 kHz and measure all the emissions detected.

5.4. Test result

PASS (The testing data was attached in the next pages.)

2.4G:
ANT 0
Test Mode: IEEE 802.11b TX
Test CH1: 2412MHz

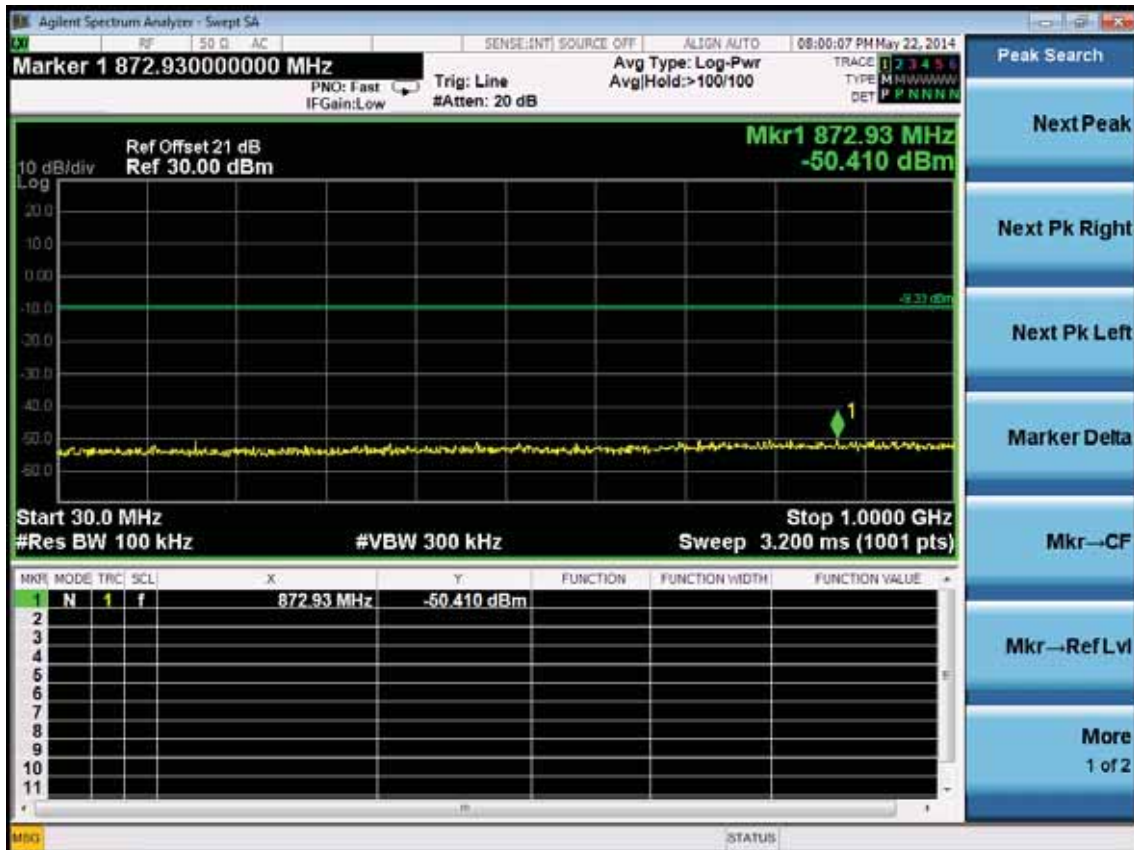
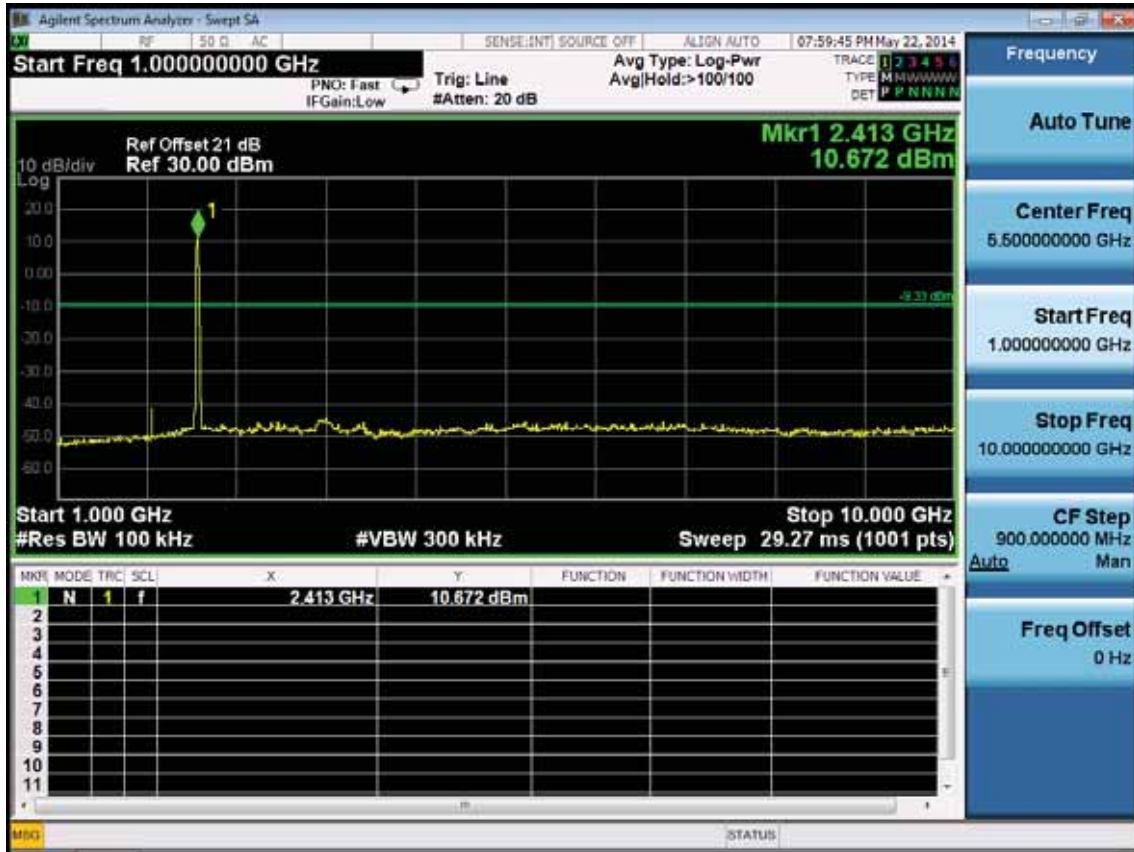

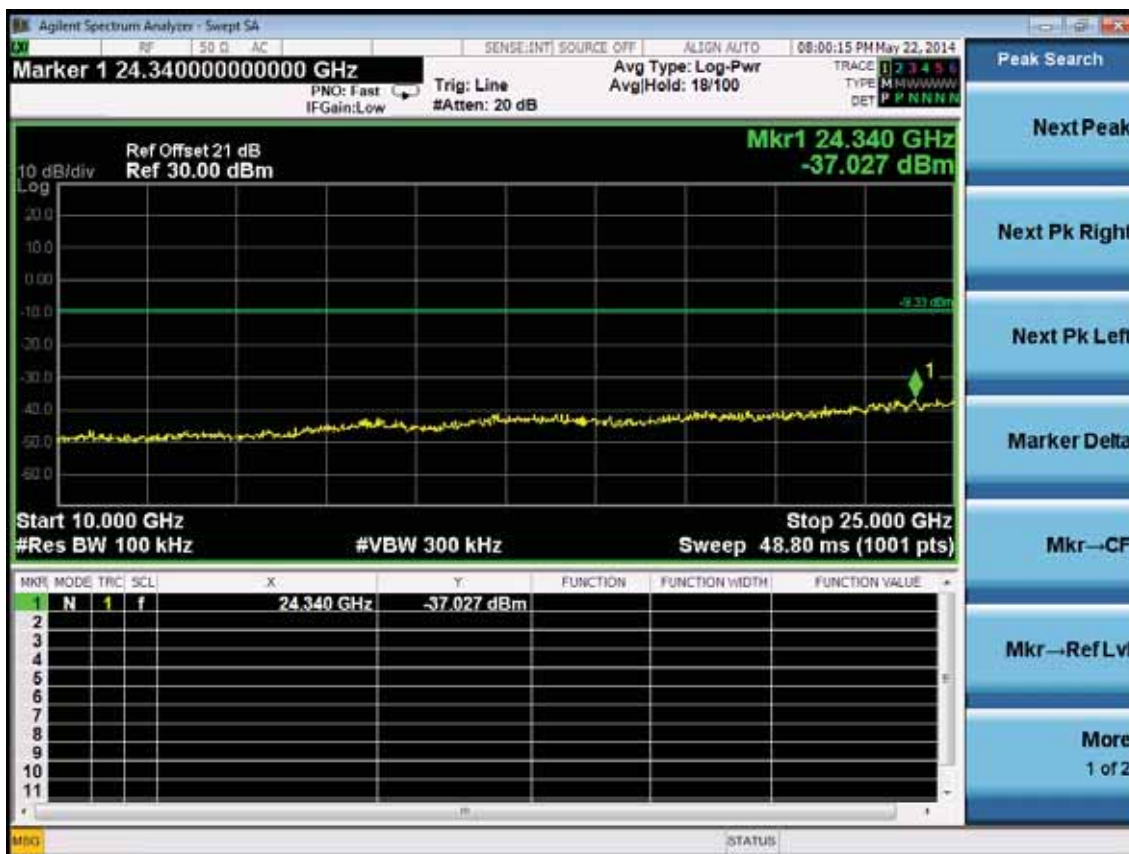

Test CH6: 2437MHz

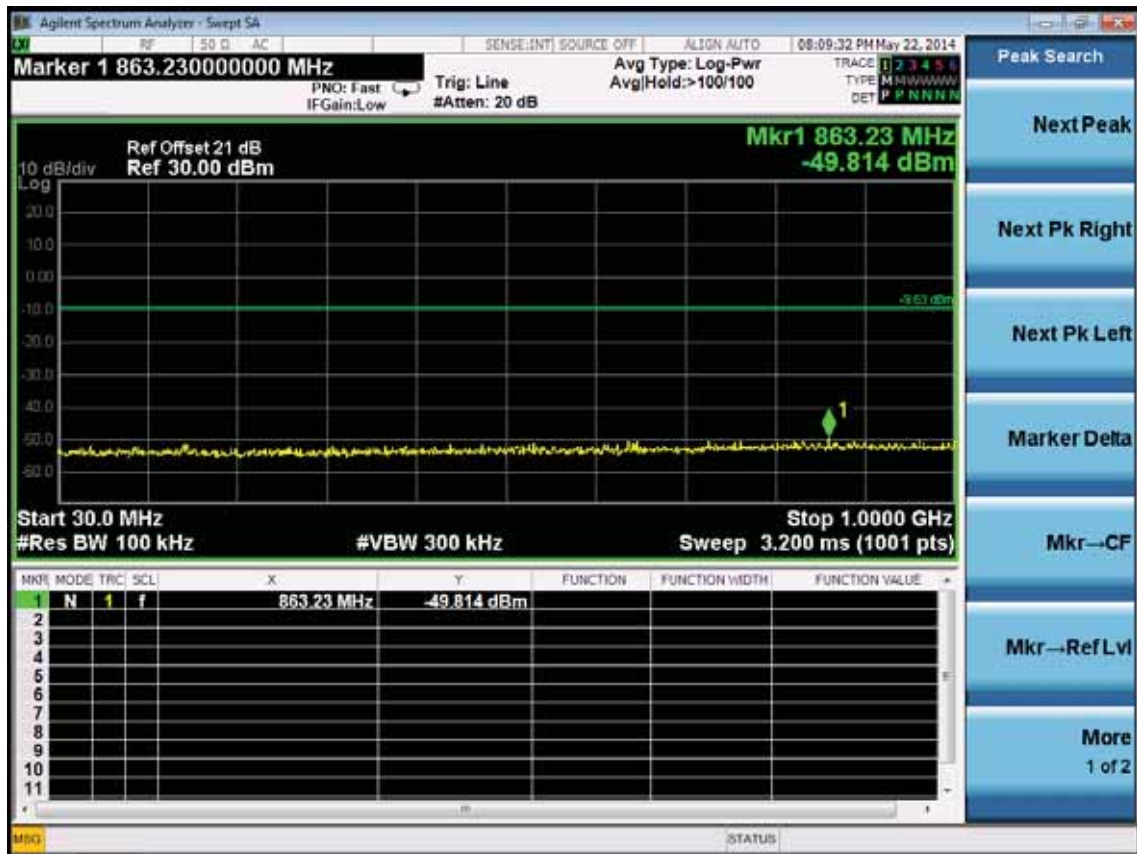
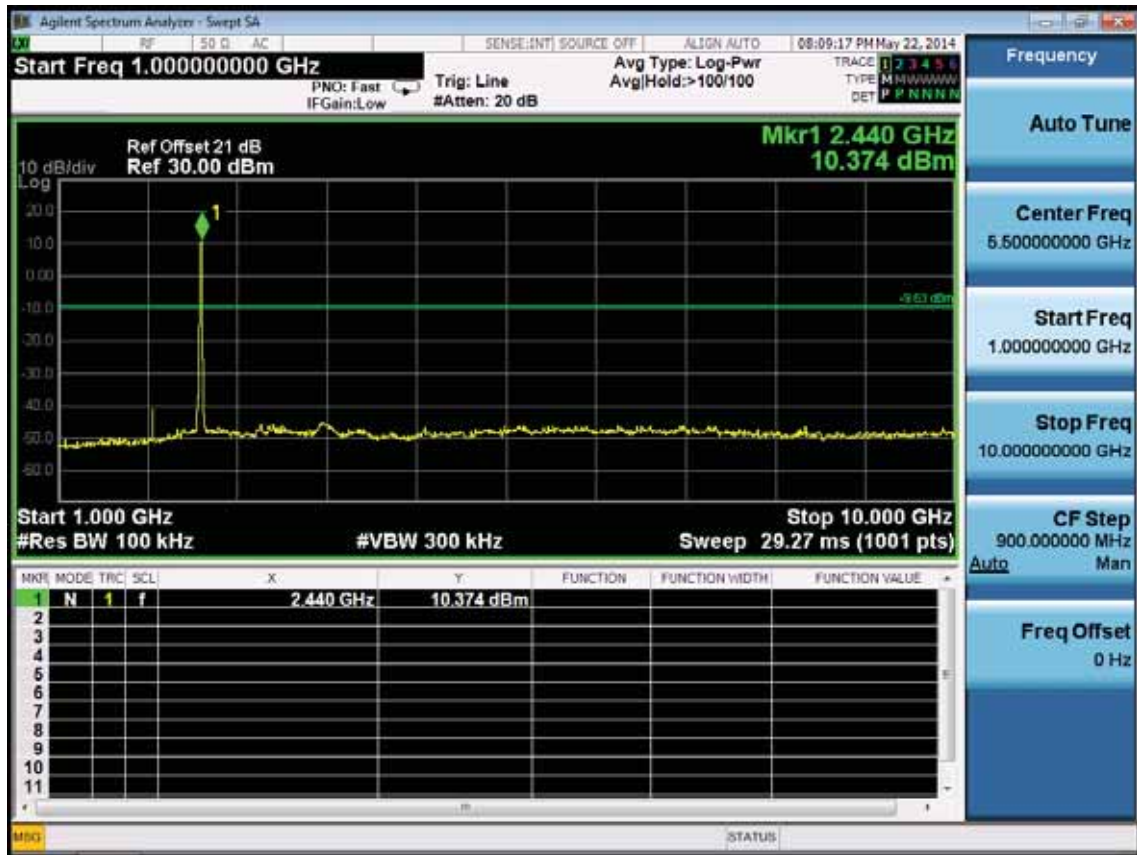

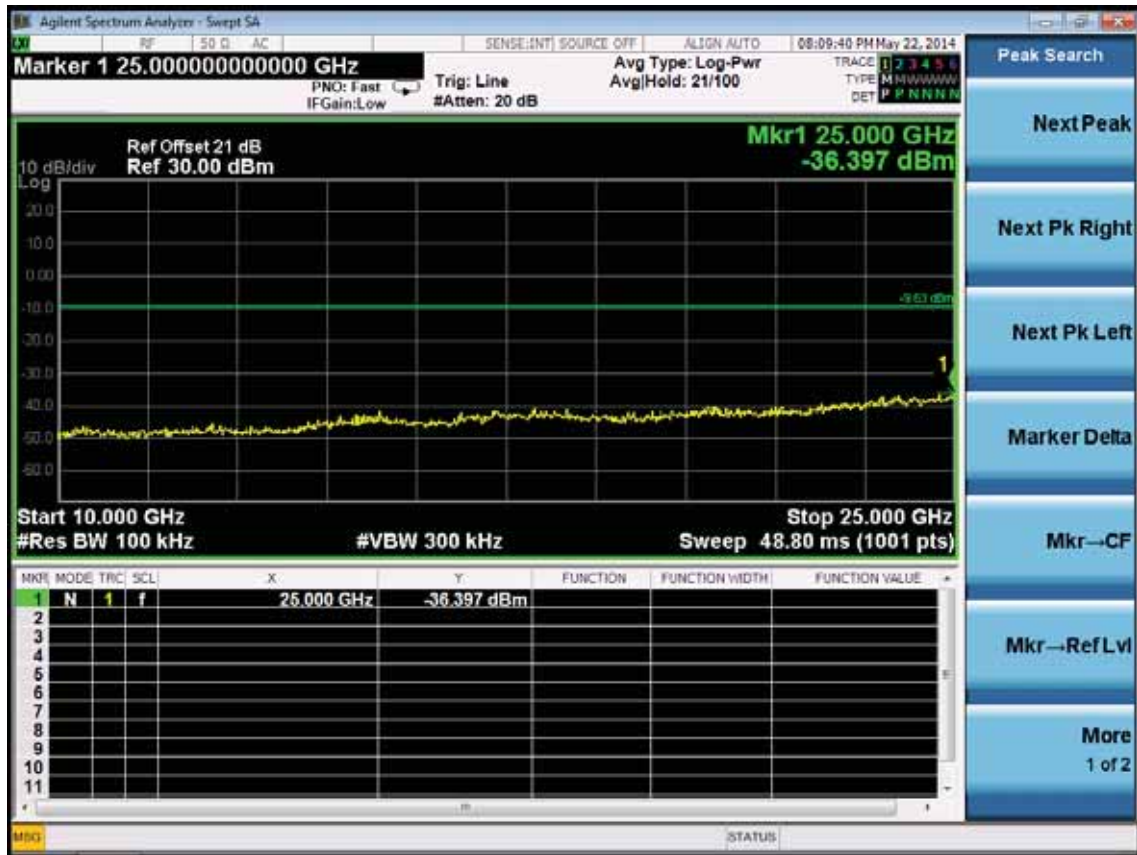

Test CH11: 2462MHz



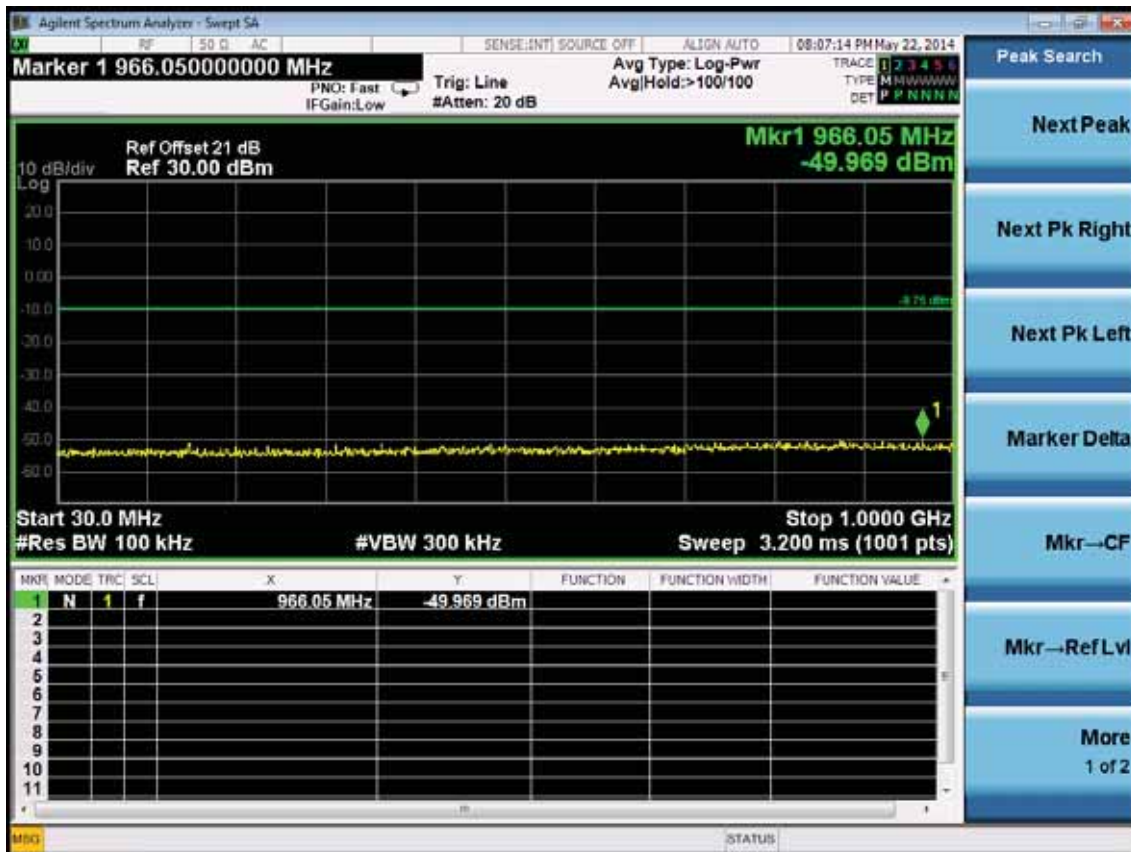
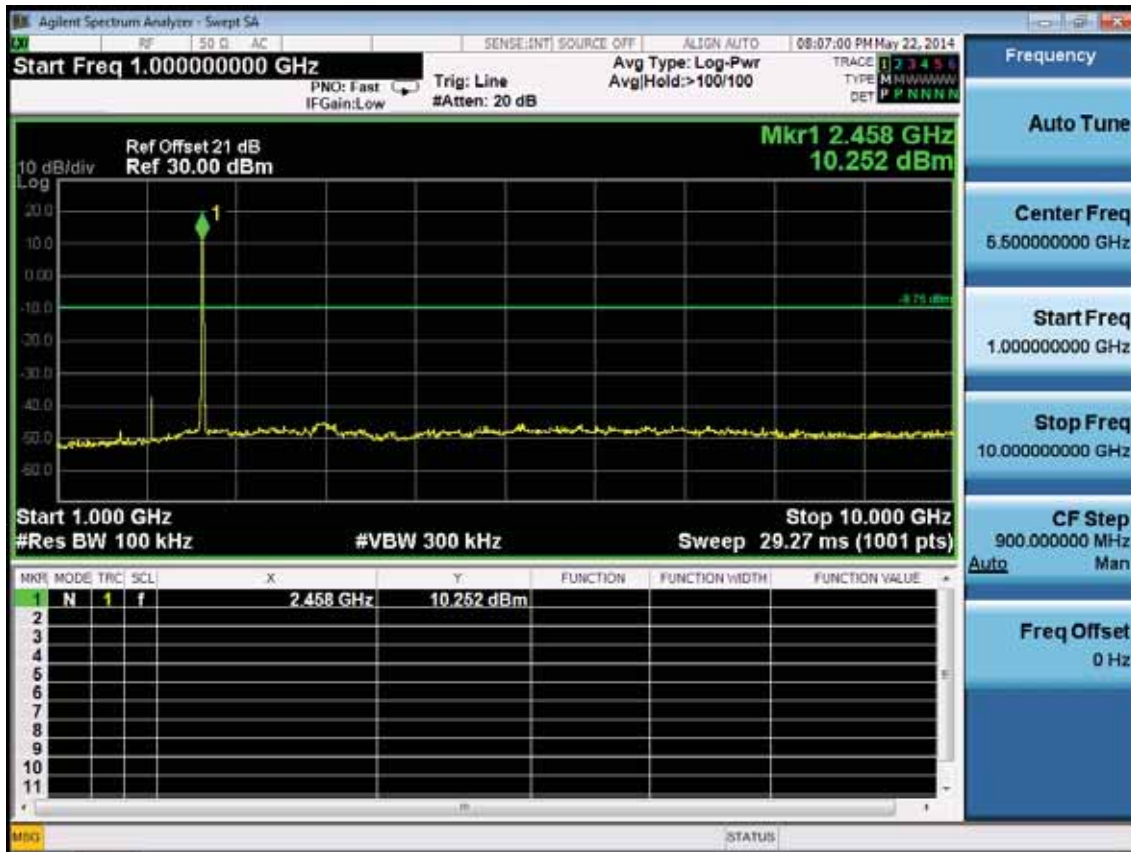

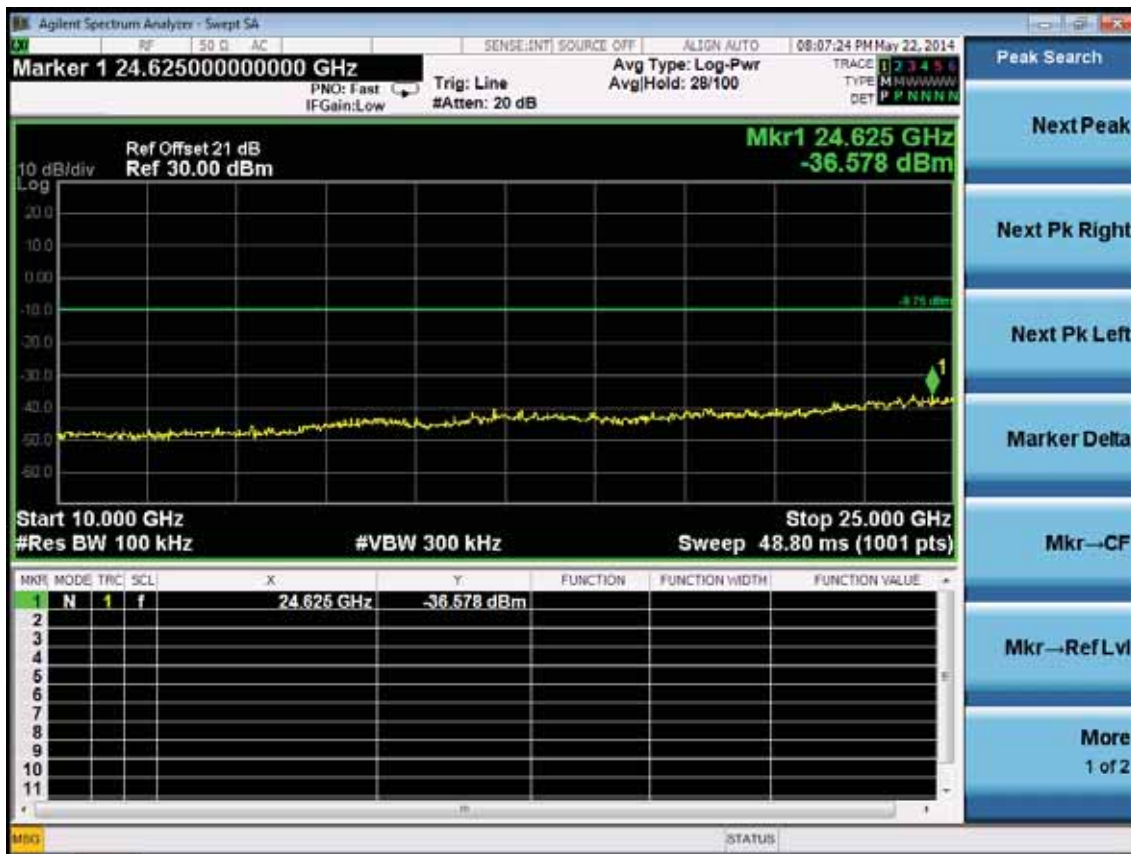

Test Mode: IEEE 802.11g TX
 Test CH1: 2412MHz

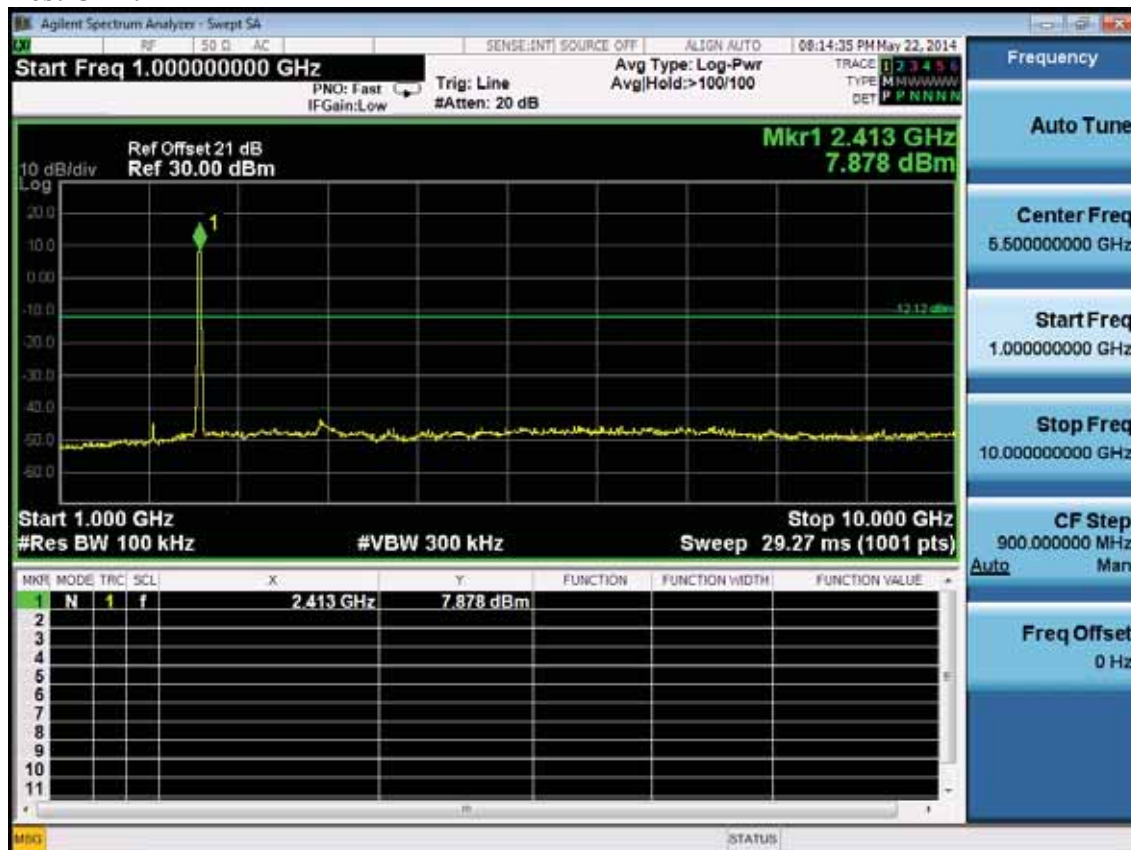

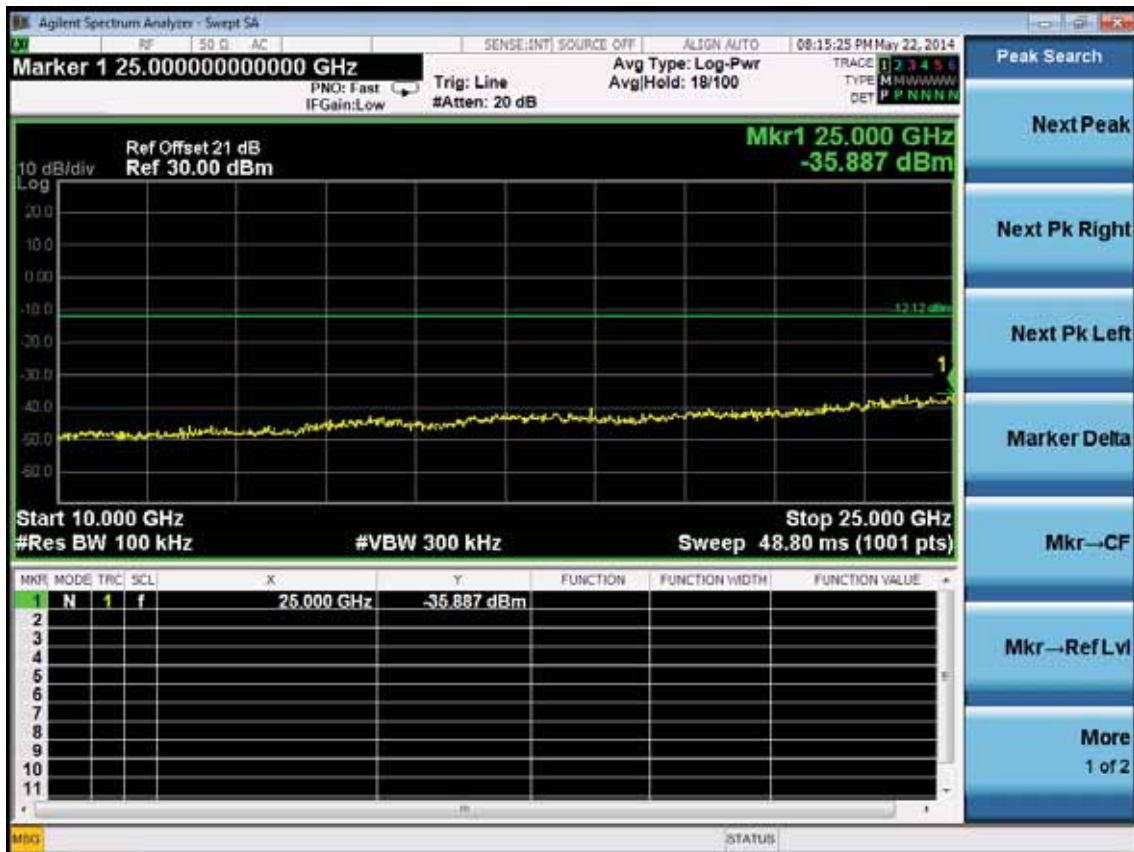
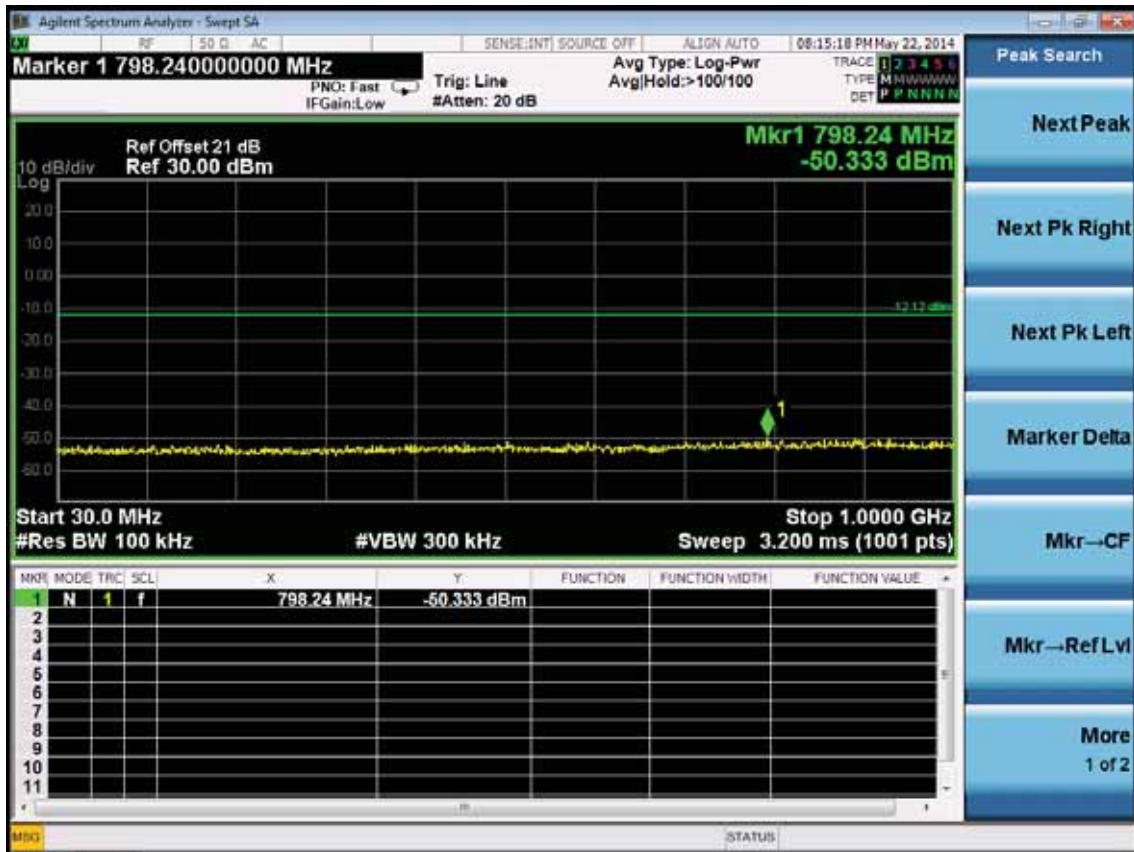



Test CH6: 2437MHz

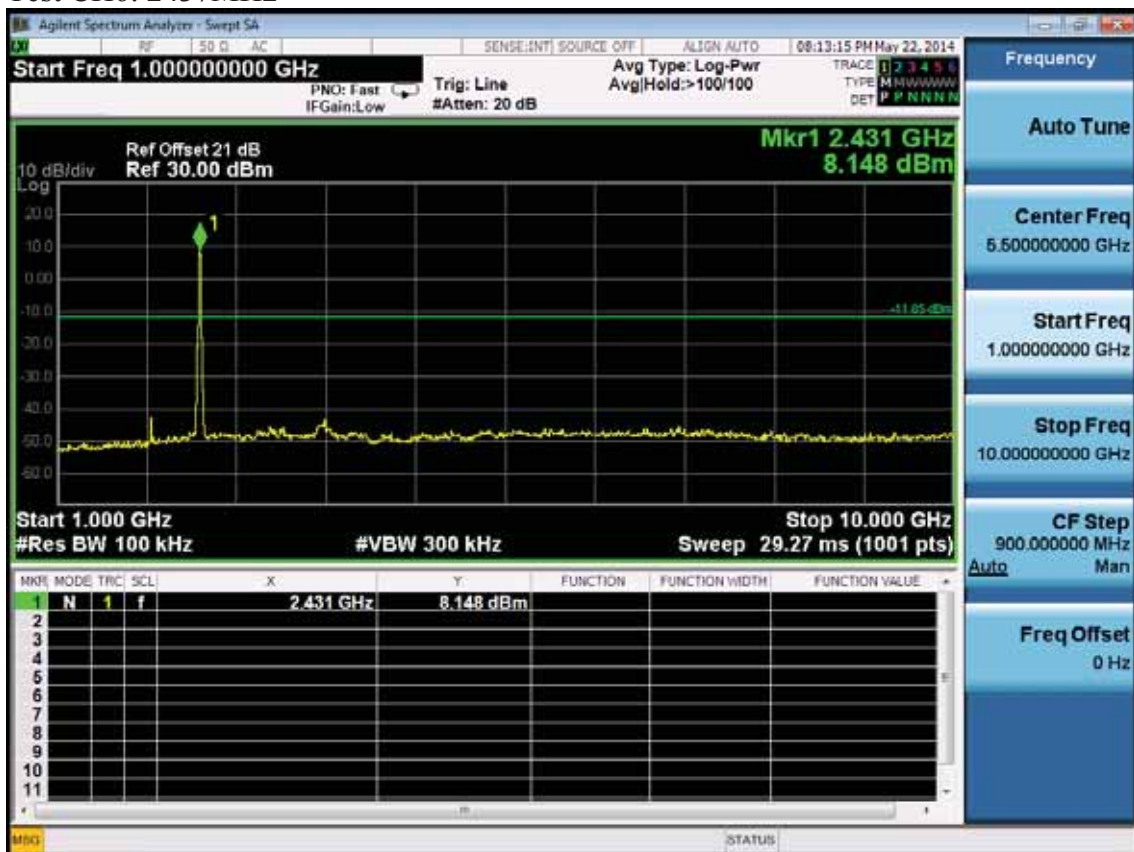

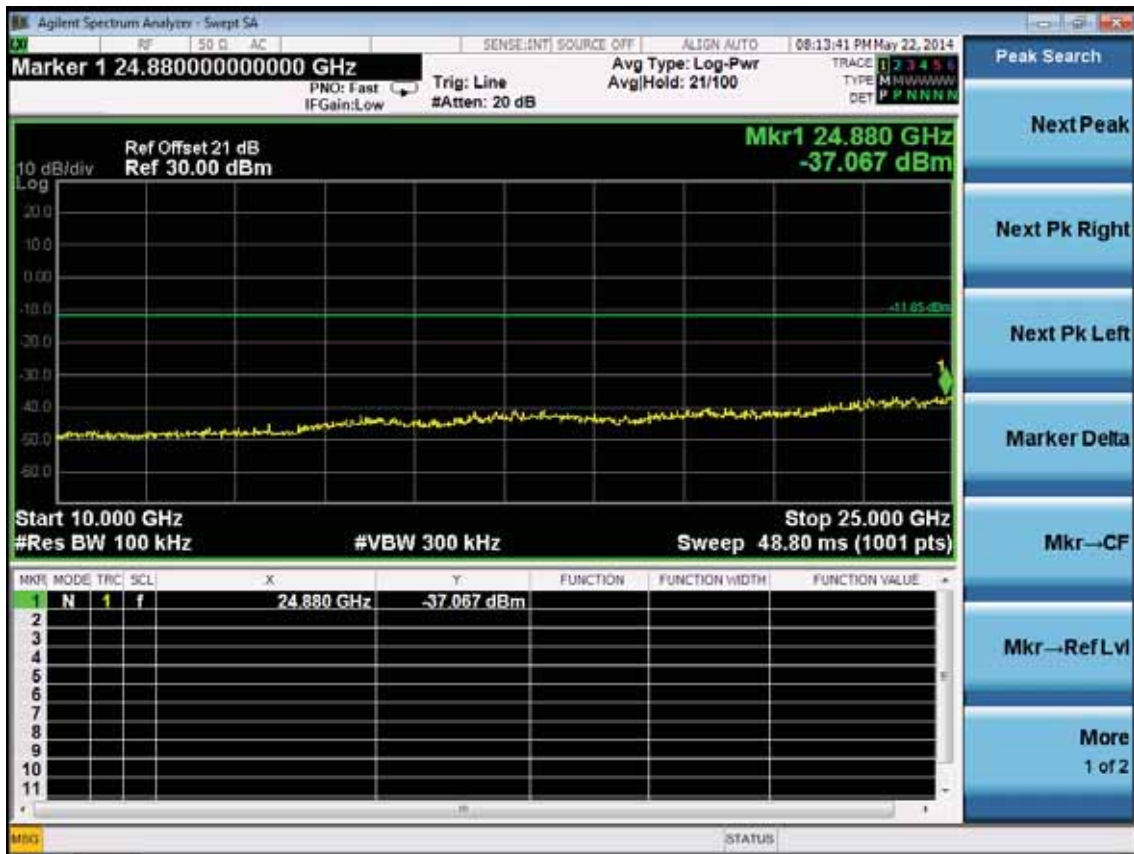
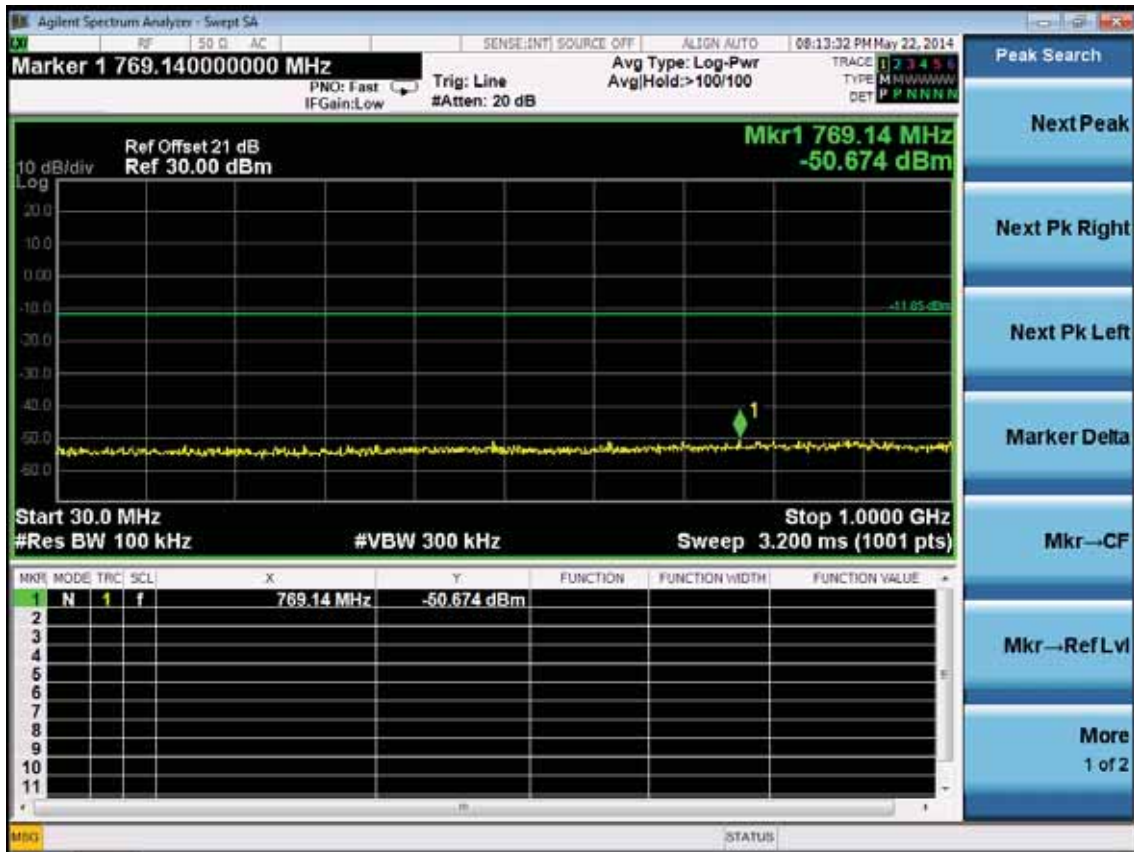

Test CH11: 2462MHz

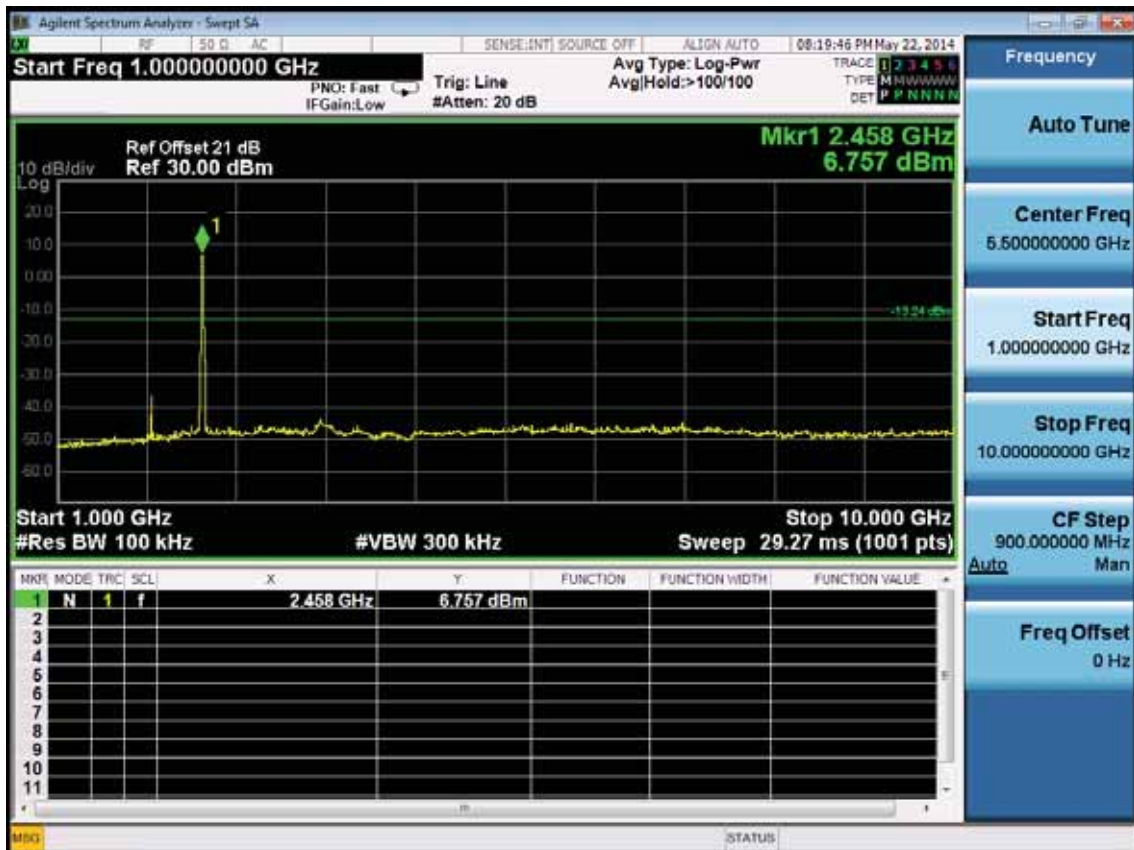

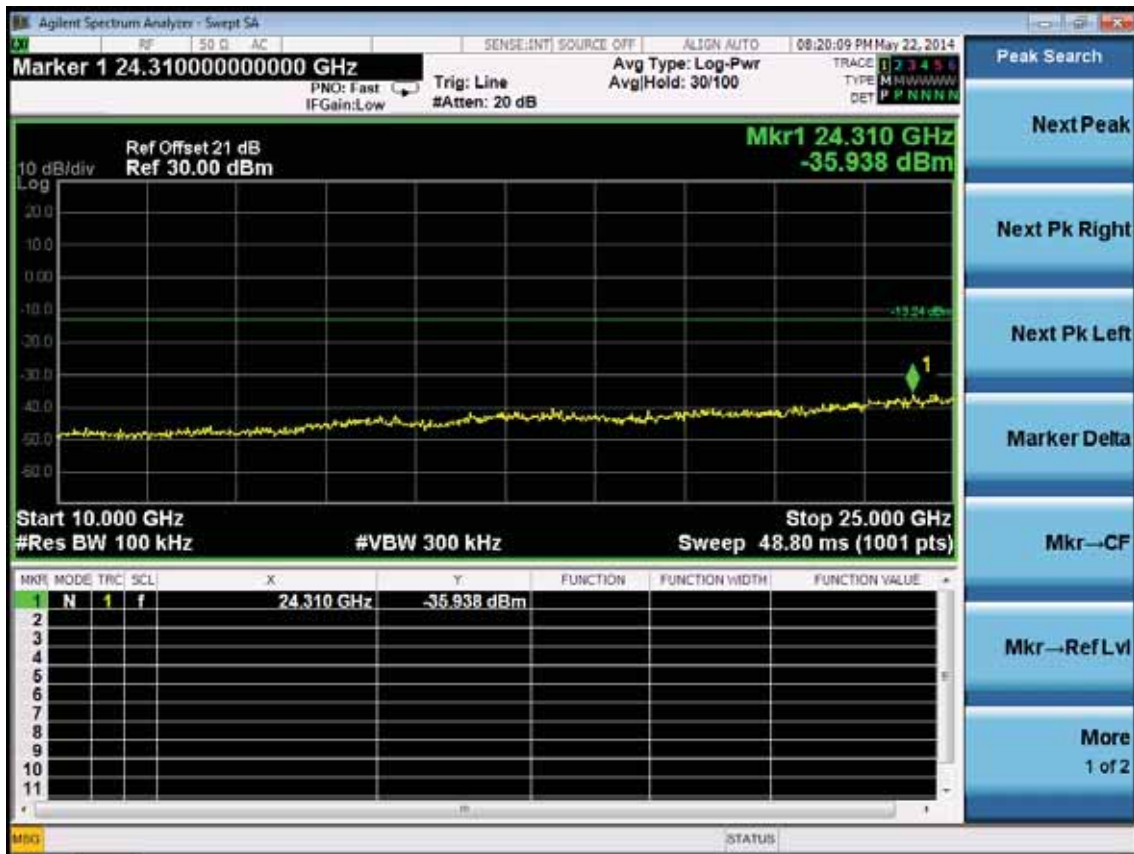
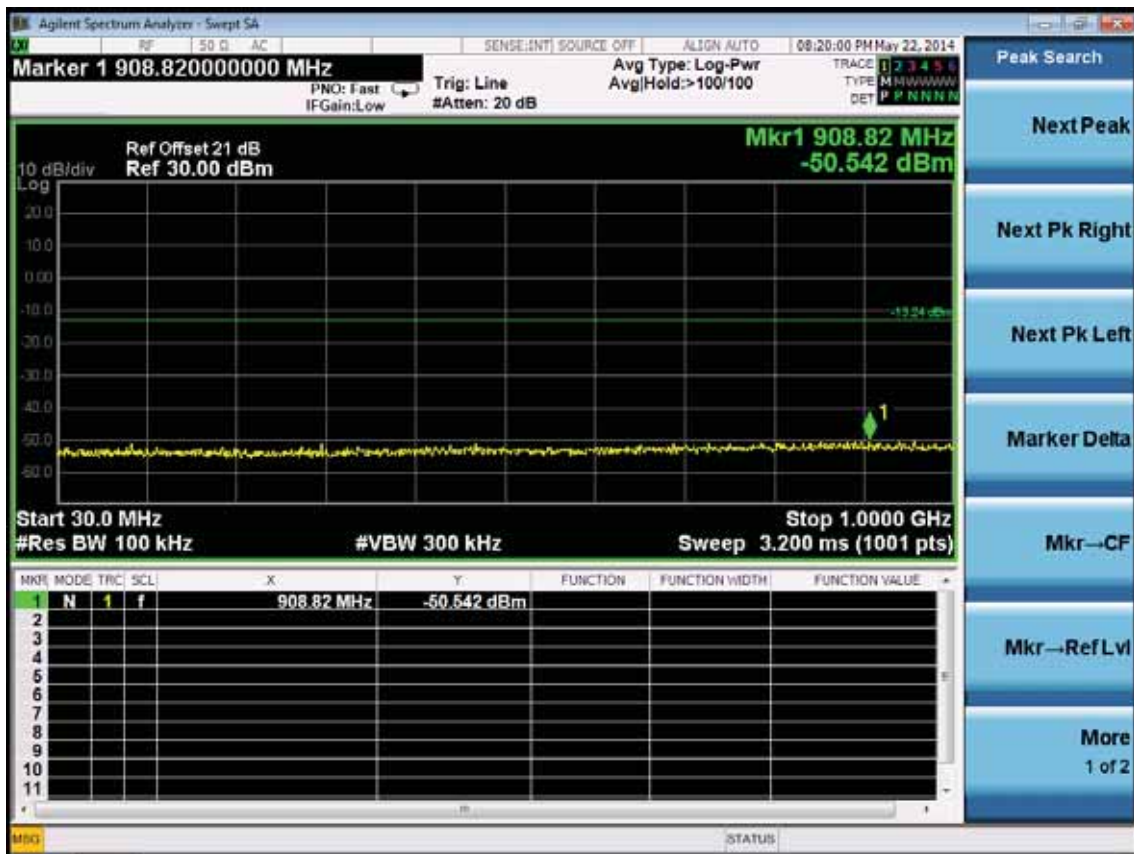

Test Mode: IEEE 802.11n HT20 TX
 Test CH1: 2412MHz

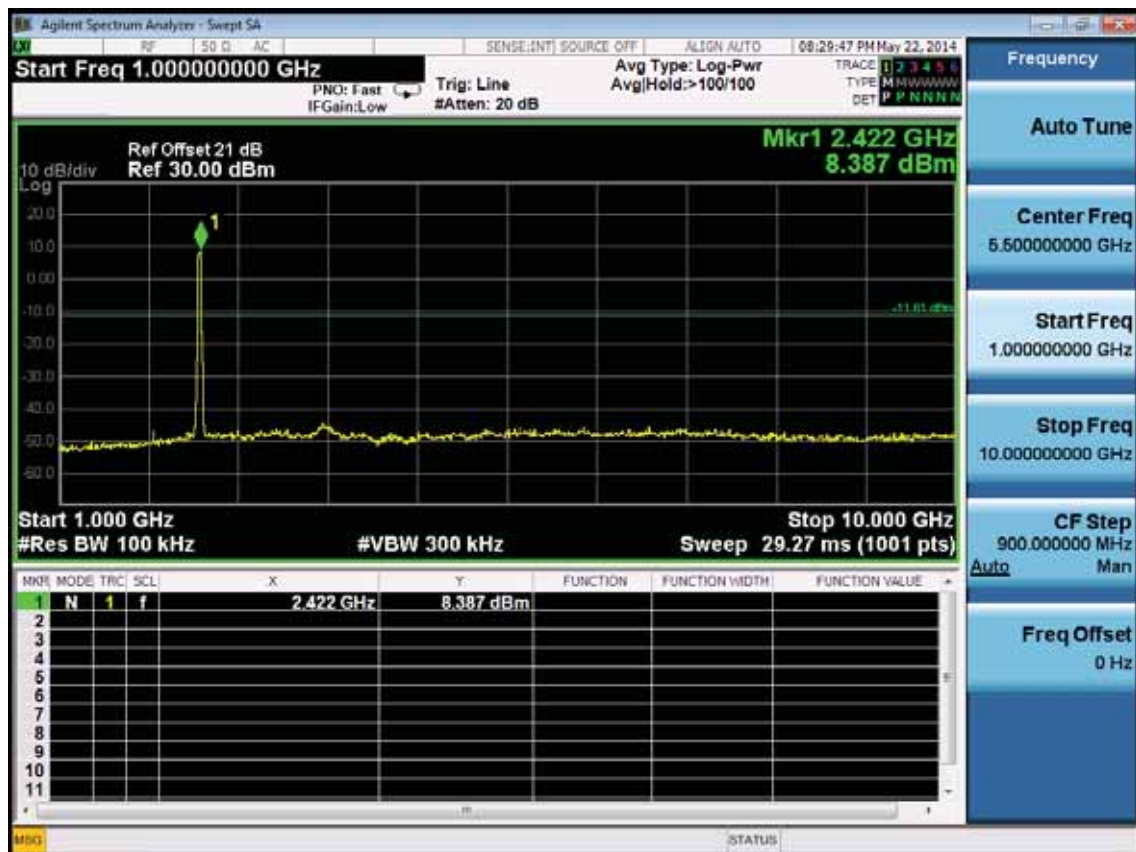

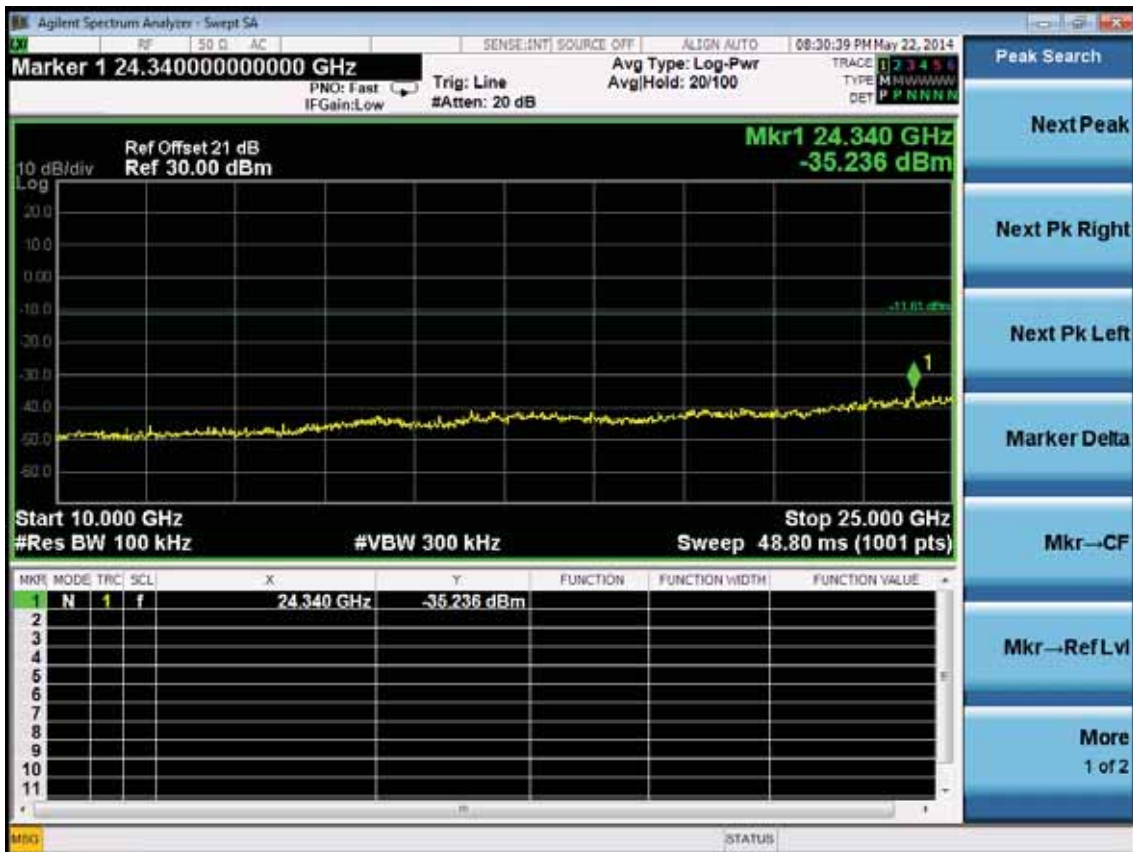
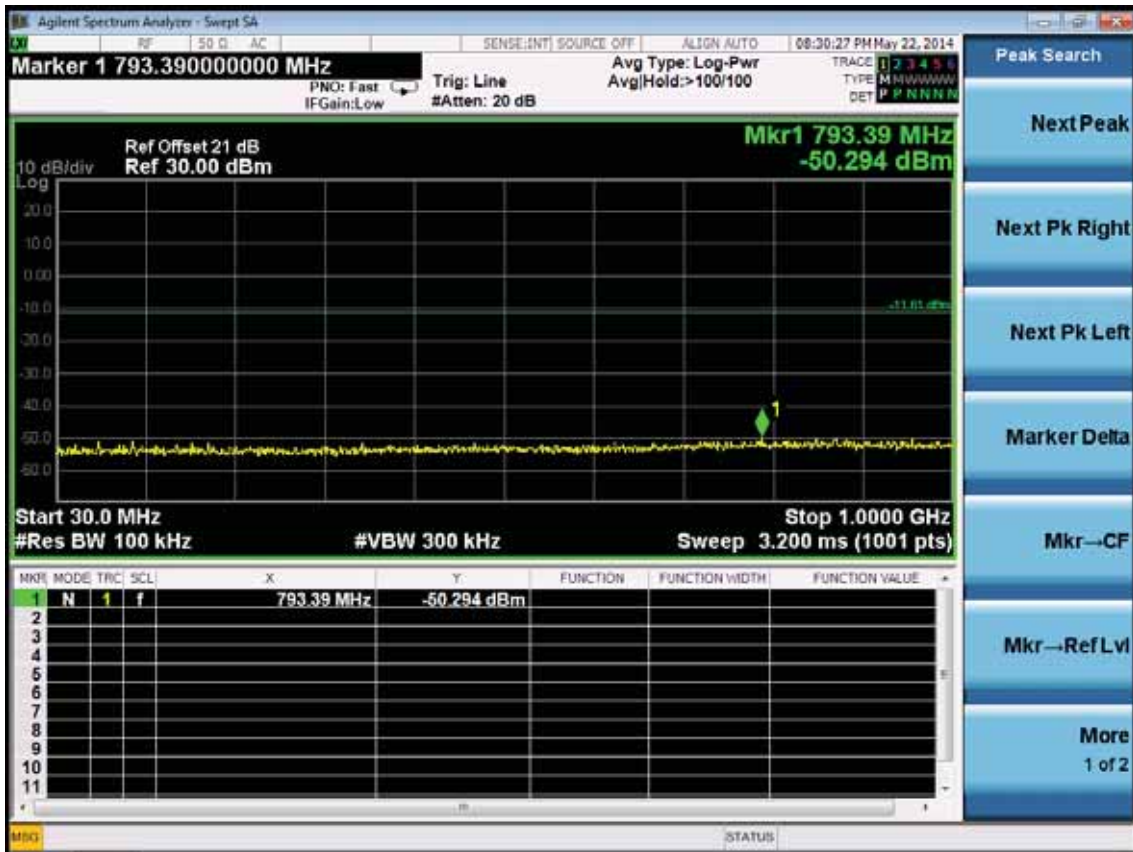

Test CH6: 2437MHz

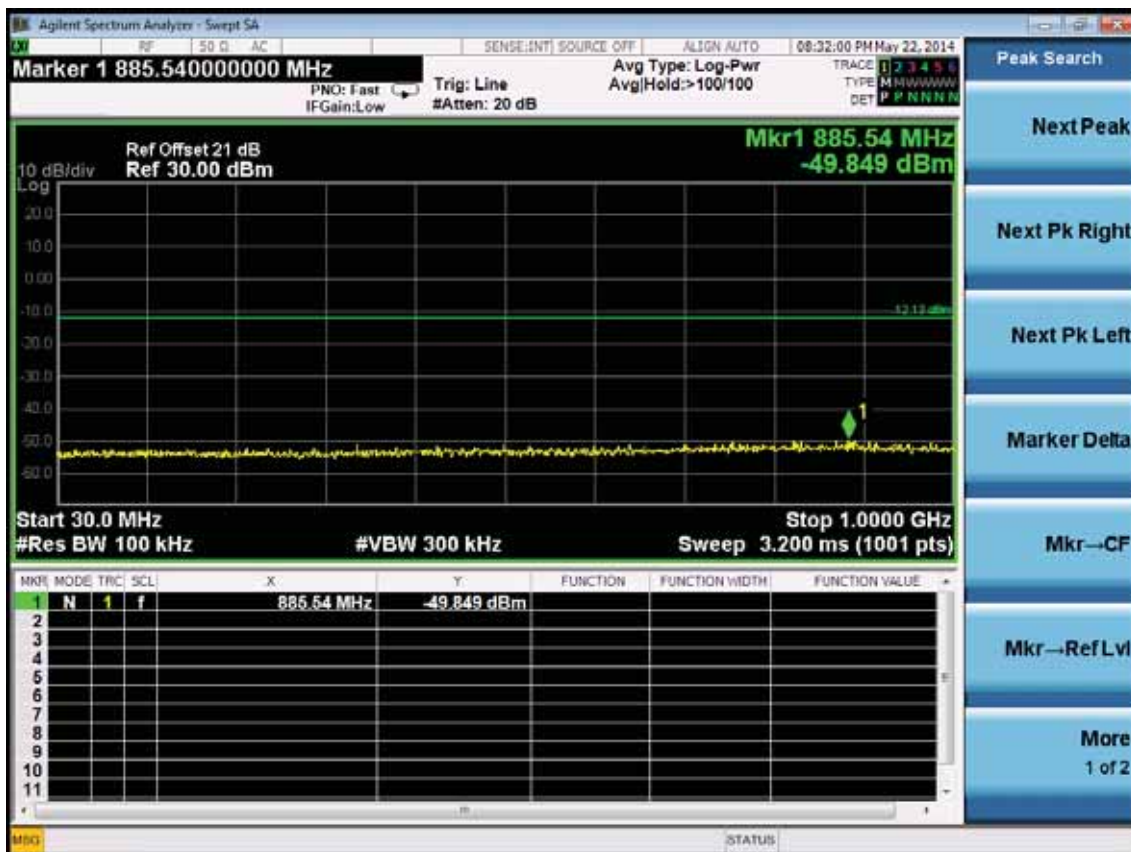
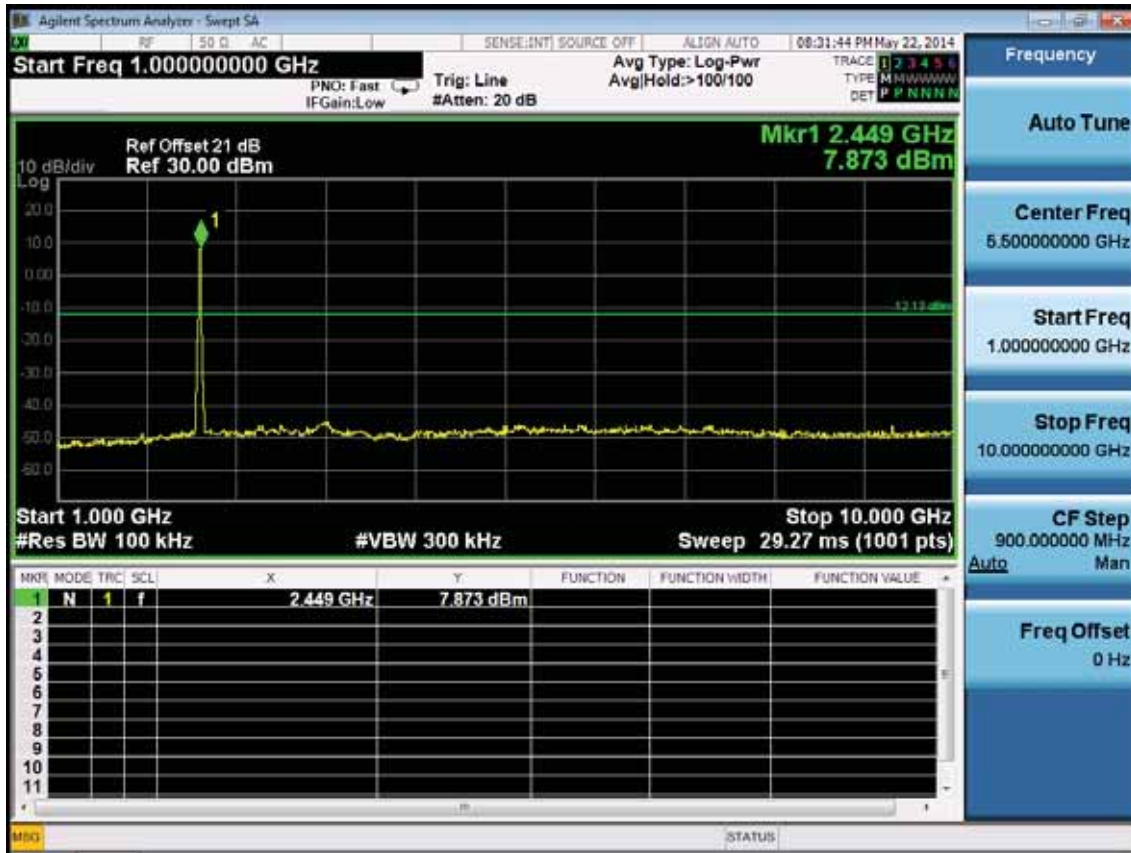

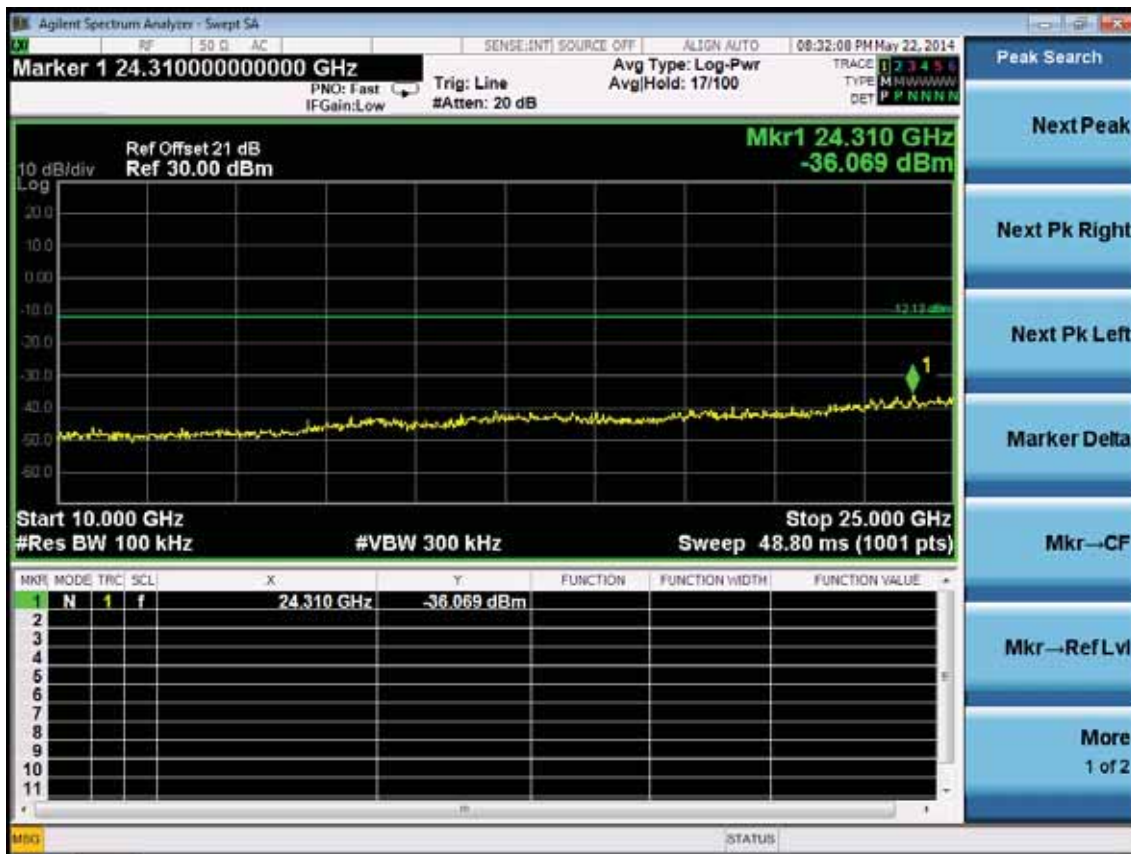

Test CH11: 2462MHz

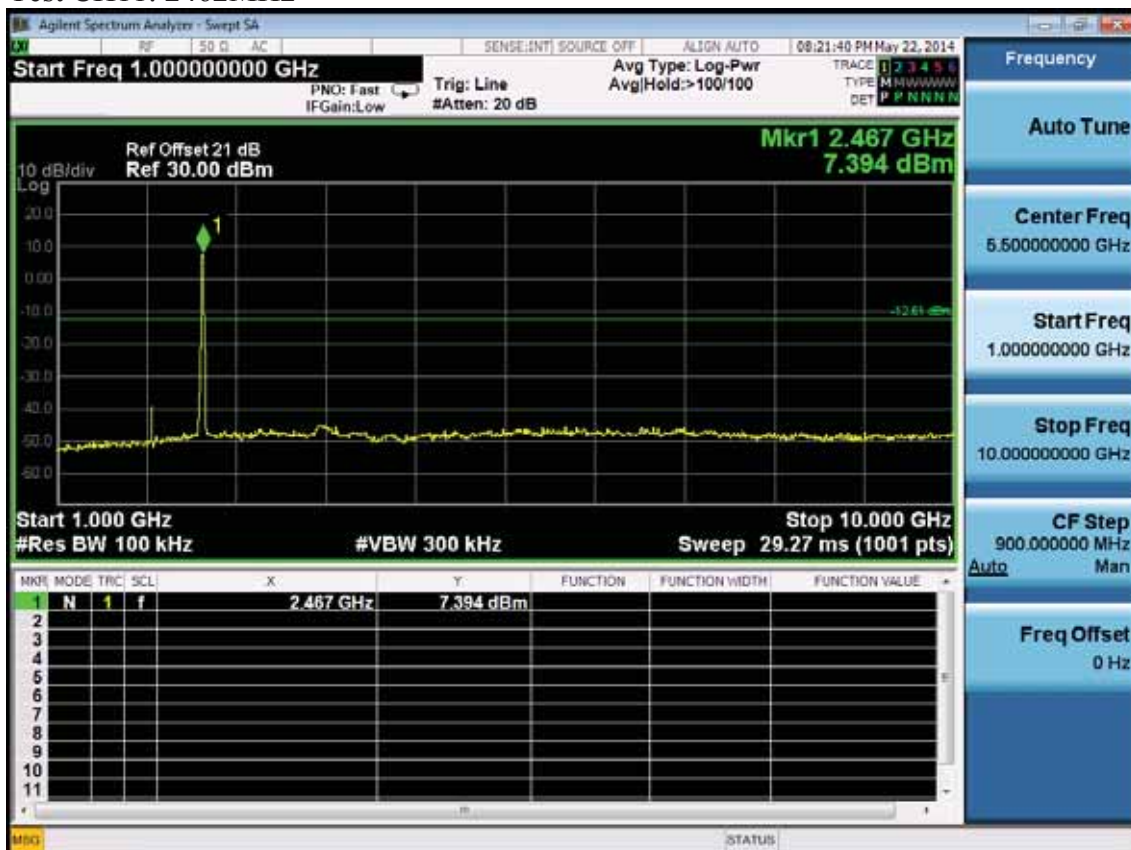

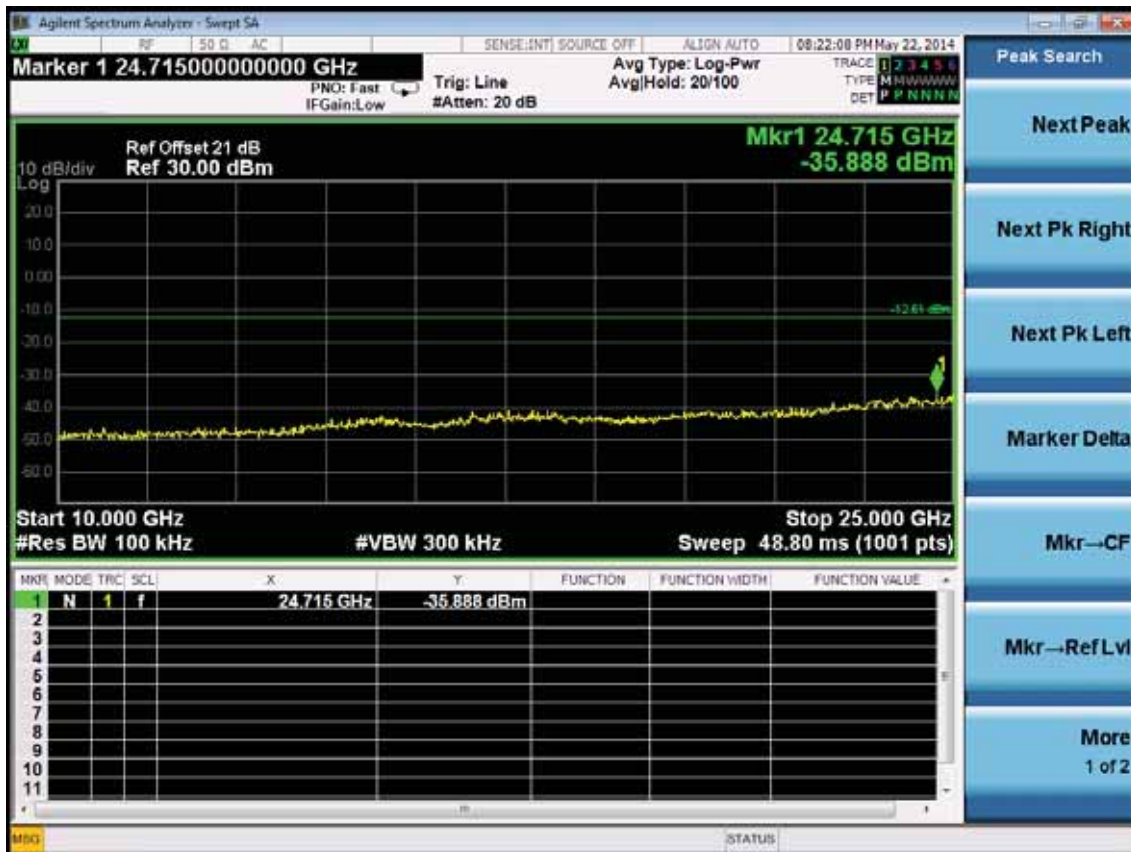
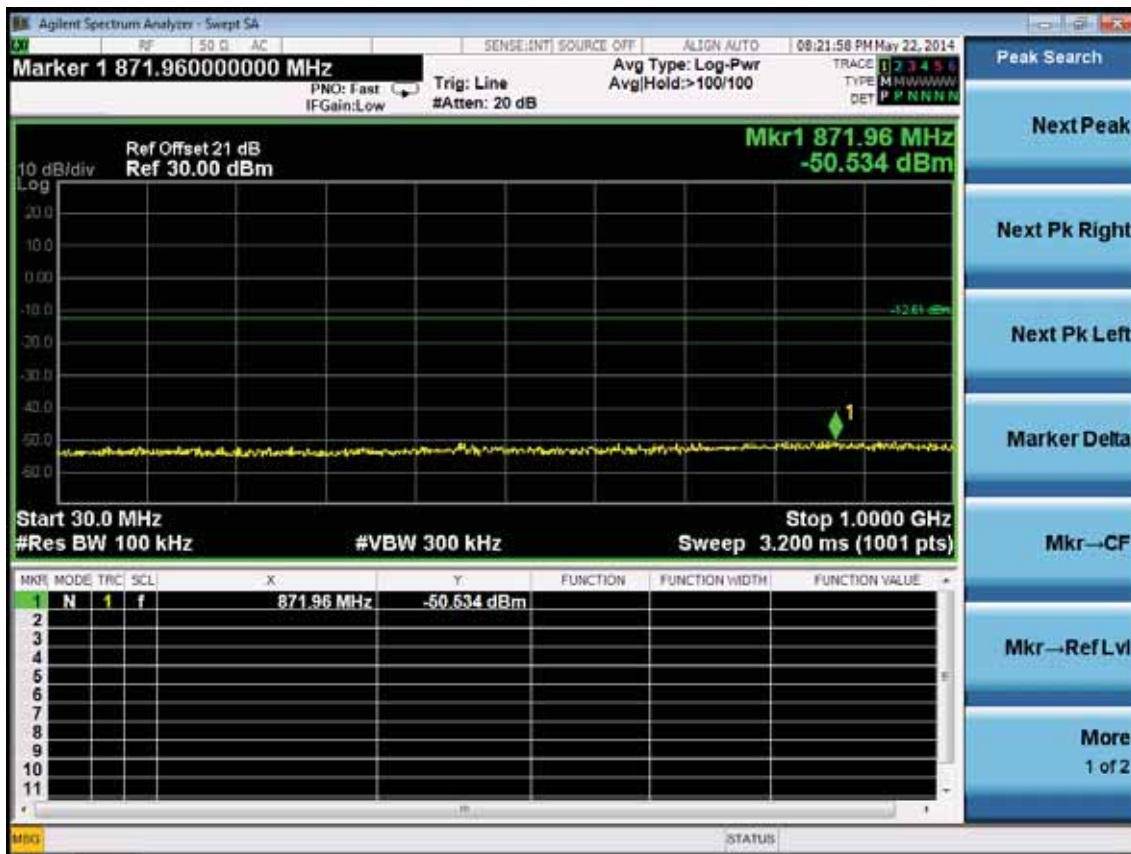



Test Mode: IEEE 802.11n HT40 TX
Test CH1: 2422MHz

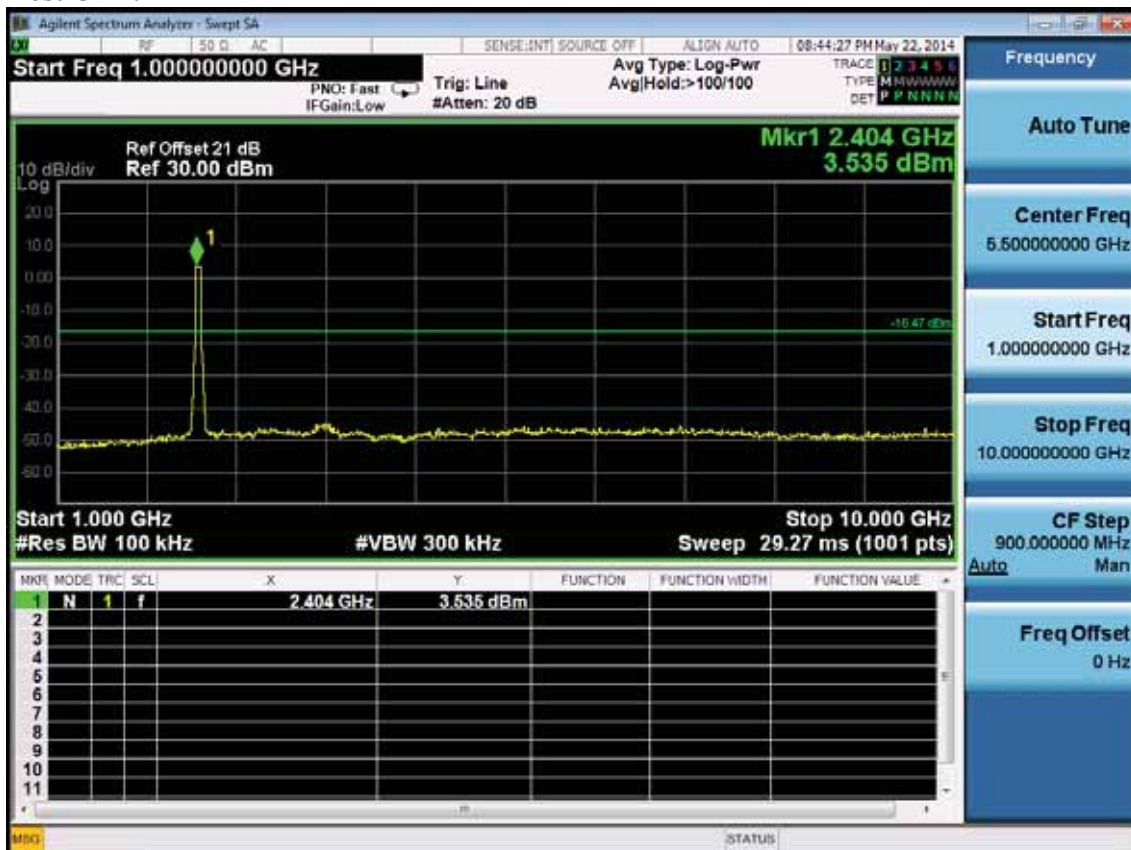

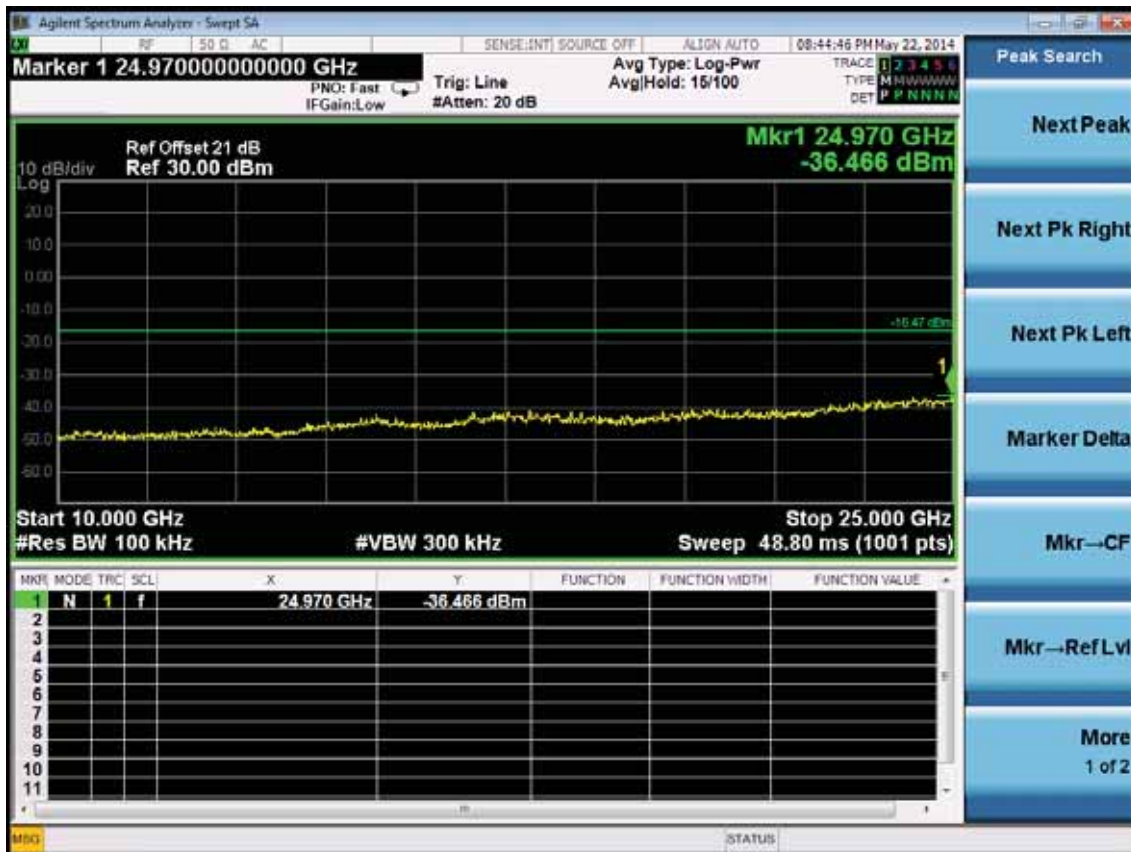
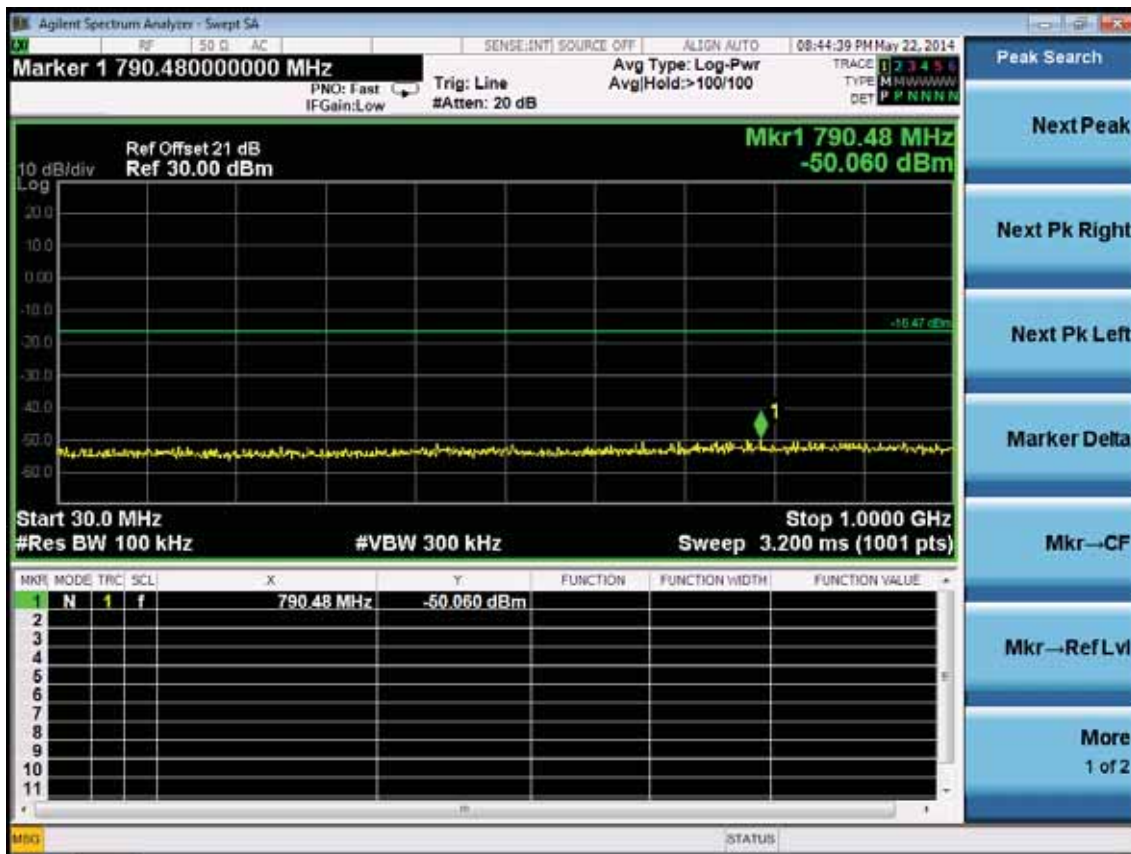



Test CH4: 2437MHz

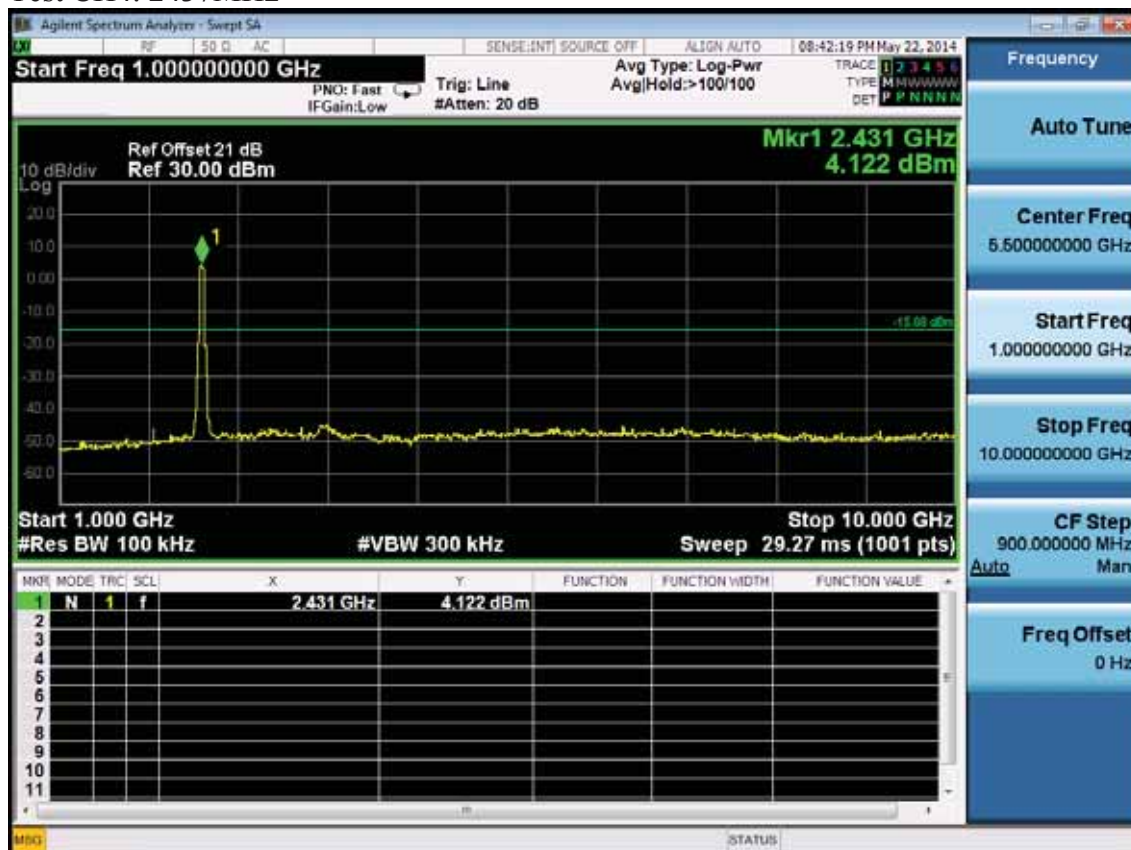

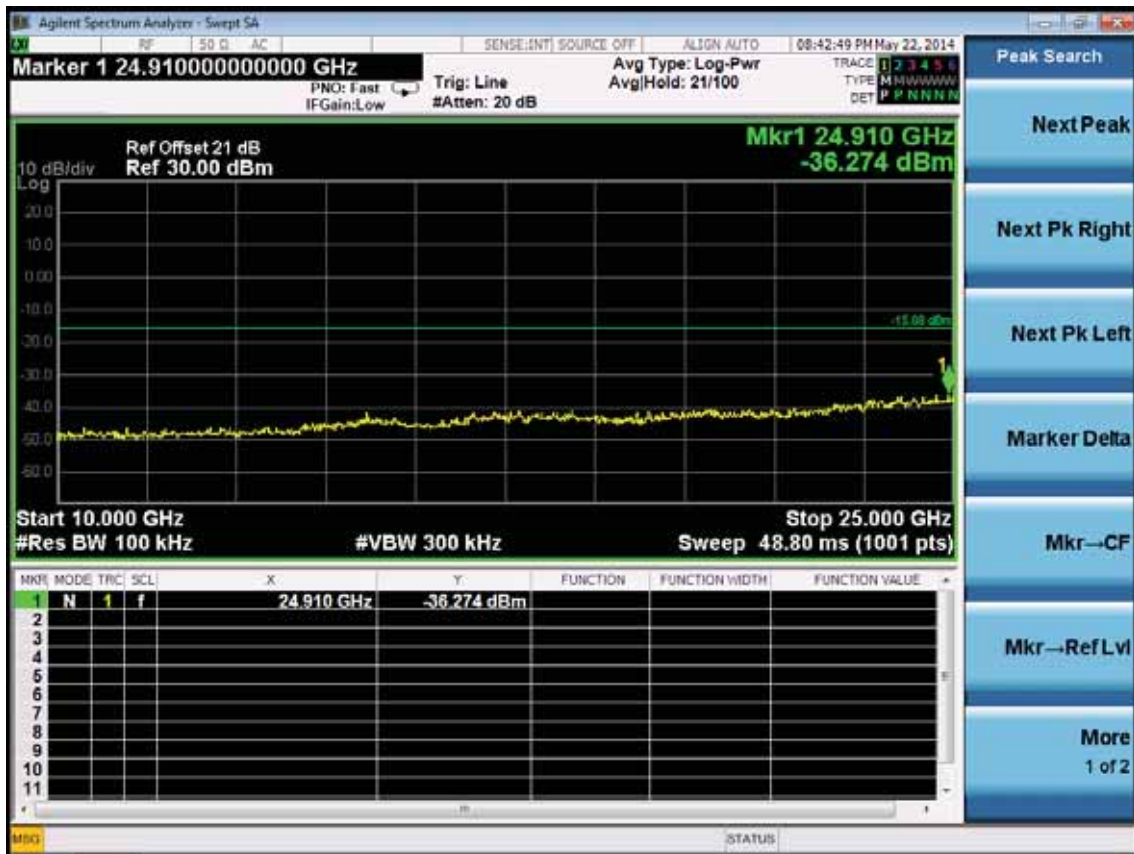
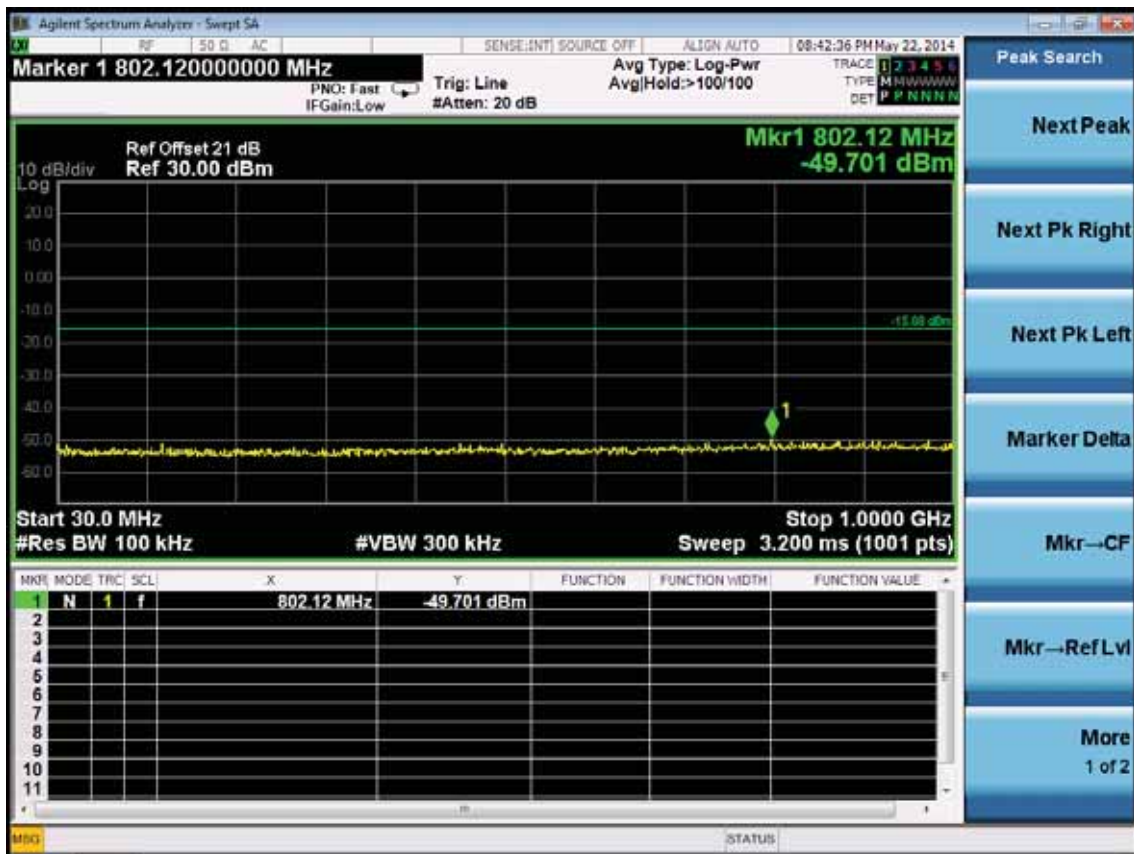

Test CH7: 2452MHz

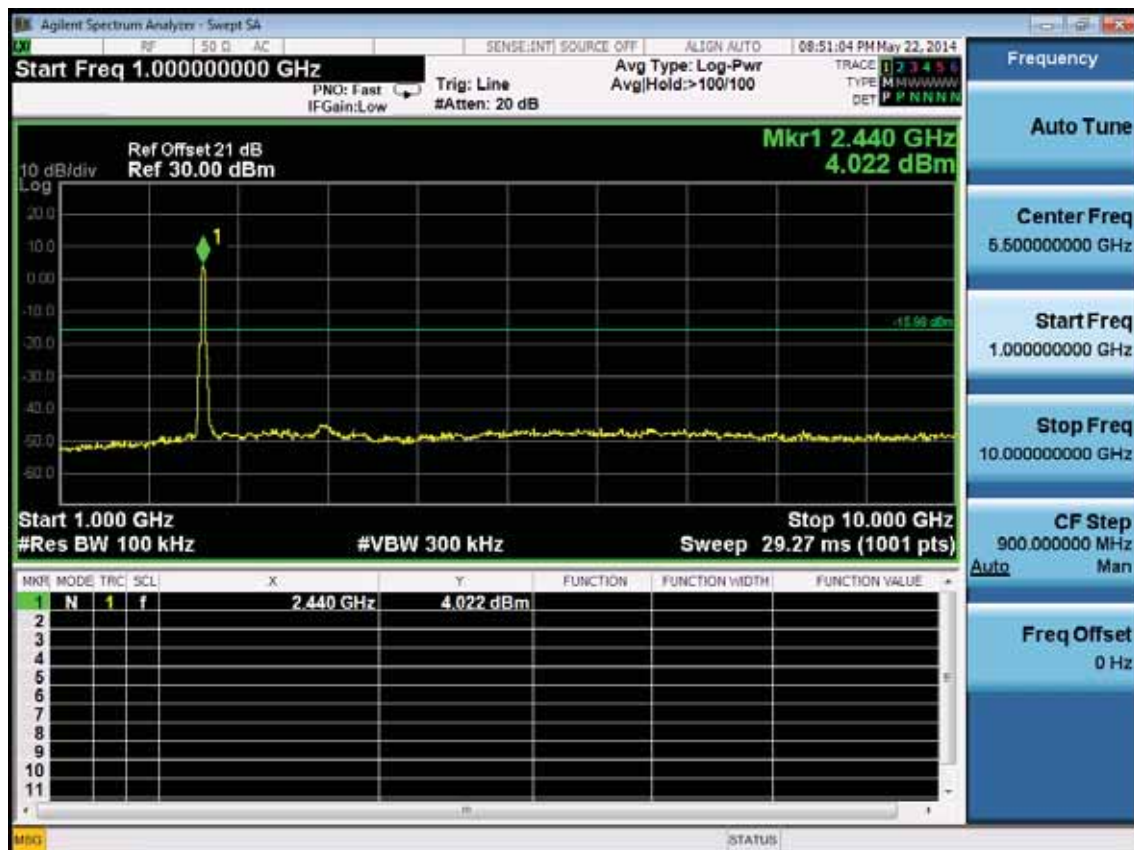

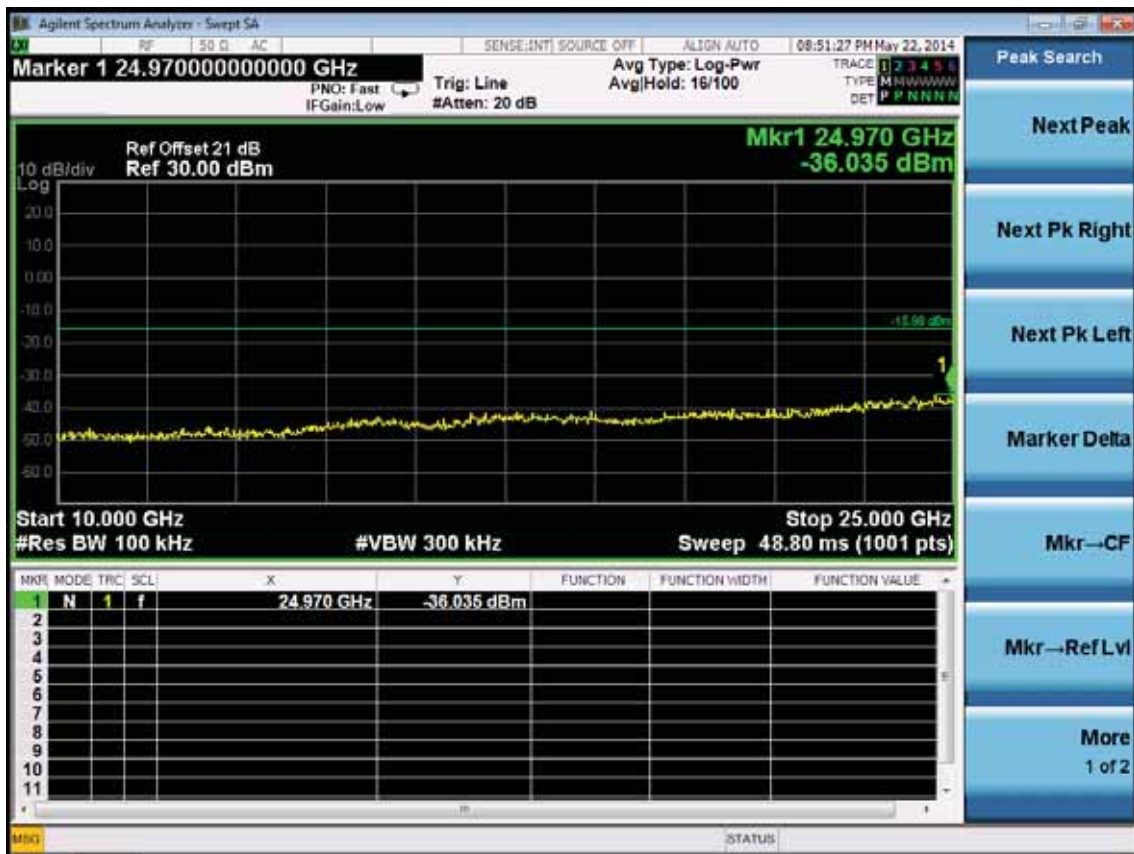
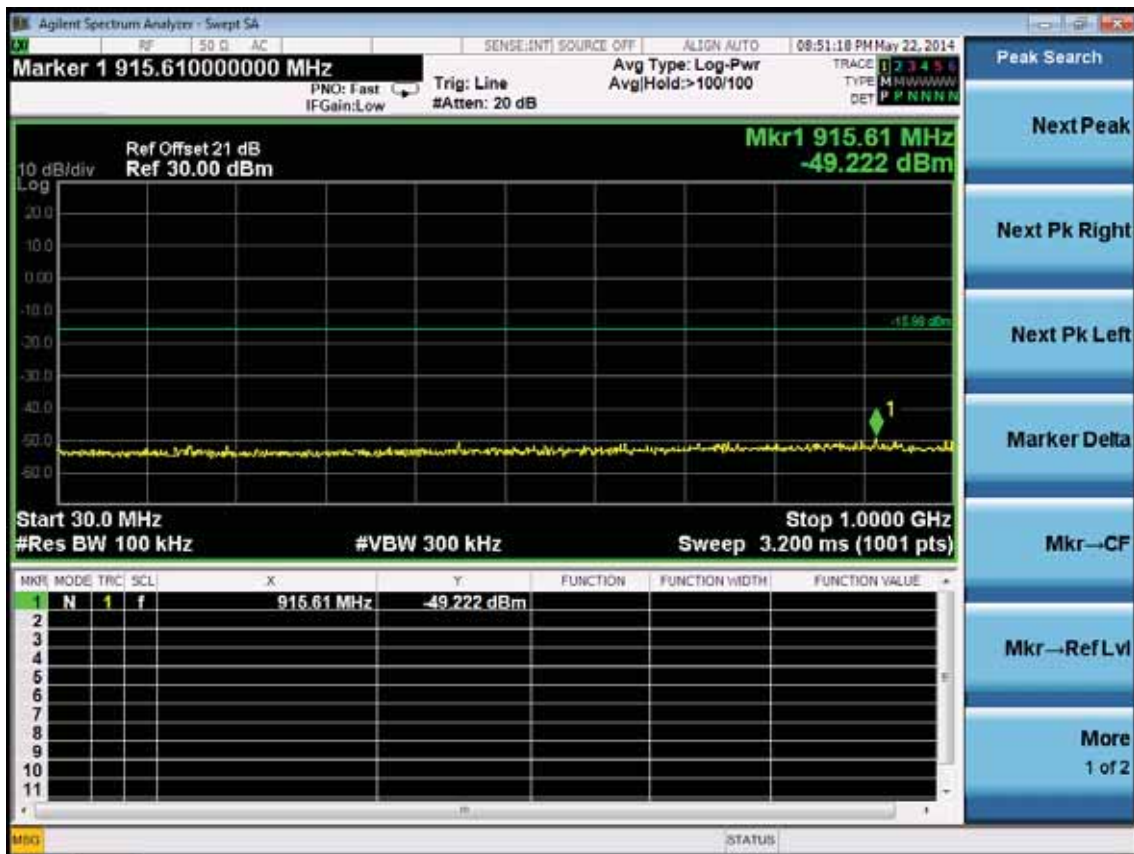

ANT 1:
 Test Mode: IEEE 802.11b TX
 Test CH1: 2412MHz

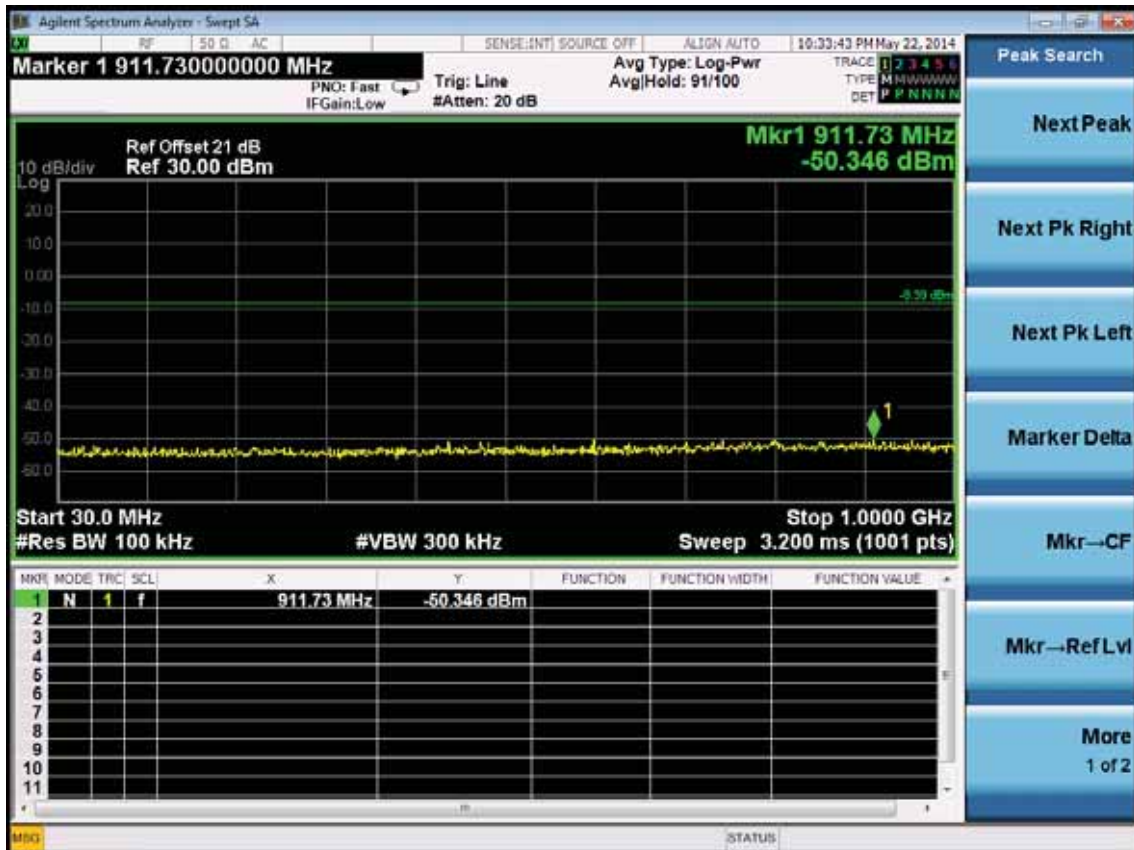
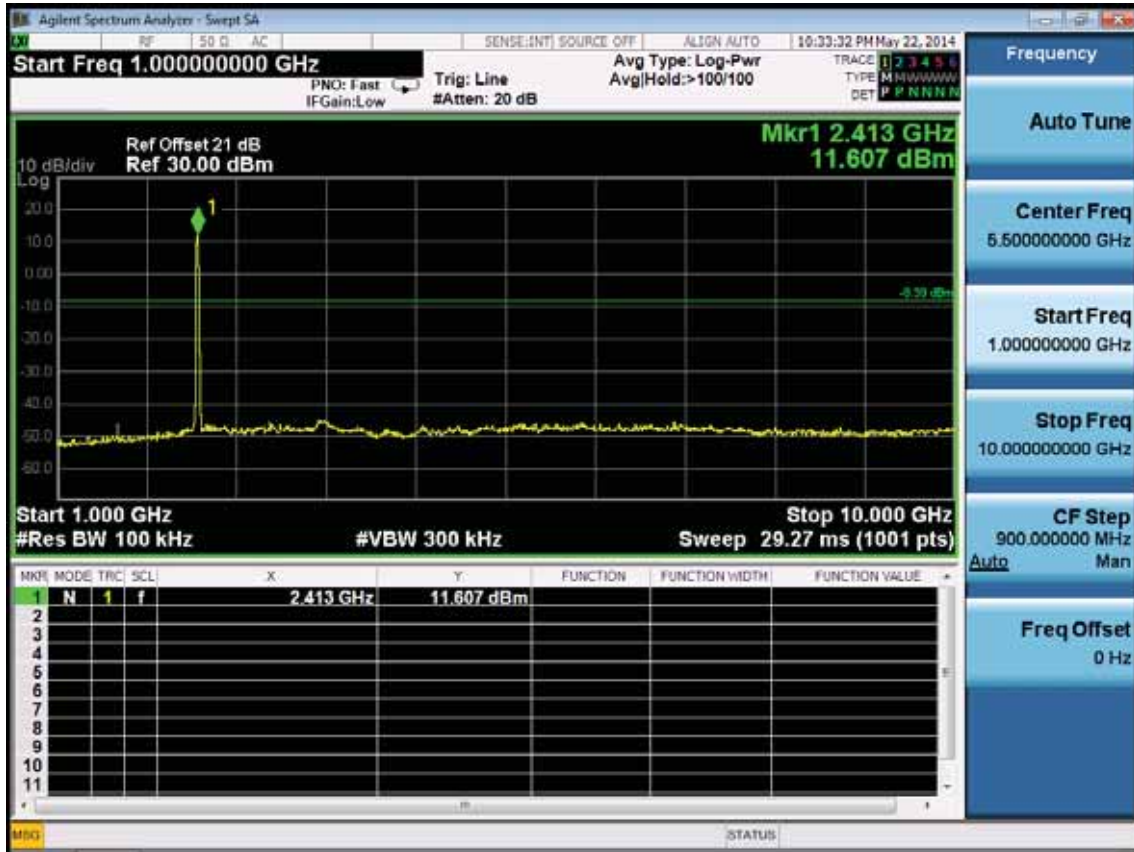

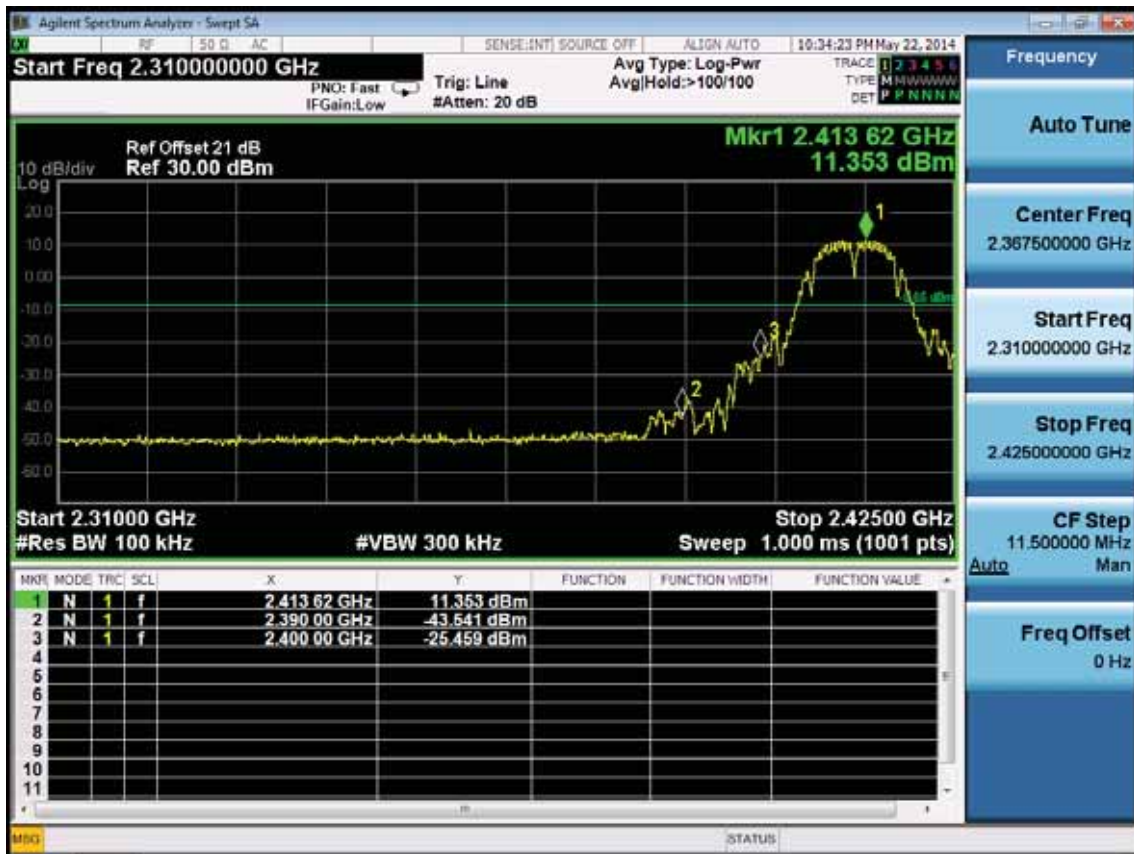
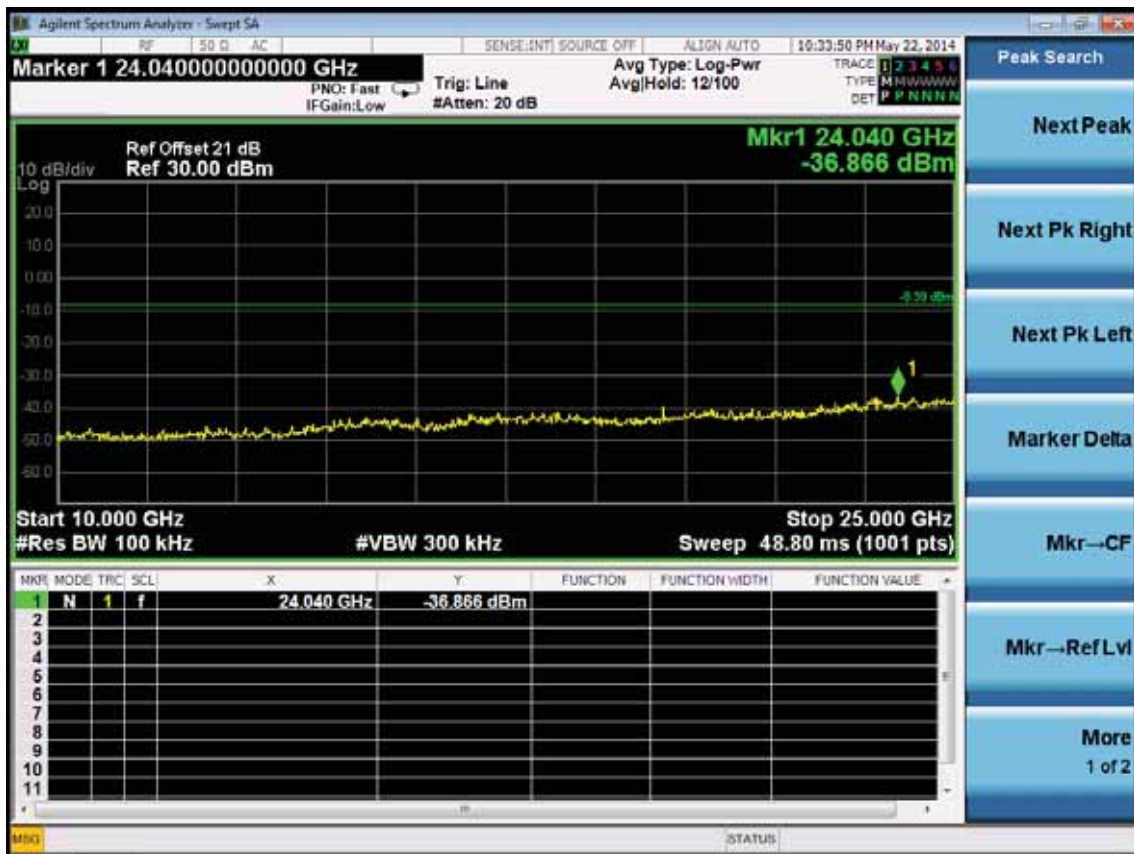

Test CH6: 2437MHz

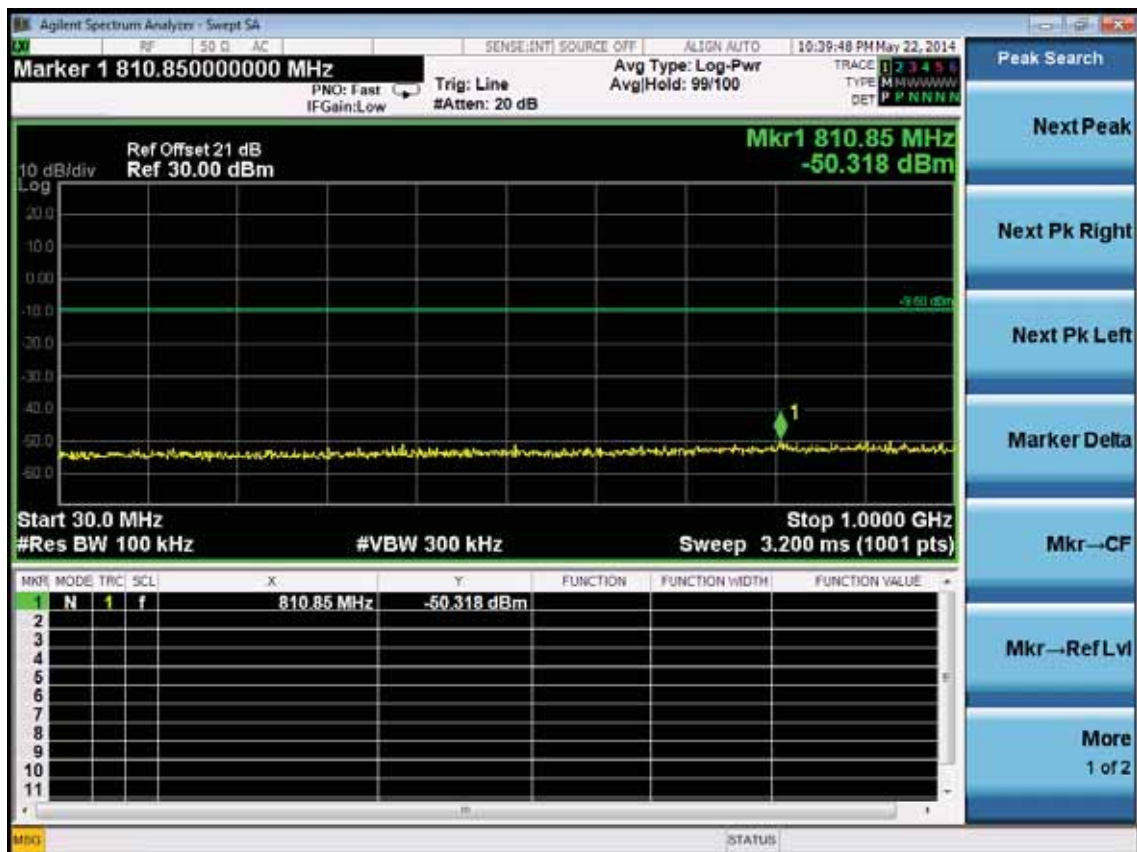
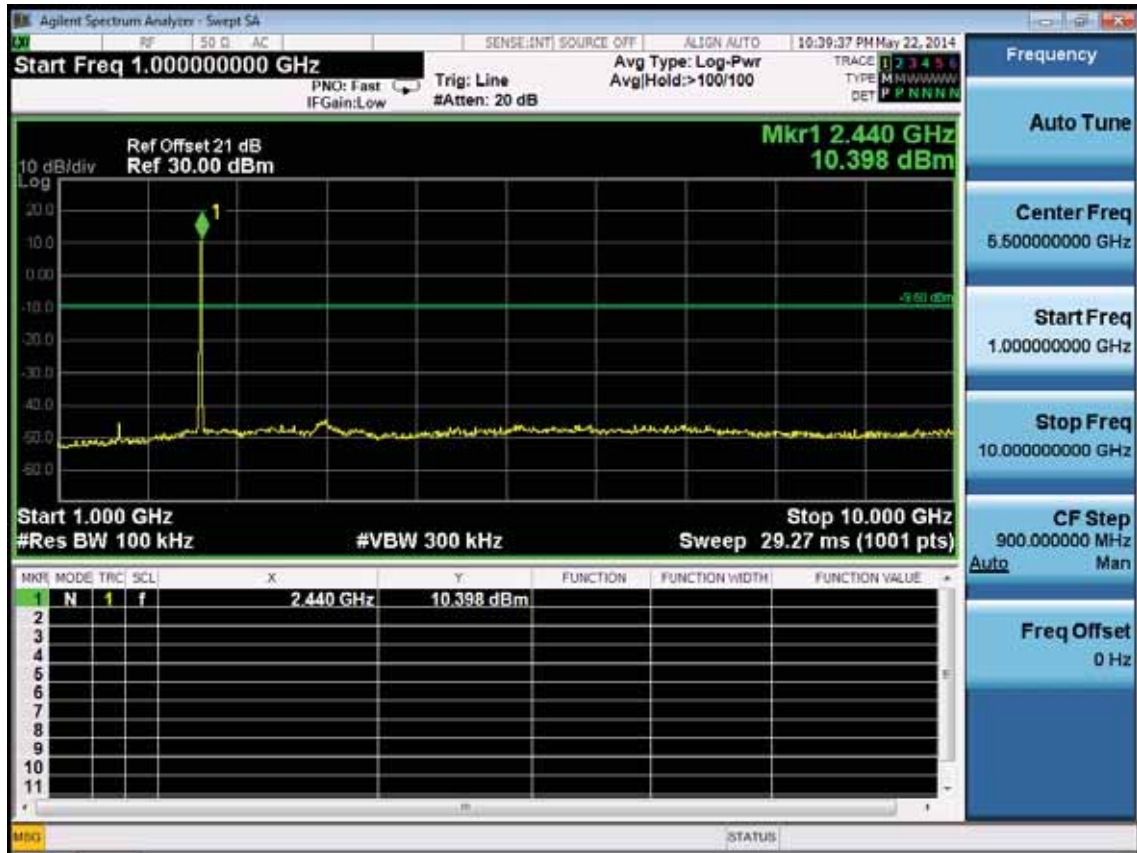

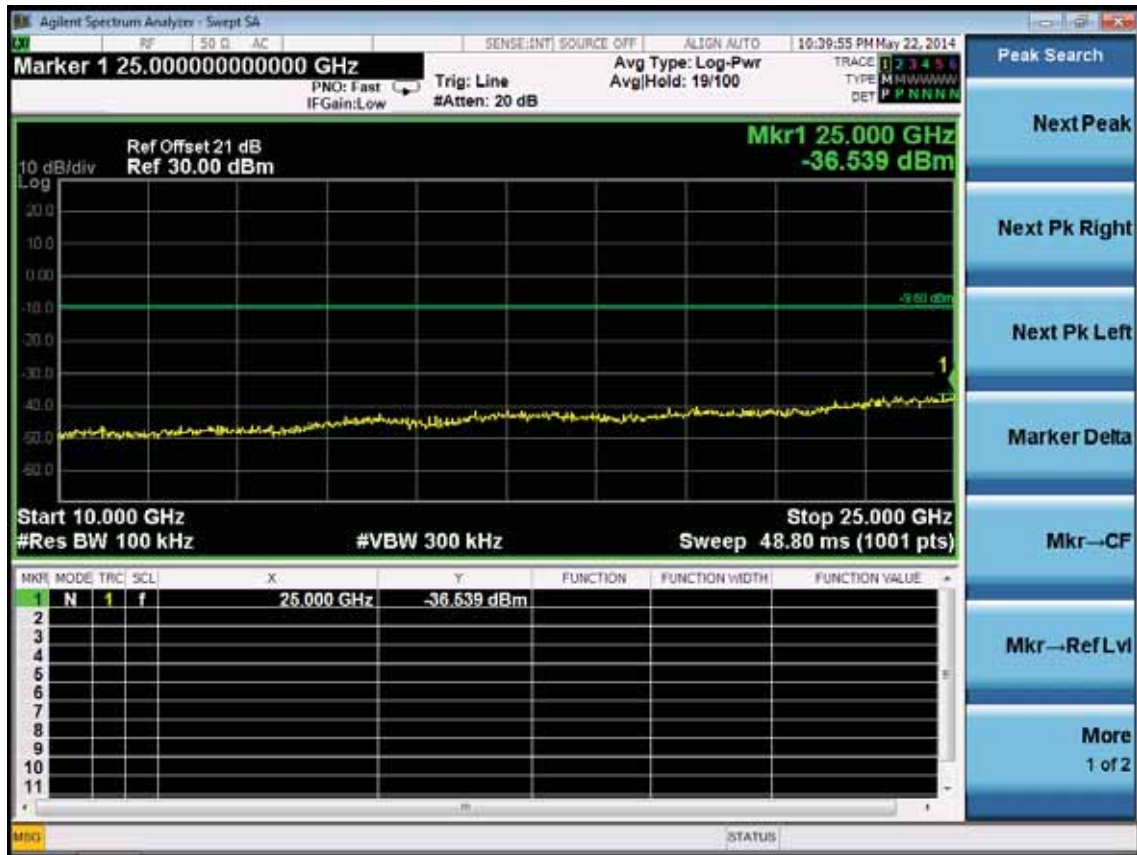

Test CH11: 2462MHz



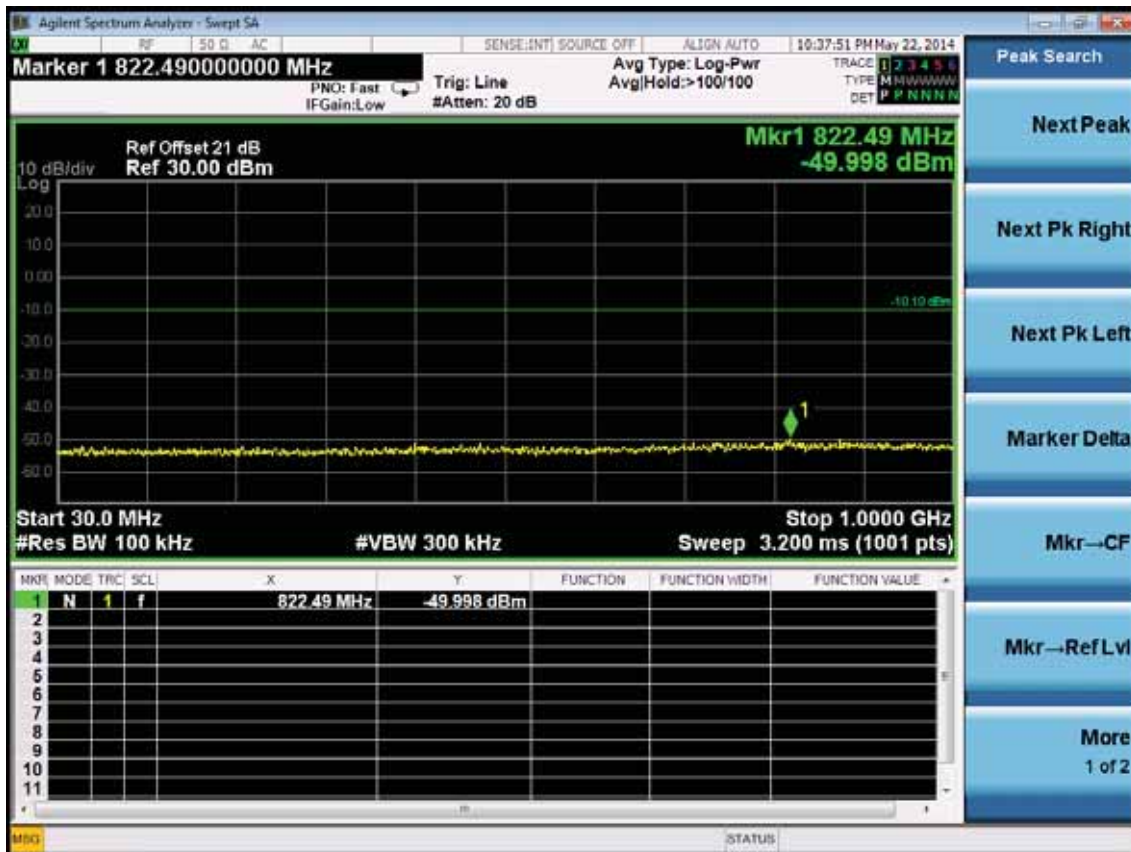
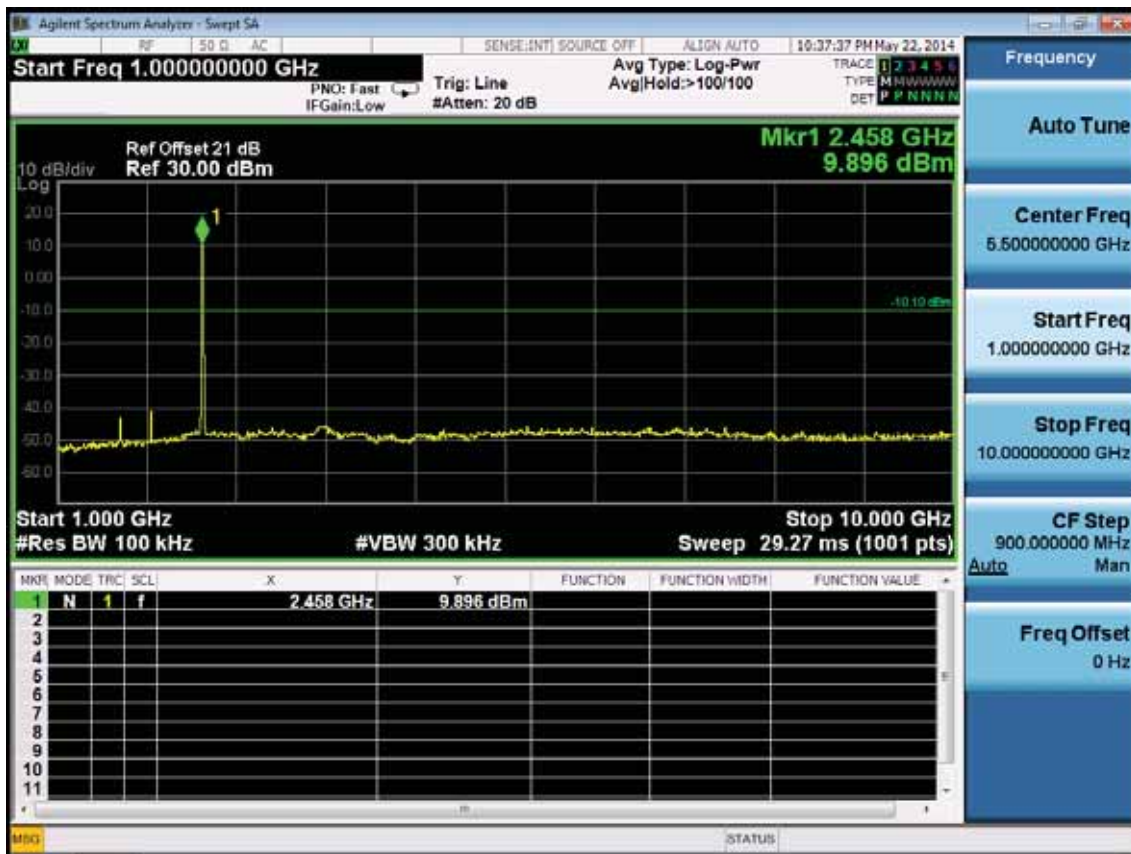

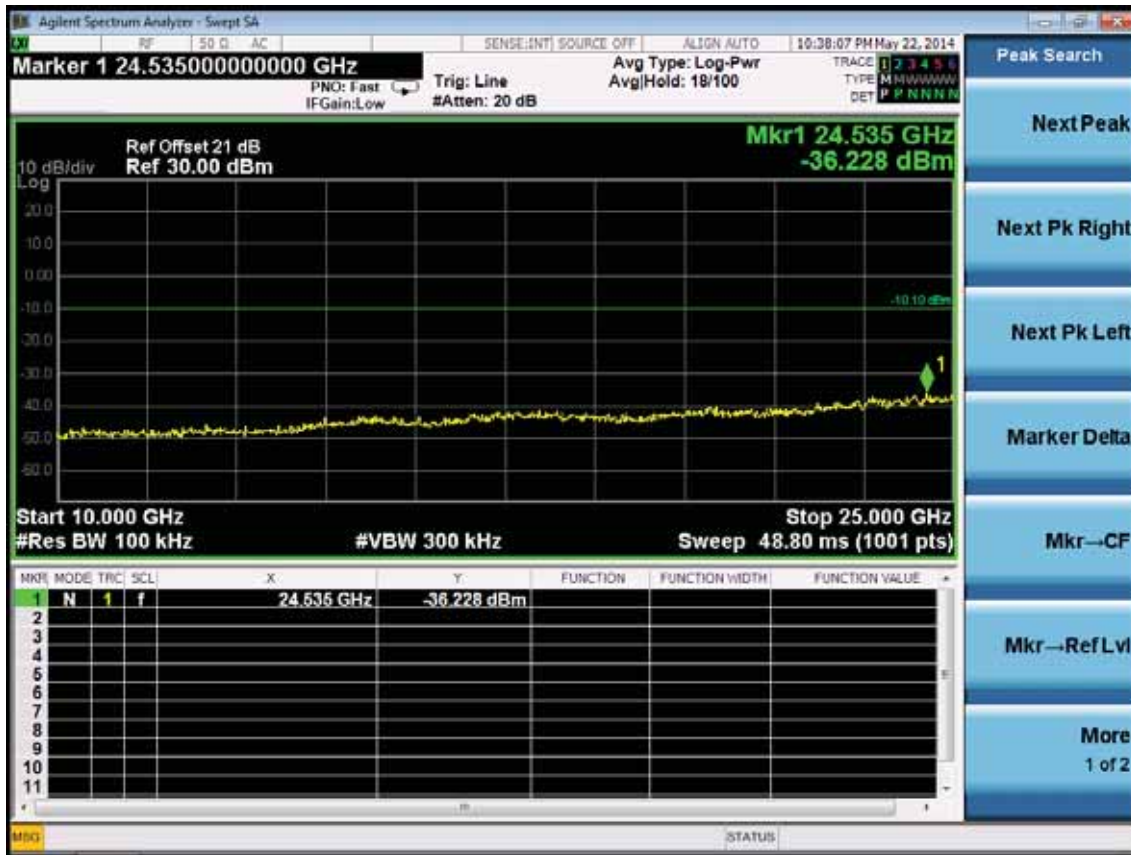

Test Mode: IEEE 802.11g TX
 Test CH1: 2412MHz

