

FCC Radio Test Report

FCC ID: TE7AX10

This report concerns: **Original Grant**

Project No. : 1905C079
Equipment : AX1500 Wi-Fi 6 Router
Test Model : Archer AX10, Archer AX1500
Series Model : N/A
Applicant : TP-Link Technologies Co., Ltd.
Address : Building 24(floors1,3,4,5) and 28(floors1-4) Central
Science and Technology Park, Shennan Rd,
Nanshan, Shenzhen, China

Date of Receipt : May 20, 2019
Date of Test : May 23, 2019 ~ Jul. 10, 2019
Issued Date : Jul. 24, 2019
Tested by : BTL Inc.

Testing Engineer : 

(Welly Zhou)

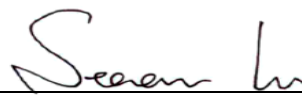
Technical Manager : 

(Steven Lu)

Authorized Signatory : 

(Ethan Ma)

B T L I N C .

No.3, Jinshagang 1st Road, Shixia, Dalang Town, Dongguan,
Guangdong, China.

TEL: +86-769-8318-3000 FAX: +86-769-8319-6000



Certificate #5123.02

Declaration

BTL represents to the client that testing is done in accordance with standard procedures as applicable and that test instruments used has been calibrated with standards traceable to international standard(s) and/or national standard(s).

BTL's reports apply only to the specific samples tested under conditions. It is manufacture's responsibility to ensure that additional production units of this model are manufactured with the identical electrical and mechanical components. **BTL** shall have no liability for any declarations, inferences or generalizations drawn by the client or others from **BTL** issued reports.

The report must not be used by the client to claim product certification, approval, or endorsement by NVLAP, NIST, A2LA, or any agency of the U.S. Government.

This report is the confidential property of the client. As a mutual protection to the clients, the public and ourselves, the test report shall not be reproduced, except in full, without our written approval.

BTL's laboratory quality assurance procedures are in compliance with the **ISO/IEC 17025** requirements, and accredited by the conformity assessment authorities listed in this test report.

BTL is not responsible for the sampling stage, so the results only apply to the sample as received.

The information, data and test plan are provided by manufacturer which may affect the validity of results, so it is manufacturer's responsibility to ensure that the apparatus meets the essential requirements of applied standards and in all the possible configurations as representative of its intended use.

Limitation

For the use of the authority's logo is limited unless the Test Standard(s)/Scope(s)/Item(s) mentioned in this test report is (are) included in the conformity assessment authorities acceptance respective.

Please note that the measurement uncertainty is provided for informational purpose only and are not use in determining the Pass/Fail results.

Table of Contents

Page

REPORT ISSUED HISTORY	6
1 . GENERAL SUMMARY	7
2 . SUMMARY OF TEST RESULTS	8
2.1 TEST FACILITY	9
2.2 MEASUREMENT UNCERTAINTY	9
3 . GENERAL INFORMATION	10
3.1 GENERAL DESCRIPTION OF EUT	10
3.2 DESCRIPTION OF TEST MODES	12
3.3 PARAMETERS OF TEST SOFTWARE	14
3.4 DUTY CYCLE	15
3.5 BLOCK DIAGRAM SHOWING THE CONFIGURATION OF SYSTEM TESTED	16
3.6 SUPPORT UNITS	16
4 . AC POWER LINE CONDUCTED EMISSIONS TEST	17
4.1 LIMIT	17
4.2 TEST PROCEDURE	17
4.3 DEVIATION FROM TEST STANDARD	17
4.4 TEST SETUP	18
4.5 EUT OPERATION CONDITIONS	18
4.6 EUT TEST CONDITIONS	18
4.7 TEST RESULTS	18
5 . RADIATED EMISSIONS TEST	19
5.1 LIMIT	19
5.2 TEST PROCEDURE	20
5.3 DEVIATION FROM TEST STANDARD	20
5.4 TEST SETUP	21
5.5 EUT OPERATION CONDITIONS	22
5.6 EUT TEST CONDITIONS	22
5.7 TEST RESULTS - 9 KHZ TO 30 MHZ	22
5.8 TEST RESULTS - 30 MHZ TO 1000 MHZ	22
5.9 TEST RESULTS - ABOVE 1000 MHZ	22
6 . BANDWIDTH TEST	23
6.1 LIMIT	23
6.2 TEST PROCEDURE	23

Table of Contents	Page
6.3 DEVIATION FROM STANDARD	23
6.4 TEST SETUP	23
6.5 EUT OPERATION CONDITIONS	23
6.6 EUT TEST CONDITIONS	23
6.7 TEST RESULTS	23
7 . MAXIMUM AVERAGE OUTPUT POWER TEST	24
7.1 LIMIT	24
7.2 TEST PROCEDURE	24
7.3 DEVIATION FROM STANDARD	24
7.4 TEST SETUP	24
7.5 EUT OPERATION CONDITIONS	24
7.6 EUT TEST CONDITIONS	24
7.7 TEST RESULTS	24
8 . CONDUCTED SPURIOUS EMISSIONS	25
8.1 LIMIT	25
8.2 TEST PROCEDURE	25
8.3 DEVIATION FROM STANDARD	25
8.4 TEST SETUP	25
8.5 EUT OPERATION CONDITIONS	25
8.6 EUT TEST CONDITIONS	25
8.7 TEST RESULTS	25
9 . POWER SPECTRAL DENSITY TEST	26
9.1 LIMIT	26
9.2 TEST PROCEDURE	26
9.3 DEVIATION FROM STANDARD	26
9.4 TEST SETUP	26
9.5 EUT OPERATION CONDITIONS	26
9.6 EUT TEST CONDITIONS	26
9.7 TEST RESULTS	26
10 . MEASUREMENT INSTRUMENTS LIST	27
11 . EUT TEST PHOTO	29
APPENDIX A - AC POWER LINE CONDUCTED EMISSIONS	33
APPENDIX B - RADIATED EMISSION - 9 KHZ TO 30 MHZ	36

Table of Contents**Page**

APPENDIX C - RADIATED EMISSION - 30 MHZ TO 1000 MHZ	41
APPENDIX D - RADIATED EMISSION- ABOVE 1000 MHZ	44
APPENDIX E - BANDWIDTH	125
APPENDIX F - MAXIMUM AVERAGE OUTPUT POWER	130
APPENDIX G - CONDUCTED SPURIOUS EMISSIONS	134
APPENDIX H - POWER SPECTRAL DENSITY	142

REPORT ISSUED HISTORY

Report Version	Description	Issued Date
R00	Original Issue.	Jul. 24, 2019

1. GENERAL SUMMARY

Equipment : AX1500 Wi-Fi 6 Router
Brand Name : tp-link
Test Model : Archer AX10, Archer AX1500
Series Model : N/A
Applicant : TP-Link Technologies Co., Ltd.
Manufacturer : TP-Link Technologies Co., Ltd.
Address : Building 24(floors1,3,4,5) and 28(floors1-4) Central Science and Technology Park, Shennan Rd, Nanshan, Shenzhen, China
Date of Test : May 23, 2019 ~ Jul. 10, 2019
Test Sample : Engineering Sample No.: DG19061085
Standard(s) : FCC Part15, Subpart C (15.247)
ANSI C63.10-2013
FCC KDB 558074 D01 DTS Meas Guidance v05r02
FCC KDB 662911 D01 Multiple Transmitter Output v02r01

The above equipment has been tested and found compliance with the requirement of the relative standards by BTL Inc.

The test data, data evaluation, and equipment configuration contained in our test report (Ref No. BTL-FCCP-1-1905C079) were obtained utilizing the test procedures, test instruments, test sites that has been accredited by the Authority of A2LA according to the ISO/IEC 17025 quality assessment standard and technical standard(s).

Test results included in this report are only for the WLAN 2.4 GHz part.

2. SUMMARY OF TEST RESULTS

Test procedures according to the technical standard(s):

FCC Part15, Subpart C (15.247)				
Standard(s) Section	Test Item	Test Result	Judgment	Remark
15.207	AC Power Line Conducted Emissions	APPENDIX A	PASS	-----
15.247(d) 15.205(a) 15.209(a)	Radiated Emissions	APPENDIX B APPENDIX C APPENDIX D	PASS	-----
15.247(a)(2)	Bandwidth	APPENDIX E	PASS	-----
15.247(b)(3)	Maximum Average Output Power	APPENDIX F	PASS	-----
15.247(d)	Conducted Spurious Emissions	APPENDIX G	PASS	-----
15.247(e)	Power Spectral Density	APPENDIX H	PASS	-----
15.203	Antenna Requirement	-----	PASS	Note (2)

Note:

- (1) "N/A" denotes test is not applicable in this test report.
- (2) The device what use a permanently attached antenna were considered sufficient to comply with the provisions of 15.203.

2.1 TEST FACILITY

The test facilities used to collect the test data in this report is at the location of No.3,Jinshagang 1st Road, Shixia, Dalang Town, Dongguan, Guangdong, China.

BTL's Test Firm Registration Number for FCC: 357015

BTL's Designation Number for FCC: CN1240

2.2 MEASUREMENT UNCERTAINTY

ISO/IEC 17025 requires that an estimate of the measurement uncertainties associated with the emissions test results be included in the report. The measurement uncertainties given below are based on a 95% confidence level (based on a coverage factor (k=2))

The BTL measurement uncertainty as below table:

A. AC power line conducted emissions test:

Test Site	Method	Measurement Frequency Range	U, (dB)
DG-C02	CISPR	150 kHz ~ 30 MHz	2.32

B. Radiated emissions test:

Test Site	Method	Measurement Frequency Range	Ant. H / V	U, (dB)
DG-CB03	CISPR	9 KHz~30 MHz	V	3.79
		9 KHz~30 MHz	H	3.57
		30 MHz~200 MHz	V	3.82
		30 MHz~200 MHz	H	3.78
		200 MHz~1,000 MHz	V	4.10
		200 MHz~1,000 MHz	H	4.06
		1 GHz~18 GHz	V	3.12
		1 GHz~18 GHz	H	3.68
		18 GHz~40 GHz	V	4.15
		18 GHz~40 GHz	H	4.14

Note: Unless specifically mentioned, the uncertainty of measurement has not been taken into account to declare the compliance or non-compliance to the specification.

3. GENERAL INFORMATION

3.1 GENERAL DESCRIPTION OF EUT

Equipment	AX1500 Wi-Fi 6 Router
Brand Name	tp-link
Test Model	Archer AX10, Archer AX1500
Series Model	N/A
Model Difference(s)	Only differ in model name.
Software Version	ver1-0-0-P1[20190430-rel14274]
Hardware Version	1.0
Power Source	DC voltage supplied from AC/DC adapter. Brand / Model: AMIGO / AMS159A-1201000FU
Power Rating	I/P: 100-240V~ 50-60Hz 0.5A O/P: 12V --- 1.0A
Operation Frequency	2412 MHz ~ 2462 MHz
Modulation Type	IEEE 802.11b: DSSS IEEE 802.11g: OFDM IEEE 802.11n: OFDM
Bit Rate of Transmitter	IEEE 802.11b: 11/5.5/2/1 Mbps IEEE 802.11g: 54/48/36/24/18/12/9/6 Mbps IEEE 802.11n: up to 300 Mbps
Maximum Average Output Power	IEEE 802.11b: 18.49 dBm (0.0706 W) IEEE 802.11g: 22.14 dBm (0.1637 W) IEEE 802.11n (HT20): 22.90 dBm (0.1950 W) IEEE 802.11n (HT40): 16.78 dBm (0.0476 W)

Note:

1. For a more detailed features description, please refer to the manufacturer's specifications or the user's manual.

2. Channel List:

CH01 - CH11 for IEEE 802.11b, IEEE 802.11g, IEEE 802.11n (HT20) CH03 - CH09 for IEEE 802.11n (HT40)							
Channel	Frequency (MHz)	Channel	Frequency (MHz)	Channel	Frequency (MHz)	Channel	Frequency (MHz)
01	2412	04	2427	07	2442	10	2457
02	2417	05	2432	08	2447	11	2462
03	2422	06	2437	09	2452		

3. Antenna Specification:

Ant.	Brand	P/N	Antenna Type	Connector	Gain (dBi)
1	TP-LINK	3101502558	Dipole	Weld	3.82
2	TP-LINK	3101502557	Dipole	Weld	3.82

Note: This EUT supports CDD, and all antennas have the same gain,
 Directional gain = $G_{ANT} + \text{Array Gain}$, where Array Gain is as follows:

For power spectral density measurements, $N_{ANT} = 2, N_{SS} = 1$.

So Directional gain = $G_{ANT} + \text{Array Gain} = 10 \log(N_{ANT}/N_{SS}) \text{ dB}$
 $= 3.82 + 10 \log(2/1) \text{ dBi} = 6.83$.

Then, the power density limit is $8 - (6.83 - 6) = 7.17$.

For power measurements, Array Gain = 0 dB ($N_{ANT} \leq 4$), so the Directional gain = 3.82.

4. Table for Antenna Configuration:

Operating Mode	TX Mode	
	1X	2TX
IEEE 802.11b	Ant. 1	-
IEEE 802.11g	-	V (Ant. 1 + Ant. 2)
IEEE 802.11n (HT20)	-	V (Ant. 1 + Ant. 2)
IEEE 802.11n (HT40)	-	V (Ant. 1 + Ant. 2)

3.2 DESCRIPTION OF TEST MODES

The test system was pre-tested based on the consideration of all possible combinations of EUT operation mode.

Pretest Mode	Description
Mode 1	TX B Mode Channel 01/06/11
Mode 2	TX G Mode Channel 01/06/11
Mode 3	TX N-20 MHz Mode Channel 01/06/11
Mode 4	TX N-40 MHz Mode Channel 03/06/09
Mode 5	TX B Mode Channel 01/02/06/10/11
Mode 6	TX G Mode Channel 01/02/06/10/11
Mode 7	TX N-20 MHz Mode Channel 01/02/06/10/11
Mode 8	TX N-40 MHz Mode Channel 03/04/06/08/09
Mode 9	TX N-20 MHz Mode Channel 06

Following mode(s) as (were) found to be the worst case(s) and selected for the final test.

AC power line conducted emissions test	
Final Test Mode:	Description
Mode 5	TX N-20 MHz Mode Channel 06

Radiated emissions test - Below 1GHz	
Final Test Mode:	Description
Mode 5	TX N-20 MHz Mode Channel 06

Radiated emissions test- Above 1GHz	
Final Test Mode:	Description
Mode 1	TX B Mode Channel 01/06/11
Mode 2	TX G Mode Channel 01/06/11
Mode 3	TX N-20 MHz Mode Channel 01/06/11
Mode 4	TX N-40 MHz Mode Channel 03/06/09
Mode 5	TX B Mode Channel 01/02/06/10/11
Mode 6	TX G Mode Channel 01/02/06/10/11
Mode 7	TX N-20 MHz Mode Channel 01/02/06/10/11
Mode 8	TX N-40 MHz Mode Channel 03/04/06/08/09

Conducted test	
Final Test Mode:	Description
Mode 1	TX B Mode Channel 01/06/11
Mode 2	TX G Mode Channel 01/06/11
Mode 3	TX N-20 MHz Mode Channel 01/06/11
Mode 4	TX N-40 MHz Mode Channel 03/06/09

NOTE:

- (1) The measurements are performed at the high, middle, low available channels.
- (2) All the bit rate of transmitter have been tested and found the lowest rate is found to be the worst case and recorded.
- (3) For radiated emission below 1 GHz test, the IEEE 802.11n20 channel 06 is found to be the worst case and recorded.
- (4) For radiated emission above 1 GHz test, 1GHz~26.5GHz have been pre-tested and in this report only recorded the worst case. The remaining spurious points are all below the limit value of 20dB.

3.3 PARAMETERS OF TEST SOFTWARE

Test Software	accessMTool v3.1.0.3		
Frequency (MHz)	2412	2437	2462
IEEE 802.11b	72	75	72
IEEE 802.11g	44	76	43
IEEE 802.11n (HT20)	44	78	43
Frequency (MHz)	2422	2437	2452
IEEE 802.11n (HT40)	41	53	42

3.4 DUTY CYCLE

If duty cycle is $\geq 98\%$, duty factor is not required.
 If duty cycle is $< 98\%$, duty factor shall be considered.
 The output power = measured power + duty factor.

IEEE 802.11b

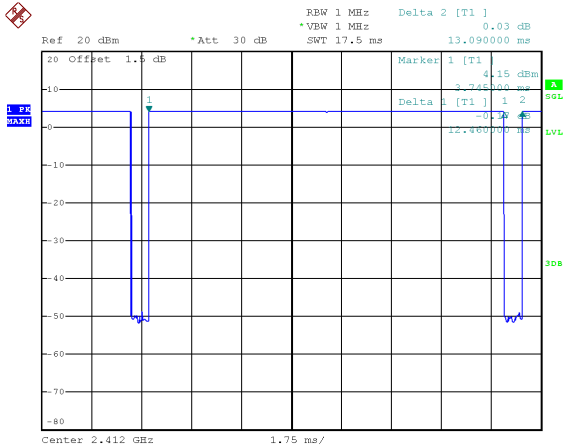

Date: 11.JUN.2019 14:38:16

Duty cycle = $12.460 \text{ ms} / 13.090 \text{ ms} = 95.19\%$
 Duty Factor = $10 \log(1/\text{Duty cycle}) = 0.21$
IEEE 802.11n (HT20)

IEEE 802.11g

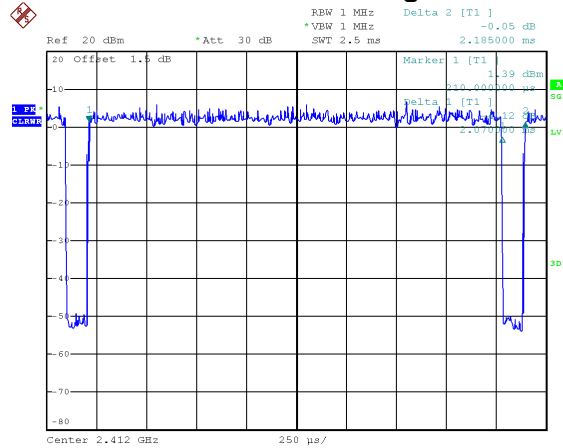

Date: 11.JUN.2019 14:38:44

Duty cycle = $2.070 \text{ ms} / 2.185 \text{ ms} = 94.74\%$
 Duty Factor = $10 \log(1/\text{Duty cycle}) = 0.23$
IEEE 802.11n (HT40)

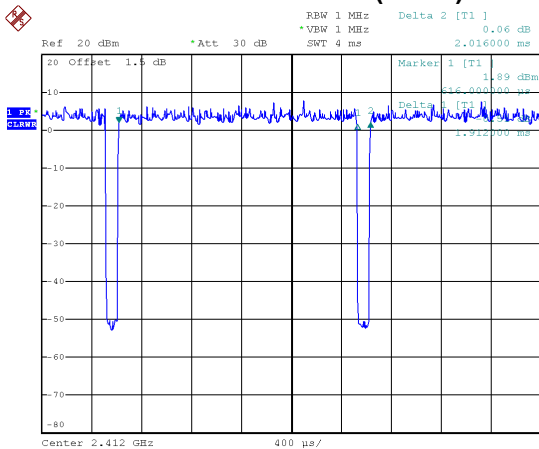

Date: 11.JUN.2019 14:39:04

Duty cycle = $1.912 \text{ ms} / 2.016 \text{ ms} = 94.84\%$
 Duty Factor = $10 \log(1/\text{Duty cycle}) = 0.23$,

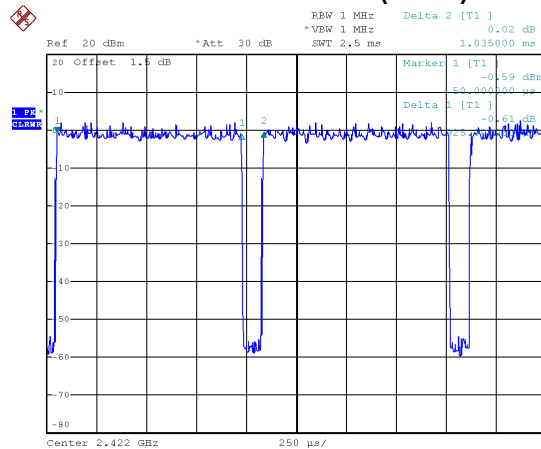

Date: 11.JUN.2019 14:39:43

Duty cycle = $0.925 \text{ ms} / 1.035 \text{ ms} = 89.37\%$
 Duty Factor = $10 \log(1/\text{Duty cycle}) = 0.49$

NOTE:

For IEEE 802.11g and IEEE 802.11n (HT20):
 For radiated emissions frequency above 1 GHz, the resolution bandwidth of test receiver/spectrum analyzer is 1 MHz and the video bandwidth is 1 kHz (Duty cycle $< 98\%$).

For IEEE 802.11n (HT40):

For radiated emissions frequency above 1 GHz, the resolution bandwidth of test receiver/spectrum analyzer is 1 MHz and the video bandwidth is 2 kHz (Duty cycle $< 98\%$).

3.5 BLOCK DIAGRAM SHOWING THE CONFIGURATION OF SYSTEM TESTED

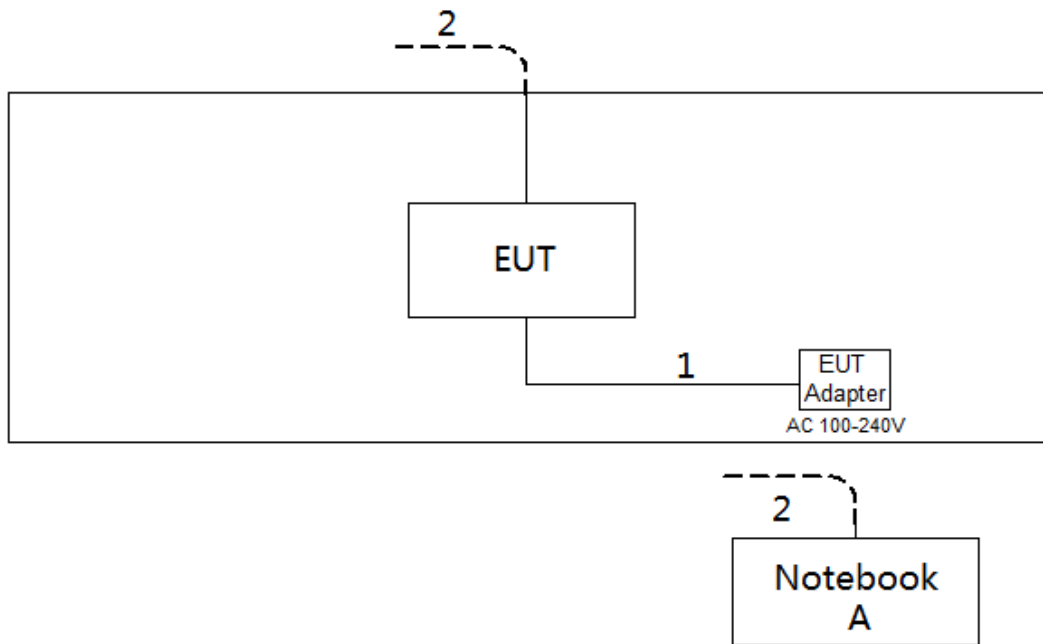

3.6 SUPPORT UNITS

Item	Equipment	Brand	Model No.	Series No.
A	Notebook	Dell	Inspiron 15-7559	N/A

Item	Cable Type	Shielded Type	Ferrite Core	Length
1	DC Cable	NO	NO	1.5m
2	RJ45 Cable	NO	NO	10m

4. AC POWER LINE CONDUCTED EMISSIONS TEST

4.1 LIMIT

Frequency of Emission (MHz)	Limit (dB μ V)	
	Quasi-peak	Average
0.15 - 0.50	66 to 56*	56 to 46*
0.50 - 5.0	56	46
5.0 - 30.0	60	50

NOTE:

- (1) The tighter limit applies at the band edges.
- (2) The limit of " * " marked band means the limitation decreases linearly with the logarithm of the frequency in the range.

The following table is the setting of the receiver

Receiver Parameters	Setting
Attenuation	10 dB
Start Frequency	0.15 MHz
Stop Frequency	30 MHz
IF Bandwidth	9 kHz

4.2 TEST PROCEDURE

- a. The EUT was placed 0.8 meters from the horizontal ground plane with EUT being connected to the power mains through a line impedance stabilization network (LISN). All other support equipment powered from additional LISN(s). The LISN provide 50 Ohm/ 50uH of coupling impedance for the measuring instrument.
- b. Interconnecting cables that hang closer than 40 cm to the ground plane shall be folded back and forth in the center forming a bundle 30 to 40 cm long.
- c. I/O cables that are not connected to a peripheral shall be bundled in the center. The end of the cable may be terminated, if required, using the correct terminating impedance. The overall length shall not exceed 1 m.
- d. LISN at least 80 cm from nearest part of EUT chassis.
- e. For the actual test configuration, please refer to the related Item -EUT Test Photos.

4.3 DEVIATION FROM TEST STANDARD

No deviation

4.4 TEST SETUP

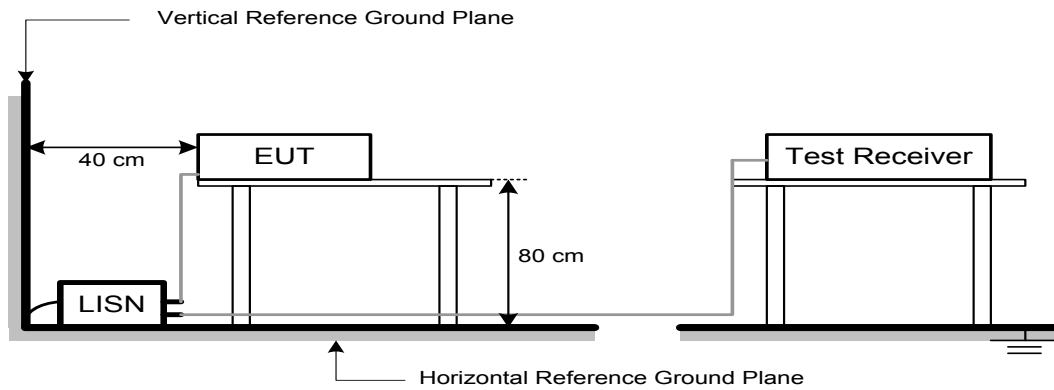

4.5 EUT OPERATION CONDITIONS

EUT was programmed to be in continuously transmitting mode.

4.6 EUT TEST CONDITIONS

Temperature: 25°C Relative Humidity: 53% Test Voltage: AC 120V/60Hz

4.7 TEST RESULTS

Please refer to the APPENDIX A.

5. RADIATED EMISSIONS TEST

5.1 LIMIT

In case the emission fall within the restricted band specified on 15.205(a), then the 15.209(a) limit in the table below has to be followed.

LIMITS OF RADIATED EMISSION MEASUREMENT (9 kHz-1000 MHz)

Frequency (MHz)	Field Strength (microvolts/meter)	Measurement Distance (meters)
0.009-0.490	2400/F(kHz)	300
0.490-1.705	24000/F(kHz)	30
1.705-30.0	30	30
30-88	100	3
88-216	150	3
216-960	200	3
Above 960	500	3

LIMITS OF RADIATED EMISSION MEASUREMENT (Above 1000 MHz)

Frequency (MHz)	(dBuV/m at 3 m)	
	Peak	Average
Above 1000	74	54

NOTE:

- (1) The limit for radiated test was performed according to FCC PART 15C.
- (2) The tighter limit applies at the band edges.
- (3) Emission level (dBuV/m)=20log Emission level (uV/m).
- (4) The test result calculated as following:
 Measurement Value = Reading Level + Correct Factor
 Correct Factor = Antenna Factor + Cable Loss - Amplifier Gain(if use)
 Margin Level = Measurement Value - Limit Value

Spectrum Parameter	Setting
Attenuation	Auto
Start Frequency	1000 MHz
Stop Frequency	10th carrier harmonic
RBW / VBW (Emission in restricted band)	1 MHz / 3 MHz for Peak, 1 MHz / 1/T for Average

Receiver Parameter	Setting
Attenuation	Auto
Start ~ Stop Frequency	9 kHz~90 kHz for PK/AVG detector
Start ~ Stop Frequency	90 kHz~110 kHz for QP detector
Start ~ Stop Frequency	110 kHz~490 kHz for PK/AVG detector
Start ~ Stop Frequency	490 kHz~30 MHz for QP detector
Start ~ Stop Frequency	30 MHz~1000 MHz for QP detector

5.2 TEST PROCEDURE

- a. The measuring distance of 3 m shall be used for measurements. The EUT was placed on the top of a rotating table 0.8 meter above the ground at a 3 meter semi-anechoic chamber. The table was rotated 360 degrees to determine the position of the highest radiation.(below 1 GHz)
- b. The measuring distance of 3 m shall be used for measurements. The EUT was placed on the top of a rotating table 1.5 meter above the ground at a 3 meter semi-anechoic chamber. The table was rotated 360 degrees to determine the position of the highest radiation.(above 1 GHz)
- c. The height of the equipment or of the substitution antenna shall be 0.8m or 1.5m; the height of the test antenna shall vary between 1 m to 4 m. Both horizontal and vertical polarizations of the antenna are set to make the measurement.
- d. For each suspected emission, the EUT was arranged to its worst case and then the antenna was tuned to heights find the maximum reading (used Bore sight function).
- e. The receiver system was set to peak and average detect function and specified bandwidth with maximum hold mode when the test frequency is above 1 GHz.
- f. The initial step in collecting radiated emission data is a receiver peak detector mode pre-scanning the measurement frequency range. Significant peaks are then marked and then Quasi Peak detector mode re-measured.
- g. All readings are Peak unless otherwise stated QP in column of Note. Peak denotes that the Peak reading compliance with the QP Limits and then QP Mode measurement didn't perform. (below 1 GHz)
- h. All readings are Peak Mode value unless otherwise stated AVG in column of Note. If the Peak Mode Measured value compliance with the Peak Limits and lower than AVG Limits, the EUT shall be deemed to meet both Peak & AVG Limits and then only Peak Mode was measured, but AVG Mode didn't perform. (above 1 GHz)
- i. For the actual test configuration, please refer to the related Item -EUT Test Photos.

5.3 DEVIATION FROM TEST STANDARD

No deviation

5.4 TEST SETUP

9 kHz-30 MHz

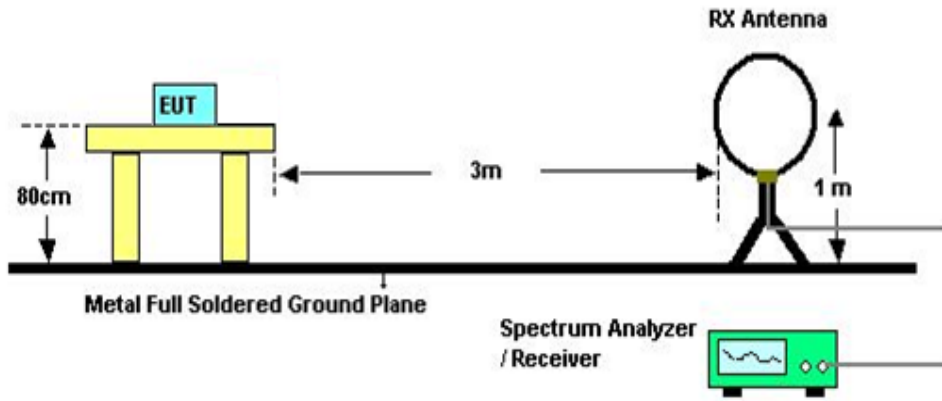

30 MHz to 1 GHz

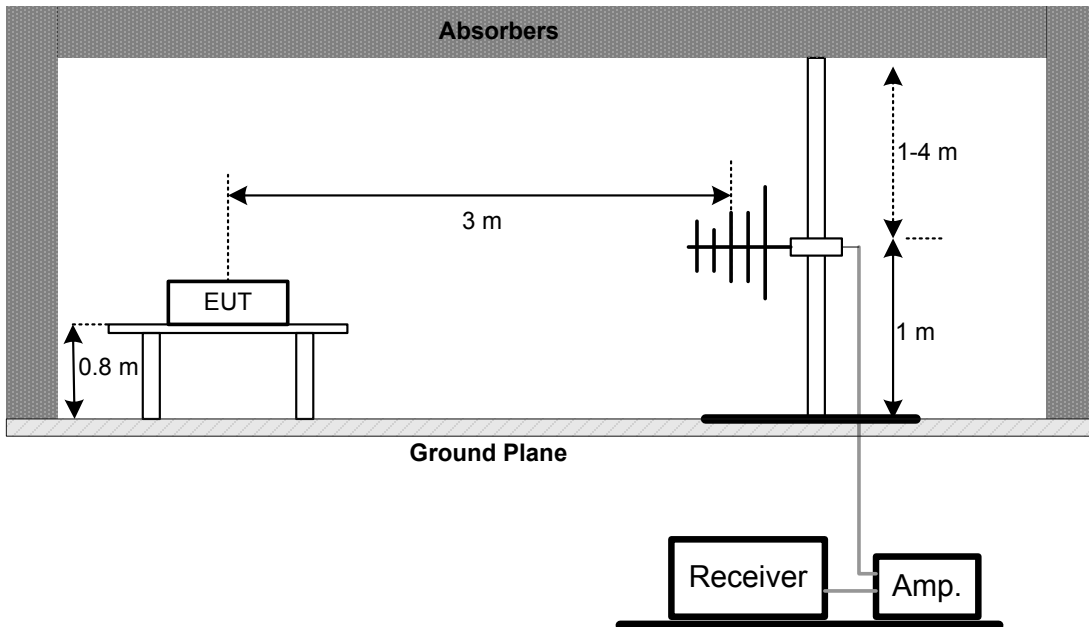

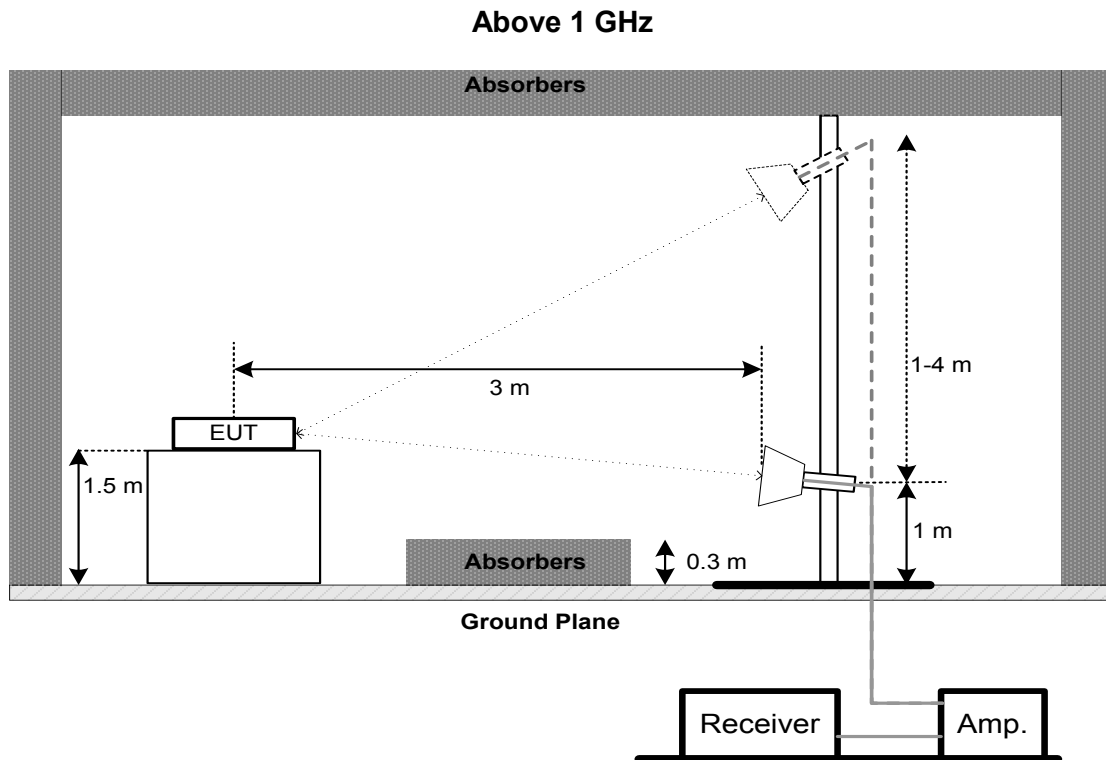

5.5 EUT OPERATION CONDITIONS

The EUT was programmed to be in continuously transmitting mode.

5.6 EUT TEST CONDITIONS

Temperature: 26°C Relative Humidity: 66% Test Voltage: AC 120V/60Hz

5.7 TEST RESULTS - 9 KHZ TO 30 MHZ

Please refer to the APPENDIX B

Remark:

- (1) Distance extrapolation factor = $40 \log (\text{specific distance} / \text{test distance})$ (dB).
- (2) Limit line = specific limits (dBuV) + distance extrapolation factor.

5.8 TEST RESULTS - 30 MHZ TO 1000 MHZ

Please refer to the APPENDIX C.

5.9 TEST RESULTS - ABOVE 1000 MHZ

Please refer to the APPENDIX D.

Remark:

- (1) No limit: This is fundamental signal, the judgment is not applicable.
For fundamental signal judgment was referred to Peak output test.

6. BANDWIDTH TEST

6.1 LIMIT

FCC Part15, Subpart C (15.247)		
Section	Test Item	Limit
15.247(a)(2)	6 dB Bandwidth	Minimum 500 kHz
	99% Emission Bandwidth	-

6.2 TEST PROCEDURE

- a. The EUT was directly connected to the spectrum analyzer and antenna output port as show in the block diagram below.
- b. Spectrum Setting:
 - For 6 dB Bandwidth : RBW= 100 kHz, VBW=300 kHz, Sweep time = 2.5 ms.
 - For 99% Emission Bandwidth B/G/N-20 Mode: RBW= 300 KHz, VBW=1 MHz, Sweep time = 2.5 ms.
 - For 99% Emission Bandwidth N-40 Mode: RBW= 1 MHz, VBW=3 MHz, Sweep time = 2.5 ms.
- c. The bandwidth was performed in accordance with method 11.8.1 of ANSI C63.10-2013.

6.3 DEVIATION FROM STANDARD

No deviation.

6.4 TEST SETUP



6.5 EUT OPERATION CONDITIONS

The EUT was programmed to be in continuously transmitting mode.

6.6 EUT TEST CONDITIONS

Temperature: 23°C Relative Humidity: 64% Test Voltage: AC 120V/60Hz

6.7 TEST RESULTS

Please refer to the APPENDIX E.

7. MAXIMUM AVERAGE OUTPUT POWER TEST

7.1 LIMIT

FCC Part15, Subpart C (15.247)		
Section	Test Item	Limit
15.247(b)(3)	Maximum Average Output Power	1 Watt or 30dBm

7.2 TEST PROCEDURE

- a. The EUT was directly connected to the power meter and antenna output port as show in the block diagram below.
- b. The maximum conducted output power was performed in accordance with method 11.9.2.3.1 of ANSI C63.10-2013 and FCC KDB 662911 D01 v02r01 Multiple Transmitter Output.

7.3 DEVIATION FROM STANDARD

No deviation.

7.4 TEST SETUP



7.5 EUT OPERATION CONDITIONS

The EUT was programmed to be in continuously transmitting mode.

7.6 EUT TEST CONDITIONS

Temperature: 23°C Relative Humidity: 64% Test Voltage: AC 120V/60Hz

7.7 TEST RESULTS

Please refer to the APPENDIX F.

8. CONDUCTED SPURIOUS EMISSIONS

8.1 LIMIT

In any 100 kHz bandwidth outside the frequency band in which the spread spectrum or digitally modulated intentional radiator is operating, the radio frequency power that is produced by the intentional radiator shall be at least 20 dB below that in the 100 kHz bandwidth within the band that contains the highest level of the desired power, based on either an RF conducted or a radiated measurement, provided the transmitter demonstrates compliance with the peak Output Power limits. If the transmitter complies with the Output Power limits based on the use of RMS averaging over a time interval, as permitted under paragraph (b)(3) of this section, the attenuation required under this paragraph shall be 30 dB instead of 20 dB. Attenuation below the general limits specified in Section 15.209(a) is not required.

8.2 TEST PROCEDURE

- a. The EUT was directly connected to the spectrum analyzer and antenna output port as show in the block diagram below.
- b. Spectrum Setting: RBW= 100 kHz, VBW=300 kHz, Sweep time = Auto.

8.3 DEVIATION FROM STANDARD

No deviation.

8.4 TEST SETUP



8.5 EUT OPERATION CONDITIONS

The EUT was programmed to be in continuously transmitting mode.

8.6 EUT TEST CONDITIONS

Temperature: 23°C Relative Humidity: 64% Test Voltage: AC 120V/60Hz

8.7 TEST RESULTS

Please refer to the APPENDIX G.

9. POWER SPECTRAL DENSITY TEST

9.1 LIMIT

FCC Part15, Subpart C (15.247)		
Section	Test Item	Limit
15.247(e)	Power Spectral Density	8 dBm (in any 3 kHz)

9.2 TEST PROCEDURE

- a. The EUT was directly connected to the spectrum analyzer and antenna output port as show in the block diagram below.
- b. Spectrum Setting: RBW=3 kHz, VBW=10 kHz, Sweep time = Auto.
- c. The Power Spectral Density was performed in accordance with method 11.10.2 of ANSI C63.10-2013.

9.3 DEVIATION FROM STANDARD

No deviation.

9.4 TEST SETUP

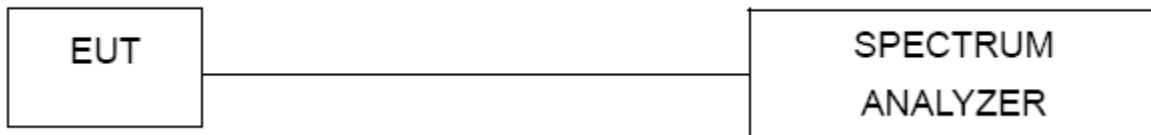

9.5 EUT OPERATION CONDITIONS

The EUT was programmed to be in continuously transmitting mode.

9.6 EUT TEST CONDITIONS

Temperature: 23°C Relative Humidity: 64% Test Voltage: AC 120V/60Hz

9.7 TEST RESULTS

Please refer to the APPENDIX H.

10. MEASUREMENT INSTRUMENTS LIST

AC Power Line Conducted Emissions					
Item	Kind of Equipment	Manufacturer	Type No.	Serial No.	Calibrated until
1	EMI Test Receiver	R&S	ESCI	100382	Mar. 10, 2020
2	LISN	EMCO	3816/2	52765	Mar. 10, 2020
3	50ohm Terminator	SHX	TF5-3	15041305	Mar. 10, 2020
4	Artificial-Mains Network	SCHWARZBECK	NSLK 8127	8127685	Mar. 10, 2020
5	TRANSIENT LIMITER	EM	EM-7600	772	Mar. 10, 2020
6	Measurement Software	Farad	EZ-EMC Ver.NB-03A1-01	N/A	N/A
7	Cable	N/A	RG223	12m	Mar. 12, 2020

Radiated Emissions - 9 kHz to 30 MHz					
Item	Kind of Equipment	Manufacturer	Type No.	Serial No.	Calibrated until
1	Loop Antenna	EM	EM-6876-1	230	Jan. 15, 2020
2	Cable	N/A	RG 213/U	C-102	May 31, 2020
3	EMI Test Receiver	R&S	ESCI	100895	Mar. 10, 2020
4	Measurement Software	Farad	EZ-EMC Ver.NB-03A1-01	N/A	N/A

Radiated Emissions - 30 MHz to 1 GHz					
Item	Kind of Equipment	Manufacturer	Type No.	Serial No.	Calibrated until
1	Antenna	Schwarzbeck	VULB9160	9160-3232	Mar. 09, 2020
2	Amplifier	HP	8447D	2944A09673	Aug. 11, 2019
3	Receiver	Agilent	N9038A	MY52130039	Aug. 11, 2019
4	Cable	emci	LMR-400(30MHz-1GHz)(8m+5m)	N/A	May 24, 2020
5	Controller	CT	SC100	N/A	N/A
6	Controller	MF	MF-7802	MF780208416	N/A
7	Measurement Software	Farad	EZ-EMC Ver.NB-03A1-01	N/A	N/A

Radiated Emissions - Above 1 GHz					
Item	Kind of Equipment	Manufacturer	Type No.	Serial No.	Calibrated until
1	Double Ridged Guide Antenna	ETS	3115	75789	Mar. 09, 2020
2	Broad-Band Horn Antenna	Schwarzbeck	BBHA 9170	9170319	Jun. 23, 2020
3	Amplifier	Agilent	8449B	3008A02333	Mar. 10, 2020
4	Microwave Preamplifier With Adaptor	EMC INSTRUMENT	EMC2654045	980039 & HA01	Mar. 10, 2020
5	Receiver	Agilent	N9038A	MY52130039	Aug. 11, 2019
6	Controller	CT	SC100	N/A	N/A
7	Controller	MF	MF-7802	MF780208416	N/A
8	Cable	mitron	B10-01-01-12M	18072744	Jul. 30, 2019
9	Measurement Software	Farad	EZ-EMC Ver.NB-03A1-01	N/A	N/A

Bandwidth & Antenna Conducted Spurious Emissions & Power Spectral Density					
Item	Kind of Equipment	Manufacturer	Type No.	Serial No.	Calibrated until
1	Spectrum Analyzer	R&S	FSP40	100185	Aug. 11, 2019

Maximum Output Power					
Item	Kind of Equipment	Manufacturer	Type No.	Serial No.	Calibrated until
1	Peak Power Analyzer	Keysight	8990B	MY51000506	Nov. 26, 2019
2	Wideband power sensor	Keysight	N1923A	MY58310004	Nov. 26, 2019

Remark: "N/A" denotes no model name, serial no. or calibration specified.
 All calibration period of equipment list is one year.

11. EUT TEST PHOTO**AC Power Line Conducted Emissions Test Photos**

Radiated Emissions Test Photos

9 kHz to 30 MHz



Radiated Emissions Test Photos

30 MHz to 1 GHz

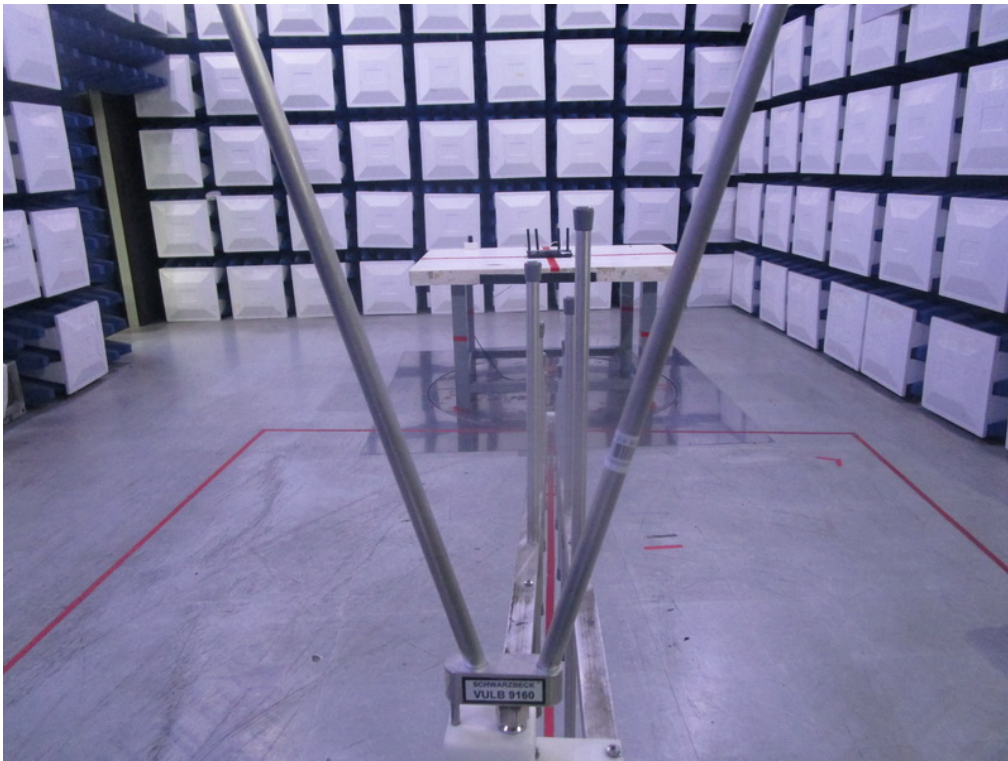

Radiated Emissions Test Photos
Above 1 GHz

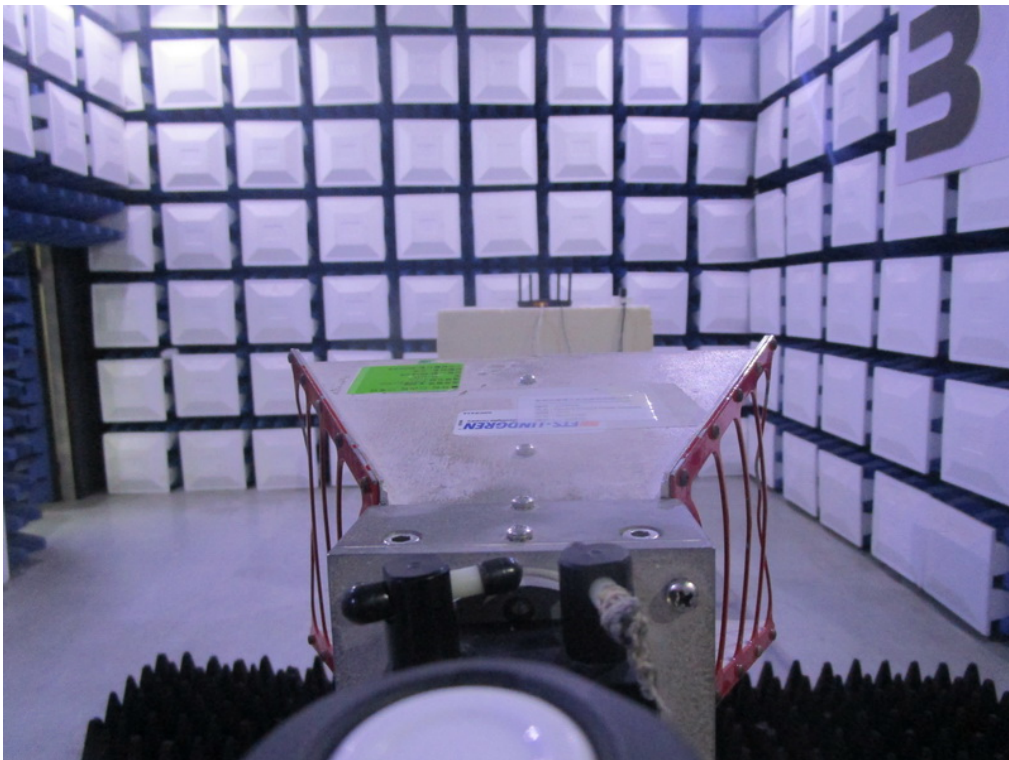
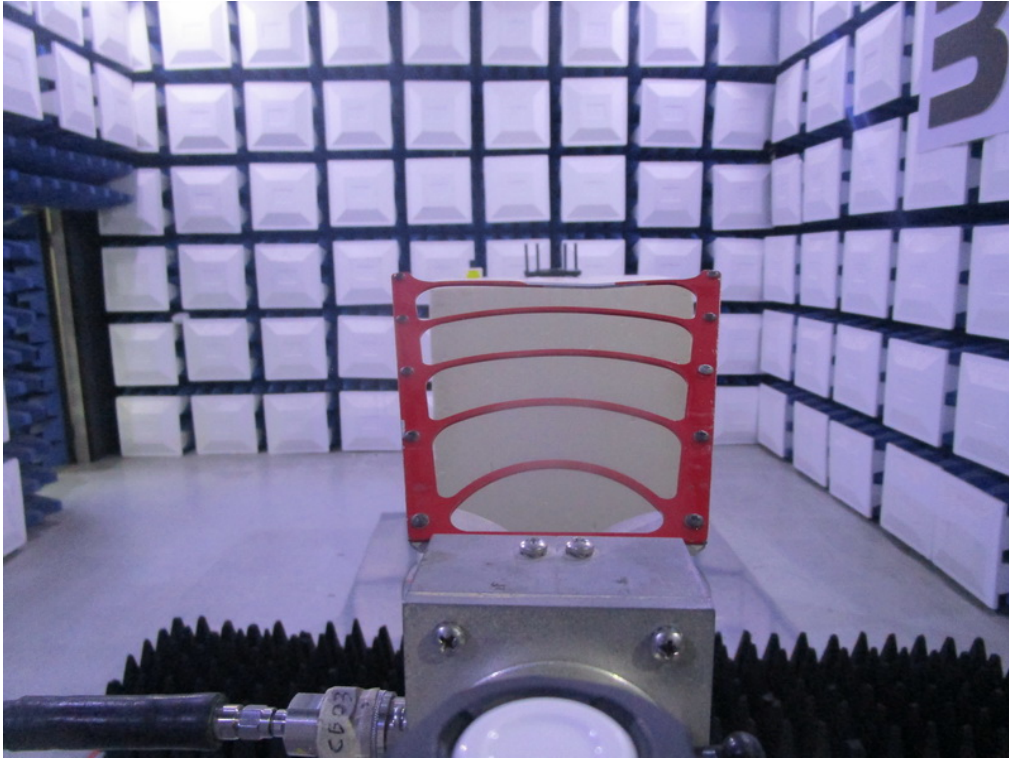

APPENDIX A - AC POWER LINE CONDUCTED EMISSIONS

Test Mode: TX N20 MODE CHANNEL 06

Line

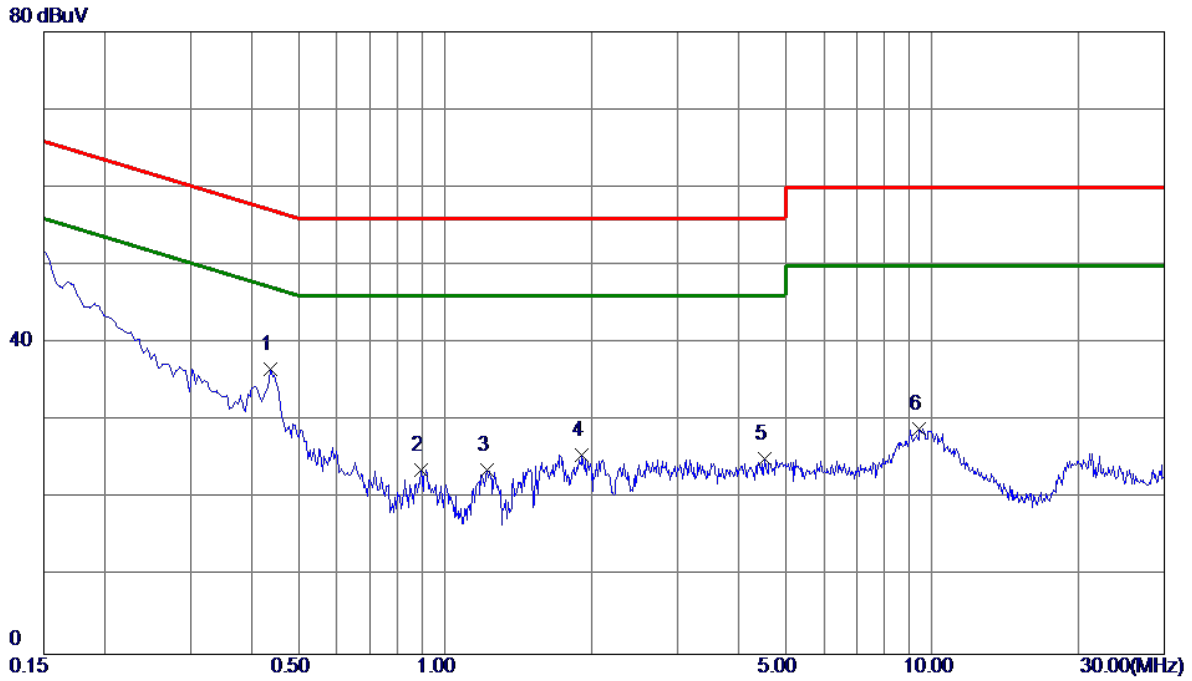

No.	Freq. MHz	Reading Level dBuV	Correct Factor dB	Measure ment dBuV	Limit dBuV	Margin dB	Detector	Comment
1 *	0.4380	26.76	9.87	36.63	57.10	-20.47	Peak	
2	0.8925	13.74	9.91	23.65	56.00	-32.35	Peak	
3	1.2164	13.81	9.94	23.75	56.00	-32.25	Peak	
4	1.9095	15.67	9.99	25.66	56.00	-30.34	Peak	
5	4.5420	14.98	10.16	25.14	56.00	-30.86	Peak	
6	9.4020	18.57	10.46	29.03	60.00	-30.97	Peak	

REMARKS:

- (1) Measurement Value = Reading Level + Correct Factor.
- (2) Margin Level = Measurement Value - Limit Value.

Test Mode: TX N20 MODE CHANNEL 06

Neutral

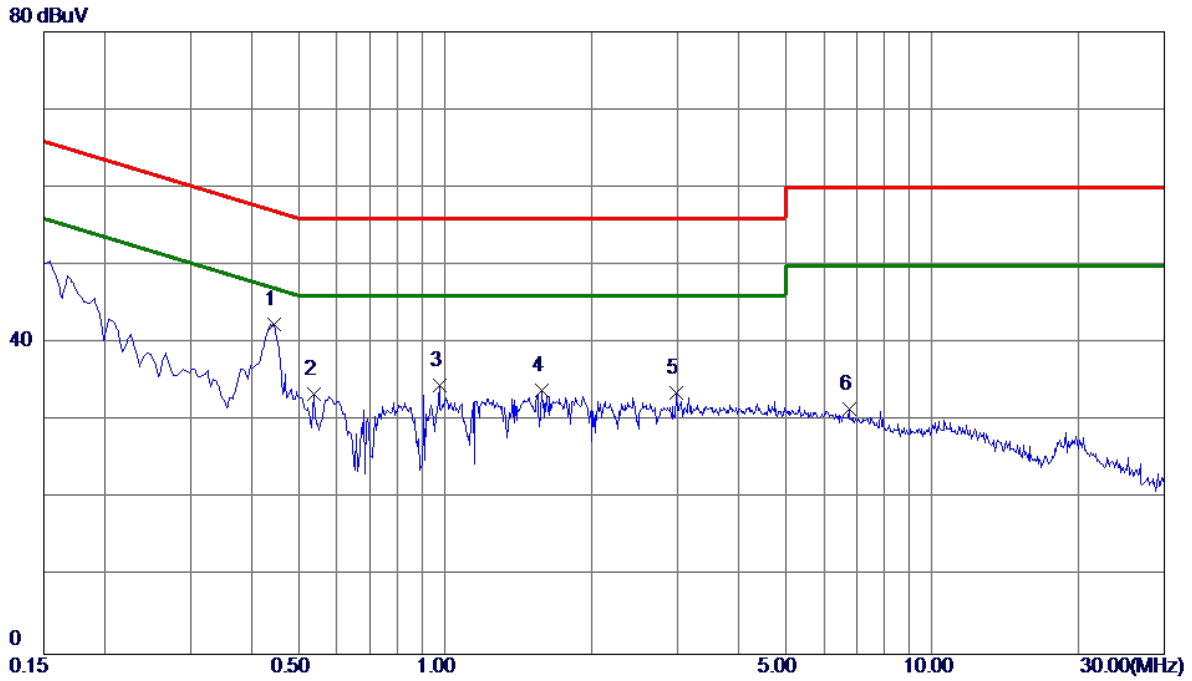

No.	Freq. MHz	Reading Level dBuV	Correct Factor dB	Measure ment dBuV	Limit dBuV	Margin dB	Detector	Comment
1 *	0.4470	32.44	10.02	42.46	56.93	-14.47	Peak	
2	0.5370	23.38	10.03	33.41	56.00	-22.59	Peak	
3	0.9735	24.41	10.11	34.52	56.00	-21.48	Peak	
4	1.5809	23.76	10.16	33.92	56.00	-22.08	Peak	
5	2.9895	23.36	10.25	33.61	56.00	-22.39	Peak	
6	6.7605	20.94	10.56	31.50	60.00	-28.50	Peak	

REMARKS:

- (1) Measurement Value = Reading Level + Correct Factor.
- (2) Margin Level = Measurement Value - Limit Value.

APPENDIX B - RADIATED EMISSION - 9 KHZ TO 30 MHZ

Test Mode: TX N20 MODE CHANNEL 06

Ant 0°

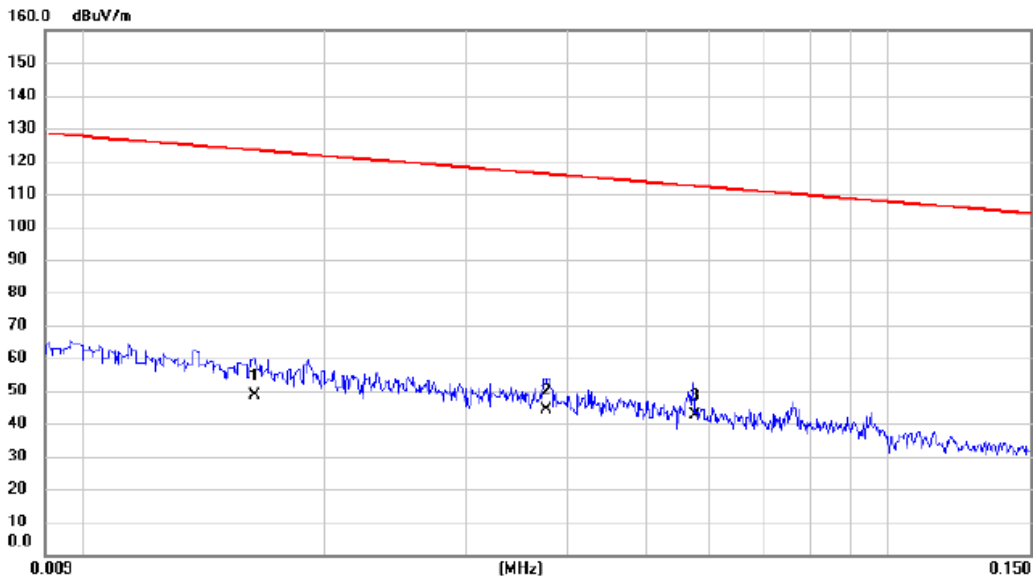

No.	Mk.	Freq.	Reading Level	Correct Factor	Measurement	Limit	Margin		
		MHz	dBuV	dB	dBuV/m	dBuV/m	dB	Detector	Comment
1		0.016	33.60	14.90	48.50	123.31	-74.81	AVG	
2		0.038	30.20	13.89	44.09	116.10	-72.01	AVG	
3	*	0.058	28.90	13.81	42.71	112.41	-69.70	AVG	

REMARKS:

- (1) Measurement Value = Reading Level + Correct Factor.
- (2) Margin Level = Measurement Value - Limit Value.

Test Mode: TX N20 MODE CHANNEL 06

Ant 0°

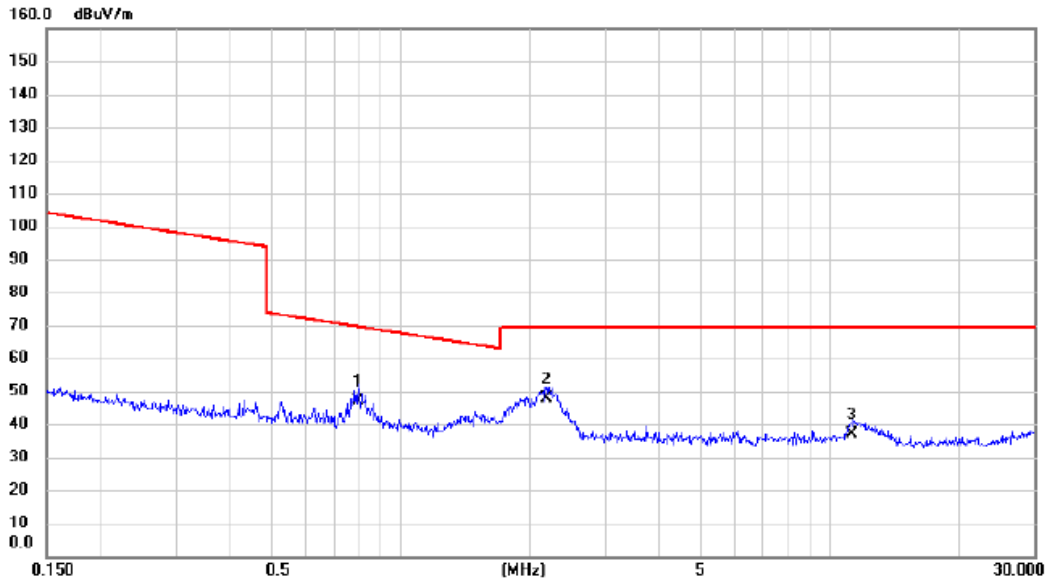

No.	Mk.	Freq. MHz	Reading Level dBuV	Correct Factor dB	Measure- ment dBuV/m	Limit dBuV/m	Margin dB	Detector	Comment
1		0.796	34.30	12.56	46.86	69.59	-22.73	QP	
2	*	2.190	36.10	11.71	47.81	69.54	-21.73	QP	
3		11.317	25.20	11.61	36.81	69.54	-32.73	QP	

REMARKS:

- (1) Measurement Value = Reading Level + Correct Factor.
- (2) Margin Level = Measurement Value - Limit Value.

Test Mode: TX N20 MODE CHANNEL 06

Ant 90°

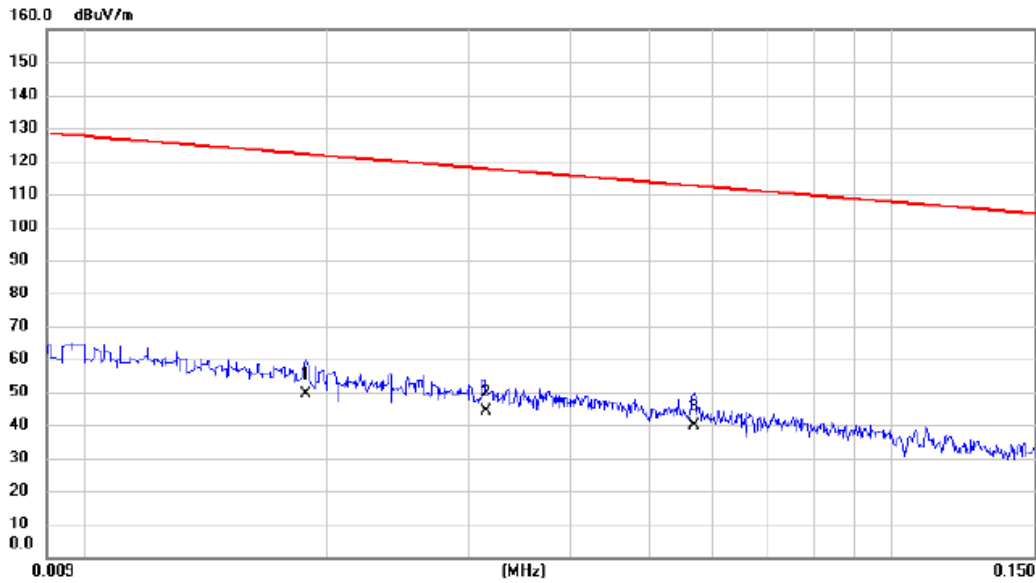

No.	Mk.	Freq. MHz	Reading Level dBuV	Correct Factor dB	Measure- ment dBuV/m	Limit dBuV/m	Margin dB	Detector	Comment
1		0.019	35.30	14.18	49.48	122.12	-72.64	AVG	
2		0.031	30.20	13.86	44.06	117.67	-73.61	AVG	
3	*	0.057	26.10	13.82	39.92	112.52	-72.60	AVG	

REMARKS:

- (1) Measurement Value = Reading Level + Correct Factor.
- (2) Margin Level = Measurement Value - Limit Value.

Test Mode: TX N20 MODE CHANNEL 06

Ant 90°

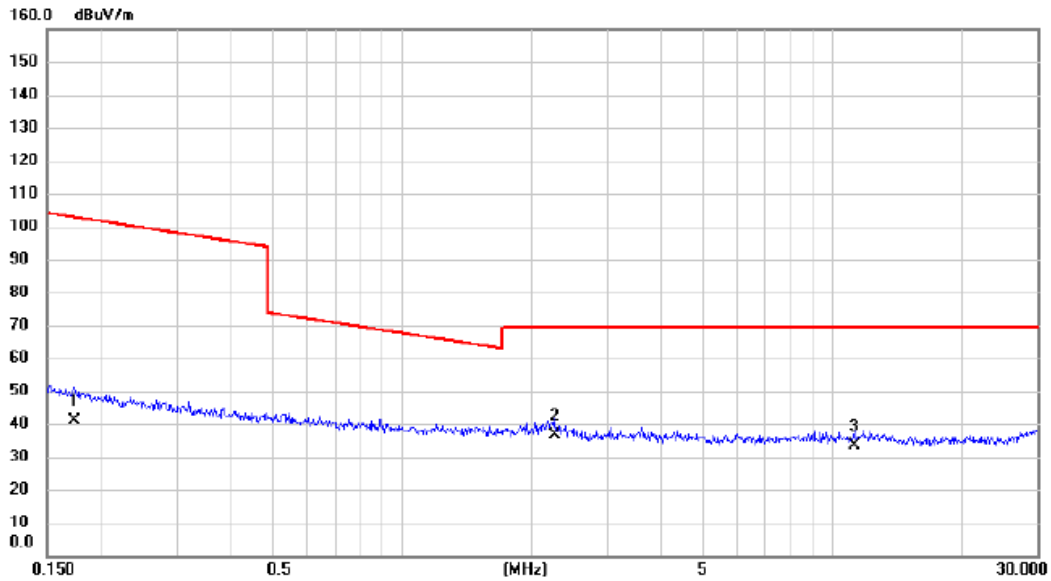

No.	Mk.	Freq. MHz	Reading Level dBuV	Correct Factor dB	Measure- ment dBuV/m	Limit dBuV/m	Margin dB	Detector	Comment
1		0.173	27.50	13.58	41.08	102.84	-61.76	AVG	
2	*	2.261	25.10	11.66	36.76	69.54	-32.78	QP	
3		11.257	21.60	11.61	33.21	69.54	-36.33	QP	

REMARKS:

- (1) Measurement Value = Reading Level + Correct Factor.
- (2) Margin Level = Measurement Value - Limit Value.

APPENDIX C - RADIATED EMISSION - 30 MHZ TO 1000 MHZ

Test Mode: TX N20 MODE CHANNEL 06

Vertical

80 dBuV/m

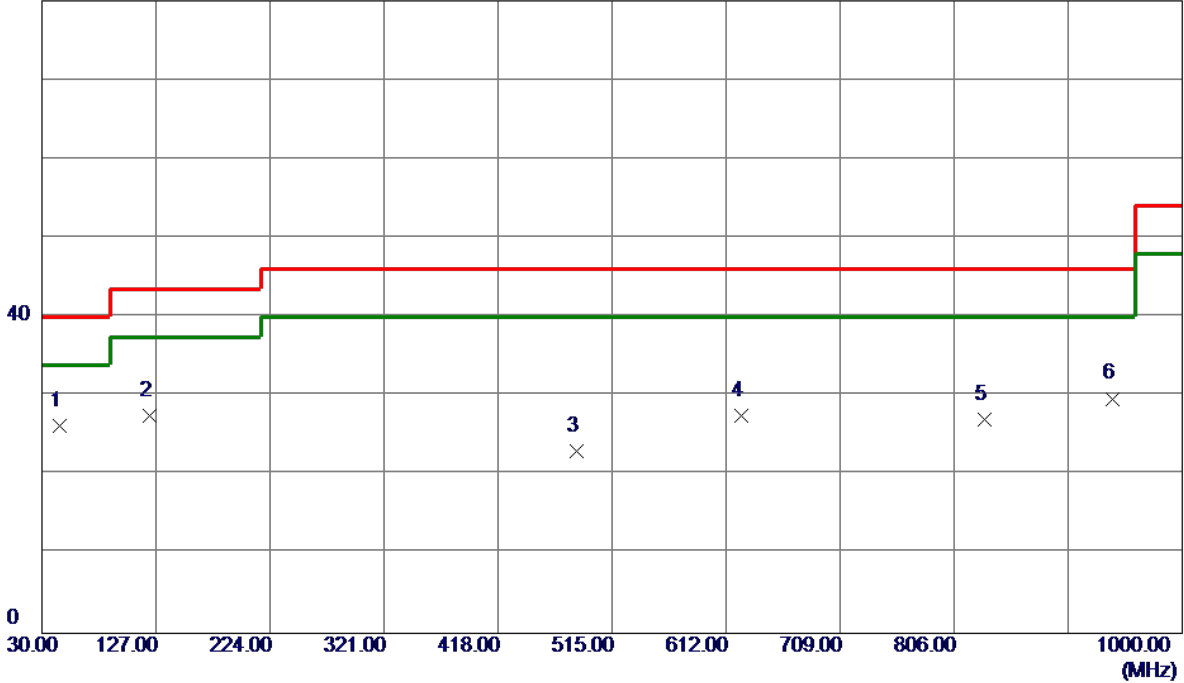

No.	Freq. MHz	Reading Level dBuV/m	Correct Factor dB	Measure ment dBuV/m	Limit dBuV/m	Margin dB	Detector	Comment
1 *	45.5200	40.56	-14.39	26.17	40.00	-13.83	Peak	
2	121.1800	40.69	-13.10	27.59	43.50	-15.91	Peak	
3	484.4450	30.92	-7.88	23.04	46.00	-22.96	Peak	
4	625.0949	32.71	-5.26	27.45	46.00	-18.55	Peak	
5	832.1900	29.68	-2.58	27.10	46.00	-18.90	Peak	
6	940.8300	30.60	-0.92	29.68	46.00	-16.32	Peak	

REMARKS:

- (1) Measurement Value = Reading Level + Correct Factor.
- (2) Margin Level = Measurement Value - Limit Value.

Test Mode: TX N20 MODE CHANNEL 06

Horizontal

80 dBuV/m

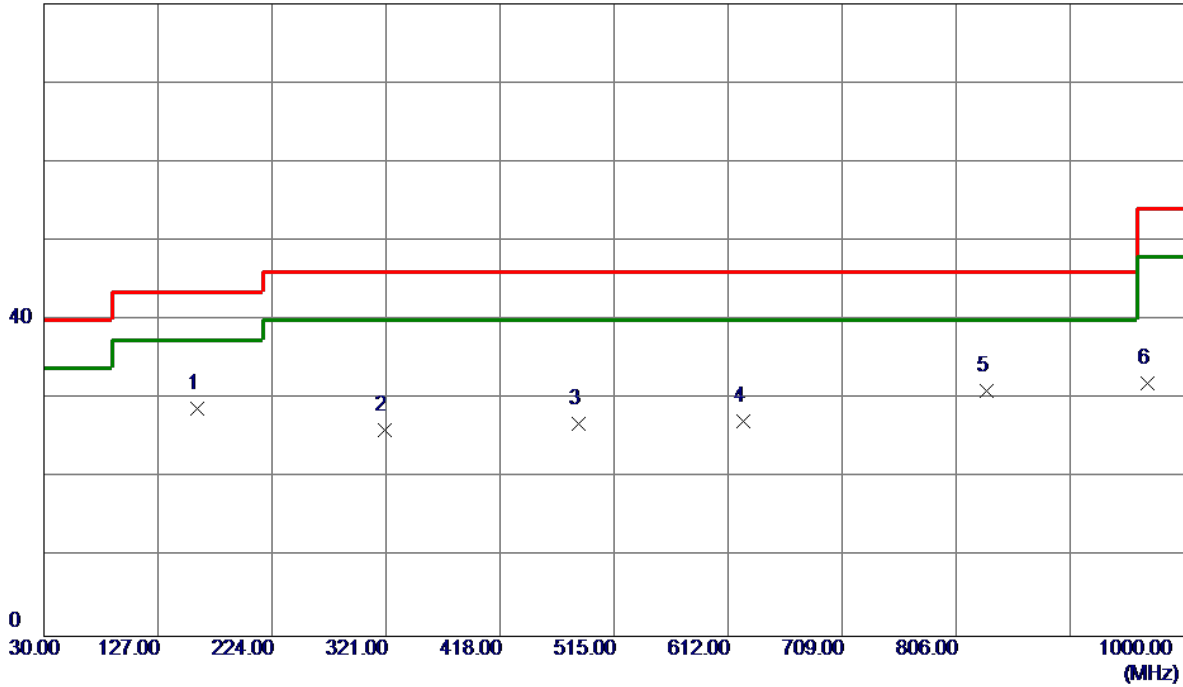

No.	Freq. MHz	Reading Level dBuV/m	Correct Factor dB	Measure ment dBuV/m	Limit dBuV/m	Margin dB	Detector	Comment
1 *	159.9800	39.84	-11.07	28.77	43.50	-14.73	Peak	
2	320.0300	37.24	-11.23	26.01	46.00	-19.99	Peak	
3	484.4450	34.82	-7.88	26.94	46.00	-19.06	Peak	
4	625.0949	32.41	-5.26	27.15	46.00	-18.85	Peak	
5	832.1900	33.56	-2.58	30.98	46.00	-15.02	Peak	
6	968.9600	32.37	-0.38	31.99	54.00	-22.01	Peak	

REMARKS:

- (1) Measurement Value = Reading Level + Correct Factor.
- (2) Margin Level = Measurement Value - Limit Value.

APPENDIX D - RADIATED EMISSION- ABOVE 1000 MHZ

Test Mode: TX B Mode 2412 MHz

Vertical

130 dBuV/m

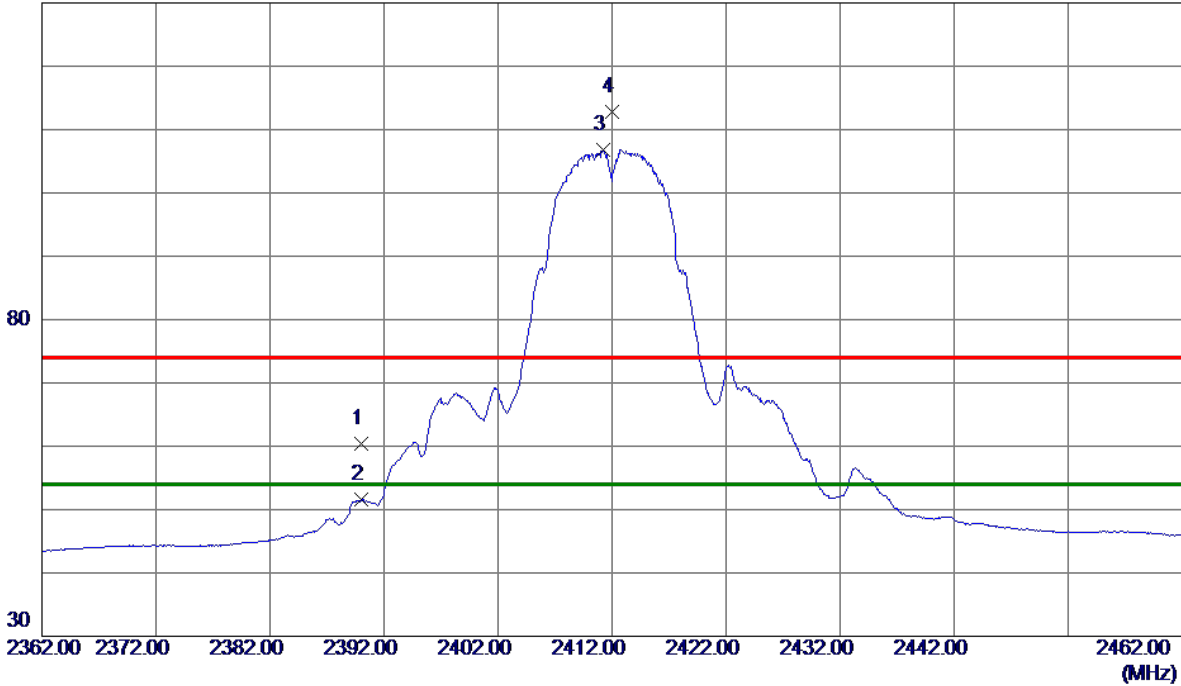

No.	Freq. MHz	Reading Level dBuV/m	Correct Factor dB	Measure ment dBuV/m	Limit dBuV/m	Margin dB	Detector	Comment
1	2390.0000	52.85	7.56	60.41	74.00	-13.59	Peak	
2	2390.0000	43.98	7.56	51.54	54.00	-2.46	AVG	
3 *	2411.2000	99.18	7.64	106.82	54.00	52.82	AVG	No Limit
4	2412.0000	105.23	7.64	112.87	74.00	38.87	Peak	No Limit

REMARKS:

- (1) Measurement Value = Reading Level + Correct Factor.
- (2) Margin Level = Measurement Value - Limit Value.

Test Mode: TX B Mode 2412 MHz

Vertical

80 dBuV/m

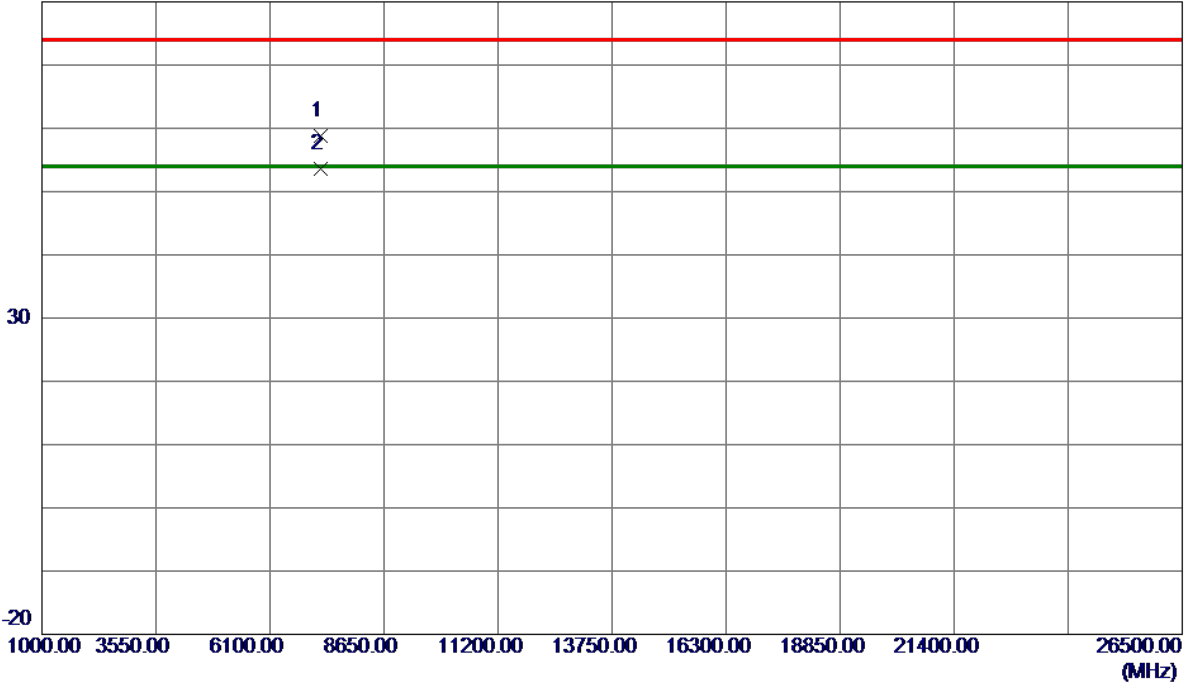

No.	Freq. MHz	Reading Level dBuV/m	Correct Factor dB	Measure ment dBuV/m	Limit dBuV/m	Margin dB	Detector	Comment
1	7235.9930	50.90	7.81	58.71	74.00	-15.29	Peak	
2 *	7236.7920	45.72	7.81	53.53	54.00	-0.47	AVG	

REMARKS:

- (1) Measurement Value = Reading Level + Correct Factor.
- (2) Margin Level = Measurement Value - Limit Value.

Test Mode: TX B Mode 2412 MHz

Horizontal

130 dBuV/m

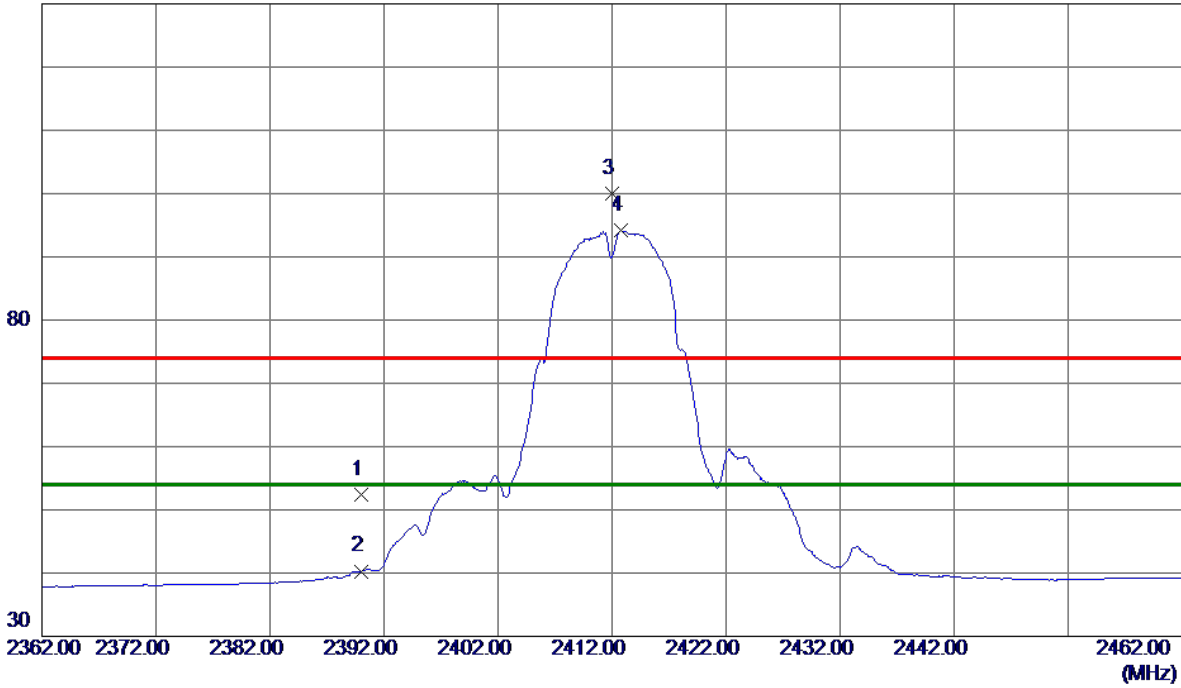

No.	Freq. MHz	Reading Level dBuV/m	Correct Factor dB	Measure ment dBuV/m	Limit dBuV/m	Margin dB	Detector	Comment
1	2390.0000	44.77	7.56	52.33	74.00	-21.67	Peak	
2	2390.0000	32.74	7.56	40.30	54.00	-13.70	AVG	
3	2412.0000	92.30	7.64	99.94	74.00	25.94	Peak	No Limit
4 *	2412.7500	86.54	7.64	94.18	54.00	40.18	AVG	No Limit

REMARKS:

(1) Measurement Value = Reading Level + Correct Factor.

(2) Margin Level = Measurement Value - Limit Value.

Test Mode: TX B Mode 2412 MHz

Horizontal

80 dBuV/m

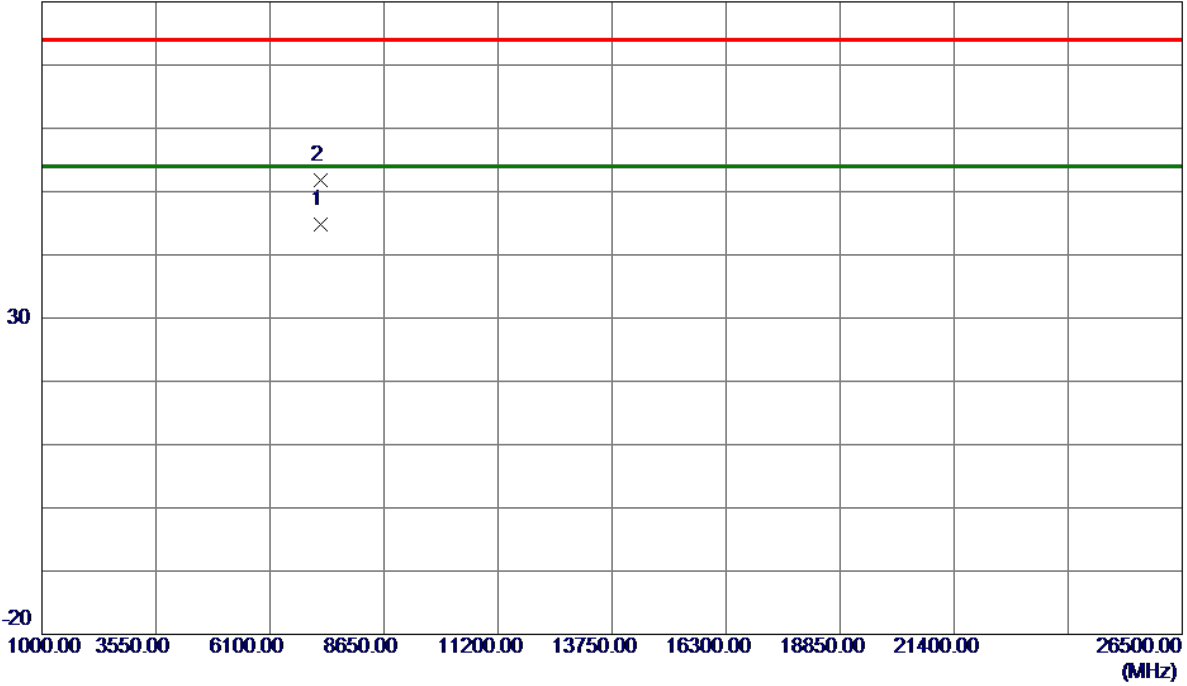

No.	Freq. MHz	Reading Level dBuV/m	Correct Factor dB	Measure ment dBuV/m	Limit dBuV/m	Margin dB	Detector	Comment
1 *	7235.1550	36.98	7.81	44.79	54.00	-9.21	AVG	
2	7236.1450	43.93	7.81	51.74	74.00	-22.26	Peak	

REMARKS:

- (1) Measurement Value = Reading Level + Correct Factor.
- (2) Margin Level = Measurement Value - Limit Value.

Test Mode: TX B Mode 2417 MHz

Vertical

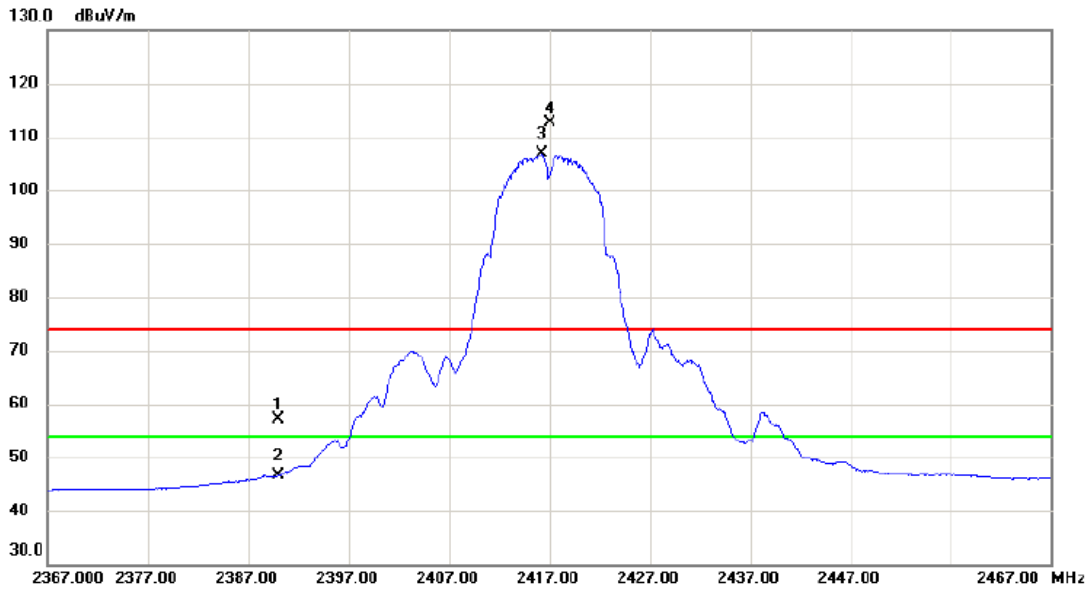

No.	Mk.	Freq. MHz	Reading Level dBuV	Correct Factor dB	Measurement dBuV/m	Limit dBuV/m	Margin dB	Detector	Comment
1		2390.000	49.51	7.57	57.08	74.00	-16.92	peak	
2		2390.000	39.01	7.57	46.58	54.00	-7.42	AVG	
3	*	2416.250	99.23	7.66	106.89	54.00	52.89	AVG	No Limit
4	X	2417.000	104.90	7.66	112.56	74.00	38.56	peak	No Limit

REMARKS:

- (1) Measurement Value = Reading Level + Correct Factor.
- (2) Margin Level = Measurement Value - Limit Value.

Test Mode: TX B Mode 2417 MHz

Vertical

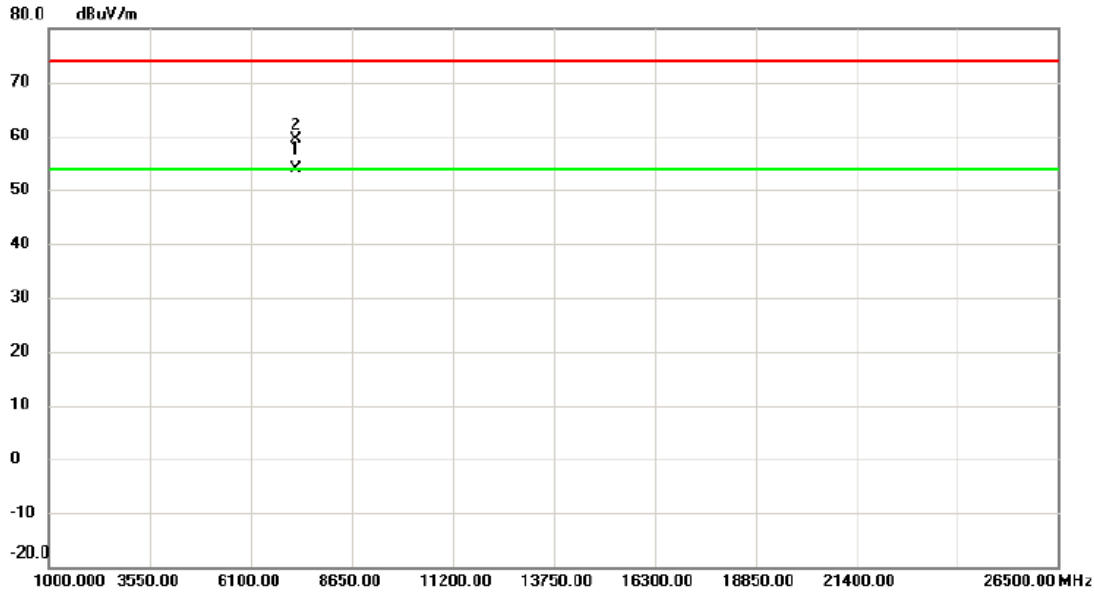

No.	Mk.	Freq. MHz	Reading Level dBuV	Correct Factor dB	Measure- ment dBuV/m	Limit dBuV/m	Margin dB	Detector	Comment
1	*	7250.260	46.02	7.82	53.84	54.00	-0.16	AVG	
2		7250.975	51.61	7.82	59.43	74.00	-14.57	peak	

REMARKS:

- (1) Measurement Value = Reading Level + Correct Factor.
- (2) Margin Level = Measurement Value - Limit Value.

Test Mode: TX B Mode 2417 MHz

Horizontal

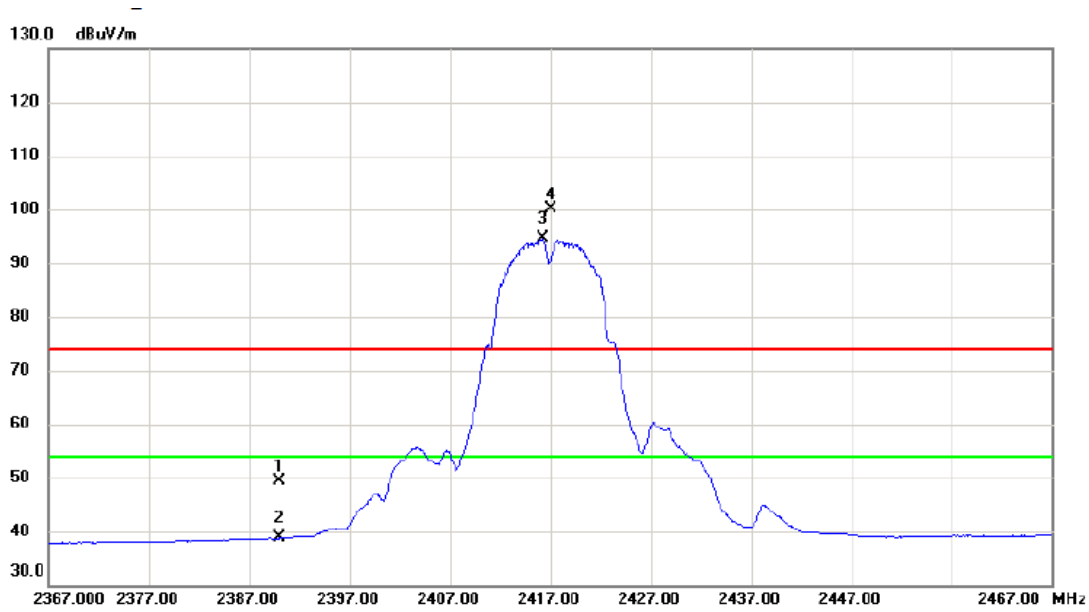

No.	Mk.	Freq. MHz	Reading Level dBuV	Correct Factor dB	Measure- ment dBuV/m	Limit dBuV/m	Margin dB	Detector	Comment
1		2390.000	41.85	7.57	49.42	74.00	-24.58	peak	
2		2390.000	31.19	7.57	38.76	54.00	-15.24	AVG	
3	*	2416.250	86.91	7.66	94.57	54.00	40.57	AVG	No Limit
4	X	2417.000	92.37	7.66	100.03	74.00	26.03	peak	No Limit

REMARKS:

- (1) Measurement Value = Reading Level + Correct Factor.
- (2) Margin Level = Measurement Value - Limit Value.

Test Mode: TX B Mode 2417 MHz

Horizontal

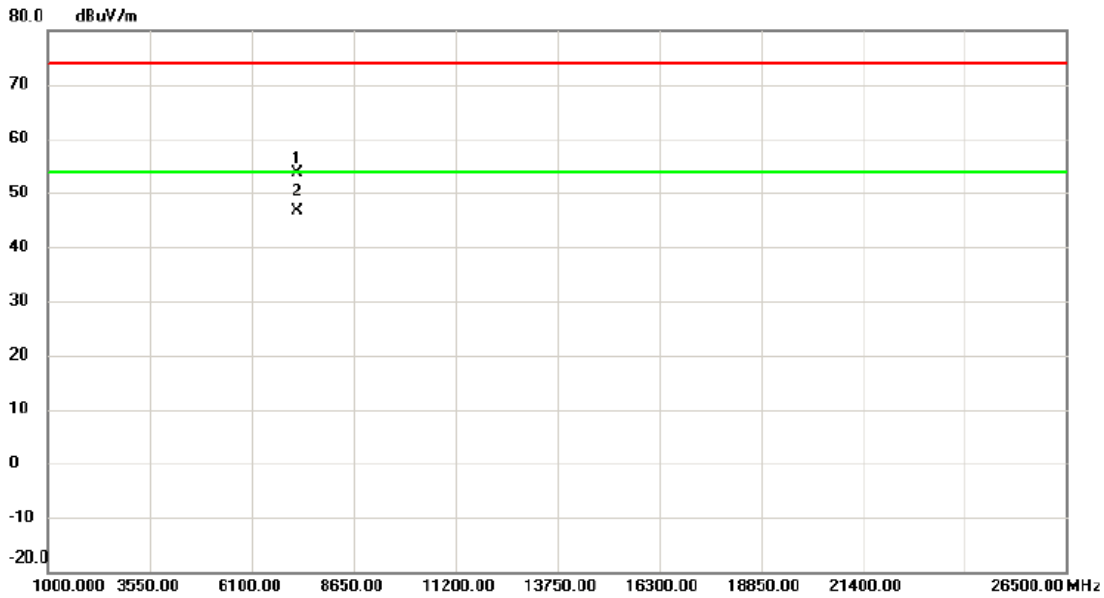

No.	Mk.	Freq. MHz	Reading Level dBuV	Correct Factor dB	Measure- ment dBuV/m	Limit dBuV/m	Margin dB	Detector	Comment
1		7251.095	45.71	7.82	53.53	74.00	-20.47	peak	
2	*	7251.740	38.73	7.82	46.55	54.00	-7.45	AVG	

REMARKS:

- (1) Measurement Value = Reading Level + Correct Factor.
- (2) Margin Level = Measurement Value - Limit Value.

Test Mode: TX B Mode 2437 MHz

Vertical

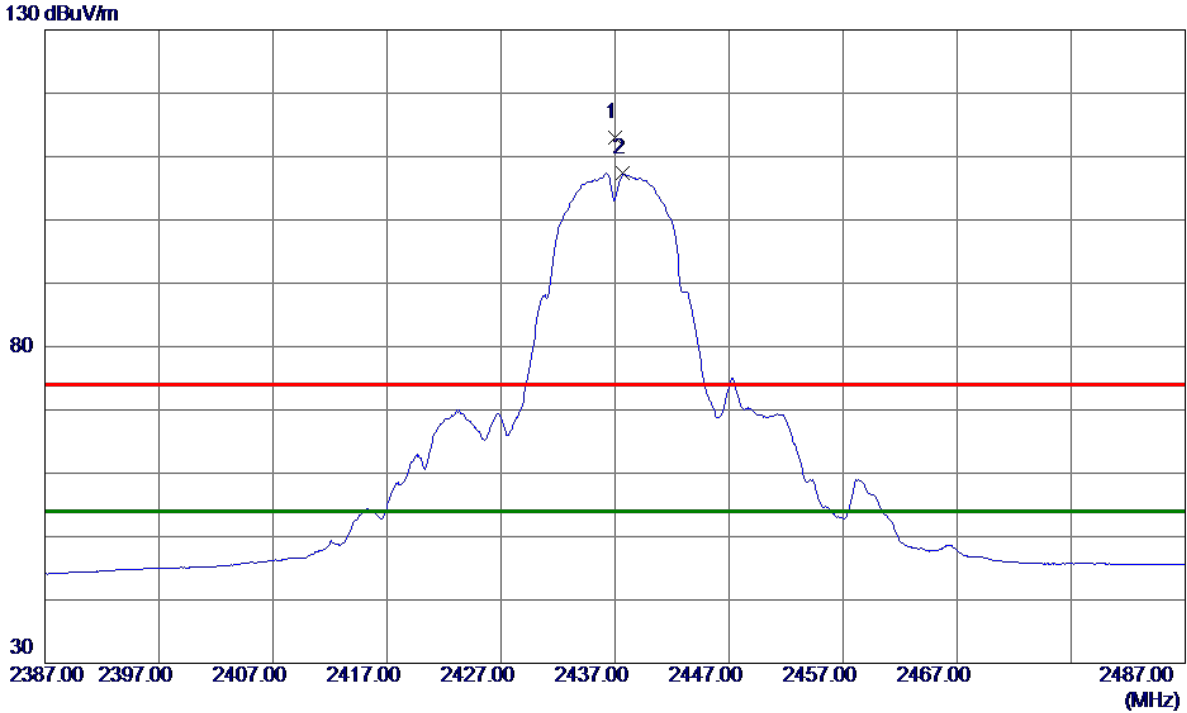

No.	Freq. MHz	Reading Level dBuV/m	Correct Factor dB	Measure ment dBuV/m	Limit dBuV/m	Margin dB	Detector	Comment
1	2437.0000	105.28	7.72	113.00	74.00	39.00	Peak	No Limit
2 *	2437.7000	99.61	7.72	107.33	54.00	53.33	AVG	No Limit

REMARKS:

- (1) Measurement Value = Reading Level + Correct Factor.
- (2) Margin Level = Measurement Value - Limit Value.

Test Mode: TX B Mode 2437 MHz

Vertical

80 dBuV/m

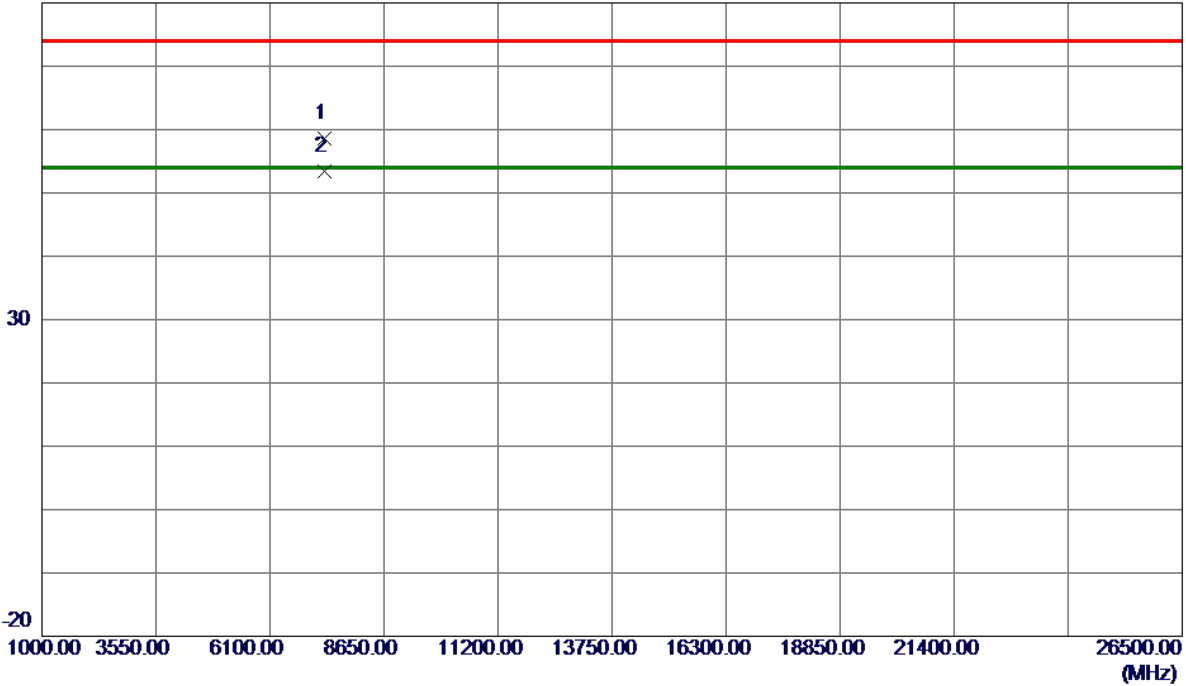

No.	Freq. MHz	Reading Level dBuV/m	Correct Factor dB	Measure ment dBuV/m	Limit dBuV/m	Margin dB	Detector	Comment
1	7311.0250	50.67	7.90	58.57	74.00	-15.43	Peak	
2 *	7311.7500	45.58	7.90	53.48	54.00	-0.52	AVG	

REMARKS:

- (1) Measurement Value = Reading Level + Correct Factor.
- (2) Margin Level = Measurement Value - Limit Value.

Test Mode: TX B Mode 2437 MHz

Horizontal

130 dBuV/m

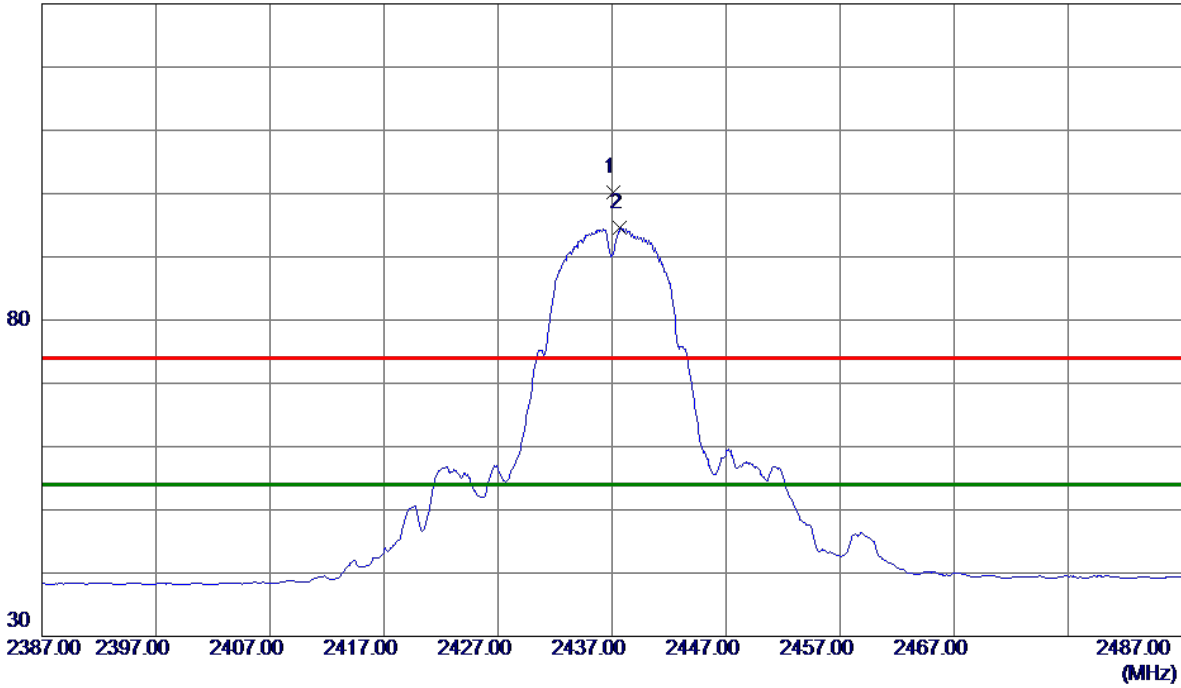

No.	Freq. MHz	Reading Level dBuV/m	Correct Factor dB	Measure ment dBuV/m	Limit dBuV/m	Margin dB	Detector	Comment
1	2437.1000	92.47	7.72	100.19	74.00	26.19	Peak	No Limit
2 *	2437.7000	86.87	7.72	94.59	54.00	40.59	AVG	No Limit

REMARKS:

(1) Measurement Value = Reading Level + Correct Factor.

(2) Margin Level = Measurement Value - Limit Value.

Test Mode: TX B Mode 2437 MHz

Horizontal

80 dBuV/m

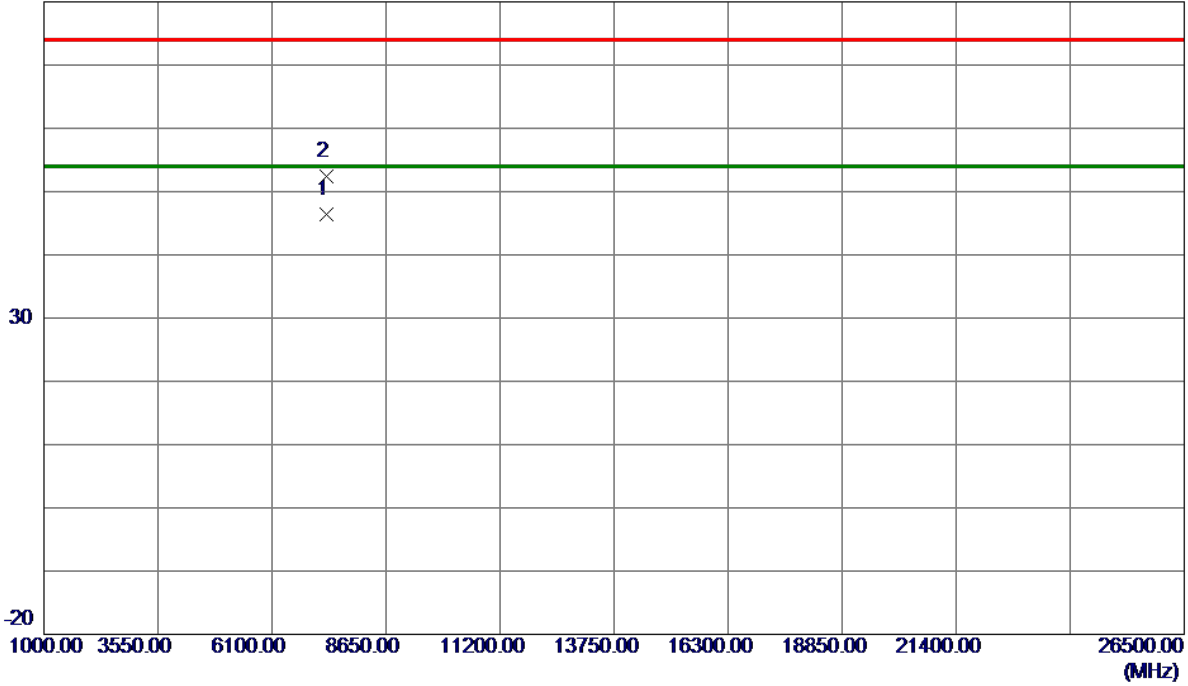

No.	Freq. MHz	Reading Level dBuV/m	Correct Factor dB	Measure ment dBuV/m	Limit dBuV/m	Margin dB	Detector	Comment
1 *	7310.2450	38.44	7.90	46.34	54.00	-7.66	AVG	
2	7311.4200	44.54	7.90	52.44	74.00	-21.56	Peak	

REMARKS:

- (1) Measurement Value = Reading Level + Correct Factor.
- (2) Margin Level = Measurement Value - Limit Value.

Test Mode: TX B Mode 2457 MHz

Vertical

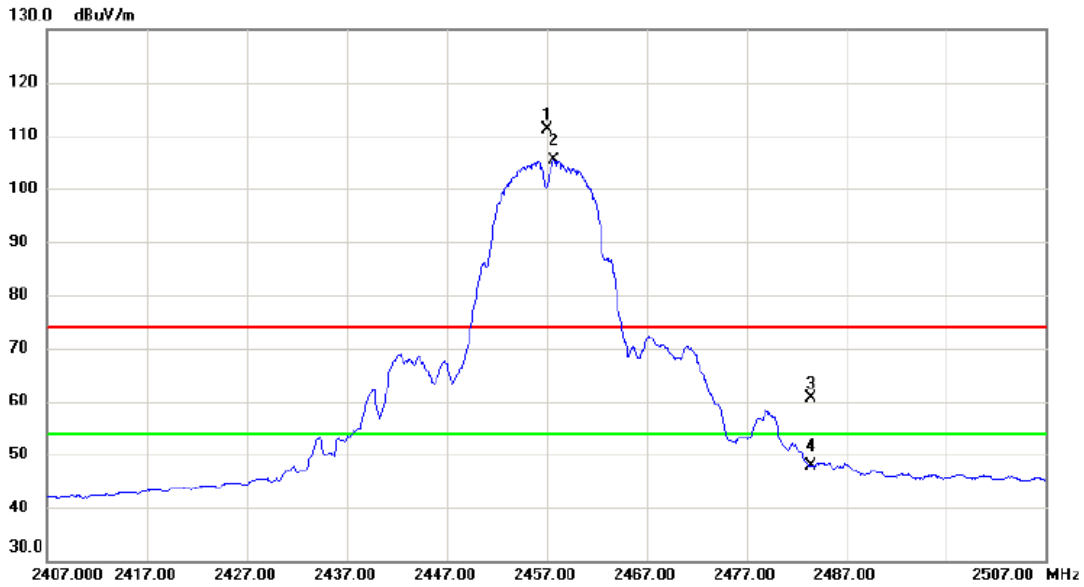

No.	Mk.	Freq. MHz	Reading Level dBuV	Correct Factor dB	Measure- ment dBuV/m	Limit dBuV/m	Margin dB	Detector	Comment
1	X	2457.000	103.46	7.79	111.25	74.00	37.25	peak	No Limit
2	*	2457.700	97.49	7.79	105.28	54.00	51.28	AVG	No Limit
3		2483.500	52.69	7.87	60.56	74.00	-13.44	peak	
4		2483.500	39.98	7.87	47.85	54.00	-6.15	AVG	

REMARKS:

- (1) Measurement Value = Reading Level + Correct Factor.
- (2) Margin Level = Measurement Value - Limit Value.

Test Mode: TX B Mode 2457 MHz

Vertical

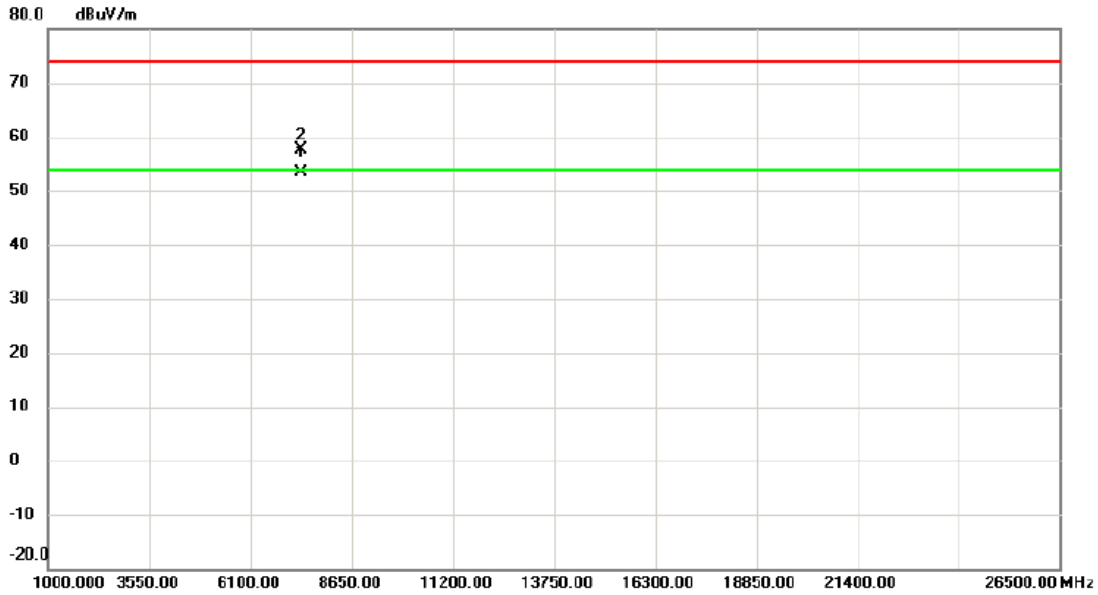

No.	Mk.	Freq. MHz	Reading Level dBuV	Correct Factor dB	Measure- ment dBuV/m	Limit dBuV/m	Margin dB	Detector	Comment
1	*	7370.305	45.44	7.98	53.42	54.00	-0.58	AVG	
2		7370.930	49.54	7.98	57.52	74.00	-16.48	peak	

REMARKS:

- (1) Measurement Value = Reading Level + Correct Factor.
- (2) Margin Level = Measurement Value - Limit Value.

Test Mode: TX B Mode 2457 MHz

Horizontal

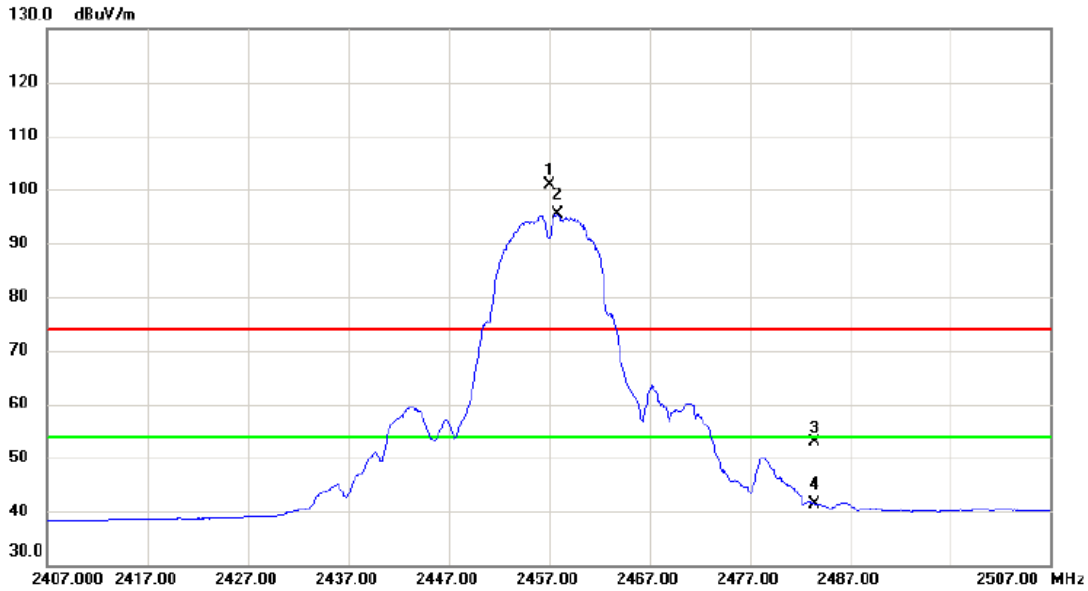

No.	Mk.	Freq. MHz	Reading Level dBuV	Correct Factor dB	Measure- ment dBuV/m	Limit dBuV/m	Margin dB	Detector	Comment
1	X	2457.050	93.10	7.79	100.89	74.00	26.89	peak	No Limit
2	*	2457.800	87.61	7.79	95.40	54.00	41.40	AVG	No Limit
3		2483.500	45.02	7.87	52.89	74.00	-21.11	peak	
4		2483.500	33.57	7.87	41.44	54.00	-12.56	AVG	

REMARKS:

- (1) Measurement Value = Reading Level + Correct Factor.
- (2) Margin Level = Measurement Value - Limit Value.

Test Mode: TX B Mode 2457 MHz

Horizontal

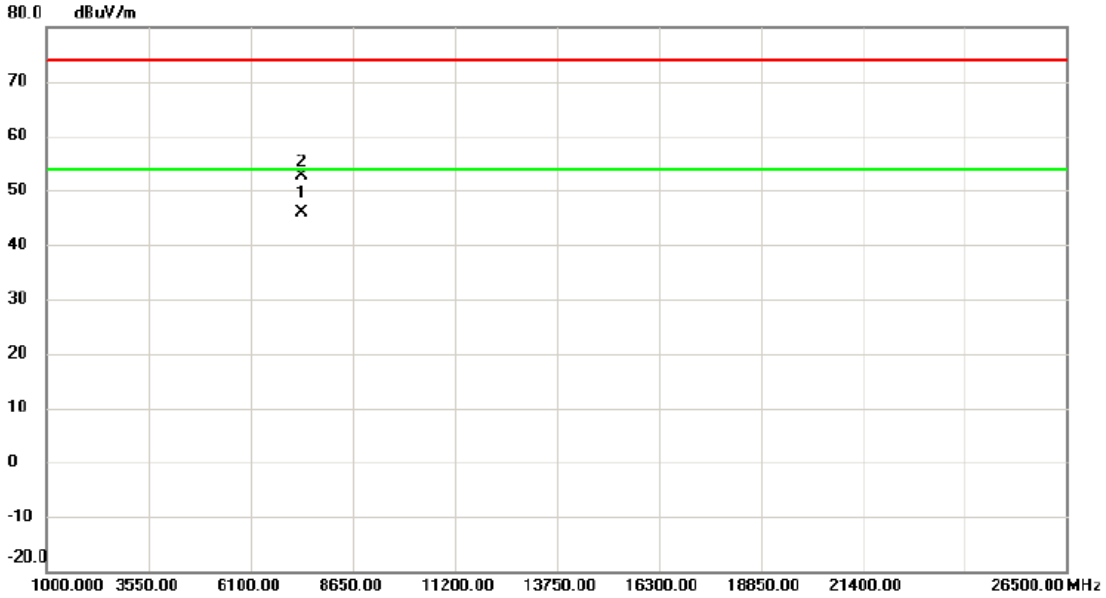

No.	Mk.	Freq. MHz	Reading Level dBuV	Correct Factor dB	Measure- ment dBuV/m	Limit dBuV/m	Margin dB	Detector	Comment
1	*	7370.305	37.78	7.98	45.76	54.00	-8.24	AVG	
2		7370.965	44.61	7.98	52.59	74.00	-21.41	peak	

REMARKS:

- (1) Measurement Value = Reading Level + Correct Factor.
- (2) Margin Level = Measurement Value - Limit Value.

Test Mode: TX B Mode 2462 MHz

Vertical

130 dBuV/m

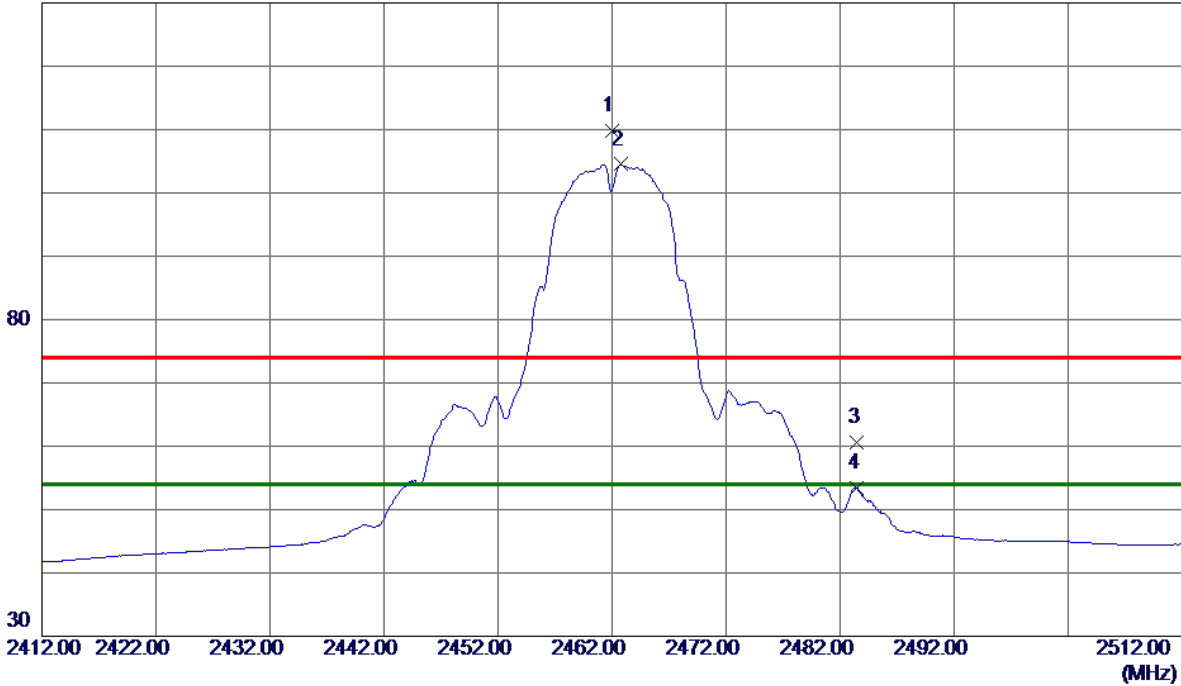

No.	Freq. MHz	Reading Level dBuV/m	Correct Factor dB	Measure ment dBuV/m	Limit dBuV/m	Margin dB	Detector	Comment
1	2462.0000	102.04	7.80	109.84	74.00	35.84	Peak	No Limit
2 *	2462.7500	96.69	7.81	104.50	54.00	50.50	AVG	No Limit
3	2483.5000	52.75	7.88	60.63	74.00	-13.37	Peak	
4	2483.5000	45.53	7.88	53.41	54.00	-0.59	AVG	

REMARKS:

- (1) Measurement Value = Reading Level + Correct Factor.
- (2) Margin Level = Measurement Value - Limit Value.

Test Mode: TX B Mode 2462 MHz

Vertical

80 dBuV/m

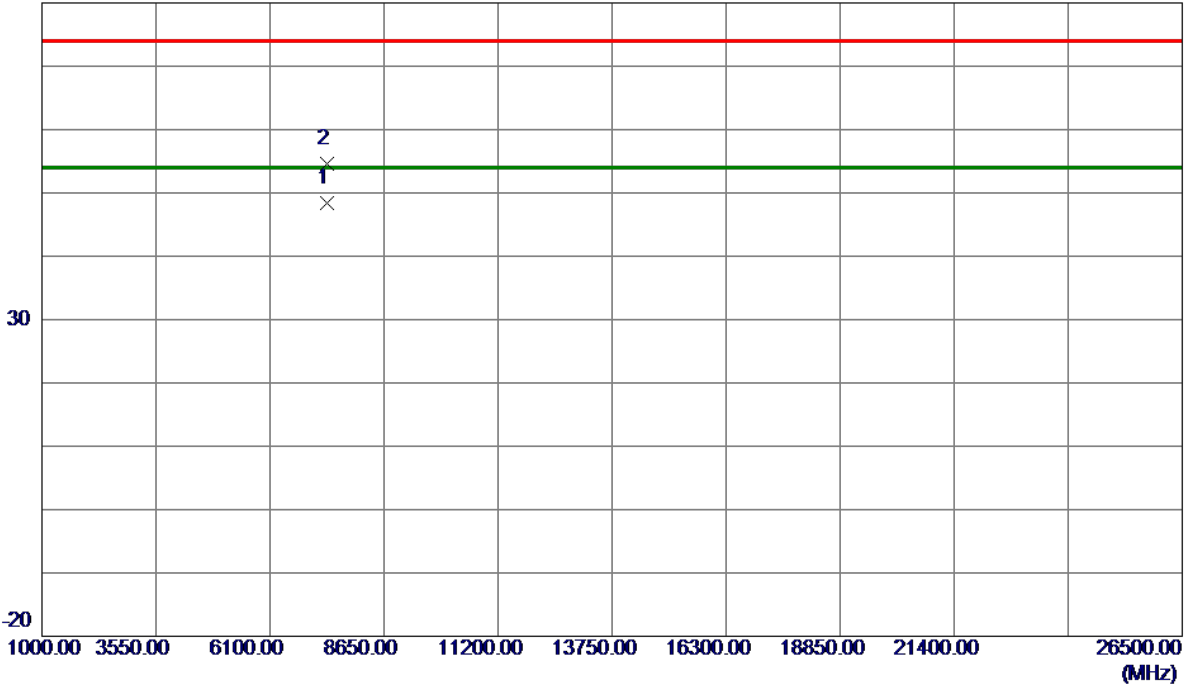

No.	Freq. MHz	Reading Level dBuV/m	Correct Factor dB	Measure ment dBuV/m	Limit dBuV/m	Margin dB	Detector	Comment
1 *	7385.2900	40.46	8.00	48.46	54.00	-5.54	AVG	
2	7385.9670	46.61	8.00	54.61	74.00	-19.39	Peak	

REMARKS:

- (1) Measurement Value = Reading Level + Correct Factor.
- (2) Margin Level = Measurement Value - Limit Value.

Test Mode: TX B Mode 2462 MHz

Horizontal

130 dBuV/m

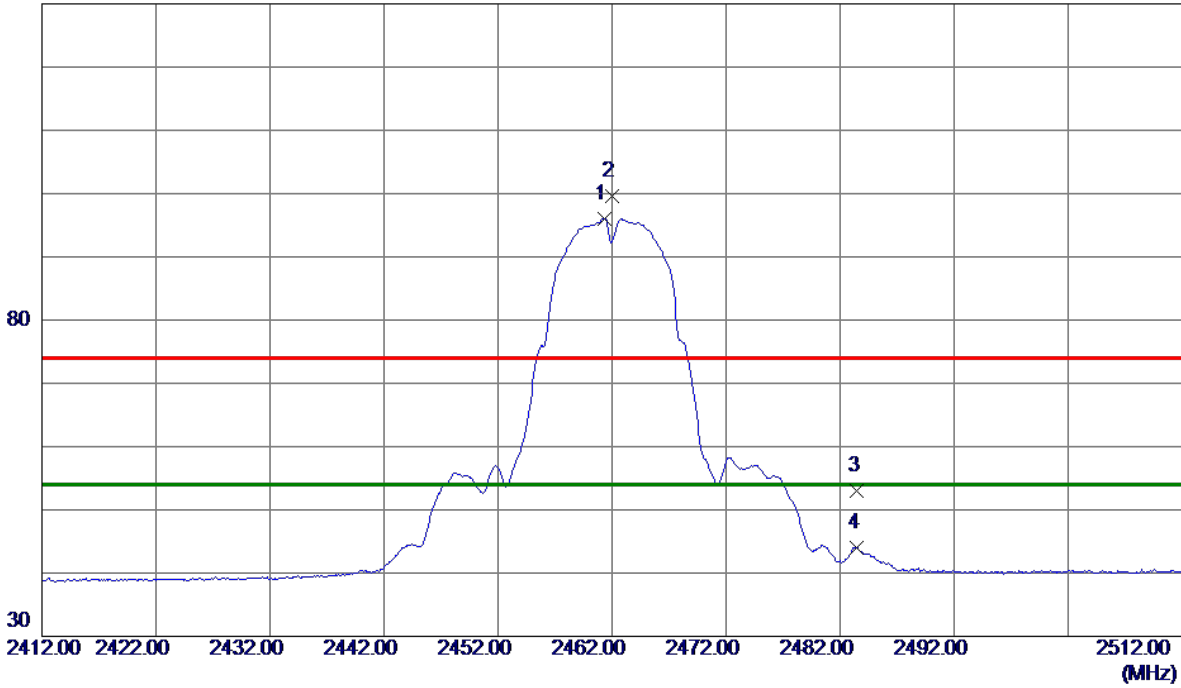

No.	Freq. MHz	Reading Level dBuV/m	Correct Factor dB	Measure ment dBuV/m	Limit dBuV/m	Margin dB	Detector	Comment
1 *	2461.3500	88.30	7.80	96.10	54.00	42.10	AVG	No Limit
2	2462.0000	91.85	7.80	99.65	74.00	25.65	Peak	No Limit
3	2483.5000	45.19	7.88	53.07	74.00	-20.93	Peak	
4	2483.5000	36.08	7.88	43.96	54.00	-10.04	AVG	

REMARKS:

- (1) Measurement Value = Reading Level + Correct Factor.
- (2) Margin Level = Measurement Value - Limit Value.

Test Mode: TX B Mode 2462 MHz

Horizontal

80 dBuV/m

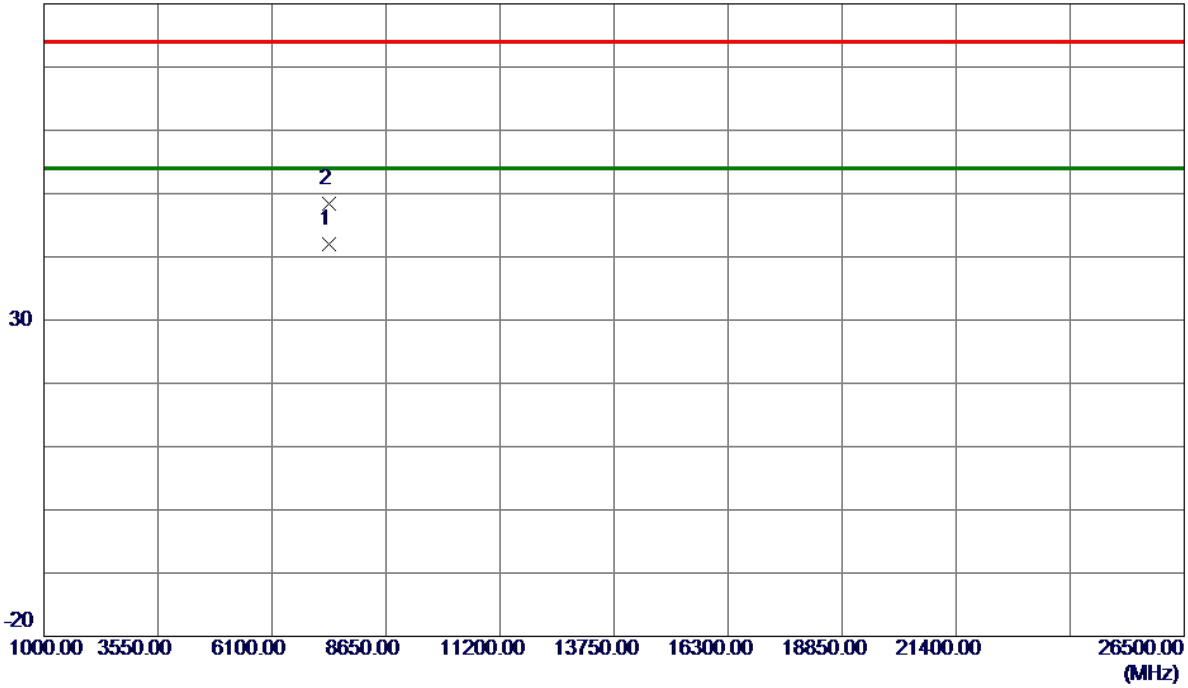

No.	Freq. MHz	Reading Level dBuV/m	Correct Factor dB	Measure ment dBuV/m	Limit dBuV/m	Margin dB	Detector	Comment
1 *	7385.2550	33.91	8.00	41.91	54.00	-12.09	AVG	
2	7386.1150	40.35	8.00	48.35	74.00	-25.65	Peak	

REMARKS:

- (1) Measurement Value = Reading Level + Correct Factor.
- (2) Margin Level = Measurement Value - Limit Value.

Test Mode: TX G Mode 2412 MHz

Vertical

130 dBuV/m

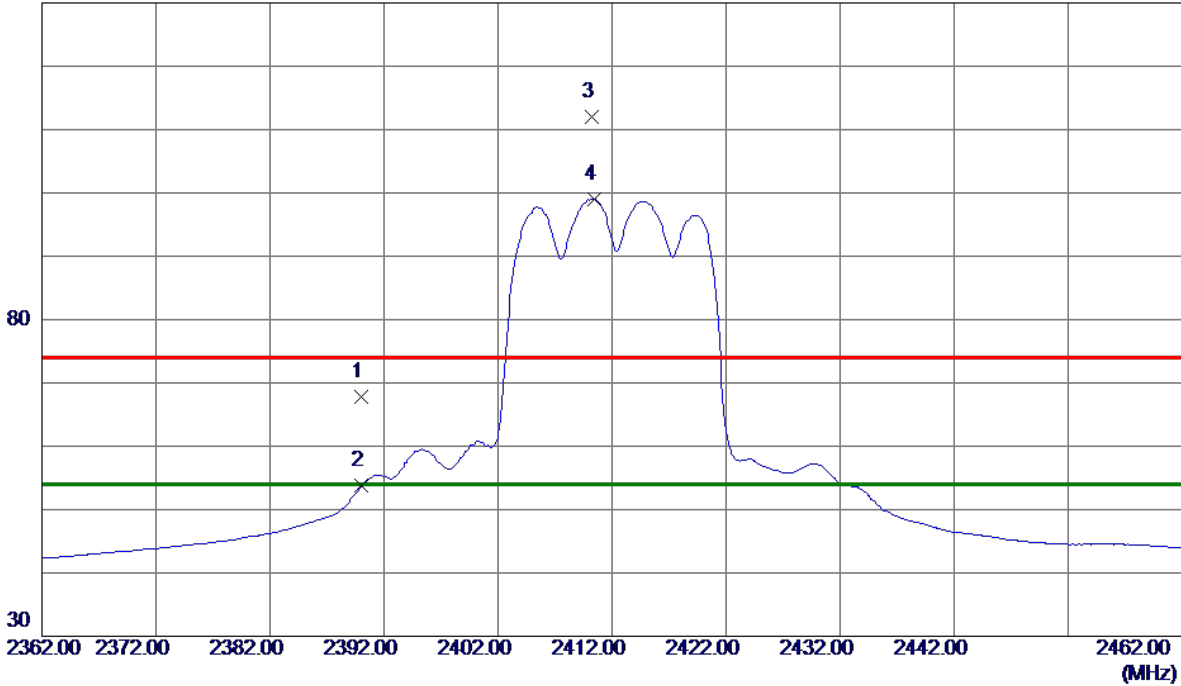

No.	Freq. MHz	Reading Level dBuV/m	Correct Factor dB	Measure ment dBuV/m	Limit dBuV/m	Margin dB	Detector	Comment
1	2390.0000	60.30	7.56	67.86	74.00	-6.14	Peak	
2	2390.0000	46.18	7.56	53.74	54.00	-0.26	AVG	
3	2410.2000	104.40	7.63	112.03	74.00	38.03	Peak	No Limit
4 *	2410.4000	91.46	7.63	99.09	54.00	45.09	AVG	No Limit

REMARKS:

- (1) Measurement Value = Reading Level + Correct Factor.
- (2) Margin Level = Measurement Value - Limit Value.

Test Mode: TX G Mode 2412 MHz

Vertical

80 dBuV/m

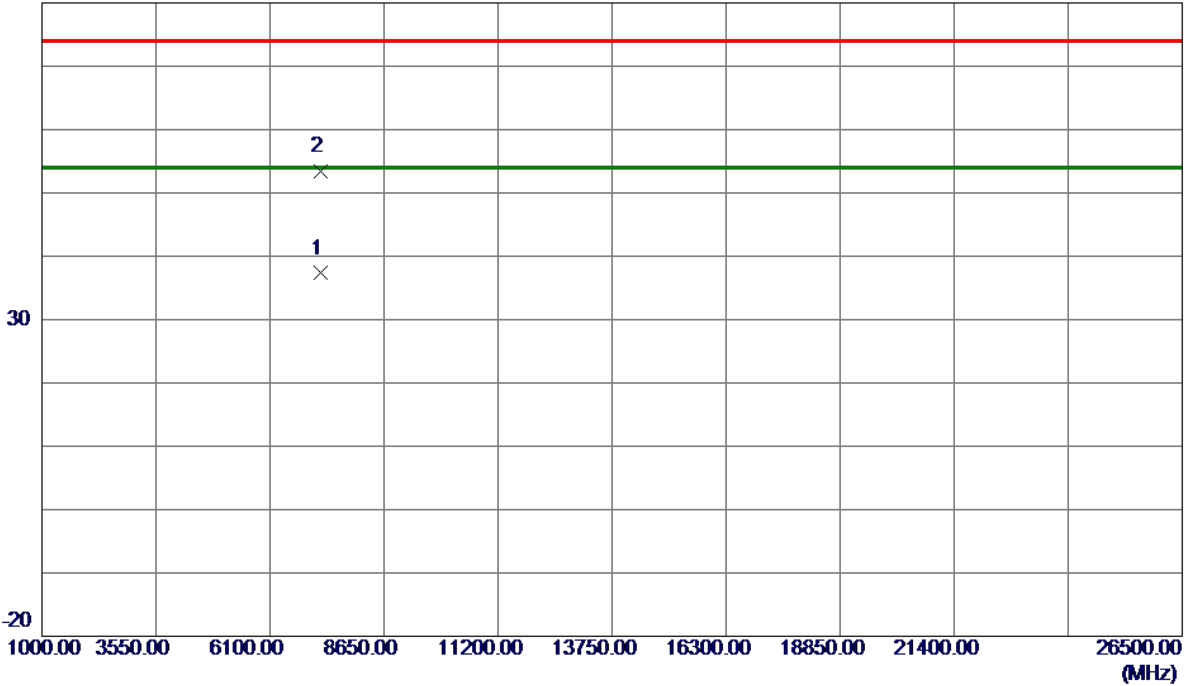

No.	Freq. MHz	Reading Level dBuV/m	Correct Factor dB	Measure ment dBuV/m	Limit dBuV/m	Margin dB	Detector	Comment
1 *	7235.8070	29.49	7.81	37.30	54.00	-16.70	AVG	
2	7235.8980	45.56	7.81	53.37	74.00	-20.63	Peak	

REMARKS:

- (1) Measurement Value = Reading Level + Correct Factor.
- (2) Margin Level = Measurement Value - Limit Value.

Test Mode: TX G Mode 2412 MHz

Horizontal

130 dBuV/m

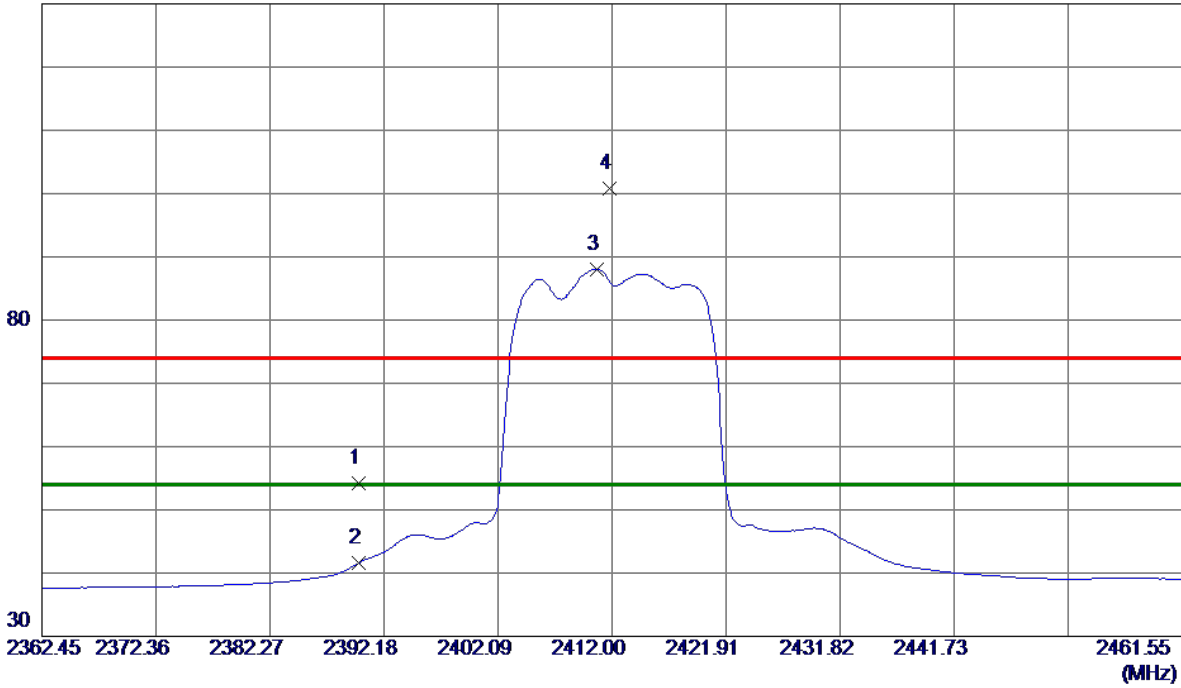

No.	Freq. MHz	Reading Level dBuV/m	Correct Factor dB	Measure ment dBuV/m	Limit dBuV/m	Margin dB	Detector	Comment
1	2390.0000	46.55	7.56	54.11	74.00	-19.89	Peak	
2	2390.0000	34.11	7.56	41.67	54.00	-12.33	AVG	
3 *	2410.6620	80.39	7.63	88.02	54.00	34.02	AVG	No Limit
4	2411.7520	93.23	7.64	100.87	74.00	26.87	Peak	No Limit

REMARKS:

- (1) Measurement Value = Reading Level + Correct Factor.
- (2) Margin Level = Measurement Value - Limit Value.

Test Mode: TX G Mode 2412 MHz

Horizontal

80 dBuV/m

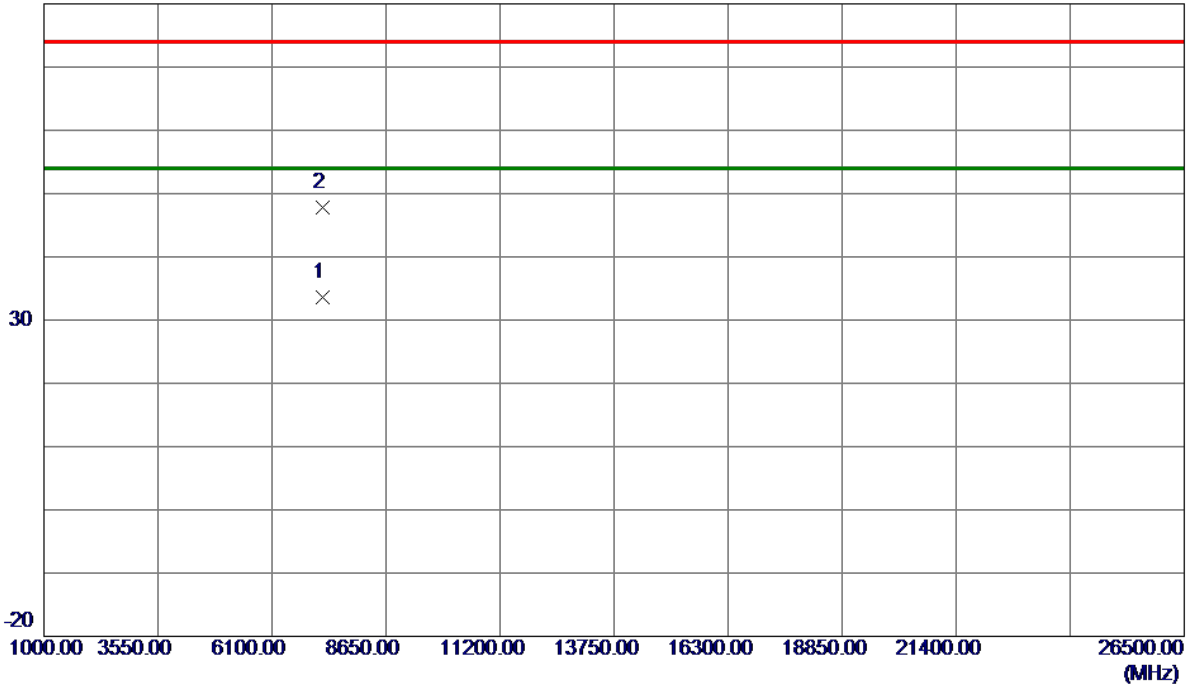

No.	Freq. MHz	Reading Level dBuV/m	Correct Factor dB	Measure ment dBuV/m	Limit dBuV/m	Margin dB	Detector	Comment
1 *	7235.6880	25.73	7.81	33.54	54.00	-20.46	AVG	
2	7237.4080	39.91	7.81	47.72	74.00	-26.28	Peak	

REMARKS:

- (1) Measurement Value = Reading Level + Correct Factor.
- (2) Margin Level = Measurement Value - Limit Value.

Test Mode: TX G Mode 2417 MHz

Vertical

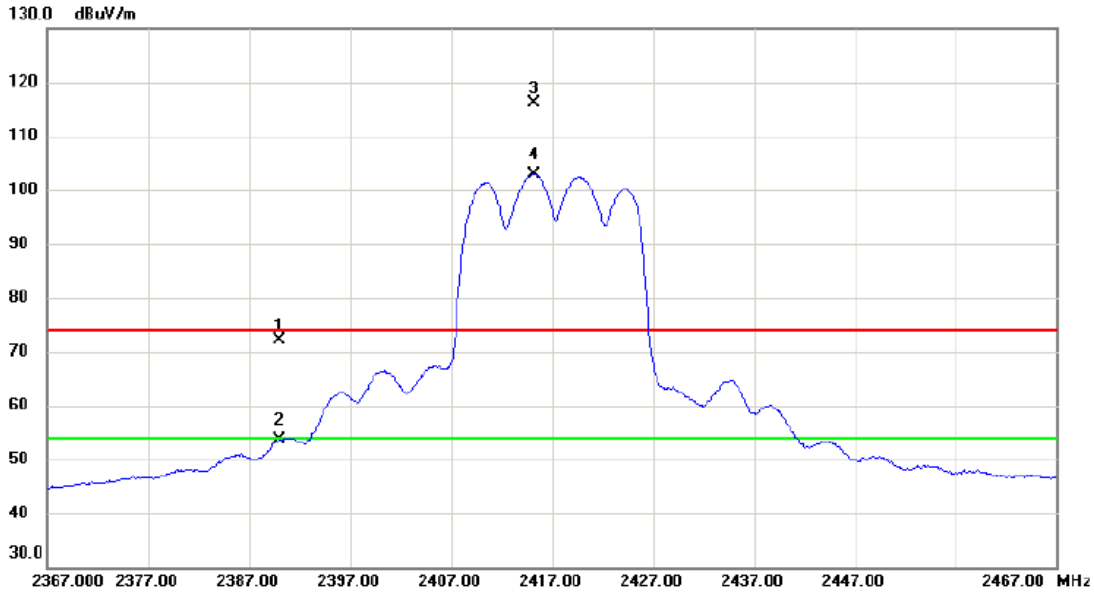

No.	Mk.	Freq. MHz	Reading Level dBuV	Correct Factor dB	Measure- ment dBuV/m	Limit dBuV/m	Margin dB	Detector	Comment
1		2390.000	64.58	7.57	72.15	74.00	-1.85	peak	
2		2390.000	46.00	7.57	53.57	54.00	-0.43	AVG	
3	X	2415.150	108.38	7.65	116.03	74.00	42.03	peak	No Limit
4	*	2415.150	95.26	7.65	102.91	54.00	48.91	AVG	No Limit

REMARKS:

(1) Measurement Value = Reading Level + Correct Factor.

(2) Margin Level = Measurement Value - Limit Value.

Test Mode: TX G Mode 2417 MHz

Vertical

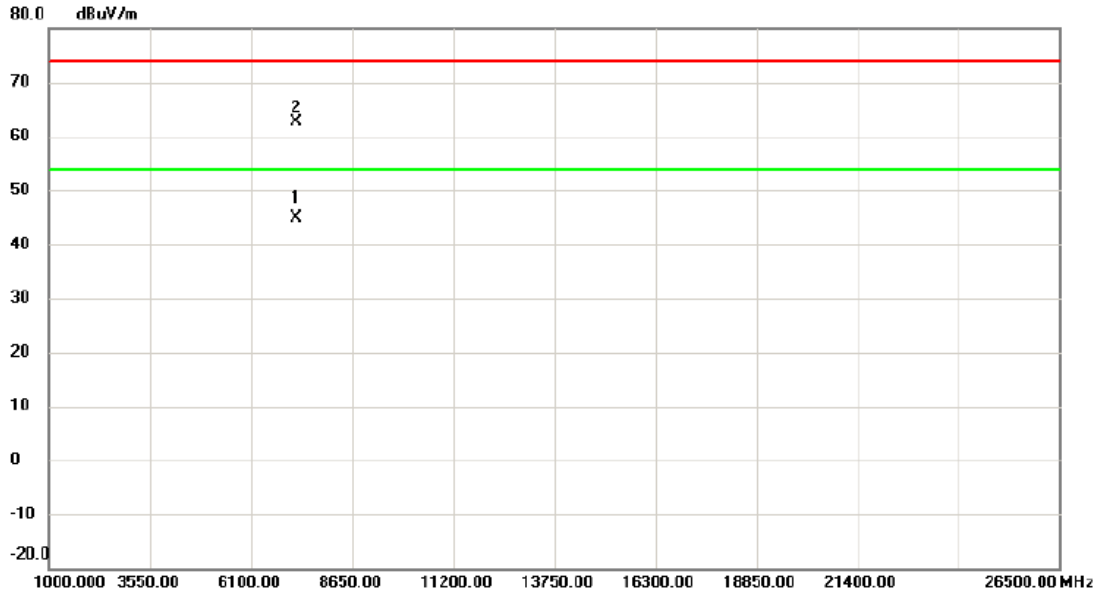

No.	Mk.	Freq. MHz	Reading Level dBuV	Correct Factor dB	Measure- ment dBuV/m	Limit dBuV/m	Margin dB	Detector	Comment
1	*	7251.517	36.94	7.82	44.76	54.00	-9.24	AVG	
2		7251.858	54.73	7.82	62.55	74.00	-11.45	peak	

REMARKS:

- (1) Measurement Value = Reading Level + Correct Factor.
- (2) Margin Level = Measurement Value - Limit Value.

Test Mode: TX G Mode 2417 MHz

Horizontal

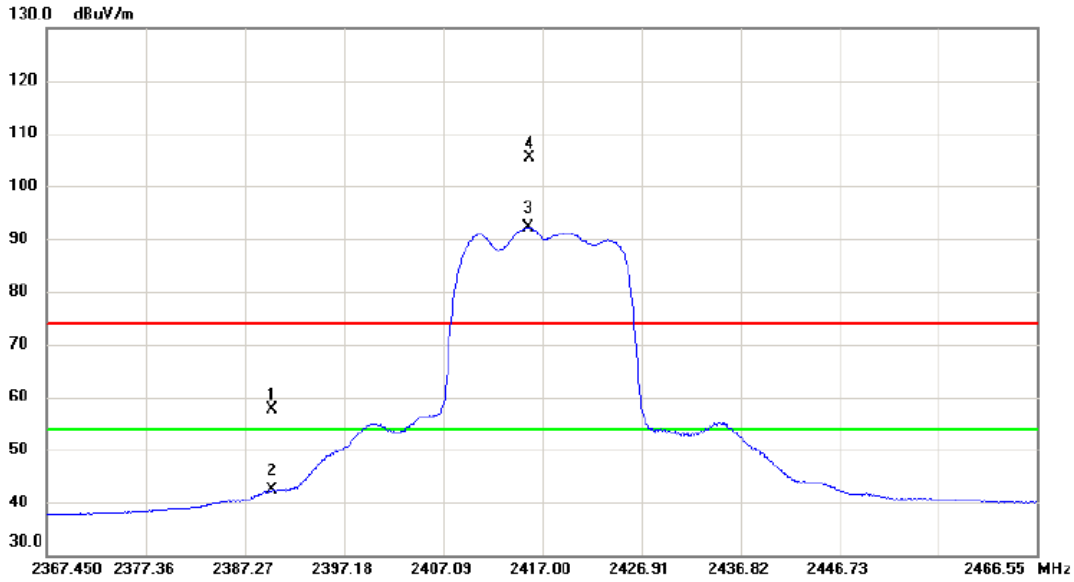

No.	Mk.	Freq. MHz	Reading Level dBuV	Correct Factor dB	Measure- ment dBuV/m	Limit dBuV/m	Margin dB	Detector	Comment
1		2390.000	50.16	7.57	57.73	74.00	-16.27	peak	
2		2390.000	34.78	7.57	42.35	54.00	-11.65	AVG	
3	*	2415.563	84.60	7.65	92.25	54.00	38.25	AVG	No Limit
4	X	2415.712	97.85	7.65	105.50	74.00	31.50	peak	No Limit

REMARKS:

- (1) Measurement Value = Reading Level + Correct Factor.
- (2) Margin Level = Measurement Value - Limit Value.

Test Mode: TX G Mode 2417 MHz

Horizontal

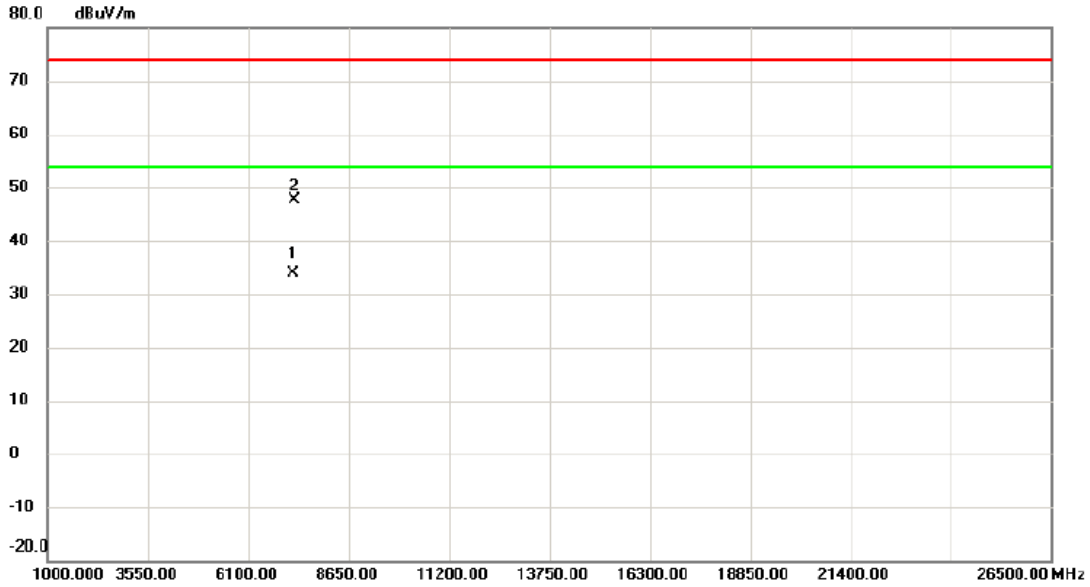

No.	Mk.	Freq. MHz	Reading Level dBuV	Correct Factor dB	Measure- ment dBuV/m	Limit dBuV/m	Margin dB	Detector	Comment
1	*	7255.257	26.14	7.83	33.97	54.00	-20.03	AVG	
2		7259.708	39.79	7.84	47.63	74.00	-26.37	peak	

REMARKS:

- (1) Measurement Value = Reading Level + Correct Factor.
- (2) Margin Level = Measurement Value - Limit Value.

Test Mode: TX G Mode 2437 MHz

Vertical

130 dBuV/m

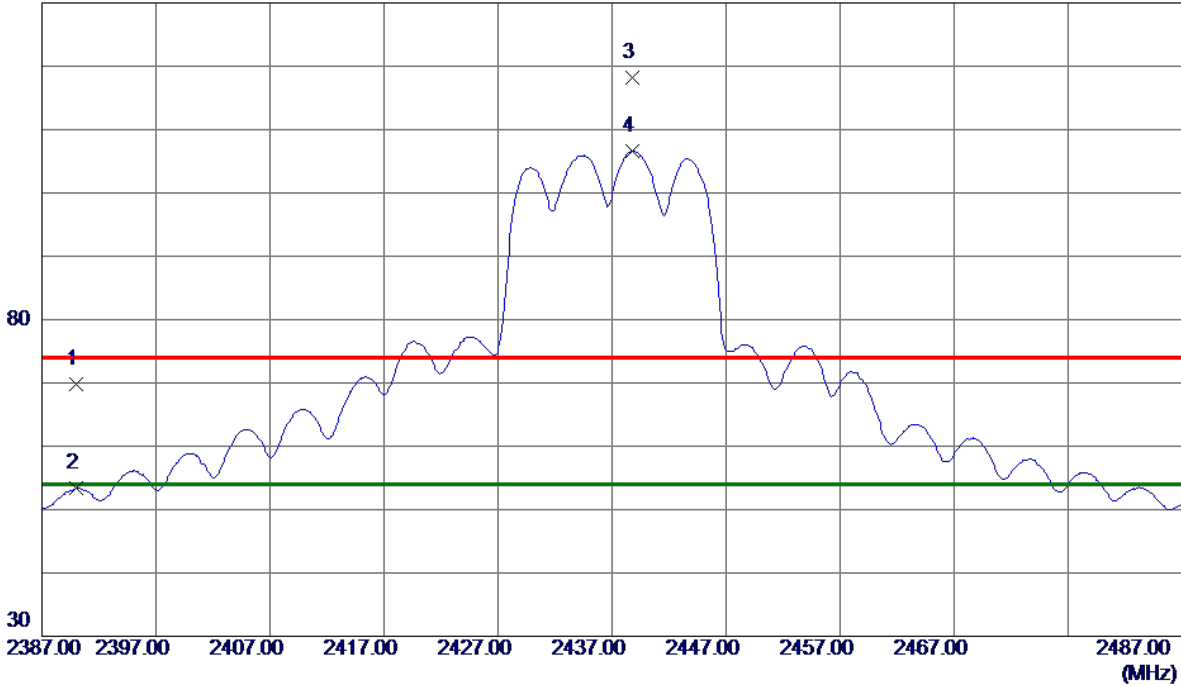

No.	Freq. MHz	Reading Level dBuV/m	Correct Factor dB	Measure ment dBuV/m	Limit dBuV/m	Margin dB	Detector	Comment
1	2390.0000	62.28	7.56	69.84	74.00	-4.16	Peak	
2	2390.0000	45.80	7.56	53.36	54.00	-0.64	AVG	
3	2438.8000	110.53	7.73	118.26	74.00	44.26	Peak	No Limit
4 *	2438.8000	98.84	7.73	106.57	54.00	52.57	AVG	No Limit

REMARKS:

- (1) Measurement Value = Reading Level + Correct Factor.
- (2) Margin Level = Measurement Value - Limit Value.

Test Mode: TX G Mode 2437 MHz

Vertical

80 dBuV/m

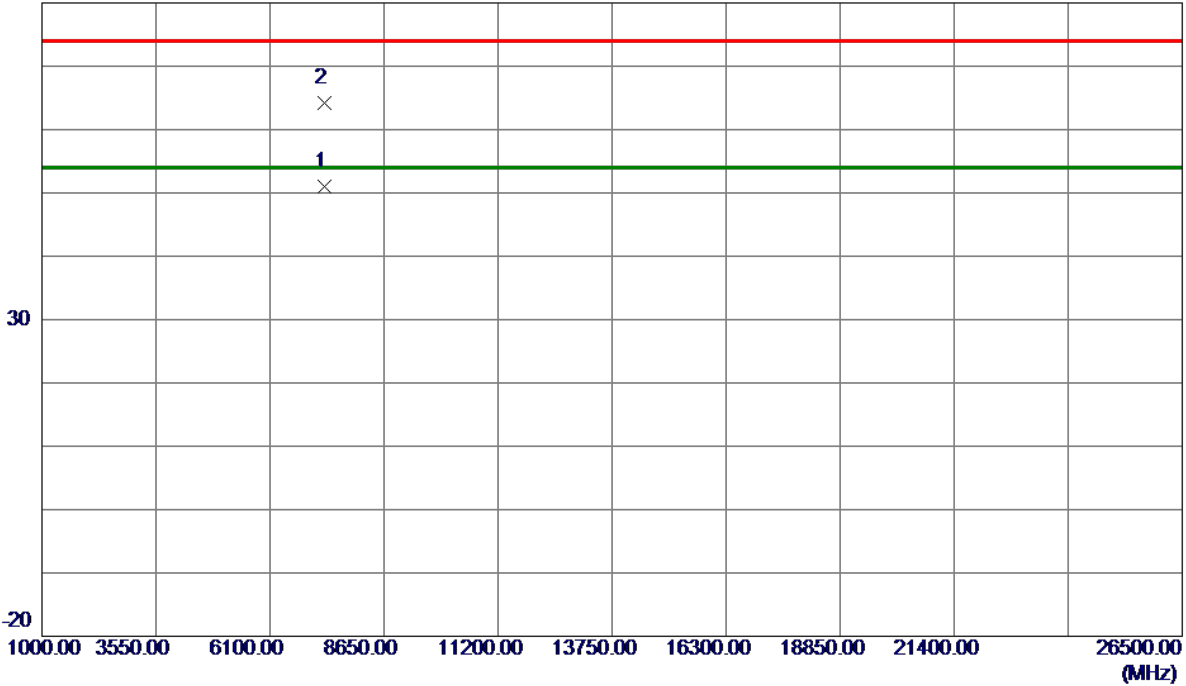

No.	Freq. MHz	Reading Level dBuV/m	Correct Factor dB	Measure ment dBuV/m	Limit dBuV/m	Margin dB	Detector	Comment
1 *	7312.0570	43.16	7.90	51.06	54.00	-2.94	AVG	
2	7322.1080	56.38	7.92	64.30	74.00	-9.70	Peak	

REMARKS:

- (1) Measurement Value = Reading Level + Correct Factor.
- (2) Margin Level = Measurement Value - Limit Value.

Test Mode: TX G Mode 2437 MHz

Horizontal

130 dBuV/m

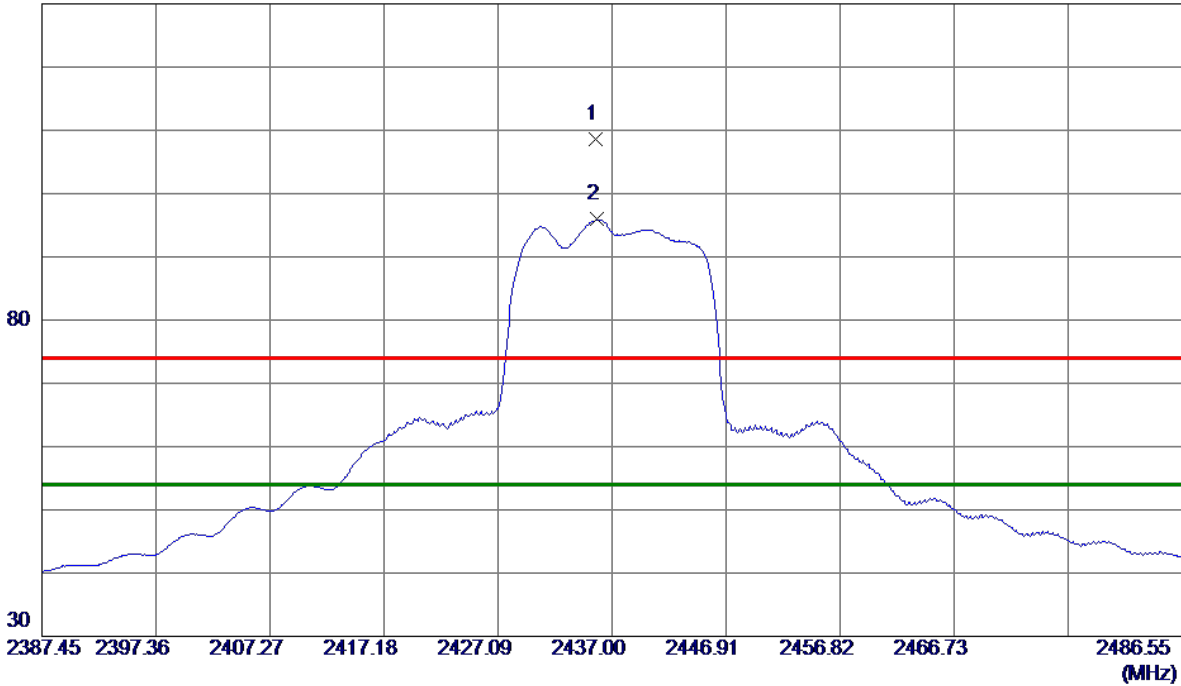

No.	Freq. MHz	Reading Level dBuV/m	Correct Factor dB	Measure ment dBuV/m	Limit dBuV/m	Margin dB	Detector	Comment
1	2435.5630	100.85	7.72	108.57	74.00	34.57	Peak	No Limit
2 *	2435.6620	88.19	7.72	95.91	54.00	41.91	AVG	No Limit

REMARKS:

(1) Measurement Value = Reading Level + Correct Factor.

(2) Margin Level = Measurement Value - Limit Value.

Test Mode: TX G Mode 2437 MHz

Horizontal

80 dBuV/m

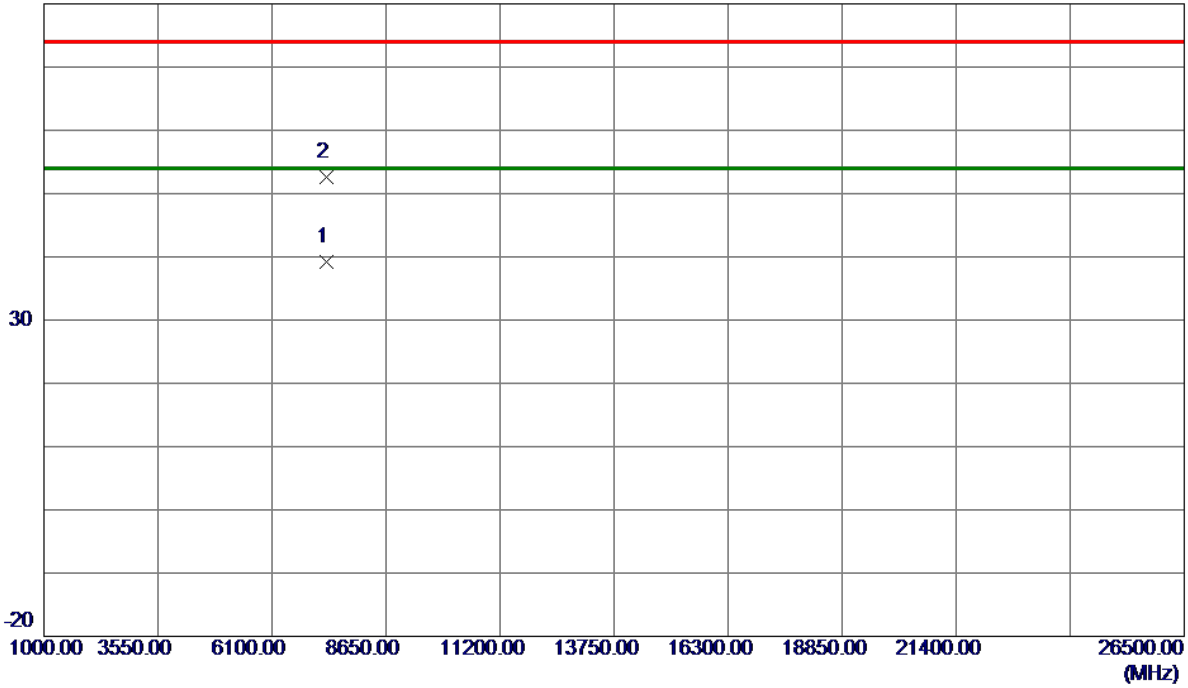

No.	Freq. MHz	Reading Level dBuV/m	Correct Factor dB	Measure ment dBuV/m	Limit dBuV/m	Margin dB	Detector	Comment
1 *	7310.7830	31.30	7.90	39.20	54.00	-14.80	AVG	
2	7310.8820	44.78	7.90	52.68	74.00	-21.32	Peak	

REMARKS:

- (1) Measurement Value = Reading Level + Correct Factor.
- (2) Margin Level = Measurement Value - Limit Value.

Test Mode: TX G Mode 2457 MHz

Vertical

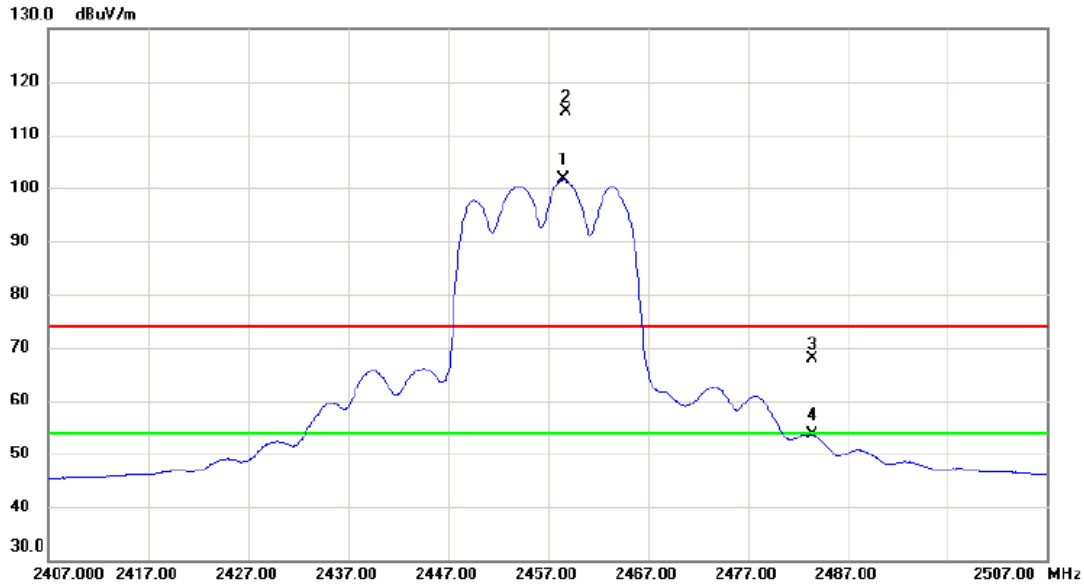

No. Mk.	Freq. MHz	Reading Level dBuV	Correct Factor dB	Measurement dBuV/m	Limit dBuV/m	Margin dB	Detector	Comment
1 *	2458.600	93.75	7.79	101.54	54.00	47.54	AVG	No Limit
2 X	2458.850	106.69	7.79	114.48	74.00	40.48	peak	No Limit
3	2483.500	60.13	7.87	68.00	74.00	-6.00	peak	
4	2483.500	45.67	7.87	53.54	54.00	-0.46	AVG	

REMARKS:

- (1) Measurement Value = Reading Level + Correct Factor.
- (2) Margin Level = Measurement Value - Limit Value.

Test Mode: TX G Mode 2457 MHz

Vertical

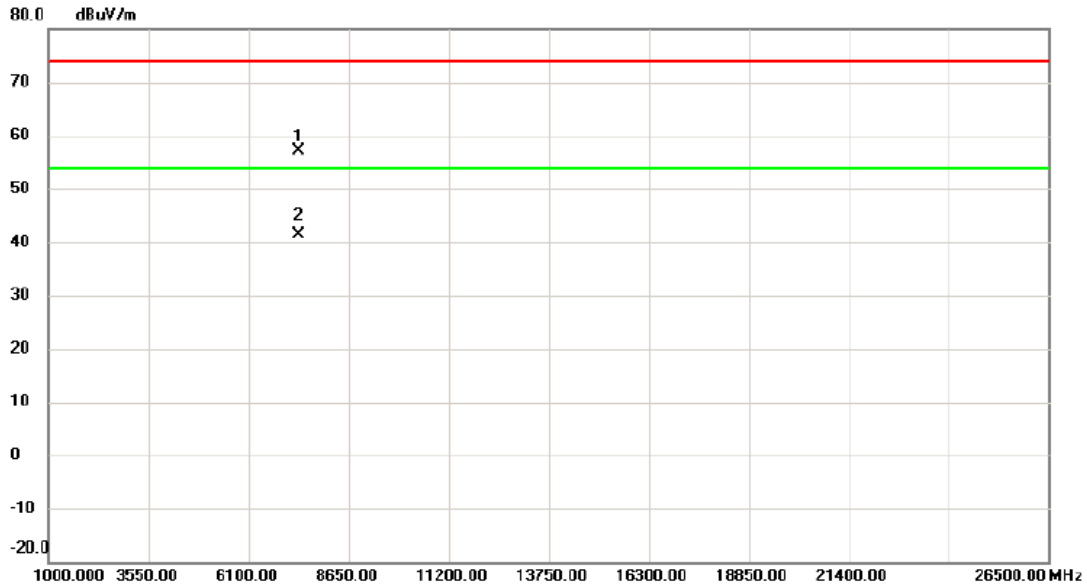

No.	Mk.	Freq. MHz	Reading Level dBuV	Correct Factor dB	Measure- ment dBuV/m	Limit dBuV/m	Margin dB	Detector	Comment
1		7371.557	49.15	7.98	57.13	74.00	-16.87	peak	
2	*	7371.868	33.28	7.98	41.26	54.00	-12.74	AVG	

REMARKS:

- (1) Measurement Value = Reading Level + Correct Factor.
- (2) Margin Level = Measurement Value - Limit Value.

Test Mode: TX G Mode 2457 MHz

Horizontal

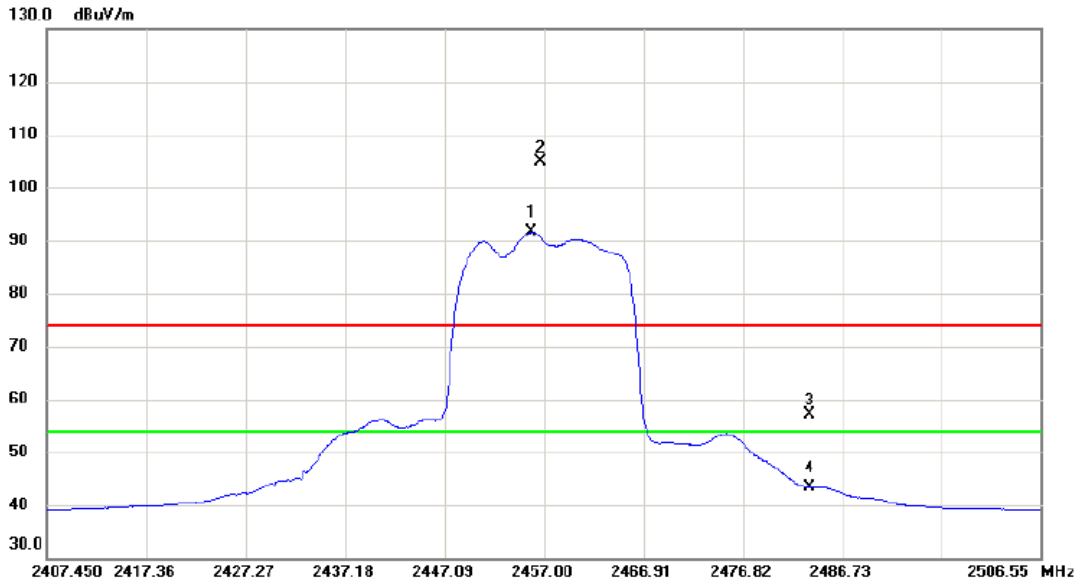

No.	Mk.	Freq. MHz	Reading Level dBuV	Correct Factor dB	Measure- ment dBuV/m	Limit dBuV/m	Margin dB	Detector	Comment
1	*	2455.761	83.92	7.78	91.70	54.00	37.70	AVG	No Limit
2	X	2456.703	97.12	7.78	104.90	74.00	30.90	peak	No Limit
3		2483.500	49.35	7.87	57.22	74.00	-16.78	peak	
4		2483.500	35.58	7.87	43.45	54.00	-10.55	AVG	

REMARKS:

- (1) Measurement Value = Reading Level + Correct Factor.
- (2) Margin Level = Measurement Value - Limit Value.

Test Mode: TX G Mode 2457 MHz

Horizontal

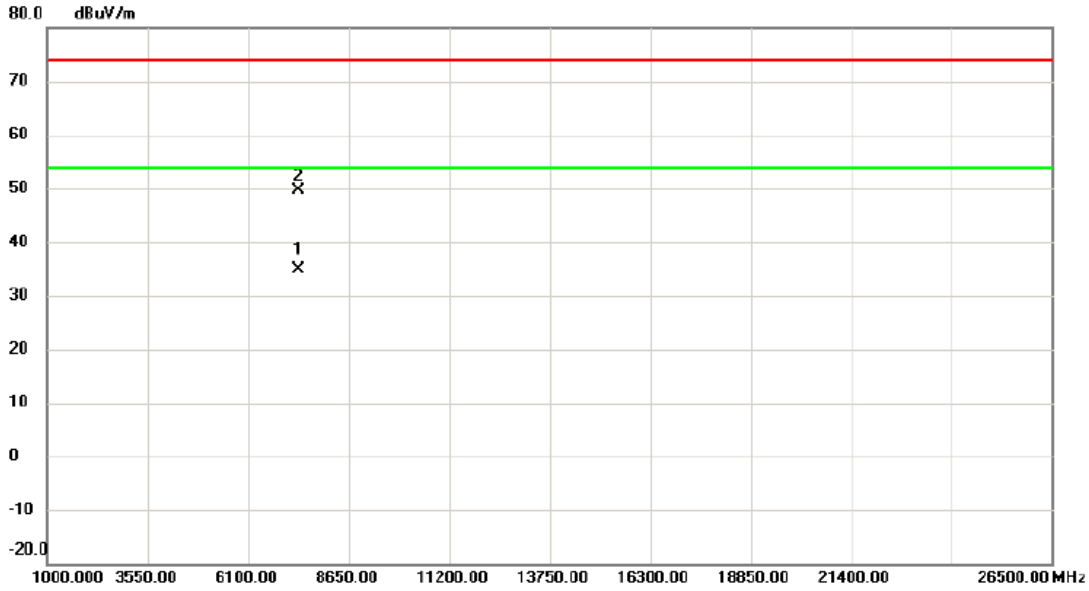

No.	Mk.	Freq. MHz	Reading Level dBuV	Correct Factor dB	Measure- ment dBuV/m	Limit dBuV/m	Margin dB	Detector	Comment
1	*	7371.057	26.95	7.98	34.93	54.00	-19.07	AVG	
2		7371.118	41.70	7.98	49.68	74.00	-24.32	peak	

REMARKS:

(1) Measurement Value = Reading Level + Correct Factor.

(2) Margin Level = Measurement Value - Limit Value.

Test Mode: TX G Mode 2462 MHz

Vertical

130 dBuV/m

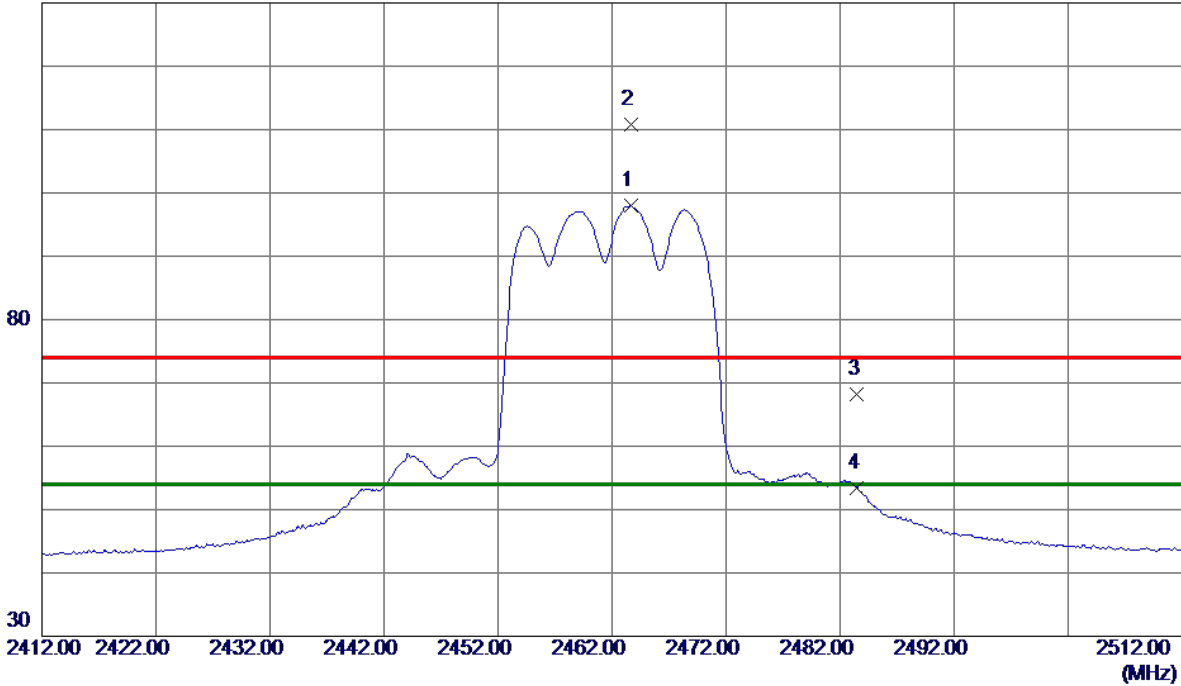

No.	Freq. MHz	Reading Level dBuV/m	Correct Factor dB	Measure ment dBuV/m	Limit dBuV/m	Margin dB	Detector	Comment
1 *	2463.6500	90.12	7.81	97.93	54.00	43.93	AVG	No Limit
2	2463.7000	103.07	7.81	110.88	74.00	36.88	Peak	No Limit
3	2483.5000	60.28	7.88	68.16	74.00	-5.84	Peak	
4	2483.5000	45.45	7.88	53.33	54.00	-0.67	AVG	

REMARKS:

- (1) Measurement Value = Reading Level + Correct Factor.
- (2) Margin Level = Measurement Value - Limit Value.

Test Mode: TX G Mode 2462 MHz

Vertical

80 dBuV/m

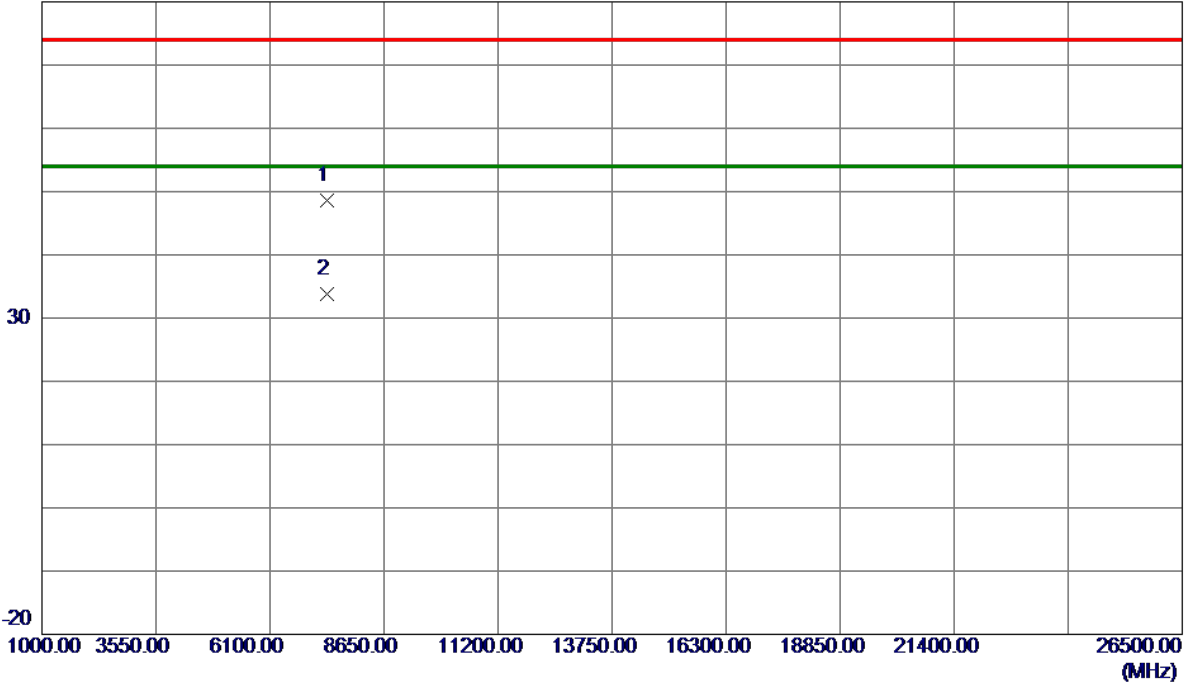

No.	Freq. MHz	Reading Level dBuV/m	Correct Factor dB	Measure ment dBuV/m	Limit dBuV/m	Margin dB	Detector	Comment
1	7375.7480	40.56	7.98	48.54	74.00	-25.46	Peak	
2 *	7386.3180	25.89	8.00	33.89	54.00	-20.11	AVG	

REMARKS:

- (1) Measurement Value = Reading Level + Correct Factor.
- (2) Margin Level = Measurement Value - Limit Value.

Test Mode: TX G Mode 2462 MHz

Horizontal

130 dBuV/m

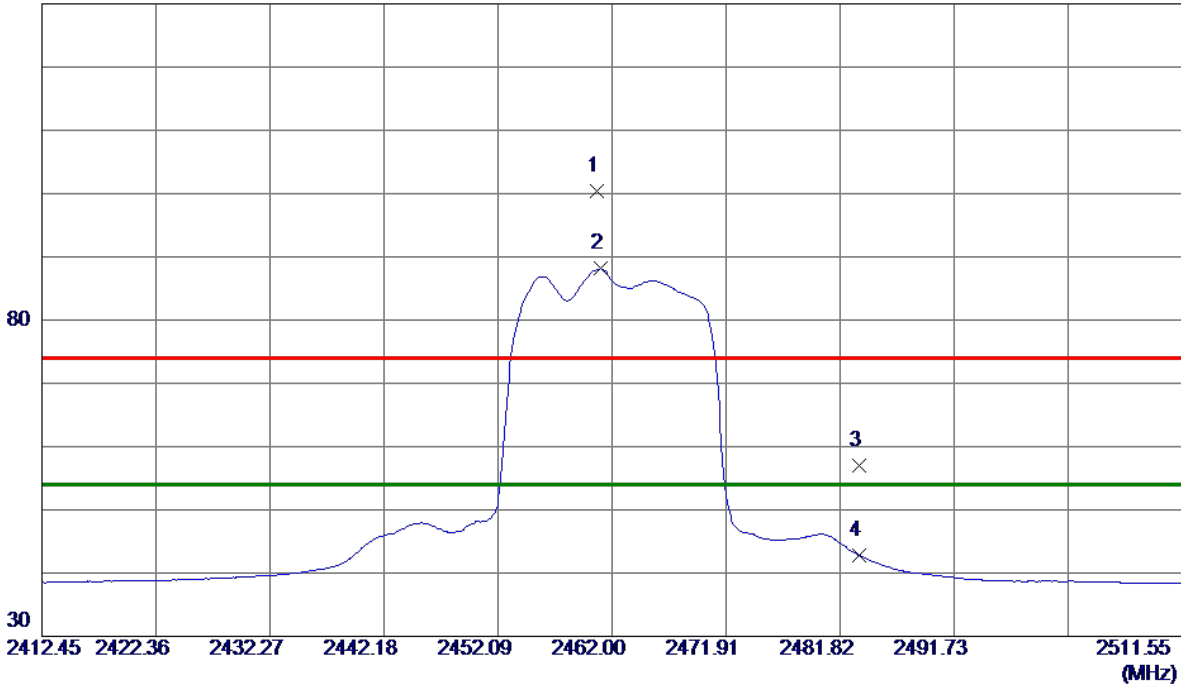

No.	Freq. MHz	Reading Level dBuV/m	Correct Factor dB	Measure ment dBuV/m	Limit dBuV/m	Margin dB	Detector	Comment
1	2460.7120	92.57	7.80	100.37	74.00	26.37	Peak	No Limit
2 *	2460.9590	80.34	7.80	88.14	54.00	34.14	AVG	No Limit
3	2483.5000	49.16	7.88	57.04	74.00	-16.96	Peak	
4	2483.5000	34.90	7.88	42.78	54.00	-11.22	AVG	

REMARKS:

(1) Measurement Value = Reading Level + Correct Factor.

(2) Margin Level = Measurement Value - Limit Value.

Test Mode: TX G Mode 2462 MHz

Horizontal

80 dBuV/m

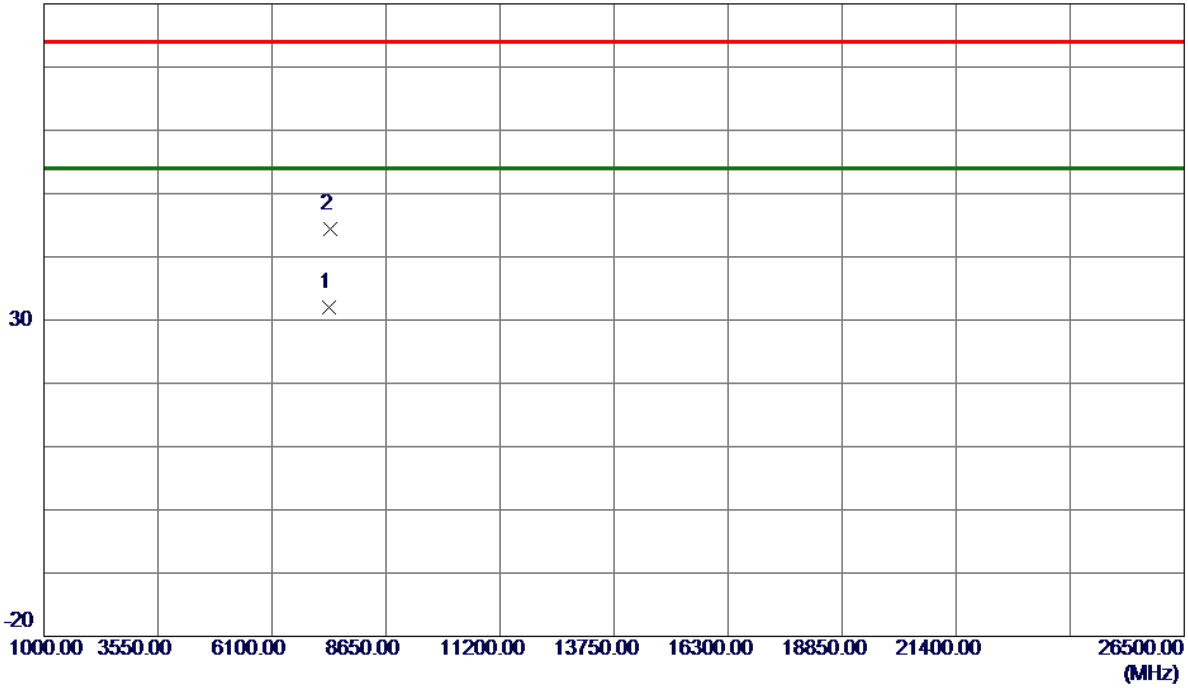

No.	Freq. MHz	Reading Level dBuV/m	Correct Factor dB	Measure ment dBuV/m	Limit dBuV/m	Margin dB	Detector	Comment
1 *	7382.7380	24.08	7.99	32.07	54.00	-21.93	AVG	
2	7390.9170	36.38	8.00	44.38	74.00	-29.62	Peak	

REMARKS:

(1) Measurement Value = Reading Level + Correct Factor.

(2) Margin Level = Measurement Value - Limit Value.

Test Mode: TX N-20M Mode 2412 MHz

Vertical

130 dBuV/m

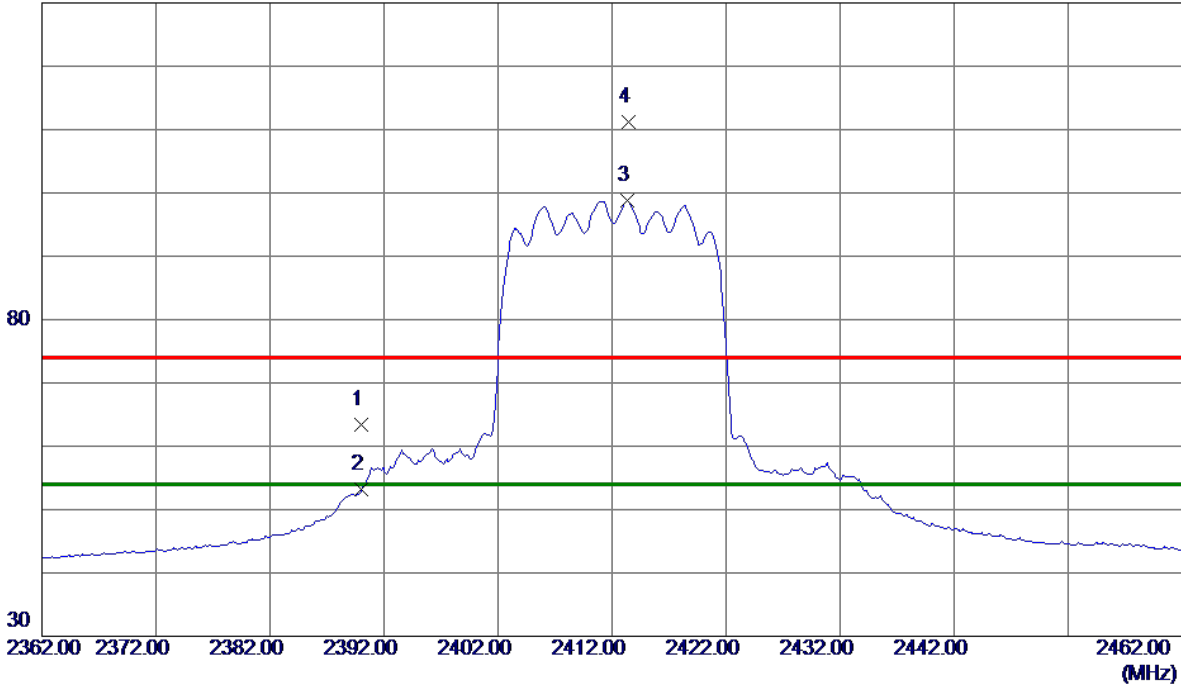

No.	Freq. MHz	Reading Level dBuV/m	Correct Factor dB	Measure ment dBuV/m	Limit dBuV/m	Margin dB	Detector	Comment
1	2390.0000	55.91	7.56	63.47	74.00	-10.53	Peak	
2	2390.0000	45.64	7.56	53.20	54.00	-0.80	AVG	
3 *	2413.3500	91.14	7.64	98.78	54.00	44.78	AVG	No Limit
4	2413.4500	103.54	7.64	111.18	74.00	37.18	Peak	No Limit

REMARKS:

- (1) Measurement Value = Reading Level + Correct Factor.
- (2) Margin Level = Measurement Value - Limit Value.

Test Mode: TX N-20M Mode 2412 MHz

Vertical

80 dBuV/m

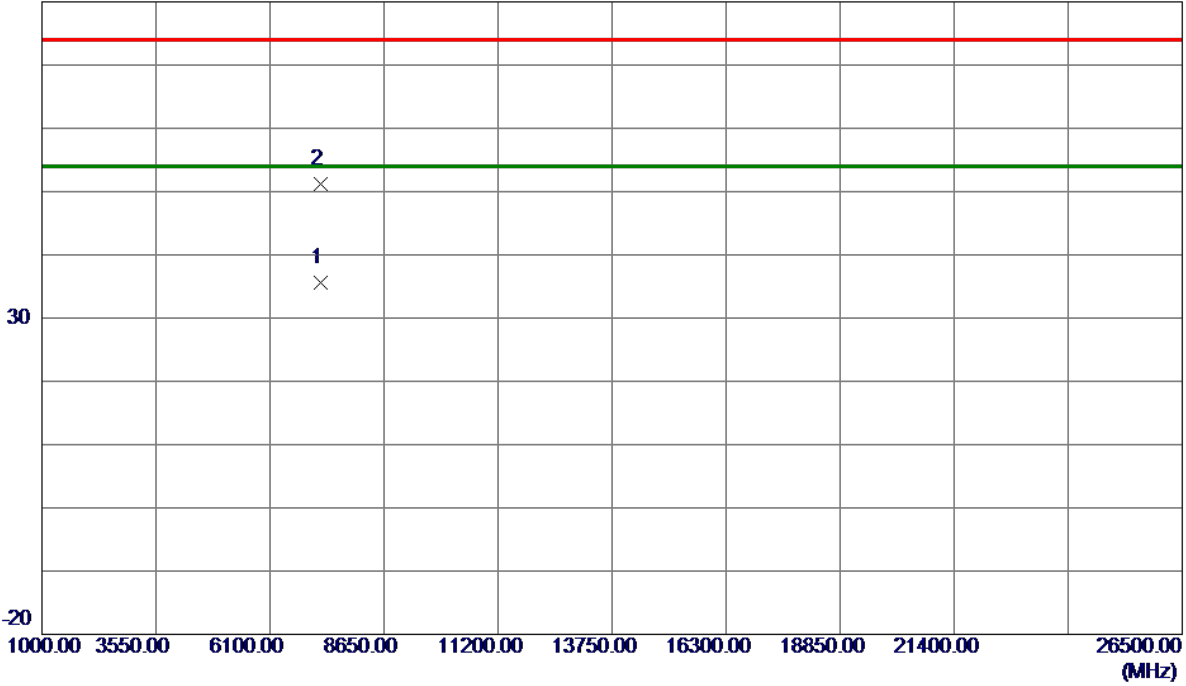

No.	Freq. MHz	Reading Level dBuV/m	Correct Factor dB	Measure ment dBuV/m	Limit dBuV/m	Margin dB	Detector	Comment
1 *	7236.0870	27.73	7.81	35.54	54.00	-18.46	AVG	
2	7239.1770	43.40	7.81	51.21	74.00	-22.79	Peak	

REMARKS:

- (1) Measurement Value = Reading Level + Correct Factor.
- (2) Margin Level = Measurement Value - Limit Value.

Test Mode: TX N-20M Mode 2412 MHz

Horizontal

130 dBuV/m

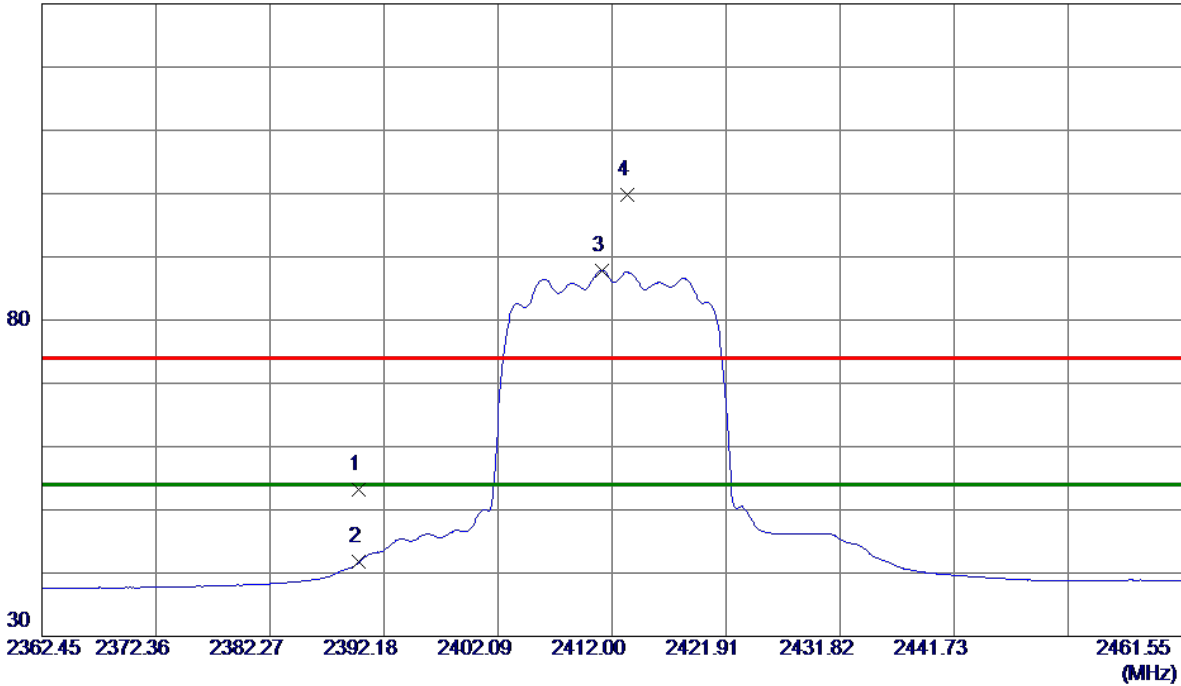

No.	Freq. MHz	Reading Level dBuV/m	Correct Factor dB	Measure ment dBuV/m	Limit dBuV/m	Margin dB	Detector	Comment
1	2390.0000	45.70	7.56	53.26	74.00	-20.74	Peak	
2	2390.0000	34.17	7.56	41.73	54.00	-12.27	AVG	
3 *	2411.1080	80.22	7.63	87.85	54.00	33.85	AVG	No Limit
4	2413.3380	92.11	7.64	99.75	74.00	25.75	Peak	No Limit

REMARKS:

(1) Measurement Value = Reading Level + Correct Factor.

(2) Margin Level = Measurement Value - Limit Value.

Test Mode: TX N-20M Mode 2412 MHz

Horizontal

80 dBuV/m

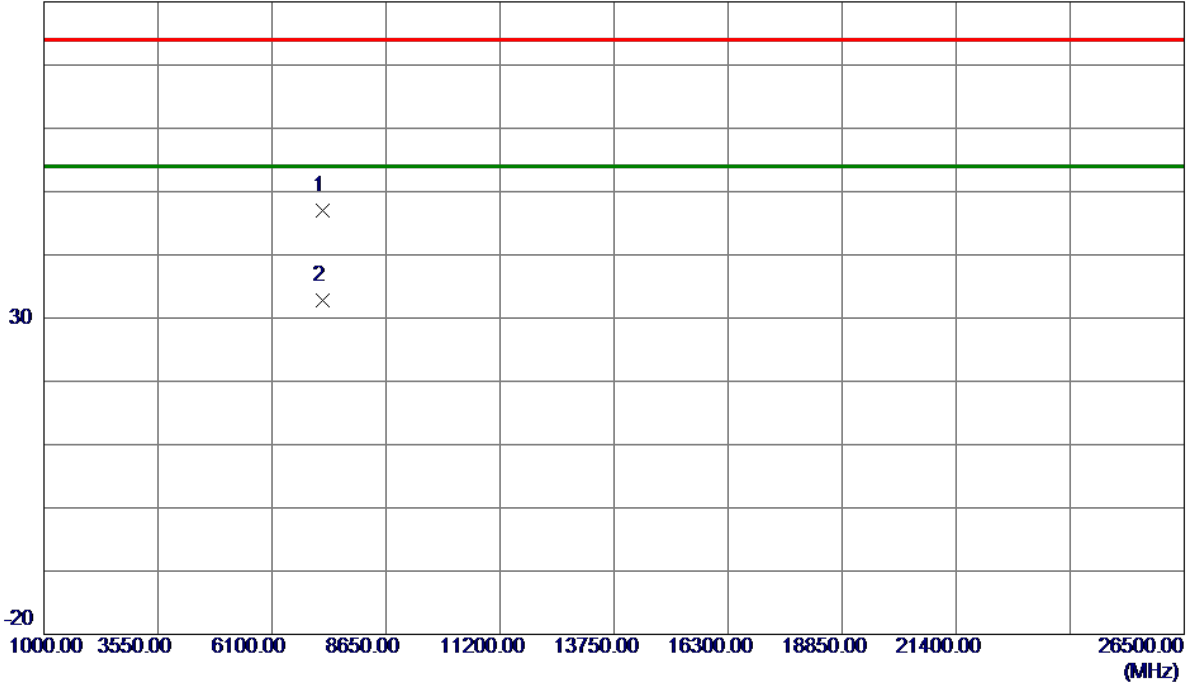

No.	Freq. MHz	Reading Level dBuV/m	Correct Factor dB	Measure ment dBuV/m	Limit dBuV/m	Margin dB	Detector	Comment
1	7228.7780	39.23	7.80	47.03	74.00	-26.97	Peak	
2 *	7235.9380	24.96	7.81	32.77	54.00	-21.23	AVG	

REMARKS:

(1) Measurement Value = Reading Level + Correct Factor.

(2) Margin Level = Measurement Value - Limit Value.

Test Mode: TX N-20M Mode 2417 MHz

Vertical

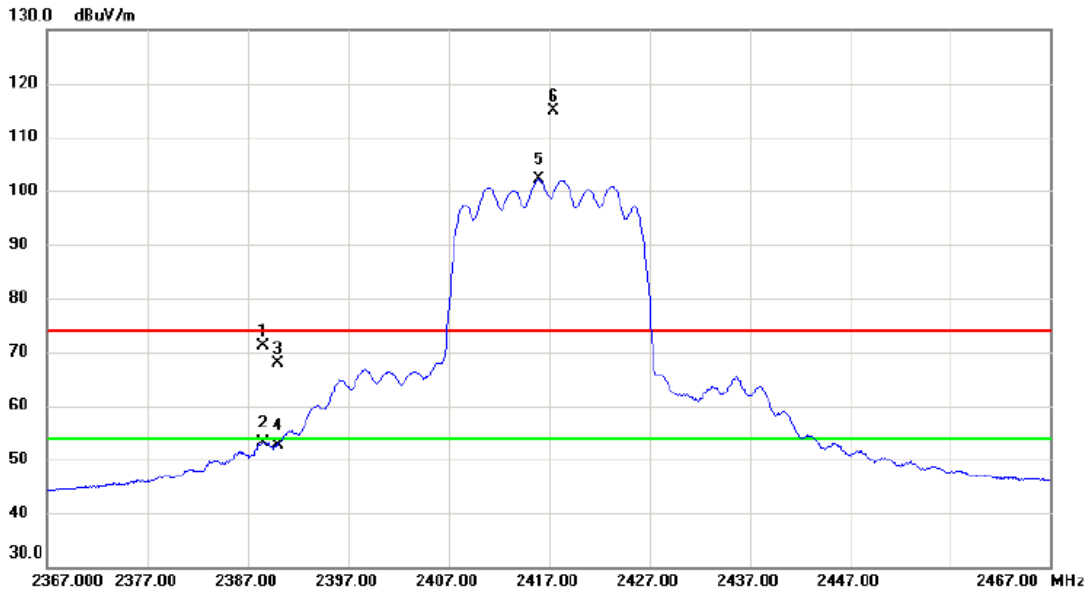

No.	Mk.	Freq. MHz	Reading Level dBuV	Correct Factor dB	Measure- ment dBuV/m	Limit dBuV/m	Margin dB	Detector	Comment
1		2388.600	63.64	7.56	71.20	74.00	-2.80	peak	
2		2388.600	45.65	7.56	53.21	54.00	-0.79	AVG	
3		2390.000	60.25	7.57	67.82	74.00	-6.18	peak	
4		2390.000	44.96	7.57	52.53	54.00	-1.47	AVG	
5	*	2416.000	94.44	7.66	102.10	54.00	48.10	AVG	No Limit
6	X	2417.500	107.18	7.66	114.84	74.00	40.84	peak	No Limit

REMARKS:

- (1) Measurement Value = Reading Level + Correct Factor.
- (2) Margin Level = Measurement Value - Limit Value.

Test Mode: TX N-20M Mode 2417 MHz

Vertical

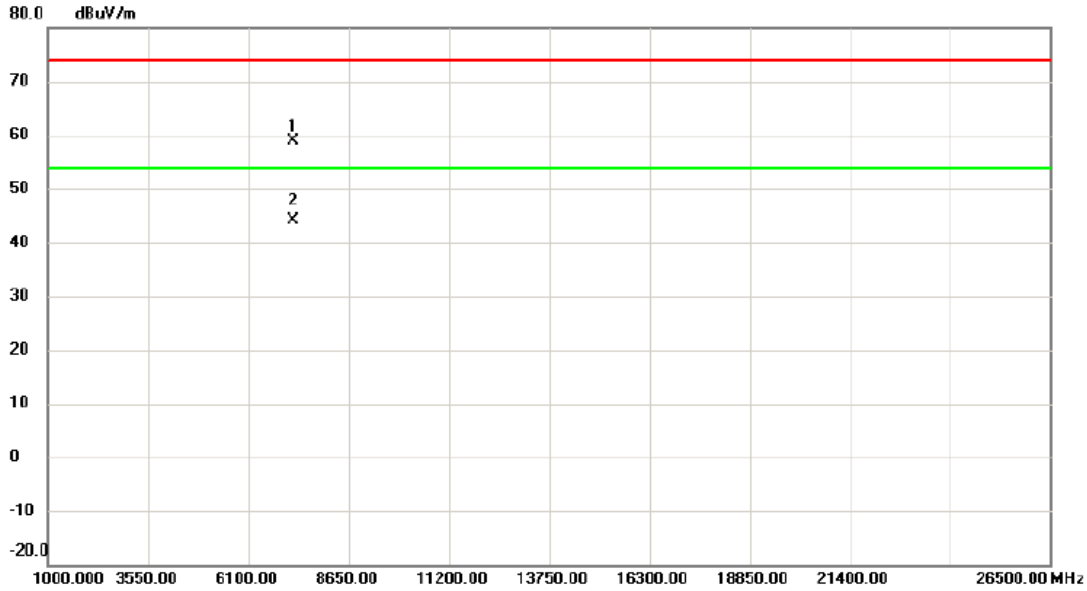

No.	Mk.	Freq.	Reading Level	Correct Factor	Measurement	Limit	Margin	Detector	Comment
		MHz	dBuV	dB	dBuV/m	dBuV/m	dB		
1		7250.667	51.18	7.82	59.00	74.00	-15.00	peak	
2	*	7251.198	36.20	7.82	44.02	54.00	-9.98	AVG	

REMARKS:

- (1) Measurement Value = Reading Level + Correct Factor.
- (2) Margin Level = Measurement Value - Limit Value.

Test Mode: TX N-20M Mode 2417 MHz

Horizontal

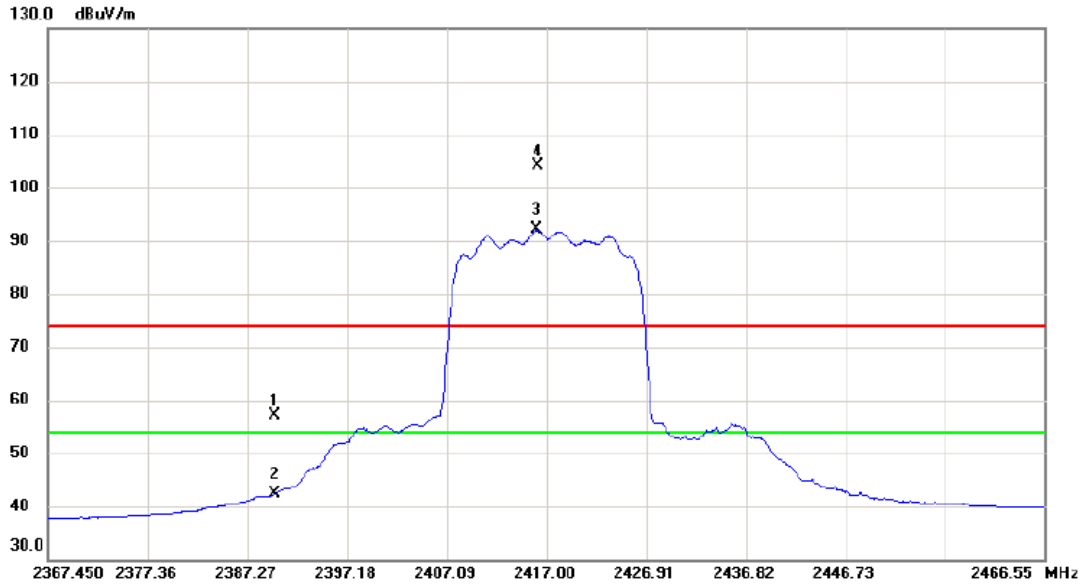

No.	Mk.	Freq. MHz	Reading Level dBuV	Correct Factor dB	Measure- ment dBuV/m	Limit dBuV/m	Margin dB	Detector	Comment
1		2390.000	49.44	7.57	57.01	74.00	-16.99	peak	
2		2390.000	34.92	7.57	42.49	54.00	-11.51	AVG	
3	*	2416.059	84.37	7.66	92.03	54.00	38.03	AVG	No Limit
4	X	2416.158	96.53	7.66	104.19	74.00	30.19	peak	No Limit

REMARKS:

- (1) Measurement Value = Reading Level + Correct Factor.
- (2) Margin Level = Measurement Value - Limit Value.

Test Mode: TX N-20M Mode 2417 MHz

Horizontal

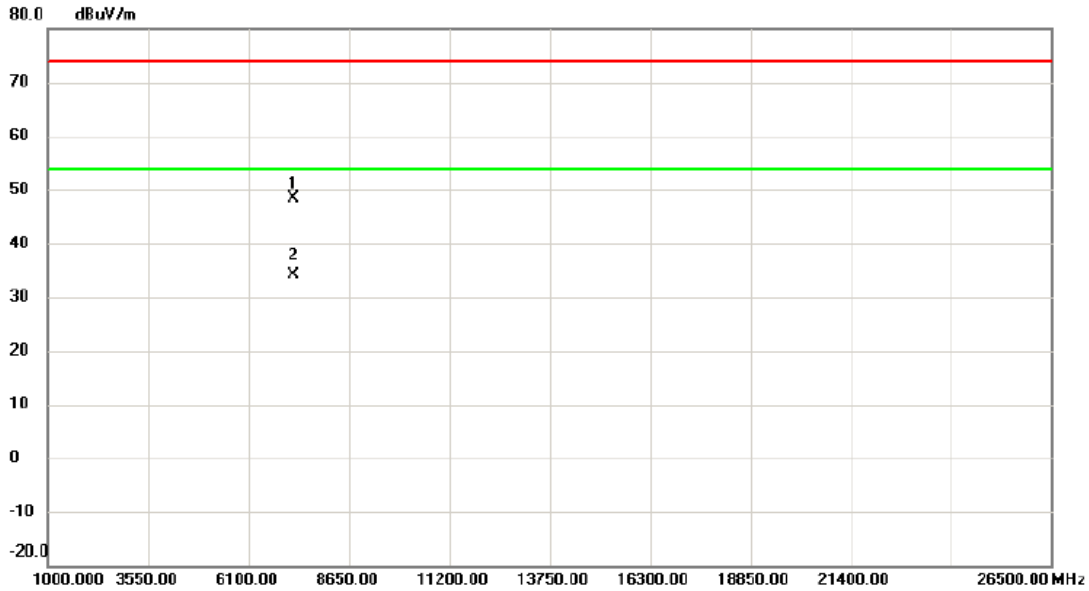

No.	Mk.	Freq. MHz	Reading Level dBuV	Correct Factor dB	Measure- ment dBuV/m	Limit dBuV/m	Margin dB	Detector	Comment
1		7250.738	40.44	7.82	48.26	74.00	-25.74	peak	
2	*	7255.458	26.21	7.83	34.04	54.00	-19.96	AVG	

REMARKS:

- (1) Measurement Value = Reading Level + Correct Factor.
- (2) Margin Level = Measurement Value - Limit Value.

Test Mode: TX N-20M Mode 2437 MHz

Vertical

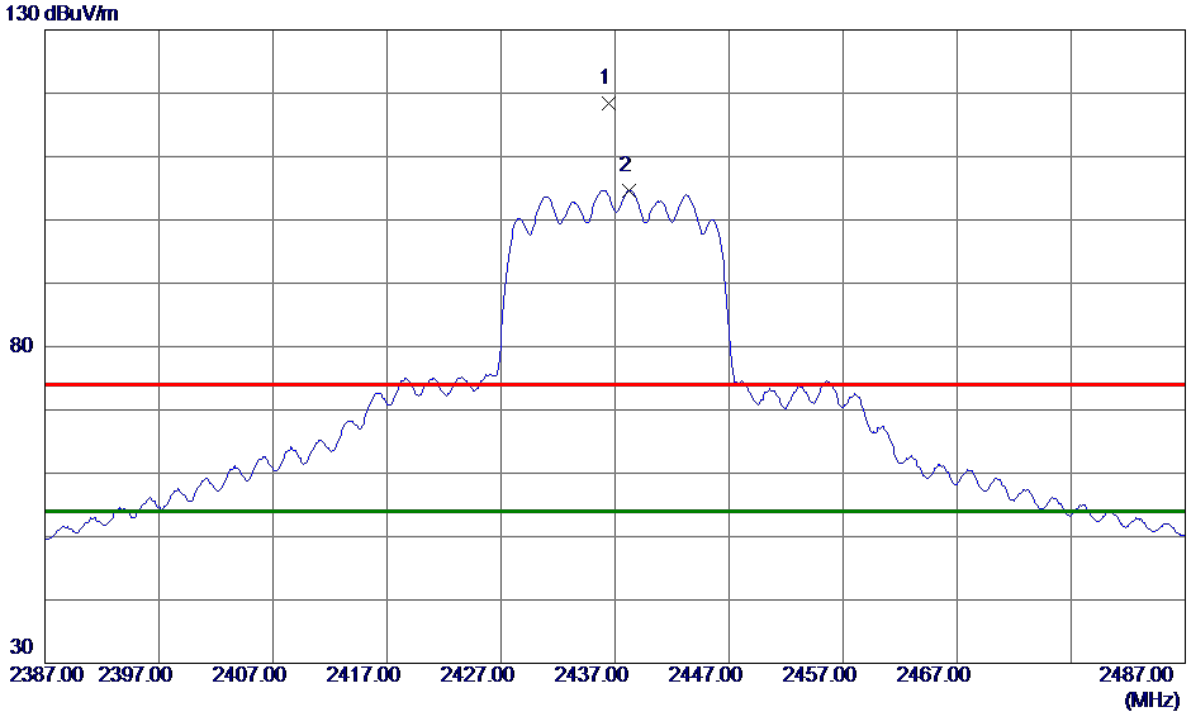

No.	Freq. MHz	Reading Level dBuV/m	Correct Factor dB	Measure ment dBuV/m	Limit dBuV/m	Margin dB	Detector	Comment
1	2436.4500	110.59	7.72	118.31	74.00	44.31	Peak	No Limit
2 *	2438.2000	96.95	7.72	104.67	54.00	50.67	AVG	No Limit

REMARKS:

- (1) Measurement Value = Reading Level + Correct Factor.
- (2) Margin Level = Measurement Value - Limit Value.

Test Mode: TX N-20M Mode 2437 MHz

Vertical

80 dBuV/m

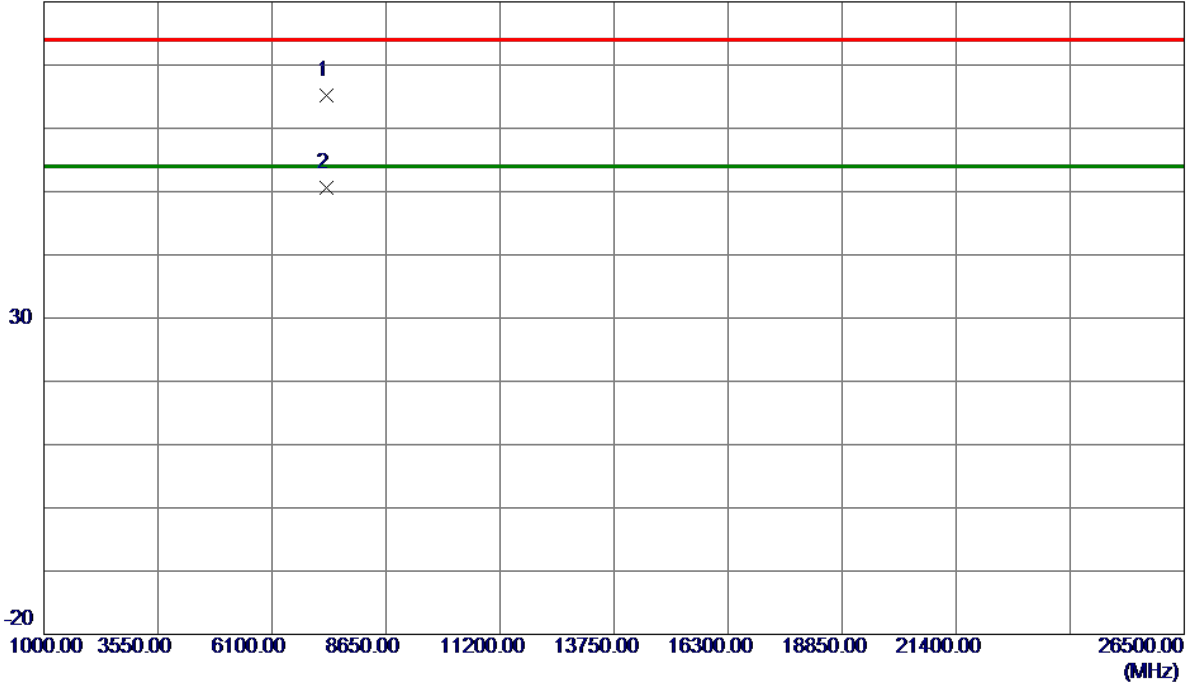

No.	Freq. MHz	Reading Level dBuV/m	Correct Factor dB	Measure ment dBuV/m	Limit dBuV/m	Margin dB	Detector	Comment
1	7311.2970	57.25	7.90	65.15	74.00	-8.85	Peak	
2 *	7311.3580	42.67	7.90	50.57	54.00	-3.43	AVG	

REMARKS:

(1) Measurement Value = Reading Level + Correct Factor.

(2) Margin Level = Measurement Value - Limit Value.

Test Mode: TX N-20M Mode 2437 MHz

Horizontal

130 dBuV/m

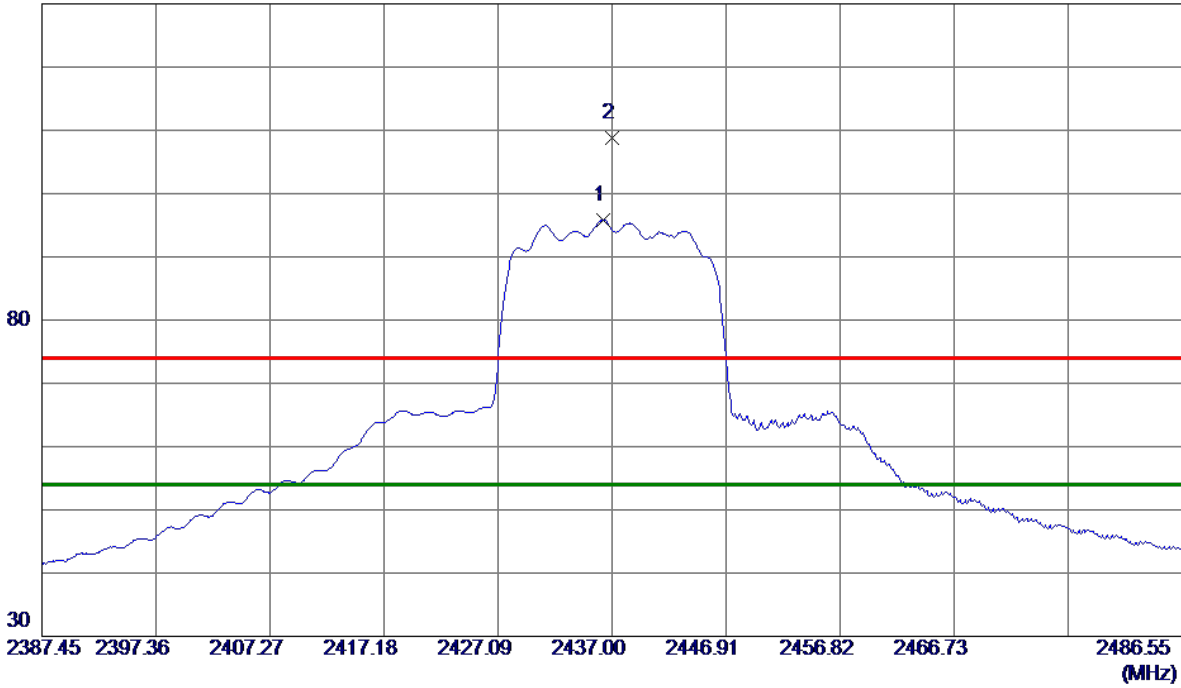

No.	Freq. MHz	Reading Level dBuV/m	Correct Factor dB	Measure ment dBuV/m	Limit dBuV/m	Margin dB	Detector	Comment
1 *	2436.2070	88.14	7.72	95.86	54.00	41.86	AVG	No Limit
2	2436.9500	101.12	7.72	108.84	74.00	34.84	Peak	No Limit

REMARKS:

(1) Measurement Value = Reading Level + Correct Factor.

(2) Margin Level = Measurement Value - Limit Value.

Test Mode: TX N-20M Mode 2437 MHz

Horizontal

80 dBuV/m

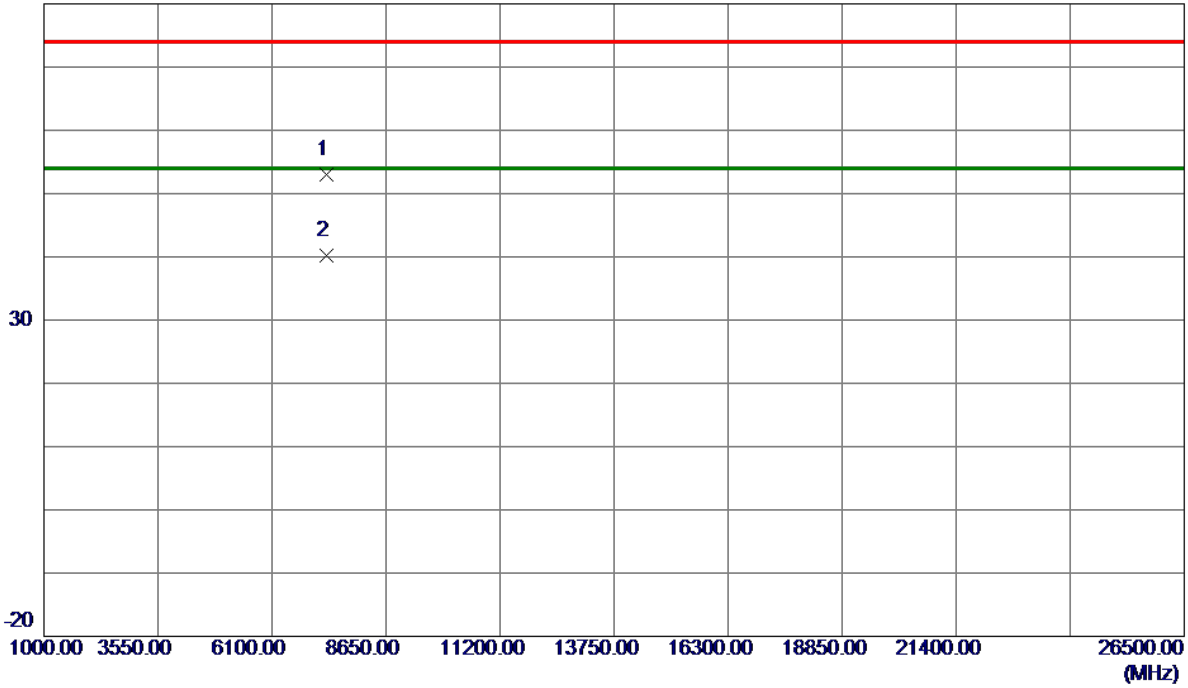

No.	Freq. MHz	Reading Level dBuV/m	Correct Factor dB	Measure ment dBuV/m	Limit dBuV/m	Margin dB	Detector	Comment
1	7313.5870	45.05	7.91	52.96	74.00	-21.04	Peak	
2 *	7315.9170	32.28	7.91	40.19	54.00	-13.81	AVG	

REMARKS:

(1) Measurement Value = Reading Level + Correct Factor.

(2) Margin Level = Measurement Value - Limit Value.

Test Mode: TX N-20M Mode 2457 MHz

Vertical

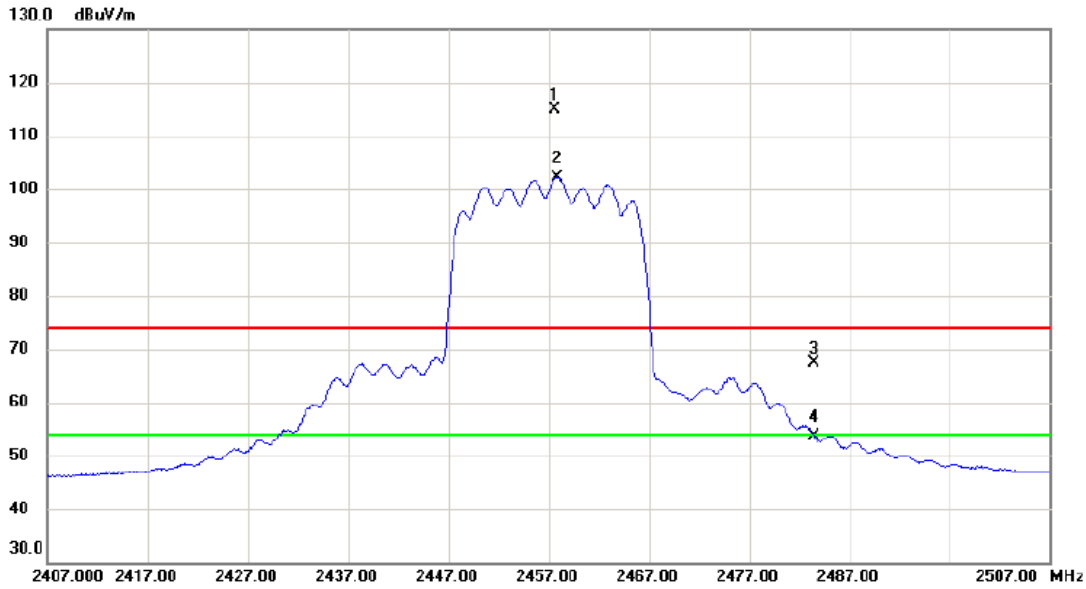

No.	Mk.	Freq. MHz	Reading Level dBuV	Correct Factor dB	Measure- ment dBuV/m	Limit dBuV/m	Margin dB	Detector	Comment
1	X	2457.550	107.12	7.79	114.91	74.00	40.91	peak	No Limit
2	*	2457.900	94.46	7.79	102.25	54.00	48.25	AVG	No Limit
3		2483.500	59.40	7.87	67.27	74.00	-6.73	peak	
4		2483.500	45.71	7.87	53.58	54.00	-0.42	AVG	

REMARKS:

- (1) Measurement Value = Reading Level + Correct Factor.
- (2) Margin Level = Measurement Value - Limit Value.

Test Mode: TX N-20M Mode 2457 MHz

Vertical

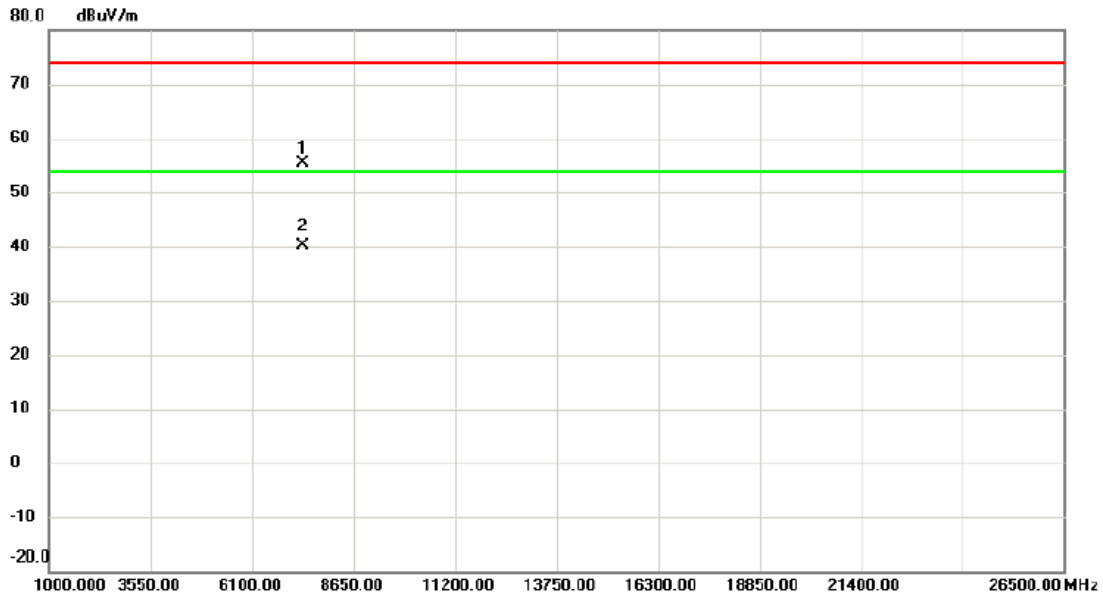

No.	Mk.	Freq. MHz	Reading Level dBuV	Correct Factor dB	Measure- ment dBuV/m	Limit dBuV/m	Margin dB	Detector	Comment
1		7371.017	47.43	7.98	55.41	74.00	-18.59	peak	
2	*	7371.087	32.17	7.98	40.15	54.00	-13.85	AVG	

REMARKS:

- (1) Measurement Value = Reading Level + Correct Factor.
- (2) Margin Level = Measurement Value - Limit Value.

Test Mode: TX N-20M Mode 2457 MHz

Horizontal

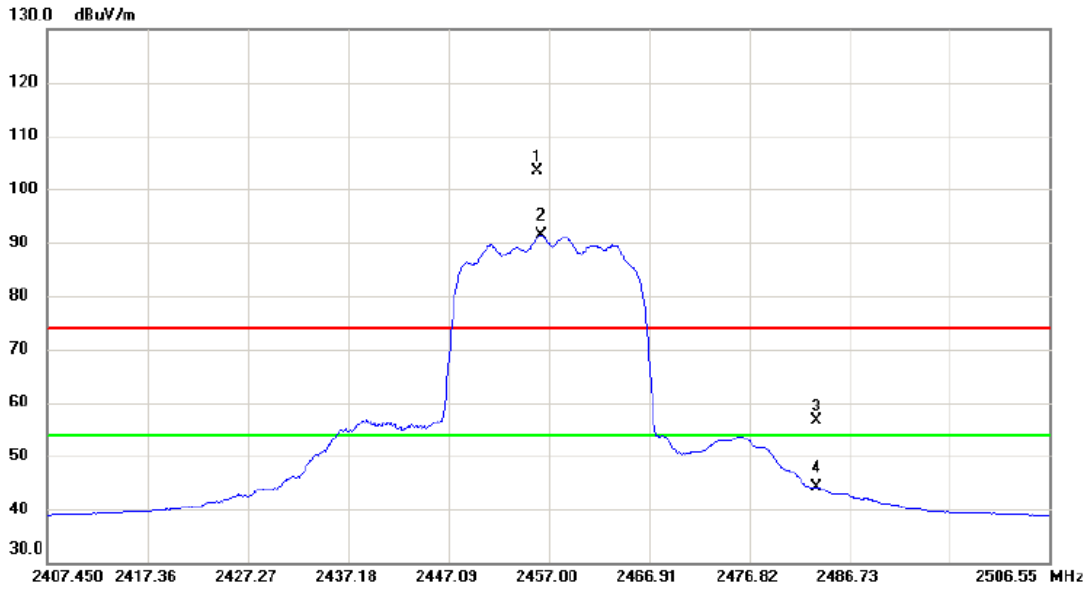

No.	Mk.	Freq. MHz	Reading Level dBuV	Correct Factor dB	Measure- ment dBuV/m	Limit dBuV/m	Margin dB	Detector	Comment
1	X	2455.860	95.48	7.78	103.26	74.00	29.26	peak	No Limit
2	*	2456.306	83.62	7.78	91.40	54.00	37.40	AVG	No Limit
3		2483.500	48.82	7.87	56.69	74.00	-17.31	peak	
4		2483.500	36.29	7.87	44.16	54.00	-9.84	AVG	

REMARKS:

- (1) Measurement Value = Reading Level + Correct Factor.
- (2) Margin Level = Measurement Value - Limit Value.

Test Mode: TX N-20M Mode 2457 MHz

Horizontal

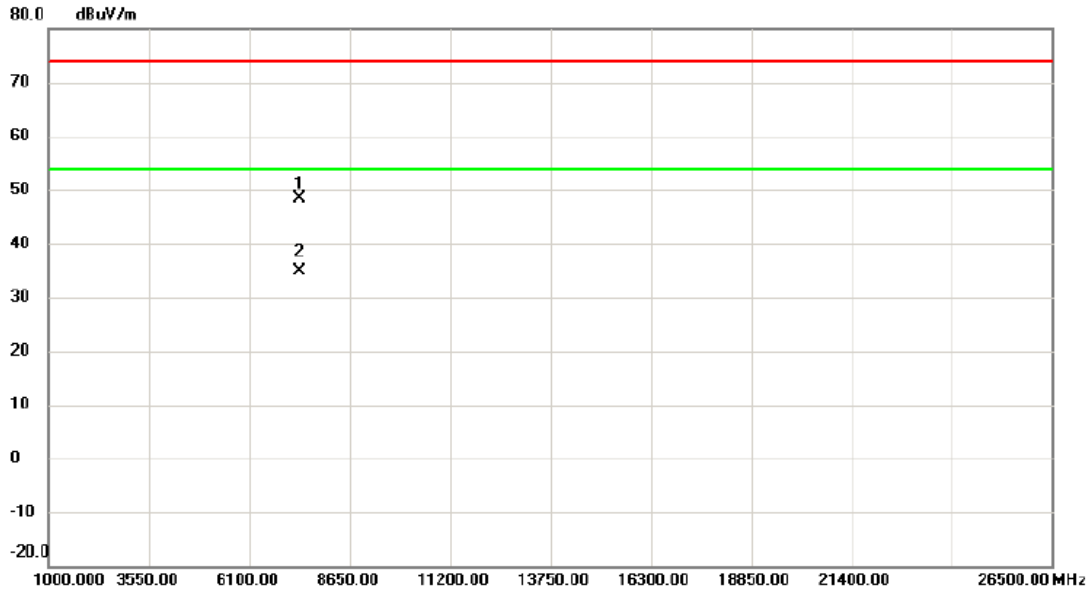

No.	Mk.	Freq. MHz	Reading Level dBuV	Correct Factor dB	Measure- ment dBuV/m	Limit dBuV/m	Margin dB	Detector	Comment
1		7370.938	40.44	7.98	48.42	74.00	-25.58	peak	
2	*	7371.257	26.88	7.98	34.86	54.00	-19.14	AVG	

REMARKS:

- (1) Measurement Value = Reading Level + Correct Factor.
- (2) Margin Level = Measurement Value - Limit Value.

Test Mode: TX N-20M Mode 2462 MHz

Vertical

130 dBuV/m

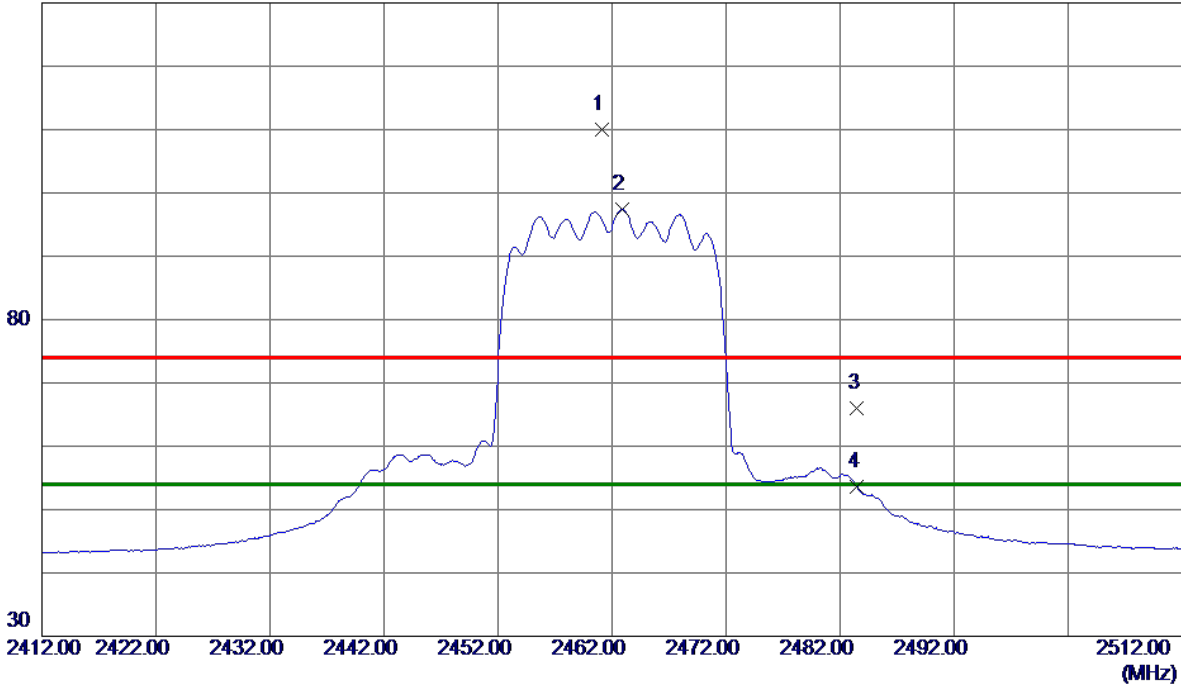

No.	Freq. MHz	Reading Level dBuV/m	Correct Factor dB	Measurement dBuV/m	Limit dBuV/m	Margin dB	Detector	Comment
1	2461.1500	102.10	7.80	109.90	74.00	35.90	Peak	No Limit
2 *	2462.8500	89.59	7.81	97.40	54.00	43.40	AVG	No Limit
3	2483.5000	58.07	7.88	65.95	74.00	-8.05	Peak	
4	2483.5000	45.68	7.88	53.56	54.00	-0.44	AVG	

REMARKS:

- (1) Measurement Value = Reading Level + Correct Factor.
- (2) Margin Level = Measurement Value - Limit Value.

Test Mode: TX N-20M Mode 2462 MHz

Vertical

80 dBuV/m

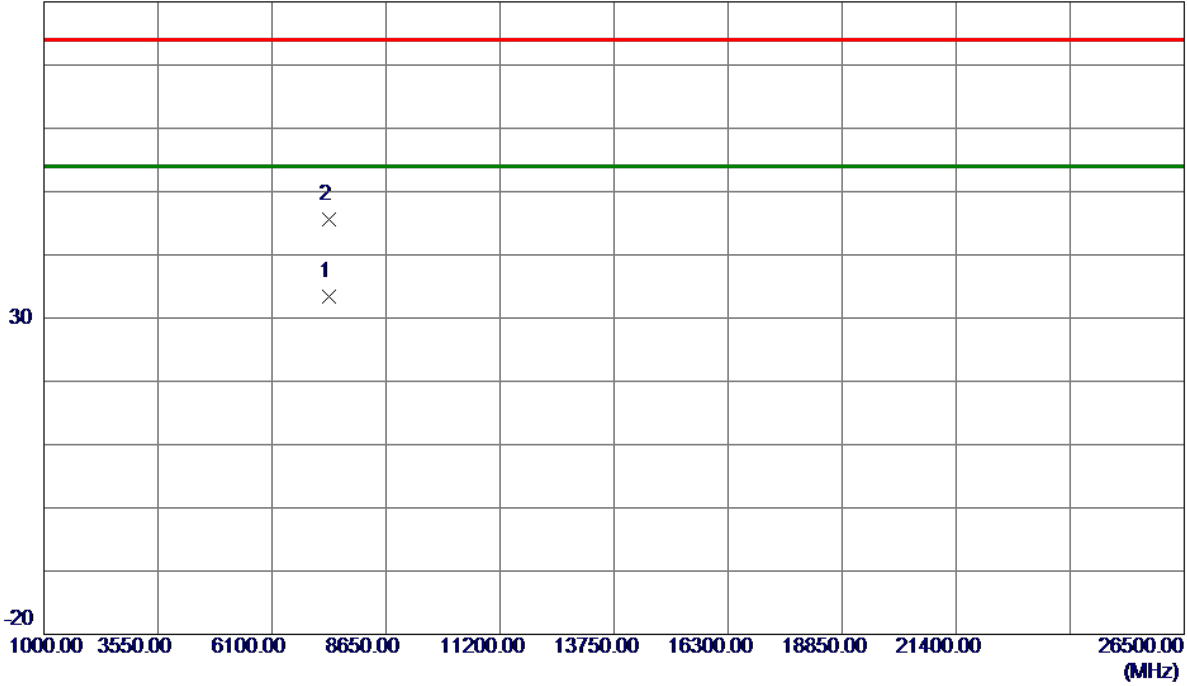

No.	Freq. MHz	Reading Level dBuV/m	Correct Factor dB	Measure ment dBuV/m	Limit dBuV/m	Margin dB	Detector	Comment
1 *	7381.2900	25.44	7.99	33.43	54.00	-20.57	AVG	
2	7386.0600	37.65	8.00	45.65	74.00	-28.35	Peak	

REMARKS:

- (1) Measurement Value = Reading Level + Correct Factor.
- (2) Margin Level = Measurement Value - Limit Value.

Test Mode: TX N-20M Mode 2462 MHz

Horizontal

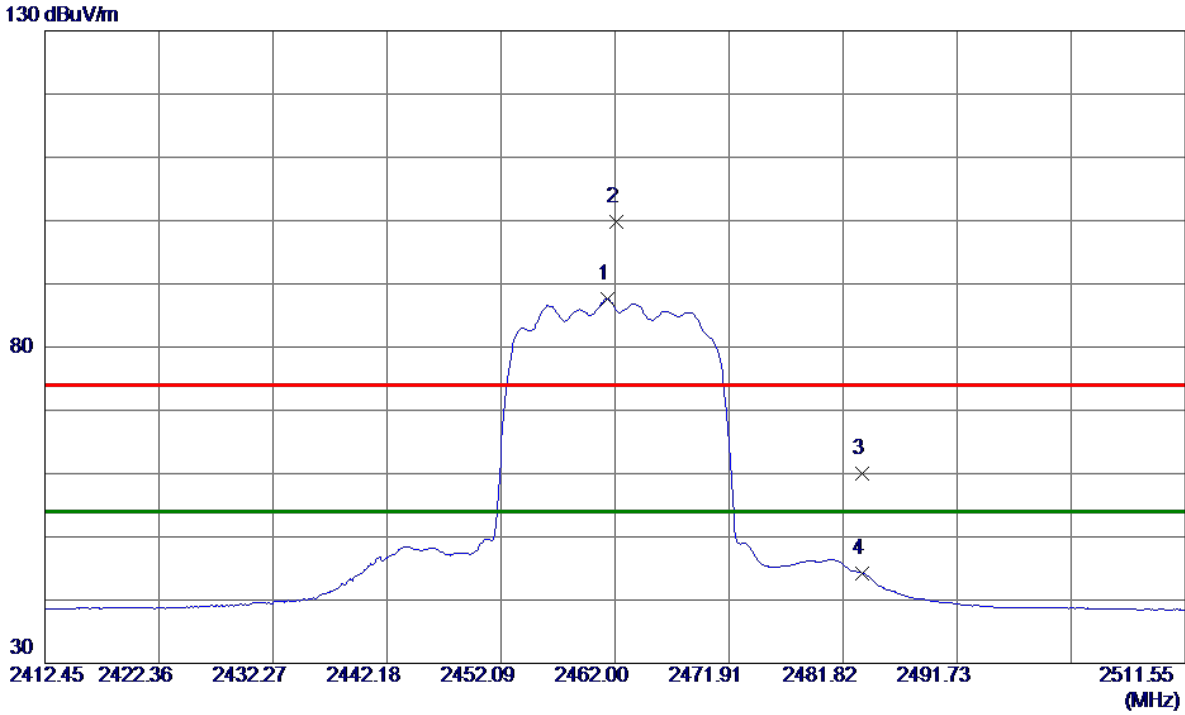

No.	Freq. MHz	Reading Level dBuV/m	Correct Factor dB	Measure ment dBuV/m	Limit dBuV/m	Margin dB	Detector	Comment
1 *	2461.3060	79.80	7.80	87.60	54.00	33.60	AVG	No Limit
2	2462.0990	91.93	7.80	99.73	74.00	25.73	Peak	No Limit
3	2483.5000	52.04	7.88	59.92	74.00	-14.08	Peak	
4	2483.5000	36.38	7.88	44.26	54.00	-9.74	AVG	

REMARKS:

(1) Measurement Value = Reading Level + Correct Factor.

(2) Margin Level = Measurement Value - Limit Value.

Test Mode: TX N-20M Mode 2462 MHz

Horizontal

80 dBuV/m

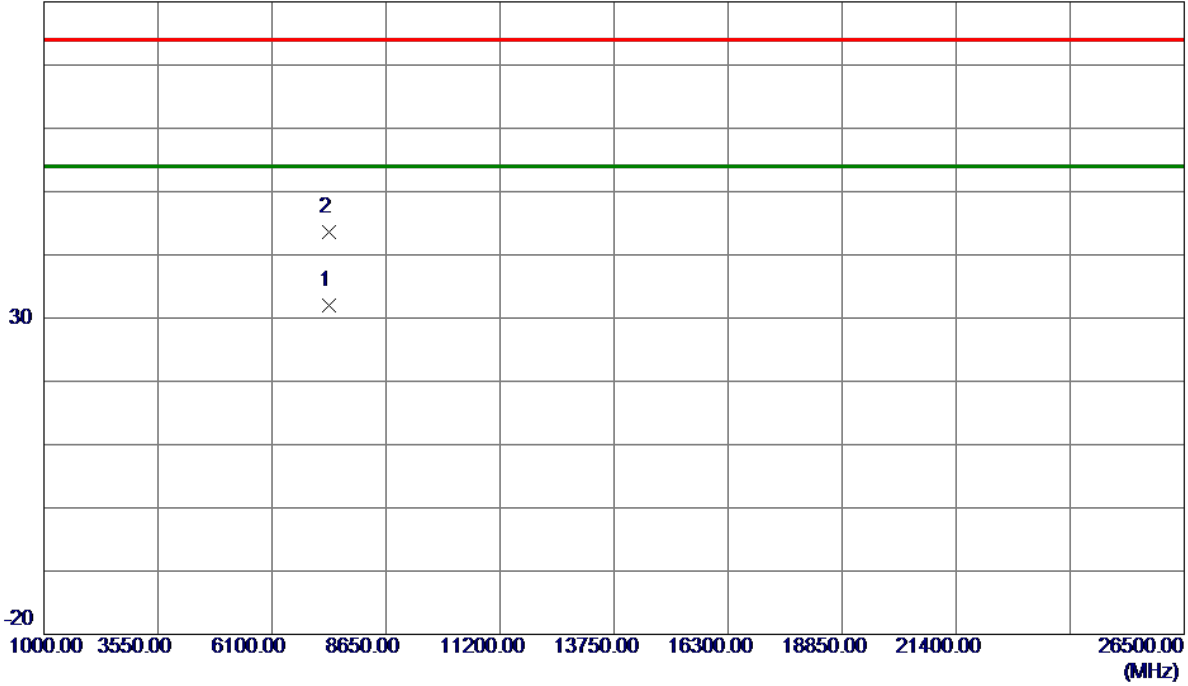

No.	Freq. MHz	Reading Level dBuV/m	Correct Factor dB	Measure ment dBuV/m	Limit dBuV/m	Margin dB	Detector	Comment
1 *	7381.0400	23.92	7.99	31.91	54.00	-22.09	AVG	
2	7384.4300	35.69	7.99	43.68	74.00	-30.32	Peak	

REMARKS:

(1) Measurement Value = Reading Level + Correct Factor.

(2) Margin Level = Measurement Value - Limit Value.

Test Mode: TX N-40M Mode 2422MHz

Vertical

130 dBuV/m

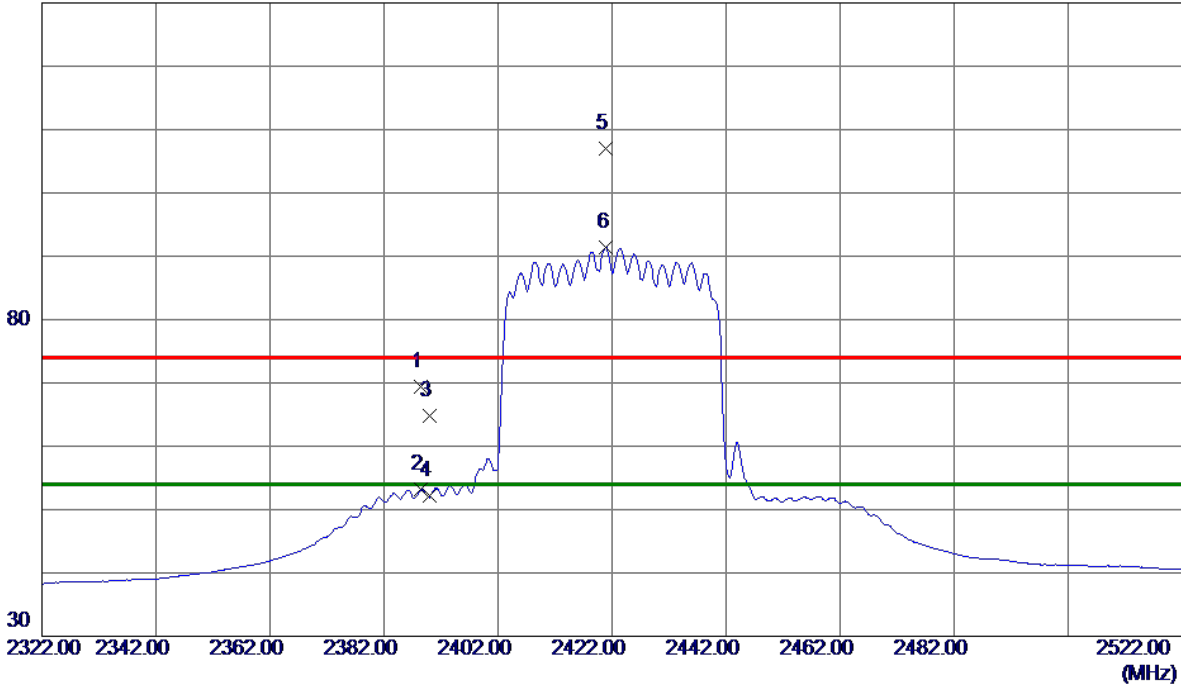

No.	Freq. MHz	Reading Level dBuV/m	Correct Factor dB	Measure ment dBuV/m	Limit dBuV/m	Margin dB	Detector	Comment
1	2388.5000	61.77	7.56	69.33	74.00	-4.67	Peak	
2	2388.5000	45.55	7.56	53.11	54.00	-0.89	AVG	
3	2390.0000	57.28	7.56	64.84	74.00	-9.16	Peak	
4	2390.0000	44.56	7.56	52.12	54.00	-1.88	AVG	
5	2420.9000	99.26	7.67	106.93	74.00	32.93	Peak	No Limit
6 *	2421.0000	83.69	7.67	91.36	54.00	37.36	AVG	No Limit

REMARKS:

- (1) Measurement Value = Reading Level + Correct Factor.
- (2) Margin Level = Measurement Value - Limit Value.

Test Mode: TX N-40M Mode 2422MHz

Vertical

80 dBuV/m

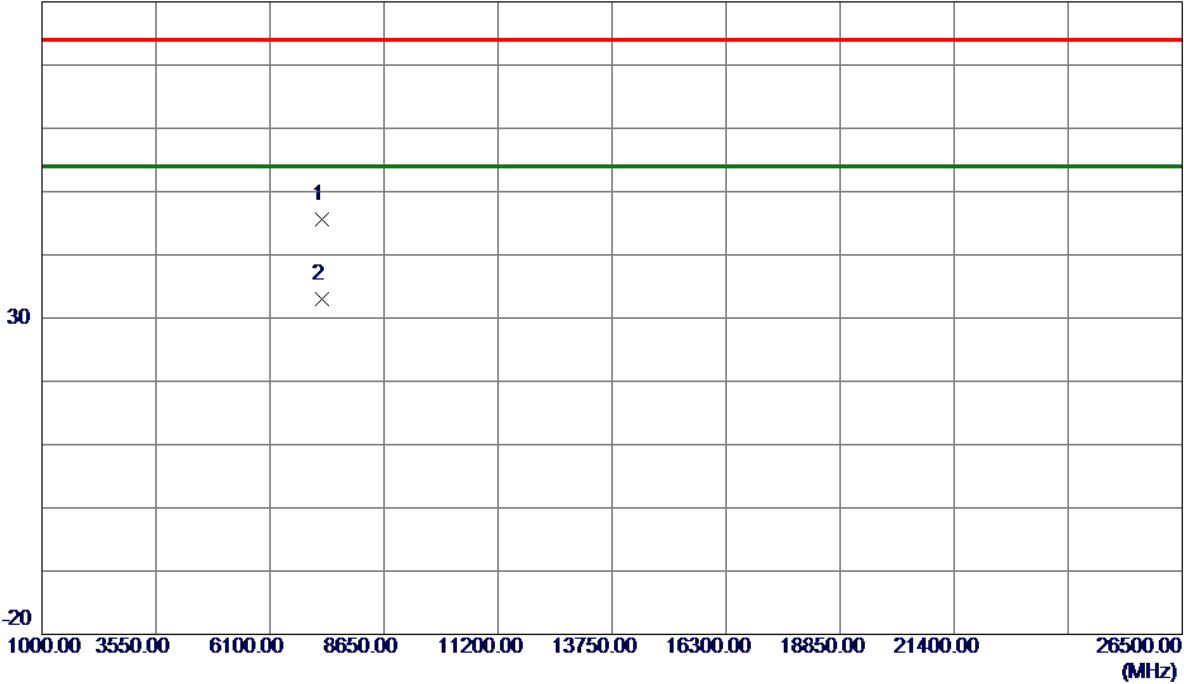

No.	Freq. MHz	Reading Level dBuV/m	Correct Factor dB	Measure ment dBuV/m	Limit dBuV/m	Margin dB	Detector	Comment
1	7248.9500	37.73	7.82	45.55	74.00	-28.45	Peak	
2 *	7266.4250	25.22	7.85	33.07	54.00	-20.93	AVG	

REMARKS:

- (1) Measurement Value = Reading Level + Correct Factor.
- (2) Margin Level = Measurement Value - Limit Value.

Test Mode: TX N-40M Mode 2422MHz

Horizontal

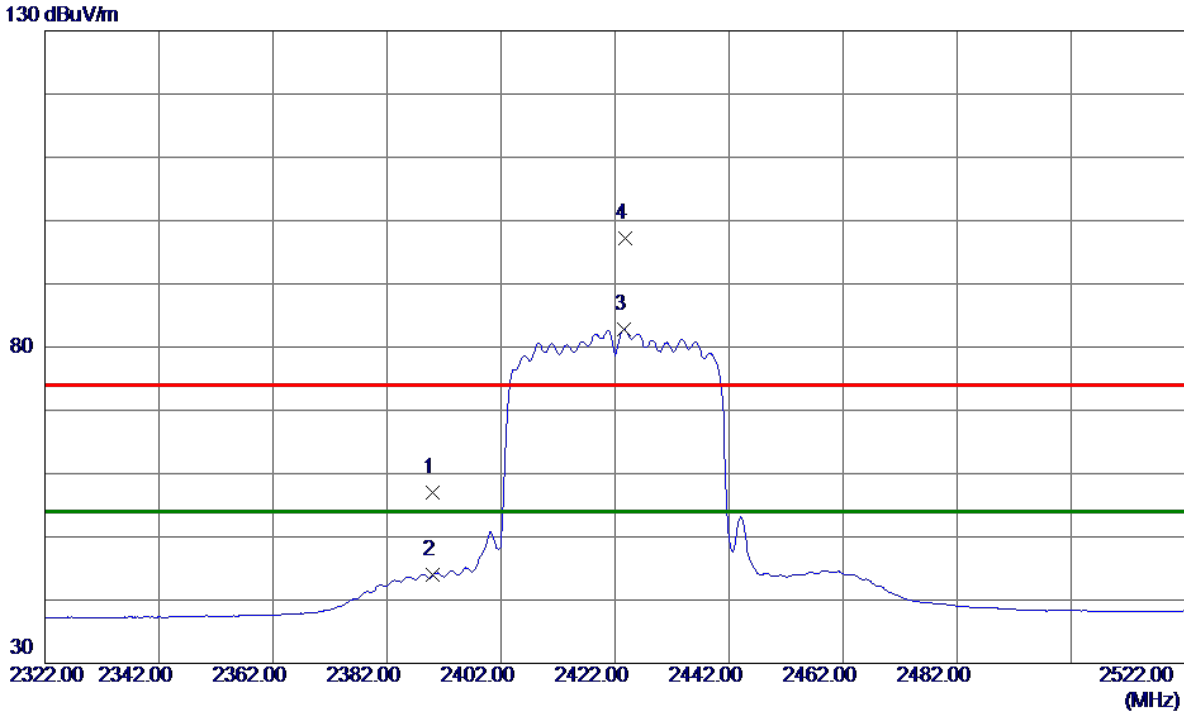

No.	Freq. MHz	Reading Level dBuV/m	Correct Factor dB	Measure ment dBuV/m	Limit dBuV/m	Margin dB	Detector	Comment
1	2390.0000	49.47	7.56	57.03	74.00	-16.97	Peak	
2	2390.0000	36.35	7.56	43.91	54.00	-10.09	AVG	
3 *	2423.6000	75.11	7.68	82.79	54.00	28.79	AVG	No Limit
4	2423.7000	89.48	7.68	97.16	74.00	23.16	Peak	No Limit

REMARKS:

(1) Measurement Value = Reading Level + Correct Factor.

(2) Margin Level = Measurement Value - Limit Value.

Test Mode: TX N-40M Mode 2422MHz

Horizontal

80 dBuV/m

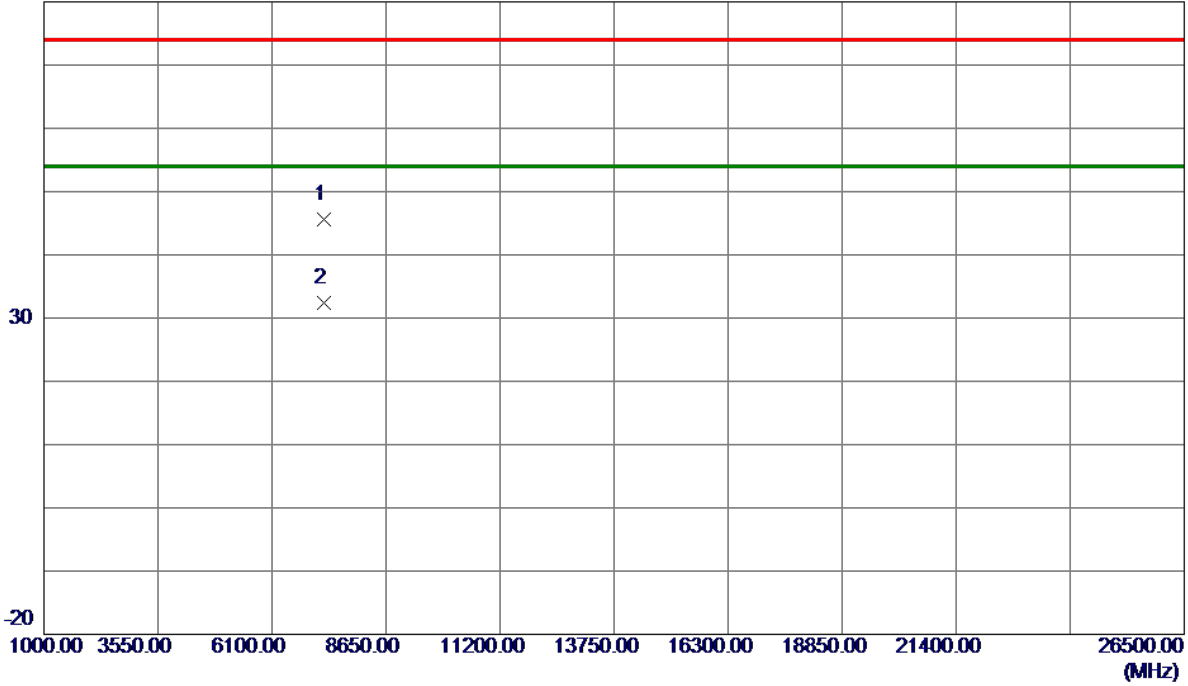

No.	Freq. MHz	Reading Level dBuV/m	Correct Factor dB	Measure ment dBuV/m	Limit dBuV/m	Margin dB	Detector	Comment
1	7253.6000	37.83	7.83	45.66	74.00	-28.34	Peak	
2 *	7258.9500	24.49	7.84	32.33	54.00	-21.67	AVG	

REMARKS:

(1) Measurement Value = Reading Level + Correct Factor.

(2) Margin Level = Measurement Value - Limit Value.

Test Mode: TX N-40M Mode 2427 MHz

Vertical

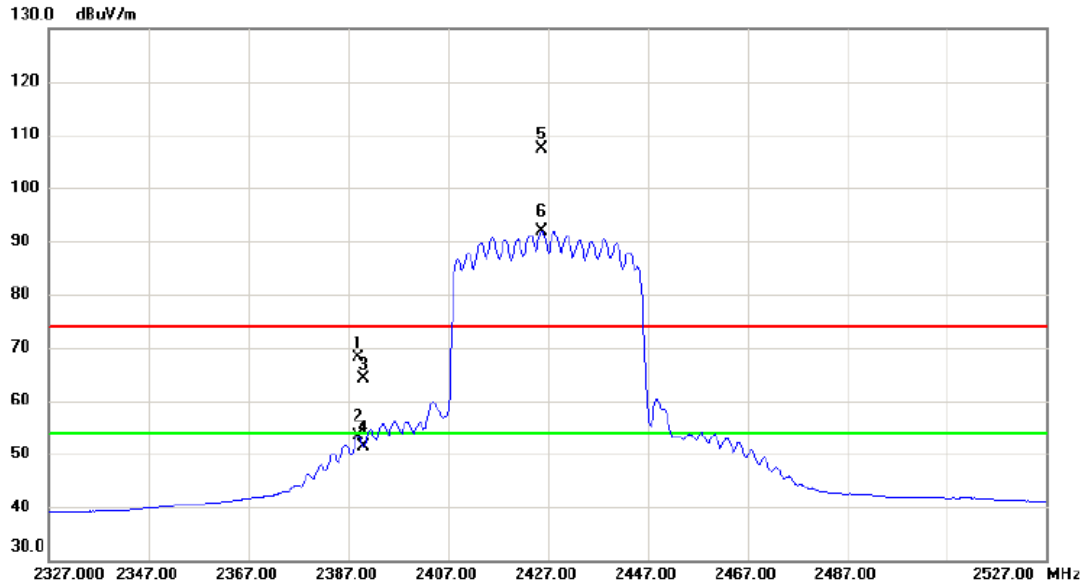

No. Mk.	Freq. MHz	Reading Level dBuV	Correct Factor dB	Measurement dBuV/m	Limit dBuV/m	Margin dB	Detector	Comment
1	2388.900	60.64	7.57	68.21	74.00	-5.79	peak	
2	2388.900	45.82	7.57	53.39	54.00	-0.61	AVG	
3	2390.000	56.48	7.57	64.05	74.00	-9.95	peak	
4	2390.000	43.83	7.57	51.40	54.00	-2.60	AVG	
5 X	2425.700	99.67	7.69	107.36	74.00	33.36	peak	No Limit
6 *	2425.900	84.22	7.69	91.91	54.00	37.91	AVG	No Limit

REMARKS:

- (1) Measurement Value = Reading Level + Correct Factor.
- (2) Margin Level = Measurement Value - Limit Value.

Test Mode: TX N-40M Mode 2427 MHz

Vertical

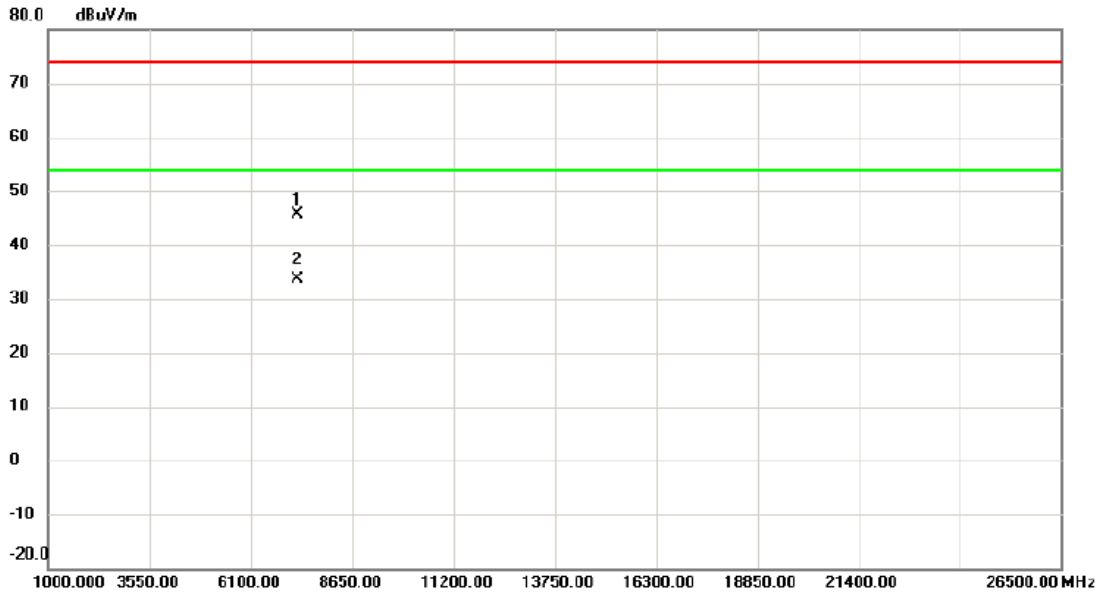

No.	Mk.	Freq. MHz	Reading Level dBuV	Correct Factor dB	Measure- ment dBuV/m	Limit dBuV/m	Margin dB	Detector	Comment
1		7257.600	37.79	7.83	45.62	74.00	-28.38	peak	
2	*	7281.075	25.75	7.87	33.62	54.00	-20.38	AVG	

REMARKS:

- (1) Measurement Value = Reading Level + Correct Factor.
- (2) Margin Level = Measurement Value - Limit Value.

Test Mode: TX N-40M Mode 2427 MHz

Horizontal

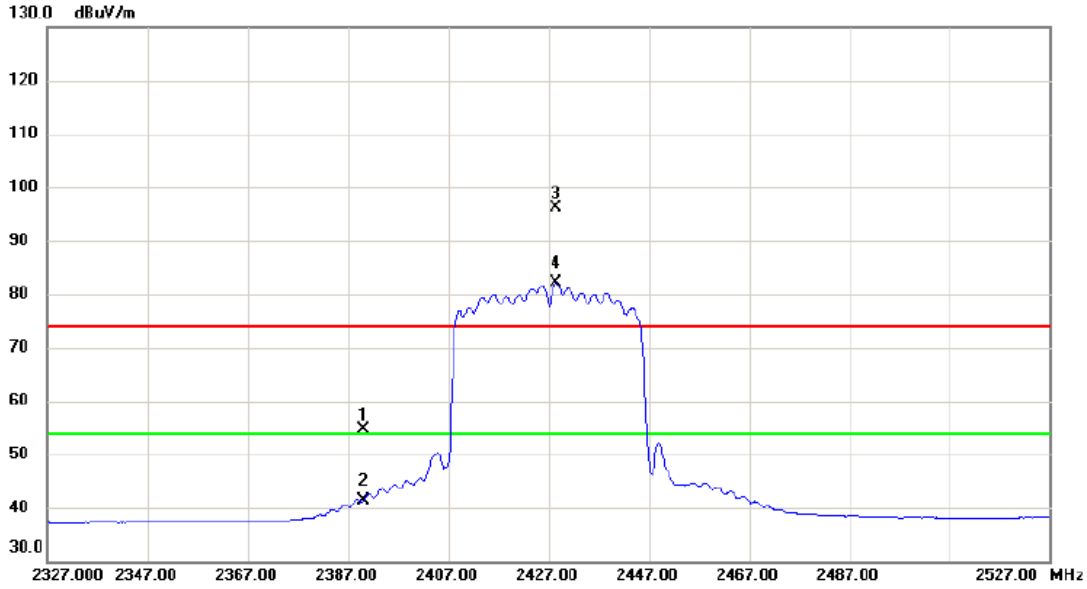

No.	Mk.	Freq. MHz	Reading Level dBuV	Correct Factor dB	Measure- ment dBuV/m	Limit dBuV/m	Margin dB	Detector	Comment
1		2390.000	47.14	7.57	54.71	74.00	-19.29	peak	
2		2390.000	33.83	7.57	41.40	54.00	-12.60	AVG	
3	X	2428.500	88.48	7.69	96.17	74.00	22.17	peak	No Limit
4	*	2428.600	74.33	7.69	82.02	54.00	28.02	AVG	No Limit

REMARKS:

- (1) Measurement Value = Reading Level + Correct Factor.
- (2) Margin Level = Measurement Value - Limit Value.

Test Mode: TX N-40M Mode 2427 MHz

Horizontal

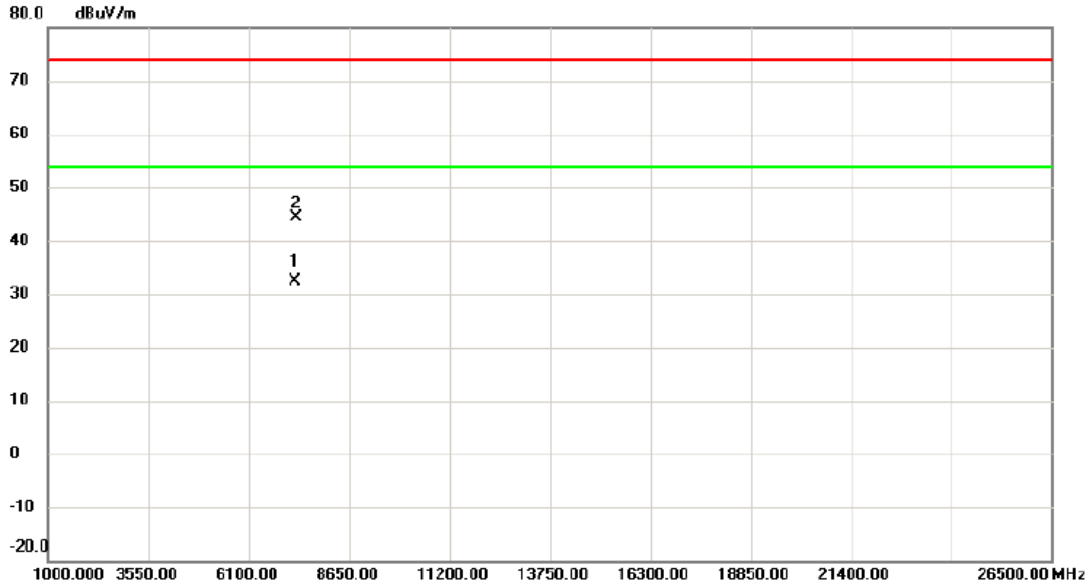

No.	Mk.	Freq. MHz	Reading Level dBuV	Correct Factor dB	Measure- ment dBuV/m	Limit dBuV/m	Margin dB	Detector	Comment
1	*	7265.150	24.53	7.85	32.38	54.00	-21.62	AVG	
2		7303.650	36.46	7.89	44.35	74.00	-29.65	peak	

REMARKS:

(1) Measurement Value = Reading Level + Correct Factor.

(2) Margin Level = Measurement Value - Limit Value.

Test Mode: TX N-40M Mode 2437 MHz

Vertical

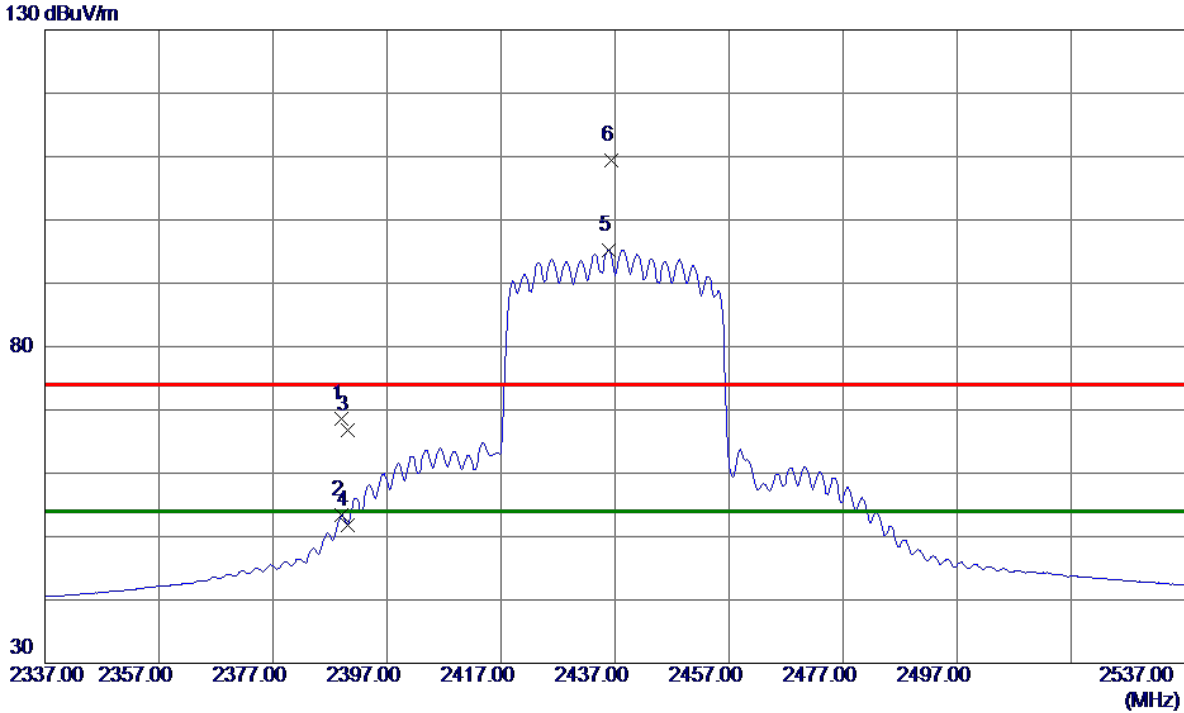

No.	Freq. MHz	Reading Level dBuV/m	Correct Factor dB	Measure ment dBuV/m	Limit dBuV/m	Margin dB	Detector	Comment
1	2389.1000	60.95	7.56	68.51	74.00	-5.49	Peak	
2	2389.1000	45.83	7.56	53.39	54.00	-0.61	AVG	
3	2390.0000	59.18	7.56	66.74	74.00	-7.26	Peak	
4	2390.0000	44.21	7.56	51.77	54.00	-2.23	AVG	
5 *	2435.9000	87.57	7.72	95.29	54.00	41.29	AVG	No Limit
6	2436.3000	101.76	7.72	109.48	74.00	35.48	Peak	No Limit

REMARKS:

- (1) Measurement Value = Reading Level + Correct Factor.
- (2) Margin Level = Measurement Value - Limit Value.

Test Mode: TX N-40M Mode 2437 MHz

Vertical

80 dBuV/m

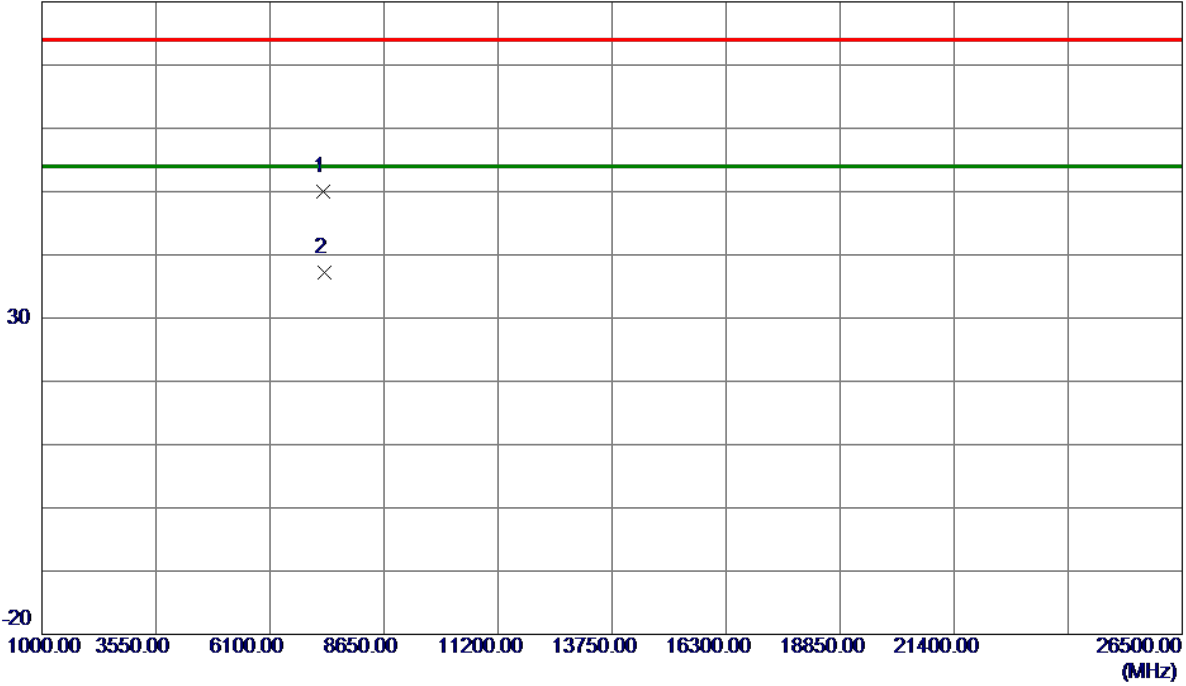

No.	Freq. MHz	Reading Level dBuV/m	Correct Factor dB	Measure ment dBuV/m	Limit dBuV/m	Margin dB	Detector	Comment
1	7296.3750	42.07	7.88	49.95	74.00	-24.05	Peak	
2 *	7313.8750	29.38	7.91	37.29	54.00	-16.71	AVG	

REMARKS:

- (1) Measurement Value = Reading Level + Correct Factor.
- (2) Margin Level = Measurement Value - Limit Value.

Test Mode: TX N-40M Mode 2437 MHz

Horizontal

130 dBuV/m

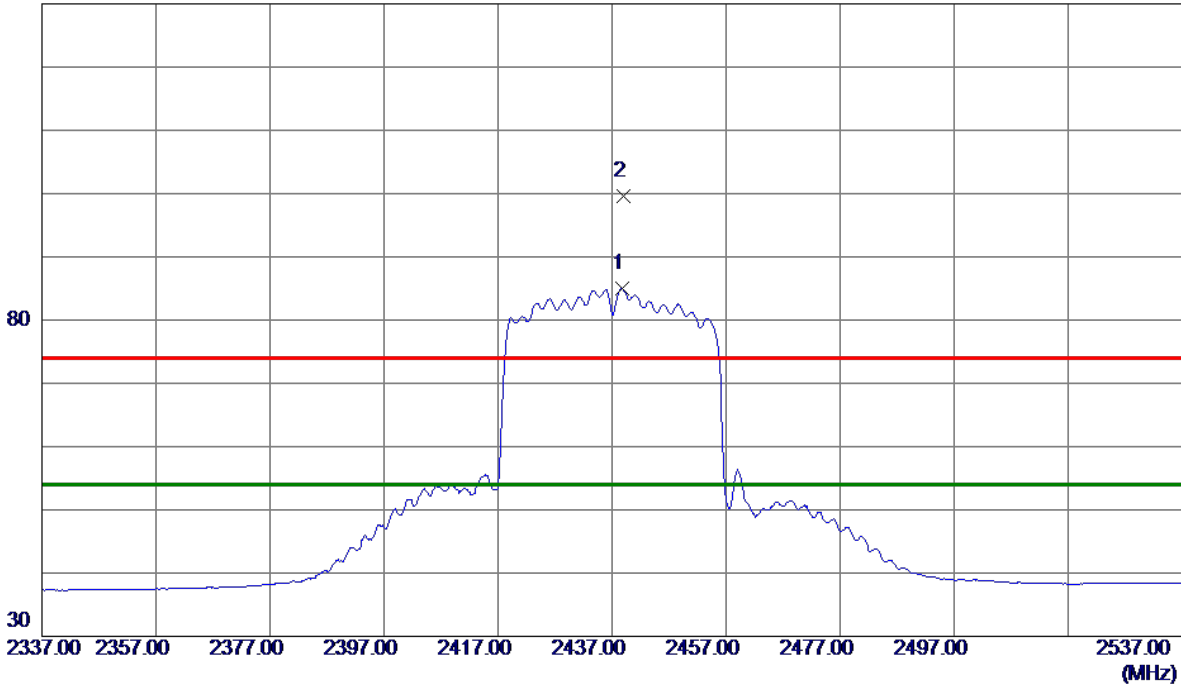

No.	Freq. MHz	Reading Level dBuV/m	Correct Factor dB	Measure ment dBuV/m	Limit dBuV/m	Margin dB	Detector	Comment
1 *	2438.7000	77.26	7.73	84.99	54.00	30.99	AVG	No Limit
2	2439.0000	91.93	7.73	99.66	74.00	25.66	Peak	No Limit

REMARKS:

(1) Measurement Value = Reading Level + Correct Factor.

(2) Margin Level = Measurement Value - Limit Value.

Test Mode: TX N-40M Mode 2437 MHz

Horizontal

80 dBuV/m

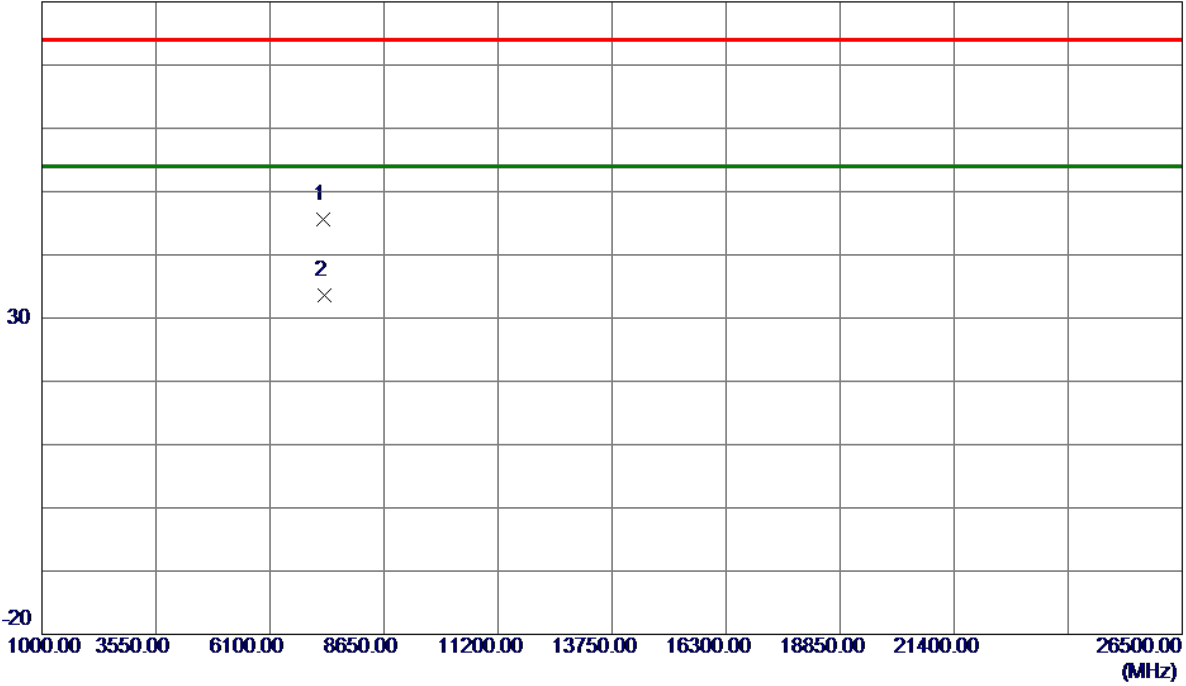

No.	Freq. MHz	Reading Level dBuV/m	Correct Factor dB	Measure ment dBuV/m	Limit dBuV/m	Margin dB	Detector	Comment
1	7294.1750	37.65	7.88	45.53	74.00	-28.47	Peak	
2 *	7306.1000	25.77	7.90	33.67	54.00	-20.33	AVG	

REMARKS:

(1) Measurement Value = Reading Level + Correct Factor.

(2) Margin Level = Measurement Value - Limit Value.

Test Mode: TX N-40M Mode 2447 MHz

Vertical

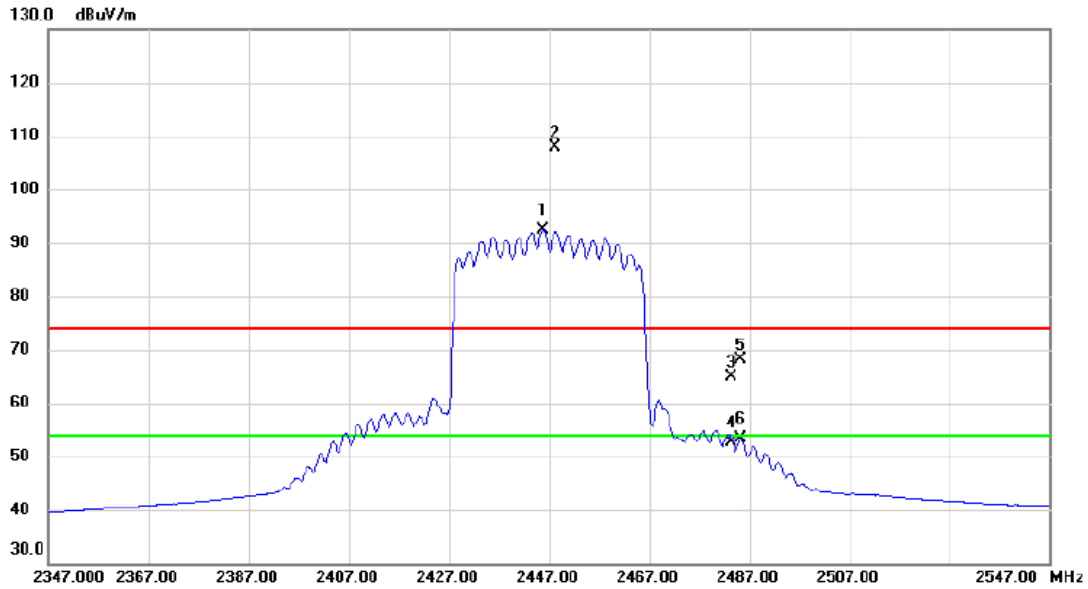

No.	Mk.	Freq. MHz	Reading Level dBuV	Correct Factor dB	Measure- ment dBuV/m	Limit dBuV/m	Margin dB	Detector	Comment
1	*	2445.900	84.75	7.75	92.50	54.00	38.50	AVG	No Limit
2	X	2448.200	100.20	7.76	107.96	74.00	33.96	peak	No Limit
3		2483.500	56.89	7.87	64.76	74.00	-9.24	peak	
4		2483.500	44.78	7.87	52.65	54.00	-1.35	AVG	
5		2485.300	60.23	7.88	68.11	74.00	-5.89	peak	
6		2485.300	45.60	7.88	53.48	54.00	-0.52	AVG	

REMARKS:

- (1) Measurement Value = Reading Level + Correct Factor.
- (2) Margin Level = Measurement Value - Limit Value.

Test Mode: TX N-40M Mode 2447 MHz

Vertical

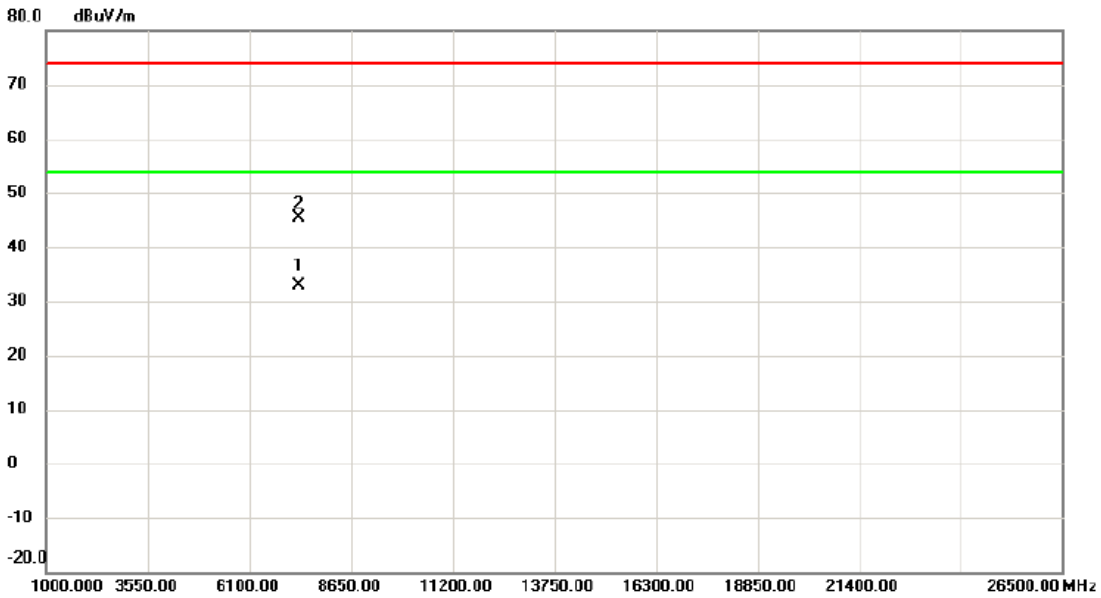

No.	Mk.	Freq. MHz	Reading Level dBuV	Correct Factor dB	Measure- ment dBuV/m	Limit dBuV/m	Margin dB	Detector	Comment
1	*	7333.975	24.86	7.93	32.79	54.00	-21.21	AVG	
2		7336.075	37.33	7.94	45.27	74.00	-28.73	peak	

REMARKS:

(1) Measurement Value = Reading Level + Correct Factor.

(2) Margin Level = Measurement Value - Limit Value.

Test Mode: TX N-40M Mode 2447 MHz

Horizontal

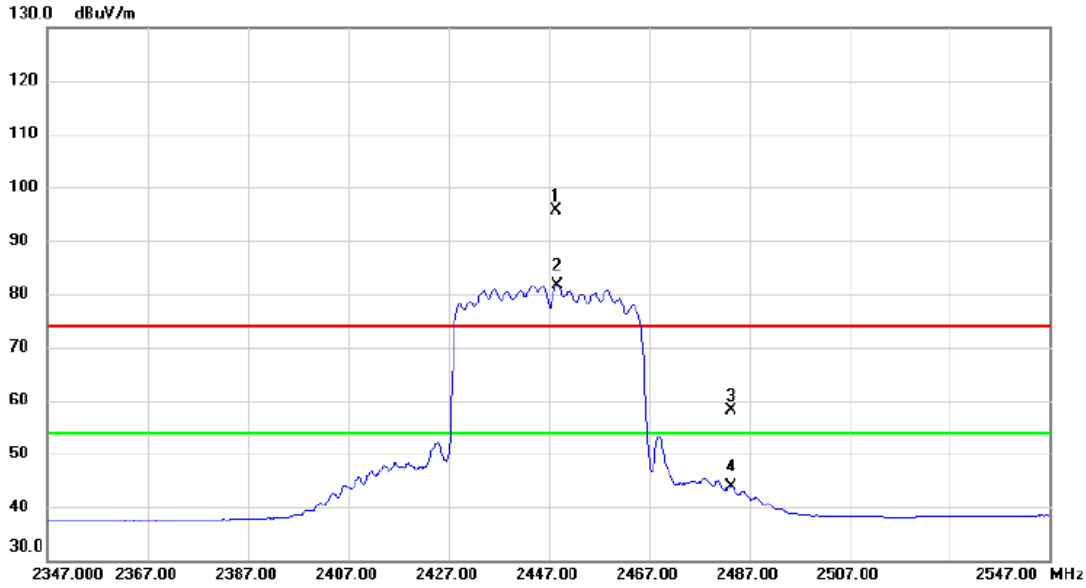

No.	Mk.	Freq. MHz	Reading Level dBuV	Correct Factor dB	Measure- ment dBuV/m	Limit dBuV/m	Margin dB	Detector	Comment
1	X	2448.500	87.93	7.76	95.69	74.00	21.69	peak	No Limit
2	*	2448.700	73.84	7.76	81.60	54.00	27.60	AVG	No Limit
3		2483.500	50.34	7.87	58.21	74.00	-15.79	peak	
4		2483.500	35.89	7.87	43.76	54.00	-10.24	AVG	

REMARKS:

- (1) Measurement Value = Reading Level + Correct Factor.
- (2) Margin Level = Measurement Value - Limit Value.

Test Mode: TX N-40M Mode 2447 MHz

Horizontal

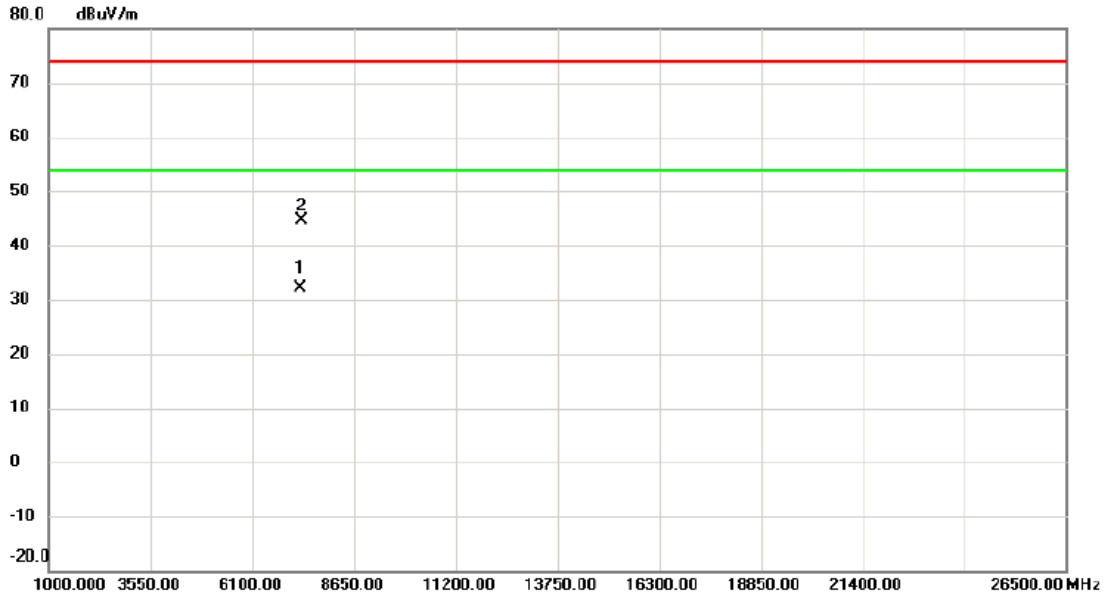

No.	Mk.	Freq.	Reading Level	Correct Factor	Measurement	Limit	Margin		
		MHz	dBuV	dB	dBuV/m	dBuV/m	dB	Detector	Comment
1	*	7317.925	24.23	7.91	32.14	54.00	-21.86	AVG	
2		7326.400	36.77	7.92	44.69	74.00	-29.31	peak	

REMARKS:

- (1) Measurement Value = Reading Level + Correct Factor.
- (2) Margin Level = Measurement Value - Limit Value.

Test Mode: TX N-40M Mode 2452 MHz

Vertical

130 dBuV/m

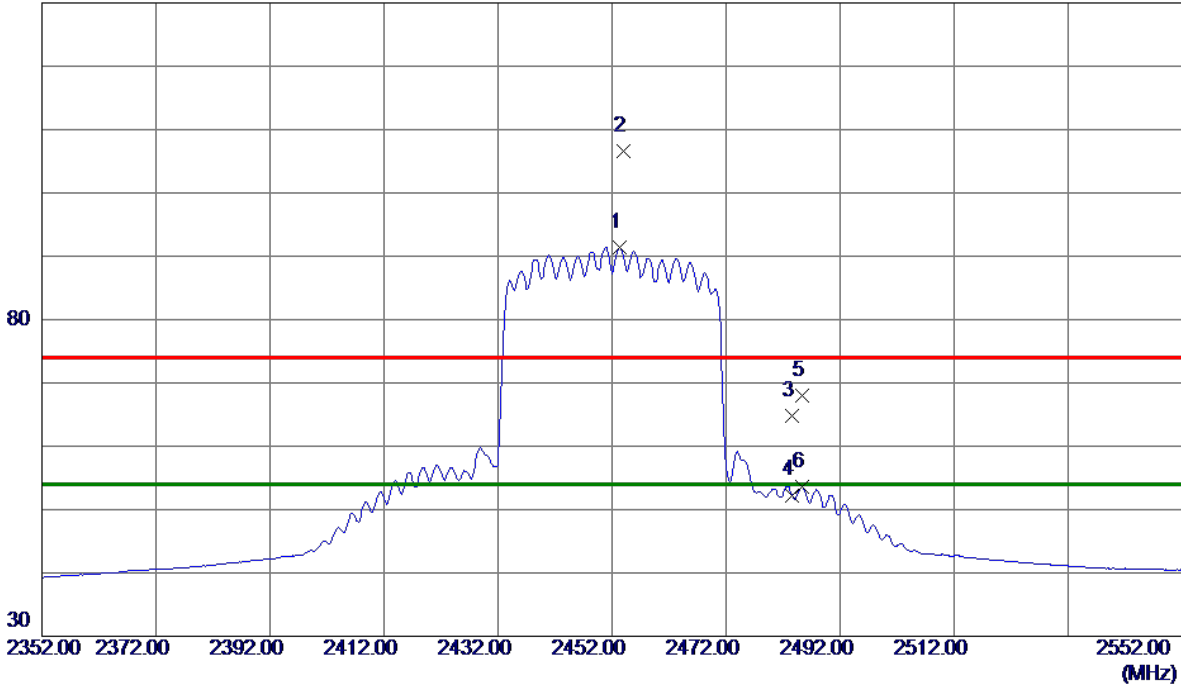

No.	Freq. MHz	Reading Level dBuV/m	Correct Factor dB	Measure ment dBuV/m	Limit dBuV/m	Margin dB	Detector	Comment
1 *	2453.3000	83.67	7.77	91.44	54.00	37.44	AVG	No Limit
2	2454.0000	98.86	7.78	106.64	74.00	32.64	Peak	No Limit
3	2483.5000	56.86	7.88	64.74	74.00	-9.26	Peak	
4	2483.5000	44.42	7.88	52.30	54.00	-1.70	AVG	
5	2485.3000	60.11	7.88	67.99	74.00	-6.01	Peak	
6	2485.3000	45.70	7.88	53.58	54.00	-0.42	AVG	

REMARKS:

(1) Measurement Value = Reading Level + Correct Factor.

(2) Margin Level = Measurement Value - Limit Value.

Test Mode: TX N-40M Mode 2452 MHz

Vertical

80 dBuV/m

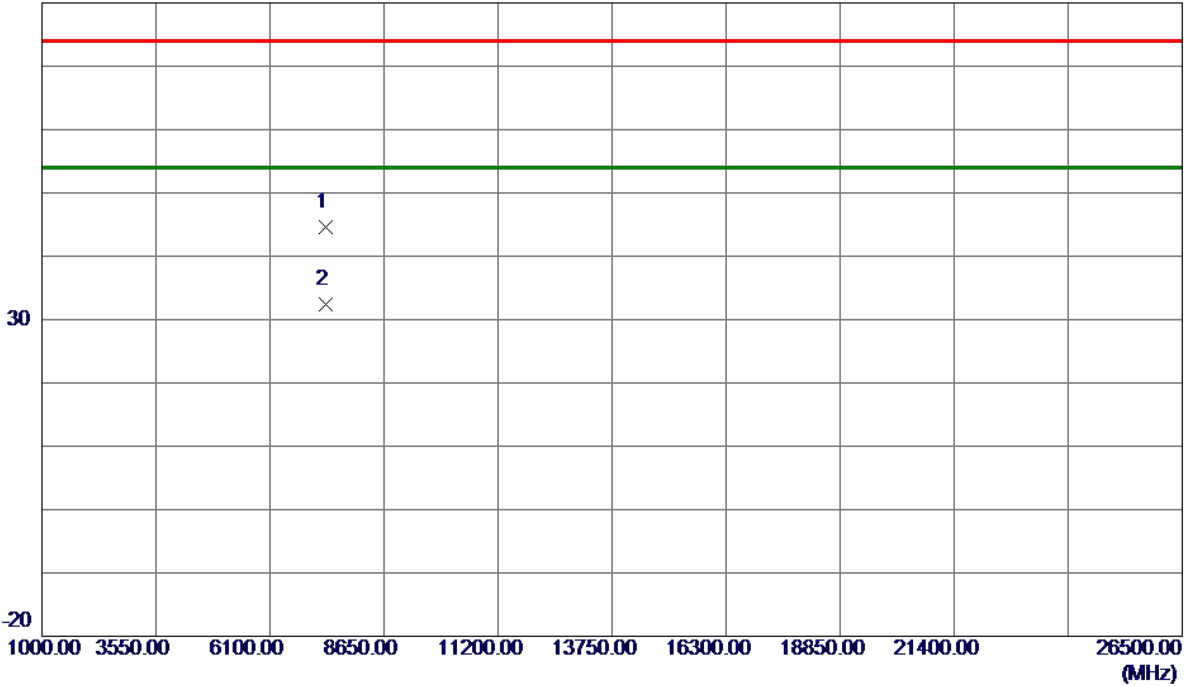

No.	Freq. MHz	Reading Level dBuV/m	Correct Factor dB	Measure ment dBuV/m	Limit dBuV/m	Margin dB	Detector	Comment
1	7339.5500	36.71	7.94	44.65	74.00	-29.35	Peak	
2 *	7351.6250	24.53	7.95	32.48	54.00	-21.52	AVG	

REMARKS:

- (1) Measurement Value = Reading Level + Correct Factor.
- (2) Margin Level = Measurement Value - Limit Value.

Test Mode: TX N-40M Mode 2452 MHz

Horizontal

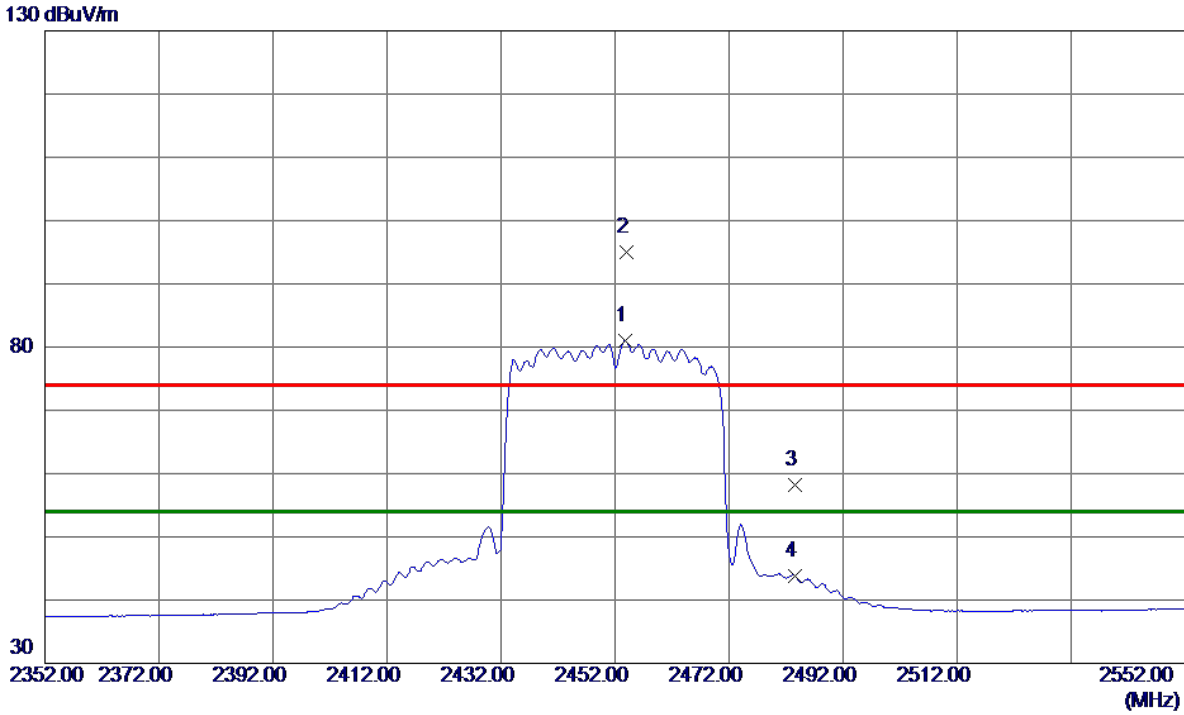

No.	Freq. MHz	Reading Level dBuV/m	Correct Factor dB	Measure ment dBuV/m	Limit dBuV/m	Margin dB	Detector	Comment
1 *	2453.7000	73.22	7.78	81.00	54.00	27.00	AVG	No Limit
2	2454.0000	87.28	7.78	95.06	74.00	21.06	Peak	No Limit
3	2483.5000	50.32	7.88	58.20	74.00	-15.80	Peak	
4	2483.5000	35.94	7.88	43.82	54.00	-10.18	AVG	

REMARKS:

(1) Measurement Value = Reading Level + Correct Factor.

(2) Margin Level = Measurement Value - Limit Value.

Test Mode: TX N-40M Mode 2452 MHz

Horizontal

80 dBuV/m

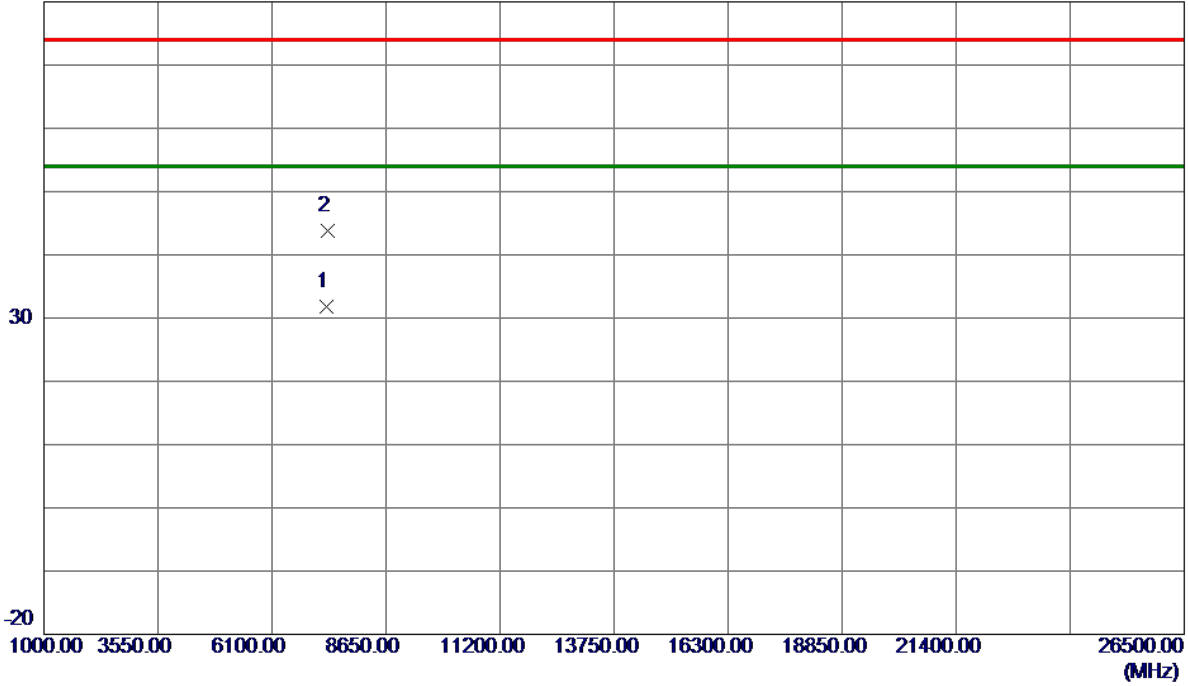

No.	Freq. MHz	Reading Level dBuV/m	Correct Factor dB	Measure ment dBuV/m	Limit dBuV/m	Margin dB	Detector	Comment
1 *	7331.6250	23.91	7.93	31.84	54.00	-22.16	AVG	
2	7347.5000	35.93	7.95	43.88	74.00	-30.12	Peak	

REMARKS:

(1) Measurement Value = Reading Level + Correct Factor.

(2) Margin Level = Measurement Value - Limit Value.

APPENDIX E - BANDWIDTH

Test Mode	TX B Mode
-----------	-----------

Channel	Frequency (MHz)	6 dB Bandwidth (MHz)	6 dB Bandwidth Min. Limit (kHz)	Result
01	2412	8.58	500	Complies
06	2437	8.10	500	Complies
11	2462	8.11	500	Complies

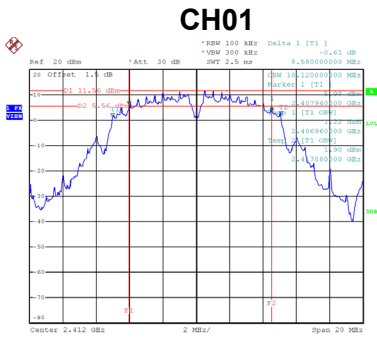

Date: 15.JUN.2019 18:55:47

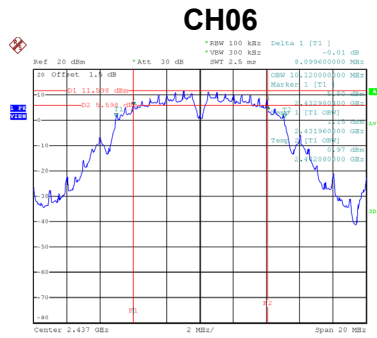

Date: 15.JUN.2019 18:58:07

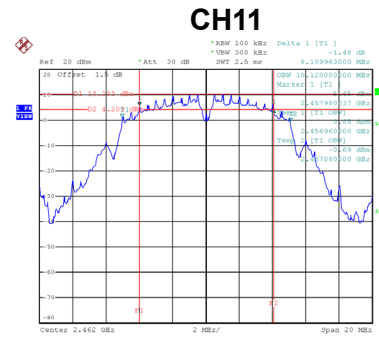

Date: 15.JUN.2019 19:06:10

Test Mode	TX B Mode
-----------	-----------

Channel	Frequency (MHz)	99 % Emission Bandwidth (MHz)	Result
01	2412	10.38	Complies
06	2437	10.38	Complies
11	2462	10.38	Complies

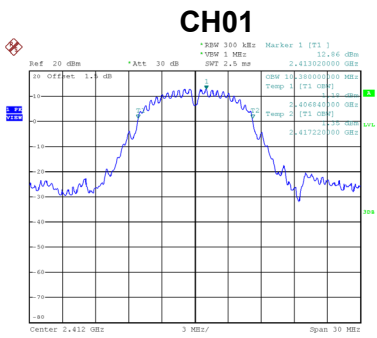

Date: 15.JUN.2019 20:57:20

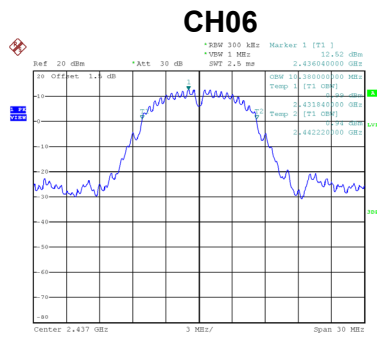

Date: 15.JUN.2019 20:56:52

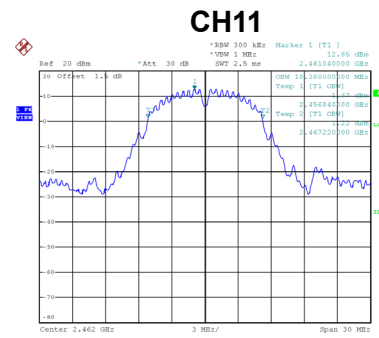

Date: 15.JUN.2019 20:56:24

Test Mode	TX G Mode
-----------	-----------

Channel	Frequency (MHz)	6 dB Bandwidth (MHz)	6 dB Bandwidth Min. Limit (kHz)	Result
01	2412	14.91	500	Complies
06	2437	15.16	500	Complies
11	2462	14.60	500	Complies

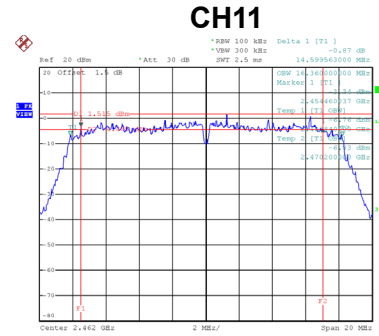
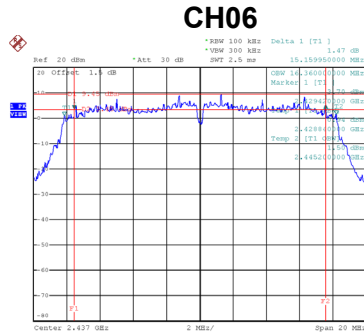
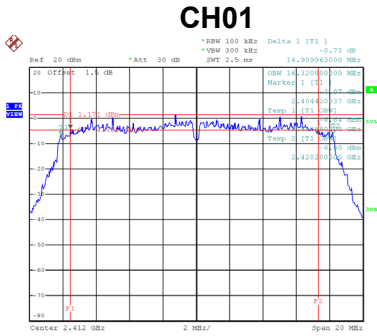

Date: 15 JUN 2019 19:09:39

Date: 15 JUN 2019 19:11:19

Date: 15 JUN 2019 19:12:29

Test Mode	TX G Mode
-----------	-----------

Channel	Frequency (MHz)	99 % Emission Bandwidth (MHz)	Result
01	2412	16.50	Complies
06	2437	21.30	Complies
11	2462	16.50	Complies

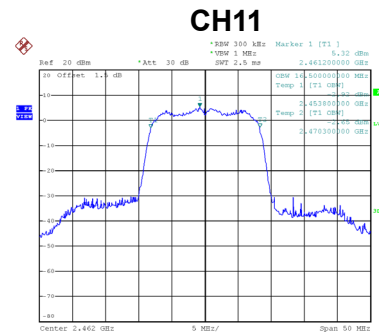
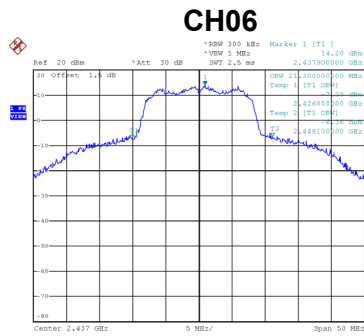
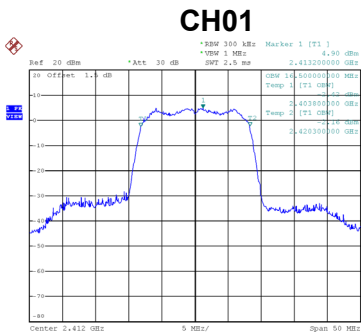

Date: 15 JUN 2019 20:48:07

Date: 15 JUN 2019 20:50:47

Date: 15 JUN 2019 20:52:01

Test Mode	TX N-20M Mode
-----------	---------------

Channel	Frequency (MHz)	6 dB Bandwidth (MHz)	6 dB Bandwidth Min. Limit (kHz)	Result
01	2412	15.08	500	Complies
06	2437	15.50	500	Complies
11	2462	15.31	500	Complies

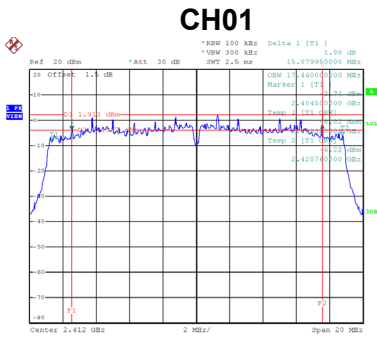

Date: 15.JUN.2019 19:23:31

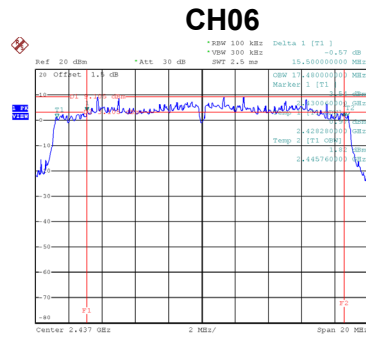

Date: 15.JUN.2019 19:26:10

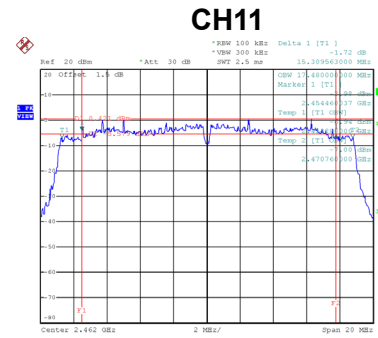

Date: 15.JUN.2019 19:27:45

Test Mode	TX N-20M Mode
-----------	---------------

Channel	Frequency (MHz)	99 % Emission Bandwidth (MHz)	Result
01	2412	17.70	Complies
06	2437	17.90	Complies
11	2462	21.30	Complies

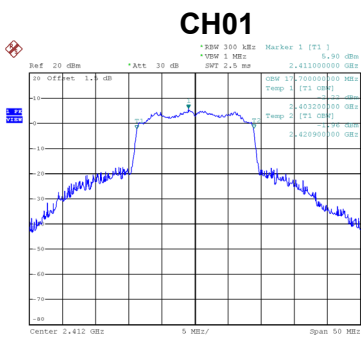

Date: 15.JUN.2019 20:46:08

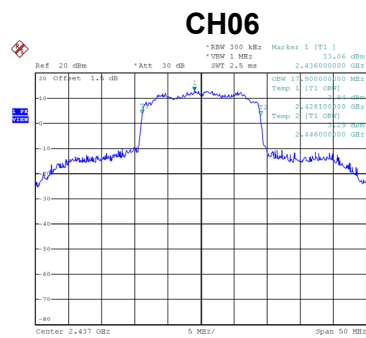

Date: 15.JUN.2019 20:42:35

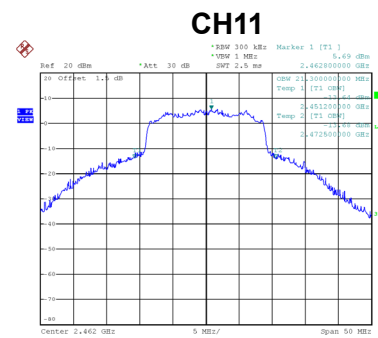

Date: 15.JUN.2019 20:40:16